



US010589320B1

(12) **United States Patent**  
**Mayfield et al.**

(10) **Patent No.:** US 10,589,320 B1  
(45) **Date of Patent:** Mar. 17, 2020

(54) **SYSTEM COMPRISING A PORTABLE SWITCHING DEVICE FOR USE WITH A PORTABLE ELECTRONIC DEVICE**

(71) Applicant: **GUI GLOBAL PRODUCTS, LTD.**,  
Houston, TX (US)

(72) Inventors: **Walter G. Mayfield**, Houston, TX  
(US); **Daniel Martin Valdez**,  
Kingwood, TX (US)

(73) Assignee: **GUI GLOBAL PRODUCTS, LTD.**,  
Houston, TX (US)

(\* ) Notice: Subject to any disclaimer, the term of this  
patent is extended or adjusted under 35  
U.S.C. 154(b) by 0 days.

(21) Appl. No.: **16/698,223**

(22) Filed: **Nov. 27, 2019**

**Related U.S. Application Data**

(63) Continuation of application No. 16/502,935, filed on  
Jul. 3, 2019, now Pat. No. 10,493,496, which is a  
continuation of application No. 16/460,770, filed on  
Jul. 2, 2019, which is a continuation of application  
No. 16/388,691, filed on Apr. 18, 2019, now  
abandoned, which is a continuation of application No.  
(Continued)

(51) **Int. Cl.**  
*G06F 1/16* (2006.01)  
*H05K 5/00* (2006.01)  
*H05K 7/00* (2006.01)  
*B08B 1/00* (2006.01)  
*A45C 11/00* (2006.01)  
*G06F 1/32* (2019.01)  
*B08B 11/04* (2006.01)  
*H04M 1/21* (2006.01)  
*H04M 1/02* (2006.01)  
*H04B 1/3816* (2015.01)

(52) **U.S. Cl.**  
CPC ..... *B08B 1/006* (2013.01); *A45C 11/00*  
(2013.01); *B08B 1/002* (2013.01); *B08B 11/04*  
(2013.01); *G06F 1/32* (2013.01); *H04M 1/21*  
(2013.01); *H04B 1/3816* (2013.01); *H04M*  
*1/0266* (2013.01)

(58) **Field of Classification Search**  
CPC . G06F 1/32; G06F 1/16; G06F 1/1601; G06F  
1/1603; G06F 1/1605; G06F 1/1607;  
G06F 1/1609; G06F 1/1611; B08B 1/002;  
B08B 1/006  
USPC ..... 361/679.01, 679.02, 679.21-679.3  
See application file for complete search history.

(56) **References Cited**

U.S. PATENT DOCUMENTS

2005/0107131 A1\* 5/2005 Abramov ..... H04M 1/0258  
455/569.1  
2005/0284904 A1\* 12/2005 Knapp ..... A45F 5/02  
224/269

(Continued)

*Primary Examiner* — Anthony M Haughton  
(74) *Attorney, Agent, or Firm* — Mossman, Kumar &  
Tyler, PC

(57) **ABSTRACT**

A lens and/or a view screen of an electronic device having  
at least one case can be cleaned by wiping the view screen  
with a cleaning component wherein the cleaning component  
is configured to selectively couple to the at least one case or  
some other substrate using a magnetic attractive force. The  
cleaning devices may have secondary applications such as  
securing fly fishing lures, activating or deactivating a device  
having a magnetic switch, or preventing sunglasses from  
sinking. They may also be manufactured without a cleaning  
component for use with the secondary applications.

**13 Claims, 13 Drawing Sheets**

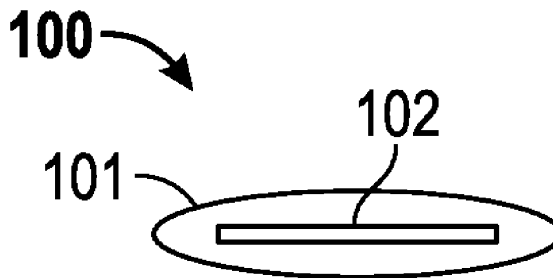
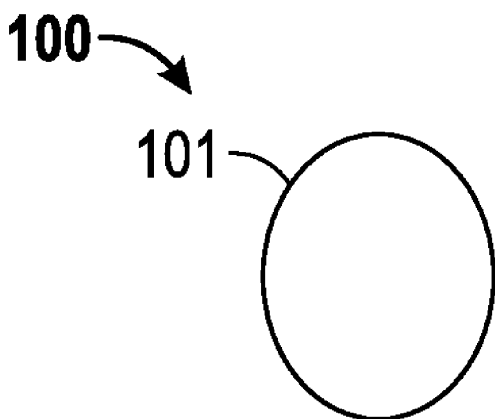

Samsung v. GUI  
IPR2021-00338  
Exhibit 1001

**Related U.S. Application Data**

16/041,594, filed on Jul. 20, 2018, now Pat. No. 10,272,474, which is a continuation of application No. 15/852,000, filed on Dec. 22, 2017, now Pat. No. 10,259,021, which is a continuation of application No. 15/597,005, filed on May 16, 2017, now abandoned, which is a continuation of application No. 14/343,665, filed as application No. PCT/US2012/049562 on Aug. 3, 2012, now abandoned.

- (60) Provisional application No. 61/661,090, filed on Jun. 18, 2012, provisional application No. 61/619,229, filed on Apr. 2, 2012, provisional application No. 61/592,344, filed on Jan. 30, 2012, provisional application No. 61/576,834, filed on Dec. 16, 2011, provisional application No. 61/569,093, filed on Dec. 9, 2011, provisional application No. 61/568,031, filed on Dec. 7, 2011, provisional application No. 61/561,087, filed on Nov. 17, 2011, provisional

application No. 61/555,310, filed on Nov. 3, 2011, provisional application No. 61/515,752, filed on Aug. 5, 2011.

(56)

**References Cited**

U.S. PATENT DOCUMENTS

2006/0238281	A1 *	10/2006	Steinberg .....	H01H 36/0013 335/207
2008/0103637	A1 *	5/2008	Bliven .....	F16B 2/20 701/1
2008/0244847	A1 *	10/2008	Richter .....	A47L 25/00 15/105
2009/0078478	A1 *	3/2009	Newman .....	G06F 3/03545 178/19.01
2010/0011524	A1 *	1/2010	Roebach .....	B08B 1/00 15/105
2011/0192857	A1 *	8/2011	Rothbaum .....	B25F 1/00 220/694

\* cited by examiner

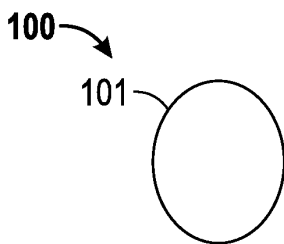

FIG. 1A

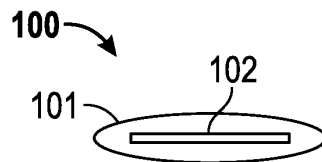

FIG. 1B

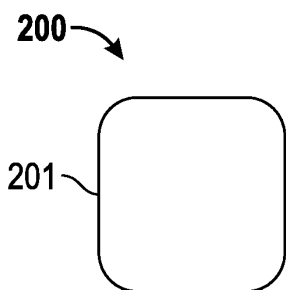

FIG. 2A

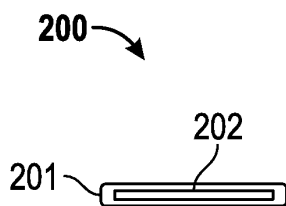

FIG. 2B

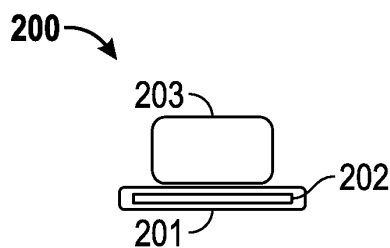

FIG. 2C

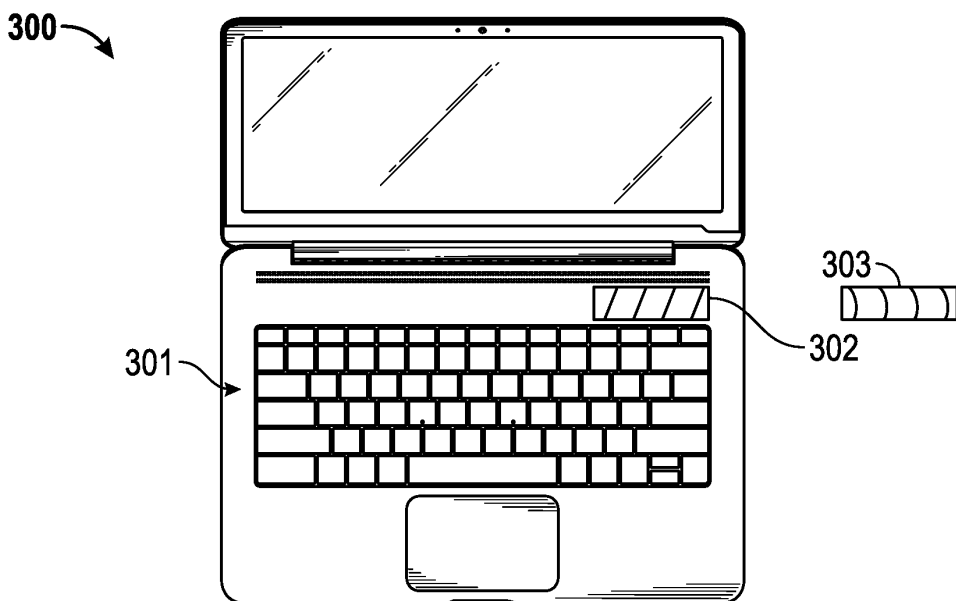

FIG. 3

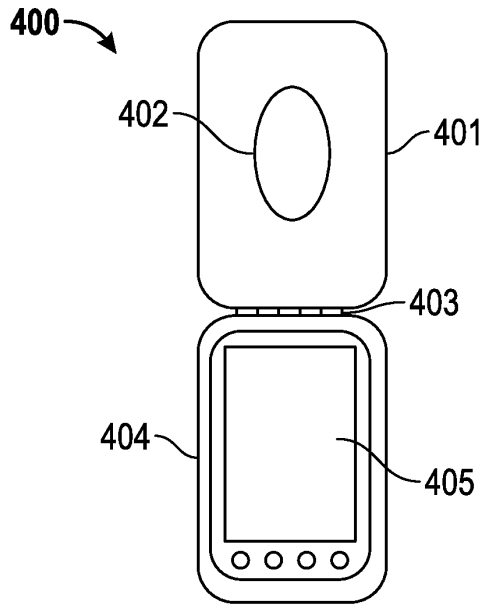

FIG. 4

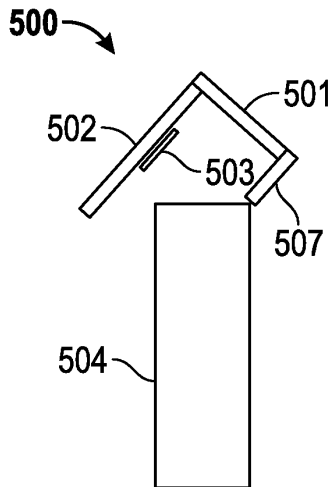

FIG. 5A

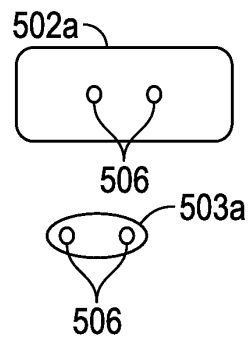

FIG. 5B

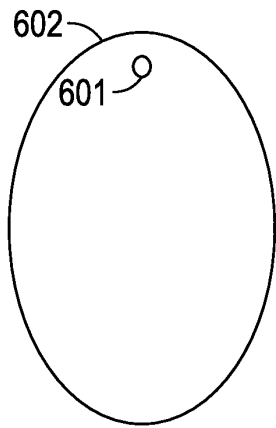

FIG. 6

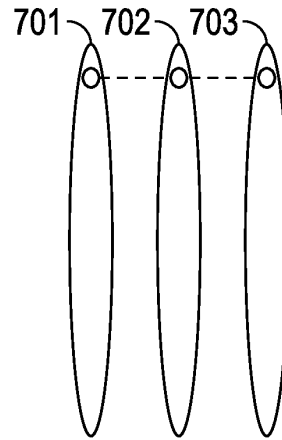

FIG. 7

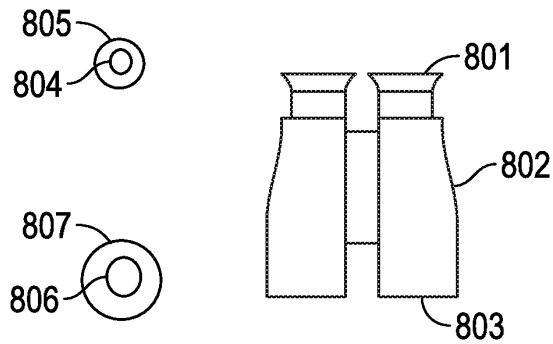

FIG. 8

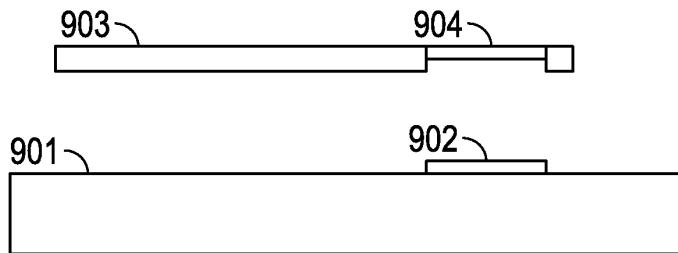

FIG. 9

# Explore Litigation Insights

Docket Alarm provides insights to develop a more informed litigation strategy and the peace of mind of knowing you're on top of things.

## Real-Time Litigation Alerts



Keep your litigation team up-to-date with **real-time alerts** and advanced team management tools built for the enterprise, all while greatly reducing PACER spend.

Our comprehensive service means we can handle Federal, State, and Administrative courts across the country.

## Advanced Docket Research



With over 230 million records, Docket Alarm's cloud-native docket research platform finds what other services can't. Coverage includes Federal, State, plus PTAB, TTAB, ITC and NLRB decisions, all in one place.

Identify arguments that have been successful in the past with full text, pinpoint searching. Link to case law cited within any court document via Fastcase.

## Analytics At Your Fingertips



Learn what happened the last time a particular judge, opposing counsel or company faced cases similar to yours.

Advanced out-of-the-box PTAB and TTAB analytics are always at your fingertips.

## API

Docket Alarm offers a powerful API (application programming interface) to developers that want to integrate case filings into their apps.

## LAW FIRMS

Build custom dashboards for your attorneys and clients with live data direct from the court.

Automate many repetitive legal tasks like conflict checks, document management, and marketing.

## FINANCIAL INSTITUTIONS

Litigation and bankruptcy checks for companies and debtors.

## E-DISCOVERY AND LEGAL VENDORS

Sync your system to PACER to automate legal marketing.