



US007251197B2

(12) **United States Patent**
Yoshida et al.

(10) **Patent No.:** **US 7,251,197 B2**
(45) **Date of Patent:** **Jul. 31, 2007**

(54) **WRIST-WORN COMMUNICATIONS APPARATUS**

- (75) Inventors: **Kaoru Yoshida, Ome (JP); Yoshiyuki Murata, Ome (JP)**
- (73) Assignee: **Casio Computer Co., Ltd., Tokyo (JP)**
- (*) Notice: Subject to any disclaimer, the term of this patent is extended or adjusted under 35 U.S.C. 154(b) by 100 days.

- (21) Appl. No.: **10/531,368**
- (22) PCT Filed: **Jan. 30, 2004**
- (86) PCT No.: **PCT/JP2004/000959**
- § 371 (c)(1), (2), (4) Date: **Apr. 13, 2005**

- (87) PCT Pub. No.: **WO2004/068732**
- PCT Pub. Date: **Aug. 12, 2004**

- (65) **Prior Publication Data**
US 2005/0265125 A1 Dec. 1, 2005

- (30) **Foreign Application Priority Data**
Jan. 30, 2003 (JP) 2003-021320
Feb. 10, 2003 (JP) 2003-032486

- (51) **Int. Cl.**
G04B 47/00 (2006.01)
G04C 11/02 (2006.01)
H04B 1/38 (2006.01)
- (52) **U.S. Cl.** **368/10; 368/13; 368/47; 368/282; 455/90.3; 455/344**
- (58) **Field of Classification Search** **368/4, 368/10, 13, 47, 88, 281, 292; 455/90.3, 344**
See application file for complete search history.

(56) **References Cited**

U.S. PATENT DOCUMENTS

5,239,521 A	8/1993	Blonder	
5,260,915 A *	11/1993	Houlihan	368/10
5,381,387 A *	1/1995	Blonder et al.	368/10
5,467,324 A *	11/1995	Houlihan	368/10
5,564,082 A	10/1996	Blonder et al.	
6,078,803 A	6/2000	Fernandez Martinez	
6,215,985 B1	4/2001	Tolvanen	
6,311,071 B1	10/2001	Voroba et al.	
2003/0019894 A1	1/2003	Caldana	

FOREIGN PATENT DOCUMENTS

EP	0 572 252 A1	12/1993
EP	0 684 704 A2	11/1995
EP	0 782 308 A1	7/1997
EP	0 907 279 A2	4/1999
WO	WO 98/05148 A1	2/1998
WO	WO 01/61970 A2	8/2001

* cited by examiner

Primary Examiner—Vit W. Miska
(74) *Attorney, Agent, or Firm*—Frishauf, Holtz, Goodman & Chick, P.C.

(57) **ABSTRACT**

A watch of the communications apparatus is worn on a user's wrist by bands. A support member pivoted on the band is then turned so as to extend in the transverse direction of the bands. A speaker unit is provided on the support member so as to face in a transverse direction of the band while a microphone unit is disposed on the support member so as to face in a direction perpendicular to a surface of the band. When a user communicates with the other party, the speaker unit provided on the support member is directed toward the user's ear. This causes the microphone unit provided on the support member to be directed easily toward the user's mouth. Alternatively a hinged lid is provided the lid carrying a key-in unit or a display and a speaker unit.

8 Claims, 20 Drawing Sheets

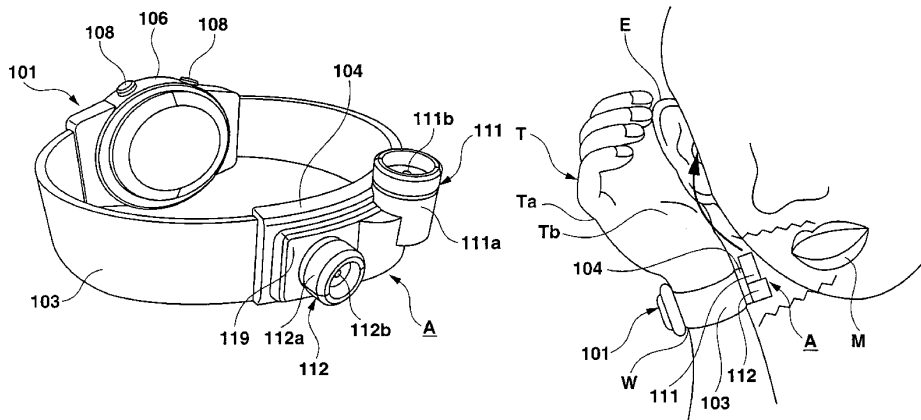

Samsung v. GUI
IPR2021-00337
Exhibit 1020

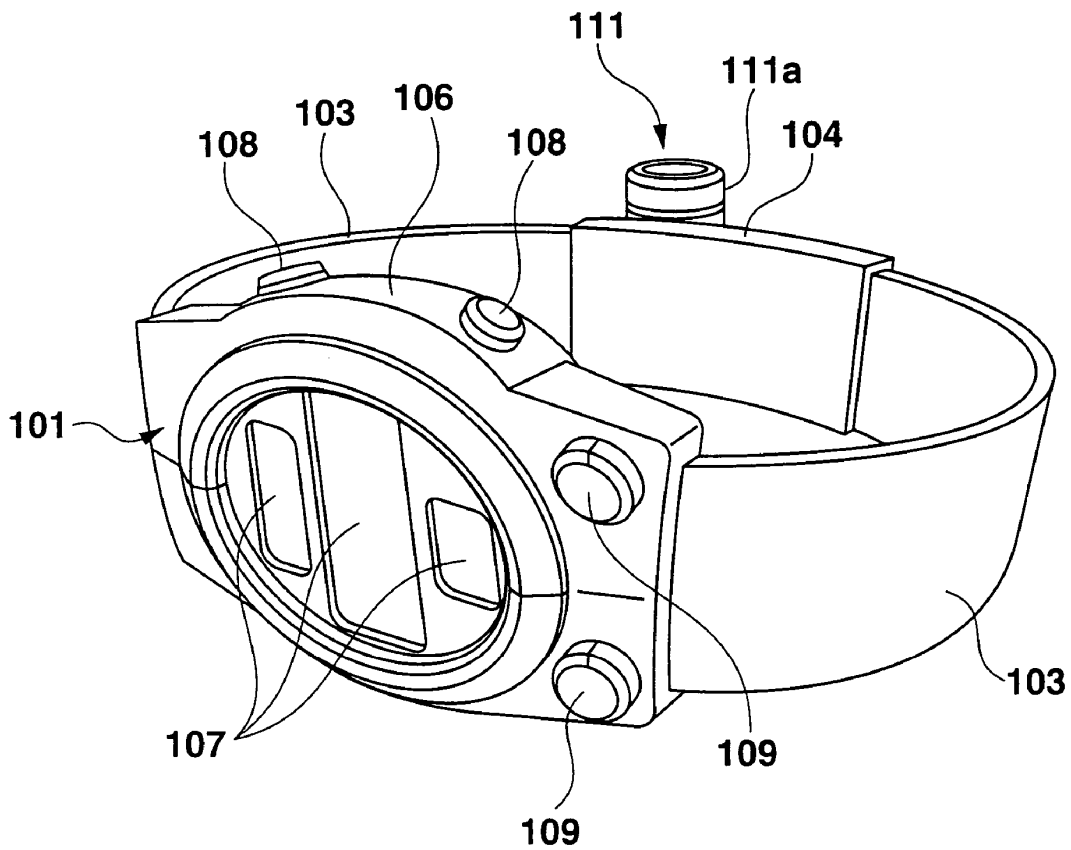

FIG.1

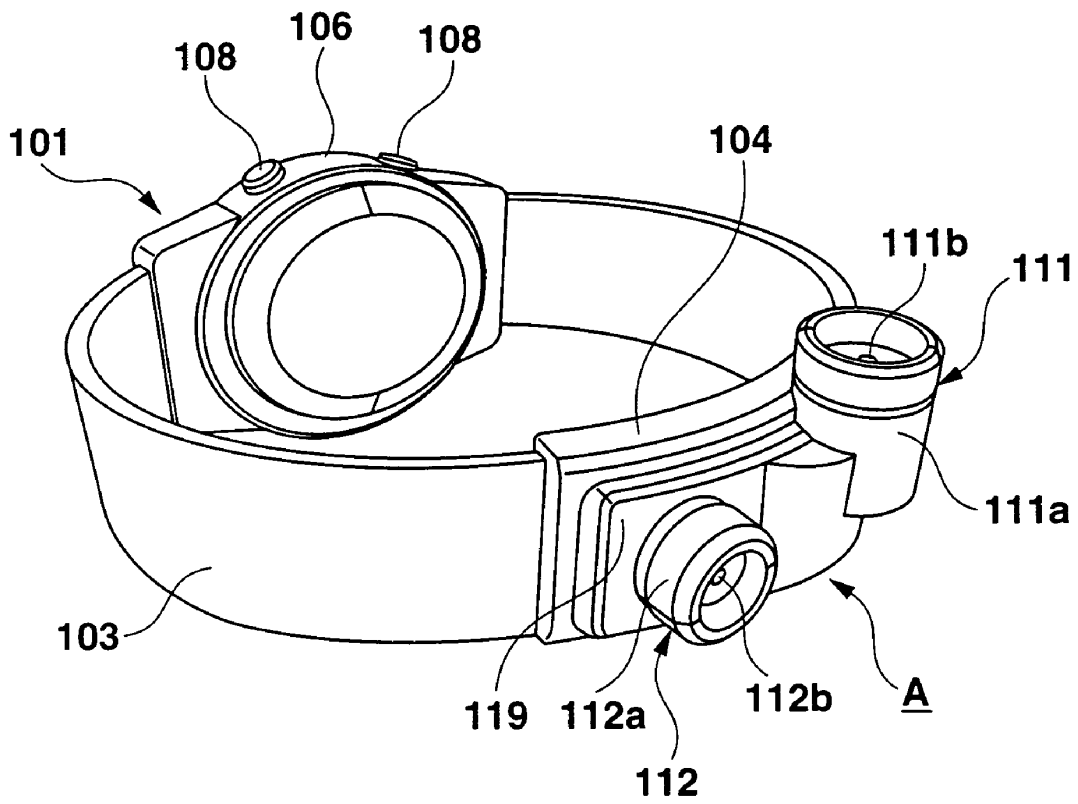

FIG. 2

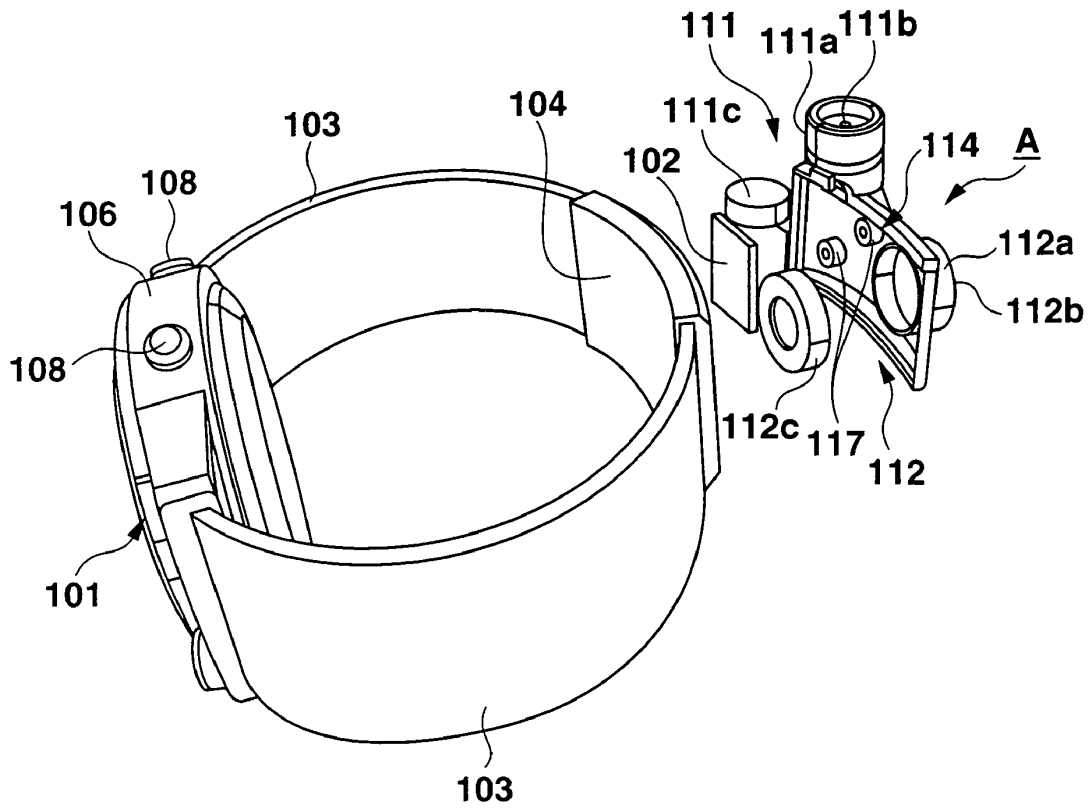

FIG.3

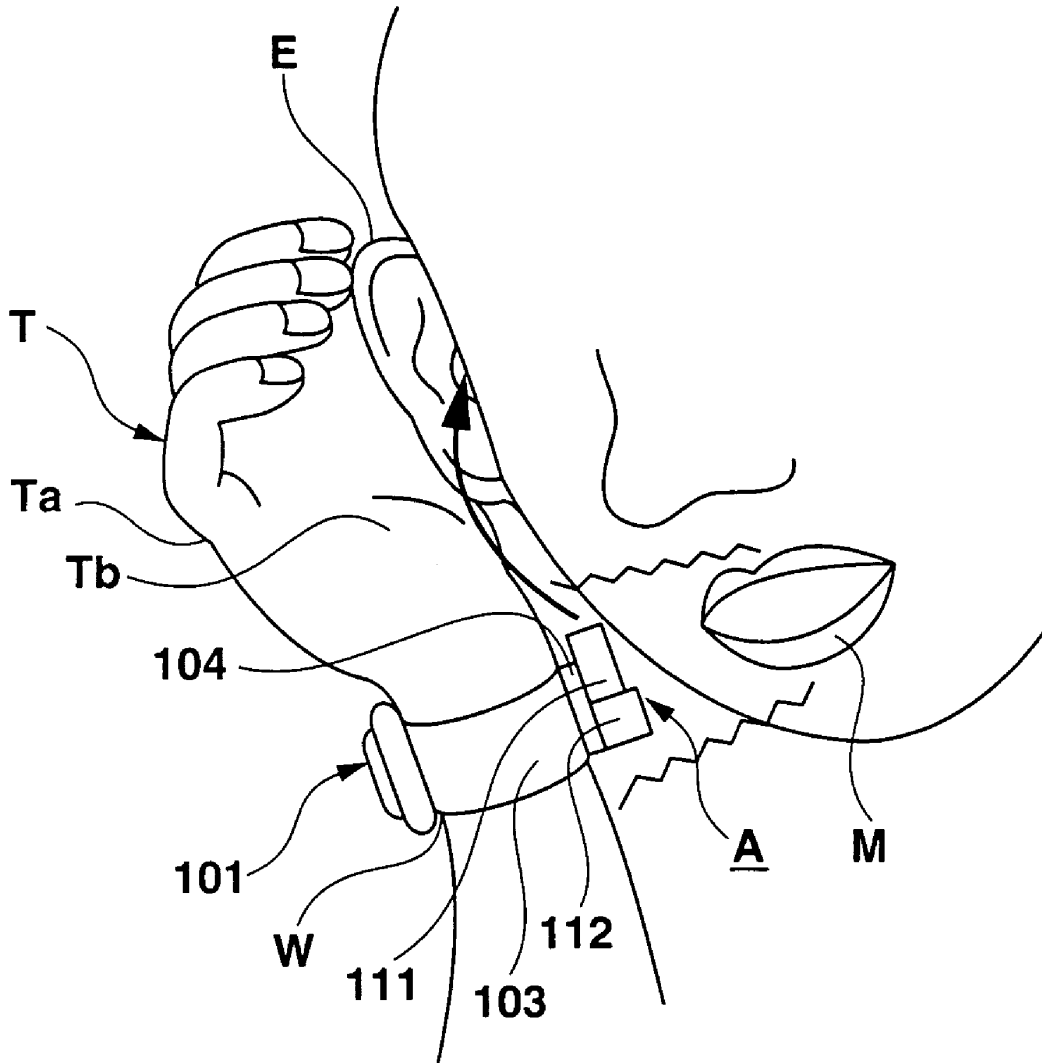

FIG.4

Explore Litigation Insights

Docket Alarm provides insights to develop a more informed litigation strategy and the peace of mind of knowing you're on top of things.

Real-Time Litigation Alerts



Keep your litigation team up-to-date with **real-time alerts** and advanced team management tools built for the enterprise, all while greatly reducing PACER spend.

Our comprehensive service means we can handle Federal, State, and Administrative courts across the country.

Advanced Docket Research



With over 230 million records, Docket Alarm's cloud-native docket research platform finds what other services can't. Coverage includes Federal, State, plus PTAB, TTAB, ITC and NLRB decisions, all in one place.

Identify arguments that have been successful in the past with full text, pinpoint searching. Link to case law cited within any court document via Fastcase.

Analytics At Your Fingertips



Learn what happened the last time a particular judge, opposing counsel or company faced cases similar to yours.

Advanced out-of-the-box PTAB and TTAB analytics are always at your fingertips.

API

Docket Alarm offers a powerful API (application programming interface) to developers that want to integrate case filings into their apps.

LAW FIRMS

Build custom dashboards for your attorneys and clients with live data direct from the court.

Automate many repetitive legal tasks like conflict checks, document management, and marketing.

FINANCIAL INSTITUTIONS

Litigation and bankruptcy checks for companies and debtors.

E-DISCOVERY AND LEGAL VENDORS

Sync your system to PACER to automate legal marketing.