



US 20060152576A1

(19) **United States**

(12) **Patent Application Publication**
Kiessling et al.

(10) **Pub. No.: US 2006/0152576 A1**

(43) **Pub. Date: Jul. 13, 2006**

(54) **MOBILE COMMUNICATION DEVICE
HAVING DETACHABLE WIRELESS
CAMERA AND CAMERA MODULE FOR A
MOBILE COMMUNICATION DEVICE**

Publication Classification

(51) **Int. Cl.**
H04B 1/38 (2006.01)

(75) **Inventors: Michael Kiessling, Freising (DE);
Kenneth A. Tuchman, Munich (DE)**

(52) **U.S. Cl.** **348/14.01**

Correspondence Address:
HITT GAINES P.C.
P.O. BOX 832570
RICHARDSON, TX 75083 (US)

(57) **ABSTRACT**

A mobile communication device and a camera module configured to be attached to a suitable mobile communication device. In one embodiment, the device includes: (1) a main body having a radio frequency receiver and (2) a camera module detachably coupled to the main body and having a radio frequency transmitter, the radio frequency receiver and the radio frequency transmitter configured to cooperate to establish a radio frequency connection for transmitting data from the camera module to the main body.

(73) **Assignee: Agere Systems Incorporated, Allentown, PA**

(21) **Appl. No.: 11/033,197**

(22) **Filed: Jan. 11, 2005**

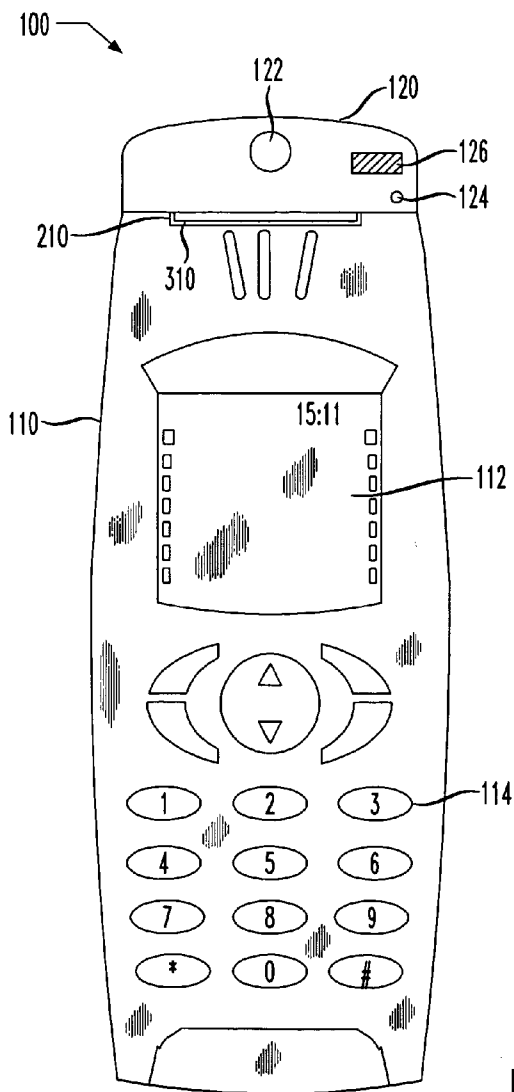

Samsung v. GUI
IPR2021-00337
Exhibit 1016

FIG. 1

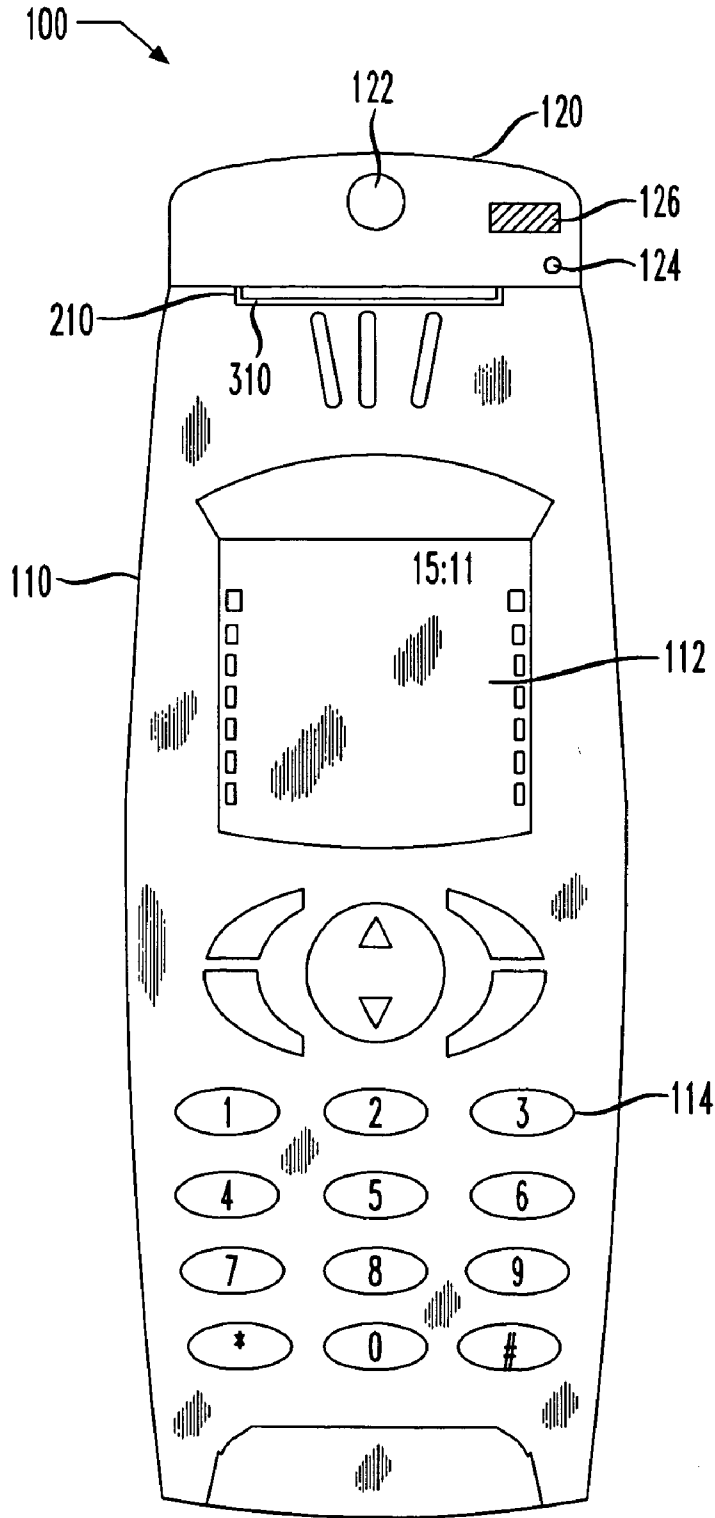

FIG. 2

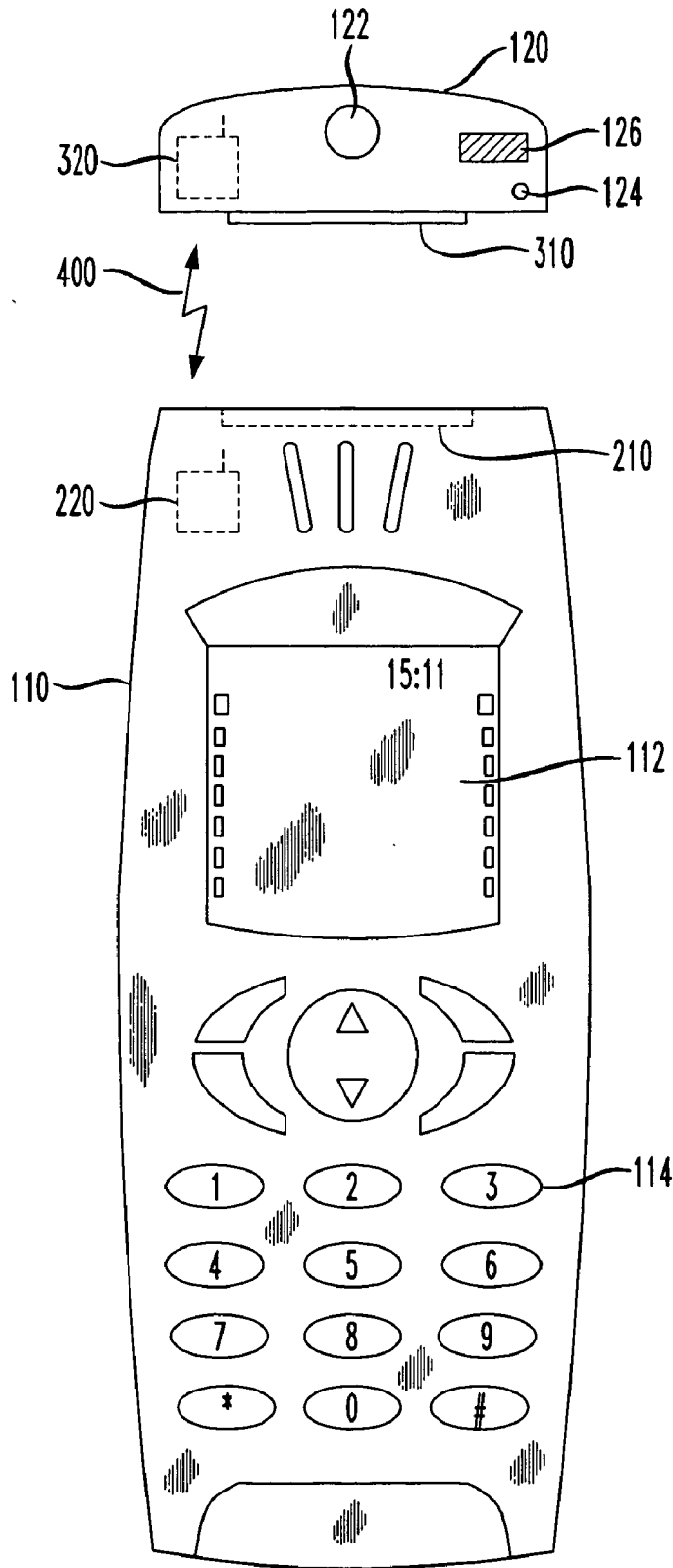

FIG. 3

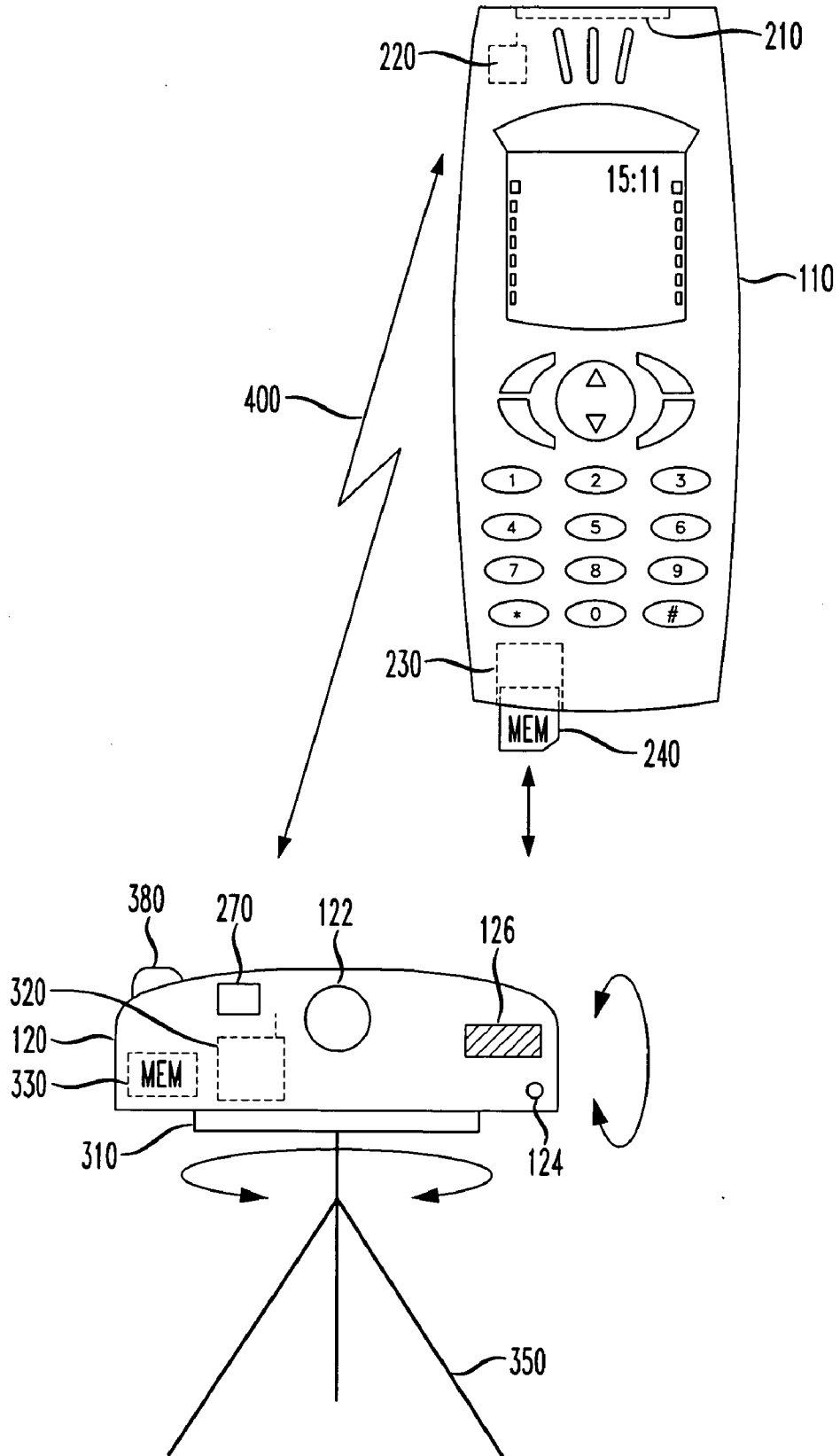
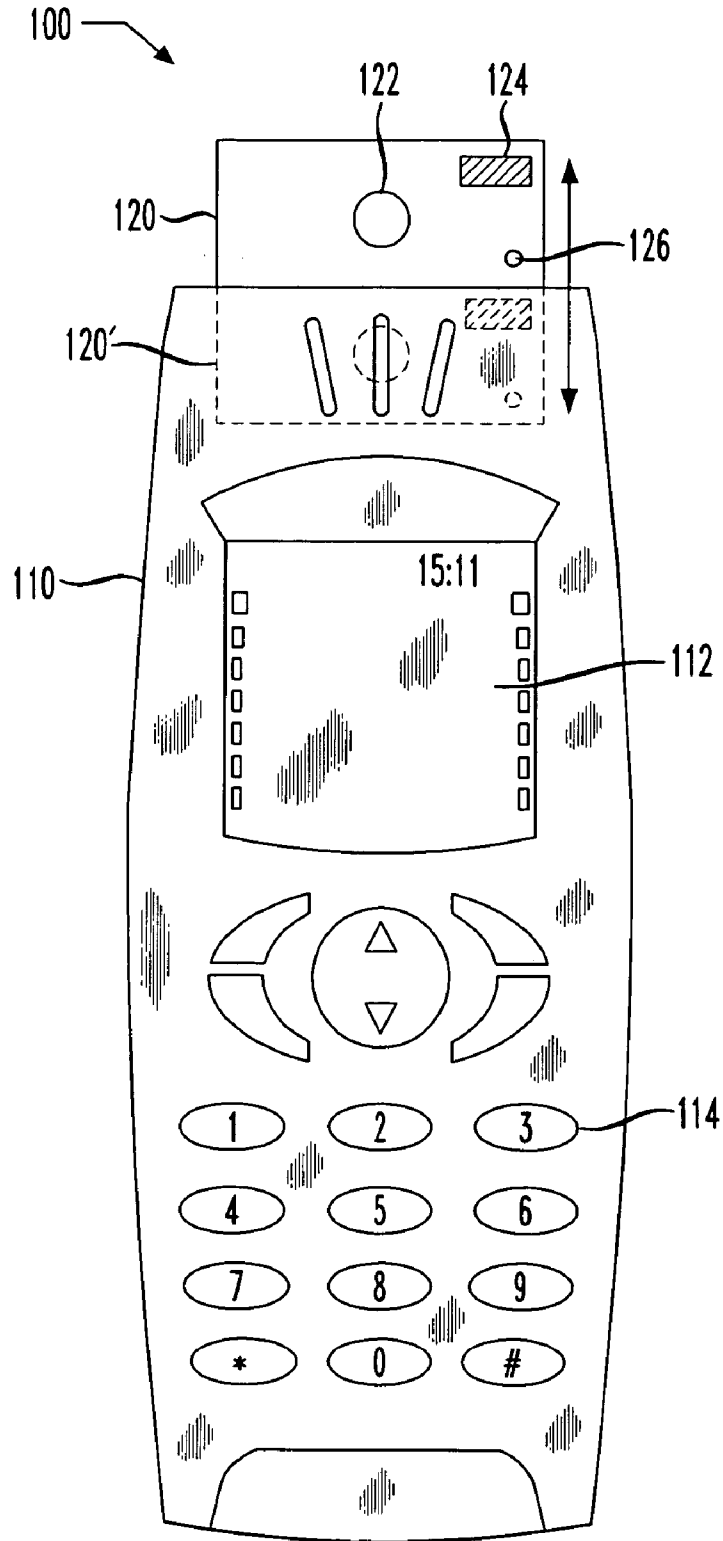

FIG. 4



Explore Litigation Insights

Docket Alarm provides insights to develop a more informed litigation strategy and the peace of mind of knowing you're on top of things.

Real-Time Litigation Alerts



Keep your litigation team up-to-date with **real-time alerts** and advanced team management tools built for the enterprise, all while greatly reducing PACER spend.

Our comprehensive service means we can handle Federal, State, and Administrative courts across the country.

Advanced Docket Research



With over 230 million records, Docket Alarm's cloud-native docket research platform finds what other services can't. Coverage includes Federal, State, plus PTAB, TTAB, ITC and NLRB decisions, all in one place.

Identify arguments that have been successful in the past with full text, pinpoint searching. Link to case law cited within any court document via Fastcase.

Analytics At Your Fingertips



Learn what happened the last time a particular judge, opposing counsel or company faced cases similar to yours.

Advanced out-of-the-box PTAB and TTAB analytics are always at your fingertips.

API

Docket Alarm offers a powerful API (application programming interface) to developers that want to integrate case filings into their apps.

LAW FIRMS

Build custom dashboards for your attorneys and clients with live data direct from the court.

Automate many repetitive legal tasks like conflict checks, document management, and marketing.

FINANCIAL INSTITUTIONS

Litigation and bankruptcy checks for companies and debtors.

E-DISCOVERY AND LEGAL VENDORS

Sync your system to PACER to automate legal marketing.