

(19) **United States**

(12) **Patent Application Publication** (10) **Pub. No.: US 2003/0164895 A1**

Viinikanoja et al.

(43) **Pub. Date: Sep. 4, 2003**

(54) **MOBILE TERMINAL DEVICE HAVING CAMERA SYSTEM**

Publication Classification

(76) Inventors: **Jarkko Viinikanoja**, Tampere (FI);
Jukka Yrjanainen, Ylojarvi (FI)

(51) **Int. Cl.⁷** **H04N 5/225**
(52) **U.S. Cl.** **348/375; 348/211.2; 348/340;**
348/360

Correspondence Address:
ANTONELLI TERRY STOUT AND KRAUS
SUITE 1800
1300 NORTH SEVENTEENTH STREET
ARLINGTON, VA 22209

(57) **ABSTRACT**

The present invention is a camera system which is usable with a mobile terminal. The camera system includes a lens module and at least one mechanism for changing optical properties by interacting with the lens module. The camera system may be built into the mobile terminal or attached thereto as an external module.

(21) Appl. No.: **09/987,849**

(22) Filed: **Nov. 16, 2001**

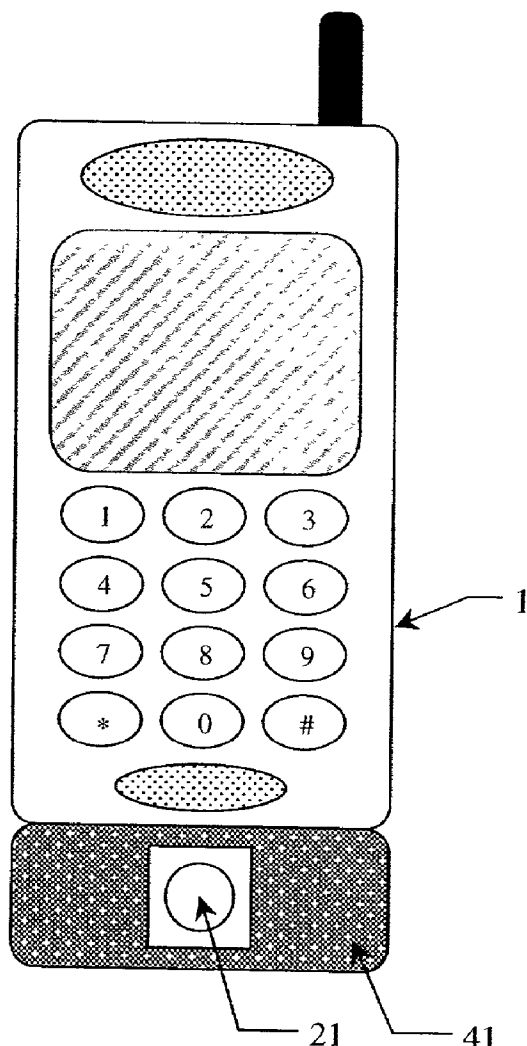

Samsung v. GUI
IPR2021-00336
Exhibit 1017

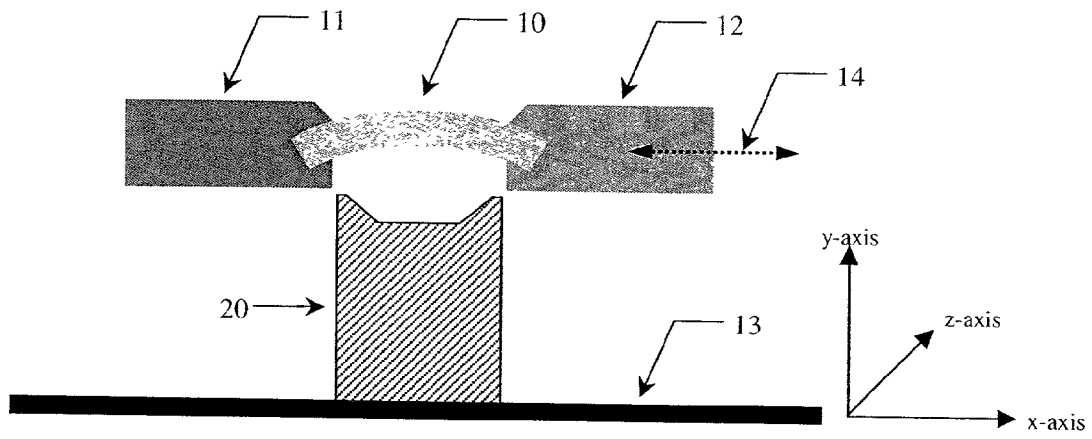

Fig. 1

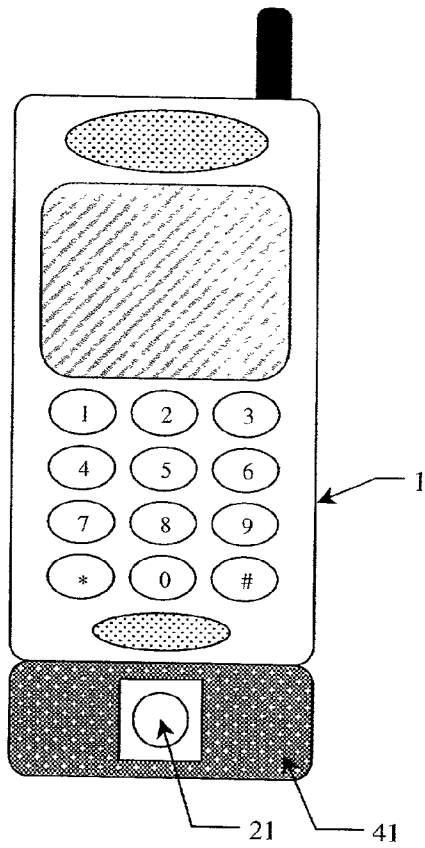

Fig. 2a

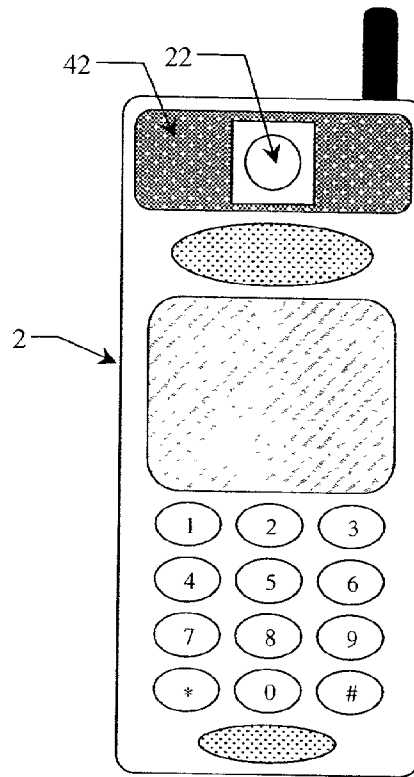

Fig. 2b

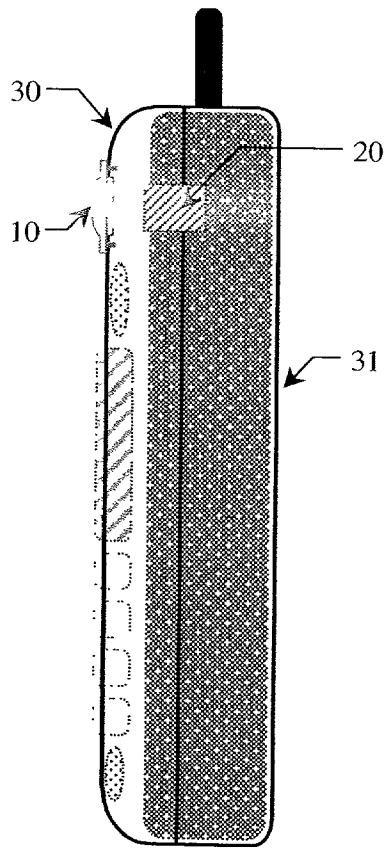

Fig. 2c

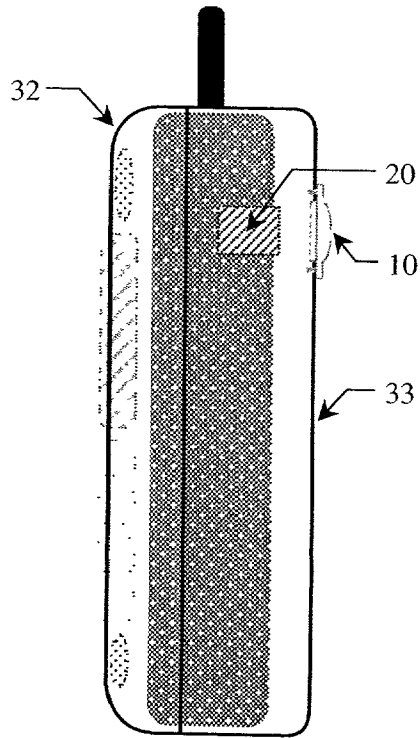

Fig. 2d

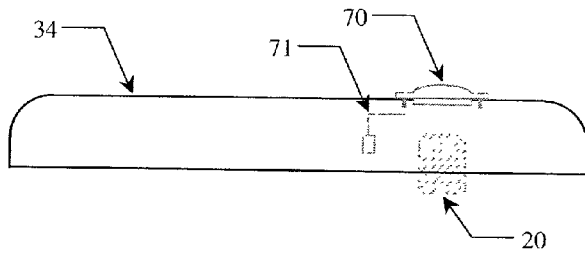

Fig. 3a
(side view)

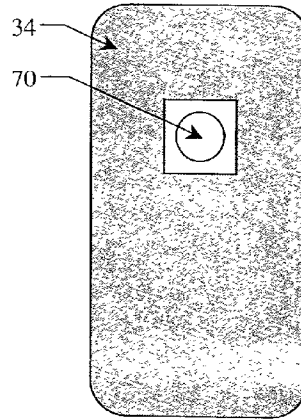

Fig. 3b
(back view)

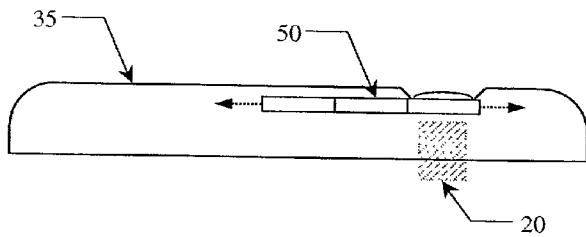

Fig. 4a
(side view)

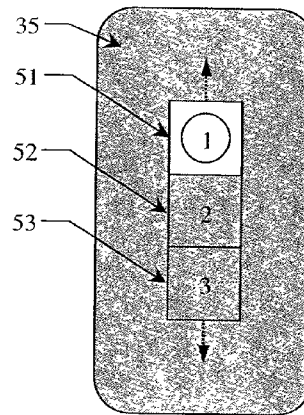

Fig. 4b
(back view)

Explore Litigation Insights

Docket Alarm provides insights to develop a more informed litigation strategy and the peace of mind of knowing you're on top of things.

Real-Time Litigation Alerts



Keep your litigation team up-to-date with **real-time alerts** and advanced team management tools built for the enterprise, all while greatly reducing PACER spend.

Our comprehensive service means we can handle Federal, State, and Administrative courts across the country.

Advanced Docket Research



With over 230 million records, Docket Alarm's cloud-native docket research platform finds what other services can't. Coverage includes Federal, State, plus PTAB, TTAB, ITC and NLRB decisions, all in one place.

Identify arguments that have been successful in the past with full text, pinpoint searching. Link to case law cited within any court document via Fastcase.

Analytics At Your Fingertips



Learn what happened the last time a particular judge, opposing counsel or company faced cases similar to yours.

Advanced out-of-the-box PTAB and TTAB analytics are always at your fingertips.

API

Docket Alarm offers a powerful API (application programming interface) to developers that want to integrate case filings into their apps.

LAW FIRMS

Build custom dashboards for your attorneys and clients with live data direct from the court.

Automate many repetitive legal tasks like conflict checks, document management, and marketing.

FINANCIAL INSTITUTIONS

Litigation and bankruptcy checks for companies and debtors.

E-DISCOVERY AND LEGAL VENDORS

Sync your system to PACER to automate legal marketing.