



US 20080166005A1

(19) **United States**

(12) **Patent Application Publication**
Terlizzi et al.

(10) **Pub. No.: US 2008/0166005 A1**

(43) **Pub. Date: Jul. 10, 2008**

(54) **HEADSET ELECTRONICS**

(75) Inventors: **Jeffrey J. Terlizzi**, San Francisco, CA (US); **Emery A. Sanford**, San Francisco, CA (US); **M. Evans Hankey**, San Francisco, CA (US); **Terry Tikalsky**, Sunnyvale, CA (US); **John Tang**, San Carlos, CA (US); **Daniele De Iuliis**, San Francisco, CA (US); **Peter Russell-Clark**, San Francisco, CA (US)

on Jan. 6, 2007, provisional application No. 60/879,193, filed on Jan. 6, 2007, provisional application No. 60/879,195, filed on Jan. 6, 2007, provisional application No. 60/936,965, filed on Jun. 22, 2007.

Publication Classification

- (51) **Int. Cl.**
H04R 25/00 (2006.01)
- (52) **U.S. Cl.** **381/375; 381/380**

(57) **ABSTRACT**

A wireless headset device that includes an earbud assembly and a primary housing assembly, fixed to the earbud assembly, is provided. The earbud assembly can include an earbud flexible circuit board having mounted thereon a receiver and processing circuitry. The primary housing assembly can include a microphone and a primary housing flexible circuit board electrically coupled to the earbud circuit board and the microphone. In some embodiments, the headset device can include at least one flexible circuit board and the primary housing can include a connector assembly. The at least one flexible circuit board can be electrically coupled to the connector assembly and can include Universal Serial Bus (USB) circuitry operative to process USB protocol communications and serial circuitry operative to process serial protocol communications.

Correspondence Address:

ROPES & GRAY LLP
PATENT DOCKETING 39/361, 1211 AVENUE OF THE AMERICAS
NEW YORK, NY 10036-8704

(73) Assignee: **Apple Inc**, Cupertino, CA (US)

(21) Appl. No.: **11/824,443**

(22) Filed: **Jun. 28, 2007**

Related U.S. Application Data

(60) Provisional application No. 60/878,852, filed on Jan. 5, 2007, provisional application No. 60/879,177, filed

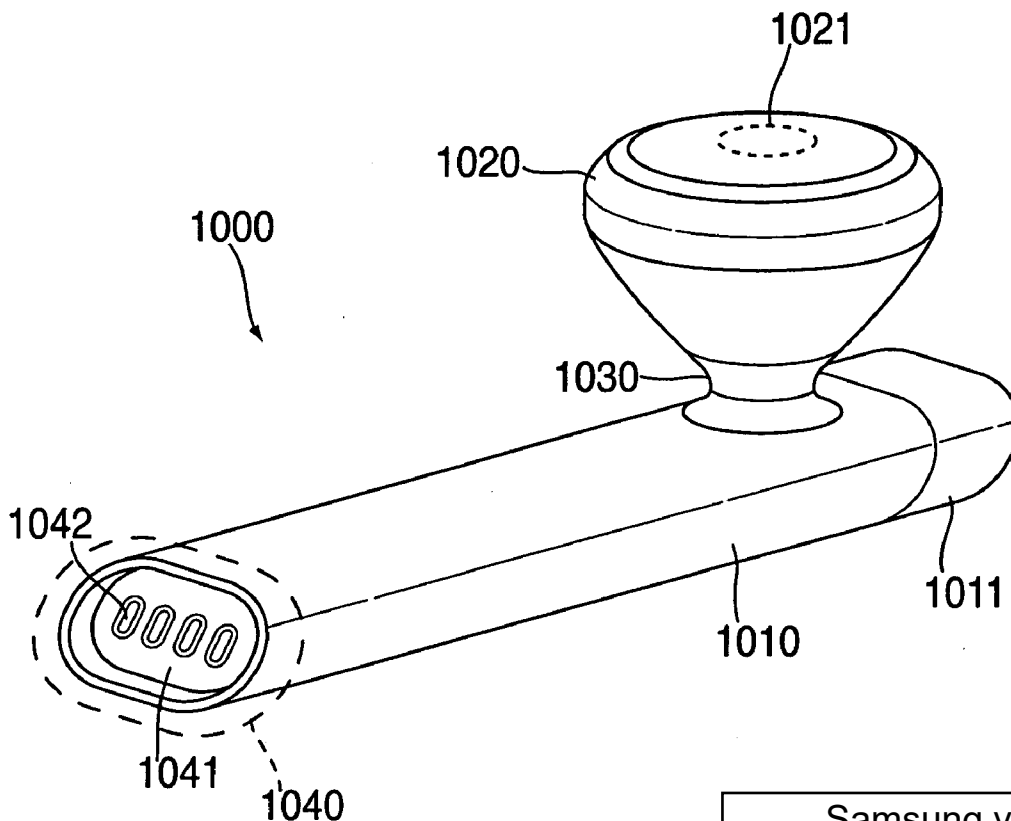

Samsung v. GUI
IPR2021-00336
Exhibit 1015

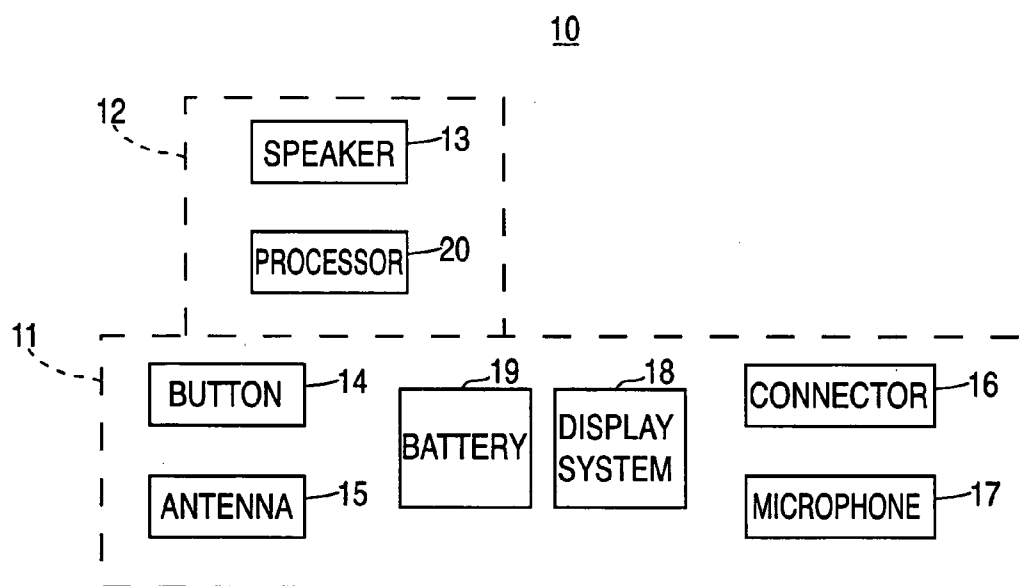

FIG. 1

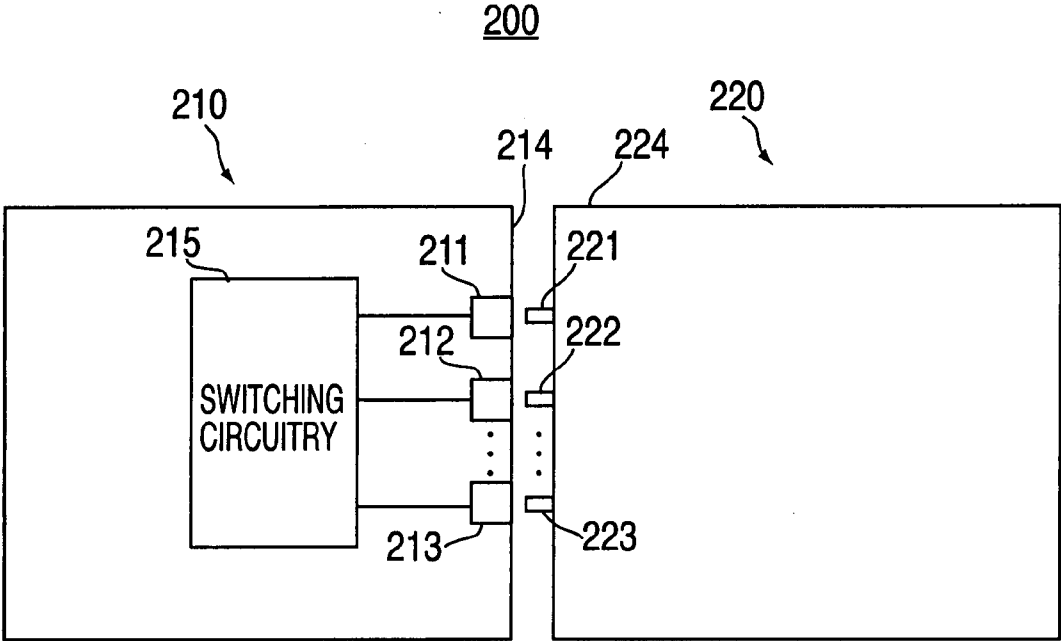

FIG. 2

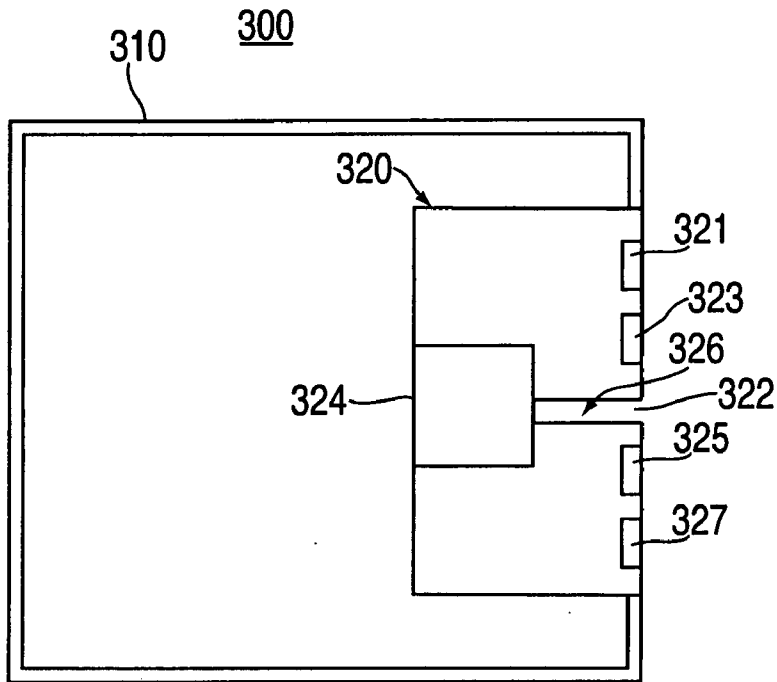

FIG. 3

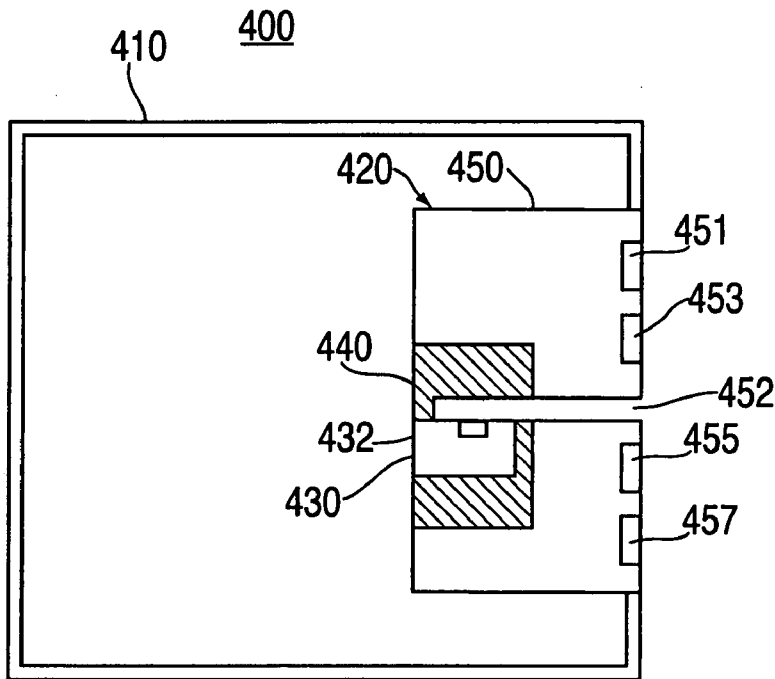

FIG. 4

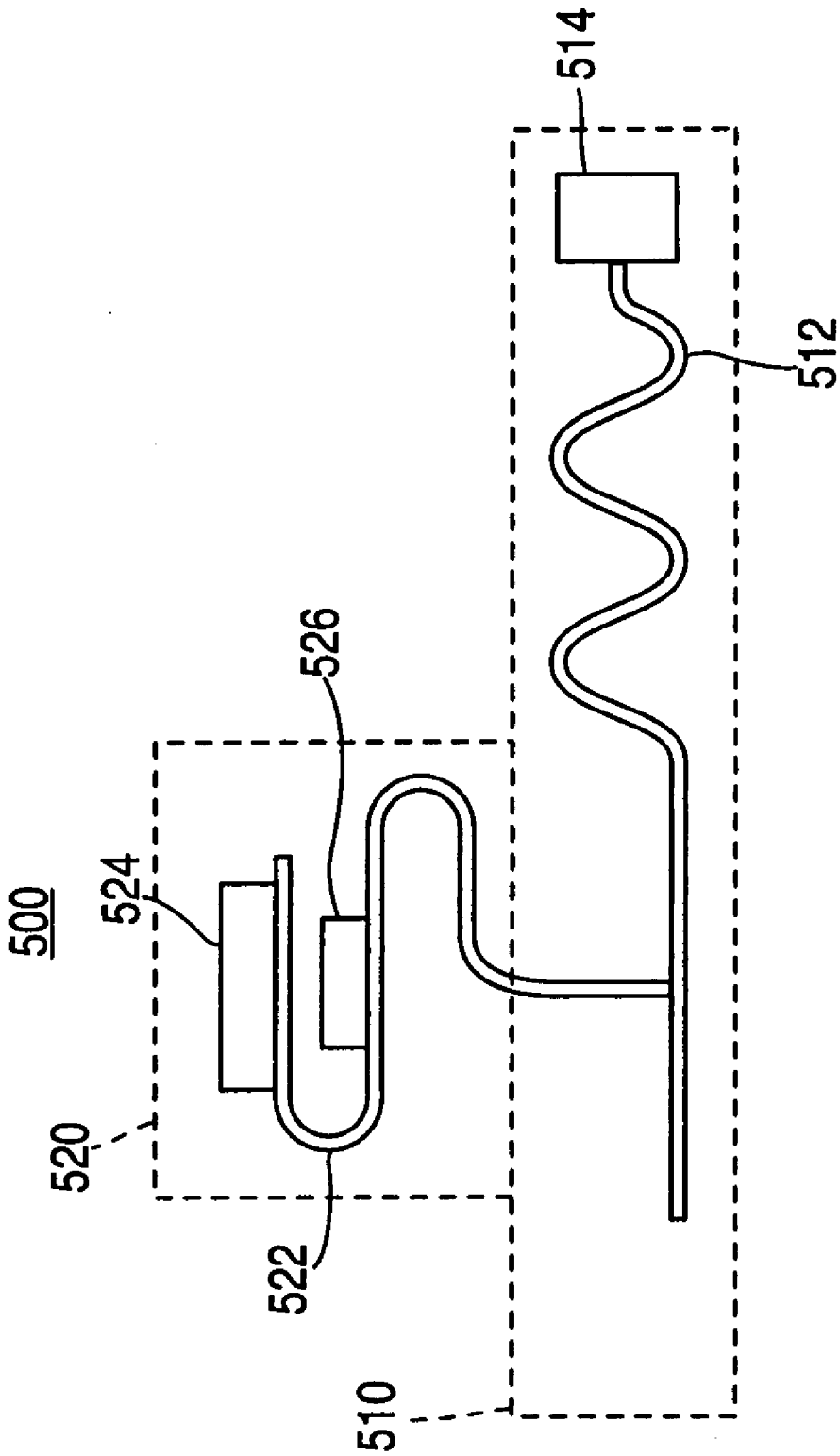

FIG. 5

Explore Litigation Insights

Docket Alarm provides insights to develop a more informed litigation strategy and the peace of mind of knowing you're on top of things.

Real-Time Litigation Alerts



Keep your litigation team up-to-date with **real-time alerts** and advanced team management tools built for the enterprise, all while greatly reducing PACER spend.

Our comprehensive service means we can handle Federal, State, and Administrative courts across the country.

Advanced Docket Research



With over 230 million records, Docket Alarm's cloud-native docket research platform finds what other services can't. Coverage includes Federal, State, plus PTAB, TTAB, ITC and NLRB decisions, all in one place.

Identify arguments that have been successful in the past with full text, pinpoint searching. Link to case law cited within any court document via Fastcase.

Analytics At Your Fingertips



Learn what happened the last time a particular judge, opposing counsel or company faced cases similar to yours.

Advanced out-of-the-box PTAB and TTAB analytics are always at your fingertips.

API

Docket Alarm offers a powerful API (application programming interface) to developers that want to integrate case filings into their apps.

LAW FIRMS

Build custom dashboards for your attorneys and clients with live data direct from the court.

Automate many repetitive legal tasks like conflict checks, document management, and marketing.

FINANCIAL INSTITUTIONS

Litigation and bankruptcy checks for companies and debtors.

E-DISCOVERY AND LEGAL VENDORS

Sync your system to PACER to automate legal marketing.