

UNITED STATES PATENT AND TRADEMARK OFFICE

---

BEFORE THE PATENT TRIAL AND APPEAL BOARD

---

APPLE INC.,  
Petitioner,

v.

MASIMO CORPORATION,  
Patent Owner.

---

Case IPR2021-00193  
Patent 10,299,708

---

**PETITIONER'S MOTION TO FILE SUPPLEMENTAL INFORMATION  
PURSUANT TO 37 C.F.R. § 42.123**

## **I. INTRODUCTION**

Pursuant to 37 C.F.R § 42.123(a), and under the authorization granted by the Board on July 7, 2021, Petitioner hereby moves to submit Exhibit 1040 (“Declaration of Jacob Munford”), Exhibit 1041 (“Declaration of Gordon MacPherson: Mendelson-2003”), and Exhibit 1042 (“Declaration of Gordon MacPherson: Mendelson-2006”) as supplemental information.

Petitioner requested authorization to file this motion on July 2, 2021, within one month of the June 3, 2021 date of institution for IPR2021-00193. As explained in more detail below, Exhibits 1040 to 1042 provide further testimony supporting the public accessibility and authenticity of prior art references relied upon in the challenges set forth in the IPR2021-00193 Petition. For at least that reason, Exhibits 1040 to 1042 are relevant to a claim for which trial has been instituted. Accordingly, both requirements of 37 C.F.R § 42.123(a) have been met.

Further, counsel for Petitioner and Patent Owner conferred prior to Petitioner’s request for authorization to submit this motion, and Patent Owner does not oppose this motion. Petitioner now so moves.

## **II. BACKGROUND**

On November 20, 2020, Petitioner filed a Petition for *inter partes* review of claims 1-29 of U.S. Pat. No. 10,299,708 (“the ’708 patent”), which was assigned case number IPR2021-00193. On May June 3, 2021, the Board instituted trial on

all challenged claims of the '708 patent, determining that Petitioner had demonstrated a reasonable likelihood that Petitioner would prevail in showing the unpatentability of at least one of the challenged claims.

On June 17, 2021, pursuant to 37 C.F.R. § 42.64(b)(1), Patent Owner served Petitioner with objections to evidence, which included assertions that various prior art references that had been relied upon in the Petition had not been established as prior art, in addition to objections to the previously-submitted declaration of librarian Jacob Robert Munford (Exhibit 1026). On June 30, 2021, pursuant to 37 C.F.R. § 42.64(b)(2), and in response to Patent Owner's objections, Petitioner served Patent Owner with supplemental evidence including: (1) an additional declaration from Mr. Munford ("Declaration of Jacob Munford"; Exhibit 1040); (2) a declaration from IEEE's Director of Board Governance & IP Operations, Gordon MacPherson, regarding Mendelson-2003 ("Declaration of Gordon MacPherson: Mendelson-2003"; Exhibit 1041); and (3) a declaration from IEEE's Director of Board Governance & IP Operations, Gordon MacPherson, regarding Mendelson-2006 ("Declaration of Gordon MacPherson: Mendelson-2006"; Exhibit 1042).

Exhibit 1040 provides further testimony supporting the public accessibility and authenticity of the prior art references relied upon in the challenges set forth in the IPR2021-00193 Petition, with supporting appendices.

Exhibit 1041 provides further testimony supporting the public accessibility and authenticity of Mendelson-2003 (Exhibit 1024), which was relied upon in the challenges set forth in the IPR2021-00193 Petition.

Exhibit 1042 provides further testimony supporting the public accessibility and authenticity of Mendelson-2006 (Exhibit 1016), which was relied upon in the challenges set forth in the IPR2021-00193 Petition.

On July 2, 2021, Petitioner requested authorization from the Board to file a motion to submit the declarations of Jacob Robert Munford and Gordon MacPherson as supplemental information in each of IPR2021-00193, IPR2021-00195, IPR2021-00208, and IPR2021-00209. On July 7, 2021, the Board authorized Petitioner to file a motion to submit supplemental information in each of the indicated proceedings. In accordance with the Board's authorization, Petitioner hereby moves to submit Exhibits 1040 to 1042 as supplemental information in IPR2021-00193.

### **III. ARGUMENTS**

Under 37 C.F.R. § 42.123(a), a party may file a motion to submit supplemental information in accordance with the following two requirements: (1) "A request for the authorization to file a motion to submit supplemental information is made within one month of the date the trial is instituted"; and (2)

“The supplemental information must be relevant to a claim for which the trial has been instituted.”

The instant Motion meets both of these requirements. First, Petitioner requested authorization to file this motion on July 2, 2021, within one month of the June 3, 2021 date of institution for IPR2021-00193. Second, Exhibits 1040 to 1042 provide further testimony supporting the public accessibility and authenticity of prior art references relied upon in the challenges set forth in the IPR2021-00193 Petition and, for at least that reason, Exhibits 1040 to 1042 are relevant to a claim for which trial has been instituted. *See, e.g., Valeo v. Magna Elecs.*, IPR2014-01204 Pap. 26 at 5 (PTAB Apr. 10, 2015); *Palo Alto Networks, Inc. v. Juniper Networks, Inc.*, IPR2013-00369 Pap. 37 at 3 (PTAB Feb. 5, 2014)(“[e]vidence that allegedly confirms the public accessibility of references that serve as the basis of the grounds of unpatentability authorized...is relevant to the claims of the...patent for which this trial was instituted”); *Motorola Solutions, Inc. v. Mobile Scanning Tech.*, IPR 2013-00093 Pap. 37 at 2-3 (PTAB Jun. 28, 2013).

Moreover, like the supplemental information admitted in *Valeo*, *Palo Alto Networks*, and *Motorola Solutions, Inc.*, Exhibits 1040 to 1042 do not change the grounds of unpatentability authorized in the proceeding, and instead merely confirm the public accessibility and authenticity of prior art references originally provided with the Petition. Further, because Patent Owner has been in possession

of the supplemental information in the form of supplemental evidence since June 30, 2021, which is nearly two months prior to the August 27, 2021 due date of the Patent Owner's response, the Patent Owner has reasonable time to review Exhibits 1040 to 1042 and is not prejudiced or otherwise burdened by entry of this supplemental evidence into the record as supplemental information. Similarly, the entry of Exhibits 1040 to 1042 now, as supplemental information, would not limit the Board's ability to complete this proceeding in a timely fashion.

Accordingly, Petitioner respectfully submits that Exhibits 1040 to 1042 should be submitted into evidence as supplemental information, and requests the same.

#### **IV. CONCLUSION**

Petitioner respectfully requests that the Board grant this motion to submit Exhibits 1040 to 1042 as supplemental information in IPR2021-00193.

Respectfully submitted,

Dated: July 9, 2021

/Hyun Jin In/  
W. Karl Renner, Reg. No. 41,265  
Roberto J. Devoto, Reg. No. 55,108  
Hyun Jin In, Reg. No. 70,014  
Fish & Richardson P.C.  
3200 RBC Plaza, 60 South Sixth Street  
Minneapolis, MN 55402  
T: 202-783-5553

**CERTIFICATE OF SERVICE**

Pursuant to 37 CFR §§ 42.6(e)(4)(i) *et seq.*, the undersigned certifies that on July 9, 2021, a complete and entire copy of this “PETITIONER’S MOTION TO FILE SUPPLEMENTAL INFORMATION PURSUANT TO 37 C.F.R. § 42.123” and its attached exhibits were provided by electronic mail to the Patent Owner by serving the correspondence e-mail address of record as follows:

Joseph R. Re  
Stephen W. Larson  
Jarom D. Kesler  
Jacob L. Peterson  
Knobbe, Martens, Olson, & Bear, LLP  
2040 Main St., 14th Floor  
Irvine, CA 92614

Email: [AppleIPR2021-0193-708@knobbe.com](mailto:AppleIPR2021-0193-708@knobbe.com)

/Edward G. Faeth/  
Edward G. Faeth  
Fish & Richardson P.C.  
3200 RBC Plaza  
60 South Sixth Street  
Minneapolis, MN 55402  
(202) 626-6420

**IN THE UNITED STATES PATENT AND TRADEMARK OFFICE**

In re Patent of: Poeze, et al.  
U.S. Patent No.: 10,299,708 Attorney Docket No.: 50095-0009IP1  
Issue Date: May 28, 2019  
Appl. Serial No.: 16/261,366  
Filing Date: Jan. 29, 2019  
Title: MULTI-STREAM DATA COLLECTION SYSTEM FOR  
NON-INVASIVE MEASUREMENT OF BLOOD  
CONSTITUENTS

**Mail Stop Patent Board**

Patent Trial and Appeal Board  
U.S. Patent and Trademark Office  
P.O. Box 1450  
Alexandria, VA 22313-1450

**DECLARATION OF JACOB ROBERT MUNFORD**



1. My name is Jacob Robert Munford. I am over the age of 18, have personal knowledge of the facts set forth herein, and am competent to testify to the same.
  
2. I earned a Master of Library and Information Science (MLIS) from the University of Wisconsin-Milwaukee in 2009. I have over ten years of experience in the library/information science field. Beginning in 2004, I have served in various positions in the public library sector including Assistant Librarian, Youth Services Librarian and Library Director. I have attached my Curriculum Vitae as Appendix A.
  
3. During my career in the library profession, I have been responsible for materials acquisition for multiple libraries. In that position, I have cataloged, purchased and processed incoming library works. That includes purchasing materials directly from vendors, recording publishing data from the material in question, creating detailed material records for library catalogs and physically preparing that material for circulation. In addition to my experience in acquisitions, I was also responsible for analyzing large collections of library materials, tailoring library records for optimal catalog

search performance and creating lending agreements between libraries during my time as a Library Director.

4. I am fully familiar with the catalog record creation process in the library sector. In preparing a material for public availability, a library catalog record describing that material would be created. These records are typically written in Machine Readable Catalog (herein referred to as “MARC”) code and contain information such as a physical description of the material, metadata from the material’s publisher, and date of library acquisition. In particular, the 008 field of the MARC record is reserved for denoting the date of creation of the library record itself. As this typically occurs during the process of preparing materials for public access, it is my experience that an item’s MARC record indicates the date of an item’s public availability.
5. Typically, in creating a MARC record, a librarian would gather various bits of metadata such as book title, publisher and subject headings among others and assign each value to a relevant numerical field. For example, a book’s physical description is tracked in field 300 while title/attribution is tracked in field 245. The 008 field of the MARC record is reserved for denoting the creation of the library record itself. As this is the only date reflecting the inclusion of said materials within the library’s collection, it is my experience

that an item's 008 field accurately indicates the date of an item's public availability.

6. This declaration is being drafted as of June 2021. Public and university libraries in my area have been closed for months due to the COVID-19 pandemic. My state, Pennsylvania, has a travel advisory, which has affected my ability to travel. In my experience, library catalog records are accurate descriptions of a library's collection and my lack of physical access to libraries at this time creates no doubt in my determinations of authenticity or availability of the exhibits noted below.
  
7. I have reviewed Exhibit 1024, a copy of an article entitled "Measurement Site and Photodetector Size Considerations in Optimizing Power Consumption of a Wearable Reflectance Pulse Oximeter" by Y. Mendelson and C. Pujary as published in the *Proceedings of the 25<sup>th</sup> Annual International Conference of the IEEE Engineering in Medicine and Biology Society, September 17 – 21, 2003* (hereinafter referred to as "2003 IEEE conference publication").
  
8. Attached hereto as Appendix MENDELSON01 is a true and correct copy of the MARC record for the 2003 IEEE conference publication, as held by the

Pennsylvania State University's library. I secured this record myself from the library's public catalog.

9. The MARC record contained within Appendix MENDELSON01 accurately describes the title, author, publisher, and ISBN number of the 2003 IEEE conference publication. In comparing the listed fields in Appendix MENDELSON01 to Exhibit 1024, it is my determination that Exhibit 1024 is a true and correct copy of the "Measurement Site and Photodetector Size Considerations in Optimizing Power Consumption of a Wearable Reflectance Pulse Oximeter" article, and that the copy of the 2003 IEEE conference publication in Pennsylvania State University's library includes the article in Exhibit 1024.

10. The 008 field of the MARC record noted on page 1 of Appendix MENDELSON01 indicates that the 2003 IEEE conference publication was first cataloged by the Pennsylvania State University's library as of February 4, 2004. Based on this information and considering the dates of the conference, it is my determination that the 2003 IEEE conference publication, which included the article published as Exhibit 1024, was made available to the public by the Pennsylvania State University at least as of February 4, 2004.

11. Attached hereto as Appendix IEEE02 is a true and correct copy of a declaration made by Mr. Gordon MacPherson, “Director Board Governance & IP Operations of The Institute of Electrical and Electronics Engineers, Incorporated.” Mr. MacPherson’s declaration Appendix IEEE02 states that the “IEEE publishes and makes available technical articles and standards” as part of its “ordinary course of business,” and that these publications are “made available for public download through the IEEE digital library, IEEE Xplore.”

12. Mr. MacPherson’s declaration includes, as Exhibit A, an article referred to as “Y. Mendelson and C. Pujary, ‘Measurement site and photodetector size considerations in optimizing power consumption of a wearable reflectance pulse oximeter’, Proceedings of the 25th Annual International Conference of the IEEE Engineering in Medicine and Biology Society, September 17 – 21, 2003,” which was obtained “through IEEE Xplore, where it is maintained in the ordinary course of IEEE’s business.” Exhibit A also includes a screen capture of the IEEE Xplore portal page for the above-noted article.

13. In comparing the listed fields in Exhibit A of Appendix IEEE02 to Appendix MENDELSON01 and comparing Exhibit A of Appendix IEEE02 to Exhibit 1024, it is my determination that Exhibit 1024 is a true and correct copy of the “Measurement site and photodetector size considerations in optimizing power consumption of a wearable reflectance pulse oximeter” article, and that the copy of the 2003 IEEE conference publication in Pennsylvania State University’s library includes the article in Exhibit 1024.

14. I have reviewed Exhibit 1016, a copy of an article entitled “A Wearable Reflectance Pulse Oximeter for Remote Physiological Monitoring” by Y. Mendelson, R. J. Duckworth, and G. Comtois, as published in the *Proceedings of the 28<sup>th</sup> Annual International Conference of the IEEE Engineering in Medicine and Biology Society, August 30 – September 3, 2006* (hereinafter referred to as “2006 IEEE conference publication”).

15. Attached hereto as Appendix MENDELSON02 is a true and correct copy of the MARC record for the 2006 IEEE conference publication, as held by Cornell University’s library. I secured this record myself from the library’s public catalog.

16. The MARC record contained within Appendix MENDELSON02 accurately describes the title, author, publisher, and ISBN number of the 2006 IEEE conference publication. In comparing the listed fields in Appendix MENDELSON02 to Exhibit 1016, it is my determination that Exhibit 1016 is a true and correct copy of the “A Wearable Reflectance Pulse Oximeter for Remote Physiological Monitoring” article, and that the copy of the 2006 IEEE conference publication in Cornell University’s library includes the article in Exhibit 1016.

17. The 008 field of the MARC record noted on page 1 of Appendix MENDELSON02 indicates that the 2006 IEEE conference publication was first cataloged by Cornell University’s library as of December 26, 2007. Based on this information and considering the dates of the conference, it is my determination that the 2006 IEEE conference publication, which included the article published as Exhibit 1016, was made available to the public by Cornell University at least as of December 26, 2007.

18. Additionally, I accessed a copy of the 2006 IEEE conference publication through the Pennsylvania State University’s online library catalog portal.

19. Attached hereto as Appendix MENDELSON06 is a true and correct copy of the catalog entry for the 2006 IEEE conference publication as maintained by the Pennsylvania State University. I secured this record myself from the library's public catalog.

20. Attached hereto as Appendix MENDELSON07 is a true and correct copy of the table of contents for the 2006 IEEE conference publication. I secured this record, as provided by the Pennsylvania State University's library through the catalog entry for the 2006 IEEE conference publication as shown in Appendix MENDELSON06, myself.

21. I have reviewed Appendix MENDELSON10, a copy of an article entitled "A Wearable Reflectance Pulse Oximeter for Remote Physiological Monitoring" by Y. Mendelson, R. J. Duckworth, and G. Comtois, as published in the 2006 IEEE conference publication. I secured this document myself through the table of contents for the 2006 IEEE conference publication as shown in Appendix MENDELSON07.

22. Attached hereto as Appendix MENDELSON05 is a true and correct copy of the MARC record for the 2006 IEEE conference publication, as held by the



Pennsylvania State University's library in its online catalog indicated by the catalog entry as shown in Appendix MENDELSON06. The Pennsylvania State University's online library catalog entry as shown in Appendix MENDELSON06 directs the user to a portal page within the IEEE's online repository, IEEE Xplore, for an article entitled "A Wearable Reflectance Pulse Oximeter for Remote Physiological Monitoring" by Y. Mendelson, R. J. Duckworth, and G. Comtois. I secured this record myself from the library's public catalog through the table of contents listing as captured in Appendix MENDELSON07.

23. The MARC record contained within Appendix MENDELSON05 accurately describes the title, author, publisher, and ISBN number of the 2006 IEEE conference publication. In comparing the listed fields in Appendix MENDELSON05 to Appendix MENDELSON10, it is my determination that (1) Appendix MENDELSON10 is a true and correct copy of the "A Wearable Reflectance Pulse Oximeter for Remote Physiological Monitoring" article by Y. Mendelson, R. J. Duckworth, and G. Comtois, as published in the 2006 IEEE conference publication, that (2) the digital copy of the 2006 IEEE conference publication in the Pennsylvania State University's library catalog includes the article in Appendix

MENDELSON10, and that (3) the digital copy of the 2006 IEEE conference publication in the Pennsylvania State University's library catalog is the same as the "A Wearable Reflectance Pulse Oximeter for Remote Physiological Monitoring" article by Y. Mendelson, R. J. Duckworth, and G. Comtois, as published in the 2006 IEEE conference publication that is made publicly available by the Pennsylvania State University through the IEEE's online repository, IEEE Xplore.

24. The 008 field of the MARC record noted on page 1 of Appendix

MENDELSON05 indicates that the 2006 IEEE conference publication was first cataloged by the Pennsylvania State University's library as of December 26, 2007. Based on this information and considering the dates of the conference, it is my determination that the 2006 IEEE conference publication, which included the article published as Appendix MENDELSON10, was made available to the public by the Pennsylvania State University at least as of December 26, 2007.

25. Furthermore, I accessed a copy of the 2006 IEEE conference publication directly through the IEEE's online repository, IEEE Xplore.

26. I have reviewed Appendix MENDELSON12, a copy of an article entitled “A Wearable Reflectance Pulse Oximeter for Remote Physiological Monitoring” by Y. Mendelson, R. J. Duckworth, and G. Comtois, as published in the 2006 IEEE conference publication. I secured this record myself from the IEEE’s online repository, IEEE Xplore.

27. Attached hereto as Appendix IEEE01 is a true and correct copy of a declaration made by Mr. Gordon MacPherson, “Director Board Governance & IP Operations of The Institute of Electrical and Electronics Engineers, Incorporated.” Mr. MacPherson’s declaration Appendix IEEE01 states that the “IEEE publishes and makes available technical articles and standards” as part of its “ordinary course of business,” and that these publications are “made available for public download through the IEEE digital library, IEEE Xplore.”

28. Mr. MacPherson’s declaration includes, as Exhibit A, an article referred to as “Y. Mendelson, R. J. Duckworth, and G. Comtois, “A Wearable Reflectance Pulse Oximeter for Remote Physiological Monitoring”, 2006 International Conference of the IEEE Engineering in Medicine and Biology Society, August 30, 2006 - September 3, 2006,” which was obtained

“through IEEE Xplore, where it is maintained in the ordinary course of IEEE’s business.” Exhibit A also includes a screen capture of the IEEE Xplore portal page for the article referred to as “Y. Mendelson, R. J. Duckworth, and G. Comtois, “A Wearable Reflectance Pulse Oximeter for Remote Physiological Monitoring”, 2006 International Conference of the IEEE Engineering in Medicine and Biology Society, August 30, 2006 - September 3, 2006.”

29. In comparing the screen capture of the IEEE Xplore portal in Exhibit A of IEEE01 to the portal to which I was directed from the Pennsylvania State University’s library system, it is my determination that the IEEE Xplore portal represented in Exhibit A is the same IEEE Xplore portal (1) to which I was directed from the Pennsylvania State University’s library system and (2) through which I secured the article published as Appendix MENDELSON10.

30. Based on this information, it is my determination that the IEEE Xplore portal to which I was directed from the Pennsylvania State University’s library system and through which I accessed the IEEE repository and secured the article published as Appendix MENDELSON10 was authentic.

31. In comparing the screen capture of the IEEE Xplore portal in Exhibit A of IEEE01 to the IEEE Xplore portal through which I secured the article published as MENDELSON12, it is my determination that the IEEE Xplore portal represented in Exhibit A is the same IEEE Xplore portal through which I secured the article published as Appendix MENDELSON12.

32. Based on this information, it is my determination that the IEEE Xplore portal through which I accessed the IEEE repository and secured the article published as Appendix MENDELSON12 was authentic.

33. In comparing the listed fields in Exhibit A of Appendix IEEE01 to Appendix MENDELSON02 and to Appendix MENDELSON05 and comparing Exhibit A of Appendix IEEE01 to Exhibit 1016 and to Appendix MENDELSON10, it is my determination that each of Exhibit A of Appendix IEEE01, Exhibit 1016, and Appendix MENDELSON10 is a true and correct copy of the article entitled “A Wearable Reflectance Pulse Oximeter for Remote Physiological Monitoring” by Y. Mendelson, R. J. Duckworth, and G. Comtois, as published in the 2006 IEEE conference publication.

34. In comparing Exhibit A of Appendix IEEE01 to Exhibit 1016 and to Appendix MENDELSON12, it is my determination that each of Exhibit A of Appendix IEEE01, Exhibit 1016, and Appendix MENDELSON12 is a true and correct copy of the article entitled “A Wearable Reflectance Pulse Oximeter for Remote Physiological Monitoring” by Y. Mendelson, R. J. Duckworth, and G. Comtois, as published in the 2006 IEEE conference publication.

35. Based on this information, it is my determination that each of Exhibit A of IEEE01, Exhibit 1016, Appendix MENDELSON10, and Appendix MENDELSON12 is a true and correct copy of the article entitled “A Wearable Reflectance Pulse Oximeter for Remote Physiological Monitoring” by Y. Mendelson, R. J. Duckworth, and G. Comtois as published in the 2006 IEEE conference publication, and that the 2006 IEEE conference publication containing Exhibit 1016 was cataloged and made available to the public by the IEEE through its online repository, IEEE Xplore, at least as of September 3, 2006.

36. Based on this information, it is my determination that each of Exhibit A of IEEE01, Exhibit 1016, Appendix MENDELSON10, and Appendix

MENDELSON12 is a true and correct copy of the article entitled “A Wearable Reflectance Pulse Oximeter for Remote Physiological Monitoring” by Y. Mendelson, R. J. Duckworth, and G. Comtois, as published in the 2006 IEEE conference publication, and that the 2006 IEEE conference publication containing Exhibit 1016 was cataloged and made available to the public by Cornell University at least as of December 26, 2007.

37. Based on this information, it is my determination that each of Exhibit A of IEEE01, Exhibit 1016, Appendix MENDELSON10, and Appendix MENDELSON12 is a true and correct copy of the article entitled “A Wearable Reflectance Pulse Oximeter for Remote Physiological Monitoring” by Y. Mendelson, R. J. Duckworth, and G. Comtois, as published in the 2006 IEEE conference publication, and that the 2006 IEEE conference publication containing Exhibit 1016 was cataloged and made available to the public by the Pennsylvania State University at least as of December 26, 2007.

38. I have reviewed Appendix COMTOIS04, a copy of an article entitled “A noise reference input to an adaptive filter algorithm for signal processing in a wearable pulse oximeter” by G. Comtois and Y. Mendelson, as published

in the *Proceedings of the 2007 IEEE 33rd Annual Northeast Bioengineering Conference, March 10 – 11, 2007* (hereinafter referred to as “2007 IEEE conference publication”). I secured this copy of the 2007 IEEE conference publication through the Pennsylvania State University’s online library catalog portal.

39. Attached hereto as Appendix COMTOIS02 is a true and correct copy of the catalog entry for the 2007 IEEE conference publication as maintained by the Pennsylvania State University. I secured this record myself from the library’s public catalog.

40. Attached hereto as Appendix COMTOIS03 is a true and correct copy of the table of contents for the 2007 IEEE conference publication. I secured this record, as provided by the Pennsylvania State University’s library through the catalog entry for the 2007 IEEE conference publication as shown in Appendix COMTOIS02, myself.

41. Attached hereto as Appendix COMTOIS01 is a true and correct copy of the MARC record for the 2007 IEEE conference publication, as held by the Pennsylvania State University’s library in its online catalog. I secured this



record myself from the library's public catalog through the table of contents listing as captured in COMTOIS03.

42. The MARC record contained within Appendix COMTOIS01 accurately describes the title, author, publisher, and ISBN number of the 2007 IEEE conference publication. In comparing the listed fields in Appendix COMTOIS01 to COMTOIS04, it is my determination that COMTOIS04 is a true and correct copy of the “A noise reference input to an adaptive filter algorithm for signal processing in a wearable pulse oximeter” article, and that the copy of the 2007 IEEE conference publication in the Pennsylvania State University’s library includes the article in COMTOIS04.

43. The 008 field of the MARC record noted on page 1 of Appendix COMTOIS01 indicates that the 2007 IEEE conference publication was first cataloged by the Pennsylvania State University’s library as of January 24, 2007. Based on this information and considering the dates of the conference, it is my determination that the 2007 IEEE conference publication, which included the article published as Appendix COMTOIS04, was made available to the public by the Pennsylvania State University at least as of January 24, 2007.

44. Attached hereto as Appendix COMTOIS05 is a true and correct copy of the MARC record for the 2007 IEEE conference publication, as held by University of Wyoming's library in its online catalog. I secured this record myself from the library's public catalog.

45. The MARC record contained within Appendix COMTOIS05 accurately describes the title, author, publisher, and ISBN number of the 2007 IEEE conference publication. In comparing the listed fields in Appendix COMTOIS05 to COMTOIS04, it is my determination that the copy of the 2007 IEEE conference publication in University of Wyoming's library includes the article in COMTOIS04.

46. The 008 field of the MARC record noted on page 1 of Appendix COMTOIS05 indicates that the 2007 IEEE conference publication was first cataloged by University of Wyoming's library as of January 24, 2007. Based on this information and considering the dates of the conference, it is my determination that the 2007 IEEE conference publication, which included the article published as COMTOIS04, was made available to the public by University of Wyoming at least as of January 24, 2007.

47. In reviewing the listed citations at page 2 of COMTOIS04, it is my determination that the “A noise reference input to an adaptive filter algorithm for signal processing in a wearable pulse oximeter” article cites the article entitled “A Wearable Reflectance Pulse Oximeter for Remote Physiological Monitoring” by Y. Mendelson, R. J. Duckworth, and G. Comtois, as published in the 2006 IEEE conference publication. Accordingly, it is my determination that the 2006 IEEE conference publication containing Exhibit 1016 would have been publicly available at least as early as the publication date of the 2007 IEEE conference publication: January 24, 2007.

48. I have reviewed COMTOIS10, a copy of an article entitled “A Comparative Evaluation of Adaptive Noise Cancellation Algorithms for Minimizing Motion Artifacts in a Forehead-Mounted Wearable Pulse Oximeter” by G. Comtois, Y. Mendelson, and P. Ramuka, as published in the *Proceedings of the 29th Annual International Conference of the IEEE EMBS Cité Internationale, Lyon, France, August 23 – 26, 2007* (hereinafter referred to as “2007 IEEE EMBS conference publication”).

49. I obtained a copy of the 2007 IEEE EMBS conference publication through the Pennsylvania State University's online library catalog portal.

50. Attached hereto as Appendix COMTOIS06 is a true and correct copy of the catalog entry for the 2007 IEEE EMBS conference publication as maintained by the Pennsylvania State University. I secured this record myself from the library's public catalog.

51. Attached hereto as Appendix COMTOIS07 is a true and correct copy of the table of contents for the 2007 IEEE EMBS conference publication. I secured this record, as provided by the Pennsylvania State University's library through the catalog entry for the 2007 IEEE EMBS conference publication as shown in Appendix COMTOIS06, myself.

52. Attached hereto as Appendix COMTOIS08 is a true and correct copy of the MARC record for the 2007 IEEE EMBS conference publication, as held by the Pennsylvania State University's library in its online catalog. I secured this record myself from the library's public catalog through the table of contents listing as captured in COMTOIS07.

53. The MARC record contained within Appendix COMTOIS08 accurately describes the title, author, publisher, and ISBN number of the 2007 IEEE EMBS conference publication. In comparing the listed fields in Appendix COMTOIS08 to COMTOIS10, it is my determination that COMTOIS10 is a true and correct copy of the “A Comparative Evaluation of Adaptive Noise Cancellation Algorithms for Minimizing Motion Artifacts in a Forehead-Mounted Wearable Pulse Oximeter” article, and that the copy of the 2007 IEEE EMBS conference publication in the Pennsylvania State University’s library includes the article in COMTOIS10.

54. The 008 field of the MARC record noted on page 1 of Appendix COMTOIS08 indicates that the 2007 IEEE EMBS conference publication was first cataloged by the Pennsylvania State University’s library as of June 5, 2008. Based on this information and considering the dates of the conference, it is my determination that the 2007 IEEE EMBS conference publication, which included the article published as COMTOIS10, was made available to the public by the Pennsylvania State University at least as of June 5, 2008.

55. Attached hereto as Appendix COMTOIS09 is a true and correct copy of the MARC record for the 2007 IEEE EMBS conference publication, as held by Library of Congress in its online catalog. I secured this record myself from the Library's public catalog.

56. The MARC record contained within Appendix COMTOIS09 accurately describes the title, author, publisher, and ISBN number of the 2007 IEEE EMBS conference publication. In comparing the listed fields in Appendix COMTOIS09 to COMTOIS10, it is my determination that the copy of the 2007 IEEE EMBS conference publication in the Library of Congress includes the article in COMTOIS10.

57. The 008 field of the MARC record noted on page 1 of Appendix COMTOIS09 indicates that the 2007 IEEE EMBS conference publication was first cataloged by the Library of Congress as of June 5, 2008. Based on this information and considering the dates of the conference, it is my determination that the 2007 IEEE EMBS conference publication, which included the article published as COMTOIS10, was made available to the public by the Library of Congress at least as of June 5, 2008.

58. In reviewing the listed citations at page 4 of COMTOIS10, it is my determination that the “A Comparative Evaluation of Adaptive Noise Cancellation Algorithms for Minimizing Motion Artifacts in a Forehead-Mounted Wearable Pulse Oximeter” article cites the article entitled “A Wearable Reflectance Pulse Oximeter for Remote Physiological Monitoring” by Y. Mendelson, R. J. Duckworth, and G. Comtois, as published in the 2006 IEEE conference publication. Accordingly, it is my determination that the 2006 IEEE conference publication containing Exhibit 1016 would have been publicly available at least as early as the publication date of the 2007 IEEE EMBS conference publication, June 5, 2008.

59. I have reviewed Exhibit 1015, a copy of an article entitled “Design and Evaluation of a New Reflectance Pulse Oximeter Sensor” by Y. Mendelson, et al., as published in the *Journal of the Association for the Advancement of Medical Instrumentation, Vol. 22, No. 4, 1988* (hereinafter referred to as “1988 publication”).

60. Attached hereto as Appendix MENDELSON03 is a true and correct copy of the MARC record for the 1988 publication held by the Pennsylvania State University’s library. I secured this record myself from the library’s public catalog.

61. The MARC record contained within Appendix MENDELSON03 accurately describes the title, author, publisher, and ISSN number of the *Journal of the Association for the Advancement of Medical Instrumentation*. The 949 field of a MARC record is used for institution-specific notations and the 949 fields of this MARC record indicate the Pennsylvania State University's issue level holdings for the *Journal of the Association for the Advancement of Medical Instrumentation*, demonstrating that the Pennsylvania State University's collection contains volumes 17 – 22. These journal holdings clearly include Volume 22, No. 4, which corresponds to the 1988 publication. In comparing the listed fields in Appendix MENDELSON03 to Exhibit 1015, it is my determination that Exhibit 1015 is a true and correct copy of the "Design and Evaluation of a New Reflectance Pulse Oximeter Sensor" article, and that the copy of the 1988 publication in Pennsylvania State University's library includes the article in Exhibit 1015.

62. The 008 field of the MARC record noted on page 1 of Appendix MENDELSON03 indicates that the *Journal of the Association for the Advancement of Medical Instrumentation* was first cataloged by the Pennsylvania State University's library as of August 8, 1983. The 362 field of the MARC record indicates Pennsylvania State University's acquisition of



this material ceased as of Vol. 22, No. 6. Based on this information, it is my determination that the 1988 publication, which included the article published as Exhibit 1015, was made available to the public by the Pennsylvania State University shortly after initial publication in August 1988.

63. I have reviewed Exhibit 1022, a technical document entitled *QuickSpecs:*

*HP iPAQ Pocket PC hd150 Series, Version 3, November 20, 2003*

(hereinafter referred to as “2003 iPAQ Spec.”)

64. Attached hereto as Appendix QUICKSPECS01 is a true and correct copy of

the 2003 iPAQ Spec. as a PDF file entitled ‘iPaq\_4150\_quick-specs.pdf’. I

secured this copy myself from

[ftp://ftp.abcddata.com.pl/HP/Ipaq/Retired%20Products/h4150/iPaq\\_4150\\_qui](ftp://ftp.abcddata.com.pl/HP/Ipaq/Retired%20Products/h4150/iPaq_4150_quick_specs.pdf)

[ck\\_specs.pdf](ftp://ftp.abcddata.com.pl/HP/Ipaq/Retired%20Products/h4150/iPaq_4150_quick_specs.pdf). In comparing Appendix QUICKSPECS01 to Exhibit 1022, it

is my determination that Exhibit 1022 is a true and correct copy of the 2003

iPAQ Spec.

65. Attached hereto as Appendix QUICKSPECS02 is a true and correct copy of

the FTP file tree for the website hosting the 2003 iPAQ Spec. I secured this

record myself from

<ftp://ftp.abcddata.com.pl/HP/Ipaq/Retired%20Products/h4150/>. FTP is a web

technology that allows the transfer of files without the need for a formal webpage. FTP software autogenerates a file tree for each file offered and logs the date of creation within that file tree. The entry for 'iPaq\_4150\_quick-specs.pdf' indicates this file was uploaded to this FTP server as of November 20, 2003. As such, it is my determination that the 2003 iPAQ Spec. in Exhibit 1022 was available to the public on the Internet via this FTP server at least as of November 20, 2003.

66. I have been retained on behalf of the Petitioner to provide assistance in the above-illustrated matter in establishing the authenticity and public availability of the documents discussed in this declaration. I am being compensated for my services in this matter at the rate of \$100.00 per hour plus reasonable expenses. My statements are objective, and my compensation does not depend on the outcome of this matter.

67.I declare under penalty of perjury that the foregoing is true and correct. I hereby declare that all statements made herein of my own knowledge are true and that all statements made on information and belief are believed to be true; and further that these statements were made the knowledge that willful false statements and the like so made are punishable by fine or imprisonment, or both, under Section 1001 of Title 18 of the United States Code.

Dated: 6/30/2021

A handwritten signature in black ink, appearing to read 'Jacob Robert Munford', written in a cursive style.

Jacob Robert Munford

# **APPENDIX A**

## Appendix A - Curriculum Vitae

### Education

University of Wisconsin-Milwaukee - MS, Library & Information Science, 2009  
Milwaukee, WI

- Coursework included cataloging, metadata, data analysis, library systems, management strategies and collection development.
- Specialized in library advocacy and management.

Grand Valley State University - BA, English Language & Literature, 2008  
Allendale, MI

- Coursework included linguistics, documentation and literary analysis.
- Minor in political science with a focus in local-level economics and government.

### Professional Experience

Researcher / Expert Witness, October 2017 – present

Freelance

Pittsburgh, Pennsylvania

- Material authentication and public accessibility determination. Declarations of authenticity and/or public accessibility provided upon research completion. Depositions provided on request.
- Research provided on topics of public library operations, material publication history, digital database services and legacy web resources.
- Past clients include Apple, Fish & Richardson, Erise IP, Baker Botts and other firms working in patent law.

Library Director, February 2013 - March 2015

Dowagiac District Library

Dowagiac, Michigan

- Executive administrator of the Dowagiac District Library. Located in Southwest Michigan, this library has a service area of 13,000, an annual

operating budget of over \$400,000 and total assets of approximately \$1,300,000.

- Developed careful budgeting guidelines to produce a 15% surplus during the 2013-2014 & 2014-2015 fiscal years.
- Using this budget surplus, oversaw significant library investments including the purchase of property for a future building site, demolition of existing buildings and building renovation projects on the current facility.
- Led the organization and digitization of the library's archival records.
- Served as the public representative for the library, developing business relationships with local school, museum and tribal government entities.
- Developed an objective-based analysis system for measuring library services - including a full collection analysis of the library's 50,000+ circulating items and their records.

November 2010 - January 2013

Librarian & Branch Manager, Anchorage Public Library

Anchorage, Alaska

- Headed the 2013 Anchorage Reads community reading campaign including event planning, staging public performances and creating marketing materials for mass distribution.
- Co-led the social media department of the library's marketing team, drafting social media guidelines, creating original content and instituting long-term planning via content calendars.
- Developed business relationships with The Boys & Girls Club, Anchorage School District and the US Army to establish summer reading programs for children.

June 2004 - September 2005, September 2006 - October 2013

Library Assistant, Hart Area Public Library

Hart, MI

- Responsible for verifying imported MARC records and original MARC cataloging for the local-level collection as well as the Michigan Electronic Library.
- Handled OCLC Worldcat interlibrary loan requests & fulfillment via ongoing communication with lending libraries.

## Professional Involvement

### Alaska Library Association - Anchorage Chapter

- Treasurer, 2012

### Library Of Michigan

- Level VII Certification, 2008
- Level II Certification, 2013

### Michigan Library Association Annual Conference 2014

- New Directors Conference Panel Member

### Southwest Michigan Library Cooperative

- Represented the Dowagiac District Library, 2013-2015

## Professional Development

### Library Of Michigan Beginning Workshop, May 2008

Petoskey, MI

- Received training in cataloging, local history, collection management, children's literacy and reference service.

### Public Library Association Intensive Library Management Training, October 2011

Nashville, TN

- Attended a five-day workshop focused on strategic planning, staff management, statistical analysis, collections and cataloging theory.

### Alaska Library Association Annual Conference 2012 - Fairbanks, February 2012

Fairbanks, AK

- Attended seminars on EBSCO advanced search methods, budgeting, cataloging, database usage and marketing.

## **APPENDIX COMTOIS01**



 Covid 19 updates and more information about using the Libraries while you're remote.



Catalog

Bookmarks  Course Reserves My Account

Keyword  Search...

 Search

[Advanced search](#) [Start Over](#)

[Bookmark](#) [Share](#)

## MARC View

```
LEADER 01048nam a22002532 4500
001 20027490
003 SIRSI
005 20170314130250.0
006 m d
007 cr n
008 070124s2007uuuunju s||||||| 2|eng|d
010 a| 88646567
020 a| 9781424410323
020 a| 1424410320 (Trade Paper) c| USD 340.00 Retail Price (Publisher) 9| Active Record
037 a| 07CH37883 b| 00066573
040 a| BIP US d| WaSeSS
245 0 0 a| 2007 IEEE 33rd Annual Northeast Bioengineering Conference h| [electronic resource]
260 a| Piscataway : b| IEEE c| Jan. 2007
506 a| License restrictions may limit access.
521 a| Scholarly & Professional b| IEEE
655 0 a| Electronic books.
856 4 0 u| http://SK8E54MC2L.search.serialssolutions.com/?
sid=sersol&SS_jc=TC0001764037&title=2007%20IEEE%2033rd%20Annual%20Northeast%20Bioengineering%20Conference
955 a| Books In Print, (c) 2016 R.R. Bowker LLC
949 a| Electronic resource w| ASIS c| 1 i| 20027490-1001 I| ONLINE m| ONLINE r| Y s| Y t| ONLINE u| 3/21/2017 o| .STAFF. 360 MARC
```



Copyright ©2019 The Pennsylvania State University. All rights reserved. Except where otherwise noted, this work is subject to a Creative Commons Attribution 4.0 license. Details and exceptions.

[Legal Statements](#) | [PSU Hotlines](#)

### PENN STATE UNIVERSITY LIBRARIES

[Libraries Home](#) (814) 865-6368  
[Libraries Intranet \(Staff Only\)](#)  
[Accessibility Help](#)  
[Website Feedback](#)  
[Policies and Guidelines](#)  
[Staff Directory](#)

### CONNECT WITH PENN STATE UNIVERSITY LIBRARIES

 Facebook  
 Twitter  
 Instagram

## **APPENDIX COMTOIS02**

 Covid 19 updates and more information about using the Libraries while you're remote.



Catalog

Bookmarks  Course Reserves My Account

Keyword  Search...

 Search

[Advanced search](#) [Start Over](#)

[← Previous](#) | 1 of 51 | [Next →](#)

[Bookmark](#) [Share](#)



## 2007 IEEE 33rd Annual Northeast Bioengineering Conference [electronic resource]

Published: Piscataway : IEEE Jan. 2007

Access Online: [serialssolutions.com](http://serialssolutions.com)

ASK  
A LIBRARIAN 

### Restrictions on Access:

License restrictions may limit access.

### Genre(s):

[Electronic books](#)

### ISBN:

9781424410323 and 1424410320 (Trade Paper)

### Audience Notes:

Scholarly & Professional IEEE

[View MARC record](#) | catkey: 20027490



Copyright ©2019 The Pennsylvania State University. All rights reserved. Except where otherwise noted, this work is subject to a Creative Commons Attribution 4.0 license. Details and exceptions.

[Legal Statements](#) | [PSU Hotlines](#)

### PENN STATE UNIVERSITY LIBRARIES

[Libraries Home](#) (814) 865-6368  
[Libraries Intranet \(Staff Only\)](#)  
[Accessibility Help](#)  
[Website Feedback](#)  
[Policies and Guidelines](#)  
[Staff Directory](#)

### CONNECT WITH PENN STATE UNIVERSITY LIBRARIES

[Facebook](#)  
[Twitter](#)  
[Instagram](#)

## **APPENDIX COMTOIS03**

IEEE.org | IEEE Xplore | IEEE-SA | IEEE Spectrum | More Sites Cart Create Account Personal Sign In

**IEEE Xplore** Browse ▾ My Settings ▾ Help ▾ Access provided by: Penn State University Sign Out

All Q

Search within Publication ADVANCED SEARCH

Browse Conferences > Annual Northeast Bioengineering... > 2007 IEEE 33rd Annual Northeast... ?

## Annual Northeast Bioengineering Conference

[Copy Persistent Link](#) [Browse Title List](#) [Sign up for Conference Alerts](#)

**Proceedings** | All Proceedings | Popular

2007 IEEE 33rd Annual Northeast Bioengineering Conference DOI: 10.1109/NEBC12548.2007

Search within results Download PDFs ▾ | Per Page: 25 ▾ | Export ▾ | Email Selected Results ▾

Showing 51-75 of 164

- Select All on Page Sort By: Sequence ▾
- Development of a TLM to investigate the effect of a resistive interface in digital flat panel x-ray detectors** 🔒  
J.A. Segui; W. Zhao  
Publication Year: 2007 , Page(s): 88 - 89  
[Abstract](#) [\(html\)](#) [PDF \(492 Kb\)](#) [C](#)
  - Spectral separation resolves partial volume effect in MRSI: A validation study** 🔒  
Yuzhuo Su; Sunitha B. Thakur; Karimi Sasan; Shuyan Du; Paul Sajda; Wei Huang; Lucas C. Parra  
Publication Year: 2007 , Page(s): 90 - 91  
[Abstract](#) [\(html\)](#) [PDF \(1409 Kb\)](#) [C](#)
  - Micro particle size measurements using modulated light scattering spectrum from SDOCT** 🔒  
Zhijia Yuan; Zhenguo Wang; Yingtian Pan  
Publication Year: 2007 , Page(s): 92 - 93  
[Abstract](#) [\(html\)](#) [PDF \(238 Kb\)](#) [C](#)
  - Optimization of pinhole emission imaging systems for small animal imaging** 🔒  
Lili Zhou; Parmeshwar Khurd; Gene Gindi  
Publication Year: 2007 , Page(s): 94 - 95  
[Abstract](#) [\(html\)](#) [PDF \(1307 Kb\)](#) [C](#)
  - Development of ventricular expansion and increased pulsatile CSF flow in a rat model** 🔒  
S. Rashid; M.E. Wagshul; M. Yu; H. Benveniste; J. Li; J. P. McAllister  
Publication Year: 2007 , Page(s): 96 - 97  
[Abstract](#) [\(html\)](#) [PDF \(1317 Kb\)](#) [C](#)
  - The design of a thermal-sweating manikin to evaluate the comfort of prostheses. part II: sweating system** 🔒  
Christopher R. Berglind; Matthew J. Solomito; Judy L. Cezeaux; Steven Schreiner; Steven Thomsen  
Publication Year: 2007 , Page(s): 98 - 99  
[Abstract](#) [\(html\)](#) [PDF \(1409 Kb\)](#) [C](#)

**Refine**

**Author** ▾

**Affiliation** ▾

**Conference Location** ▾

---

**Quick Links**

[Search for Upcoming Conferences](#)

[IEEE Publication Recommender](#)



[IEEE Author Center](#)

**Proceedings**



The proceedings of this conference will be available for purchase through Curran Associates.

**Bioengineering Conference (NEBC), 2007 IEEE 33rd Annual Northeast**



Print on Demand [Purchase at Partner](#)

- Next generation device for recording daylong hand-arm vibration and grip force waveforms**   
E.R. Bernstein; D.R. Peterson  
Publication Year: 2007 , Page(s): 100 - 101  
[▶ Abstract](#) [\(html\)](#)  (1092 Kb) 



---

- Distal upper extremity motion during keyboarding**   
E.J. Bill; D.R. Peterson  
Publication Year: 2007 , Page(s): 102 - 103  
[▶ Abstract](#) [\(html\)](#)  (1249 Kb) 



---

- The effects of pH on the electrophysiological properties of the CNS of *lymnaea stagnalis***   
Kristina Bruen; Whitney Capwell; Shaun Russell; John DiCecco; Ying Sun  
Publication Year: 2007 , Page(s): 104 - 105  
Cited by: Papers (1)  
[▶ Abstract](#) [\(html\)](#)  (906 Kb) 



---

- A noise reference input to an adaptive filter algorithm for signal processing in a wearable pulse oximeter**   
G. Comtois; Y. Mendelson  
Publication Year: 2007 , Page(s): 106 - 107  
Cited by: Papers (10)  
[▶ Abstract](#) [\(html\)](#)  (205 Kb) 



---

- Parametric optimization for EPGVF snake using ANOVA and Taguchi method**   
Runhong Deng; Martin. D. Fox  
Publication Year: 2007 , Page(s): 108 - 109  
[▶ Abstract](#) [\(html\)](#)  (1111 Kb) 



---

- Effect of localized ambient humidity on electrostatic skin resistance**   
Anandnayan Jayaraman; Kurt A. Kaczmarek; Mitchell E. Tyler; Uchechukwu O. Okpara  
Publication Year: 2007 , Page(s): 110 - 111  
Cited by: Papers (2)  
[▶ Abstract](#) [\(html\)](#)  (1295 Kb) 



---

- Decomposition of MEG signals with sparse representations**   
Tolga E. Ozkurt; Mingui Sun; Robert J. Scabassi  
Publication Year: 2007 , Page(s): 112 - 113  
Cited by: Papers (1)  
[▶ Abstract](#) [\(html\)](#)  (254 Kb) 



---

- Identifying frequency-domain features for an EEG-based pain measurement system**   
D. Rissacher; R. Dowman; S.A.C. Schuckers  
Publication Year: 2007 , Page(s): 114 - 115  
Cited by: Papers (11)  
[▶ Abstract](#) [\(html\)](#)  (133 Kb) 



---

- A novel framework for AC field-effects on action potential coherence and phase**   
T. Radman; Y. Su; J.H. An; L. Parra; M. Bikson  
Publication Year: 2007 , Page(s): 116 - 117  
[▶ Abstract](#) [\(html\)](#)  (2240 Kb) 

---

- A stethoscope-mounted cardiac synchronizer**   
Seth Wolpert; Curtis Rager; Thomas Nifong  
Publication Year: 2007 , Page(s): 118 - 119  
[▶ Abstract](#) [\(html\)](#)  (850 Kb) 

---

- Denoising DWI based on regularized filter**   
X. F. Zhang; H. Ye; W.F. Tian; W.F. Chen  
Publication Year: 2007 , Page(s): 120 - 121  
[▶ Abstract](#) [\(html\)](#)  (304 Kb) 

- A depth-first search algorithm automatic initialization splitting of snakes**  
 Liang Zhu; Martin Fox  
 Publication Year: 2007 , Page(s): 122 - 123  
 Cited by: Patents (4)

▶ Abstract
[\(html\)](#)
 (417 Kb)
- A prototype volume conduction platform for implantable devices**  
 Steven A. Hackworth; Mingui Sun; Robert J. Sclabassi  
 Publication Year: 2007 , Page(s): 124 - 125  
 Cited by: Papers (2)

▶ Abstract
[\(html\)](#)
 (1102 Kb)
- Heart rate variability analysis before and during exposing to low pulsed microwaves in mammals**  
 Ahmed Kamal  
 Publication Year: 2007 , Page(s): 126 - 127

▶ Abstract
[\(html\)](#)
 (958 Kb)
- Restoration of multi-channel spectral estimation affected by sampling jitters**  
 Taikang Ning; Sagar Bhandari; Nikolay A. Atanasov  
 Publication Year: 2007 , Page(s): 128 - 129

▶ Abstract
[\(html\)](#)
 (1083 Kb)
- 3-D sign language synthesis**  
 Amanda Irving; Richard Foulds  
 Publication Year: 2007 , Page(s): 130 - 131  
 Cited by: Papers (1)

▶ Abstract
 (66 Kb)
- Bone's mechanical properties, as determined by MicroCT, are dependent on precise contour lines**  
 C. Bosch; S. Lublinsky; S. Xu; E. Ozcivici; S. Judex  
 Publication Year: 2007 , Page(s): 132 - 133

▶ Abstract
[\(html\)](#)
 (1043 Kb)
- Neuronal feedback control system based on dsPIC processor**  
 Eugene Chabot; Ying Sun  
 Publication Year: 2007 , Page(s): 134 - 135

▶ Abstract
 (66 Kb)
- Comparison of mathematical models of fast oscillatory rhythms in inspiratory discharges**  
 X. Chen; I.C. Solomon; K.H. Chon  
 Publication Year: 2007 , Page(s): 136 - 137

▶ Abstract
[\(html\)](#)
 (1090 Kb)

<b>IEEE Personal Account</b> <a href="#">CHANGE USERNAME/PASSWORD</a>	<b>Purchase Details</b> <a href="#">PAYMENT OPTIONS</a> <a href="#">VIEW PURCHASED DOCUMENTS</a>	<b>Profile Information</b> <a href="#">COMMUNICATIONS PREFERENCES</a> <a href="#">PROFESSION AND EDUCATION</a> <a href="#">TECHNICAL INTERESTS</a>	<b>Need Help?</b> US & CANADA: +1 800 678 4333 WORLDWIDE: +1 732 981 0060 <a href="#">CONTACT &amp; SUPPORT</a>	<b>Follow</b> 
--	--	---	--	-------------------

About IEEE *Xplore* | [Contact Us](#) | [Help](#) | [Accessibility](#) | [Terms of Use](#) | [Nondiscrimination Policy](#) | [Sitemap](#) | [Privacy & Opting Out of Cookies](#)  
 A not-for-profit organization, IEEE is the world's largest technical professional organization dedicated to advancing technology for the benefit of humanity.  
 © Copyright 2021 IEEE - All rights reserved. Use of this web site signifies your agreement to the terms and conditions.

## **APPENDIX COMTOIS04**



# A Noise Reference Input to an Adaptive Filter Algorithm for Signal Processing in a Wearable Pulse Oximeter

G. Comtois, Y. Mendelson

Department of Biomedical Engineering, Worcester Polytechnic Institute, Worcester, MA 01609

**Abstract**—A wearable battery-operated pulse oximeter has been developed for rapid field triage applications. The wearable system comprises three units: a small ( $\phi = 22\text{mm}$ ) and lightweight (4.5g) reflectance-mode optical sensor module (SM), a receiver module (RM), and Personal Digital Assistant (PDA). The information acquired by the forehead-mounted SM is transmitted wirelessly via a RF link to the waist-worn RM which processes the data and transmits it wirelessly to the PDA. Since photoplethysmographic (PPG)-based measurements, which are used by the pulse oximeter to determine arterial oxygen saturation ( $\text{SpO}_2$ ) and heart rate (HR), can be degraded significantly during motion, the implementation of a reliable pulse oximeter for field applications requires sophisticated noise rejection algorithms. To minimize the effects of motion artifacts, which can lead to measurement dropouts, inaccurate readings and false alarms, a 16<sup>th</sup>-order, least-mean squares (LMS), adaptive noise canceling (ANC) algorithm was implemented off-line in Matlab to process the PPG signals. This algorithm was selected because its computational requirement is comparable to a finite impulse response filter. Filter parameters were optimized for computational speed and measurement accuracy. A tri-axial MEMS accelerometer (ACC) served as a noise reference input to the ANC algorithm.

## I. INTRODUCTION

A primary factor limiting the accuracy of pulse oximetry is poor signal-to-noise ratio caused by motion artifacts [1]. Since PPG measurements to determine  $\text{SpO}_2$  and HR are degraded during movements, the implementation of a robust pulse oximeter for field applications requires sophisticated noise rejection algorithms. To minimize the effects of motion artifacts, several groups proposed to employ ANC algorithms utilizing a noise reference from a MEMS accelerometer

(ACC) [2-6]. Despite promising results, utilizing this approach to recover corrupted PPG signals was limited to HR derived from sensors attached to the fingers. However, these studies did not report if  $\text{SpO}_2$  accuracy is improved. Since the fingers are generally more vulnerable to motion artifacts, the aim of this study was to investigate if ANC is effective in minimizing both  $\text{SpO}_2$  and HR errors induced during jogging in a custom, forehead-mounted, pulse oximeter and also quantify the individual contributions of each ACC axis.

## II. MATERIALS

Measurements were acquired from a custom wireless pulse oximeter [7]. A tri-axial MEMS accelerometer embedded within the SM provides reference noise inputs to the ANC algorithm. Key features of this wearable system are its small-size, robustness, and low-power consumption, which are essential attributes for wearable devices used in field applications.

## III. METHODS

Body accelerations and PPG data were collected simultaneously from a healthy male volunteer during five outdoor and treadmill jogging trials. Each study comprised a 1-minute free jogging (rates: 3.75–6.5mph), framed by 2-minute resting intervals. The X, Y, and Z axis of the ACC were oriented according to the anatomical planes illustrated in Fig. 1. For validation, reference  $\text{SpO}_2$  and HR were acquired concurrently from the Masimo SET<sup>®</sup> transmission pulse oximeter by a sensor attached to the subject's hand which remained stationary during the study. A Polar<sup>™</sup> ECG monitor, attached across the chest, provided reference HR data.



Fig. 1: ACC axis orientations.

#### IV. RESULTS AND DISCUSSION

FFT analysis of the infrared (IR) PPG and ACC signals during jogging are shown in Fig. 2. The power spectra between 1.8–2.2Hz correspond to variations in subject’s HR. Similarly, the higher dominant frequency around 2.45Hz coincides with the subject’s up-down movement rate and is clearly registered by the X-axis signal of the ACC (Fig. 2B).

Table 1 shows averaged differences between SpO<sub>2</sub> and HR values measured by the Masimo pulse oximeter and Polar HR monitor compared to the custom pulse oximeter acquired PPG signals that were processed either without or by the ANC algorithm. Results revealed that in all cases, utilizing an ANC algorithm can produce more accurate SpO<sub>2</sub> measurements. Furthermore, using the vertically-oriented X-axis of the ACC as the primary noise reference produced more significant improvements. It was disappointing to note, however, that the Masimo pulse oximeter, which is considered immune to a wide range of motion-induced artifacts, was unable to track changes in HR during jogging compared to the Polar monitor and our custom pulse oximeter.

The ability to measure HR reliably is important in a pulse oximeter since HR values are commonly used as an indicator to assess the reliability of SpO<sub>2</sub> readings. The data also showed that although a uniaxial ACC is sufficient, practically, a triaxial ACC is more advantageous since measurements would be less sensitive to sensor misalignment or inadvertent changes in sensor positioning during movements.

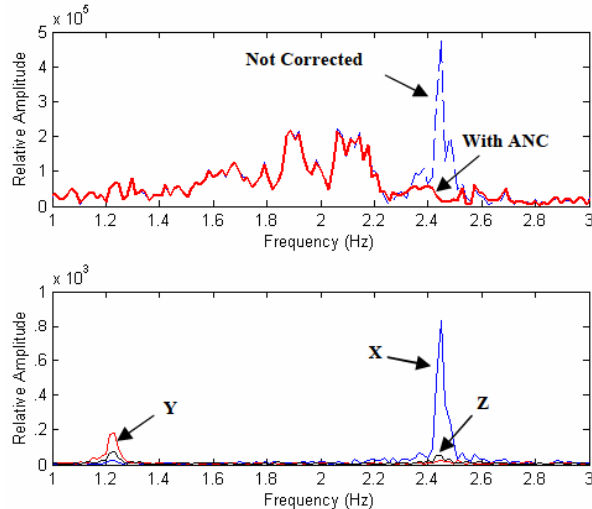

Fig. 2: (Top): Typical frequency spectra of pre-adapted (dashed), and post adapted (solid) PPG signals. (Bottom): Reference ACC signals during treadmill running.

Table 1: Percent SpO<sub>2</sub> and HR differences (*Bias ± SD*) measured during jogging (N = 300).

	Masimo SET®		Polar™
	SpO <sub>2</sub>	HR	HR
Not Corrected	2.5 ± 1.5	59.7 ± 22.7	6.6 ± 3.6
ANC (X)	1.9 ± 1.2	54.4 ± 19.4	1.8 ± 1.4
ANC (Y)	2.3 ± 1.4	57.5 ± 22.2	5.2 ± 3.5
ANC (Z)	2.3 ± 1.5	56.8 ± 20.9	4.0 ± 2.8
ANC (X+Y+Z)	2.0 ± 1.3	58.0 ± 21.8	2.7 ± 1.7

#### V. CONCLUSIONS

This study demonstrated that an embedded MEMS ACC can provide a reference noise input for implementing an ANC algorithm, thereby improving both SpO<sub>2</sub> and HR measurements by a wearable forehead-mounted pulse oximeter during jogging.

#### ACKNOWLEDGMENT

This work is supported by the U.S. Army MRMC under Contract DAMD17-03-2-0006. The views, opinions and/or findings are those of the author and should not be construed as an official Department of the Army position, policy or decision unless so designated by other documentation.

#### REFERENCES

- [1] S.W. Kästle, E. Konecny, Determining the artifact sensitivity of recent pulse oximeters during laboratory benchmarking, *J. Clin. Mon. & Comp.*, vol. 16, pp. 509, 2000.
- [2] J.Y.A. Foo, S.J. Wilson, A computational system to optimize noise rejection in photoplethysmography signals during motion or poor perfusion states, *Med. Biol. Eng. Comput.*, vol. 44, pp. 140, 2006.
- [3] L.B. Wood, H.H. Asada, Noise cancellation model validation for reduced motion artifact wearable PPG sensors using MEMS accelerometers, *Proc. 28<sup>th</sup> IEEE/EMBS Ann. Int. Conf.*, pp. 3525, 2006.
- [4] H.H. Asada, H. Jiang, P. Gibbs, Active noise cancellation using MEMS accelerometers for motion-tolerant wearable bio-sensors, *Proc. 26<sup>th</sup> Int. Conf. IEEE/EMBS*, pp. 2157, 2004.
- [5] A.R. Relente, L.G. Sison, Characterization and adaptive filtering of motion artifacts in pulse oximetry using accelerometers, *Proc. 2<sup>nd</sup> Joint EMBS/BMES Conf.*, pp. 1769, 2002.
- [6] M.A.D. Raya, L.G. Sison, Adaptive noise cancelling of motion artifacts in stress ECG signals using accelerometer, *Proc. 2<sup>nd</sup> Joint EMBS/BMES Conf.*, pp. 1756, 2002.
- [7] Y. Mendelson, R.J. Duckworth, G. Comtois, A wearable reflectance pulse oximeter for remote physiological monitoring, *Proc. 28<sup>th</sup> IEEE/EMBS Ann. Int. Conf.*, pp. 912, 2006.

## **APPENDIX COMTOIS05**

STUDENTS | PARENTS | ALUMNI | PEOPLE | WYOWEB | VIRTUAL TOUR | GIVE | EVENTS

**UW** NAVIGATION **A-Z DIRECTORY** Search  Go

**UW** Libraries LOCATIONS SERVICES HELP ABOUT

APPLY NOW

My Accounts Hours Study Rooms Chat Help Email Us

## Catalog search results

New Search Save to my lists Save Record See regular display

```
LEADER 00000nam a2200301u b4500
001 ssj0001764037
003 WaSeSS
005 20200913041606.0
006 m d
007 cr n
008 070124s2007uuuunju o||||||| 2|eng|d
020 |z9781424410323
020 |z1424410320 (Trade Paper)|cUSD 340.00 Retail Price
(Publisher)
035 (WaSeSS)ssj0001764037
037 07CH37883|b00066573
040 BIP US|dWaSeSS|erda
099 ONLINE
130 0 2007 IEEE 33rd Annual Northeast Bioengineering Conference
(Online)
245 10 2007 IEEE 33rd Annual Northeast Bioengineering Conference
264 1 Piscataway : |bIEEE|cJan. 2007
336 text|btxt|2rdacontent
337 computer|bc|2rdamedia
338 online resource|bcr|2rdacarrier
506 Access limited to University of Wyoming-affiliated
patrons.
521 Scholarly & Professional|bIEEE
710 2 IEEE.
856 40 |zVIEW FULL TEXT|uhttp://
VH7QX3XE2P.search.serialssolutions.com/?V=1.0&L=VH7QX3XE2P
&S=JCS&C=TC0001764037&T=marc&tab=BOOKS
955 Books In Print, (c) 2016 R.R. Bowker LLC
955 Books In Print, (c) 2016 R.R. Bowker LLC
955 Books In Print, (c) 2016 R.R. Bowker LLC
```

**University Libraries**  
 Dept. 3334  
 1000 E. University Ave.  
 Laramie, WY 82071  
 (307) 766-3190  
 (800) 442-6757

**Give to UW Libraries**

Connect with us:  
   

Contact  
 Feedback  
 Policies  
 About  
 Accessibility  
 A - Z  
 Maps

## **APPENDIX COMTOIS06**

 Covid 19 updates and more information about using the Libraries while you're remote.



Catalog

Bookmarks  Course Reserves My Account

Keyword  Search...

 Search

[Advanced search](#) [Start Over](#)

[Bookmark](#) [Share](#)



# 2007 Annual International Conference of the IEEE Engineering in Medicine and Biology Society [electronic resource] : Lyon, France, 22-26 August 2007

 **ASK**  
A LIBRARIAN

**Corporate Author:** [IEEE Engineering in Medicine and Biology Society. Annual Conference \(29th : 2007 : Lyon, France\)](#)

**Published:** [New York?] : IEEE, EMB ; Piscataway, NJ : IEEE Service Center [distributor], c2007.

**Physical Description:** 16 v. (cx, 6759, 13, 46 p.) : ill. ; 28 cm.

**Additional Creators:** [IEEE Engineering in Medicine and Biology Society](#)

**Access Online:** [serialssolutions.com](#)

#### Restrictions on Access:

License restrictions may limit access.

#### Subject(s):

[Biomedical engineering—Congresses](#)  
[Biomedical materials—Congresses](#)  
[Biosensors—Congresses](#)

#### Genre(s):

[Electronic books](#)

#### ISBN:

9781424407873 and 1424407877

#### Bibliography Note:

Includes bibliographical references.

[View MARC record](#) | catkey: 14765041



Copyright ©2019 The Pennsylvania State University. All rights reserved. Except where otherwise noted, this work is subject to a Creative Commons Attribution 4.0 license. Details and exceptions.

[Legal Statements](#) | [PSU Hotlines](#)

#### PENN STATE UNIVERSITY LIBRARIES

[Libraries Home](#) (814) 865-6368  
[Libraries Intranet \(Staff Only\)](#)  
[Accessibility Help](#)  
[Website Feedback](#)  
[Policies and Guidelines](#)  
[Staff Directory](#)

#### CONNECT WITH PENN STATE UNIVERSITY LIBRARIES

 [Facebook](#)  
 [Twitter](#)  
 [Instagram](#)

## **APPENDIX COMTOIS07**

IEEE.org | IEEE Xplore | IEEE-SA | IEEE Spectrum | More Sites Cart Create Account Personal Sign In

**IEEE Xplore**® Browse ▾ My Settings ▾ Help ▾ Access provided by: Penn State University Sign Out

ADVANCED SEARCH

Browse Conferences > Annual International Conferenc... > 2007 29th Annual International...

## Annual International Conference of the IEEE Engineering in Medicine and Biology Society (EMBC)

[Copy Persistent Link](#) [Browse Title List](#) [Sign up for Conference Alerts](#)

Proceedings All Proceedings Popular

2007 29th Annual International Conference of the IEEE Engineering in Medicine and Biology Society

DOI: 10.1109/EMBC10204.2007

[Download PDFs](#) | [Per Page: 10](#) | [Export](#) | [Email Selected Results](#)

Showing 401-410 of 1,727

### Refine

Author ▾

Affiliation ▾

Conference Location ▾

### Quick Links

[Search for Upcoming Conferences](#)

[IEEE Publication Recommender](#)

[IEEE Author Center](#)

### Proceedings

The proceedings of this conference will be available for purchase through Curran Associates.

Engineering in Medicine and Biology Society (EMBC), 2007 Annual International Conference of the IEEE

Print on Demand [Purchase at Partner](#)

Select All on Page

Sort By: [Sequence](#) ▾

**A Novel Approach to Classify Significant ECG Data Based on Heart Instantaneous Frequency and ECG-derived Respiration using Conductive Textiles**   
Yeon Sik. Noh; Sung Jun. Park; Sung Bin. Park; Hyung Ro. Yoon  
Publication Year: 2007 , Page(s): 1503 - 1506  
Cited by: Papers (1)

[Abstract](#) [\(html\)](#)  (357 Kb) 

**Roll-over Detection and Sleep Quality Measurement using a Wearable Sensor**   
Hiroyasu Miwa; Shin-ichiro Sasahara; Toshihiro Matsui  
Publication Year: 2007 , Page(s): 1507 - 1510  
Cited by: Papers (26) | Patents (2)

[Abstract](#) [\(html\)](#)  (604 Kb) 

**Estimating Intensity of Physical Activity: A Comparison of Wearable Accelerometer and Gyro Sensors and 3 Sensor Locations**   
J. Parkka; M. Ermes; K. Antila; M. van Gils; A. Manttari; H. Nieminen  
Publication Year: 2007 , Page(s): 1511 - 1514  
Cited by: Papers (23)

[Abstract](#) [\(html\)](#)  (335 Kb) 

**A New Model for Programming Software in Body Sensor Networks**   
Talles M. G. de A. Barbosa; Iwens G. Sene; Adson F. da Rocha; Francisco A. de O. Nascimento; Joao L. A. Carvalho; Hervaldo S. Carvalho  
Publication Year: 2007 , Page(s): 1515 - 1518

[Abstract](#) [\(html\)](#)  (419 Kb) 

**A Study on the Implementation of a Portable u-Healthcare System using SNMP and AODV**   
Jungho Seo; Jungil Heo; Suyoung Lim; Jinsoo Ahn; Wooshik Kim  
Publication Year: 2007 , Page(s): 1519 - 1522  
Cited by: Papers (5)

[Abstract](#) [\(html\)](#)  (610 Kb) 

**Development of Health Monitoring System based on Three-dimensional Imaging using Bio-signals and Motion Data** 



Tsuyoshi Matsukawa; Tomohiro Umetani; Kiyoko Yokoyama

Publication Year: 2007 , Page(s): 1523 - 1527

Cited by: Papers (1)

▶ Abstract (html) PDF (2001 Kb) ©

**A Comparative Evaluation of Adaptive Noise Cancellation Algorithms for Minimizing Motion Artifacts in a Forehead-Mounted Wearable Pulse Oximeter** 

Gary Comtois; Yitzhak Mendelson; Piyush Ramuka

Publication Year: 2007 , Page(s): 1528 - 1531

Cited by: Papers (19) | Patents (15)

▶ Abstract (html) PDF (239 Kb) ©

**Reducing Motion Artefacts of Capacitive Sensors** 

Bas Feddes; Lena Gourmelon; Mohammed Meftah; Ton Ikkink

Publication Year: 2007 , Page(s): 1532 - 1532

Cited by: Papers (2)

▶ Abstract (html) PDF (74 Kb) ©

**Quantification of Motion Artifact in ECG Electrode Design** 

Kenneth Kearney; Chris Thomas; Eric McAdams

Publication Year: 2007 , Page(s): 1533 - 1536

Cited by: Papers (8) | Patents (4)

▶ Abstract (html) PDF (218 Kb) ©

**On the reliability of pulse oximetry at the sternum** 

J. Sola; O. Chetelat; J. Krauss

Publication Year: 2007 , Page(s): 1537 - 1537

Cited by: Papers (5)

▶ Abstract (html) PDF (255 Kb) ©

Previous < **41** 42 43 44 45 46 47 48 49 50 > Next

**IEEE Personal Account**

CHANGE USERNAME/PASSWORD

**Purchase Details**

PAYMENT OPTIONS

VIEW PURCHASED DOCUMENTS

**Profile Information**

COMMUNICATIONS PREFERENCES

PROFESSION AND EDUCATION

TECHNICAL INTERESTS

**Need Help?**

US & CANADA: +1 800 678 4333

WORLDWIDE: +1 732 981 0060

CONTACT & SUPPORT

**Follow**



About IEEE Xplore | Contact Us | Help | Accessibility | Terms of Use | Nondiscrimination Policy | Sitemap | Privacy & Opting Out of Cookies  
A not-for-profit organization, IEEE is the world's largest technical professional organization dedicated to advancing technology for the benefit of humanity.

© Copyright 2021 IEEE - All rights reserved. Use of this web site signifies your agreement to the terms and conditions.

## **APPENDIX COMTOIS08**

🔔 Covid-19 updates and more information about using the Libraries while you're remote.

**Catalog** Bookmarks Course Reserves My Account

Keyword Search Search Advanced search Start Over

Bookmark Share

## MARC View

LEADER 01553nam a22003134a 4500  
001 14765041  
003 SIRSI  
005 20150414130207.0  
006 m d  
007 cr n  
008 080605s2007 nyua sb 101 0 eng d  
010 a | 2008274007  
020 a | 9781424407873  
020 a | 1424407877  
040 a | DLC c | DLC d | DLC d | WaSe55  
050 0 0 a | R856.A2 b | I344 2007  
110 2 a | IEEE Engineering in Medicine and Biology Society. b | Annual Conference n | (29th : d | 2007 : c | Lyon, France)  
245 1 0 a | 2007 Annual International Conference of the IEEE Engineering in Medicine and Biology Society h | [electronic resource] : b | Lyon, France, 22-26 August 2007.  
260 a | [New York?] : b | IEEE, EMB ; a | Piscataway, NJ : b | IEEE Service Center [distributor], c | c2007.  
300 a | 16 v. (cx, 6759, 13, 46 p.) : b | ill. : c | 28 cm.  
504 a | Includes bibliographical references.  
506 a | License restrictions may limit access.  
650 0 a | Biomedical engineering v | Congresses.  
650 0 a | Biomedical materials v | Congresses.  
650 0 a | Biosensors v | Congresses.  
655 0 a | Electronic books.  
710 2 a | IEEE Engineering in Medicine and Biology Society.  
856 4 0 u | http://SK8E54MC2L.search.serialssolutions.com/?sid=sersol&55\_jc=TC0000394408&title=2007%20Annual%20International%20Conference%20of%20the%20IEEE%20Engineering%20in%20Medicine%20and%20Biology%20Society%20%3A%20Lyon%2C%20France%2C%2022-26%20August%202007  
949 a | Electronic resource w | ASIS c | 1 | 14765041-1001 | | ONLINE m | ONLINE r | Y s | Y t | ONLINE u | 4/22/2015 o | .STAFF. 360 MARC

**PennState** Copyright ©2019 The Pennsylvania State University. All rights reserved. Except where otherwise noted, this work is subject to a Creative Commons Attribution 4.0 license. Details and exceptions.

**PENN STATE UNIVERSITY LIBRARIES** (717) 863-6388  
Library Home  
Library Inmate Staff Only  
Accessibility Help  
Website Feedback  
Policies and Guidelines  
Staff Directory

**CONNECT WITH PENN STATE UNIVERSITY LIBRARIES**  
Facebook  
Twitter  
Instagram

Legal Statements | PSU Hotlines

## **APPENDIX COMTOIS09**

Library buildings are closed to the public until further notice. The LC Catalog is available. However, Automated Call Slip service is only available to some patrons. [More](#)



CATALOG

LC Catalog Quick Search



LOGIN



SEARCH OPTIONS

Refine Your Search

BOOK

## 2007 Annual International Conference of the IEEE Engineering in ...

Full Record MARC Tags

000 01287cam a22002654a 4500  
001 15317761  
005 20140814095918.0  
008 080605s2007 nyua b 101 0 eng  
906 \_\_ |a 7 |b cbc |c orignew |d 2 |e ncip |f 20 |g y-gencatlg  
925 0\_ |a acquire |b 2 shelf copies |x policy default  
955 \_\_ |a pv15 2008-06-05 2 v. (p. 2110-2531 & p. 3377-3797) to ASCD |a jf09 2008-07-31 to Med for R856? |i jb08 2008-08-26 |e jb08 2008-08-26 to Dewey |t xh14 2010-03-10 copy 2 (v 1-5, 7-8, 10-16) to BCCD  
010 \_\_ |a 2008274007  
020 \_\_ |a 9781424407873  
020 \_\_ |a 1424407877  
040 \_\_ |a DLC |c DLC |d DLC  
050 00 |a R856.A2 |b I344 2007  
110 2\_ |a IEEE Engineering in Medicine and Biology Society. |b Annual Conference |n (29th) : |d 2007 : |c Lyon, France)  
245 10 |a 2007 Annual International Conference of the IEEE Engineering in Medicine and Biology Society : |b Lyon, France, 22-26 August 2007.  
260 \_\_ |a [New York?] : |b IEEE, EMB ; |a Piscataway, NJ : |b IEEE Service Center [distributor], |c c2007.  
300 \_\_ |a 16 v. (cx, 6759, 13, 46 p.) : |b ill. ; |c 28 cm.  
504 \_\_ |a Includes bibliographical references.  
650 \_0 |a Biomedical engineering |v Congresses.  
650 \_0 |a Biomedical materials |v Congresses.  
650 \_0 |a Biosensors |v Congresses.  
710 2\_ |a IEEE Engineering in Medicine and Biology Society.



BOOK

PRINT RECORD

SAVE RECORD

EMAIL RECORD

CITE RECORD

MARCXML Record  
MODS Record

Report Record Errors  
Ask a Librarian  
Feedback

Request this item

LC Find It

Item Availability

### Item Availability

CALL NUMBER R856.A2 I344 2007  
Copy 2

Request in Jefferson or Adams Building Reading Rooms

Status Not Charged

CALL NUMBER R856.A2 I344 2007  
Copy 1  
30th (2008)- cataloged as a serial in LC

Request in Jefferson or Adams Building Reading Rooms

Status Not Charged



[Subscribe \(Patron Services\)](#) [Ask a Librarian](#) [Feedback](#) [Search/Browse Help](#)

[Speech Enabled](#) [Accessibility](#) [Legal](#) [Inspector General](#) [External Link Disclaimer](#) [USA.gov](#)

## **APPENDIX COMTOIS10**

# A Comparative Evaluation of Adaptive Noise Cancellation Algorithms for Minimizing Motion Artifacts in a Forehead-Mounted Wearable Pulse Oximeter

Gary Comtois, *Member IEEE*, Yitzhak Mendelson, *Member IEEE*, Piyush Ramuka

**Abstract**— Wearable physiological monitoring using a pulse oximeter would enable field medics to monitor multiple injuries simultaneously, thereby prioritizing medical intervention when resources are limited. However, a primary factor limiting the accuracy of pulse oximetry is poor signal-to-noise ratio since photoplethysmographic (PPG) signals, from which arterial oxygen saturation ( $SpO_2$ ) and heart rate (HR) measurements are derived, are compromised by movement artifacts. This study was undertaken to quantify  $SpO_2$  and HR errors induced by certain motion artifacts utilizing accelerometry-based adaptive noise cancellation (ANC). Since the fingers are generally more vulnerable to motion artifacts, measurements were performed using a custom forehead-mounted wearable pulse oximeter developed for real-time remote physiological monitoring and triage applications. This study revealed that processing motion-corrupted PPG signals by least mean squares (LMS) and recursive least squares (RLS) algorithms can be effective to reduce  $SpO_2$  and HR errors during jogging, but the degree of improvement depends on filter order. Although both algorithms produced similar improvements, implementing the adaptive LMS algorithm is advantageous since it requires significantly less operations.

## I. INTRODUCTION

THE implementation of wearable diagnostic devices would enable real-time remote physiological assessment and triage of military combatants, firefighters, miners, mountaineers, and other individuals operating in dangerous and high-risk environments. This, in turn, would allow first responders and front-line medics working under stressful conditions to better prioritize medical intervention when resources are limited, thereby extending more effective care to casualties with the most urgent needs.

Employing commercial off-the-shelf (COTS) solutions, for example finger pulse oximeters to monitor arterial blood oxygen saturation ( $SpO_2$ ) and heart rate (HR), or adhesive-type disposable electrodes for ECG monitoring, are

Manuscript received April 2, 2007. This work is supported by the U.S. Army MRMC under Contract DAMD17-03-2-0006. The views, opinions and/or findings are those of the author and should not be construed as an official Department of the Army position, policy or decision unless so designated by other documentation.

Y. Mendelson is a Professor in the Department of Biomedical Engineering, Worcester Polytechnic Institute, Worcester, MA 01609 USA (phone: 508-831-5103; fax: 508-831-5541; email: ym@wpi.edu).

G. Comtois is a graduate student in the Department of Biomedical Engineering, Worcester Polytechnic Institute, Worcester, MA 01609 USA (comtoisg@wpi.edu).

P. Ramuka is a graduate student in the Department of Biomedical Engineering, Worcester Polytechnic Institute, Worcester, MA 01609 USA (pramuka@wpi.edu).

impractical for field applications because they limit mobility and can interfere with regular activity. Equally important, since these devices are designed for clinical settings where patient movements are relatively constrained, motion artifacts during field applications can drastically affect measurement accuracy while subjects remain active.

Practically, the primary factor limiting the reliability of pulse oximetry is attributed to poor signal-to-noise ratio (SNR) due to motion artifacts. Since photoplethysmographic (PPG) signals, which are used to determine  $SpO_2$  and HR, are obscured during movements, the implementation of a robust pulse oximeter for field applications requires sophisticated noise rejection algorithms to eliminate erroneous readings and prevent false alarms.

To minimize the effects of motion artifacts in wearable pulse oximeters, several groups proposed various algorithms to accomplish adaptive noise cancellation (ANC) utilizing a noise reference signal obtained from an accelerometer (ACC) that is incorporated into the sensor to represent body movements [1]-[3]. These groups demonstrated promising feasibility for movement artifact rejection in PPG signals acquired from the finger. However, they did not present quantifiable data showing whether accelerometry-based ANC resulted in more accurate determination of  $SpO_2$  and HR derived from PPG signals acquired from more motion-tolerant body locations that are more suitable for mobile applications.

## II. BACKGROUND

Generally, linear filtering with a fixed cut-off frequency is not effective in removing in-band noise with spectral overlap and temporal similarity that is common between the signal and artifact. Thus, we utilized ANC techniques to filter noisy PPG waveforms acquired during field experiments. The performance of this signal processing approach was evaluated based on its potential to lower  $SpO_2$  and HR measurement errors.

Among the most popular ANC algorithms are the least mean squares (LMS) and recursive least squares (RLS) algorithms. Briefly, to attenuate the in-band noise component in the desired signal, these algorithms assume that the reference noise received from the ACC is statistically correlated with the additive noise component in the corrupted PPG signal, whereas the additive noise is uncorrelated with the noise-free PPG signal. An error signal is used to adjust continuously the filter's tap-weights in order to minimize the SNR of the noise-corrected PPG signal.



The performance of ANC algorithms is highly dependent on various filter parameters, including filter order ( $M$ ). Accordingly, careful consideration must be given to the selection of these parameters and the trade-off between algorithm complexity and its computation time.

Although the basic principles of the LMS and RLS techniques share certain similarities, the LMS algorithm attempts to minimize only the current error value, whereas in the RLS algorithm, the error considered is the total error from the beginning to the current data point. Furthermore, the performance of each algorithm depends on different parameters. For example, the step size ( $\mu$ ) has a profound effect on the convergence behavior of the LMS algorithm. Similarly, the forgetting factor ( $\lambda$ ) determines how the RLS algorithm treats past data inputs.

Compared to the LMS algorithm, the RLS algorithm has generally a faster convergence rate and smaller error. However, this advantage comes at the expense of increasing complexity and longer computational time which increases rapidly and non-linearly with filter order.

### III. METHODS

To simulate movement artifacts, we performed a series of outdoor and indoor experiments that were intended to determine the effectiveness of using the accelerometer-based ANC algorithms in processing motion-corrupted PPG signals acquired by a forehead pulse oximeter. The focus of this study was to compare the performance of each algorithm by quantifying the improvement in  $SpO_2$  and HR accuracy generated during typical activities that are expected to induce considerable motion artifacts in the field.

Data were collected by a custom forehead-mounted pulse oximeter developed in our laboratory as a platform for real-time remote physiological monitoring and triage applications [4]-[6]. The prototype wearable system is comprised of three units: A battery-operated optical Sensor Module (SM) mounted on the forehead, a belt-mounted Receiver Module (RM) mounted on the subject's waist, and a Personal Digital Assistant (PDA) carried by a remote observer. The red (R) and infrared (IR) PPG signals acquired by the small ( $\phi = 22\text{mm}$ ) and lightweight (4.5g) SM are transmitted wirelessly via an RF link to the RM. The data processed by the RM can be transmitted wirelessly over a short range to the PDA or a PC, giving the observer the capability to periodically or continuously monitor the medical condition of multiple subjects. The system can be programmed to alert on alarm conditions, such as sudden trauma, or when physiological values are out of their normal range. Dedicated software was used to filter the reflected PPG signals and compute  $SpO_2$  and HR based on the relative amplitude and frequency content of the PPG signals. A triaxial MEMS-type ACC embedded within the SM was used to get a quantitative measure of physical activity. The information obtained through the tilt sensing property of the ACC is also used to determine body posture. Posture and acceleration, combined with physiological measurements, are valuable indicators to assess the status of an injured person in the field.

Body accelerations and PPG data were collected concurrently from 7 healthy volunteers during 32 jogging experiments. These jogging experiments comprised 16 treadmill, 12 indoor, and 4 outdoor exercises. Each experiment comprised a 1-minute free jogging at speeds corresponding to 3.75–6.5 mph, framed by 2-minute resting intervals. For validation, reference  $SpO_2$  and HR were acquired concurrently from the Masimo transmission pulse oximeter sensor attached to the subject's fingertip which was kept in a relatively stationary position throughout the study. We chose the Masimo pulse oximeter because it employs unique signal extraction technology (SET<sup>®</sup>) designed to greatly extend its utility into high motion environments. A Polar<sup>™</sup> ECG monitor, attached across the subject's chest, provided reference HR data.

The ACC provided reference noise inputs to the ANC algorithms. The X, Y, and Z axes of the triaxial ACC were oriented according to the anatomical planes as illustrated in Fig. 1. Accelerations generated during movement depend upon the types of activity performed. Generally, during jogging, acceleration is greatest in the vertical direction, although the accelerations in the other two orthogonal directions are not negligible. Therefore, the noise reference input applied to the ANC algorithms was obtained by summing all three orthogonal axes of the ACC. By combining signals from all three axes, measurements become insensitive to sensor positioning and inadvertent sensor misalignment that may occur during movements. To compensate for differences in response times, the  $SpO_2$  and HR measurements acquired from each device were processed using an 8-second weighted moving average.

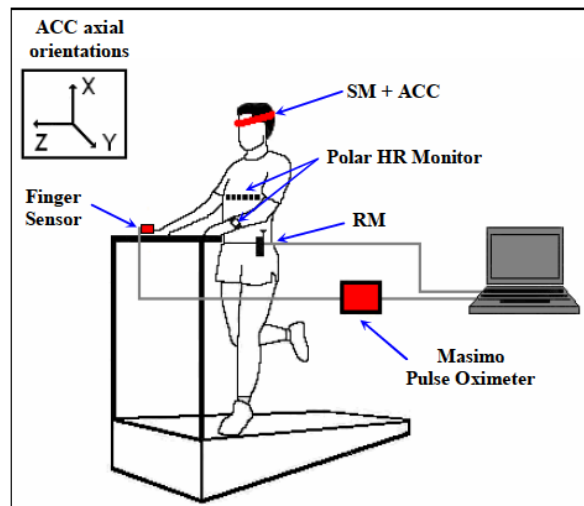

Fig. 1: Experimental setup for data collection.

The outputs of the MEMS ACC and raw PPG signals were acquired in real-time at a rate of 80 s/s using a custom written LabVIEW<sup>®</sup> program. Data were processed off-line using Matlab programming. The ANC algorithms were implemented in Matlab with parameters optimized for computational speed and measurement accuracy. The LMS algorithm was implemented using a constant  $\mu$  of 0.016. The

selected filter parameters for the RLS algorithm were  $\lambda = 0.99$  and an inverse correlation matrix  $P = 0.1$ . These filter parameters were found to be optimal in preliminary experiments. For comparison, data were processed by each algorithm using variable order filters.

#### IV. RESULTS

SpO<sub>2</sub> and HR data were derived from the R and IR PPG signals utilizing custom extraction algorithms. SpO<sub>2</sub> root mean squared errors (RMSE) were quantified based on the differences between the readings measured by the custom and Masimo pulse oximeters, whereas HR errors were defined with respect to the Polar HR monitor. For comparison, RMSE were determined by processing the PPG signals off-line either with or without the ANC algorithms.

Fig. 2 shows a representative tracing of SpO<sub>2</sub> and HR measurements obtained from the custom pulse oximeter with and without ANC. Reference measurements obtained simultaneously from the Masimo pulse oximeter and Polar HR monitor during resting and outdoor jogging were also included for comparison.

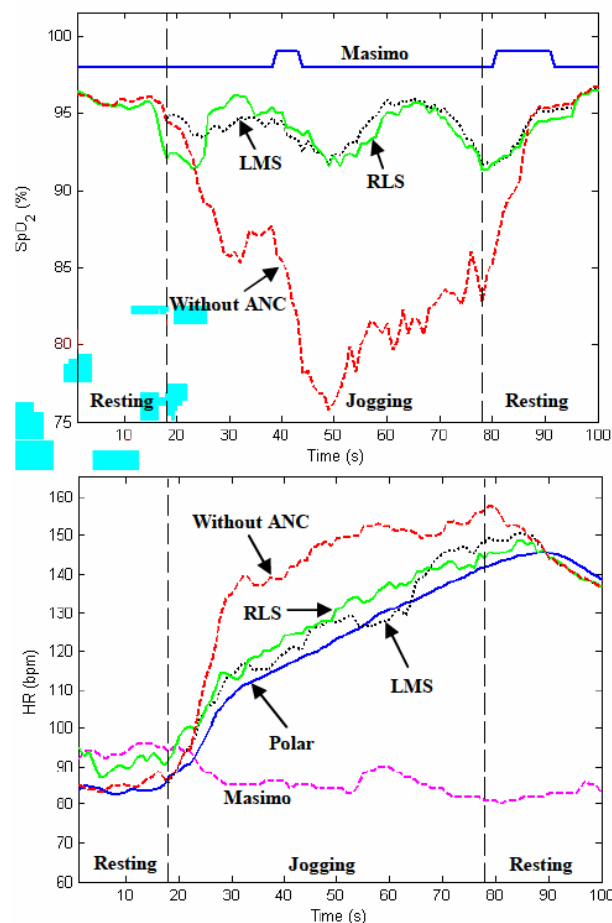

Fig. 2. Representative SpO<sub>2</sub> (top) and HR (bottom) measurements obtained during outdoor jogging. Filter order  $M = 16$ .

Spectral analysis of the data using FFT revealed that during jogging frequency components associated with body acceleration and the subject's HR shared a relatively small

frequency band ranging between 1.5–3.0 Hz. Further analysis of the data showed that in 8 out of the 32 jogging experiments (25%), the cardiac-synchronized frequencies and movement-induced acceleration frequencies shared a common band.

The averaged errors observed from the series of 32 experiments are summarized in Figures 3 and 4. Analysis of the data clearly revealed that utilizing either the LMS or RLS algorithm to process the noise-corrupted PPG signals can improve both SpO<sub>2</sub> and HR accuracy during jogging. Although the degree of improvement varied, because different methods are employed to compute SpO<sub>2</sub> and HR from the PPG signal, these figures show that the performance of both algorithms depends on filter order used to implement each algorithm.

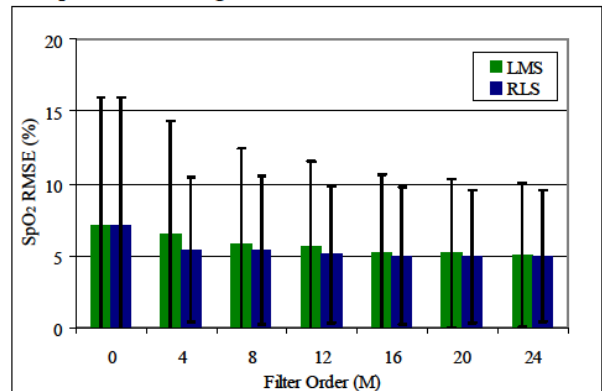

Fig. 3. Averaged SpO<sub>2</sub> errors for varying filter orders. Error bars indicate  $\pm 1SD$ . For comparison,  $M = 0$  represents the error obtained without ANC.

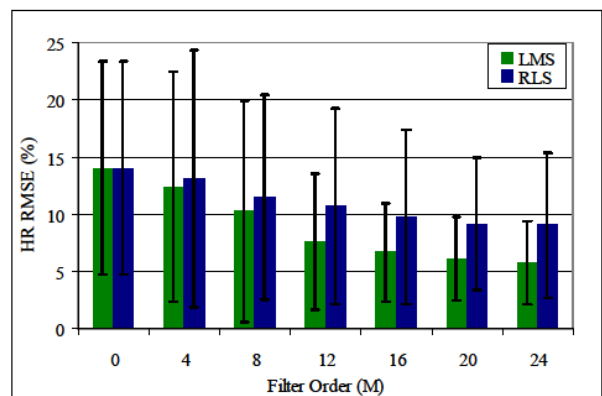

Fig. 4. Averaged HR errors for varying filter orders. Error bars indicate  $\pm 1SD$ . For comparison,  $M = 0$  represents the error obtained without ANC.

#### V. DISCUSSION

Pulse oximeters are used routinely in many clinical settings where patients are at rest. Their usage in other areas is limited because of motion artifacts which is the primary contributor to errors and high rates of false alarms. In order to design wearable cost-effective devices that are suitable for field deployment, it is important to ensure that the device is robust against motion induced disturbances. PPG signals recorded from the forehead are generally less prone to movement artifacts compared to PPG signals recorded from

a finger. Nonetheless, morphological distortions of the underlying PPG waveforms, from which SpO<sub>2</sub> and HR measurements are derived, could lead to measurement errors, false alarms, and frequent dropouts when subjects remain active. For example, as shown in Fig. 2, it is evident that the Masimo pulse oximeter, which employs advanced signal extraction technology designed to greatly extend its utility into high motion environments, was clearly unable to accurately track SpO<sub>2</sub> and HR while the subject was jogging. Although to a lesser extent, we also noticed more pronounced fluctuations in SpO<sub>2</sub> recorded by the wearable forehead pulse oximeter during jogging. These fluctuations are likely caused by PPG waveforms obscured by motion artifacts associated with heavier breathing.

To address the need to improve the performance of a prototype reflectance pulse oximeter during jogging, we investigated the effectiveness of a MEMS ACC as a noise reference input to two popular ANC algorithms. We chose the LMS and RLS adaptive routines since other investigators showed the promising utility of these algorithms to reduce errors attributed to motion artifacts in pulse oximeters [1]-[3].

Analysis of the data acquired during jogging experiments showed that ANC implemented using the LMS and RLS algorithms can help to improve considerably the accuracy of a pulse oximeter, as shown in Fig. 2. However, although the differences are not considered clinically significant, we found that processing the corrupted PPG signals by each algorithm produced slightly different improvements. These differences are anticipated since different computational principles are employed by a pulse oximeter.

Since ANC-based filtering implements an adaptive notch filter with a notch frequency corresponding to the dominant frequency of the measured ACC signal, we expected that an overlap of the HR and movement-induced ACC frequencies would attenuate the fundamental cardiac-synchronized frequency of the PPG signals and, therefore significantly affecting SpO<sub>2</sub> and HR measurements. However, separate analysis of the data from experiments where body accelerations and cardiac rhythms were found to be synchronized confirmed that applying either the LMS or RLS algorithm did not adversely impact the ability to obtain accurate SpO<sub>2</sub> and HR readings while subjects remain active.

As shown in Fig. 3 and Fig. 4, we found that the degree of improvement depends on the filter order (M) used to implement each adaptive algorithm, however filters order greater than 24 produced diminished improvements. Furthermore, we also found that the LMS algorithm was slightly more effective in reducing HR errors compared to the RLS implementation.

Given similar performances, it is important to take into consideration the complexity of the LMS and RLS algorithms and the trade-off between algorithmic complexity and computation time. These principal tradeoffs are important since our goal is to implement ANC to improve the performance of a wearable pulse oximeter during motion. For example, compared to the LMS algorithm, the RLS algorithm has a faster convergence rate which is

essential in real-time applications. However, this comes at the expense of a longer computational time since the RLS algorithm requires  $M^2$  operations per iteration. Considering for example that an implementation based on a 24<sup>th</sup>-order filter would provide an acceptable error reduction, this implies that the LMS algorithm would require only 24 operations compared to 576 operations that will be required to implement an adaptive RLS algorithm. Table 1 summarizes the relative execution times of the LMS and RLS adaptive algorithms for processing one data point.

Table 1. Execution times for LMS and RLS algorithms

Filter Order	LMS (ms)	RLS (ms)
2	1.0	6.5
4	1.8	18.5
8	3.2	63.0
16	6.2	235.0

## VI. CONCLUSIONS

This study was designed to investigate the performance of accelerometry-based ANC implemented using the LMS and RLS algorithms as an effective method to minimizing both SpO<sub>2</sub> and HR errors induced during movement. Measurements were performed using a custom, forehead-mounted wearable pulse oximeter that was developed in our laboratory to serve as a platform for real-time remote physiological monitoring and triage applications. The results obtained in this study revealed that processing motion-corrupted PPG signals by the LMS and RLS algorithm can reduce HR and SpO<sub>2</sub> errors during jogging. Although both algorithms produced similar improvements, the implementation of the adaptive LMS algorithm is preferred since it requires significantly less operations.

## REFERENCES

- [1] J. Y. A. Foo, S. J. Wilson, "A computational system to optimize noise rejection in photoplethysmography signals during motion or poor perfusion states," *Med. Biol. Eng. Comput.*, 2006, pp. 140-145.
- [2] L. B. Wood, H. H. Asada, "Noise cancellation model validation for reduced motion artifact wearable PPG sensors using MEMS accelerometers," in *Proc. 28<sup>th</sup> IEEE/EMBS Ann. Int. Conf.*, New York, 2006, pp. 3525-3528.
- [3] A.R. Relente, L.G. Sison, Characterization and adaptive filtering of motion artifacts in pulse oximetry using accelerometers, *Proc. 2<sup>nd</sup> Joint EMBS/BMES Conf.*, Houston, TX, 2002, 1769-1770.
- [4] Y. Mendelson and V. Floroff, A PDA based *ad-hoc* mobile wireless pulse oximeter, in *Proc. IASTED International Conference Telehealth 2005*, Banff, Canada, 2005, pp. 1-6.
- [5] Y. Mendelson, R. J. Duckworth, G. Comtois, "A wearable reflectance pulse oximeter for remote physiological monitoring," in *Proc. 28<sup>th</sup> IEEE EMBS Annual International Conf.*, New York, 2006, pp. 912-915.
- [6] G. Comtois, Y. Mendelson, "A noise reference input to an adaptive filter algorithm for signal processing in a wearable pulse oximeter," in *Proc. 33<sup>rd</sup> Annual Northeast Bioengineering Conf.*, New York, 2007, pp. 106-107.

## **APPENDIX MENDELSON01**

Welcome back! Our libraries are open with [limited hours](#), [new safety guidelines](#) and [updated services](#) including [curbside pickup](#). Please visit our [Remote Resources page](#) and our [COVID-19 page](#) for more information.



Catalog

Bookmarks 0 Course Reserves My Account

Keyword Search...

Search

Advanced search Start Over

Bookmark Share

## MARC View

LEADER 03618cam a2200409 a 4500  
001 2687279  
003 SIRSI  
005 20151215101812.0  
008 040204t20032003njua b 101 0 eng d  
019 a| MARS  
020 a| 0780377893 (4 v. set)  
035 a| (OCoLC)54350995  
040 a| MoKL c| MoKL d| OCoLC d| UtOrBLW  
110 2 a| IEEE Engineering in Medicine and Biology Society. b| Annual Conference n| (25th : d| 2003 : c| Cancún, Mexico)  
245 1 0 a| Proceedings of the 25th Annual International Conference of the IEEE Engineering in Medicine and Biology Society : b| A new beginning for human health : 17-21 September, 2003, Cancún, Mexico / c| conference chair and co-chair, Jorge E. Monzón, José C. Príncipe [and others] ; IEEE [and others].  
246 3 0 a| New beginning for human health  
246 3 0 a| 25th Annual International Conference of the IEEE Engineering in Medicine and Biology Society  
246 3 0 a| Engineering in medicine and biology  
264 1 a| Piscataway, New Jersey : b| IEEE, c| [2003]  
264 4 c| ©2003  
300 a| 4 volumes : b| illustrations ; c| 28 cm  
336 a| text b| txt 2| rdacontent  
337 a| unmediated b| n 2| rdamedia  
338 a| volume b| nc 2| rdacarrier  
500 a| "IEEE Catalog Number: 03CH37439"--T.p. verso.  
504 a| Includes bibliographic references and author index.  
530 a| Also available via the World Wide Web.  
650 0 a| Biomedical engineering v| Congresses.  
650 0 a| Biomedical materials v| Congresses.  
650 0 a| Biosensors v| Congresses.  
700 1 a| Monzón, Jorge E.  
700 1 a| Príncipe, J. C. q| (José C.)  
710 2 a| Institute of Electrical and Electronics Engineers.  
949 a| R856.A2I344 2003 v.1 w| LC c| 1 i| 000053667144 d| 1/12/2012 e| 10/10/2011 I| HATHIETAS m| UP-ANNEX n| 1 r| Y s| Y t| ONLINE u| 3/16/2004 o| .STAFF. Digitized Copy Instructions: Do not delete or replace the barcode in this item record. It links to the digitized copy of this volume. If WITHDRAWING the volume or REPLACING a barcode, update the item record to reflect an ONLINE resource. Add a new barcode by adding a second item record. See Access Services Training Bulletin no. 25 for full instructions.  
949 a| R856.A2I344 2003 v.2 w| LC c| 1 i| 000053657404 d| 1/12/2012 e| 10/10/2011 I| HATHIETAS m| UP-ANNEX n| 1 r| Y s| Y t| ONLINE u| 3/16/2004 o| .STAFF. Digitized Copy Instructions: Do not delete or replace the barcode in this item record. It links to the digitized copy of this volume. If WITHDRAWING the volume or REPLACING a barcode, update the item record to reflect an ONLINE resource. Add a new barcode by adding a second item record. See Access Services Training Bulletin no. 25 for full instructions.  
949 a| R856.A2I344 2003 v.3 w| LC c| 1 i| 000053667403 d| 1/12/2012 e| 10/10/2011 I| HATHIETAS m| UP-ANNEX n| 1 r| Y s| Y t| ONLINE u| 3/16/2004 o| .STAFF. Digitized Copy Instructions: Do not delete or replace the barcode in this item record. It links to the digitized copy of this volume. If WITHDRAWING the volume or REPLACING a barcode, update the item record to reflect an ONLINE resource. Add a new barcode by adding a second item record. See Access Services Training Bulletin no. 25 for full instructions.  
949 a| R856.A2I344 2003 v.4 w| LC c| 1 i| 000053667137 d| 1/12/2012 e| 10/10/2011 I| HATHIETAS m| UP-ANNEX n| 1 r| Y s| Y t| ONLINE u| 3/16/2004 o| .STAFF. Digitized Copy Instructions: Do not delete or replace the barcode in this item record. It links to the digitized copy of this volume. If WITHDRAWING the volume or REPLACING a barcode, update the item record to reflect an ONLINE resource. Add a new barcode by adding a second item record. See Access Services Training Bulletin no. 25 for full instructions.

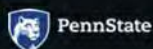

[exceptions.](#)

[Legal Statements | PSU Hotlines](#)

[Libraries Intranet \(Staff Only\)](#)

[Accessibility Help](#)

[Website Feedback](#)

[Policies and Guidelines](#)

[Staff Directory](#)

[Facebook](#)

[Twitter](#)

[Instagram](#)

## **APPENDIX MENDELSON02**

Enhanced online resources and other COVID-19 updates »



# LIBRARY CATALOG

MENU

[Sign in](#) | [Selected Items \(0\)](#) | [Search History](#) | [Search Tips](#) | [Borrow Direct](#) | [Interlibrary Loan](#)

All Fields



[ADVANCED SEARCH](#) | [ASK A LIBRARIAN](#) | [MY ACCOUNT](#)

Chat with Us

[Back to item](#)

## Librarian View

```
LEADER 02149cam a22004574a 4500
001 9874630
005 20180515124517.0
006 m o d
007 cr n
008 071226s2006 nyua ob 101 0 eng d
020 #a 1424400325
035 #a (WaSeSS)OCM1ssj0000394402
035 #a (OCoLC)275723396
035 #a 9874630
040 #a DLC #c DLC #d DLC #d WaSeSS
050 0 0 #a R856.A2 #b I344 2006
110 2 #a IEEE Engineering in Medicine and Biology Society. #b Annual Conference #n (28th : #d 2006 : #c New York, N.Y.)
245 1 0 #a 2006 28th Annual International Conference of the IEEE Engineering in Medicine and Biology Society : #b New York, NY, 30 August - 3 September 2006.
260 #a [New York?] : #b IEEE ; #a Piscataway, NJ : #b IEEE Service Center [distributor], #c c2006.
300 #a 1 online resource.
336 #a text #2 rdacontent
337 #a computer #2 rdamedia
338 #a online resource #2 rdacarrier
504 #a Includes bibliographical references and author index.
506 #a License restrictions may limit access.
650 0 #a Biomedical engineering #v Congresses.
650 0 #a Biomedical materials #v Congresses.
650 0 #a Biosensors #v Congresses.
650 7 #a Biomedical engineering. #2 fast #0 (OCoLC)fst00832568
650 7 #a Biomedical materials. #2 fast #0 (OCoLC)fst00832586
650 7 #a Biosensors. #2 fast #0 (OCoLC)fst00832703
655 7 #a Conference papers and proceedings. #2 fast #0 (OCoLC)fst01423772
710 2 #a Institute of Electrical and Electronics Engineers.
856 4 0 #3 Full text available from IEEE/IET Electronic Library (IEL) #i ssid=ssj0000394402; dbcode=RIE; providercode=PRVIEE #u http://proxy.library.cornell.edu/login?url=https://ieeexplore.ieee.org/servlet/opac?punumber=4028925 #z Connect to text.
899 2 #a PRVIEE_RIE
948 2 #a 20180515 #b m #d batch #e lts
948 3 #a 20180515 #h SerialSolutions #i COO_360MARC_Update_20180514_monographs_changed.mrc.uc
948 0 #a 20170411 #b i #d batch #e lts
948 1 #a 20170411 #b s #d batch #e lts #f ebk
948 3 #a 20170411 #h SerialSolutions #i COO_360MARC_Update_20170410_monographs_new.mrc.uc
948 2 #a 20170703 #b m #d batch #e lts #x WorldShare
```

CONTACT US

[? Ask a Librarian](#)

[Feedback](#)

[Release Notes](#)

RESOURCES

[Library Website](#) | [Search](#) | [Catalog](#) | [Articles & Full Text](#) | [Databases](#) | [E-journal Titles](#) | [Images](#)



## **APPENDIX MENDELSON03**

Welcome back! Our libraries are open with [limited hours](#), [new safety guidelines](#) and [updated services](#) including [curbside pickup](#). Please visit our [Remote Resources page](#) and our [COVID-19 page](#) for more information.



Catalog

Bookmarks 0 Course Reserves My Account

Keyword Search...

Search

Advanced search Start Over

Bookmark Share

## MARC View

LEADER 02022nas a22004451a 4500  
001 1382884  
003 SIRSI  
005 20151215010416.0  
008 830808 19739999xx bu 0 0eng d  
010 a| 73643617  
019 a| MARS  
022 0 a| 0090-6689  
032 a| 709820 b| USPS  
035 a| LIAS1405187  
035 a| (OCoLC)1786771  
040 a| PSt c| PSt d| WaOLN d| UtOrBLW  
050 0 0 a| R856.A1 b| A85  
245 0 0 a| Medical instrumentation.  
264 1 a| Arlington, Va. : b| AAMI, c| [1973]-1988.  
300 a| 16 volumes : b| illustrations ; c| 29 cm  
336 a| text b| txt 2| rdacontent  
337 a| unmediated b| n 2| rdamedia  
338 a| volume b| nc 2| rdacarrier  
362 0 a| Vol. 7, no. 1 (Jan./Feb. 1973)-v. 22, no. 6 (Dec. 1988).  
550 a| "Journal of the Association for the Advancement of Medical Instrumentation".  
650 0 a| Medical instruments and apparatus v| Periodicals.  
650 0 a| Biomedical engineering v| Periodicals.  
650 0 a| Prosthesis v| Periodicals.  
710 2 a| Association for the Advancement of Medical Instrumentation.  
780 0 0 t| JAAMI: journal of the Association for the Advancement of Medical Instrumentation.  
780 0 5 t| Clinical engineering. g| 1981-  
785 0 7 t| Biomedical technology today.  
785 0 7 t| Biomedical instrumentation & technology.  
936 1 a| Vol. 17, no. 1 (Jan./Feb. 1983).  
949 a| R856.A1A85 v.17 1983 w| LCPER c| 1 i| 000073945314 || HATHIETAS m| UP-ANNEX r| Y s| Y t| ONLINE u| 10/10/2012 z| 8263  
949 a| R856.A1A85 v.18 1984 w| LCPER c| 1 i| 000073946120 || HATHIETAS m| UP-ANNEX r| Y s| Y t| ONLINE u| 10/10/2012 z| 8263  
949 a| R856.A1A85 v.19 1985 w| LCPER c| 1 i| 000073946205 || HATHIETAS m| UP-ANNEX r| Y s| Y t| ONLINE u| 10/10/2012 z| 8263  
949 a| R856.A1A85 v.20 1986 w| LCPER c| 1 i| 000073946199 || HATHIETAS m| UP-ANNEX r| Y s| Y t| ONLINE u| 10/10/2012 z| 8263  
949 a| R856.A1A85 v.21 1987 w| LCPER c| 1 i| 000073946182 || HATHIETAS m| UP-ANNEX r| Y s| Y t| ONLINE u| 10/10/2012 z| 8263  
949 a| R856.A1A85 v.22 1988 w| LCPER c| 1 i| 000073946175 || HATHIETAS m| UP-ANNEX r| Y s| Y t| ONLINE u| 10/10/2012 z| 8263  
852 0 1 a| PSt b| UP-ANNEX c| CATO-2 h| R856.A1 i| A85  
866 0 8| 0 a| v.17(1983)-v.22(1988)



Copyright ©2019 The Pennsylvania State University. All rights reserved. Except where otherwise noted, this work is subject to a Creative Commons Attribution 4.0 license. Details and exceptions.

[Legal Statements](#) | [PSU Hotlines](#)

### PENN STATE UNIVERSITY LIBRARIES

[Libraries Home](#) (814) 865-6368  
[Libraries Intranet \(Staff Only\)](#)  
[Accessibility Help](#)  
[Website Feedback](#)  
[Policies and Guidelines](#)  
[Staff Directory](#)

### CONNECT WITH PENN STATE UNIVERSITY LIBRARIES

[Facebook](#)  
[Twitter](#)  
[Instagram](#)

## **APPENDIX MENDELSON04**

# The CATALOG

Connecting Public Libraries in Allegheny County, PA

Your Library	Tips & Resources	Booklists	Find Articles	Interlibrary Loan	Get a Library Card
--------------	------------------	-----------	---------------	-------------------	--------------------

```

LEADER 00000cas 2200000 a 4500
001 1752544
003 OCoLC
005 20150414134057.0
007 cr unu|||||
008 751101c1964999nyumr p 0 a0eng
010 57058289
016 7 I03620000|2DNLM
019 185059399
022 0 0018-9294|21
030 IEBEAX
032 815900|BUSPS
035 (OCoLC)1752544|z(OCoLC)185059399
040 DLC|cMUL|dNSD|dYUS|dOCL|dNSD|dHUL|dSER|dRCS|dNSD|dAIP|dDLC
|dAIP|dDLC|dAIP|dNSD|dNST|dNSD|dNST|dMXC|dMYG|dCUS|dOCL
|dMYG|dLYU|dIEEEX|dOCLCQ|dNSD|dNLGGC|dLVB|dUtoRBLW
042 nsdp|alc
049 CPLL
050 00 R895.A1|bI25
082 04 610/.28|219
210 0 IEEE trans. biomed. eng.|b(Print)
222 0 IEEE transactions on biomedical engineering|b(Print)
245 00 IEEE transactions on bio-medical engineering /|cBio-
medical Engineering Group.
246 3 Institute of Electrical and Electronics Engineers
transactions on bio-medical engineering
246 30 IEEE transactions on biomedical engineering
246 30 Transactions on bio-medical engineering
260 New York, N.Y. :|bInstitute of Electrical and Electronics
Engineers,|c1964-
300 volumes :|billustrations, portraits ;|c28 cm
310 Monthly|b<, Jan. 1979- >
321 Bimonthly|b<, Nov. 1975- >
321 Quarterly,|b1964-<Jan. 1969>
336 text|btxt|2rdacontent
337 unmediated|bn|2rdamedia
338 volume|bnc|2rdacarrier
362 0 Vol. BME-11, no. 1 & 2 (Jan./Apr. 1964)-
510 2 Chemical abstracts|x0009-2258|b1864-1982
530 Also issued online.
550 Vols. for 1964-Oct. 1964 issued by the Bio-medical
Engineering Group of the IEEE; Jan. 1965-<Nov. 1975> by
the IEEE Engineering in Medicine and Biology Group; <,
Jan. 1979- > by the IEEE Engineering in Medicine and
Biology Society.
650 0 Biomedical engineering|vPeriodicals.
650 0 Medical electronics|vPeriodicals.
650 0 Medical physics|vPeriodicals.
710 2 Institute of Electrical and Electronics Engineers.|bBio-
medical Engineering Group.
710 2 IEEE Engineering in Medicine and Biology Group.
710 2 IEEE Engineering in Medicine and Biology Society.
776 1 |tIEEE transactions on biomedical engineering (Online)
|x1558-2531|w(DLC) 2005215246|w(OCoLC)44459946
780 00 |tIEEE transactions on bio-medical electronics|x0096-0616
|w(DLC)sf 84001208|w(OCoLC)1642035
856 41 |uhttps://ieeexplore.ieee.org/servlet/opac?punumber=10
891 20 |9853|81|av.|bno.|u12|vr|i(year)|j(month)|wm
891 41 |9863|81.1|a<49>|b<1>|i<2002>|j<01>
994 c0|bcPL
    
```

Location	Carnegie Library of Pittsburgh - Off Site Storage (Please ask for assistance)
Lib Has	Volume 11 (1964) to Volume 14 (1967).
Location	CLP Main (Oakland) Second Floor - Magazines
Lib Has	Volume 15 (1968) to volume 56, no. 3 (2009).

## **APPENDIX MENDELSON05**

Covid 19 updates and more information about using the Libraries while you're remote.

PennState University Libraries **Catalog** Bookmarks Course Reserves My Account

Keyword Search Search Advanced search Start Over

Bookmark Share

## MARC View

```

LEADER 01580nam a22003014a 4500
001 20027320
003 SIRSI
005 20170314130250.0
006 m d
007 cr n
008 071226s2006 nyua sb 101 0 eng d
010 a| 2007282734
020 a| 1424400325
040 a| DLC c| DLC d| DLC d| WaSe55
050 0 0 a| R856.A2 b| I344 2006
110 2 a| IEEE Engineering in Medicine and Biology Society. b| Annual Conference n | (28th : d) 2006 : c| New York, N.Y.)
245 1 0 a| 2006 28th Annual International Conference of the IEEE Engineering in Medicine and Biology Society h | [electronic resource] : b| New York, NY, 30 August - 3 September 2006.
260 a| [New York?] : b| IEEE : a| Piscataway, NJ : b| IEEE Service Center [distributor], c | c2006.
300 a| 15 v. (lxxxvii, 6468, 47 p.) : b | ill. : c | 28 cm.
504 a| Includes bibliographical references and author index.
506 a| License restrictions may limit access.
650 0 a| Biomedical engineering v| Congresses.
650 0 a| Biomedical materials v| Congresses.
650 0 a| Biosensors v| Congresses.
655 0 a| Electronic books.
710 2 a| Institute of Electrical and Electronics Engineers.
856 4 0 u| http://SK8E54MC2L.search.serialsolutions.com/?sid=sersol&SS_c=TC0000394402&title=2006%2028th%20Annual%20International%20Conference%20of%20the%20IEEE%20Engineering%20in%20Medicine%20and%20Biology%20Society%20%3A%20New%20York%2C%20NY%2C%2030%20August%20%203%20September%202006
949 a| Electronic resource w| ASIS c| 1 | 20027320-1001 | | ONLINE m | ONLINE r | Y s | Y t | ONLINE u | 3/21/2017 o | _STAFF. 360 MARC
  
```

**PennState** Copyright ©2019 The Pennsylvania State University. All rights reserved. Except where otherwise noted, this work is subject to a Creative Commons Attribution 4.0 license. Details and exceptions.

Legal Notices | PUL Website

**PENN STATE UNIVERSITY LIBRARIES**  
 Librarian Home (814) 863-6446  
 Librarian/Staff (Staff Only)  
 Accessibility Help  
 Website Feedback  
 Privacy and Data  
 Staff Directory

**CONNECT WITH PENN STATE UNIVERSITY LIBRARIES**  
 Facebook  
 Twitter  
 Instagram

## **APPENDIX MENDELSON06**

 [Covid 19 updates and more information about using the Libraries while you're remote.](#)



Catalog

Bookmarks  Course Reserves My Account

Keyword  Search...

 Search

[Advanced search](#) [Start Over](#)

[← Previous](#) | **15 of 105** | [Next →](#)

[Bookmark](#) [Share](#)



## 2006 28th Annual International Conference of the IEEE Engineering in Medicine and Biology Society [electronic resource] : New York, NY, 30 August - 3 September 2006

 ASK  
A LIBRARIAN

**Corporate Author:** [IEEE Engineering in Medicine and Biology Society. Annual Conference \(28th : 2006 : New York, N.Y.\)](#)

**Published:** [\[New York?\] : IEEE ; Piscataway, NJ : IEEE Service Center \[distributor\], c2006.](#)

**Physical Description:** [15 v. \(lxxxvii, 6468, 47 p.\): ill. ; 28 cm.](#)

**Additional Creators:** [Institute of Electrical and Electronics Engineers](#)

**Access Online:** [serialsolutions.com](#)

### Restrictions on Access:

License restrictions may limit access.

### Subject(s):

[Biomedical engineering—Congresses](#)  
[Biomedical materials—Congresses](#)  
[Biosensors—Congresses](#)

### Genre(s):

[Electronic books](#)

### ISBN:

1424400325

### Bibliography Note:

Includes bibliographical references and author index.

[View MARC record](#) | catkey: 20027320

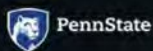

Copyright ©2019 The Pennsylvania State University. All rights reserved. Except where otherwise noted, this work is subject to a [Creative Commons Attribution 4.0 license](#). Details and exceptions.

[Legal Statements](#) | [PSU Hotlines](#)

### PENN STATE UNIVERSITY LIBRARIES

[Libraries Home](#) (814) 865-6368  
[Libraries Intranet \(Staff Only\)](#)  
[Accessibility Help](#)  
[Website Feedback](#)  
[Policies and Guidelines](#)  
[Staff Directory](#)

### CONNECT WITH PENN STATE UNIVERSITY LIBRARIES

 Facebook  
 Twitter  
 Instagram



## **APPENDIX MENDELSON07**

IEEE.org | IEEE Xplore | IEEE-SA | IEEE Spectrum | More Sites Cart Create Account Personal Sign In

**IEEE Xplore** Browse ▾ My Settings ▾ Help ▾ Access provided by: Penn State University Sign Out

All Q

Search within Publication ADVANCED SEARCH

Browse Conferences > Annual International Conferenc... > 2006 International Conference ...

## Annual International Conference of the IEEE Engineering in Medicine and Biology Society (EMBC)

[Copy Persistent Link](#) [Browse Title List](#) [Sign up for Conference Alerts](#)

**Proceedings** All Proceedings Popular

2006 International Conference of the IEEE Engineering in Medicine and Biology Society

DOI: 10.1109/IEMBS10037.2006

30 Aug.-3 Sept. 2006 Volume : ▾

Search within results Q

Download PDFs ▾ | Per Page: 25 ▾ | Export ▾ | Email Selected Results ▾

Showing 251-275 of 1,651

**Refine**  Select All on Page Sort By: Sequence ▾

**Author** ▾

**Affiliation** ▾

**Conference Location** ▾

---

**Quick Links**

[Search for Upcoming Conferences](#)



[IEEE Publication Recommender](#)

[IEEE Author Center](#)

---

**Modeling the electrode-electrolyte interface for recording and stimulating electrodes** 🔒



John B. Troy; Donald R. Cantrell; Allen Tafflove; Rodney S. Ruoff  
Publication Year: 2006 , Page(s): 879 - 881  
Cited by: Papers (3)

▶ Abstract [\(html\)](#)  (134 Kb) 

---

**In vivo and In vitro Differences in the Charge-injection and Electrochemical Properties of Iridium Oxide Electrodes** 🔒



Stuart F. Cogan  
Publication Year: 2006 , Page(s): 882 - 885  
Cited by: Papers (23)

▶ Abstract [\(html\)](#)  (307 Kb) 

---

**In Vitro and In Vivo Charge Capacity of AIROF Microelectrodes** 🔒



Z. Hu; P. R. Troyk; T. P. Brawn; D. Margoliash; S. F. Cogan  
Publication Year: 2006 , Page(s): 886 - 889  
Cited by: Papers (15)

▶ Abstract [\(html\)](#)  (405 Kb) 

---

**Charge Injection Capacity of TiN Electrodes for an Extended Voltage Range** 🔒



Mustafa Patan; Tosha Shah; Mesut Sahin  
Publication Year: 2006 , Page(s): 890 - 892  
Cited by: Papers (5)































▶ Abstract [\(html\)](#)  (201 Kb) 





























---

**Optimizing Deep Brain Stimulation Parameter Selection with Detailed Models of the Electrode-Tissue Interface** 🔒

Cameron C. McIntyre; Christopher R. Butson; Christopher B. Moks; Angela M. Noecker  
Publication Year: 2006 , Page(s): 893 - 895  
Cited by: Papers (26)

▶ Abstract [\(html\)](#)  (208 Kb) 

- Effects of Nano Red Elemental Selenium on Sodium Currents in Rat Dorsal Root Ganglion Neurons**   
Huijun Yuan; Jiarui Lin; Tonghan Lan  
Publication Year: 2006 , Page(s): 896 - 899  
Cited by: Papers (1)  
▶ Abstract [\(html\)](#)  (344 Kb) 
- 
- A Non Invasive Wearable Sensor for the Measurement of Brain Temperature**   
A. Dittmar; C. Gehin; G. Delhomme; D. Boivin; G. Dumont; C. Mott  
Publication Year: 2006 , Page(s): 900 - 902  
Cited by: Papers (17) | Patents (13)  
▶ Abstract [\(html\)](#)  (317 Kb) 
- 
- Acquiring High-Rate Neural Spike Data with Hardware-Constrained Embedded Sensors**   
Shahin Farshchi; Aleksey Pesterev; Wan-Lun Ho; Jack W. Judy  
Publication Year: 2006 , Page(s): 903 - 907  
Cited by: Papers (7) | Patents (1)  
▶ Abstract [\(html\)](#)  (366 Kb) 
- 
- Wearable, Cuff-less PPG-Based Blood Pressure Monitor with Novel Height Sensor**   
Phillip A. Shaltis; Andrew Reisner; H. Harry Asada  
Publication Year: 2006 , Page(s): 908 - 911  
Cited by: Papers (37) | Patents (4)  
▶ Abstract [\(html\)](#)  (224 Kb) 
- 
- A Wearable Reflectance Pulse Oximeter for Remote Physiological Monitoring**   
Y. Mendelson; R. J. Duckworth; G. Comtois  
Publication Year: 2006 , Page(s): 912 - 915  
Cited by: Papers (52) | Patents (18)  
▶ Abstract [\(html\)](#)  (341 Kb) 
- 
- An Application of Capacitive Electrode for Detecting Electrocardiogram of Neonates and Infants**   
Tsuyoshi Kato; Akinori Ueno; Sachiyo Kataoka; Hiroshi Hoshino; Yoji Ishiyama  
Publication Year: 2006 , Page(s): 916 - 919  
Cited by: Papers (26) | Patents (1)  
▶ Abstract [\(html\)](#)  (243 Kb) 
- 
- Non-Invasive Respiration Rate Estimation Using Ultra-Wideband Distributed Cognitive Radar System**   
Yifan Chen; Erry Gunawan; Kay Soon Low; Yongmin Kim; Cheong Boon Soh; A. Rahim Leyman; Lin Lin Thi  
Publication Year: 2006 , Page(s): 920 - 923  
Cited by: Papers (9)  
▶ Abstract [\(html\)](#)  (253 Kb) 
- 
- Temporal Tracking of Coronaries in MSCTA by Means of 3D Geometrical Moments**   
S. Laguitton; C. Boldak; A. Bousse; G. Yang; C. Toumoulin  
Publication Year: 2006 , Page(s): 924 - 927  
Cited by: Papers (1)  
▶ Abstract [\(html\)](#)  (382 Kb) 
- 
- Endocardium and Epicardium Contour Modeling Based on Markov Random Fields and Active Contours**   
Lucilio Cordero-Grande; Pablo Casaseca-de-la-Higuera; Marcos Martin-Fernandez; Carlos Alberola-Lopez  
Publication Year: 2006 , Page(s): 928 - 931  
Cited by: Papers (1)  
▶ Abstract [\(html\)](#)  (254 Kb) 
- 
- Automated Pericardial Fat Quantification in CT Data**   
Alok N. Bandekar; Morteza Naghavi; Ioannis A. Kakadiaris  
Publication Year: 2006 , Page(s): 932 - 935  
Cited by: Papers (15)  
▶ Abstract [\(html\)](#)  (446 Kb) 

- Model-Based Image Reconstruction for Dynamic Cardiac Perfusion MRI from Sparse Data**   
Suyash P. Awate; Edward V. R. DiBella; Tolga Tasdizen; Ross T. Whitaker  
Publication Year: 2006 , Page(s): 936 - 941  
Cited by: Papers (6) | Patents (1)  
[▶ Abstract](#) [\(html\)](#)  (764 Kb) 
- Immune Cells Detection of the In Vivo Rejecting Heart in USPIO-Enhanced Magnetic Resonance Imaging**   
Hsun-Hsien Chang; Jose M. F. Moura; Yijun L. Wu; Chien Ho  
Publication Year: 2006 , Page(s): 942 - 945  
Cited by: Papers (3)  
[▶ Abstract](#) [\(html\)](#)  (459 Kb) 
- Analysis of Breathing Air Flow Patterns in Thermal Imaging**   
Jin Fei; Ioannis Pavlidis  
Publication Year: 2006 , Page(s): 946 - 952  
Cited by: Papers (15) | Patents (30)  
[▶ Abstract](#) [\(html\)](#)  (358 Kb) 
- Evaluation of feature-based registration in dynamic infrared imaging for breast cancer diagnosis**   
Valentina Agostini; Silvia Delsanto; Filippo Molinari; Marco Knafnitz  
Publication Year: 2006 , Page(s): 953 - 956  
Cited by: Papers (6) | Patents (15)  
[▶ Abstract](#) [\(html\)](#)  (477 Kb) 
- Segmentation and Landmark Identification in Infrared Images of the Human Body**   
C.L. Herry; M. Frize; R.A. Goubran  
Publication Year: 2006 , Page(s): 957 - 960  
Cited by: Papers (6)  
[▶ Abstract](#) [\(html\)](#)  (481 Kb) 
- Field-warp registration for biomedical high-resolution thermal infrared images**   
Andrea Tangherlini; Arcangelo Merla; Gian Luca Romani  
Publication Year: 2006 , Page(s): 961 - 964  
Cited by: Papers (6)  
[▶ Abstract](#) [\(html\)](#)  (295 Kb) 
- Overlay of thermal and visual medical images using skin detection and image registration**   
Gerald Schaefer; Roger Tait; Shao Ying Zhu  
Publication Year: 2006 , Page(s): 965 - 967  
Cited by: Papers (11)  
[▶ Abstract](#) [\(html\)](#)  (358 Kb) 
- A biomechanical model of the pelvic cavity: first steps**   
C. Rubod; M. Boukerrou; J. Rousseau; R. Viard; M. Brieu; P. Dubois  
Publication Year: 2006 , Page(s): 968 - 971  
Cited by: Papers (4) | Patents (3)  
[▶ Abstract](#) [\(html\)](#)  (324 Kb) 
- A Comparison of Adaptive and Non-Adaptive EEG Source Localization Algorithms Using a Realistic Head Model**   
John P. Russell; Zoltan J. Koles  
Publication Year: 2006 , Page(s): 972 - 975  
Cited by: Papers (1)  
[▶ Abstract](#) [\(html\)](#)  (275 Kb) 
- Removal of ocular artifacts for high resolution EEG studies: a simulation study**   
Laura Astolfi; Febo Cincotti; Donatella Mattia; Fabio Babiloni; Maria Grazia Marciani; Fabrizio De Vico Fallani; Marco Mattiocco; Fumikazu Miwakeichi; Yoko Yamaguchi; Pablo Martinez; Serenella Salinari; Andrea Tocci; Hovagim Bakardjian; Francois Benoit Vialatte; Andrzej Cichocki  
Publication Year: 2006 , Page(s): 976 - 979

Publication Year: 2000, Page(s): 270 - 272

Cited by: Papers (1)

▶ Abstract (html) PDF (261 Kb) ©

Previous < 11 12 13 14 15 16 17 18 19 20 > Next

#### IEEE Personal Account

CHANGE USERNAME/PASSWORD

#### Purchase Details

PAYMENT OPTIONS

VIEW PURCHASED DOCUMENTS

#### Profile Information

COMMUNICATIONS PREFERENCES

PROFESSION AND EDUCATION

TECHNICAL INTERESTS

#### Need Help?

US & CANADA: +1 800 678 4333

WORLDWIDE: +1 732 981 0060

CONTACT & SUPPORT

#### Follow



About IEEE Xplore | Contact Us | Help | Accessibility | Terms of Use | Nondiscrimination Policy | Sitemap | Privacy & Opting Out of Cookies  
A not-for-profit organization, IEEE is the world's largest technical professional organization dedicated to advancing technology for the benefit of humanity.

© Copyright 2021 IEEE - All rights reserved. Use of this web site signifies your agreement to the terms and conditions.

## **APPENDIX MENDELSON10**

## A Wearable Reflectance Pulse Oximeter for Remote Physiological Monitoring

Y. Mendelson\*, *Member, IEEE*, R. J. Duckworth, *Member, IEEE*, and G. Comtois, *Student Member, IEEE*

**Abstract**—To save life, casualty care requires that trauma injuries are accurately and expeditiously assessed in the field. This paper describes the initial bench testing of a wireless wearable pulse oximeter developed based on a small forehead mounted sensor. The battery operated device employs a lightweight optical reflectance sensor and incorporates an annular photodetector to reduce power consumption. The system also has short range wireless communication capabilities to transfer arterial oxygen saturation ( $SpO_2$ ), heart rate (HR), body acceleration, and posture information to a PDA. It has the potential for use in combat casualty care, such as for remote triage, and by first responders, such as firefighters.

### I. INTRODUCTION

STEADY advances in noninvasive physiological sensing, hardware miniaturization, and wireless communication are leading to the development of new wearable technologies that have broad and important implications for civilian and military applications [1]-[2]. For example, the emerging development of compact, low-power, small-size, light-weight, and unobtrusive wearable devices may facilitate remote noninvasive monitoring of vital signs from soldiers during training exercises and combat. Telemetry of physiological information via a short-range wirelessly-linked personal area network can also be useful for firefighters, hazardous material workers, mountain climbers, or emergency first-responders operating in harsh and hazardous environments. The primary goals of such a wireless mobile platform would be to keep track of an injured person's vital signs, thus readily allowing the telemetry of physiological information to medical providers, and support emergency responders in making critical and often life saving decisions in order to expedite rescue operations. Having wearable physiological monitoring could offer far-forward medics numerous advantages, including the ability to determine a casualty's condition remotely without exposing the first

responders to increased risks, quickly identifying the severity of injuries especially when the injured are greatly dispersed over large geographical terrains and often out-of-site, and continuously tracking the injured condition until they arrive safely at a medical care facility.

Several technical challenges must be overcome to address the unmet demand for long-term continuous physiological monitoring in the field. In order to design more compact sensors and improved wearable instrumentation, perhaps the most critical challenges are to develop more power efficient and low-weight devices. To become effective, these technologies must also be robust, comfortable to wear, and cost-effective. Additionally, before wearable devices can be used effectively in the field, they must become unobtrusive and should not hinder a person's mobility. Employing commercial off-the-shelf (COTS) solutions, for example finger pulse oximeters to monitor blood oxygenation and heart rate, or standard adhesive-type disposable electrodes for ECG monitoring, is not practical for many field applications because they limit mobility and can interfere with normal tasks.

A potentially attractive approach to aid emergency medical teams in remote triage operations is the use of a wearable pulse oximeter to wirelessly transmit heart rate (HR) and arterial oxygen saturation ( $SpO_2$ ) to a remote location. Pulse oximetry is a widely accepted method that is used for noninvasive monitoring of  $SpO_2$  and HR. The method is based on spectrophotometric measurements of changes in the optical absorption of deoxyhemoglobin (Hb) and oxyhemoglobin ( $HbO_2$ ). Noninvasive spectrophotometric measurements of  $SpO_2$  are performed in the visible (600-700nm) and near-infrared (700-1000nm) spectral regions. Pulse oximetry also relies on the detection of photoplethysmographic (PPG) signals produced by variations in the quantity of arterial blood that is associated with periodic contractions and relaxations of the heart. Measurements can be performed in either transmission or reflection modes. In transmission pulse oximetry, the sensor can be attached across a fingertip, foot, or earlobe. In this configuration, the light emitting diodes (LEDs) and photodetector (PD) in the sensor are placed on opposite sides of a peripheral pulsating vascular bed. Alternatively, in reflection pulse oximetry, the LEDs and PD are both mounted side-by-side on the same planar substrate to enable readings from multiple body locations where transillumination measurements are not feasible. Clinically, forehead reflection pulse oximetry has been used as an alternative approach to conventional transmission-based

Manuscript received April 3, 2006. This work is supported by the U.S. Army Medical Research and Materiel Command under Contract No. DAMD17-03-2-0006. The views, opinions and/or findings are those of the author and should not be construed as an official Department of the Army position, policy, or decision, unless so designated by other documentation.

\*Corresponding author – Y. Mendelson is a Professor in the Department of Biomedical Engineering, Worcester Polytechnic Institute, Worcester, MA 01609 USA (phone: 508-831-5103; fax: 508-831-5541; e-mail: ym@wpi.edu).

R. J. Duckworth is a Professor in the Department of Electrical and Computer Engineering, Worcester Polytechnic Institute, Worcester, MA 01609 USA (rjduck@ece.wpi.edu).

G. Comtois is a M. S. student in the Department of Biomedical Engineering, Worcester Polytechnic Institute, Worcester, MA 01609 USA (comtoisg@wpi.edu).

oximetry when peripheral circulation to the extremities is compromised.

Pulse oximetry was initially intended for in-hospital use on patients undergoing or recovering from surgery. During the past few years, several companies have developed smaller pulse oximeters, some including data transmission via telemetry, to further expand the applications of pulse oximetry. For example, battery-operated pulse oximeters are now attached to patients during emergency transport as they are being moved from a remote location to a hospital, or between hospital wards. Some companies are also offering smaller units with improved electronic filtering of noisy PPG signals.

Several reports described the development of a wireless pulse oximeter that may be suitable for remote physiological monitoring [3]-[4]. Despite the steady progress in miniaturization of pulse oximeters over the years, to date, the most significant limitation is battery longevity and lack of telemetric communication. In this paper, we describe a prototype forehead-based reflectance pulse oximeter suitable for remote triage applications.

## II. SYSTEM ARCHITECTURE

The prototype system, depicted in Fig. 1, consists of a body-worn pulse oximeter that receives and processes the PPG signals measured by a small ( $\phi = 22\text{mm}$ ) and lightweight (4.5g) optical reflectance transducer. The system

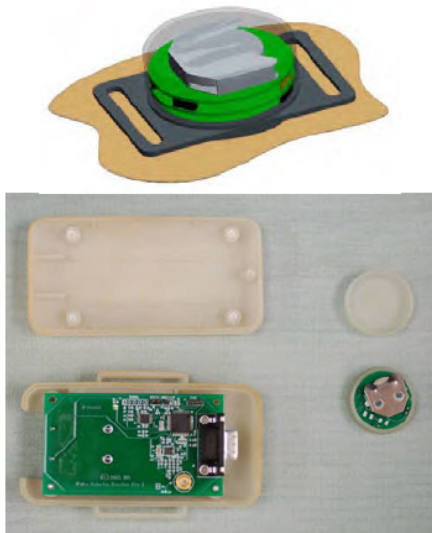

Fig. 1. (Top) Attachment of Sensor Module to the skin; (Bottom) photograph of the Receiver Module (left) and Sensor Module (right).

consists of three units: A Sensor Module, consisting of the optical transducer, a stack of round PCBs, and a coin-cell battery. The information acquired by the Sensor Module is transmitted wirelessly via an RF link over a short range to a body-worn Receiver Module. The data processed by the Receiver Module can be transmitted wirelessly to a PDA. The PDA can monitor multiple wearable pulse oximeters simultaneously and allows medics to collect vital physiological information to enhance their ability to extend more effective care to those with the most urgent needs. The

system can be programmed to alert on alarm conditions, such as sudden trauma, or physiological values out of their normal range. It also has the potential for use in combat casualty care, such as for remote triage, and for use by first responders, such as firefighters.

Key features of this system are small-size, robustness, and low-power consumption, which are essential attributes of wearable physiological devices, especially for military applications. The system block diagram (Fig. 2), is described in more detail below.

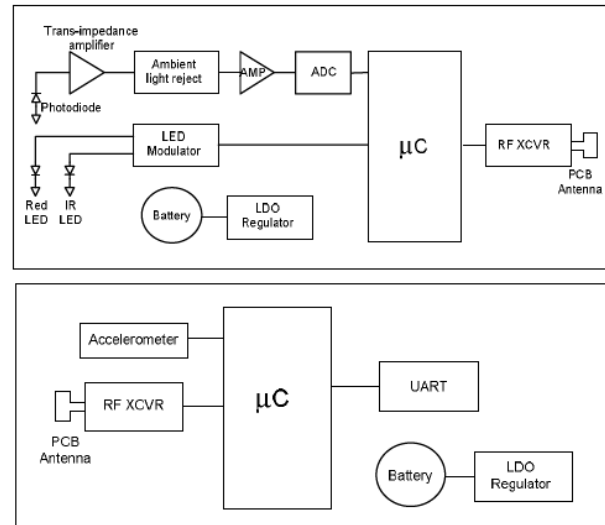

Fig. 2. System block diagram of the wearable, wireless, pulse oximeter. Sensor Module (top), Receiver Module (bottom).

*Sensor Module:* The Sensor Module contains analog signal processing circuitry, ADC, an embedded microcontroller, and a RF transceiver. The unit is small enough so the entire module can be integrated into a headband or a helmet. The unit is powered by a CR2032 type coin cell battery with 220mAh capacity, providing at least 5 days of operation.

*Receiver Module:* The Receiver Module contains an embedded microcontroller, RF transceiver for communicating with the Sensor Module, and a Universal Asynchronous Receive Transmit (UART) for connection to a PC. Signals acquired by the Sensor Module are received by the embedded microcontroller which synchronously converts the corresponding PD output to R and IR PPG signals. Dedicated software is used to filter the signals and compute  $\text{SpO}_2$  and HR based on the relative amplitude and frequency content of the reflected PPG signals. A tri-axis MEMS accelerometer detects changes in body activity, and the information obtained through the tilt sensing property of the accelerometer is used to determine the orientation of the person wearing the device.

To facilitate bi-directional wireless communications between the Receiver Module and a PDA, we used the DPAC Airborne™ LAN node module (DPAC Technologies, Garden Grove, CA). The DPAC module operates at a frequency of 2.4GHz, is 802.11b wireless compliant, and has a relatively small ( $1.6 \times 1.17 \times 0.46$  inches) footprint. The wireless module runs off a 3.7VDC and includes a built-in



TCP/IP stack, a radio, a base-band processor, an application processor, and software for a “drop-in” WiFi application. It has the advantage of being a plug-and-play device that does not require any programming and can connect with other devices through a standard UART.

**PDA:** The PDA was selected based on size, weight, and power consumption. Furthermore, the ability to carry the user interface with the medic also allows for greater flexibility during deployment. We chose the HP iPAQ h4150 PDA because it can support both 802.11b and Bluetooth™ wireless communication. It contains a modest amount of storage and has sufficient computational resources for the intended application. The use of a PDA as a local terminal also provides a low-cost touch screen interface. The user-friendly touch screen of the PDA offers additional flexibility. It enables multiple controls to occupy the same physical space and the controls appear only when needed. Additionally, a touch screen reduces development cost and time, because no external hardware is required. The data from the wireless-enabled PDA can also be downloaded or streamed to a remote base station via Bluetooth or other wireless communication protocols. The PDA can also serve to temporarily store vital medical information received from the wearable unit.

A dedicated National Instruments LabVIEW program was developed to control all interactions between the PDA and the wearable unit via a graphical user interface (GUI). One part of the LabVIEW software is used to control the flow of information through the 802.11b radio system on the PDA. A number of LabVIEW VIs programs are used to establish a connection, exchange data, and close the connection between the wearable pulse oximeter and the PDA. The LabVIEW program interacts with the Windows CE™ drivers of the PDA’s wireless system. The PDA has special drivers provided by the manufacturer that are used by Windows CE™ to interface with the 802.11b radio hardware. The LabVIEW program interacts with Windows CE™ on a higher level and allows Windows CE™ to handle the drivers and the direct control of the radio hardware.

The user interacts with the wearable system using a simple GUI, as depicted in Fig. 3.



Fig. 3. Sample PDA Graphical User Interface (GUI).

The GUI was configured to present the input and output information to the user and allows easy activation of various

functions. In cases of multiple wearable devices, it also allows the user to select which individual to monitor prior to initiating the wireless connection. Once a specific wearable unit is selected, the user connects to the remote device via the System Control panel that manages the connection and sensor control buttons. The GUI also displays the subject’s vital signs, activity level, body orientation, and a scrollable PPG waveform that is transmitted by the wearable device.

The stream of data received from the wearable unit is distributed to various locations on the PDA’s graphical display. The most prominent portion of the GUI display is the scrolling PPG waveform, shown in Fig. 3. Numerical SpO<sub>2</sub> and HR values are displayed in separate indicator windows. A separate tri-color indicator is used to annotate the subject’s activity level measured by the wearable accelerometer. This activity level was color coded using green, yellow, or red to indicate low or no activity, moderate activity, or high activity, respectively. In addition, the subject’s orientation is represented by a blue indicator that changes orientation according to body posture. Alarm limits could be set to give off a warning sign if the physiological information exceeds preset safety limits.

One of the unique features of this PDA-based wireless system architecture is the flexibility to operate in a free roaming mode. In this ad-hoc configuration, the system’s integrity depends only on the distance between each node. This allows the PDA to communicate with a remote unit that is beyond the PDA’s wireless range. The ad-hoc network would therefore allow medical personnel to quickly distribute sensors to multiple casualties and begin immediate triage, thereby substantially simplifying and reducing deployment time.

**Power Management:** Several features were incorporated into the design in order to minimize the power consumption of the wearable system. The most stringent consideration was the total operating power required by the Sensor Module, which has to drive the R and IR LEDs, process the data, and transmit this information wirelessly to the Receive Module. To keep the overall size of the Sensor Module as small as, it was designed to run on a watch style coin-cell battery.

It should be noted that low power management without compromising signal quality is an essential requirement in optimizing the design of wearable pulse oximeter. Commercially available transducers used with transmission and reflection pulse oximeters employ high brightness LEDs and a small PD element, typically with an active area ranging between 12 to 15mm<sup>2</sup>. One approach to lowering the power consumption of a wireless pulse oximeter, which is dominated by the current required to drive the LEDs, is to reduce the LED duty cycle. Alternatively, minimizing the drive currents supplied to the R and IR LEDs can also achieve a significant reduction in power consumption. However, with reduced current drive, there can be a direct impact on the quality of the detected PPGs. Furthermore, since most of the light emitted from the LEDs is diffused by the skin and subcutaneous tissues, in a predominantly forward-scattering direction, only a small fraction of the incident light is normally backscattered from the skin. In

addition, the backscattered light intensity is distributed over a region that is concentric with respect to the LEDs. Consequently, the performance of reflectance pulse oximetry using a small PD area is significantly degraded. To overcome this limitation, we showed that a concentric array of either discrete PDs, or an annularly-shaped PD ring, could be used to increase the amount of backscattered light detected by a reflectance type pulse oximeter sensor [5]-[7].

Besides a low-power consuming sensor, afforded by lowering the driving currents of the LEDs, a low duty cycle was employed to achieve a balance between low power consumption and adequate performance. In the event that continuous monitoring is not required, more power can be conserved by placing the device in an ultra low-power standby mode. In this mode, the radio is normally turned off and is only enabled for a periodic beacon to maintain network association. Moreover, a decision to activate the wearable pulse oximeter can be made automatically in the event of a patient alarm, or based on the activity level and posture information derived from the on-board accelerometer. The wireless pulse oximeter can also be activated or deactivated remotely by a medic as needed, thereby further minimizing power consumption.

### III. IN VIVO EVALUATIONS

Initial laboratory evaluations of the wearable pulse oximeter included simultaneous HR and SpO<sub>2</sub> measurements. The Sensor Module was positioned on the forehead using an elastic headband. Baseline recordings were made while the subject was resting comfortably and breathing at a normal tidal rate. Two intermittent recordings were also acquired while the subject held his breath for about 30 seconds. Fig. 4 displays about 4 minutes of SpO<sub>2</sub> and HR recordings acquired simultaneously by the sensor.

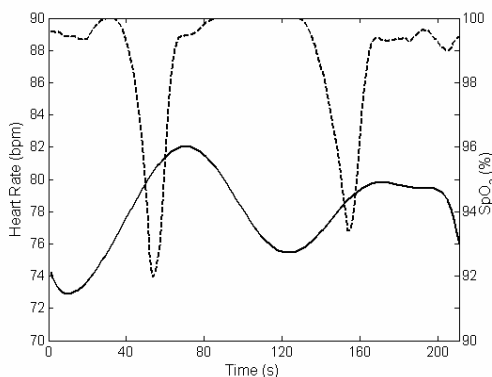

Fig. 4. Typical HR (solid line) and SpO<sub>2</sub> (dashed line) recording of two voluntary hypoxic episodes.

The pronounced drops in SpO<sub>2</sub> and corresponding increases in HR values coincide with the hypoxic events associated with the two breath holding episodes.

### IV. DISCUSSION

The emerging development of compact, low power, small size, light weight, and unobtrusive wearable devices can facilitate remote noninvasive monitoring of vital

physiological signs. Wireless physiological information can be useful to monitor soldiers during training exercises and combat missions, and help emergency first-responders operating in harsh and hazardous environments. Similarly, wearable physiological devices could become critical in helping to save lives following a civilian mass casualty. The primary goal of such a wireless mobile platform would be to keep track of an injured person's vital signs via a short-range wirelessly-linked personal area network, thus readily allowing RF telemetry of vital physiological information to command units and remote off-site base stations for continuous real-time monitoring by medical experts.

The preliminary bench testing plotted in Fig. 4 showed that the SpO<sub>2</sub> and HR readings are within an acceptable clinical range. Similarly, the transient changes measured during the two breath holding maneuvers confirmed that the response time of the custom pulse oximeter is adequate for detecting hypoxic episodes.

### V. CONCLUSION

A wireless, wearable, reflectance pulse oximeter has been developed based on a small forehead-mounted sensor. The battery-operated device employs a lightweight optical reflectance sensor and incorporates an annular photodetector to reduce power consumption. The system has short range wireless communication capabilities to transfer SpO<sub>2</sub>, HR, body acceleration, and posture information to a PDA carried by medics or first responders. The information could enhance the ability of first responders to extend more effective medical care, thereby saving the lives of critically injured persons.

### ACKNOWLEDGMENT

The authors would like to acknowledge the financial support provided by the U.S. Army Medical Research and Materiel Command referenced.

### REFERENCES

- [1] G. S. F. Ling, B. K. Day, P. Rhee, and J. M. Ecklund, "In search of technological solutions to battlefield management of combat casualties," *SPIE Conference on Battlefield Biomedical Technologies*, SPIE vol. 3712, Apr. 1999.
- [2] D. Malan, T. Fulford-Jones, M. Welsh, and S. Moulton, "CodeBlue: An ad-hoc sensor network infrastructure for emergency medical care," *International Workshop on Wearable and Implantable Body Sensor Networks*, 2004.
- [3] U. Anliker et al., "AMON: A wearable multiparameter medical monitoring and alert system," *IEEE Trans. on Information Technology in Biomedicine*, 8(4), 2004.
- [4] Y. Mendelson and V. Floroff, "A PDA based *ad-hoc* mobile wireless pulse oximeter," *Proc. IASTED International Conference Telehealth 2005*, Banff, Canada, 2005.
- [5] Y. Mendelson and C. J. Pujary, "Minimization of LED power consumption in the design of a wearable pulse oximeter," *IASTED International Conference BioMED 2003*, Salzburg, Austria, 2003.
- [6] Y. Mendelson and C. J. Pujary, "Measurement site and photodetector size considerations in optimizing power consumption of a wearable reflectance pulse oximeter," *Proc. of the 25<sup>th</sup> Annual International IEEE/EMBS Conference*, Cancun, Mexico, 2003.
- [7] P. Branche and Y. Mendelson, "Signal quality and power consumption of a new prototype reflectance pulse oximeter sensor," *Proc. of the 31<sup>th</sup> Annual Northeast Bioengineering Conference*, Hoboken, NJ, 2005.

## **APPENDIX MENDELSON12**

## A Wearable Reflectance Pulse Oximeter for Remote Physiological Monitoring

Y. Mendelson\*, *Member, IEEE*, R. J. Duckworth, *Member, IEEE*, and G. Comtois, *Student Member, IEEE*

**Abstract**—To save life, casualty care requires that trauma injuries are accurately and expeditiously assessed in the field. This paper describes the initial bench testing of a wireless wearable pulse oximeter developed based on a small forehead mounted sensor. The battery operated device employs a lightweight optical reflectance sensor and incorporates an annular photodetector to reduce power consumption. The system also has short range wireless communication capabilities to transfer arterial oxygen saturation ( $SpO_2$ ), heart rate (HR), body acceleration, and posture information to a PDA. It has the potential for use in combat casualty care, such as for remote triage, and by first responders, such as firefighters.

### I. INTRODUCTION

STEADY advances in noninvasive physiological sensing, hardware miniaturization, and wireless communication are leading to the development of new wearable technologies that have broad and important implications for civilian and military applications [1]-[2]. For example, the emerging development of compact, low-power, small-size, light-weight, and unobtrusive wearable devices may facilitate remote noninvasive monitoring of vital signs from soldiers during training exercises and combat. Telemetry of physiological information via a short-range wirelessly-linked personal area network can also be useful for firefighters, hazardous material workers, mountain climbers, or emergency first-responders operating in harsh and hazardous environments. The primary goals of such a wireless mobile platform would be to keep track of an injured person's vital signs, thus readily allowing the telemetry of physiological information to medical providers, and support emergency responders in making critical and often life saving decisions in order to expedite rescue operations. Having wearable physiological monitoring could offer far-forward medics numerous advantages, including the ability to determine a casualty's condition remotely without exposing the first

responders to increased risks, quickly identifying the severity of injuries especially when the injured are greatly dispersed over large geographical terrains and often out-of-site, and continuously tracking the injured condition until they arrive safely at a medical care facility.

Several technical challenges must be overcome to address the unmet demand for long-term continuous physiological monitoring in the field. In order to design more compact sensors and improved wearable instrumentation, perhaps the most critical challenges are to develop more power efficient and low-weight devices. To become effective, these technologies must also be robust, comfortable to wear, and cost-effective. Additionally, before wearable devices can be used effectively in the field, they must become unobtrusive and should not hinder a person's mobility. Employing commercial off-the-shelf (COTS) solutions, for example finger pulse oximeters to monitor blood oxygenation and heart rate, or standard adhesive-type disposable electrodes for ECG monitoring, is not practical for many field applications because they limit mobility and can interfere with normal tasks.

A potentially attractive approach to aid emergency medical teams in remote triage operations is the use of a wearable pulse oximeter to wirelessly transmit heart rate (HR) and arterial oxygen saturation ( $SpO_2$ ) to a remote location. Pulse oximetry is a widely accepted method that is used for noninvasive monitoring of  $SpO_2$  and HR. The method is based on spectrophotometric measurements of changes in the optical absorption of deoxyhemoglobin (Hb) and oxyhemoglobin ( $HbO_2$ ). Noninvasive spectrophotometric measurements of  $SpO_2$  are performed in the visible (600-700nm) and near-infrared (700-1000nm) spectral regions. Pulse oximetry also relies on the detection of photoplethysmographic (PPG) signals produced by variations in the quantity of arterial blood that is associated with periodic contractions and relaxations of the heart. Measurements can be performed in either transmission or reflection modes. In transmission pulse oximetry, the sensor can be attached across a fingertip, foot, or earlobe. In this configuration, the light emitting diodes (LEDs) and photodetector (PD) in the sensor are placed on opposite sides of a peripheral pulsating vascular bed. Alternatively, in reflection pulse oximetry, the LEDs and PD are both mounted side-by-side on the same planar substrate to enable readings from multiple body locations where transillumination measurements are not feasible. Clinically, forehead reflection pulse oximetry has been used as an alternative approach to conventional transmission-based

Manuscript received April 3, 2006. This work is supported by the U.S. Army Medical Research and Materiel Command under Contract No. DAMD17-03-2-0006. The views, opinions and/or findings are those of the author and should not be construed as an official Department of the Army position, policy, or decision, unless so designated by other documentation.

\*Corresponding author – Y. Mendelson is a Professor in the Department of Biomedical Engineering, Worcester Polytechnic Institute, Worcester, MA 01609 USA (phone: 508-831-5103; fax: 508-831-5541; e-mail: ym@wpi.edu).

R. J. Duckworth is a Professor in the Department of Electrical and Computer Engineering, Worcester Polytechnic Institute, Worcester, MA 01609 USA (rjduck@ece.wpi.edu).

G. Comtois is a M. S. student in the Department of Biomedical Engineering, Worcester Polytechnic Institute, Worcester, MA 01609 USA (comtoisg@wpi.edu).

oximetry when peripheral circulation to the extremities is compromised.

Pulse oximetry was initially intended for in-hospital use on patients undergoing or recovering from surgery. During the past few years, several companies have developed smaller pulse oximeters, some including data transmission via telemetry, to further expand the applications of pulse oximetry. For example, battery-operated pulse oximeters are now attached to patients during emergency transport as they are being moved from a remote location to a hospital, or between hospital wards. Some companies are also offering smaller units with improved electronic filtering of noisy PPG signals.

Several reports described the development of a wireless pulse oximeter that may be suitable for remote physiological monitoring [3]-[4]. Despite the steady progress in miniaturization of pulse oximeters over the years, to date, the most significant limitation is battery longevity and lack of telemetric communication. In this paper, we describe a prototype forehead-based reflectance pulse oximeter suitable for remote triage applications.

## II. SYSTEM ARCHITECTURE

The prototype system, depicted in Fig. 1, consists of a body-worn pulse oximeter that receives and processes the PPG signals measured by a small ( $\phi = 22\text{mm}$ ) and lightweight (4.5g) optical reflectance transducer. The system

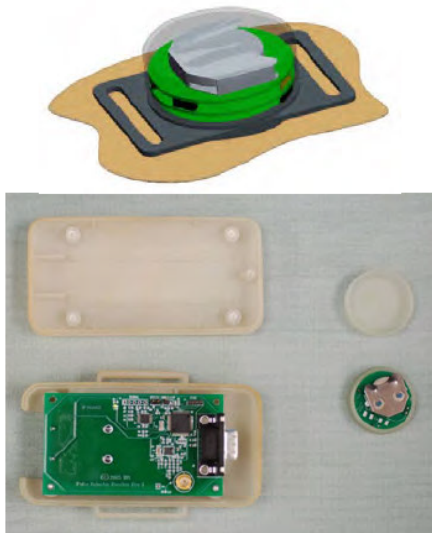

Fig. 1. (Top) Attachment of Sensor Module to the skin; (Bottom) photograph of the Receiver Module (left) and Sensor Module (right).

consists of three units: A Sensor Module, consisting of the optical transducer, a stack of round PCBs, and a coin-cell battery. The information acquired by the Sensor Module is transmitted wirelessly via an RF link over a short range to a body-worn Receiver Module. The data processed by the Receiver Module can be transmitted wirelessly to a PDA. The PDA can monitor multiple wearable pulse oximeters simultaneously and allows medics to collect vital physiological information to enhance their ability to extend more effective care to those with the most urgent needs. The

system can be programmed to alert on alarm conditions, such as sudden trauma, or physiological values out of their normal range. It also has the potential for use in combat casualty care, such as for remote triage, and for use by first responders, such as firefighters.

Key features of this system are small-size, robustness, and low-power consumption, which are essential attributes of wearable physiological devices, especially for military applications. The system block diagram (Fig. 2), is described in more detail below.

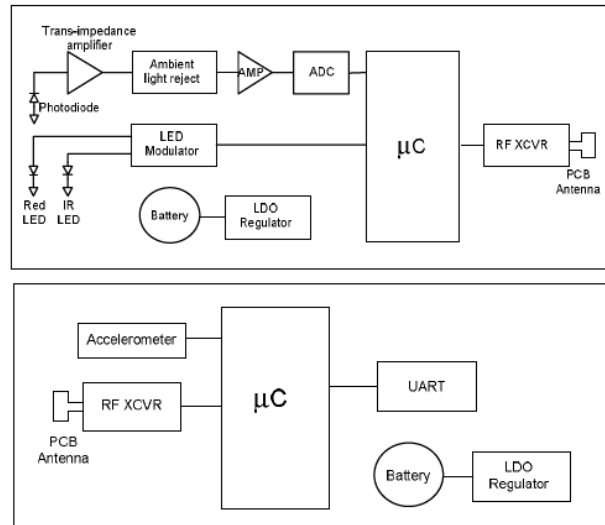

Fig. 2. System block diagram of the wearable, wireless, pulse oximeter. Sensor Module (top), Receiver Module (bottom).

**Sensor Module:** The Sensor Module contains analog signal processing circuitry, ADC, an embedded microcontroller, and a RF transceiver. The unit is small enough so the entire module can be integrated into a headband or a helmet. The unit is powered by a CR2032 type coin cell battery with 220mAh capacity, providing at least 5 days of operation.

**Receiver Module:** The Receiver Module contains an embedded microcontroller, RF transceiver for communicating with the Sensor Module, and a Universal Asynchronous Receive Transmit (UART) for connection to a PC. Signals acquired by the Sensor Module are received by the embedded microcontroller which synchronously converts the corresponding PD output to R and IR PPG signals. Dedicated software is used to filter the signals and compute  $\text{SpO}_2$  and HR based on the relative amplitude and frequency content of the reflected PPG signals. A tri-axis MEMS accelerometer detects changes in body activity, and the information obtained through the tilt sensing property of the accelerometer is used to determine the orientation of the person wearing the device.

To facilitate bi-directional wireless communications between the Receiver Module and a PDA, we used the DPAC Airborne™ LAN node module (DPAC Technologies, Garden Grove, CA). The DPAC module operates at a frequency of 2.4GHz, is 802.11b wireless compliant, and has a relatively small ( $1.6 \times 1.17 \times 0.46$  inches) footprint. The wireless module runs off a 3.7VDC and includes a built-in

TCP/IP stack, a radio, a base-band processor, an application processor, and software for a “drop-in” WiFi application. It has the advantage of being a plug-and-play device that does not require any programming and can connect with other devices through a standard UART.

*PDA:* The PDA was selected based on size, weight, and power consumption. Furthermore, the ability to carry the user interface with the medic also allows for greater flexibility during deployment. We chose the HP iPAQ h4150 PDA because it can support both 802.11b and Bluetooth™ wireless communication. It contains a modest amount of storage and has sufficient computational resources for the intended application. The use of a PDA as a local terminal also provides a low-cost touch screen interface. The user-friendly touch screen of the PDA offers additional flexibility. It enables multiple controls to occupy the same physical space and the controls appear only when needed. Additionally, a touch screen reduces development cost and time, because no external hardware is required. The data from the wireless-enabled PDA can also be downloaded or streamed to a remote base station via Bluetooth or other wireless communication protocols. The PDA can also serve to temporarily store vital medical information received from the wearable unit.

A dedicated National Instruments LabVIEW program was developed to control all interactions between the PDA and the wearable unit via a graphical user interface (GUI). One part of the LabVIEW software is used to control the flow of information through the 802.11b radio system on the PDA. A number of LabVIEW VIs programs are used to establish a connection, exchange data, and close the connection between the wearable pulse oximeter and the PDA. The LabVIEW program interacts with the Windows CE™ drivers of the PDA’s wireless system. The PDA has special drivers provided by the manufacturer that are used by Windows CE™ to interface with the 802.11b radio hardware. The LabVIEW program interacts with Windows CE™ on a higher level and allows Windows CE™ to handle the drivers and the direct control of the radio hardware.

The user interacts with the wearable system using a simple GUI, as depicted in Fig. 3.



Fig. 3. Sample PDA Graphical User Interface (GUI).

The GUI was configured to present the input and output information to the user and allows easy activation of various

functions. In cases of multiple wearable devices, it also allows the user to select which individual to monitor prior to initiating the wireless connection. Once a specific wearable unit is selected, the user connects to the remote device via the System Control panel that manages the connection and sensor control buttons. The GUI also displays the subject’s vital signs, activity level, body orientation, and a scrollable PPG waveform that is transmitted by the wearable device.

The stream of data received from the wearable unit is distributed to various locations on the PDA’s graphical display. The most prominent portion of the GUI display is the scrolling PPG waveform, shown in Fig. 3. Numerical SpO<sub>2</sub> and HR values are displayed in separate indicator windows. A separate tri-color indicator is used to annotate the subject’s activity level measured by the wearable accelerometer. This activity level was color coded using green, yellow, or red to indicate low or no activity, moderate activity, or high activity, respectively. In addition, the subject’s orientation is represented by a blue indicator that changes orientation according to body posture. Alarm limits could be set to give off a warning sign if the physiological information exceeds preset safety limits.

One of the unique features of this PDA-based wireless system architecture is the flexibility to operate in a free roaming mode. In this ad-hoc configuration, the system’s integrity depends only on the distance between each node. This allows the PDA to communicate with a remote unit that is beyond the PDA’s wireless range. The ad-hoc network would therefore allow medical personnel to quickly distribute sensors to multiple casualties and begin immediate triage, thereby substantially simplifying and reducing deployment time.

*Power Management:* Several features were incorporated into the design in order to minimize the power consumption of the wearable system. The most stringent consideration was the total operating power required by the Sensor Module, which has to drive the R and IR LEDs, process the data, and transmit this information wirelessly to the Receive Module. To keep the overall size of the Sensor Module as small as, it was designed to run on a watch style coin-cell battery.

It should be noted that low power management without compromising signal quality is an essential requirement in optimizing the design of wearable pulse oximeter. Commercially available transducers used with transmission and reflection pulse oximeters employ high brightness LEDs and a small PD element, typically with an active area ranging between 12 to 15mm<sup>2</sup>. One approach to lowering the power consumption of a wireless pulse oximeter, which is dominated by the current required to drive the LEDs, is to reduce the LED duty cycle. Alternatively, minimizing the drive currents supplied to the R and IR LEDs can also achieve a significant reduction in power consumption. However, with reduced current drive, there can be a direct impact on the quality of the detected PPGs. Furthermore, since most of the light emitted from the LEDs is diffused by the skin and subcutaneous tissues, in a predominantly forward-scattering direction, only a small fraction of the incident light is normally backscattered from the skin. In

addition, the backscattered light intensity is distributed over a region that is concentric with respect to the LEDs. Consequently, the performance of reflectance pulse oximetry using a small PD area is significantly degraded. To overcome this limitation, we showed that a concentric array of either discrete PDs, or an annularly-shaped PD ring, could be used to increase the amount of backscattered light detected by a reflectance type pulse oximeter sensor [5]-[7].

Besides a low-power consuming sensor, afforded by lowering the driving currents of the LEDs, a low duty cycle was employed to achieve a balance between low power consumption and adequate performance. In the event that continuous monitoring is not required, more power can be conserved by placing the device in an ultra low-power standby mode. In this mode, the radio is normally turned off and is only enabled for a periodic beacon to maintain network association. Moreover, a decision to activate the wearable pulse oximeter can be made automatically in the event of a patient alarm, or based on the activity level and posture information derived from the on-board accelerometer. The wireless pulse oximeter can also be activated or deactivated remotely by a medic as needed, thereby further minimizing power consumption.

### III. IN VIVO EVALUATIONS

Initial laboratory evaluations of the wearable pulse oximeter included simultaneous HR and SpO<sub>2</sub> measurements. The Sensor Module was positioned on the forehead using an elastic headband. Baseline recordings were made while the subject was resting comfortably and breathing at a normal tidal rate. Two intermittent recordings were also acquired while the subject held his breath for about 30 seconds. Fig. 4 displays about 4 minutes of SpO<sub>2</sub> and HR recordings acquired simultaneously by the sensor.

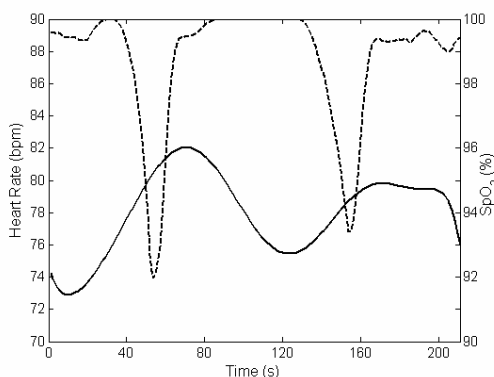

Fig. 4. Typical HR (solid line) and SpO<sub>2</sub> (dashed line) recording of two voluntary hypoxic episodes.

The pronounced drops in SpO<sub>2</sub> and corresponding increases in HR values coincide with the hypoxic events associated with the two breath holding episodes.

### IV. DISCUSSION

The emerging development of compact, low power, small size, light weight, and unobtrusive wearable devices can facilitate remote noninvasive monitoring of vital

physiological signs. Wireless physiological information can be useful to monitor soldiers during training exercises and combat missions, and help emergency first-responders operating in harsh and hazardous environments. Similarly, wearable physiological devices could become critical in helping to save lives following a civilian mass casualty. The primary goal of such a wireless mobile platform would be to keep track of an injured person's vital signs via a short-range wirelessly-linked personal area network, thus readily allowing RF telemetry of vital physiological information to command units and remote off-site base stations for continuous real-time monitoring by medical experts.

The preliminary bench testing plotted in Fig. 4 showed that the SpO<sub>2</sub> and HR readings are within an acceptable clinical range. Similarly, the transient changes measured during the two breath holding maneuvers confirmed that the response time of the custom pulse oximeter is adequate for detecting hypoxic episodes.

### V. CONCLUSION

A wireless, wearable, reflectance pulse oximeter has been developed based on a small forehead-mounted sensor. The battery-operated device employs a lightweight optical reflectance sensor and incorporates an annular photodetector to reduce power consumption. The system has short range wireless communication capabilities to transfer SpO<sub>2</sub>, HR, body acceleration, and posture information to a PDA carried by medics or first responders. The information could enhance the ability of first responders to extend more effective medical care, thereby saving the lives of critically injured persons.

### ACKNOWLEDGMENT

The authors would like to acknowledge the financial support provided by the U.S. Army Medical Research and Materiel Command referenced.

### REFERENCES

- [1] G. S. F. Ling, B. K. Day, P. Rhee, and J. M. Ecklund, "In search of technological solutions to battlefield management of combat casualties," *SPIE Conference on Battlefield Biomedical Technologies*, SPIE vol. 3712, Apr. 1999.
- [2] D. Malan, T. Fulford-Jones, M. Welsh, and S. Moulton, "CodeBlue: An ad-hoc sensor network infrastructure for emergency medical care," *International Workshop on Wearable and Implantable Body Sensor Networks*, 2004.
- [3] U. Anliker et al., "AMON: A wearable multiparameter medical monitoring and alert system," *IEEE Trans. on Information Technology in Biomedicine*, 8(4), 2004.
- [4] Y. Mendelson and V. Floroff, "A PDA based *ad-hoc* mobile wireless pulse oximeter," *Proc. IASTED International Conference Telehealth 2005*, Banff, Canada, 2005.
- [5] Y. Mendelson and C. J. Pujary, "Minimization of LED power consumption in the design of a wearable pulse oximeter," *IASTED International Conference BioMED 2003*, Salzburg, Austria, 2003.
- [6] Y. Mendelson and C. J. Pujary, "Measurement site and photodetector size considerations in optimizing power consumption of a wearable reflectance pulse oximeter," *Proc. of the 25<sup>th</sup> Annual International IEEE/EMBS Conference*, Cancun, Mexico, 2003.
- [7] P. Branche and Y. Mendelson, "Signal quality and power consumption of a new prototype reflectance pulse oximeter sensor," *Proc. of the 31<sup>th</sup> Annual Northeast Bioengineering Conference*, Hoboken, NJ, 2005.

## **APPENDIX QUICKSPECS01**



### Overview



- |                                     |                            |
|-------------------------------------|----------------------------|
| 1. Active Bluetooth/WLAN Indicator  | 6. Inbox Button            |
| 2. Power Button                     | 7. 5-Way Navigation Button |
| 3. LED Power/Notification Indicator | 8. Contacts Button         |
| 4. Color Display                    | 9. Calendar Button         |
| 5. iTask Button                     |                            |

### At A Glance

- Integrated WLAN 802.11b<sup>1</sup>
- Integrated Bluetooth™<sup>1</sup>
- Integrated SD expansion slot
- Microsoft® Windows® Mobile™ 2003 software for Pocket PC
- Dazzling Transflective TFT color with LED backlight display
- Removable/rechargeable battery
- Stay productive with Pocket versions of familiar applications like Microsoft Outlook , Word and Excel

**NOTE 1:** A standard WLAN infrastructure, other devices enabled with Bluetooth, and a service contract with a wireless airtime provider may be required for applicable wireless communication. Wireless Internet use requires a separately purchased service contract. Check with a service provider for availability and coverage in your area. Not all web content available.

### Standard Features

#### Models

##### iPAQ Pocket PC h4150 – 64-MB SDRAM

FA174A#ABA – US Commercial, English

FA174A#ABC – French Canadian

FA174A#ABG – Australia, New Zealand

FA174A#ABU – UK, English

FA174A#ABB – Euro English

FA174A#ABD – German

FA174A#ABF – French

FA174A#ABZ – Italian

FA174A#ABE – Spanish

FA174A#B16 – Latin America, Spanish

FA174A#AC4 – Brazilian Portuguese

FA174A#ABJ – Japanese

FA174A#UUF – APD, English

FA174A#AB2 – S-Chinese

FA174A#AB0 – Taiwan, T-Chinese

FA174A#AB5 – Hong Kong, T-Chinese

FA174A#AB1 – Korean

FA174A#ARE – Malaysia

##### iPAQ Pocket PC h4155 – 64-MB SDRAM

FA175A#ABA – US Retail, English

<b>Processor</b>	400 MHz Intel® Xscale™ technology-based processor	
<b>Memory</b>	<b>SDRAM</b>	64-MB (55-MB user accessible) Up to 2.8-MB iPAQ File Store (varies by SKU)
	<b>ROM</b>	32-MB
<b>Display</b>	<b>Type</b>	Transflective type TFT color with LED backlight
	<b>Number of Colors</b>	64K color (65,536 colors) 16-bit
	<b>Touch Screen</b>	Yes
	<b>Resolution (W x H)</b>	240 x 320
	<b>Viewable Image Size</b>	3.5 in (89 mm)
<b>Hardware Buttons/ Reset Buttons</b>	One power button, one recording button, one soft reset switch, four software programmable application buttons, one 5-way navigation button	
<b>Stylus</b>	One (extra stylus included in the box)	
<b>Audio</b>	Integrated microphone, speaker and one 3.5 mm headphone jack, MP3 stereo (through audio jack)	
<b>Notification Systems</b>	<b>Alarms</b>	Solid amber LED (right) - battery in unit fully charged Flashing amber LED (right) - battery in unit is charging Flashing green LED (right) - event alarm/notification Flashing green LED (left) - WLAN active Flashing blue LED (left) - Bluetooth active
	<b>Notification</b>	Sound and message on the display

### Standard Features

---

<b>Cradle Interfaces</b>	<b>Connector</b>	1
	<b>Cable</b>	1 USB cable connects to PC
	<b>DC Jack connector for AC Adapter</b>	1
	<b>Additional battery charger</b>	Charge additional slim or extended batter

---

<b>SD Slot</b>	Support SDIO and SD/MMC type standard
----------------	---------------------------------------

---

<b>Power Supply</b>	<b>Battery</b>	Removable/Rechargeable 1000 mAh Lithium-Ion user swappable battery. Estimated usage time of fully charged battery up to 12 hours (no wireless, no backlight). Optional extended 1800 mAh Lithium-Ion battery available for purchase.
	<b>AC Power</b>	AC Input: 100~240 Vac, 50/60 Hz, AC Input current: 0.2 Aac max Output Voltage: 5Vdc (typical), Output Current: 2A (typical)

**NOTE:** Battery run time varies based on the usage pattern of an individual user and the configuration of the handheld. Use of internal wireless capabilities and backlight will significantly decrease battery run time.

---

<b>Ergonomic Design Features</b>	Instant-on/off and Backlight
	5-way Navigation button
	Touch-sensitive display for stylus
	4 programmable application launch buttons - defaults configured for Calendar, Contacts, Inbox, and iTask buttons
	Record button
	2 alarm settings
Built-in speaker	

---

<b>HP Exclusive Applications</b>	Bluetooth Manager
	iPAQ File Store: non-volatile storage in flash ROM (not available in Japanese, Simplified Chinese, Traditional Chinese and Korean versions)
	iPAQ Backup: utility for Backup/Restore to Main Memory, Memory Card or iPAQ File Store
	iPAQ iTask Manager: access and launch programs easily
	iPAQ Image Zone: view images and create slide shows
	Utilities: Self Test, iPAQ Audio, Power Status

---

### Standard Features

#### Companion CD from HP

#### APPLICATIONS

##### Full Versions

HP Web registration  
HP Mobile Print Center  
Westtek ClearVue Suite  
F-Secure FileCrypto Data Encryption  
Colligo Personal Edition  
Adobe PDF Viewer  
RealOne Player for Pocket PC  
iPresenter PowerPoint converter  
MobiMate WorldMate  
Resco File Explorer 2003 - U.S. Retail only

##### CD LINKS

NetMotion  
Avaya IP Softphone  
IP Blue VTGO!  
Cisco CallManager  
Pocket Presence Running Voice IP  
Vindigo  
Audible Manager and Audible Player (Service plan required to download and play Audible content - link)  
SingleTap  
Handango  
Pocket Backup Plus

##### Additional Documentation

Safety and Comfort Guide on PDF, and User Guide on PDF

**NOTE:** Programs may vary based on SKU. Some programs are accessed through CD links to download web sites.

---

#### Operating System

Microsoft Windows Mobile 2003 software for Pocket PC - Premium edition  
Pocket versions of Microsoft software are included (Outlook, Word, Excel and Internet Explorer for Pocket PC)

---

#### Operating System Applications

Powered by Microsoft Windows Mobile 2003 for Pocket PC  
Calendar, Contacts, Tasks, Voice Recorder, Notes, Pocket Word (with Spellchecker), Pocket Excel, Pocket Internet Explorer, Windows Media Player 9 (MP3, audio and video streaming), Calculator, Solitaire, Jawbreaker, Inbox (with Spell Checker for email), Microsoft Reader (eBooks), File Explorer, Pictures, Terminal Services Client, VPN Client, Infrared Beaming, Clock, Align Screen, Memory, Volume control, ClearType Tuner (except for Asian languages)

---

#### Additional Software and links

Outlook 2002, Microsoft ActiveSync 3.7 (Desktop device synchronization), Microsoft Reader eBooks, Links to Microsoft websites for additional downloadable applications (some programs may require purchase of additional desktop software to utilize Pocket PC versions)

---

#### Service and Support

One-year parts and labor in most regions; two-year warranty in Europe (one-year warranty for rechargeable battery pack) 90 days technical support for software in all regions. Optional HP Care Pack available in North America for Next Business Day replacement (at additional charge)

---

### Standard Features

<b>WLAN Specifications<sup>1</sup> Radio Specifications</b>	<b>RF Network Standard</b>	IEEE 802 Part 11b (802.11b)
	<b>Frequency Band</b>	2.4000 to 2.4835 GHz 2.4465 to 2.4835 GHz (France) 2.4000 to 2.497 GHz (Japan)
	<b>Antenna type</b>	Embedded Inverted F Antenna
	<b>WEP Security</b>	64/128-bit compliant to IEEE 802.11 Compliant to 802.1X
	<b>Network Architecture Models</b>	Ad-hoc (Peer to Peer) Infrastructure (Access Points Required)
	<b>Modulation Technique</b>	Direct Sequence Spread Spectrum
	<b>Modulation Schemes</b>	DBPSK, DQPSK, CCK
	<b>Receiver Sensitivity - Packet Error Rate (8E-2)</b>	11 Mbps: <-80 dBm 5.5 Mbps: <-82 dBm 2 Mbps: <-86 dBm 1 Mbps: <-89 dBm
	<b>Maximum Receive Level</b>	-10dBm (1/2/5.5/11 Mbps)
	<b>Output Power (maximum)</b>	15 dBm (limited due to FCC SARS requirements)
	<b>Power Management</b>	Radio On/Off control through Microsoft Connection icon, Power Save mode available in Power Settings
	<b>Power Consumption</b>	Transfer mode: < 380 mA, average Receive mode: < 280 mA, average
	<b>Power Saving Option</b>	802.11 Compliant Power Saving, idle mode 25 mA
	<b>Media Access Protocol</b>	CSMA/CA (Collision Avoidance) with ACK
	<b>Protocols Supported</b>	TCP/IP IPX/SPX UDP
	<b>SAR</b>	1.0 mW/g
	<b>Throughput</b>	>4.5 Mbps
	<b>Operating Distance</b>	Up to 1000 feet - open sight
	<b>Certifications</b>	All necessary regulatory approvals for countries we support including: WECA Wi-Fi approval FCC (47 CFR) Part 15C, Section 15.247&15.249 ETS 300 328, ETS 301 489-1 Low Voltage Directive IEC950 UL, CSA, and CE Mark

**NOTE:** <sup>1</sup> A standard WLAN infrastructure, other devices enabled with Bluetooth, and a service contract with a wireless airtime provider may be required for applicable wireless communication. Wireless Internet use requires a separately purchased service contract. Check with a service provider for availability and coverage in your area. Not all web content available.

### Standard Features

<b>Bluetooth Specifications<sup>1</sup></b>	<b>Technology</b>	High-speed, low-power, short-range
	<b>Bluetooth specification</b>	1.1 compliant (2.4-GHz Industrial Scientific Medical Band)
	<b>System interface</b>	High-speed UART processor interface
	<b>User Interface</b>	Bluetooth Manager
	<b>Device type</b>	Class II device; up to 4 dBm transmit, typical 10 meter range
	<b>Power</b>	3.3V 5% Peak current - typical TX current at approximately 30mA - typical RX current at approximately 50 mA
	<b>Receiver sensitivity</b>	-78 dBm
	<b>Regulatory standards</b>	R&T#-EN 300 328 and EN 300 826, UL 1950, CB Safety Scheme inclusive of EN 60950 and IEC 950, FCC Part 15 subpart C, Canadian, CE
	<b>Profile Support</b>	General Access Profile Service Discovery Application Profile Serial Port Profile Generic Object Exchange Profile File Transfer Profile Dial-Up Networking Profile LAN Access Profile Object Push Profile Personal Area Networking Profile Basic Printing Profile Hard Copy Replacement Profile (printing)
	<b>Usage Models<sup>1</sup></b>	<b>Service Discovery</b> Determine what Bluetooth devices are within range and support authorization <b>File Transfer</b> File and directory browsing and navigation on another Bluetooth device. File copying Object manipulation - including add, delete, create new folders etc. <b>Serial Port</b> Synchronization between PDAs and PCs <b>Dial Up Networking</b> Wireless link to WAN thru Bluetooth enabled cell phone <sup>1</sup> Agnostic to WAN technology Send/receive SMS messages <b>LAN Access</b> Wireless link to Corporate LAN using Bluetooth and appropriate Bluetooth access point <sup>1</sup> Corporate email, network neighborhood, access to LAN applications, file transfer, ftp, Internet browsing, etc, using TCP/IP <sup>1</sup> Access the Internet by connecting to your desktop or notebook over Bluetooth and using its network connection <sup>1</sup> <b>Generic Object Exchange and Object Push</b> Exchange business cards, tasks, documents, appointments and more <sup>1</sup> <b>Personal Area Networking</b> Collaborate, chat, play games, exchange data <sup>1</sup> Adhoc peer to peer networking <sup>1</sup> <b>Basic Printing and Hard Copy Replacement Profiles</b> Print to any HP Bluetooth enabled printer without the need for cables or specific print drivers
	<b>Certifications</b>	All necessary regulatory approvals for countries we support including: Bluetooth logo, FCC (47 CFR) Part 15C, Section 15.247&15.249 ETS 300 328, ETS 301 489-1/17 Low Voltage Directive IEC950 UL and CE Mark

**NOTE:** <sup>1</sup> A standard WLAN infrastructure, other devices enabled with Bluetooth, and a service contract with a wireless airtime provider may be required for applicable wireless communication. Wireless Internet use requires a separately purchased service contract. Check with a service provider for availability and coverage in your area. Not all web content available.

# QuickSpecs

HP iPAQ Pocket PC h4150 Series

## TechSpecs

<b>System Unit</b>	<b>Dimensions (H x W x D)</b>	4.47 in x 2.78 in x 0.5 in (113.6 mm x 70.6 mm x 13.5 mm)	
	<b>Weight</b>	4.67oz (132 g)	
	<b>Operating Temperature</b>	32° to 104° F (0° to 40° C)	
	<b>Storage Temperature</b>	-4° to 140° F (-20° to 60° C)	
	<b>Operating Humidity</b>	90% RH	
	<b>Regulatory Marks</b>	Electrical	FCC Class B, UL or CSA NRTL
	Safety	C-UL, NOM	

<b>TFT Color Display</b>	<b>Number of Colors</b>	65,536 (64K 16-bit)	
	<b>Resolution (W x H)</b>	240 x 320	
	<b>Dot Pitch</b>	0.24 mm	
	<b>Viewable Image (W x H)</b>	3.5 in (89 mm)	
	<b>Display Type</b>	64K color (16-bit) transreflective type TFT color with LED	

<b>AC Adapter</b>	<b>Dimensions (H x W x D)</b>	3 x 1.9 x 1.8 in (76 x 48 x 44 mm) (including prongs)		
	<b>Cord Length (approximate)</b>	6 ft (1.83 m)		
	<b>Power Supply Ratings</b>	<b>Voltage Range</b>	100 to 240 V Switching	
		<b>Input Current</b>	0.3 A	
		<b>Input Frequency</b>	50 to 60 Hz	
		<b>Output Voltage</b>	5 VDC	
	<b>Output Current</b>	2 Amp		

# QuickSpecs

## HP iPAQ Pocket PC h4150 Series

### Options

**NOTE:** Optional accessories are available at additional cost.

<b>Memory/Storage</b>	64-MB SD Memory Card	253478-B21	FA134A#AC3
	128 MB SD Memory Card	253479-B21	FA135A#AC3
	256 MB SD Memory Card	287464-B21	FA136A#AC3
	512-MB SD Memory Card	344310-B21	FA184A#AC3
<b>Power</b>	1800 mAh Lithium Ion Extended Battery	343110-001	FA192A#AC3
	1000 mAh Lithium Ion Slim Battery	343111-001	FA191A#AC3
	Auto Adapter	253508-B21	FA125A#AC3
	Charger Adapter	274707-B21	FA133A#AC3
	AC Adapter		
	U.S., Canada, Latin America, Japan, Taiwan	253629-001	FA130A#ABA
	Australia	253629-011	FA130A#ABG
Europe, Brazil	253629-021	FA130A#ABB	
United Kingdom, Asia Pacific, Hong Kong	253629-031	FA130A#ABU	
<b>Synchronization</b>	Desktop Cradle	343116-001	FA188A#AC3
	USB Charge/Sync Cable		FA122A#AC3
<b>Other</b>	Stylus Three-pack	331311-B21	FA113#AC3
	Foldable Keyboard	249693-xxx	FA118A#xxx
	Micro keyboard		FA162A#AC3
<b>Performance</b>	Photosmart Mobile Camera (SDIO Camera)		FA185A#AC3
	iPAQ Navigation System (U.S. only)		FA196A#AC3
<b>Cases</b>	Nylon Case	339657-B21	FA161A#AC3
	Leather Belt Case	339656-B21	FA160A#AC3
	Custom Cases: to view and order go to: <a href="http://www.casesonline.com/">http://www.casesonline.com/</a>		



## HP iPAQ Pocket PC h4150 is a Microsoft® Windows® Powered Pocket PC

For more information on HP iPAQ Pocket PC, visit our website at <http://www.hp.com/go/iPAQ>

©2003 Hewlett-Packard Development Company, L.P.

The information in this document is subject to change without notice.

The only warranties for HP products and services are set forth in the express warranty statements accompanying such products and services. Nothing herein should be construed as constituting an additional warranty. HP shall not be liable for technical or editorial errors or omissions contained herein. Microsoft, Windows and the Windows Logo are registered trademarks or trademarks of Microsoft Corporation in the United States and/or other countries. Intel is a registered trademark of Intel Corporation in the U.S. and/or other countries.













## **APPENDIX QUICKSPECS02**

## Index of /HP/Ipq/Retired Products/h4150

---

 [\[parent directory\]](#)

	<b>Name</b>	<b>Size</b>	<b>Date Modified</b>
	<a href="#">iPaq_4150_quick_specs.pdf</a>	290 kB	11/20/03, 7:00:00 PM
	<a href="#">iPaq_h4000_Series_User_Guide.pdf</a>	2.4 MB	11/20/03, 7:00:00 PM
	<a href="#">iPaq_h4150_1.JPG</a>	124 kB	11/20/03, 7:00:00 PM
	<a href="#">iPaq_h4150_2.JPG</a>	169 kB	11/20/03, 7:00:00 PM
	<a href="#">iPaq_h4150_3.JPG</a>	375 kB	11/20/03, 7:00:00 PM
	<a href="#">iPaq_h4150_4.JPG</a>	227 kB	11/20/03, 7:00:00 PM
	<a href="#">iPaq_h4150_with_desktop_cradle.JPG</a>	172 kB	11/20/03, 7:00:00 PM
	<a href="#">iPaq_h4150_with_photosmart_digital_camera.JPG</a>	117 kB	11/20/03, 7:00:00 PM

## **APPENDIX IEEE01**



**DECLARATION OF GORDON MACPHERSON**

I, Gordon MacPherson, am over twenty-one (21) years of age. I have never been convicted of a felony, and I am fully competent to make this declaration. I declare the following to be true to the best of my knowledge, information and belief:

1. I am Director Board Governance & IP Operations of The Institute of Electrical and Electronics Engineers, Incorporated (“IEEE”).
2. IEEE is a neutral third party in this dispute.
3. I am not being compensated for this declaration and IEEE is only being reimbursed for the cost of the article I am certifying.
4. Among my responsibilities as Director Board Governance & IP Operations, I act as a custodian of certain records for IEEE.
5. I make this declaration based on my personal knowledge and information contained in the business records of IEEE.
6. As part of its ordinary course of business, IEEE publishes and makes available technical articles and standards. These publications are made available for public download through the IEEE digital library, IEEE Xplore.
7. It is the regular practice of IEEE to publish articles and other writings including article abstracts and make them available to the public through IEEE Xplore. IEEE maintains copies of publications in the ordinary course of its regularly conducted activities.
8. The article below has been attached as Exhibit A to this declaration:

A.	Y. Mendelson, R. J. Duckworth, and G. Comtois, “A Wearable Reflectance Pulse Oximeter for Remote Physiological Monitoring”, 2006 International Conference of the IEEE Engineering in Medicine and Biology Society, August 30, 2006 - September 3, 2006.
----	---

9. I obtained a copy of Exhibit A through IEEE Xplore, where it is maintained in the ordinary course of IEEE’s business. Exhibit A is a true and correct copy of the Exhibit, as it existed on or about April 30, 2021.

10. The article and abstract from IEEE Xplore shows the date of publication. IEEE Xplore populates this information using the metadata associated with the publication.
11. Y. Mendelson, R. J. Duckworth, and G. Comtois, “A Wearable Reflectance Pulse Oximeter for Remote Physiological Monitoring” was published in the 2006 International Conference of the IEEE Engineering in Medicine and Biology Society. The 2006 International Conference of the IEEE Engineering in Medicine and Biology Society was held from August 30, 2006 - September 3, 2006. Copies of the conference proceedings were made available no later than the last day of the conference. The article is currently available for public download from the IEEE digital library, IEEE Xplore.
12. I hereby declare that all statements made herein of my own knowledge are true and that all statements made on information and belief are believed to be true, and further that these statements were made with the knowledge that willful false statements and the like are punishable by fine or imprisonment, or both, under 18 U.S.C. § 1001.

I declare under penalty of perjury that the foregoing statements are true and correct.

Executed on: 5/3/2021

DocuSigned by:  
*Gordon Macpherson*  
E768DB210F4E4EF...

DocuSign Envelope ID: 3595DB4B-1765-4589-8185-7AD82F0E2BC1

# EXHIBIT A



All



ADVANCED SEARCH

Conferences > 2006 International Conference...

Back to Results

# A Wearable Reflectance Pulse Oximeter for Remote Physiological Monitoring

Publisher: **IEEE**

[Cite This](#)

PDF

<< Results

Y. Mendelson ; R. J. Duckworth ; G. Comtois **All Authors**

**52**  
Paper  
Citations

**35**  
Patent  
Citations

**1303**  
Full  
Text Views



Export to

Collabratec

**Alerts**

Manage

Content Alerts

Add to Citation

Alerts

## More Like This

Development of an Implantable Pulse Oximeter  
IEEE Transactions on Biomedical Engineering  
Published: 2008

Wearable System for Monitoring of Oxygen Concentration in Breath Based on Optical Sensor  
IEEE Sensors Journal  
Published: 2015

**Show More**

Abstract

Document Sections

I. Introduction

II. System Architecture

III. In Vivo Evaluations

IV. Discussion

V. Conclusion

**Authors**

Figures

References

Citations

Keywords

Metrics

Downl  
PDF

**Abstract:**To save life, casualty care requires that trauma injuries are accurately and expeditiously assessed in the field. This paper describes the initial bench testing of a wire... **View more**

### Metadata

#### Abstract:

To save life, casualty care requires that trauma injuries are accurately and expeditiously assessed in the field. This paper describes the initial bench testing of a wireless wearable pulse oximeter developed based on a small forehead mounted sensor. The battery operated device employs a lightweight optical reflectance sensor and incorporates an annular photodetector to reduce power consumption. The system also has short range wireless communication capabilities to transfer arterial oxygen saturation (SpO<sub>2</sub>), heart rate (HR), body acceleration, and posture information to a PDA. It has the potential for use in combat casualty care, such as for remote triage, and by first responders, such as firefighters

**Published in:** 2006 International Conference of the IEEE Engineering in Medicine and Biology Society

**Date of Conference:** 30 Aug.-3 Sept. 2006 **INSPEC Accession Number:** 9220069

DOI: 10.1109/IEMBS.2006.260137

**Date Added to IEEE Xplore:** 15 December 2016 **Publisher:** IEEE

**Print ISBN:** 1-4244-0032-5

**Conference Location:** New York, NY, USA

**Print ISSN:** 1557-170X

**PubMed ID:** 17946007  
Y. Mendelson

Department of Biomedical Engineering, Worcester Polytechnic Institute, Worcester, MA, USA

R. J. Duckworth  
Department of Electrical and Computer Engineering, Worcester Polytechnic Institute, Worcester, MA, USA

G. Comtois  
Department of Biomedical Engineering, Worcester Polytechnic Institute, Worcester, MA, USA

 **Contents**

**I. Introduction**

Steady advances in noninvasive physiological sensing, hardware miniaturization, and wireless communication are leading to the development of new wearable technologies that have broad and important implications for civilian and military applications [1]–[2]. For example, the emerging development of compact, low-power, small-size, light-weight, and unobtrusive wearable devices may facilitate remote noninvasive monitoring of vital signs from soldiers during training exercises and combat. Telemetry of physiological information via a short-range wirelessly-linked personal area network can also be useful for firefighters, hazardous material workers, mountain climbers, or emergency first-responders operating in harsh and hazardous environments. The primary goal of this mobile platform would be to keep track of an injured person's vital signs, thus readily allowing the telemetry of physiological information to medical providers, and support emergency responders in making critical and often life saving decisions in order to expedite rescue operations. Having wearable physiological monitoring could offer far-forward medics numerous advantages, including the ability to determine a casualty's condition remotely without exposing the first responders to increased risks, quickly identifying the severity of injuries especially when the injured are greatly dispersed over large geographical terrains and often out-of-site, and continuously tracking the injured condition until they arrive safely at a medical care facility.

**Authors** 

Y. Mendelson  
Department of Biomedical Engineering, Worcester Polytechnic Institute, Worcester, MA, USA

R. J. Duckworth  
Department of Electrical and Computer Engineering, Worcester Polytechnic Institute, Worcester, MA, USA

G. Comtois  
Department of Biomedical Engineering, Worcester Polytechnic Institute, Worcester, MA, USA



<a href="#">Figures</a>	▼
<a href="#">References</a>	▼
<a href="#">Citations</a>	▼
<a href="#">Keywords</a>	▼
<a href="#">Metrics</a>	▼

#### IEEE Personal Account

[CHANGE USERNAME/PASSWORD](#)

#### Purchase Details

[PAYMENT OPTIONS](#)

[VIEW PURCHASED DOCUMENTS](#)

#### Profile Information

[COMMUNICATIONS PREFERENCES](#)

[PROFESSION AND EDUCATION](#)

[TECHNICAL INTERESTS](#)

#### Need Help?

[US & CANADA: +1 800 678 4333](#)

[WORLDWIDE: +1 732 981 0060](#)

[CONTACT & SUPPORT](#)

#### Follow



[About IEEE Xplore](#) | [Contact Us](#) | [Help](#) | [Accessibility](#) | [Terms of Use](#) | [Nondiscrimination Policy](#) | [Sitemap](#) | [Privacy & Opting Out of Cookies](#)

A not-for-profit organization, IEEE is the world's largest technical professional organization dedicated to advancing technology for the benefit of humanity.

© Copyright 2021 IEEE - All rights reserved. Use of this web site signifies your agreement to the terms and conditions.

#### IEEE Account

» [Change Username/Password](#)

» [Update Address](#)

#### Purchase Details

» [Payment Options](#)

» [Order History](#)

» [View Purchased Documents](#)

#### Profile Information

» [Communications Preferences](#)

» [Profession and Education](#)

» [Technical Interests](#)

#### Need Help?

» **US & Canada:** +1 800 678 4333

» **Worldwide:** +1 732 981 0060

» [Contact & Support](#)

[About IEEE Xplore](#) | [Contact Us](#) | [Help](#) | [Accessibility](#) | [Terms of Use](#) | [Nondiscrimination Policy](#) | [Sitemap](#) | [Privacy & Opting Out of Cookies](#)

A not-for-profit organization, IEEE is the world's largest technical professional organization dedicated to advancing technology for the benefit of humanity.

© Copyright 2021 IEEE - All rights reserved. Use of this web site signifies your agreement to the terms and conditions.

## A Wearable Reflectance Pulse Oximeter for Remote Physiological Monitoring

Y. Mendelson\*, *Member, IEEE*, R. J. Duckworth, *Member, IEEE*, and G. Comtois, *Student Member, IEEE*

**Abstract**—To save life, casualty care requires that trauma injuries are accurately and expeditiously assessed in the field. This paper describes the initial bench testing of a wireless wearable pulse oximeter developed based on a small forehead mounted sensor. The battery operated device employs a lightweight optical reflectance sensor and incorporates an annular photodetector to reduce power consumption. The system also has short range wireless communication capabilities to transfer arterial oxygen saturation (SpO<sub>2</sub>), heart rate (HR), body acceleration, and posture information to a PDA. It has the potential for use in combat casualty care, such as for remote triage, and by first responders, such as firefighters.

### I. INTRODUCTION

STEADY advances in noninvasive physiological sensing, hardware miniaturization, and wireless communication are leading to the development of new wearable technologies that have broad and important implications for civilian and military applications [1]-[2]. For example, the emerging development of compact, low-power, small-size, light-weight, and unobtrusive wearable devices may facilitate remote noninvasive monitoring of vital signs from soldiers during training exercises and combat. Telemetry of physiological information via a short-range wirelessly-linked personal area network can also be useful for firefighters, hazardous material workers, mountain climbers, or emergency first-responders operating in harsh and hazardous environments. The primary goals of such a wireless mobile platform would be to keep track of an injured person's vital signs, thus readily allowing the telemetry of physiological information to medical providers, and support emergency responders in making critical and often life saving decisions in order to expedite rescue operations. Having wearable physiological monitoring could offer far-forward medics numerous advantages, including the ability to determine a casualty's condition remotely without exposing the first

responders to increased risks, quickly identifying the severity of injuries especially when the injured are greatly dispersed over large geographical terrains and often out-of-site, and continuously tracking the injured condition until they arrive safely at a medical care facility.

Several technical challenges must be overcome to address the unmet demand for long-term continuous physiological monitoring in the field. In order to design more compact sensors and improved wearable instrumentation, perhaps the most critical challenges are to develop more power efficient and low-weight devices. To become effective, these technologies must also be robust, comfortable to wear, and cost-effective. Additionally, before wearable devices can be used effectively in the field, they must become unobtrusive and should not hinder a person's mobility. Employing commercial off-the-shelf (COTS) solutions, for example finger pulse oximeters to monitor blood oxygenation and heart rate, or standard adhesive-type disposable electrodes for ECG monitoring, is not practical for many field applications because they limit mobility and can interfere with normal tasks.

A potentially attractive approach to aid emergency medical teams in remote triage operations is the use of a wearable pulse oximeter to wirelessly transmit heart rate (HR) and arterial oxygen saturation (SpO<sub>2</sub>) to a remote location. Pulse oximetry is a widely accepted method that is used for noninvasive monitoring of SpO<sub>2</sub> and HR. The method is based on spectrophotometric measurements of changes in the optical absorption of deoxyhemoglobin (Hb) and oxyhemoglobin (HbO<sub>2</sub>). Noninvasive spectrophotometric measurements of SpO<sub>2</sub> are performed in the visible (600-700nm) and near-infrared (700-1000nm) spectral regions. Pulse oximetry also relies on the detection of photoplethysmographic (PPG) signals produced by variations in the quantity of arterial blood that is associated with periodic contractions and relaxations of the heart. Measurements can be performed in either transmission or reflection modes. In transmission pulse oximetry, the sensor can be attached across a fingertip, foot, or earlobe. In this configuration, the light emitting diodes (LEDs) and photodetector (PD) in the sensor are placed on opposite sides of a peripheral pulsating vascular bed. Alternatively, in reflection pulse oximetry, the LEDs and PD are both mounted side-by-side on the same planar substrate to enable readings from multiple body locations where transillumination measurements are not feasible. Clinically, forehead reflection pulse oximetry has been used as an alternative approach to conventional transmission-based

Manuscript received April 3, 2006. This work is supported by the U.S. Army Medical Research and Materiel Command under Contract No. DAMD17-03-2-0006. The views, opinions and/or findings are those of the author and should not be construed as an official Department of the Army position, policy, or decision, unless so designated by other documentation.

\*Corresponding author – Y. Mendelson is a Professor in the Department of Biomedical Engineering, Worcester Polytechnic Institute, Worcester, MA 01609 USA (phone: 508-831-5103; fax: 508-831-5541; e-mail: ym@wpi.edu).

R. J. Duckworth is a Professor in the Department of Electrical and Computer Engineering, Worcester Polytechnic Institute, Worcester, MA 01609 USA (rjduck@ece.wpi.edu).

G. Comtois is a M. S. student in the Department of Biomedical Engineering, Worcester Polytechnic Institute, Worcester, MA 01609 USA (comtoisg@wpi.edu).

oximetry when peripheral circulation to the extremities is compromised.

Pulse oximetry was initially intended for in-hospital use on patients undergoing or recovering from surgery. During the past few years, several companies have developed smaller pulse oximeters, some including data transmission via telemetry, to further expand the applications of pulse oximetry. For example, battery-operated pulse oximeters are now attached to patients during emergency transport as they are being moved from a remote location to a hospital, or between hospital wards. Some companies are also offering smaller units with improved electronic filtering of noisy PPG signals.

Several reports described the development of a wireless pulse oximeter that may be suitable for remote physiological monitoring [3]-[4]. Despite the steady progress in miniaturization of pulse oximeters over the years, to date, the most significant limitation is battery longevity and lack of telemetric communication. In this paper, we describe a prototype forehead-based reflectance pulse oximeter suitable for remote triage applications.

## II. SYSTEM ARCHITECTURE

The prototype system, depicted in Fig. 1, consists of a body-worn pulse oximeter that receives and processes the PPG signals measured by a small ( $\phi = 22\text{mm}$ ) and lightweight (4.5g) optical reflectance transducer. The system

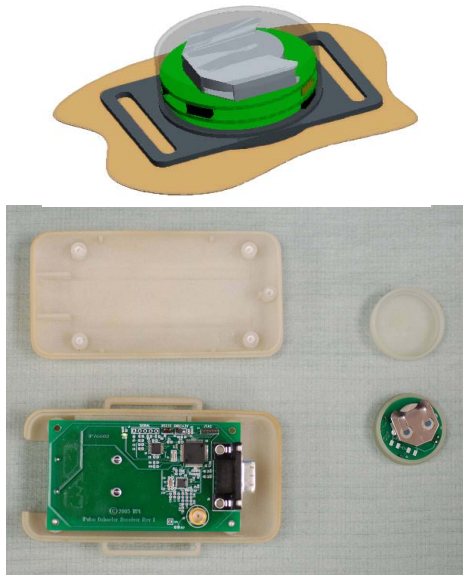

Fig. 1. (Top) Attachment of Sensor Module to the skin; (Bottom) photograph of the Receiver Module (left) and Sensor Module (right).

consists of three units: A Sensor Module, consisting of the optical transducer, a stack of round PCBs, and a coin-cell battery. The information acquired by the Sensor Module is transmitted wirelessly via an RF link over a short range to a body-worn Receiver Module. The data processed by the Receiver Module can be transmitted wirelessly to a PDA. The PDA can monitor multiple wearable pulse oximeters simultaneously and allows medics to collect vital physiological information to enhance their ability to extend more effective care to those with the most urgent needs. The

system can be programmed to alert on alarm conditions, such as sudden trauma, or physiological values out of their normal range. It also has the potential for use in combat casualty care, such as for remote triage, and for use by first responders, such as firefighters.

Key features of this system are small-size, robustness, and low-power consumption, which are essential attributes of wearable physiological devices, especially for military applications. The system block diagram (Fig. 2), is described in more detail below.

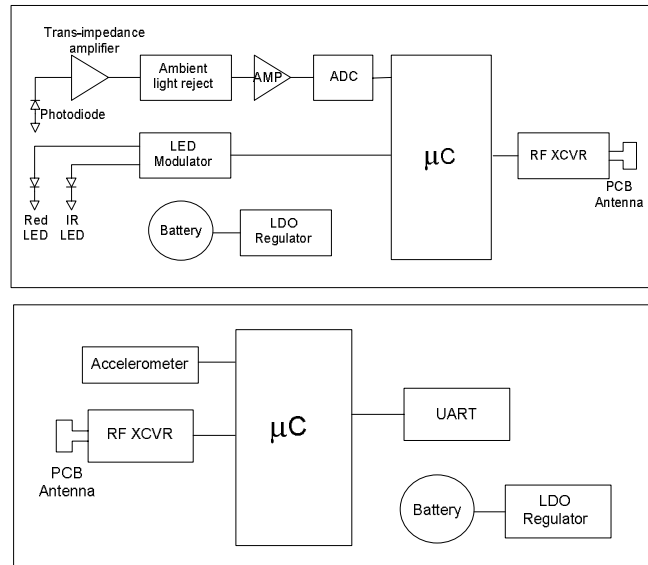

Fig. 2. System block diagram of the wearable, wireless, pulse oximeter. Sensor Module (top), Receiver Module (bottom).

**Sensor Module:** The Sensor Module contains analog signal processing circuitry, ADC, an embedded microcontroller, and a RF transceiver. The unit is small enough so the entire module can be integrated into a headband or a helmet. The unit is powered by a CR2032 type coin cell battery with 220mAh capacity, providing at least 5 days of operation.

**Receiver Module:** The Receiver Module contains an embedded microcontroller, RF transceiver for communicating with the Sensor Module, and a Universal Asynchronous Receive Transmit (UART) for connection to a PC. Signals acquired by the Sensor Module are received by the embedded microcontroller which synchronously converts the corresponding PD output to R and IR PPG signals. Dedicated software is used to filter the signals and compute  $\text{SpO}_2$  and HR based on the relative amplitude and frequency content of the reflected PPG signals. A tri-axis MEMS accelerometer detects changes in body activity, and the information obtained through the tilt sensing property of the accelerometer is used to determine the orientation of the person wearing the device.

To facilitate bi-directional wireless communications between the Receiver Module and a PDA, we used the DPAC Airborne™ LAN node module (DPAC Technologies, Garden Grove, CA). The DPAC module operates at a frequency of 2.4GHz, is 802.11b wireless compliant, and has a relatively small ( $1.6 \times 1.17 \times 0.46$  inches) footprint. The wireless module runs off a 3.7VDC and includes a built-in

TCP/IP stack, a radio, a base-band processor, an application processor, and software for a “drop-in” WiFi application. It has the advantage of being a plug-and-play device that does not require any programming and can connect with other devices through a standard UART.

*PDA:* The PDA was selected based on size, weight, and power consumption. Furthermore, the ability to carry the user interface with the medic also allows for greater flexibility during deployment. We chose the HP iPAQ h4150 PDA because it can support both 802.11b and Bluetooth™ wireless communication. It contains a modest amount of storage and has sufficient computational resources for the intended application. The use of a PDA as a local terminal also provides a low-cost touch screen interface. The user-friendly touch screen of the PDA offers additional flexibility. It enables multiple controls to occupy the same physical space and the controls appear only when needed. Additionally, a touch screen reduces development cost and time, because no external hardware is required. The data from the wireless-enabled PDA can also be downloaded or streamed to a remote base station via Bluetooth or other wireless communication protocols. The PDA can also serve to temporarily store vital medical information received from the wearable unit.

A dedicated National Instruments LabVIEW program was developed to control all interactions between the PDA and the wearable unit via a graphical user interface (GUI). One part of the LabVIEW software is used to control the flow of information through the 802.11b radio system on the PDA. A number of LabVIEW VIs programs are used to establish a connection, exchange data, and close the connection between the wearable pulse oximeter and the PDA. The LabVIEW program interacts with the Windows CE™ drivers of the PDA’s wireless system. The PDA has special drivers provided by the manufacturer that are used by Windows CE™ to interface with the 802.11b radio hardware. The LabVIEW program interacts with Windows CE™ on a higher level and allows Windows CE™ to handle the drivers and the direct control of the radio hardware.

The user interacts with the wearable system using a simple GUI, as depicted in Fig. 3.

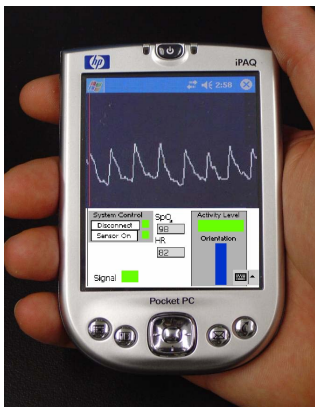

Fig. 3. Sample PDA Graphical User Interface (GUI).

The GUI was configured to present the input and output information to the user and allows easy activation of various

functions. In cases of multiple wearable devices, it also allows the user to select which individual to monitor prior to initiating the wireless connection. Once a specific wearable unit is selected, the user connects to the remote device via the System Control panel that manages the connection and sensor control buttons. The GUI also displays the subject’s vital signs, activity level, body orientation, and a scrollable PPG waveform that is transmitted by the wearable device.

The stream of data received from the wearable unit is distributed to various locations on the PDA’s graphical display. The most prominent portion of the GUI display is the scrolling PPG waveform, shown in Fig. 3. Numerical SpO<sub>2</sub> and HR values are displayed in separate indicator windows. A separate tri-color indicator is used to annotate the subject’s activity level measured by the wearable accelerometer. This activity level was color coded using green, yellow, or red to indicate low or no activity, moderate activity, or high activity, respectively. In addition, the subject’s orientation is represented by a blue indicator that changes orientation according to body posture. Alarm limits could be set to give off a warning sign if the physiological information exceeds preset safety limits.

One of the unique features of this PDA-based wireless system architecture is the flexibility to operate in a free roaming mode. In this ad-hoc configuration, the system’s integrity depends only on the distance between each node. This allows the PDA to communicate with a remote unit that is beyond the PDA’s wireless range. The ad-hoc network would therefore allow medical personnel to quickly distribute sensors to multiple casualties and begin immediate triage, thereby substantially simplifying and reducing deployment time.

*Power Management:* Several features were incorporated into the design in order to minimize the power consumption of the wearable system. The most stringent consideration was the total operating power required by the Sensor Module, which has to drive the R and IR LEDs, process the data, and transmit this information wirelessly to the Receive Module. To keep the overall size of the Sensor Module as small as, it was designed to run on a watch style coin-cell battery.

It should be noted that low power management without compromising signal quality is an essential requirement in optimizing the design of wearable pulse oximeter. Commercially available transducers used with transmission and reflection pulse oximeters employ high brightness LEDs and a small PD element, typically with an active area ranging between 12 to 15mm<sup>2</sup>. One approach to lowering the power consumption of a wireless pulse oximeter, which is dominated by the current required to drive the LEDs, is to reduce the LED duty cycle. Alternatively, minimizing the drive currents supplied to the R and IR LEDs can also achieve a significant reduction in power consumption. However, with reduced current drive, there can be a direct impact on the quality of the detected PPGs. Furthermore, since most of the light emitted from the LEDs is diffused by the skin and subcutaneous tissues, in a predominantly forward-scattering direction, only a small fraction of the incident light is normally backscattered from the skin. In

addition, the backscattered light intensity is distributed over a region that is concentric with respect to the LEDs. Consequently, the performance of reflectance pulse oximetry using a small PD area is significantly degraded. To overcome this limitation, we showed that a concentric array of either discrete PDs, or an annularly-shaped PD ring, could be used to increase the amount of backscattered light detected by a reflectance type pulse oximeter sensor [5]-[7].

Besides a low-power consuming sensor, afforded by lowering the driving currents of the LEDs, a low duty cycle was employed to achieve a balance between low power consumption and adequate performance. In the event that continuous monitoring is not required, more power can be conserved by placing the device in an ultra low-power standby mode. In this mode, the radio is normally turned off and is only enabled for a periodic beacon to maintain network association. Moreover, a decision to activate the wearable pulse oximeter can be made automatically in the event of a patient alarm, or based on the activity level and posture information derived from the on-board accelerometer. The wireless pulse oximeter can also be activated or deactivated remotely by a medic as needed, thereby further minimizing power consumption.

### III. IN VIVO EVALUATIONS

Initial laboratory evaluations of the wearable pulse oximeter included simultaneous HR and SpO<sub>2</sub> measurements. The Sensor Module was positioned on the forehead using an elastic headband. Baseline recordings were made while the subject was resting comfortably and breathing at a normal tidal rate. Two intermittent recordings were also acquired while the subject held his breath for about 30 seconds. Fig. 4 displays about 4 minutes of SpO<sub>2</sub> and HR recordings acquired simultaneously by the sensor.

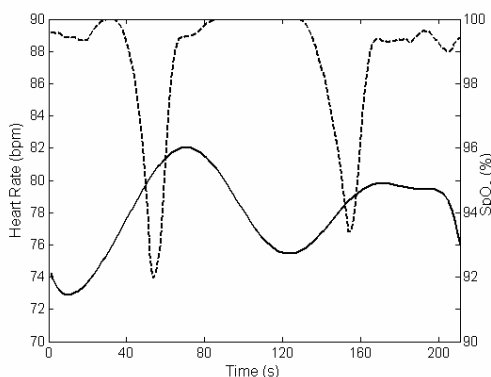

Fig. 4. Typical HR (solid line) and SpO<sub>2</sub> (dashed line) recording of two voluntary hypoxic episodes.

The pronounced drops in SpO<sub>2</sub> and corresponding increases in HR values coincide with the hypoxic events associated with the two breath holding episodes.

### IV. DISCUSSION

The emerging development of compact, low power, small size, light weight, and unobtrusive wearable devices can facilitate remote noninvasive monitoring of vital

physiological signs. Wireless physiological information can be useful to monitor soldiers during training exercises and combat missions, and help emergency first-responders operating in harsh and hazardous environments. Similarly, wearable physiological devices could become critical in helping to save lives following a civilian mass casualty. The primary goal of such a wireless mobile platform would be to keep track of an injured person's vital signs via a short-range wirelessly-linked personal area network, thus readily allowing RF telemetry of vital physiological information to command units and remote off-site base stations for continuous real-time monitoring by medical experts.

The preliminary bench testing plotted in Fig. 4 showed that the SpO<sub>2</sub> and HR readings are within an acceptable clinical range. Similarly, the transient changes measured during the two breath holding maneuvers confirmed that the response time of the custom pulse oximeter is adequate for detecting hypoxic episodes.

### V. CONCLUSION

A wireless, wearable, reflectance pulse oximeter has been developed based on a small forehead-mounted sensor. The battery-operated device employs a lightweight optical reflectance sensor and incorporates an annular photodetector to reduce power consumption. The system has short range wireless communication capabilities to transfer SpO<sub>2</sub>, HR, body acceleration, and posture information to a PDA carried by medics or first responders. The information could enhance the ability of first responders to extend more effective medical care, thereby saving the lives of critically injured persons.

### ACKNOWLEDGMENT

The authors would like to acknowledge the financial support provided by the U.S. Army Medical Research and Materiel Command referenced.

### REFERENCES

- [1] G. S. F. Ling, B. K. Day, P. Rhee, and J. M. Ecklund, "In search of technological solutions to battlefield management of combat casualties," *SPIE Conference on Battlefield Biomedical Technologies*, SPIE vol. 3712, Apr. 1999.
- [2] D. Malan, T. Fulford-Jones, M. Welsh, and S. Moulton, "CodeBlue: An ad-hoc sensor network infrastructure for emergency medical care," *International Workshop on Wearable and Implantable Body Sensor Networks*, 2004.
- [3] U. Anliker et al., "AMON: A wearable multiparameter medical monitoring and alert system," *IEEE Trans. on Information Technology in Biomedicine*, 8(4), 2004.
- [4] Y. Mendelson and V. Floroff, "A PDA based *ad-hoc* mobile wireless pulse oximeter," *Proc. IASTED International Conference Telehealth 2005*, Banff, Canada, 2005.
- [5] Y. Mendelson and C. J. Pujary, "Minimization of LED power consumption in the design of a wearable pulse oximeter," *IASTED International Conference BioMED 2003*, Salzburg, Austria, 2003.
- [6] Y. Mendelson and C. J. Pujary, "Measurement site and photodetector size considerations in optimizing power consumption of a wearable reflectance pulse oximeter," *Proc. of the 25<sup>th</sup> Annual International IEEE/EMBS Conference*, Cancun, Mexico, 2003.
- [7] P. Branche and Y. Mendelson, "Signal quality and power consumption of a new prototype reflectance pulse oximeter sensor," *Proc. of the 31<sup>st</sup> Annual Northeast Bioengineering Conference*, Hoboken, NJ, 2005.

## **APPENDIX IEEE02**



**DECLARATION OF GORDON MACPHERSON**

I, Gordon MacPherson, am over twenty-one (21) years of age. I have never been convicted of a felony, and I am fully competent to make this declaration. I declare the following to be true to the best of my knowledge, information and belief:

1. I am Director Board Governance & IP Operations of The Institute of Electrical and Electronics Engineers, Incorporated (“IEEE”).
2. IEEE is a neutral third party in this dispute.
3. I am not being compensated for this declaration and IEEE is only being reimbursed for the cost of the article I am certifying.
4. Among my responsibilities as Director Board Governance & IP Operations, I act as a custodian of certain records for IEEE.
5. I make this declaration based on my personal knowledge and information contained in the business records of IEEE.
6. As part of its ordinary course of business, IEEE publishes and makes available technical articles and standards. These publications are made available for public download through the IEEE digital library, IEEE Xplore.
7. It is the regular practice of IEEE to publish articles and other writings including article abstracts and make them available to the public through IEEE Xplore. IEEE maintains copies of publications in the ordinary course of its regularly conducted activities.
8. The article below has been attached as Exhibit A to this declaration:

A.	Y. Mendelson and C. Pujary, “Measurement site and photodetector size considerations in optimizing power consumption of a wearable reflectance pulse oximeter”, Proceedings of the 25th Annual International Conference of the IEEE Engineering in Medicine and Biology Society, September 17 – 21, 2003.
----	--

9. I obtained a copy of Exhibit A through IEEE Xplore, where it is maintained in the ordinary course of IEEE’s business. Exhibit A is a true and correct copy of the Exhibit, as it existed on or about April 30, 2021.

10. The article and abstract from IEEE Xplore shows the date of publication. IEEE Xplore populates this information using the metadata associated with the publication.
11. Y. Mendelson and C. Pujary, “Measurement site and photodetector size considerations in optimizing power consumption of a wearable reflectance pulse oximeter” was published in the Proceedings of the 25th Annual International Conference of the IEEE Engineering in Medicine and Biology Society. The 25th Annual International Conference of the IEEE Engineering in Medicine and Biology Society was held from September 17 – 21, 2003. Copies of the conference proceedings were made available no later than the last day of the conference. The article is currently available for public download from the IEEE digital library, IEEE Xplore.
12. I hereby declare that all statements made herein of my own knowledge are true and that all statements made on information and belief are believed to be true, and further that these statements were made with the knowledge that willful false statements and the like are punishable by fine or imprisonment, or both, under 18 U.S.C. § 1001.

I declare under penalty of perjury that the foregoing statements are true and correct.

Executed on: 5/3/2021

DocuSigned by:  
*Gordon Macpherson*  
E768DB210F4E4EF...



DocuSign Envelope ID: 3595DB4B-1765-4589-8185-7AD82F0E2BC1

# EXHIBIT A



Institutional Sign In

All



ADVANCED SEARCH

Conferences > Proceedings of the 25th Annual...

Back to Results

# Measurement site and photodetector size considerations in optimizing power consumption of a wearable reflectance pulse oximeter

Publisher: IEEE

Cite This



<< Results

Y. Mendelson ; C. Pujary All Authors

31 Paper Citations

103 Patent Citations

1327 Full Text Views



Export to Collabratec

## Alerts

Manage Content Alerts

Add to Citation Alerts

### More Like This

An optical micro-instrumentation system for measurement of fluorescent proteins in whole-cell biosensors  
2006 Bio Micro and Nanosystems Conference  
Published: 2006

Surface Modification for Protein and DNA Immobilization onto GMR Biosensor  
IEEE Transactions on Magnetics  
Published: 2013

Show More

### Abstract

#### Document Sections

- 1. Introduction
- II. METHODOLOGY
- III. RESULTS
- IV. Discussion
- V. Conclusion

Downl PDF

**Abstract:**Site selection and power consumption play a crucial role in optimizing the design of a wearable pulse oximeter for long-term telemedicine application. In this study we in... [View more](#)

#### Metadata

**Abstract:** Site selection and power consumption play a crucial role in optimizing the design of a wearable pulse oximeter for long-term telemedicine application. In this study we investigated the potential power saving in the design of a reflectance pulse oximeter taking into consideration measurement site and sensor configuration. In-vivo experiments suggest that battery longevity could be extended considerably by employing a wide annularly shaped photodetector ring configuration and performing SpO<sub>2</sub> measurements from the forehead region.

**Published in:** Proceedings of the 25th Annual International Conference of the IEEE Engineering in Medicine and Biology Society (IEEE Cat. No.03CH37439)

**Date of Conference:** 17-21 Sept. 2003 **INSPEC Accession Number:** 7954280

**Date Added to IEEE Xplore:** 05 April 2004 **DOI:** 10.1109/IEMBS.2003.1280775

Authors

Figures

References

Citations

Keywords

Metrics

More Like This

### ☰ Contents

#### 1. Introduction

Noninvasive pulse oximetry is a widely accepted method for monitoring arterial hemoglobin oxygen saturation (SpO<sub>2</sub>). Oxygen saturation is an important physiological variable since insufficient oxygen supply to vital organs can quickly lead to irreversible brain damage or result in death.

Sign in to Continue Reading

Authors



Figures



References



Citations



Keywords



Metrics



#### IEEE Personal Account

#### Purchase Details

#### Profile Information

#### Need Help?

#### Follow

CHANGE USERNAME/PASSWORD

PAYMENT OPTIONS

COMMUNICATIONS PREFERENCES

US & CANADA: +1 800 678 4333



VIEW PURCHASED DOCUMENTS

PROFESSION AND EDUCATION

WORLDWIDE: +1 732 981 0060

TECHNICAL INTERESTS

CONTACT & SUPPORT

About IEEE Xplore | Contact Us | Help | Accessibility | Terms of Use | Nondiscrimination Policy | Sitemap | Privacy & Opting Out of Cookies

A not-for-profit organization, IEEE is the world's largest technical professional organization dedicated to advancing technology for the benefit of humanity.

© Copyright 2021 IEEE - All rights reserved. Use of this web site signifies your agreement to the terms and conditions.

#### IEEE Account

#### Purchase Details

#### Profile Information

#### Need Help?

» Change Username/Password

» Payment Options

» Communications Preferences

» **US & Canada:** +1 800 678 4333

» Update Address

» Order History

» Profession and Education

» **Worldwide:** +1 732 981 0060

» View Purchased Documents

» Technical Interests

» Contact & Support

About IEEE Xplore | Contact Us | Help | Accessibility | Terms of Use | Nondiscrimination Policy | Sitemap | Privacy & Opting Out of Cookies

A not-for-profit organization, IEEE is the world's largest technical professional organization dedicated to advancing technology for the benefit of humanity.

© Copyright 2021 IEEE - All rights reserved. Use of this web site signifies your agreement to the terms and conditions.

## Measurement Site and Photodetector Size Considerations in Optimizing Power Consumption of a Wearable Reflectance Pulse Oximeter

Y. Mendelson, Ph.D., C. Pujary, B.E.

Department of Biomedical Engineering, and Bioengineering Institute  
Worcester Polytechnic Institute, Worcester, MA 01609, USA

**Abstract**— Site selection and power consumption play a crucial role in optimizing the design of a wearable pulse oximeter for long-term telemedicine application. In this study we investigated the potential power saving in the design of a reflectance pulse oximeter taking into consideration measurement site and sensor configuration. *In-vivo* experiments suggest that battery longevity could be extended considerably by employing a wide annularly shaped photodetector ring configuration and performing SpO<sub>2</sub> measurements from the forehead region.

**Keywords**— pulse oximeter, wearable sensors, telemedicine

### I. INTRODUCTION

Noninvasive pulse oximetry is a widely accepted method for monitoring arterial hemoglobin oxygen saturation (SpO<sub>2</sub>). Oxygen saturation is an important physiological variable since insufficient oxygen supply to vital organs can quickly lead to irreversible brain damage or result in death.

Pulse oximetry is based on spectrophotometric measurements of changes in blood color. The method relies on the detection of a photoplethysmographic (PPG) signal produced by variations in the quantity of arterial blood associated with periodic cardiac contraction and relaxation.

Pulse oximeter sensors are comprised of light emitting diodes (LEDs) and a silicon photodetector (PD). Typically, a red (R) LED with a peak emission wavelength around 660 nm, and an infrared (IR) LED with a peak emission wavelength around 940 nm are used as light sources. SpO<sub>2</sub> values are derived based on an empirically calibrated function by which the time-varying (AC) signal component of the PPG at each wavelength is divided by the corresponding time-invariant (DC) component which is due to light absorption and scattering by bloodless tissue, residual arterial blood volume during diastole, and non-pulsatile venous blood.

SpO<sub>2</sub> measurements can be performed in either transmission or reflection modes. In transmission mode, the sensor is usually attached across a fingertip or earlobe such that the LEDs and PD are placed on opposite sides of a pulsating vascular bed. Alternatively, in reflection pulse oximetry, the LEDs and PD are both mounted side-by-side facing the same side of the vascular bed. This configuration enables measurements from multiple locations on the body where transmission measurements are not feasible.

Backscattered light intensity can vary significantly between different anatomical locations. For example, optical reflectance from the forehead region is typically strong

because of the relatively thin skin covering the skull combined with a higher density of blood vessels. On the contrary, other anatomical locations, such as the limbs or torso, have a much lower density of blood vessels and, in addition, lack a dominant skeletal structure in close proximity to the skin that helps to reflect some of the incident light. Therefore, the AC components of the reflected PPGs from these body locations are considerably smaller. Consequently, it is more difficult to perform accurate pulse oximetry measurement from these body locations without enhancing cutaneous circulation using artificial vasodilatation.

Sensors used with commercial transmission or reflection pulse oximeters employ a single PD element, typically with an active area of about 12-15mm<sup>2</sup>. Normally, a relatively small PD chip is adequate for measuring strong transmission PPGs since most of the light emitted from the LEDs is diffused by the skin and subcutaneous tissues predominantly in a forward-scattering direction. However, in reflection mode, only a small fraction of the incident light is backscattered by the subcutaneous layers. Additionally, the backscattered light intensity reaching the skin surface is normally distributed over a relatively large area surrounding the LEDs. Hence, the design of a reflectance-mode pulse oximeter depends on the ability to fabricate a sensor that has improved sensitivity and can detect sufficiently strong PPGs from various locations on the body combined with sophisticated digital signal algorithms to process the relatively weak and often noisy signals.

To improve the accuracy and reliability of reflection pulse oximeters, several sensor designs have been described based on a radial arrangement of discrete PDs or LEDs. For example, Mendelson *et al* [1]-[2] and Konig *et al* [3] addressed the aspect of unfavorable SNR by developing a reflectance sensor prototype consisting of multiple discrete PDs mounted symmetrically around a pair of R and IR LEDs. Takatani *et al* [4]-[5] described a different sensor configuration based on 10 LEDs arranged symmetrically around a single PD chip.

The U.S. military has long been interested in combining noninvasive physiological sensors with wireless communication and global positioning to monitor soldier's vital signs in real-time. Similarly, remote monitoring of a person's health status who is located in a dangerous environment, such as mountain climbers or divers, could be beneficial. However, to gain better acceptability and address the unmet demand for long term continuous monitoring, several technical issues must be solved in order to design more compact sensors and instrumentation that are power

efficient, low-weight, reliable and comfortable to wear before they could be used routinely in remote monitoring applications. For instance, real-time continuous physiological monitoring from soldiers during combat using existing pulse oximeters is unsuitable because commercial oximeters involve unwieldy wires connected to the sensor, and sensor attachment to a fingertip restrains normal activity. Therefore, there is a need to develop a battery-efficient pulse oximeter that could monitor oxygen saturation and heart rate noninvasively from other locations on the body besides the fingertips.

To meet future needs, low power management without compromising signal quality becomes a key requirement in optimizing the design of a wearable pulse oximeter. However, high brightness LEDs commonly used in pulse oximeters requires relatively high current pulses, typically in the range between 100-200mA. Thus, minimizing the drive currents supplied to the LEDs would contribute considerably toward the overall power saving in the design of a more efficient pulse oximeter, particularly in wearable wireless applications. In previous studies we showed that the driving currents supplied to the LEDs in a reflection and transmission pulse oximeter sensors could be lowered significantly without compromising the quality of the PPGs by increasing the overall size of the PD [6]-[8]. Hence, by maximizing the light collected by the sensor, a very low power-consuming sensor could be developed, thereby extending the overall battery life of a pulse oximeter intended for telemedicine applications. In this paper we investigate the power savings achieved by widening the overall active area of the PD and comparing the LEDs driving currents required to produce acceptable PPG signals from the wrist and forehead regions as two examples of convenient body locations for monitoring SpO<sub>2</sub> utilizing a prototype reflectance pulse oximeter.

## II. METHODOLOGY

### A. Experimental setup

To study the potential power savings, we constructed a prototype reflectance sensor comprising twelve identical Silicon PD chips (active chip area: 2mm x 3mm) and a pair of R and IR LEDs. As shown schematically in Fig. 1, six PDs were positioned in a close inner-ring configuration at a radial distance of 6.0mm from the LEDs. The second set of six PDs spaced equally along an outer-ring, separated from the LEDs by a radius of 10.0mm. Each cluster of six PDs were wired in parallel and connected through a central hub to the common summing input of a current-to-voltage converter. The analog signals from the common current-to-voltage converter were subsequently separated into AC and DC components by signal conditioning circuitry. The analog signal components were then digitized at a 50Hz rate for 30 seconds intervals using a National Instruments DAQ card installed in a PC under the control of a virtual instrument implemented using LabVIEW 6.0 software.

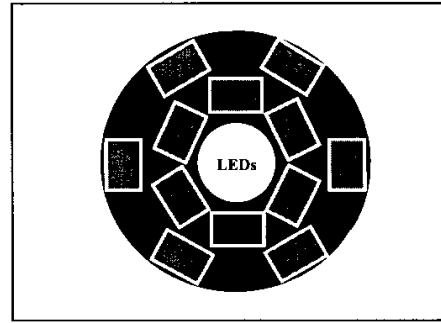

Fig. 1. Prototype reflectance sensor configuration showing the relative positions of the rectangular-shaped PDs and the LEDs.

### B. In Vivo Experiments

A series of *in vivo* experiments were performed to quantify and compare the PPG magnitudes measured by the two sets of six PDs. The prototype sensor was mounted on the dorsal side of the wrist or the center of the forehead below the hairline. These representative regions were selected as two target locations for the development of a wearable telesensor because they provide a flat surface for mounting a reflectance sensor which for example could be incorporated into a wrist watch device or attached to a soldier's helmet without using a double-sided adhesive tape. After the sensor was securely attached, the minimum peak currents flowing through each LED was adjusted while the output of the amplifier was monitored continuously to assure that distinguishable and stable PPGs were observed from each set of PDs and the electronics were not saturated.

Two sets of measurements were acquired from each body location. In the first set of experiments we kept the currents supplied to the LEDs at a constant level and the magnitude of the PPGs measured from each set of six PDs were compared. To estimate the minimum peak currents required to drive the LEDs for the near and far-positioned PDs, we performed a second series of measurements where the driving currents were adjusted until the amplitude of the respective PPG reached approximately a constant amplitude.

## III. RESULTS

Typical examples of reflected PPG signals measured by the inner set of six PDs from the forehead and wrist for a constant peak LED current (R: 8.5mA, IR: 4.2mA) are plotted respectively in Fig. 2.

The relative RMS amplitudes of the PPG signals measured by the six near (N) and far (F) PDs, and the combination of all 12 PDs (N+F) are plotted in Fig. 3(a) and 3(b) for a peak R LED drive current of 8.5mA and a peak IR LED drive current of 4.2mA, respectively. Analysis of the data revealed that there is a considerable difference between the signals measured by each set of PDs and amplitude of the respective PPG signals depends on measurement site.

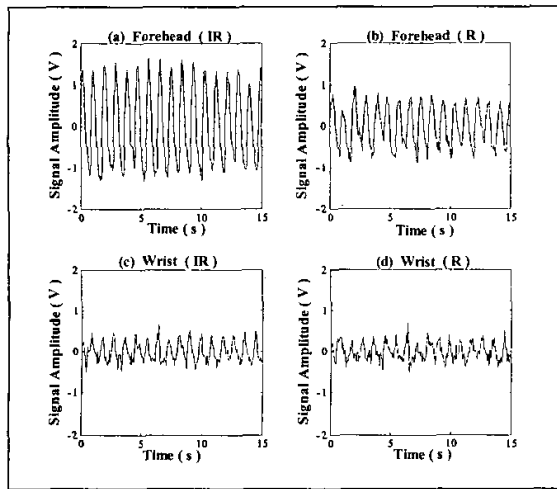

Fig. 2. Raw PPG signals measured from the forehead (a and b) and wrist (c and d) for constant LED driving currents.

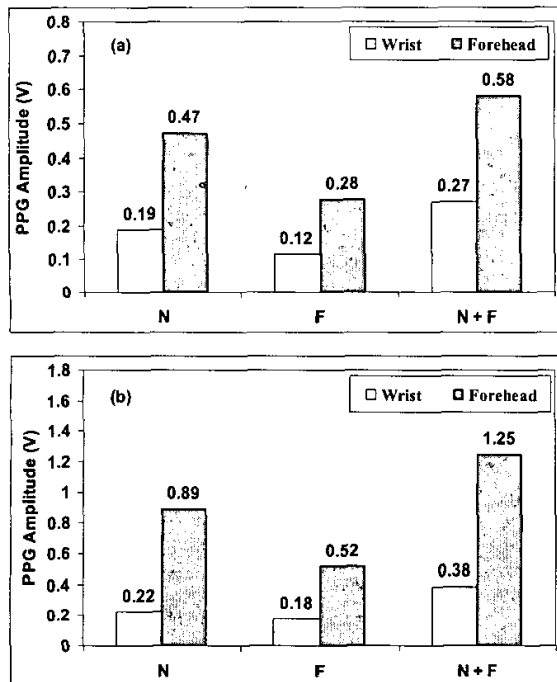

Fig. 3. PPG signal amplitudes measured by the near (N), far (F) and combination (N+F) PDs from the wrist and forehead for constant R and IR LED drive currents corresponding to 8.5mA (a) and 4.2mA (b), respectively.

Fig. 4 compares the relative peak LED currents required to maintain a constant AC RMS amplitude of approximately  $0.840(\pm 0.017)V$  for the N, F and (N+F) PDs measured from the forehead.

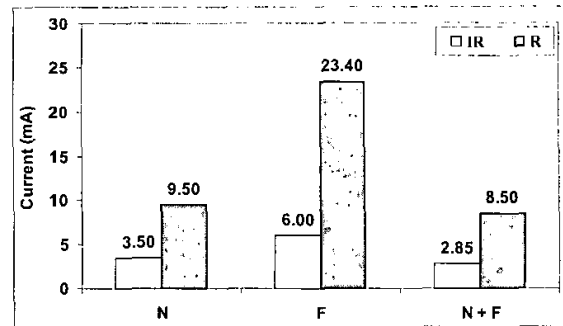

Fig. 4. Relative LED peak driving currents required to maintain a constant PPG amplitude of 0.840V RMS for the near (N), far (F) and combination (N+F) PD configurations. Measurements were obtained from the forehead.

#### IV. DISCUSSION

The successful design of a practical wearable pulse oximeter presents several unique challenges. In addition to user acceptability, the other most important issues are sensor placement and power consumption. For example, utilizing disposable tape or a reusable spring-loaded device for attachment of pulse oximeter sensors, as commonly practiced in clinical medicine, poses significant limitations, especially in ambulatory applications.

Several studies have shown that oximetry readings may vary significantly according to sensor location. For example, tissue blood volume varies in different parts of the body depending on the number and arrangement of blood vessels near the surface of the skin. Other factors, such as sensor-to-skin contact, can influence the distribution of blood close to the skin surface and consequently can cause erroneous readings. Therefore, to ensure consistent performance, it is important to pay close attention to the design of optical sensors used in reflectance pulse oximetry and the selection of suitable sites for sensor attachment.

The current consumed by the LEDs in a battery powered pulse oximeter is inversely proportional to the battery life. Hence, minimizing the current required to drive the LEDs is a critical design consideration, particularly in optimizing the overall power consumption of a wearable pulse oximeter. However, reduced LED driving currents directly impacts the incident light intensity and, therefore, could lead to deterioration in the quality of the measured PPGs. Consequently, lower LED drive currents could result in unreliable and inaccurate reading by a pulse oximeter.

From the data presented in Fig. 2, it is evident that the amplitude and quality of the recorded PPGs vary significantly between the forehead and the wrist. We also observed that using relatively low peak LED driving currents, we had to apply a considerable amount of external pressure on the sensor in order to measure discernable PPG

signals from the wrist. In contrast, using minimal contact pressure and similar LED driving currents produced significantly larger and less noisy PPG signals from the forehead. These noticeable differences are due to the lower density of superficial blood vessels on the arms compared to the highly vascular forehead skin combined with a strong light reflection from the forehead bone. Additionally, during conditions of peripheral vasoconstriction, a sensor placed on the forehead can maintain stronger PPGs longer compared to a finger sensor [9].

Despite the noticeable differences between the PPG signals measured from the wrist and forehead, the data plotted in Fig. 3 also revealed that considerable stronger PPGs could be obtained by widening the active area of the PD which helps to collect a bigger proportion of backscattered light intensity. The additional increase, however, depends on the area and relative position of the PD with respect to the LEDs. For example, utilizing the outer-ring configuration, the overall increase in the average amplitudes of the R and IR PPGs measured from the forehead region was 23% and 40%, respectively. Similarly, the same increase in PD area produced an increase in the PPG signals measured from the wrist, but with a proportional higher increase of 42% and 73%.

The data presented in Fig. 4 confirmed that in order to produce constant PPG amplitudes, significantly higher currents are required to drive the LEDs when backscattered light is measured by the outer PD set compared to the inner set. This observation was expected since the backscattered light intensity measured is inversely related to the separation distance between the PD and the LEDs [10]. In comparing the three different PD configurations, we found that by combining both PD sets to simulate a single large PD area, it is possible to further reduce the driving currents of the LEDs without compromising the amplitude or quality of the detected PPGs.

Lastly, we used the LED peak driving currents plotted in Fig. 4 to estimate the expected battery life of a typical 220mAh Lithium coin size battery assuming that a similar battery is used to power the optical components of a wearable pulse oximeter. Table 1 summarizes the estimated battery life for the different PD configurations tested in this study. The calculations are based on LEDs pulsed continuously at a typical duty cycle of approximately 1.5%.

**Table 1.** Comparison of estimated battery life for different PD configurations. Values based on forehead measurements for a typical 220mAh coin size battery.

PD CONFIGURATION	BATTERY LIFE [Days]
Near	45.8
Far	20.3
Near+Far	52.5

Note that the estimated values given in Table 1 are very conservative since they rely only on the power consumed by the LEDs without taking into consideration the additional

power demand imposed by other components of a wearable pulse oximeter. Nevertheless, the considerable differences in the estimated power consumptions clearly points out the practical advantage gained by using a reflection sensor comprising a large ring-shaped PD area to perform SpO<sub>2</sub> measurements from the forehead region.

## V. CONCLUSION

Site selection and LED driving currents are critical design consideration in optimizing the overall power consumption of a wearable battery-operated reflectance pulse oximeter. In this study we investigated the potential power saving in a ring-shaped sensor configuration comprising two sets of photodetectors arranged in a concentric ring configuration. *In-vivo* experiments revealed that battery longevity could be extended considerably by employing a wide annular PD and limiting SpO<sub>2</sub> measurements to the forehead region.

## ACKNOWLEDGMENT

We gratefully acknowledge the support by the Department of Defense under Cooperative Agreement DAMD17-03-2-0006.

## REFERENCES

- [1] Y. Mendelson, J.C. Kent, B.L. Yocum and M.J. Birle, "Design and Evaluation of new reflectance pulse oximeter sensor," *Medical Instrumentation*, Vol. 22, no. 4, pp. 167-173, Aug. 1988.
- [2] Y. Mendelson, M.J. McGinn, "Skin reflectance pulse oximetry: *in vivo* measurements from the forearm and calf," *Journal of Clinical Monitoring*, Vol. 37(1), pp. 7-12, 1991.
- [3] V. Konig, R. Huch, A. Huch, "Reflectance pulse oximetry - principles and obstetric application in the Zurich system," *Journal of Clinical Monitoring*, Vol. 14, pp. 403-412, 1998.
- [4] S. Takatani, C. Davies, N. Sakakibara, et al, "Experimental and clinical evaluation of a noninvasive reflectance pulse oximeter sensor," *Journal. Clinical Monitoring*, 8(4), pp. 257-266, 1992.
- [5] M. Nogawa, C.T. Ching, T. Ida, K. Itakura, S. Takatani, "A new hybrid reflectance optical pulse oximetry sensor for lower oxygen saturation measurement and for broader clinical application," in *Proc SPIE*, Vol. 2976, pp. 78-87, 1997.
- [6] C. Pujary, M. Savage, Y. Mendelson, "Photodetector size considerations in the design of a noninvasive reflectance pulse oximeter for telemedicine applications," in *Proc. IEEE 29<sup>th</sup> Annu. Northeast Bioengineering Conf.*, Newark, USA, 2003.
- [7] M. Savage, C. Pujary, Y. Mendelson, "Optimizing power consumption in the design of a wearable wireless telesensor: Comparison of pulse oximeter modes," in *Proc. IEEE 29<sup>th</sup> Annu. Northeast Bioengineering Conf.*, Newark, USA, 2003.
- [8] Y. Mendelson, C. Pujary, M. Savage, "Minimization of LED power consumption in the design of a wearable pulse oximeter," in *Proc. International Association of Science and Technology for Development, International Conf. BioMED 2003*, Salzburg, Austria, June 25-27, 2003.
- [9] D.E. Bebout, P.D. Mannheim, C.C. Wun, "Site-dependent differences in the time to detect changes in saturation during low perfusion," *Critical Care Medicine*, Vol. 29, no. 12, p. A115, 2001.
- [10] Y. Mendelson, B.D. Ochs, "Noninvasive pulse oximetry utilizing skin reflectance photoplethysmography," *IEEE Trans Biomed. Eng.*, Vol. 35, no. 10, pp. 798-805, Oct 1988.



**DECLARATION OF GORDON MACPHERSON**

I, Gordon MacPherson, am over twenty-one (21) years of age. I have never been convicted of a felony, and I am fully competent to make this declaration. I declare the following to be true to the best of my knowledge, information and belief:

- 1. I am Director Board Governance & IP Operations of The Institute of Electrical and Electronics Engineers, Incorporated (“IEEE”).
- 2. IEEE is a neutral third party in this dispute.
- 3. I am not being compensated for this declaration and IEEE is only being reimbursed for the cost of the article I am certifying.
- 4. Among my responsibilities as Director Board Governance & IP Operations, I act as a custodian of certain records for IEEE.
- 5. I make this declaration based on my personal knowledge and information contained in the business records of IEEE.
- 6. As part of its ordinary course of business, IEEE publishes and makes available technical articles and standards. These publications are made available for public download through the IEEE digital library, IEEE Xplore.
- 7. It is the regular practice of IEEE to publish articles and other writings including article abstracts and make them available to the public through IEEE Xplore. IEEE maintains copies of publications in the ordinary course of its regularly conducted activities.
- 8. The article below has been attached as Exhibit A to this declaration:

A.	Y. Mendelson and C. Pujary, “Measurement site and photodetector size considerations in optimizing power consumption of a wearable reflectance pulse oximeter”, Proceedings of the 25th Annual International Conference of the IEEE Engineering in Medicine and Biology Society, September 17 – 21, 2003.
----	--

- 9. I obtained a copy of Exhibit A through IEEE Xplore, where it is maintained in the ordinary course of IEEE’s business. Exhibit A is a true and correct copy of the Exhibit, as it existed on or about April 30, 2021.



10. The article and abstract from IEEE Xplore shows the date of publication. IEEE Xplore populates this information using the metadata associated with the publication.
11. Y. Mendelson and C. Pujary, “Measurement site and photodetector size considerations in optimizing power consumption of a wearable reflectance pulse oximeter” was published in the Proceedings of the 25th Annual International Conference of the IEEE Engineering in Medicine and Biology Society. The 25th Annual International Conference of the IEEE Engineering in Medicine and Biology Society was held from September 17 – 21, 2003. Copies of the conference proceedings were made available no later than the last day of the conference. The article is currently available for public download from the IEEE digital library, IEEE Xplore.
12. I hereby declare that all statements made herein of my own knowledge are true and that all statements made on information and belief are believed to be true, and further that these statements were made with the knowledge that willful false statements and the like are punishable by fine or imprisonment, or both, under 18 U.S.C. § 1001.

I declare under penalty of perjury that the foregoing statements are true and correct.

Executed on: 5/3/2021

DocuSigned by:  
*Gordon Macpherson*  
E768DB210F4E4EF...

DocuSign Envelope ID: 3595DB4B-1765-4589-8185-7AD82F0E2BC1

# EXHIBIT A



Institutional Sign In

All



ADVANCED SEARCH

Conferences > Proceedings of the 25th Annual...

Back to Results

# Measurement site and photodetector size considerations in optimizing power consumption of a wearable reflectance pulse oximeter

Publisher: IEEE

Cite This

PDF

<< Results

Y. Mendelson ; C. Pujary All Authors

31 Paper Citations

103 Patent Citations

1327 Full Text Views



Export to Collabratec

## Alerts

Manage Content Alerts

Add to Citation Alerts

### More Like This

An optical micro-instrumentation system for measurement of fluorescent proteins in whole-cell biosensors  
2006 Bio Micro and Nanosystems Conference  
Published: 2006

Surface Modification for Protein and DNA Immobilization onto GMR Biosensor  
IEEE Transactions on Magnetics  
Published: 2013

Show More

### Abstract

#### Document Sections

- 1. Introduction
- II. METHODOLOGY
- III. RESULTS
- IV. Discussion
- V. Conclusion

Download PDF

**Abstract:**Site selection and power consumption play a crucial role in optimizing the design of a wearable pulse oximeter for long-term telemedicine application. In this study we in... [View more](#)

#### Metadata

**Abstract:** Site selection and power consumption play a crucial role in optimizing the design of a wearable pulse oximeter for long-term telemedicine application. In this study we investigated the potential power saving in the design of a reflectance pulse oximeter taking into consideration measurement site and sensor configuration. In-vivo experiments suggest that battery longevity could be extended considerably by employing a wide annularly shaped photodetector ring configuration and performing SpO<sub>2</sub> measurements from the forehead region.

**Published in:** Proceedings of the 25th Annual International Conference of the IEEE Engineering in Medicine and Biology Society (IEEE Cat. No.03CH37439)

**Date of Conference:** 17-21 Sept. 2003 **INSPEC Accession Number:** 7954280

**Date Added to IEEE Xplore:** 05 April 2004 **DOI:** 10.1109/IEMBS.2003.1280775

Authors

Figures

References

Citations

Keywords

Metrics

More Like This

### ☰ Contents

#### 1. Introduction

Noninvasive pulse oximetry is a widely accepted method for monitoring arterial hemoglobin oxygen saturation (SpO<sub>2</sub>). Oxygen saturation is an important physiological variable since insufficient oxygen supply to vital organs can quickly lead to irreversible brain damage or result in death.

Sign in to Continue Reading

Authors	▼
Figures	▼
References	▼
Citations	▼
Keywords	▼
Metrics	▼

#### IEEE Personal Account

CHANGE USERNAME/PASSWORD

#### Purchase Details

PAYMENT OPTIONS  
VIEW PURCHASED DOCUMENTS

#### Profile Information

COMMUNICATIONS PREFERENCES  
PROFESSION AND EDUCATION  
TECHNICAL INTERESTS

#### Need Help?

US & CANADA: +1 800 678 4333  
WORLDWIDE: +1 732 981 0060  
CONTACT & SUPPORT

#### Follow



[About IEEE Xplore](#) | [Contact Us](#) | [Help](#) | [Accessibility](#) | [Terms of Use](#) | [Nondiscrimination Policy](#) | [Sitemap](#) | [Privacy & Opting Out of Cookies](#)

A not-for-profit organization, IEEE is the world's largest technical professional organization dedicated to advancing technology for the benefit of humanity.

© Copyright 2021 IEEE - All rights reserved. Use of this web site signifies your agreement to the terms and conditions.

#### IEEE Account

» Change Username/Password  
» Update Address

#### Purchase Details

» Payment Options  
» Order History  
» View Purchased Documents

#### Profile Information

» Communications Preferences  
» Profession and Education  
» Technical Interests

#### Need Help?

» **US & Canada:** +1 800 678 4333  
» **Worldwide:** +1 732 981 0060  
» Contact & Support

[About IEEE Xplore](#) | [Contact Us](#) | [Help](#) | [Accessibility](#) | [Terms of Use](#) | [Nondiscrimination Policy](#) | [Sitemap](#) | [Privacy & Opting Out of Cookies](#)

A not-for-profit organization, IEEE is the world's largest technical professional organization dedicated to advancing technology for the benefit of humanity.

© Copyright 2021 IEEE - All rights reserved. Use of this web site signifies your agreement to the terms and conditions.

## Measurement Site and Photodetector Size Considerations in Optimizing Power Consumption of a Wearable Reflectance Pulse Oximeter

Y. Mendelson, Ph.D., C. Pujary, B.E.

Department of Biomedical Engineering, and Bioengineering Institute  
Worcester Polytechnic Institute, Worcester, MA 01609, USA

**Abstract**— Site selection and power consumption play a crucial role in optimizing the design of a wearable pulse oximeter for long-term telemedicine application. In this study we investigated the potential power saving in the design of a reflectance pulse oximeter taking into consideration measurement site and sensor configuration. *In-vivo* experiments suggest that battery longevity could be extended considerably by employing a wide annularly shaped photodetector ring configuration and performing SpO<sub>2</sub> measurements from the forehead region.

**Keywords**— pulse oximeter, wearable sensors, telemedicine

### I. INTRODUCTION

Noninvasive pulse oximetry is a widely accepted method for monitoring arterial hemoglobin oxygen saturation (SpO<sub>2</sub>). Oxygen saturation is an important physiological variable since insufficient oxygen supply to vital organs can quickly lead to irreversible brain damage or result in death.

Pulse oximetry is based on spectrophotometric measurements of changes in blood color. The method relies on the detection of a photoplethysmographic (PPG) signal produced by variations in the quantity of arterial blood associated with periodic cardiac contraction and relaxation.

Pulse oximeter sensors are comprised of light emitting diodes (LEDs) and a silicon photodetector (PD). Typically, a red (R) LED with a peak emission wavelength around 660 nm, and an infrared (IR) LED with a peak emission wavelength around 940 nm are used as light sources. SpO<sub>2</sub> values are derived based on an empirically calibrated function by which the time-varying (AC) signal component of the PPG at each wavelength is divided by the corresponding time-invariant (DC) component which is due to light absorption and scattering by bloodless tissue, residual arterial blood volume during diastole, and non-pulsatile venous blood.

SpO<sub>2</sub> measurements can be performed in either transmission or reflection modes. In transmission mode, the sensor is usually attached across a fingertip or earlobe such that the LEDs and PD are placed on opposite sides of a pulsating vascular bed. Alternatively, in reflection pulse oximetry, the LEDs and PD are both mounted side-by-side facing the same side of the vascular bed. This configuration enables measurements from multiple locations on the body where transmission measurements are not feasible.

Backscattered light intensity can vary significantly between different anatomical locations. For example, optical reflectance from the forehead region is typically strong

because of the relatively thin skin covering the skull combined with a higher density of blood vessels. On the contrary, other anatomical locations, such as the limbs or torso, have a much lower density of blood vessels and, in addition, lack a dominant skeletal structure in close proximity to the skin that helps to reflect some of the incident light. Therefore, the AC components of the reflected PPGs from these body locations are considerably smaller. Consequently, it is more difficult to perform accurate pulse oximetry measurement from these body locations without enhancing cutaneous circulation using artificial vasodilatation.

Sensors used with commercial transmission or reflection pulse oximeters employ a single PD element, typically with an active area of about 12-15mm<sup>2</sup>. Normally, a relatively small PD chip is adequate for measuring strong transmission PPGs since most of the light emitted from the LEDs is diffused by the skin and subcutaneous tissues predominantly in a forward-scattering direction. However, in reflection mode, only a small fraction of the incident light is backscattered by the subcutaneous layers. Additionally, the backscattered light intensity reaching the skin surface is normally distributed over a relatively large area surrounding the LEDs. Hence, the design of a reflectance-mode pulse oximeter depends on the ability to fabricate a sensor that has improved sensitivity and can detect sufficiently strong PPGs from various locations on the body combined with sophisticated digital signal algorithms to process the relatively weak and often noisy signals.

To improve the accuracy and reliability of reflection pulse oximeters, several sensor designs have been described based on a radial arrangement of discrete PDs or LEDs. For example, Mendelson *et al* [1]-[2] and König *et al* [3] addressed the aspect of unfavorable SNR by developing a reflectance sensor prototype consisting of multiple discrete PDs mounted symmetrically around a pair of R and IR LEDs. Takatani *et al* [4]-[5] described a different sensor configuration based on 10 LEDs arranged symmetrically around a single PD chip.

The U.S. military has long been interested in combining noninvasive physiological sensors with wireless communication and global positioning to monitor soldier's vital signs in real-time. Similarly, remote monitoring of a person's health status who is located in a dangerous environment, such as mountain climbers or divers, could be beneficial. However, to gain better acceptability and address the unmet demand for long term continuous monitoring, several technical issues must be solved in order to design more compact sensors and instrumentation that are power

efficient, low-weight, reliable and comfortable to wear before they could be used routinely in remote monitoring applications. For instance, real-time continuous physiological monitoring from soldiers during combat using existing pulse oximeters is unsuitable because commercial oximeters involve unwieldy wires connected to the sensor, and sensor attachment to a fingertip restrains normal activity. Therefore, there is a need to develop a battery-efficient pulse oximeter that could monitor oxygen saturation and heart rate noninvasively from other locations on the body besides the fingertips.

To meet future needs, low power management without compromising signal quality becomes a key requirement in optimizing the design of a wearable pulse oximeter. However, high brightness LEDs commonly used in pulse oximeters requires relatively high current pulses, typically in the range between 100-200mA. Thus, minimizing the drive currents supplied to the LEDs would contribute considerably toward the overall power saving in the design of a more efficient pulse oximeter, particularly in wearable wireless applications. In previous studies we showed that the driving currents supplied to the LEDs in a reflection and transmission pulse oximeter sensors could be lowered significantly without compromising the quality of the PPGs by increasing the overall size of the PD [6]-[8]. Hence, by maximizing the light collected by the sensor, a very low power-consuming sensor could be developed, thereby extending the overall battery life of a pulse oximeter intended for telemedicine applications. In this paper we investigate the power savings achieved by widening the overall active area of the PD and comparing the LEDs driving currents required to produce acceptable PPG signals from the wrist and forehead regions as two examples of convenient body locations for monitoring SpO<sub>2</sub> utilizing a prototype reflectance pulse oximeter.

## II. METHODOLOGY

### A. Experimental setup

To study the potential power savings, we constructed a prototype reflectance sensor comprising twelve identical Silicon PD chips (active chip area: 2mm x 3mm) and a pair of R and IR LEDs. As shown schematically in Fig. 1, six PDs were positioned in a close inner-ring configuration at a radial distance of 6.0mm from the LEDs. The second set of six PDs spaced equally along an outer-ring, separated from the LEDs by a radius of 10.0mm. Each cluster of six PDs were wired in parallel and connected through a central hub to the common summing input of a current-to-voltage converter. The analog signals from the common current-to-voltage converter were subsequently separated into AC and DC components by signal conditioning circuitry. The analog signal components were then digitized at a 50Hz rate for 30 seconds intervals using a National Instruments DAQ card installed in a PC under the control of a virtual instrument implemented using LabVIEW 6.0 software.

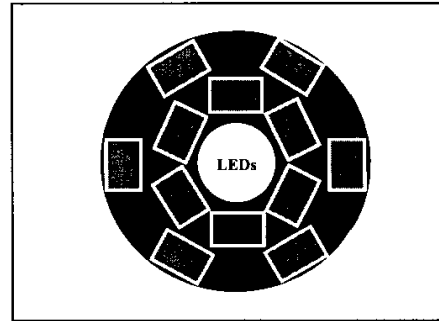

Fig. 1. Prototype reflectance sensor configuration showing the relative positions of the rectangular-shaped PDs and the LEDs.

### B. In Vivo Experiments

A series of *in vivo* experiments were performed to quantify and compare the PPG magnitudes measured by the two sets of six PDs. The prototype sensor was mounted on the dorsal side of the wrist or the center of the forehead below the hairline. These representative regions were selected as two target locations for the development of a wearable telesensor because they provide a flat surface for mounting a reflectance sensor which for example could be incorporated into a wrist watch device or attached to a soldier's helmet without using a double-sided adhesive tape. After the sensor was securely attached, the minimum peak currents flowing through each LED was adjusted while the output of the amplifier was monitored continuously to assure that distinguishable and stable PPGs were observed from each set of PDs and the electronics were not saturated.

Two sets of measurements were acquired from each body location. In the first set of experiments we kept the currents supplied to the LEDs at a constant level and the magnitude of the PPGs measured from each set of six PDs were compared. To estimate the minimum peak currents required to drive the LEDs for the near and far-positioned PDs, we performed a second series of measurements where the driving currents were adjusted until the amplitude of the respective PPG reached approximately a constant amplitude.

## III. RESULTS

Typical examples of reflected PPG signals measured by the inner set of six PDs from the forehead and wrist for a constant peak LED current (R: 8.5mA, IR: 4.2mA) are plotted respectively in Fig. 2.

The relative RMS amplitudes of the PPG signals measured by the six near (N) and far (F) PDs, and the combination of all 12 PDs (N+F) are plotted in Fig. 3(a) and 3(b) for a peak R LED drive current of 8.5mA and a peak IR LED drive current of 4.2mA, respectively. Analysis of the data revealed that there is a considerable difference between the signals measured by each set of PDs and amplitude of the respective PPG signals depends on measurement site.

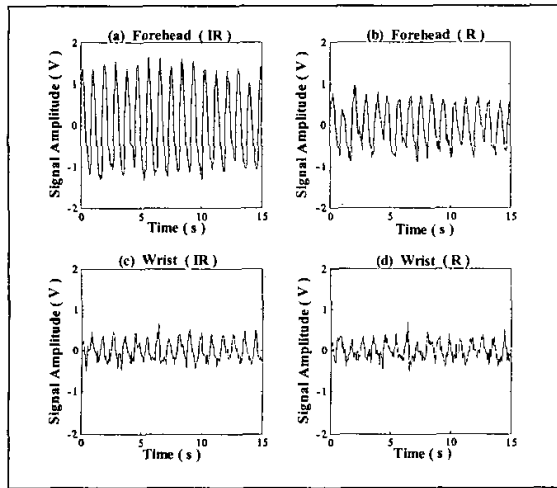

Fig. 2. Raw PPG signals measured from the forehead (a and b) and wrist (c and d) for constant LED driving currents.

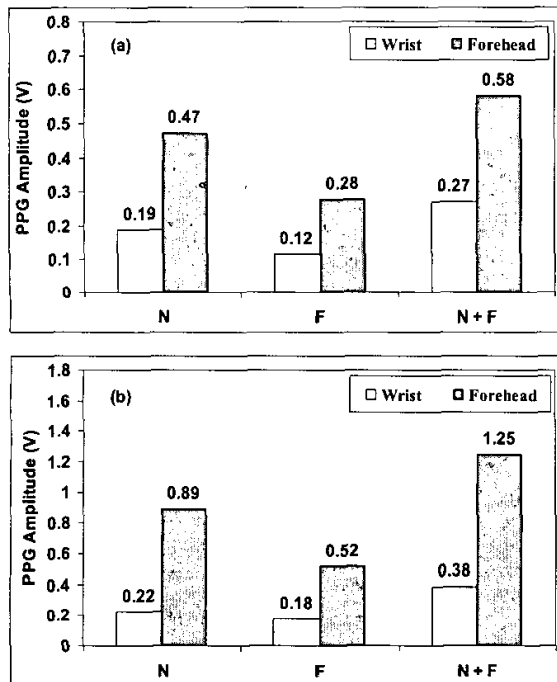

Fig. 3. PPG signal amplitudes measured by the near (N), far (F) and combination (N+F) PDs from the wrist and forehead for constant R and IR LED drive currents corresponding to 8.5mA (a) and 4.2mA (b), respectively.

Fig. 4 compares the relative peak LED currents required to maintain a constant AC RMS amplitude of approximately 0.840( $\pm$ 0.017)V for the N, F and (N+F) PDs measured from the forehead.

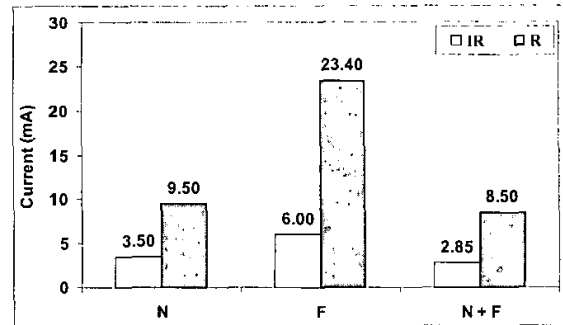

Fig. 4. Relative LED peak driving currents required to maintain a constant PPG amplitude of 0.840V RMS for the near (N), far (F) and combination (N+F) PD configurations. Measurements were obtained from the forehead.

#### IV. DISCUSSION

The successful design of a practical wearable pulse oximeter presents several unique challenges. In addition to user acceptability, the other most important issues are sensor placement and power consumption. For example, utilizing disposable tape or a reusable spring-loaded device for attachment of pulse oximeter sensors, as commonly practiced in clinical medicine, poses significant limitations, especially in ambulatory applications.

Several studies have shown that oximetry readings may vary significantly according to sensor location. For example, tissue blood volume varies in different parts of the body depending on the number and arrangement of blood vessels near the surface of the skin. Other factors, such as sensor-to-skin contact, can influence the distribution of blood close to the skin surface and consequently can cause erroneous readings. Therefore, to ensure consistent performance, it is important to pay close attention to the design of optical sensors used in reflectance pulse oximetry and the selection of suitable sites for sensor attachment.

The current consumed by the LEDs in a battery powered pulse oximeter is inversely proportional to the battery life. Hence, minimizing the current required to drive the LEDs is a critical design consideration, particularly in optimizing the overall power consumption of a wearable pulse oximeter. However, reduced LED driving currents directly impacts the incident light intensity and, therefore, could lead to deterioration in the quality of the measured PPGs. Consequently, lower LED drive currents could result in unreliable and inaccurate reading by a pulse oximeter.

From the data presented in Fig. 2, it is evident that the amplitude and quality of the recorded PPGs vary significantly between the forehead and the wrist. We also observed that using relatively low peak LED driving currents, we had to apply a considerable amount of external pressure on the sensor in order to measure discernable PPG

signals from the wrist. In contrast, using minimal contact pressure and similar LED driving currents produced significantly larger and less noisy PPG signals from the forehead. These noticeable differences are due to the lower density of superficial blood vessels on the arms compared to the highly vascular forehead skin combined with a strong light reflection from the forehead bone. Additionally, during conditions of peripheral vasoconstriction, a sensor placed on the forehead can maintain stronger PPGs longer compared to a finger sensor [9].

Despite the noticeable differences between the PPG signals measured from the wrist and forehead, the data plotted in Fig. 3 also revealed that considerable stronger PPGs could be obtained by widening the active area of the PD which helps to collect a bigger proportion of backscattered light intensity. The additional increase, however, depends on the area and relative position of the PD with respect to the LEDs. For example, utilizing the outer-ring configuration, the overall increase in the average amplitudes of the R and IR PPGs measured from the forehead region was 23% and 40%, respectively. Similarly, the same increase in PD area produced an increase in the PPG signals measured from the wrist, but with a proportional higher increase of 42% and 73%.

The data presented in Fig. 4 confirmed that in order to produce constant PPG amplitudes, significantly higher currents are required to drive the LEDs when backscattered light is measured by the outer PD set compared to the inner set. This observation was expected since the backscattered light intensity measured is inversely related to the separation distance between the PD and the LEDs [10]. In comparing the three different PD configurations, we found that by combining both PD sets to simulate a single large PD area, it is possible to further reduce the driving currents of the LEDs without compromising the amplitude or quality of the detected PPGs.

Lastly, we used the LED peak driving currents plotted in Fig. 4 to estimate the expected battery life of a typical 220mAh Lithium coin size battery assuming that a similar battery is used to power the optical components of a wearable pulse oximeter. Table 1 summarizes the estimated battery life for the different PD configurations tested in this study. The calculations are based on LEDs pulsed continuously at a typical duty cycle of approximately 1.5%.

**Table 1.** Comparison of estimated battery life for different PD configurations. Values based on forehead measurements for a typical 220mAh coin size battery.

PD CONFIGURATION	BATTERY LIFE [Days]
Near	45.8
Far	20.3
Near+Far	52.5

Note that the estimated values given in Table 1 are very conservative since they rely only on the power consumed by the LEDs without taking into consideration the additional

power demand imposed by other components of a wearable pulse oximeter. Nevertheless, the considerable differences in the estimated power consumptions clearly points out the practical advantage gained by using a reflection sensor comprising a large ring-shaped PD area to perform SpO<sub>2</sub> measurements from the forehead region.

## V. CONCLUSION

Site selection and LED driving currents are critical design consideration in optimizing the overall power consumption of a wearable battery-operated reflectance pulse oximeter. In this study we investigated the potential power saving in a ring-shaped sensor configuration comprising two sets of photodetectors arranged in a concentric ring configuration. *In-vivo* experiments revealed that battery longevity could be extended considerably by employing a wide annular PD and limiting SpO<sub>2</sub> measurements to the forehead region.

## ACKNOWLEDGMENT

We gratefully acknowledge the support by the Department of Defense under Cooperative Agreement DAMD17-03-2-0006.

## REFERENCES

- [1] Y. Mendelson, J.C. Kent, B.L. Yocum and M.J. Birle, "Design and Evaluation of new reflectance pulse oximeter sensor," *Medical Instrumentation*, Vol. 22, no. 4, pp. 167-173, Aug. 1988.
- [2] Y. Mendelson, M.J. McGinn, "Skin reflectance pulse oximetry: *in vivo* measurements from the forearm and calf," *Journal of Clinical Monitoring*, Vol. 37(1), pp. 7-12, 1991.
- [3] V. Konig, R. Huch, A. Huch, "Reflectance pulse oximetry - principles and obstetric application in the Zurich system," *Journal of Clinical Monitoring*, Vol. 14, pp. 403-412, 1998.
- [4] S. Takatani, C. Davies, N. Sakakibara, et al, "Experimental and clinical evaluation of a noninvasive reflectance pulse oximeter sensor," *Journal. Clinical Monitoring*, 8(4), pp. 257-266, 1992.
- [5] M. Nogawa, C.T. Ching, T. Ida, K. Itakura, S. Takatani, "A new hybrid reflectance optical pulse oximetry sensor for lower oxygen saturation measurement and for broader clinical application," in *Proc SPIE*, Vol. 2976, pp. 78-87, 1997.
- [6] C. Pujary, M. Savage, Y. Mendelson, "Photodetector size considerations in the design of a noninvasive reflectance pulse oximeter for telemedicine applications," in *Proc. IEEE 29<sup>th</sup> Annu. Northeast Bioengineering Conf.*, Newark, USA, 2003.
- [7] M. Savage, C. Pujary, Y. Mendelson, "Optimizing power consumption in the design of a wearable wireless telesensor: Comparison of pulse oximeter modes," in *Proc. IEEE 29<sup>th</sup> Annu. Northeast Bioengineering Conf.*, Newark, USA, 2003.
- [8] Y. Mendelson, C. Pujary, M. Savage, "Minimization of LED power consumption in the design of a wearable pulse oximeter," in *Proc. International Association of Science and Technology for Development, International Conf. BioMED 2003*, Salzburg, Austria, June 25-27, 2003.
- [9] D.E. Bebout, P.D. Mannheimer, C.C. Wun, "Site-dependent differences in the time to detect changes in saturation during low perfusion," *Critical Care Medicine*, Vol. 29, no. 12, p. A115, 2001.
- [10] Y. Mendelson, B.D. Ochs, "Noninvasive pulse oximetry utilizing skin reflectance photoplethysmography," *IEEE Trans Biomed. Eng.*, Vol. 35, no. 10, pp. 798-805, Oct 1988.





**DECLARATION OF GORDON MACPHERSON**

I, Gordon MacPherson, am over twenty-one (21) years of age. I have never been convicted of a felony, and I am fully competent to make this declaration. I declare the following to be true to the best of my knowledge, information and belief:

1. I am Director Board Governance & IP Operations of The Institute of Electrical and Electronics Engineers, Incorporated (“IEEE”).
2. IEEE is a neutral third party in this dispute.
3. I am not being compensated for this declaration and IEEE is only being reimbursed for the cost of the article I am certifying.
4. Among my responsibilities as Director Board Governance & IP Operations, I act as a custodian of certain records for IEEE.
5. I make this declaration based on my personal knowledge and information contained in the business records of IEEE.
6. As part of its ordinary course of business, IEEE publishes and makes available technical articles and standards. These publications are made available for public download through the IEEE digital library, IEEE Xplore.
7. It is the regular practice of IEEE to publish articles and other writings including article abstracts and make them available to the public through IEEE Xplore. IEEE maintains copies of publications in the ordinary course of its regularly conducted activities.
8. The article below has been attached as Exhibit A to this declaration:

A.	Y. Mendelson, R. J. Duckworth, and G. Comtois, “A Wearable Reflectance Pulse Oximeter for Remote Physiological Monitoring”, 2006 International Conference of the IEEE Engineering in Medicine and Biology Society, August 30, 2006 - September 3, 2006.
----	---

9. I obtained a copy of Exhibit A through IEEE Xplore, where it is maintained in the ordinary course of IEEE’s business. Exhibit A is a true and correct copy of the Exhibit, as it existed on or about April 30, 2021.

10. The article and abstract from IEEE Xplore shows the date of publication. IEEE Xplore populates this information using the metadata associated with the publication.
11. Y. Mendelson, R. J. Duckworth, and G. Comtois, “A Wearable Reflectance Pulse Oximeter for Remote Physiological Monitoring” was published in the 2006 International Conference of the IEEE Engineering in Medicine and Biology Society. The 2006 International Conference of the IEEE Engineering in Medicine and Biology Society was held from August 30, 2006 - September 3, 2006. Copies of the conference proceedings were made available no later than the last day of the conference. The article is currently available for public download from the IEEE digital library, IEEE Xplore.
12. I hereby declare that all statements made herein of my own knowledge are true and that all statements made on information and belief are believed to be true, and further that these statements were made with the knowledge that willful false statements and the like are punishable by fine or imprisonment, or both, under 18 U.S.C. § 1001.

I declare under penalty of perjury that the foregoing statements are true and correct.

Executed on: 5/3/2021

DocuSigned by:  
*Gordon Macpherson*  
E768DB210F4E4EF...

DocuSign Envelope ID: 3595DB4B-1765-4589-8185-7AD82F0E2BC1

# EXHIBIT A



All



ADVANCED SEARCH

Conferences > 2006 International Conference...

Back to Results

# A Wearable Reflectance Pulse Oximeter for Remote Physiological Monitoring

Publisher: IEEE

Cite This

PDF

<< Results

Y. Mendelson ; R. J. Duckworth ; G. Comtois All Authors

52 Paper Citations

35 Patent Citations

1303 Full Text Views



Export to

Collabratec

Alerts

Manage

Content Alerts

Add to Citation

Alerts

## More Like This

Development of an Implantable Pulse Oximeter  
IEEE Transactions on Biomedical Engineering  
Published: 2008

Wearable System for Monitoring of Oxygen Concentration in Breath Based on Optical Sensor  
IEEE Sensors Journal  
Published: 2015

Show More

Abstract

Document Sections

I. Introduction

II. System Architecture

III. In Vivo Evaluations

IV. Discussion

V. Conclusion

Authors

Figures

References

Citations

Keywords

Metrics

Downl PDF

**Abstract:**To save life, casualty care requires that trauma injuries are accurately and expeditiously assessed in the field. This paper describes the initial bench testing of a wire... **View more**

### Metadata

#### Abstract:

To save life, casualty care requires that trauma injuries are accurately and expeditiously assessed in the field. This paper describes the initial bench testing of a wireless wearable pulse oximeter developed based on a small forehead mounted sensor. The battery operated device employs a lightweight optical reflectance sensor and incorporates an annular photodetector to reduce power consumption. The system also has short range wireless communication capabilities to transfer arterial oxygen saturation (SpO<sub>2</sub>), heart rate (HR), body acceleration, and posture information to a PDA. It has the potential for use in combat casualty care, such as for remote triage, and by first responders, such as firefighters

**Published in:** 2006 International Conference of the IEEE Engineering in Medicine and Biology Society

**Date of Conference:** 30 Aug.-3 Sept. 2006 **INSPEC Accession Number:** 9220069

DOI: 10.1109/IEMBS.2006.260137

**Date Added to IEEE Xplore:** 15 December 2016 **Publisher:** IEEE

**Print ISBN:** 1-4244-0032-5

**Conference Location:** New York, NY, USA

**Print ISSN:** 1557-170X

**PubMed ID:** 17946007  
Y. Mendelson

Department of Biomedical Engineering, Worcester Polytechnic Institute, Worcester, MA, USA

R. J. Duckworth  
Department of Electrical and Computer Engineering, Worcester Polytechnic Institute, Worcester, MA, USA

G. Comtois  
Department of Biomedical Engineering, Worcester Polytechnic Institute, Worcester, MA, USA

 **Contents**

**I. Introduction**

Steady advances in noninvasive physiological sensing, hardware miniaturization, and wireless communication are leading to the development of new wearable technologies that have broad and important implications for civilian and military applications [1]–[2]. For example, the emerging development of compact, low-power, small-size, light-weight, and unobtrusive wearable devices may facilitate remote noninvasive monitoring of vital signs from soldiers during training exercises and combat. Telemetry of physiological information via a short-range wirelessly-linked personal area network can also be useful for firefighters, hazardous material workers, mountain climbers, or emergency first-responders operating in harsh and hazardous environments. The primary goal of this mobile platform would be to keep track of an injured person's vital signs, thus readily allowing the telemetry of physiological information to medical providers, and support emergency responders in making critical and often life saving decisions in order to expedite rescue operations. Having wearable physiological monitoring could offer far-forward medics numerous advantages, including the ability to determine a casualty's condition remotely without exposing the first responders to increased risks, quickly identifying the severity of injuries especially when the injured are greatly dispersed over large geographical terrains and often out-of-site, and continuously tracking the injured condition until they arrive safely at a medical care facility.

**Authors** 

Y. Mendelson  
Department of Biomedical Engineering, Worcester Polytechnic Institute, Worcester, MA, USA

R. J. Duckworth  
Department of Electrical and Computer Engineering, Worcester Polytechnic Institute, Worcester, MA, USA

G. Comtois  
Department of Biomedical Engineering, Worcester Polytechnic Institute, Worcester, MA, USA

<a href="#">Figures</a>	▼
<a href="#">References</a>	▼
<a href="#">Citations</a>	▼
<a href="#">Keywords</a>	▼
<a href="#">Metrics</a>	▼

#### IEEE Personal Account

[CHANGE USERNAME/PASSWORD](#)

#### Purchase Details

[PAYMENT OPTIONS](#)

[VIEW PURCHASED DOCUMENTS](#)

#### Profile Information

[COMMUNICATIONS PREFERENCES](#)

[PROFESSION AND EDUCATION](#)

[TECHNICAL INTERESTS](#)

#### Need Help?

[US & CANADA: +1 800 678 4333](#)

[WORLDWIDE: +1 732 981 0060](#)

[CONTACT & SUPPORT](#)

#### Follow



[About IEEE Xplore](#) | [Contact Us](#) | [Help](#) | [Accessibility](#) | [Terms of Use](#) | [Nondiscrimination Policy](#) | [Sitemap](#) | [Privacy & Opting Out of Cookies](#)

A not-for-profit organization, IEEE is the world's largest technical professional organization dedicated to advancing technology for the benefit of humanity.

© Copyright 2021 IEEE - All rights reserved. Use of this web site signifies your agreement to the terms and conditions.

#### IEEE Account

» [Change Username/Password](#)

» [Update Address](#)

#### Purchase Details

» [Payment Options](#)

» [Order History](#)

» [View Purchased Documents](#)

#### Profile Information

» [Communications Preferences](#)

» [Profession and Education](#)

» [Technical Interests](#)

#### Need Help?

» **US & Canada:** +1 800 678 4333

» **Worldwide:** +1 732 981 0060

» [Contact & Support](#)

[About IEEE Xplore](#) | [Contact Us](#) | [Help](#) | [Accessibility](#) | [Terms of Use](#) | [Nondiscrimination Policy](#) | [Sitemap](#) | [Privacy & Opting Out of Cookies](#)

A not-for-profit organization, IEEE is the world's largest technical professional organization dedicated to advancing technology for the benefit of humanity.

© Copyright 2021 IEEE - All rights reserved. Use of this web site signifies your agreement to the terms and conditions.

## A Wearable Reflectance Pulse Oximeter for Remote Physiological Monitoring

Y. Mendelson\*, *Member, IEEE*, R. J. Duckworth, *Member, IEEE*, and G. Comtois, *Student Member, IEEE*

**Abstract**—To save life, casualty care requires that trauma injuries are accurately and expeditiously assessed in the field. This paper describes the initial bench testing of a wireless wearable pulse oximeter developed based on a small forehead mounted sensor. The battery operated device employs a lightweight optical reflectance sensor and incorporates an annular photodetector to reduce power consumption. The system also has short range wireless communication capabilities to transfer arterial oxygen saturation (SpO<sub>2</sub>), heart rate (HR), body acceleration, and posture information to a PDA. It has the potential for use in combat casualty care, such as for remote triage, and by first responders, such as firefighters.

### I. INTRODUCTION

STEADY advances in noninvasive physiological sensing, hardware miniaturization, and wireless communication are leading to the development of new wearable technologies that have broad and important implications for civilian and military applications [1]-[2]. For example, the emerging development of compact, low-power, small-size, light-weight, and unobtrusive wearable devices may facilitate remote noninvasive monitoring of vital signs from soldiers during training exercises and combat. Telemetry of physiological information via a short-range wirelessly-linked personal area network can also be useful for firefighters, hazardous material workers, mountain climbers, or emergency first-responders operating in harsh and hazardous environments. The primary goals of such a wireless mobile platform would be to keep track of an injured person's vital signs, thus readily allowing the telemetry of physiological information to medical providers, and support emergency responders in making critical and often life saving decisions in order to expedite rescue operations. Having wearable physiological monitoring could offer far-forward medics numerous advantages, including the ability to determine a casualty's condition remotely without exposing the first

responders to increased risks, quickly identifying the severity of injuries especially when the injured are greatly dispersed over large geographical terrains and often out-of-site, and continuously tracking the injured condition until they arrive safely at a medical care facility.

Several technical challenges must be overcome to address the unmet demand for long-term continuous physiological monitoring in the field. In order to design more compact sensors and improved wearable instrumentation, perhaps the most critical challenges are to develop more power efficient and low-weight devices. To become effective, these technologies must also be robust, comfortable to wear, and cost-effective. Additionally, before wearable devices can be used effectively in the field, they must become unobtrusive and should not hinder a person's mobility. Employing commercial off-the-shelf (COTS) solutions, for example finger pulse oximeters to monitor blood oxygenation and heart rate, or standard adhesive-type disposable electrodes for ECG monitoring, is not practical for many field applications because they limit mobility and can interfere with normal tasks.

A potentially attractive approach to aid emergency medical teams in remote triage operations is the use of a wearable pulse oximeter to wirelessly transmit heart rate (HR) and arterial oxygen saturation (SpO<sub>2</sub>) to a remote location. Pulse oximetry is a widely accepted method that is used for noninvasive monitoring of SpO<sub>2</sub> and HR. The method is based on spectrophotometric measurements of changes in the optical absorption of deoxyhemoglobin (Hb) and oxyhemoglobin (HbO<sub>2</sub>). Noninvasive spectrophotometric measurements of SpO<sub>2</sub> are performed in the visible (600-700nm) and near-infrared (700-1000nm) spectral regions. Pulse oximetry also relies on the detection of photoplethysmographic (PPG) signals produced by variations in the quantity of arterial blood that is associated with periodic contractions and relaxations of the heart. Measurements can be performed in either transmission or reflection modes. In transmission pulse oximetry, the sensor can be attached across a fingertip, foot, or earlobe. In this configuration, the light emitting diodes (LEDs) and photodetector (PD) in the sensor are placed on opposite sides of a peripheral pulsating vascular bed. Alternatively, in reflection pulse oximetry, the LEDs and PD are both mounted side-by-side on the same planar substrate to enable readings from multiple body locations where transillumination measurements are not feasible. Clinically, forehead reflection pulse oximetry has been used as an alternative approach to conventional transmission-based

Manuscript received April 3, 2006. This work is supported by the U.S. Army Medical Research and Materiel Command under Contract No. DAMD17-03-2-0006. The views, opinions and/or findings are those of the author and should not be construed as an official Department of the Army position, policy, or decision, unless so designated by other documentation.

\*Corresponding author – Y. Mendelson is a Professor in the Department of Biomedical Engineering, Worcester Polytechnic Institute, Worcester, MA 01609 USA (phone: 508-831-5103; fax: 508-831-5541; e-mail: ym@wpi.edu).

R. J. Duckworth is a Professor in the Department of Electrical and Computer Engineering, Worcester Polytechnic Institute, Worcester, MA 01609 USA (rjduck@ece.wpi.edu).

G. Comtois is a M. S. student in the Department of Biomedical Engineering, Worcester Polytechnic Institute, Worcester, MA 01609 USA (comtoisg@wpi.edu).

oximetry when peripheral circulation to the extremities is compromised.

Pulse oximetry was initially intended for in-hospital use on patients undergoing or recovering from surgery. During the past few years, several companies have developed smaller pulse oximeters, some including data transmission via telemetry, to further expand the applications of pulse oximetry. For example, battery-operated pulse oximeters are now attached to patients during emergency transport as they are being moved from a remote location to a hospital, or between hospital wards. Some companies are also offering smaller units with improved electronic filtering of noisy PPG signals.

Several reports described the development of a wireless pulse oximeter that may be suitable for remote physiological monitoring [3]-[4]. Despite the steady progress in miniaturization of pulse oximeters over the years, to date, the most significant limitation is battery longevity and lack of telemetric communication. In this paper, we describe a prototype forehead-based reflectance pulse oximeter suitable for remote triage applications.

## II. SYSTEM ARCHITECTURE

The prototype system, depicted in Fig. 1, consists of a body-worn pulse oximeter that receives and processes the PPG signals measured by a small ( $\phi = 22\text{mm}$ ) and lightweight (4.5g) optical reflectance transducer. The system

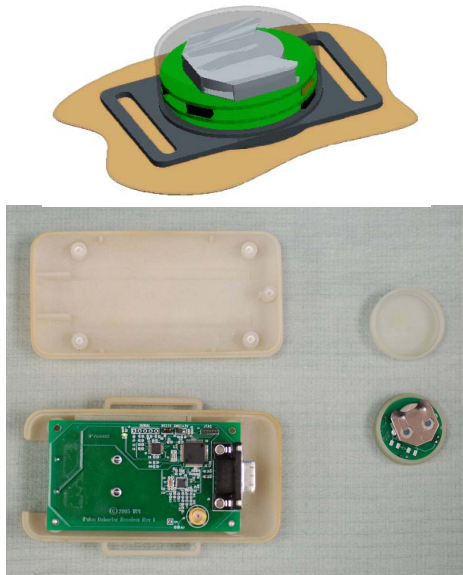

Fig. 1. (Top) Attachment of Sensor Module to the skin; (Bottom) photograph of the Receiver Module (left) and Sensor Module (right).

consists of three units: A Sensor Module, consisting of the optical transducer, a stack of round PCBs, and a coin-cell battery. The information acquired by the Sensor Module is transmitted wirelessly via an RF link over a short range to a body-worn Receiver Module. The data processed by the Receiver Module can be transmitted wirelessly to a PDA. The PDA can monitor multiple wearable pulse oximeters simultaneously and allows medics to collect vital physiological information to enhance their ability to extend more effective care to those with the most urgent needs. The

system can be programmed to alert on alarm conditions, such as sudden trauma, or physiological values out of their normal range. It also has the potential for use in combat casualty care, such as for remote triage, and for use by first responders, such as firefighters.

Key features of this system are small-size, robustness, and low-power consumption, which are essential attributes of wearable physiological devices, especially for military applications. The system block diagram (Fig. 2), is described in more detail below.

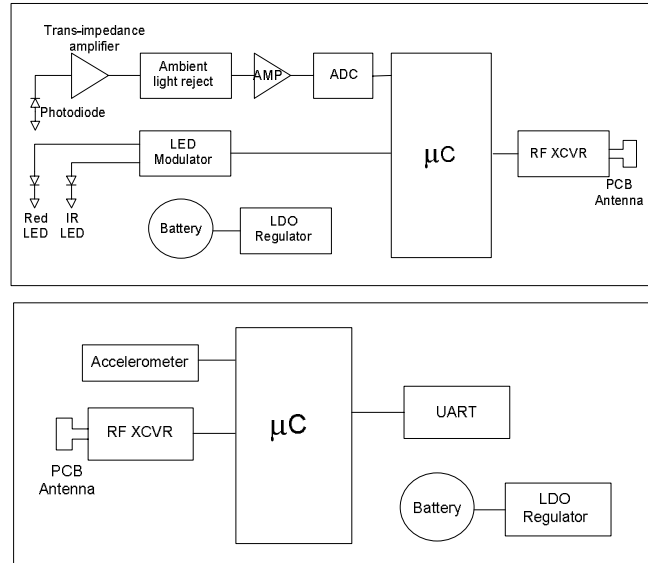

Fig. 2. System block diagram of the wearable, wireless, pulse oximeter. Sensor Module (top), Receiver Module (bottom).

**Sensor Module:** The Sensor Module contains analog signal processing circuitry, ADC, an embedded microcontroller, and a RF transceiver. The unit is small enough so the entire module can be integrated into a headband or a helmet. The unit is powered by a CR2032 type coin cell battery with 220mAh capacity, providing at least 5 days of operation.

**Receiver Module:** The Receiver Module contains an embedded microcontroller, RF transceiver for communicating with the Sensor Module, and a Universal Asynchronous Receive Transmit (UART) for connection to a PC. Signals acquired by the Sensor Module are received by the embedded microcontroller which synchronously converts the corresponding PD output to R and IR PPG signals. Dedicated software is used to filter the signals and compute  $\text{SpO}_2$  and HR based on the relative amplitude and frequency content of the reflected PPG signals. A tri-axis MEMS accelerometer detects changes in body activity, and the information obtained through the tilt sensing property of the accelerometer is used to determine the orientation of the person wearing the device.

To facilitate bi-directional wireless communications between the Receiver Module and a PDA, we used the DPAC Airborne™ LAN node module (DPAC Technologies, Garden Grove, CA). The DPAC module operates at a frequency of 2.4GHz, is 802.11b wireless compliant, and has a relatively small ( $1.6 \times 1.17 \times 0.46$  inches) footprint. The wireless module runs off a 3.7VDC and includes a built-in



TCP/IP stack, a radio, a base-band processor, an application processor, and software for a “drop-in” WiFi application. It has the advantage of being a plug-and-play device that does not require any programming and can connect with other devices through a standard UART.

*PDA:* The PDA was selected based on size, weight, and power consumption. Furthermore, the ability to carry the user interface with the medic also allows for greater flexibility during deployment. We chose the HP iPAQ h4150 PDA because it can support both 802.11b and Bluetooth™ wireless communication. It contains a modest amount of storage and has sufficient computational resources for the intended application. The use of a PDA as a local terminal also provides a low-cost touch screen interface. The user-friendly touch screen of the PDA offers additional flexibility. It enables multiple controls to occupy the same physical space and the controls appear only when needed. Additionally, a touch screen reduces development cost and time, because no external hardware is required. The data from the wireless-enabled PDA can also be downloaded or streamed to a remote base station via Bluetooth or other wireless communication protocols. The PDA can also serve to temporarily store vital medical information received from the wearable unit.

A dedicated National Instruments LabVIEW program was developed to control all interactions between the PDA and the wearable unit via a graphical user interface (GUI). One part of the LabVIEW software is used to control the flow of information through the 802.11b radio system on the PDA. A number of LabVIEW VIs programs are used to establish a connection, exchange data, and close the connection between the wearable pulse oximeter and the PDA. The LabVIEW program interacts with the Windows CE™ drivers of the PDA’s wireless system. The PDA has special drivers provided by the manufacturer that are used by Windows CE™ to interface with the 802.11b radio hardware. The LabVIEW program interacts with Windows CE™ on a higher level and allows Windows CE™ to handle the drivers and the direct control of the radio hardware.

The user interacts with the wearable system using a simple GUI, as depicted in Fig. 3.



Fig. 3. Sample PDA Graphical User Interface (GUI).

The GUI was configured to present the input and output information to the user and allows easy activation of various

functions. In cases of multiple wearable devices, it also allows the user to select which individual to monitor prior to initiating the wireless connection. Once a specific wearable unit is selected, the user connects to the remote device via the System Control panel that manages the connection and sensor control buttons. The GUI also displays the subject’s vital signs, activity level, body orientation, and a scrollable PPG waveform that is transmitted by the wearable device.

The stream of data received from the wearable unit is distributed to various locations on the PDA’s graphical display. The most prominent portion of the GUI display is the scrolling PPG waveform, shown in Fig. 3. Numerical SpO<sub>2</sub> and HR values are displayed in separate indicator windows. A separate tri-color indicator is used to annotate the subject’s activity level measured by the wearable accelerometer. This activity level was color coded using green, yellow, or red to indicate low or no activity, moderate activity, or high activity, respectively. In addition, the subject’s orientation is represented by a blue indicator that changes orientation according to body posture. Alarm limits could be set to give off a warning sign if the physiological information exceeds preset safety limits.

One of the unique features of this PDA-based wireless system architecture is the flexibility to operate in a free roaming mode. In this ad-hoc configuration, the system’s integrity depends only on the distance between each node. This allows the PDA to communicate with a remote unit that is beyond the PDA’s wireless range. The ad-hoc network would therefore allow medical personnel to quickly distribute sensors to multiple casualties and begin immediate triage, thereby substantially simplifying and reducing deployment time.

*Power Management:* Several features were incorporated into the design in order to minimize the power consumption of the wearable system. The most stringent consideration was the total operating power required by the Sensor Module, which has to drive the R and IR LEDs, process the data, and transmit this information wirelessly to the Receive Module. To keep the overall size of the Sensor Module as small as, it was designed to run on a watch style coin-cell battery.

It should be noted that low power management without compromising signal quality is an essential requirement in optimizing the design of wearable pulse oximeter. Commercially available transducers used with transmission and reflection pulse oximeters employ high brightness LEDs and a small PD element, typically with an active area ranging between 12 to 15mm<sup>2</sup>. One approach to lowering the power consumption of a wireless pulse oximeter, which is dominated by the current required to drive the LEDs, is to reduce the LED duty cycle. Alternatively, minimizing the drive currents supplied to the R and IR LEDs can also achieve a significant reduction in power consumption. However, with reduced current drive, there can be a direct impact on the quality of the detected PPGs. Furthermore, since most of the light emitted from the LEDs is diffused by the skin and subcutaneous tissues, in a predominantly forward-scattering direction, only a small fraction of the incident light is normally backscattered from the skin. In

addition, the backscattered light intensity is distributed over a region that is concentric with respect to the LEDs. Consequently, the performance of reflectance pulse oximetry using a small PD area is significantly degraded. To overcome this limitation, we showed that a concentric array of either discrete PDs, or an annularly-shaped PD ring, could be used to increase the amount of backscattered light detected by a reflectance type pulse oximeter sensor [5]-[7].

Besides a low-power consuming sensor, afforded by lowering the driving currents of the LEDs, a low duty cycle was employed to achieve a balance between low power consumption and adequate performance. In the event that continuous monitoring is not required, more power can be conserved by placing the device in an ultra low-power standby mode. In this mode, the radio is normally turned off and is only enabled for a periodic beacon to maintain network association. Moreover, a decision to activate the wearable pulse oximeter can be made automatically in the event of a patient alarm, or based on the activity level and posture information derived from the on-board accelerometer. The wireless pulse oximeter can also be activated or deactivated remotely by a medic as needed, thereby further minimizing power consumption.

### III. IN VIVO EVALUATIONS

Initial laboratory evaluations of the wearable pulse oximeter included simultaneous HR and SpO<sub>2</sub> measurements. The Sensor Module was positioned on the forehead using an elastic headband. Baseline recordings were made while the subject was resting comfortably and breathing at a normal tidal rate. Two intermittent recordings were also acquired while the subject held his breath for about 30 seconds. Fig. 4 displays about 4 minutes of SpO<sub>2</sub> and HR recordings acquired simultaneously by the sensor.

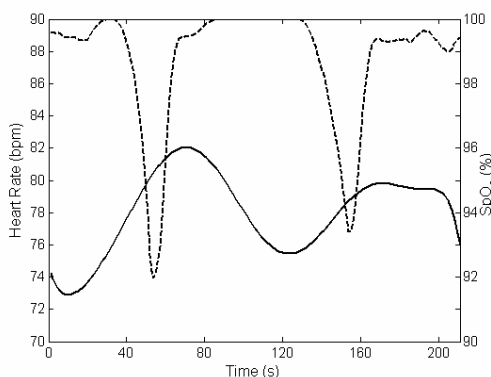

Fig. 4. Typical HR (solid line) and SpO<sub>2</sub> (dashed line) recording of two voluntary hypoxic episodes.

The pronounced drops in SpO<sub>2</sub> and corresponding increases in HR values coincide with the hypoxic events associated with the two breath holding episodes.

### IV. DISCUSSION

The emerging development of compact, low power, small size, light weight, and unobtrusive wearable devices can facilitate remote noninvasive monitoring of vital

physiological signs. Wireless physiological information can be useful to monitor soldiers during training exercises and combat missions, and help emergency first-responders operating in harsh and hazardous environments. Similarly, wearable physiological devices could become critical in helping to save lives following a civilian mass casualty. The primary goal of such a wireless mobile platform would be to keep track of an injured person's vital signs via a short-range wirelessly-linked personal area network, thus readily allowing RF telemetry of vital physiological information to command units and remote off-site base stations for continuous real-time monitoring by medical experts.

The preliminary bench testing plotted in Fig. 4 showed that the SpO<sub>2</sub> and HR readings are within an acceptable clinical range. Similarly, the transient changes measured during the two breath holding maneuvers confirmed that the response time of the custom pulse oximeter is adequate for detecting hypoxic episodes.

### V. CONCLUSION

A wireless, wearable, reflectance pulse oximeter has been developed based on a small forehead-mounted sensor. The battery-operated device employs a lightweight optical reflectance sensor and incorporates an annular photodetector to reduce power consumption. The system has short range wireless communication capabilities to transfer SpO<sub>2</sub>, HR, body acceleration, and posture information to a PDA carried by medics or first responders. The information could enhance the ability of first responders to extend more effective medical care, thereby saving the lives of critically injured persons.

### ACKNOWLEDGMENT

The authors would like to acknowledge the financial support provided by the U.S. Army Medical Research and Materiel Command referenced.

### REFERENCES

- [1] G. S. F. Ling, B. K. Day, P. Rhee, and J. M. Ecklund, "In search of technological solutions to battlefield management of combat casualties," *SPIE Conference on Battlefield Biomedical Technologies*, SPIE vol. 3712, Apr. 1999.
- [2] D. Malan, T. Fulford-Jones, M. Welsh, and S. Moulton, "CodeBlue: An ad-hoc sensor network infrastructure for emergency medical care," *International Workshop on Wearable and Implantable Body Sensor Networks*, 2004.
- [3] U. Anliker et al., "AMON: A wearable multiparameter medical monitoring and alert system," *IEEE Trans. on Information Technology in Biomedicine*, 8(4), 2004.
- [4] Y. Mendelson and V. Floroff, "A PDA based *ad-hoc* mobile wireless pulse oximeter," *Proc. IASTED International Conference Telehealth 2005*, Banff, Canada, 2005.
- [5] Y. Mendelson and C. J. Pujary, "Minimization of LED power consumption in the design of a wearable pulse oximeter," *IASTED International Conference BioMED 2003*, Salzburg, Austria, 2003.
- [6] Y. Mendelson and C. J. Pujary, "Measurement site and photodetector size considerations in optimizing power consumption of a wearable reflectance pulse oximeter," *Proc. of the 25<sup>th</sup> Annual International IEEE/EMBS Conference*, Cancun, Mexico, 2003.
- [7] P. Branche and Y. Mendelson, "Signal quality and power consumption of a new prototype reflectance pulse oximeter sensor," *Proc. of the 31<sup>st</sup> Annual Northeast Bioengineering Conference*, Hoboken, NJ, 2005.