



US006834326B1

(12) **United States Patent**
Wang et al.

(10) **Patent No.:** **US 6,834,326 B1**
(45) **Date of Patent:** **Dec. 21, 2004**

(54) **RAID METHOD AND DEVICE WITH NETWORK PROTOCOL BETWEEN CONTROLLER AND STORAGE DEVICES**

(75) Inventors: **Peter S. S. Wang**, Cupertino, CA (US); **David C. Lee**, San Jose, CA (US)

(73) Assignee: **3Com Corporation**, Marlborough, MA (US)

(*) Notice: Subject to any disclaimer, the term of this patent is extended or adjusted under 35 U.S.C. 154(b) by 0 days.

(21) Appl. No.: **09/527,904**

(22) Filed: **Mar. 17, 2000**

Related U.S. Application Data

(60) Provisional application No. 60/180,574, filed on Feb. 4, 2000.

(51) **Int. Cl.**⁷ **G06F 12/02**

(52) **U.S. Cl.** **711/114; 711/162; 711/154; 711/161; 370/355; 370/356**

(58) **Field of Search** 711/114, 4, 162, 711/161, 154; 709/200; 710/1; 370/351-356

(56) **References Cited**

U.S. PATENT DOCUMENTS

| | | | | | |
|-----------|----|---|---------|------------------|---------|
| 5,805,920 | A | * | 9/1998 | Sprenkle et al. | 710/1 |
| 6,000,020 | A | * | 12/1999 | Chin et al. | 711/162 |
| 6,098,155 | A | * | 8/2000 | Chong, Jr. | 711/138 |
| 6,138,176 | A | * | 10/2000 | McDonald et al. | 710/6 |
| 6,141,788 | A | * | 10/2000 | Rosenberg et al. | 714/774 |
| 6,148,414 | A | * | 11/2000 | Brown et al. | 714/11 |
| 6,272,522 | B1 | * | 8/2001 | Lin et al. | 709/200 |
| 6,304,942 | B1 | * | 10/2001 | DeKoning | 711/114 |
| 6,378,039 | B1 | * | 4/2002 | Obara et al. | 709/105 |
| 6,529,996 | B1 | * | 3/2003 | Nguyen et al. | 711/114 |

OTHER PUBLICATIONS

D. Meyer, Introduction to IP Multicast (Jun., 1998) from www.nanog.org/mtg-9806/ppt/davemeyer/, pp. 1-49.

T. Maufer and C. Semeria, Introduction to IP Multicast Routing, IETF Internet Draft (Apr. or May 1996), pp. 1-54.

C. Semeria and T. Maufer, Introduction to IP Multicast Routing (undated) from www.cs.utexas.edu/users/dragon/cs378/resources/mult1.pdf.

Juan-Mariano de Goyeneche "Multicast Over TCP/IP HOWTO" Mar. 20, 1998 consisting of 34 pages <http://www.linuxdoc.org/HOWTO/Multicast-HOWTO.html>.

B. Quinn "IP Multicast Applications: Challenges and Solutions" Nov. 1998 IP Multicast Initiative pp. 1-16.

B. Quinn "IP Multicast Applications: Challenges and Solutions" Jun. 25, 1999 Stardust Forums pp. 1-25.

* cited by examiner

Primary Examiner—Mano Padmanabhan

Assistant Examiner—Jasmine Song

(74) *Attorney, Agent, or Firm*—Ernest J. Beffel, Jr.; Haynes Beffel & Wolfeld LLP

(57) **ABSTRACT**

The present invention relates to transparent access to a redundant array of inexpensive devices. In particular, it provides a method and device for connecting redundant disk drives to a controller, preferably an intelligent switch, via a network. The disks are controlled by commands transported across the network. Commands may be SCSI, IDE/ATA or other commands. The network may comprise ethernet, fiber channel or other physical layer protocol. Commands can be encapsulated in IP packets and transmitted using either a reliable or unreliable transport protocol. Multicasting of packets from the controller to the multiple disk drives is part of the present invention.

74 Claims, 10 Drawing Sheets

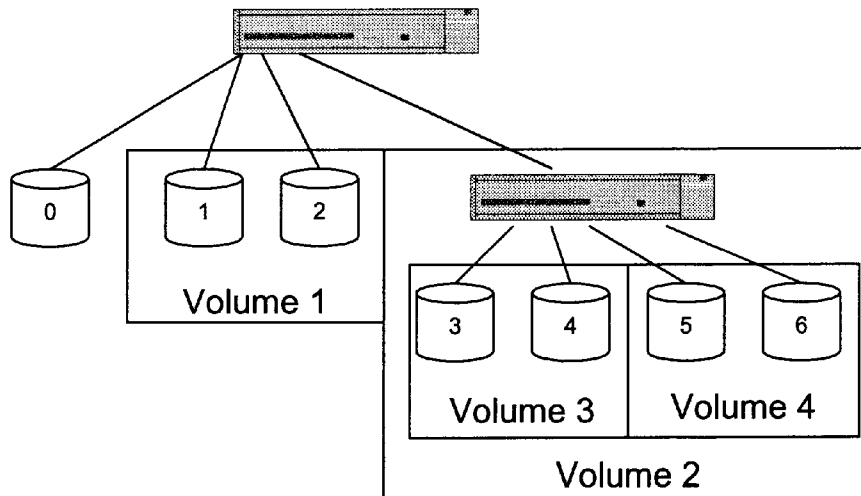

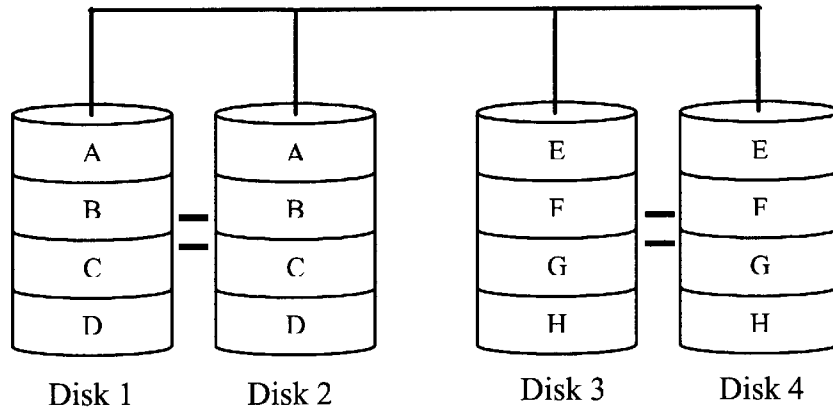

Fig. 1

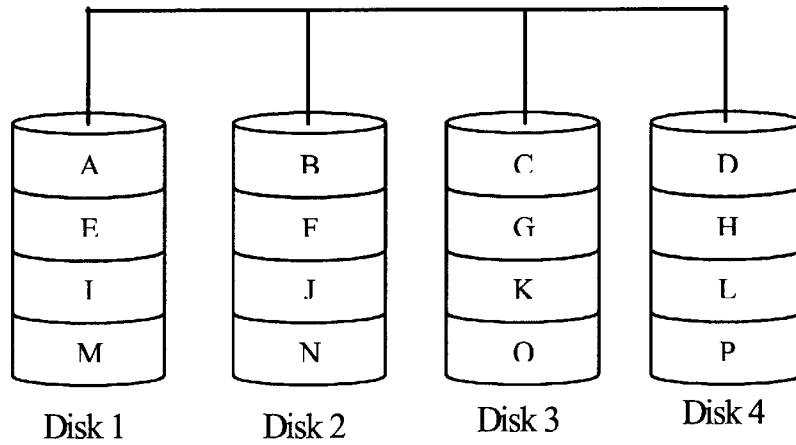

Fig. 2

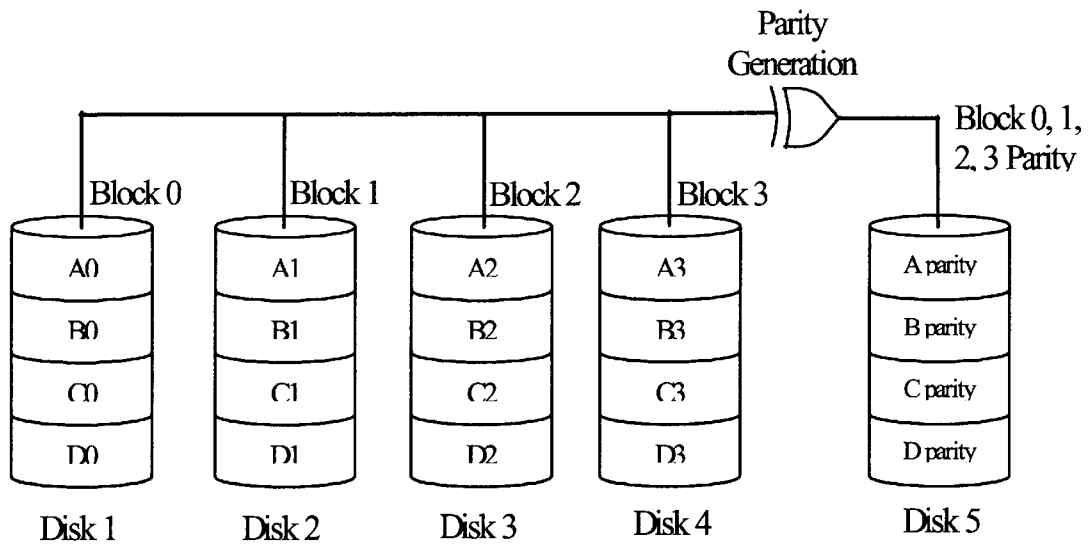

Fig. 3

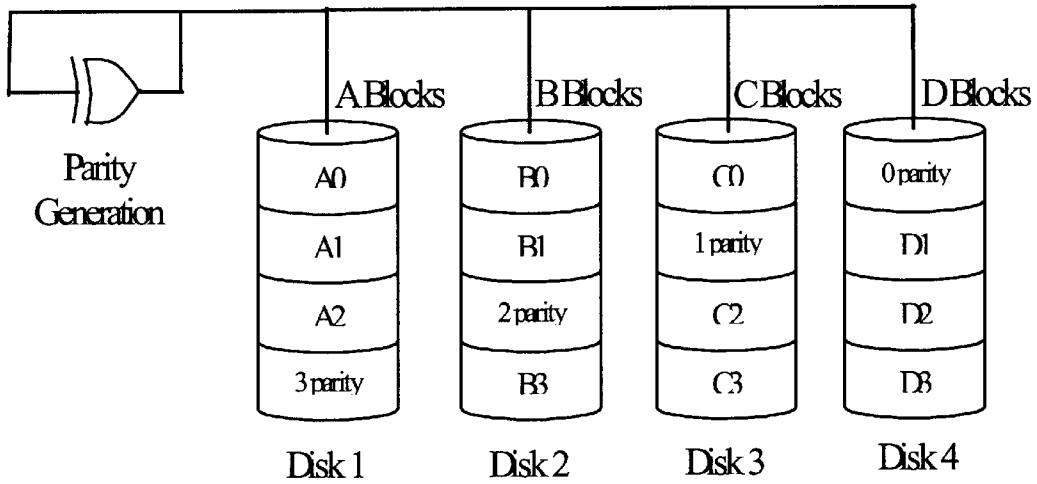

Fig. 4

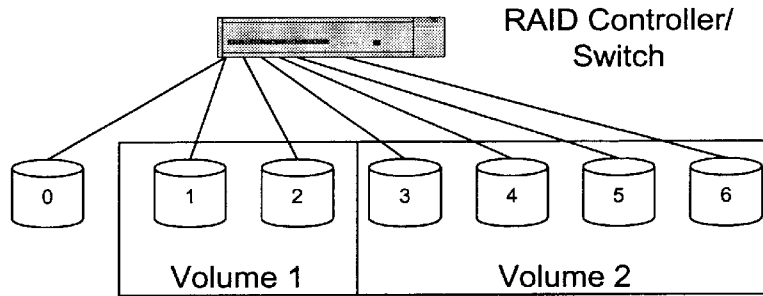

Fig. 5

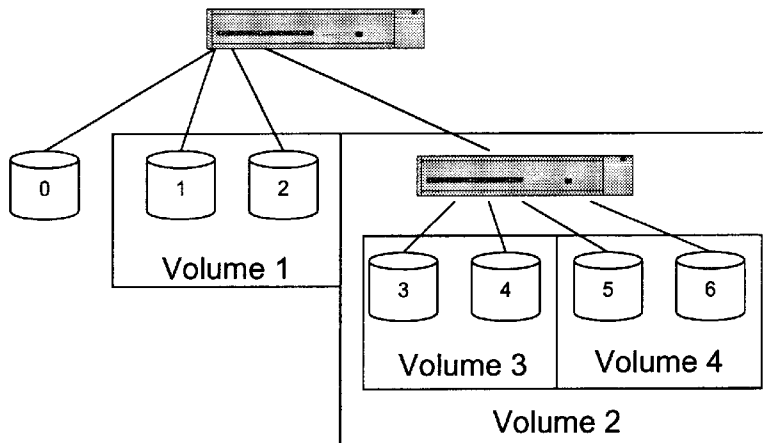

Fig. 6

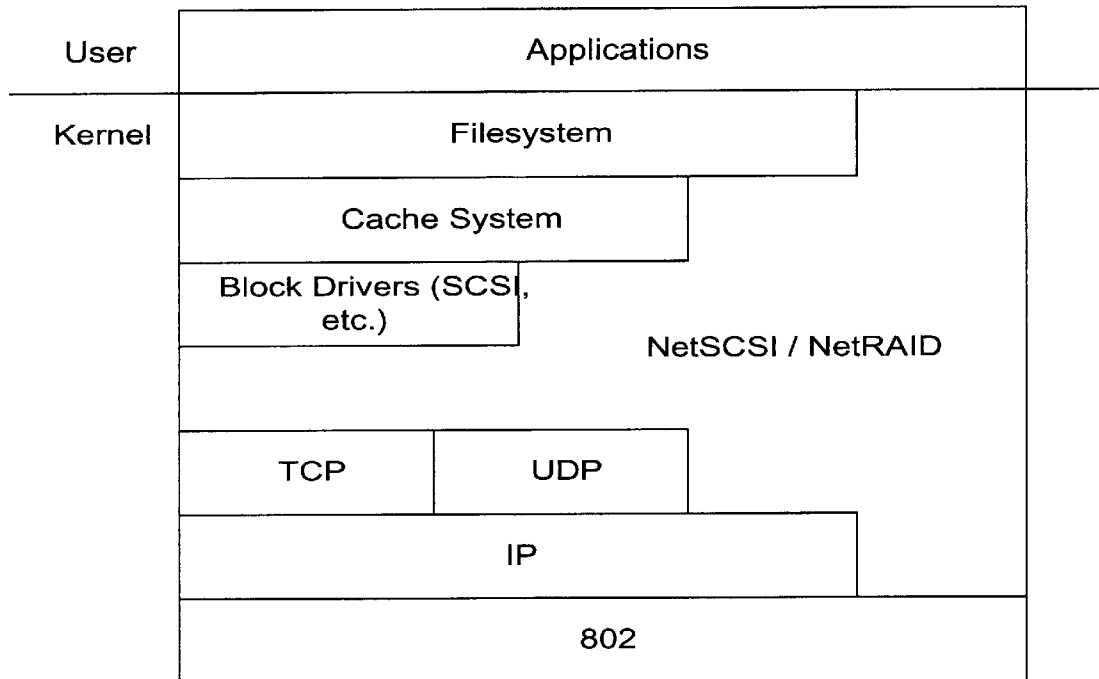

Fig. 7

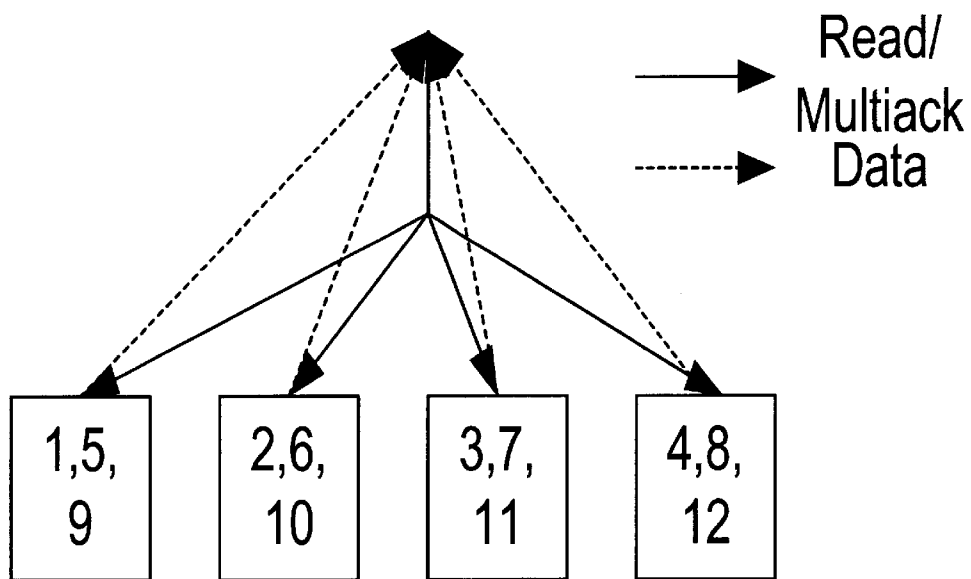

Fig. 8a

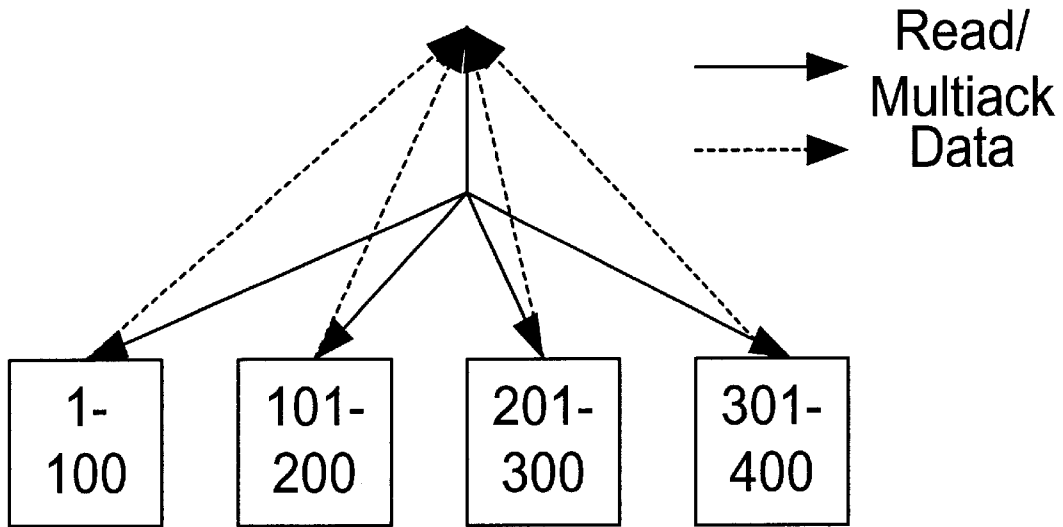

Fig. 8b

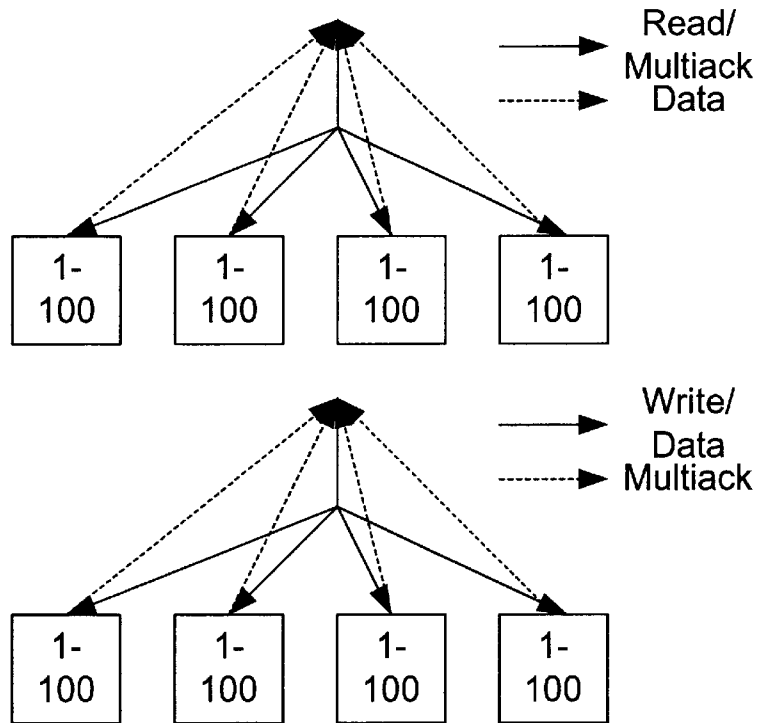

Fig. 8c

Explore Litigation Insights

Docket Alarm provides insights to develop a more informed litigation strategy and the peace of mind of knowing you're on top of things.

Real-Time Litigation Alerts



Keep your litigation team up-to-date with **real-time alerts** and advanced team management tools built for the enterprise, all while greatly reducing PACER spend.

Our comprehensive service means we can handle Federal, State, and Administrative courts across the country.

Advanced Docket Research



With over 230 million records, Docket Alarm's cloud-native docket research platform finds what other services can't. Coverage includes Federal, State, plus PTAB, TTAB, ITC and NLRB decisions, all in one place.

Identify arguments that have been successful in the past with full text, pinpoint searching. Link to case law cited within any court document via Fastcase.

Analytics At Your Fingertips



Learn what happened the last time a particular judge, opposing counsel or company faced cases similar to yours.

Advanced out-of-the-box PTAB and TTAB analytics are always at your fingertips.

API

Docket Alarm offers a powerful API (application programming interface) to developers that want to integrate case filings into their apps.

LAW FIRMS

Build custom dashboards for your attorneys and clients with live data direct from the court.

Automate many repetitive legal tasks like conflict checks, document management, and marketing.

FINANCIAL INSTITUTIONS

Litigation and bankruptcy checks for companies and debtors.

E-DISCOVERY AND LEGAL VENDORS

Sync your system to PACER to automate legal marketing.