

- [54] **PERSONAL COMMUNICATOR HAVING IMPROVED ZOOM AND PAN FUNCTIONS FOR EDITING INFORMATION ON TOUCH SENSITIVE DISPLAY**
- [75] Inventors: **David J. Allard; Francis J. Canova, Jr.**, both of Boynton Beach; **Debra A. G. Johnson**, Fort Lauderdale; **Charles S. Lanier**, Delray Beach; **James R. Lewis**, Coconut Creek; **Byron K. Tiller**, Boca Raton; **William Villafana, Davie**; **Raymond L. Yee**, Coral Springs, all of Fla.

5,119,079	6/1992	Hube et al.	340/712
5,119,135	6/1992	Baldwin	355/218
5,157,384	10/1992	Greanias et al.	340/706
5,166,666	11/1992	Tanaka	340/706
5,184,314	2/1993	Kelly et al.	364/709.01
5,187,776	2/1993	Yanker	395/157
5,201,034	4/1993	Matsuura et al.	395/155
5,204,813	4/1993	Samph et al.	364/419
5,252,951	10/1993	Tannenbaum et al.	345/156
5,260,697	11/1993	Barrett et al.	345/173
5,317,140	5/1994	Dunthorn	250/221
5,341,466	8/1994	Perlin et al.	395/139
5,353,356	10/1994	Waugh et al.	382/8
5,363,211	11/1994	Hasebe et al.	358/451

[73] Assignee: **International Business Machines Corporation**, Armonk, N.Y.

Primary Examiner—Alyssa H. Bowler
Assistant Examiner—Walter D. Davis
Attorney, Agent, or Firm—George E. Grosser

[21] Appl. No.: 521,333

[57] **ABSTRACT**

[22] Filed: **Aug. 29, 1995**

A mobile, hand-held personal communicator includes a casing for housing a cellular phone, modem, and data processing system. Graphics image files are stored and can be selectively displayed on a touchscreen display. A zoom function magnifies areas of a graphics image, such as a fax image, that has been received and stored in the PC. When the zoom function is selected, the user touches the screen, and a magnification frame or window appears. When the user removes his/her finger, the area within the frame is magnified. The user can also drag the frame around the screen, while still touching the screen, to select a specific area to be magnified when the user releases the screen. A pan function allows the user to shift the image within a viewing area. The user can pan the image by touching the display at an initial touch point, and moving his/her finger keeping it in contact with the screen, to shift the touch point to a new touch point. Upon releasing the new touch point, the image is redrawn in a new position corresponding to the change in position between the initial and new touch points.

Related U.S. Application Data

- [63] Continuation of Ser. No. 146,341, Nov. 1, 1993, abandoned.
- [51] **Int. Cl.⁶** **G06F 15/66**
- [52] **U.S. Cl.** **395/800; 395/139; 395/326; 382/298; 345/121; 345/130; 345/173**
- [58] **Field of Search** 395/800, 139, 395/157; 345/156, 173; 364/DIG. 1, 521, 518; 382/47, 8; 340/700, 731, 712

[56] **References Cited**

U.S. PATENT DOCUMENTS

4,587,630	5/1986	Straton et al.	364/DIG. 2
4,755,811	7/1988	Slavin et al.	340/731
4,790,028	12/1988	Ramage	382/47
4,833,625	5/1989	Fisher et al.	364/518
4,899,292	2/1990	Montagna et al.	364/521
5,051,927	9/1991	Tada et al.	364/521

9 Claims, 5 Drawing Sheets

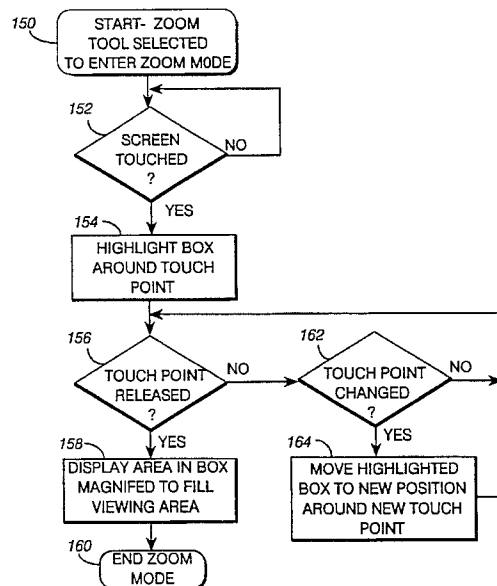

FIG. 1

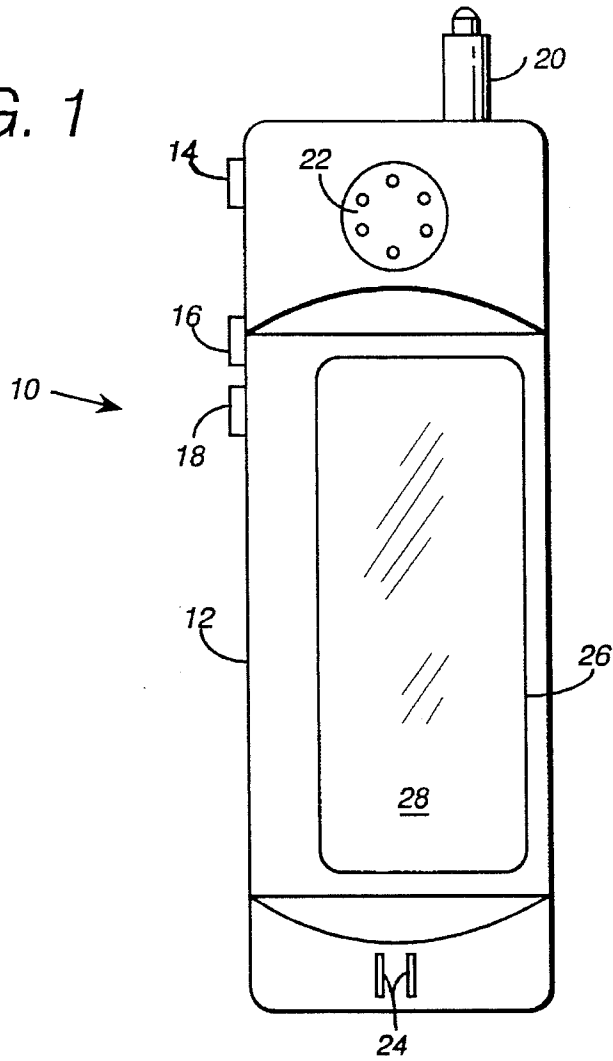

FIG. 2

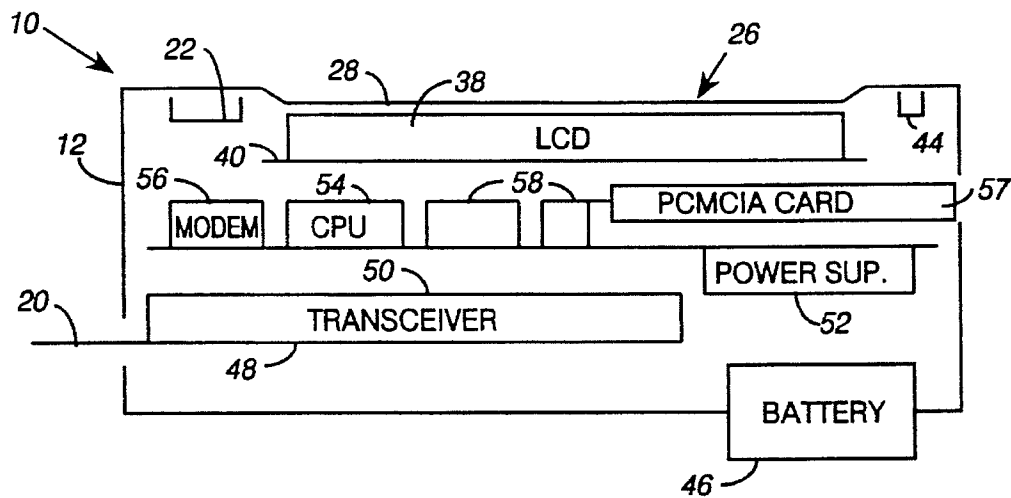

FIG. 3

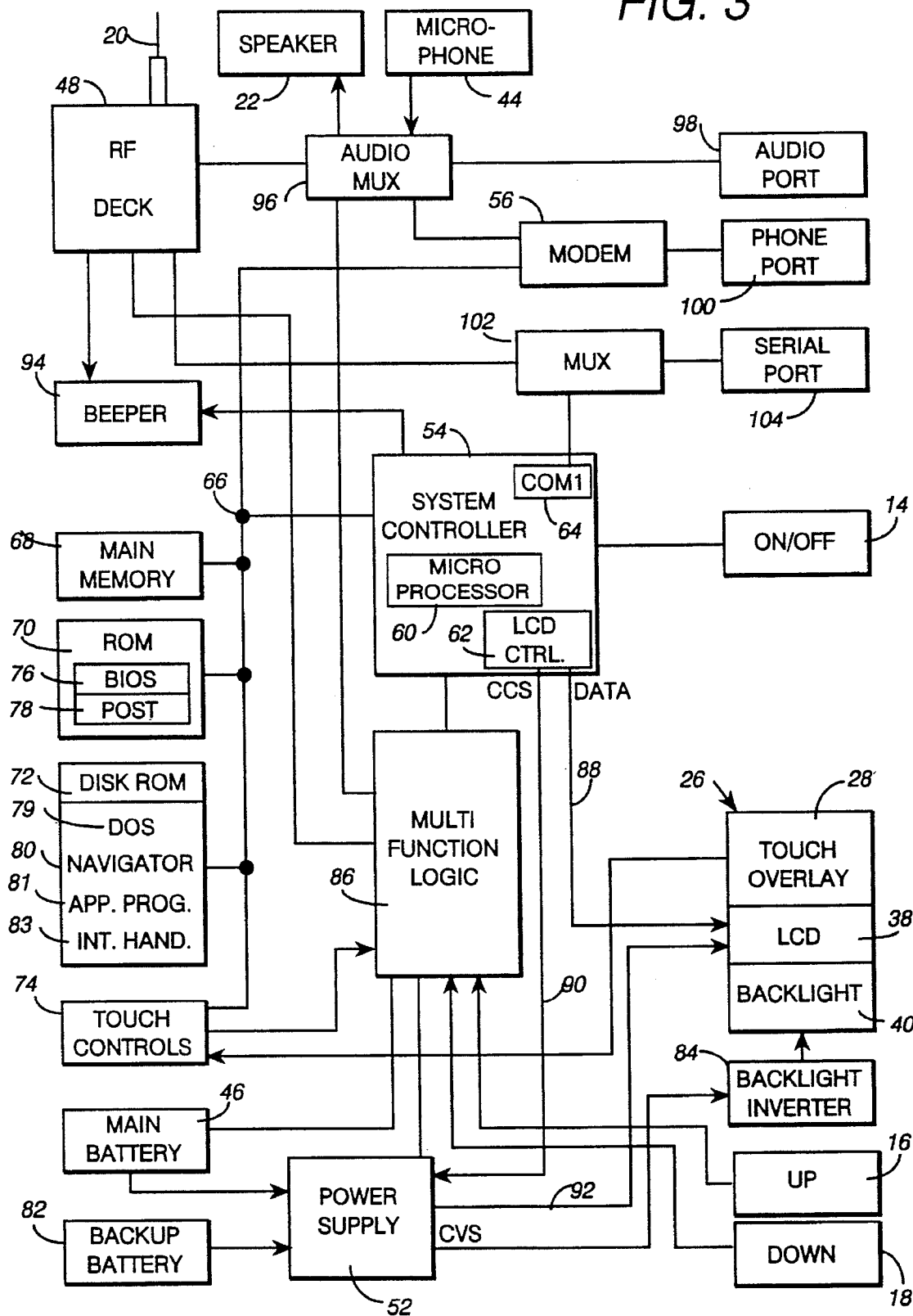
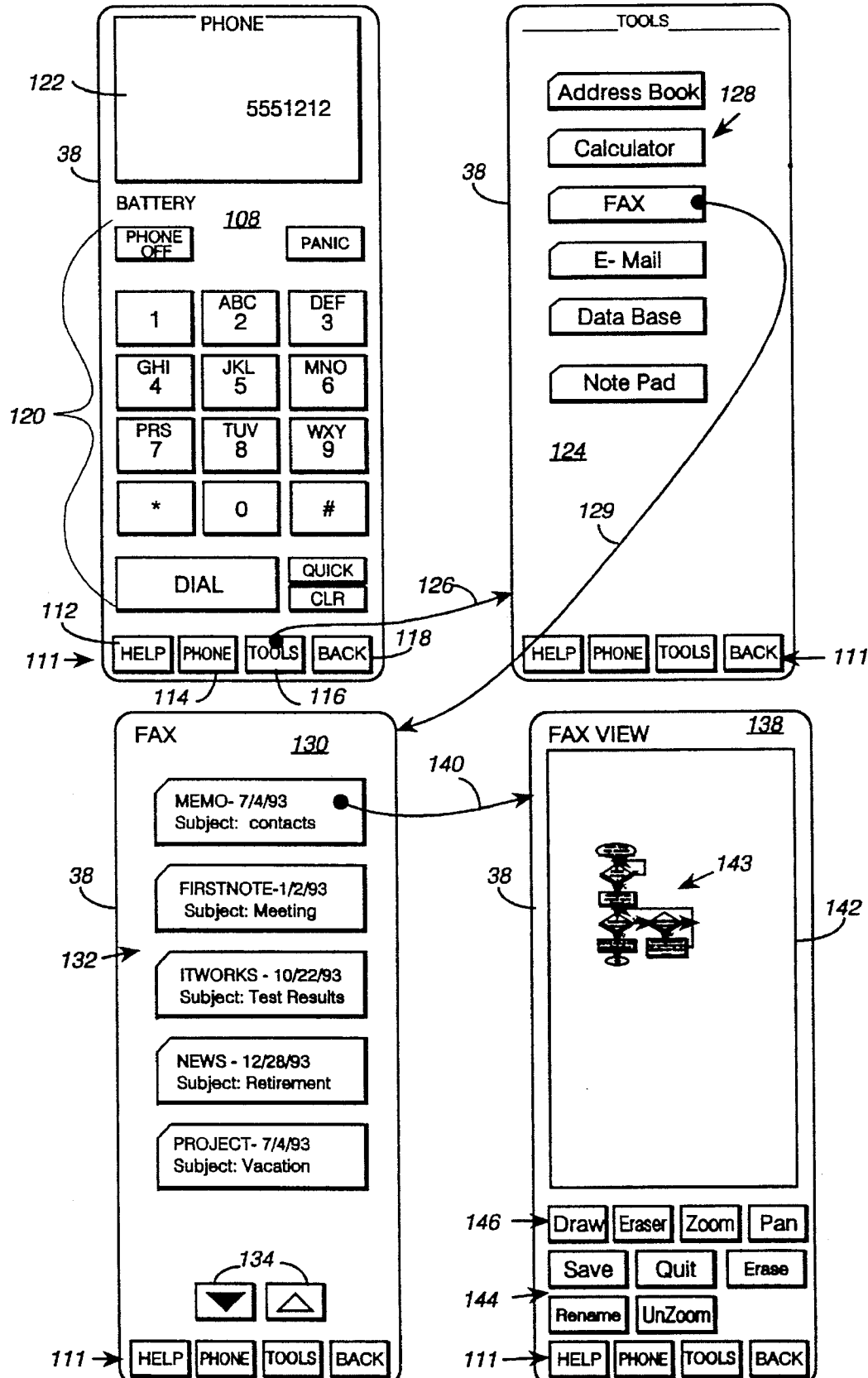
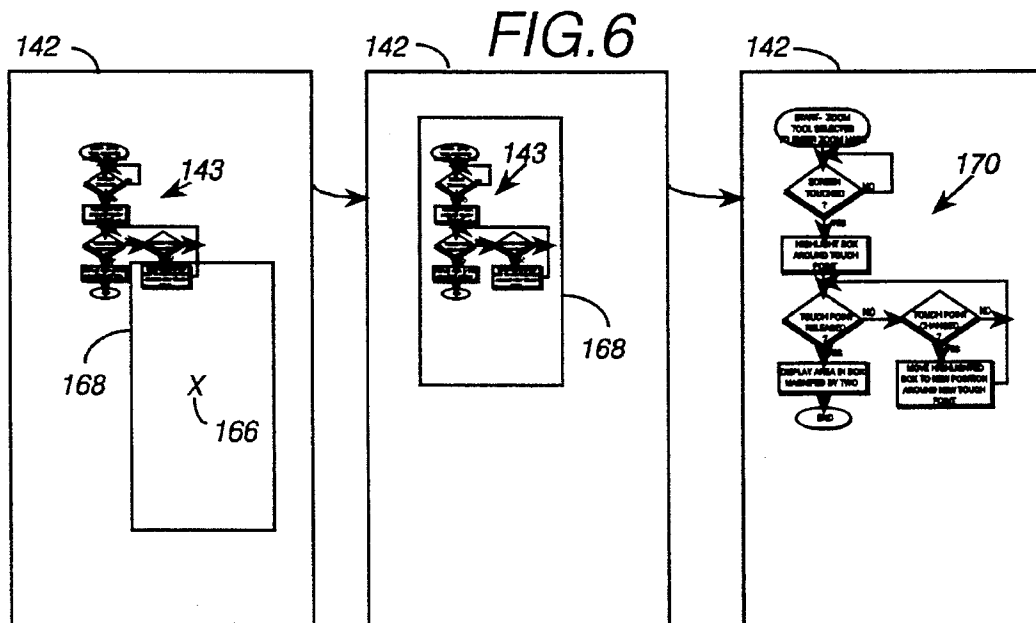
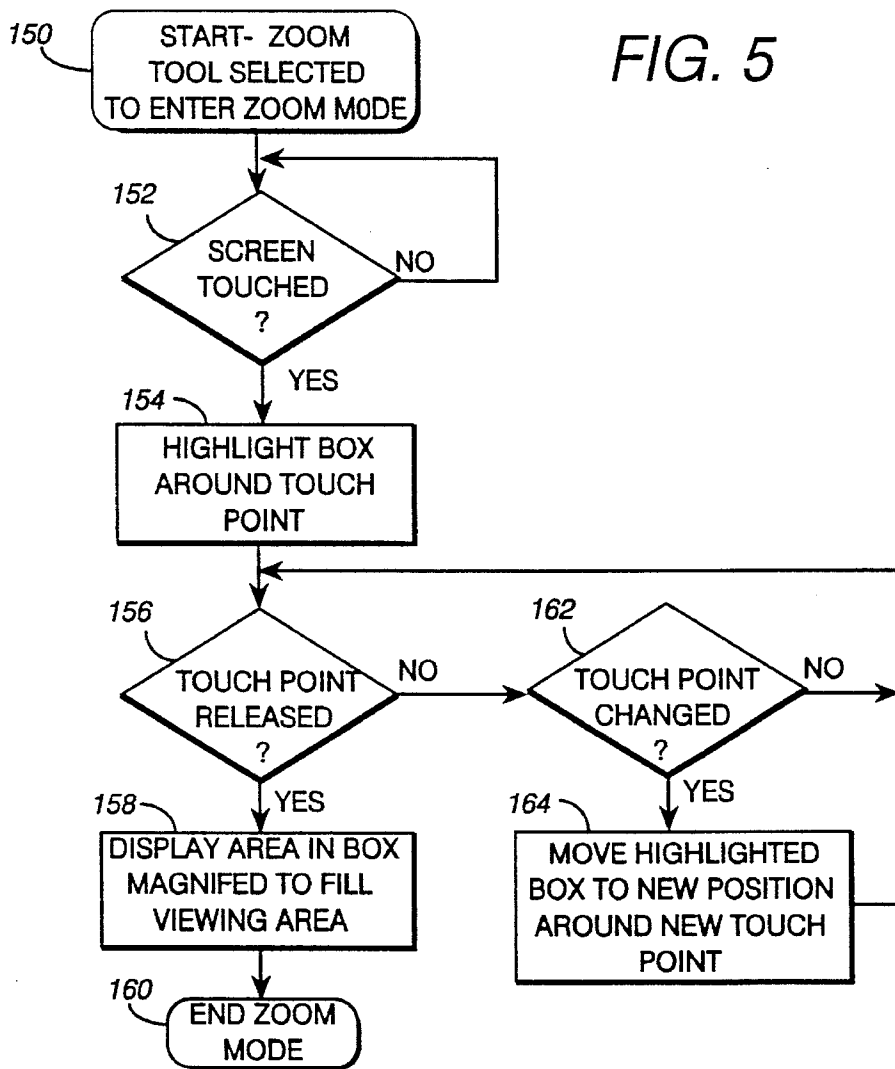

FIG. 4





Explore Litigation Insights

Docket Alarm provides insights to develop a more informed litigation strategy and the peace of mind of knowing you're on top of things.

Real-Time Litigation Alerts



Keep your litigation team up-to-date with **real-time alerts** and advanced team management tools built for the enterprise, all while greatly reducing PACER spend.

Our comprehensive service means we can handle Federal, State, and Administrative courts across the country.

Advanced Docket Research



With over 230 million records, Docket Alarm's cloud-native docket research platform finds what other services can't. Coverage includes Federal, State, plus PTAB, TTAB, ITC and NLRB decisions, all in one place.

Identify arguments that have been successful in the past with full text, pinpoint searching. Link to case law cited within any court document via Fastcase.

Analytics At Your Fingertips



Learn what happened the last time a particular judge, opposing counsel or company faced cases similar to yours.

Advanced out-of-the-box PTAB and TTAB analytics are always at your fingertips.

API

Docket Alarm offers a powerful API (application programming interface) to developers that want to integrate case filings into their apps.

LAW FIRMS

Build custom dashboards for your attorneys and clients with live data direct from the court.

Automate many repetitive legal tasks like conflict checks, document management, and marketing.

FINANCIAL INSTITUTIONS

Litigation and bankruptcy checks for companies and debtors.

E-DISCOVERY AND LEGAL VENDORS

Sync your system to PACER to automate legal marketing.