

IN THE UNITED STATES PATENT AND TRADEMARK OFFICE

In re Patent of: Jeroen Poeze, et al.
U.S. Patent No.: 10,631,765 Attorney Docket No.: 50095-0024IP2
Issue Date: April 28, 2020
Appl. Serial No.: 16/725,478
Filing Date: December 23, 2019
Title: MULTI-STREAM DATA COLLECTION SYSTEM FOR
NONINVASIVE MEASUREMENT OF BLOOD
CONSTITUENTS

Mail Stop Patent Board

Patent Trial and Appeal Board
U.S. Patent and Trademark Office
P.O. Box 1450
Alexandria, VA 22313-1450

DECLARATION OF JACOB ROBERT MUNFORD

1. My name is Jacob Robert Munford. I am over the age of 18, have personal knowledge of the facts set forth herein, and am competent to testify to the same.

2. I earned a Master of Library and Information Science (MLIS) from the University of Wisconsin-Milwaukee in 2009. I have over ten years of experience in the library/information science field. Beginning in 2004, I have served in various positions in the public library sector including Assistant Librarian, Youth Services Librarian and Library Director. I have attached my Curriculum Vitae as Appendix A.

3. During my career in the library profession, I have been responsible for materials acquisition for multiple libraries. In that position, I have cataloged, purchased and processed incoming library works. That includes purchasing materials directly from vendors, recording publishing data from the material in question, creating detailed material records for library catalogs and physically preparing that material for circulation. In addition to my experience in acquisitions, I was also responsible for analyzing large collections of library materials, tailoring library records for optimal catalog

search performance and creating lending agreements between libraries during my time as a Library Director.

4. I am fully familiar with the catalog record creation process in the library sector. In preparing a material for public availability, a library catalog record describing that material would be created. These records are typically written in Machine Readable Catalog (herein referred to as “MARC”) code and contain information such as a physical description of the material, metadata from the material’s publisher, and date of library acquisition. In particular, the 008 field of the MARC record is reserved for denoting the date of creation of the library record itself. As this typically occurs during the process of preparing materials for public access, it is my experience that an item’s MARC record indicates the date of an item’s public availability.

5. Typically, in creating a MARC record, a librarian would gather various bits of metadata such as book title, publisher and subject headings among others and assign each value to a relevant numerical field. For example, a book’s physical description is tracked in field 300 while title/attribution is tracked in field 245. The 008 field of the MARC record is reserved for denoting the creation of the library record itself. As this is the only date reflecting the inclusion of said materials within the library’s collection, it is my experience

that an item's 008 field accurately indicates the date of an item's public availability.

6. This declaration is being drafted as of September 2020. Public and university libraries in my area have been closed for months due to the COVID-19 pandemic. My state, Pennsylvania, has a travel advisory, which has affected my ability to travel. In my experience, library catalog records are accurate descriptions of a library's collection and my lack of physical access to libraries at this time creates no doubt in my determinations of authenticity or availability of the exhibits noted below.

7. I have reviewed Exhibit 1010, a copy of an article entitled "A Wearable Reflectance Pulse Oximeter for Remote Physiological Monitoring" by Y. Mendelson, R. J. Duckworth, and G. Comtois, as published in the *Proceedings of the 28th Annual International Conference of the IEEE Engineering in Medicine and Biology Society, August 30 – September 3, 2006* (hereinafter referred to as "2006 IEEE conference publication").

8. Attached hereto as Appendix MENDELSON02 is a true and correct copy of the MARC record for the 2006 IEEE conference publication, as held by

Cornell University's library. I secured this record myself from the library's public catalog.

9. The MARC record contained within Appendix MENDELSON02 accurately describes the title, author, publisher, and ISSN number of the 2006 IEEE conference publication. In comparing the information listed in Appendix MENDELSON02 to Exhibit 1010, it is my determination that the copy of the 2006 IEEE conference publication in Cornell University's library is the same as the copy of the 2006 IEEE conference publication in Exhibit 1010.

10. The 008 field of the MARC record noted on page 1 of Appendix MENDELSON02 indicates that the 2006 IEEE conference publication was first cataloged by Cornell University's library as of December 26, 2007. Based on this information and considering the dates of the conference, it is my determination that the 2006 IEEE conference publication, which included the article published as Exhibit 1010, was made available to the public by Cornell University at least as of December 26, 2007.

11. I have reviewed Exhibit 1017, a copy of an article entitled "Design and Evaluation of a New Reflectance Pulse Oximeter Sensor" by Y. Mendelson, et al., as published in the *Journal of the Association for the Advancement of*

Medical Instrumentation, Vol. 22, No. 4, 1988 (hereinafter referred to as “1988 publication”).

12. Attached hereto as Appendix MENDELSON03 is a true and correct copy of the MARC record for the 1988 publication held by the University of Pennsylvania’s library. I secured this record myself from the library’s public catalog.

13. The MARC record contained within Appendix MENDELSON03 accurately describes the title, author, publisher, and ISSN number of the *Journal of the Association for the Advancement of Medical Instrumentation*. The 949 field of a MARC record is used for institution-specific notations and the 949 fields of this MARC record indicate the University of Pennsylvania’s issue level holdings for the *Journal of the Association for the Advancement of Medical Instrumentation*, demonstrating that the University of Pennsylvania’s collection contains volumes 17 – 22. These journal holdings clearly include Volume 22, No. 4, which corresponds to the 1988 publication. In comparing the listed fields in Appendix MENDELSON03 to Exhibit 1017, it is my determination that Exhibit 1017 is a true and correct copy of the “Design and Evaluation of a New Reflectance Pulse Oximeter

Sensor” article, and that the copy of the 1988 publication in University of Pennsylvania’s library includes the article in Exhibit 1017.

14. The 008 field of the MARC record noted on page 1 of Appendix MENDELSON03 indicates that the *Journal of the Association for the Advancement of Medical Instrumentation* was first cataloged by the University of Pennsylvania’s library as of August 8, 1983. The 362 field of the MARC record indicates University of Pennsylvania’s acquisition of this material ceased as of Vol. 22, No. 6. Based on this information, it is my determination that the 1988 publication, which included the article published as Exhibit 1017, was made available to the public by the University of Pittsburgh shortly after initial publication in August 1988.

15. I have reviewed Exhibit 1018, a copy of an article entitled “Skin Reflectance Pulse Oximetry: In Vivo Measurements From the Forearm and Calf” by Y. Mendelson and M.J. McGinn as published in *Journal of Clinical Monitoring, January 1991* (hereinafter referred to as the “1991 publication”).

16. Attached hereto as Appendix MENDELSON04 is a true and correct copy of the MARC record for the 1991 publication held by the Ohio State University library. I secured this record myself from the library's public catalog.

17. The MARC record contained within Appendix MENDELSON04 accurately describes the title, author, publisher, and ISSN number of the *Journal of Clinical Monitoring*. The 'Lib Has.' field of this MARC record indicates Ohio State University's issue level holdings for the *Journal of Clinical Monitoring*, demonstrating that Ohio State University's collection contains volumes 1 (1985) – volume 13 (1997). Accordingly, Ohio State's journal holdings range clearly includes the January 1991 edition. In comparing the information listed in Appendix MENDELSON04 to Exhibit 1018, it is my determination that Exhibit 1018 is a true and correct copy of the "Skin Reflectance Pulse Oximetry: In Vivo Measurements From the Forearm and Calf" article, and that the copy of the 1991 publication in Ohio State University's library includes the article in Exhibit 1018.

18. The 008 field of the MARC record noted on page 1 of Appendix MENDELSON04 indicates that the *Journal of Clinical Monitoring* was first cataloged by Ohio State University's library as of August 23, 1999. The 'Lib has' field of this record indicates Ohio State University's acquisition of this

material ceased as of Vol. 13. Based on this information, it is my determination that the 1991 publication, which included the article published as Exhibit 1018, was made available to the public by Ohio State University at least as of August 23, 1999.

19. I have reviewed Exhibit 1022, a copy of the book entitled *Master Visually Windows Mobile* by Bill Landon and Matthew Miller (hereinafter referred to as “Landon”).

20. Attached hereto as Appendix LANDON01 is a true and correct copy of the MARC record for Landon as held by Rowan University’s library. I secured this record myself from the library’s public catalog.

21. The MARC record contained within Appendix LANDON01 accurately describes the title, author, publisher, and ISBN number of Landon. In comparing the listed fields in Appendix LANDON01 to Exhibit 1022, it is my determination that Exhibit 1022 is a true and correct copy of Landon and is the same as the copy of Landon in Rowan University.

22. The 008 field of the MARC record contained within Appendix LANDON01 indicates that Landon was first cataloged by Rowan University’s library as of September 17, 2004. Based on this information, it is my determination

that Landon was made available to the public by Rowan University at least as of September 17, 2004.

23. I have reviewed Exhibit 1021, a copy of the book entitled *How to Do Everything with Windows Mobile* by Frank McPherson (hereinafter referred to as “McPherson”).

24. Attached hereto as Appendix MCPHERSON01 is a true and correct copy of the MARC record for McPherson as held by the Carnegie Library of Pittsburgh. I secured this record myself from the library’s public catalog.

25. The MARC record contained within Appendix MCPHERSON01 accurately describes the title, author, publisher, and ISBN number of McPherson. In comparing the listed fields in Appendix MCPHERSON01 to Exhibit 1021, it is my determination that Exhibit 1021 is a true and correct copy of McPherson, and is the same as the copy of McPherson in the Carnegie Library.

26. The 008 field of the MARC record contained within Appendix MCPHERSON01 indicates that McPherson was first cataloged by the Carnegie Library of Pittsburgh as of June 5, 2006. Based on this information, it is my determination that McPherson was first made available

to the public by the Carnegie Library of Pittsburgh at least as of June 5, 2006.

27. I have reviewed Exhibit 1019, a copy of the book entitled *Design of Pulse Oximeters* by John G. Webster (hereinafter referred to as “Webster”).

28. Attached hereto as Appendix WEBSTER01 is a true and correct copy of the MARC record for Webster as held by the University of Pennsylvania’s library. I secured this record myself from the library’s public catalog.

29. The MARC record contained within Appendix WEBSTER01 accurately describes the title, author, publisher, and ISBN number of Webster. In comparing the listed fields in Appendix WEBSTER01 to Exhibit 1019, it is my determination that Exhibit 1019 is a true and correct copy of Webster, and is the same as the copy of Webster in University of Pennsylvania’s library.

30. The 008 field of the MARC record noted in page 1 of Appendix WEBSTER01 indicates that Webster was first cataloged by the University of Pennsylvania’s library as of November 26, 1997. Based on this information, it is my determination that Webster was made available to the public by the University of Pennsylvania at least as of November 26, 1997.

31. I have reviewed Exhibit 1023, a copy of an article entitled “Stimulating Student Learning with a Novel ‘In-House’ Pulse Oximeter Design” by Jianchu Yao and Steve Warren as published in the *Proceedings of the 2005 American Society for Engineering Education Annual Conference & Exposition* (hereinafter referred to as “2005 Conference Proceedings”).

32. Attached hereto as Appendix YAO01 is a true and correct copy of the MARC record for the 2005 Conference Proceedings as held by Cornell University’s library. I secured this record myself from the library’s public catalog.

33. The MARC record contained within Appendix YAO01 accurately describes the title, author, publisher, and ISBN number of the 2005 Conference Proceedings. In comparing the listed fields in Appendix YAO01 to Exhibit 1023, it is my determination that Exhibit 1023 is a true and correct copy of the “Stimulating Student Learning with a Novel ‘In-House’ Pulse Oximeter Design” article, and that the copy of the 2005 Conference Proceedings in Cornell University’s library includes the article in Exhibit 1023.

34. The 008 field of the MARC record contained within Appendix YAO01 indicates that the 2005 Conference Proceedings was first cataloged by the

Cornell University's library as of May 24, 1999. Based on this information and considering the dates of the conference, it is my determination that the 2005 Conference Proceedings, which includes the article entitled "Stimulating Student Learning with a Novel 'In-House' Pulse Oximeter Design," was made available to the public by Cornell University at least as of May 24, 1999.

35. I have reviewed Exhibit 1020, a copy of a technical document entitled

QuickSpecs: HP iPAQ Pocket PC hd150 Series, Version 3, November 20, 2003 (hereinafter referred to as "2003 iPAQ Spec.")

36. Attached hereto as Appendix QUICKSPECS01 is a true and correct copy of

the 2003 iPAQ Spec. as a PDF file entitled 'iPaq_4150_quick-specs.pdf'. I secured this copy myself from

ftp://ftp.abcddata.com.pl/HP/Ipaq/Retired%20Products/h4150/iPaq_4150_quick_specs.pdf. In comparing Appendix QUICKSPECS01 to Exhibit 1020, it is my determination that Exhibit 1020 is a true and correct copy of the 2003 iPAQ Spec.

37. Attached hereto as Appendix QUICKSPECS02 is a true and correct copy of

the FTP file tree for the website hosting the 2003 iPAQ Spec. I secured this

record myself from

<ftp://ftp.abcddata.com.pl/HP/Ipaq/Retired%20Products/h4150/>. FTP is a web technology that allows the transfer of files without the need for a formal webpage. FTP software autogenerates a file tree for each file offered and logs the date of creation within that file tree. The entry for ‘iPaq_4150_quick-specs.pdf’ indicates this file was uploaded to this FTP server as of November 20, 2003. As such, it is my determination that the 2003 iPAQ Spec. in Exhibit 1020 was available to the public on the Internet via this FTP server at least as of November 20, 2003.

38. I have reviewed Exhibit 1027, a copy of the manual entitled *National Instruments LabVIEW: User Manual November 2001 Edition* (hereinafter referred to as the “2001 Manual”).

39. Attached hereto as Appendix NATIONAL01 is a true and correct copy of the 2001 Manual. I secured this copy from National Instruments at <http://www.ni.com/pdf/manuals/320999d>. In comparing Appendix NATIONAL01 to Exhibit 1027, it is my determination that Exhibit 1027 is a true and correct copy of the 2001 Manual.

40. Attached hereto as Appendix NATIONAL02 are screen captures from the Internet Archive's Wayback Machine. The Internet Archive is a digital library formally certified by the State of California as a public library and makes its materials available to the general public. The Internet Archive's Wayback Machine service archives webpages as of a certain capture date to track changes in the web over time. I consider the Internet Archive's internal records keeping to be as rigorous and detailed as several other library's records. The Internet Archive's record for <http://www.ni.com/pdf/manuals/320999d> indicates this material has been archived by the Internet Archive since July 27, 2015 with multiple archival captures since that date. As such, it is my determination that the 2001 Manual was available on the Internet at least as of July 27, 2015.

41. I have been retained on behalf of the Petitioner to provide assistance in the above-illustrated matter in establishing the authenticity and public availability of the documents discussed in this declaration. I am being compensated for my services in this matter at the rate of \$100.00 per hour plus reasonable expenses. My statements are objective, and my compensation does not depend on the outcome of this matter.

42.I declare under penalty of perjury that the foregoing is true and correct. I

hereby declare that all statements made herein of my own knowledge are true and that all statements made on information and belief are believed to be true; and further that these statements were made the knowledge that willful false statements and the like so made are punishable by fine or imprisonment, or both, under Section 1001 of Title 18 of the United States Code.

Dated: 9/28/20

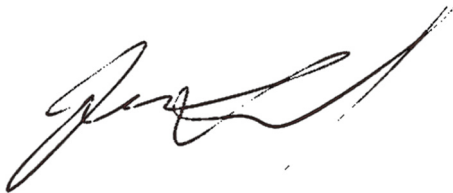
A handwritten signature in black ink, appearing to read 'Jacob Robert Munford', with a stylized, cursive script.

Jacob Robert Munford

APPENDIX A

Appendix A - Curriculum Vitae

Education

University of Wisconsin-Milwaukee - MS, Library & Information Science, 2009
Milwaukee, WI

- Coursework included cataloging, metadata, data analysis, library systems, management strategies and collection development.
- Specialized in library advocacy and management.

Grand Valley State University - BA, English Language & Literature, 2008
Allendale, MI

- Coursework included linguistics, documentation and literary analysis.
- Minor in political science with a focus in local-level economics and government.

Professional Experience

Researcher / Expert Witness, October 2017 – present

Freelance

Pittsburgh, Pennsylvania

- Material authentication and public accessibility determination. Declarations of authenticity and/or public accessibility provided upon research completion. Depositions provided on request.
- Research provided on topics of public library operations, material publication history, digital database services and legacy web resources.
- Past clients include Apple, Fish & Richardson, Erise IP, Baker Botts and other firms working in patent law.

Library Director, February 2013 - March 2015

Dowagiac District Library

Dowagiac, Michigan

- Executive administrator of the Dowagiac District Library. Located in Southwest Michigan, this library has a service area of 13,000, an annual

operating budget of over \$400,000 and total assets of approximately \$1,300,000.

- Developed careful budgeting guidelines to produce a 15% surplus during the 2013-2014 & 2014-2015 fiscal years.
- Using this budget surplus, oversaw significant library investments including the purchase of property for a future building site, demolition of existing buildings and building renovation projects on the current facility.
- Led the organization and digitization of the library's archival records.
- Served as the public representative for the library, developing business relationships with local school, museum and tribal government entities.
- Developed an objective-based analysis system for measuring library services - including a full collection analysis of the library's 50,000+ circulating items and their records.

November 2010 - January 2013

Librarian & Branch Manager, Anchorage Public Library

Anchorage, Alaska

- Headed the 2013 Anchorage Reads community reading campaign including event planning, staging public performances and creating marketing materials for mass distribution.
- Co-led the social media department of the library's marketing team, drafting social media guidelines, creating original content and instituting long-term planning via content calendars.
- Developed business relationships with The Boys & Girls Club, Anchorage School District and the US Army to establish summer reading programs for children.

June 2004 - September 2005, September 2006 - October 2013

Library Assistant, Hart Area Public Library

Hart, MI

- Responsible for verifying imported MARC records and original MARC cataloging for the local-level collection as well as the Michigan Electronic Library.
- Handled OCLC Worldcat interlibrary loan requests & fulfillment via ongoing communication with lending libraries.

Professional Involvement

Alaska Library Association - Anchorage Chapter

- Treasurer, 2012

Library Of Michigan

- Level VII Certification, 2008
- Level II Certification, 2013

Michigan Library Association Annual Conference 2014

- New Directors Conference Panel Member

Southwest Michigan Library Cooperative

- Represented the Dowagiac District Library, 2013-2015

Professional Development

Library Of Michigan Beginning Workshop, May 2008

Petoskey, MI

- Received training in cataloging, local history, collection management, children's literacy and reference service.

Public Library Association Intensive Library Management Training, October 2011

Nashville, TN

- Attended a five-day workshop focused on strategic planning, staff management, statistical analysis, collections and cataloging theory.

Alaska Library Association Annual Conference 2012 - Fairbanks, February 2012

Fairbanks, AK

- Attended seminars on EBSCO advanced search methods, budgeting, cataloging, database usage and marketing.

APPENDIX MENDELSON02

[Enhanced online resources and other COVID-19 updates »](#)



LIBRARY CATALOG



[Sign in](#) | [Selected Items \(0\)](#) | [Search History](#) | [Search Tips](#) | [Borrow Direct](#) | [Interlibrary Loan](#)



[ADVANCED SEARCH](#) | [ASK A LIBRARIAN](#) | [MY ACCOUNT](#)

Chat with Us

[Back to item](#)

Librarian View

```
LEADER 02149cam a22004574a 4500
001 9874630
005 20180515124517.0
006 m o d
007 cr n
008 071226s2006 nyua ob 101 0 eng d
020 #a 1424400325
035 #a (WaSeSS)OCMissj0000394402
035 #a (OCoLC)275723396
035 #a 9874630
040 #a DLC #c DLC #d DLC #d WaSeSS
050 0 0 #a R856.A2 #b I344 2006
110 2 #a IEEE Engineering in Medicine and Biology Society. #b Annual Conference #n (28th : #d 2006 : #c New
York, N.Y.)
245 1 0 #a 2006 28th Annual International Conference of the IEEE Engineering in Medicine and Biology Society : #b
New York, NY, 30 August - 3 September 2006.
260 #a [New York?] : #b IEEE ; #a Piscataway, NJ : #b IEEE Service Center [distributor], #c c2006.
300 #a 1 online resource.
336 #a text #2 rdacontent
337 #a computer #2 rdamedia
338 #a online resource #2 rdacarrier
504 #a Includes bibliographical references and author index.
506 #a License restrictions may limit access.
650 0 #a Biomedical engineering #v Congresses.
650 0 #a Biomedical materials #v Congresses.
650 0 #a Biosensors #v Congresses.
650 7 #a Biomedical engineering. #2 fast #0 (OCoLC)fst00832568
650 7 #a Biomedical materials. #2 fast #0 (OCoLC)fst00832586
650 7 #a Biosensors. #2 fast #0 (OCoLC)fst00832703
655 7 #a Conference papers and proceedings. #2 fast #0 (OCoLC)fst01423772
710 2 #a Institute of Electrical and Electronics Engineers.
856 4 0 #3 Full text available from IEEE/IET Electronic Library (IEL) #i ssid=ssj0000394402; dbcode=RIE;
providercode=PRVIEE #u http://proxy.library.cornell.edu/login?
url=https://ieeexplore.ieee.org/servlet/opac?punumber=4028925 #z Connect to text.
899 2 #a PRVIEE_RIE
948 2 #a 20180515 #b m #d batch #e lts
948 3 #a 20180515 #h SerialSolutions #i COO_360MARC_Update_20180514_monographs_changed.mrc.uc
948 0 #a 20170411 #b i #d batch #e lts
948 1 #a 20170411 #b s #d batch #e lts #f ebk
948 3 #a 20170411 #h SerialSolutions #i COO_360MARC_Update_20170410_monographs_new.mrc.uc
948 2 #a 20170703 #b m #d batch #e lts #x WorldShare
```

CONTACT US

[? Ask a Librarian](#)

[Feedback](#)

[Release Notes](#)

RESOURCES

[Library Website](#) | [Search](#) | [Catalog](#) | [Articles & Full Text](#) | [Databases](#) | [E-journal Titles](#) | [Images](#)

APPENDIX MENDELSON03

Welcome back! Our libraries are open with [limited hours](#), [new safety guidelines](#) and [updated services](#) including [curbside pickup](#). Please visit our [Remote Resources page](#) and our [COVID-19 page](#) for more information.



Catalog

Bookmarks 0 Course Reserves My Account

Keyword Search...

Search

Advanced search Start Over

Bookmark Share

MARC View

LEADER 02022nas a22004451a 4500
001 1382884
003 SIRSI
005 20151215010416.0
008 830808 19739999xx bu 0 0eng d
010 a| 73643617
019 a| MARS
022 0 a| 0090-6689
032 a| 709820 b| USPS
035 a| LIAS1405187
035 a| (OCoLC)1786771
040 a| PSt c| PSt d| WaOLN d| UtOrBLW
050 0 0 a| R856.A1 b| A85
245 0 0 a| Medical instrumentation.
264 1 a| Arlington, Va. : b| AAMI, c| [1973]-1988.
300 a| 16 volumes : b| illustrations ; c| 29 cm
336 a| text b| txt 2| rdacontent
337 a| unmediated b| n 2| rdamedia
338 a| volume b| nc 2| rdacarrier
362 0 a| Vol. 7, no. 1 (Jan./Feb. 1973)-v. 22, no. 6 (Dec. 1988).
550 a| "Journal of the Association for the Advancement of Medical Instrumentation".
650 0 a| Medical instruments and apparatus v| Periodicals.
650 0 a| Biomedical engineering v| Periodicals.
650 0 a| Prosthesis v| Periodicals.
710 2 a| Association for the Advancement of Medical Instrumentation.
780 0 0 t| JAAMI: journal of the Association for the Advancement of Medical Instrumentation.
780 0 5 t| Clinical engineering. g| 1981-
785 0 7 t| Biomedical technology today.
785 0 7 t| Biomedical instrumentation & technology.
936 1 a| Vol. 17, no. 1 (Jan./Feb. 1983).
949 a| R856.A1A85 v.17 1983 w| LCPER c| 1 i| 000073945314 || HATHIETAS m| UP-ANNEX r| Y s| Y t| ONLINE u| 10/10/2012 z| 8263
949 a| R856.A1A85 v.18 1984 w| LCPER c| 1 i| 000073946120 || HATHIETAS m| UP-ANNEX r| Y s| Y t| ONLINE u| 10/10/2012 z| 8263
949 a| R856.A1A85 v.19 1985 w| LCPER c| 1 i| 000073946205 || HATHIETAS m| UP-ANNEX r| Y s| Y t| ONLINE u| 10/10/2012 z| 8263
949 a| R856.A1A85 v.20 1986 w| LCPER c| 1 i| 000073946199 || HATHIETAS m| UP-ANNEX r| Y s| Y t| ONLINE u| 10/10/2012 z| 8263
949 a| R856.A1A85 v.21 1987 w| LCPER c| 1 i| 000073946182 || HATHIETAS m| UP-ANNEX r| Y s| Y t| ONLINE u| 10/10/2012 z| 8263
949 a| R856.A1A85 v.22 1988 w| LCPER c| 1 i| 000073946175 || HATHIETAS m| UP-ANNEX r| Y s| Y t| ONLINE u| 10/10/2012 z| 8263
852 0 1 a| PSt b| UP-ANNEX c| CATO-2 h| R856.A1 i| A85
866 0 8| 0 a| v.17(1983)-v.22(1988)



Copyright ©2019 The Pennsylvania State University. All rights reserved. Except where otherwise noted, this work is subject to a Creative Commons Attribution 4.0 license. Details and exceptions.

Legal Statements | PSU Hotlines

PENN STATE UNIVERSITY LIBRARIES

Libraries Home (814) 865-6368
Libraries Intranet (Staff Only)
Accessibility Help
Website Feedback
Policies and Guidelines
Staff Directory

CONNECT WITH PENN STATE UNIVERSITY LIBRARIES

Facebook
Twitter
Instagram

APPENDIX MENDELSON04

As a precaution, materials may be delayed or temporarily unavailable due to quarantine restrictions. Thank you for your patience.

Catalog home Regular display Return to browsing Limit /Sort Another search (Search History)

LEADER 00000cas a2200673i 44500
001 42209756
003 OcoLC
005 20160418025040.0
006 m o d
007 cr |||||||
008 990823d19851997ne br p o 0 0eng c
010 2007233979
019 253607660
022 2214-7330|10748-1977|2j
030 JCMOEH
035 (OcoLC)42209756|z(OcoLC)253607660
037 |bkLwuer Academic Publishers, Spuiboulevard 50, P.O. Box
17, 3300 AA Dordrecht, The Netherlands
040 F#A|beng|cF#A|dOCLCQ|dGUA|dTXA|dLGG|dOCLCQ|dOCLCF|dIUL
|dOCLCQ|erda
042 pcc
049 OH1A
050 14 R857.P36|bI588
090 R857.P36|b368
130 0 Journal of clinical monitoring (Online)
222 0 Journal of clinical monitoring|b(Online)
245 10 Journal of clinical monitoring
246 3 J Clin Monit
260 |31985-1990 :|a[Boston, MA] :|b[Little, Brown and Co.],
|c[1985]-@1997
260 |31996-1997 :|a[Hingham, MA] ;|a[Dordrecht] :|bkLwuer
Academic Publishers
310 Bimonthly,|b1994-1997
321 Quarterly,|b1985-1993
336 text|btxt|2rdacontent
337 computer|bc|2rdamedia
338 online resource|bcr|2rdacarrier
362 1 Began with: Vol. 1, no. 1 (Jan. 1985); ceased with: vol.
13, no. 6 (Nov. 1997)
506 Available to OhioLINK libraries
538 Mode of access: World Wide Web
550 Official journal of: Society for Technology in Anesthesia,
-Nov. 1997
588 Description based on: Vol. 1, no. 1 (Jan. 1985); title
from PDF article running title (SpringerLink, viewed May 7,
2012)
588 Final issue consulted: Vol. 13, no. 6 (Nov. 1997)
(SpringerLink, viewed Dec. 17, 2007)
650 0 Medical care|vPeriodicals
650 0 Patient monitoring|vPeriodicals
650 2 Monitoring, Physiologic
650 7 Medical care.|2fast|0(OcoLC)fst01013753
650 7 Patient monitoring.|2fast|0(OcoLC)fst01055018
655 2 Periodicals
655 7 Periodicals.|2fast|0(OcoLC)fst01411641
710 2 Ohio Library and Information Network
710 2 Society for Technology in Anesthesia
776 08 |iPrint version:|tJournal of clinical monitoring|x0748-
1977|w(DLC)sn 84006424|w(OcoLC)10897663
785 17 |tInternational journal of clinical monitoring and
computing (Online)|x2214-7314|w(OcoLC)42209706
785 17 |tJournal of clinical monitoring and computing (Online)
|x1573-2614|w(DLC) 2007233984|w(OcoLC)41569988
799 Kluwer
856 40 |uhttp://rave.ohiolink.edu/ejournals/issn/07481977/
|zConnect to resource (OhioLINK EJC)|3v.1(1985)-v.13(1997)
load OhioLINK EJC201605additional
910 MARS
910 &gac001114 sg100302 osupfw|aMARS
993 Vendor record
995 Material type update s => v 161031 mh

Location

Web E-Journals

Lib. Has

v.1(1985)-v.13(1997)



THE OHIO STATE UNIVERSITY
UNIVERSITY LIBRARIES



© The Ohio State University - University Libraries

1858 Neil Avenue Mall | Columbus, Ohio 43210 | 614-292-OSUL (6785)

[Request an alternate format of this page](#) | [Accessibility](#) | [Privacy Policy](#) | [Contact Us](#)



[Copyright Information](#) | [Details and Exceptions](#)

APPENDIX LANDON01

```

leader 01081cam a22003611a 4500
001 993402473405201
005 20150731130506.0
008 040917s2004 nju 001 0 eng d
010 ##$a 2004103154
020 ##$a0764558897 (pbk.)
035 ##$a(0CoLC)56527815
035 ##$a(NjGbS)340247-rowandb
040 ##$aCQU $cCQU $dNJG $dUtOrBLW
049 ##$aNJGA
090 ##$aQA76.76.A65 $bL25 2004
092 ##$a005.446 $bL259m
100 1#$aLandon, Bill.
245 10$aMaster visually Windows Mobile 2003 / $cby Bill Landon and Matthew Miller.
246 3#$aWindows Mobile 2003
264 #1$aHoboken, NJ : $bWiley, $c[2004]
264 #4$c02004
300 ##$a311 pages : $billustrations ; $c23 cm.
336 ##$atext $btxt $2rdacontent
337 ##$aunmediated $bn $2rdamedia
338 ##$avolume $bnc $2rdacarrier
490 1#$aVisual read less, learn more
500 ##$a"From MaranGraphics & Wiley Publishing"--T.p.
500 ##$aIncludes index.
650 #0$aPocket computers.
700 1#$aMiller, Matthew.
710 2#$aMaranGraphics Inc.
830 #0$aVisual read less, learn more.
994 ##$aC0 $bNJG
998 ##$aUtOrBLW

```

APPENDIX MCPHERSON01

The CATALOG

Connecting Public Libraries in Allegheny County, PA

Your Library	Tips & Resources	Booklists	Find Articles	Interlibrary Loan	Get a Library Card
------------------------------	--------------------------------------	---------------------------	-------------------------------	-----------------------------------	------------------------------------

[Start Over](#)
[Add to Wish List](#)
[Regular Display](#)
[Another Search](#)

```

LEADER 00000nam 220000Ia 4500
001 69854494
003 OCoLC
005 20150415175204.0
008 060605s2006 nyua 001 0 eng d
020 0072262508 (pbk.)
040 KZT|cKZT|dQBX|dcPL|dUtOrBLW
049 CPLL
082 04 004.165|222
090 QA76.5|b.M37 2006x
100 1 McPherson, Frank.
245 10 How to do everything with Windows Mobile /|cFrank
    McPherson.
246 30 Windows Mobile
250 [4th ed.].
260 New York :|bMcGraw-Hill,|c2006.
300 xviii, 414 pages :|billustrations ;|c24 cm.
336 text|btxt|2rdacontent
337 unmediated|bn|2rdamedia
338 volume|bnc|2rdacarrier
490 1 How to do everything with
500 Edition statement from p. xv.
500 Rev. ed. of: How to do everything with your pocket PC. 3rd
    ed. 2003.
500 "Covers pocket PCs, pocket PC phones, and smartphones"--
    Cover.
500 Includes index.
520 "Pocket PCs, Pocket PC Phones, and Smartphones are part of
    a series of hardware devices that run the Microsoft
    Windows CE.NET operating system and application software.
    Also in the series are the Handheld PC, Auto PC, and
    embedded devices. The combination of Windows CE.NET and
    application software is known as Windows Mobile Software
    for pocket PCs, Pocket PC Phones, and Smartphones." --
    xvii.
630 00 Microsoft Windows (Computer file)
650 0 Pocket computers.
650 0 Operating systems (Computers)
700 1 McPherson, Frank.|tHow to do everything with your pocket
    PC.
830 0 How to do everything with--
994 C0|bcPL
997 nleds
997 xasjr
997 xagap
    
```

LOCATION	CALL #	STATUS
Penn Hills Non-Fiction	004.165 MCP	AVAILABLE

APPENDIX WEBSTER01

Welcome back! Our libraries are open with [limited hours](#), [new safety guidelines](#) and [updated services](#) including [curbside pickup](#). Please visit our [Remote Resources page](#) and our [COVID-19 page](#) for more information.



Catalog

Bookmarks 0 Course Reserves My Account

Keyword Search...

Search

Advanced search Start Over

Bookmark

Share

MARC View

LEADER 01207nam a22003258a 4500
001 1441469
003 SIRSI
005 20151215023516.0
008 971126t19971997xxk b 000 0 eng d
010 a| 97037908
019 a| MARS
020 a| 0750304677 (alk. paper)
035 a| LIAS2049620
035 a| (OCoLC)37553776
040 c| PSt d| WaOLN d| UtOrBLW
050 0 0 a| QP99.3.O9 b| D47 1997
245 0 0 a| Design of pulse oximeters / c| edited by J.G. Webster.
264 1 a| Bristol ; a| Philadelphia : b| Institute of Physics Pub., c| [1997]
264 4 c| ©1997
300 a| xvi, 244 pages : b| illustrations ; c| 24 cm.
336 a| text b| txt 2| rdacontent
337 a| unmediated b| n 2| rdamedia
338 a| volume b| nc 2| rdacarrier
490 1 a| Medical science series
504 a| Includes bibliographical references and index.
650 0 a| Pulse oximeters x| Design and construction.
700 1 a| Webster, John G., d| 1932-
830 0 a| Medical science series.
949 a| QP99.3.O9D47 1997 w| LC c| 1 i| 000032305944 d| 9/10/2015 e| 6/25/2015 l| PATERNO-4 m| UP-PAT n| 14 r| Y s| Y t| BOOK u| 4/13/2001
949 a| QP99.3.O9D47 1997 w| LC c| 1 i| 000032031126 d| 10/14/2015 e| 6/29/2015 l| STACKS-WB m| WILKESBAR n| 2 r| Y s| Y t| BOOKFLOAT u| 4/13/2001



Copyright ©2019 The Pennsylvania State University. All rights reserved. Except where otherwise noted, this work is subject to a Creative Commons Attribution 4.0 license. Details and exceptions.

[Legal Statements](#) | [PSU Hotlines](#)

PENN STATE UNIVERSITY LIBRARIES

[Libraries Home](#) (814) 865-6368
[Libraries Intranet \(Staff Only\)](#)
[Accessibility Help](#)
[Website Feedback](#)
[Policies and Guidelines](#)
[Staff Directory](#)

CONNECT WITH PENN STATE UNIVERSITY LIBRARIES

[Facebook](#)
[Twitter](#)
[Instagram](#)

APPENDIX YAO01

Enhanced online resources and other COVID-19 updates »



LIBRARY CATALOG



[Sign in](#) | [Selected Items \(0\)](#) | [Search History](#) | [Search Tips](#) | [Borrow Direct](#) | [Interlibrary Loan](#)

Chat with Us

All Fields



[ADVANCED SEARCH](#) | [ASK A LIBRARIAN](#) | [MY ACCOUNT](#)

[Back to item](#)

Librarian View

```
LEADER 02957cai a2200589 a 4500
001 4455886
005 20161206092910.0
006 m d
007 cr cn-----
008 990524c199u9999dcuar so 1 a2eng
010 #a 2010201646
012 #l 1
022 0 #a 1525-1977
035 #a 4455886
035 #a (OCoLC)233610754
037 #b American Society for Engineering Education, 1818 N St, NW, #600, Washingto, DC 20007
040 #a COF #c COF #d DLC #d NIC
042 #a pcc #a nsdp
082 1 0 #a 621 #2 14
110 2 #a American Society for Engineering Education. #b Conference.
245 1 0 #a ASEE annual conference & exposition #h [electronic resource].
246 1 3 #a ASEE annual conference and exposition
246 1 3 #a American Society for Engineering Education annual conference and exposition proceedings
246 1 3 #a ASEE annual conference and exposition proceedings
246 3 #a ASEE annual conference proceedings
246 1 #i At head of title: #a Annual conference proceedings
246 3 #a ASEE American Society for Engineering Education conferences
246 3 #a ASEE conferences
246 3 #a ASEE conference proceedings
260 #a Washington, D.C. : #b American Society for Engineering Education
310 #a Annual
362 1 #a Coverage as of Nov. 15, 2010: 1996-2010.
500 #a Title from caption (American Society for Engineering Education's website, viewed on Feb. 4, 2010).
500 #a Some conferences also have distinctive titles.
520 #a Searchable database of the papers presented at the annual conference.
580 #a Content renamed: ASEE annual conference and exposition
650 0 #a Engineering #x Study and teaching #v Congresses.
650 0 #a Technical education #v Congresses.
650 7 #a Engineering #x Study and teaching #2 fast #0 (OCoLC)fst00910417
650 7 #a Technical education #2 fast #0 (OCoLC)fst01144838
655 7 #a Conference papers and proceedings #2 fast #0 (OCoLC)fst01423772
776 0 8 #i Also available on CD-ROM: #a American Society for Engineering Education. Conference. #t ASEE annual
conference & exposition proceedings #x 2153-5868 #w (DLC) 2004252709 #w (OCoLC)54985837
776 1 #a American Society for Engineering Education. #b Conference. #t ASEE annual conference proceedings #w
(DLC)sn 97038238 #x 1524-4857
780 0 0 #a American Society for Engineering Education. Conference. #s ASEE Annual Conference proceedings (Online)
#x 1524-4644 #w (DLC)sn 99003676 #w (OCoLC)41068751
785 0 0 #a American Society for Engineering Education. Conference. #t ASEE annual conference & exposition #x
2153-5965 #w (DLC) 2010201646 #w (OCoLC)233610754
856 4 0 #u http://wwtemp.asee.org/conferences/paper-search-form.cfm #z Connect to full text.
906 #a wo
948 1 #a 20021127 #b c #d sok1 #e lts #f ? #f emisc
948 3 #a 20030319 #h 948EJournal #i bib-extract
948 2 #a 20141226 #b m #d batch #e lts #x addfast
948 2 #a 20161206 #b m #d batch #e lts #x fix655fast
975 #a Full text
```

[? Ask a Librarian](#)

[Feedback](#)

[Release Notes](#)

RESOURCES

[Library Website](#) | [Search](#) | [Catalog](#) | [Articles & Full Text](#) | [Databases](#) | [E-journal Titles](#) | [Images](#)

© 2020 Cornell University Library | [Privacy](#) | [Web Accessibility Assistance](#)

APPENDIX QUICKSPECS01

Overview

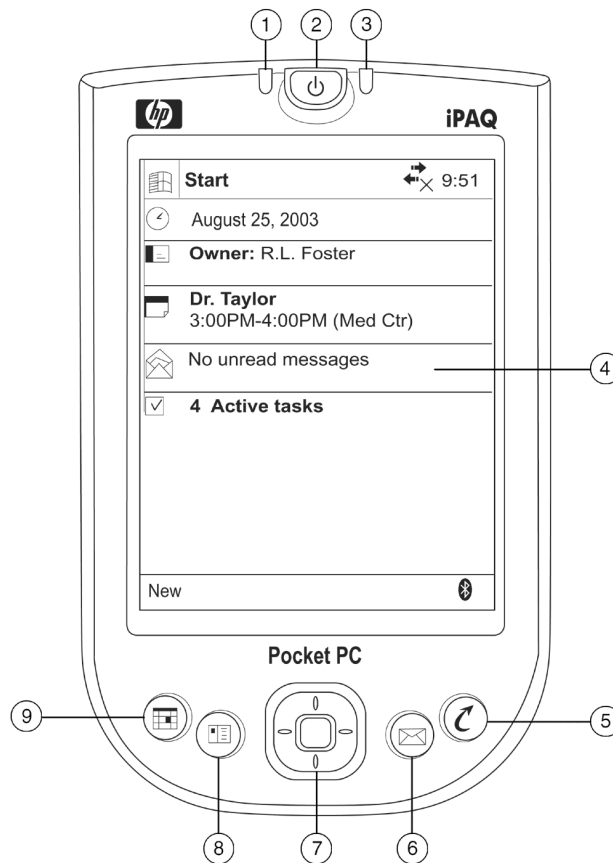

- | | |
|-------------------------------------|----------------------------|
| 1. Active Bluetooth/WLAN Indicator | 6. Inbox Button |
| 2. Power Button | 7. 5-Way Navigation Button |
| 3. LED Power/Notification Indicator | 8. Contacts Button |
| 4. Color Display | 9. Calendar Button |
| 5. iTask Button | |

At A Glance

- Integrated WLAN 802.11b¹
- Integrated Bluetooth™¹
- Integrated SD expansion slot
- Microsoft® Windows® Mobile™ 2003 software for Pocket PC
- Dazzling Transflective TFT color with LED backlight display
- Removable/rechargeable battery
- Stay productive with Pocket versions of familiar applications like Microsoft Outlook , Word and Excel

NOTE ¹: A standard WLAN infrastructure, other devices enabled with Bluetooth, and a service contract with a wireless airtime provider may be required for applicable wireless communication. Wireless Internet use requires a separately purchased service contract. Check with a service provider for availability and coverage in your area. Not all web content available.

Standard Features

Models

iPAQ Pocket PC h4150 – 64-MB SDRAM

- FA174A#ABA – US Commercial, English
- FA174A#ABC – French Canadian
- FA174A#ABG – Australia, New Zealand
- FA174A#ABU – UK, English
- FA174A#ABB – Euro English
- FA174A#ABD – German
- FA174A#ABF – French
- FA174A#ABZ – Italian
- FA174A#ABE – Spanish
- FA174A#B16 – Latin America, Spanish
- FA174A#AC4 – Brazilian Portuguese
- FA174A#ABJ – Japanese
- FA174A#UUF – APD, English
- FA174A#AB2 – S-Chinese
- FA174A#AB0 – Taiwan, T-Chinese
- FA174A#AB5 – Hong Kong, T-Chinese
- FA174A#AB1 – Korean
- FA174A#ARE – Malaysia

iPAQ Pocket PC h4155 – 64-MB SDRAM

- FA175A#ABA – US Retail, English

Processor	400 MHz Intel® Xscale™ technology-based processor	
Memory	SDRAM	64-MB (55-MB user accessible) Up to 2.8-MB iPAQ File Store (varies by SKU)
	ROM	32-MB
Display	Type	Transflective type TFT color with LED backlight
	Number of Colors	64K color (65,536 colors) 16-bit
	Touch Screen	Yes
	Resolution (W x H)	240 x 320
	Viewable Image Size	3.5 in (89 mm)
Hardware Buttons/ Reset Buttons	One power button, one recording button, one soft reset switch, four software programmable application buttons, one 5-way navigation button	
Stylus	One (extra stylus included in the box)	
Audio	Integrated microphone, speaker and one 3.5 mm headphone jack, MP3 stereo (through audio jack)	
Notification Systems	Alarms	Solid amber LED (right) - battery in unit fully charged Flashing amber LED (right) - battery in unit is charging Flashing green LED (right) - event alarm/notification Flashing green LED (left) - WLAN active Flashing blue LED (left) - Bluetooth active
	Notification	Sound and message on the display



Standard Features

Cradle Interfaces	Connector	1
	Cable	1 USB cable connects to PC
	DC Jack connector for AC Adapter	1
	Additional battery charger	Charge additional slim or extended batter

SD Slot	Support SDIO and SD/MMC type standard
----------------	---------------------------------------

Power Supply	Battery	Removable/Rechargeable 1000 mAh Lithium-Ion user swappable battery. Estimated usage time of fully charged battery up to 12 hours (no wireless, no backlight). Optional extended 1800 mAh Lithium-Ion battery available for purchase.
	AC Power	AC Input: 100~240 Vac, 50/60 Hz, AC Input current: 0.2 Aac max Output Voltage: 5Vdc (typical), Output Current: 2A (typical)

NOTE: Battery run time varies based on the usage pattern of an individual user and the configuration of the handheld. Use of internal wireless capabilities and backlight will significantly decrease battery run time.

Ergonomic Design Features	Instant-on/off and Backlight
	5-way Navigation button
	Touch-sensitive display for stylus
	4 programmable application launch buttons - defaults configured for Calendar, Contacts, Inbox, and iTask buttons
	Record button
	2 alarm settings
Built-in speaker	

HP Exclusive Applications	Bluetooth Manager
	iPAQ File Store: non-volatile storage in flash ROM (not available in Japanese, Simplified Chinese, Traditional Chinese and Korean versions)
	iPAQ Backup: utility for Backup/Restore to Main Memory, Memory Card or iPAQ File Store
	iPAQ iTask Manager: access and launch programs easily
	iPAQ Image Zone: view images and create slide shows
	Utilities: Self Test, iPAQ Audio, Power Status

Standard Features

Companion CD from HP APPLICATIONS

Full Versions

HP Web registration
HP Mobile Print Center
Westtek ClearVue Suite
F-Secure FileCrypto Data Encryption
Colligo Personal Edition
Adobe PDF Viewer
RealOne Player for Pocket PC
iPresenter PowerPoint converter
MobiMate WorldMate
Resco File Explorer 2003 - U.S. Retail only

CD LINKS

NetMotion
Avaya IP Softphone
IP Blue VTGO!
Cisco CallManager
Pocket Presence Running Voice IP
Vindigo
Audible Manager and Audible Player (Service plan required to download and play Audible content - link)
SingleTap
Handango
Pocket Backup Plus

Additional Documentation

Safety and Comfort Guide on PDF, and User Guide on PDF

NOTE: Programs may vary based on SKU. Some programs are accessed through CD links to download web sites.

Operating System	Microsoft Windows Mobile 2003 software for Pocket PC - Premium edition Pocket versions of Microsoft software are included (Outlook, Word, Excel and Internet Explorer for Pocket PC)
-------------------------	---

Operating System Applications	Powered by Microsoft Windows Mobile 2003 for Pocket PC Calendar, Contacts, Tasks, Voice Recorder, Notes, Pocket Word (with Spellchecker), Pocket Excel, Pocket Internet Explorer, Windows Media Player 9 (MP3, audio and video streaming), Calculator, Solitaire, Jawbreaker, Inbox (with Spell Checker for email), Microsoft Reader (eBooks), File Explorer, Pictures, Terminal Services Client, VPN Client, Infrared Beaming, Clock, Align Screen, Memory, Volume control, ClearType Tuner (except for Asian languages)
--------------------------------------	--

Additional Software and links	Outlook 2002, Microsoft ActiveSync 3.7 (Desktop device synchronization), Microsoft Reader eBooks, Links to Microsoft websites for additional downloadable applications (some programs may require purchase of additional desktop software to utilize Pocket PC versions)
--------------------------------------	--

Service and Support	One-year parts and labor in most regions; two-year warranty in Europe (one-year warranty for rechargeable battery pack) 90 days technical support for software in all regions. Optional HP Care Pack available in North America for Next Business Day replacement (at additional charge)
----------------------------	--

Standard Features

WLAN Specifications¹ Radio Specifications	RF Network Standard	IEEE 802 Part 11b (802.11b)
	Frequency Band	2.4000 to 2.4835 GHz 2.4465 to 2.4835 GHz (France) 2.4000 to 2.497 GHz (Japan)
	Antenna type	Embedded Inverted F Antenna
	WEP Security	64/128-bit compliant to IEEE 802.11 Compliant to 802.1X
	Network Architecture Models	Ad-hoc (Peer to Peer) Infrastructure (Access Points Required)
	Modulation Technique	Direct Sequence Spread Spectrum
	Modulation Schemes	DBPSK, DQPSK, CCK
	Receiver Sensitivity - Packet Error Rate (8E-2)	11 Mbps: <-80 dBm 5.5 Mbps: <-82 dBm 2 Mbps: <-86 dBm 1 Mbps: <-89 dBm
	Maximum Receive Level	-10dBm (1/2/5.5/11 Mbps)
	Output Power (maximum)	15 dBm (limited due to FCC SARS requirements)
	Power Management	Radio On/Off control through Microsoft Connection icon, Power Save mode available in Power Settings
	Power Consumption	Transfer mode: < 380 mA, average Receive mode: < 280 mA, average
	Power Saving Option	802.11 Compliant Power Saving, idle mode 25 mA
	Media Access Protocol	CSMA/CA (Collision Avoidance) with ACK
	Protocols Supported	TCP/IP IPX/SPX UDP
	SAR	1.0 mW/g
	Throughput	>4.5 Mbps
	Operating Distance	Up to 1000 feet - open sight
	Certifications	All necessary regulatory approvals for countries we support including: WECA Wi-Fi approval FCC (47 CFR) Part 15C, Section 15.247&15.249 ETS 300 328, ETS 301 489-1 Low Voltage Directive IEC950 UL, CSA, and CE Mark

NOTE: ¹ A standard WLAN infrastructure, other devices enabled with Bluetooth, and a service contract with a wireless airtime provider may be required for applicable wireless communication. Wireless Internet use requires a separately purchased service contract. Check with a service provider for availability and coverage in your area. Not all web content available.

Standard Features

Bluetooth Specifications¹	<p>Technology High-speed, low-power, short-range</p> <p>Bluetooth specification 1.1 compliant (2.4-GHz Industrial Scientific Medical Band)</p> <p>System interface High-speed UART processor interface</p> <p>User Interface Bluetooth Manager</p> <p>Device type Class II device; up to 4 dBm transmit, typical 10 meter range</p> <p>Power 3.3V 5% Peak current - typical TX current at approximately 30mA - typical RX current at approximately 50 mA</p> <p>Receiver sensitivity -78 dBm</p> <p>Regulatory standards R&T#-EN 300 328 and EN 300 826, UL 1950, CB Safety Scheme inclusive of EN 60950 and IEC 950, FCC Part 15 subpart C, Canadian, CE</p> <p>Profile Support General Access Profile Service Discovery Application Profile Serial Port Profile Generic Object Exchange Profile File Transfer Profile Dial-Up Networking Profile LAN Access Profile Object Push Profile Personal Area Networking Profile Basic Printing Profile Hard Copy Replacement Profile (printing)</p>
Usage Models ¹	<p>Service Discovery Determine what Bluetooth devices are within range and support authorization</p> <p>File Transfer File and directory browsing and navigation on another Bluetooth device. File copying Object manipulation - including add, delete, create new folders etc.</p> <p>Serial Port Synchronization between PDAs and PCs</p> <p>Dial Up Networking Wireless link to WAN thru Bluetooth enabled cell phone¹ Agnostic to WAN technology Send/receive SMS messages</p> <p>LAN Access Wireless link to Corporate LAN using Bluetooth and appropriate Bluetooth access point¹ Corporate email, network neighborhood, access to LAN applications, file transfer, ftp, Internet browsing, etc, using TCP/IP¹ Access the Internet by connecting to your desktop or notebook over Bluetooth and using its network connection¹</p> <p>Generic Object Exchange and Object Push Exchange business cards, tasks, documents, appointments and more¹</p> <p>Personal Area Networking Collaborate, chat, play games, exchange data¹ Adhoc peer to peer networking¹</p> <p>Basic Printing and Hard Copy Replacement Profiles Print to any HP Bluetooth enabled printer without the need for cables or specific print drivers</p>
Certifications	<p>All necessary regulatory approvals for countries we support including: Bluetooth logo, FCC (47 CFR) Part 15C, Section 15.247&15.249 ETS 300 328, ETS 301 489-1/17 Low Voltage Directive IEC950 UL and CE Mark</p>

NOTE: ¹ A standard WLAN infrastructure, other devices enabled with Bluetooth, and a service contract with a wireless airtime provider may be required for applicable wireless communication. Wireless Internet use requires a separately purchased service contract. Check with a service provider for availability and coverage in your area. Not all web content available.

QuickSpecs

TechSpecs

System Unit	Dimensions (H x W x D)	4.47 in x 2.78 in x 0.5 in (113.6 mm x 70.6 mm x 13.5 mm)	
	Weight	4.67oz (132 g)	
	Operating Temperature	32° to 104° F (0° to 40° C)	
	Storage Temperature	-4° to 140° F (-20° to 60° C)	
	Operating Humidity	90% RH	
	Regulatory Marks	Electrical	FCC Class B, UL or CSA NRTL
	Safety	C-UL, NOM	

TFT Color Display	Number of Colors	65,536 (64K 16-bit)	
	Resolution (W x H)	240 x 320	
	Dot Pitch	0.24 mm	
	Viewable Image (W x H)	3.5 in (89 mm)	
	Display Type	64K color (16-bit) transreflective type TFT color with LED	

AC Adapter	Dimensions (H x W x D)	3 x 1.9 x 1.8 in (76 x 48 x 44 mm) (including prongs)		
	Cord Length (approximate)	6 ft (1.83 m)		
	Power Supply Ratings	Voltage Range	100 to 240 V Switching	
		Input Current	0.3 A	
		Input Frequency	50 to 60 Hz	
		Output Voltage	5 VDC	
Output Current		2 Amp		

Options

NOTE: Optional accessories are available at additional cost.

Memory/Storage	64-MB SD Memory Card	253478-B21	FA134A#AC3
	128 MB SD Memory Card	253479-B21	FA135A#AC3
	256 MB SD Memory Card	287464-B21	FA136A#AC3
	512-MB SD Memory Card	344310-B21	FA184A#AC3
Power	1800 mAh Lithium Ion Extended Battery	343110-001	FA192A#AC3
	1000 mAh Lithium Ion Slim Battery	343111-001	FA191A#AC3
	Auto Adapter	253508-B21	FA125A#AC3
	Charger Adapter	274707-B21	FA133A#AC3
	AC Adapter		
	U.S., Canada, Latin America, Japan, Taiwan	253629-001	FA130A#ABA
	Australia	253629-011	FA130A#ABG
	Europe, Brazil	253629-021	FA130A#ABB
United Kingdom, Asia Pacific, Hong Kong	253629-031	FA130A#ABU	
Synchronization	Desktop Cradle	343116-001	FA188A#AC3
	USB Charge/Sync Cable		FA122A#AC3
Other	Stylus Three-pack	331311-B21	FA113#AC3
	Foldable Keyboard	249693-xxx	FA118A#xxx
	Micro keyboard		FA162A#AC3
Performance	Photosmart Mobile Camera (SDIO Camera)		FA185A#AC3
	iPAQ Navigation System (U.S. only)		FA196A#AC3
Cases	Nylon Case	339657-B21	FA161A#AC3
	Leather Belt Case	339656-B21	FA160A#AC3
	Custom Cases: to view and order go to: http://www.casesonline.com/		



HP iPAQ Pocket PC h4150 is a Microsoft® Windows® Powered Pocket PC

For more information on HP iPAQ Pocket PC, visit our website at <http://www.hp.com/go/iPAQ>

©2003 Hewlett-Packard Development Company, L.P.

The information in this document is subject to change without notice.









The only warranties for HP products and services are set forth in the express warranty statements accompanying such products and services. Nothing herein should be construed as constituting an additional warranty. HP shall not be liable for technical or editorial errors or omissions contained herein. Microsoft, Windows and the Windows Logo are registered trademarks or trademarks of Microsoft Corporation in the United States and/or other countries. Intel is a registered trademark of Intel Corporation in the U.S. and/or other countries.



APPENDIX QUICKSPECS02

Index of /HP/Ipaq/Retired Products/h4150

 [parent directory]

	Name	Size	Date Modified
	iPaq_4150_quick_specs.pdf	290 kB	11/20/03, 7:00:00 PM
	iPaq_h4000_Series_User_Guide.pdf	2.4 MB	11/20/03, 7:00:00 PM
	iPaq_h4150_1.JPG	124 kB	11/20/03, 7:00:00 PM
	iPaq_h4150_2.JPG	169 kB	11/20/03, 7:00:00 PM
	iPaq_h4150_3.JPG	375 kB	11/20/03, 7:00:00 PM
	iPaq_h4150_4.JPG	227 kB	11/20/03, 7:00:00 PM
	iPaq_h4150_with_desktop_cradle.JPG	172 kB	11/20/03, 7:00:00 PM
	iPaq_h4150_with_photosmart_digital_camera.JPG	117 kB	11/20/03, 7:00:00 PM

APPENDIX NATIONAL01

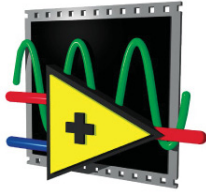

NATIONAL INSTRUMENTS™
LabVIEW™

User Manual

Worldwide Technical Support and Product Information

ni.com

National Instruments Corporate Headquarters

11500 North Mopac Expressway Austin, Texas 78759-3504 USA Tel: 512 683 0100

Worldwide Offices

Australia 03 9879 5166, Austria 0662 45 79 90 0, Belgium 02 757 00 20, Brazil 011 284 5011,
Canada (Calgary) 403 274 9391, Canada (Montreal) 514 288 5722, Canada (Ottawa) 613 233 5949,
Canada (Québec) 514 694 8521, Canada (Toronto) 905 785 0085, China (Shanghai) 021 6555 7838,
China (ShenZhen) 0755 3904939, Czech Republic 02 2423 5774, Denmark 45 76 26 00, Finland 09 725 725 11,
France 01 48 14 24 24, Germany 089 741 31 30, Greece 30 1 42 96 427, Hong Kong 2645 3186,
India 91805275406, Israel 03 6120092, Italy 02 413091, Japan 03 5472 2970, Korea 02 596 7456,
Malaysia 603 9596711, Mexico 001 800 010 0793, Netherlands 0348 433466, New Zealand 09 914 0488,
Norway 32 27 73 00, Poland 0 22 528 94 06, Portugal 351 1 726 9011, Russia 095 2387139,
Singapore 2265886, Slovenia 386 3 425 4200, South Africa 11 805 8197, Spain 91 640 0085,
Sweden 08 587 895 00, Switzerland 056 200 51 51, Taiwan 02 2528 7227, United Kingdom 01635 523545

For further support information, see the *Technical Support Resources* appendix. To comment on the documentation, send e-mail to techpubs@ni.com.

© 1992, 2001 National Instruments Corporation. All rights reserved.

Important Information

Warranty

The media on which you receive National Instruments software are warranted not to fail to execute programming instructions, due to defects in materials and workmanship, for a period of 90 days from date of shipment, as evidenced by receipts or other documentation. National Instruments will, at its option, repair or replace software media that do not execute programming instructions if National Instruments receives notice of such defects during the warranty period. National Instruments does not warrant that the operation of the software shall be uninterrupted or error free.

A Return Material Authorization (RMA) number must be obtained from the factory and clearly marked on the outside of the package before any equipment will be accepted for warranty work. National Instruments will pay the shipping costs of returning to the owner parts which are covered by warranty.

National Instruments believes that the information in this document is accurate. The document has been carefully reviewed for technical accuracy. In the event that technical or typographical errors exist, National Instruments reserves the right to make changes to subsequent editions of this document without prior notice to holders of this edition. The reader should consult National Instruments if errors are suspected. In no event shall National Instruments be liable for any damages arising out of or related to this document or the information contained in it.

EXCEPT AS SPECIFIED HEREIN, NATIONAL INSTRUMENTS MAKES NO WARRANTIES, EXPRESS OR IMPLIED, AND SPECIFICALLY DISCLAIMS ANY WARRANTY OF MERCHANTABILITY OR FITNESS FOR A PARTICULAR PURPOSE. CUSTOMER'S RIGHT TO RECOVER DAMAGES CAUSED BY FAULT OR NEGLIGENCE ON THE PART OF NATIONAL INSTRUMENTS SHALL BE LIMITED TO THE AMOUNT THEREOF PAID BY THE CUSTOMER. NATIONAL INSTRUMENTS WILL NOT BE LIABLE FOR DAMAGES RESULTING FROM LOSS OF DATA, PROFITS, USE OF PRODUCTS, OR INCIDENTAL OR CONSEQUENTIAL DAMAGES, EVEN IF ADVISED OF THE POSSIBILITY THEREOF. This limitation of the liability of National Instruments will apply regardless of the form of action, whether in contract or tort, including negligence. Any action against National Instruments must be brought within one year after the cause of action accrues. National Instruments shall not be liable for any delay in performance due to causes beyond its reasonable control. The warranty provided herein does not cover damages, defects, malfunctions, or service failures caused by owner's failure to follow the National Instruments installation, operation, or maintenance instructions; owner's modification of the product; owner's abuse, misuse, or negligent acts; and power failure or surges, fire, flood, accident, actions of third parties, or other events outside reasonable control.

Copyright

Under the copyright laws, this publication may not be reproduced or transmitted in any form, electronic or mechanical, including photocopying, recording, storing in an information retrieval system, or translating, in whole or in part, without the prior written consent of National Instruments Corporation.

Portions © 1991-1999 Compuware Corporation

Uses libmng, an open-source initiative by Gerard Juyn, © 2000, 2001 G. Juyn, www.libmng.com

Based in part on the works of the Independent JPEG Group (IJG) © 1991-1998, Thomas G. Lane, www.ijg.org

Uses lcms (little CMS) by Marti Maria Saguer, distributed under LGPL, www.littlecms.com

Uses zlib, a patent-free (de)compression-library, © 1995-1998 Jean-loup Gailly and Mark Adler, <http://www.info-zip.org/pub/infozip/zlib>

Trademarks

ComponentWorks™, DAQPad™, DataSocket™, HiQ™, HiQ-Script™, LabVIEW™, National Instruments™, NI™, ni.com™, NI-488™, NI-488.2™, NI-DAQ™, NI-FBUS™, NI-VISA™, and SCXI™ are trademarks of National Instruments Corporation.

Product and company names mentioned herein are trademarks or trade names of their respective companies.

Patents

The product described in this manual may be protected by one or more U.S. patents, foreign patents, or pending applications. Refer to ni.com/legal/patents for the most current list of patents covering this product.

The LabVIEW software is covered by one or more of the following Patents: United States Patent No(s): 4,901,221; 4,914,568; 5,291,587; 5,301,301; 5,301,336; 5,475,851; 5,481,740; 5,481,741; 5,497,500; 5,504,917; 5,583,988; 5,610,828; 5,652,909; 5,732,277; 5,734,863; 5,737,622; 5,764,546; 5,784,275; 5,821,934; 5,847,953; 5,905,649; 5,920,479; 5,974,254; 5,990,906; 6,064,812; 6,064,816; 6,102,965; 6,138,270; D384051; D387750; D384050; D384052; European Patent No(s): 0242131; Japanese Patent No(s): 3,016,783; Canadian Patent No(s): 1285655

Various other software products may be included with this version of LabVIEW. If any software products listed below are included, they are covered by various Patents as follows:

The LabVIEW Signal Processing Toolset is covered by one or more of the following Patents: U.S. Patent No(s): 5,353,233; 6,108,609; European Patent No(s): 0632899; Japanese Patent No(s): 2,697,957

The LabVIEW Datalogging and Supervisory Control Module is covered by one or more of the following Patents: U.S. Patent No(s): 5,966,532; 6,053,951

LabVIEW Real-Time is covered by one or more of the following Patents: U.S. Patent No(s): 6,173,438

The LabVIEW PID Control Toolset is covered by one or more of the following Patents: U.S. Patent No(s): 6,081,751

The IVI Driver Toolset is covered by one or more of the following Patents: U.S. Patent No(s): 5,963,726; 6,085,156

The NI-VISA software is covered by one or more of the following Patents: U.S. Patent No(s): 5,724,272; 5,710,727; 5,847,955; 5,640,572; 5,771,388; 5,627,988; 5,717,614

The NI-DAQ software is covered by one or more of the following Patents: U.S. Patent No(s): 5,619,702; 6,067,584; 6,096,094; 6,052,743; 6,148,438; 5,926,775; 5,987,530; 6,073,205

The NI-488 or NI-488.2 (NI-GPIB) software is covered by one or more of the following Patents: U.S. Patent No(s): 5,974,541; 5,964,892; 5,958,028; 5,987,530; 6,073,205

The NI-FBUS software, including one or more of the NI-FBUS Configurator software or the NI-FBUS Monitor software, is covered by one or more of the following Patents: U.S. Patent No(s): 5,854,890; 5,796,721; 5,850,523; 5,971,581; 6,141,596; 6,076,952; 5,978,850

WARNING REGARDING USE OF NATIONAL INSTRUMENTS PRODUCTS

(1) NATIONAL INSTRUMENTS PRODUCTS ARE NOT DESIGNED WITH COMPONENTS AND TESTING FOR A LEVEL OF RELIABILITY SUITABLE FOR USE IN OR IN CONNECTION WITH SURGICAL IMPLANTS OR AS CRITICAL COMPONENTS IN ANY LIFE SUPPORT SYSTEMS WHOSE FAILURE TO PERFORM CAN REASONABLY BE EXPECTED TO CAUSE SIGNIFICANT INJURY TO A HUMAN.

(2) IN ANY APPLICATION, INCLUDING THE ABOVE, RELIABILITY OF OPERATION OF THE SOFTWARE PRODUCTS CAN BE IMPAIRED BY ADVERSE FACTORS, INCLUDING BUT NOT LIMITED TO FLUCTUATIONS IN ELECTRICAL POWER SUPPLY, COMPUTER HARDWARE MALFUNCTIONS, COMPUTER OPERATING SYSTEM SOFTWARE FITNESS, FITNESS OF COMPILERS AND DEVELOPMENT SOFTWARE USED TO DEVELOP AN APPLICATION, INSTALLATION ERRORS, SOFTWARE AND HARDWARE COMPATIBILITY PROBLEMS, MALFUNCTIONS OR FAILURES OF ELECTRONIC MONITORING OR CONTROL DEVICES, TRANSIENT FAILURES OF ELECTRONIC SYSTEMS (HARDWARE AND/OR SOFTWARE), UNANTICIPATED USES OR MISUSES, OR ERRORS ON THE PART OF THE USER OR APPLICATIONS DESIGNER (ADVERSE FACTORS SUCH AS THESE ARE HEREAFTER COLLECTIVELY TERMED "SYSTEM FAILURES"). ANY APPLICATION WHERE A SYSTEM FAILURE WOULD CREATE A RISK OF HARM TO PROPERTY OR PERSONS (INCLUDING THE RISK OF BODILY INJURY AND DEATH) SHOULD NOT BE RELIANT SOLELY UPON ONE FORM OF ELECTRONIC SYSTEM DUE TO THE RISK OF SYSTEM FAILURE. TO AVOID DAMAGE, INJURY, OR DEATH, THE USER OR APPLICATION DESIGNER MUST TAKE REASONABLY PRUDENT STEPS TO PROTECT AGAINST SYSTEM FAILURES, INCLUDING BUT NOT LIMITED TO BACK-UP OR SHUT DOWN MECHANISMS. BECAUSE EACH END-USER SYSTEM IS CUSTOMIZED AND DIFFERS FROM NATIONAL INSTRUMENTS' TESTING PLATFORMS AND BECAUSE A USER OR APPLICATION DESIGNER MAY USE NATIONAL INSTRUMENTS PRODUCTS IN COMBINATION WITH OTHER PRODUCTS IN A MANNER NOT EVALUATED OR CONTEMPLATED BY NATIONAL INSTRUMENTS, THE USER OR APPLICATION DESIGNER IS ULTIMATELY RESPONSIBLE FOR VERIFYING AND VALIDATING THE SUITABILITY OF NATIONAL INSTRUMENTS PRODUCTS WHENEVER NATIONAL INSTRUMENTS PRODUCTS ARE INCORPORATED IN A SYSTEM OR APPLICATION, INCLUDING, WITHOUT LIMITATION, THE APPROPRIATE DESIGN, PROCESS AND SAFETY LEVEL OF SUCH SYSTEM OR APPLICATION.

Contents

About This Manual

Organization of This Manual	xvii
Conventions	xviii

PART I LabVIEW Concepts

Chapter 1

Introduction to LabVIEW

LabVIEW Documentation Resources	1-1
LabVIEW Example VIs and Tools	1-3
LabVIEW Example VIs	1-3
LabVIEW Tools	1-3

Chapter 2

Introduction to Virtual Instruments

Front Panel	2-1
Block Diagram	2-2
Terminals	2-3
Nodes	2-4
Wires	2-4
Structures	2-4
Icon and Connector Pane	2-4
Using and Customizing VIs and SubVIs	2-5

Chapter 3

LabVIEW Environment

Controls Palette	3-1
Functions Palette	3-1
Navigating the Controls and Functions Palettes	3-2
Tools Palette	3-2
Menus and the Toolbar	3-3
Menus	3-3
Shortcut Menus	3-3
Shortcut Menus in Run Mode	3-3
Toolbar	3-4

Customizing Your Work Environment	3-4
Customizing the Controls and Functions Palettes.....	3-4
Adding VIs and Controls to the User Library and the Instrument Library	3-4
Creating and Editing Palette Views.....	3-5
How LabVIEW Stores Views	3-5
Building ActiveX Subpalettes	3-5
Representing Toolsets in the Palettes	3-6
Setting Work Environment Options.....	3-6
How LabVIEW Stores Options	3-6
Windows.....	3-6
Macintosh.....	3-6
UNIX.....	3-7

Chapter 4

Building the Front Panel

Configuring Objects on the Front Panel.....	4-1
Showing and Hiding Optional Elements.....	4-2
Changing Controls to Indicators and Vice Versa.....	4-2
Replacing Front Panel Objects.....	4-2
Setting Keyboard Shortcuts for Controls	4-3
Controlling Button Behavior with Key Navigation.....	4-3
Setting the Navigation Order of Front Panel Objects.....	4-4
Coloring Objects	4-4
Using Imported Graphics	4-4
Grouping and Locking Objects	4-5
Resizing Objects	4-5
Scaling Front Panel Objects.....	4-5
Adding Space to Front Panel without Resizing Window	4-7
Front Panel Controls and Indicators.....	4-7
3D and Classic Controls and Indicators.....	4-7
Slides, Knobs, Dials, and Digital Displays	4-8
Slide Controls and Indicators	4-8
Rotary Controls and Indicators.....	4-8
Digital Controls and Indicators.....	4-9
Color Boxes	4-9
Color Ramps	4-9
Buttons, Switches, and Lights.....	4-10
Text Entry Boxes, Labels, and Path Displays	4-10
String Controls and Indicators.....	4-10
Path Controls and Indicators.....	4-10
Invalid Paths.....	4-11
Empty Paths.....	4-11

Array and Cluster Controls and Indicators	4-11
Tab Controls	4-11
Listboxes	4-12
Ring and Enumerated Type Controls and Indicators	4-13
Ring Controls	4-13
Enumerated Type Controls	4-13
Advanced Enumerated Type Controls and Indicators	4-13
I/O Name Controls and Indicators	4-14
Waveform Control	4-15
References to Objects or Applications	4-15
Dialog Controls	4-15
Labeling	4-16
Captions	4-16
Text Characteristics	4-17
Designing User Interfaces	4-18
Using Front Panel Controls and Indicators	4-18
Designing Dialog Boxes	4-19
Selecting the Screen Size	4-19

Chapter 5

Building the Block Diagram

Relationship between Front Panel Objects and Block Diagram Terminals	5-1
Block Diagram Objects	5-1
Block Diagram Terminals	5-1
Control and Indicator Data Types	5-2
Constants	5-4
Universal Constants	5-4
User-Defined Constants	5-4
Block Diagram Nodes	5-5
Functions Overview	5-6
Numeric Functions	5-6
Boolean Functions	5-6
String Functions	5-7
Array Functions	5-7
Cluster Functions	5-7
Comparison Functions	5-8
Time and Dialog Functions	5-8
File I/O Functions	5-8
Waveform Functions	5-8
Application Control Functions	5-9
Advanced Functions	5-9
Adding Terminals to Block Diagram Functions	5-9

Using Wires to Link Block Diagram Objects.....	5-10
Automatically Wiring Objects	5-11
Manually Wiring Objects.....	5-12
Selecting Wires	5-12
Removing Broken Wires.....	5-12
Coercion Dots	5-12
Polymorphic VIs and Functions	5-13
Polymorphic VIs	5-13
Building Polymorphic VIs.....	5-14
Polymorphic Functions	5-16
Handling Variant Data.....	5-16
Numeric Units and Strict Type Checking	5-17
Units and Strict Type Checking	5-18
Block Diagram Data Flow.....	5-20
Data Dependency and Artificial Data Dependency	5-20
Missing Data Dependencies	5-21
Data Flow and Managing Memory	5-21
Designing the Block Diagram	5-22

Chapter 6

Running and Debugging VIs

Running VIs.....	6-1
Configuring How a VI Runs	6-1
Correcting Broken VIs	6-2
Finding Causes for Broken VIs.....	6-2
Common Causes of Broken VIs.....	6-3
Debugging Techniques.....	6-3
Execution Highlighting.....	6-4
Single-Stepping.....	6-4
Probe Tool.....	6-4
Breakpoints	6-5
Suspending Execution.....	6-5
Determining the Current Instance of a SubVI.....	6-6
Commenting Out Sections of Block Diagrams.....	6-6
Disabling Debugging Tools.....	6-6
Undefined or Unexpected Data	6-7
Unexpected and Default Data in Loops	6-7
For Loops.....	6-7
While Loops	6-8
Default Data in Arrays	6-8
Preventing Undefined Data.....	6-8
Error Checking and Error Handling	6-8
Checking for Errors.....	6-9

Error Handling	6-9
Error Clusters	6-10
Using While Loops for Error Handling	6-10
Using Case Structures for Error Handling	6-10

Chapter 7 Creating VIs and SubVIs

Planning and Designing Your Project	7-1
Designing Projects with Multiple Developers.....	7-2
Using Built-In VIs and Functions	7-2
Building Instrument Control and Data Acquisition VIs and Functions	7-2
Building VIs That Access Other VIs.....	7-3
Building VIs That Communicate with Other Applications	7-3
SubVIs	7-4
Watching for Common Operations	7-4
Setting up the Connector Pane	7-6
Setting Required, Recommended, and Optional Inputs and Outputs	7-7
Creating an Icon	7-8
Creating SubVIs from Sections of a VI.....	7-8
Designing SubVIs.....	7-8
Viewing the Hierarchy of VIs	7-9
Saving VIs.....	7-10
Advantages of Saving VIs as Individual Files	7-10
Advantages of Saving VIs as Libraries	7-10
Managing VIs in Libraries.....	7-11
Naming VIs	7-11
Saving for a Previous Version.....	7-11
Distributing VIs	7-12
Building Stand-Alone Applications and Shared Libraries	7-12

PART II Building and Editing VIs

Chapter 8 Loop and Case Structures

For Loop and While Loop Structures	8-2
For Loops.....	8-2
While Loops	8-2
Avoiding Infinite While Loops	8-3

Auto-Indexing Loops	8-4
Auto-Indexing to Set the For Loop Count.....	8-4
Auto-Indexing with While Loops.....	8-5
Shift Registers in Loops.....	8-5
Controlling Timing	8-6
Case and Sequence Structures.....	8-6
Case Structures.....	8-6
Case Selector Values and Data Types	8-7
Input and Output Tunnels	8-8
Using Case Structures for Error Handling.....	8-8
Sequence Structures	8-8
Avoiding Overusing Sequence Structures	8-10
Event-Driven Programming	8-11
What Are Events?	8-11
Using Events in LabVIEW	8-12
Event Structures	8-12
Configuring Events	8-13
Filter and Notify Events	8-13
Event Example.....	8-14

Chapter 9

Grouping Data Using Strings, Arrays, and Clusters

Strings.....	9-1
Strings on the Front Panel.....	9-2
String Display Types	9-2
Tables	9-2
Programmatically Editing Strings.....	9-3
Formatting Strings.....	9-4
Format Specifiers.....	9-4
Numerics and Strings	9-5
Converting Data Types to XML	9-5
Using XML-Based Data Types	9-6
LabVIEW XML Schema	9-7
Grouping Data with Arrays and Clusters	9-8
Arrays.....	9-8
Indexes.....	9-8
Examples of Arrays	9-8
Restrictions for Arrays.....	9-11
Creating Array Controls, Indicators, and Constants.....	9-11
Array Index Display	9-11
Array Functions	9-12
Automatically Resizing Array Functions.....	9-12
Clusters.....	9-13

Chapter 10

Local and Global Variables

Local Variables	10-1
Creating Local Variables	10-2
Global Variables	10-2
Creating Global Variables	10-2
Read and Write Variables	10-3
Using Local and Global Variables Carefully	10-4
Initializing Local and Global Variables	10-4
Race Conditions.....	10-4
Memory Considerations when Using Local Variables.....	10-5
Memory Considerations when Using Global Variables.....	10-5

Chapter 11

Graphs and Charts

Types of Graphs and Charts.....	11-1
Graph and Chart Options	11-2
Multiple X- and Y-Scales on Graphs and Charts	11-2
Anti-Aliased Line Plots for Graphs and Charts.....	11-2
Customizing Graph and Chart Appearance.....	11-3
Customizing Graphs	11-3
Graph Cursors	11-4
Scale Options	11-5
Waveform Graph Scale Legend	11-5
Graph Scale Formatting	11-5
Using Smooth Updates.....	11-5
Customizing Charts	11-6
Chart History Length	11-6
Chart Update Modes	11-6
Overlaid Versus Stacked Plots	11-6
Waveform and XY Graphs	11-7
Single-Plot Waveform Graph Data Types.....	11-8
Multiplot Waveform Graph.....	11-8
Single-Plot XY Graph Data Types	11-9
Multiplot XY Graph Data Types	11-10
Waveform Charts	11-10
Intensity Graphs and Charts.....	11-11
Color Mapping.....	11-12
Intensity Chart Options.....	11-13
Intensity Graph Options	11-13
Digital Graphs	11-13
Masking Data.....	11-15

3D Graphs.....	11-15
Waveform Data Type	11-16

Chapter 12

Graphics and Sound VIs

Using the Picture Indicator	12-1
Picture Plots VIs	12-3
Using the Polar Plot VI as a SubVI.....	12-3
Using the Waveform Plot VI as a SubVI.....	12-3
Using the Smith Plot VIs as SubVIs	12-4
Picture Functions VIs	12-5
Creating and Modifying Colors with the Picture Functions VIs	12-6
Graphics Formats VIs.....	12-6
Sound VIs	12-7

Chapter 13

File I/O

Basics of File I/O.....	13-1
Choosing a File I/O Format.....	13-2
When to Use Text Files.....	13-2
When to Use Binary Files	13-3
When to Use Datalog Files	13-4
Using High-Level File I/O VIs.....	13-5
Using Low-Level and Advanced File I/O VIs and Functions.....	13-6
Disk Streaming.....	13-7
Creating Text and Spreadsheet Files	13-8
Formatting and Writing Data to Files	13-8
Scanning Data from Files.....	13-9
Creating Binary Files.....	13-9
Creating Datalog Files.....	13-10
Writing Waveforms to Files	13-10
Reading Waveforms from Files.....	13-11
Flow-Through Parameters	13-12
Creating Configuration Files	13-12
Using Configuration Settings Files	13-13
Windows Configuration Settings File Format	13-13
Logging Front Panel Data	13-15
Automatic and Interactive Front Panel Datalogging.....	13-15
Viewing the Logged Front Panel Data Interactively	13-16
Deleting a Record	13-16
Clearing the Log-File Binding.....	13-16
Changing the Log-File Binding	13-17

Retrieving Front Panel Data Programmatically	13-17
Retrieving Front Panel Data Using a SubVI.....	13-17
Specifying Records.....	13-18
Retrieving Front Panel Data Using File I/O Functions.....	13-18

Chapter 14 Documenting and Printing VIs

Documenting VIs	14-1
Creating VI and Object Descriptions	14-2
Setting up the VI Revision History	14-2
Revision Numbers.....	14-2
Printing Documentation.....	14-3
Saving to HTML or RTF Files.....	14-3
Selecting Graphic Formats for HTML Files.....	14-4
Naming Conventions for Graphic Files.....	14-4
Creating Your Own Help Files	14-4
Printing VIs.....	14-5
Printing the Active Window	14-5
Printing Reports.....	14-5
Printing Programmatically.....	14-6
Printing at Completion	14-6
Using a SubVI to Selectively Print at Completion	14-7
Additional Printing Techniques.....	14-7

Chapter 15 Customizing VIs

Configuring the Appearance and Behavior of VIs	15-1
Customizing Menus	15-2
Creating Menus	15-2
Menu Selection Handling	15-3

Chapter 16 Programmatically Controlling VIs

Capabilities of the VI Server	16-1
Building VI Server Applications	16-2
Application and VI References	16-3
Manipulating Application and VI Settings	16-3
Property Nodes	16-3
Implicitly Linked Property Nodes.....	16-4
Invoke Nodes.....	16-4
Manipulating Application Class Properties and Methods.....	16-5

Manipulating VI Class Properties and Methods	16-5
Manipulating Application and VI Class Properties and Methods.....	16-6
Dynamically Loading and Calling VIs.....	16-7
Call By Reference Nodes and Strictly Typed VI Refnums	16-7
Editing and Running VIs on Remote Computers	16-8
Controlling Front Panel Objects.....	16-8
Strictly Typed and Weakly Typed Control Refnums.....	16-9

Chapter 17

Networking in LabVIEW

Choosing among File I/O, VI Server, ActiveX, and Networking	17-1
LabVIEW as a Network Client and Server	17-2
Using DataSocket Technology	17-2
Specifying a URL.....	17-3
Data Formats Supported by DataSocket	17-4
Using DataSocket on the Front Panel	17-5
Reading and Writing Live Data through the Block Diagram	17-6
DataSocket and Variant Data.....	17-7
Publishing VIs on the Web.....	17-9
Web Server Options	17-9
Creating HTML Documents	17-9
Publishing Front Panel Images	17-10
Front Panel Image Formats.....	17-10
Viewing and Controlling Front Panels Remotely	17-10
Configuring the Server for Clients.....	17-11
Remote Panel License	17-11
Viewing and Controlling Front Panels in LabVIEW or from	
a Web Browser.....	17-12
Viewing and Controlling Front Panels in LabVIEW	17-12
Viewing and Controlling Front Panels from a Web Browser	17-12
Functionality Not Supported in Viewing and Controlling Remote	
Front Panels.....	17-13
Low-Level Communications Applications.....	17-14
TCP and UDP.....	17-14
DDE (Windows)	17-15
Apple Events and PPC Toolbox (Macintosh).....	17-15
Pipe VIs (UNIX)	17-15
Executing System-Level Commands (Windows and UNIX)	17-15

Chapter 18 ActiveX

ActiveX Objects, Properties, Methods, and Events	18-1
ActiveX VIs, Functions, Controls, and Indicators	18-2
LabVIEW as an ActiveX Client	18-3
Accessing an ActiveX-Enabled Application	18-3
Inserting an ActiveX Object on the Front Panel	18-4
Setting ActiveX Properties	18-4
ActiveX Property Browser	18-4
ActiveX Property Pages	18-5
Property Nodes	18-5
LabVIEW as an ActiveX Server	18-6
Support for Custom ActiveX Automation Interfaces	18-6
Using Constants to Set Parameters in ActiveX VIs	18-6

Chapter 19 Calling Code from Text-Based Programming Languages

Call Library Function Node	19-1
Code Interface Node	19-1

Chapter 20 Formulas and Equations

Methods for Using Equations in LabVIEW	20-1
Formula Nodes	20-2
Using the Formula Node	20-2
Variables in the Formula Node	20-3
Expression Nodes	20-4
Polymorphism in Expression Nodes	20-4
Using HiQ with LabVIEW	20-5
HiQ and MATLAB Script Nodes	20-5
Programming Suggestions for HiQ and MATLAB Scripts	20-6
HiQ Support Files Required with a LabVIEW Application	20-7

Appendix A Organization of LabVIEW

Organization of the LabVIEW Directory Structure	A-1
Libraries	A-1
Structure and Support	A-2
Learning and Instruction	A-2
Documentation	A-2

Miscellaneous File	A-2
Macintosh.....	A-2
Suggested Location for Saving Files.....	A-3

Appendix B

Polymorphic Functions

Numeric Conversion.....	B-1
Polymorphism for Numeric Functions	B-2
Polymorphism for Boolean Functions.....	B-4
Polymorphism for Array Functions.....	B-5
Polymorphism for String Functions	B-5
Polymorphism for String Conversion Functions	B-5
Polymorphism for Additional String to Number Functions.....	B-5
Polymorphism for Cluster Functions.....	B-6
Polymorphism for Comparison Functions.....	B-6
Polymorphism for Log Functions.....	B-7

Appendix C

Comparison Functions

Comparing Boolean Values.....	C-1
Comparing Strings.....	C-1
Comparing Numerics.....	C-2
Comparing Arrays and Clusters	C-2
Arrays.....	C-2
Compare Elements Mode	C-2
Compare Aggregates Mode	C-3
Clusters.....	C-3
Compare Elements Mode	C-3
Compare Aggregates Mode	C-3

Appendix D

Masking Digital Data

Appendix E

Technical Support Resources

Glossary

Index

About This Manual

This manual describes the LabVIEW graphical programming environment and techniques for building applications in LabVIEW, such as test and measurement, data acquisition, instrument control, datalogging, measurement analysis, and report generation applications.

Use this manual to learn about LabVIEW programming features, including the LabVIEW user interface and programming work spaces, and the LabVIEW palettes, tools, and dialog boxes. This manual does not include specific information about each palette, tool, menu, dialog box, control, or built-in VI or function. Refer to the *LabVIEW Help* for more information about these items and for detailed, step-by-step instructions for using LabVIEW features and for building specific applications. Refer to the *LabVIEW Documentation Resources* section of Chapter 1, *Introduction to LabVIEW*, for more information about the *LabVIEW Help* and accessing it.

The *LabVIEW User Manual* is also available in Portable Document Format (PDF). If you select the **Complete** install option, LabVIEW installs PDF versions of all LabVIEW manuals, which you can access by selecting **Help»Search the LabVIEW Bookshelf** in LabVIEW.



Note You must have Adobe Acrobat Reader 4.0 or later installed to view the PDFs. Refer to the Adobe Systems Incorporated Web site at www.adobe.com to download Acrobat Reader.

You can access the PDFs from the *LabVIEW Help*, but you must install the PDFs to do so. Refer to the *LabVIEW Release Notes* or *LabVIEW Upgrade Notes* for more information about installing PDF versions of the LabVIEW manuals. Refer to the *LabVIEW Documentation Resources* section of Chapter 1, *Introduction to LabVIEW*, for information about accessing the PDFs in the *LabVIEW Bookshelf*.

Organization of This Manual

The *LabVIEW User Manual* includes two sections. Part I, *LabVIEW Concepts*, describes programming concepts for building applications in LabVIEW. The chapters in this section introduce you to the LabVIEW programming environment and help you plan your application.

Part II, *Building and Editing VIs*, describes LabVIEW features, VIs, and functions you can use to make your applications operate in specific ways. The chapters in this section describe the use of each LabVIEW feature and outline each class of VIs and functions.

Conventions

The following conventions appear in this manual:

» The » symbol leads you through nested menu items and dialog box options to a final action. The sequence **File»Page Setup»Options** directs you to pull down the **File** menu, select the **Page Setup** item, and select **Options** from the last dialog box.



This icon denotes a tip, which alerts you to advisory information.



This icon denotes a note, which alerts you to important information.



This icon denotes a caution, which advises you of precautions to take to avoid injury, data loss, or a system crash.

bold Bold text denotes items that you must select or click in the software, such as menu items and dialog box options. Bold text also denotes parameter names, controls and buttons on the front panel, dialog boxes, sections of dialog boxes, menu names, and palette names.

italic Italic text denotes variables, emphasis, a cross reference, or an introduction to a key concept. This font also denotes text that is a placeholder for a word or value that you must supply.

`monospace` Text in this font denotes text or characters that you should enter from the keyboard, sections of code, programming examples, and syntax examples. This font is also used for the proper names of disk drives, paths, directories, programs, subprograms, subroutines, device names, functions, operations, variables, filenames and extensions, and code excerpts.

`monospace bold` Bold text in this font denotes the messages and responses that the computer automatically prints to the screen. This font also emphasizes lines of code that are different from the other examples.

`monospace italic` Italic text in this font denotes text that is a placeholder for a word or value that you must supply.

Platform

Text in this font denotes a specific platform and indicates that the text following it applies only to that platform.

right-click

(Macintosh) Press <Command>-click to perform the same action as a right-click.

Part I

LabVIEW Concepts

This part describes programming concepts for building applications in LabVIEW. The chapters in this section introduce you to the LabVIEW programming environment and help you plan your application.

Part I, *LabVIEW Concepts*, contains the following chapters:

- Chapter 1, *Introduction to LabVIEW*, describes LabVIEW, its extensive documentation, and tools to help you design and build VIs.
- Chapter 2, *Introduction to Virtual Instruments*, describes the components of virtual instruments, or VIs.
- Chapter 3, *LabVIEW Environment*, describes the LabVIEW palettes, tools, and menus you use to build the front panels and block diagrams of VIs. This chapter also describes how to customize the LabVIEW palettes and set several work environment options.
- Chapter 4, *Building the Front Panel*, describes how to build the front panel of a VI.
- Chapter 5, *Building the Block Diagram*, describes how to build the block diagram of a VI.
- Chapter 6, *Running and Debugging VIs*, describes how to configure how a VI runs and to identify problems with block diagram organization or with the data passing through the block diagram.
- Chapter 7, *Creating VIs and SubVIs*, describes how to create your own VIs and subVIs, distribute VIs, and build stand-alone applications and shared libraries.

Introduction to LabVIEW

LabVIEW is a graphical programming language that uses icons instead of lines of text to create applications. In contrast to text-based programming languages, where instructions determine program execution, LabVIEW uses dataflow programming, where the flow of data determines execution.

In LabVIEW, you build a user interface by using a set of tools and objects. The user interface is known as the front panel. You then add code using graphical representations of functions to control the front panel objects. The block diagram contains this code. In some ways, the block diagram resembles a flowchart.

You can purchase several add-on software toolsets for developing specialized applications. All the toolsets integrate seamlessly in LabVIEW. Refer to the National Instruments Web site at ni.com for more information about these toolsets.

LabVIEW Documentation Resources

LabVIEW includes extensive documentation for new and experienced LabVIEW users. All LabVIEW manuals and Application Notes are also available as PDFs. You must have Adobe Acrobat Reader 4.0 or later installed to view the PDFs. Refer to the Adobe Systems Incorporated Web site at www.adobe.com to download Acrobat Reader. Refer to the National Instruments Product Manuals Library at ni.com for updated documentation resources.

- **LabVIEW Bookshelf**—Use this PDF to search PDF versions of all the LabVIEW manuals and Application Notes. Access the *LabVIEW Bookshelf* by selecting **Help»Search the LabVIEW Bookshelf**.
- **Getting Started with LabVIEW**—Use this manual to familiarize yourself with the LabVIEW graphical programming environment and the basic LabVIEW features you use to build data acquisition and instrument control applications.
- **LabVIEW Tutorial**—Use this tutorial to learn basic LabVIEW concepts. The tutorial guides you through several activities to familiarize you with graphical programming. Access the *LabVIEW*

Tutorial by selecting **Help»VI, Function, and How-To Help** or by clicking the **LabVIEW Tutorial** button in the **LabVIEW** dialog box.

- **LabVIEW Quick Reference Card**—Use this card to get started with LabVIEW quickly. The card describes the LabVIEW palettes and general editing, wiring, and debugging techniques.
- **LabVIEW User Manual**—Use this manual to learn about LabVIEW programming concepts, techniques, features, VIs, and functions you can use to create test and measurement, data acquisition, instrument control, datalogging, measurement analysis, and report generation applications.
- **LabVIEW Help**—Use this help file as a reference for information about LabVIEW palettes, menus, tools, VIs, and functions. The *LabVIEW Help* also includes step-by-step instructions for using LabVIEW features. Access the *LabVIEW Help* by selecting **Help»VI, Function, and How-To Help**.

The *LabVIEW Help* includes links to the following resources:

- *LabVIEW Tutorial*
- *LabVIEW Bookshelf*, which includes PDF versions of all the LabVIEW manuals and Application Notes
- Technical support resources on the National Instruments Web site, such as the Developer Zone, the KnowledgeBase, and the Product Manuals Library



Note (Macintosh and UNIX) National Instruments recommends that you use Netscape 6.0 or later to view the *LabVIEW Help*.

- **LabVIEW Measurements Manual**—Use this manual to learn more about building data acquisition and instrument control applications in LabVIEW. If you are a new LabVIEW user, read the *Getting Started with LabVIEW* manual and the *LabVIEW User Manual* before you read this manual.
- **LabVIEW Development Guidelines**—Use this manual to learn how to build VIs that are easy to understand, use, and revise. The manual describes project tracking, design, and documentation techniques.



Note The printed *LabVIEW Development Guidelines* manual is available only in the LabVIEW Professional Development System. The PDF is available in all packages of LabVIEW.

- **Getting Started with Point-By-Point VIs**—Use this guide to learn about the point-by-point analysis VIs for LabVIEW.
- **Using External Code in LabVIEW**—Use this manual to learn how to use Code Interface Nodes and external subroutines to import code written in text-based programming languages. The manual includes information about shared external subroutines, libraries of functions, memory and file manipulation routines, and diagnostic routines. The manual also includes information about calling DLLs.



Note The *Using External Code in LabVIEW* manual is available only as a PDF.

- **LabVIEW Application Notes**—Use the LabVIEW Application Notes to learn about advanced or specialized LabVIEW concepts and applications. Refer to the NI Developer Zone at ni.com for new and updated Application Notes.
- **LabVIEW VXI VI Reference Manual**—Use this manual to learn about the VXI VIs for LabVIEW. This manual is a companion guide to the *NI-VXI Programmer Reference Manual* that comes with the VXI hardware.



Note The *LabVIEW VXI VI Reference Manual* is available only as a PDF.

LabVIEW Example VIs and Tools

Use the LabVIEW example VIs and tools to help you design and build VIs.

LabVIEW Example VIs

LabVIEW includes hundreds of example VIs you can use and incorporate into your own VIs. You can modify an example to fit your application, or you can copy and paste from one or more examples into your own VI. Browse or search the example VIs by selecting **Help»Find Examples**. Refer to the NI Developer Zone at ni.com for additional example VIs.

LabVIEW Tools

LabVIEW includes many tools to help you quickly configure your measurement devices, including the following. You can access these tools from the **Tools** menu.

- **(Windows)** Measurement & Automation Explorer helps you configure National Instruments hardware and software.

- **(Macintosh)** The NI-DAQ Configuration Utility helps you configure National Instruments DAQ hardware.
- **(Macintosh)** The DAQ Channel Wizard helps you define what type of device is connected to the DAQ hardware channels. After you define a channel, the DAQ Channel Wizard remembers the settings.
- **(Windows and Macintosh)** The DAQ Channel Viewer lists the configured DAQ channels.
- **(Windows and Macintosh)** The DAQ Solution Wizard helps you find solutions for common DAQ applications. You can choose from example VIs or create custom VIs.

Introduction to Virtual Instruments

LabVIEW programs are called virtual instruments, or VIs, because their appearance and operation imitate physical instruments, such as oscilloscopes and multimeters. Every VI uses functions that manipulate input from the user interface or other sources and display that information or move it to other files or other computers.

A VI contains the following three components:

- **Front panel**—Serves as the user interface.
- **Block diagram**—Contains the graphical source code that defines the functionality of the VI.
- **Icon and connector pane**—Identifies the VI so that you can use the VI in another VI. A VI within another VI is called a subVI. A subVI corresponds to a subroutine in text-based programming languages.

For more information...

Refer to the *LabVIEW Help* for more information about creating VIs and subVIs.

Front Panel

The front panel is the user interface of the VI. Figure 2-1 shows an example of a front panel.

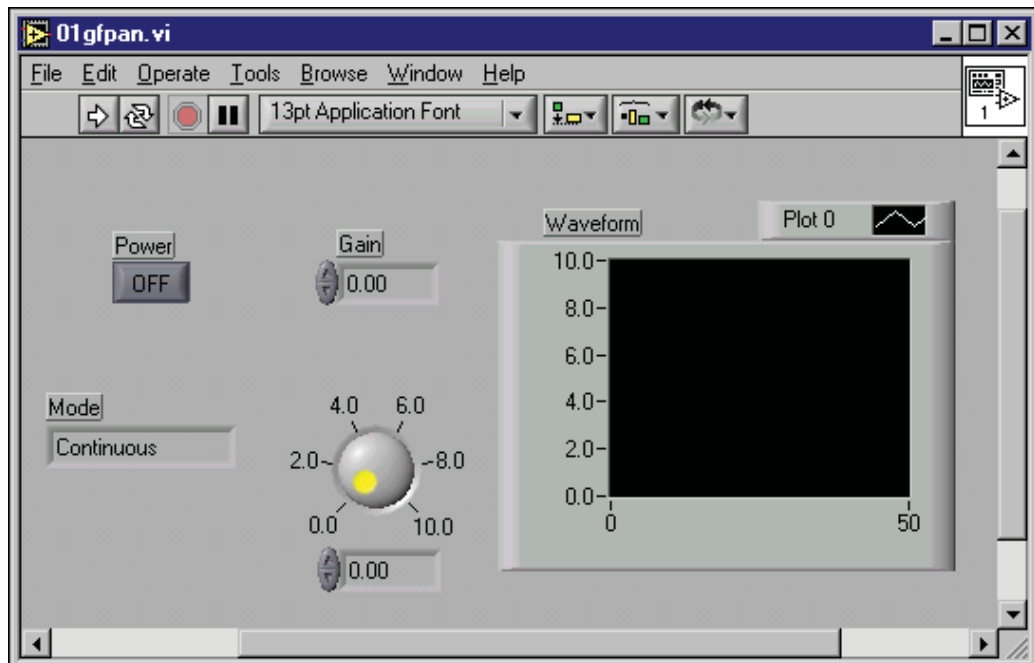

Figure 2-1. Example of a Front Panel

You build the front panel with controls and indicators, which are the interactive input and output terminals of the VI, respectively. Controls are knobs, push buttons, dials, and other input devices. Indicators are graphs, LEDs, and other displays. Controls simulate instrument input devices and supply data to the block diagram of the VI. Indicators simulate instrument output devices and display data the block diagram acquires or generates. Refer to Chapter 4, *Building the Front Panel*, for more information about the front panel.

Block Diagram

After you build the front panel, you add code using graphical representations of functions to control the front panel objects. The block diagram contains this graphical source code. Front panel objects appear as terminals on the block diagram. Refer to Chapter 5, *Building the Block Diagram*, for more information about the block diagram.

The VI in Figure 2-2 shows several primary block diagram objects—terminals, functions, and wires.

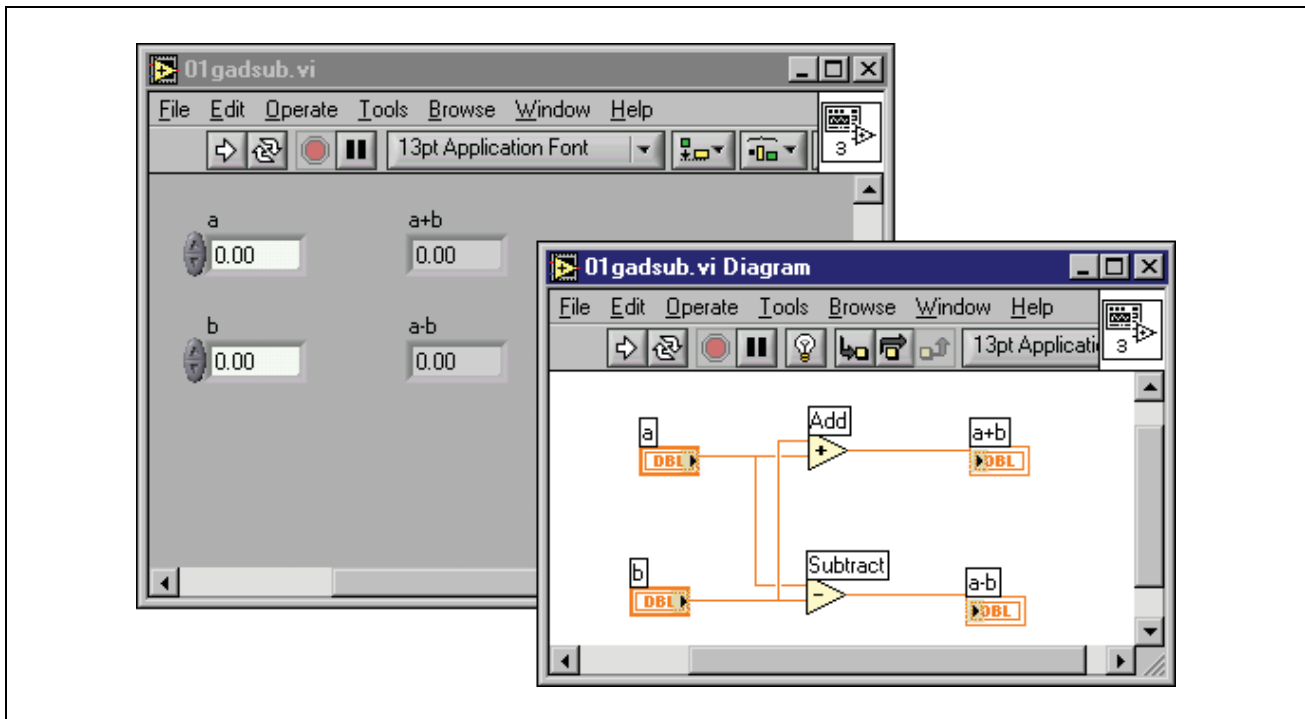

Figure 2-2. Example of a Block Diagram and Corresponding Front Panel

Terminals



The terminals represent the data type of the control or indicator. For example, a DBL terminal, shown at left, represents a double-precision, floating-point numeric control or indicator. Refer to the *Control and Indicator Data Types* section of Chapter 5, *Building the Block Diagram*, for more information about data types in LabVIEW and their graphical representations.

Terminals are entry and exit ports that exchange information between the front panel and block diagram. Data you enter into the front panel controls (**a** and **b** in Figure 2-2) enter the block diagram through the control terminals. The data then enter the Add and Subtract functions. When the Add and Subtract functions complete their internal calculations, they produce new data values. The data flow to the indicator terminals, where they exit the block diagram, reenter the front panel, and appear in front panel indicators.

Nodes

Nodes are objects on the block diagram that have inputs and/or outputs and perform operations when a VI runs. They are analogous to statements, operators, functions, and subroutines in text-based programming languages. The Add and Subtract functions in Figure 2-2 are nodes. Refer to the *Block Diagram Nodes* section of Chapter 5, *Building the Block Diagram*, for more information about nodes.

Wires

You transfer data among block diagram objects through wires. In Figure 2-2, wires connect the control and indicator DBL terminals to the Add and Subtract functions. Each wire has a single data source, but you can wire it to many VIs and functions that read the data. Wires are different colors, styles, and thicknesses, depending on their data types. A broken wire appears as a dashed black line. Refer to the *Using Wires to Link Block Diagram Objects* section of Chapter 5, *Building the Block Diagram*, for more information about wires.

Structures

Structures are graphical representations of the loops and case statements of text-based programming languages. Use structures on the block diagram to repeat blocks of code and to execute code conditionally or in a specific order. Refer to Chapter 8, *Loop and Case Structures*, for examples and more information about structures.

Icon and Connector Pane



After you build a VI front panel and block diagram, build the icon and the connector pane so you can use the VI as a subVI. Every VI displays an icon, such as the one shown at left, in the upper right corner of the front panel and block diagram windows. An icon is a graphical representation of a VI. It can contain text, images, or a combination of both. If you use a VI as a subVI, the icon identifies the subVI on the block diagram of the VI. You can double-click on the icon to customize or edit it. Refer to the *Creating an Icon* section of Chapter 7, *Creating VIs and SubVIs*, for more information about icons.



You also need to build a connector pane, shown at left, to use the VI as a subVI. The connector pane is a set of terminals that corresponds to the controls and indicators of that VI, similar to the parameter list of a function call in text-based programming languages. The connector pane defines the

inputs and outputs you can wire to the VI so you can use it as a subVI. A connector pane receives data at its input terminals and passes the data to the block diagram code through the front panel controls and receives the results at its output terminals from the front panel indicators.

When you view the connector pane for the first time, you see a connector pattern. You can select a different pattern if you want. The connector pane generally has one terminal for each control or indicator on the front panel. You can assign up to 28 terminals to a connector pane. If you anticipate changes to the VI that would require a new input or output, leave extra terminals unassigned. Refer to the *Setting up the Connector Pane* section of Chapter 7, *Creating VIs and SubVIs*, for more information about setting up connector panes.



Note Try not to assign more than 16 terminals to a VI. Too many terminals can reduce the readability and usability of the VI.

Using and Customizing VIs and SubVIs

After you build a VI and create its icon and connector pane, you can use it as a subVI. Refer to the *SubVIs* section of Chapter 7, *Creating VIs and SubVIs*, for more information about subVIs.

You can save VIs as individual files, or you can group several VIs together and save them in a VI library. Refer to the *Saving VIs* section of Chapter 7, *Creating VIs and SubVIs*, for more information about saving VIs in libraries.

You can customize the appearance and behavior of a VI. You also can create custom menus for every VI you build, and you can configure VIs to show or hide menu bars. Refer to Chapter 15, *Customizing VIs*, for more information about customizing a VI.

LabVIEW Environment

Use the LabVIEW palettes, tools, and menus to build the front panels and block diagrams of VIs. You can customize the **Controls** and **Functions** palettes, and you can set several work environment options.

For more information...

Refer to the *LabVIEW Help* for more information about using the palettes, menus, and toolbar, and customizing your work environment.

Controls Palette

The **Controls** palette is available only on the front panel. The **Controls** palette contains the controls and indicators you use to create the front panel. The controls and indicators are located on subpalettes based on the types of controls and indicators. Refer to the *Front Panel Controls and Indicators* section of Chapter 4, *Building the Front Panel*, for more information about the types of controls and indicators.

Select **Window»Show Controls Palette** or right-click the front panel workspace to display the **Controls** palette. You can place the **Controls** palette anywhere on the screen.

You can change the way the **Controls** palette appears. Refer to the *Customizing the Controls and Functions Palettes* section of this chapter for more information about customizing the **Controls** palette.

Functions Palette

The **Functions** palette is available only on the block diagram. The **Functions** palette contains the VIs and functions you use to build the block diagram. The VIs and functions are located on subpalettes based on the types of VIs and functions. Refer to the *Functions Overview* section of Chapter 5, *Building the Block Diagram*, for more information about the types of VIs and functions.

Select **Window»Show Functions Palette** or right-click the block diagram workspace to display the **Functions** palette. You can place the **Functions** palette anywhere on the screen.

You can change the way the **Functions** palette appears. Refer to the *Customizing the Controls and Functions Palettes* section of this chapter for more information about customizing the **Functions** palette.

Navigating the Controls and Functions Palettes

Use the navigation buttons on the **Controls** and **Functions** palettes to navigate and search for controls, VIs, and functions. When you click a subpalette icon, the entire palette changes to the subpalette you selected. You also can right-click a VI icon on the palette and select **Open VI** from the shortcut menu to open the VI.

The **Controls** and **Functions** palettes contain the following navigation buttons:



- **Up**—Takes you up one level in the palette hierarchy.



- **Search**—Changes the palette to search mode. In search mode, you can perform text-based searches to locate controls, VIs, or functions in the palettes.



- **Options**—Opens the **Function Browser Options** dialog box, from which you can configure the appearance of the palettes.

Tools Palette

The **Tools** palette is available on the front panel and the block diagram. A tool is a special operating mode of the mouse cursor. The cursor corresponds to the icon of the tool selected in the palette. Use the tools to operate and modify front panel and block diagram objects.

Select **Window»Show Tools Palette** to display the **Tools** palette. You can place the **Tools** palette anywhere on the screen.



Tip Press the <Shift> key and right-click to display a temporary version of the **Tools** palette at the location of the cursor.

If automatic tool selection is enabled and you move the cursor over objects on the front panel or block diagram, LabVIEW automatically selects the corresponding tool from the **Tools** palette. Toggle automatic tool selection

by clicking the **Automatic Tool Selection** button in the **Tools** palette or by pressing the <Shift-Tab> keys.

Menus and the Toolbar

Use the menu and toolbar items to operate and modify front panel and block diagram objects. Use the toolbar buttons to run VIs.

Menus

The menus at the top of a VI window contain items common to other applications, such as **Open**, **Save**, **Copy**, and **Paste**, and other items specific to LabVIEW. Some menu items also list shortcut key combinations.

(Macintosh) The menus appear at the top of the screen.



Note Some menu items are unavailable while a VI is in run mode.

Shortcut Menus

The most often-used menu is the object shortcut menu. All LabVIEW objects and empty space on the front panel and block diagram have associated shortcut menus. Use the shortcut menu items to change the look or behavior of front panel and block diagram objects. To access the shortcut menu, right-click the object, front panel, or block diagram.

(Macintosh) Press the <Command> key and click the object, front panel, or block diagram.

Shortcut Menus in Run Mode

When a VI is running, or is in run mode, all front panel objects have an abridged set of shortcut menu items. Use the abridged shortcut menu items to cut, copy, or paste the contents of the object, to set the object to its default value, or to read the description of the object.

Some of the more complex controls have additional options. For example, the array shortcut menu includes items to copy a range of values or go to the last element of the array.

Toolbar

Use the toolbar buttons to run and edit a VI. When you run a VI, buttons appear on the toolbar that you can use to debug the VI.

Customizing Your Work Environment

You can change the way the **Controls** and **Functions** palettes appear, and you can use the **Options** dialog box to set other work environment options.

Customizing the Controls and Functions Palettes

You can customize the **Controls** and **Functions** palettes in the following ways:

- Add VIs and controls to the palettes.
- Set up different views for different users, hiding some VIs and functions to make LabVIEW easier to use for one user while providing the full palettes for another user.
- Rearrange the built-in palettes to make the VIs and functions you use frequently more accessible.
- Convert a set of ActiveX controls into custom controls and add them to the palettes.
- Add toolsets to palettes.

Adding VIs and Controls to the User Library and the Instrument Library

The simplest method for adding VIs and controls to the **Controls** and **Functions** palettes is to save them in the `user.lib` directory. When you restart LabVIEW, the **Functions»User Libraries** and **Controls»User Controls** palettes contain subpalettes for each directory, VI library (`.lib`), or menu (`.mnu`) file in `user.lib`, and icons for each file in `user.lib`. LabVIEW automatically updates the palettes when you relaunch LabVIEW after you add files to or remove files from specific directories.

The **Functions»Instrument I/O»Instrument Drivers** palette corresponds to the `instr.lib` directory. Save instrument drivers in this directory to make them easily accessible on the **Functions** palette.

When you add VIs or controls to the **Controls** and **Functions** palettes using this method, you cannot determine the exact location of the VIs or controls on the palettes.

Creating and Editing Palette Views

To control the exact location of the VIs and controls you add to the **Controls** and **Functions** palettes, you must create a palette view. LabVIEW includes four built-in palette views—default, basic, data acquisition, and test & measurement.

LabVIEW stores **Controls** and **Functions** palette information in the `labview\menus` directory. The `menus` directory contains directories that correspond to each view that you create or install. If you run LabVIEW on a network, you can define individual `menus` directories for each user, which makes it easy to transfer views to other people.

When you create a new view of a palette, LabVIEW uses a copy of the original default view, upon which you can apply any changes. LabVIEW copies the original built-in palette located in the `labview\menus` directory before you make any changes. The protection of the built-in palettes ensures that you can experiment with the palettes without corrupting the original view.

How LabVIEW Stores Views

The `.mnu` files and `.lib` files contain one **Controls** palette and one **Functions** palette each. In addition, each file contains an icon for the **Controls** and **Functions** palettes. You must store each subpalette you create in a separate `.mnu` file.

When you select a view, LabVIEW checks the `menus` directory for a directory that corresponds to that view. It builds the top-level **Controls** and **Functions** palettes and subpalettes from the `root.mnu` file in that directory that LabVIEW automatically creates every time you create a view.

For each VI or control, LabVIEW creates an icon on the palette. For each subdirectory, `.mnu` file, or `.lib` file, LabVIEW creates a subpalette on the palette.

Building ActiveX Subpalettes

If you use ActiveX controls on the front panel, select **Tools»Advanced»Import ActiveX Controls** to convert a set of ActiveX controls to custom controls and add them to the **Controls** palette. LabVIEW saves the controls in the `user.lib` directory by default because all files and directories in `user.lib` automatically appear in the palettes.

Representing Toolsets in the Palettes

Toolsets you install in `vi.lib\addons` automatically appear on the top level of the **Controls** and **Functions** palettes after you restart LabVIEW. If you have toolsets installed elsewhere, you can move the toolsets to the `addons` directory for easier access.



Caution Do *not* save your own VIs and controls in the `vi.lib` directory because LabVIEW overwrites these files when you upgrade. Save your VIs and controls in the `user.lib` directory to add them to the **Controls** and **Functions** palettes.

Setting Work Environment Options

Select **Tools»Options** to customize LabVIEW. Use the **Options** dialog box to set options for paths, performance and disk issues, front panels, block diagrams, undo, debugging tools, colors, fonts, printing, the **History** window, time and date formats, and other LabVIEW features.

Use the top pull-down menu in the **Options** dialog box to select among the different categories of options.

How LabVIEW Stores Options

You do not have to edit options manually or know their exact format because the **Options** dialog box does it for you. LabVIEW stores options differently on each platform.

Windows

LabVIEW stores options in a `labview.ini` file in the LabVIEW directory. The file format is similar to other `.ini` files. It begins with a LabVIEW section marker followed by the option name and the values, such as `offscreenUpdates=True`.

If you want to use a different options file, specify the file in the shortcut you use to start LabVIEW. For example, to use an options file on your computer named `lvrc` instead of `labview.ini`, right-click the LabVIEW icon on the desktop and select **Properties**. Click the **Shortcut** tab and type `labview -pref lvrc` in the **Target** text box.

Macintosh

LabVIEW stores options in the LabVIEW Preferences text file in the **System»Preferences** folder.

If you want to use a different options file, copy the LabVIEW Preferences file to the **LabVIEW** folder and make options changes in the **Options** dialog box. When you launch LabVIEW, it first looks for an options file in the **LabVIEW** folder. If it does not find the file there, it looks in the **System** folder. If it does not find the file there, it creates a new one in the **System** folder. LabVIEW writes all changes you make in the **Options** dialog box to the first LabVIEW Preferences file it finds.

UNIX

LabVIEW stores options in the `.labviewrc` file in your home directory. If you change an option in the **Options** dialog box, LabVIEW writes the change to the `.labviewrc` file. You can create a `labviewrc` file in the program directory to store options that are the same for all users, such as the VI search path. Use the `.labviewrc` file to store options that are different for each user, such as font or color settings, because entries in the `.labviewrc` file in your home directory override conflicting entries in the program directory.

For example, if you installed the LabVIEW files in `/opt/labview`, LabVIEW first reads options from `/opt/labview/labviewrc`. If you change an option in the **Options** dialog box, such as the application font, LabVIEW writes that change to the `.labviewrc` file. The next time you start LabVIEW, it uses the application font option in the `.labviewrc` file instead of the default application font defined in `/opt/labview/labviewrc`.

Option entries consist of an option name followed by a colon and a value. The option name is the executable followed by a period (.) and an option. When LabVIEW searches for option names, the search is case sensitive. You can enclose the option value in double or single quotation marks. For example, to use a default precision of double, add the following entry to the `.labviewrc` file in your home directory.

```
labview.defPrecision : double
```

If you want to use a different options file, specify the file on the command line when you start LabVIEW. For example, to use a file named `lvrc` in the `test` directory instead of `.labviewrc`, type `labview -pref /test/lvrc`. LabVIEW writes all changes you make in the **Options** dialog box to the `lvrc` options file. When you specify an options file on the command line, LabVIEW still reads the `labviewrc` file in the program directory, but the options file specified on the command line overrides conflicting entries in the program directory.

Building the Front Panel

The front panel is the user interface of a VI. Generally, you design the front panel first, then design the block diagram to perform tasks on the inputs and outputs you create on the front panel. Refer to Chapter 5, *Building the Block Diagram*, for more information about the block diagram.

You build the front panel with controls and indicators, which are the interactive input and output terminals of the VI, respectively. Controls are knobs, push buttons, dials, and other input devices. Indicators are graphs, LEDs, and other displays. Controls simulate instrument input devices and supply data to the block diagram of the VI. Indicators simulate instrument output devices and display data the block diagram acquires or generates.

Select **Window»Show Controls Palette** to display the **Controls** palette, then select controls and indicators from the **Controls** palette and place them on the front panel.

For more information...

Refer to the *LabVIEW Help* for more information about designing and configuring the front panel.

Configuring Objects on the Front Panel

You can customize the front panel by using the control and indicator shortcut menus, by setting the order of front panel objects, and by using imported graphics. You also can manually resize front panel objects and set them to automatically resize when the window size changes. Refer to the *LabVIEW Custom Controls, Indicators, and Type Definitions* Application Note for more information about creating and using custom controls, indicators, and type definitions.

Showing and Hiding Optional Elements

Front panel controls and indicators have optional elements you can show or hide. View a list of the available elements by right-clicking an object and selecting **Visible Items** from the shortcut menu. Most objects have a label and a caption. Refer to the *Labeling* section of this chapter for more information about labels and captions.

Changing Controls to Indicators and Vice Versa

LabVIEW initially configures objects in the **Controls** palette as controls or indicators based on their typical use. For example, if you select a toggle switch from the **Controls»Boolean** palette, it appears on the front panel as a control because a toggle switch is usually an input device. If you select an LED, it appears on the front panel as an indicator because an LED is usually an output device.

Some palettes contain a control and an indicator for the same type or class of object. For example, the **Controls»Numeric** palette contains a digital control and a digital indicator.

You can change controls to indicators and vice versa by right-clicking the object and selecting **Change to Control** or **Change to Indicator** from the shortcut menu.

Replacing Front Panel Objects

You can replace a front panel object with a different control or indicator. When you right-click an object and select **Replace** from the shortcut menu, a temporary **Controls** palette appears, even if the **Controls** palette is already open. Select a control or indicator from the temporary **Controls** palette to replace the current object on the front panel.

Selecting **Replace** from the shortcut menu preserves as much information as possible about the original object, such as its name, description, default data, dataflow direction (control or indicator), color, size, and so on. However, the new object retains its own data type. Wires from the terminal of the object or local variables remain on the block diagram, but they might be broken. For example, if you replace a numeric terminal with a string terminal, the original wire remains on the block diagram, but is broken.

The more the new object resembles the object you are replacing, the more original characteristics you can preserve. For example, if you replace a slide with a different style slide, the new slide has the same height, scale, value, name, description, and so on. If you replace the slide with a string

control instead, LabVIEW preserves only the name, description, and dataflow direction because a slide does not have much in common with a string control.

You also can paste objects from the clipboard to replace existing front panel controls and indicators. This method does not preserve any characteristics of the old object, but the wires remain connected to the object.

Setting Keyboard Shortcuts for Controls

You can assign keyboard shortcuts to controls so users can navigate the front panel without a mouse. Right-click the control and select **Advanced»Key Navigation** from the shortcut menu to open the **Key Navigation** dialog box.

When a user enters the keyboard shortcut while running the VI, the associated control receives the focus. If the control is a text or digital control, LabVIEW highlights the text so you can edit it. If the control is Boolean, press the spacebar or the <Enter> key to change its value.

The **Advanced»Key Navigation** shortcut menu item is dimmed for indicators because you cannot enter data in an indicator.

Controlling Button Behavior with Key Navigation

You can associate function keys with various buttons that control the behavior of a front panel. You can define a button in a VI to behave like a dialog box so that pressing the <Enter> key becomes the same as clicking the default button.

(Macintosh and Sun) Pressing the <Return> key becomes the same as clicking the default button.

If you associate the <Enter> or the <Return> key with a dialog box button, LabVIEW automatically draws that button with a thick border around it.

If you associate the <Enter> or the <Return> key with a control, no string control on that front panel can receive a carriage return. Consequently, all strings on that front panel are limited to a single line. You can use scroll bars to navigate longer strings.

If you cycle to a Boolean control and press the <Enter> or the <Return> key, the Boolean control changes, even if another control uses the <Enter> or the <Return> key as its keyboard shortcut. The assigned <Enter> or <Return> keyboard shortcut applies only when a Boolean control is not selected.

Setting the Navigation Order of Front Panel Objects

You can set the navigation order of front panel objects by selecting **Edit»Set Tabbing Order**. You can then press the <Tab> key to navigate those objects while running the VI.

Controls and indicators on a front panel have an order, called panel order, that is unrelated to their position on the front panel. The first control or indicator you create on the front panel is element 0, the second is 1, and so on. If you delete a control or indicator, the panel order adjusts automatically.

The panel order determines the navigation order while a VI is running. The panel order also determines the order in which the controls and indicators appear in the records of datalog files you create when you log the front panel data. Refer to the *Logging Front Panel Data* section of Chapter 13, *File I/O*, for more information about logging data.

To prevent users from accessing a control by pressing the <Tab> key while running the VI, place a checkmark in the **Skip this control when tabbing** checkbox in the **Key Navigation** dialog box.

Coloring Objects

You can change the color of many objects but not all of them. For example, block diagram terminals of front panel objects and wires use specific colors for the type and representation of data they carry, so you cannot change them.

Use the Coloring tool and right-click an object or workspace to add or change the color of front panel objects or the front panel and block diagram workspaces. You also can change the default colors for most objects by selecting **Tools»Options** and selecting **Colors** from the top pull-down menu.

Using Imported Graphics

You can import graphics from other applications to use as front panel backgrounds, items in ring controls, and parts of other controls and indicators. Refer to the *LabVIEW Custom Controls, Indicators, and Type Definitions* Application Note for more information about using graphics in controls.

To import a graphic, copy it to the clipboard and paste it on the front panel. You also can select **Edit»Import Picture from File**.

Refer to the `examples\general\controls\custom.llb` for examples of controls with imported graphics.

Grouping and Locking Objects

Use the Positioning tool to select the front panel objects you want to group and lock together. Click the **Reorder** button on the toolbar and select **Group** or **Lock** from the pull-down menu. Grouped objects maintain their relative arrangement and size when you use the Positioning tool to move and resize them. Locked objects maintain their location on the front panel and you cannot delete them until you unlock them. You can set objects to be grouped and locked at the same time. Tools other than the Positioning tool work normally with grouped or locked objects.

Resizing Objects

You can change the size of most front panel objects. When you move the Positioning tool over a resizable object, resizing handles appear at the corners of a rectangular object, and resizing circles appear on a circular object. When you resize an object, the font size remains the same. Resizing a group of objects resizes all the objects within the group.

Some objects change size only horizontally or vertically when you resize them, such as digital numeric controls and indicators. Others keep the same proportions when you resize them, such as knobs. The Positioning cursor appears the same, but the dashed border that surrounds the object moves in only one direction.

You can manually restrict the growth direction when you resize an object. To restrict the growth vertically or horizontally or to maintain the current proportions of the object, press the <Shift> key as you click the object and drag it. To resize an object around its center point, press <Ctrl-Shift> and click the resizing cursors.

(Macintosh) Press the <Option-Shift> keys. **(Sun)** Press the <Meta-Shift> keys. **(Linux)** Press the <Alt-Shift> keys.

Scaling Front Panel Objects

You can set the front panel objects to scale, or automatically resize in relation to the window size, when you resize the front panel window. You can set one object on the front panel to scale, or you can set all objects on the front panel to scale. However, you cannot set multiple objects to scale on the front panel unless you set all of them to scale or unless you group the objects first. To scale an object, select the object and select **Edit»Scale Object With Panel**.

If you set a single front panel object to scale, the object resizes itself automatically in relation to any change in the front panel window size. The other objects on the front panel reposition themselves to remain consistent with their previous placement on the front panel but do not scale to fit the new window size of the front panel.

Immediately after you designate a single object on the front panel to scale automatically, gray lines outline several regions on the front panel, as shown in Figure 4-1. The regions define the positions of the other front panel objects in relation to the object you want to scale. When you resize the front panel window, the object you set to scale automatically resizes and repositions itself relative to its original location. The gray lines disappear when you run the VI.

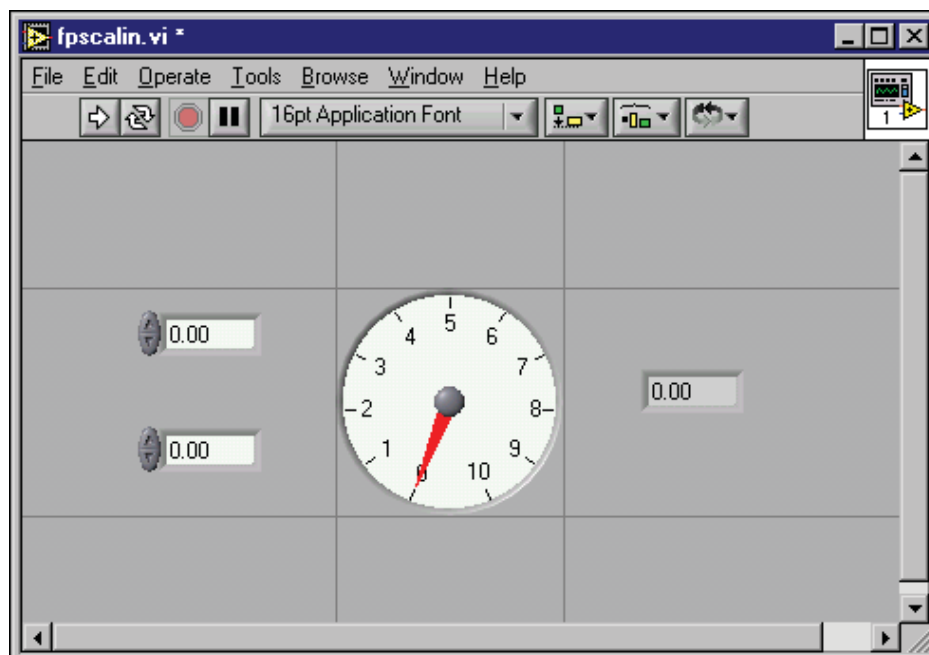

Figure 4-1. Front Panel with Object Set to Scale

When LabVIEW scales objects automatically, it follows the same conventions as when you resize an object manually. For example, some objects can resize only horizontally or vertically, and the font size remains the same when you resize an object.

After LabVIEW automatically scales an object, the object might not scale back to its exact original size when you size the window back to its original position. Before you save the VI, select **Edit>Undo** to restore the original front panel window and object sizes.

You can set an array to scale or set the objects within an array to scale. If you set the array to scale, you adjust the number of rows and columns you can see within the array. If you set the objects within the array to scale, you always see the same number of rows and columns, though different sizes, within the array.

You also can set a cluster to scale or set the objects within the cluster to scale. If you set the objects within the cluster to scale, the cluster will adjust as well.

Adding Space to Front Panel without Resizing Window

You can add space to the front panel without resizing the window. To increase the space between crowded or tightly grouped objects, press the <Ctrl> key and use the Positioning tool to click the front panel workspace. While holding the key combination, drag out a region the size you want to insert.

(Macintosh) Press the <Option> key. **(Sun)** Press the <Meta> key.

(Linux) Press the <Alt> key.

A rectangle marked by a dashed border defines where space will be inserted. Release the key combination to add the space.

Front Panel Controls and Indicators

Use the front panel controls and indicators located on the **Controls** palette to build the front panel. Controls are knobs, push buttons, dials, and other input devices. Indicators are graphs, LEDs, and other displays. Controls simulate instrument input devices and supply data to the block diagram of the VI. Indicators simulate instrument output devices and display data the block diagram acquires or generates.

3D and Classic Controls and Indicators

Many front panel objects have a high-color, three-dimensional appearance. Set your monitor to display at least 16-bit color for optimal appearance of the objects.

The 3D front panel objects also have corresponding low-color, two-dimensional objects. Use the 2D controls and indicators located on the **Controls»Classic Controls** palette to create VIs for 256-color and 16-color monitor settings.

Slides, Knobs, Dials, and Digital Displays

Use the numeric controls and indicators located on the **Controls»Numeric** and **Controls»Classic Controls»Numeric** palettes to simulate slides, knobs, dials, and digital displays. The palette also includes color boxes and a color ramp for setting color values. Use numeric controls and indicators to enter and display numeric data.

Slide Controls and Indicators

The slide controls and indicators include vertical and horizontal slides, a tank, and a thermometer. Change the value of a slide control or indicator by using the Operating tool to drag the slider to a new position, by clicking a point of the slide object, or by using the optional digital display. If you drag the slider to a new position and the VI is running during the change, the control passes intermediate values to the VI, depending on how often the VI reads the control.

Slide controls or indicators can display more than one value. Right-click the object and select **Add Slider** from the shortcut menu to add more sliders. The data type of a control with multiple sliders is a cluster that contains each of the numeric values. Refer to the *Clusters* section of Chapter 9, *Grouping Data Using Strings, Arrays, and Clusters*, for more information about clusters.

Rotary Controls and Indicators

The rotary controls and indicators include knobs, dials, gauges, and meters. The rotary objects operate similarly to the slide controls and indicators. Change the value of a rotary control or indicator by moving the needles, by clicking a point of the rotary object, or by using the optional digital display.

Rotary controls or indicators can display more than one value. Right-click the object and select **Add Needle** from the shortcut menu to add new needles. The data type of a control with multiple needles is a cluster that contains each of the numeric values. Refer to the *Clusters* section of Chapter 9, *Grouping Data Using Strings, Arrays, and Clusters*, for more information about clusters.

Digital Controls and Indicators

Digital controls and indicators are the simplest way to enter and display numeric data. You can resize these front panel objects horizontally to accommodate more digits. You can change the value of a digital control or indicator by using the following methods:

- Use the Operating or Labeling tool to click inside the digital display window and enter numbers from the keyboard.
- Use the Operating tool to click the increment or decrement arrow buttons of a digital control.
- Use the Operating or Labeling tool to place the cursor to the right of the digit you want to change and press the up or down arrow key on the keyboard.

Color Boxes

A color box displays a color that corresponds to a specified value. For example, you can use color boxes to indicate different conditions, such as out-of-range values. The color value is expressed as a hexadecimal number with the form RRGGBB. The first two digits control the red color value. The second two digits control the green color value. The last two digits control the blue color value.

Set the color of the color box by clicking it with the Operating or Coloring tool to display the color picker.

Color Ramps

A color ramp uses color to display its numeric value. You configure a color scale that consists of at least two arbitrary markers, each with a numeric value and a corresponding display color. As the input value changes, the color displayed changes to the color that corresponds to that value. Color ramps are useful for visually indicating data ranges, such as a warning range for when a gauge reaches dangerous values. For example, you can use a color ramp to set the color scale for intensity charts and graphs. Refer to the *Intensity Graphs and Charts* section of Chapter 11, *Graphs and Charts*, for more information about intensity charts and graphs.

Right-click the color ramp and use the shortcut menu options to customize the appearance, size, colors, and number of colors.

You also can add a color ramp to any knob, dial, or gauge on the front panel. Meters have a visible color ramp by default.

Buttons, Switches, and Lights

Use the Boolean controls and indicators located on the **Controls»Boolean** and **Controls»Classic Controls»Boolean** palettes to simulate buttons, switches, and lights. Use Boolean controls and indicators to enter and display Boolean (TRUE/FALSE) values. For example, if you are monitoring the temperature of an experiment, you can place a Boolean warning light on the front panel to indicate when the temperature goes above a certain level.

Use the shortcut menu to customize the appearance of Boolean objects and how they behave when you click them.

Text Entry Boxes, Labels, and Path Displays

Use the string and path controls and indicators located on the **Controls»String & Path** and **Controls»Classic Controls»String & Path** palettes to simulate text entry boxes and labels and to enter or return the location of a file or directory.

String Controls and Indicators

Enter or edit text in a string control on the front panel by using the Operating tool or the Labeling tool. By default, new or changed text does not pass to the block diagram until you terminate the edit session. You terminate the edit session by clicking elsewhere on the panel, changing to a different window, clicking the **Enter** button on the toolbar, or pressing the <Enter> key on the numeric keypad. Pressing the <Enter> key on the keyboard enters a carriage return.

(Macintosh and Sun) Pressing the <Return> key on the keyboard enters a carriage return.

Refer to the *Strings on the Front Panel* section of Chapter 9, *Grouping Data Using Strings, Arrays, and Clusters*, for more information about the string control and indicator.

Path Controls and Indicators

Use path controls and indicators to enter or return the location of a file or directory. Path controls and indicators work similarly to string controls and indicators, but LabVIEW formats the path using the standard syntax for the platform you are using.

Invalid Paths

If a function that returns a path fails, the function returns an invalid path value, `Not a Path`, in the indicator. Use the `Not a Path` value as the default value for a path control, so you can detect when the user fails to provide a path and display a file dialog box with options for selecting a path. Use the `File Dialog` function to display a file dialog box.

Empty Paths

An empty path in a path control appears as an empty string on Windows and Macintosh and as a slash (/) on UNIX. Use empty paths to prompt the user to specify a path. When you wire an empty path to a file input/output (I/O) function, the empty path refers to the list of drives mapped to the computer.

(Macintosh) The empty path refers to the mounted volumes.

(UNIX) The empty path refers to the root directory.

Array and Cluster Controls and Indicators

Use the array and cluster controls and indicators located on the **Controls»Arrays & Cluster** and **Controls»Classic Controls»Array & Cluster** palettes to create arrays and clusters of other controls and indicators. Refer to the *Grouping Data with Arrays and Clusters* section of Chapter 9, *Grouping Data Using Strings, Arrays, and Clusters* for more information about arrays and clusters.

The **Array & Cluster** palettes also contain standard error cluster controls and indicators, the variant control, and the tab control. Refer to the *Error Clusters* section of Chapter 6, *Running and Debugging VIs*, for more information about error clusters. Refer to the *Handling Variant Data* section of Chapter 5, *Building the Block Diagram*, for more information about the variant control.

Tab Controls

Use tab controls to overlap front panel controls and indicators in a smaller area. A tab control consists of pages and tabs. Place front panel objects on each page of a tab control and use the tab as the selector for displaying different pages. You can place an unlimited number of front panel objects on a tab control.

Tab controls are useful when you have several front panel objects that are used together or during a specific phase of operation. For example, you might have a VI that requires the user to first configure several settings

before a test can start, then allows the user to modify aspects of the test as it progresses, and finally allows the user to display and store only pertinent data.

On the block diagram, the tab control is an enumerated type control by default. Terminals for controls and indicators placed on the tab control appear as any other block diagram terminal. Refer to the *Enumerated Type Controls* section of this chapter for more information about enumerated type controls.

Listboxes

Use the listbox controls located on the **Controls»List & Table** and **Controls»Classic Controls»List & Table** palettes to give users a list of items from which to select. You can configure listboxes to accept single or multiple selections. Use the multicolumn listbox to display more information about each item, such as the size of the item and the date it was created.

Use the Property Node of the listbox control to modify list items and to gather information about list items in the following ways:

- Set item strings.
- Add a symbol next to the list item, as in the **Save** dialog box, where directories and files have different symbols.
- Disable individual items in the list.
- Insert separator lines between list items.
- Detect currently selected items by reading the value of the control.
- Detect which items, if any, the user double-clicked.

Refer to the *Property Nodes* section of Chapter 16, *Programmatically Controlling VIs*, for more information about Property Nodes.

Listboxes support type completion, which means that you type the first few characters and LabVIEW finds a matching item in the listbox. Press the <Tab> key to move to the next matching item. Press the <Shift-Tab> keys to move to the previous matching item.

Listboxes automatically have scroll bars, but the scroll bars are activated only when the listbox includes more information than it can display.

Ring and Enumerated Type Controls and Indicators

Use the ring and enumerated type controls and indicators located on the **Controls»Ring & Enum** and **Controls»Classic Controls»Ring & Enum** palettes to create a list of strings you can cycle through.

Ring Controls

Ring controls are numeric objects that associate numeric values with strings or pictures. Ring controls appear as pull-down menus that users can cycle through to make selections.

Ring controls are useful for selecting mutually exclusive items, such as trigger modes. For example, use a ring control for users to select from continuous, single, and external triggering.

The order of the items in the ring control is based on the order you enter the items. Each item has a numeric value that ranges from 0 to $n-1$, where n is the number of items. The ring control displays the last item if the user enters any value greater than or equal to $n-1$ and the first item if the user enters any value less than or equal to zero.

Ring controls support type completion, and the pull-down menus of ring controls can have scroll bars.

Enumerated Type Controls

Use enumerated type controls to give users a list of actions from which to select. An enumerated type control, or enum, is similar to a ring control of strings. However, with an enumerated type control, the value is a string instead of a number as with ring controls. For example, you can use an enumerated type control to select the cases of a Case structure. Refer to the *Case Structures* section of Chapter 8, *Loop and Case Structures*, for more information about Case structures.

The enumerated type control data type is unsigned byte, unsigned word, or unsigned long. Right-click the enumerated type control and select **Representation** from the shortcut menu to change the data type of the control.

Advanced Enumerated Type Controls and Indicators

All arithmetic functions except Increment and Decrement treat the enumerated type control the same as an unsigned numeric. Increment increments the last enumerated value to the first, and Decrement decrements the first enumerated value to the last. When coercing a signed

integer to an enumerated type, negative numbers are changed to equal the first enumerated value, and out-of-range positive numbers are changed to equal the last enumerated value. Out-of-range unsigned integers are always changed to equal the last enumerated value.

If you connect a floating-point value to an enumerated type indicator, the number is converted to the closest enumeration item, which is one of the values in the enumerated type indicator. LabVIEW handles out-of-range numbers as previously described. If you connect an enumerated control to any numeric value, the value is the enumerated type index. To wire an enumerated type control to an enumerated type indicator, the enumeration items must match. The indicator can have additional items beyond the items in the control.

I/O Name Controls and Indicators

Use the I/O name controls and indicators located on the **Controls»I/O** or **Controls»Classic Controls»I/O** palettes to pass DAQ channel names, VISA resource names, and IVI logical names you configure to I/O VIs to communicate with an instrument or a DAQ device.

I/O name constants are located on the **Functions»Instrument** and **Functions»DAQ** palettes.

(Windows) Use Measurement & Automation Explorer, available from the **Tools** menu, to configure DAQ channel names, VISA resource names, and IVI logical names.

(Macintosh) Use the NI-DAQ Configuration Utility, available from the **Tools** menu, to configure National Instruments DAQ hardware. Use the DAQ Channel Wizard, available from the **Tools** menu, to configure DAQ channel names.

(Macintosh and UNIX) Use the configuration utilities for your instrument to configure VISA resource names and IVI logical names. Refer to the documentation for your instrument for more information about the configuration utilities.

The IMAQ session control is a unique identifier that represents the connection to the hardware.

Waveform Control

Use the waveform control located on the **Controls»I/O** or **Controls»Classic Controls»I/O** palettes to manipulate individual data elements of a waveform. Refer to the *Waveform Data Type* section of Chapter 11, *Graphs and Charts*, for more information about the waveform data type.

References to Objects or Applications

Use the reference number controls and indicators located on the **Controls»Refnum** and **Controls»Classic Controls»Refnum** palettes to work with files, directories, devices, and network connections. Use the control refnum to pass front panel object information to subVIs. Refer to the *Controlling Front Panel Objects* section of Chapter 16, *Programmatically Controlling VIs*, for more information about control refnums.

A reference number, or refnum, is a unique identifier for an object, such as a file, device, or network connection. When you open a file, device, or network connection, LabVIEW creates a refnum associated with that file, device, or network connection. All operations you perform on open files, devices, or network connections use the refnums to identify each object. Use a refnum control or indicator to pass a refnum into or out of a VI. For example, use a refnum control or indicator to modify the contents of the file that a refnum is referencing without closing and reopening the file.

Because a refnum is a temporary pointer to an open object, it is valid only for the period during which the object is open. If you close the object, LabVIEW disassociates the refnum with the object, and the refnum becomes obsolete. If you open the object again, LabVIEW creates a new refnum that is different from the first refnum.

LabVIEW remembers information associated with each refnum, such as the current location for reading from or writing to the object and the degree of user access, so you can perform concurrent but independent operations on a single object. If a VI opens an object multiple times, each open operation returns a different refnum.

Dialog Controls

Use the dialog controls located on the **Controls»Dialog Controls** palette in dialog boxes you create. The dialog controls and indicators are designed specifically for use in dialog boxes, and include ring controls, buttons, tabbed dialog boxes, checkboxes, and radio buttons. These controls differ from those that appear on the front panel only in terms of appearance. These controls appear in the colors you have set up for your desktop.

Because the dialog controls change appearance depending on which platform you run the VI, the appearance of controls in VIs you create is compatible on all LabVIEW platforms. When you run the VI on a different platform, the dialog controls adapt their color and appearance to match the standard dialog box controls for that platform.

Select **File»VI Properties** and select **Window Appearance** from the **Category** pull-down menu to hide the menu bar and scroll bars and to create VIs that look and behave like standard dialog boxes for each platform. Refer to the *Configuring the Appearance and Behavior of VIs* section of Chapter 15, *Customizing VIs*, for more information about configuring the appearance and behavior of VIs.

Labeling

Use labels to identify objects on the front panel and block diagram.

LabVIEW includes two kinds of labels—owned labels and free labels. Owned labels belong to and move with a particular object and annotate that object only. You can move an owned label independently, but when you move the object that owns the label, the label moves with the object. You can hide owned labels, but you cannot copy or delete them independently of their owners. You also can display a unit label for numeric controls by selecting **Visible Items»Unit Label** from the shortcut menu. Refer to the *Numeric Units and Strict Type Checking* section of Chapter 5, *Building the Block Diagram*, for more information about numeric units.

Free labels are not attached to any object, and you can create, move, rotate, or delete them independently. Use them to annotate front panels and block diagrams.

Use the Labeling tool to create free labels or to edit either type of label.

Captions

Front panel objects also can have captions. Right-click the object and select **Visible Items»Caption** from the shortcut menu to display the caption. Unlike a label, a caption does not affect the name of the object, and you can use it as a more descriptive object label. The caption does not appear on the block diagram.

Text Characteristics

LabVIEW uses fonts already installed on your computer. Use the **Text Settings** pull-down menu on the toolbar to change the attributes of text. If you select objects or text before you make a selection from the **Text Settings** pull-down menu, the changes apply to everything you select. If you select nothing, the changes apply to the default font. Changing the default font does not change the font of existing labels. It affects only those labels you create from that point on.

Select **Font Dialog** from the **Text Settings** pull-down menu on the front panel to apply specific font styles to text you have selected. If you do not select any text, the **Panel Default** option contains a checkmark. If you select **Text Settings»Font Dialog** from the block diagram without selecting any objects, the **Diagram Default** option contains a checkmark. You can set different fonts for the front panel and for the block diagram. For example, you can have a small font on the block diagram and a large one on the front panel.

The **Text Settings** pull-down menu contains the following built-in fonts:

- **Application Font**—Default font used for **Controls** and **Functions** palettes and text in new controls
- **System Font**—Used for menus
- **Dialog Font**—Used for text in dialog boxes

When you transfer a VI that contains one of these built-in fonts to another platform, the fonts correspond as closely as possible.

The **Text Settings** pull-down menu also has **Size**, **Style**, **Justify**, and **Color** submenu items.

Font selections you make from any of these submenus apply to objects you selected. For example, if you select a new font while you have a knob and a graph selected, the labels, scales, and digital displays all change to the new font.

LabVIEW preserves as many font attributes as possible when you make a change. For example, if you change several objects to the Courier font, the objects retain their size and styles if possible. When you use the **Text Settings** dialog box, LabVIEW changes the objects you select to the text characteristics you select. If you select one of the built-in fonts or the current font, LabVIEW changes the selected objects to the font and size associated with that font.

When you work with objects that have multiple pieces of text, like slides, font changes you make affect the objects or text you currently have selected. For example, if you select the entire slide and select **Style»Bold** from the **Text Settings** pull-down menu, the scale, digital display, and label all change to a bold font. If you select only the label and select **Bold**, only the label changes to a bold font. If you select text from a scale marker and select **Bold**, all the markers change to a bold font.

Designing User Interfaces

If a VI serves as a user interface or a dialog box, front panel appearance and layout are important. Design the front panel so users can easily identify what actions to perform. You can design front panels that look similar to instruments or other devices.

Refer to the *LabVIEW Development Guidelines* manual for more information about designing user interfaces.

Refer to the *Case and Sequence Structures* section of Chapter 8, *Loop and Case Structures*, for information about using events to enhance the functionality of user interfaces.

Using Front Panel Controls and Indicators

Controls and indicators are the main components of the front panel. When you design the front panel, consider how users interact with the VI and group controls and indicators logically. If several controls are related, add a decorative border around them or put them in a cluster. Use the decorations located on the **Controls»Decorations** and **Controls»Classic Controls»Decorations** palettes to group or separate objects on a front panel with boxes, lines, or arrows. These objects are for decoration only and do not display data.

Do not place front panel objects too closely together. Try to leave some blank space to make the front panel easier to read. Blank space also prevents users from accidentally clicking the wrong control or button.

Assign specific names to buttons and use common terminology. Use names like Start, Stop, and Save instead of OK. Specific names make it easier for users to use the VI.

Use the default LabVIEW fonts and colors. LabVIEW replaces the built-in fonts with comparable font families on different platforms. If you select a different font, LabVIEW substitutes the closest match if the font is

unavailable on a computer. LabVIEW handles colors similarly to fonts. If a color is not available on a computer, LabVIEW replaces it with the closest match. You also can use system colors to adapt the appearance of a front panel to the system colors of any computer that runs the VI.

Avoid placing objects on top of other objects. Placing a label or any other object over or partially covering a control or indicator slows down screen updates and can make the control or indicator flicker.

Designing Dialog Boxes

If a VI contains consecutive dialog boxes that appear in the same screen location, organize them so that the buttons in the first dialog box do not directly line up with the buttons in the next dialog box. Users might double-click a button in the first dialog box and unknowingly click a button in the subsequent dialog box. Refer to the *Dialog Controls* section of this chapter for more information about the dialog controls.

Selecting the Screen Size

When you design a VI, consider whether the front panel can display on computers with different screen resolutions. Select **File»VI Properties**, select **Window Size** in the **Category** pull-down menu, and place a checkmark in the **Maintain Proportions of Window for Different Monitor Resolutions** checkbox to maintain front panel window proportions relative to the screen resolution.

Building the Block Diagram

After you build the front panel, you add code using graphical representations of functions to control the front panel objects. The block diagram contains this graphical source code.

For more information...

Refer to the *LabVIEW Help* for more information about designing and configuring the block diagram.

Relationship between Front Panel Objects and Block Diagram Terminals

Front panel objects appear as terminals on the block diagram. Double-click a block diagram terminal to highlight the corresponding control or indicator on the front panel.

Terminals are entry and exit ports that exchange information between the front panel and block diagram. Data you enter into the front panel controls enter the block diagram through the control terminals. When the VI finishes running, the output data flow to the indicator terminals, where they exit the block diagram, reenter the front panel, and appear in front panel indicators.

Block Diagram Objects

Objects on the block diagram include terminals, nodes, and functions. You build block diagrams by connecting the objects with wires.

Block Diagram Terminals



Block diagram terminals represent the data type of the front panel control or indicator. For example, a DBL terminal, shown at left, represents a double-precision, floating-point numeric control or indicator.

A terminal is any point to which you can attach a wire, other than to another wire. LabVIEW has control and indicator terminals, node terminals, constants, and specialized terminals on structures, such as the input and output terminals on the Formula Node. You use wires to connect terminals and pass data to other terminals. Right-click a block diagram object and select **Visible Items»Terminals** from the shortcut menu to view the terminals. Right-click the object and select **Visible Items»Terminals** again to hide the terminals. This shortcut menu item is not available for expandable functions.

Control and Indicator Data Types

Table 5-1 shows the symbols for the different types of control and indicator terminals. The color and symbol of each terminal indicate the data type of the control or indicator. Control terminals have a thicker border than indicator terminals. Also, a blank arrow appears on the right if the terminal is a control, and an arrow appears on the left if the terminal is an indicator.

Table 5-1. Control and Indicator Terminals



















































Control	Indicator	Data Type	Color
		Single-precision floating-point numeric	Orange
		Double-precision floating-point numeric	Orange
		Extended-precision floating-point numeric	Orange
		Complex single-precision floating-point numeric	Orange
		Complex double-precision floating-point numeric	Orange
		Complex extended-precision floating-point numeric	Orange
		Signed 8-bit integer numeric	Blue
		Signed 16-bit integer numeric	Blue
		Signed 32-bit integer numeric	Blue
		Unsigned 8-bit integer numeric	Blue
		Unsigned 16-bit integer numeric	Blue
		Unsigned 32-bit integer numeric	Blue
		Enumerated type	Blue
		Boolean	Green
		String	Pink

Table 5-1. Control and Indicator Terminals (Continued)

Control	Indicator	Data Type	Color
		Array—Encloses the data type of its elements in square brackets and takes the color of that data type.	Varies
 	 	Cluster—Encloses several data types. Cluster data types are brown if the elements of the cluster are the same type or pink if the elements of the cluster are different types.	Brown or Pink
		Path	Aqua
		Waveform—Cluster of elements that carries the data, start time, and Δt of a waveform. Refer to the <i>Waveform Data Type</i> section of Chapter 11, <i>Graphs and Charts</i> , for more information about the waveform data type.	Brown
		Reference number (refnum)	Aqua
		Variant—Includes the control or indicator name, the data type information, and the data itself. Refer to the <i>Handling Variant Data</i> section of this chapter for more information about the variant data type.	Purple
		Polymorphic—Indicates that a VI or function accepts more than one kind of data type. Refer to the <i>Polymorphic VIs and Functions</i> section of this chapter for more information about polymorphism VIs and functions.	Purple
		I/O name—Passes DAQ channel names, VISA resource names, and IVI logical names you configure to I/O VIs to communicate with an instrument or a DAQ device. Refer to the <i>I/O Name Controls and Indicators</i> section of Chapter 4, <i>Building the Front Panel</i> , for more information about the I/O name data type.	Purple
		Picture—Displays pictures that can contain lines, circles, text, and other types of graphic shapes. Refer to the <i>Using the Picture Indicator</i> section of Chapter 12, <i>Graphics and Sound VIs</i> , for more information about the picture data type.	Blue

Many data types have a corresponding set of functions that can manipulate the data. Refer to the *Functions Overview* section of this chapter for information about which functions to use with each data type.

Constants

Constants are terminals on the block diagram that supply fixed data values to the block diagram. Universal constants are constants with fixed values, such as pi (π) and infinity (∞). User-defined constants are constants you define and edit before you run a VI.

Label a constant by right-clicking the constant and selecting **Visible Items»Label** from the shortcut menu. Universal constants have predetermined values for their labels that you can edit by using the Operating tool or the Labeling tool.

Most constants are located at the bottom or top of their palettes.

Universal Constants

Use universal constants for mathematical computations and formatting strings or paths. LabVIEW includes the following types of universal constants:

- **Universal numeric constants**—A set of high-precision and commonly used mathematical and physical values, such as the natural logarithm base (e) and the speed of light. The universal numeric constants are located on the **Functions»Numeric»Additional Numeric Constants** palette.
- **Universal string constants**—A set of commonly used non-displayable string characters, such as line feed and carriage return. The universal string constants are located on the **Functions»String** palette.
- **Universal file constants**—A set of commonly used file path values, such as Not a Path, Not a Refnum, and Default Directory. The universal file constants are located on the **Functions»File I/O»File Constants** palette.

User-Defined Constants

The **Functions** palette includes constants organized by type, such as Boolean, numeric, ring, enumerated type, color box, listbox, string, array, cluster, and path constants.

Create a user-defined constant by right-clicking an input terminal of a VI or function and selecting **Create Constant** from the shortcut menu. You cannot change the value of user-defined constants when the VI is running.

You also can create a constant by dragging a front panel control to the block diagram. LabVIEW creates a constant that contains the value of the front panel control at the time you dragged it to the block diagram. The front panel control remains on the front panel. Changing the value of the control does not affect the constant value and vice versa.

Use the Operating or Labeling tool to click the constant and edit its value. If automatic tool selection is enabled, double-click the constant to switch to the Labeling tool and edit the value.

Block Diagram Nodes

Nodes are objects on the block diagram that have inputs and/or outputs and perform operations when a VI runs. They are analogous to statements, operators, functions, and subroutines in text-based programming languages. LabVIEW includes the following types of nodes:

- **Functions**—Built-in execution elements, comparable to an operator, function, or statement. Refer to the *Functions Overview* section of this chapter for more information about the functions available in LabVIEW.
- **SubVIs**—VIs used on the block diagram of another VI, comparable to subroutines. Refer to the *SubVIs* section of Chapter 7, *Creating VIs and SubVIs*, for more information about using subVIs on the block diagram.
- **Structures**—Process control elements, such as Sequence structures, Case structures, For Loops, or While Loops. Refer to Chapter 8, *Loop and Case Structures*, for more information about using structures.
- **Formula Nodes**—Resizable structures for entering equations directly into a block diagram. Refer to the *Formula Nodes* section of Chapter 20, *Formulas and Equations*, for more information about using Formula Nodes.
- **Property Nodes**—Sets or finds properties of a class. Refer to the *Property Nodes* section of Chapter 16, *Programmatically Controlling VIs*, for more information about using Property Nodes.
- **Invoke Nodes**—Executes methods of a class. Refer to the *Invoke Nodes* section of Chapter 16, *Programmatically Controlling VIs*, for more information about using Invoke Nodes.
- **Code Interface Nodes (CINs)**—Calls code from text-based programming languages. Refer to the *Code Interface Node* section of Chapter 19, *Calling Code from Text-Based Programming Languages*, for more information about calling code from text-based programming languages.



After you build a VI front panel and block diagram, build the connector pane, shown at left, so you can use the VI as a subVI. The connector pane is a set of terminals that corresponds to the controls and indicators of that VI, similar to the parameter list of a function call in text-based programming languages. The connector pane defines the inputs and outputs you can wire to the VI so you can use it as a subVI. Refer to the *Setting up the Connector Pane* section of Chapter 7, *Creating VIs and SubVIs*, for more information about setting up connector panes.

Functions Overview

Functions are the essential operating elements of LabVIEW. Function icons on the **Functions** palette have pale yellow backgrounds and black foregrounds. Functions do not have front panels or block diagrams but do have connector panes.

The **Functions** palette also includes the VIs that ship with LabVIEW. Use these VIs as subVIs when you build data acquisition, instrument control, communication, and other VIs. Refer to the *Using Built-In VIs and Functions* section of Chapter 7, *Creating VIs and SubVIs*, for more information about using the built-in VIs.

Numeric Functions

Use the Numeric functions located on the **Functions»Numeric** palette to create and perform arithmetic, trigonometric, logarithmic, and complex mathematical operations on numbers and to convert numbers from one data type to another.

Boolean Functions

Use the Boolean functions located on the **Functions»Boolean** palette to perform logical operations on single Boolean values or arrays of Boolean values, such as the following tasks:

- Change a TRUE value to a FALSE value and vice versa.
- Determine which Boolean value to return if you receive two or more Boolean values.
- Convert a Boolean value to a number (either 1 or 0).
- Perform compound arithmetic on two or more Boolean values.

String Functions

Use the String functions located on the **Functions»String** palette to perform the following tasks:

- Concatenate two or more strings.
- Extract a subset of strings from a string.
- Search for and replace characters or subsets of strings in a string.
- Convert data into strings.
- Format a string for use in a word processing or spreadsheet application.

Refer to the *Strings* section of Chapter 9, *Grouping Data Using Strings, Arrays, and Clusters*, for more information about using the String functions.

Array Functions

Use the Array functions located on the **Functions»Array** palette to create and manipulate arrays, such as the following tasks:

- Extract individual data elements from an array.
- Add individual data elements to an array.
- Split arrays.

Refer to the *Arrays* section of Chapter 9, *Grouping Data Using Strings, Arrays, and Clusters*, for more information about using the Array functions.

Cluster Functions

Use the Cluster functions located on the **Functions»Cluster** palette to create and manipulate clusters, such as the following tasks:

- Extract individual data elements from a cluster.
- Add individual data elements to a cluster.
- Break a cluster out into its individual data elements.

Refer to the *Clusters* section of Chapter 9, *Grouping Data Using Strings, Arrays, and Clusters*, for more information about using the Cluster functions.

Comparison Functions

Use the Comparison functions located on the **Functions»Comparison** palette to compare Boolean values, strings, numerics, arrays, and clusters.

Refer to Appendix C, *Comparison Functions*, for more information about using the Comparison functions.

Time and Dialog Functions

Use the Time and Dialog functions located on the **Functions»Time & Dialog** palette to perform the following tasks:

- Manipulate the speed at which an operation executes.
- Retrieve time and date information from your computer clock.
- Create dialog boxes to prompt users with instructions.

This palette also includes the Error Handler VIs. Refer to the *Error Checking and Error Handling* section of Chapter 6, *Running and Debugging VIs*, for more information about using the Error Handler VIs.

File I/O Functions

Use the File I/O functions located on the **Functions»File I/O** palette to perform the following tasks:

- Open and close files.
- Read from and write to files.
- Create directories and files you specify in the path control.
- Retrieve directory information.
- Write strings, numbers, arrays, and clusters to files.

The **File I/O** palette also includes VIs that perform common file I/O tasks. Refer to Chapter 13, *File I/O*, for more information about using the File I/O VIs and functions.

Waveform Functions

Use the Waveform functions located on the **Functions»Waveform** palette to perform the following tasks:

- Build waveforms that include the waveform values, channel information, and timing information.
- Extract individual data elements from a waveform.
- Edit individual data elements of a waveform.

Refer to Part II, *DAQ Basics*, of the *LabVIEW Measurements Manual* for more information about creating and using waveforms in VIs.

Application Control Functions

Use the Application Control functions located on the **Functions»Application Control** palette to programmatically control VIs and LabVIEW applications on your local computer or across a network. Refer to Chapter 16, *Programmatically Controlling VIs*, for more information about using the Application Control functions.

Advanced Functions

Use the Advanced functions located on the **Functions»Advanced** palette to call code from libraries, such as dynamic link libraries (DLLs), to manipulate LabVIEW data for use in other applications, to create and manipulate Windows registry keys, and to call a section of code from text-based programming languages. Refer to the *Using External Code in LabVIEW* manual for more information about using the Advanced functions.

Adding Terminals to Block Diagram Functions

You can change the number of terminals for some functions. For example, to build an array with 10 elements, you must add 10 terminals.

You can add terminals to expandable functions by using the Positioning tool to drag the corner of the function. You also can use the Positioning tool to remove terminals from expandable functions, but you cannot remove a terminal that is already wired. You must first delete the existing wire to remove the terminal.

You also can add or remove terminals by right-clicking one of the terminals on the icon and selecting **Add Input**, **Add Output**, **Remove Input**, or **Remove Output** from the shortcut menu. Depending on the function, you can add terminals for inputs, outputs, or refnum controls. The **Add Input** and **Add Output** shortcut menu items add a terminal immediately after the terminal you right-clicked. The **Remove Input** and **Remove Output** shortcut menu items remove the terminal you right-clicked. If you use the shortcut menu items to remove a wired terminal, LabVIEW removes the terminal and disconnects the wire.

Using Wires to Link Block Diagram Objects

You transfer data among block diagram objects through wires. Each wire has a single data source, but you can wire it to many VIs and functions that read the data. Wires are different colors, styles, and thicknesses depending on their data types. A broken wire appears as a dashed black line. Refer to the *LabVIEW Quick Reference Card* for more information about wire data types.

Wire stubs are the truncated wires that appear next to unwired terminals when you move the Wiring tool over a VI or function node. They indicate the data type of each terminal. A tip strip also appears, listing the name of the terminal. After you wire a terminal, the wire stub for that terminal does not appear when you move the Wiring tool over its node.

A wire segment is a single horizontal or vertical piece of wire. A bend in a wire is where two segments join. The point at which three or four wire segments join is a junction. A wire branch contains all the wire segments from junction to junction, terminal to junction, or terminal to terminal if there are no junctions in between. Figure 5-1 shows a wire segment, bend, and junction.

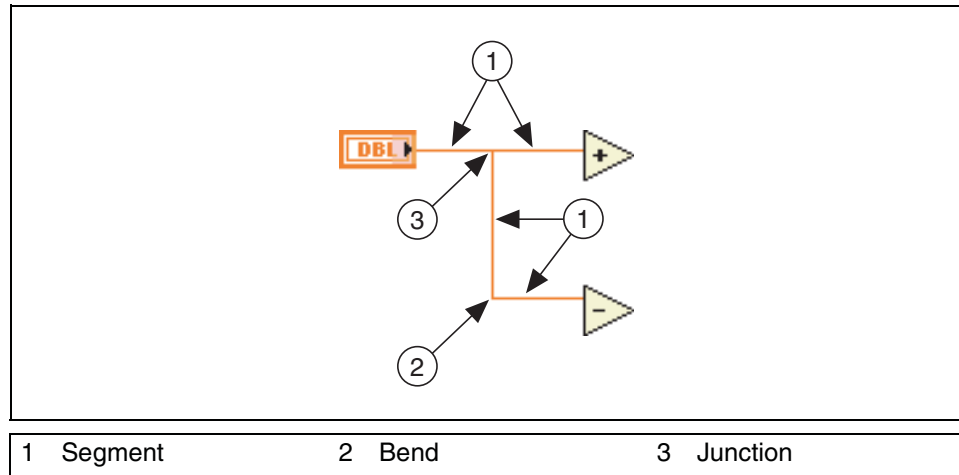

Figure 5-1. Wire Segment, Bend, and Junction

You can wire terminals vertically or horizontally depending on the direction in which you first move the Wiring tool. The wire connects to the center of the terminal, regardless of where you click the terminal. After you click the terminal, switch between horizontal and vertical direction by pressing the spacebar.

While you are wiring a terminal, bend the wire at a 90 degree angle once by moving the cursor in either a vertical or horizontal direction. To bend a wire in multiple directions, click the mouse button to set the wire and then drag the wire in the new direction. You can repeatedly set the wire and drag it in new directions.

To undo the last point where you set the wire, press the <Shift> key and click anywhere on the block diagram.

(Macintosh) Press the <Option> key and click. **(UNIX and Linux)** Click the middle mouse button.

When you cross wires, a small gap appears in the first wire you drew to indicate that the first wire is under the second wire.



Caution Crossing wires can clutter a block diagram and make the block diagram difficult to debug.

Automatically Wiring Objects

If you have automatic wiring enabled, LabVIEW automatically wires objects as you place them on the block diagram. You also can automatically wire objects already on the block diagram. LabVIEW connects the terminals that best match and leaves terminals that do not match unconnected.

As you move a selected object close to other objects on the block diagram, LabVIEW draws temporary wires to show you valid connections. When you release the mouse button to place the object on the block diagram, LabVIEW automatically connects the wires.

Toggle automatic wiring by pressing the space bar while you move an object using the Positioning tool.

By default, automatic wiring is enabled when you select an object from the **Functions** palette or when you copy an object already on the block diagram by pressing the <Ctrl> key and dragging the object. Automatic wiring is disabled by default when you use the Positioning tool to move an object already on the block diagram.

(Macintosh) Press the <Option> key. **(Sun)** Press the <Meta> key. **(Linux)** Press the <Alt> key.

Manually Wiring Objects

Use the Wiring tool to manually connect the terminals on one block diagram node to the terminals on another block diagram node. The cursor point of the tool is the tip of the unwound wire spool. When you move the Wiring tool over a node, the terminal blinks, and, on VIs and functions, the name of the terminal appears in a tip strip.

Select **Help»Show Context Help** to display the **Context Help** window, which lists each terminal of the VI or function to show you exactly where wires must connect. The **Context Help** window does not display terminals for expandable functions, such as the Build Array function.

Selecting Wires

Select wires by using the Positioning tool to single-click, double-click, or triple-click them. Single-clicking a wire selects one segment of the wire. Double-clicking a wire selects a branch. Triple-clicking a wire selects the entire wire.

Removing Broken Wires

A broken wire appears as a dashed black line. Broken wires occur for a variety of reasons, such as when you try to wire two objects with incompatible data types. Move the Wiring tool over a broken wire to view a tip strip that describes why the wire is broken. Triple-click the wire with the Positioning tool and press the <Delete> key to remove a broken wire.



Note Do not confuse a dashed black wire with a dotted green wire. A dotted green wire represents a Boolean data type.

You can remove all broken wires by selecting **Edit»Remove Broken Wires**.



Caution Use caution when removing all broken wires. Sometimes a wire appears broken because you are not finished wiring the block diagram.

Coercion Dots

Coercion dots appear on block diagram nodes to alert you that you wired two different data types together. The dot means that LabVIEW converted the value passed into the node to a different representation. For example, if you wire a control with a double-precision floating-point representation value of 3.02 into an indicator with an integer representation, a coercion dot appears on the indicator, and the indicator is 3.

The block diagram places a coercion dot on the border of a terminal where the conversion takes place to indicate that automatic numeric conversion occurred.

Because VIs and functions can have many terminals, a coercion dot can appear inside an icon if you wire through one terminal to another terminal, as shown in the following example.

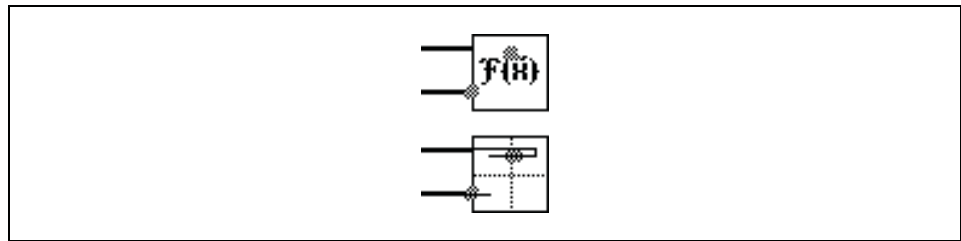

Coercion dots can cause a VI to use more memory and increase its run time. Try to keep data types consistent in your VIs.

Polymorphic VIs and Functions

Polymorphic VIs and functions can adjust to input data of different data types. Most LabVIEW structures are polymorphic, as are some VIs and functions.

Polymorphic VIs

Polymorphic VIs accept different data types for a single input or output terminal. A polymorphic VI is a collection of subVIs with the same connector pane patterns. Each subVI is an instance of the polymorphic VI.

For example, the Read Key VI is polymorphic. Its **default value** terminal accepts Boolean, double-precision floating-point numeric, signed 32-bit integer numeric, path, string, or unsigned 32-bit integer numeric data.

The data types you wire to the inputs of a polymorphic VI determine the instance to use. If the polymorphic VI does not contain a subVI for that data type, a broken wire appears. You can select the instance you want to act as the default instance by right-clicking the polymorphic VI, selecting **Select Type** from the shortcut menu, and selecting the subVI.

Building Polymorphic VIs

Build your own polymorphic VIs when you perform the same operation on different data types. You can build polymorphic VIs only in the LabVIEW Professional Development System.

For example, if you want to perform the same mathematical operation on a single-precision floating-point numeric, an array of numerics, or a waveform, you could create three separate VIs—Compute Number, Compute Array, and Compute Waveform. When you need to perform the operation, you place one of these VIs on the block diagram, depending on the data type you use as an input.

Instead of manually placing a version of the VI on the block diagram, you can create and use a single polymorphic VI. The polymorphic Compute VI contains three instances of the VI, as shown in Figure 5-2.

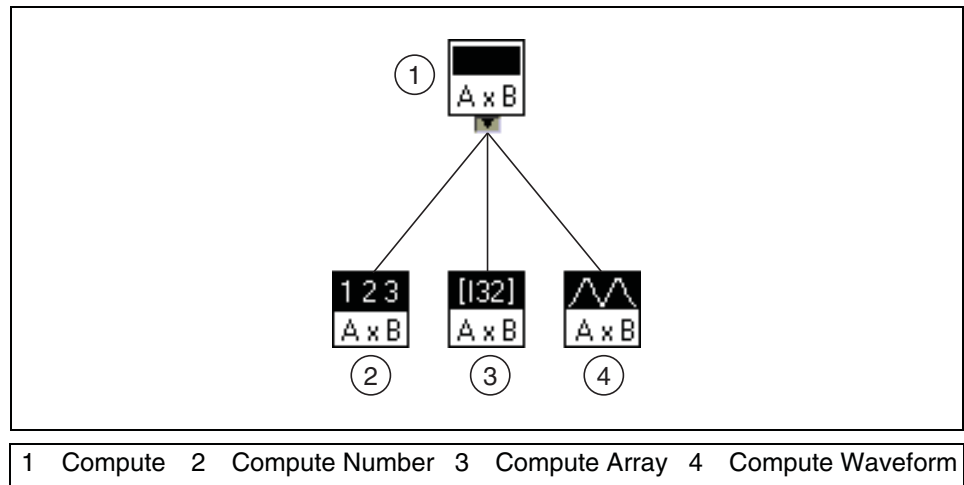

Figure 5-2. Example of a Polymorphic VI

The Compute VI statically links the correct instance of the VI based on the data type you wire to the Compute subVI on the block diagram, as shown in Figure 5-3.

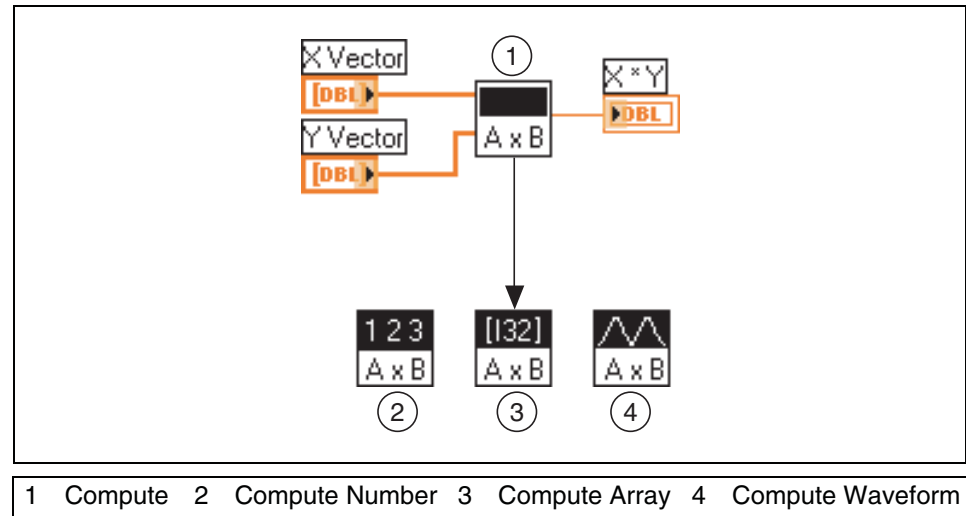

Figure 5-3. Polymorphic VI Calling a SubVI

Polymorphic VIs differ from most VIs in that they do not have a block diagram or a front panel.

Consider the following issues when you build polymorphic VIs:

- All VIs you include in the polymorphic VI must have the same connector pane pattern, because the connector pane of the polymorphic VI matches the connector pane of the VIs you use to create the polymorphic VI.
- The inputs and outputs on the connector pane of each instance of the VI must correspond to the inputs and outputs on the connector pane of the polymorphic VI.
- The VIs you use to build polymorphic VIs do not have to consist of the same subVIs and functions.
- Each of the front panels of the VIs do not have to have the same number of objects. However, each front panel must have at least the same number of controls and indicators that make up the connector pane of the polymorphic VI.
- You can create an icon for a polymorphic VI.
- You cannot use polymorphic VIs in other polymorphic VIs.

When you create complete documentation for a VI that includes a polymorphic subVI, the polymorphic VI and the VIs it invokes appear in the **List of SubVIs**.

Polymorphic Functions

Functions are polymorphic to varying degrees—none, some, or all of their inputs can be polymorphic. Some function inputs accept numerics or Boolean values. Some accept numerics or strings. Some accept not only scalar numerics but also arrays of numerics, clusters of numerics, arrays of clusters of numerics, and so on. Some accept only one-dimensional arrays although the array elements can be of any type. Some functions accept all types of data, including complex numerics. Refer to Appendix B, *Polymorphic Functions*, for more information about polymorphic functions.

Handling Variant Data

Variant data do not conform to a specific data type and they contain attributes, such as channel names and channel units. LabVIEW represents variant data with the variant data type. The variant data type differs from other data types because it includes the control or indicator name, the data type information, and the data itself.

Use the Variant functions located on the **Functions»Advanced»Data Manipulation»Variant** palette to create and manipulate variant data. You can convert any LabVIEW data type to the variant data type to use variant data in other VIs and functions. For example, if you convert a string to variant data, the variant data type stores the text and indicates that the text is a string.

Use the variant data type when it is important to manipulate data independently of data type. You also can represent data independently of type without using the variant data type by flattening the data into strings. For example, the **Get All Control Values** method returns information about the controls and indicators from a VI as an array of clusters. Each cluster in the array contains the data type and value of each control or indicator. The cluster contains the name of the control or indicator as a string, the data type as an array of 16-bit integers, and the data as flattened strings, as shown in Figure 5-4.

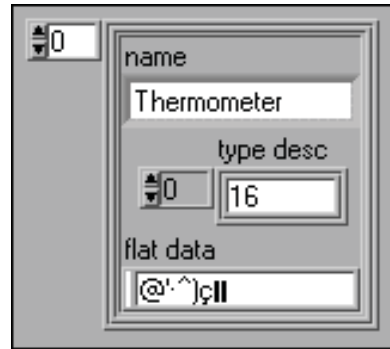

Figure 5-4. Cluster of Flattened Numeric Data

However, using flattened data has limitations, because LabVIEW cannot coerce flattened data. Also, attempting to unflatten a flattened integer as an extended-precision floating-point number fails. Use the variant data type to work with data independently of data type instead of flattening the data. Refer to the *Flattened Data* section of the *LabVIEW Data Storage* Application Note for more information about flattening and unflattening data.

You can add attributes to further identify the variant data. For example, an attribute to the variant data type can identify from which data acquisition device channel the data came.

Variant data also are useful when you write to or read from memory in LabVIEW and perform operations that involve stacks (last-in-first-out), queues (first-in-first-out), smart buffers, or trees. These kinds of operations treat data independently of the data types.

Numeric Units and Strict Type Checking

You can associate physical units of measure, such as meters or kilometers/second, with any numeric control that has floating-point representation.

Units for a control appear in a separate owned label, called the unit label. Display the unit label by right-clicking the control and selecting **Visible Items»Unit Label** from the shortcut menu.

When LabVIEW displays the unit label, you can enter a unit using standard abbreviations such as m for meters, ft for feet, s for seconds, and so on.



Note You cannot use units in Formula Nodes.

Units and Strict Type Checking

When you associate units with an object, you can wire only objects that have compatible units. LabVIEW uses strict type checking to verify that units are compatible. If you wire two objects with incompatible units, LabVIEW returns an error. For example, LabVIEW returns an error if you wire an object with mile as its unit type to an object with liter as its unit type, because a mile is a unit of distance and a liter is a unit of volume.

Figure 5-5 shows wiring objects with compatible units. In this figure, LabVIEW automatically scales the **distance** indicator to display kilometers instead of meters because kilometers is the unit for the indicator.

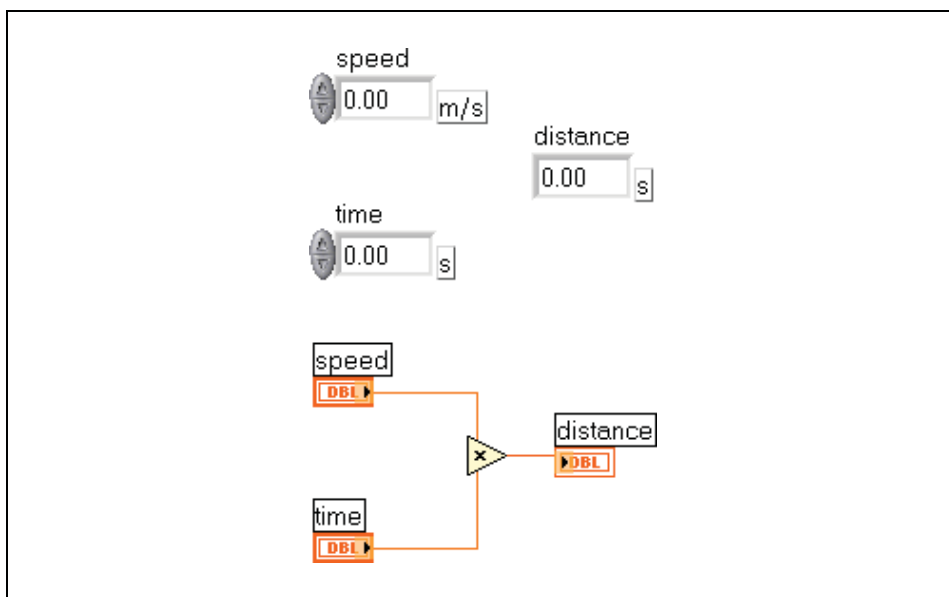

Figure 5-5. Wiring Objects with Compatible Units

An error occurs in Figure 5-6 because **distance** has a unit type of seconds. To correct the error, change seconds to a unit of distance, such as kilometers, as shown in Figure 5-5.

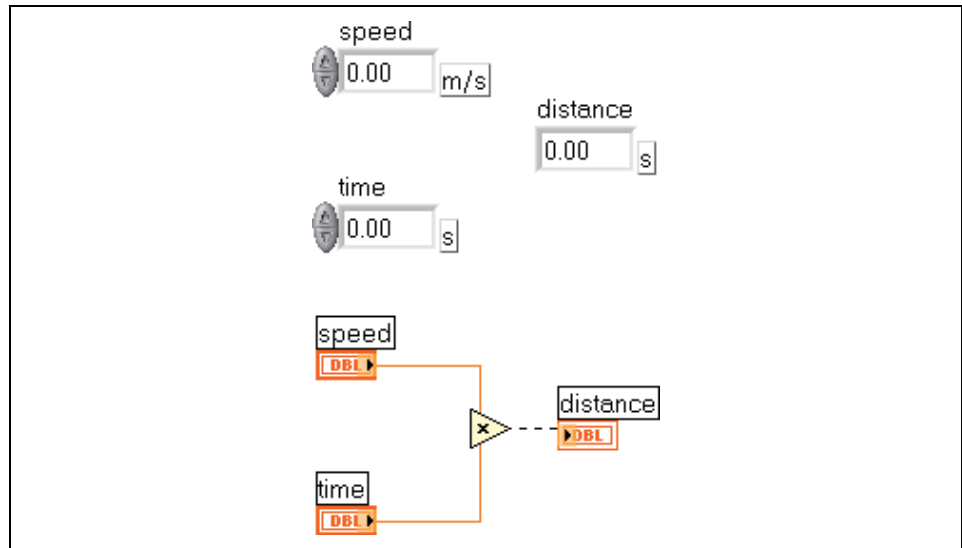

Figure 5-6. Wiring Objects with Incompatible Units Results in Broken Wires

To view the error, move the Wiring tool over the broken wire until a tip appears or right-click the broken wire and select **List Errors** from the shortcut menu. The **Error list** window lists the following error:

You have connected numeric data types that have incompatible units.

Some VIs and functions are ambiguous with respect to units. You cannot use these VIs and functions with other terminals that have units. For example, the Increment function is ambiguous with respect to units. If you use distance units, the Increment function cannot tell whether to add one meter, one kilometer, or one foot. Because of this ambiguity, you cannot use the Increment function and other functions that increment or decrement values with data that have associated units.

To avoid ambiguity in this example, use a numeric constant with the proper unit and the Add function to create your own increment unit function, as shown in Figure 5-7.

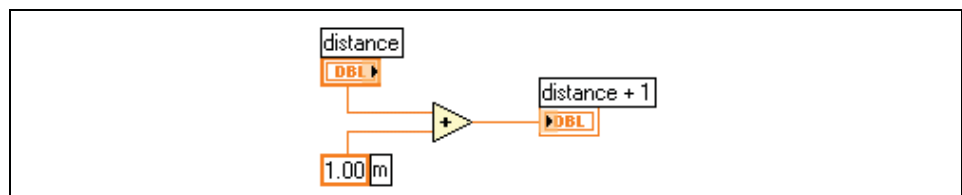

Figure 5-7. Creating an Increment Function with Units

Block Diagram Data Flow

LabVIEW follows a dataflow model for running VIs. A block diagram node executes when all its inputs are available. When a node completes execution, it supplies data to its output terminals and passes the output data to the next node in the dataflow path.

Visual Basic, C++, JAVA, and most other text-based programming languages follow a control flow model of program execution. In control flow, the sequential order of program elements determines the execution order of a program.

In LabVIEW, because the flow of data rather than the sequential order of commands determines the execution order of block diagram elements, you can create block diagrams that have simultaneous operations. LabVIEW is a multitasking and multithreaded system, running multiple execution threads and multiple VIs simultaneously. Refer to the *Using LabVIEW to Create Multithreaded VIs for Maximum Performance and Reliability* Application Note for more information about performing tasks simultaneously in LabVIEW.

Data Dependency and Artificial Data Dependency

The control flow model of execution is instruction driven. Dataflow execution is data driven, or data dependent. A node that receives data from another node always executes after the other node completes execution.

Block diagram nodes not connected by wires can execute in any order. Although the *LabVIEW Development Guidelines* manual recommends using a left-to-right and top-to-bottom layout, nodes do not necessarily execute in left-to-right, top-to-bottom order.

You can use a Sequence structure to control execution order when natural data dependency does not exist. Refer to the *Sequence Structures* section of Chapter 8, *Loop and Case Structures*, for more information about Sequence structures. You also can use flow-through parameters to control execution order. Refer to the *Flow-Through Parameters* section of Chapter 13, *File I/O*, for more information about flow-through parameters.

You also can create an artificial data dependency, in which the receiving node does not actually use the data received. Instead, the receiving node uses the arrival of data to trigger its execution. Refer to the Timing Template (data dep) VI in the `examples\general\structs.llb` for an example of using artificial data dependency.

Missing Data Dependencies

Do not assume left-to-right or top-to-bottom execution when no data dependency exists. Make sure you explicitly define the sequence of events when necessary by wiring the dataflow.

In the following example, no dependency exists between the Read File function and the Close File function because the Read File function is not wired to the Close File function. This example might not work as expected because there is no way to determine which function runs first. If the Close File function runs first, the Read File function does not work.

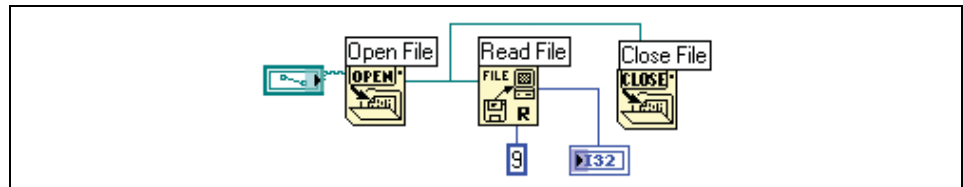

The following block diagram establishes a dependency by wiring an output of the Read File function to the Close File function. The Close File function does not run until it receives the output of the Read File function.

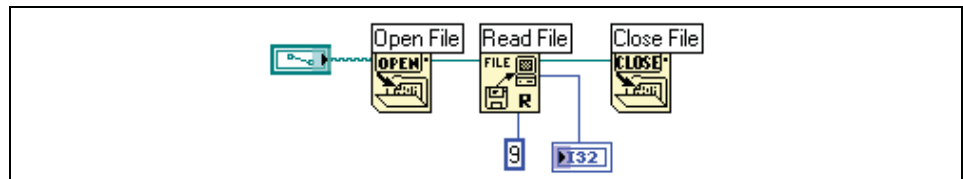

Data Flow and Managing Memory

Dataflow execution makes managing memory easier than the control flow model of execution. In LabVIEW, you do not allocate variables or assign values to them. Instead, you create a block diagram with wires that represent the transition of data.

VIs and functions that generate data automatically allocate the memory for that data. When the VI or function no longer uses the data, LabVIEW deallocates the associated memory. When you add new data to an array or a string, LabVIEW allocates enough memory to manage the new data.

Because LabVIEW automatically handles memory management, you have less control over when memory is allocated or deallocated. If your VI works with large sets of data, you need to understand when memory allocation takes place. Understanding the principles involved can help you write VIs with significantly smaller memory requirements. Minimizing

memory usage can help you increase the speed at which VIs run. Refer to the *LabVIEW Performance and Memory Management* Application Note for more information about memory allocation.

Designing the Block Diagram

Use the following guidelines to design block diagrams:

- Use a left-to-right and top-to-bottom layout. Although the positions of block diagram elements do not determine execution order, avoid wiring from right to left to keep the block diagram organized and easy to understand. Only wires and structures determine execution order.
- Avoid creating a block diagram that occupies more than one or two screens. If a block diagram becomes large and complex, it can be difficult to understand or debug.
- Decide if you can reuse some components of the block diagram in other VIs or if a section of the block diagram fits together as a logical component. If so, divide the block diagram into subVIs that perform specific tasks. Using subVIs helps you manage changes and debug the block diagrams quickly. Refer to the *SubVIs* section of Chapter 7, *Creating VIs and SubVIs*, for more information about subVIs.
- Use the error handling VIs, functions, and parameters to manage errors on the block diagram. Refer to the *Error Checking and Error Handling* section of Chapter 6, *Running and Debugging VIs*, for more information about handling errors.
- Improve the appearance of the block diagram by wiring efficiently. Poor wire organization might not produce errors, but it can make the block diagram difficult to read or debug, or make the VI appear to do things it does not do.
- Avoid wiring under a structure border or between overlapped objects, because LabVIEW might hide some segments of the resulting wire.
- Avoid placing objects on top of wires. Wires connect only those objects you click. Placing a terminal or icon on top of a wire makes it appear as if a connection exists when it does not.
- Use the Coloring tool and right-click the block diagram workspace to add or change the color of the workspace.
- Increase the space between crowded or tightly grouped objects by pressing the <Ctrl> key and use the Positioning tool to click the block diagram workspace. While holding the key combination, drag out a region the size you want to insert.

(Macintosh) Press the <Option> key. **(Sun)** Press the <Meta> key. **(Linux)** Press the <Alt> key.

A rectangle marked by a dashed border defines where space will be inserted. Release the key combination to add the space.

Refer to the *LabVIEW Development Guidelines* manual for more information about designing the block diagram.

Running and Debugging VIs

To run a VI, you must wire all the subVIs, functions, and structures with the data types the terminals expect. Sometimes a VI produces data or runs in a way you do not expect. You can use LabVIEW to configure how a VI runs and to identify problems with block diagram organization or with the data passing through the block diagram.

For more information...

Refer to the *LabVIEW Help* for more information about debugging VIs.

Running VIs



Running a VI executes the operation for which you designed the VI. You can run a VI if the **Run** button on the toolbar appears as a solid white arrow, shown at left. The solid white arrow also indicates you can use the VI as a subVI if you create a connector pane for the VI.

A VI runs when you click the **Run** or **Run Continuously** buttons or the single-stepping buttons on the block diagram toolbar. Clicking the **Run** button runs the VI once. The VI stops when the VI completes its data flow. Clicking the **Run Continuously** button runs the VI continuously until you stop it manually. Clicking the single-stepping buttons runs the VI in incremental steps. Refer to the *Single-Stepping* section of this chapter for more information about using the single-stepping buttons to debug a VI.



Note Avoid using the **Abort Execution** button to stop a VI. Either let the VI complete its data flow or design a method to stop the VI programmatically. By doing so, the VI is at a known state. For example, place a button on the front panel that stops the VI when you click the button.

Configuring How a VI Runs

Select **File»VI Properties** and select **Execution** from the **Category** pull-down menu to configure how a VI runs. For example, you can configure a VI to run immediately when it opens or to pause when called as a subVI. You also can configure the VI to run at different priorities. For

example, if it is crucial that a VI runs without waiting for another operation to complete, configure the VI to run at time-critical (highest) priority. Refer to the *Using LabVIEW to Create Multithreaded VIs for Maximum Performance and Reliability* Application Note for more information about creating multithreaded VIs. Refer to Chapter 15, *Customizing VIs*, for more information about configuring how VIs run.

Correcting Broken VIs



If a VI does not run, it is a broken, or nonexecutable, VI. The **Run** button often appears broken, shown at left, when you create or edit a VI. If it is still broken when you finish wiring the block diagram, the VI is broken and will not run.

Finding Causes for Broken VIs

Click the broken **Run** button or select **Window»Show Error List** to find out why a VI is broken. The **Error list** window lists all the errors. The **VI List** section lists the names of all VIs in memory that have errors. The **errors and warnings** section lists the errors and warnings for the VI you select in the **VI List** section. The **Details** section describes the errors and in some cases recommends how to correct the errors or how to find more information about them. Select **Help** to open an online help file that lists LabVIEW errors and their descriptions.

Click the **Show Error** button or double-click the error description to display the relevant block diagram or front panel and highlight the object that contains the error.



The toolbar includes the **Warning** button, shown at left, if a VI includes a warning and you placed a checkmark in the **Show Warnings** checkbox in the **Error list** window.

Configure LabVIEW to always show warnings in the **Error list** window by selecting **Tools»Options**, selecting **Debugging** from the top pull-down menu, and placing a checkmark in the **Show warnings in error box by default** checkbox. You can make this change with the **Error list** window open and see the change immediately.

Warnings do not prevent you from running a VI. They are designed to help you avoid potential problems in VIs.

Common Causes of Broken VIs

The following list contains common reasons why a VI is broken while you edit it:

- The block diagram contains a broken wire because of a mismatch of data types or a loose, unconnected end. Refer to the *Using Wires to Link Block Diagram Objects* section of Chapter 5, *Building the Block Diagram*, for more information about wiring block diagram objects.
- A required block diagram terminal is unwired. Select **Help»Show Context Help** or refer to the *LabVIEW Help* to see which parameters a block diagram node requires.
- A subVI is broken or you edited its connector pane after you placed its icon on the block diagram of the VI. Refer to the *SubVIs* section of Chapter 7, *Creating VIs and SubVIs*, for more information about subVIs.

Debugging Techniques

If a VI is not broken, but you get unexpected data, you can use the following techniques to identify and correct problems with the VI or the block diagram data flow:

- Wire the **error in** and **error out** parameters at the bottom of most built-in VIs and functions. These parameters detect errors encountered in each node on the block diagram and indicate if and where an error occurred. You also can use these parameters in the VIs you build. Refer to the *Error Handling* section of this chapter for more information about using these parameters.
- Use execution highlighting to watch the data move through the block diagram.
- Single-step through the VI to view each action of the VI on the block diagram.
- Use the Probe tool to check intermediate values as a VI runs.
- Use breakpoints to pause execution, so you can single-step or insert probes.
- Suspend the execution of a subVI to edit values of controls and indicators, to control the number of times it runs, or to go back to the beginning of the execution of the subVI.
- Comment out a section of the block diagram to determine if the VI performs better without it.

Execution Highlighting



View an animation of the execution of the block diagram by clicking the **Highlight Execution** button, shown at left. Execution highlighting shows the movement of data on the block diagram from one node to another using bubbles that move along the wires. Use execution highlighting in conjunction with single-stepping to see how data move from node to node through a VI.



Note Execution highlighting greatly reduces the speed at which the VI runs.

If the **error out** cluster reports an error, the error value appears next to **error out** with a red border. If no error occurs, **OK** appears next to **error out** with a green border. Refer to the *Error Clusters* section of this chapter for more information about error clusters.

Single-Stepping



Single-step through a VI to view each action of the VI on the block diagram as the VI runs. The single-stepping buttons, shown at left, affect execution only in a VI or subVI in single-step mode. Enter single-step mode by clicking the **Step Over** or **Step Into** button on the block diagram toolbar. Move the cursor over the **Step Over**, **Step Into**, or **Step Out** button to view a tip strip that describes the next step if you click that button. You can single-step through subVIs or run them normally.



If you single-step through a VI with execution highlighting on, an execution glyph, shown at left, appears on the icons of the subVIs that are currently running.

Probe Tool



Use the Probe tool, shown at left, to check intermediate values on a wire as a VI runs. Use the Probe tool if you have a complicated block diagram with a series of operations, any one of which might return incorrect data. Use the Probe tool with execution highlighting, single-stepping, and breakpoints to determine if and where data are incorrect. If data are available, the probe immediately updates during single-stepping or when you pause at a breakpoint. When execution pauses at a node because of single-stepping or a breakpoint, you also can probe the wire that just executed to see the value that flowed through that wire.

You also can create a custom probe to specify which indicator you use to view the probed data. For example, if you are viewing numeric data, you

can choose to see that data in a chart within the probe. Right-click a wire and select **Custom Probe**, then specify the indicator you want to use.

Breakpoints



Use the Breakpoint tool, shown at left, to place a breakpoint on a VI, node, or wire on the block diagram and pause execution at that location. When you set a breakpoint on a wire, execution pauses after data pass through the wire. Place a breakpoint on the block diagram workspace to pause execution after all nodes on the block diagram execute.

When a VI pauses at a breakpoint, LabVIEW brings the block diagram to the front and uses a marquee to highlight the node or wire that contains the breakpoint. When you move the cursor over an existing breakpoint, the black area of the Breakpoint tool cursor appears white.

When you reach a breakpoint during execution, you can take the following actions:

- Single-step through execution using the single-stepping buttons.
- Probe wires to check intermediate values.
- Continue running to the next breakpoint or until the VI finishes running.

LabVIEW saves breakpoints with a VI, but they are active only when you run the VI.

Suspending Execution

Suspend execution of a subVI to edit values of controls and indicators, to control the number of times it runs before returning to the caller, or to go back to the beginning of the execution of the subVI. You can cause all calls to a subVI to start with execution suspended, or you can suspend a specific call to a subVI.

To suspend all calls to a subVI, open the subVI and select **Operate» Suspend when Called**. The subVI automatically suspends when another VI calls it. If you select this menu item when single-stepping, the subVI does not suspend immediately. The subVI suspends when it is called.

To suspend a specific subVI call, right-click the subVI node on the block diagram and select **SubVI Node Setup** from the shortcut menu. Place a checkmark in the **Suspend when called** checkbox to suspend execution only at that instance of the subVI.

The **Hierarchy Window**, which you display by selecting **Browse»Show VI Hierarchy**, indicates whether a VI is paused or suspended. An arrow glyph indicates a VI that is running regularly or single-stepping. A pause glyph indicates a paused or suspended VI. A green pause glyph, or a hollow glyph in black and white, indicates a VI that pauses when called. A red pause glyph, or a solid glyph in black and white, indicates a VI that is currently paused. An exclamation point glyph indicates that the subVI is suspended. A VI can be suspended and paused at the same time.

Determining the Current Instance of a SubVI

When you pause a subVI, the **Call list** pull-down menu in the toolbar lists the chain of callers from the top-level VI down to the subVI. This is not the same list you see when you select **Browse»This VI's Callers**, which lists all calling VIs regardless of whether they are currently running. Use the **Call list** menu to determine the current instance of the subVI if the block diagram contains more than one instance. When you select a VI from the **Call list** menu, its block diagram opens, and LabVIEW highlights the current instance of the subVI.

Commenting Out Sections of Block Diagrams

You can run a VI with a section of the block diagram disabled, similar to commenting out a section of code in a text-based programming language. Disable a section of the block diagram to determine if the VI performs better without it.

Place the section you want to disable inside a Case structure and use a Boolean constant to run both cases. Refer to the *Case Structures* section of Chapter 8, *Loop and Case Structures*, for more information about using Case structures. You also can create a copy of the VI and delete that section of the block diagram from the copy. Discard the version of the VI you decide not to use.

Disabling Debugging Tools

You can disable the debugging tools to reduce memory requirements and to increase performance slightly. Right-click the connector pane and select **VI Properties**. Select **Execution** in the **Category** pull-down menu and remove the checkmark from the **Allow Debugging** checkbox.

Undefined or Unexpected Data

Undefined data, which are `NaN` (not a number) or `Inf` (infinity), invalidate all subsequent operations. Floating-point operations return the following two symbolic values that indicate faulty computations or meaningless results:

- `NaN` (not a number) represents a floating-point value that invalid operations produce, such as taking the square root of a negative number.
- `Inf` (infinity) represents a floating-point value that operations produce, such as dividing a number by zero.

LabVIEW does not check for overflow or underflow conditions on integer values. Overflow and underflow for floating-point numbers is in accordance with IEEE 754, *Standard for Binary Floating-Point Arithmetic*.

Floating-point operations propagate `NaN` and `Inf` faithfully. When you explicitly or implicitly convert `NaN` or `Inf` to integers or Boolean values, the values become meaningless. For example, dividing 1 by zero produces `Inf`. Converting `Inf` to a 16-bit integer produces the value 32,767, which appears to be a normal value. Refer to the [Numeric Conversion](#) section of Appendix B, *Polymorphic Functions*, for more information about converting numeric values.

Before you convert data to integer data types, use the Probe tool to check intermediate floating-point values for validity. Check for `NaN` by wiring the Comparison function Not A Number/Path/Refnum? to the value you suspect is invalid.

Unexpected and Default Data in Loops

For Loops produce unexpected values when the iteration count is zero for an auto-indexed For Loop. While Loops produce default data when the shift register is not initialized.

For Loops

For Loops produce unexpected values if you wire 0 to the count terminal of the For Loop or if you wire an empty array to the For Loop as an input with auto-indexing enabled. The loop does not execute, and only output tunnel with auto-indexing disabled contains unexpected values. Use shift registers to transfer values through a loop regardless of whether the loop executes.

Refer to the *For Loop and While Loop Structures* section of Chapter 8, *Loop and Case Structures*, for more information about For Loops, auto-indexing, and shift registers.

While Loops

If you do not initialize a shift register on a While Loop, the output is the default value for the parameter (0, FALSE, empty string, and so on) or the last value loaded into the shift register when you last ran the VI.

Default Data in Arrays

Indexing beyond the bounds of an array produces the default value for the array element parameter. You can use the Array Size function to determine the size of the array. Refer to the *Arrays* section of Chapter 9, *Grouping Data Using Strings, Arrays, and Clusters*, for more information about arrays. Refer to the *Auto-Indexing Loops* section of Chapter 8, *Loop and Case Structures*, for more information about indexing. You can index beyond the bounds of an array inadvertently by indexing an array past the last element using a While Loop, by supplying too large a value to the **index** input of an Index Array function, or by supplying an empty array to an Index Array function.

Preventing Undefined Data

Do not rely on special values such as NaN, Inf, or empty arrays to determine if a VI produces undefined data. Instead, confirm that the VI produces defined data by making the VI report an error if it encounters a situation that is likely to produce undefined data.

For example, if you create a VI that uses an incoming array to auto-index a For Loop, determine what you want the VI to do when the input array is empty. Either produce an output error code or substitute defined data for the values that the loop creates.

Error Checking and Error Handling

Debugging, which is enabled automatically in LabVIEW, checks the block diagram nodes for errors. You can verify the debugging setting by selecting **File»VI Properties** and selecting **Execution** in the **Category** pull-down menu. The **Allow Debugging** contains a checkmark by default. Each error has a numeric code and a corresponding error message. Use the LabVIEW error handling VIs, functions, and parameters to manage errors. For example, if LabVIEW encounters an error, you can display the error

message in a dialog box. Use error handling in conjunction with the debugging tools to find and manage errors. National Instruments strongly recommends error handling.

Checking for Errors

No matter how confident you are in the VI you create, you cannot predict every problem a user can encounter. Without a mechanism to check for errors, you know only that the VI does not work properly. Error checking tells you why and where errors occur.

When you perform any kind of input and output (I/O), consider the possibility that errors might occur. Almost all I/O functions return error information. Include error checking in VIs, especially for I/O operations (file, serial, instrumentation, data acquisition, and communication), and provide a mechanism to handle errors appropriately.

Checking for errors in VIs can help you identify the following problems:

- You initialized communications incorrectly or wrote improper data to an external device.
- An external device lost power, is broken, or is working improperly.
- You upgraded the operating system software, which changed the path to a file or the functionality of a VI or library. You might notice a problem in a VI or a system program.

Error Handling

LabVIEW does not handle errors automatically. Instead, you choose the error handling method you want to use. For example, if an I/O VI on the block diagram times out, you might not want the entire application to stop. You also might want the VI to retry for a certain period of time. In LabVIEW, you can make these error handling decisions on the block diagram of the VI.

VIs and functions return errors in one of two ways—with numeric error codes or with an error cluster. Typically, functions use numeric error codes, and VIs use an error cluster, usually with error inputs and outputs. Refer to the *Error Clusters* section of this chapter for more information about error clusters.

Error handling in LabVIEW follows the dataflow model. Just as data flow through a VI, so can error information. Wire the error information from the beginning of the VI to the end. Include an error handler VI at the end of the VI to determine if the VI ran without errors. Use the **error in** and **error out**

clusters in each VI you use or build to pass the error information through the VI.

As the VI runs, LabVIEW tests for errors at each execution node. If LabVIEW does not find any errors, the node executes normally. If LabVIEW detects an error, the node passes the error to the next node without executing. The next node does the same thing, and so on. At the end of the execution flow, LabVIEW reports the error.

Error Clusters

The error clusters located on the **Controls»Array & Cluster** palette include the following components of information:

- **status** is a Boolean value that reports TRUE if an error occurred. Most VIs, functions, and structures that accept Boolean data also recognize this parameter. For example, you can wire an error cluster to the Boolean inputs of the Stop, Quit LabVIEW, or Select functions. If an error occurs, the error cluster passes a TRUE value to the function.
- **code** is a signed 32-bit integer that identifies the error numerically. A non-zero error code coupled with a **status** of FALSE signals a warning rather than a fatal error.
- **source** is a string that identifies where the error occurred.

Using While Loops for Error Handling

You can wire an error cluster to the conditional terminal of a While Loop to stop the iteration of the While Loop. When you wire the error cluster to the conditional terminal, only the TRUE or FALSE value of the **status** parameter of the error cluster is passed to the terminal. When an error occurs, the While Loop stops.

When an error cluster is wired to the conditional terminal, the shortcut menu items **Stop if True** and **Continue if True** change to **Stop on Error** and **Continue while Error**.

Using Case Structures for Error Handling

When you wire an error cluster to the selector terminal of a Case structure, the case selector label displays two cases, **Error** and **No Error**, and the border of the Case structure changes color—red for **Error** and green for **No Error**. If an error occurs, the Case structure executes the **Error** subdiagram. Refer to the *Case Structures* section of Chapter 8, *Loop and Case Structures*, for more information about using Case structures.

Creating VIs and SubVIs

After you learn how to build a front panel and block diagram, you can create your own VIs and subVIs, distribute VIs, and build stand-alone applications and shared libraries.

Refer to the *LabVIEW Development Guidelines* manual for more information about planning your project, including information about common development pitfalls and tools you can use to develop your project.

For more information...

Refer to the *LabVIEW Help* for more information about creating and using subVIs, saving VIs, and building stand-alone applications and shared libraries.

Planning and Designing Your Project

Before you develop your own VIs, create a list of tasks your users will need to perform. Determine the user interface components and the number and type of controls and indicators you need for data analysis, displaying analysis results, and so on. Think about and discuss with prospective users or other project team members how and when the user will need to access functions and features. Create sample front panels to show to prospective users or project team members and determine if the front panel helps your users accomplish their tasks. Use this interactive process to refine the user interface as necessary.

Divide your application into manageable pieces at logical places. Begin with a high-level block diagram that includes the main components of your application. For example, the block diagram could include a block for configuration, a block for acquisition, a block for analysis of the acquired data, a block for displaying analysis results, a block for saving the data to disk, and a block to handle errors.

After you design the high-level block diagram, define the inputs and outputs. Then, design the subVIs that make up the main components of the high-level block diagram. Using subVIs makes the high-level block

diagram easy to read, debug, understand, and maintain. You also can create subVIs for common or frequent operations that you can reuse. Test subVIs as you create them. You can create higher level test routines, but catching errors in a small module is easier than testing a hierarchy of several VIs. You might find that the initial design of the high-level block diagram is incomplete. Using subVIs to accomplish low-level tasks makes it easier to modify or reorganize your application. Refer to the *SubVIs* section of this chapter for more information about subVIs.

Select **Help»Find Examples** for examples of block diagrams and subVIs.

Designing Projects with Multiple Developers

If multiple developers work on the same project, define programming responsibilities, interfaces, and coding standards up front to ensure the development process and the application work well.

Keep master copies of the project VIs on a single computer and institute a source code control policy. Consider using the LabVIEW Professional Development System, which includes source code control tools that simplify file sharing. The tools also include a utility to compare VIs and view the changes that were made between versions of VIs. Refer to the *Source Code Control* section of Chapter 2, *Incorporating Quality into the Development Process*, in the *LabVIEW Development Guidelines* manual for more information about using source code control.

Using Built-In VIs and Functions

LabVIEW includes VIs and functions to help you build specific applications, such as data acquisition VIs and functions, VIs that access other VIs, and VIs that communicate with other applications. You can use these VIs as subVIs in your application to reduce development time. Refer to the *SubVIs* section of this chapter for more information about subVIs.

Building Instrument Control and Data Acquisition VIs and Functions

You can use the built-in VIs and functions to control external instruments, such as oscilloscopes, and to acquire data, such as readings from a thermocouple.

Use the Instrument I/O VIs and functions located on the **Functions»Instrument I/O** palette to control external instruments. To control instruments in LabVIEW, you must have the correct hardware installed, powered on, and operating on your computer. The VIs and functions you

use to control instruments depend on the instrumentation communication protocols your hardware supports. Refer to the *LabVIEW Measurements Manual* for more information about building VIs to control instruments.

Use the Data Acquisition VIs and functions located on the **Functions»Data Acquisition** palette to acquire data from DAQ devices. To use these VIs, you must have the NI-DAQ driver software and DAQ hardware installed. Refer to the *LabVIEW Measurements Manual* for more information about installing the NI-DAQ driver software and DAQ hardware and building VIs to acquire data. After you acquire data, you can use the built-in Analyze, Report Generation, and Mathematics VIs and functions to analyze, generate reports, and perform mathematical operations on that data. Refer to the *Analysis Concepts* manual for more information about analysis and mathematical concepts in LabVIEW.

Building VIs That Access Other VIs

Use the Application Control VIs and functions located on the **Functions»Application Control** palette to control how VIs behave when called as subVIs or run by the user. You can use these VIs and functions to configure multiple VIs at the same time. Also, if you are on a network with other LabVIEW users, you can use these VIs and functions to access and control VIs remotely. Refer to Chapter 16, *Programmatically Controlling VIs*, for more information about controlling VIs remotely.

Building VIs That Communicate with Other Applications

Use the File I/O VIs and functions located on the **Functions»File I/O** palette to write data to or read data from other applications, such as Microsoft Excel. You can use these VIs and functions to generate reports or incorporate data from another application in the VI. Refer to Chapter 13, *File I/O*, for more information about passing data to and from other applications.

Use the Communication VIs and functions located on the **Functions»Communication** palette to transfer LabVIEW data across the Web using a communication protocol such as FTP and to build client-server applications using communication protocols. Refer to Chapter 17, *Networking in LabVIEW*, for more information about communicating with other applications on the network or on the Web.

(Windows) Use the ActiveX functions located on the **Functions»Communication»ActiveX** palette to add ActiveX objects to VIs or to control ActiveX-enabled applications. Refer to Chapter 18, *ActiveX*, for more information about using ActiveX technology.

SubVIs

After you build a VI and create its icon and connector pane, you can use it in another VI. A VI called from the block diagram of another VI is called a subVI. A subVI corresponds to a subroutine in text-based programming languages. A subVI node corresponds to a subroutine call in text-based programming languages. The node is not the subVI itself, just as a subroutine call statement in a program is not the subroutine itself. A block diagram that contains several identical subVI nodes calls the same subVI several times.

The subVI controls and indicators receive data from and return data to the block diagram of the calling VI. Select VIs on the **Functions»Select a VI** palette and place them on the block diagram to create a subVI call to that VI.



Note Before you can use a VI as a subVI, you must set up a connector pane. Refer to the [Setting up the Connector Pane](#) section of this chapter for more information about setting up a connector pane.

You can edit a subVI by using the Operating or Positioning tool to double-click the subVI on the block diagram. When you save the subVI, the changes affect all calls to the subVI, not just the current instance.

Watching for Common Operations

As you create VIs, you might find that you perform a certain operation frequently. Consider using subVIs or loops to perform that operation repetitively. For example, the following block diagram contains two identical operations.

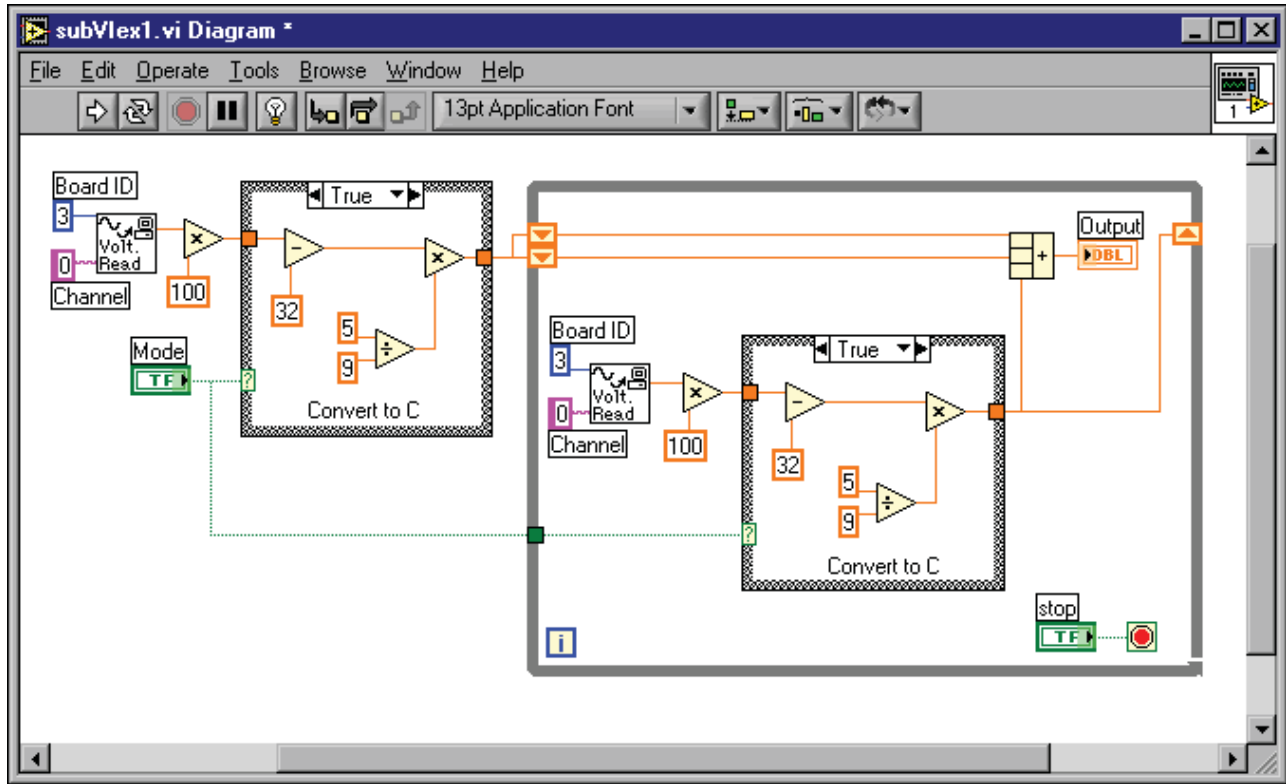

You can create a subVI that performs that operation and call the subVI twice, as shown in the following block diagram.

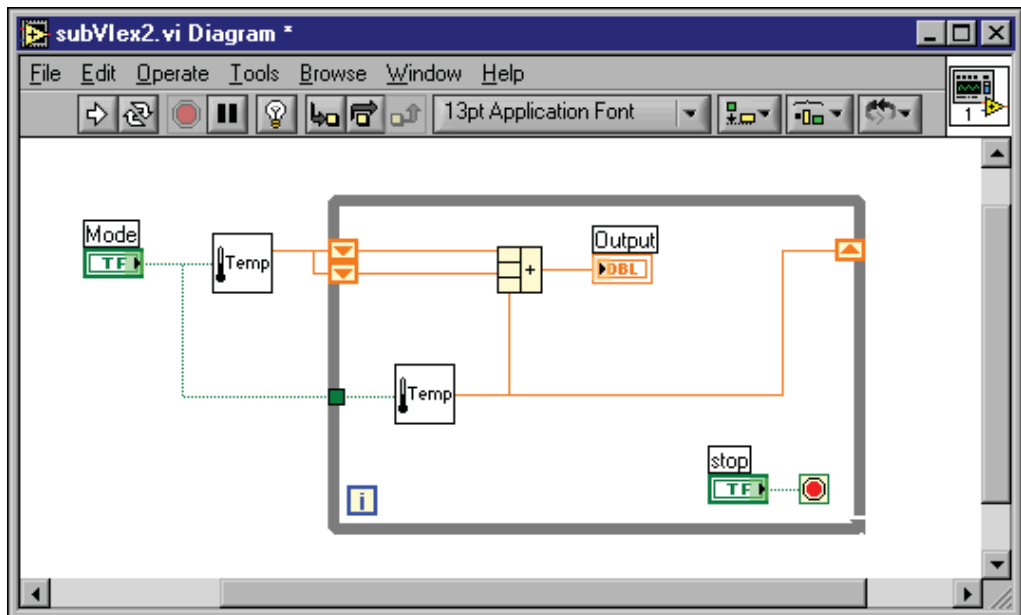

You also can reuse the subVI in other VIs. Refer to Chapter 8, *Loop and Case Structures*, for more information about using loops to combine common operations.

Setting up the Connector Pane



To use a VI as a subVI, you need to build a connector pane, shown at left. The connector pane is a set of terminals that corresponds to the controls and indicators of that VI, similar to the parameter list of a function call in text-based programming languages. The connector pane defines the inputs and outputs you can wire to the VI so you can use it as a subVI. Refer to the *Icon and Connector Pane* section of Chapter 2, *Introduction to Virtual Instruments*, for more information about connector panes.

Define connections by assigning a front panel control or indicator to each of the connector pane terminals. To define a connector pane, right-click the icon in the upper right corner of the front panel window and select **Show Connector** from the shortcut menu. The connector pane replaces the icon. Each rectangle on the connector pane represents a terminal. Use the rectangles to assign inputs and outputs. The number of terminals LabVIEW displays on the connector pane depends on the number of controls and indicators on the front panel.

The connector pane has, at most, 28 terminals. If your front panel contains more than 28 controls and indicators that you want to use programmatically, group some of them into a cluster and assign the cluster to a terminal on the connector pane. Refer to the *Clusters* section of Chapter 9, *Grouping Data Using Strings, Arrays, and Clusters*, for more information about grouping data using clusters.



Note Try not to assign more than 16 terminals to a VI. Too many terminals can reduce the readability and usability of the VI.

Select a different terminal pattern for a VI by right-clicking the connector pane and selecting **Patterns** from the shortcut menu. Select a connector pane pattern with extra terminals. You can leave the extra terminals unconnected until you need them. This flexibility enables you to make changes with minimal effect on the hierarchy of the VIs.

If you create a group of subVIs that you use together often, give the subVIs a consistent connector pane with common inputs in the same location to help you remember where to locate each input. If you create a subVI that produces an output another subVI uses as the input, align the input and output connections to simplify the wiring patterns. Place the **error in**

clusters on the lower left corner of the front panel and the **error out** clusters on the lower right corner.

Figure 7-1 shows examples of improperly and properly aligned error clusters.

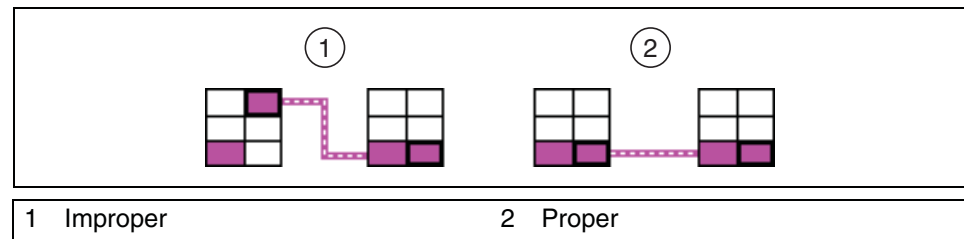

Figure 7-1. Improperly and Properly Aligned Error Clusters

Setting Required, Recommended, and Optional Inputs and Outputs

You can designate which inputs and outputs are required, recommended, and optional to prevent users from forgetting to wire subVI connections.

Right-click a terminal in the connector pane and select **This Connection Is** from the shortcut menu. A checkmark indicates the terminal setting. Select **Required**, **Recommended**, or **Optional**.

For terminal inputs, required means that the block diagram on which the subVI is dropped will be broken if the required inputs are not wired. Required is not available for terminal outputs. For terminal inputs and outputs, recommended means that the block diagram on which the subVI is dropped can be run if the input is not wired but the **Warnings** dialog box will generate a warning that the input has not been wired. Optional means that the block diagram on which the subVI is dropped can be run and will not generate any warnings if the terminal input or output is not wired.

Inputs and outputs of VIs in `vi.lib` are already marked as **Required**, **Recommended**, or **Optional**. LabVIEW sets inputs and outputs of VIs you create to **Recommended** by default. Set a terminal setting to required only if the VI must have the input or output to run properly.

In the **Context Help** window, required connections are bold, recommended connections are plain text, and optional connections are dimmed if you have the **Detailed** view selected or do not appear if you have the **Simple** view selected.

Creating an Icon



Every VI displays an icon, shown at left, in the upper right corner of the front panel and block diagram windows. An icon is a graphical representation of a VI. It can contain text, images, or a combination of both. If you use a VI as a subVI, the icon identifies the subVI on the block diagram of the VI.

The default icon contains a number that indicates how many new VIs you have opened since launching LabVIEW. Create custom icons to replace the default icon by right-clicking the icon in the upper right corner of the front panel or block diagram and selecting **Edit Icon** from the shortcut menu or by double-clicking the icon in the upper right corner of the front panel.

You also can drag a graphic from anywhere in your file system and drop it in the upper right corner of the front panel or block diagram. LabVIEW converts the graphic to a 32 × 32 pixel icon.

Depending on the type of monitor you use, you can design a separate icon for monochrome, 16-color, and 256-color mode. LabVIEW uses the monochrome icon for printing unless you have a color printer.

Creating SubVIs from Sections of a VI

Convert a section of a VI into a subVI by using the Positioning tool to select the section of the block diagram you want to reuse and selecting **Edit» Create SubVI**. An icon for the new subVI replaces the selected section of the block diagram. LabVIEW creates controls and indicators for the new subVI and wires the subVI to the existing wires.

Creating a subVI from a selection is convenient but still requires careful planning to create a logical hierarchy of VIs. Consider which objects to include in the selection and avoid changing the functionality of the resulting VI.

Designing SubVIs

If users do not need to view the front panel of a subVI, you can spend less time on its appearance, including colors and fonts. However, front panel organization is still important because you might need to view the front panel while you debug the VI.

Place the controls and indicators as they appear in the connector pane. Place the controls on the left of the front panel and the indicators on the right. Place the **error in** clusters on the lower left of the front panel and

the **error out** clusters on the lower right. Refer to the *Setting up the Connector Pane* section of this chapter for more information about setting up a connector pane.

If a control has a default value, put the default value in parentheses as part of the control name. Also include measurement units, if applicable, in the control name. For example, if a control sets the high limit temperature and has a default value of 75 °F, name the control **high limit temperature (75 degF)**. If you will use the subVI on multiple platforms, avoid using special characters in control names. For example, use **degF** instead of **°F**.

Name Boolean controls so users can determine what the control does in the TRUE state. Use names like **Cancel**, **Reset**, and **Initialize** that describe the action taken.

Viewing the Hierarchy of VIs

The **Hierarchy Window** displays a graphical representation of the calling hierarchy for all VIs in memory, including type definitions and global variables. Select **Browse»Show VI Hierarchy** to display the **Hierarchy Window**. Use this window to view the subVIs and other nodes that make up the current VI.

As you move the Operating tool over objects in the **Hierarchy Window**, LabVIEW displays the name of each VI. You can use the Positioning tool to drag a VI from the **Hierarchy Window** to the block diagram to use the VI as a subVI in another VI. You also can select and copy a node or several nodes to the clipboard and paste them on other block diagrams. Double-click a VI in the **Hierarchy Window** to display the front panel of that VI.

A VI that contains subVIs has an arrow button on its border. Click this arrow button to show or hide subVIs. A red arrow button appears when all subVIs are hidden. A black arrow button appears when all subVIs are displayed.

Saving VIs

You can save VIs as individual files or you can group several VIs together and save them in a VI library. VI library files end with the extension `.llb`. National Instruments recommends that you save VIs as individual files, organized in directories, especially if multiple developers are working on the same project.

Advantages of Saving VIs as Individual Files

The following list describes reasons to save VIs as individual files:

- You can use the file system to manage the individual files.
- You can use subdirectories.
- You can store VIs and controls in individual files more robustly than you can store your entire project in the same file.
- You can use the Professional Development System built-in source code control tools or third-party source code control tools.

Advantages of Saving VIs as Libraries

The following list describes reasons to save VIs as libraries:

- You can use up to 255 characters to name your files.
(**Macintosh**) MacOS 9.x or earlier limits you to 31 characters for filenames, but has no limit on characters for library names.
- You can transfer a VI library to other platforms more easily than you can transfer multiple individual VIs.
- You can slightly reduce the file size of your project because VI libraries are compressed to reduce disk space requirements.
- You can mark VIs in a library as top-level so when you open the library, LabVIEW automatically opens all the top-level VIs in that library.



Note LabVIEW stores many of its built-in VIs and examples in VI libraries to ensure consistent storage locations on all platforms.

If you use VI libraries, consider dividing your application into multiple VI libraries. Put the high-level VIs in one VI library and set up other libraries to contain VIs separated by function. Saving changes to a VI in a library takes longer than saving changes to an individual VI, because the operating system must write the changes to a larger file. Saving changes to a large library also can increase memory requirements and decrease performance. Try to limit the size of each library to approximately 1 MB.

Managing VIs in Libraries

Use the VI Library Manager, available by selecting **Tools»VI Library Manager**, to simplify copying, renaming, and deleting files within VI libraries. You also can use this tool to create new VI libraries and directories and convert VI libraries to and from directories. Creating new VI libraries and directories and converting VI libraries to and from directories is important if you need to manage your VIs with source code control tools.

Before you use the VI Library Manager, close all VIs that might be affected to avoid performing a file operation on a VI already in memory.

Naming VIs

When you save VIs, use descriptive names. Descriptive names, such as `Temperature Monitor.vi` and `Serial Write & Read.vi`, make it easy to identify a VI and know how you use it. If you use ambiguous names, such as `VI#1.vi`, you might find it difficult to identify VIs, especially if you have saved several VIs.

Consider whether your users will run the VIs on another platform. Avoid using characters that some operating systems reserve for special purposes, such as `\ : / ? * < >` and `#`.

(Macintosh) Keep VI names less than 31 characters if your users might run them on MacOS 9.x or earlier.

Saving for a Previous Version

You can save VIs for a previous version of LabVIEW to make upgrading LabVIEW convenient and to help you maintain the VIs in two versions of LabVIEW when necessary. If you upgrade to a new version of LabVIEW, you can go back to the last version of the VIs.

When you save a VI for the previous version, LabVIEW converts not just that VI but all the VIs in its hierarchy, excluding `vi.lib` files.

Often a VI uses functionality not available in the previous version of LabVIEW. In such cases, LabVIEW saves as much of the VI as it can and produces a report of what it cannot convert. The report appears immediately in the **Warnings** dialog box. Click the **OK** button to acknowledge these warnings and close the dialog box. Click the **Save** button to save the warnings to a text file to review later.

Distributing VIs

If you want to distribute VIs to other computers or to other users, consider if you want to include block diagram source code users can edit or if you want to hide or remove the block diagram. Select **File»Save With Options** to save VIs without the block diagrams to reduce the file size and prevent users from changing the source code. Saving a VI without the block diagram also prevents users from moving the VI to another platform or from upgrading the VI to a future version of LabVIEW.



Caution If you save VIs without block diagrams, do *not* overwrite the original versions of the VIs. Save the VIs in different directories or use different names.

Instead of removing the block diagram, you can assign password protection to the block diagrams. The block diagram is still available, but users must enter a password to view or edit the block diagram.

Another option for distributing VIs is to create a stand-alone application or shared library. A stand-alone application or shared library is appropriate when you do not expect your users to edit the VIs. Users can run your application or use the shared library, but they cannot edit or view the block diagrams. Stand-alone applications contain simplified menus.

Refer to the *Porting and Localizing LabVIEW VIs* Application Note for more information about porting VIs among platforms and localizing VIs.

Building Stand-Alone Applications and Shared Libraries

Select **Tools»Build Application or Shared Library (DLL)** to use the Application Builder to create stand-alone applications and installers or shared libraries (DLLs) for VIs. Use shared libraries if you want to call the VIs in the shared library using text-based programming languages. Shared libraries are useful when you want to share the functionality of the VIs you build with text-based programming language developers.



Note The LabVIEW Professional Development System includes the Application Builder. If you use the LabVIEW Base Package or Full Development System, you can purchase the Application Builder separately.

Use the tabs in the **Build Application or Shared Library (DLL)** dialog box to configure various settings for the application or shared library you want to build. After you define these settings, save them in a script so you can easily rebuild the application if necessary.

Users can run your application or use the shared library, but they cannot edit or view the block diagrams.

Refer to the *LabVIEW Application Builder Release Notes* for more information about installing the Application Builder.

Building and Editing VIs

This part describes LabVIEW features, VIs, and functions you can use to make your applications operate in specific ways. The chapters in this section describe the usefulness of each LabVIEW feature and outline each class of VIs and functions.

Part II, *Building and Editing VIs*, contains the following chapters:

- Chapter 8, *Loop and Case Structures*, describes how to use structures on the block diagram to repeat blocks of code and to execute code conditionally or in a specific order.
- Chapter 9, *Grouping Data Using Strings, Arrays, and Clusters*, describes how to use strings, arrays, and clusters to group data.
- Chapter 10, *Local and Global Variables*, describes how to use local and global variables pass information between locations in your application that you cannot connect with a wire.
- Chapter 11, *Graphs and Charts*, describes how to use graphs and charts to display plots of data in a graphical form.
- Chapter 12, *Graphics and Sound VIs*, describes how to display or modify graphics and sound in VIs.
- Chapter 13, *File I/O*, describes how to perform file I/O operations.
- Chapter 14, *Documenting and Printing VIs*, describes how to document and print VIs.
- Chapter 15, *Customizing VIs*, describes how to configure VIs and subVIs to work according to your application needs.
- Chapter 16, *Programmatically Controlling VIs*, describes how to communicate with VIs and other instances of LabVIEW so you can programmatically control VIs and LabVIEW.

- Chapter 17, *Networking in LabVIEW*, describes how to use VIs to communicate, or network, with other processes, including those that run on other applications or on remote computers.
- Chapter 18, *ActiveX*, describes how to provide a public set of objects, commands, and functions that other Windows applications can access.
- Chapter 19, *Calling Code from Text-Based Programming Languages*, describes how to call code from text-based programming languages and use DLLs.
- Chapter 20, *Formulas and Equations*, describes how to use equations in VIs.

Loop and Case Structures

Structures are graphical representations of the loops and case statements of text-based programming languages. Use structures on the block diagram to repeat blocks of code and to execute code conditionally or in a specific order.

Like other nodes, structures have terminals that connect them to other block diagram nodes, execute automatically when input data are available, and supply data to output wires when execution completes.

Each structure has a distinctive, resizable border to enclose the section of the block diagram that executes according to the rules of the structure. The section of the block diagram inside the structure border is called a subdiagram. The terminals that feed data into and out of structures are called tunnels. A tunnel is a connection point on a structure border.

For more information...

Refer to the *LabVIEW Help* for more information about using structures.

Use the following structures located on the **Functions»Structures** palette to control how a block diagram executes processes:

- **For Loop**—Executes a subdiagram a set number of times.
- **While Loop**—Executes a subdiagram until a condition is met.
- **Case structure**—Contains multiple subdiagrams, only one of which executes depending on the input value passed to the structure.
- **Sequence structure**—Contains one or more subdiagrams, which execute in sequential order.
- **Formula Node**—Performs mathematical operations based on numeric input. Refer to the *Formula Nodes* section of Chapter 20, *Formulas and Equations*, for information about using Formula Nodes.
- **Event Structure**—Contains one or more subdiagrams that execute depending on how the user interacts with the VI.

Right-click the border of the structure to display the shortcut menu.

For Loop and While Loop Structures

Use the For Loop and the While Loop to control repetitive operations.

For Loops



A For Loop, shown at left, executes a subdiagram a set number of times.

The value in the count terminal (an input terminal), shown at left, indicates how many times to repeat the subdiagram. Set the count explicitly by wiring a value from outside the loop to the left or top side of the count terminal, or set the count implicitly with auto-indexing. Refer to the [Auto-Indexing to Set the For Loop Count](#) section of this chapter for more information about setting the count implicitly.



The iteration terminal (an output terminal), shown at left, contains the number of completed iterations. The iteration count always starts at zero. During the first iteration, the iteration terminal returns 0.

Both the count and iteration terminals are signed long integers. If you wire a floating-point number to the count terminal, LabVIEW rounds it and coerces it to within range. If you wire 0 or a negative number to the count terminal, the loop does not execute.

Add shift registers to the For Loop to pass data from the current iteration to the next iteration. Refer to the [Shift Registers in Loops](#) section of this chapter for more information about adding shift registers to a loop.

While Loops



Similar to a Do Loop or a Repeat-Until Loop in text-based programming languages, a While Loop, shown at left, executes a subdiagram until a condition is met.



The While Loop executes the subdiagram until the conditional terminal, an input terminal, receives a specific Boolean value. The default behavior and appearance of the conditional terminal is **Continue If True**, shown at left. When a conditional terminal is **Continue If True**, the While Loop executes its subdiagram until the conditional terminal receives a FALSE value. You can change the behavior and appearance of the conditional terminal by right-clicking the terminal or the border of the While Loop and selecting **Stop If True**, shown at left. You also can use the Operating tool to click the conditional terminal to change the condition. When a conditional terminal is **Stop If True**, the While Loop executes its subdiagram until the conditional terminal receives a TRUE value. Because the VI checks the



conditional terminal at the end of each iteration, the While Loop always executes at least one time. The VI is broken if you do not wire the conditional terminal.

You also can perform basic error handling using the conditional terminal of a While Loop. When you wire an error cluster to the conditional terminal, only the TRUE or FALSE value of the **status** parameter of the error cluster passes to the terminal. Also, the **Stop If True** and **Continue If True** shortcut menu items change to **Stop If Error** and **Continue while Error**. Refer to the *Error Checking and Error Handling* section of Chapter 6, *Running and Debugging VIs*, for more information about error clusters and error handling.



The iteration terminal (an output terminal), shown at left, contains the number of completed iterations. The iteration count always starts at zero. During the first iteration, the iteration terminal returns 0.

Add shift registers to the While Loop to pass data from the current iteration to the next iteration. Refer to the *Shift Registers in Loops* section of this chapter for more information about adding shift registers to a loop.

Avoiding Infinite While Loops

If you place the terminal of the Boolean control outside the While Loop, as shown in Figure 8-1, and the control is set to FALSE if the conditional terminal is **Stop If True** when the loop starts, you cause an infinite loop. You also cause an infinite loop if the control outside the loop is set to TRUE and the conditional terminal is **Continue If True**.

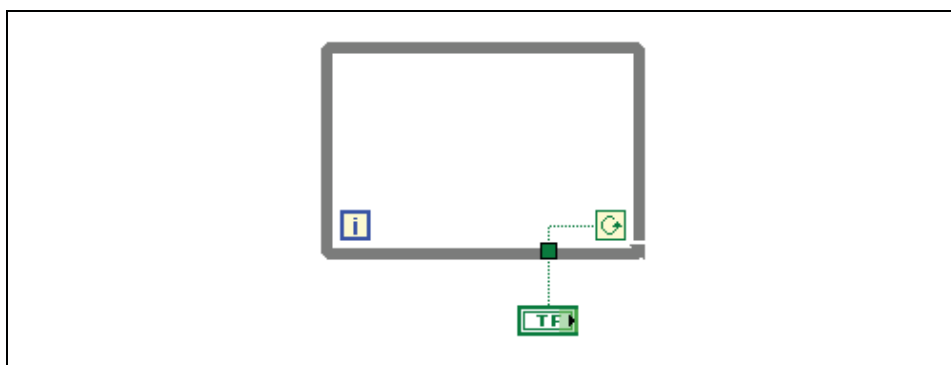

Figure 8-1. Infinite While Loop

Changing the value of the control does not stop the infinite loop because the value is only read once, before the loop starts. To stop an infinite loop, you must abort the VI by clicking the **Abort** button on the toolbar.

Auto-Indexing Loops

If you wire an array to a For Loop or While Loop input tunnel, you can read and process every element in that array by enabling auto-indexing. Refer to Chapter 9, *Grouping Data Using Strings, Arrays, and Clusters*, for more information about arrays.

When you wire an array to an input tunnel on the loop border and enable auto-indexing on the input tunnel, elements of that array enter the loop one at a time, starting with the first element. When auto-indexing is disabled, the entire array is passed into the loop. When you auto-index an array output tunnel, the output array receives a new element from every iteration of the loop. Therefore, auto-indexed output arrays are always equal in size to the number of iterations.

Right-click the tunnel at the loop border and select **Enable Indexing** or **Disable Indexing** from the shortcut menu to enable or disable auto-indexing. Auto-indexing for While Loops is disabled by default.

The loop indexes scalar elements from 1D arrays, 1D arrays from 2D arrays, and so on. The opposite occurs at output tunnels. Scalar elements accumulate sequentially into 1D arrays, 1D arrays accumulate into 2D arrays, and so on.

Auto-Indexing to Set the For Loop Count

If you enable auto-indexing on an array wired to a For Loop input terminal, LabVIEW sets the count terminal to the array size so you do not need to wire the count terminal. Because you can use For Loops to process arrays an element at a time, LabVIEW enables auto-indexing by default for every array you wire to a For Loop. Disable auto-indexing if you do not need to process arrays an element at a time.

If you enable auto-indexing for more than one tunnel or if you wire the count terminal, the count becomes the smaller of the choices. For example, if two auto-indexed arrays enter the loop, with 10 and 20 elements respectively, and you wire a value of 15 to the count terminal, the loop executes 10 times, and the loop indexes only the first 10 elements of the second array. If you plot data from two sources on one graph and you want to plot the first 100 elements, wire 100 to the count terminal. If one of the data sources includes only 50 elements, the loop executes 50 times and indexes only the first 50 elements. Use the Array Size function to determine the size of arrays.

When you auto-index an array output tunnel, the output array receives a new element from every iteration of the loop. Therefore, auto-indexed output arrays are always equal in size to the number of iterations. For example, if the loop executes 10 times, the output array has 10 elements. If you disable auto-indexing on an output tunnel, only the element from the last iteration of the loop passes to the next node on the block diagram. A bracketed glyph appears on the loop border to indicate that auto-indexing is enabled. The thickness of the wire between the output tunnel and the next node also indicates the loop is using auto-indexing. The wire is thicker when you use auto-indexing because the wire contains an array, instead of a scalar.

Auto-Indexing with While Loops

If you enable auto-indexing for an array entering a While Loop, the While Loop indexes the array the same way a For Loop does. However, the number of iterations a While Loop executes is not limited by the size of the array because the While Loop iterates until a specific condition is met. When a While Loop indexes past the end of the input array, the default value for the array element type passes into the loop. You can prevent the default value from passing into the While Loop by using the Array Size function. The Array Size function indicates how many elements are in the array. Set up the While Loop to stop executing when it has iterated the same number of times as the array size.



Caution Because you cannot determine the size of the output array in advance, enabling auto-indexing for the output of a For Loop is more efficient than with a While Loop. Iterating too many times can cause your system to run out of memory.

Shift Registers in Loops

Use shift registers on For Loops and While Loops to transfer values from one loop iteration to the next. Shift registers are similar to static variables in text-based programming languages.



A shift register appears as a pair of terminals, shown at left, directly opposite each other on the vertical sides of the loop border. The right terminal contains an up arrow and stores data on the completion of an iteration. LabVIEW transfers the data connected to the right side of the register to the next iteration. Create a shift register by right-clicking the left or right border of a loop and selecting **Add Shift Register** from the shortcut menu.

A shift register transfers any data type and automatically changes to the data type of the first object wired to the shift register. The data you wire to the terminals of each shift register must be the same type. You can create multiple shift registers on a structure, and you can have more than one left terminal to remember more than one previous value.

After the loop executes, the last value stored in the shift register remains at the right terminal. If you wire the right terminal outside the loop, the wire transfers the last value stored in the shift register.

If you do not initialize the register, the loop uses the value written to the register when the loop last executed or the default value for the data type if the loop has never executed.

Use a loop with an uninitialized shift register to run a VI repeatedly so that each time the VI runs, the initial output of the shift register is the last value from the previous execution. Use an uninitialized shift register to preserve state information between subsequent executions of a VI.

Controlling Timing

You might want to control the speed at which a process executes, such as the speed at which data are plotted to a chart. You can use a wait function in the loop to wait an amount of time in milliseconds you want to wait before the loop re-executes.

Case and Sequence Structures

Case, Sequence, and Event structures contain multiple subdiagrams, only one of which is visible at a time. A Case structure executes one subdiagram depending on the input value passed to the structure. A Sequence structure executes all its subdiagrams in sequential order.

Case Structures

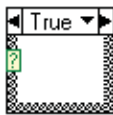

A Case structure, shown at left, has two or more subdiagrams, or cases. Only one subdiagram is visible at a time, and the structure executes only one case at a time. An input value determines which subdiagram executes. The Case structure is similar to case statements or `if...then...else` statements in text-based programming languages.

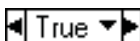

The case selector label at the top of the Case structure, shown at left, contains the name of the selector value that corresponds to the case in the center and decrement and increment arrows on each side. Click the

decrement and increment arrows to scroll through the available cases. You also can click the down arrow next to the case name and select a case from the pull-down menu.



Wire an input value, or selector, to the selector terminal, shown at left, to determine which case executes. You must wire an integer, Boolean value, string, or enumerated type value to the selector terminal. You can position the selector terminal anywhere on the left border of the Case structure. If the type of selector terminal is Boolean, the structure has a TRUE case and a FALSE case. If the selector terminal is an integer, string, or enumerated type value, the structure can have arbitrarily many cases.

Specify a default case for the Case structure to handle out-of-range values. Otherwise, you must explicitly list every possible input value. For example, if the selector is an integer and you specify cases for 1, 2, and 3, you must specify a default case to execute if the input value is 4 or any other valid integer value.

Case Selector Values and Data Types

You can enter a single value or lists and ranges of values in the case selector label. For lists, use commas to separate values. For numeric ranges, specify a range as 10..20, meaning all numbers from 10 to 20 inclusively. You also can use open-ended ranges. For example, ..100 represents all numbers less than or equal to 100. You also can combine lists and ranges, for example ..5, 6, 7..10, 12, 13, 14. When you enter values that contain overlapping ranges in the same case selector label, the Case structure redisplay the label in a more compact form. The previous example redisplay as ..10, 12..14. For string ranges, a range of a..c includes all of a and b, but not c. A range of a..c, c includes the ending value of c.

When you enter string and enumerated values in a case selector label, the values display in quotation marks, for example "red", "green", and "blue". However, you do not need to type the quotation marks when you enter the values unless the string or enumerated value contains a comma or range symbol (", " or ".."). In a string value, use special backslash codes for non-alphanumeric characters, such as \r for a carriage return, \n for a line feed, and \t for a tab. Refer to the *LabVIEW Help* for a list of these backslash codes.

If you change the data type of the wire connected to the selector terminal of a Case structure, the Case structure automatically converts the case selector values to the new data type when possible. If you convert a numeric value, for example 19, to a string, the string value is "19". If you convert a

string to a numeric value, LabVIEW converts only those string values that represent a number. The other values remain strings. If you convert a number to a Boolean value, LabVIEW converts 0 to FALSE and 1 to TRUE, and all other numeric values become strings.

If you enter a selector value that is not the same type as the object wired to the selector terminal, the value appears red to indicate that you must delete or edit the value before the structure can execute, and the VI will not run. Also, because of the possible round-off error inherent in floating-point arithmetic, you cannot use floating-point numerics as case selector values. If you wire a floating-point value to the case, LabVIEW rounds the value to the nearest even integer. If you type a floating-point value in the case selector label, the value appears red to indicate that you must delete or edit the value before the structure can execute.

Input and Output Tunnels

You can create multiple input and output tunnels for a Case structure. Inputs are available to all cases, but cases do not need to use each input. However, you must define each output tunnel for each case. When you create an output tunnel in one case, tunnels appear at the same position on the border in all the other cases. If at least one output tunnel is not wired, all output tunnels on the structure appear as white squares. You can define a different data source for the same output tunnel in each case, but the data types must be compatible for each case. You also can right-click the output tunnel and select **Use Default If Unwired** from the shortcut menu to use the default value for the tunnel data type for all unwired tunnels.

Using Case Structures for Error Handling

When you wire an error cluster to the Selector terminal of a Case structure, the case selector label displays two cases, `Error` and `No Error`, and the border of the Case structure changes color—red for `Error` and green for `No Error`. The Case structure executes the appropriate case subdiagram based on the error state. Refer to the [Error Handling](#) section of Chapter 6, *Running and Debugging VIs*, for more information about handling errors.

Sequence Structures

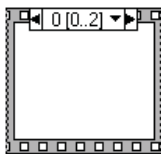

A Sequence structure, shown at left, contains one or more subdiagrams, or frames, which execute in sequential order. The frame label at the top of the Sequence structure is similar to the case selector label of the Case structure. The frame label contains the frame number in the center and decrement and increment arrows on each side. Click the decrement and increment arrows to scroll through the available frames. You also can click the down arrow

next to the frame number and select a frame from the pull-down menu. Unlike the case selector label, you cannot enter values in the frame label. When you add, delete, or rearrange frames in a Sequence structure, LabVIEW automatically adjusts the numbers in the frame labels.

A Sequence structure executes frame 0, then frame 1, then frame 2, until the last frame executes. The Sequence structure does not complete execution or return any data until the last frame finishes.

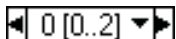

The sequence selector identifier at the top of the Sequence structure, shown at left, contains the current frame number and range of frames in the center and decrement and increment arrow buttons on each side. For example, in the sequence selector identifier shown at left, 0 is the current frame number and [0..2] is the range of frames. Click the decrement and increment arrow buttons to scroll through the available frames.

Use the Sequence structure to control the execution order when natural data dependency does not exist. A node that receives data from another node depends on the other node for data and always executes after the other node completes execution.

Within each frame of a Sequence structure, as in the rest of the block diagram, data dependency determines the execution order of nodes. Refer to the *Data Dependency and Artificial Data Dependency* section of Chapter 5, *Building the Block Diagram*, for more information about data dependency.

The tunnels of Sequence structures can have only one data source, unlike Case structures. The output can emit from any frame, but data leave the Sequence structure only when all frames complete execution, not when the individual frames complete execution. As with Case structures, data at input tunnels are available to all frames.



To pass data from one frame to any subsequent frame, use a sequence local terminal, shown at left. An outward-pointing arrow appears in the sequence local terminal of the frame that contains the data source. The terminal in subsequent frames contains an inward-pointing arrow, indicating that the terminal is a data source for that frame. You cannot use the sequence local terminal in frames that precede the first frame where you wired the sequence local.

Refer to the `examples\general\structs.llb` for examples of using Sequence structures.

Avoiding Overusing Sequence Structures

To take advantage of the inherent parallelism in LabVIEW, avoid overusing Sequence structures. Sequence structures guarantee the order of execution and prohibit parallel operations. For example, asynchronous tasks that use I/O devices, such as PXI, GPIB, serial ports, and DAQ devices, can run concurrently with other operations if Sequence structures do not prevent them from doing so. Sequence structures also hide sections of the block diagram and interrupt the natural left-to-right flow of data.

When you need to control the execution order, consider establishing data dependency between the nodes. For example, you can use error I/O to control the execution order of I/O. Refer to the *Error Handling* section of Chapter 6, *Running and Debugging VIs*, for more information about error I/O.

Also, do not use Sequence structures if you want to update an indicator from different frames of the Sequence structure. For example, a VI used in a test application might have a **Status** indicator that displays the name of the current test in progress. If each test is a subVI called from a different frame, you cannot update the indicator from each frame, as shown by the broken wire in the following block diagram.

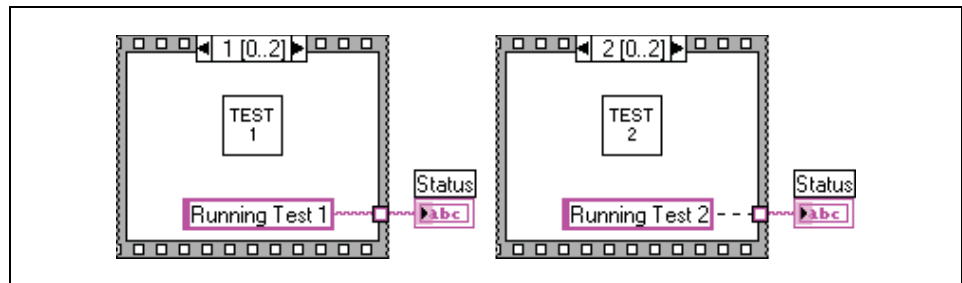

Because all frames of a Sequence structure execute before any data pass out of the structure, only one frame can assign a value to the **Status** indicator.

Instead, use a Case structure and a While Loop, as shown in the following example.

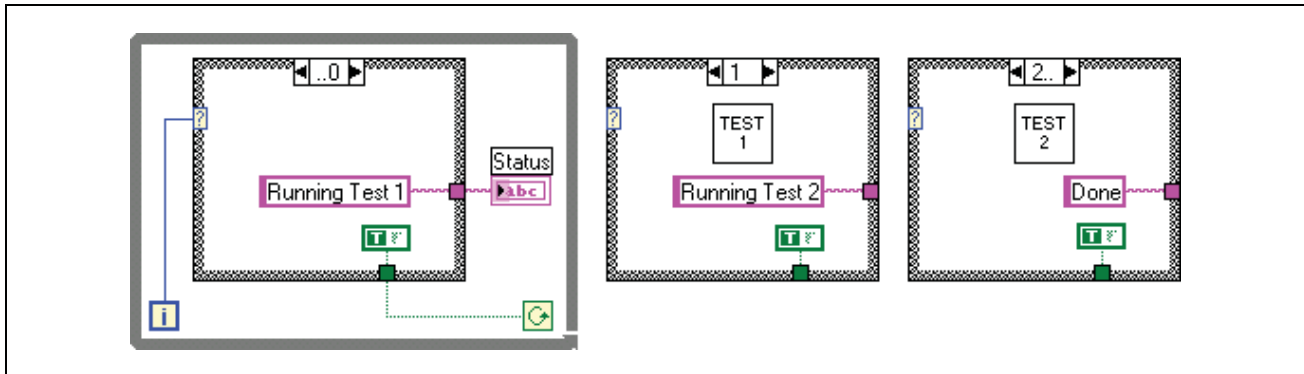

Each case in the Case structure is equivalent to a Sequence structure frame. Each iteration of the While Loop executes the next case. The **Status** indicator displays the status of the VI for each case. The **Status** indicator is updated in the case before the one that calls the corresponding subVI because data pass out of the structure after each case executes.

Unlike a Sequence structure, a Case structure can pass data to end the While Loop during any case. For example, if an error occurs while running the first test, the Case structure can pass FALSE to the conditional terminal to end the loop. However, a Sequence structure must execute all its frames even if an error occurs.

Event-Driven Programming

LabVIEW is a dataflow programming environment where the flow of data determines the execution order of block diagram elements. With events in LabVIEW, the user's direct interaction with objects on the front panel and the order of the block diagram elements can determine the flow of data.



Note Event-driven programming is available only in the LabVIEW Full and Professional Development Systems.

What Are Events?

Events are caused by actions the user performs. For example, clicking the mouse generates a mouse event, pressing a key on the keyboard generates a keyboard event, and so on. In an event-driven program, the program first waits for events to occur, responds to those events, then returns to waiting for the next event. How the program responds depends on the code written for that specific event. The order in which an event-driven program executes depends on which events occur and on the order in which those events occur.

Using Events in LabVIEW

Events are very useful in user interface design. Use events to synchronize your actions on the front panel with block diagram execution. You can use events to detect when a user changes a value, closes the front panel, exits the application, and so on. By using an Event structure to execute code specific to an event, you reduce the need for the block diagram to poll the front panel to determine which actions the user performed. This reduces processing time and simplifies the block diagram.



Note Events wait only for direct user interaction on the front panel. Events do not work if you use VI Server, global variables, local variables, and so on to change VI or front panel objects programmatically.

Refer to the *LabVIEW Help* for information about caveats when using Event structures, and for information about available events.

Event Structures

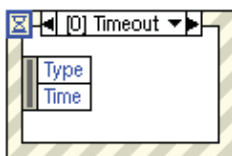

Use the Event structure, shown at left, to handle events in an application. As with a Case structure, you can add multiple cases to the Event structure. You can then configure those cases to handle one or more events. When those events occur, LabVIEW executes the corresponding case. Place Event structures inside While Loops to handle a series of events until a terminating condition occurs.



Caution If you place an Event structure inside a While Loop and a terminating condition stops the While Loop, you can continue to generate events, but the Event structure does not execute and handle them. This can cause your user interface to lock.



Note If you build a VI that contains an Event structure using the Full or Professional Development Systems, you can run that VI in the LabVIEW Base Package, and LabVIEW retains the Event structure functionality. However, you cannot edit the Event structure in the LabVIEW Base Package.



Use the Timeout terminal at the top left of the Event structure, shown at left, to specify the number of milliseconds an Event structure waits until an event occurs. The default is -1 , which means to wait indefinitely. If the timeout expires before an event occurs, and you have configured a case to handle the timeout event, LabVIEW generates a timeout event.



The Event Data Node, shown at left, is similar in appearance to the Unbundle By Name function. This node is attached to the inside left and right borders of each event case. You can resize this node vertically, and you

can set each element in the node to access an arbitrary Event Data Field, like you can with the Unbundle By Name function. The node displays data that is different in each case of the Event structure depending on which event(s) you configure that case to handle. If you configure a single case to handle multiple events, only the data that is common to all handled event types is available.



The Event Selector label at the top of the Event structure, shown at left, displays which case is currently selected, including the events handled for that case.



Note Like a Case structure, the Event structure supports tunnels. However, by default you do not have to wire the Event structure output tunnels for every case. All unwired tunnels use the default value for the tunnel data type. Right-click a tunnel and deselect **Use Default If Unwired** from the shortcut menu to revert to the default Case structure behavior where tunnels must be wired in all cases.

Events are grouped into classes, such as Application, VI, and Control. The event data always includes a reference to the object that triggered the event. If a single case is handling multiple events for controls of different VI Server classes, the event source control reference is the common parent class of all classes. For example, if you configure a single case in the Event structure to handle events for a digital numeric control and a color ramp control, the type of the event source control reference is Numeric because the digital numeric and color ramp controls are in the Numeric class.

Configuring Events

Right-click the Event structure border and select **Edit Events Handled by This Case** from the shortcut menu to display the **Edit Events** dialog box. Use this dialog box to edit single or multiple cases.

Filter and Notify Events

There are two types of events—notify and filter. Notify events tell LabVIEW that a user action has already occurred, such as when a user changes the value of a control. For example, you can write a VI that notifies the Event structure on the block diagram when the user clicks a button on the front panel. Because the value changes when the user clicks the button, the Event structure is notified. The Event structure can handle multiple notify events at one time. If you configure a single case to handle multiple notify events, only the data that is common to all handled event types is available.

Filter events allow control over how the user interface behaves. With filter events, you can validate or change the event data before the user interface can process it, or you can discard the event data entirely, preventing the change from affecting the VI. For example, you can configure a Menu Selection event that does not allow the user to interactively close the front panel of the VI. You also can configure a Key Down event to modify all characters typed into a string control so they are uppercase, or you can modify the event to filter unwanted characters.

The existence of terminals on the right side of the Event structure, such as the Discard terminal, identify a filter event.



Note Unlike notify events, a single case in the Event structure can handle multiple filter events only if the data the events return are identical. If you try to group two events that do not return identical data, such as Key Down and Mouse Down, the VI is broken.

Event Example

The following example shows an Event structure configured with the Menu Selection (User) event. This event captures menu selections made using the user-defined menu named `sample.rtm`. **ItemTag** returns which menu item was selected and **MenuRef** returns the refnum to the menu bar. Refer to the `examples\general\uievents.llb` for more examples of using events.

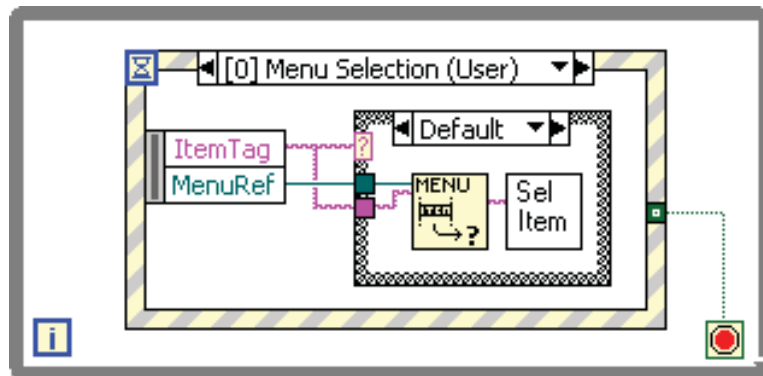

Note If you configure the Event structure to handle menu events, and have the Get Menu Selection function configured for the same menu item, the Event structure takes precedence and LabVIEW ignores the Get Menu Selection function. In any given VI you should use either the Event structure or the Get Menu Selection function.

Grouping Data Using Strings, Arrays, and Clusters

Use strings, arrays, and clusters to group data. Strings group sequences of ASCII characters. Arrays group data elements of the same type. Clusters group data elements of mixed types.

For more information...

Refer to the *LabVIEW Help* for more information about grouping data using strings, arrays, and clusters.

Strings

A string is a sequence of displayable or non-displayable ASCII characters. Strings provide a platform-independent format for information and data. Some of the more common applications of strings include the following:

- Creating simple text messages.
- Passing numeric data as character strings to instruments and then converting the strings to numerics.
- Storing numeric data to disk. To store numerics in an ASCII file, you must first convert numerics to strings before writing the numerics to a disk file.
- Instructing or prompting the user with dialog boxes.

On the front panel, strings appear as tables, text entry boxes, and labels. Edit and manipulate strings with the String functions on the block diagram. You format strings for use in other applications, such as word processing applications and spreadsheets, or for use within other VIs and functions.

Strings on the Front Panel

Use the string control and indicator located on the **Controls»String & Path** palette to simulate text entry boxes and labels. Refer to the *String Controls and Indicators* section of Chapter 4, *Building the Front Panel*, for more information about string controls and indicators.

String Display Types

Right-click a string control or indicator on the front panel to select from the display types shown in Table 9-1. The table also shows an example message in each display type.

Table 9-1. String Display Types

Display Type	Description	Message
Normal Display	Displays printable characters using the font of the control. Non-printable characters display as boxes.	There are four display types. \ is a backslash.
'\` Codes Display	Displays backslash codes for all non-printable characters.	There\sare\sfour\sdisplay\stypes.\n\\\sis\sasbackslash.
Password Display	Displays an asterisk (*) for each character including spaces.	***** *****
Hex Display	Displays the ASCII value of each character in hex instead of the character itself.	5468 6572 6520 6172 6520 666F 7572 2064 6973 706C 6179 2074 7970 6573 2E0A 5C20 6973 2061 2062 6163 6B73 6C61 7368 2E

Tables

Use the table control located on the **Controls»List & Table** palette to create a table on the front panel. Each cell in a table is a string, and each cell resides in a column and a row. Therefore, a table is a display for a 2D array of strings. Figure 9-1 shows a table and all its parts. Refer to the *Arrays* section of this chapter for more information about arrays.

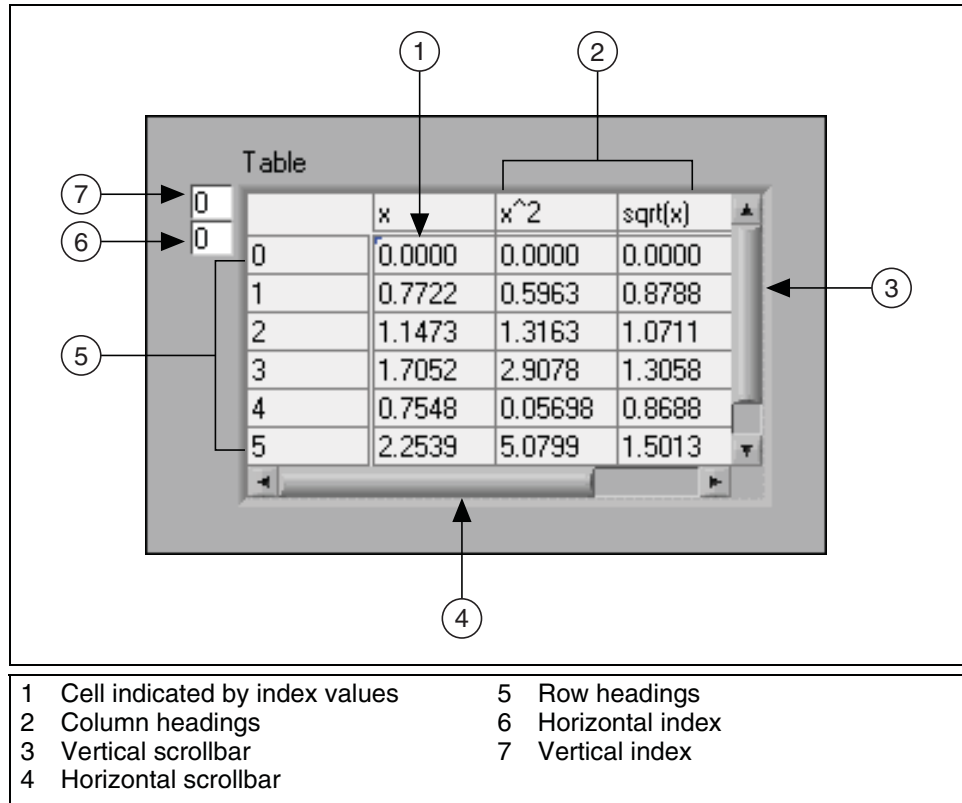

Figure 9-1. Parts of a Table

Programmatically Editing Strings

Use the String functions located on the **Functions»String** palette to edit strings in the following ways:

- Search for, retrieve, and replace characters or substrings within a string.
- Change all text in a string to upper case or lower case.
- Find and retrieve matching patterns within a string.
- Retrieve a line from a string.
- Rotate and reverse text within a string.
- Concatenate two or more strings.
- Delete characters from a string.

Refer to the `examples\general\strings.llb` for examples of using the String functions to edit strings.

Formatting Strings

To use data in another VI, function, or application, you often must convert the data to a string and then format the string in a way that the VI, function, or application can read. For example, Microsoft Excel expects strings that include delimiters, which Excel uses to segregate numbers or words into cells.

For example, to write a 1D array of numerics to a spreadsheet using the Write File function, you must format the array into a string and separate each numeric with a delimiter, such as a tab. To write an array of numerics to a spreadsheet using the Write to Spreadsheet File VI, you must format the array with the Array to Spreadsheet String function and specify a format and a delimiter.

Use the String functions located on the **Functions»String** palette to perform the following tasks:

- Concatenate two or more strings.
- Extract a subset of strings from a string.
- Convert data into strings.
- Format a string for use in a word processing or spreadsheet application.

Use the File I/O VIs and functions located on the **Functions»File I/O** palette to save strings to text and spreadsheet files.

Format Specifiers

In many cases, you must enter one or more format specifiers in the **format string** parameter of a String function to format a string. A format specifier code that indicates how to convert data to or from a string. LabVIEW uses conversion codes to determine the textual format of the parameter. For example, a format specifier of %x converts a hex integer to or from a string.

The Format Into String and Scan From String functions can use multiple format specifiers in the **format string** parameter, one for each input or output to the expandable function.

The Array To Spreadsheet String and Spreadsheet String To Array functions use only one format specifier in the **format string** parameter because these functions have only one input to convert. LabVIEW treats any extra specifiers you insert into these functions as literal strings with no special meaning.

Numerics and Strings

Numeric data and string data differ because string data are ASCII characters and numeric data are not. Text and spreadsheet files accept strings only. To write numeric data to a text or spreadsheet file, you must first convert the numeric data to a string.

To add a set of numerics to an existing string, convert the numeric data to a string and use the Concatenate Strings or another String function to add the new string to the existing string. Use the String/Number Conversion functions located on the **Functions»String»String/Number Conversion** palette to convert numerics to strings.

A string can include a set of numerics you display in a graph or chart. For example, you can read a text file that includes a set of numerics that you want to plot to a chart. However, those numerics are in ASCII text, so you must read the numerics as a string and then format the string into a set of numerics before you plot the numerics to a chart.

Figure 9-2 shows a string that includes a set of numerics, converts the string to numerics, builds an array of numerics, and plots the numerics to a graph.

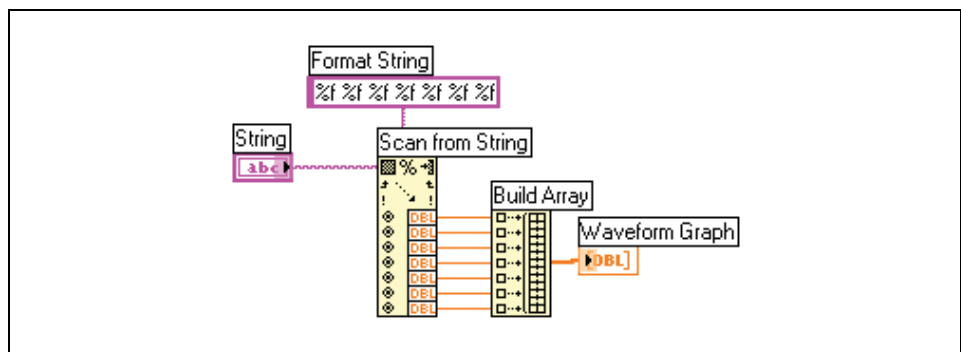

Figure 9-2. Converting a String to Numerics

Converting Data Types to XML

Extensible Markup Language (XML) is a formatting standard that uses tags to describe data. Unlike an HTML tag, an XML tag does not tell a browser how to format a piece of data. Instead, an XML tag identifies a piece of data.

For example, suppose you are a bookseller who sells books on the Web. You want to classify each book in your library by the following criteria:

- Type of book (fiction or nonfiction)
- Title

- Author
- Publisher
- Price
- Genre(s)
- Synopsis
- Number of pages

You can create an XML file for each book. The XML file for a book titled *Touring Germany's Great Cathedrals* would be similar to the following:

```
<nonfiction>
<Title>Touring Germany's Great Cathedrals</Title>
<Author>Tony Walters</Author>
<Publisher>Douglas Drive Publishing</Publisher>
<PriceUS>$29.99</PriceUS>
<Genre>Travel</Genre>
<Genre>Architecture</Genre>
<Genre>History</Genre>
<Synopsis>This book fully illustrates twelve of
Germany's most inspiring cathedrals with full-color
photographs, scaled cross-sections, and time lines of
their construction.</Synopsis>
<Pages>224</Pages>
</nonfiction>
```

Similarly, you can classify LabVIEW data by name, value, and type. You can represent a string control for a user name in XML as follows:

```
<String>
<Name>User Name</Name>
<Value>Reggie Harmon</Value>
</String>
```

Using XML-Based Data Types

Converting LabVIEW data to XML formats the data so that when you save the data to a file, you easily can identify the value(s), name(s), and type of the data from the tags that describe the data. For example, if you convert an array of temperature values to XML and save that data to a text file, you

easily can identify the temperature values by locating the <Value> tag that identifies each temperature.

Use the Flatten to XML function located on the **Functions»Advanced»Data Manipulation** palette to convert a LabVIEW data type to XML format. The following example generates 100 simulated temperatures, plots the array of temperatures to a chart, converts the array of numbers to the XML format, and writes the XML data to the `temperatures.xml` file.

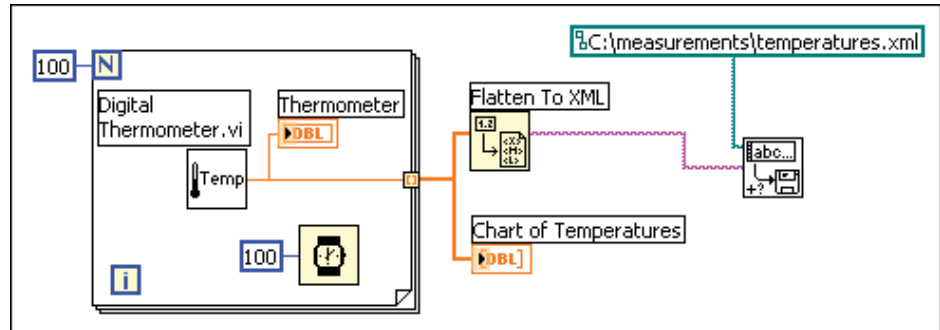

Use the Unflatten from XML function located on the **Functions»Advanced»Data Manipulation** palette to convert a data type in the XML format into LabVIEW data. The following example reads the 100 temperatures in the `temperatures.xml` file and plots the array of temperatures to a chart.

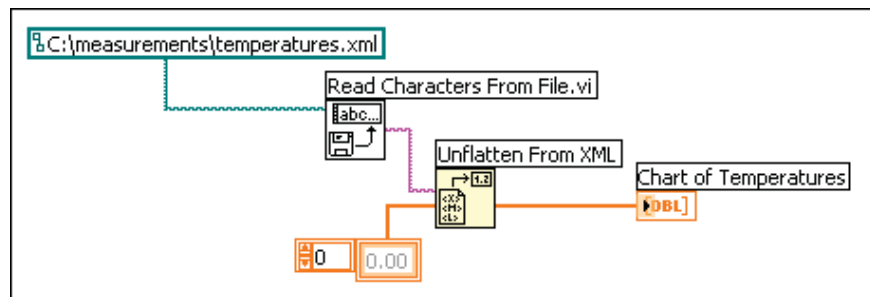

Note Although you can flatten LabVIEW Variant data to XML, attempting to unflatten variant data from XML results in an empty LabVIEW variant.

LabVIEW XML Schema

LabVIEW converts data to an established XML schema. Currently, you cannot create customized schemas, and you cannot control how LabVIEW tags each piece of data. Also, you cannot convert entire VIs or functions to XML.

Grouping Data with Arrays and Clusters

Use the array and cluster controls and functions located on the **Controls»Array & Cluster, Functions»Array**, and **Functions»Cluster** palettes to group data. Arrays group data elements of the same type. Clusters group data elements of mixed types.

Arrays

An array consists of elements and dimensions. Elements are the data that make up the array. A dimension is the length, height, or depth of an array. An array can have one or more dimensions and as many as $2^{31} - 1$ elements per dimension, memory permitting.

You can build arrays of numeric, Boolean, path, string, waveform, and cluster data types. Consider using arrays when you work with a collection of similar data and when you perform repetitive computations. Arrays are ideal for storing data you collect from waveforms or data generated in loops, where each iteration of a loop produces one element of the array.

You cannot create arrays of arrays. However, you can use a multidimensional array or create an array of clusters where each cluster contains one or more arrays. Refer to the [Restrictions for Arrays](#) section of this chapter for more information about the types of elements an array can contain. Refer to the [Clusters](#) section for more information about clusters.

Indexes

To locate a particular element in an array requires one index per dimension. In LabVIEW, indexes let you navigate through an array and retrieve elements, rows, columns, and pages from an array on the block diagram.

Examples of Arrays

An example of a simple array is a text array that lists the nine planets of our solar system. LabVIEW represents this as a 1D array of strings with nine elements.

Array elements are ordered. An array uses an index so you can readily access any particular element. The index is zero-based, which means it is in the range 0 to $n - 1$, where n is the number of elements in the array. For example, $n = 9$ for the nine planets, so the index ranges from 0 to 8. Earth is the third planet, so it has an index of 2.

Another example of an array is a waveform represented as a numeric array in which each successive element is the voltage value at successive time intervals, as shown in Figure 9-3.

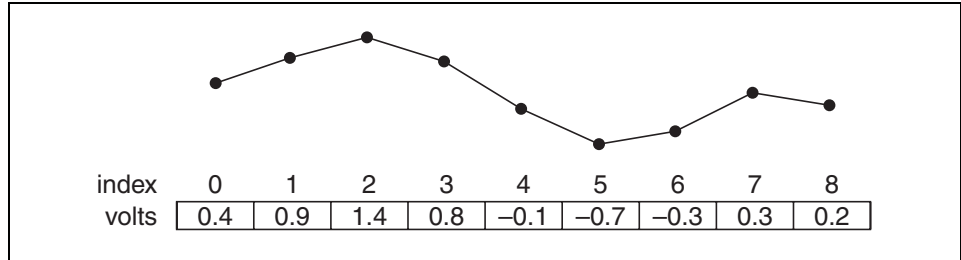

Figure 9-3. Waveform in an Array of Numerics

A more complex example of an array is a graph represented as an array of points where each point is a cluster containing a pair of numerics that represent the X and Y coordinates, as shown in Figure 9-4.

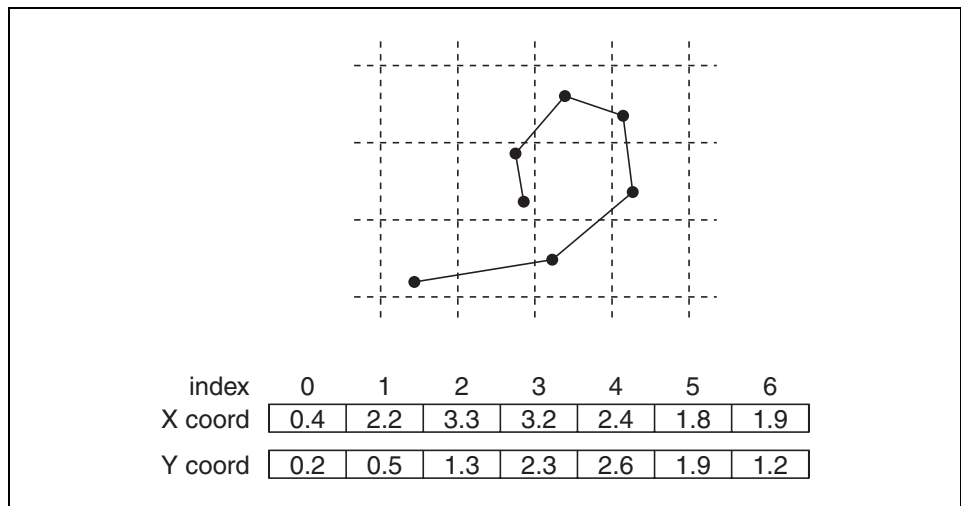

Figure 9-4. Graph in an Array of Points

The previous examples use 1D arrays. A 2D array stores elements in a grid. It requires a column index and a row index to locate an element, both of which are zero-based. Figure 9-5 shows an 6 column by 4 row 2D array, which contains $6 \times 4 = 24$ elements.

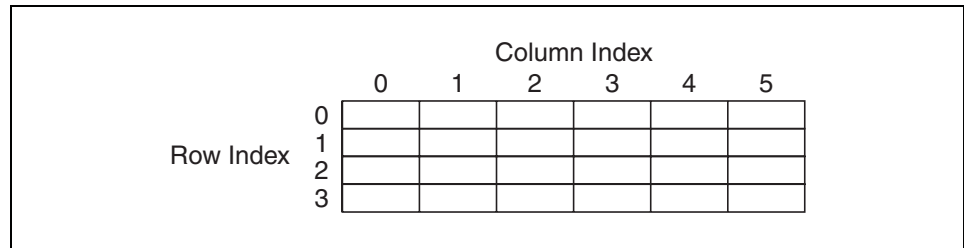

Figure 9-5. 6-Column by 4-Row 2D Array

For example, a chessboard has eight columns and eight rows for a total of 64 positions. Each position can be empty or have one chess piece. You can represent a chessboard as a 2D array of strings. Each string is the name of the piece that occupies the corresponding location on the board, or an empty string if the location is empty.

You can generalize the 1D array examples in Figures 9-3 and 9-4 to two dimensions by adding a row to the array. Figure 9-6 shows a collection of waveforms represented as a 2D array of numerics. The row index selects the waveform, and the column index selects the point on the waveform.

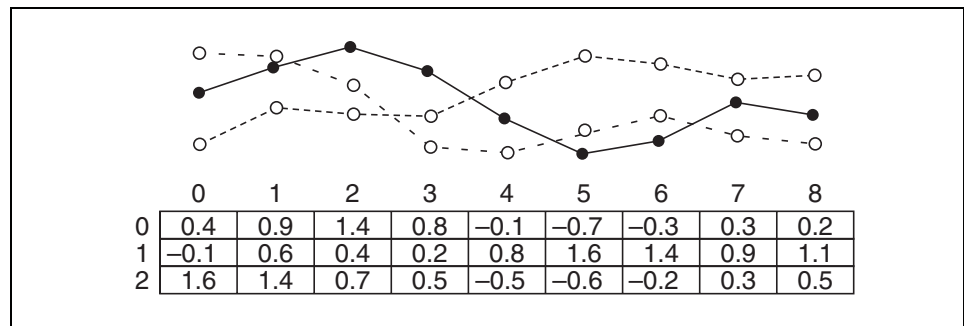

Figure 9-6. Multiple Waveforms in a 2D Array of Numerics

Refer to the `examples\general\arrays.llb` for more examples of arrays.

Restrictions for Arrays

You can create an array of almost any data type, with the following exceptions:

- You cannot create an array of arrays. However, you can use a multidimensional array or use the Build Cluster Array function to create an array of clusters where each cluster contains one or more arrays.
- You cannot create an array of non-XY graphs because a graph is an array data type and an array cannot contain another array. However, you can have an array of non-XY graphs if the graph is in a cluster.
- You cannot create an array of charts.

Creating Array Controls, Indicators, and Constants

Create an array control or indicator on the front panel by placing an array shell on the front panel, as shown in Figure 9-7, and dragging a data object or element, which can be a numeric, Boolean, string, path, refnum, or cluster control or indicator, into the array shell.

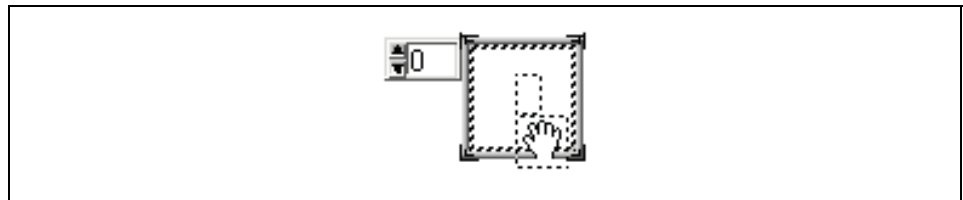

Figure 9-7. Array Shell

The array shell automatically resizes to accommodate the new object, whether a small Boolean control or a large 3D graph.

To display a particular element on the front panel, either type the index number in the index display or use the arrows on the index display to navigate to that number.

To create an array constant on the block diagram, select **Functions»Array»Array Constant** to place the array shell on the front panel, then place a string constant, numeric constant, or cluster constant in the array shell. You can use an array constant as a basis for comparison with another array.

Array Index Display

A 2D array contains rows and columns. As shown in Figure 9-8, the upper display of the two boxes on the left is the row index and the lower display is the column index. The combined display to the right of the row and

column displays shows the value at the specified position. Figure 9-8 shows that the value at row 6, column 13, is 66.

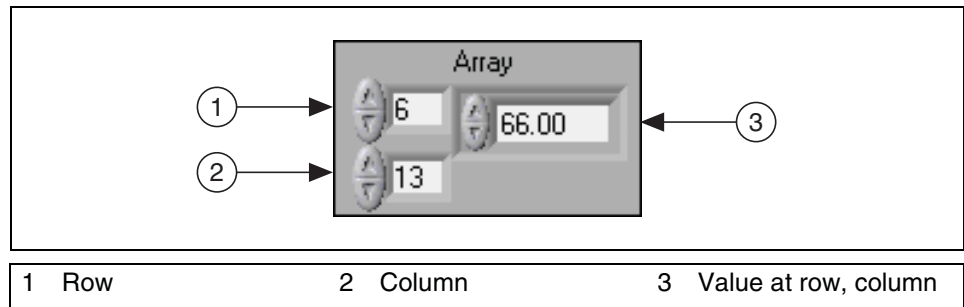

Figure 9-8. Array Control

Rows and columns are zero-based, meaning the first column is column 0, the second column is column 1, and so on. Changing the index display for the following array to row 1, column 2 displays a value of 6.

0	1	2	3
4	5	6	7
8	9	10	11

If you try to display a column or row that is out of the range of the array dimensions, the array control is dimmed to indicate that there is no value defined, and LabVIEW displays the default value of the data type. The default value of the data type depends on the data type of the array.

Use the Positioning tool to show more than one row or column at a time.

Array Functions

Use the Array functions located on the **Functions»Array** palette to create and manipulate arrays, such as the following tasks:

- Extract individual data elements from an array.
- Insert, delete, or replace data elements in an array.
- Split arrays.

Automatically Resizing Array Functions

The Index Array, Replace Array Subset, Insert Into Array, Delete From Array, and Array Subset functions automatically resize to match the dimensions of the input array you wire. For example, if you wire a 1D array to one of these functions, the function shows a single index input. If you

wire a 2D array to the same function, it shows two index inputs—one for the row and one for the column.

You can access more than one element, or subarray (row, column, or page) with these functions by using the Positioning tool to manually resize the function. When you expand one of these functions, the functions expand in increments determined by the dimensions of the array wired to the function. If you wire a 1D array to one of these functions, the function expands by a single index input. If you wire a 2D array to the same function, the function expands by two index inputs—one for the row and one for the column.

The index inputs you wire determine the shape of the subarray you want to access or modify. For example, if the input to an Index Array function is a 2D array and you wire only the **row** input, you extract a complete 1D row of the array. If you wire only the **column** input, you extract a complete 1D column of the array. If you wire the **row** input and the **column** input, you extract a single element of the array. Each input group is independent and can access any portion of any dimension of the array.

The block diagram shown in Figure 9-9 uses the Index Array function to retrieve a row and an element from a 2D array.

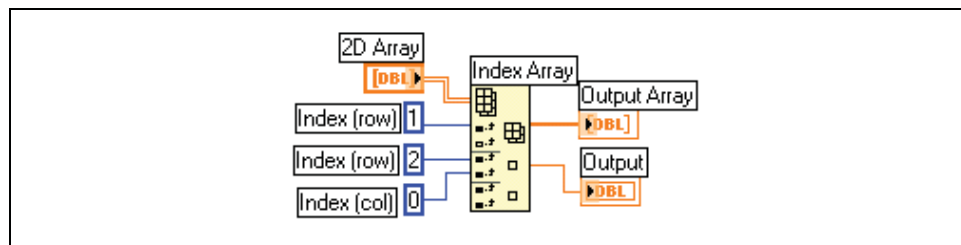

Figure 9-9. Indexing a 2D Array

To access multiple consecutive values in an array, expand the Index Array function, but do not wire values to the index inputs in each increment. For example, to retrieve the first, second, and third rows from a 2D array, expand the Index Array function by three increments and wire 1D array indicators to each **sub-array** output.

Clusters

Clusters group data elements of mixed types, such as a bundle of wires, as in a telephone cable, where each wire in the cable represents a different element of the cluster. A cluster is similar to a record or a struct in text-based programming languages.

Bundling several data elements into clusters eliminates wire clutter on the block diagram and reduces the number of connector pane terminals that subVIs need. The connector pane has, at most, 28 terminals. If your front panel contains more than 28 controls and indicators that you want to use programmatically, group some of them into a cluster and assign the cluster to a terminal on the connector pane.

Although cluster and array elements are both ordered, you must unbundle all cluster elements at once rather than index one element at a time. You also can use the Unbundle By Name function to access specific cluster elements. Clusters also differ from arrays in that they are a fixed size. Like an array, a cluster is either a control or an indicator. A cluster cannot contain a mixture of controls and indicators.

Most clusters on the block diagram have a pink wire pattern and data type icon. Clusters of numerics, sometimes referred to as points, have a brown wire pattern and data type icon. You can wire brown numeric clusters to Numeric functions, such as Add or Square Root, to perform the same operation simultaneously on all elements of the cluster.

Cluster elements have a logical order unrelated to their position in the shell. The first object you place in the cluster is element 0, the second is element 1, and so on. If you delete an element, the order adjusts automatically. The cluster order determines the order in which the elements appear as terminals on the Bundle and Unbundle functions on the block diagram. You can view and modify the cluster order by right-clicking the cluster border and selecting **Reorder Controls In Cluster** from the shortcut menu.

To wire clusters, both clusters must have the same number of elements. Corresponding elements, determined by the cluster order, must have compatible data types. For example, if a double-precision floating-point numeric in one cluster corresponds in cluster order to a string in the another cluster, the wire on the block diagram appears broken and the VI does not run. If numerics of different representations, LabVIEW coerces them to the same representation. Refer to the *Numeric Conversion* section of Appendix B, *Polymorphic Functions*, for more information about numeric conversion.

Use the Cluster functions located on the **Functions»Cluster** palette to create and manipulate clusters, such as the following tasks:

- Extract individual data elements from a cluster.
- Add individual data elements to a cluster.
- Break a cluster out into its individual data elements.

Local and Global Variables

In LabVIEW, you read data from or write data to a front panel object using its block diagram terminal. However, a front panel object has only one block diagram terminal, and your application might need to access the data in that terminal from more than one location.

Local and global variables pass information between locations in your application that you cannot connect with a wire. Use local variables to access front panel objects from more than one location in a single VI. Use global variables to access and pass data among several VIs.

For more information...

Refer to the *LabVIEW Help* for more information about using local and global variables.

Local Variables

Use local variables to access front panel objects from more than one location in a single VI and pass data between block diagram structures that you cannot connect with a wire.

With a local variable, you can write to or read from a control or indicator on the front panel. Writing to a local variable is similar to passing data to any other terminal. However, with a local variable you can write to it even if it is a control or read from it even if it is an indicator. In effect, with a local variable, you can access a front panel object as both an input and an output.

For example, if the user interface requires users to log in, you can clear the **Login** and **Password** prompts each time a new user logs in. Use a local variable to read from the **Login** and **Password** string controls when a user logs in and to write empty strings to these controls when the user logs out.

Creating Local Variables

Right-click an existing front panel object or block diagram terminal and select **Create»Local Variable** from the shortcut menu to create a local variable. A local variable icon for the object appears on the block diagram.



You also can select **Functions»Structures»Local Variable** and place a local variable on the block diagram. The local variable node, shown at left, is not yet associated with a control or indicator. Right-click the local variable node and select a front panel object from the **Select Item** shortcut menu. The shortcut menu lists all the front panel objects that have owned labels.

LabVIEW uses owned labels to associate local variables with front panel objects, so label the front panel controls and indicators with descriptive owned labels. Refer to the *Labeling* section of Chapter 4, *Building the Front Panel*, for more information about owned and free labels.

Global Variables

Use global variables to access and pass data among several VIs that run simultaneously. Global variables are built-in LabVIEW objects. When you create a global variable, LabVIEW automatically creates a special global VI, which has a front panel but no block diagram. Add controls and indicators to the front panel of the global VI to define the data types of the global variables it contains. In effect, this front panel is a container from which several VIs can access data.

For example, suppose you have two VIs running simultaneously. Each VI contains a While Loop and writes data points to a waveform chart. The first VI contains a Boolean control to terminate both VIs. You must use a global variable to terminate both loops with a single Boolean control. If both loops were on a single block diagram within the same VI, you could use a local variable to terminate the loops.

Creating Global Variables



Select **Functions»Structures»Global Variable** and place a global variable, shown at left, on the block diagram. Double-click the global variable node to display the front panel of the global VI. Place controls and indicators on this front panel the same way you do on a standard front panel.

LabVIEW uses owned labels to identify global variables, so label the front panel controls and indicators with descriptive owned labels. Refer to the *Labeling* section of Chapter 4, *Building the Front Panel*, for more information about owned and free labels.

You can create several single global VIs, each with one front panel object, or you can create one global VI with multiple front panel objects. A global VI with multiple objects is more efficient because you can group related variables together. The block diagram of a VI can include several global variable nodes that are associated with controls and indicators on the front panel of a global VI. These global variable nodes are either copies of the first global variable node that you placed on the block diagram of the global VI, or they are the global variable nodes of global VIs that you placed on the current VI. You place global VIs on other VIs the same way you place subVIs on other VIs. Each time you place a new global variable node on a block diagram, LabVIEW creates a new VI associated only with that global variable node and copies of it. Refer to the *SubVIs* section of Chapter 7, *Creating VIs and SubVIs*, for more information about subVIs.

After you finish placing objects on the global VI front panel, save it and return to the block diagram of the original VI. You must then select the object in the global VI that you want to access. Right-click the global variable node and select a front panel object from the **Select Item** shortcut menu. The shortcut menu lists all the front panel objects that have owned labels.

Read and Write Variables

After you create a local or global variable, you can read data from a variable or write data to it. By default, a new variable receives data. This kind of variable works as an indicator and is a write local or global. When you write new data to the local or global variable, the associated front panel control or indicator updates to the new data.

You also can configure a variable to behave as a data source, or a read local or global. Right-click the variable and select **Change To Read** from the shortcut menu to configure the variable to behave as a control. When this node executes, the VI reads the data in the associated front panel control or indicator.

To change the variable to receive data from the block diagram rather than provide data, right-click the variable and select **Change To Write** from the shortcut menu.

On the block diagram, you can distinguish read locals or globals from write locals or globals the same way you distinguish controls from indicators. A read local or global has a thick border similar to a control. A write local or global has a thin border similar to an indicator.

Refer to the examples\general\locals.llb and examples\general\globals.llb for examples of using local and global variables.

Using Local and Global Variables Carefully

Local and global variables are advanced LabVIEW concepts. They are inherently not part of the LabVIEW dataflow execution model. Block diagrams can become difficult to read when you use local and global variables, so you should use them carefully. Misusing local and global variables, such as using them instead of a connector pane or using them to access values in each frame of a Sequence structure, can lead to unexpected behavior in VIs. Overusing local and global variables, such as using them to avoid long wires across the block diagram or using them instead of data flow, slows performance. Refer to the *Block Diagram Data Flow* section of Chapter 5, *Building the Block Diagram*, for more information about the LabVIEW dataflow execution model.

Initializing Local and Global Variables

Verify that the local and global variables contain known data values before the VI runs. Otherwise, the variables might contain data that cause the VI to behave incorrectly.

If you do not initialize the variable before the VI reads the variable for the first time, the variable contains the default value of the associated front panel object.

Race Conditions

Because VIs follow a dataflow execution model, LabVIEW local and global variables do not behave like local and global variables in text-based programming languages. A race condition occurs when two or more pieces of code that execute in parallel change the value of the same shared resource, typically a local or global variable. Figure 10-1 shows an example of a race condition.

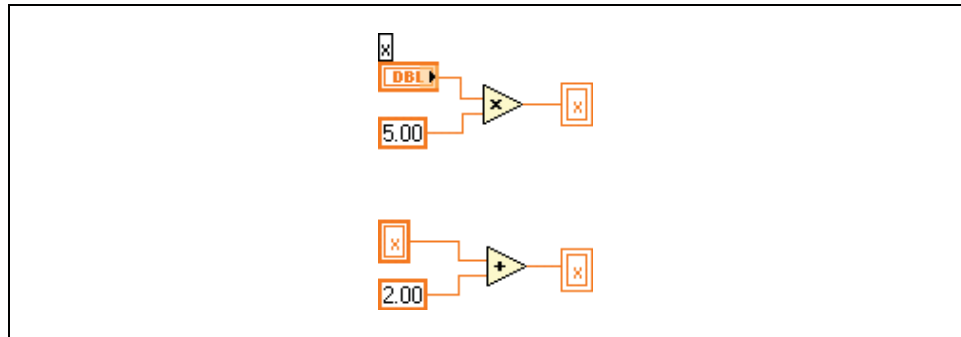

Figure 10-1. Race Condition

The output of this VI depends on the order in which the operations run. Because there is no data dependency between the two operations, there is no way to determine which runs first. To avoid race conditions, do not write to the same variable you read from. Refer to the *Data Dependency and Artificial Data Dependency* section of Chapter 5, *Building the Block Diagram*, for more information about data dependency.

If you use global variables in VIs that execute in parallel, you can use an additional Boolean global variable to indicate when global variable data changes. Other VIs can monitor this Boolean global variable to determine if the data changed and to read the new value.

Memory Considerations when Using Local Variables

When you create subVIs, you create a connector pane that describes how to pass data to and from the subVI. The connector pane does not make copies of data buffers from calling VIs.

Local variables make copies of data buffers. When you read from a local variable, you create a new buffer for the data from its associated control.

If you use local variables to transfer large amounts of data from one place on the block diagram to another, you generally use more memory and, consequently, have slower execution speed than if you transfer data using a wire.

Memory Considerations when Using Global Variables

When you read from a global variable, LabVIEW creates a copy of the data stored in that global variable.

When you manipulate large arrays and strings, the time and memory required to manipulate global variables can be considerable. Manipulating global variables is especially inefficient when dealing with arrays, because

if you modify only a single array element, LabVIEW stores the entire array. If you read from the global variable in several places in an application, you create several memory buffers, which is inefficient and slows performance.

Graphs and Charts

Use graphs and charts to display plots of data in a graphical form.

Graphs and charts differ in the way they display and update data. VIs with graphs usually collect the data in an array and then plot the data to the graph, which is similar to a spreadsheet that first stores the data then generates a plot of it. In contrast, a chart appends new data points to those already in the display. On a chart, you can see the current reading or measurement in context with data previously acquired.

For more information...

Refer to the *LabVIEW Help* for more information about using graphs and charts.

Types of Graphs and Charts

The graphs and charts located on the **Controls»Graph** palette include the following types:

- **Waveform Chart and Graph**—Displays data acquired at a constant rate.
- **XY Graph**—Displays data acquired at a non-constant rate, such as data acquired when a trigger occurs.
- **Intensity Chart and Graph**—Displays 3D data on a 2D plot by using color to display the values of the third dimension.
- **Digital Waveform Graph**—Displays data as pulses or groups of digital lines. Computers transfer digital data to other computers in pulses.
- **(Windows) 3D Graphs**—Displays 3D data on a 3D plot in an ActiveX object on the front panel.

Refer to `examples\general\graphs` for examples of graphs and charts.

Graph and Chart Options

Although graphs and charts plot data differently, they have several common options that you access from the shortcut menu. Refer to the *Customizing Graphs* and *Customizing Charts* sections of this chapter for more information about the options available only on graphs or only on charts.

Waveform and XY graphs and charts have different options than intensity, digital, and 3D graphs and charts. Refer to the *Intensity Graphs and Charts*, *3D Graphs*, and *Digital Graphs* sections of this chapter for more information about intensity, digital, and 3D graph and chart options.

Multiple X- and Y-Scales on Graphs and Charts

All graphs and charts support multiple x- and y-scales. Use multiple scales on a graph or chart to display multiple plots that do not share a common x- or y-scale. Right-click the x- or y-scale of the waveform graph or chart and select **Duplicate Scale** from the shortcut menu to add multiple x- or y-scales to the graph or chart.

Anti-Aliased Line Plots for Graphs and Charts

You can improve the appearance of line plots in charts and graphs by using anti-aliased lines. When you enable anti-aliased line drawing, line plots appear smoother. Anti-aliased line drawing does not alter line widths, line styles, point styles, and so on.



Note Anti-aliased line drawing is not available on digital waveform graphs.

To enable anti-aliased line plots, right-click the plot legend and select **Anti-aliased** from the shortcut menu. If the plot legend is not visible, right-click the chart or graph and select **Visible Items»Plot Legend** from the shortcut menu.



Note Because anti-aliased line drawing can be computation intensive, using anti-aliased line plots can slow performance.

Customizing Graph and Chart Appearance

You customize the appearance of graphs and charts by showing or hiding options. Right-click the graph or chart and select **Visible Items** from the shortcut menu to display or hide the following options:

- **Plot Legend**—Defines the color and style of the plot(s). Resize the legend to display multiple plots.
- **Scale Legend**—Defines labels for scales and configures scale properties.
- **Graph Palette**—Changes scaling and formatting while a VI is running.
- **X Scale and Y Scale**—Formats the x- and y-scales. Refer to the [Scale Options](#) section of this chapter for more information about scales.
- **Cursor Legend (graph only)**—Displays a marker at a defined point coordinate. You can display multiple cursors on a graph.
- **Scrollbar (chart only)**—Scrolls through the data in the chart. Use the scroll bar to view data that the buffer does not currently display.

Customizing Graphs

You can modify the behavior of graph cursors, scaling options, and graph axes. Figure 11-1 illustrates the elements of a graph.

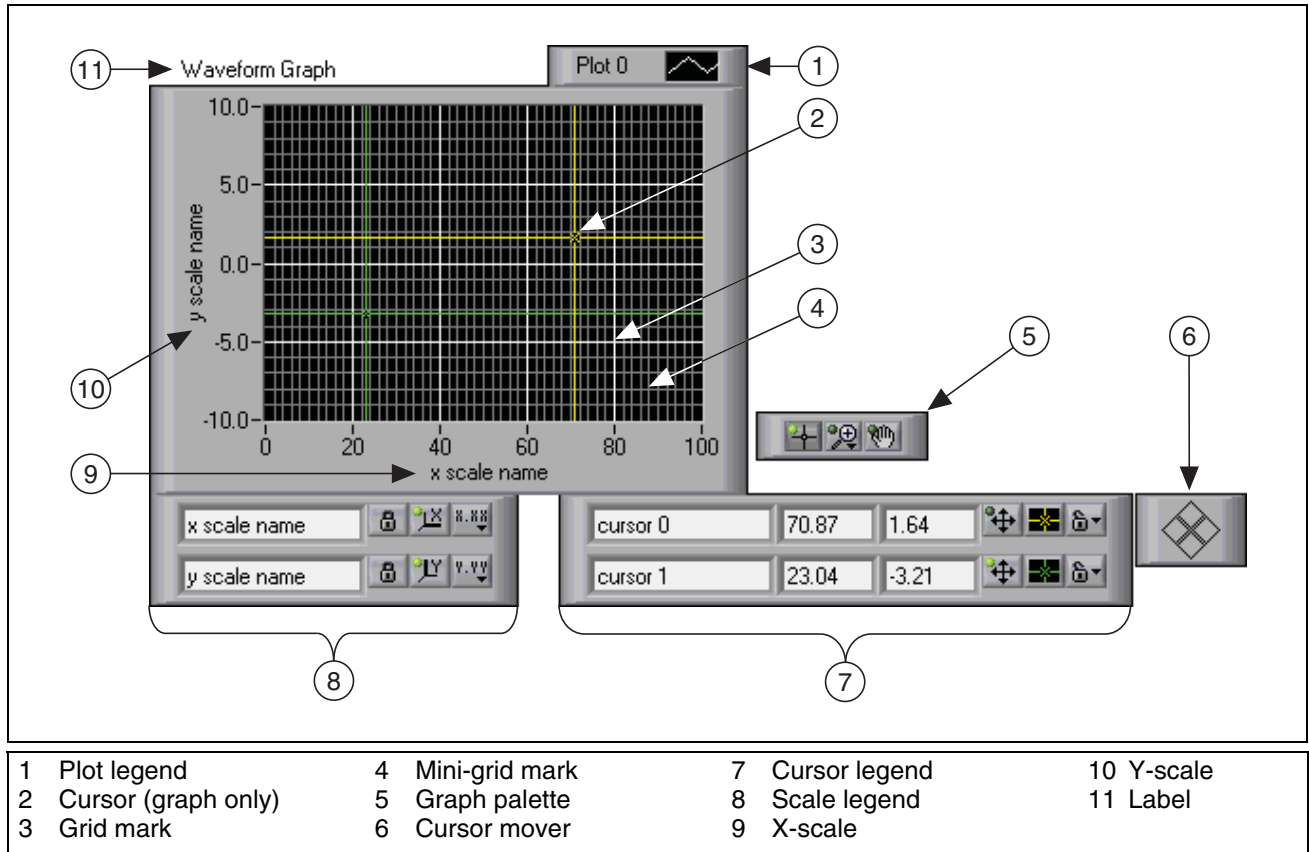

Figure 11-1. Graph Elements

You add most of the items listed in the legend above by right-clicking the graph, selecting **Visible Items** from the shortcut menu, and selecting the appropriate element.

Graph Cursors

Cursors on graphs allow you to read the exact value of a point on a plot. The cursor value displays in the cursor legend. Add a cursor to a graph by right-clicking the graph, selecting **Visible Items»Cursor Legend** from the shortcut menu, and clicking anywhere in a cursor legend row to activate a cursor. Use the Positioning tool to expand the cursor legend to add multiple cursors.

You can place cursors and a cursor display on all graphs, and you can label the cursor on the plot. You can set a cursor to lock onto a plot, and you can move multiple cursors at the same time. A graph can have any number of cursors.

Refer to the Zoom Graph VI in the `examples\general\graphs\zoom.llb` for an example of reading cursor values and programmatically zooming in and out of a graph using the cursors.

Scale Options

Graphs can automatically adjust their horizontal and vertical scales to reflect the data you wire to them. This behavior is called autoscaling. Turn autoscaling on or off by right-clicking the graph and selecting **X Scale»Autoscale X** or **Y Scale»Autoscale Y** from the shortcut menu. By default, autoscaling is enabled for graphs. However, autoscaling can slow performance.

Use the Operating or Labeling tool to change the horizontal or vertical scale directly.

Waveform Graph Scale Legend

Use the scale legend to label scales and configure scale properties.



Use the Operating tool to click the **Scale Format** button, shown at left, to configure the format, precision, and mapping mode.



Use the **Scale Lock** button, shown at left, to toggle autoscaling for each scale, the visibility of scales, scale labels, and plots, and to format scale labels, grids, grid lines, and grid colors.

Graph Scale Formatting

You can format the scales of a graph to represent either absolute or relative time or amplitude. Use absolute time format to display the time, date, or both for a scale. If you do not want LabVIEW to assume a date, use relative time format. To select absolute or relative time format, right-click the graph, select the scale you want to modify, and select **Formatting** from the shortcut menu. The **Formatting** dialog box appears, where you specify different properties of the graph scale. By default, the x-axis represents relative time and the y-axis represents amplitude.

Using Smooth Updates

Right-click the graph and select **Advanced»Smooth Updates** from the shortcut menu to use an offscreen buffer to minimize flashing. Using **Smooth Updates** can slow performance depending on the computer and video system you use.

Customizing Charts

Unlike graphs, which display an entire waveform that overwrites the data already stored, charts update periodically and maintain a history of the data previously stored.

You can customize the waveform and intensity charts located on the **Controls»Graph** palette to match your data display requirements or to display more information. Options available for charts include a scroll bar, a legend, a palette, a digital display, and representation of scales with respect to time. You can modify the behavior of chart history length, update modes, and plot displays.

Chart History Length

LabVIEW stores data points already added to the chart in a buffer, or the chart history. The default size for a chart history buffer is 1,024 data points. You can configure the history buffer by right-clicking the chart and selecting **Chart History Length** from the shortcut menu. You can view previously collected data using the chart scroll bar. Right-click the chart and select **Visible Items»Scrollbar** from the shortcut menu to display a scroll bar.

Chart Update Modes

Charts use three different modes to scroll data. Right-click the chart and select **Advanced»Update Mode** from the shortcut menu. Select **Strip Chart**, **Scope Chart**, or **Sweep Chart**. The default mode is **Strip Chart**. A strip chart shows running data continuously scrolling from left to right across the chart. A scope chart shows one item of data, such as a pulse or wave, scrolling partway across the chart from left to the right. A sweep display is similar to an EKG display. A sweep works similarly to a scope except it shows the old data on the right and the new data on the left separated by a vertical line.

Overlaid Versus Stacked Plots

You can display multiple plots on a chart by using a single vertical scale, called overlaid plots, or by using multiple vertical scales, called stacked plots. Figure 11-2 shows examples of overlaid plots and stacked plots.

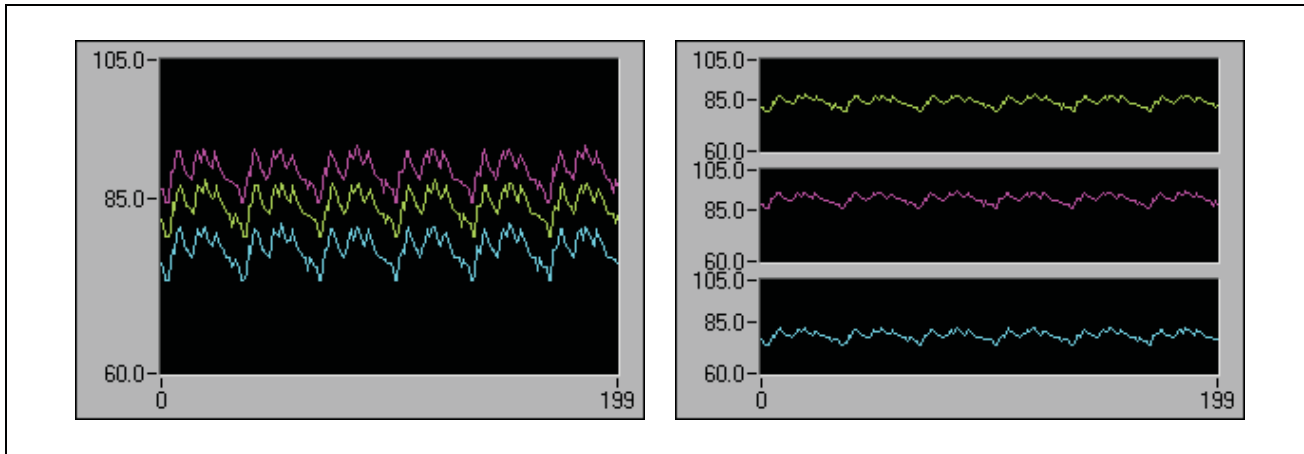

Figure 11-2. Charts with Overlaid and Stacked Plots

Refer to the Charts VI in the `examples\general\graphs\charts.llb` for examples of different kinds of charts and the data types they accept.

Waveform and XY Graphs

Waveform graphs display evenly sampled measurements. XY graphs display any set of points, evenly sampled or not. Figure 11-3 shows examples of a waveform graph and an XY graph.

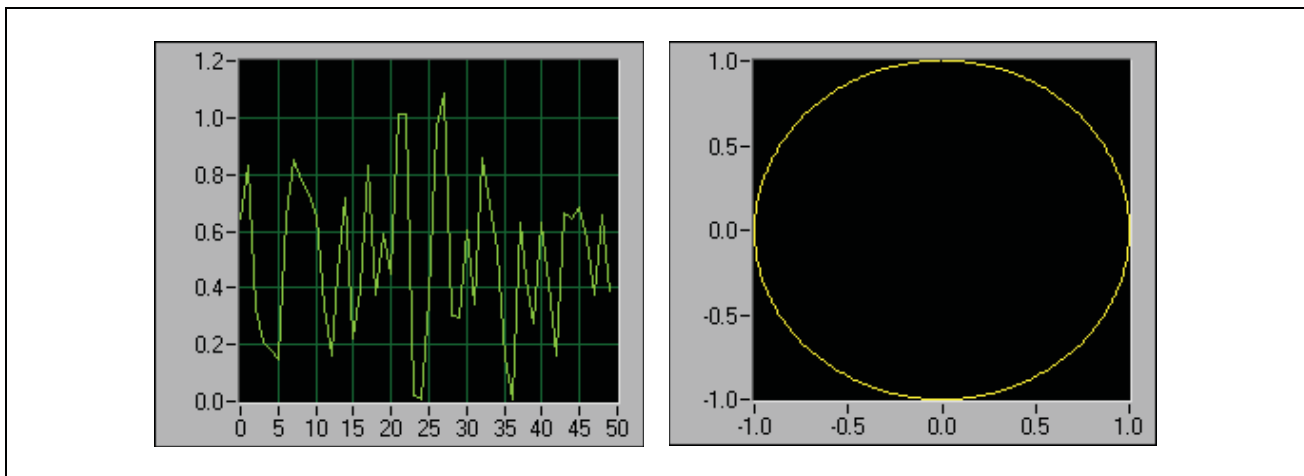

Figure 11-3. Waveform and XY Graphs

The waveform graph plots only single-valued functions, as in $y = f(x)$, with points evenly distributed along the x-axis, such as acquired time-varying waveforms. The XY graph is a general-purpose, Cartesian graphing object that plots multivalued functions, such as circular shapes or waveforms with

a varying timebase. Both graphs can display plots containing any number of points.

Both types of graphs accept several data types, which minimizes the extent to which you must manipulate data before you display it.

Single-Plot Waveform Graph Data Types

The waveform graph accepts two data types for single-plot waveform graphs.

The graph accepts a single array of values and interprets the data as points on the graph and increments the x index by one starting at $x = 0$. The graph also accepts a cluster of an initial x value, a Δx , and an array of y data.

Refer to the Waveform Graph VI in the `examples\general\graphs\gengraph.llb` for examples of the data types that single-plot waveform graphs accept.

Multiplot Waveform Graph

A multiplot waveform graph accepts a 2D array of values, where each row of the array is a single plot. The graph interprets the data as points on the graph and increments the x index by one, starting at $x = 0$. Wire a 2D array data type to the graph, right-click the graph, and select **Transpose Array** from the shortcut menu to handle each column of the array as a plot. This is particularly useful when you sample multiple channels from a DAQ device because the device returns the data as 2D arrays with each channel stored as a separate column. Refer to the (Y) Multi Plot 1 graph in the Waveform Graph VI in the `examples\general\graphs\gengraph.llb` for an example of a graph that accepts this data type.

A multiplot waveform graph also accepts a cluster of an x value, a Δx value, and a 2D array of y data. The graph interprets the y data as points on the graph and increments the x index by Δx , starting at $x = 0$. This data type is useful for displaying multiple signals all sampled at the same regular rate. Refer to the (X₀, dX, Y) Multi Plot 3 graph in the Waveform Graph VI in the `examples\general\graphs\gengraph.llb` for an example of a graph that accepts this data type.

A multiplot waveform graph accepts a plot array where the array contains clusters. Each cluster contains a point array that contains the y data. The inner array describes the points in a plot, and the outer array has one cluster for each plot. Figure 11-4 shows this array of the y cluster.

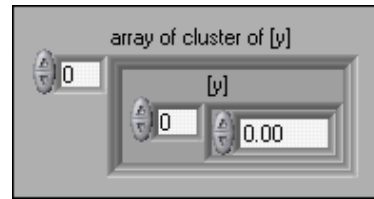

Figure 11-4. Array of Cluster y

Use a multiplot waveform graph instead of a 2D array if the number of elements in each plot is different. For example, when you sample data from several channels using different time amounts from each channel, use this data structure instead of a 2D array because each row of a 2D array must have the same number of elements. The number of elements in the interior arrays of an array of clusters can vary. Refer to the (Y) Multi Plot 2 graph in the Waveform Graph VI in the `examples\general\graphs\gengraph.llb` for an example of a graph that accepts this data type.

A multiplot waveform graph accepts a cluster of an initial x value, a Δx value, and array that contains clusters. Each cluster contains a point array that contains the y data. You use the Bundle function to bundle the arrays into clusters and you use the Build Array function to build the resulting clusters into an array. You also can use the Build Cluster Array, which creates arrays of clusters that contain inputs you specify. Refer to the (Xo, dX, Y) Multi Plot 2 graph in the Waveform Graph VI in the `examples\general\graphs\gengraph.llb` for an example of a graph that accepts this data type.

A multiplot waveform graph accepts an array of clusters of an x value, a Δx value, and an array of y data. This is the most general of the multiplot waveform graph data types because you can indicate a unique starting point and increment for the x -axis of each plot. Refer to the (Xo, dX, Y) Multi Plot 1 graph in the Waveform Graph VI in the `examples\general\graphs\gengraph.llb` for an example of a graph that accepts this data type.

Single-Plot XY Graph Data Types

The single-plot XY graph accepts a cluster that contains an x array and a y array. The XY graph also accepts an array of points, where a point is a cluster that contains an x value and a y value.

Refer to the XY Graph VI in the `examples\general\graph\gengraph.llb` for an example of single-plot XY graph data types.

Multiplot XY Graph Data Types

The multiplot XY graph accepts an array of plots, where a plot is a cluster that contains an x array and a y array. The multiplot XY graph also accepts an array of clusters of plots, where a plot is an array of points. A point is a cluster that contains an x value and a y value.

Refer to the XY Graph VI in the `examples\general\graph\gengraph.llb` for an example of multiplot XY graph data types.

Waveform Charts

The waveform chart is a special type of numeric indicator that displays one or more plots. Refer to the `examples\general\graphs\charts.llb` for examples of waveform charts.

You can pass charts a single value or multiple values at a time. As with the waveform graph, LabVIEW interprets the data as points on the graph and increments the x index by one starting at $x = 0$. The chart treats these inputs as new data for a single plot.

The chart redraws less frequently when you pass it multiple points at a time.

To pass data for multiple plots to a waveform chart, you can bundle the data together into a cluster of scalar numerics, where each numeric represents a single point for each of the plots.

If you want to pass multiple points for plots in a single update, wire an array of clusters of numerics to the chart. Each numeric represents a single y value point for each of the plots.

If you cannot determine the number of plots you want to display until run time, or you want to pass multiple points for multiple plots in a single update, wire a 2D array of data to the chart. As with the waveform graph, by default, waveform charts handle rows as new data for each plot. Wire a 2D array data type to the chart, right-click the chart, and select **Transpose Array** from the shortcut menu to treat columns in the array as new data for each plot.

Intensity Graphs and Charts

Use the intensity graph and chart to display 3D data on a 2D plot by placing blocks of color on a Cartesian plane. For example, you can use intensity graphs and charts to display patterned data, such as temperature patterns and terrain, where the magnitude represents altitude. The intensity graph and chart accept a 2D array of numbers. Each number in the array represents a specific color. The indexes of the elements in the 2D array set the plot locations for the colors. Figure 11-5 shows the concept of the intensity chart operation.

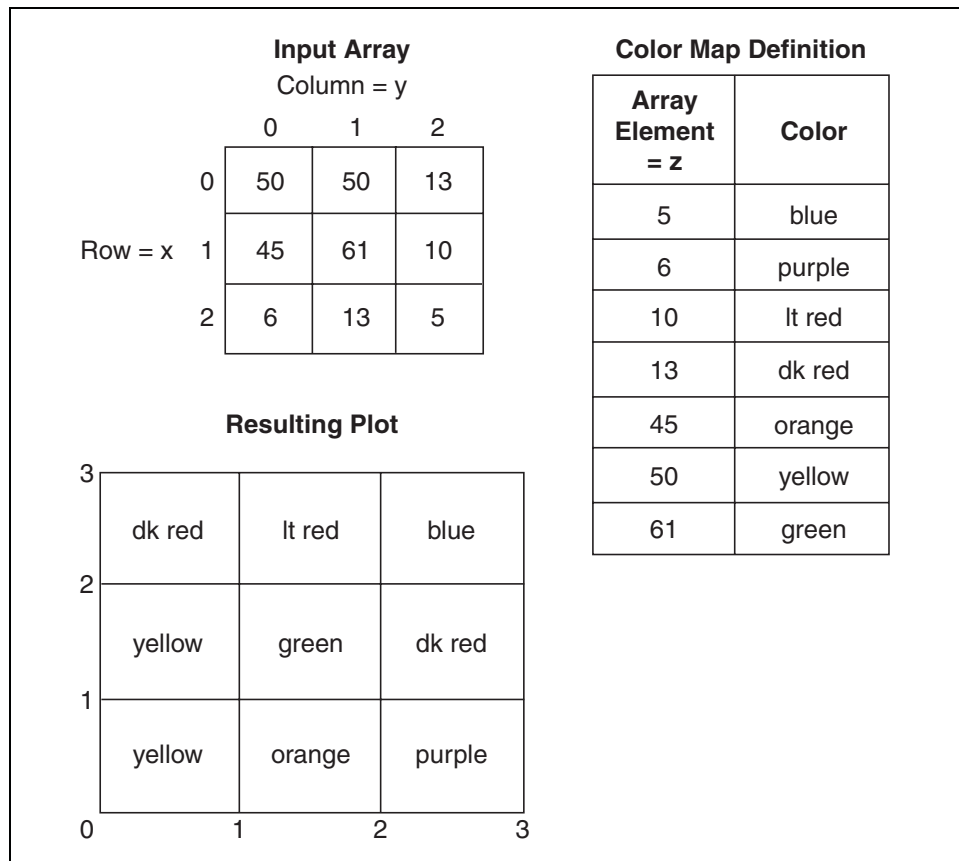

Figure 11-5. Intensity Chart Color Map

The rows of the data pass into the display as new columns on the graph or chart. If you want rows to appear as rows on the display, wire a 2D array data type to the graph or chart, right-click the graph or chart, and select **Transpose Array** from the shortcut menu.

The array indexes correspond to the lower left vertex of the block of color. The block of color has a unit area, which is the area between the two points, as defined by the array indexes. The intensity graph or chart can display up

to 256 discrete colors. To display large quantities of data on an intensity chart, make sure enough memory is available.

After you plot a block of data on an intensity chart, the origin of the Cartesian plane shifts to the right of the last data block. When the chart processes new data, the new data appear to the right of the old data. When a chart display is full, the oldest data scroll off the left side of the chart. This behavior is similar to the behavior of strip charts. Refer to the *Chart Update Modes* section of this chapter for more information about these charts.

Refer to the `examples\general\graphs\intgraph.llb` for examples of the intensity chart and graph.

Color Mapping

You can set the color mapping interactively for intensity graphs and charts the same way you define the colors for a color ramp numeric control. Refer to the *Color Ramps* section of Chapter 4, *Building the Front Panel*, for more information about color ramps.

You can set the color mapping for the intensity graph and chart programmatically by using the Property Node in two ways. Typically, you specify the value-to-color mappings in the Property Node. For this method, specify the **Z Scale: Marker Values** property. This property consists of an array of clusters, in which each cluster contains a numeric limit value and the corresponding color to display for that value. When you specify the color mapping in this manner, you can specify an upper out-of-range color using the **Z Scale: High Color** property and a lower out-of-range color using the **Z Scale: Low Color** property. The intensity graph and chart is limited to a total of 254 colors, with the lower and upper out-of-range colors bringing the total to 256 colors. If you specify more than 254 colors, the intensity graph or chart creates the 254-color table by interpolating among the specified colors.

If you display a bitmap on the intensity graph, you specify a color table using the **Color Table** property. With this method, you can specify an array of up to 256 colors. Data passed to the chart are mapped to indexes in this color table based on the color scale of the intensity chart. If the color scale ranges from 0 to 100, a value of 0 in the data is mapped to index 1, and a value of 100 is mapped to index 254, with interior values interpolated between 1 and 254. Anything below 0 is mapped to the out-of-range below color (index 0), and anything above 100 is mapped to the out-of-range above color (index 255).



Note The colors you want the intensity graph or chart to display are limited to the exact colors and number of colors your video card can display. You are also limited by the number of colors allocated for your display.

Intensity Chart Options

The intensity chart shares many of the optional parts of the waveform charts, which you can show or hide by right-clicking the chart and selecting **Visible Items** from the shortcut menu. In addition, because the intensity chart includes color as a third dimension, a scale similar to a color ramp control defines the range and mappings of values to colors.

Like waveform charts, the intensity chart maintains a history of data, or buffer, from previous updates. You can configure this buffer by right-clicking the chart and selecting **Chart History Length** from the shortcut menu. The default size for an intensity chart is 128 data points. The intensity chart display can be memory intensive. For example, displaying a single-precision chart with a history of 512 points and 128 *y* values requires $512 * 128 * 4$ bytes (size of a single-precision number), or 256 KB.

Intensity Graph Options

The intensity graph works the same as the intensity chart, except it does not retain previous data and does not include update modes. Each time new data pass to an intensity graph, the new data replace old data.

The intensity graph can have cursors like other graphs. Each cursor displays the *x*, *y*, and *z* values for a specified point on the graph.

Digital Graphs

Use the waveform graph to display digital data, especially when you work with timing diagrams or logic analyzers. Refer to Chapter 8, *Digital I/O*, of the *LabVIEW Measurements Manual* for more information about acquiring digital data.

The waveform graph in Figure 11-6 displays an array of six 8-bit unsigned integers. The graph represents the integers in binary format, and each bit represents a plot on the graph.

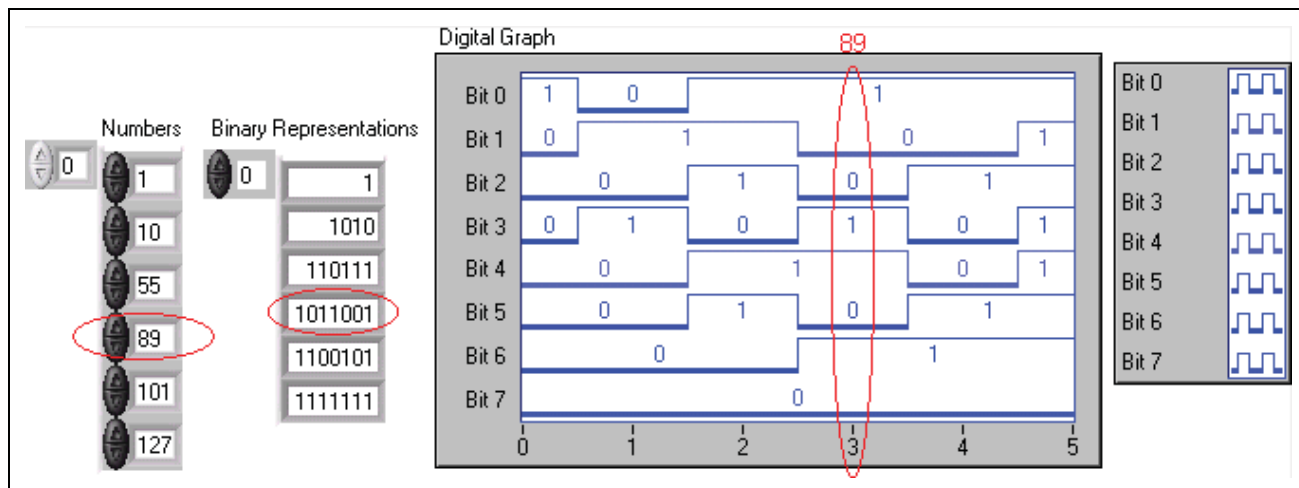

Figure 11-6. Graphing Integers Digitally

The **Binary Representations** column in Figure 11-6 corresponds to the first plot, Bit 0, on the digital graph. The **Number** column corresponds to the second plot, Bit 1, and so on. For example, the number 89 requires seven bits of memory. The binary graphical representation of the number 89 appears on point 3 on the graph.

To build a VI that displays digital data, use the Bundle function to assemble the trigger time (X0), Δx (dX), the array of numbers, and the number of ports, as shown in Figure 11-7.

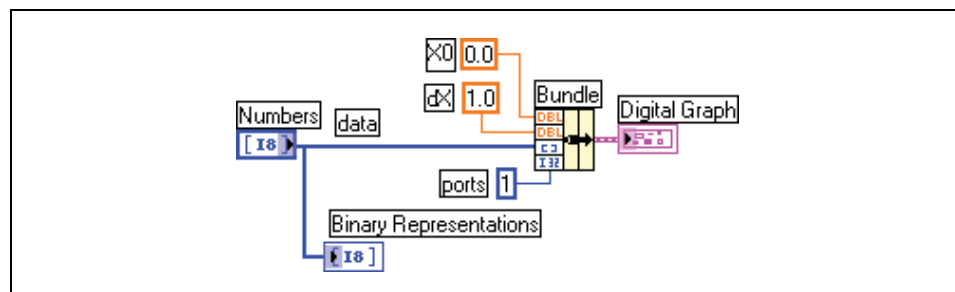

Figure 11-7. Using Bundle Function with Digital Graph

ports specifies the number of data elements to treat as a single integer. If you have 8-bit data represented as an 8-bit integer, the number of ports is one. Also, if you have 32-bit data represented as a 32-bit integer, the number of ports is one. If you have three sources of 8-bit data, you have 24 bits to represent as a single integer. In this case, use the Interleave function to interleave the 8-bit data and specify the number of ports as three, as shown in Figure 11-8.

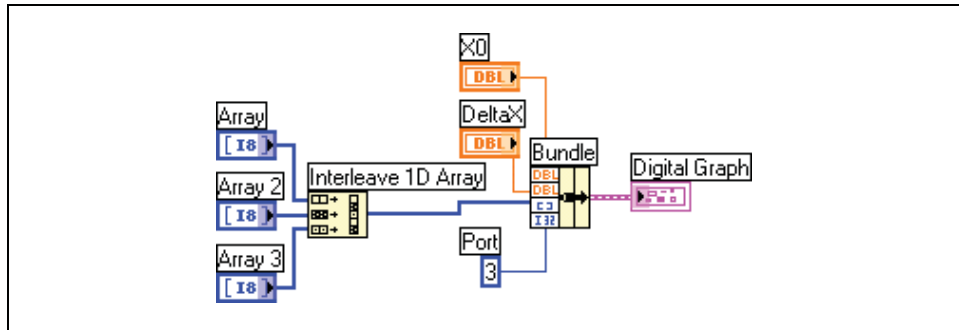

Figure 11-8. Using Interleave Function with Digital Graph

In Figure 11-8, enter 3 in **Port** to graph all three arrays of 8-bit data. Enter 2 in **Port** to graph two arrays of 8-bit data. Enter 5 in **Port** to graph five arrays of 8-bit data. This results in 16 of the 40 bits containing no values.

Masking Data

The VI in Figure 11-6 produces a graph in which each plot represents one bit in the data. You also can select, reorder, and combine bits in the data before you display it on the graph. Selecting, reordering, and combining bits is called masking the data.

Use a mask to combine the plots of two or more different bits and display them on a single plot. If you have an array of 8-bit integers, you can plot up to 8 bits on a single plot. If you have an array of 16-bit integers, you can display up to 16 bits on a single plot, and so on. You also can plot the same bit two or more times on a single plot. Refer to Appendix D, *Masking Digital Data*, for more information about masking digital data.

3D Graphs



Note The 3D graph controls are available only for Windows in the LabVIEW Full and Professional Development Systems.

For many real-world data sets, such as the temperature distribution on a surface, joint time-frequency analysis, and the motion of an airplane, you need to visualize data in three dimensions. With the 3D graphs, you can visualize three-dimensional data and alter the way that data appear by modifying the 3D graph properties.

The following 3D graphs are available:

- **3D Surface**—Draws a surface in 3D space. When you drop this control on the front panel, LabVIEW wires it to a subVI that receives the data that represent the surface.
- **3D Parametric**—Draws a complex surface in 3D space. When you drop this control on the front panel, LabVIEW wires it to a subVI that receives the data that represent the surface.
- **3D Curve**—Draws a line in 3D space. When you drop this control on the front panel, LabVIEW wires it to a subVI that receives the data that represent the line.

Use the 3D graphs in conjunction with the 3D Graph VIs located on the **Functions»Graphics & Sound»3D Graph Properties** palette to plot curves and surfaces. A curve contains individual points on the graph, each point having an x , y , and z coordinate. The VI then connects these points with a line. A curve is ideal for visualizing the path of a moving object, such as the flight path of an airplane.

The 3D graphs use ActiveX technology and VIs that handle 3D representation. You can set properties for the VIs located on the **Functions»Graphics & Sound»3D Graph Properties** palette to change behavior at run time, including setting basic, axes, grid, and projection properties.

A surface plot uses x , y , and z data to plot points on the graph. The surface plot then connects these points, forming a three-dimensional surface view of the data. For example, you could use a surface plot for terrain mapping.

When you select a 3D graph, LabVIEW places an ActiveX Container on the front panel that contains a 3D graph control. LabVIEW also places a reference to the 3D graph control on the block diagram. LabVIEW wires this reference to one of the three 3D Graph VIs.

Waveform Data Type

The waveform data type is a cluster of elements that carries the data, start time, and Δt of a waveform. You can create waveforms using the **Build Waveform** function located on the **Functions»Waveform** palette. Many of the VIs and functions you use to acquire or analyze waveforms accept and return the waveform data type by default. When you wire a waveform data type to a waveform graph or chart, the graph or chart automatically plots a waveform based on the data, start time, and Δx of the waveform. When you

wire an array of waveform data types to a waveform graph or chart, the graph or chart automatically plots all the waveforms. Refer to Chapter 5, *Introduction to Data Acquisition in LabVIEW*, of the *LabVIEW Measurements Manual* for more information about using the waveform data type.

Graphics and Sound VIs

Use the Graphics and Sound VIs and functions located on the **Functions»Graphics & Sound** palette to display or modify graphics and sound in VIs.

For more information...

Refer to the *LabVIEW Help* for more information about using graphics and sound in VIs.

Using the Picture Indicator

The picture indicator located on the **Controls»Graph»Ctrls** palette is a general purpose indicator for displaying pictures that can contain lines, circles, text, and other types of graphic shapes. Because you have pixel-level control over the picture indicator, you can create nearly any graphics object.

The picture indicator has a pixel-based coordinate system in which the origin (0,0) is the pixel located at the top left corner of the control. The horizontal (x) component of a coordinate increases toward the right, and the vertical (y) coordinate increases toward the bottom.

If a picture is too large for the picture indicator that displays it, LabVIEW crops the picture so you can see only the pixels that fit within the display region of the indicator. Use the Positioning tool to resize the indicator and run the VI again to view the entire picture.

To programmatically read or change the size of the picture area of the picture indicator, use the **Draw Area Size** property. To read the size of the entire picture indicator, use the **Bounds** property. You also can use the Positioning tool to select the indicator, select **Edit»Customize Control**, and use the **Control Parts** window of the Control Editor to determine the size of the entire picture indicator and the size of the display region of the picture indicator.



When you place a picture indicator on the front panel, it appears as a blank rectangular area, and a corresponding terminal, shown at left, appears on the block diagram. Use the Picture Functions VIs located on the **Functions»Graphics & Sound»Picture Functions** palette instead of a graphics application to modify and add functionality to graphics in LabVIEW.

To display an image in a picture indicator, you must use the Picture Functions VIs to specify a set of drawing instructions. Each VI takes a set of inputs that describes a drawing instruction. Based on these inputs, the VI creates a compact description of these specifications that you pass to the picture indicator for display.

You can connect the pictures you create with the Picture Functions VIs only to a picture indicator or to the **picture** input of a Picture Functions VI. LabVIEW draws the picture when it updates the picture indicator on an open front panel.

Each Picture Functions VI concatenates its drawing instruction to the previous drawing instruction(s) of the **picture** input and output. If the **picture** input is unwired, the **picture** output returns a blank rectangular drawing area.

The following block diagram uses the Draw Rect VI to draw two overlapping rectangles.

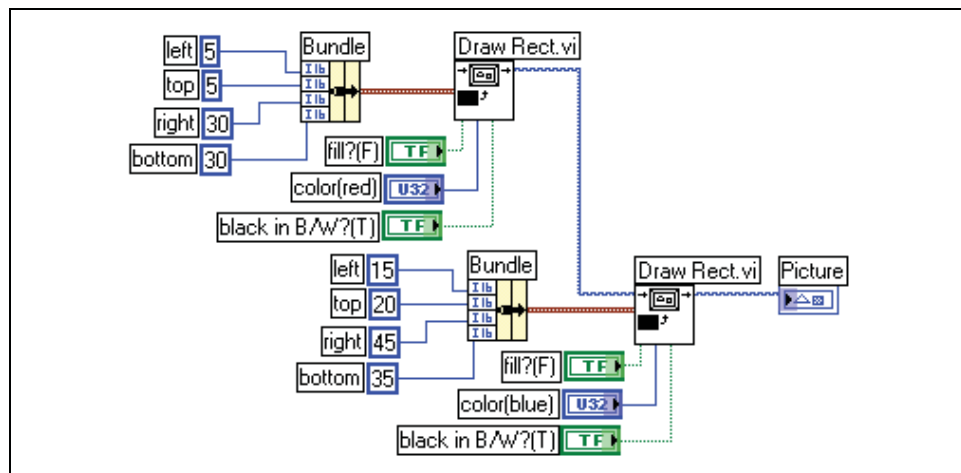

The **black in B/W?** Boolean control indicates whether the rectangle is black or white if you display it on a monochrome monitor. If you create a set of VIs that use the picture indicator and you want the VIs to run on all monitors, you must use the **black in B/W?** control.

Picture Plots VIs

Use the Picture Plot VIs located on the **Functions»Graphics & Sound»Picture Plots** palette to create common types of graphs using the picture indicator. These graphs include a polar plot, a waveform graph display, a Smith plot, and a graph scale.

The Picture Plot VIs use low-level drawing functions to create a graphical display of your data and customize the drawing code to add functionality. These graphical displays are not as interactive as the built-in LabVIEW controls, but you can use them to visualize information in ways the built-in controls currently cannot. Use the Plot Waveform VI to create a plot with slightly different functionality than built-in LabVIEW graphs.

Using the Polar Plot VI as a SubVI

Use the Polar Plot VI to draw specific, contiguous quadrants of a polar graph or the entire graph at once. As with the built-in LabVIEW graphs, you can specify the color of the components, include a grid, and specify the range and format for the scales.

The Polar Plot VI provides a large amount of functionality in a single VI. Consequently, the VI includes complicated clusters for inputs. You can use default values and custom controls to decrease the complexity of the VI. Instead of creating your own cluster input on the block diagram, copy a custom control from the Polar Plot Demo VI in the `examples\picture\demos.llb` and place it on your front panel.

Using the Waveform Plot VI as a SubVI

Use the Plot Waveform VI, which emulates the behavior of the built-in waveform graph, to draw waveforms in a variety of styles, including points, connected lines, and bars. As with the built-in LabVIEW waveform graphs, you can specify the color of the components, include a grid, and specify the range and format for the scales.

The Waveform Plot VI provides a large amount of functionality in a single VI. Consequently, the VI includes complicated clusters for inputs. You can use default values and custom controls to decrease the complexity of the VIs. Instead of creating your own cluster input, copy a custom control from the Waveform and XY Plots VI in the `examples\picture\demos.llb` and place it on your front panel.

The Plot XY VI and the Plot Multi-XY VI are similar to the Plot Waveform VI. You use different controls to specify the cosmetic appearance of the plot because the XY plotting VIs have three plot styles—two scatter plot styles and a plot style where a line is drawn at each unique x -position to mark the minimum and maximum y -values for that x -value.

Using the Smith Plot VIs as SubVIs

Use the Smith Plot VIs to study transmission line behavior, such as in the telecommunications industry. A transmission line is a medium through which you transmit energy and signals. A transmission line can be a wire or it can be the atmosphere through which a signal transmits. Transmission lines have an effect on the signal that is transmitting. This effect, called the impedance of the transmission line, can attenuate or phase shift an AC signal.

The impedance of the transmission line is a measure of the resistance and the reactance of the line. The impedance, z , is commonly listed as a complex number of the form $z = r + jx$, where both resistance (r) and reactance (x) are components.

Use the Smith Plot VIs to display impedances of transmission lines. The plot consists of circles of constant resistance and reactance.

You can plot a given impedance, $r + jx$, by locating the intersection of the appropriate r circle and x circle. After you plot the impedance, use the Smith Plot VIs as visual aids to match impedance and to calculate the reflection coefficient of a transmission line.

The Smith Plot VIs provide a large amount of functionality in each single VI. Consequently, many of these VIs include complicated clusters for inputs. You can use default values and custom controls to decrease the complexity of the VIs. Instead of creating your own cluster input, copy a custom control from the Smith Plot example VIs in the `examples\picture\demos.llb` and place it on your front panel.

If you are graphing load impedances, you can represent an impedance as a complex number of the form $r + jx$.

To avoid losing detail in the Smith plot, use the Normalize Smith Plot VI to normalize the data. You can pass the data you normalize with the Normalize Smith Plot VI directly to the Smith Plot VI. You usually scale Smith plot data with respect to the characteristic impedance (Z_0) of the system.

Picture Functions VIs

Use the Picture Functions VIs located on the **Functions»Graphics & Sound»Picture Functions** palette to draw shapes and enter text into a picture indicator. You can draw points, lines, shapes, and pixmaps. Pixmaps of unflattened data are 2D arrays of color, where each value corresponds to a color.

The first row of the **Picture Functions** palette contains VIs you use to draw points and lines. A point is a cluster of two 16-bit signed integers that represent the x- and y-coordinates of a pixel. When you draw, the picture remembers the position of the graphics pen.

For most of the Picture Functions VIs, you must specify absolute coordinates—that is, relative to the origin (0,0). With Draw Line VI and Move Pen VI, you can specify either absolute or relative coordinates. Relative coordinates are relative to the current location of the pen. You can use the Move Pen VI to change the location of the pen without drawing. Only the Draw Point VI, Move Pen VI, Draw Line VI, and Draw Multiple Lines VI change the location of the pen.

The second row of the **Picture Functions** palette contains VIs you use to draw a filled shape. Each of these VIs draws a shape in a rectangular area of a picture. You specify a rectangle as a cluster of four values that represent the left, top, right, and bottom pixels. With the Draw Arc VI, the rectangle describes the size of an oval. Additional parameters specify the portion of the oval (the arc) you want to draw.

The third row of the **Picture Functions** palette contains VIs you use to draw text in a picture. The Get Text Rect VI does not draw any text. Instead, you use it to calculate the size of a bounding rectangle of a string.

The fourth row of the **Picture Functions** palette contains VIs you use to draw pixmaps in a picture. In addition to specifying the 2D array of data, you also specify the color table for corresponding array values to colors. The 2D array corresponds to a grid of pixels. These VIs convert each value in the data array into a color by using the value as an index into the color table array.

The last row of the **Picture Functions** palette contains the Empty Picture constant, which you use whenever you need to start with or make changes to an empty picture.

Creating and Modifying Colors with the Picture Functions VIs

Many of the Picture Functions VIs have a **color** input to modify the color of the shapes and text. The easiest way to create a color is to use a color box constant located on the **Functions»Numeric»Additional Numeric Constants** palette and click the constant to select a color.

To create colors as the result of calculations rather than with color box constants, you need to understand how a color box specifies a color using a numeric value.

A 32-bit signed integer represents a color, and the lower three bytes represent the red, green, and blue components of the color. For a range of blue colors, create an array of 32-bit integers where only the values of the low bytes change because the low byte contains the blue component. To create a range of gray colors, create an array of 32-bit integers where the red, green, and blue values of each element are the same.

Graphics Formats VIs

Use the Graphics Formats VIs located on the **Functions»Graphics & Sound»Graphics Formats** palette to read data from and write data to several standard graphic file formats, including bitmap (.bmp), Portable Network Graphics (.png), and Joint Photographic Experts Group (.jpg) files. You can use these VIs to perform the following tasks:

- Read data from a bitmap file for display in a picture indicator.
- Read data for image manipulation.
- Write an image for viewing in other applications.

Bitmap data are 2D arrays in which the data type of each point varies depending on the color depth. For example, in a black-and-white, or 1-bit, image, each point is Boolean. In 4-bit and 8-bit images, each point is an index in a color table. For 24-bit true-color images, each point is a mixture of red, green, and blue (RGB) values.

The VIs that read and write graphics files work with data in a simple, flattened format that is closer to the way graphic files are written to disk, with the data stored in a 1D array. These graphics files are pixmap, which are similar in concept to bitmaps. You can display this flattened data directly using the Draw Flattened Pixmap VI located on the **Functions»Graphics & Sound»Picture Functions** palette. This palette contains VIs for drawing pixmaps that are 2D arrays of 1-bit (black and white), 4-bit, 8-bit, and 24-bit data.

To manipulate the data as a 2D array, you can convert it to the appropriate format using the Unflatten Pixmap VI and Flatten Pixmap VI located on the **Functions»Graphics & Sound»Graphics Formats** palette.

Sound VIs

Use the Sound VIs located on the **Functions»Graphics & Sound»Sound** palette to integrate sound files and functions into your VIs. You can use these VIs to perform the following tasks:

- Create VIs that play sound files, such as a recorded warning, when users perform certain actions.
- Create a VI that plays a sound file when the VI starts or finishes running or when you reach a certain point in the VI.
- Configure a sound input device to acquire sound data. Use the Sound Input VIs to acquire the sound data. You also can read any sound information coming through the device.
- Configure a sound output device to accept sound data from other Sound VIs. You can control the volume of the sound going through the device, play or pause the sound, and clear the sound from your system.

File I/O

File I/O operations pass data to and from files. Use the File I/O VIs and functions located on the **Functions»File I/O** palette to handle all aspects of file I/O, including the following:

- Opening and closing data files
- Reading data from and writing data to files
- Reading from and writing to spreadsheet-formatted files
- Moving and renaming files and directories
- Changing file characteristics
- Creating, modifying, and reading a configuration file

Use the high-level VIs to perform common I/O operations. Use the low-level VIs and functions to control each file I/O operation individually.

For more information...

Refer to the *LabVIEW Help* for more information about performing file I/O operations.

Basics of File I/O

A typical file I/O operation involves the following process.

1. Create or open a file. Indicate where an existing file resides or where you want to create a new file by specifying a path or responding to a dialog box to direct LabVIEW to the file location. After the file opens, a refnum represents the file. Refer to the *References to Objects or Applications* section of Chapter 4, *Building the Front Panel*, for more information about refnums.
2. Read from or write to the file.
3. Close the file.

Most File I/O VIs and functions perform only one step in a file I/O operation. However, some high-level File I/O VIs designed for common file

I/O operations perform all three steps. Although these VIs are not always as efficient as the low-level functions, you might find them easier to use.

Choosing a File I/O Format

The File I/O VIs you use depend on the format of the files. You can read data from or write data to files in three formats—text, binary, and datalog. The format you use depends on the data you acquire or create and the applications that will access that data.

Use the following basic guidelines to determine which format to use:

- If you want to make your data available to other applications, such as Microsoft Excel, use text files because they are the most common and the most portable.
- If you need to randomly access reads or writes or if speed and compact disk space are crucial, use binary files because they are more efficient than text files in disk space and in speed.
- If you want to manipulate complex records of data or different data types in LabVIEW, use datalog files because they are the best way to store data if you intend to access the data only from LabVIEW and you need to store complex data structures.

When to Use Text Files

Use text format files for your data to make it available to other users or applications, if disk space and file I/O speed are not crucial, if you do not need to perform random access reads or writes, and if numeric precision is not important.

Text files are the easiest format to use and to share. Almost any computer can read from or write to a text file. A variety of text-based programs can read text-based files. Most instrument control applications use text strings.

Store data in text files when you want to access it from another application, such as a word processing or spreadsheet application. To store data in text format, use the String functions located on the **Functions»String** palette to convert all data to text strings. Text files can contain information of different data types.

Text files typically take up more memory than binary and datalog files if the data is not originally in text form, such as graph or chart data, because the ASCII representation of data usually is larger than the data itself. For example, you can store the number -123.4567 in 4 bytes as a

single-precision floating-point number. However, its ASCII representation takes 9 bytes, one for each character.

In addition, it is difficult to randomly access numeric data in text files. Although each character in a string takes up exactly 1 byte of space, the space required to express a number as text typically is not fixed. To find the ninth number in a text file, LabVIEW must first read and convert the preceding eight numbers.

You might lose precision if you store numeric data in text files. Computers store numeric data as binary data, and typically you write numeric data to a text file in decimal notation. A loss of precision might occur when you read the data from the text file. Loss of precision is not an issue with binary files.

Refer to the `examples\file\smp1file.llb` and `examples\file\sprdsht.llb` for examples of using file I/O with text files.

When to Use Binary Files

A binary file uses a fixed number of storage bytes on disk. For example, storing any number from 0 to 4 billion in binary format, such as 1, 1,000, or 1,000,000, takes up 4 bytes for each number.

Use binary files to save numeric data and to access specific numbers from a file or randomly access numbers from a file. Binary files are machine readable only, unlike text files, which are human readable. Binary files are the most compact and fastest format for storing data. You can use multiple data types in binary files, but it is uncommon.

Binary files are more efficient because they use less disk space and because you do not need to convert data to and from a text representation when you store and retrieve data. A binary file can represent 256 values in 1 byte of disk space. Often, binary files contain a byte-for-byte image of the data as it was stored in memory, except for cases like extended and complex numerics. When the file contains a byte-for-byte image of the data as it was stored in memory, reading the file is faster because conversion is not necessary. Refer to the *LabVIEW Data Storage Application Note* for more information about how LabVIEW stores data.



Note Text and binary files are both known as byte stream files, which means they store data as a sequence of characters or bytes.

Refer to the Read Binary File and Write Binary File VIs in the `examples\file\smplfile.llb` for examples of reading and writing an array of double-precision floating-point values to and from a binary file, respectively.

When to Use Datalog Files

Use datalog files to access and manipulate data only in LabVIEW and to store complex data structures quickly and easily.

Datalog files are files only LabVIEW can create and read. Unlike binary files that require similar data types when storing, you can use datalog files to store several different data types in one record of a file. For example, in one datalog file you can store strings, numerics, and clusters.

A datalog file stores data as a sequence of identically structured records, similar to a spreadsheet, where each row represents a record. Each record in a datalog file must have the same data types associated with it. LabVIEW writes each record to the file as a cluster containing the data to store. However, the components of a datalog record can be any data type, which you determine when you create the file.

For example, you can create a datalog whose record data type is a cluster of a string and a number. Then, each record of the datalog is a cluster of a string and a number. However, the first record could be ("abc" , 1), while the second record could be ("xyz" , 7).

Using datalog files requires little manipulation, which makes writing and reading much faster. It also simplifies data retrieval because you can read the original blocks of data back as a record without having to read all records that precede it in the file. Random access is fast and easy with datalog files because all you need to access the record is the record number. LabVIEW sequentially assigns the record number to each record when it creates the datalog file.

You can access datalog files from the front panel and from the block diagram. Refer to the [Logging Front Panel Data](#) section of this chapter for more information about accessing datalog files from the front panel.

LabVIEW writes a record to a datalog file each time the associated VI runs. You cannot overwrite a record after LabVIEW writes it to a datalog file. When you read a datalog file, you can read one or more records at a time.

Refer to the `examples\file\datalog.llb` for examples of reading and writing datalog files.

Using High-Level File I/O VIs

Use the high-level File I/O VIs located on the top row of the **Functions»File I/O** palette to perform common I/O operations, such as writing to or reading from the following types of data:

- Characters to or from text files
- Lines from text files
- 1D or 2D arrays of single-precision numerics to or from spreadsheet text files
- 1D or 2D arrays of single-precision numerics or signed 16-bit integers to or from binary files

You can save time and programming effort by using the high-level VIs to write to and read from files. The high-level VIs perform read or write operations in addition to opening and closing the file. Avoid placing the high-level VIs in loops, because the VIs perform open and close operations each time they run. Refer to the *Disk Streaming* section for more information about keeping files open while you perform multiple operations.

The high-level VIs expect a file path input. If you do not wire a file path, a dialog box appears for you to specify a file to read from or write to. If an error occurs, the high-level VIs display a dialog box that describes the error. You can choose to halt execution or to continue.

Figure 13-1 shows how to use the high-level Write To Spreadsheet File VI to send numbers to a Microsoft Excel spreadsheet file. When you run this VI, LabVIEW prompts you to write the data to an existing file or to create a new file.

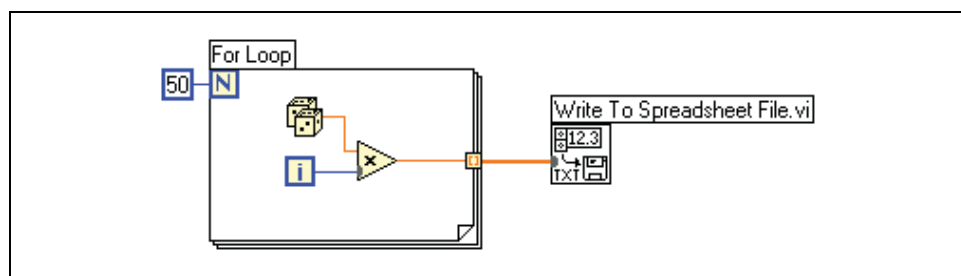

Figure 13-1. Using a High-Level VI to Write to a Spreadsheet

Use the Binary File VIs located on the **Functions»File I/O»Binary File VIs** palette to read from and write to files in binary format. Data can be integers or single-precision floating-point numerics.

Using Low-Level and Advanced File I/O VIs and Functions

Use low-level File I/O VIs and functions located on the middle row of the **Functions»File I/O** palette and the Advanced File I/O functions located on the **Functions»File I/O»Advanced File Functions** palette to control each file I/O operation individually.

Use the principal low-level functions to create or open a file, write data to or read data from the file, and close the file. Use the other low-level functions to perform the following tasks:

- Create directories.
- Move, copy, or delete files.
- List directory contents.
- Change file characteristics.
- Manipulate paths.



A path, shown at left, is a LabVIEW data type that identifies the location of a file on disk. The path describes the volume that contains the file, the directories between the top-level of the file system and the file, and the name of the file. Enter or display a path using the standard syntax for a given platform with the path control or indicator. Refer to the *Path Controls and Indicators* section of Chapter 4, *Building the Front Panel*, for more information about path controls and indicators.

Figure 13-2 shows how to use low-level VIs and functions to send numbers to a Microsoft Excel spreadsheet file. When you run this VI, the Open/Create/Replace VI opens the `numbers.xls` file. The Write File function writes the string of numbers to the file. The Close function closes the file. If you do not close the file, the file stays in memory and is not accessible from other applications or to other users.

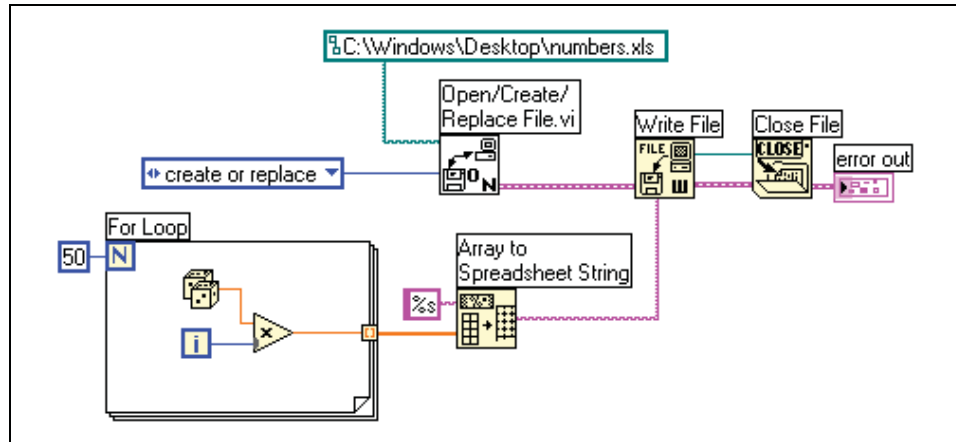

Figure 13-2. Using a Low-Level VI to Write to a Spreadsheet

Compare the VI in Figure 13-2 to the VI in Figure 13-1, which completes the same task. In Figure 13-2, you have to use the Array To Spreadsheet String function to format the array of numbers as a string. The Write To Spreadsheet File VI in Figure 13-1 opens the file, converts the array of numbers to a string, and closes the file.

Refer to the Write Datalog File Example VI in the `examples\file\datalog.llb` for an example of using low-level file I/O VIs and functions.

Disk Streaming

You also can use the low-level File I/O VIs and functions for disk streaming, which saves memory resources. Disk streaming is a technique for keeping files open while you perform multiple write operations, for example, within a loop. Although the high-level write operations are easy to use, they add the overhead of opening and closing the file each time they execute. Your VIs can be more efficient if you avoid opening and closing the same files frequently.

Disk streaming reduces the number of times the function interacts with the operating system to open and close the file. To create a typical disk-streaming operation, place the Open/Create/Replace File VI before the loop and the Close File function after the loop. Continuous writing to a file then can occur within the loop without the overhead associated with opening and closing the file.

Disk streaming is ideal in lengthy data acquisition operations where speed is critical. You can write data continuously to a file while acquisition is still in progress. For best results, avoid running other VIs and functions, such as Analyze VIs and functions, until you complete the acquisition.

Creating Text and Spreadsheet Files

To write data to a text or spreadsheet file, you must convert your data to a string. To write data to a spreadsheet file, you must format the string as a spreadsheet string, which is a string that includes delimiters, such as tabs. Refer to the *Formatting Strings* section of Chapter 9, *Grouping Data Using Strings, Arrays, and Clusters*, for more information about formatting strings.

Writing text to text files requires no formatting because most word processing applications that read text do not require formatted text. To write a text string to a text file, use the Write Characters To File VI, which automatically opens and closes the file.

Use the Write To Spreadsheet File VI or the Array To Spreadsheet String function to convert a set of numbers from a graph, a chart, or an acquisition into a spreadsheet string. Refer to the *Using High-Level File I/O VIs* and *Using Low-Level and Advanced File I/O VIs and Functions* sections of this chapter for more information about using these VIs and functions.

Reading text from a word processing application might result in errors because word processing applications format text with different fonts, colors, styles, and sizes that the spreadsheet file VIs cannot process.

If you want to write numbers and text to a spreadsheet or word processing application, use the String functions located on the **Functions»String** palette and the Array functions located on the **Functions»Array** palette to format the data and to combine the strings. Then write the data to a file. Refer to Chapter 9, *Grouping Data Using Strings, Arrays, and Clusters*, for more information about using these functions to format and combine data.

Formatting and Writing Data to Files

Use the Format Into File function to format string, numeric, path, and Boolean data as text and to write the formatted text to a file. Often you can use this function instead of separately formatting the string with the Format Into String function and writing the resulting string with the Write Characters To File VI or Write File function.

You can append or overwrite existing data in a file with the Format Into File function. Use the Seek function to set a file mark in a refnum. After the Format into File function writes the resulting string, the file mark is set to the end of the text.

Refer to the *Formatting Strings* section of Chapter 9, *Grouping Data Using Strings, Arrays, and Clusters*, for more information about formatting strings.

Scanning Data from Files

Use the Scan From File function to scan text in a file for string, numeric, path, and Boolean values and then convert the text into a data type. Often you can use this function instead of reading data from a file with the Read File function or Read Characters From File VI and scanning the resulting string with the Scan From String function.

Use the Scan From File function to read formatted text in the file. Use the Seek function to set the mark where the scanning starts.

Creating Binary Files

To create a binary file, acquire a set of numbers and write them to a file. You do not have to format the numbers unless you want to use the high-level Binary File I/O VIs located on the **Functions»File I/O»Binary File VIs** palette.

Use the Write To I16 and Write To SGL VIs to save 1D and 2D arrays of numbers to a file. You must first format the numbers as 16-bit integers or single-precision floating-point numerics. Use the Read I16 and Read SGL VIs to read the files you created.

To write numbers of different data types, such as double-precision floating-point numerics or 32-bit unsigned integers, use the low-level or Advanced File functions located on the **Functions»File I/O»Advanced File Functions** palette. When you read the file, use the Read File function and specify the data type of the number.

Refer to the Read Binary File and Write Binary File VIs in the `examples\file\smp1file.llb` for examples of writing and reading floating-point numerics to and from a binary file.

Creating Datalog Files

You can create and read datalog files by enabling front panel datalogging or by using the low-level or Advanced File functions located on the **Functions»File I/O»Advanced File Functions** palette to acquire data and write the data to a file. Refer to the *Logging Front Panel Data* section of this chapter for more information about creating and accessing datalog files from the front panel.

You do not have to format the data in a datalog file. However, when you write or read datalog files, you must specify the data type. For example, if you acquire a temperature reading with the time and date the temperature was recorded, you write the data to a datalog file and specify the data as a cluster of one number and two strings. Refer to the Simple Temp Datalogger VI in the `examples\file\datalog.llb` for an example of writing data to a datalog file.

If you read a file that includes a temperature reading with the time and date the temperature was recorded, you specify that you want to read a cluster of one number and two strings. Refer to the Simple Temp Datalog Reader VI in the `examples\file\datalog.llb` for an example of reading a datalog file.

Writing Waveforms to Files

Use the Write Waveforms to File and Export Waveforms to Spreadsheet File VIs located on the **Functions»Waveform»Waveform File I/O** palette to send waveforms to files. You can write waveforms to spreadsheet, text, or datalog files.

If you expect to use the waveform you create only in a VI, save the waveform as a datalog file (.log). Refer to the *When to Use Datalog Files* section of this chapter for more information about datalogging.

The VI in Figure 13-3 acquires multiple waveforms, displays them on a graph, and writes them to a Microsoft Excel spreadsheet file.

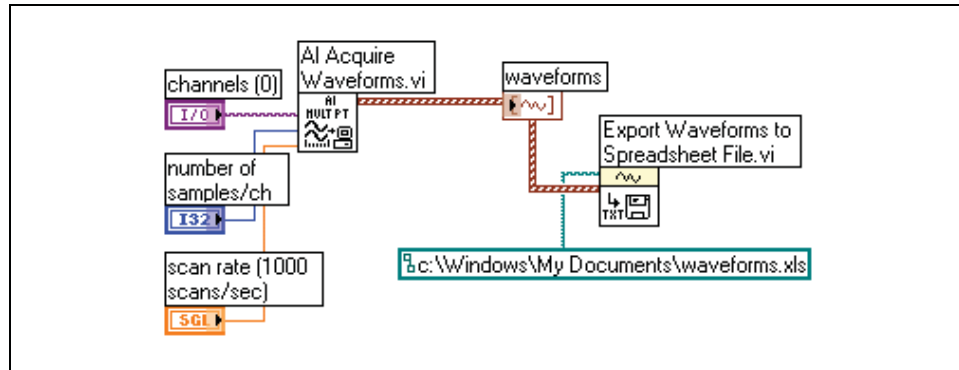

Figure 13-3. Writing Multiple Waveforms to a Spreadsheet File

Reading Waveforms from Files

Use the Read Waveform from File VI located on the **Functions»Waveform»Waveform File I/O** palette to read waveforms from a file. After you read a single waveform, you can add or edit waveform data type components with the Build Waveform function located on the **Functions»Waveform** palette, or you can extract waveform components with the Get Waveform Attribute function located on the **Functions»Waveform** palette.

The VI in Figure 13-4 reads a waveform from a file, edits the **dt** component of the waveform, and plots the edited waveform to a graph.

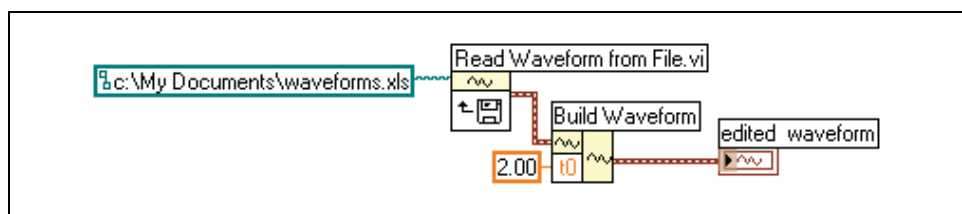

Figure 13-4. Reading a Waveform from a File

The Read Waveform from File VI also reads multiple waveforms from a file. The VI returns an array of waveform data types, which you can display in a multiplot graph. If you want to access a single waveform from a file, you must index the array of waveform data types, as shown in Figure 13-5. Refer to the *Arrays* section of Chapter 9, *Grouping Data Using Strings, Arrays, and Clusters*, for more information about indexing arrays. The VI accesses a file that includes multiple waveforms. The Index Array function reads the first and third waveforms in the file and plots them on two separate waveform graphs. Refer to Chapter 8, *Loop and Case Structures*, for more information about graphs.

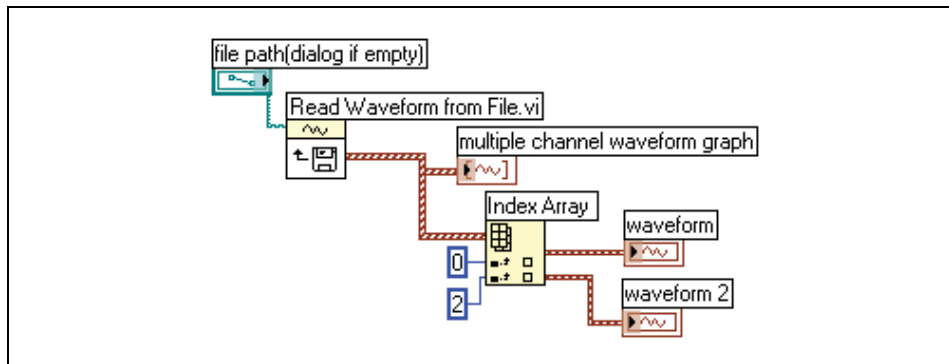

Figure 13-5. Reading Multiple Waveforms from a File

Flow-Through Parameters

Many File I/O VIs and functions contain flow-through parameters, typically a refnum or path, that return the same value as the corresponding input parameter. Use these parameters to control the execution order of the functions. By wiring the flow-through output of the first node you want to execute to the corresponding input of the next node you want to execute, you create artificial data dependency. Without these flow-through parameters, you have to use Sequence structures to ensure that file I/O operations take place in the order you want. Refer to the *Data Dependency and Artificial Data Dependency* section of Chapter 5, *Building the Block Diagram*, for more information about artificial data dependency.

Creating Configuration Files

Use the Configuration File VIs located on the **Functions»File I/O»Configuration File VIs** palette to read and create standard Windows configuration settings (.ini) files and to write platform-specific data, such as paths, in a platform-independent format so that you can use the files these VIs generate across multiple platforms.

Refer to the `examples\file\config.llb` for examples of using the Configuration File VIs.



Note The standard extension for Windows configuration settings files is .ini, but the Configuration File VIs work with files with any extension, provided the content is in the correct format. Refer to the *Windows Configuration Settings File Format* section of this chapter for more information about configuring the content.

Using Configuration Settings Files

A standard Windows configuration settings file is a specific format for storing data in a text file. You can programmatically access data within the .ini file easily because it follows a specific format.

For example, consider a configuration settings file with the following contents:

```
[Data]
Value=7.2
```

You can use the Configuration File VIs to read this data, as shown in Figure 13-6. This VI uses the Read Key VI to read the **key** named `Value` from the **section** called `Data`. This VI works regardless of how the file changes, provided the file remains in the Windows configuration settings file format.

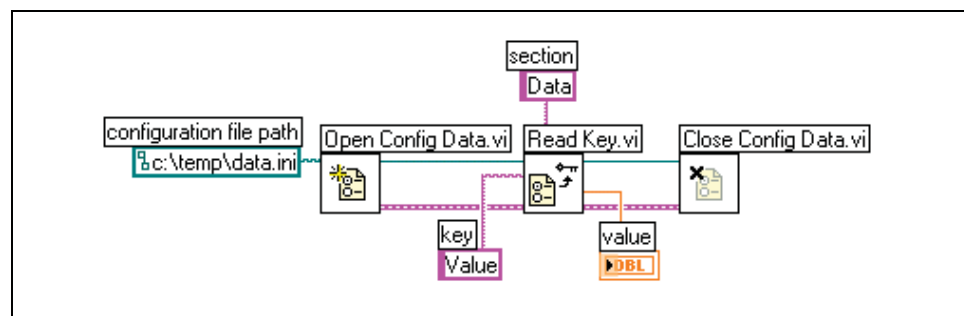

Figure 13-6. Reading Data from an .ini File

Windows Configuration Settings File Format

Windows configuration settings files are text files divided into named sections. Brackets enclose each section name. Every section name in a file must be unique. The sections contain key/value pairs separated by an equal sign (=). Within each section, every key name must be unique. The key name represents a configuration preference, and the value name represents the setting for that preference. The following example shows the arrangement of the file:

```
[Section 1]
key1=value
key2=value

[Section 2]
key1=value
key2=value
```

Use the following data types with Configuration File VIs for the value portion of the **key** parameter:

- String
- Path
- Boolean
- 64-bit double-precision floating-point numeric
- 32-bit signed integer
- 32-bit unsigned integer

The Configuration File VIs can read and write raw or escaped string data. The VIs read and write raw data byte by byte, without converting the data to ASCII. In converted, or escaped, strings LabVIEW stores any non-displayable text characters in the configuration settings file with the equivalent hexadecimal escape codes, such as `\0D` for a carriage return. In addition, LabVIEW stores backslash characters in the configuration settings file as double backslashes, such as `\\` for `\`. Set the **read raw string?** or **write raw string?** inputs of the Configuration File VIs to **TRUE** for raw data and to **FALSE** for escaped data.

When VIs write to a configuration file, they place quotation marks around any string or path data that contain a space character. If a string contains quotation marks, LabVIEW stores them as `\"`. If you read and/or write to configuration files using a text editor, you might notice that LabVIEW replaced quotation marks with `\"`.

LabVIEW stores path data in a platform-independent format, the standard UNIX format for paths, in `.ini` files. The VIs interpret the absolute path `/c/temp/data.dat` stored in a configuration settings file as follows:

- **(Windows)** `c:\temp\data.dat`
- **(Macintosh)** `c:temp:data.dat`
- **(UNIX)** `/c/temp/data.dat`

The VIs interpret the relative path `temp/data.dat` as follows:

- **(Windows)** `temp\data.dat`
- **(Macintosh)** `:temp:data.dat`
- **(UNIX)** `temp/data.dat`

Logging Front Panel Data

Use front panel datalogging to record data for use in other VIs and in reports. For example, you can log data from a graph and use that data in another graph in a separate VI.

Each time a VI runs, front panel datalogging saves the front panel data to a separate datalog file, which is in the format of delimited text. You can retrieve the data in the following ways:

- Use the same VI from which you recorded the data to retrieve the data interactively.
- Use the VI as a subVI to retrieve the data programmatically.
- Use the File I/O VIs and functions to retrieve the data.

Each VI maintains a log-file binding that records the location of the datalog file where LabVIEW maintains the logged front panel data. Log-file binding is the association between a VI and the datalog file to which you log the VI data.

A datalog file contains records that include a timestamp and the data from each time you ran the VI. When you access a datalog file, you select which record you want by running the VI in retrieval mode and using the front panel controls to view the data. When you run the VI in retrieval mode, a numeric control appears at the top of the front panel, so you can navigate among the records. Refer to Figure 13-7 for an example of this numeric control.

Automatic and Interactive Front Panel Datalogging

Select **Operate»Log at Completion** to enable automatic logging. The first time you log front panel data for a VI, LabVIEW prompts you to name the datalog file. LabVIEW logs data each time you run the VI and appends a new record to the datalog file each additional time you run the VI. You cannot overwrite a record after LabVIEW writes it to a datalog file.

To log your data interactively, select **Operate»Data Logging»Log**. LabVIEW appends the data to the datalog file immediately. Log your data interactively so you can select when to log the data. Logging your data automatically logs the data each time you run the VI.



Note A waveform chart logs only one data point at a time with front panel datalogging. If you wire an array to the chart indicator, the datalog file contains a subset of the array the chart displays.

Viewing the Logged Front Panel Data Interactively

After you log data, you can view it interactively by selecting **Operate»Data Logging»Retrieve**. The data retrieval toolbar appears, as shown in Figure 13-7.

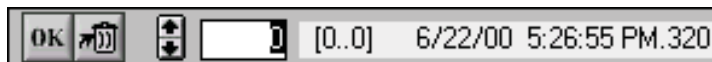

Figure 13-7. Data Retrieval Toolbar

The highlighted number indicates the data record you are viewing. The numbers in square brackets indicate the range of records you logged for the current VI. You log a record each time you run the VI. The date and time indicate when you logged the selected record. View the next or previous record by clicking the increment or decrement arrows. You also can use the up and down arrow keys on your keyboard.

In addition to the data retrieval toolbar, the front panel appearance changes according to the record you select in the toolbar. For example, when you click the increment arrow and advance to another record, the controls and indicator display the data for that particular record at the time you logged the data. Click the **OK** button to exit retrieval mode and return to the VI whose datalog file you were viewing.

Deleting a Record

While in retrieval mode, you can delete specific records. Mark for deletion an individual record in retrieval mode by viewing that record and clicking the **Trash** button. If you click the **Trash** button again, the record is no longer marked for deletion.

Select **Operate»Data Logging»Purge Data** while in retrieval mode to delete all the records you marked for deletion.

If you do not select **Operate»Data Logging»Purge Data** before you click the **OK** button, LabVIEW prompts you to delete the marked records.

Clearing the Log-File Binding

Use log-file binding to associate a VI with the datalog file to use when logging or retrieving front panel data. You can have two or more datalog files associated with one VI. This might help you test or compare the VI data. For example, you could compare the data logged the first time you run the VI to the data logged the second time you run the VI. To associate more

than one datalog file with a VI, you must clear the log-file binding by selecting **Operate»Data Logging»Clear Log File Binding**. LabVIEW prompts you to specify a datalog file the next time you run the VI either with automatic logging enabled or when you choose to log data interactively.

Changing the Log-File Binding

Change the log-file binding to log front panel data to or retrieve front panel data from a different log file by selecting **Operate»Data Logging»Change Log File Binding**. LabVIEW prompts you to select a different log file or to create a new one. You might change log-file binding when you want to retrieve different data into a VI or append data from the VI to another datalog file.

Retrieving Front Panel Data Programmatically

You also can retrieve logged data using a subVI or using the File I/O VIs and functions.

Retrieving Front Panel Data Using a SubVI

When you right-click a subVI and select **Enable Database Access** from the shortcut menu, a yellow box appears around the subVI, as shown in Figure 13-8.

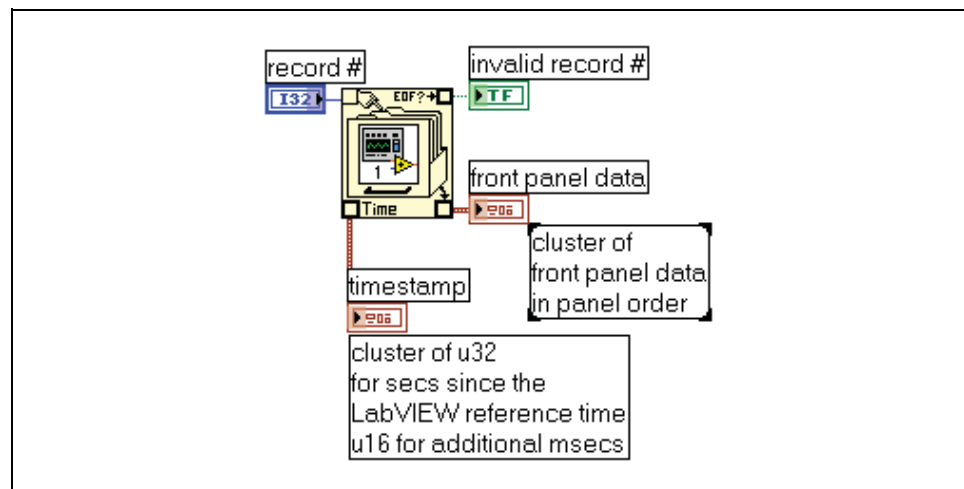

Figure 13-8. Retrieving Logged Data

The yellow box that looks like a filing cabinet includes terminals for accessing data from the datalog file. When you enable database access for the subVI, the inputs and outputs of the subVI actually act as outputs, returning their logged data. **record #** indicates the record to retrieve,

invalid record # indicates whether the record number exists, **timestamp** is the time the record was created, and **front panel data** is a cluster of the front panel objects. You can access the data of a front panel object by wiring the **front panel data** cluster to the Unbundle function.

You also can retrieve values for specific inputs and outputs by wiring directly to the corresponding terminal on the subVI, as shown in Figure 13-9.

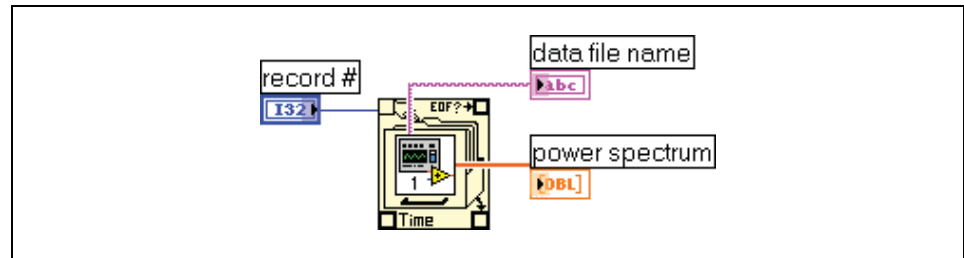

Figure 13-9. Retrieving Logged Data through SubVI Terminals

If you run the VI, the subVI does not run. Instead, it returns the logged data from its front panel to the VI front panel as a cluster.

Specifying Records

The subVI has n logged records, and you can wire any number from $-n$ to $n - 1$ to the **record #** terminal of the subVI. You can access records relative to the first logged record using non-negative record numbers. 0 represents the first record, 1 represents the second record, and so on, through $n - 1$, which represents the last record.

You can access records relative to the last logged record using negative record numbers. -1 represents the last record, -2 represents the second to the last, and so on, through $-n$, which represents the first record. If you wire a number outside the range $-n$ to $n - 1$ to the **record #** terminal, the **invalid record #** output is TRUE, and the subVI retrieves no data.

Retrieving Front Panel Data Using File I/O Functions

You also can retrieve data you logged from the front panel by using File I/O VIs and functions, such as the Read File function. The data type of each record in the front panel datalog file creates two clusters. One cluster contains a timestamp, and the other cluster contains the front panel data. The timestamp cluster includes an unsigned 32-bit integer that represents seconds and an unsigned 16-bit integer that represents milliseconds elapsed since the LabVIEW reference time, which is midnight, January 1, 1904.

You access the records of front panel datalog files with the same File I/O functions you use to access datalog files you created programmatically. Enter the **datalog record type** as the type input to the File Open function, as shown in Figure 13-10.

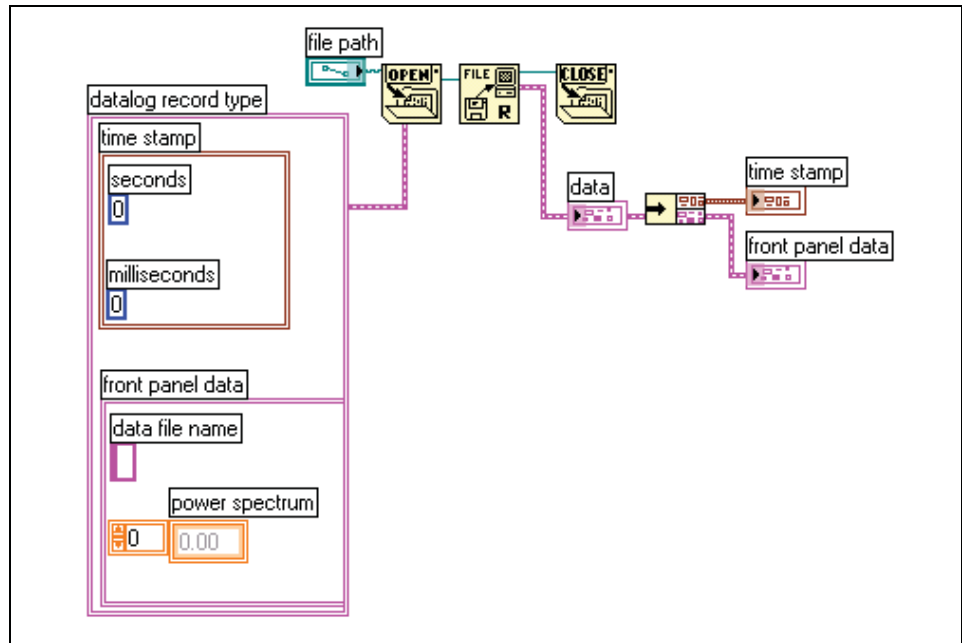

Figure 13-10. Retrieving Logged Data Using the File Open Function

Documenting and Printing VIs

You can use LabVIEW to document and print VIs.

The *Documenting VIs* section of this chapter describes how to record information about the block diagram and/or the front panel at any stage of development in printed documentation about VIs.

The *Printing VIs* section of this chapter describes options for printing VIs. Some options are more appropriate for printing information about VIs, and others are more appropriate for reporting the data and results the VIs generate. Several factors affect which printing method you use, including if you want to print manually or programmatically, how many options you need for the report format, if you need the functionality in the stand-alone applications you build, and on which platforms you run the VIs.

The *Printing Reports* section of this chapter describes how to print reports in LabVIEW.

For more information...

Refer to the *LabVIEW Help* for more information about documenting and printing VIs.

Documenting VIs

You can use LabVIEW to track development, document a finished VI, and create instructions for users of VIs. You can view documentation within LabVIEW, print it, and save it to HTML or RTF files.



Note You cannot print VI documentation in any format in built applications.

To use printed documentation most effectively, create VI and object descriptions and set up the VI revision history.

Creating VI and Object Descriptions

Create descriptions for VIs and their objects, such as controls and indicators, to describe the purpose of the VI or object and to give users instructions for using the VI or object. You can view the descriptions in LabVIEW or print them.

Create, edit, and view VI descriptions by selecting **File»VI Properties** and selecting **Documentation** from the **Category** pull-down menu. Create, edit, and view object descriptions by right-clicking the object and selecting **Description and Tip** from the shortcut menu. Tip strips are brief descriptions that appear when you move the cursor over an object. If you do not enter a tip in the **Description and Tip** dialog box, no tip strip appears. The VI or object description appears in the **Context Help** window when you move the cursor over the VI icon or object, respectively. Select **Help»Show Context Help** to display the **Context Help** window. The VI or object description also appears in any VI documentation you generate.

Setting up the VI Revision History

Use the **History** window in each VI to display the development history of the VI, including revision numbers. Record and track the changes you make to the VI in the **History** window as you make them. Select **Tools»VI Revision History** to display the **History** window. You also can print the revision history. Refer to the *Printing Documentation* section of this chapter for more information about printing the revision history.

Revision Numbers

The revision number is an easy way to track changes to a VI. The revision number starts at zero and increases incrementally every time you save the VI. The current revision number stored on disk appears in the **History** window. To display the current revision number in the titlebar of the VI, select **Tools»Options**, select **Revision History** from the top pull-down menu, and place a checkmark in the **Show revision number in titlebar** checkbox.

The number LabVIEW displays in the titlebar of the **History** window and the titlebar of the VI is the next revision number, which is the current revision number plus one. When you add a comment to the history, the header of the comment includes the next revision number. The revision number does not increase when you save a VI if you change only the **History** window.

Revision numbers are independent of comments in the **History** window. Gaps in revision numbers between comments indicate that you saved the VI without a comment.

Because the history is strictly a development tool, LabVIEW automatically removes the history when you remove the block diagram of a VI. Refer to the *Distributing VIs* section of Chapter 7, *Creating VIs and SubVIs*, for more information about removing the block diagram. The **History** window is not available in the run-time version of a VI. The **General** page of the **VI Properties** dialog box displays the revision number, even for VIs without block diagrams. Click the **Reset** button in the **History** window to erase the revision history and reset the revision number to zero.

Printing Documentation

Select **File»Print** to print VI documentation or save it to HTML or RTF files. You can select a built-in format or create a custom format for documentation. The documentation you create can include the following items:

- Connector pane and icon
- Front panel and block diagram
- Controls, indicators, and data types
- VI hierarchy
- List of subVIs
- Revision history

Saving to HTML or RTF Files

You can save VI documentation to HTML or RTF files. You can import HTML and RTF files into most word processing applications, and you can use HTML and RTF files to create compiled help files. You also can use the HTML files LabVIEW generates to display VI documentation on the Web. Refer to the *Creating Your Own Help Files* section of this chapter for more information about using HTML and RTF files to create help files. Refer to Chapter 16, *Programmatically Controlling VIs*, for more information about creating HTML and RTF files programmatically.

When you save documentation to an RTF file, specify if you want to create a file suitable for online help files or for word processing. In the help file format, LabVIEW saves the graphics to external bitmap files. In the word processing file format, LabVIEW embeds the graphics in the document. For HTML files, LabVIEW saves all graphics externally in the JPEG or PNG formats.

Selecting Graphic Formats for HTML Files

When you save documentation to an HTML file, you can select the format of the graphics files and the color depth.

The JPEG format compresses graphics well but can lose some graphic detail. This format works best for photos. For line art, front panels, and block diagrams, JPEG compression can result in fuzzy graphics and uneven colors. JPEG graphics are always 24-bit graphics. If you select a lower color depth, black-and-white for example, graphics save with the depth you requested, but the result is still a 24-bit graphic.

The PNG format also compresses graphics well, although not always as well as the JPEG format. However, PNG compression does not lose any detail. Also, it supports 1-bit, 4-bit, 8-bit, and 24-bit graphics. For lower bit depth, the resulting graphic compresses much better than JPEG. The PNG format replaces the Graphics Interchange Format (GIF). Although the PNG format has advantages over both JPEG and GIF, it is not as well supported by most Web browsers.

The GIF format also compresses graphics well and is supported by most Web browsers. Because of licensing issues, LabVIEW does not save graphics as compressed GIF files but might in the future. Use a graphics-format converter to convert the uncompressed GIF files that LabVIEW saves to compressed GIF files. You also can use a graphics-format converter to convert the PNG graphics to GIF graphics. Start out with PNG graphics because they are lossless reproductions of the original graphics. Modify the HTML file to which you saved the VI documentation to refer to the GIF graphics with the .gif extension.

Naming Conventions for Graphic Files

When you save HTML files or RTF files with external graphics, LabVIEW saves the control and indicator terminals to graphic files with consistent names. If a VI has multiple terminals of the same type, LabVIEW creates one graphic file that contains each terminal. For example, if a VI has three 32-bit signed integer inputs, LabVIEW creates a single `ci32.jpg` file.

Creating Your Own Help Files

You can use the HTML or RTF files LabVIEW generates to create your own compiled help files. **(Windows)** You can compile the individual HTML files LabVIEW generates into an HTML Help file.

You can compile the RTF files LabVIEW generates into a **(Windows)** WinHelp, **(Macintosh)** QuickHelp, or **(UNIX)** HyperHelp file.

Create links from VIs to HTML files or compiled help files by selecting **File»VI Properties** and selecting **Documentation** from the **Category** pull-down menu.

Printing VIs

You can use the following primary methods to print VIs in LabVIEW:

- Select **File»Print Window** to print the contents of the active window.
- Select **File»Print** to print more comprehensive information about a VI, including information about the front panel, block diagram, subVIs, controls, VI history, and so on. Refer to the *Printing Documentation* section of this chapter for more information about using this method to print VIs.
- Use the Report Generation VIs to print paper reports or to save HTML reports of the information the VI generates.
- Use the VI Server to programmatically print any VI window or VI documentation at any time. Refer to Chapter 16, *Programmatically Controlling VIs*, for more information about using this method to print VIs.

Printing the Active Window

Select **File»Print Window** to print the contents of the active front panel or block diagram window with the minimum number of prompts. LabVIEW prints the workspace of the active window but is not limited by the active window size. LabVIEW does not print the titlebar, menu bar, toolbar, or scroll bars.

Select **File»VI Properties** and select **Print Options** from the **Category** pull-down menu for more control over how LabVIEW prints a VI when you select **File»Print Window** or when you print programmatically. Refer to the *Printing Programmatically* section of this chapter for more information about printing programmatically.

Printing Reports

Use the Report Generation VIs located on the **Functions»Report Generation** palette to print paper reports or to save HTML reports of the information the VI generates. Create a basic report using the Easy Text Report VI or generate more complex reports using the other Report Generation VIs.



Note HTML-based report generation is available only in the LabVIEW Full and Professional Development Systems.

You can use the Report Generation VIs to perform the following tasks:

- Set the report headers and footers.
- Set text font, size, style, and color.
- Set margins and tabs.
- Determine which information appears on which line or page of a report.
- Set the report orientation—portrait or landscape.
- Include text from other files in a report.
- Clear information from an existing report.
- Automatically print a paper report or save an HTML report.
- Append text, graphics, or tables to a report.
- Dispose of a report after it prints.

Printing Programmatically

Use any of the following methods to print VIs programmatically rather than interactively with the **Print** dialog boxes that appear when you select **File»Print Window** and **File»Print**:

- Set a VI to automatically print its front panel every time it finishes running.
- Create a subVI to print the VI.
- Use the VI Server to programmatically print any VI window or VI documentation at any time. Refer to Chapter 16, *Programmatically Controlling VIs*, for more information about using this method to print VIs.

Printing at Completion

Select **Operate»Print at Completion** to print a VI when it finishes running. You also can select **File»VI Properties**, select **Print Options** from the **Category** pull-down menu, and place a checkmark in the **Automatically Print Panel Every Time VI Completes Execution** checkbox.

When you select this option, LabVIEW prints the contents of the front panel every time the VI finishes running. If you use the VI as a subVI, LabVIEW prints when that subVI finishes running and before the subVI returns to the caller.

Using a SubVI to Selectively Print at Completion

In some cases, you might not want a VI to print every time it finishes running. You might want printing to occur only if the user clicks a button or if some condition occurs, such as a test failure. You also might want more control over the format for the printout, or you might want to print only a subset of the controls. In these cases, you can use a subVI that is set to print at completion.

Create a subVI and format the front panel the way you want LabVIEW to print it. Instead of selecting **Operate»Print at Completion** while in the VI, select it while in the subVI. When you want to print, call the subVI and pass the data to it to print.

Additional Printing Techniques

If standard LabVIEW printing methods do not meet your needs, you can use the following additional techniques:

- Print data on a line-by-line basis. If you have a line-based printer connected to a serial port, use the Serial Compatibility VIs to send text to the printer. Doing so generally requires some knowledge of the command language of the printer.
- Export data to other applications, such as Microsoft Excel, save the data to a file, and print from the other application.
- **(Windows and UNIX)** Use the System Exec VI.
- **(Macintosh)** Use the AESend Print Document VI.
- **(Windows)** Use ActiveX Automation to make another application print data. Refer to Chapter 18, [ActiveX](#), for more information about ActiveX.

Customizing VIs

You can configure VIs and subVIs to work according to your application needs. For example, if you plan to use a VI as a subVI that requires user input, configure the VI so that its front panel appears each time you call it.

You can configure a VI in many ways, either within the VI itself or programmatically by using the VI Server. Refer to Chapter 16, *Programmatically Controlling VIs*, for more information about using the VI Server to configure several VIs to behave identically.

For more information...

Refer to the *LabVIEW Help* for more information about customizing VIs.

Configuring the Appearance and Behavior of VIs

Select **File»VI Properties** to configure the appearance and behavior of a VI. Use the **Category** pull-down menu at the top of the dialog box to select from several different option categories, including the following:

- **General**—Displays the current path where a VI is saved, its revision number, revision history, and any changes made since the VI was last saved. You also can use this page to edit an icon.
- **Documentation**—Use this page to add a description of the VI and link to a help file topic. Refer to the *Documenting VIs* section of Chapter 14, *Documenting and Printing VIs*, for more information about the documentation options.
- **Security**—Use this page to lock or password-protect a VI.
- **Window Appearance**—Use this page to configure various window settings.
- **Window Size**—Use this page to set the size of the window.
- **Execution**—Use this page to configure how a VI runs. For example, you can configure a VI to run immediately when it opens or to pause when called as a subVI. You also can configure the VI to run at different priorities. For example, if it is crucial that a VI runs without

waiting for another operation to complete, configure the VI to run at time-critical (highest) priority. Refer to the *Using LabVIEW to Create Multithreaded VIs for Maximum Performance and Reliability* Application Note for more information about creating multithreaded VIs.

Customizing Menus

You can create custom menus for every VI you build, and you can configure VIs to show or hide menu bars. Show and hide menu bars by selecting **File»VI Properties**, selecting **Windows Appearance** from the **Category** pull-down menu, clicking the **Customize** button, and placing or removing a checkmark from the **Show Menu Bar** checkbox.

Configuring menus includes creating the menu and providing the block diagram code that executes when the user selects the various menu items.



Note Custom menus appear only while the VI runs.

Creating Menus

You can build custom menus or modify the default LabVIEW menus statically when you edit the VI or programmatically when you run the VI. When you select **Edit»Run-Time Menu** and create a menu in the **Menu Editor** dialog box, LabVIEW creates a run-time menu (`.rtm`) file so you can have a custom menu bar on a VI rather than the default menu bar. After you create and save the `.rtm` file, you must maintain the same relative path between the VI and the `.rtm` file.

Use the **Menu Editor** dialog box to associate a custom `.rtm` file with a VI. When the VI runs, it loads the menu from the `.rtm` file. You also can use the **Menu Editor** dialog box to build custom menus either with application items, which are menu items LabVIEW provides in the default menu, or with user items, which are menu items you add. LabVIEW defines the behavior of application items, but you control the behavior of user items with the block diagram. Refer to the *Menu Selection Handling* section of this chapter for more information about handling user menu item selections.

Use the Menu Editor dialog box to customize menus when editing a VI. Use the Menu functions located on the **Functions»Application Control»Menu** palette to customize menus programmatically at run time. The functions allow you to insert, delete, and modify the attributes of user

items. You can only add or delete application items because LabVIEW defines the behavior and state of application items.

Menu Selection Handling

When you create a custom menu, you assign each menu item a unique, case-insensitive string identifier called a tag. When the user selects a menu item, you retrieve its tag programmatically using the Get Menu Selection function. LabVIEW provides a handler on the block diagram for each menu item based on the tag value of each menu item. The handler is a While Loop and Case structure combination that allows you to determine which, if any, menu is selected and to execute the appropriate code.

After you build a custom menu, build a Case structure on the block diagram that executes, or handles, each item in the custom menu. This process is called menu selection handling. LabVIEW handles all application items implicitly.

In Figure 15-1, the Get Menu Selection function reads the menu item the user selects and passes the menu item into the Case structure, where the menu item executes.

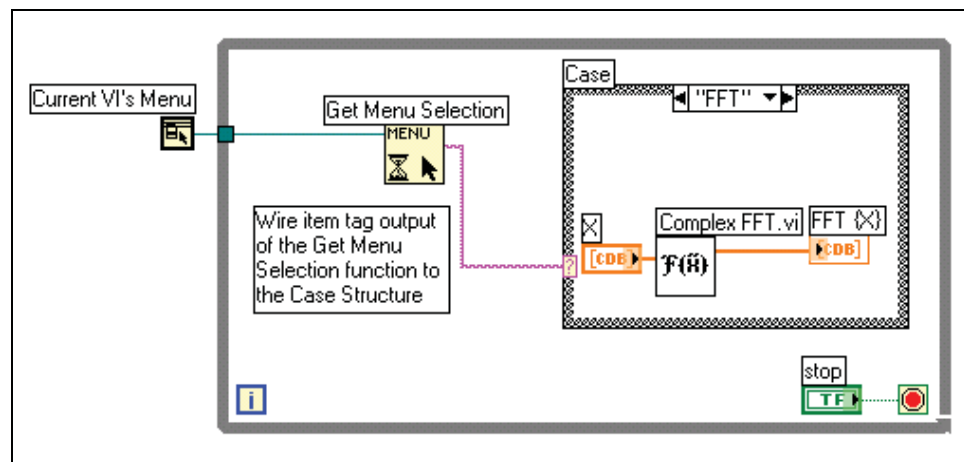

Figure 15-1. Block Diagram Using Menu Handling

If you know that a certain menu item takes a long time to process, wire a Boolean control to the **block menu** input of the Get Menu Selection function and set the Boolean control to TRUE to disable the menu bar so the user cannot select anything else on the menu while LabVIEW processes the menu item. Wire a TRUE value to the Enable Menu Tracking function to enable the menu bar after LabVIEW processes the menu item.

Programmatically Controlling VIs

You can access the VI Server through block diagrams, ActiveX technology, and the TCP protocol to communicate with VIs and other instances of LabVIEW so you can programmatically control VIs and LabVIEW. You can perform VI Server operations on a local computer or remotely across a network.

For more information...

Refer to the *LabVIEW Help* for more information about programmatically controlling VIs.

Capabilities of the VI Server

Use the VI Server to perform the following programmatic operations:

- Call a VI remotely.
- Configure an instance of LabVIEW to be a server that exports VIs you can call from other instances of LabVIEW on the Web. For example, if you have a data acquisition application that acquires and logs data at a remote site, you can sample that data occasionally from your local computer. By changing your LabVIEW preferences, you can make some VIs accessible on the Web so that transferring the latest data is as easy as a subVI call. The VI Server handles the networking details. The VI Server also works across platforms, so the client and the server can run on different platforms.
- Edit the properties of a VI and LabVIEW. For example, you can dynamically determine the location of a VI window or scroll a front panel so that a part of it is visible. You also can programmatically save any changes to disk.
- Update the properties of multiple VIs rather than manually using the **File»VI Properties** dialog box for each VI.

- Retrieve information about an instance of LabVIEW, such as the version number and edition. You also can retrieve environment information, such as the platform on which LabVIEW is running.
- Dynamically load VIs into memory when another VI needs to call them, rather than loading all subVIs when you open a VI.
- Create a plug-in architecture for the application to add functionality to the application after you distribute it to customers. For example, you might have a set of data filtering VIs, all of which take the same parameters. By designing the application to dynamically load these VIs from a plug-in directory, you can ship the application with a partial set of these VIs and make more filtering options available to users by placing the new filtering VIs in the plug-in directory.

Building VI Server Applications

The programming model for VI Server applications is based on refnums. Refnums also are used in file I/O, network connections, and other objects in LabVIEW. Refer to the *References to Objects or Applications* section Chapter 4, *Building the Front Panel*, for more information about refnums.

Typically, you open a refnum to an instance of LabVIEW or to a VI. You then use the refnum as a parameter to other VIs. The VIs get (read) or set (write) properties, execute methods, or dynamically load a referenced VI. Finally, you close the refnum, which releases the referenced VI from memory.

Use the following functions and nodes located on the **Functions» Application Control** palette to build VI Server applications:

- **Open Application Reference**—Opens a refnum to the local or remote application you are accessing through the server or to access a remote instance of LabVIEW. Use the Open VI Reference function to access a VI on the local or remote computer.
- **Property Node**—Gets and sets VI or application properties. Refer to the *Property Nodes* section of this chapter for more information about properties.
- **Invoke Node**—Invokes methods on a VI or application. Refer to the *Invoke Nodes* section of this chapter for more information about methods.
- **Call By Reference Node**—Dynamically calls the referenced VI.
- **Close LV Object Reference**—Closes the refnum to the VI or application you accessed using the VI Server.

Application and VI References

You access VI Server functionality through references to two main classes of objects—the Application object and the VI object. After you create a reference to one of these objects, you can pass the reference to a VI or function that performs an operation on the object.

An Application refnum refers to a local or remote instance of LabVIEW. You can use Application properties and methods to change LabVIEW preferences and return system information. A VI refnum refers to a VI in the instance of LabVIEW.

With a refnum to an instance of LabVIEW, you can retrieve information about the LabVIEW environment, such as the platform on which LabVIEW is running, the version number, or a list of all VIs currently in memory. You also can set information, such as the current user name or the list of VIs exported to other instances of LabVIEW.

When you get a refnum to a VI, you load the VI into memory. After you get the refnum, the VI stays in memory until you close the refnum. If you have multiple refnums to an open VI at the same time, the VI stays in memory until you close all refnums to the VI. With a refnum to a VI, you can update all the properties of the VI available in the **File»VI Properties** dialog box as well as dynamic properties, such as front panel window position. You also can programmatically print the VI, save it to another location, and export and import its strings to translate into another language.

Manipulating Application and VI Settings

Use the VI Server to get and set application and VI settings by using the Property and Invoke Nodes. You can get and set many application and VI settings only through the Property and Invoke Nodes.

Refer to `examples\viserver` for examples of using the Application and VI Class properties and methods.

Property Nodes

Use the Property Node to get and set various properties on an application or VI. Select properties from the node by using the Operating tool to click the property terminal or by right-clicking the white area of the node and selecting **Properties** from the shortcut menu.

You can read or write multiple properties using a single node. Use the Positioning tool to resize the Property Node to add new terminals. A small direction arrow to the right of the property indicates a property you read. A small direction arrow to the left of the property indicates a property you write. Right-click the property and select **Change to Read** or **Change to Write** from the shortcut menu to change the operation of the property.

The node executes from top to bottom. The Property Node does not execute if an error occurs before it executes, so always check for the possibility of errors. If an error occurs in a property, LabVIEW ignores the remaining properties and returns an error. The **error out** cluster contains information about which property caused the error.

Implicitly Linked Property Nodes

When you create a Property Node from a front panel object by right-clicking the object and selecting **Create»Property Node** from the shortcut menu, LabVIEW creates a Property Node on the block diagram that is implicitly linked to the front panel object. Because these Property Nodes are implicitly linked to the object from which it was created, they have no **refnum** input, and you do not need to wire the Property Node to the terminal of the front panel object or the control refnum. Refer to the *Controlling Front Panel Objects* section of this chapter for more information about control refnums.

Invoke Nodes

Use the Invoke Node to perform actions, or methods, on an application or a VI. Unlike the Property Node, a single Invoke Node executes only a single method on an application or VI. Select a method by using the Operating tool to click the method terminal or by right-clicking the white area of the node and selecting **Methods** from the shortcut menu.

The name of the method is always the first terminal in the list of parameters in the Invoke Node. If the method returns a value, the method terminal displays the return value. Otherwise, the method terminal has no value.

The Invoke Node lists the parameters from top to bottom with the name of the method at the top and the optional parameters in gray at the bottom.

Manipulating Application Class Properties and Methods

You can get or set properties on a local or remote instance of LabVIEW, perform methods on LabVIEW, or both. Figure 16-1 shows how to display all VIs in memory on a local computer in a string array on the front panel.

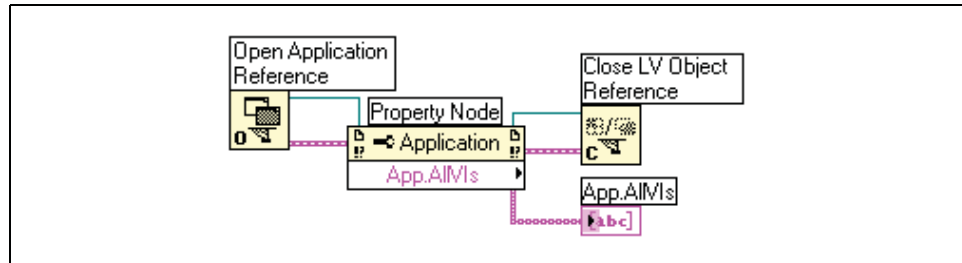

Figure 16-1. Displaying All VIs in Memory on a Local Computer

To find the VIs in memory on a remote computer, wire a string control to the **machine name** input of the Open Application Reference function, as shown in Figure 16-2, and enter the IP address or domain name. You also must select the **Exported VIs in Memory** property because the **All VIs in Memory** property used in Figure 16-1 applies only to local instances of LabVIEW.

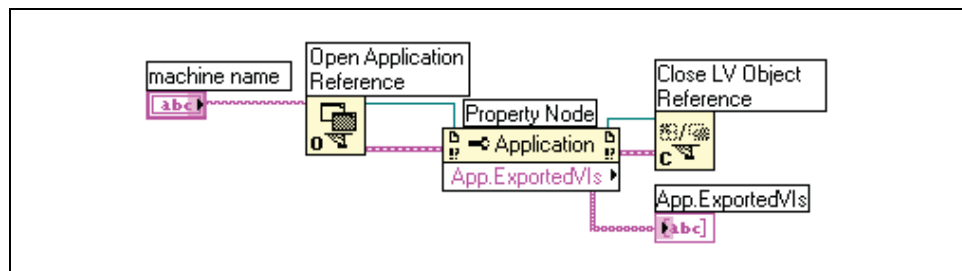

Figure 16-2. Displaying All VIs in Memory on a Remote Computer

Manipulating VI Class Properties and Methods

You can get or set properties of a VI, perform methods on a VI, or both. In Figure 16-3, LabVIEW reinitializes the front panel objects of a VI to their default values using the Invoke Node. The front panel opens and displays the default values using the Property Node.

Before you can access properties and methods of a VI, you must create a refnum to that VI with the Open VI Reference function. Use the Invoke Node to invoke a method on a VI.

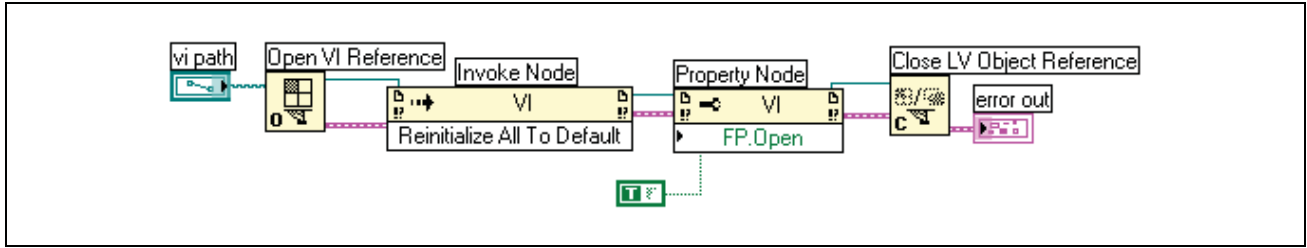

Figure 16-3. Using VI Class Property and Invoke Nodes

After you wire Open VI Reference to the Invoke Node, you can access all the VI Class methods.

The Property Node operates similarly to the Invoke Node. After you wire a VI refnum to the Property Node, you can access all the VI Class properties.

Manipulating Application and VI Class Properties and Methods

In some VIs, you must access both Application and VI Class properties or methods. You must open and close the Application and VI Class refnums separately, as shown in Figure 16-4.

Figure 16-4 shows how to determine the VIs in memory on a local computer and to display the path to each of the VIs on the front panel. To find all the VIs in memory, you must access an Application Class property. To determine the paths to each of these VIs, you must access a VI Class property. The number of VIs in memory determines the number of times the For Loop executes. Place the Open VI Reference and Close LV Object Reference functions inside the For Loop because you need a VI refnum for each VI in memory. Do not close the Application refnum until the For Loop finishes retrieving all the VI paths.

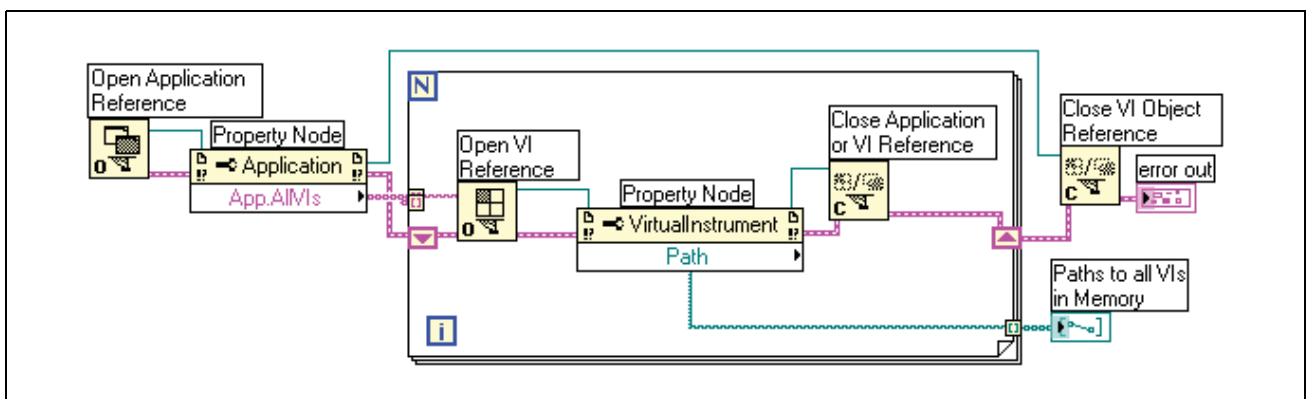

Figure 16-4. Using Application and VI Class Properties and Methods

Dynamically Loading and Calling VIs

You can dynamically load VIs instead of using statically linked subVI calls. A statically linked subVI is one you place directly on the block diagram of a caller VI. It loads at the same time the caller VI loads.

Unlike statically linked subVIs, dynamically loaded subVIs do not load until the caller VI makes the call to the subVI. If you have a large caller VI, you can save load time and memory by dynamically loading the subVI because the subVI does not load until the caller VI needs it, and you can release it from memory after the operation completes.

Call By Reference Nodes and Strictly Typed VI Refnums

Use the Call By Reference Node to dynamically call VIs.

The Call By Reference Node requires a strictly typed VI refnum. The strictly typed VI refnum identifies the connector pane of the VI you are calling. It does not create a permanent association to the VI or contain other VI information, such as the name and location. You can wire the Call By Reference Node inputs and outputs just like you wire any other VI.

Figure 16-5 shows how to use the Call By Reference Node to dynamically call the Frequency Response VI. The Call By Reference Node requires the use of the Open VI Reference and the Close LV Object Reference functions, similar to the functions you use for the Property Node and Invoke Node. However, the Call By Reference Node requires that you wire a strictly typed VI refnum to the **type specifier VI Refnum** input of the Open VI Reference function. Wire a strictly typed VI refnum by selecting **Controls»Refnum»VI Refnum** and placing the refnum on the front panel. Right-click the refnum and select **Select VI Server Class»Browse** from the shortcut menu. The **Choose the VI to open** dialog box prompts you for a VI.

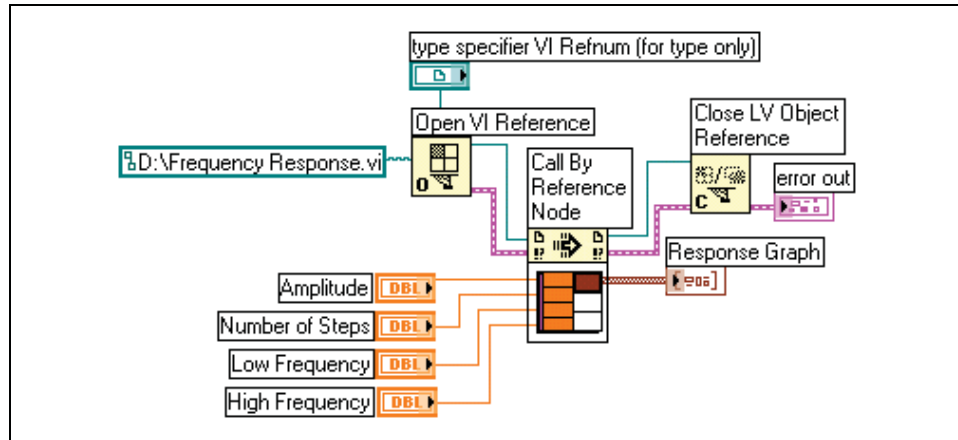

Figure 16-5. Using the Call By Reference Node

The VI you specify for strictly typed refnums provides only the connector pane information. That is, no permanent association is made between the refnum and the VI. In particular, avoid confusing selecting the VI connector pane with getting a refnum to the selected VI. You specify a particular VI using the **vi path** input on the Open VI Reference function.

Editing and Running VIs on Remote Computers

An important aspect of both Application and VI refnums is their network transparency. This means you can open refnums to objects on remote computers in the same way you open refnums to those objects on your computer.

After you open a refnum to a remote object, you can treat it in exactly the same way as a local object, with a few restrictions. For operations on a remote object, the VI Server sends the information about the operation across the network and sends the results back. The application looks almost identical regardless of whether the operation is remote or local.

Controlling Front Panel Objects

Use control refnums located on the **Controls»Refnum** and **Controls»Classic Controls»Refnum** palettes to pass front panel object references to other VIs. After you pass a control refnum to a subVI, use Property Nodes and Invoke Nodes to read and write properties and invoke methods of the referenced front panel object. Refer to the *Case and Sequence Structures* section of Chapter 8, *Loop and Case Structures*, for information about using events to control block diagram behavior programmatically through front panel objects.

Strictly Typed and Weakly Typed Control Refnums

Strictly typed control refnums accept only control refnums of the same kind of data. For example, if the type of a strictly typed control refnum is a slide of 32-bit integers, you can wire a slide of 32-bit integers, a slide of 8-bit integers, or a slide of double-precision scalars to the control refnum terminal, but not a slide of a cluster of 32-bit integers.

Control refnums you create from a control are strictly typed by default. A red star in the lower left corner of the control refnum on the front panel indicates the control refnum is strictly typed. On the block diagram, (strict) appears on the Property Node or Invoke Node wired to the control refnum terminal to indicate that the control refnum is strictly typed.



Note Because the latch mechanical actions are incompatible with strictly typed control refnums, Boolean controls with latch mechanical action produce weakly typed control refnums.

Weakly typed control refnums are more flexible in the type of data they accept. For example, if the type of a weakly typed control refnum is slide, you can wire a 32-bit integer slide, single-precision slide, or a cluster of 32-bit integer slides to the control refnum terminal. If the type of a weakly typed control refnum is control, you can wire a control refnum of any type of control to the control refnum terminal.



Note When you wire a Property Node to a weakly typed control refnum terminal, the value produces variant data, which might require conversion before you can use the data. The History Data property for charts is available only if the chart refnum is strictly typed. Refer to the *Handling Variant Data* section of Chapter 5, *Building the Block Diagram*, for more information about variant data.

Networking in LabVIEW

VIs can communicate, or network, with other processes, including those that run on other applications or on remote computers. Use the networking features in LabVIEW to perform the following tasks:

- Share live data with other VIs running on a network using National Instruments DataSocket technology.
- Publish front panel images and VI documentation on the Web.
- Build VIs that communicate with other applications and VIs through low-level protocols, such as TCP, UDP, DDE, Apple events, and PPC Toolbox.

For more information...

Refer to the *LabVIEW Help* for more information about networking in LabVIEW.

Choosing among File I/O, VI Server, ActiveX, and Networking

Networking might not be the best solution for your application. If you want to create a file that contains data other VIs and applications can read, use the File I/O VIs and functions. Refer to Chapter 13, *File I/O*, for more information about using the File I/O VIs and functions.

If you want to control other VIs, use the VI Server. Refer to Chapter 16, *Programmatically Controlling VIs*, for more information about controlling VIs and other LabVIEW applications on local and remote computers.

(Windows) If you want to access the features of many Microsoft applications, such as embedding a waveform graph in an Excel spreadsheet, use the ActiveX VIs and functions. Refer to Chapter 18, *ActiveX*, for more information about accessing ActiveX-enabled applications and permitting other ActiveX applications access to LabVIEW.

LabVIEW as a Network Client and Server

You can use LabVIEW as a client to subscribe to data and use features in other applications or as a server to make LabVIEW features available to other applications. Refer to Chapter 16, *Programmatically Controlling VIs*, for more information about using the VI Server to control VIs on local and remote computers. You control VIs by accessing properties and invoking methods using the Property Node and Invoke Node, respectively.

Before you can access the properties and invoke methods of another application, you must establish the network protocol you use to access the properties and methods. Protocols you can use include HTTP and TCP/IP. The protocol you select depends on the application. For example, the HTTP protocol is ideal for publishing on the Web, but you cannot use the HTTP protocol to build a VI that listens for data that another VI creates. To do that, use the TCP protocol.

Refer to the *Low-Level Communications Applications* section of this chapter for more information about communications protocols LabVIEW supports.

(Windows) Refer to Chapter 18, *ActiveX*, for more information about using ActiveX technology with LabVIEW as an ActiveX server or client.

Using DataSocket Technology

Use National Instruments DataSocket technology to share live data with other VIs and other applications, such as National Instruments ComponentWorks, on the Web, or on your local computer. DataSocket pulls together established communication protocols for measurement and automation in much the same way a Web browser pulls together different Internet technologies.

DataSocket technology provides access to several input and output mechanisms from the front panel through the **DataSocket Connection** dialog box. Right-click a front panel object and select **Data Operations» DataSocket Connection** from the shortcut menu to display the **DataSocket Connection** dialog box. You publish (write) or subscribe to (read) data by specifying a URL, in much the same way you specify URLs in a Web browser.

For example, if you want to share the data in a thermometer indicator on the front panel with other computers on the Web, publish the thermometer data by specifying a URL in the **DataSocket Connection** dialog box. Users on other computers subscribe to the data by placing a thermometer on their front panel and selecting the URL in the **DataSocket Connection** dialog box. Refer to the *Using DataSocket on the Front Panel* section of this chapter for more information about using DataSocket technology on the front panel.

Refer to the *Integrating the Internet into Your Measurement System* white paper for more information about DataSocket technology. This white paper is available as a PDF from the Installation CD, in the `manuals` directory, or from the National Instruments Web site at `ni.com`.

Specifying a URL

URLs use communication protocols, such as `dstp`, `ftp`, and `file`, to transfer data. The protocol you use in a URL depends on the type of data you want to publish and how you configure your network.

You can use the following protocols when you publish or subscribe to data using DataSocket:

- **DataSocket Transport Protocol (`dstp`)**—The native protocol for DataSocket connections. When you use this protocol, the VI communicates with the DataSocket server. You must provide a named tag for the data, which is appended to the URL. The DataSocket connection uses the named tag to address a particular data item on a DataSocket server. To use this protocol, you must run a DataSocket server.
- **(Windows) OLE for Process Control (`opc`)**—Designed specifically for sharing real-time production data, such as data generated by industrial automation operations. To use this protocol, you must run an OPC server.
- **(Windows) `logos`**—An internal National Instruments technology for transmitting data between the network and your local computer.
- **File Transfer Protocol (`ftp`)**—You can use this protocol to specify a file from which to read data.
- **`file`**—You can use this protocol to provide a link to a local or network file that contains data.

Table 17-1 shows examples of each protocol URL.

Table 17-1. Example DataSocket URLs

URL	Example
dstp	dstp://servername.com/numeric, where numeric is the named tag for the data
opc	opc:\National Instruments.OPCTest\item1 opc:\\machine\National Instruments.OPCModbus\Modbus Demo Box.4:0 opc:\\machine\National Instruments.OPCModbus\Modbus Demo Box.4:0?updaterate=100&deadband=0.7
logos	logos://computer_name/process/data_item_name
ftp	ftp://ftp.ni.com/datasocket/ping.wav
file	file:ping.wav file:c:\mydata\ping.wav file:\\machine\mydata\ping.wav

Use the `dstp`, `opc`, and `logos` URLs to share live data because these protocols can update remote and local controls and indicators. Use the `ftp` and `file` URLs to read data from files because these protocols cannot update remote and local controls and indicators.

Refer to the `examples/comm/datasktx.llb` for examples of using DataSocket connections.

Data Formats Supported by DataSocket

Use DataSocket to publish and subscribe to the following data:

- **Raw text**—Use raw text to deliver a string to a string indicator.
- **Tabbed text**—Use tabbed text, as in a spreadsheet, to publish data in arrays. LabVIEW interprets tabbed text as an array of data.
- **wav data**—Use `.wav` data to publish a sound to a VI or function.
- **Variant data**—Use variant data to subscribe to data from another application, such as a ComponentWorks control.

Using DataSocket on the Front Panel

Use front panel DataSocket connections to publish or subscribe to live data in a front panel object. When you share the data of a front panel object with other users, you publish data. When users retrieve the published data and view it on their front panel, users subscribe to the data.

DataSocket connections differ from Web Server and ActiveX connections because you can use DataSocket connections directly from the front panel without any block diagram programming. Each front panel control or indicator can publish or subscribe to data through its own DataSocket connection. Front panel DataSocket connections publish only the data, not a graphic of the front panel control, so the VIs that subscribe through a DataSocket connection can perform their own operations on the data.

You can set the value of a front panel control directly on the front panel and then publish the data, or you can build a block diagram, wire the output of a VI or function to an indicator, and publish the data from that indicator. Typical scenarios for using DataSocket connections with controls and indicators include the following:

- Publish a value from a front panel control to manipulate a control and publish the data for other users to subscribe to through a control or indicator. For example, if you place a knob on your front panel that raises or lowers temperature, a user on another computer can subscribe to the data and use it in a control wired to a subVI or function, or view the data in an indicator. A user cannot manipulate a front panel control on his or her VI while the control subscribes to data from the DataSocket connection.
- Publish a value that appears in a front panel indicator so another user can subscribe to the data and view the data in a control or indicator on his or her front panel, or use the results as data in a control wired to an input in a subVI or function. For example, a VI that calculates the mean temperature and displays the temperature in a thermometer on the front panel can publish the temperature data.
- Subscribe to a value from a front panel indicator to view data in a front panel indicator on your VI that appears in a control or indicator on the front panel of another VI.
- Subscribe to a value from a front panel control to view data in a front panel control on your VI that appears in a control or indicator on the front panel of another VI. If you subscribe to the data with a control, you can use the data in your VI by wiring the control to an input of a subVI or function.

- Publish from and subscribe to a front panel control so users can manipulate a control on the front panel of your VI from the front panels of their VIs. When you run the VI, the front panel control on your VI retrieves the current value that another VI or application published through the DataSocket connection. When a user changes the control value on his or her front panel, the DataSocket connection publishes the new value to the front panel control of your VI. If you then manipulate the value of your front panel control, your VI publishes the value to the front panels of other users.

The front panel objects that subscribe to data do not have to be the same kind of objects that publish the data. However, the front panel objects must be the same data type or, if they are numeric data, they must coerce. For example, you can use a digital indicator in your VI to view the data a thermometer in another VI generates. The thermometer can be a floating-point number, and the digital indicator can be an integer.

Front panel DataSocket connections are primarily intended for sharing live data. To read data in local files, FTP servers, or Web servers, use the DataSocket Read function located on the **Functions»Communication»DataSocket** palette, the File I/O VIs and functions located on the **Functions»File I/O** palette, or the Application Control VIs and functions located on the **Functions»Application Control** palette. National Instruments recommends you publish only raw text and variant data for live front panel updates.

Reading and Writing Live Data through the Block Diagram

From the block diagram, you can programmatically read or write data using the DataSocket functions located on the **Functions»Communication»DataSocket** palette.

Use the DataSocket Write function to write live data through a DataSocket connection programmatically. Figure 17-1 shows how to write a numeric value.

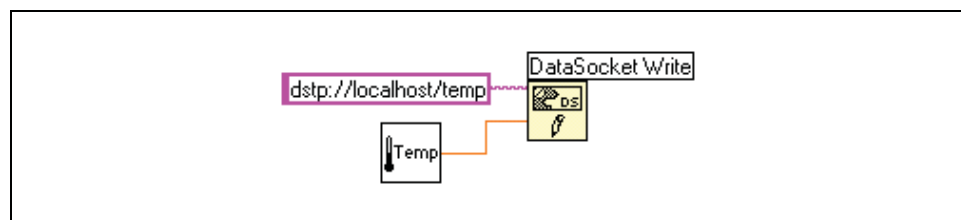

Figure 17-1. Publishing Data Using DataSocket Write

The DataSocket Write function is polymorphic, so you can wire most data types to the **data** input. Refer to the *Polymorphic VIs and Functions* section of Chapter 5, *Building the Block Diagram*, for more information about polymorphic VIs and functions.

Use the DataSocket Read function to read live data from a DataSocket connection programmatically. Figure 17-2 shows how to read data and convert it to a double-precision floating-point number.

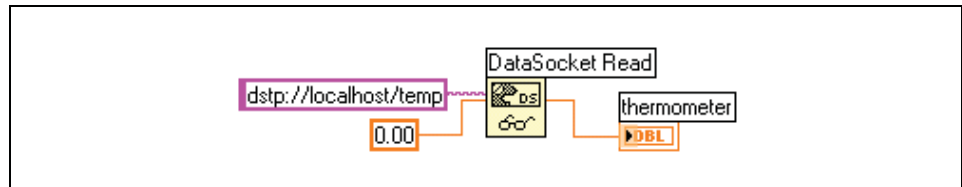

Figure 17-2. Reading a Single Value Using DataSocket Read

Convert live data to a specific data type by wiring a control or constant to the **type** input of DataSocket Read. If you do not specify a type, the **data** output of DataSocket Read returns variant data, which you must manipulate with the Variant to Data function located on the **Functions»DataSocket»Variant** palette. In some cases, you must convert variant data to LabVIEW data.

DataSocket and Variant Data

In some cases, the VI or other application that programmatically reads the data cannot convert the data back into its original data type, such as when you subscribe to data from another application. Also, you might want to add an attribute to the data, such as a timestamp or warning, which the data types do not permit.

In these cases, use the To Variant function located on the **Functions»DataSocket»Variant** palette to programmatically convert the data you write to a DataSocket connection to variant data. Figure 17-3 shows a block diagram that continually acquires a temperature reading, converts the data to variant data, and adds a timestamp as an attribute to the data.

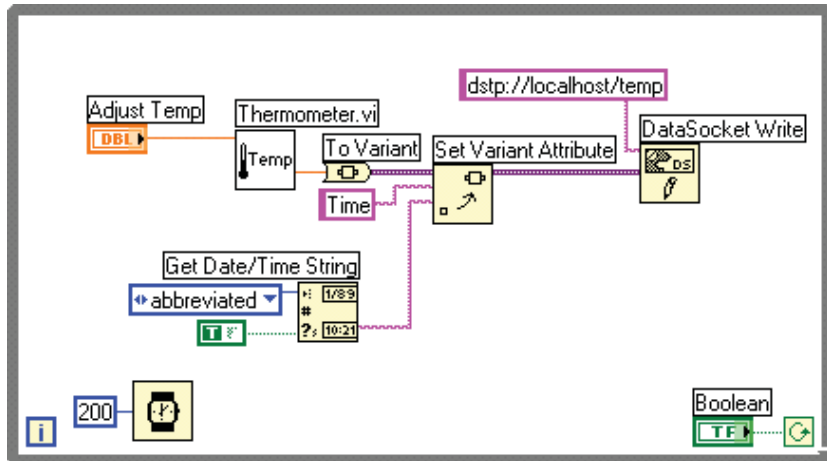

Figure 17-3. Converting Live Temperature Data to Variant Data

When another VI reads the live data, the VI must convert the variant data to a data type it can manipulate. Figure 17-4 shows a block diagram that continually reads temperature data from a DataSocket connection, converts the variant data into a temperature reading, retrieves the timestamp attribute associated with each reading, and displays the temperature and the timestamp on the front panel.

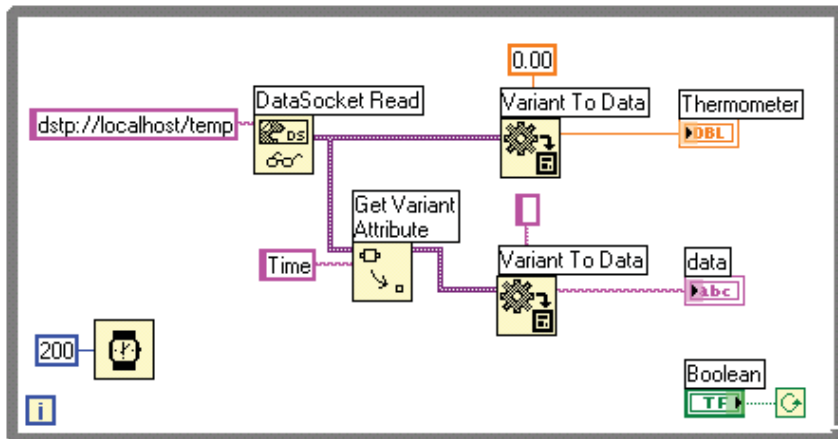

Figure 17-4. Converting Live Variant Data to Temperature Data

Publishing VIs on the Web

Use the LabVIEW Web Server to create HTML documents, publish front panel images on the Web, and embed VIs in a Web page. You can control browser access to the published front panels and configure which VIs are visible on the Web.



Note Use the LabVIEW Enterprise Connectivity Toolset to control VIs on the Web and to add more security features to VIs you publish on the Web. Refer to the National Instruments Web site at ni.com for more information about this toolset.

Web Server Options

Select **Tools»Options** and select one of the **Web Server** items in the top pull-down menu to set the following options:

- Set up the root directory and log file.
- Enable the Web Server.
- Control browser access to VI front panels.
- Configure which VI front panels are visible on the Web.

You must enable the Web Server in the **Web Server: Configuration** page of the **Options** dialog box before you can publish VIs on the Web. You also can enable the Web Server with the Web Publishing Tool, described in the following section. The VIs must be in memory before you publish them.

Creating HTML Documents

Select **Tools»Web Publishing Tool** to use the Web Publishing Tool to accomplish the following tasks:

- Create an HTML document.
- Embed static or animated images of the front panel in an HTML document. Currently only Netscape browsers support animated images.
- Embed a VI that clients can view and control remotely.
- Add text above and below the embedded VI front panel image.
- Place a border around an image or embedded VI.
- Preview the document.
- Save the document to disk.
- Enable the Web Server for publishing HTML documents and front panel images on the Web.

Publishing Front Panel Images

Use a `.snap` URL in a Web browser or an HTML document to return a static image of the front panel of a VI currently in memory. The query parameters in the URL specify the VI name and the attributes of the image. For example, use `http://web.server.address/.snap?VIName.vi`, where `VIName.vi` is the name of the VI you want to view.

Use a `.monitor` URL to return an animated image of the front panel of a VI currently in memory. The query parameters in the URL specify the VI name, attributes of the animation, and attributes of the image. For example, use `http://web.server.address/.monitor?VIName.vi`, where `VIName.vi` is the name of the VI you want to view.

Front Panel Image Formats

The Web Server can generate images of front panels in the JPEG and PNG image formats.

The JPEG format compresses graphics well but can lose some graphic detail. This format works best for photos. For line art, front panels, and block diagrams, JPEG compression can result in fuzzy graphics and uneven colors. The PNG format also compresses graphics well, although not always as well as the JPEG format. However, PNG compression does not lose any detail.

Viewing and Controlling Front Panels Remotely

You can view and control a VI front panel remotely, either from within LabVIEW or from within a Web browser, by connecting to the LabVIEW built-in Web Server. When you open a front panel remotely from a client, the Web Server sends the front panel to the client, but the block diagram and all the subVIs remain on the server computer. You can interact with the front panel in the same way as if the VI were running on the client, except the block diagram executes on the server. Use this feature to publish entire front panels or to control your remote applications safely, easily, and quickly.



Note Use the LabVIEW Web Server if you want to control entire VIs. Use the DataSocket server to read and write data on a single front panel control in a VI. Refer to the [Using DataSocket Technology](#) section of this chapter for more information about using the DataSocket Server.

Configuring the Server for Clients

The user at the server computer must first configure the server before a client can view and control a front panel remotely using LabVIEW or a Web browser. Configure the Web Server by selecting **Tools»Options** and selecting the **Web Server** pages from the top pull-down menu. Use these pages to control browser access to the server and to specify which front panels are visible remotely. You also can use these pages to set a time limit on how long any particular remote client can control a VI.

The Web Server allows multiple clients to connect simultaneously to the same front panel, but only one client at a time can control the front panel. The user at the server computer can regain control of any VI at any time. When the controller changes a value on the front panel, all client front panels reflect that change. However, client front panels do not reflect all changes. In general, client front panels do not reflect changes made to the display on front panel objects, but rather to the actual values in the front panel objects. For example, if the controller changes the mapping mode or marker spacing of a scale of a chart or if the controller shows and hides a scrollbar for a chart, only the controller front panel reflects these changes.

Remote Panel License

You must configure a license to support the number of clients that potentially could connect to your server. By default, the remote front panel license included with LabVIEW allows one client to view and control a front panel. When you exceed the number of clients allowed by your license, the client receives a message that contains information you specify in the `LicenseErrorMessage.txt` file in `labview\www`. In this message, you might want to include information about who the client should contact, such as the server administrator or the person in your organization responsible for upgrading the remote panel license. If you do not enter anything in this file, a default error message appears on the client computer indicating that their connection request was denied.



Note Although you can use any LabVIEW development system to build VIs that clients can view and control remotely, only the Full and Professional Development Systems support viewing and controlling those VIs remotely.

Viewing and Controlling Front Panels in LabVIEW or from a Web Browser

A client can view and control a front panel remotely from LabVIEW or from a Web browser.



Note Before you can view and control a front panel remotely, you must enable the Web Server on the server computer where the VI you want to view and control is located.

Viewing and Controlling Front Panels in LabVIEW

To view a remote front panel using LabVIEW as a client, open a new VI and select **Operate»Remote Panel Connect** to display the **Open Remote Panel** dialog box. Use this dialog box to specify the server Internet address and the VI you want to view. By default, the remote VI front panel is initially in observer mode. You can request control by placing a checkmark in the **Request Control of the VI** checkbox in the **Open Remote Panel** dialog box when you request a VI. When the VI appears on your computer, right-click anywhere on the front panel and select **Request Control of the VI** from the shortcut menu. You also can access this menu by clicking the status bar at the bottom of the front panel window. If no other client is currently in control, a message appears indicating that you have control of the front panel. If another client is currently controlling the VI, the server queues your request until the other client relinquishes control. Only the user at the server computer can monitor the client queue list by selecting **Tools»Remote Panel Connection Manager**.

All VIs you want clients to view and control must be in memory. If the requested VI is in memory, the server sends the front panel of the VI to the requesting client. If the VI is not in memory, the **Connection Status** section of the **Open Remote Panel** dialog box displays an error message.

Viewing and Controlling Front Panels from a Web Browser

If you want clients who do not have LabVIEW installed to be able to view and control a front panel remotely using a Web browser, they must install the LabVIEW Run-Time Engine. The LabVIEW Run-Time Engine includes a LabVIEW browser plug-in package that installs in the browser plug-in directory. The LabVIEW CD contains an installer for the LabVIEW Run-Time Engine.

Clients install the LabVIEW run-time engine and the user at the server computer creates an HTML file that includes an <OBJECT> tag that

references the VI you want clients to view and control. This tag contains a URL reference to a VI and information that directs the Web browser to pass the VI to the LabVIEW browser plug-in. Clients navigate to the Web Server by entering the Web address of the Web Server in the address or URL field at the top of the Web browser window. The plug-in displays the front panel in the Web browser window and communicates with the Web Server so the client can interact with the remote front panel. Clients request control by selecting **Request Control of the VI** at the bottom of the remote front panel window in their Web browser or by right-clicking anywhere on the front panel and selecting **Request Control of the VI** from the shortcut menu.



Note National Instruments recommends that you use Netscape 4.7 or later or Internet Explorer 5.0 or later when viewing and controlling front panels in a Web browser.

Functionality Not Supported in Viewing and Controlling Remote Front Panels

Because of the constraints of a Web browser, user interface applications that attempt to manipulate the dimensions and location of a front panel do not work properly when that front panel is displayed as a part of a Web page. Although the Web Server and the LabVIEW browser plug-in attempt to preserve the fidelity of complex user interface applications—in particular, those that present dialog boxes and subVI windows—some applications might not work properly in the context of a Web browser. National Instruments recommends that you do not export these types of applications for use in a Web browser.

In general, avoid exporting data-intensive VIs for remote viewing and controlling. For example, front panels that have several charts increase network load, which causes front panel updates to be slow. Also, VIs that have While Loops but no wait function limit background tasks from performing in a reasonable amount of time, making front panels unresponsive when viewed or controlled remotely.

Additionally, some VIs might not work exactly the same way from a remote computer as they do when run locally. ActiveX controls embedded on a front panel do not display on a remote client because they draw and operate almost completely independent of LabVIEW. If a VI presents the standard file dialog box, the controller receives an error because you cannot browse a file system remotely. Also, the **Browse** button of a path control is disabled in remote panels.

Clients viewing a front panel remotely might see different behavior depending on whether the front panel they are connecting to is from a built application. Specifically, if the front panel is from a built application, any programmatic changes to the front panel made before the client connects to the front panel are not reflected on the client computer. For example, if a property node changes a caption on a control before a client connects to that front panel, the client will see the original caption of the control, not the changed caption.

Block diagrams that achieve certain user interface effects by polling properties of a front panel control might experience decreases in performance when you control the VI from a remote computer. You can improve the performance of these VIs by using the Wait for Front Panel Activity function.

Low-Level Communications Applications

LabVIEW supports several low-level protocols you can use to communicate between computers.

Each protocol is different, especially in the way it refers to the network location of a remote application. Each protocol generally is incompatible with other protocols. For example, if you want to communicate between Macintosh and Windows, you must use a protocol that works on both platforms, such as TCP.

TCP and UDP

Transmission Control Protocol (TCP) and User Datagram Protocol (UDP) are available on all platforms LabVIEW supports. TCP is a reliable, connection-based protocol. It provides error detection and ensures that data arrive in order and without duplication. For these reasons, TCP is usually the best choice for network applications.

Although UDP can give higher performance than TCP and does not require a connection, it does not guarantee delivery. Typically, use UDP in applications in which guaranteed delivery is not critical. For example, an application might transmit data to a destination frequently enough that a few lost segments of data are not problematic. Refer to the *Using LabVIEW with TCP/IP and UDP* Application Note for more information about using TCP and UDP in LabVIEW applications.

DDE (Windows)

Dynamic Data Exchange (DDE) works at a higher level than TCP to exchange commands and data between clients and servers. DDE is a good choice for communication with standard off-the-shelf applications such as Microsoft Excel. Refer to the *Using DDE in LabVIEW* Application Note for more information about using DDE in LabVIEW applications.

Apple Events and PPC Toolbox (Macintosh)

The more common Macintosh-only form of communication is Apple events. As with DDE, use Apple events to send messages to request actions or return information from other Macintosh applications.

Program-to-Program Communication (PPC) Toolbox is a lower level form of sending and receiving data between Macintosh applications. PPC Toolbox gives higher performance than Apple events because the overhead required to transmit information is lower. However, because PPC Toolbox does not define the types of information you can transfer, many applications do not support it. PPC Toolbox is the best method to send large amounts of information between applications that support PPC Toolbox. Refer to the *Using Apple Events and the PPC Toolbox to Communicate with LabVIEW Applications on the Macintosh* Application Note for more information about using Apple events and PPC Toolbox in LabVIEW applications.

Pipe VIs (UNIX)

Use the Pipe VIs to open, close, read, and write to UNIX named pipes. Use named pipes to communicate between LabVIEW and unrelated processes.

Executing System-Level Commands (Windows and UNIX)

Use the System Exec VI to execute or launch other Windows applications or UNIX command-line applications from within VIs. With the System Exec VI, you execute a system-level command line that can include any parameters supported by the application you want to launch.

ActiveX

With ActiveX Automation, a Windows application, such as LabVIEW, provides a public set of objects, commands, and functions that other Windows applications can access. You can use LabVIEW as an ActiveX client to access the objects, properties, methods, and events associated with other ActiveX-enabled applications. LabVIEW also can act as an ActiveX server, so other ActiveX-enabled applications can access LabVIEW objects, properties, and methods.

In this manual, *ActiveX* refers to Microsoft's ActiveX technology and OLE technology. This technology is available only on Windows. Refer to the Microsoft Developer's Network documentation, *Inside OLE*, by Kraig Brockschmidt, second edition, and *Essential COM*, by Don Box, for more information about ActiveX.

For more information...

Refer to the *LabVIEW Help* for more information about using ActiveX technology.

ActiveX Objects, Properties, Methods, and Events

ActiveX-enabled applications include objects that have exposed properties and methods that other applications can access. Objects can be visible to the users, such as buttons, windows, pictures, documents, and dialog boxes, or invisible to the user, such as application objects. You access an application by accessing an object associated with that application and setting a property or invoking a method of that object.

Refer to the *Manipulating Application and VI Settings* section of Chapter 16, *Programmatically Controlling VIs*, for more information about objects, properties, and methods.

Events are the actions taken on an object, such as clicking a mouse, pressing a key, or running out of memory. Whenever these actions occur to the object, the object sends an event to alert the ActiveX container along with the event-specific data.

Refer to the ActiveX Event Template VI and the List ActiveX Events VI in the `examples\comm\axevent.llb` and the FamilyTree VI and the MultiEvents VI in the `examples\comm` directory for examples of using ActiveX events in LabVIEW and examples of using the ActiveX Events VIs.

ActiveX VIs, Functions, Controls, and Indicators

Use the following VIs, functions, controls, and indicators to access the objects, properties, methods, and events associated with other ActiveX-enabled applications:

- Use the automation refnum control located on the **Controls»ActiveX** palette to create a reference to an ActiveX object. Right-click this control on the front panel to select an object from the type library you want to access.
- Use the Automation Open function located on the **Functions»Communication»ActiveX** palette to open an ActiveX object.
- Use the ActiveX container located on the **Controls»ActiveX** palette to access and display an ActiveX object on the front panel. Right-click this control to select the object you want to access.
- Use the Property Node located on the **Functions»Communication»ActiveX** palette to get (read) and set (write) the properties associated with an ActiveX object.
- Use the Invoke Node located on the **Functions»Communication»ActiveX** palette to invoke the methods associated with an ActiveX object.
- Use the ActiveX Events VIs located on the **Functions»Communication»ActiveX»ActiveX Events** palette to manage the events that occur to an ActiveX object you placed in the ActiveX container on the front panel.
- Use the ActiveX variant control and indicator located on the **Controls»ActiveX** palette to pass data to or from subVIs. You also can use it to display but not modify the data. Refer to the *Handling Variant Data* section of Chapter 5, *Building the Block Diagram*, for more information about variant data.

LabVIEW as an ActiveX Client

When LabVIEW accesses the objects associated with another ActiveX-enabled application, it is acting as an ActiveX client. You can use LabVIEW as an ActiveX client in the following ways:

- Open an application, such as Microsoft Excel, create a document, and add data to that document.
- Embed a document, such as a Microsoft Word document or an Excel spreadsheet, on the front panel.
- Place a button or other object from another application, such as a **Help** button that calls the other application help file, on the front panel.
- Link to an ActiveX control you built with another application.

LabVIEW accesses an ActiveX object with the automation refnum control and the ActiveX container, both of which are front panel objects. Use the automation refnum control to select an ActiveX object. Use the ActiveX container to select a displayable ActiveX object, such as a button or document and place it on the front panel. Both objects appear as automation refnum controls on the block diagram.

Accessing an ActiveX-Enabled Application

To access an ActiveX-enabled application, use the automation refnum control on the block diagram to create a reference to an application. Wire the control to the Automation Open function, which opens the calling application. Use the Property Node to select and access the properties associated with the object. Use the Invoke Node to select and access the methods associated with the object. Close the reference to the object using the Automation Close function. Closing the reference removes the object from memory.

For example, you can build a VI that opens Microsoft Excel so it appears on the user's screen, creates a workbook, creates a spreadsheet, creates a table in LabVIEW, and writes that table to the Excel spreadsheet.

Refer to the Write Table To XL VI in the `examples\comm\ExcelExamples.llb` for an example of using LabVIEW as an Excel client.



Note Applications that include ActiveX custom interfaces appear with a  icon. Click the icon to select an object for the custom interface. Refer to the [Support for Custom ActiveX Automation Interfaces](#) section in this chapter for more information about custom interfaces.

Inserting an ActiveX Object on the Front Panel

To insert an ActiveX control on the front panel, use the ActiveX container to select the ActiveX object or document and access the properties and methods associated with that object. You can set the properties for an ActiveX object using the ActiveX Property Browser or property pages, or you can set the properties programmatically using the Property Node. Refer to the *Setting ActiveX Properties* section in this chapter for more information about setting ActiveX properties.

Use the Invoke Node to invoke the methods associated with the object.

For example, you can display a Web page on the front panel by using an ActiveX container to access the Microsoft Web Browser object, selecting the Navigate class of methods, selecting the URL method, and specifying the URL.

If you use the ActiveX container, you do not have to wire the automation refnum control on the block diagram to the Automation Open function or close the reference to the object using the Automation Close function. You can wire directly to the Invoke Node or Property Node because the ActiveX container embeds the calling application in LabVIEW. However, if the ActiveX container includes properties or methods that return other automation refnum references, you must close those other refnum controls.

Setting ActiveX Properties

After you call or insert an ActiveX object or document, you can set the properties associated with that object or document using the ActiveX Property Browser, property pages, and the Property Node.

ActiveX Property Browser

Use the ActiveX Property Browser to view and set all the properties associated with an ActiveX object or document in an ActiveX container. To access the ActiveX Property Browser, right-click the object or document in the container on the front panel and select **Property Browser** from the shortcut menu. You also can select **Tools»Advanced»ActiveX Property Browser**. The ActiveX Property Browser is an easy way to set the properties of an ActiveX control interactively, but you cannot use the browser to set properties programmatically, and you can use the ActiveX Property Browser only with ActiveX objects in a container. The ActiveX Property Browser is not available in Run mode.

ActiveX Property Pages

Many ActiveX objects include property pages, which organize the properties associated with the object on separate tabs. To access ActiveX property pages, right-click the object or document in the container on the front panel and select the name of the object from the shortcut menu.

Like the ActiveX Property Browser, ActiveX property pages are an easy way to set the properties of an ActiveX control interactively, but you cannot use them to set properties programmatically, and you can use property pages only with ActiveX objects in a container. Also, property pages are not available for all ActiveX objects.

Property Nodes

Use the Property Node to set ActiveX properties programmatically. For example, if you use an ActiveX control to warn a user when a temperature exceeds a limit, use the Property Node to set the Value property of the object to specify the limit.

The following example changes the Value property of the CWButton ActiveX object, which is part of the Component Works Control Library, when the temperature reaches 85 degrees Fahrenheit or higher.

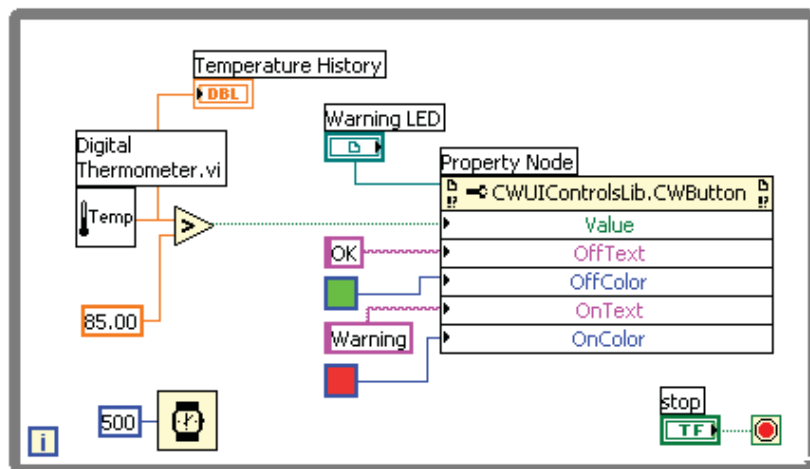

In this case, the CWButton acts as an LED, changes colors, and displays Warning when the temperature reaches the limit, which is the on state of the CWButton object.



Note In this example, you could use the ActiveX Property Browser or property pages to set the OffText, OffColor, OnText, and OnColor properties for the CWButton because you do not need to set those properties programmatically. Refer to the [ActiveX Property](#)

Browser and *ActiveX Property Pages* sections in this chapter for more information about the ActiveX Property Browser and property pages, respectively.

LabVIEW as an ActiveX Server

The LabVIEW application, VIs, and control properties and methods are available through ActiveX calls from other applications. Other ActiveX-enabled applications, such as Microsoft Excel, can request properties, methods, and individual VIs from LabVIEW, and LabVIEW acts as an ActiveX server.

For example, you can embed a VI graph in an Excel spreadsheet and, from the spreadsheet, enter data in the VI inputs and run the VI. When you run the VI, the data plot to the graph.

Refer to the `examples\comm\freqresp.xls` for an example of using LabVIEW properties and methods in an Excel spreadsheet.

Support for Custom ActiveX Automation Interfaces

If you are writing an ActiveX client that accesses properties and methods from an ActiveX server using LabVIEW, you can access custom interfaces exposed by the server. The ActiveX server writer must make sure the parameters of the properties and methods in these custom interfaces have Automation (IDispatch) data types. Refer to your server development programming environment documentation for more information about accessing custom interfaces.

Using Constants to Set Parameters in ActiveX VIs

Some parameters in ActiveX nodes take a discrete list of valid values. Select the descriptive name in the ring constant to set these parameter values. To access the ring constant when building an ActiveX VI, right-click the parameter of the node that accepts data values and select **Create Constant** from the shortcut menu. The selections available in the ring constant depend on the refnum passed to the node. Figures 18-1 and 18-2 show examples of using ring and numeric constants to set parameter values.

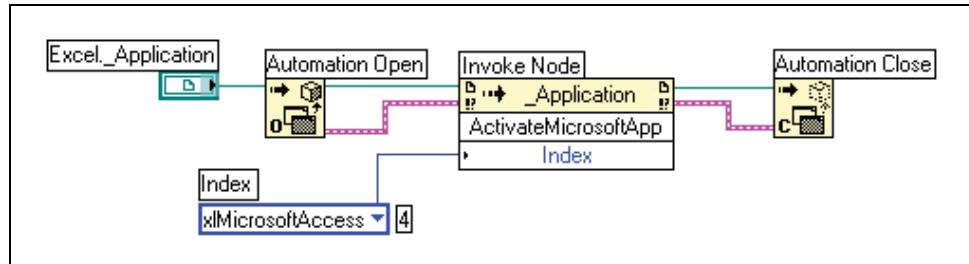

Figure 18-1. Setting a Data Value with a Ring Constant

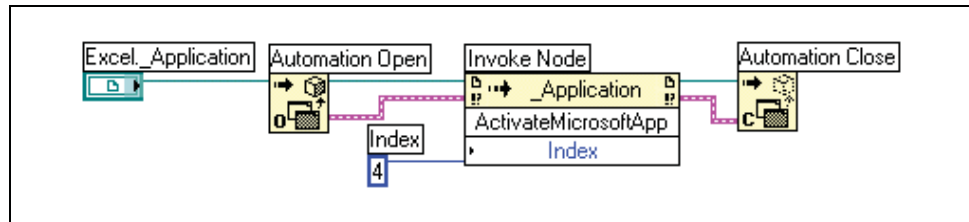

Figure 18-2. Setting a Data Value with a Numeric Constant

Parameters that accept data values have a small arrow to the left of the parameter name. To view the corresponding numeric data value, right-click the ring constant and select **Visible Items»Digital Display** from the shortcut menu.

The VIs in Figures 18-1 and 18-2 both access the Microsoft Excel application and execute a method. The **Index** parameter of the **ActivateMicrosoftApp** method has the following options: **MicrosoftWord**, **MicrosoftPowerPoint**, **MicrosoftMail**, **MicrosoftAccess**, **MicrosoftFoxPro**, **MicrosoftProject**, and **MicrosoftSchedulePlus**.

To identify the numeric value of the **Index** parameter that corresponds to the **MicrosoftAccess** option in Figure 18-1, select the **MicrosoftAccess** option from the pull-down menu in the ring constant. The numeric value of the currently selected option appears in a box next to the ring constant. Instead of using a ring constant, you can enter the numeric value of an option into a numeric constant, as shown in Figure 18-2.

Calling Code from Text-Based Programming Languages

You can call most standard shared libraries in LabVIEW using the Call Library Function Node. You also can call C code in LabVIEW using the Code Interface Node (CIN).

Refer to the *Using External Code in LabVIEW* manual for more information about calling code from text-based programming languages.

For more information...

Refer to the *LabVIEW Help* for more information about calling code from text-based programming languages.

Call Library Function Node

Use the Call Library Function Node to call most standard shared libraries or DLLs. With this function, you can create an interface in LabVIEW to call existing libraries or new libraries specifically written for use with LabVIEW. National Instruments recommends using the Call Library Function Node to create an interface to external code.

Code Interface Node

Use the CIN as an alternative method for calling source code written in C. The Call Library Function Node generally is easier to use than the CIN.

Formulas and Equations

When you want to use a complicated equation in LabVIEW, you do not have to wire together various arithmetic functions on the block diagram. You can develop equations in a familiar, mathematical environment and then integrate the equations into an application.

Use the Formula Node and Expression Node to perform mathematical operations in the LabVIEW environment. For more advanced functionality, you can link to the mathematics applications HiQ and MATLAB to develop equations. HiQ and MATLAB are software packages that help you organize and visualize real-world math, science, and engineering problems.

For more information...

Refer to the *LabVIEW Help* for more information about using equations and the syntax to use, available functions and operators, and descriptions of possible errors.

Methods for Using Equations in LabVIEW

You can use the Formula Node, Expression Node, HiQ-Script node, and MATLAB script node to perform mathematical operations on the block diagram.



Note You must have HiQ or MATLAB installed on your computer to use the script nodes because LabVIEW uses ActiveX technology to pass the script to HiQ or MATLAB for execution. LabVIEW uses ActiveX technology, which is available only on Windows, to implement the script nodes. Therefore, script nodes are available only on Windows.

Because National Instruments ships HiQ with LabVIEW, you can install the software at no extra cost to gain more functionality in handling equations.

The script nodes are similar to the Formula Node, but they allow you to import an existing HiQ or MATLAB script in ASCII form and run the script in LabVIEW. As with a Formula Node, you can pass data to and from the node.

Formula Nodes

The Formula Node is a convenient text-based node you can use to perform mathematical operations on the block diagram. You do not have to access any external code or applications, and you do not have to wire low-level arithmetic functions to create equations. In addition to text-based equation expressions, the Formula Node can accept text-based versions of if statements, while loops, for loops, and do loops, which are familiar to C programmers. These programming elements are similar to what you find in C programming but are not identical.

Formula Nodes are useful for equations that have many variables or are otherwise complicated and for using existing text-based code. You can copy and paste the existing text-based code into a Formula Node rather than recreating it graphically.

Formula Nodes use type checking to make sure that array indexes are numeric data and that operands to the bit operations are integer data. Formula Nodes also check to make sure array indexes are in range. For arrays, an out-of-range value defaults to zero, and an out-of-range assignment defaults to `nop` to indicate no operation occurs.

Formula Nodes also perform automatic type conversion.

Using the Formula Node

The Formula Node located on the **Functions»Structures** and **Functions»Mathematics»Formula** palettes is a resizable box similar to the For Loop, While Loop, Case structure, and Sequence structure. However, instead of containing a subdiagram, the Formula Node contains one or more C-like statements delimited by semicolons, as in the following example. As with C, add comments by enclosing them inside a slash/asterisk pair (`/*comment*/`).

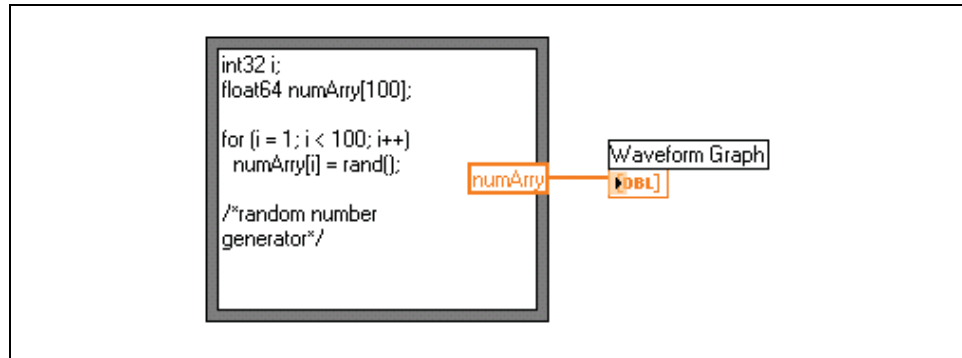

Refer to the Equations VI in the `examples\general\structs.llb` for an example of using a Formula Node.

Variables in the Formula Node

When you work with variables, remember the following points:

- There is no limit to the number of variables or equations in a Formula Node.
- No two inputs and no two outputs can have the same name, but an output can have the same name as an input.
- Declare an input variable by right-clicking the Formula Node border and selecting **Add Input** from the shortcut menu. You cannot declare input variables inside the Formula Node.
- Declare an output variable by right-clicking the Formula Node border and selecting **Add Output** from the shortcut menu. The output variable name must match either an input variable name or the name of a variable you declare inside the Formula Node.
- You can change whether a variable is an input or an output by right-clicking it and selecting **Change to Input** or **Change to Output** from the shortcut menu.
- You can declare and use a variable inside the Formula Node without relating it to an input or output wire.
- You must wire all input terminals.
- Variables can be floating-point numeric scalars, whose precision depends on the configuration of your computer. You also can use integers and arrays of numerics for variables.
- Variables cannot have units.

Expression Nodes

Use Expression Nodes to calculate expressions, or equations, that contain a single variable. Expression Nodes are useful when an equation has only one variable but is otherwise complicated.

Expression Nodes use the value you pass to the input terminal as the value of the variable. The output terminal returns the value of the calculation.

For example, consider this simple equation:

$$x \times x + 33 \times (x + 5)$$

The block diagram in the following figure uses Numeric functions to represent this equation.

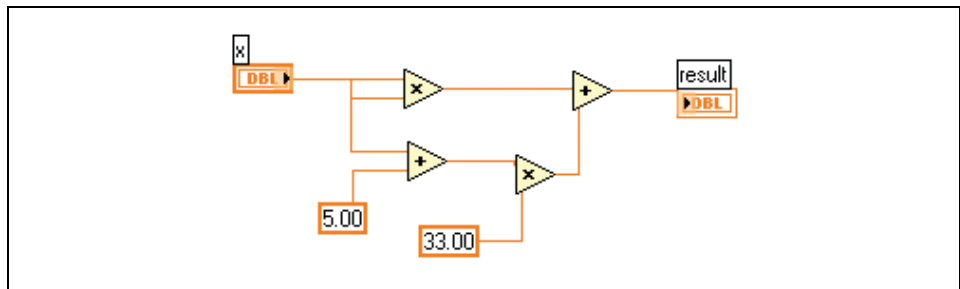

Use an Expression Node, as shown in the following figure, to create a much simpler block diagram.

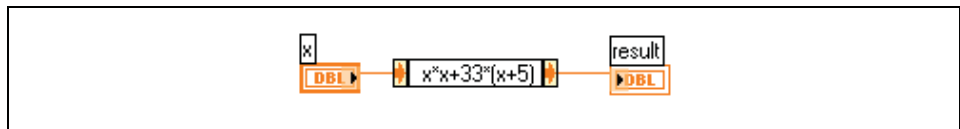

Polymorphism in Expression Nodes

The input terminal of an Expression Node is the same data type as the control or constant you wire to it. The output terminal is the same data type as the input terminal. The data type of the input can be any non-complex scalar number, array of non-complex scalar numbers, or cluster of non-complex scalar numbers. With arrays and clusters, the expression node applies the equation to each element of an input array or cluster.

Using HiQ with LabVIEW

HiQ is a high-performance, interactive, problem-solving environment where you can analyze, visualize, and document real-world science and engineering problems. HiQ uses a virtual notebook interface and a programming language called HiQ-Script. The notebook has pages, sections, and tabs where you can place and arrange objects such as text, numerics, and graphs.

Use the VIs located on the **Functions»Communication»HiQ** palette to control HiQ from LabVIEW and transfer data between the two applications in various formats. You must install HiQ to use these VIs. Use these HiQ VIs to launch HiQ, access and manipulate HiQ Notebooks to analyze and visualize data, and run a HiQ-Script within a Notebook.

Refer to the *HiQ Help* for more information about HiQ functionality, including the mathematical features, function reference, and syntax information.

Refer to `examples\comm\hiq` for examples of setting up and using the HiQ VIs.

HiQ and MATLAB Script Nodes

Use the HiQ and MATLAB script nodes located on the **Functions»Mathematics»Formula** palette to load and edit HiQ and MATLAB scripts on the block diagram so LabVIEW can work with their advanced mathematics functionality.

You must have HiQ or MATLAB installed to use script nodes. If you already have a script written in HiQ or MATLAB, you can import it into the script node.











You assign script node terminals as inputs or outputs for the variables in the script to pass values between HiQ or MATLAB and LabVIEW. You can determine the function of a terminal by the way the equation is written. For example, if the script contains the assignment statement, $X = i + 3$, you can assign i as an input terminal to control how the script node calculates X , and you can assign X to an output terminal to retrieve the final result of the script calculation.

If you do not already have a script written, you can place a script node on the block diagram and create a script using HiQ or MATLAB syntax. LabVIEW communicates with the script server engine, which is a program

that runs the script. LabVIEW communicates and controls the script server engine using an industry-established protocol. Script server engines are installed with HiQ or MATLAB.

Because of the nature of the HiQ and MATLAB script languages, the script node cannot determine the data type of terminals you created. You must assign a LabVIEW data type to each script node terminal. The script node in LabVIEW recognizes the data types HiQ or MATLAB support. Table 20-1 shows LabVIEW data types and the corresponding data types in HiQ and MATLAB.

Table 20-1. LabVIEW, HiQ, and MATLAB Data Types

LabVIEW Data Type	HiQ Data Type	MATLAB Data Type
	Integer	—
	Real	Real
	Text	—
	Integer Vector	—
	Real Vector	Real Vector
	Integer Matrix	—
	Real Matrix	Real Matrix
	Complex	Complex
	Complex Vector	Complex Vector
	Complex Matrix	Complex Matrix

Programming Suggestions for HiQ and MATLAB Scripts

The following programming techniques make it easier to debug a script:

- Write the script and run it in HiQ or MATLAB for testing and debugging purposes before you import it into LabVIEW.
- Right-click the HiQ script node and select **Edit In Server** from the shortcut menu to edit, debug, compile, and run in the script a native HiQ script window.

- Verify the data types. When you create a new input or output, make sure that the data type of the terminal is correct. In both HiQ and MATLAB, a variable can change its type during computation. You can use the Error In and Error Out functions to keep track of this.
- Create controls and indicators for the inputs and outputs so you can monitor the values that the script nodes are passing between LabVIEW and HiQ or MATLAB. This allows you to pinpoint where a script node calculates a value incorrectly, if necessary.
- Take advantage of the error-checking parameters for debugging information. Create an indicator for the **error out** terminal on a script node so you can view error information at run time. Formula Nodes show errors at compile time.

HiQ Support Files Required with a LabVIEW Application

After you build a LabVIEW application that includes calls to the HiQ VIs, you must consider the target computer that runs the application.

Calling the HiQ script node in the LabVIEW code launches HiQ. If you are distributing a LabVIEW application that contains a HiQ script, the target machine must have HiQ installed.

The following table lists which files you need based on how you use and distribute LabVIEW and HiQ.

Files to Distribute	Software Currently Available on Target	What to Install
LabVIEW application VIs with HiQ script node	LabVIEW (any version) installed; no HiQ installed	Licensed copy of HiQ that is available with LabVIEW
Executable	No LabVIEW and no HiQ installed	HiQ Reader enables others to view HiQ Professional Notebooks and run scripts. You can distribute the HiQ Reader free from the LabVIEW Full or Professional Development System CD. Refer to the National Instruments Web site at ni.com to download the HiQ Reader.

Organization of LabVIEW

This appendix describes the structure of the LabVIEW file system and the suggested locations for saving files.

Organization of the LabVIEW Directory Structure

This section describes the structure of the LabVIEW file system for Windows, Macintosh, and UNIX. LabVIEW installs driver software for GPIB, DAQ, VISA, IVI, Motion Control, and IMAQ hardware depending on platform availability. Refer to Chapter 3, *Installing and Configuring Your Measurement Hardware*, of the *LabVIEW Measurements Manual* for information about configuring your hardware.

As described in the *LabVIEW Release Notes* that come with the software, your LabVIEW directory contains the following groupings after you complete the installation.

Libraries

- `user.lib`—Contains controls and VIs you create. LabVIEW displays controls on the **Controls»User Controls** palette and VIs on the **Functions»User Libraries** palette. This directory does not change if you upgrade or remove LabVIEW.
- `vi.lib`—Contains libraries of built-in VIs, including GPIB, analysis, and DAQ VIs. LabVIEW displays these VIs in related groups on the **Functions** palette. Do not save files into `vi.lib` because LabVIEW overwrites these files when you upgrade.
- `instr.lib`—Contains instrument drivers used to control PXI, VXI, GPIB, serial, and computer-based instruments. When you install National Instruments instrument drivers, place them in this directory, and LabVIEW adds them to the **Instrument I/O»Instrument Drivers** palette.

Structure and Support

- `menus`—Contains files LabVIEW uses to configure the structure of the **Controls** and **Functions** palettes.
- `resource`—Contains additional support files for the LabVIEW application. Do not save files into this directory because LabVIEW overwrites these files when you upgrade.
- `project`—Contains files that become items on the LabVIEW **Tools** menu.
- `templates`—Contains templates for common VIs.
- `www`—Location of HTML files you can access through the Web Server.

Learning and Instruction

- `activity`—Contains VIs you use to complete the activities in the *LabVIEW Tutorial*. The `activity\solution` directory contains the completed VIs for each activity.
- `examples`—Contains example VIs. Select **Help»Find Examples** to browse or search the examples.

Documentation

- `manuals`—Contains documentation in PDF format. This folder does not contain the help files. Access the PDFs by selecting **Help»Search the LabVIEW Bookshelf**.
- `help`—Contains the help files. Access the *LabVIEW Help* by selecting **Help»VI, Function, and How-To Help**.

Miscellaneous File

- `serpdrv`—Support file for accessing the serial port on Windows and UNIX. Distribute this file with any application that uses the serial port on these platforms.

Macintosh

In addition to the above directories, Macintosh users have a shared libraries folder that contains support files for the LabVIEW application.

Suggested Location for Saving Files

LabVIEW installs the `vi.lib` and the `resource` directories for LabVIEW system purposes only. Do not save your files in these directories.

You can save your files in the following directories:

- `user.lib`—Any commonly used VIs that you want to appear on the **Functions»User Libraries** palette. Use for `vi.lib` extensions.



Note Save subVIs in the `user.lib` directory only if they are portable, without modification, across projects. Paths to VIs in `user.lib` are absolute. Paths to subVIs you save elsewhere are relative to the parent VI. Therefore, copying a VI from `user.lib` to modify it for a special case does not change the path to its subVIs located in `user.lib`.

- `instr.lib`—Any instrument driver VI that you want to appear on the **Instrument I/O»Instrument Drivers** palette.
- `project`—VIs you use to extend LabVIEW capabilities. VIs you store in this directory appear on the **Tools** menu.
- `www`—Location of HTML files you can access through the Web Server.
- `help`—Any VIs, PDFs, and `.hlp` files that you want to make available on the **Help** menu.

You also can create a directory anywhere on your hard drive to store LabVIEW files that you create. Refer to the *Saving VIs* section of Chapter 7, *Creating VIs and SubVIs*, for more information about creating directories.

Polymorphic Functions

Functions are polymorphic to varying degrees—none, some, or all of their inputs can be polymorphic. Some function inputs accept numerics or Boolean values. Some accept numerics or strings. Some accept not only scalar numerics but also arrays of numerics, clusters of numerics, arrays of clusters of numerics, and so on. Some accept only one-dimensional arrays although the array elements can be of any type. Some functions accept all types of data, including complex numerics. Refer to the *Polymorphic Units in LabVIEW Application Note* for more information about creating and using polymorphic units.

For more information...

Refer to the *LabVIEW Help* for more information about polymorphic functions.

Numeric Conversion

You can convert any numeric representation to any other numeric representation. When you wire two or more numeric inputs of different representations to a function, the function usually returns output in the larger or wider format. The functions coerce the smaller representations to the widest representation before execution and LabVIEW places a coercion dot on the terminal where the conversion takes place.

Some functions, such as Divide, Sine, and Cosine, always produce floating-point output. If you wire integers to their inputs, these functions convert the integers to double-precision, floating-point numbers before performing the calculation.

For floating-point, scalar quantities, it is usually best to use double-precision, floating-point numbers. Single-precision, floating-point numbers save little or no run time and overflow much more easily. The analysis libraries, for example, use double-precision, floating-point numbers. You should only use extended-precision, floating-point numbers when necessary. The performance and precision of extended-precision arithmetic varies among the platforms. Refer to the *Undefined or*

Unexpected Data section of Chapter 6, *Running and Debugging VIs*, for more information about floating-point overflow.

For integers, it is usually best to use a 32-bit signed integer.

If you wire an output to a destination that has a different numeric representation, LabVIEW converts the data according to the following rules:

- **Signed or unsigned integer to floating-point number**—Conversion is exact, except for long integers to single-precision, floating-point numbers. In this case, LabVIEW reduces the precision from 32 bits to 24 bits.
- **Floating-point number to signed or unsigned integer**—LabVIEW moves out-of-range values to the integer's minimum or maximum value. Most integer objects, such as the iteration terminal of a For Loop, round floating-point numbers. LabVIEW rounds a fractional part of 0.5 to the nearest even integer. For example, LabVIEW rounds 6.5 to 6 rather than 7.
- **Integer to integer**—LabVIEW does not move out-of-range values to the integer's minimum or maximum value. If the source is smaller than the destination, LabVIEW extends the sign of a signed source and places zeros in the extra bits of an unsigned source. If the source is larger than the destination, LabVIEW copies only the least significant bits of the value.

Polymorphism for Numeric Functions

The arithmetic functions take numeric input data. With some exceptions noted in the function descriptions, the output has the same numeric representation as the input or, if the inputs have different representations, the output is the wider of the inputs.

The arithmetic functions work on numbers, arrays of numbers, clusters of numbers, arrays of clusters of numbers, complex numbers, and so on. A formal and recursive definition of the allowable input type is as follows:

Numeric type = numeric scalar OR array [*numeric type*] OR cluster [*numeric types*]

The numeric scalars can be floating-point numbers, integers, or complex floating-point numbers. LabVIEW does not allow you to use arrays of arrays.

Arrays can have any number of dimensions of any size. Clusters can have any number of elements. The output type of functions is of the same numeric representation as the input type. For functions with one input, the functions operate on each element of the array or cluster.

For functions with two inputs, you can use the following input combinations:

- **Similar**—Both inputs have the same structure, and the output has the same structure as the inputs.
- **One scalar**—One input is a numeric scalar, the other is an array or cluster, and the output is an array or cluster.
- **Array of**—One input is a numeric array, the other is the numeric type itself, and the output is an array.

For similar inputs, LabVIEW performs the function on the respective elements of the structures. For example, LabVIEW can add two arrays element by element. Both arrays must have the same dimensionality. You can add arrays with differing numbers of elements; the output of such an addition has the same number of elements as the smallest input. Clusters must have the same number of elements, and the respective elements must be of the same type.

You cannot use the Multiply function to do matrix multiplication. If you use the Multiply function with two matrices, LabVIEW takes the first number in the first row of the first matrix, multiplies it by the first number in the first row of the second matrix, and so on.

For operations involving a scalar and an array or cluster, LabVIEW performs the function on the scalar and the respective elements of the structure. For example, LabVIEW can subtract a number from all elements of an array, regardless of the dimensionality of the array.

For operations that involve a numeric type and an array of that type, LabVIEW performs the function on each array element. For example, a graph is an array of points, and a point is a cluster of two numeric types, x and y . To offset a graph by 5 units in the x direction and 8 units in the y direction, you can add a point, (5, 8), to the graph.

The following example shows the possible polymorphic combinations of the Add function.

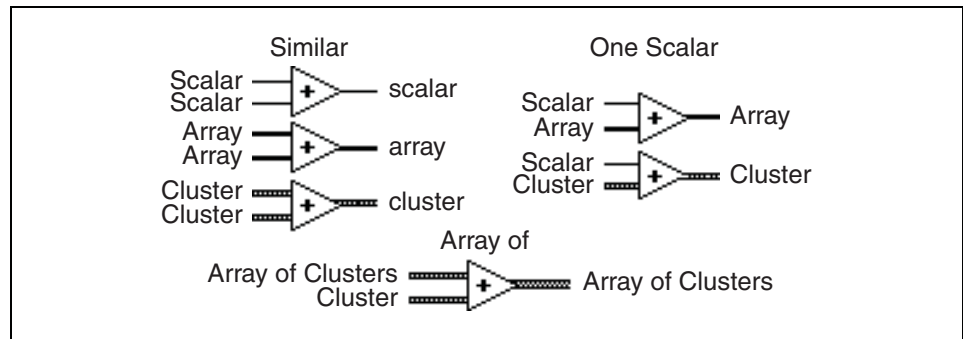

Polymorphism for Boolean Functions

The logical functions take either Boolean or numeric input data. If the input is numeric, LabVIEW performs a bit-wise operation. If the input is an integer, the output has the same representation. If the input is a floating-point number, LabVIEW rounds it to a long integer, and the output is a long integer.

The logical functions work on arrays of numbers or Boolean values, clusters of numbers or Boolean values, arrays of clusters of numbers or Boolean values, and so on.

A formal and recursive definition of the allowable input type is as follows:

Logical type = Boolean scalar OR numeric scalar OR
array [*logical type*] OR cluster [*logical types*]

except that complex numbers and arrays of arrays are not allowed.

Logical functions with two inputs can have the same input combinations as the arithmetic functions. However, the logical functions have the further restriction that the base operations can only be between two Boolean values or two numbers. For example, you cannot have an AND between a Boolean value and a number. The following example shows some combinations of Boolean values for the AND function.

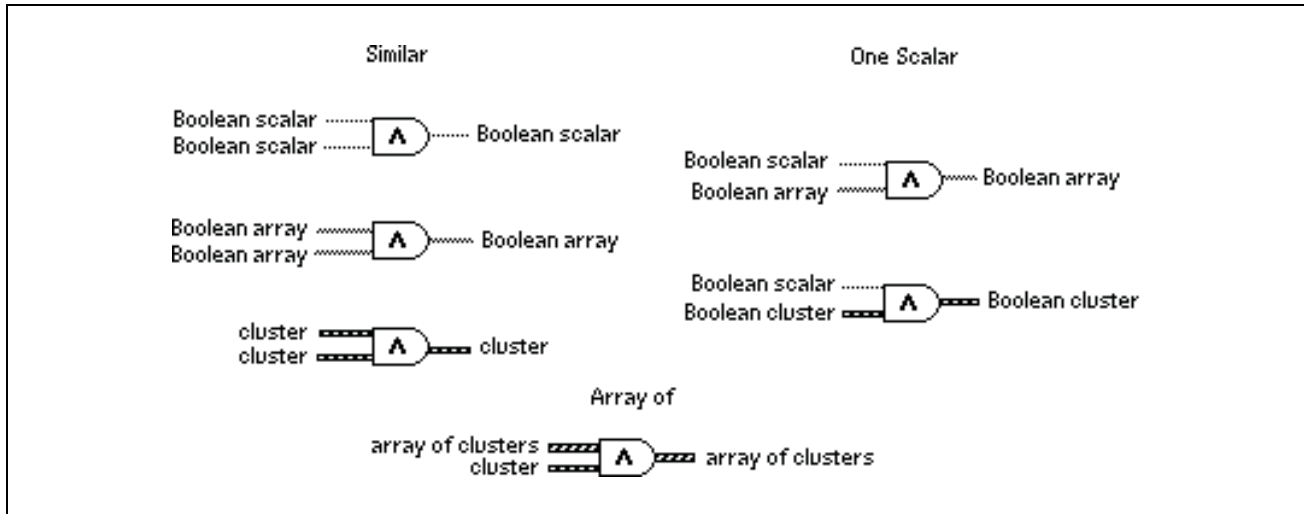

Polymorphism for Array Functions

Most of the array functions accept n -dimensional arrays of any type. However, the wiring diagrams in the function descriptions show numeric arrays as the default data type.

Polymorphism for String Functions

String Length, To Upper Case, To Lower Case, Reverse String, and Rotate String accept strings, clusters and arrays of strings, and arrays of clusters. To Upper Case and To Lower Case also accept numbers, clusters of numbers, and arrays of numbers, interpreting them as ASCII codes for characters. Width and precision inputs must be scalar.

Polymorphism for String Conversion Functions

The Path To String and String To Path functions are polymorphic. That is, they work on scalar values, arrays of scalars, clusters of scalars, arrays of clusters of scalars, and so on. The output has the same composition as the input but with the new type.

Polymorphism for Additional String to Number Functions

To Decimal, To Hex, To Octal, To Engineering, To Fractional, and To Exponential accept clusters and arrays of numbers and produce clusters and arrays of strings. From Decimal, From Hex, From Octal, and From Exponential/Fract/Sci accept clusters and arrays of strings and produce clusters and arrays of numbers. Width and precision inputs must be scalar.

Polymorphism for Cluster Functions

The Bundle and Unbundle functions do not show the data type for their individual input or output terminals until you wire objects to these terminals. When you wire them, these terminals look similar to the data types of the corresponding front panel control or indicator terminals.

Polymorphism for Comparison Functions

The functions Equal?, Not Equal?, and Select take inputs of any type, as long as the inputs are the same type.

The functions Greater or Equal?, Less or Equal?, Less?, Greater?, Max & Min, and In Range? take inputs of any type except complex, path, or refnum, as long as the inputs are the same type. You can compare numbers, strings, Booleans, arrays of strings, clusters of numbers, clusters of strings, and so on. However, you cannot compare a number to a string or a string to a Boolean, and so on.

The functions that compare values to zero accept numeric scalars, clusters, and arrays of numbers. These functions output Boolean values in the same data structure as the input.

The Not A Number/Path/Refnum function accepts the same input types as functions that compare values to zero. This function also accepts paths and refnums. Not A Number/Path/Refnum outputs Boolean values in the same data structure as the input.

The functions Decimal Digit?, Hex Digit?, Octal Digit?, Printable?, and White Space? accept a scalar string or number input, clusters of strings or non-complex numbers, arrays of strings or non-complex numbers, and so on. The output consists of Boolean values in the same data structure as the input.

The function Empty String/Path? accepts a path, a scalar string, clusters of strings, arrays of strings, and so on. The output consists of Boolean values in the same data structure as the input.

You can use the Equal?, Not Equal?, Not A Number/Path/Refnum?, Empty String/Path?, and Select functions with paths and refnums, but no other Comparison functions accept paths or refnums as inputs.

Comparison functions that use arrays and clusters normally produce Boolean arrays and clusters of the same structure. You can right-click the function and select **Compare Aggregates**, in which case the function outputs a single Boolean value. The function compares aggregates by comparing the first set of elements to produce the output, unless the first elements are equal, in which case the function compares the second set of elements, and so on.

Polymorphism for Log Functions

The Logarithmic functions take numeric input data. If the input is an integer, the output is a double-precision, floating-point number. Otherwise, the output has the same numeric representation as the input.

These functions work on numbers, arrays of numbers, clusters of numbers, arrays of clusters of numbers, complex numbers, and so on. A formal and recursive definition of the allowable input type is as follows:

Numeric type = numeric scalar OR array [numeric type] OR
cluster [numeric types]

except that arrays of arrays are not allowed.

Arrays can be any size and can have any number of dimensions. Clusters can have any number of elements. The output type is of the same numeric representation as the input, and the functions operate on each element of the cluster or array. Refer to the *Polymorphism for Numeric Functions* section of this chapter for more information about two-input polymorphic functions. Allowable input type combinations for the two-input Logarithmic functions include the following:

- **Similar**—Both inputs have the same structure, and the output has the same structure as the inputs.
- **One scalar**—One input is a numeric scalar, the other is a numeric array or cluster, and the output is an array or cluster.



Comparison Functions

Use the Comparison functions located on the **Functions»Comparison** palette to compare Boolean values, strings, numerics, arrays, and clusters. Most Comparison functions test one input or compare two inputs and return a Boolean value.

For more information...

Refer to the *LabVIEW Help* for more information about Comparison functions.

Comparing Boolean Values

The Comparison functions treat the Boolean value TRUE as greater than the Boolean value FALSE.

Comparing Strings

LabVIEW compares strings based on the numerical equivalent of the ASCII characters. For example, a (with a decimal value of 97) is greater than A (65), which is greater than the numeral 0 (48), which is greater than the space character (32). LabVIEW compares characters one by one from the beginning of the string until an inequality occurs, at which time the comparison ends. For example, LabVIEW evaluates the strings `abcd` and `abef` until it finds `c`, which is less than the value of `e`. The presence of a character is greater than the absence of one. Thus, the string `abcd` is greater than `abc` because the first string is longer.

The functions that test the category of a string character, such as the `Decimal Digit?` and `Printable?` functions, evaluate only the first character of the string.

Comparing Numerics

The Comparison functions convert numeric values to the same representation before comparing them. Comparisons with one or two inputs having the value Not a Number (NaN) return a value that indicates inequality. Refer to the *Undefined or Unexpected Data* section of Chapter 6, *Running and Debugging VIs*, for more information about the NaN value.

Comparing Arrays and Clusters

Some Comparison functions have two modes for comparing arrays or clusters of data. In Compare Aggregates mode, if you compare two arrays or clusters, the function returns a single scalar value. In Compare Elements mode, the function compares the elements individually and returns an array or cluster of Boolean values.

In Compare Aggregates mode, the string comparison and array comparison operations follow exactly the same process—the string is treated as an array of ASCII characters.

Some Comparison functions operate only in Compare Aggregates, so the shortcut menu options do not appear.

Arrays

When comparing multi-dimensional arrays, each array entered in the function must have the same number of dimensions. The Comparison functions that do not have the Compare Aggregates or Compare Elements modes compare arrays the same way as they compare strings—one element at a time starting with the first element until they encounter an inequality.

Compare Elements Mode

In Compare Elements mode, Comparison functions output an array of Boolean values of the same dimensions as the input arrays. Each dimension of the output array is the size of the smaller of the two input arrays in that dimension. Along each dimension such as row, column, or page, the functions compare corresponding element values in each input array to produce the corresponding Boolean value in the output array.

Compare Aggregates Mode

In Compare Aggregates mode, comparison functions output a single Boolean result. LabVIEW considers corresponding values that appear later in the input arrays as secondary to values appearing earlier in the input arrays. LabVIEW performs the following steps to determine the result of the comparison:

- LabVIEW compares corresponding elements in each input array, starting at the beginning of the array.
- If the corresponding elements are *not* equal, LabVIEW stops—the result of this comparison is used as the output of the comparison function.
- If the corresponding elements are equal, LabVIEW processes the next pair of values, until it finds an inequality or reaches the end of one of the input arrays.
- If all values in the input arrays are equal but one array has extra elements at the end, the longer array is considered greater than the shorter one. For example, LabVIEW considers the array `[1, 2, 3, 2]` to be greater than the array `[1, 2, 3]`.

Clusters

Clusters you want to compare must include the same number of elements, each element in the clusters must be of compatible types, and the elements must be in the same cluster order. For example, a cluster of a DBL and a string can be compared to a cluster of an I32 and a string.

Compare Elements Mode

In Compare Elements mode, Comparison functions output a cluster of Boolean elements, one for each corresponding element in the input clusters.

Compare Aggregates Mode

In Compare Aggregates mode, Comparison functions output a single Boolean result. LabVIEW compares corresponding elements until an inequality is found, which determines the result. The function considers the two clusters equal only if all elements are equal.

Use Compare Aggregates mode on clusters if you are comparing two records containing sorted data, where elements later in the cluster are considered secondary keys to elements earlier in the cluster. For example, a cluster containing two strings, last name followed by first name, would compare the first name fields only if the last name fields matched.

D

Masking Digital Data

On the block diagram, create a mask by bundling the digital waveform with a 2D array of integers, as shown in Figure D-1.

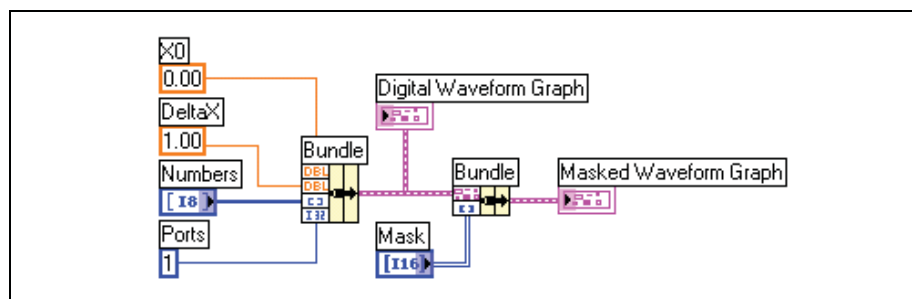

Figure D-1. Masking Digital Data

Combine bits by specifying values in each row of the 2D **Mask** array.

For example, consider a 1D array that consists of seven 8-bit numbers: 1, 2, 7, 32, 55, 82, and 127. The following table displays the binary representations of these numbers.

	1	2	7	32	55	82	127
Bit 0	1	0	1	0	1	0	1
Bit 1	0	1	1	0	1	1	1
Bit 2	0	0	1	0	1	0	1
Bit 3	0	0	0	0	0	0	1
Bit 4	0	0	0	0	1	1	1
Bit 5	0	0	0	1	1	0	1
Bit 6	0	0	0	0	0	1	1
Bit 7	0	0	0	0	0	0	0

Using a mask, you can plot one bit on a graph and overlay another bit on the same plot. For example, Bit 1 includes the values 0, 1, 1, 0, 1, 1, and 1, as shown in the following plot.

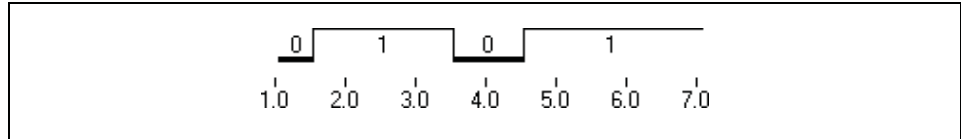

Bit 5 includes the values 0, 0, 0, 1, 1, 0, and 1, as shown in the following plot.

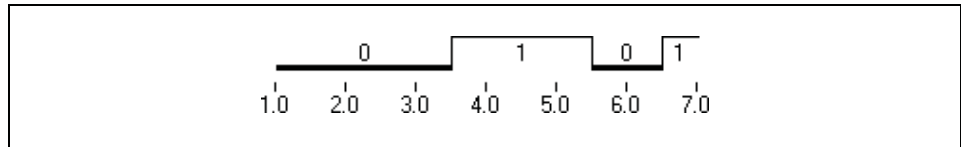

A mask is a 2D array. Each row in the array represents a plot on the digital graph. To display Bits 1 and 5 on the plot, enter 1 in one element of the array and 5 in another element, as shown in Figure D-2. Enter -1 in the other elements of the array that should not plot a bit.

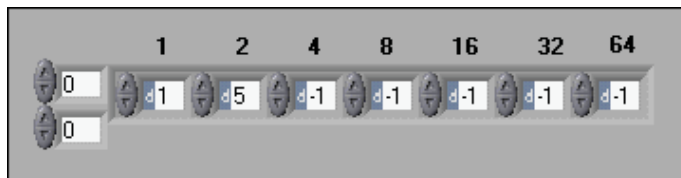
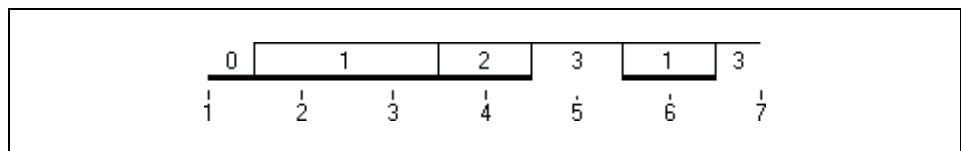

Figure D-2. Example of a Mask Array Control

In this example, each element in the array is identified by power of two (2^0 through 2^6). Use these numbers to identify which element in the array plots a bit to the graph. In this example, element 1 plots Bit 1 to the graph, so any value of 1 in the bit assigns a 1 in the plot, and any value of 0 assigns a 0 to the plot. Element 2 plots Bit 5 to the graph, so any value of 1 in the bit assigns a 2 to the plot, and any value of 0 assigns a 0 to the plot.

The array in Figure D-2 results in the following plot on the digital waveform graph.



This plot indicates the following:

- Bit 1 and Bit 5 in the first element include a value of 0.
- Bit 1 includes a value of 1 in both the second and third elements. Bit 5 includes a value of 0 in both the second and third elements.
- Bit 1 in the fourth element includes a value of 0. Bit 5 in the fourth element includes a value of 1.
- Bit 1 and Bit 5 in the fifth element include a value of 1.
- Bit 1 in the sixth element includes a value of 1. Bit 5 in the sixth element includes a value of 0.
- Bit 1 and Bit 5 in the seventh element include a value of 1.

The numbers that appear in the plot are derived from the following equation:

$$\begin{aligned}
 & [\text{bit value (1 or 0)}] \times [2]^{\text{element number}} \\
 & + [\text{another bit value (1 or 0)}] \times [2]^{\text{another element number}} \\
 & \quad \vdots \\
 & + [n \text{ bit value (1 or 0)}] \times [2]^n \text{ element number} \\
 \hline
 & \text{point value of the plot}
 \end{aligned}$$

In Figure D-3, the fourth (8) and sixth (32) elements plot Bits 5 and 1, respectively.

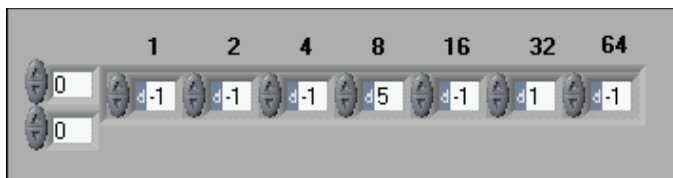
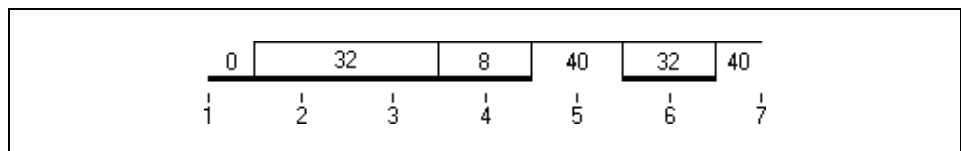

Figure D-3. Specifying the Same Bits in Different Elements

The array in Figure D-3 results in the following plot. Notice how the plots look similar, but the numeric values differ.



Each row in the mask corresponds to a plot on the graph. Add a new row to the mask to add a new plot on the digital graph, as shown in the Figure D-4.

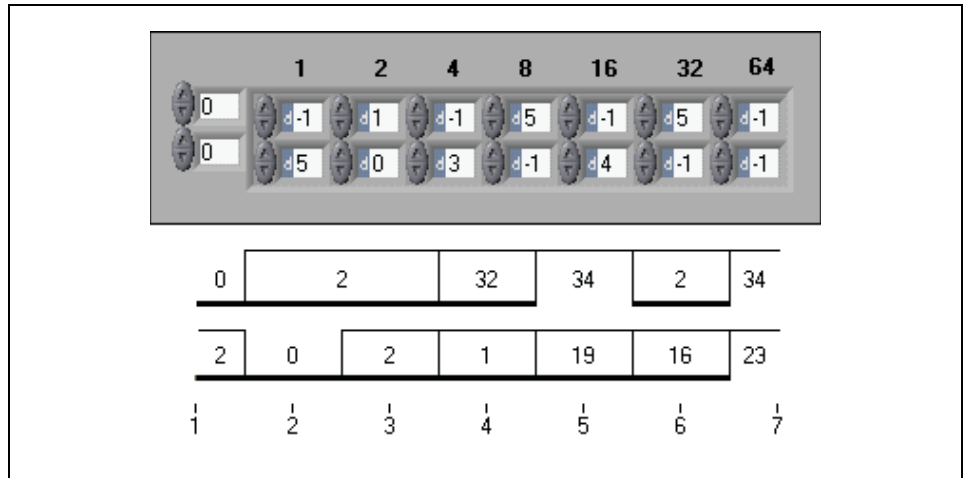

Figure D-4. Creating Two Plots of Masked Data on a Digital Waveform Graph



Technical Support Resources

Web Support

National Instruments Web support is your first stop for help in solving installation, configuration, and application problems and questions. Online problem-solving and diagnostic resources include frequently asked questions, knowledge bases, product-specific troubleshooting wizards, manuals, drivers, software updates, and more. Web support is available through the Technical Support section of ni.com.

NI Developer Zone

The NI Developer Zone at ni.com/zone is the essential resource for building measurement and automation systems. At the NI Developer Zone, you can easily access the latest example programs, system configurators, tutorials, technical news, as well as a community of developers ready to share their own techniques.

Customer Education

National Instruments provides a number of alternatives to satisfy your training needs, from self-paced tutorials, videos, and interactive CDs to instructor-led hands-on courses at locations around the world. Visit the Customer Education section of ni.com for online course schedules, syllabi, training centers, and class registration.

System Integration

If you have time constraints, limited in-house technical resources, or other dilemmas, you may prefer to employ consulting or system integration services. You can rely on the expertise available through our worldwide network of Alliance Program members. To find out more about our Alliance system integration solutions, visit the System Integration section of ni.com.

Worldwide Support

National Instruments has offices located around the world to help address your support needs. You can access our branch office Web sites from the Worldwide Offices section of ni.com. Branch office Web sites provide up-to-date contact information, support phone numbers, e-mail addresses, and current events.

If you have searched the technical support resources on our Web site and still cannot find the answers you need, contact your local office or National Instruments corporate. Phone numbers for our worldwide offices are listed at the front of this manual.

Glossary

Prefix	Meaning	Value
m-	milli-	10^{-3}
k-	kilo-	10^3
M-	mega-	10^6

Numbers/Symbols

Δ	Delta; difference. Δx denotes the value by which x changes from one index to the next.
π	Pi.
∞	Infinity.
1D	One-dimensional.
2D	Two-dimensional.

A

A	Amperes.
absolute coordinates	Picture coordinates relative to the origin (0,0) of the picture indicator.
absolute path	File or directory path that describes the location relative to the top level of the file system.
AC	Alternating current.
active window	Window that is currently set to accept user input, usually the frontmost window. The titlebar of an active window is highlighted. Make a window active by clicking it or by selecting it from the Windows menu.
application software	Application created using the LabVIEW Development System and executed in the LabVIEW Run-Time System environment.

array	Ordered, indexed list of data elements of the same type.
artificial data dependency	Condition in a dataflow programming language in which the arrival of data, rather than its value, triggers execution of a node.
ASCII	American Standard Code for Information Interchange.
auto-indexing	Capability of loop structures to disassemble and assemble arrays at their borders. As an array enters a loop with auto-indexing enabled, the loop automatically disassembles it extracting scalars from 1D arrays, 1D arrays extracted from 2D arrays, and so on. Loops assemble data into arrays as data exit the loop in the reverse order.
autoscaling	Ability of scales to adjust to the range of plotted values. On graph scales, autoscaling determines maximum and minimum scale values.
B	
block diagram	Pictorial description or representation of a program or algorithm. The block diagram, consists of executable icons called nodes and wires that carry data between the nodes. The block diagram is the source code for the VI. The block diagram resides in the block diagram window of the VI.
Boolean controls and indicators	Front panel objects to manipulate and display Boolean (TRUE or FALSE) data.
breakpoint	Pause in execution used for debugging.
Breakpoint tool	Tool to set a breakpoint on a VI, node, or wire.
broken Run button	Button that replaces the Run button when a VI cannot run because of errors.
broken VI	VI that cannot or run because of errors; signified by a broken arrow in the broken Run button.
buffer	Temporary storage for acquired or generated data.
byte stream file	File that stores data as a sequence of ASCII characters or bytes.

C

case	One subdiagram of a Case structure.
Case structure	Conditional branching control structure, that executes one of its subdiagrams based on the input to the Case structure. It is the combination of the IF, THEN, ELSE, and CASE statements in control flow languages.
channel	Pin or wire lead to which you apply or from which you read the analog or digital signal. Analog signals can be single-ended or differential. For digital signals, you group channels to form ports. Ports usually consist of either four or eight digital channels.
channel name	Unique name given to a channel configuration in the DAQ Channel Wizard.
chart	2D display of one or more plots in which the display retains previous data, up to a maximum that you define. The chart receives the data and updates the display point by point or array by array, retaining a certain number of past points in a buffer for display purposes. <i>See also</i> scope chart , strip chart , and sweep chart .
checkbox	Small square box in a dialog box you can select or clear. Checkboxes generally are associated with multiple options that you can set. You can select more than one checkbox.
CIN	<i>See</i> Code Interface Node (CIN).
cloning	To make a copy of a control or another object by clicking it while pressing the <Ctrl> key and dragging the copy to its new location. (Macintosh) Press the <Option> key. (Sun) Press the <Meta> key. (Linux) Press the <Alt> key. (UNIX) You also can clone an object by clicking the object with the middle mouse button and then dragging the copy to its new location.
cluster	A set of ordered, unindexed data elements of any data type, including numeric, Boolean, string, array, or cluster. The elements must be all controls or all indicators.
Code Interface Node (CIN)	CIN. Special block diagram node through which you can link text-based code to a VI.

coercion	Automatic conversion LabVIEW performs to change the numeric representation of a data element.
coercion dot	Dot on a terminal that indicates that one of two terminals wired together LabVIEW has converted to match the data type of the other.
Color Copying tool	Copies colors for pasting with the Coloring tool.
Coloring tool	Tool to set foreground and background colors.
compile	Process that converts high-level code to machine-executable code. LabVIEW compiles VIs automatically before they run for the first time after you create or edit alteration.
conditional terminal	Terminal of a While Loop that contains a Boolean value that determines if the VI performs another iteration.
configuration utility	Refers to Measurement & Automation Explorer on Windows and to the NI-DAQ Configuration Utility on Macintosh.
connector	Part of the VI or function node that contains input and output terminals. Data pass to and from the node through a connector.
connector pane	Region in the upper right corner of a front panel or block diagram window that displays the VI terminal pattern. It defines the inputs and outputs you can wire to a VI.
constant	See universal constant and user-defined constant .
Context Help window	Special window in LabVIEW that displays the names and locations of the terminals for a VI or function, the description of controls and indicators, the values of universal constants, and descriptions and data types of control attributes.
control	Front panel object for entering data to a VI interactively or to a subVI programmatically, such as a knob, push button, or dial.
control flow	Programming system in which the sequential order of instructions determines execution order. Most text-based programming languages are control flow languages.
Controls palette	Palette that contains front panel controls, indicators, and decorative objects.
conversion	Changing the type of a data element.

count terminal	Terminal of a For Loop whose value determines the number of times the For Loop executes its subdiagram.
current VI	VI whose front panel, block diagram, or Icon Editor is the active window.
curve in 3D	Special parametric plot $(x(t), y(t), z(t))$, where the parameter t runs over a given interval.

D

D	Delta; Difference. Δx denotes the value by which x changes from one index to the next.
DAQ	<i>See</i> data acquisition.
DAQ Channel Wizard	Utility that guides you through naming and configuring DAQ analog and digital channels. Available in the Data Neighborhood of Measurement & Automation Explorer (Windows) or DAQ Channel Wizard (Macintosh).
data acquisition	DAQ. Process of acquiring data, typically from A/D or digital input plug-in devices.
data dependency	Condition in a dataflow programming language in which a node cannot execute until it receives data from another node. <i>See also</i> artificial data dependency .
data flow	Programming system that consists of executable nodes that execute only when they receive all required input data and produce output automatically when they execute. LabVIEW is a dataflow system.
datalog file	File that stores data as a sequence of records of a single, arbitrary data type that you specify when you create the file. Although all the records in a datalog file must be a single type, that type can be complex. For example, you can specify that each record is a cluster that contains a string, a number, and an array.
datalogging	Generally, to acquire data and simultaneously store it in a disk file. LabVIEW file I/O VIs and functions can log data.
data type	Format for information. In LabVIEW, acceptable data types for most VIs and functions are numeric, array, string, Boolean, path, refnum, enumeration, waveform, and cluster.
DDE	<i>See</i> dynamic data exchange .

default	Preset value. Many VI inputs use a default value if you do not specify a value.
device	<p>Instrument or controller that is addressable as a single entity and controls or monitors real-world I/O points. A device is often connected to the host computer through some type of communication network or can be a plug-in device.</p> <p>For data acquisition (DAQ) applications, a DAQ device is inside your computer or attached directly to the parallel port of your computer. Plug-in boards, PCMCIA cards, and devices such as the DAQPad-1200, which connects to your computer's parallel port, are all examples of DAQ devices. SCXI modules are distinct from devices, with the exception of the SCXI-1200, which is a hybrid.</p>
directory	Structure for organizing files into convenient groups. A directory is like an address that shows the location of files. A directory can contain files or subdirectories of files.
discrete	Having discontinuous values of the independent variable, usually time.
dithering	Addition of Gaussian noise to an analog input signal. By applying dithering and then averaging the input data, you can effectively increase the resolution by another one-half bit.
DLL	Dynamic Link Library.
drag	To use the cursor on the screen to select, move, copy, or delete objects.
drive	Letter in the range a-z followed by a colon (:), to indicate a logical disk drive.
driver	Software that controls a specific hardware device, such as a DAQ device.
dynamic data exchange	DDE. Method to pass data between applications, without user involvement or monitoring.

E

empty array	Array that has zero elements but has a defined data type. For example, an array that has a numeric control in its data display window but has no defined values for any element is an empty numeric array.
error in	Error structure that enters a VI.

error message	Indication of a software or hardware malfunction or of an unacceptable data entry attempt.
error out	The error structure that leaves a VI.
error structure	Consists of a Boolean status indicator, a numeric code indicator, and a string source indicator.
event	Condition or state of an analog or digital signal.
Event Data Node	Node attached to the left and right sides of an Event structure indicating the available data for the event you configured that case to handle. If you configure a single case to handle multiple events, only the data that is common to all handled event types is available.
execution highlighting	Debugging technique that animates VI execution to illustrate the data flow in the VI.
external trigger	Voltage pulse from an external source that triggers an event, such as A/D conversion.
F	
FIFO	First-in-first-out memory buffer. The first data stored is the first data sent to the acceptor.
file refnum	<i>See</i> refnum .
filtering	Type of signal conditioning that allows you to filter unwanted signals from the signal you are trying to measure.
flattened data	Data of any type that has been converted to a string, usually for writing the data to a file.
For Loop	Iterative loop structure that executes its subdiagram a set number of times. Equivalent to text-based code: <code>For i = 0 to n - 1, do...</code>
Formula Node	Node that executes equations you enter as text. Especially useful for lengthy equations too cumbersome to build in block diagram form.
frame	Subdiagram of a Sequence structure.
free label	Label on the front panel or block diagram that does not belong to any other object.

front panel	Interactive user interface of a VI. Front panel appearance imitates physical instruments, such as oscilloscopes and multimeters.
function	Built-in execution element, comparable to an operator, function, or statement in a text-based programming language.
Functions palette	Palette that contains VIs, functions, block diagram structures, and constants.

G

General Purpose Interface Bus	GPIB—synonymous with HP-IB. The standard bus used for controlling electronic instruments with a computer. Also called IEEE 488 bus because it is defined by ANSI/IEEE Standards 488-1978, 488.1-1987, and 488.2-1992.
global variable	Accesses and passes data among several VIs on a block diagram.
glyph	Small picture or icon.
GPIB	<i>See</i> General Purpose Interface Bus.
graph	2D display of one or more plots. A graph receives and plots data as a block.
graph control	Front panel object that displays data in a Cartesian plane.
group	Collection of input or output channels or ports that you define. Groups can contain analog input, analog output, digital input, digital output, or counter/timer channels. A group can contain only one type of channel. Use a task ID number to refer to a group after you create it. You can define up to 16 groups at one time. To erase a group, pass an empty channel array and the group number to the group configuration VI. You do not need to erase a group to change its membership. If you reconfigure a group whose task is active, LabVIEW clears the task and returns a warning. LabVIEW does not restart the task after you reconfigure the group.

H

handle	Pointer to a pointer to a block of memory that manages reference arrays and strings. An array of strings is a handle to a block of memory that contains handles to strings.
--------	---

hex	Hexadecimal. Base-16 number system.
Hierarchy Window	Window that graphically displays the hierarchy of VIs and subVIs.
I	
I/O	Input/Output. The transfer of data to or from a computer system involving communications channels, operator input devices, and/or data acquisition and control interfaces.
icon	Graphical representation of a node on a block diagram.
IEEE	Institute for Electrical and Electronic Engineers.
indicator	Front panel object that displays output, such as a graph or LED.
Inf	Digital display value for a floating-point representation of infinity.
instrument driver	VI that controls a programmable instrument.
integer	Any of the natural numbers, their negatives, or zero.
intensity map/plot	Method of displaying three dimensions of data on a 2D plot with the use of color.
IP	Internet protocol.
iteration terminal	Terminal of a For Loop or While Loop that contains the current number of completed iterations.
L	
label	Text object used to name or describe objects or regions on the front panel or block diagram.
Labeling tool	Tool to create labels and enter text into text windows.
LabVIEW	Laboratory Virtual Instrument Engineering Workbench. LabVIEW is a graphical programming language that uses icons instead of lines of text to create programs.
LED	Light-emitting diode.

legend	Object a chart or graph owns to displays the names and plot styles of plots on that chart or graph.
library	See VI library .
listbox	Box within a dialog box that lists all available choices for a command. For example, a list of filenames on a disk.
LLB	VI Library.
local variable	Variable that enables you to read or write to one of the controls or indicators on the front panel of a VI.

M

matrix	2D array.
Measurement & Automation Explorer	The standard National Instruments hardware configuration and diagnostic environment for Windows.
memory buffer	See buffer .
menu bar	Horizontal bar that lists the names of the main menus of an application. The menu bar appears below the titlebar of a window. Each application has a menu bar that is distinct for that application, although some menus and commands are common to many applications.
method	A procedure that is executed when an object receives a message. A method is always associated with a class.
multithreaded application	Application that runs several different threads of execution independently. On a multiple processor computer, the different threads might be running on different processors simultaneously.

N

NaN	Digital display value for a floating-point representation of <i>not a number</i> . Typically the result of an undefined operation, such as $\log(-1)$.
NI-DAQ	Comprehensive driver software included with all National Instruments DAQ hardware.

node Program execution element. Nodes are analogous to statements, operators, functions, and subroutines in text-based programming languages. On a block diagram, nodes include functions, structures, and subVIs.

numeric controls and indicators Front panel objects to manipulate and display numeric data.

O

object Generic term for any item on the front panel or block diagram, including controls, indicators, nodes, wires, and imported pictures.

Object Shortcut Menu tool Tool to access a shortcut menu for an object.

OLE Object Linking and Embedding.

one-dimensional Having one dimension, as in the case of an array that has only one row of elements.

Operating tool Tool to enter data into controls operate them.

P

palette Display of icons that represent possible options.

panel window VI window that contains the front panel, the toolbar, and the icon and connector panes.

picture Series of graphics instructions that a picture indicator uses to create a picture.

picture indicator General-purpose indicator for displaying pictures that can contain lines, circles, text, and other types of graphic shapes.

pixel Smallest unit of a digitized picture.

pixmap Standard format for storing pictures in which a color value represents each pixel. A bitmap is a black and white version of a pixmap.

plot Graphical representation of an array of data shown either on a graph or a chart.

point	Cluster that contains two 16-bit integers that represent horizontal and vertical coordinates.
polymorphism	Ability of a node to automatically adjust to data of different representation, type, or structure.
Positioning tool	Tool to move and resize objects.
PPC	Program-to-program communication.
probe	Debugging feature for checking intermediate values in a VI.
Probe tool	Tool to create probes on wires.
programmatic printing	Automatic printing of a VI front panel after execution.
Property Node	Sets or finds the properties of a VI or application.
pull-down menus	Menus accessed from a menu bar. Pull-down menu options are usually general in nature.
PXI	PCI eXtensions for Instrumentation. A modular, computer-based instrumentation platform.

R

race condition	Occurs when two or more pieces of code that execute in parallel change the value of the same shared resource, typically a global or local variable.
range	Region between the limits within which a quantity is measured, received, or transmitted. Expressed by stating the lower and upper range values.
rectangle	Cluster that contains four 16-bit integers. The first two values describe the vertical and horizontal coordinates of the top left corner. The last two values describe the vertical and horizontal coordinates of the bottom right corner.
refnum	Reference number. An identifier that LabVIEW associates with a file you open. Use the refnum to indicate that you want a function or VI to perform an operation on the open file.
relative coordinates	Picture coordinates relative to the current location of the pen.

representation	Subtype of the numeric data type, of which there are signed and unsigned byte, word, and long integers, as well as single-, double-, and extended-precision floating-point numbers.
resizing handles	Angled handles on the corner of objects that indicate resizing points.
ring control	Special numeric control that associates 32-bit integers, starting at 0 and increasing sequentially, with a series of text labels or graphics.

S

sample	Single analog or digital input or output data point.
scalar	Number that a point on a scale can represent. A single value as opposed to an array. Scalar Booleans and clusters are explicitly singular instances of their respective data types.
scale	Part of chart, graph, and some numeric controls and indicators that contains a series of marks or points at known intervals to denote units of measure.
scope chart	Numeric indicator modeled on the operation of an oscilloscope.
Scroll tool	Tool to move through windows.
SCXI	Signal Conditioning eXtensions for Instrumentation. The National Instruments product line for conditional low-level signals within an external chassis near sensors, so only high-level signals in a noisy environment are sent to DAQ devices.
sequence local	Terminal to pass data between the frames of a Sequence structure.
Sequence structure	Program control structure that executes its subdiagrams in numeric order. Use this structure to force nodes that are not data dependent to execute in the order you want.
shift register	Optional mechanism in loop structures to pass the value of a variable from one iteration of a loop to a subsequent iteration. Shift registers are similar to static variables in text-based programming languages.
shortcut menu	Menu accessed by right-clicking an object. Menu options pertain to that object specifically.
slider	Moveable part of slide controls and indicators.

string	Representation of a value as text.
string controls and indicators	Front panel objects to manipulate and display text.
strip chart	Numeric plotting indicator modeled after a paper strip chart recorder, which scrolls as it plots data.
structure	Program control element, such as a Sequence structure, Case structure, For Loop, or While Loop.
subdiagram	Block diagram within the border of a structure.
subVI	VI used on the block diagram of another VI. Comparable to a subroutine.
sweep chart	Numeric indicator modeled on the operation of an oscilloscope. It is similar to a scope chart, except that a line sweeps across the display to separate old data from new data.
syntax	Set of rules to which statements must conform in a particular programming language.

T

TCP	Transmission Control Protocol.
terminal	Object or region on a node through which data pass.
tip strip	Small yellow text banners that identify the terminal name and make it easier to identify terminals for wiring.
tool	Special cursor to perform specific operations.
toolbar	Bar that contains command buttons to run and debug VIs.
Tools palette	Palette that contains tools you can use to edit and debug front panel and block diagram objects.
top-level VI	VI at the top of the VI hierarchy. This term distinguishes the VI from its subVIs.
tunnel	Data entry or exit terminal on a structure.

two-dimensional Having two dimensions, as in the case of an array that has several rows and columns.

type definition Master copy of a custom object that several VIs can use.

U

UDP User Datagram Protocol.

universal constant Uneditable block diagram object that emits a particular ASCII character or standard numeric constant, for example, π .

user-defined constant Block diagram object that emits a value you set.

V

vector 1D array.

VI *See* virtual instrument (VI).

VI class A reference to a virtual instrument that allows access to VI properties and methods.

VI library Special file that contains a collection of related VIs for a specific use.

VI Server Mechanism for controlling VIs and LabVIEW applications programmatically, locally and remotely.

virtual instrument (VI) Program in LabVIEW that models the appearance and function of a physical instrument.

Virtual Instrument Software Architecture VISA. Single interface library for controlling GPIB, VXI, RS-232, and other types of instruments.

VISA *See* Virtual Instrument Software Architecture.

VXI VME eXtensions for Instrumentation (bus).

W

waveform	Multiple voltage readings taken at a specific sampling rate.
waveform chart	Indicator that plots data points at a certain rate.
While Loop	Loop structure that repeats a section of code until a condition is met.
wire	Data path between nodes.
wire bend	Point where two wire segments join.
wire branch	Section of wire that contains all the wire segments from junction to junction, terminal to junction, or terminal to terminal if there are no junctions between.
wire junction	Point where three or more wire segments join.
wire segment	Single horizontal or vertical piece of wire.
wire stubs	Truncated wires that appear next to unwired terminals when you move the Wiring tool over a VI or function node.
Wiring tool	Tool to define data paths between terminals.

Index

Numerics

- 2D controls and indicators, 4-7
- 3D controls and indicators, 4-7
- 3D graphs, 11-15

A

ActiveX, 18-1

- accessing ActiveX-enabled applications, 18-3
- building subpalettes, 3-5
- clients, 18-3
- constants for setting parameters, 18-6
- containers, 18-2
- controls, 18-2
- custom interfaces, 18-6
- events, 18-1
- for running script nodes, 20-2
- functions, 18-2
- indicators, 18-2
- inserting objects on front panel, 18-4
- invoking methods. *See the LabVIEW Help.*
- networking and, 17-1
- objects, 18-1
- properties, 18-1
- Property Browser, 18-4
- Property Node, 18-5
- property pages, 18-5
- remote front panels, 17-13
- selecting custom interfaces, 18-3
- servers, 18-6
- setting parameters using constants, 18-6
- setting properties, 18-4
- setting properties programmatically, 18-5
- VI Server, 16-1
- viewing properties, 18-4
- VIs, 18-2

adding

- controls to libraries, 3-4
- directories to VI search path. *See the LabVIEW Help.*
- graphic to VI icon. *See the LabVIEW Help.*
- terminals to functions, 5-9
- VIs to libraries, 3-4

add-on toolsets, 1-1

- in palettes, 3-6

advanced functions, 5-9

aligning objects. *See the LabVIEW Help.*

Alliance Program, E-1

animated front panel images, 17-10

annotations, 4-16

- editing. *See the LabVIEW Help.*

anti-aliased line plots, 11-2

Apple events, 17-15

Application Builder. *See stand-alone applications.*

application control functions, 5-9

application font, 4-17

application notes, 1-3

Application object

- manipulating settings, 16-3
- VI Server, 16-3

applications

- building stand-alone, 7-12
- distributing VIs, 7-12
- building VI Server, 16-2

arithmetic. *See equations.*

arrays, 9-8

- auto-indexing loops, 8-4
- comparing, C-2
- constants, 9-11
- controls and indicators, 4-11
- data type (table), 5-3

converting clusters to and from. *See the LabVIEW Help.*
 creating, 9-11
 default data, 6-8
 deleting elements. *See the LabVIEW Help.*
 dimensions, 9-8
 examples, 9-8
 1D arrays, 9-8
 2D arrays, 9-10
 functions, 5-7
 global variables, 10-5
 indexes, 9-8
 display, 9-11
 inserting elements. *See the LabVIEW Help.*
 moving. *See the LabVIEW Help.*
 polymorphism, B-5
 replacing elements. *See the LabVIEW Help.*
 resizing. *See the LabVIEW Help.*
 restrictions, 9-11
 size of, 6-8
 artificial data dependency, 5-20
 assigning
 passwords to block diagrams, 7-12
 auto-constant labels
 displaying. *See the LabVIEW Help.*
 auto-indexing, 8-4
 For Loops, 8-4
 unexpected data, 6-7
 While Loops, 8-5
 automatic wiring, 5-11
 automation
 custom interfaces, 18-6
 refnum control, 18-2

B

background color of front panel objects. *See the LabVIEW Help.*

binary
 creating files, 13-9
 file I/O, 13-3
 floating-point arithmetic, 6-7
 bitmap files, 12-6
 blink speed. *See the LabVIEW Help.*
 block diagram, 2-2
 adding space without resizing, 5-22
 aligning objects. *See the LabVIEW Help.*
 coercion dots, 5-12
 commenting out sections, 6-6
 constants, 5-4
 controlling source code, 7-2
 copying objects. *See the LabVIEW Help.*
 creating controls and indicators. *See the LabVIEW Help.*
 data flow, 5-20
 data types (table), 5-2
 DataSocket, 17-6
 deleting objects. *See the LabVIEW Help.*
 designing, 5-22
 finding terminals. *See the LabVIEW Help.*
 fonts, 4-17
 functions, 5-6
 inserting objects. *See the LabVIEW Help.*
 labels, 4-16
 creating. *See the LabVIEW Help.*
 editing. *See the LabVIEW Help.*
 resizing. *See the LabVIEW Help.*
 nodes, 5-5
 objects, 5-1
 options, 3-6
 password protecting, 7-12
 planning, 7-1
 printing, 14-5
 removing objects. *See the LabVIEW Help.*
 reordering objects. *See the LabVIEW Help.*
 replacing objects. *See the LabVIEW Help.*
 spacing objects evenly. *See the LabVIEW Help.*

- structures, 8-1
 - using. *See the LabVIEW Help.*
- terminals, 5-1
 - adding to functions, 5-9
 - control and indicator (table), 5-2
 - displaying, 5-2
 - front panel objects and, 5-1
 - removing from functions, 5-9
- variant data, 5-16
- VI Server, 16-1
- wiring automatically, 5-11
- wiring manually, 5-10, 5-12

BMP files, 12-6

Boolean controls and indicators, 4-10

- comparing values, C-1
- data type (table), 5-2
- using. *See the LabVIEW Help.*

Boolean functions, 5-6

- polymorphism, B-4

Breakpoint tool

- debugging VIs, 6-5
- highlighting breakpoints. *See the LabVIEW Help.*

broken VIs

- common causes, 6-3
- correcting, 6-2
- displaying errors, 6-2

broken wires, 5-12

buffered data

- local variables, 10-5

buffers

- variant data, 5-17

building

- block diagram, 5-1
- front panel, 4-1
- instrument driver applications. *See the LabVIEW Help.*
- measurement and automation systems, E-1
- polymorphic VIs, 5-14

- shared libraries, 7-12
 - distributing VIs, 7-12
- stand-alone applications, 7-12
 - distributing VIs, 7-12
- subVIs, 7-4
- VI Server applications, 16-2
- VIs, 7-1

buttons

- controlling with keyboard shortcuts, 4-3
- front panel, 4-10

byte stream files, 13-3

C

C code

- calling from LabVIEW, 19-1

calculating equations, 20-1

Call By Reference Node, 16-7

Call Library Function Node, 19-1

callback, 8-12

callers

- chain of, 6-6
- displaying, 6-6

calling code from text-based programming languages, 19-1

calling VIs dynamically, 16-7

canceling existing errors. *See the LabVIEW Help.*

captions, 4-16

- creating. *See the LabVIEW Help.*
- subVI tip strips. *See the LabVIEW Help.*

Case structures, 8-6

- data types, 8-7
- error handling, 6-10
- selector terminals, 8-7
 - values, 8-7
- specifying a default case, 8-7
- using. *See the LabVIEW Help.*

chain of callers

- displaying, 6-6

- changing palette views. *See the LabVIEW Help.*
- character formatting, 4-17
- charts, 11-1
 - adding plots. *See the LabVIEW Help.*
 - anti-aliased line plots, 11-2
 - clearing. *See the LabVIEW Help.*
 - creating. *See the LabVIEW Help.*
 - customizing appearance, 11-3
 - customizing behavior, 11-6
 - history length, 11-6
 - intensity, 11-11
 - options, 11-13
 - multiple scales, 11-2
 - options, 11-2
 - overlaid plots, 11-6
 - remote front panels, 17-13
 - scrolling, 11-3
 - stacked plots, 11-6
 - types, 11-1
 - waveform, 11-10
 - zooming. *See the LabVIEW Help.*
- checking available disk space. *See the LabVIEW Help.*
- CIN, 19-1
- classic controls and indicators, 4-7
- clearing
 - graphs and charts. *See the LabVIEW Help.*
 - indicators. *See the LabVIEW Help.*
- clients
 - ActiveX, 18-3
 - LabVIEW for remote front panels, 17-12
 - multiple for remote front panels, 17-11
 - Web browser for remote front panels, 17-12
- cloning objects on front panel or block diagram. *See the LabVIEW Help.*
- clusters, 9-13
 - comparing, C-2
 - controls and indicators, 4-11
 - data type (table), 5-3
- converting arrays to and from. *See the LabVIEW Help.*
- error, 6-9
 - components, 6-10
 - reports. *See the LabVIEW Help.*
- functions, 5-7
- moving. *See the LabVIEW Help.*
- order of elements, 9-14
 - modifying, 9-14
 - See also the LabVIEW Help.*
- polymorphism, B-6
- resizing. *See the LabVIEW Help.*
- wire patterns, 9-14
- Code Interface Node, 19-1
- coercion dots, 5-12
- color
 - boxes, 4-9
 - creating in graphics, 12-6
 - high-color controls and indicators, 4-7
 - low-color controls and indicators, 4-7
 - mapping, 11-12
 - modifying in graphics, 12-6
 - options, 3-6
 - picker, 4-9
 - ramps, 4-9
 - rotary controls and indicators, 4-9
- coloring
 - background objects. *See the LabVIEW Help.*
 - defining user colors. *See the LabVIEW Help.*
 - foreground objects. *See the LabVIEW Help.*
 - front panel objects, 4-4
 - copying colors. *See the LabVIEW Help.*
 - system colors, 4-19
 - See also the LabVIEW Help.*
 - transparent objects. *See the LabVIEW Help.*

- command line
 - launching VIs. *See the LabVIEW Help.*
- commenting out sections of a block diagram
 - debugging VIs, 6-6
- communication, 17-1
 - ActiveX, 18-1
 - Apple events, 17-15
 - DataSocket, 17-2
 - DDE, 17-15
 - executing system-level commands, 17-15
 - file I/O, 13-1
 - functions, 7-3
 - low-level, 17-14
 - Macintosh, 17-15
 - pipes, 17-15
 - PPC, 17-15
 - protocols, 17-14
 - System Exec VI, 17-15
 - TCP, 17-14
 - UDP, 17-14
 - UNIX, 17-15
 - VI Server, 16-1
 - VIs, 7-3
- compacting memory. *See the LabVIEW Help.*
- comparing
 - arrays, C-2
 - Boolean values, C-1
 - clusters, C-2
 - numerics, C-2
 - strings, C-1
 - versions of VIs, 7-2
- Comparison functions, C-1
 - polymorphism, B-6
- computer-based instruments
 - configuring, 1-3
- conditional terminals, 8-2
- configuration file VIs
 - format, 13-13
 - purpose, 13-13
 - reading and writing .ini files, 13-12
- configuring
 - front panel objects, 4-1
 - menus, 15-2
 - servers for remote front panels, 17-11
 - LabVIEW, 17-12
 - Web browser, 17-12
 - VI appearance and behavior, 15-1
- connecting terminals, 5-10
- connector panes, 2-4
 - printing, 14-3
 - required and optional inputs and outputs, 7-7
 - setting up, 7-6
- constants, 5-4
 - arrays, 9-11
 - creating. *See the LabVIEW Help.*
 - editing. *See the LabVIEW Help.*
 - setting parameters with ActiveX, 18-6
 - universal, 5-4
 - user-defined, 5-4
- consulting services, E-1
- contacting National Instruments, E-2
- containers
 - ActiveX, 18-2
- continuously running VIs, 6-1
- control flow programming model, 5-20
- control references, 16-8
 - creating. *See the LabVIEW Help.*
 - strictly typed, 16-9
 - weakly typed, 16-9
- controlling
 - front panel objects programmatically, 16-8
 - front panel objects remotely. *See the LabVIEW Help.*
 - instruments, 7-2
 - source code, 7-2
 - VIs programmatically, 16-1
 - VIs remotely, 17-10
 - VIs when called as subVIs, 7-3

- controls, 4-1
 - 2D, 4-7
 - 3D, 4-7
 - ActiveX, 18-2
 - adding to libraries, 3-4
 - array, 4-11
 - automation refnum, 18-2
 - Boolean, 4-10
 - using. *See the LabVIEW Help.*
 - captions for subVI tip strips. *See the LabVIEW Help.*
 - changing to indicators, 4-2
 - classic, 4-7
 - cluster, 4-11
 - color box, 4-9
 - color ramp, 4-9
 - coloring, 4-4
 - configuring, 4-1
 - creating on block diagram. *See the LabVIEW Help.*
 - data types (table), 5-2
 - dialog, 4-15
 - using. *See the LabVIEW Help.*
 - digital, 4-9
 - displaying optional elements, 4-2
 - enumerated type, 4-13
 - advanced, 4-13
 - using. *See the LabVIEW Help.*
 - grouping and locking, 4-5
 - guidelines for using on front panel, 4-18
 - hidden. *See the LabVIEW Help.*
 - hiding
 - See also the LabVIEW Help.*
 - optional elements, 4-2
 - high-color, 4-7
 - I/O name, 4-14
 - keyboard shortcuts, 4-3
 - listbox, 4-12
 - using. *See the LabVIEW Help.*
 - low-color, 4-7
 - naming, 7-9
 - numeric, 4-8
 - using. *See the LabVIEW Help.*
 - optional, 7-7
 - palette, 3-1
 - customizing, 3-4
 - navigating and searching, 3-2
 - path, 4-10
 - using. *See the LabVIEW Help.*
 - printing, 14-3
 - refnum, 4-15
 - using. *See the LabVIEW Help.*
 - replacing, 4-2
 - required, 7-7
 - resizing, 4-5
 - in relation to window size, 4-5
 - ring, 4-13
 - using. *See the LabVIEW Help.*
 - rotary, 4-8
 - slide, 4-8
 - string, 4-10
 - display types, 9-2
 - tables, 9-2
 - tab, 4-11
 - terminals (table), 5-2
 - type definitions, 4-1
 - user interface design, 4-18
- conventions used in this manual, xviii
- converting
 - arrays to and from clusters. *See the LabVIEW Help.*
 - directories to libraries. *See the LabVIEW Help.*
 - LabVIEW data types to HTML, 9-6
 - libraries to directories. *See the LabVIEW Help.*
 - numerics to strings, 9-5
 - XML to LabVIEW data, 9-7
- cooperation level
 - setting. *See the LabVIEW Help.*

copying
 objects on front panel or block diagram.
See the LabVIEW Help.
 VIs, A-3

correcting
 VIs, 6-2
 debugging techniques, 6-3

count terminals, 8-2
 auto-indexing to set, 8-4

creating
 arrays, 9-11
 binary files, 13-9
 charts. *See the LabVIEW Help.*
 control references. *See the LabVIEW Help.*
 datalog files, 13-10
 graphs. *See the LabVIEW Help.*
 icons, 7-8
 menus, 15-2
 object descriptions, 14-2
 palette views, 3-5
 revision history, 14-2
 spreadsheet files, 13-8
 subpalettes. *See the LabVIEW Help.*
 subVIs, 7-8
 situations to avoid. *See the LabVIEW Help.*
 text files, 13-8
 tip strips, 14-2
 user-defined constants, 5-4
 VI descriptions, 14-2

cursors
 adding to graphs. *See the LabVIEW Help.*
 graph, 11-4

custom automation interfaces, 18-6

customer
 education, E-1
 technical support, E-1

customizing
 error codes. *See the LabVIEW Help.*
 front panel objects, 4-1

menus, 15-2
 palettes, 3-4
 VI appearance and behavior, 15-1
 work environment, 3-4

D

DAQ

Channel Viewer, 1-4
 Channel Wizard, 1-4
 Configuration Utility, 1-4
 passing channel names, 4-14
 Solution Wizard, 1-4
 VIs and functions, 7-3

data acquisition. *See* DAQ.

data bubbles
 displaying during execution highlighting.
See the LabVIEW Help.

data dependency, 5-20
 artificial, 5-20
 controlling with Sequence structures, 8-9
 flow-through parameters, 13-12
 missing, 5-21
 race conditions, 10-4

data flow
 observing, 6-4

data types
 Case structures, 8-7
 control and indicator (table), 5-2
 converting from XML, 9-7
 converting to XML, 9-6
 HiQ (table), 20-6
 MATLAB (table), 20-6
 printing, 14-3
 waveform, 11-16

dataflow programming model, 5-20
 managing memory, 5-21

datalog file I/O, 13-4
 creating files, 13-10

datalogging, 13-15
 automatic, 13-15

- changing log-file binding, 13-17
- clearing log-file binding, 13-16
- deleting records, 13-16
- interactive, 13-15
- retrieving data programmatically, 13-17
- DataSocket, 17-2
 - block diagram, 17-6
 - controlling front panel objects. *See the LabVIEW Help.*
 - formats for data, 17-4
 - front panel, 17-5
 - protocols, 17-3
 - URLs, 17-3
 - variant data, 17-7
- date format
 - options, 3-6
- DDE, 17-15
- deallocating memory. *See the LabVIEW Help.*
- debugging
 - broken VIs, 6-2
 - default data, 6-8
 - disabling debugging tools, 6-6
 - executable VIs. *See the LabVIEW Help.*
 - hidden wires, 5-22
 - HiQ and MATLAB scripts, 20-6
 - loops, 6-7
 - options, 3-6
 - structures. *See the LabVIEW Help.*
 - techniques, 6-3
 - Breakpoint tool, 6-5
 - commenting out sections of a block diagram, 6-6
 - error handling, 6-8
 - execution highlighting, 6-4
 - Probe tool, 6-4
 - single-stepping, 6-4
 - suspending execution, 6-5
 - tools
 - disabling, 6-6
 - undefined data, 6-7
- decimal point
 - localized. *See the LabVIEW Help.*
- default cases, 8-7
- default data
 - arrays, 6-8
 - While Loops, 6-8
- defining
 - error codes. *See the LabVIEW Help.*
 - user colors. *See the LabVIEW Help.*
- deleting
 - array elements. *See the LabVIEW Help.*
 - broken wires, 5-12
 - datalog records, 13-16
 - objects on front panel or block diagram. *See the LabVIEW Help.*
 - palette views. *See the LabVIEW Help.*
 - structures. *See the LabVIEW Help.*
- designing
 - block diagram, 5-22
 - dialog boxes, 4-19
 - front panel, 4-18
 - projects, 7-1
 - subVIs, 7-8
- Developer Zone, E-1
- developing VIs, 7-1
 - guidelines, 1-2
 - tracking development. *See documenting VIs.*
- development resources, E-1
- diagnostic resources, E-1
- dialog boxes
 - controls, 4-15
 - using. *See the LabVIEW Help.*
 - designing, 4-19
 - font, 4-17
 - native file. *See the LabVIEW Help.*
 - remote front panels, 17-13
 - ring controls, 4-13
- dialog functions, 5-8

- dials
 - See also* numerics.
 - adding color ramps, 4-9
 - front panel, 4-8
- digital controls and indicators, 4-9
- digital graphs, 11-13
 - anti-aliased line plots, 11-2
 - masking data, 11-15, D-1
- dimensions
 - arrays, 9-8
- directories
 - converting libraries to. *See the LabVIEW Help.*
 - converting to libraries. *See the LabVIEW Help.*
- directory paths. *See* paths.
- directory structure of LabVIEW
 - Macintosh, A-2
 - organization, A-1
- disabling
 - debugging tools, 6-6
 - sections of a block diagram
 - debugging VIs, 6-6
- disk space
 - checking. *See the LabVIEW Help.*
 - options, 3-6
- disk streaming, 13-7
- displaying
 - auto-constant labels. *See the LabVIEW Help.*
 - chain of callers, 6-6
 - errors, 6-2
 - front panels remotely, 17-10
 - hidden front panel objects. *See the LabVIEW Help.*
 - optional elements in front panel
 - objects, 4-2
 - terminals, 5-2
 - tip strips. *See the LabVIEW Help.*
 - warnings, 6-2
- distributing
 - objects on the front panel. *See the LabVIEW Help.*
 - VIs, 7-12
- DLLs
 - building, 7-12
 - distributing VIs, 7-12
 - calling from LabVIEW, 19-1
- Do Loops. *See* While Loops.
- documentation
 - conventions used in this manual, xviii
 - directory structure, A-2
 - guide, 1-1
 - introduction to this manual, xvii
 - online library, E-1
 - organization of this manual, xvii
 - PDF library, 1-1
 - using this manual, xvii
 - using with other resources, 1-1
- documenting VIs, 14-1
 - creating object and VI descriptions, 14-2
 - creating tip strips, 14-2
 - help files, 14-4
 - linking to help files you create. *See the LabVIEW Help.*
 - printing, 14-3
 - programmatically, 14-3
 - revision history, 14-2
- dots
 - coercion, 5-12
- dragging and dropping. *See the LabVIEW Help.*
- drawing
 - See also* graphics.
 - smooth updates. *See the LabVIEW Help.*
- drivers
 - instrument, E-1
 - LabVIEW. *See the LabVIEW Help.*
- drop-through clicking. *See the LabVIEW Help.*
- dstp DataSocket protocol, 17-3
- Dynamic Data Exchange, 17-15

E

- editing
 - front panel objects, 4-1
 - labels. *See the LabVIEW Help.*
 - menus, 15-2
 - palette views, 3-5
 - shortcut menus of polymorphic VIs. *See the LabVIEW Help.*
- embedding objects using ActiveX, 18-4
- empty paths, 4-11
- enumerated type controls, 4-13
 - advanced, 4-13
 - data type (table), 5-2
 - using. *See the LabVIEW Help.*
- equations
 - Expression Nodes, 20-4
 - Formula Nodes, 20-2
 - HiQ
 - ActiveX, 20-2
 - debugging scripts, 20-6
 - script node, 20-5
 - VIs, 20-5
 - integrating into LabVIEW, 20-1
 - MATLAB
 - ActiveX, 20-2
 - debugging scripts, 20-6
 - script node, 20-5
 - methods for using, 20-1
- errors
 - broken VIs, 6-2
 - canceling existing. *See the LabVIEW Help.*
 - checking for, 6-9
 - clusters, 6-9
 - components, 6-10
 - connector pane, 7-6
 - reports. *See the LabVIEW Help.*
 - codes, 6-9
 - debugging techniques, 6-3
 - defining custom. *See the LabVIEW Help.*
 - displaying, 6-2
 - exception control. *See the LabVIEW Help.*
 - finding, 6-2
 - handling, 6-8
 - instrument control. *See the LabVIEW Help.*
 - methods, 6-9
 - using Case structures, 6-10
 - using While Loops, 6-10
 - I/O, 6-9
 - list, 6-2
 - normal conditions as. *See the LabVIEW Help.*
 - notification. *See the LabVIEW Help.*
 - units incompatible, 5-18
 - window, 6-2
- Event structures, 8-12
 - using. *See the LabVIEW Help.*
- events
 - ActiveX, 18-1
 - available in LabVIEW. *See the LabVIEW Help.*
 - filter, 8-13
 - handling, 8-12
 - caveats. *See the LabVIEW Help.*
 - notify, 8-13
- example programs, E-1
- examples, 1-3
 - arrays, 9-8
 - 1D arrays, 9-8
 - 2D arrays, 9-10
- exception control. *See the LabVIEW Help.*
- executable VIs
 - debugging. *See the LabVIEW Help.*
- executing system-level commands, 17-15
- execution
 - flow, 5-20
 - controlling with Sequence structures, 8-9

- highlighting
 - debugging VIs, 6-4
 - displaying data bubbles. *See the LabVIEW Help.*
 - probing automatically. *See the LabVIEW Help.*
 - suspending
 - debugging VIs, 6-5
 - Expression Nodes, 20-4
- F**
- FAQs, E-1
 - FIFO
 - variant data, 5-17
 - file DataSocket protocol, 17-3
 - file I/O, 13-1
 - advanced file functions, 13-6
 - basic operation, 13-1
 - binary files, 13-3
 - creating, 13-9
 - byte stream files, 13-3
 - configuration file VIs
 - format, 13-13
 - purpose, 13-13
 - reading and writing .ini files, 13-12
 - datalog files, 13-4
 - creating, 13-10
 - disk streaming, 13-7
 - flow-through parameters, 13-12
 - formats, 13-2
 - functions, 5-8
 - high-level VIs, 13-5
 - logging front panel data, 13-15
 - low-level VIs and functions, 13-6
 - networking and, 17-1
 - paths, 13-6
 - reading waveforms, 13-11
 - refnums, 13-1
 - spreadsheet files
 - creating, 13-8
 - text files, 13-2
 - creating, 13-8
 - writing waveforms, 13-10
 - file sharing, 7-2
 - finding
 - controls, VIs, and functions on the palettes, 3-2
 - errors, 6-2
 - objects, text, and VIs. *See the LabVIEW Help.*
 - first-in-first-out
 - variant data, 5-17
 - fixing
 - VIs, 6-2
 - debugging techniques, 6-3
 - flattened data
 - variant data and, 5-17
 - floating-point numbers
 - converting, B-1
 - overflow and underflow, 6-7
 - flow of execution, 5-20
 - flow-through parameters, 13-12
 - fonts
 - application, 4-17
 - dialog, 4-17
 - options, 3-6
 - settings, 4-17
 - system, 4-17
 - For Loops, 8-2
 - auto-indexing to set count, 8-4
 - controlling timing, 8-6
 - count terminals, 8-2
 - iteration terminals, 8-2
 - shift registers, 8-5
 - unexpected data, 6-7
 - using. *See the LabVIEW Help.*
 - foreground color of front panel objects. *See the LabVIEW Help.*
 - format string parameter, 9-4

- formats for file I/O, 13-2
 - binary files, 13-3
 - datalog files, 13-4
 - text files, 13-2
- formatting
 - graph scales, 11-5
 - strings, 9-4
 - specifiers, 9-4
 - text on front panel, 4-17
- Formula Nodes, 20-2
 - entering C-like statements, 20-2
 - entering equations, 20-2
 - illustration, 20-3
 - variables, 20-3
- formulas. *See* equations.
- free labels, 4-16
 - creating. *See* the *LabVIEW Help*.
- frequently asked questions, E-1
- front panel, 2-1
 - adding space without resizing, 4-7
 - aligning objects. *See* the *LabVIEW Help*.
 - captions, 4-16
 - creating. *See* the *LabVIEW Help*.
 - changing controls to and from
 - indicators, 4-2
 - clearing indicators. *See* the *LabVIEW Help*.
 - coloring objects, 4-4
 - background and foreground. *See* the *LabVIEW Help*.
 - copying colors. *See* the *LabVIEW Help*.
 - configuring objects, 4-1
 - controlling objects
 - programmatically, 16-8
 - controlling objects remotely. *See* the *LabVIEW Help*.
 - controlling remotely, 17-10
 - controls, 4-7
 - copying objects. *See* the *LabVIEW Help*.
 - datalogging, 13-15
 - DataSocket, 17-5
 - defining window size. *See* the *LabVIEW Help*.
 - deleting objects. *See* the *LabVIEW Help*.
 - designing, 4-18
 - displaying optional object elements, 4-2
 - displaying with different screen
 - resolutions, 4-19
 - distributing objects. *See* the *LabVIEW Help*.
 - finding objects. *See* the *LabVIEW Help*.
 - fonts, 4-17
 - grouping and locking objects, 4-5
 - hidden objects. *See* the *LabVIEW Help*.
 - hiding
 - objects. *See* the *LabVIEW Help*.
 - optional object elements, 4-2
 - importing graphics, 4-4
 - indicators, 4-7
 - inserting objects using ActiveX, 18-4
 - keyboard shortcuts, 4-3
 - labels, 4-16
 - creating. *See* the *LabVIEW Help*.
 - editing. *See* the *LabVIEW Help*.
 - resizing. *See* the *LabVIEW Help*.
 - logging data, 13-15
 - objects
 - block diagram terminals and, 5-1
 - options, 3-6
 - order of objects, 4-4
 - overlapping objects, 4-11
 - planning, 7-1
 - printing, 14-5
 - publishing images on Web, 17-10
 - removing objects. *See* the *LabVIEW Help*.
 - reordering objects. *See* the *LabVIEW Help*.
 - replacing objects, 4-2
 - resizing objects, 4-5
 - in relation to window size, 4-5

- retrieving data
 - using file I/O functions, 13-18
 - using subVIs, 13-17
- scaling objects, 4-5
- setting navigation order, 4-4
- spacing objects evenly. *See the LabVIEW Help.*
- subVIs, 7-8
- text characteristics, 4-17
- transparent objects. *See the LabVIEW Help.*
- type definitions, 4-1
- viewing remotely, 17-10
- ftp DataSocket protocol, 17-3
- function key settings
 - overriding defaults. *See the LabVIEW Help.*
- functions, 5-6
 - adding terminals, 5-9
 - advanced, 5-9
 - application control, 5-9
 - array, 5-7
 - block diagram, 5-6
 - Boolean, 5-6
 - cluster, 5-7
 - dialog, 5-8
 - file I/O, 5-8
 - finding. *See the LabVIEW Help.*
 - numeric, 5-6
 - palette, 3-1
 - customizing, 3-4
 - navigating and searching, 3-2
 - window titles. *See the LabVIEW Help.*
 - polymorphic, B-1
 - reference. *See the LabVIEW Help.*
 - removing terminals, 5-9
 - resizing. *See the LabVIEW Help.*
 - string, 5-7
 - time, 5-8
 - waveform, 5-8

G

- gauges
 - See also numerics.*
 - adding color ramps, 4-9
 - front panel, 4-8
- generating reports, 14-5
 - error clusters. *See the LabVIEW Help.*
- getting started, 1-1
- GIF files, 14-4
- global variables, 10-2
 - creating, 10-2
 - initializing, 10-4
 - memory, 10-5
 - race conditions, 10-4
 - read and write, 10-3
 - using carefully, 10-4
- GPIB
 - configuring, 1-3
- graphics
 - adding to VI icon. *See the LabVIEW Help.*
 - creating colors, 12-6
 - dragging and dropping. *See the LabVIEW Help.*
 - drawing shapes, 12-5
 - entering text, 12-5
 - formats, 12-6
 - for HTML files, 14-4
 - graphs, 12-3
 - importing, 4-4
 - modifying colors, 12-6
 - picture controls and indicators
 - data type (table), 5-3
 - using, 12-1
 - pixmap, 12-5
 - publishing front panels on Web, 17-10
- graphs, 11-1
 - 3D, 11-15
 - adding plots. *See the LabVIEW Help.*
 - anti-aliased line plots, 11-2
 - clearing. *See the LabVIEW Help.*

- creating. *See the LabVIEW Help.*
 - cursors, 11-4
 - adding. *See the LabVIEW Help.*
 - customizing appearance, 11-3
 - customizing behavior, 11-3
 - digital, 11-13
 - masking data, 11-15
 - graphics, 12-3
 - intensity, 11-11
 - options, 11-13
 - multiple scales, 11-2
 - options, 11-2
 - polar, 12-3
 - scales
 - formatting, 11-5
 - scaling, 11-5
 - Smith plots, 12-4
 - smooth updates, 11-5
 - transmission lines, 12-4
 - types, 11-1
 - waveform, 11-7
 - data types, 11-8
 - XY, 11-7
 - data types, 11-9, 11-10
 - zooming. *See the LabVIEW Help.*
- grouping
- data
 - arrays, 9-8
 - clusters, 9-13
 - strings, 9-1
 - front panel objects, 4-5
 - VIs in libraries, 7-10
- guidelines for development, 1-2
- H**
- help
- technical support, E-1
- help files, 1-2
- creating your own, 14-4
 - HTML, 14-4
 - linking to VIs. *See the LabVIEW Help.*
 - RTF, 14-4
- hidden front panel objects. *See the LabVIEW Help.*
- hiding
- front panel objects. *See the LabVIEW Help.*
 - menu bar, 4-16
 - optional elements in front panel objects, 4-2
 - scroll bars, 4-16
- Hierarchy Window, 7-9
- printing, 14-3
 - searching. *See the LabVIEW Help.*
- highlighting execution
- debugging VIs, 6-4
- HiQ
- ActiveX, 20-2
 - data types, 20-6
 - debugging scripts, 20-6
 - launching from LabVIEW, 20-5
 - script node, 20-5
 - support files for LabVIEW applications, 20-7
 - VIs, 20-5
- history
- See also* revision history.
 - charts, 11-6
 - options, 3-6
- hot menus. *See the LabVIEW Help.*
- HTML
- See also* Web.
 - creating documents, 17-9
 - graphics formats, 14-4
 - help files, 14-4
 - printing reports, 14-5
 - publishing VIs on Web, 17-9
 - saving to, 14-3

I

I/O

- controls and indicators
 - data type (table), 5-3
- error, 6-9
- file. *See* file I/O.
- I/O name controls and indicators, 4-14

icons, 2-4

- creating, 7-8
- editing, 7-8
- printing, 14-3

images. *See* graphics.

impedance of transmission lines, 12-4

importing graphics, 4-4

incrementally running VIs, 6-4

indexes of arrays, 9-8

- display, 9-11

indexing loops, 8-4

- For Loops, 8-4
- While Loops, 8-5

indicators, 4-1

- 2D, 4-7
- 3D, 4-7
- ActiveX, 18-2
- array, 4-11
- Boolean, 4-10

- using. *See* the *LabVIEW Help*.

changing to controls, 4-2

classic, 4-7

clearing. *See* the *LabVIEW Help*.

cluster, 4-11

color box, 4-9

color ramp, 4-9

coloring, 4-4

configuring, 4-1

creating on block diagram. *See* the *LabVIEW Help*.

data types (table), 5-2

digital, 4-9

displaying optional elements, 4-2

enumerated type

- advanced, 4-13

grouping and locking, 4-5

guidelines for using on front panel, 4-18

hidden. *See* the *LabVIEW Help*.

hiding

- See also* the *LabVIEW Help*.

- optional elements, 4-2

high-color, 4-7

I/O name, 4-14

low-color, 4-7

numeric, 4-8

- using. *See* the *LabVIEW Help*.

optional, 7-7

path, 4-10

- using. *See* the *LabVIEW Help*.

printing, 14-3

refnum, 4-15

- using. *See* the *LabVIEW Help*.

replacing, 4-2

required, 7-7

resizing, 4-5

- in relation to window size, 4-5

rotary, 4-8

slide, 4-8

string, 4-10

- display types, 9-2

tab, 4-11

terminals (table), 5-2

type definitions, 4-1

user interface design, 4-18

Inf (infinity) floating-point value

- undefined data, 6-7

infinite While Loops, 8-3

ini files

- reading and writing, 13-12

inserting

- elements in arrays. *See* the *LabVIEW Help*.

- objects in palettes. *See* the *LabVIEW Help*.

objects on block diagram. *See the LabVIEW Help.*

installers
 building, 7-12

instances of subVIs
 determining, 6-6
 suspending execution, 6-5

instrument drivers, E-1
 LabVIEW. *See the LabVIEW Help.*

instrument library
 adding VIs and controls, 3-4

instruments
 configuring, 1-3
 controlling, 7-2

integers
 converting, B-1
 overflow and underflow, 6-7

intensity charts, 11-11
 color mapping, 11-12
 options, 11-13

intensity graphs, 11-11
 color mapping, 11-12
 options, 11-13

Internet. *See Web.*

invalid paths, 4-11

Invoke Node, 16-4
 ActiveX, 18-2

iteration terminals
 For Loops, 8-2
 While Loops, 8-3

IVI
 instrument drivers. *See the LabVIEW Help.*
 passing logical names, 4-14

J

Joint Photographic Experts Group files, 12-6

JPEG files, 12-6, 14-4
 Web Server, 17-10

K

keyboard shortcuts, 4-3
 controlling buttons, 4-3
 setting navigation order, 4-4

knobs
See also numerics.
 adding color ramps, 4-9
 front panel, 4-8

knowledge bases, E-1

L

labeling, 4-16
 captions, 4-16
 constants, 5-4
 creating free labels. *See the LabVIEW Help.*
 editing. *See the LabVIEW Help.*
 fonts, 4-17
 global variables, 10-3
 local variables, 10-2
 resizing. *See the LabVIEW Help.*
 units of measure, 5-17

labels
 displaying auto-constant. *See the LabVIEW Help.*
 transparent. *See the LabVIEW Help.*

LabVIEW, 1-1
 customizing, 3-6
 options, 3-6

labview.ini, 3-6

last-in-first-out
 variant data, 5-17

launching VIs from command line. *See the LabVIEW Help.*

learning and instruction directory
 activity, A-2
 examples, A-2
 tutorial, A-2

- libraries
 - adding VIs and controls, 3-4
 - converting directories to. *See the LabVIEW Help.*
 - converting to directories. *See the LabVIEW Help.*
 - directory structure, A-1
 - instrument, A-1
 - managing, 7-11
 - marking VIs as top-level. *See the LabVIEW Help.*
 - organization of, A-1
 - removing VIs from. *See the LabVIEW Help.*
 - saving VIs as, 7-10
 - suggested location for, A-3
 - shared, 7-12
 - distributing VIs, 7-12
 - user, A-1
 - VI, A-1
 - licenses for serving remote front panels, 17-11
 - LIFO
 - variant data, 5-17
 - lights on front panel, 4-10
 - line plots
 - anti-aliased, 11-2
 - linking VIs to HTML or compiled help files. *See the LabVIEW Help.*
 - listbox controls, 4-12
 - using. *See the LabVIEW Help.*
 - listing. *See displaying.*
 - local variables, 10-1
 - creating, 10-2
 - finding objects or terminals. *See the LabVIEW Help.*
 - initializing, 10-4
 - memory, 10-5
 - race conditions, 10-4
 - read and write, 10-3
 - using carefully, 10-4
 - localized decimal point. *See the LabVIEW Help.*
 - localizing VIs, 7-12
 - location for saving files, A-3
 - locking
 - front panel objects, 4-5
 - VIs. *See the LabVIEW Help.*
 - Logarithmic functions
 - polymorphism, B-7
 - log-file binding, 13-15
 - changing, 13-17
 - clearing, 13-16
 - logging data. *See datalogging.*
 - logging in automatically. *See the LabVIEW Help.*
 - login prompt at startup
 - displaying. *See the LabVIEW Help.*
 - logos DataSocket protocol, 17-3
 - loops
 - auto-indexing, 8-4
 - controlling timing, 8-6
 - For, 8-2
 - infinite, 8-3
 - shift registers, 8-5
 - unexpected data, 6-7
 - using. *See the LabVIEW Help.*
 - While, 8-2
 - low-level communication, 17-14
- ## M
- manual. *See documentation.*
 - mapping colors, 11-12
 - marking VIs as top-level in libraries. *See the LabVIEW Help.*
 - masking digital data, 11-15, D-1
 - mathematics. *See equations.*
 - MATLAB
 - ActiveX, 20-2
 - data types, 20-6

- debugging scripts, 20-6
 - script node, 20-5
- Measurement & Automation Explorer, 1-3
- measurement units, 5-17
- memory
 - coercion dots, 5-12
 - compacting. *See the LabVIEW Help.*
 - deallocating. *See the LabVIEW Help.*
 - disabling debugging tools, 6-6
 - global variables, 10-5
 - local variables, 10-5
 - managing with dataflow programming model, 5-21
 - reading from and writing to with variant data, 5-17
- menu bar
 - hiding, 4-16
- Menu Editor, 15-2
- menus, 3-3
 - editing, 15-2
 - handling selections, 15-3
 - hot. *See the LabVIEW Help.*
 - reference. *See the LabVIEW Help.*
 - ring controls, 4-13
 - shortcut, 3-3
 - editing for polymorphic VIs. *See the LabVIEW Help.*
- meters
 - See also numerics.*
 - adding color ramps, 4-9
 - front panel, 4-8
- methods
 - ActiveX, 18-1
- moving
 - arrays. *See the LabVIEW Help.*
 - clusters. *See the LabVIEW Help.*
 - objects. *See the LabVIEW Help.*
 - subpalettes. *See the LabVIEW Help.*
 - wires. *See the LabVIEW Help.*
- multicolumn listboxes. *See listbox controls.*

- multiple threads
 - running. *See the LabVIEW Help.*

N

- naming
 - controls, 7-9
 - VIs, 7-11
- NaN (not a number) floating-point value
 - undefined data, 6-7
- National Instruments
 - Alliance Program, E-1
 - customer education, E-1
 - Developer Zone, E-1
 - system integration services, E-1
 - technical support, E-1
 - worldwide offices, E-2
- native file dialog boxes. *See the LabVIEW Help.*
- navigation order
 - setting, 4-4
- needles
 - adding, 4-8
- networking. *See communication.*
- NI Developer Zone, E-1
- NI-DAQ Configuration Utility, 1-4
- nodes, 2-4
 - block diagram, 5-5
 - Call By Reference, 16-7
 - execution flow, 5-20
 - HiQ script node, 20-5
 - Invoke, 16-4
 - MATLAB script node, 20-5
 - Property, 16-3
 - resizing. *See the LabVIEW Help.*
- normal conditions as errors. *See the LabVIEW Help.*
- not a number (NaN) floating-point value
 - undefined data, 6-7
- Not a Path, 4-11

notification of errors. *See the LabVIEW Help.*

numbers

overflow and underflow, 6-7

numerics

changing representation. *See the LabVIEW Help.*

comparing, C-2

controls and indicators, 4-8

using. *See the LabVIEW Help.*

converting, B-1

data types (table), 5-2

equations, 20-1

formulas, 20-1

functions, 5-6

out-of-range, 4-14

polymorphism, B-2

strings and, 9-5

units of measure, 5-17

universal constants, 5-4

writing data to spreadsheet or text files, 9-5

0

objects

ActiveX, 18-1

aligning. *See the LabVIEW Help.*

block diagram, 5-1

captions on front panel, 4-16

creating. *See the LabVIEW Help.*

changing controls to and from indicators, 4-2

coloring on front panel, 4-4

copying colors. *See the LabVIEW Help.*

configuring on front panel, 4-1

controlling programmatically, 16-8

creating descriptions, 14-2

creating tip strips, 14-2

displaying optional elements, 4-2

finding. *See the LabVIEW Help.*

front panel and block diagram

terminals, 5-1

grouping and locking on front panel, 4-5

hidden on front panel. *See the LabVIEW Help.*

hiding on front panel

See also the LabVIEW Help.

optional elements, 4-2

inserting in palettes. *See the LabVIEW Help.*

inserting on block diagram. *See the LabVIEW Help.*

inserting on front panel using ActiveX, 18-4

labeling, 4-16

creating. *See the LabVIEW Help.*

editing. *See the LabVIEW Help.*

resizing. *See the LabVIEW Help.*

moving. *See the LabVIEW Help.*

overlapping on front panel, 4-11

reordering. *See the LabVIEW Help.*

replacing on block diagram. *See the LabVIEW Help.*

replacing on front panel, 4-2

resizing on front panel, 4-5

in relation to window size, 4-5

scaling on front panel, 4-5

selecting. *See the LabVIEW Help.*

setting navigation order on front panel, 4-4

spacing evenly. *See the LabVIEW Help.*

transparent. *See the LabVIEW Help.*

wiring automatically on block diagram, 5-11

wiring manually on block diagram, 5-10

OLE for Process Control DataSocket protocol, 17-3

online technical support, E-1

opc DataSocket protocol, 17-3

opening VIs in run mode. *See the LabVIEW Help.*

operators. *See* nodes.

options

setting, 3-6

See also the *LabVIEW Help*.

storing, 3-6

order of cluster elements, 9-14

modifying, 9-14

See also the *LabVIEW Help*.

order of execution, 5-20

controlling with Sequence structures, 8-9

out-of-range numbers, 4-14

overflow of numbers, 6-7

overlaid plots, 11-6

overlapping front panel objects, 4-11

overriding default function key settings. *See* the *LabVIEW Help*.

owned labels, 4-16

editing. *See* the *LabVIEW Help*.

P

palettes, 3-1

changing. *See* the *LabVIEW Help*.

color picker, 4-9

Controls, 3-1

customizing, 3-4

customizing, 3-4

Functions, 3-1

customizing, 3-4

inserting objects. *See* the *LabVIEW Help*.

navigating and searching, 3-2

organizing, 3-5

reference. *See* the *LabVIEW Help*.

sharing. *See* the *LabVIEW Help*.

Tools, 3-2

updating. *See* the *LabVIEW Help*.

views, 3-5

panel order

setting, 4-4

parameter lists. *See* connector panes.

parameters

data types (table), 5-2

password protection, 7-12

patents, *iii*

paths

adding directories to VI search path. *See* the *LabVIEW Help*.

controls and indicators, 4-10

data type (table), 5-3

using. *See* the *LabVIEW Help*.

empty, 4-11

file I/O, 13-6

invalid, 4-11

options, 3-6

remote front panels, 17-13

universal constants, 5-4

patterns

terminal, 7-6

PDF library, 1-1

performance

disabling debugging tools, 6-6

local and global variables, 10-4

options, 3-6

phone technical support, E-2

picture controls and indicators

data type (table), 5-3

using, 12-1

picture ring controls, 4-13

pictures. *See* graphics.

pipes communication, 17-15

pixmap, 12-5

planning projects, 7-1

plots

adding to graphs and charts. *See* the *LabVIEW Help*.

anti-aliased, 11-2

overlaid, 11-6

stacked, 11-6

PNG files, 12-6, 14-4

Web Server, 17-10

polar graphs, 12-3

- polymorphic
 - controls and indicators
 - data type (table), 5-3
 - Expression Nodes, 20-4
 - functions, B-1
 - units, B-1
 - VIs, 5-13
 - building, 5-14
 - editing shortcut menus. *See the LabVIEW Help.*
 - removing subVIs from. *See the LabVIEW Help.*
 - selecting a default instance. *See the LabVIEW Help.*
 - pop-up menus. *See* shortcut menus.
 - Portable Network Graphics files, 12-6
 - porting VIs, 7-12
 - PostScript printing. *See the LabVIEW Help.*
 - PPC Toolbox, 17-15
 - preferences. *See* options.
 - previous versions
 - saving VIs, 7-11
 - printing, 14-5
 - active window, 14-5
 - at completion, 14-6
 - documentation of VIs, 14-3
 - options, 3-6
 - programmatically, 14-6
 - reports, 14-5
 - saving
 - to HTML, 14-3
 - to RTF, 14-3
 - techniques, 14-7
 - using subVIs, 14-7
 - Probe tool
 - debugging VIs, 6-4
 - programming examples, E-1
 - program-to-program communication, 17-15
 - project design, 7-1
 - project planning, 7-1
 - properties
 - ActiveX, 18-1
 - setting, 18-4
 - programmatically, 18-5
 - viewing, 18-4
 - Property Node, 16-3
 - ActiveX, 18-5
 - finding objects or terminals. *See the LabVIEW Help.*
 - modifying listbox items, 4-12
 - protocols
 - DataSocket, 17-3
 - low-level communication, 17-14
 - publishing VIs on Web, 17-9
 - pull-down menus on front panel, 4-13
 - purging datalog records, 13-16
- Q**
- queues
 - variant data, 5-17
- R**
- race conditions, 10-4
 - read globals, 10-3
 - read locals, 10-3
 - reading from files, 13-1
 - records, 13-15
 - deleting, 13-16
 - specifying while retrieving front panel data using subVIs, 13-18
 - refnums
 - automation, 18-2
 - Call By Reference Node, 16-7
 - control, 16-8
 - controls and indicators, 4-15
 - data type (table), 5-3
 - using. *See the LabVIEW Help.*
 - file I/O, 13-1
 - strictly typed, 16-7

- remotely calling VIs, 16-1
 - removing
 - broken wires, 5-12
 - objects on front panel or block diagram. *See the LabVIEW Help.*
 - structures. *See the LabVIEW Help.*
 - subVIs from polymorphic VIs. *See the LabVIEW Help.*
 - terminals from functions, 5-9
 - VIs from libraries. *See the LabVIEW Help.*
 - reordering objects. *See the LabVIEW Help.*
 - repeating
 - blocks of code
 - For Loops, 8-2
 - While Loops, 8-2
 - Repeat-Until Loops. *See While Loops.*
 - replacing
 - elements in arrays. *See the LabVIEW Help.*
 - objects on block diagram. *See the LabVIEW Help.*
 - objects on front panel, 4-2
 - text in strings. *See the LabVIEW Help.*
 - reports
 - generating
 - error clusters. *See the LabVIEW Help.*
 - printing, 14-5
 - Report Generation VIs, 14-5
 - resizing
 - arrays. *See the LabVIEW Help.*
 - clusters. *See the LabVIEW Help.*
 - front panel objects, 4-5
 - in relation to window size, 4-5
 - functions. *See the LabVIEW Help.*
 - labels. *See the LabVIEW Help.*
 - nodes. *See the LabVIEW Help.*
 - tables. *See the LabVIEW Help.*
 - user-defined constants, 5-5
 - retrieving data
 - programmatically, 13-17
 - using file I/O functions, 13-18
 - using subVIs, 13-17
 - reverting to last saved versions. *See the LabVIEW Help.*
 - revision history
 - creating, 14-2
 - numbers, 14-2
 - printing, 14-3
 - revision number
 - displaying in titlebar. *See the LabVIEW Help.*
 - ring controls, 4-13
 - using. *See the LabVIEW Help.*
 - rotary controls and indicators, 4-8
 - RTF
 - saving to, 14-3
 - rtm file, 15-2
 - run mode
 - opening VIs in. *See the LabVIEW Help.*
 - running VIs, 6-1
 - run-time menu file, 15-2
- ## S
- saving files
 - suggested location for, A-3
 - saving VIs, 7-10
 - for previous versions, 7-11
 - individual files, 7-10
 - libraries, 7-10
 - reverting to last saved versions. *See the LabVIEW Help.*
 - scaling
 - front panel objects, 4-5
 - graphs, 11-5
 - schema for XML, 9-7
 - scope chart, 11-6
 - screen resolutions, 4-19

- script nodes
 - HiQ, 20-5
 - MATLAB, 20-5
- scroll bars
 - hiding, 4-16
 - listboxes, 4-12
 - ring controls, 4-13
- scrolling through a chart, 11-3
- searching
 - for controls, VIs, and functions on the palettes, 3-2
 - PDF versions of LabVIEW
 - documentation, 1-1
 - VI hierarchy. *See the LabVIEW Help.*
- selecting
 - default instance of a polymorphic VI. *See the LabVIEW Help.*
 - objects. *See the LabVIEW Help.*
 - tools manually. *See the LabVIEW Help.*
 - wires, 5-12
- selector terminals, 8-7
 - values, 8-7
- sequence local terminals, 8-9
- Sequence structures, 8-8
 - accessing values with local and global variables, 10-4
 - controlling execution order, 5-20
 - overusing, 8-10
 - using. *See the LabVIEW Help.*
- serpdrv file, A-2
- servers
 - ActiveX, 18-6
 - configuring for remote front panels, 17-11
 - LabVIEW, 17-12
 - Web browser, 17-12
- setting
 - cooperation level. *See the LabVIEW Help.*
 - work environment options, 3-6
 - See also the LabVIEW Help.*
- shared libraries
 - building, 7-12
 - distributing VIs, 7-12
 - calling from LabVIEW, 19-1
- sharing
 - files, 7-2
 - live data programmatically, 17-6
 - live data with other VIs and applications, 17-2
 - palette views. *See the LabVIEW Help.*
 - VIs, 7-12
- shift registers, 8-5
 - default data, 6-8
- shortcut menus, 3-3
 - in run mode, 3-3
- single-stepping
 - debugging VIs, 6-4
- sink terminals. *See indicators.*
- sizing. *See resizing.*
- slide controls and indicators, 4-8
 - See also numerics.*
- sliders
 - adding, 4-8
- smart buffers
 - variant data, 5-17
- Smith plots, 12-4
- smooth updates
 - during drawing. *See the LabVIEW Help.*
 - for graphs, 11-5
- sound, 12-7
- source code control, 7-2
- source code. *See block diagram.*
- source terminals. *See controls.*
- spacing objects evenly. *See the LabVIEW Help.*
- speed of execution
 - controlling, 8-6
- splitting
 - strings. *See the LabVIEW Help.*

- spreadsheet files
 - creating, 13-8
 - writing numeric data to, 9-5
- stacked plots, 11-6
- stacks
 - variant data, 5-17
- stand-alone applications
 - building, 7-12
 - distributing VIs, 7-12
- statements. *See* nodes.
- static front panel images, 17-10
- static variables. *See* shift registers.
- stepping through VIs
 - debugging VIs, 6-4
- storing
 - work environment options, 3-6
- strict type checking, 5-18
- strictly typed refnums
 - control, 16-9
 - VI, 16-7
- strings, 9-1
 - comparing, C-1
- controls
 - data type (table), 5-2
 - controls and indicators, 4-10
 - display types, 9-2
 - editing programmatically, 9-3
 - formatting, 9-4
 - specifiers, 9-4
 - functions, 5-7
 - global variables, 10-5
 - numerics to, 9-5
 - polymorphism, B-5
 - replacing text. *See* the *LabVIEW Help*.
 - splitting. *See* the *LabVIEW Help*.
 - tables, 9-2
 - universal constants, 5-4
- strip chart, 11-6
- structure and support directory
 - menus, A-2
 - project, A-2
 - resource, A-2
 - templates, A-2
 - WWW, A-2
- structure of LabVIEW directories, A-1
- structures, 8-1
 - Case, 8-6
 - debugging. *See* the *LabVIEW Help*.
 - deleting. *See* the *LabVIEW Help*.
 - Event, 8-12
 - For Loops, 8-2
 - global variables, 10-2
 - local variables, 10-1
 - on block diagram, 2-4
 - removing. *See* the *LabVIEW Help*.
 - Sequence, 8-8
 - using. *See* the *LabVIEW Help*.
 - While Loops, 8-2
 - wiring. *See* the *LabVIEW Help*.
- subpalettes
 - building ActiveX, 3-5
 - creating. *See* the *LabVIEW Help*.
 - moving. *See* the *LabVIEW Help*.
 - organizing, 3-5
- subroutines. *See* subVIs.
- subVIs, 7-4
 - building, 7-4
 - control captions for tip strips. *See* the *LabVIEW Help*.
 - controlling behavior, 7-3
 - copying, A-3
 - creating, 7-8
 - situations to avoid. *See* the *LabVIEW Help*.
 - designing, 7-8
 - determining current instance, 6-6
 - displaying chain of callers, 6-6

- displaying names when placed. *See the LabVIEW Help.*
- front panel, 7-8
- hierarchy, 7-9
- polymorphic VIs, 5-13
- printing VIs, 14-7
- remote front panels, 17-13
- removing from polymorphic VIs. *See the LabVIEW Help.*
- retrieving front panel data, 13-17
- suspending execution, 6-5
- support
 - files for calling HiQ, 20-7
 - technical, E-1
- suspending execution
 - debugging VIs, 6-5
- sweep chart, 11-6
- switches on front panel, 4-10
- symbolic colors
 - See system colors.*
- system colors, 4-19
- system colors. *See the LabVIEW Help.*
- System Exec VI, 17-15
- system font, 4-17
- system-level commands, 17-15

T

- tab controls, 4-11
 - using. *See the LabVIEW Help.*
- tabbing through front panel objects, 4-4
- tables, 9-2
 - using. *See the LabVIEW Help.*
- tanks
 - See also numerics.*
 - slide controls and indicators, 4-8
- TCP, 17-14
 - VI Server, 16-1
- technical support resources, E-1
- telephone technical support, E-2

- terminals, 2-3
 - adding to functions, 5-9
 - block diagram, 5-1
 - coercion dots, 5-12
 - conditional, 8-2
 - constants, 5-4
 - control and indicator (table), 5-2
 - count, 8-2
 - auto-indexing to set, 8-4
 - displaying, 5-2
 - displaying tip strips. *See the LabVIEW Help.*
 - finding. *See the LabVIEW Help.*
 - front panel objects and, 5-1
 - iteration
 - For Loops, 8-2
 - While Loops, 8-3
 - patterns, 7-6
 - removing from functions, 5-9
 - selector, 8-7
 - sequence local, 8-9
 - wiring, 5-10
- text
 - dragging and dropping. *See the LabVIEW Help.*
 - entry boxes, 4-10
 - finding. *See the LabVIEW Help.*
 - formatting, 4-17
 - ring controls, 4-13
- text files
 - creating, 13-8
 - file I/O, 13-2
 - writing numeric data to, 9-5
- thermometers
 - See also numerics.*
 - slide controls and indicators, 4-8
- threads
 - running multiple. *See the LabVIEW Help.*
- time format
 - options, 3-6

time functions, 5-8

timing
controlling, 8-6

tip strips
control captions. *See the LabVIEW Help.*
creating, 14-2
displaying over terminals. *See the LabVIEW Help.*
displaying. *See the LabVIEW Help.*

toolbar, 3-4

tools
palette, 3-2
selecting manually. *See the LabVIEW Help.*

toolsets, 1-1
in palettes, 3-6

tracking development. *See documenting VIs.*

training, customer, E-1

Transmission Control Protocol, 17-14

transmission lines, 12-4

transparent
labels. *See the LabVIEW Help.*
objects. *See the LabVIEW Help.*

trees
variant data, 5-17

troubleshooting resources, E-1

troubleshooting. *See debugging.*

tunnels, 8-1
input and output, 8-8

tutorial, 1-1

type completion, 4-12
listboxes, 4-12
ring controls, 4-13

type controls
enumerated, 4-13
advanced, 4-13

type definitions, 4-1

U

UDP, 17-14

undefined data, 6-7
arrays, 6-8
checking for, 6-7
For Loops, 6-7
Inf (infinity), 6-7
NaN (not a number), 6-7
preventing, 6-8
While Loops, 6-8

underflow of numbers, 6-7

undo options, 3-6

ungrouping front panel objects, 4-5

unit labels, 5-17

universal constants, 5-4

unlocking
front panel objects, 4-5
VIs. *See the LabVIEW Help.*

updating palettes. *See the LabVIEW Help.*

upgrading VIs, 7-11

URLs for DataSocket, 17-3

User Datagram Protocol, 17-14

user interface. *See front panel.*

user library
adding VIs and controls, 3-4

user-defined colors. *See the LabVIEW Help.*

user-defined constants, 5-4

user-defined error codes. *See the LabVIEW Help.*

V

variables
global, 10-2
creating, 10-2
initializing, 10-4
memory, 10-5
race conditions, 10-4
read and write, 10-3
using carefully, 10-4

- local, 10-1
 - creating, 10-2
 - initializing, 10-4
 - memory, 10-5
 - race conditions, 10-4
 - read and write, 10-3
 - using carefully, 10-4
- variant data, 5-16
 - ActiveX, 18-2
 - controls and indicators
 - data type (table), 5-3
 - converting to, 5-16
 - DataSocket, 17-7
 - editing attributes. *See the LabVIEW Help.*
 - flattened data and, 5-17
 - handling, 5-16
- versions
 - comparing, 7-2
 - reverting to last saved. *See the LabVIEW Help.*
 - saving VIs for previous, 7-11
- VI object
 - manipulating settings, 16-3
 - VI Server, 16-3
- VI search path
 - editing. *See the LabVIEW Help.*
- VI Server, 16-1
 - Application object, 16-3
 - building applications, 16-2
 - Call By Reference Node, 16-7
 - calling other instances of LabVIEW on Web, 16-1
 - calling VIs remotely, 16-1
 - capabilities, 16-1
 - controlling front panel objects, 16-8
 - Invoke Node, 16-4
 - manipulating VI settings, 16-3
 - networking and, 17-1
 - Property Node, 16-3
 - remote applications, 16-8
 - strictly typed VI refnums, 16-7
 - VI object, 16-3
 - viewing
 - See also displaying.*
 - views, 3-5
 - changing. *See the LabVIEW Help.*
 - creating, 3-5
 - deleting. *See the LabVIEW Help.*
 - editing, 3-5
 - sharing. *See the LabVIEW Help.*
 - virtual instruments. *See VIs.*
 - VIs, 2-1
 - adding to libraries, 3-4
 - broken, 6-2
 - building, 7-1
 - calling dynamically, 16-7
 - calling remotely, 16-1
 - comparing versions, 7-2
 - configuring appearance and behavior, 15-1
 - controlling on Web, 17-9
 - controlling programmatically, 16-1
 - controlling when called as subVIs, 7-3
 - copying, A-3
 - correcting, 6-2
 - creating descriptions, 14-2
 - creating tip strips, 14-2
 - debugging techniques, 6-3
 - developing, 7-1
 - distributing, 7-12
 - documenting, 14-1
 - dragging and dropping. *See the LabVIEW Help.*
 - error handling, 6-8
 - examples, 1-3
 - executable
 - debugging. *See the LabVIEW Help.*
 - finding. *See the LabVIEW Help.*
 - hierarchy, 7-9
 - launching from command line. *See the LabVIEW Help.*

- libraries, 7-10
 - loading dynamically, 16-7
 - localizing, 7-12
 - locking. *See the LabVIEW Help.*
 - marking as top-level in libraries. *See the LabVIEW Help.*
 - naming, 7-11
 - opening in run mode. *See the LabVIEW Help.*
 - polymorphic, 5-13
 - porting, 7-12
 - printing, 14-5
 - publishing on Web, 17-9
 - reference. *See the LabVIEW Help.*
 - removing from libraries. *See the LabVIEW Help.*
 - reverting to last saved versions. *See the LabVIEW Help.*
 - running, 6-1
 - saving, 7-10
 - sharing, 7-12
 - strictly typed refnums, 16-7
 - unlocking. *See the LabVIEW Help.*
 - upgrading, 7-11
- VISA
- passing resource names, 4-14
- VXI
- configuring, 1-3
 - VIs, 1-3
- W**
- warnings
 - button, 6-2
 - displaying, 6-2
 - displaying by default. *See the LabVIEW Help.*
 - waveform
 - charts, 11-10
 - controls and indicators
 - data type (table), 5-3
 - data type, 11-16
 - functions, 5-8
 - graphs, 11-7
 - data types, 11-8
 - graphics, 12-3
 - waveforms
 - reading from files, 13-11
 - writing to files, 13-10
 - weakly typed control references, 16-9
 - Web
 - calling other instances of LabVIEW, 16-1
 - controlling VIs, 17-10
 - creating HTML documents, 17-9
 - publishing VIs, 17-9
 - technical support, E-1
 - viewing front panels, 17-10
 - Web Publishing Tool, 17-9
 - Web Server, 17-9
 - clients for remote front panels
 - LabVIEW, 17-12
 - multiple, 17-11
 - Web browser, 17-12
 - controlling VIs, 17-10
 - enabling, 17-9
 - licenses for serving remote front panels, 17-11
 - options, 17-9
 - viewing front panels, 17-10
 - Web support from National Instruments, E-1
 - While Loops, 8-2
 - auto-indexing, 8-5
 - conditional terminals, 8-2
 - controlling timing, 8-6
 - default data, 6-8
 - error handling, 6-10
 - infinite, 8-3
 - iteration terminals, 8-3
 - remote front panels, 17-13
 - shift registers, 8-5
 - using. *See the LabVIEW Help.*

window size
 defining. *See the LabVIEW Help.*
 window titles in Functions palette. *See the LabVIEW Help.*
 wires, 2-4
 broken, 5-12
 moving. *See the LabVIEW Help.*
 selecting, 5-12
 wiring
 automatically, 5-11
 guides. *See the LabVIEW Help.*
 manually, 5-10, 5-12
 structures. *See the LabVIEW Help.*
 techniques, 5-22
 tool, 5-12
 units, 5-18
 wiring manually on block diagram, 5-12
 work environment options
 setting, 3-6
 See also the LabVIEW Help.
 storing, 3-6
 working space
 adding to front panel or block diagram, 4-7
 worldwide technical support, E-2
 write globals, 10-3
 write locals, 10-3
 writing to files, 13-1

X

XML
 converting data types to, 9-6
 converting from, 9-7
 example, 9-5
 schema, 9-7
 x-scales
 formatting, 11-5
 multiple, 11-2
 XY graphs, 11-7
 data types, 11-9, 11-10

Y

y-scales
 formatting, 11-5
 multiple, 11-2

Z

zooming on graphs and charts. *See the LabVIEW Help.*

APPENDIX NATIONAL02

screenshot-web.archive.org-2020.08.28-12_04_36

https://web.archive.org/web/20150727020347/http://www.ni.com/pdf/manuals/320999d
28.08.2020

INTERNET ARCHIVE
WayBackMachine

8 captures
27 Jul 2015 - 3 Mar 2019

http://www.ni.com/pdf/manuals/320999d

Go

JUN JUL AUG
27
2014 2015 2017

About this capture

LabVIEW User Manual 1 / 293



NATIONAL INSTRUMENTS™
LabVIEW™

User Manual

⊕
+
-

INTERNET ARCHIVE Explore more than 467 billion web pages saved over time
DONATE WayBackMachine http://www.ni.com/pdf/manuals/320999d

Calendar · Collections · Changes · Summary · Site Map

Saved 8 times between July 27, 2015 and March 3, 2019.

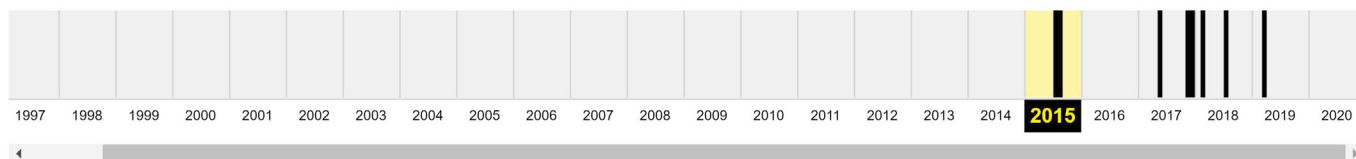

JAN	FEB	MAR	APR
1 2 3	1 2 3 4 5 6 7	1 2 3 4 5 6 7	1 2 3 4
4 5 6 7 8 9 10	8 9 10 11 12 13 14	8 9 10 11 12 13 14	5 6 7 8 9 10 11
11 12 13 14 15 16 17	15 16 17 18 19 20 21	15 16 17 18 19 20 21	12 13 14 15 16 17 18
18 19 20 21 22 23 24	22 23 24 25 26 27 28	22 23 24 25 26 27 28	19 20 21 22 23 24 25
25 26 27 28 29 30 31		29 30 31	26 27 28 29 30
MAY	JUN	JUL	AUG
1 2	1 2 3 4 5 6	1 2 3 4	1
3 4 5 6 7 8 9	7 8 9 10 11 12 13	5 6 7 8 9 10 11	2 3 4 5 6 7 8
10 11 12 13 14 15 16	14 15 16 17 18 19 20	12 13 14 15 16 17 18	9 10 11 12 13 14 15
17 18 19 20 21 22 23	21 22 23 24 25 26 27	19 20 21 22 23 24 25	16 17 18 19 20 21 22
24 25 26 27 28 29 30	28 29 30	26 27 28 29 30 31	23 24 25 26 27 28 29
31			30 31
SEP	OCT	NOV	DEC
1 2 3 4 5	1 2 3	1 2 3 4 5 6 7	1 2 3 4 5
6 7 8 9 10 11 12	4 5 6 7 8 9 10	8 9 10 11 12 13 14	6 7 8 9 10 11 12
13 14 15 16 17 18 19	11 12 13 14 15 16 17	15 16 17 18 19 20 21	13 14 15 16 17 18 19
20 21 22 23 24 25 26	18 19 20 21 22 23 24	22 23 24 25 26 27 28	20 21 22 23 24 25 26
27 28 29 30	25 26 27 28 29 30 31	29 30	27 28 29 30 31

Note

This calendar view maps the number of times <http://www.ni.com/pdf/manuals/320999d> was crawled by the Wayback Machine, not how many times the site was actually updated. More info in the [FAQ](#).

[FAQ](#) | [Contact Us](#) | [Terms of Service \(Dec 31, 2014\)](#)

The Wayback Machine is an initiative of the Internet Archive, a 501(c)(3) non-profit, building a digital library of Internet sites and other cultural artifacts in digital form. Other projects include Open Library & archive-it.org.

Your use of the Wayback Machine is subject to the Internet Archive's Terms of Use.