

**IN THE UNITED STATES PATENT AND TRADEMARK OFFICE**

In re Patent of: Jeroen Poeze et al.  
U.S. Patent No.: 10,588,554 Attorney Docket No.: 50095-0013IP1  
Issue Date: March 17, 2020  
Appl. Serial No.: 16/544,713  
Filing Date: August 19, 2019  
Title: MULTI-STREAM DATA COLLECTION SYSTEM FOR  
NONINVASIVE MEASUREMENT OF BLOOD  
CONSTITUENTS

**Mail Stop Patent Board**

Patent Trial and Appeal Board  
U.S. Patent and Trademark Office  
P.O. Box 1450  
Alexandria, VA 22313-1450

**DECLARATION OF JACOB ROBERT MUNFORD**

1. My name is Jacob Robert Munford. I am over the age of 18, have personal knowledge of the facts set forth herein, and am competent to testify to the same.
  
2. I earned a Master of Library and Information Science (MLIS) from the University of Wisconsin-Milwaukee in 2009. I have over ten years of experience in the library/information science field. Beginning in 2004, I have served in various positions in the public library sector including Assistant Librarian, Youth Services Librarian and Library Director. I have attached my Curriculum Vitae as Appendix A.
  
3. During my career in the library profession, I have been responsible for materials acquisition for multiple libraries. In that position, I have cataloged, purchased and processed incoming library works. That includes purchasing materials directly from vendors, recording publishing data from the material in question, creating detailed material records for library catalogs and physically preparing that material for circulation. In addition to my experience in acquisitions, I was also responsible for analyzing large collections of library materials, tailoring library records for optimal catalog

search performance and creating lending agreements between libraries during my time as a Library Director.

4. I am fully familiar with the catalog record creation process in the library sector. In preparing a material for public availability, a library catalog record describing that material would be created. These records are typically written in Machine Readable Catalog (herein referred to as “MARC”) code and contain information such as a physical description of the material, metadata from the material’s publisher, and date of library acquisition. In particular, the 008 field of the MARC record is reserved for denoting the date of creation of the library record itself. As this typically occurs during the process of preparing materials for public access, it is my experience that an item’s MARC record indicates the date of an item’s public availability.
  
5. Typically, in creating a MARC record, a librarian would gather various bits of metadata such as book title, publisher and subject headings among others and assign each value to a relevant numerical field. For example, a book’s physical description is tracked in field 300 while title/attribution is tracked in field 245. The 008 field of the MARC record is reserved for denoting the creation of the library record itself. As this is the only date reflecting the

inclusion of said materials within the library's collection, it is my experience that an item's 008 field accurately indicates the date of an item's public availability.

6. This declaration is being drafted as of March 2021. Public and university libraries in my area have been closed for months due to the COVID-19 pandemic. My state, Pennsylvania, has a travel advisory, which has affected my ability to travel. In my experience, library catalog records are accurate descriptions of a library's collection and my lack of physical access to libraries at this time creates no doubt in my determinations of authenticity or availability of the exhibits noted below.

7. I have reviewed Exhibit 1010, a copy of an article entitled "A Wearable Reflectance Pulse Oximeter for Remote Physiological Monitoring" by Y. Mendelson, R. J. Duckworth, and G. Comtois, as published in the *Proceedings of the 28<sup>th</sup> Annual International Conference of the IEEE Engineering in Medicine and Biology Society, August 30 – September 3, 2006* (hereinafter referred to as "2006 IEEE conference publication").



8. Attached hereto as Appendix MENDELSON02 is a true and correct copy of the MARC record for the 2006 IEEE conference publication, as held by Cornell University's library. I secured this record myself from the library's public catalog.

9. The MARC record contained within Appendix MENDELSON02 accurately describes the title, author, publisher, and ISBN number of the 2006 IEEE conference publication. In comparing the listed fields in Appendix MENDELSON02 to Exhibit 1010, it is my determination that Exhibit 1010 is a true and correct copy of the "A Wearable Reflectance Pulse Oximeter for Remote Physiological Monitoring" article, and that the copy of the 2006 IEEE conference publication in Cornell University's library includes the article in Exhibit 1010.

10. The 008 field of the MARC record noted on page 1 of Appendix MENDELSON02 indicates that the 2006 IEEE conference publication was first cataloged by Cornell University's library as of December 26, 2007. Based on this information and considering the dates of the conference, it is my determination that the 2006 IEEE conference publication, which

included the article published as Exhibit 1010, was made available to the public by Cornell University at least as of December 26, 2007.

11. Additionally, I accessed a copy of the 2006 IEEE conference publication through the Pennsylvania State University's online library catalog portal.

12. Attached hereto as Appendix MENDELSON06 is a true and correct copy of the catalog entry for the 2006 IEEE conference publication as maintained by the Pennsylvania State University. I secured this record myself from the library's public catalog.

13. Attached hereto as Appendix MENDELSON07 is a true and correct copy of the table of contents for the 2006 IEEE conference publication. I secured this record, as provided by the Pennsylvania State University's library through the catalog entry for the 2006 IEEE conference publication as shown in Appendix MENDELSON06, myself.

14. I have reviewed Appendix MENDELSON10, a copy of an article entitled "A Wearable Reflectance Pulse Oximeter for Remote Physiological Monitoring" by Y. Mendelson, R. J. Duckworth, and G. Comtois, as

published in the 2006 IEEE conference publication. I obtained this document using the table of contents for the 2006 IEEE conference publication as shown in Appendix MENDELSON07.

15. Attached hereto as Appendix MENDELSON05 is a true and correct copy of the MARC record for the 2006 IEEE conference publication, as held by the Pennsylvania State University's library in its online catalog indicated by the catalog entry as shown in Appendix MENDELSON06. The Pennsylvania State University's online library catalog entry as shown in Appendix MENDELSON06 directs the user to the IEEE's online repository, IEEE Xplore. I secured this record myself from the library's public catalog through the table of contents listing as captured in Appendix MENDELSON07.

16. The MARC record contained within Appendix MENDELSON05 accurately describes the title, author, publisher, and ISBN number of the 2006 IEEE conference publication. In comparing the listed fields in Appendix MENDELSON05 to Appendix MENDELSON10, it is my determination that (1) Appendix MENDELSON10 is a true and correct copy of the "A Wearable Reflectance Pulse Oximeter for Remote Physiological

Monitoring” article by Y. Mendelson, R. J. Duckworth, and G. Comtois, as published in the 2006 IEEE conference publication, and (2) that the digital copy of the 2006 IEEE conference publication in the Pennsylvania State University’s library catalog includes the article in Appendix MENDELSON10 and is the same as the “A Wearable Reflectance Pulse Oximeter for Remote Physiological Monitoring” article by Y. Mendelson, R. J. Duckworth, and G. Comtois, as published in the 2006 IEEE conference publication that is made publicly available by the Pennsylvania State University through the IEEE’s online repository IEEE Xplore.

17. The 008 field of the MARC record noted on page 1 of Appendix MENDELSON05 indicates that the 2006 IEEE conference publication was first cataloged by the Pennsylvania State University’s library as of December 26, 2007. Based on this information and considering the dates of the conference, it is my determination that the 2006 IEEE conference publication, which included the article published as Appendix MENDELSON10, was made available to the public by the Pennsylvania State University through its online catalog at least as of December 26, 2007.

18. In comparing the listed fields in Appendix MENDELSON02 to Appendix MENDELSON05 and comparing Exhibit 1010 to Appendix MENDELSON10, it is my determination that both of Exhibit 1010 and Appendix MENDELSON10 are true and correct copies of the article entitled “A Wearable Reflectance Pulse Oximeter for Remote Physiological Monitoring” by Y. Mendelson, R. J. Duckworth, and G. Comtois, as published in the 2006 IEEE conference publication.

19. Based on this information, it is my determination that both of Exhibit 1010 and Appendix MENDELSON10 are true and correct copies of the article entitled “A Wearable Reflectance Pulse Oximeter for Remote Physiological Monitoring” by Y. Mendelson, R. J. Duckworth, and G. Comtois, as published in the 2006 IEEE conference publication, and that the 2006 IEEE conference publication containing Exhibit 1010 was cataloged and made available to the public by Cornell University at least as of December 26, 2007.

20. Based on this information, it is my determination that both of Exhibit 1010 and MENDELSON10 are true and correct copies of the article entitled “A Wearable Reflectance Pulse Oximeter for Remote Physiological

Monitoring” by Y. Mendelson, R. J. Duckworth, and G. Comtois, as published in the 2006 IEEE conference publication, and that the 2006 IEEE conference publication containing Exhibit 1010 was cataloged and made available to the public by the Pennsylvania State University through its online catalog at least as of December 26, 2007.

21. I have reviewed Appendix MENDELSON12, a copy of an article entitled “A Wearable Reflectance Pulse Oximeter for Remote Physiological Monitoring” by Y. Mendelson, R. J. Duckworth, and G. Comtois, as published in the 2006 IEEE conference publication. I secured this record myself from the IEEE’s online repository, IEEE Xplore.

22. In comparing Appendix MENDELSON12 with Exhibit 1010, it is my determination that both of Appendix MENDELSON12 and Exhibit 1010 are true and correct copies of the “A Wearable Reflectance Pulse Oximeter for Remote Physiological Monitoring” article by Y. Mendelson, R. J. Duckworth, and G. Comtois, as published in the 2006 IEEE conference publication by the IEEE.

23. I have reviewed Appendix COMTOIS04, a copy of an article entitled “A noise reference input to an adaptive filter algorithm for signal processing in a wearable pulse oximeter” by G. Comtois and Y. Mendelson, as published in the *Proceedings of the 2007 IEEE 33rd Annual Northeast Bioengineering Conference, March 10 – 11, 2007* (hereinafter referred to as “2007 IEEE conference publication”). I secured this copy of the 2007 IEEE conference publication through the Pennsylvania State University’s online library catalog portal.

24. Attached hereto as Appendix COMTOIS02 is a true and correct copy of the catalog entry for the 2007 IEEE conference publication as maintained by the Pennsylvania State University. I secured this record myself from the library’s public catalog.

25. Attached hereto as Appendix COMTOIS03 is a true and correct copy of the table of contents for the 2007 IEEE conference publication. I secured this record, as provided by the Pennsylvania State University’s library through the catalog entry for the 2007 IEEE conference publication as shown in Appendix COMTOIS02, myself.

26. Attached hereto as Appendix COMTOIS01 is a true and correct copy of the MARC record for the 2007 IEEE conference publication, as held by the Pennsylvania State University's library in its online catalog. I secured this record myself from the library's public catalog through the table of contents listing as captured in COMTOIS03.

27. The MARC record contained within Appendix COMTOIS01 accurately describes the title, author, publisher, and ISBN number of the 2007 IEEE conference publication. In comparing the listed fields in Appendix COMTOIS01 to COMTOIS04, it is my determination that COMTOIS04 is a true and correct copy of the "A noise reference input to an adaptive filter algorithm for signal processing in a wearable pulse oximeter" article, and that the copy of the 2007 IEEE conference publication in the Pennsylvania State University's library includes the article in COMTOIS04.

28. The 008 field of the MARC record noted on page 1 of Appendix COMTOIS01 indicates that the 2007 IEEE conference publication was first cataloged by the Pennsylvania State University's library as of January 24, 2007. Based on this information and considering the dates of the conference, it is my determination that the 2007 IEEE conference publication, which



included the article published as Appendix COMTOIS04, was made available to the public by the Pennsylvania State University at least as of January 24, 2007.

29. Attached hereto as Appendix COMTOIS05 is a true and correct copy of the MARC record for the 2007 IEEE conference publication, as held by University of Wyoming's library in its online catalog. I secured this record myself from the library's public catalog.

30. The MARC record contained within Appendix COMTOIS05 accurately describes the title, author, publisher, and ISBN number of the 2007 IEEE conference publication. In comparing the listed fields in Appendix COMTOIS05 to COMTOIS04, it is my determination that the copy of the 2007 IEEE conference publication in University of Wyoming's library includes the article in COMTOIS04.

31. The 008 field of the MARC record noted on page 1 of Appendix COMTOIS05 indicates that the 2007 IEEE conference publication was first cataloged by University of Wyoming's library as of January 24, 2007. Based on this information and considering the dates of the conference, it is my

determination that the 2007 IEEE conference publication, which included the article published as COMTOIS04, was made available to the public by University of Wyoming at least as of January 24, 2007.

32. In reviewing the listed citations at page 2 of COMTOIS04, it is my determination that the “A noise reference input to an adaptive filter algorithm for signal processing in a wearable pulse oximeter” article cites the article entitled “A Wearable Reflectance Pulse Oximeter for Remote Physiological Monitoring” by Y. Mendelson, R. J. Duckworth, and G. Comtois, as published in the 2006 IEEE conference publication. As noted above in paragraphs 18 – 20, I have also determined that Exhibit 1010 and MENDELSON10 are true and correct copies of the article entitled “A Wearable Reflectance Pulse Oximeter for Remote Physiological Monitoring” by Y. Mendelson, R. J. Duckworth, and G. Comtois, as published in the 2006 IEEE conference publication. Accordingly, it is my determination that the 2006 IEEE conference publication containing Exhibit 1010 would have been publicly available at least as early as the publication date of the 2007 IEEE conference publication: January 24, 2007.

33.I have reviewed COMTOIS10, a copy of an article entitled “A Comparative Evaluation of Adaptive Noise Cancellation Algorithms for Minimizing Motion Artifacts in a Forehead-Mounted Wearable Pulse Oximeter” by G. Comtois, Y. Mendelson, and P. Ramuka, as published in the *Proceedings of the 29th Annual International Conference of the IEEE EMBS Cité Internationale, Lyon, France, August 23 – 26, 2007* (hereinafter referred to as “2007 IEEE EMBS conference publication”).

34.I obtained a copy of the 2007 IEEE EMBS conference publication through the Pennsylvania State University’s online library catalog portal.

35.Attached hereto as Appendix COMTOIS06 is a true and correct copy of the catalog entry for the 2007 IEEE EMBS conference publication as maintained by the Pennsylvania State University. I secured this record myself from the library’s public catalog.

36.Attached hereto as Appendix COMTOIS07 is a true and correct copy of the table of contents for the 2007 IEEE EMBS conference publication. I secured this record, as provided by the Pennsylvania State University’s library

through the catalog entry for the 2007 IEEE EMBS conference publication as shown in Appendix COMTOIS06, myself.

37. Attached hereto as Appendix COMTOIS08 is a true and correct copy of the MARC record for the 2007 IEEE EMBS conference publication, as held by the Pennsylvania State University's library in its online catalog. I secured this record myself from the library's public catalog through the table of contents listing as captured in COMTOIS07.

38. The MARC record contained within Appendix COMTOIS08 accurately describes the title, author, publisher, and ISBN number of the 2007 IEEE EMBS conference publication. In comparing the listed fields in Appendix COMTOIS08 to COMTOIS10, it is my determination that COMTOIS10 is a true and correct copy of the "A Comparative Evaluation of Adaptive Noise Cancellation Algorithms for Minimizing Motion Artifacts in a Forehead-Mounted Wearable Pulse Oximeter" article, and that the copy of the 2007 IEEE EMBS conference publication in the Pennsylvania State University's library includes the article in COMTOIS10.

39. The 008 field of the MARC record noted on page 1 of Appendix

COMTOIS08 indicates that the 2007 IEEE EMBS conference publication was first cataloged by the Pennsylvania State University's library as of June 5, 2008. Based on this information and considering the dates of the conference, it is my determination that the 2007 IEEE EMBS conference publication, which included the article published as COMTOIS10, was made available to the public by the Pennsylvania State University at least as of June 5, 2008.

40. Attached hereto as Appendix COMTOIS09 is a true and correct copy of the MARC record for the 2007 IEEE EMBS conference publication, as held by Library of Congress in its online catalog. I secured this record myself from the Library's public catalog.

41. The MARC record contained within Appendix COMTOIS09 accurately describes the title, author, publisher, and ISBN number of the 2007 IEEE EMBS conference publication. In comparing the listed fields in Appendix COMTOIS09 to COMTOIS10, it is my determination that the copy of the 2007 IEEE EMBS conference publication in the Library of Congress includes the article in COMTOIS10.

42. The 008 field of the MARC record noted on page 1 of Appendix

COMTOIS09 indicates that the 2007 IEEE EMBS conference publication was first cataloged by the Library of Congress as of June 5, 2008. Based on this information and considering the dates of the conference, it is my determination that the 2007 IEEE EMBS conference publication, which included the article published as COMTOIS10, was made available to the public by the Library of Congress at least as of June 5, 2008.

43. In reviewing the listed citations at page 4 of COMTOIS10, it is my

determination that the “A Comparative Evaluation of Adaptive Noise Cancellation Algorithms for Minimizing Motion Artifacts in a Forehead-Mounted Wearable Pulse Oximeter” article cites the article entitled “A Wearable Reflectance Pulse Oximeter for Remote Physiological Monitoring” by Y. Mendelson, R. J. Duckworth, and G. Comtois, as published in the 2006 IEEE conference publication. As noted above in paragraphs 18 – 20, I have also determined that Exhibit 1010 and Appendix MENDELSON10 are true and correct copies of the article entitled “A Wearable Reflectance Pulse Oximeter for Remote Physiological Monitoring” by Y. Mendelson, R. J. Duckworth, and G. Comtois, as

published in the 2006 IEEE conference publication. Accordingly, it is my determination that the 2006 IEEE conference publication containing Exhibit 1010 would have been publicly available at least as early as the publication date of the 2007 IEEE EMBS conference publication, June 5, 2008.

44. I have reviewed Exhibit 1017, a copy of an article entitled “Design and Evaluation of a New Reflectance Pulse Oximeter Sensor” by Y. Mendelson, et al., as published in the *Journal of the Association for the Advancement of Medical Instrumentation*, Vol. 22, No. 4, 1988 (hereinafter referred to as “1988 publication”).

45. Attached hereto as Appendix MENDELSON03 is a true and correct copy of the MARC record for the 1988 publication held by the Pennsylvania State University’s library. I secured this record myself from the library’s public catalog.

46. The MARC record contained within Appendix MENDELSON03 accurately describes the title, author, publisher, and ISSN number of the *Journal of the Association for the Advancement of Medical Instrumentation*. The 949 field of a MARC record is used for institution-specific notations and the 949

fields of this MARC record indicate the Pennsylvania State University's issue level holdings for the *Journal of the Association for the Advancement of Medical Instrumentation*, demonstrating that the Pennsylvania State University's collection contains volumes 17 – 22. These journal holdings clearly include Volume 22, No. 4, which corresponds to the 1988 publication. In comparing the listed fields in Appendix MENDELSON03 to Exhibit 1017, it is my determination that Exhibit 1017 is a true and correct copy of the "Design and Evaluation of a New Reflectance Pulse Oximeter Sensor" article, and that the copy of the 1988 publication in the Pennsylvania State University's library includes the article in Exhibit 1017.

47. The 008 field of the MARC record noted on page 1 of Appendix MENDELSON03 indicates that the *Journal of the Association for the Advancement of Medical Instrumentation* was first cataloged by the Pennsylvania State University's library as of August 8, 1983. The 362 field of the MARC record indicates the Pennsylvania State University's acquisition of this material ceased as of Vol. 22, No. 6. Based on this information, it is my determination that the 1988 publication, which included the article published as Exhibit 1017, was made available to the



public by the Pennsylvania State University shortly after initial publication in August 1988.

48. I have reviewed Exhibit 1018, a copy of an article entitled “Skin Reflectance Pulse Oximetry: In Vivo Measurements From the Forearm and Calf” by Y. Mendelson and M.J. McGinn as published in *Journal of Clinical Monitoring, January 1991* (hereinafter referred to as the “1991 publication”).

49. Attached hereto as Appendix MENDELSON04 is a true and correct copy of the MARC record for the 1991 publication held by the Ohio State University library. I secured this record myself from the library’s public catalog.

50. The MARC record contained within Appendix MENDELSON04 accurately describes the title, author, publisher, and ISSN number of the *Journal of Clinical Monitoring*. The ‘Lib Has.’ field of this MARC record indicates Ohio State University’s issue level holdings for the *Journal of Clinical Monitoring*, demonstrating that Ohio State University’s collection contains volumes 1 (1985) – volume 13 (1997). Accordingly, Ohio State’s journal holdings range clearly includes the January 1991 edition. In comparing the

information listed in Appendix MENDELSON04 to Exhibit 1018, it is my determination that Exhibit 1018 is a true and correct copy of the “Skin Reflectance Pulse Oximetry: In Vivo Measurements From the Forearm and Calf” article, and that the copy of the 1991 publication in Ohio State University’s library includes the article in Exhibit 1018.

51. The 008 field of the MARC record noted on page 1 of Appendix MENDELSON04 indicates that the *Journal of Clinical Monitoring* was first cataloged by Ohio State University’s library as of August 23, 1999. The ‘Lib has’ field of this record indicates Ohio State University’s acquisition of this material ceased as of Vol. 13. Based on this information, it is my determination that the 1991 publication, which included the article published as Exhibit 1018, was made available to the public by Ohio State University at least as of August 23, 1999.

52. Additionally, I obtained a copy of the 1991 publication through the Pennsylvania State University’s online library catalog portal.

53. Attached hereto as Appendix MENDELSON14 is a true and correct copy of the catalog entry for the 1991 publication as maintained by the Pennsylvania

State University. I secured this record myself from the library's public catalog.

54. Attached hereto as Appendix MENDELSON15 is a true and correct copy of the online page for the 1991 publication. I secured this record, as provided by the Pennsylvania State University's library through the catalog entry for the 1991 publication as shown in Appendix MENDELSON14, myself.

55. I have reviewed MENDELSON16, a copy of an article entitled "Skin Reflectance Pulse Oximetry: In Vivo Measurements From the Forearm and Calf" by Y. Mendelson and M.J. McGinn as published in 1991 publication. I obtained this document using the online page for the 1991 publication as shown in Appendix MENDELSON15.

56. Attached hereto as Appendix MENDELSON13 is a true and correct copy of the MARC record for the 1991 publication, as held by the Pennsylvania State University's library in its online catalog indicated by the catalog entry as shown in Appendix MENDELSON14. The Pennsylvania State University's online library catalog entry as shown in Appendix MENDELSON14 directs the user to Springer's online repository,

SpringerLink. I secured this record myself from the library's public catalog through the online page as captured in Appendix MENDELSON15.

57. The MARC record contained within Appendix MENDELSON13 accurately describes the title, author, publisher, and ISBN number of the 1991 publication. In comparing the listed fields in Appendix MENDELSON13 to MENDELSON16, it is my determination that (1) MENDELSON16 is a true and correct copy of the "Skin Reflectance Pulse Oximetry: In Vivo Measurements From the Forearm and Calf" article by Y. Mendelson and M.J. McGinn and (2) that the digital copy of the 1991 publication in the Pennsylvania State University's library catalog includes the article in MENDELSON16 and is the same as the copy of the "Skin Reflectance Pulse Oximetry: In Vivo Measurements From the Forearm and Calf" article by Y. Mendelson and M.J. McGinn that is made publicly available by the Pennsylvania State University through Springer's online repository SpringerLink.

58. The 008 field of the MARC record noted on page 2 of Appendix MENDELSON13 indicates that the 1991 publication was first cataloged by the Pennsylvania State University's library as of August 23, 1999. Based on

this information and considering the dates of publication of the journal, it is my determination that the 1991 publication, which included the article published as Appendix MENDELSON16, was made available to the public by the Pennsylvania State University through its online catalog at least as of August 23, 1999.

59. In comparing the listed fields in Appendix MENDELSON13 to Appendix MENDELSON04 and comparing Exhibit 1018 to Appendix MENDELSON16, it is my determination that both of Exhibit 1018 and Appendix MENDELSON16 are true and correct copies of the article entitled “Skin Reflectance Pulse Oximetry: In Vivo Measurements From the Forearm and Calf” article by Y. Mendelson and M.J. McGinn, as published in the 1991 publication.

60. Based on this information, it is my determination that Exhibit 1018 and Appendix MENDELSON16 are true and correct copies of the article entitled “Skin Reflectance Pulse Oximetry: In Vivo Measurements From the Forearm and Calf” article by Y. Mendelson and M.J. McGinn, as published in the 1991 publication, and that the 1991 publication containing Exhibit

1018 was cataloged and made available to the public by the Ohio State University at least as of August 23, 1999.

61. Based on this information, it is my determination that Exhibit 1018 and Appendix MENDELSON16 are true and correct copies of the article entitled “Skin Reflectance Pulse Oximetry: In Vivo Measurements From the Forearm and Calf” article by Y. Mendelson and M.J. McGinn, as published in the 1991 publication, and that the 1991 publication containing Exhibit 1018 was cataloged and made available to the public by the Pennsylvania State University through its online catalog at least as of August 23, 1999.

62. I have reviewed Exhibit 1022, a copy of the book entitled *Master Visually Windows Mobile* by Bill Landon and Matthew Miller (hereinafter referred to as “Landon”).

63. Attached hereto as Appendix LANDON01 is a true and correct copy of the MARC record for Landon as held by Rowan University’s library. I secured this record myself from the library’s public catalog.

64. The MARC record contained within Appendix LANDON01 accurately describes the title, author, publisher, and ISBN number of Landon. In comparing the listed fields in Appendix LANDON01 to Exhibit 1022, it is my determination that Exhibit 1022 is a true and correct copy of Landon and is the same as the copy of Landon in Rowan University.

65. The 008 field of the MARC record contained within Appendix LANDON01 indicates that Landon was first cataloged by Rowan University's library as of September 17, 2004. Based on this information, it is my determination that Landon was made available to the public by Rowan University at least as of September 17, 2004.

66. I have reviewed Exhibit 1021, a copy of the book entitled *How to Do Everything with Windows Mobile* by Frank McPherson (hereinafter referred to as "McPherson").

67. Attached hereto as Appendix MCPHERSON01 is a true and correct copy of the MARC record for McPherson as held by the Carnegie Library of Pittsburgh. I secured this record myself from the library's public catalog.

68. The MARC record contained within Appendix MCPHERSON01 accurately describes the title, author, publisher, and ISBN number of McPherson. In comparing the listed fields in Appendix MCPHERSON01 to Exhibit 1021, it is my determination that Exhibit 1021 is a true and correct copy of McPherson, and is the same as the copy of McPherson in the Carnegie Library.

69. The 008 field of the MARC record contained within Appendix MCPHERSON01 indicates that McPherson was first cataloged by the Carnegie Library of Pittsburgh as of June 5, 2006. Based on this information, it is my determination that McPherson was first made available to the public by the Carnegie Library of Pittsburgh at least as of June 5, 2006.

70. I have reviewed Exhibit 1019, a copy of the book entitled *Design of Pulse Oximeters* by John G. Webster (hereinafter referred to as “Webster”).

71. Attached hereto as Appendix WEBSTER01 is a true and correct copy of the MARC record for Webster as held by the Pennsylvania State University’s library. I secured this record myself from the library’s public catalog.



72. The MARC record contained within Appendix WEBSTER01 accurately describes the title, author, publisher, and ISBN number of Webster. In comparing the listed fields in Appendix WEBSTER01 to Exhibit 1019, it is my determination that Exhibit 1019 is a true and correct copy of Webster, and is the same as the copy of Webster in the Pennsylvania State University's library.

73. The 008 field of the MARC record noted in page 1 of Appendix WEBSTER01 indicates that Webster was first cataloged by the Pennsylvania State University's library as of November 26, 1997. Based on this information, it is my determination that Webster was made available to the public by the Pennsylvania State University at least as of November 26, 1997.

74. Attached hereto as Appendix WEBSTER02 is a true and correct copy of the MARC record for Webster as held by Georgia Institute of Technology's library. I secured this record myself from the library's public catalog.

75. The MARC record contained within Appendix WEBSTER02 accurately describes the title, author, publisher, and ISBN number of Webster. In comparing the listed fields in Appendix WEBSTER02 to Exhibit 1019, it is my determination that Exhibit 1019 is a true and correct copy of Webster, and is the same as the copy of Webster in Georgia Institute of Technology's library.

76. The 008 field of the MARC record noted in page 1 of Appendix WEBSTER02 indicates that Webster was first cataloged by Georgia Institute of Technology's library as of August 26, 1997. Based on this information, it is my determination that Webster was made available to the public by Georgia Institute of Technology at least as of August 26, 1997.

77. Attached hereto as Appendix WEBSTER03 is a true and correct copy of the MARC record for Webster as held by the Library of Congress. I secured this record myself from the Library's public catalog.

78. The MARC record contained within Appendix WEBSTER03 accurately describes the title, author, publisher, and ISBN number of Webster. In comparing the listed fields in Appendix WEBSTER03 to Exhibit 1019, it is

my determination that Exhibit 1019 is a true and correct copy of Webster, and is the same as the copy of Webster held by the Library of Congress.

79. The 008 field of the MARC record noted in page 1 of Appendix

WEBSTER03 indicates that Webster was first cataloged by the Library of Congress as of August 26, 1997. Based on this information, it is my determination that Webster was made available to the public by the Library of Congress at least as of August 26, 1997.

80. I have reviewed Exhibit 1023, a copy of an article entitled “Stimulating

Student Learning with a Novel ‘In-House’ Pulse Oximeter Design” by Jianchu Yao and Steve Warren as published in the *Proceedings of the 2005 American Society for Engineering Education Annual Conference & Exposition* (hereinafter referred to as “2005 Conference Proceedings”).

81. Attached hereto as Appendix YAO03 is a true and correct copy of the article

entitled “Stimulating Student Learning with a Novel ‘In-House’ Pulse Oximeter Design” by Jianchu Yao and Steve Warren as published in 2005 Conference Proceedings as published in the 2005 Conference Proceedings through the American Society for Engineering Education (ASEE)’s own

online repository. I secured this document myself from the ASEE's public website.

82. Attached hereto as Appendix YAO02 is a true and correct copy of the online entry for the article entitled "Stimulating Student Learning with a Novel 'In-House' Pulse Oximeter Design" by Jianchu Yao and Steve Warren as published in the 2005 Conference Proceedings as maintained by the ASEE. I secured this record myself from the ASEE's public website.

83. The information in Appendix YAO02 and Appendix YAO03 accurately describes the title, author, publisher, and ISSN number of the article entitled "Stimulating Student Learning with a Novel 'In-House' Pulse Oximeter Design" by Jianchu Yao and Steve Warren as published in the 2005 Conference Proceedings. In comparing the listed fields in Appendix YAO02 and Appendix YAO03 to Exhibit 1023, it is my determination that Exhibit 1023 is a true and correct copy of the article entitled "Stimulating Student Learning with a Novel 'In-House' Pulse Oximeter Design" by Jianchu Yao and Steve Warren as published in the 2005 Conference Proceedings, and is the same as the copy of the article maintained by the ASEE.

84. Based on this information, it is my determination that the article published as Exhibit 1023, was made available to the public by the ASEE at least as of June 12, 2005.

85. I have reviewed Exhibit 1020, a copy of a technical document entitled *QuickSpecs: HP iPAQ Pocket PC hd150 Series, Version 3, November 20, 2003* (hereinafter referred to as “2003 iPAQ Spec.”)

86. Attached hereto as Appendix QUICKSPECS01 is a true and correct copy of the 2003 iPAQ Spec. as a PDF file entitled ‘iPaq\_4150\_quick-specs.pdf’. I secured this copy myself from [ftp://ftp.abcddata.com.pl/HP/Ipaq/Retired%20Products/h4150/iPaq\\_4150\\_quick\\_specs.pdf](ftp://ftp.abcddata.com.pl/HP/Ipaq/Retired%20Products/h4150/iPaq_4150_quick_specs.pdf). In comparing Appendix QUICKSPECS01 to Exhibit 1020, it is my determination that Exhibit 1020 is a true and correct copy of the 2003 iPAQ Spec.

87. Attached hereto as Appendix QUICKSPECS02 is a true and correct copy of the FTP file tree for the website hosting the 2003 iPAQ Spec. I secured this record myself from <ftp://ftp.abcddata.com.pl/HP/Ipaq/Retired%20Products/h4150/>. FTP is a web

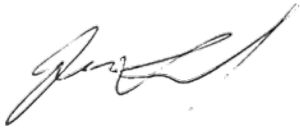
technology that allows the transfer of files without the need for a formal webpage. FTP software autogenerates a file tree for each file offered and logs the date of creation within that file tree. The entry for 'iPaq\_4150\_quick-specs.pdf' indicates this file was uploaded to this FTP server as of November 20, 2003. As such, it is my determination that the 2003 iPAQ Spec. in Exhibit 1020 was available to the public on the Internet via this FTP server at least as of November 20, 2003.

88.I have been retained on behalf of the Petitioner to provide assistance in the above-illustrated matter in establishing the authenticity and public availability of the documents discussed in this declaration. I am being compensated for my services in this matter at the rate of \$100.00 per hour plus reasonable expenses. My statements are objective, and my compensation does not depend on the outcome of this matter.

89.I declare under penalty of perjury that the foregoing is true and correct. I hereby declare that all statements made herein of my own knowledge are true and that all statements made on information and belief are believed to be true; and further that these statements were made the knowledge that willful false statements and the like so made are punishable by fine or

imprisonment, or both, under Section 1001 of Title 18 of the United States Code.

Dated: 3/30/21

A handwritten signature in black ink, appearing to read 'Jacob R. Munford', written in a cursive style.

Jacob Robert Munford

# **APPENDIX A**



## Appendix A - Curriculum Vitae

### Education

University of Wisconsin-Milwaukee - MS, Library & Information Science, 2009  
Milwaukee, WI

- Coursework included cataloging, metadata, data analysis, library systems, management strategies and collection development.
- Specialized in library advocacy and management.

Grand Valley State University - BA, English Language & Literature, 2008  
Allendale, MI

- Coursework included linguistics, documentation and literary analysis.
- Minor in political science with a focus in local-level economics and government.

### Professional Experience

Researcher / Expert Witness, October 2017 – present

Freelance

Pittsburgh, Pennsylvania

- Material authentication and public accessibility determination. Declarations of authenticity and/or public accessibility provided upon research completion. Depositions provided on request.
- Research provided on topics of public library operations, material publication history, digital database services and legacy web resources.
- Past clients include Apple, Fish & Richardson, Erise IP, Baker Botts and other firms working in patent law.

Library Director, February 2013 - March 2015

Dowagiac District Library

Dowagiac, Michigan

- Executive administrator of the Dowagiac District Library. Located in Southwest Michigan, this library has a service area of 13,000, an annual

operating budget of over \$400,000 and total assets of approximately \$1,300,000.

- Developed careful budgeting guidelines to produce a 15% surplus during the 2013-2014 & 2014-2015 fiscal years.
- Using this budget surplus, oversaw significant library investments including the purchase of property for a future building site, demolition of existing buildings and building renovation projects on the current facility.
- Led the organization and digitization of the library's archival records.
- Served as the public representative for the library, developing business relationships with local school, museum and tribal government entities.
- Developed an objective-based analysis system for measuring library services - including a full collection analysis of the library's 50,000+ circulating items and their records.

November 2010 - January 2013

Librarian & Branch Manager, Anchorage Public Library

Anchorage, Alaska

- Headed the 2013 Anchorage Reads community reading campaign including event planning, staging public performances and creating marketing materials for mass distribution.
- Co-led the social media department of the library's marketing team, drafting social media guidelines, creating original content and instituting long-term planning via content calendars.
- Developed business relationships with The Boys & Girls Club, Anchorage School District and the US Army to establish summer reading programs for children.

June 2004 - September 2005, September 2006 - October 2013

Library Assistant, Hart Area Public Library

Hart, MI

- Responsible for verifying imported MARC records and original MARC cataloging for the local-level collection as well as the Michigan Electronic Library.
- Handled OCLC Worldcat interlibrary loan requests & fulfillment via ongoing communication with lending libraries.

## Professional Involvement

### Alaska Library Association - Anchorage Chapter

- Treasurer, 2012

### Library Of Michigan

- Level VII Certification, 2008
- Level II Certification, 2013

### Michigan Library Association Annual Conference 2014

- New Directors Conference Panel Member

### Southwest Michigan Library Cooperative

- Represented the Dowagiac District Library, 2013-2015

## Professional Development

### Library Of Michigan Beginning Workshop, May 2008

#### Petoskey, MI

- Received training in cataloging, local history, collection management, children's literacy and reference service.

### Public Library Association Intensive Library Management Training, October 2011

#### Nashville, TN

- Attended a five-day workshop focused on strategic planning, staff management, statistical analysis, collections and cataloging theory.

### Alaska Library Association Annual Conference 2012 - Fairbanks, February 2012

#### Fairbanks, AK


- Attended seminars on EBSCO advanced search methods, budgeting, cataloging, database usage and marketing.

# **APPENDIX COMTOIS01**

 Covid 19 updates and more information about using the Libraries while you're remote.



Catalog

Bookmarks  Course Reserves My Account

Keyword  Search...

 Search

Advanced search Start Over

Bookmark Share 

## MARC View

```
LEADER 01048nam a22002532 4500
001 20027490
003 SIRSI
005 20170314130250.0
006 m d
007 cr n
008 070124s2007uuuunju s || || || || 2|eng|d
010 a| 88646567
020 a| 9781424410323
020 a| 1424410320 (Trade Paper) c| USD 340.00 Retail Price (Publisher) 9| Active Record
037 a| 07CH37883 b| 00066573
040 a| BIP US d| WaSeSS
245 0 0 a| 2007 IEEE 33rd Annual Northeast Bioengineering Conference h| [electronic resource]
260 a| Piscataway : b| IEEE c| Jan. 2007
506 a| License restrictions may limit access.
521 a| Scholarly & Professional b| IEEE
655 0 a| Electronic books.
856 4 0 u| http://SK8E54MC2L.search.serialssolutions.com/?
sid=sersol&SS_jc=TC0001764037&title=2007%20IEEE%2033rd%20Annual%20Northeast%20Bioengineering%20Conference
955 a| Books In Print, (c) 2016 R.R. Bowker LLC
949 a| Electronic resource w| ASIS c| 1 i| 20027490-1001 I| ONLINE m| ONLINE r| Y s| Y t| ONLINE u| 3/21/2017 o| .STAFF. 360 MARC
```



Copyright ©2019 The Pennsylvania State University. All rights reserved. Except where otherwise noted, this work is subject to a Creative Commons Attribution 4.0 license. Details and exceptions.

[Legal Statements](#) | [PSU Hotlines](#)


### PENN STATE UNIVERSITY LIBRARIES

[Libraries Home](#) (814) 865-6368  
[Libraries Intranet \(Staff Only\)](#)  
[Accessibility Help](#)  
[Website Feedback](#)  
[Policies and Guidelines](#)  
[Staff Directory](#)

### CONNECT WITH PENN STATE UNIVERSITY LIBRARIES

 Facebook  
 Twitter  
 Instagram

## **APPENDIX COMTOIS02**

 Covid 19 updates and more information about using the Libraries while you're remote.



Catalog

Bookmarks  Course Reserves My Account

Keyword  Search...

 Search

[Advanced search](#) [Start Over](#)

[← Previous](#) | 1 of 51 | [Next →](#)

[Bookmark](#) [Share](#)



## 2007 IEEE 33rd Annual Northeast Bioengineering Conference [electronic resource]

Published: Piscataway : IEEE Jan. 2007

Access Online: [serialssolutions.com](http://serialssolutions.com)



### Restrictions on Access:

License restrictions may limit access.

### Genre(s):

[Electronic books](#)

### ISBN:

9781424410323 and 1424410320 (Trade Paper)

### Audience Notes:

Scholarly & Professional IEEE

[View MARC record](#) | catkey: 20027490



Copyright ©2019 The Pennsylvania State University. All rights reserved. Except where otherwise noted, this work is subject to a Creative Commons Attribution 4.0 license. Details and exceptions.

[Legal Statements](#) | [PSU Hotlines](#)

### PENN STATE UNIVERSITY LIBRARIES

[Libraries Home](#) (814) 865-6368  
[Libraries Intranet \(Staff Only\)](#)  
[Accessibility Help](#)  
[Website Feedback](#)  
[Policies and Guidelines](#)  
[Staff Directory](#)

### CONNECT WITH PENN STATE UNIVERSITY LIBRARIES

[Facebook](#)  
[Twitter](#)  
[Instagram](#)

## **APPENDIX COMTOIS03**



IEEE.org | IEEE Xplore | IEEE-SA | IEEE Spectrum | More Sites Cart Create Account Personal Sign In

**IEEE Xplore** Browse ▾ My Settings ▾ Help ▾ PENN STATE UNIVERSITY LIBRARIES Access provided by: Penn State University Sign Out

Q

Search within Publication ADVANCED SEARCH

Browse Conferences > Annual Northeast Bioengineerin... > 2007 IEEE 33rd Annual Northeast

## Annual Northeast Bioengineering Conference

[Copy Persistent Link](#) [Browse Title List](#) [Sign up for Conference Alerts](#)

**Proceedings** All Proceedings Popular

2007 IEEE 33rd Annual Northeast Bioengineering Conference

DOI: 10.1109/NEBC12548.2007

Q

[Download PDFs ▾](#) | [Per Page: 25 ▾](#) | [Export ▾](#) | [Email Selected Results ▾](#)

Showing 51-75 of 164

**Refine**

Select All on Page Sort By: Sequence ▾

**Author** ▾

**Affiliation** ▾

**Conference Location** ▾

---

**Quick Links**

[Search for Upcoming Conferences](#)

[IEEE Publication Recommender](#)

[IEEE Author Center](#)

---

**Proceedings**

The proceedings of this conference will be available for purchase through Curran Associates.

**Bioengineering Conference (NEBEC), 2007 IEEE 33rd Annual Northeast**

Print on Demand [Purchase at Partner](#)

---

**Development of a TLM to investigate the effect of a resistive interface in digital flat panel x-ray detectors**

J.A. Segui; W. Zhao  
Publication Year: 2007, Page(s): 88 - 89

[Abstract](#) [\(html\)](#) (492 Kb)

---

**Spectral separation resolves partial volume effect in MRSI: A validation study**

Yuzhuo Su; Sunitha B. Thakur; Karimi Sasan; Shuyan Du; Paul Sajda; Wei Huang; Lucas C. Parra  
Publication Year: 2007, Page(s): 90 - 91

[Abstract](#) [\(html\)](#) (1409 Kb)

---

**Micro particle size measurements using modulated light scattering spectrum from SDOCT**

Zhijia Yuan; Zhenguo Wang; Yingtian Pan  
Publication Year: 2007, Page(s): 92 - 93

[Abstract](#) [\(html\)](#) (238 Kb)

---

**Optimization of pinhole emission imaging systems for small animal imaging**

Lili Zhou; Parmeshwar Khurd; Gene Gindi  
Publication Year: 2007, Page(s): 94 - 95

[Abstract](#) [\(html\)](#) (1307 Kb)

---

**Development of ventricular expansion and increased pulsatile CSF flow in a rat model**

S. Rashid; M.E. Wagshul; M. Yu; H. Benveniste; J. Li; J. P. McAllister  
Publication Year: 2007, Page(s): 96 - 97

[Abstract](#) [\(html\)](#) (1317 Kb)

---

**The design of a thermal-sweating manikin to evaluate the comfort of prostheses. part II: sweating system**

Christopher R. Berglind; Matthew J. Solomito; Judy L. Cezeaux; Steven Schreiner; Steven Thomsen  
Publication Year: 2007, Page(s): 98 - 99

[Abstract](#) [\(html\)](#) (408 Kb)

[Abstract](#) [pdf](#) (1245 Kb) [Open Access](#)

---

**Next generation device for recording daylong hand-arm vibration and grip force waveforms** [Open Access](#)  
 E.R. Bernstein; D.R. Peterson  
 Publication Year: 2007 , Page(s): 100 - 101  
[Abstract](#) [html](#) [pdf](#) (1092 Kb) [Open Access](#)

---

**Distal upper extremity motion during keyboarding** [Open Access](#)  
 E.J. Bill; D.R. Peterson  
 Publication Year: 2007 , Page(s): 102 - 103  
[Abstract](#) [html](#) [pdf](#) (1249 Kb) [Open Access](#)

---

**The effects of pH on the electrophysiological properties of the CNS of *Ilymnaea stagnalis*** [Open Access](#)  
 Kristina Bruen; Whitney Capwell; Shaun Russell; John DiCecco; Ying Sun  
 Publication Year: 2007 , Page(s): 104 - 105  
 Cited by: Papers (1)  
[Abstract](#) [html](#) [pdf](#) (906 Kb) [Open Access](#)

---

**A noise reference input to an adaptive filter algorithm for signal processing in a wearable pulse oximeter** [Open Access](#)  
 G. Comtois; Y. Mendelson  
 Publication Year: 2007 , Page(s): 106 - 107  
 Cited by: Papers (10)  
[Abstract](#) [html](#) [pdf](#) (205 Kb) [Open Access](#)

---

**Parametric optimization for EPGVF snake using ANOVA and Taguchi method** [Open Access](#)  
 Runhong Deng; Martin. D. Fox  
 Publication Year: 2007 , Page(s): 108 - 109  
[Abstract](#) [html](#) [pdf](#) (1111 Kb) [Open Access](#)

---

**Effect of localized ambient humidity on electrotactile skin resistance** [Open Access](#)  
 Anandnayan Jayaraman; Kurt A. Kaczmarek; Mitchell E. Tyler; Uchechukwu O. Okpara  
 Publication Year: 2007 , Page(s): 110 - 111  
 Cited by: Papers (2)  
[Abstract](#) [html](#) [pdf](#) (1295 Kb) [Open Access](#)

---

**Decomposition of MEG signals with sparse representations** [Open Access](#)  
 Tolga E. Ozkurt; Mingui Sun; Robert J. Scabassi  
 Publication Year: 2007 , Page(s): 112 - 113  
 Cited by: Papers (1)  
[Abstract](#) [html](#) [pdf](#) (254 Kb) [Open Access](#)

---

**Identifying frequency-domain features for an EEG-based pain measurement system** [Open Access](#)  
 D. Rissacher; R. Dowman; S.A.C. Schuckers  
 Publication Year: 2007 , Page(s): 114 - 115  
 Cited by: Papers (11)  
[Abstract](#) [html](#) [pdf](#) (133 Kb) [Open Access](#)

---

**A novel framework for AC field-effects on action potential coherence and phase** [Open Access](#)  
 T. Radman; Y. Su; J.H. An; L. Parra; M. Bikson  
 Publication Year: 2007 , Page(s): 116 - 117  
[Abstract](#) [html](#) [pdf](#) (2240 Kb) [Open Access](#)

---

**A stethoscope-mounted cardiac synchronizer** [Open Access](#)  
 Seth Wolpert; Curtis Rager; Thomas Nifong  
 Publication Year: 2007 , Page(s): 118 - 119  
[Abstract](#) [html](#) [pdf](#) (850 Kb) [Open Access](#)

---

**Denosing DWI based on regularized filter** [Open Access](#)  
 X. F. Zhang; H. Ye; W.F. Tian; W.F. Chen  
 Publication Year: 2007 , Page(s): 120 - 121  
[Abstract](#) [html](#) [pdf](#) (304 Kb) [Open Access](#)

- A depth-first search algorithm automatic initialization splitting of snakes**

Liang Zhu; Martin Fox  
 Publication Year: 2007 , Page(s): 122 - 123  
 Cited by: Patents (4)

▶ Abstract [\(html\)](#) (417 Kb)
- A prototype volume conduction platform for implantable devices**

Steven A. Hackworth; Mingui Sun; Robert J. Sclabassi  
 Publication Year: 2007 , Page(s): 124 - 125  
 Cited by: Papers (2)

▶ Abstract [\(html\)](#) (1102 Kb)
- Heart rate variability analysis before and during exposing to low pulsed microwaves in mammals**

Ahmed Kamal  
 Publication Year: 2007 , Page(s): 126 - 127

▶ Abstract [\(html\)](#) (958 Kb)
- Restoration of multi-channel spectral estimation affected by sampling jitters**

Taikang Ning; Sagar Bhandari; Nikolay A. Atanasov  
 Publication Year: 2007 , Page(s): 128 - 129

▶ Abstract [\(html\)](#) (1083 Kb)
- 3-D sign language synthesis**

Amanda Irving; Richard Foulds  
 Publication Year: 2007 , Page(s): 130 - 131  
 Cited by: Papers (1)

▶ Abstract (66 Kb)
- Bone's mechanical properties, as determined by MicroCT, are dependent on precise contour lines**

C. Bosch; S. Lublinsky; S. Xu; E. Ozcivici; S. Judex  
 Publication Year: 2007 , Page(s): 132 - 133

▶ Abstract [\(html\)](#) (1043 Kb)
- Neuronal feedback control system based on dsPIC processor**

Eugene Chabot; Ying Sun  
 Publication Year: 2007 , Page(s): 134 - 135

▶ Abstract (66 Kb)
- Comparison of mathematical models of fast oscillatory rhythms in inspiratory discharges**

X. Chen; I.C. Solomon; K.H. Chon  
 Publication Year: 2007 , Page(s): 136 - 137

▶ Abstract [\(html\)](#) (1090 Kb)

<p><b>IEEE Personal Account</b></p> <p>CHANGE USERNAME/PASSWORD</p>	<p><b>Purchase Details</b></p> <p>PAYMENT OPTIONS</p> <p>VIEW PURCHASED DOCUMENTS</p>	<p><b>Profile Information</b></p> <p>COMMUNICATIONS PREFERENCES</p> <p>PROFESSION AND EDUCATION</p> <p>TECHNICAL INTERESTS</p>	<p><b>Need Help?</b></p> <p>US &amp; CANADA: +1 800 678 4333</p> <p>WORLDWIDE: +1 732 981 0060</p> <p>CONTACT &amp; SUPPORT</p>	<p><b>Follow</b></p> <p> </p>
<p>About IEEE Xplore   Contact Us   Help   Accessibility   Terms of Use   Nondiscrimination Policy   Sitemap   Privacy &amp; Opting Out of Cookies</p> <p>A not-for-profit organization, IEEE is the world's largest technical professional organization dedicated to advancing technology for the benefit of humanity.</p> <p>© Copyright 2021 IEEE - All rights reserved. Use of this web site signifies your agreement to the terms and conditions.</p>				

## **APPENDIX COMTOIS04**



# A Noise Reference Input to an Adaptive Filter Algorithm for Signal Processing in a Wearable Pulse Oximeter

G. Comtois, Y. Mendelson

Department of Biomedical Engineering, Worcester Polytechnic Institute, Worcester, MA 01609

**Abstract**—A wearable battery-operated pulse oximeter has been developed for rapid field triage applications. The wearable system comprises three units: a small ( $\phi = 22\text{mm}$ ) and lightweight (4.5g) reflectance-mode optical sensor module (SM), a receiver module (RM), and Personal Digital Assistant (PDA). The information acquired by the forehead-mounted SM is transmitted wirelessly via a RF link to the waist-worn RM which processes the data and transmits it wirelessly to the PDA. Since photoplethysmographic (PPG)-based measurements, which are used by the pulse oximeter to determine arterial oxygen saturation ( $\text{SpO}_2$ ) and heart rate (HR), can be degraded significantly during motion, the implementation of a reliable pulse oximeter for field applications requires sophisticated noise rejection algorithms. To minimize the effects of motion artifacts, which can lead to measurement dropouts, inaccurate readings and false alarms, a 16<sup>th</sup>-order, least-mean squares (LMS), adaptive noise canceling (ANC) algorithm was implemented off-line in Matlab to process the PPG signals. This algorithm was selected because its computational requirement is comparable to a finite impulse response filter. Filter parameters were optimized for computational speed and measurement accuracy. A tri-axial MEMS accelerometer (ACC) served as a noise reference input to the ANC algorithm.

## I. INTRODUCTION

A primary factor limiting the accuracy of pulse oximetry is poor signal-to-noise ratio caused by motion artifacts [1]. Since PPG measurements to determine  $\text{SpO}_2$  and HR are degraded during movements, the implementation of a robust pulse oximeter for field applications requires sophisticated noise rejection algorithms. To minimize the effects of motion artifacts, several groups proposed to employ ANC algorithms utilizing a noise reference from a MEMS accelerometer

(ACC) [2-6]. Despite promising results, utilizing this approach to recover corrupted PPG signals was limited to HR derived from sensors attached to the fingers. However, these studies did not report if  $\text{SpO}_2$  accuracy is improved. Since the fingers are generally more vulnerable to motion artifacts, the aim of this study was to investigate if ANC is effective in minimizing both  $\text{SpO}_2$  and HR errors induced during jogging in a custom, forehead-mounted, pulse oximeter and also quantify the individual contributions of each ACC axis.

## II. MATERIALS

Measurements were acquired from a custom wireless pulse oximeter [7]. A tri-axial MEMS accelerometer embedded within the SM provides reference noise inputs to the ANC algorithm. Key features of this wearable system are its small-size, robustness, and low-power consumption, which are essential attributes for wearable devices used in field applications.

## III. METHODS

Body accelerations and PPG data were collected simultaneously from a healthy male volunteer during five outdoor and treadmill jogging trials. Each study comprised a 1-minute free jogging (rates: 3.75–6.5mph), framed by 2-minute resting intervals. The X, Y, and Z axis of the ACC were oriented according to the anatomical planes illustrated in Fig. 1. For validation, reference  $\text{SpO}_2$  and HR were acquired concurrently from the Masimo SET<sup>®</sup> transmission pulse oximeter by a sensor attached to the subject's hand which remained stationary during the study. A Polar<sup>™</sup> ECG monitor, attached across the chest, provided reference HR data.



Fig. 1: ACC axis orientations.

#### IV. RESULTS AND DISCUSSION

FFT analysis of the infrared (IR) PPG and ACC signals during jogging are shown in Fig. 2. The power spectra between 1.8–2.2Hz correspond to variations in subject’s HR. Similarly, the higher dominant frequency around 2.45Hz coincides with the subject’s up-down movement rate and is clearly registered by the X-axis signal of the ACC (Fig. 2B).

Table 1 shows averaged differences between SpO<sub>2</sub> and HR values measured by the Masimo pulse oximeter and Polar HR monitor compared to the custom pulse oximeter acquired PPG signals that were processed either without or by the ANC algorithm. Results revealed that in all cases, utilizing an ANC algorithm can produce more accurate SpO<sub>2</sub> measurements. Furthermore, using the vertically-oriented X-axis of the ACC as the primary noise reference produced more significant improvements. It was disappointing to note, however, that the Masimo pulse oximeter, which is considered immune to a wide range of motion-induced artifacts, was unable to track changes in HR during jogging compared to the Polar monitor and our custom pulse oximeter.

The ability to measure HR reliably is important in a pulse oximeter since HR values are commonly used as an indicator to assess the reliability of SpO<sub>2</sub> readings. The data also showed that although a uniaxial ACC is sufficient, practically, a triaxial ACC is more advantageous since measurements would be less sensitive to sensor misalignment or inadvertent changes in sensor positioning during movements.

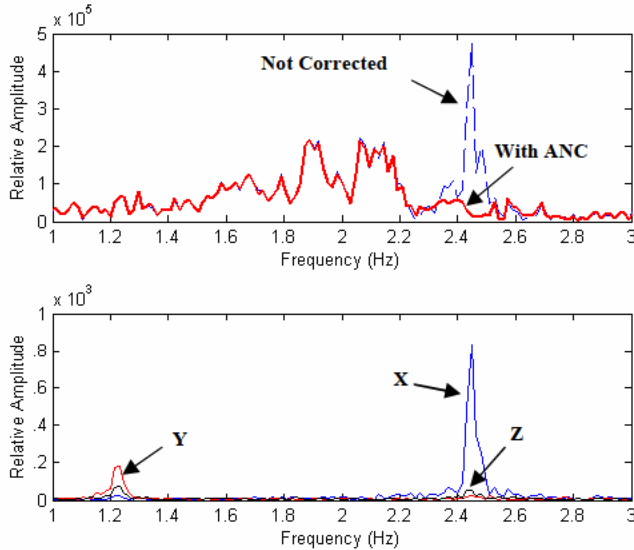


Fig. 2: (Top): Typical frequency spectra of pre-adapted (*dashed*), and post adapted (*solid*) PPG signals. (Bottom): Reference ACC signals during treadmill running.

Table 1: Percent SpO<sub>2</sub> and HR differences (*Bias ± SD*) measured during jogging (N = 300).

	Masimo SET®		Polar™
	SpO <sub>2</sub>	HR	HR
Not Corrected	2.5 ± 1.5	59.7 ± 22.7	6.6 ± 3.6
ANC (X)	1.9 ± 1.2	54.4 ± 19.4	1.8 ± 1.4
ANC (Y)	2.3 ± 1.4	57.5 ± 22.2	5.2 ± 3.5
ANC (Z)	2.3 ± 1.5	56.8 ± 20.9	4.0 ± 2.8
ANC (X+Y+Z)	2.0 ± 1.3	58.0 ± 21.8	2.7 ± 1.7

#### V. CONCLUSIONS

This study demonstrated that an embedded MEMS ACC can provide a reference noise input for implementing an ANC algorithm, thereby improving both SpO<sub>2</sub> and HR measurements by a wearable forehead-mounted pulse oximeter during jogging.

#### ACKNOWLEDGMENT

This work is supported by the U.S. Army MPMC under Contract DAMD17-03-2-0006. The views, opinions and/or findings are those of the author and should not be construed as an official Department of the Army position, policy or decision unless so designated by other documentation.

#### REFERENCES

- [1] S.W. Kästle, E. Konecny, Determining the artifact sensitivity of recent pulse oximeters during laboratory benchmarking, *J. Clin. Mon. & Comp.*, vol. 16, pp. 509, 2000.
- [2] J.Y.A. Foo, S.J. Wilson, A computational system to optimize noise rejection in photoplethysmography signals during motion or poor perfusion states, *Med. Biol. Eng. Comput.*, vol. 44, pp. 140, 2006.
- [3] L.B. Wood, H.H. Asada, Noise cancellation model validation for reduced motion artifact wearable PPG sensors using MEMS accelerometers, *Proc. 28<sup>th</sup> IEEE/EMBS Ann. Int. Conf.*, pp. 3525, 2006.
- [4] H.H. Asada, H. Jiang, P. Gibbs, Active noise cancellation using MEMS accelerometers for motion-tolerant wearable bio-sensors, *Proc. 26<sup>th</sup> Int. Conf. IEEE/EMBS*, pp. 2157, 2004.
- [5] A.R. Relente, L.G. Sison, Characterization and adaptive filtering of motion artifacts in pulse oximetry using accelerometers, *Proc. 2<sup>nd</sup> Joint EMBS/BMES Conf.*, pp. 1769, 2002.
- [6] M.A.D. Raya, L.G. Sison, Adaptive noise cancelling of motion artifacts in stress ECG signals using accelerometer, *Proc. 2<sup>nd</sup> Joint EMBS/BMES Conf.*, pp. 1756, 2002.
- [7] Y. Mendelson, R.J. Duckworth, G. Comtois, A wearable reflectance pulse oximeter for remote physiological monitoring, *Proc. 28<sup>th</sup> IEEE/EMBS Ann. Int. Conf.*, pp. 912, 2006.

## **APPENDIX COMTOIS05**

STUDENTS | PARENTS | ALUMNI | PEOPLE | WYOWEB | VIRTUAL TOUR | GIVE | EVENTS

UW NAVIGATION

A-Z DIRECTORY Search Go

APPLY NOW

LIBRARIES LOCATIONS SERVICES HELP ABOUT

My Accounts Hours Study Rooms Chat Help Email Us

## Catalog search results

New Search Save to my lists Save Record See regular display

```
LEADER 00000nam a2200301u b4500
001 ssj0001764037
003 WaSeSS
005 20200913041606.0
006 m d
007 cr n
008 070124s2007uuunju o||||||| 2|eng|d
020 |z9781424410323
020 |z1424410320 (Trade Paper)|cUSD 340.00 Retail Price
(Publisher)
035 (WaSeSS)ssj0001764037
037 07CH37883|b00066573
040 BIP US|dWaSeSS|erda
099 ONLINE
130 0 2007 IEEE 33rd Annual Northeast Bioengineering Conference
(Online)
245 10 2007 IEEE 33rd Annual Northeast Bioengineering Conference
264 1 Piscataway : |bIEEE|cJan. 2007
336 text|btxt|2rdacontent
337 computer|bc|2rdamedia
338 online resource|bcr|2rdacarrier
506 Access limited to University of Wyoming-affiliated
patrons.
521 Scholarly & Professional|bIEEE
710 2 IEEE.
856 40 |zVIEW FULL TEXT|uhttp://
VH7QX3XE2P.search.serialssolutions.com/?V=1.0&L=VH7QX3XE2P
&S=JCS&C=TC0001764037&T=marc&tab=BOOKS
955 Books In Print, (c) 2016 R.R. Bowker LLC
955 Books In Print, (c) 2016 R.R. Bowker LLC
955 Books In Print, (c) 2016 R.R. Bowker LLC
```

University Libraries  
Dept. 3334  
1000 E. University Ave.  
Laramie, WY 82071  
(307) 766-3190  
(800) 442-6757

Give to UW Libraries

Connect with us:

f i t y


Contact  
Feedback  
Policies  
About  
Accessibility  
A - Z  
Maps

UNIVERSITY OF WYOMING 1000 E. University Ave. Laramie, WY 82071  
UW Operators (307) 766-1121 | [Contact Us](#) | [Download Adobe Reader](#)

ACCREDITATION | VIRTUAL TOUR | EMERGENCY PREPAREDNESS | EMPLOYMENT AT UW | PRIVACY POLICY | HARASSMENT & DISCRIMINATION | ACCESSIBILITY




## **APPENDIX COMTOIS06**

 Covid 19 updates and more information about using the Libraries while you're remote.



Catalog

Bookmarks  Course Reserves My Account

Keyword  Search...

 Search

[Advanced search](#) [Start Over](#)

[Bookmark](#) [Share](#)



# 2007 Annual International Conference of the IEEE Engineering in Medicine and Biology Society [electronic resource] : Lyon, France, 22-26 August 2007



**Corporate Author:** [IEEE Engineering in Medicine and Biology Society. Annual Conference \(29th : 2007 : Lyon, France\)](#)

**Published:** [New York?] : IEEE, EMB ; Piscataway, NJ : IEEE Service Center [distributor], c2007.

**Physical Description:** 16 v. (cx, 6759, 13, 46 p.) : ill. ; 28 cm.

**Additional Creators:** [IEEE Engineering in Medicine and Biology Society](#)

**Access Online:** [serialssolutions.com](#)

#### Restrictions on Access:

License restrictions may limit access.

#### Subject(s):

[Biomedical engineering—Congresses](#)  
[Biomedical materials—Congresses](#)  
[Biosensors—Congresses](#)

#### Genre(s):

[Electronic books](#)

#### ISBN:

9781424407873 and 1424407877

#### Bibliography Note:

Includes bibliographical references.

[View MARC record](#) | catkey: 14765041



Copyright ©2019 The Pennsylvania State University. All rights reserved. Except where otherwise noted, this work is subject to a Creative Commons Attribution 4.0 license. Details and exceptions.

[Legal Statements](#) | [PSU Hotlines](#)

#### PENN STATE UNIVERSITY LIBRARIES

[Libraries Home](#) (814) 865-6368  
[Libraries Intranet \(Staff Only\)](#)  
[Accessibility Help](#)  
[Website Feedback](#)  
[Policies and Guidelines](#)  
[Staff Directory](#)

#### CONNECT WITH PENN STATE UNIVERSITY LIBRARIES

[Facebook](#)  
[Twitter](#)  
[Instagram](#)

## **APPENDIX COMTOIS07**

IEEE.org | IEEE Xplore | IEEE-SA | IEEE Spectrum | More Sites Cart Create Account Personal Sign In

**IEEE Xplore** Browse ▾ My Settings ▾ Help ▾ Access provided by: Penn State University Sign Out

All Q

Search within Publication ADVANCED SEARCH

Browse Conferences > Annual International Conferenc... > 2007 29th Annual International...

## Annual International Conference of the IEEE Engineering in Medicine and Biology Society (EMBC)

[Copy Persistent Link](#) [Browse Title List](#) [Sign up for Conference Alerts](#)

**Proceedings** All Proceedings Popular

2007 29th Annual International Conference of the IEEE Engineering in Medicine and Biology Society

DOI: 10.1109/EMBC10204.2007

Search within results Q

Download PDFs ▾ | Per Page: 10 ▾ | Export ▾ | Email Selected Results ▾

Showing 401-410 of 1,727

**Refine**

**Author** ▾

**Affiliation** ▾

**Conference Location** ▾

---

**Quick Links**

[Search for Upcoming Conferences](#)

[IEEE Publication Recommender](#)

[IEEE Author Center](#)

- Select All on Page Sort By: Sequence ▾
- A Novel Approach to Classify Significant ECG Data Based on Heart Instantaneous Frequency and ECG-derived Respiration using Conductive Textiles** 🔒  
Yeon Sik. Noh; Sung Jun. Park; Sung Bin. Park; Hyung Ro. Yoon  
Publication Year: 2007 , Page(s): 1503 - 1506  
Cited by: Papers (1)  
[▶ Abstract](#) [\(html\)](#) [PDF \(357 Kb\)](#) [CC](#)
  - Roll-over Detection and Sleep Quality Measurement using a Wearable Sensor** 🔒  
Hiroyasu Miwa; Shin-ichiro Sasahara; Toshihiro Matsui  
Publication Year: 2007 , Page(s): 1507 - 1510  
Cited by: Papers (26) | Patents (2)  
[▶ Abstract](#) [\(html\)](#) [PDF \(604 Kb\)](#) [CC](#)
  - Estimating Intensity of Physical Activity: A Comparison of Wearable Accelerometer and Gyro Sensors and 3 Sensor Locations** 🔒  
J. Parkka; M. Ermes; K. Antila; M. van Gils; A. Manttari; H. Nieminen  
Publication Year: 2007 , Page(s): 1511 - 1514  
Cited by: Papers (23)  
[▶ Abstract](#) [\(html\)](#) [PDF \(335 Kb\)](#) [CC](#)
  - A New Model for Programming Software in Body Sensor Networks** 🔒  
Talles M. G. de A. Barbosa; Iwens G. Sene; Adson F. da Rocha; Francisco A. de O. Nascimento; Joao L. A. Carvalho; Hervaldo S. Carvalho  
Publication Year: 2007 , Page(s): 1515 - 1518  
[▶ Abstract](#) [\(html\)](#) [PDF \(419 Kb\)](#) [CC](#)
  - A Study on the Implementation of a Portable u-Healthcare System using SNMP and AODV** 🔒  
Jungho Seo; Jungil Heo; Suyoung Lim; Jinsoo Ahn; Wooshik Kim  
Publication Year: 2007 , Page(s): 1519 - 1522  
Cited by: Papers (5)  
[▶ Abstract](#) [\(html\)](#) [PDF \(610 Kb\)](#) [CC](#)
  - Development of Health Monitoring System based on Three-dimensional Imaging using Bio-signals and Motion Data** 🔒

**Proceedings**

The proceedings of this conference will be available for purchase through Curran Associates.

**Engineering in Medicine and Biology Society (EMBC), 2007 Annual International Conference of the IEEE**

Print on Demand [Purchase at Partner](#)

Tsuyoshi Matsukawa; Tomohiro Umetani; Kiyoko Yokoyama  
Publication Year: 2007 , Page(s): 1523 - 1527  
Cited by: Papers (1)

▶ Abstract (html) PDF (2001 Kb) ©

**A Comparative Evaluation of Adaptive Noise Cancellation Algorithms for Minimizing Motion Artifacts in a Forehead-Mounted Wearable Pulse Oximeter**

Gary Comtois; Yitzhak Mendelson; Piyush Ramuka  
Publication Year: 2007 , Page(s): 1528 - 1531  
Cited by: Papers (19) | Patents (15)

▶ Abstract (html) PDF (239 Kb) ©

**Reducing Motion Artefacts of Capacitive Sensors**

Bas Feddes; Lena Gourmelon; Mohammed Meftah; Ton Ikink  
Publication Year: 2007 , Page(s): 1532 - 1532  
Cited by: Papers (2)

▶ Abstract (html) PDF (74 Kb) ©

**Quantification of Motion Artifact in ECG Electrode Design**

Kenneth Kearney; Chris Thomas; Eric McAdams  
Publication Year: 2007 , Page(s): 1533 - 1536  
Cited by: Papers (8) | Patents (4)

▶ Abstract (html) PDF (218 Kb) ©

**On the reliability of pulse oximetry at the sternum**

J. Sola; O. Chetelat; J. Krauss  
Publication Year: 2007 , Page(s): 1537 - 1537  
Cited by: Papers (5)

▶ Abstract (html) PDF (255 Kb) ©

Previous < **41** 42 43 44 45 46 47 48 49 50 > Next

**IEEE Personal Account**

CHANGE USERNAME/PASSWORD

**Purchase Details**

PAYMENT OPTIONS

VIEW PURCHASED DOCUMENTS

**Profile Information**

COMMUNICATIONS PREFERENCES

PROFESSION AND EDUCATION

TECHNICAL INTERESTS

**Need Help?**

US & CANADA: +1 800 678 4333

WORLDWIDE: +1 732 981 0060

CONTACT & SUPPORT

**Follow**



About IEEE Xplore | Contact Us | Help | Accessibility | Terms of Use | Nondiscrimination Policy | Sitemap | Privacy & Opting Out of Cookies  
A not-for-profit organization, IEEE is the world's largest technical professional organization dedicated to advancing technology for the benefit of humanity.

© Copyright 2021 IEEE - All rights reserved. Use of this web site signifies your agreement to the terms and conditions.

## **APPENDIX COMTOIS08**



**COVID-19 updates and more information about using the Libraries while you're remote.**

**PennState University Libraries** | **Catalog** | Bookmarks | Course Reserves | My Account

Keyword: Search... **Search** | Advanced search | Start Over

**Bookmark** | **Share**

## MARC View

LEADER 01553nam a22003134a 4500  
001 14765041  
003 SIRSI  
005 20150414130207.0  
006 m d  
007 cr n  
008 080605s2007 nyua sb 101 0 eng d  
010 a | 2008274007  
020 a | 9781424407873  
020 a | 1424407877  
040 a | DLC c | DLC d | DLC d | WaSeSS  
050 0 0 a | R856.A2 b | I344 2007  
110 2 a | IEEE Engineering in Medicine and Biology Society. b | Annual Conference n | (29th : d | 2007 : c | Lyon, France)  
245 1 0 a | 2007 Annual International Conference of the IEEE Engineering in Medicine and Biology Society h | [electronic resource] : b | Lyon, France, 22-26 August 2007.  
260 a | [New York?] : b | IEEE, EMB ; a | Piscataway, NJ : b | IEEE Service Center [distributor], c | c2007.  
300 a | 16 v. (cx, 6759, 13, 46 p.) : b | ill. ; c | 28 cm.  
504 a | Includes bibliographical references.  
506 a | License restrictions may limit access.  
650 0 a | Biomedical engineering v | Congresses.  
650 0 a | Biomedical materials v | Congresses.  
650 0 a | Biosensors v | Congresses.  
655 0 a | Electronic books.  
710 2 a | IEEE Engineering in Medicine and Biology Society.  
856 4 0 u | http://SK8E54MC2L.search.serialssolutions.com/?sid=sersol&SS\_jc=TC0000394408&title=2007%20Annual%20International%20Conference%20of%20the%20IEEE%20Engineering%20in%20Medicine%20and%20Biology%20Society%20%3A%20Lyon%2C%20France%2C%202022%20August%202007  
949 a | Electronic resource w | ASIS c | 1 | 14765041-1001 | | ONLINE m | ONLINE r | Y s | Y t | ONLINE u | 4/22/2015 o | .STAFF. 360 MARC

**PennState** | Copyright ©2019 The Pennsylvania State University. All rights reserved. Except where otherwise noted, this work is subject to a Creative Commons Attribution 4.0 license. Details and [more info.](#)  
[Legal Statements](#) | [PSU History](#)

**PENN STATE UNIVERSITY LIBRARIES** | (814) 863-6308  
[Library Home](#) | [Library Hours \(Staff Only\)](#) | [Accessibility Help](#) | [Website Feedback](#) | [Privacy and Guidelines](#) | [Staff Directory](#)

**CONNECT WITH PENN STATE UNIVERSITY LIBRARIES**  
[Facebook](#) | [Twitter](#) | [Instagram](#)

## **APPENDIX COMTOIS09**



Library buildings are closed to the public until further notice. The LC Catalog is available. However, Automated Call Slip service is only available to some patrons. [More](#)



CATALOG

LC Catalog Quick Search



LOGIN



SEARCH OPTIONS

Refine Your Search

BOOK

## 2007 Annual International Conference of the IEEE Engineering in ...

Full Record MARC Tags

000 01287cam a22002654a 4500  
001 15317761  
005 20140814095918.0  
008 080605s2007 nyua b 101 0 eng  
906 \_\_ |a 7 |b cbc |c orignew |d 2 |e ncip |f 20 |g y-gencatlg  
925 0\_ |a acquire |b 2 shelf copies |x policy default  
955 \_\_ |a pv15 2008-06-05 2 v. (p. 2110-2531 & p. 3377-3797) to ASCD |a jf09 2008-07-31 to Med for R856? |i jb08 2008-08-26 |e jb08 2008-08-26 to Dewey |t xh14 2010-03-10 copy 2 (v 1-5, 7-8, 10-16) to BCCD  
010 \_\_ |a 2008274007  
020 \_\_ |a 9781424407873  
020 \_\_ |a 1424407877  
040 \_\_ |a DLC |c DLC |d DLC  
050 00 |a R856.A2 |b I344 2007  
110 2\_ |a IEEE Engineering in Medicine and Biology Society. |b Annual Conference |n (29th : |d 2007 : |c Lyon, France)  
245 10 |a 2007 Annual International Conference of the IEEE Engineering in Medicine and Biology Society : |b Lyon, France, 22-26 August 2007.  
260 \_\_ |a [New York?] : |b IEEE, EMB ; |a Piscataway, NJ : |b IEEE Service Center [distributor], |c c2007.  
300 \_\_ |a 16 v. (cx, 6759, 13, 46 p.) : |b ill. ; |c 28 cm.  
504 \_\_ |a Includes bibliographical references.  
650 \_0 |a Biomedical engineering |v Congresses.  
650 \_0 |a Biomedical materials |v Congresses.  
650 \_0 |a Biosensors |v Congresses.  
710 2\_ |a IEEE Engineering in Medicine and Biology Society.



BOOK

PRINT RECORD

SAVE RECORD

EMAIL RECORD

CITE RECORD

MARCXML Record  
MODS Record

Report Record Errors  
Ask a Librarian  
Feedback

Request this Item

LC Find It

Item Availability

### Item Availability

CALL NUMBER R856.A2 I344 2007  
Copy 2

Request in Jefferson or Adams Building Reading Rooms

Status Not Charged

CALL NUMBER R856.A2 I344 2007  
Copy 1  
30th (2008)- cataloged as a serial in LC

Request in Jefferson or Adams Building Reading Rooms

Status Not Charged



[Subscribe \(Patron Services\)](#) [Ask a Librarian](#) [Feedback](#) [Search/Browse Help](#)

[Speech Enabled](#) [Accessibility](#) [Legal](#) [Inspector General](#) [External Link Disclaimer](#) [USA.gov](#) 

## **APPENDIX COMTOIS10**

# A Comparative Evaluation of Adaptive Noise Cancellation Algorithms for Minimizing Motion Artifacts in a Forehead-Mounted Wearable Pulse Oximeter

Gary Comtois, *Member IEEE*, Yitzhak Mendelson, *Member IEEE*, Piyush Ramuka

**Abstract**— Wearable physiological monitoring using a pulse oximeter would enable field medics to monitor multiple injuries simultaneously, thereby prioritizing medical intervention when resources are limited. However, a primary factor limiting the accuracy of pulse oximetry is poor signal-to-noise ratio since photoplethysmographic (PPG) signals, from which arterial oxygen saturation (SpO<sub>2</sub>) and heart rate (HR) measurements are derived, are compromised by movement artifacts. This study was undertaken to quantify SpO<sub>2</sub> and HR errors induced by certain motion artifacts utilizing accelerometry-based adaptive noise cancellation (ANC). Since the fingers are generally more vulnerable to motion artifacts, measurements were performed using a custom forehead-mounted wearable pulse oximeter developed for real-time remote physiological monitoring and triage applications. This study revealed that processing motion-corrupted PPG signals by least mean squares (LMS) and recursive least squares (RLS) algorithms can be effective to reduce SpO<sub>2</sub> and HR errors during jogging, but the degree of improvement depends on filter order. Although both algorithms produced similar improvements, implementing the adaptive LMS algorithm is advantageous since it requires significantly less operations.

## I. INTRODUCTION

THE implementation of wearable diagnostic devices would enable real-time remote physiological assessment and triage of military combatants, firefighters, miners, mountaineers, and other individuals operating in dangerous and high-risk environments. This, in turn, would allow first responders and front-line medics working under stressful conditions to better prioritize medical intervention when resources are limited, thereby extending more effective care to casualties with the most urgent needs.

Employing commercial off-the-shelf (COTS) solutions, for example finger pulse oximeters to monitor arterial blood oxygen saturation (SpO<sub>2</sub>) and heart rate (HR), or adhesive-type disposable electrodes for ECG monitoring, are

impractical for field applications because they limit mobility and can interfere with regular activity. Equally important, since these devices are designed for clinical settings where patient movements are relatively constrained, motion artifacts during field applications can drastically affect measurement accuracy while subjects remain active.

Practically, the primary factor limiting the reliability of pulse oximetry is attributed to poor signal-to-noise ratio (SNR) due to motion artifacts. Since photoplethysmographic (PPG) signals, which are used to determine SpO<sub>2</sub> and HR, are obscured during movements, the implementation of a robust pulse oximeter for field applications requires sophisticated noise rejection algorithms to eliminate erroneous readings and prevent false alarms.

To minimize the effects of motion artifacts in wearable pulse oximeters, several groups proposed various algorithms to accomplish adaptive noise cancellation (ANC) utilizing a noise reference signal obtained from an accelerometer (ACC) that is incorporated into the sensor to represent body movements [1]-[3]. These groups demonstrated promising feasibility for movement artifact rejection in PPG signals acquired from the finger. However, they did not present quantifiable data showing whether accelerometry-based ANC resulted in more accurate determination of SpO<sub>2</sub> and HR derived from PPG signals acquired from more motion-tolerant body locations that are more suitable for mobile applications.

## II. BACKGROUND

Generally, linear filtering with a fixed cut-off frequency is not effective in removing in-band noise with spectral overlap and temporal similarity that is common between the signal and artifact. Thus, we utilized ANC techniques to filter noisy PPG waveforms acquired during field experiments. The performance of this signal processing approach was evaluated based on its potential to lower SpO<sub>2</sub> and HR measurement errors.

Among the most popular ANC algorithms are the least mean squares (LMS) and recursive least squares (RLS) algorithms. Briefly, to attenuate the in-band noise component in the desired signal, these algorithms assume that the reference noise received from the ACC is statistically correlated with the additive noise component in the corrupted PPG signal, whereas the additive noise is uncorrelated with the noise-free PPG signal. An error signal is used to adjust continuously the filter's tap-weights in order to minimize the SNR of the noise-corrected PPG signal.

Manuscript received April 2, 2007. This work is supported by the U.S. Army MRMC under Contract DAMD17-03-2-0006. The views, opinions and/or findings are those of the author and should not be construed as an official Department of the Army position, policy or decision unless so designated by other documentation.

Y. Mendelson is a Professor in the Department of Biomedical Engineering, Worcester Polytechnic Institute, Worcester, MA 01609 USA (phone: 508-831-5103; fax: 508-831-5541; email: ym@wpi.edu).

G. Comtois is a graduate student in the Department of Biomedical Engineering, Worcester Polytechnic Institute, Worcester, MA 01609 USA (comtoisg@wpi.edu).

P. Ramuka is a graduate student in the Department of Biomedical Engineering, Worcester Polytechnic Institute, Worcester, MA 01609 USA (pramuka@wpi.edu).

The performance of ANC algorithms is highly dependent on various filter parameters, including filter order ( $M$ ). Accordingly, careful consideration must be given to the selection of these parameters and the trade-off between algorithm complexity and its computation time.

Although the basic principles of the LMS and RLS techniques share certain similarities, the LMS algorithm attempts to minimize only the current error value, whereas in the RLS algorithm, the error considered is the total error from the beginning to the current data point. Furthermore, the performance of each algorithm depends on different parameters. For example, the step size ( $\mu$ ) has a profound effect on the convergence behavior of the LMS algorithm. Similarly, the forgetting factor ( $\lambda$ ) determines how the RLS algorithm treats past data inputs.

Compared to the LMS algorithm, the RLS algorithm has generally a faster convergence rate and smaller error. However, this advantage comes at the expense of increasing complexity and longer computational time which increases rapidly and non-linearly with filter order.

### III. METHODS

To simulate movement artifacts, we performed a series of outdoor and indoor experiments that were intended to determine the effectiveness of using the accelerometer-based ANC algorithms in processing motion-corrupted PPG signals acquired by a forehead pulse oximeter. The focus of this study was to compare the performance of each algorithm by quantifying the improvement in SpO<sub>2</sub> and HR accuracy generated during typical activities that are expected to induce considerable motion artifacts in the field.

Data were collected by a custom forehead-mounted pulse oximeter developed in our laboratory as a platform for real-time remote physiological monitoring and triage applications [4]-[6]. The prototype wearable system is comprised of three units: A battery-operated optical Sensor Module (SM) mounted on the forehead, a belt-mounted Receiver Module (RM) mounted on the subject's waist, and a Personal Digital Assistant (PDA) carried by a remote observer. The red (R) and infrared (IR) PPG signals acquired by the small ( $\phi = 22\text{mm}$ ) and lightweight (4.5g) SM are transmitted wirelessly via an RF link to the RM. The data processed by the RM can be transmitted wirelessly over a short range to the PDA or a PC, giving the observer the capability to periodically or continuously monitor the medical condition of multiple subjects. The system can be programmed to alert on alarm conditions, such as sudden trauma, or when physiological values are out of their normal range. Dedicated software was used to filter the reflected PPG signals and compute SpO<sub>2</sub> and HR based on the relative amplitude and frequency content of the PPG signals. A triaxial MEMS-type ACC embedded within the SM was used to get a quantitative measure of physical activity. The information obtained through the tilt sensing property of the ACC is also used to determine body posture. Posture and acceleration, combined with physiological measurements, are valuable indicators to assess the status of an injured person in the field.

Body accelerations and PPG data were collected concurrently from 7 healthy volunteers during 32 jogging experiments. These jogging experiments comprised 12 treadmill, 12 indoor, and 4 outdoor exercises. Each experiment comprised a 1-minute free jogging at speeds corresponding to 3.75–6.5 mph, framed by 2-minute resting intervals. For validation, reference SpO<sub>2</sub> and HR were acquired concurrently from the Masimo transmission pulse oximeter sensor attached to the subject's fingertip which was kept in a relatively stationary position throughout the study. We chose the Masimo pulse oximeter because it employs unique signal extraction technology (SET<sup>®</sup>) designed to greatly extend its utility into high motion environments. A Polar<sup>™</sup> ECG monitor, attached across the subject's chest, provided reference HR data.

The ACC provided reference noise inputs to the ANC algorithms. The X, Y, and Z axes of the triaxial ACC were oriented according to the anatomical planes as illustrated in Fig. 1. Accelerations generated during movement depend upon the types of activity performed. Generally, during jogging, acceleration is greatest in the vertical direction, although the accelerations in the other two orthogonal directions are not negligible. Therefore, the noise reference input applied to the ANC algorithms was obtained by summing all three orthogonal axes of the ACC. By combining signals from all three axes, measurements become insensitive to sensor positioning and inadvertent sensor misalignment that may occur during movements. To compensate for differences in response times, the SpO<sub>2</sub> and HR measurements acquired from each device were processed using an 8-second weighted moving average.

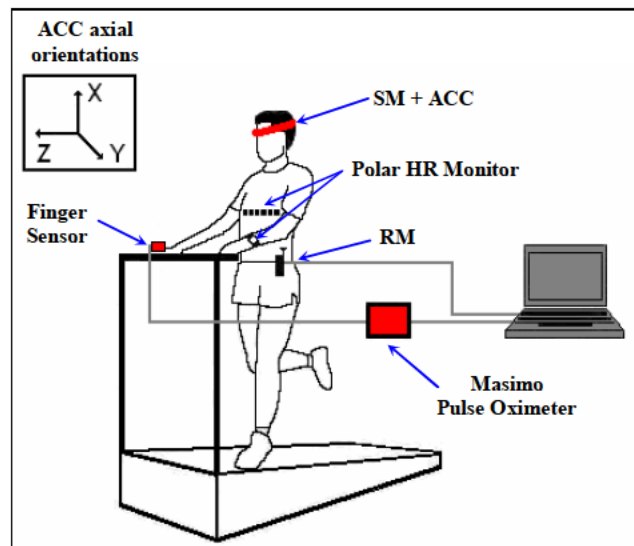


Fig. 1: Experimental setup for data collection.

The outputs of the MEMS ACC and raw PPG signals were acquired in real-time at a rate of 80 s/s using a custom written LabVIEW<sup>®</sup> program. Data were processed off-line using Matlab programming. The ANC algorithms were implemented in Matlab with parameters optimized for computational speed and measurement accuracy. The LMS algorithm was implemented using a constant  $\mu$  of 0.016. The



selected filter parameters for the RLS algorithm were  $\lambda = 0.99$  and an inverse correlation matrix  $P = 0.1$ . These filter parameters were found to be optimal in preliminary experiments. For comparison, data were processed by each algorithm using variable order filters.

#### IV. RESULTS

SpO<sub>2</sub> and HR data were derived from the R and IR PPG signals utilizing custom extraction algorithms. SpO<sub>2</sub> root mean squared errors (RMSE) were quantified based on the differences between the readings measured by the custom and Masimo pulse oximeters, whereas HR errors were defined with respect to the Polar HR monitor. For comparison, RMSE were determined by processing the PPG signals off-line either with or without the ANC algorithms.

Fig. 2 shows a representative tracing of SpO<sub>2</sub> and HR measurements obtained from the custom pulse oximeter with and without ANC. Reference measurements obtained simultaneously from the Masimo pulse oximeter and Polar HR monitor during resting and outdoor jogging were also included for comparison.

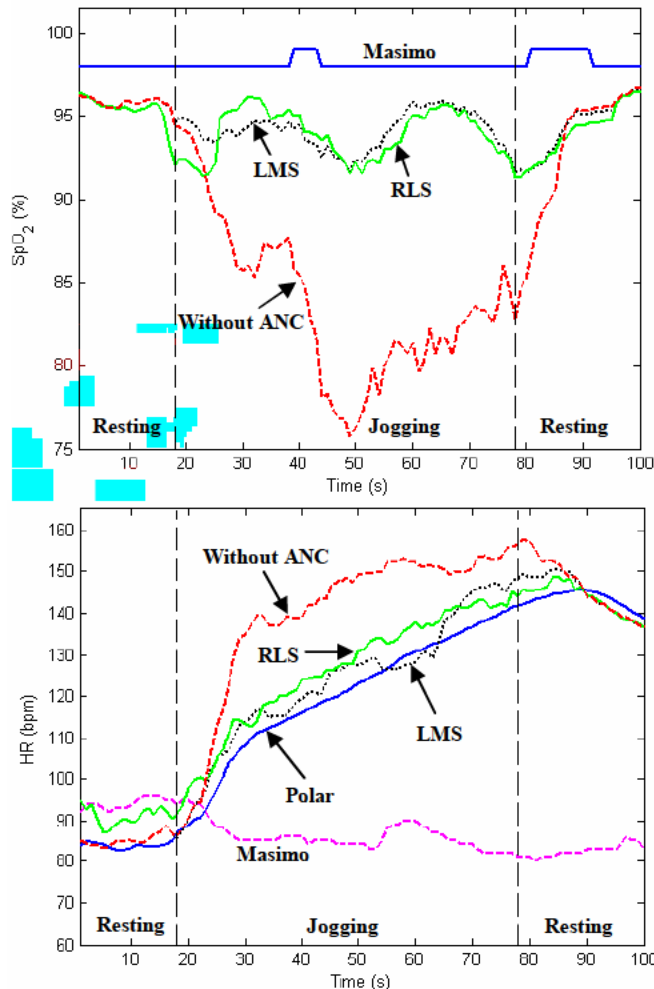


Fig. 2. Representative SpO<sub>2</sub> (top) and HR (bottom) measurements obtained during outdoor jogging. Filter order  $M = 16$ .

Spectral analysis of the data using FFT revealed that during jogging frequency components associated with body acceleration and the subject's HR shared a relatively small

frequency band ranging between 1.5–3.0 Hz. Further analysis of the data showed that in 8 out of the 32 jogging experiments (25%), the cardiac-synchronized frequencies and movement-induced acceleration frequencies shared a common band.

The averaged errors observed from the series of 32 experiments are summarized in Figures 3 and 4. Analysis of the data clearly revealed that utilizing either the LMS or RLS algorithm to process the noise-corrupted PPG signals can improve both SpO<sub>2</sub> and HR accuracy during jogging. Although the degree of improvement varied, because different methods are employed to compute SpO<sub>2</sub> and HR from the PPG signal, these figures show that the performance of both algorithms depends on filter order used to implement each algorithm.

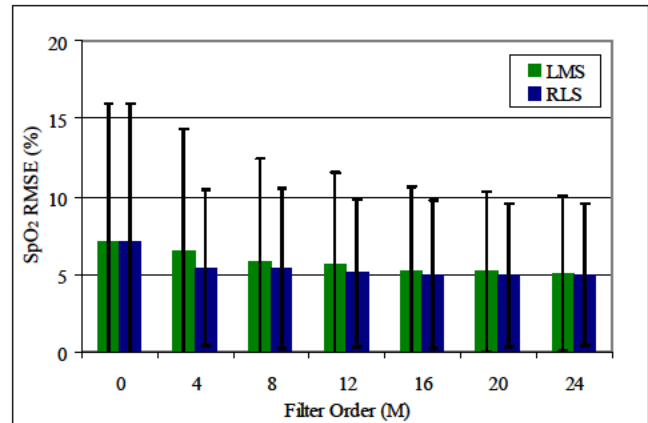


Fig. 3. Averaged SpO<sub>2</sub> errors for varying filter orders. Error bars indicate  $\pm 1SD$ . For comparison,  $M = 0$  represents the error obtained without ANC.

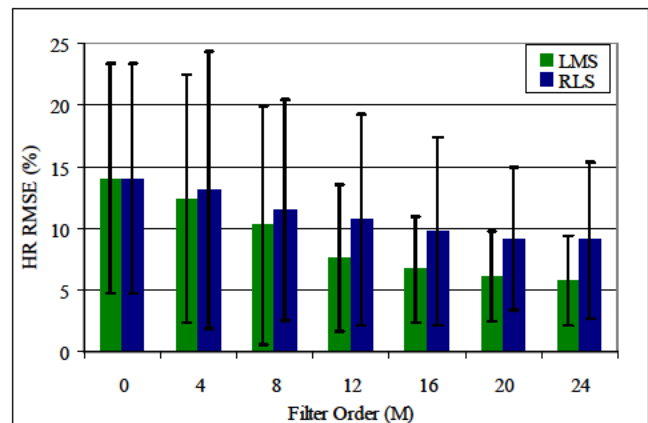


Fig. 4. Averaged HR errors for varying filter orders. Error bars indicate  $\pm 1SD$ . For comparison,  $M = 0$  represents the error obtained without ANC.

#### V. DISCUSSION

Pulse oximeters are used routinely in many clinical settings where patients are at rest. Their usage in other areas is limited because of motion artifacts which is the primary contributor to errors and high rates of false alarms. In order to design wearable cost-effective devices that are suitable for field deployment, it is important to ensure that the device is robust against motion induced disturbances. PPG signals recorded from the forehead are generally less prone to movement artifacts compared to PPG signals recorded from

a finger. Nonetheless, morphological distortions of the underlying PPG waveforms, from which SpO<sub>2</sub> and HR measurements are derived, could lead to measurement errors, false alarms, and frequent dropouts when subjects remain active. For example, as shown in Fig. 2, it is evident that the Masimo pulse oximeter, which employs advanced signal extraction technology designed to greatly extend its utility into high motion environments, was clearly unable to accurately track SpO<sub>2</sub> and HR while the subject was jogging. Although to a lesser extent, we also noticed more pronounced fluctuations in SpO<sub>2</sub> recorded by the wearable forehead pulse oximeter during jogging. These fluctuations are likely caused by PPG waveforms obscured by motion artifacts associated with heavier breathing.

To address the need to improve the performance of a prototype reflectance pulse oximeter during jogging, we investigated the effectiveness of a MEMS ACC as a noise reference input to two popular ANC algorithms. We chose the LMS and RLS adaptive routines since other investigators showed the promising utility of these algorithms to reduce errors attributed to motion artifacts in pulse oximeters [1]-[3].

Analysis of the data acquired during jogging experiments showed that ANC implemented using the LMS and RLS algorithms can help to improve considerably the accuracy of a pulse oximeter, as shown in Fig. 2. However, although the differences are not considered clinically significant, we found that processing the corrupted PPG signals by each algorithm produced slightly different improvements. These differences are anticipated since different computational principles are employed by a pulse oximeter.

Since ANC-based filtering implements an adaptive notch filter with a notch frequency corresponding to the dominant frequency of the measured ACC signal, we expected that an overlap of the HR and movement-induced ACC frequencies would attenuate the fundamental cardiac-synchronized frequency of the PPG signals and, therefore significantly affecting SpO<sub>2</sub> and HR measurements. However, separate analysis of the data from experiments where body accelerations and cardiac rhythms were found to be synchronized confirmed that applying either the LMS or RLS algorithm did not adversely impact the ability to obtain accurate SpO<sub>2</sub> and HR readings while subjects remain active.

As shown in Fig. 3 and Fig. 4, we found that the degree of improvement depends on the filter order (M) used to implement each adaptive algorithm, however filters order greater than 24 produced diminished improvements. Furthermore, we also found that the LMS algorithm was slightly more effective in reducing HR errors compared to the RLS implementation.

Given similar performances, it is important to take into consideration the complexity of the LMS and RLS algorithms and the trade-off between algorithmic complexity and computation time. These principal tradeoffs are important since our goal is to implement ANC to improve the performance of a wearable pulse oximeter during motion. For example, compared to the LMS algorithm, the RLS algorithm has a faster convergence rate which is

essential in real-time applications. However, this comes at the expense of a longer computational time since the RLS algorithm requires M<sup>2</sup> operations per iteration. Considering for example that an implementation based on a 24<sup>th</sup>-order filter would provide an acceptable error reduction, this implies that the LMS algorithm would require only 24 operations compared to 576 operations that will be required to implement an adaptive RLS algorithm. Table 1 summarizes the relative execution times of the LMS and RLS adaptive algorithms for processing one data point.

Table 1. Execution times for LMS and RLS algorithms

Filter Order	LMS (ms)	RLS (ms)
2	1.0	6.5
4	1.8	18.5
8	3.2	63.0
16	6.2	235.0

## VI. CONCLUSIONS

This study was designed to investigate the performance of accelerometry-based ANC implemented using the LMS and RLS algorithms as an effective method to minimizing both SpO<sub>2</sub> and HR errors induced during movement. Measurements were performed using a custom, forehead-mounted wearable pulse oximeter that was developed in our laboratory to serve as a platform for real-time remote physiological monitoring and triage applications. The results obtained in this study revealed that processing motion-corrupted PPG signals by the LMS and RLS algorithm can reduce HR and SpO<sub>2</sub> errors during jogging. Although both algorithms produced similar improvements, the implementation of the adaptive LMS algorithm is preferred since it requires significantly less operations.

## REFERENCES

- [1] J. Y. A. Foo, S. J. Wilson, "A computational system to optimize noise rejection in photoplethysmography signals during motion or poor perfusion states," *Med. Biol. Eng. Comput.*, 2006, pp. 140-145.
- [2] L. B. Wood, H. H. Asada, "Noise cancellation model validation for reduced motion artifact wearable PPG sensors using MEMS accelerometers," in *Proc. 28<sup>th</sup> IEEE/EMBS Ann. Int. Conf.*, New York, 2006, pp. 3525-3528.
- [3] A.R. Relente, L.G. Sison, Characterization and adaptive filtering of motion artifacts in pulse oximetry using accelerometers, *Proc. 2<sup>nd</sup> Joint EMBS/BMES Conf.*, Houston, TX, 2002, 1769-1770.
- [4] Y. Mendelson and V. Floroff, A PDA based *ad-hoc* mobile wireless pulse oximeter, in *Proc. IASTED International Conference Telehealth 2005*, Banff, Canada, 2005, pp. 1-6.
- [5] Y. Mendelson, R. J. Duckworth, G. Comtois, "A wearable reflectance pulse oximeter for remote physiological monitoring," in *Proc. 28<sup>th</sup> IEEE EMBS Annual International Conf.*, New York, 2006, pp. 912-915.
- [6] G. Comtois, Y. Mendelson, "A noise reference input to an adaptive filter algorithm for signal processing in a wearable pulse oximeter," in *Proc. 33<sup>rd</sup> Annual Northeast Bioengineering Conf.*, New York, 2007, pp. 106-107.

## **APPENDIX MENDELSON02**



Enhanced online resources and other COVID-19 updates »



# LIBRARY CATALOG

MENU

[Sign in](#) | [Selected Items \(0\)](#) | [Search History](#) | [Search Tips](#) | [Borrow Direct](#) | [Interlibrary Loan](#)

All Fields



[ADVANCED SEARCH](#) | [ASK A LIBRARIAN](#) | [MY ACCOUNT](#)

Chat with Us

[Back to item](#)

## Librarian View

```
LEADER 02149cam a22004574a 4500
001 9874630
005 20180515124517.0
006 m o d
007 cr n
008 071226s2006 nyua ob 101 0 eng d
020 :a 1424400325
035 :a (WaSeSS)OCM1ssj0000394402
035 :a (OCoLC)275723396
035 :a 9874630
040 :a DLC :c DLC :d DLC :d WaSeSS
050 0 0 :a R856.A2 :b I344 2006
110 2 :a IEEE Engineering in Medicine and Biology Society. :b Annual Conference :n (28th : :d 2006 : :c New
York, N.Y.)
245 1 0 :a 2006 28th Annual International Conference of the IEEE Engineering in Medicine and Biology Society : :b
New York, NY, 30 August - 3 September 2006.
260 :a [New York?] : :b IEEE ; :a Piscataway, NJ : :b IEEE Service Center [distributor], :c c2006.
300 :a 1 online resource.
336 :a text :2 rdacontent
337 :a computer :2 rdamedia
338 :a online resource :2 rdacarrier
504 :a Includes bibliographical references and author index.
506 :a License restrictions may limit access.
650 0 :a Biomedical engineering :v Congresses.
650 0 :a Biomedical materials :v Congresses.
650 0 :a Biosensors :v Congresses.
650 7 :a Biomedical engineering. :2 fast #0 (OCoLC)fst00832568
650 7 :a Biomedical materials. :2 fast #0 (OCoLC)fst00832586
650 7 :a Biosensors. :2 fast #0 (OCoLC)fst00832703
655 7 :a Conference papers and proceedings. :2 fast #0 (OCoLC)fst01423772
710 2 :a Institute of Electrical and Electronics Engineers.
856 4 0 :3 Full text available from IEEE/IET Electronic Library (IEL) :i ssid=ssj0000394402; dbcode=RIE;
providercode=PRVIEE :u http://proxy.library.cornell.edu/login?
url=https://ieeexplore.ieee.org/servlet/opac?punumber=4028925 :z Connect to text.
899 2 :a PRVIEE_RIE
948 2 :a 20180515 :b m :d batch :e lts
948 3 :a 20180515 :h SerialSolutions :i COO_360MARC_Update_20180514_monographs_changed.mrc.uc
948 0 :a 20170411 :b i :d batch :e lts
948 1 :a 20170411 :b s :d batch :e lts :f ebk
948 3 :a 20170411 :h SerialSolutions :i COO_360MARC_Update_20170410_monographs_new.mrc.uc
948 2 :a 20170703 :b m :d batch :e lts :x WorldShare
```

### CONTACT US

[? Ask a Librarian](#)

[Feedback](#)

[Release Notes](#)

### RESOURCES

[Library Website](#) | [Search](#) | [Catalog](#) | [Articles & Full Text](#) | [Databases](#) | [E-journal Titles](#) | [Images](#)

## **APPENDIX MENDELSON03**

Welcome back! Our libraries are open with [limited hours](#), [new safety guidelines](#) and [updated services](#) including [curbside pickup](#). Please visit our [Remote Resources page](#) and our [COVID-19 page](#) for more information.



Catalog

Bookmarks 0 Course Reserves My Account

Keyword Search...

Search

Advanced search Start Over

Bookmark Share

## MARC View

LEADER 02022nas a22004451a 4500  
001 1382884  
003 SIRSI  
005 20151215010416.0  
008 830808 19739999xx bu 0 0eng d  
010 a| 73643617  
019 a| MARS  
022 0 a| 0090-6689  
032 a| 709820 b| USPS  
035 a| LIAS1405187  
035 a| (OCoLC)1786771  
040 a| PSt c| PSt d| WaOLN d| UtOrBLW  
050 0 0 a| R856.A1 b| A85  
245 0 0 a| Medical instrumentation.  
264 1 a| Arlington, Va. : b| AAMI, c| [1973]-1988.  
300 a| 16 volumes : b| illustrations ; c| 29 cm  
336 a| text b| txt 2| rdacontent  
337 a| unmediated b| n 2| rdamedia  
338 a| volume b| nc 2| rdacarrier  
362 0 a| Vol. 7, no. 1 (Jan./Feb. 1973)-v. 22, no. 6 (Dec. 1988).  
550 a| "Journal of the Association for the Advancement of Medical Instrumentation".  
650 0 a| Medical instruments and apparatus v| Periodicals.  
650 0 a| Biomedical engineering v| Periodicals.  
650 0 a| Prosthesis v| Periodicals.  
710 2 a| Association for the Advancement of Medical Instrumentation.  
780 0 0 t| JAAMI: journal of the Association for the Advancement of Medical Instrumentation.  
780 0 5 t| Clinical engineering. g| 1981-  
785 0 7 t| Biomedical technology today.  
785 0 7 t| Biomedical instrumentation & technology.  
936 1 a| Vol. 17, no. 1 (Jan./Feb. 1983).  
949 a| R856.A1A85 v.17 1983 w| LCPER c| 1 i| 000073945314 || HATHIETAS m| UP-ANNEX r| Y s| Y t| ONLINE u| 10/10/2012 z| 8263  
949 a| R856.A1A85 v.18 1984 w| LCPER c| 1 i| 000073946120 || HATHIETAS m| UP-ANNEX r| Y s| Y t| ONLINE u| 10/10/2012 z| 8263  
949 a| R856.A1A85 v.19 1985 w| LCPER c| 1 i| 000073946205 || HATHIETAS m| UP-ANNEX r| Y s| Y t| ONLINE u| 10/10/2012 z| 8263  
949 a| R856.A1A85 v.20 1986 w| LCPER c| 1 i| 000073946199 || HATHIETAS m| UP-ANNEX r| Y s| Y t| ONLINE u| 10/10/2012 z| 8263  
949 a| R856.A1A85 v.21 1987 w| LCPER c| 1 i| 000073946182 || HATHIETAS m| UP-ANNEX r| Y s| Y t| ONLINE u| 10/10/2012 z| 8263  
949 a| R856.A1A85 v.22 1988 w| LCPER c| 1 i| 000073946175 || HATHIETAS m| UP-ANNEX r| Y s| Y t| ONLINE u| 10/10/2012 z| 8263  
852 0 1 a| PSt b| UP-ANNEX c| CATO-2 h| R856.A1 i| A85  
866 0 8 | 0 a| v.17(1983)-v.22(1988)



Copyright ©2019 The Pennsylvania State University. All rights reserved. Except where otherwise noted, this work is subject to a [Creative Commons Attribution 4.0 license](#). Details and exceptions.

[Legal Statements](#) | [PSU Hotlines](#)

### PENN STATE UNIVERSITY LIBRARIES

[Libraries Home](#) (814) 865-6368  
[Libraries Intranet \(Staff Only\)](#)  
[Accessibility Help](#)  
[Website Feedback](#)  
[Policies and Guidelines](#)  
[Staff Directory](#)

### CONNECT WITH PENN STATE UNIVERSITY LIBRARIES

[Facebook](#)  
[Twitter](#)  
[Instagram](#)

## **APPENDIX MENDELSON04**

Library Home Catalog Search

Ask Us My Account Off-campus Sign-in

As a precaution, materials may be delayed or temporarily unavailable due to quarantine restrictions. Thank you for your patience.

Catalog home Regular display Return to browsing Limit/Sort Another search

```
LEADER 00000cas a22006731 44500
001 42209756
003 OCoLC
005 20160418025040.0
006 m o d
007 cr |||||||||||
008 990823d19851997ne br p o 0 0eng c
010 2007233979
019 253607660
022 2214-7330|10748-1977|2j
030 JCMOEH
035 (OCoLC)42209756|z(OCoLC)253607660
037 |bKluwer Academic Publishers, Spuiboulevard 50, P.O. Box
17, 3300 AA Dordrecht, The Netherlands
040 F#A|beng|cF#A|dOCLCQ|dGUA|dTXA|dLGG|dOCLCQ|dOCLCF|dIUL
|dOCLCQ|erda
042 pcc
049 OHLA
050 14 R857.P36|bI588
090 R857.P36|bI68
130 0 Journal of clinical monitoring (Online)
222 0 Journal of clinical monitoring|b(Online)
245 10 Journal of clinical monitoring
246 3 J Clin Monit
260 |31985-1990 :|a[Boston, MA] :|b[Little, Brown and Co.],
|c[1985]-@1997
260 |31996-1997 :|a[Hingham, MA] ;|a[Dordrecht] :|bKluwer
Academic Publishers
310 Bimonthly,|b1994-1997
321 Quarterly,|b1985-1993
336 text|btxt|2rdacontent
337 computer|bc|2rdamedia
338 online resource|bcr|2rdacarrier
362 1 Began with: Vol. 1, no. 1 (Jan. 1985); ceased with: vol.
13, no. 6 (Nov. 1997)
506 Available to OhioLINK libraries
538 Mode of access: world wide web
550 Official journal of: Society for Technology in Anesthesia,
-Nov. 1997
588 Description based on: Vol. 1, no. 1 (Jan. 1985); title
from PDF article running title (SpringerLink, viewed May 7,
2012)
588 Final issue consulted: Vol. 13, no. 6 (Nov. 1997)
(SpringerLink, viewed Dec. 17, 2007)
650 0 Medical care|vPeriodicals
650 0 Patient monitoring|vPeriodicals
650 2 Monitoring, Physiologic
650 7 Medical care.|2fast|0(OCoLC)fst01013753
650 7 Patient monitoring.|2fast|0(OCoLC)fst01055018
655 2 Periodicals
655 7 Periodicals.|2fast|0(OCoLC)fst01411641
710 2 Ohio Library and Information Network
710 2 Society for Technology in Anesthesia
776 08 |iPrint version:|tJournal of clinical monitoring|x0748-
1977|w(DLC)sn 84006424|w(OCoLC)10897663
785 17 |tInternational journal of clinical monitoring and
computing (Online)|x2214-7314|w(OCoLC)42209706
785 17 |tJournal of clinical monitoring and computing (Online)
|x1573-2614|w(DLC) 2007233984|w(OCoLC)41569988
799 Kluwer
856 40 |uhttp://rave.ohiolink.edu/ejournals/issn/07481977/
|zConnect to resource (OhioLINK EJC)|3v.1(1985)-v.13(1997)
910 |oad OhioLINK EJC201605additional
910 MARS
910 &gac001114 sg100302 osupfw|aMARS
993 Vendor record
995 Material type update s => v 161031 mh
```

Location

Web E-Journals

Lib. Has

v.1(1985)-v.13(1997)



© The Ohio State University - University Libraries

1858 Neil Avenue Mall | Columbus, Ohio 43210 | 614-292-OSUL (6785)

[Request an alternate format of this page](#) | [Accessibility](#) | [Privacy Policy](#) | [Contact Us](#)



[Copyright Information](#) | [Details and Exceptions](#)

## **APPENDIX MENDELSON05**



COVID-19 updates and more information about using the Libraries while you're remote.

PennState University Libraries | Catalog | Bookmarks | Course Reserves | My Account

Keyword Search... Search | Advanced search | Start Over

Bookmark | Share

## MARC View

LEADER 01580nam a22003014a 4500  
001 20027320  
003 SIRSI  
005 20170314130250.0  
006 m d  
007 cr n  
008 071226s2006 nyua sb 101 0 eng d  
010 a| 2007282734  
020 a| 1424400325  
040 a| DLC c| DLC d| DLC d| WaSeSS  
050 0 0 a| R856 A2 b| I344 2006  
110 2 a| IEEE Engineering in Medicine and Biology Society. b| Annual Conference n| (28th : d| 2006 : c| New York, N.Y.)  
245 1 0 a| 2006 28th Annual International Conference of the IEEE Engineering in Medicine and Biology Society h| [electronic resource] : b| New York, NY, 30 August - 3 September 2006.  
260 a| [New York?] : b| IEEE ; a| Piscataway, NJ : b| IEEE Service Center [distributor], c| c2006.  
300 a| 15 v. (lxxxvii, 6468, 47 p.) : b| ill. : c| 28 cm.  
504 a| Includes bibliographical references and author index.  
506 a| License restrictions may limit access.  
650 0 a| Biomedical engineering v| Congresses.  
650 0 a| Biomedical materials v| Congresses.  
650 0 a| Biosensors v| Congresses.  
655 0 a| Electronic books.  
710 2 a| Institute of Electrical and Electronics Engineers.  
856 4 0 u| http://5K8E54MC2L.search.serialssolutions.com/?sid=sersol&SS\_jc=TC0000394402&title=2006%2028th%20Annual%20International%20Conference%20of%20the%20IEEE%20Engineering%20in%20Medicine%20and%20Biology%20Society%203A%20New%20York%2C%20NY%2C%2030%20August%20%203%20September%202006  
949 a| Electronic resource w| ASIS c| 1 | 20027320-1001 | | ONLINE m| ONLINE r| Y s| Y t| ONLINE u| 3/21/2017 o| \_STAFF. 360 MARC

PennState Copyright ©2019 The Pennsylvania State University. All rights reserved. Except where otherwise noted, this work is subject to a Creative Commons Attribution 4.0 International license.


Legal/Disclaimer | Privacy Policy

**PENNSYLVANIA STATE UNIVERSITY LIBRARIES**  
Library Home | Contact Us | Staff | 814-863-4444  
Open | Accessibility Help | Website Feedback | Training and Courses | Staff Directory

**CONNECT WITH PENNSYLVANIA STATE UNIVERSITY LIBRARIES**  
Facebook | Twitter | Instagram



## **APPENDIX MENDELSON06**

 Covid 19 updates and more information about using the Libraries while you're remote.



Catalog

Bookmarks  Course Reserves My Account

Keyword  Search...

 Search

[Advanced search](#) [Start Over](#)

[← Previous](#) | 15 of 105 | [Next →](#)

[Bookmark](#) [Share](#)



## 2006 28th Annual International Conference of the IEEE Engineering in Medicine and Biology Society [electronic resource] : New York, NY, 30 August - 3 September 2006



**Corporate Author:** [IEEE Engineering in Medicine and Biology Society. Annual Conference \(28th : 2006 : New York, N.Y.\)](#)

**Published:** [\[New York?\] : IEEE ; Piscataway, NJ : IEEE Service Center \[distributor\], c2006.](#)

**Physical Description:** 15 v. (lxxxvii, 6468, 47 p.) : ill. ; 28 cm.

**Additional Creators:** [Institute of Electrical and Electronics Engineers](#)

**Access Online:** [serialssolutions.com](#)

### Restrictions on Access:

License restrictions may limit access.

### Subject(s):

[Biomedical engineering—Congresses](#)  
[Biomedical materials—Congresses](#)  
[Biosensors—Congresses](#)

### Genre(s):

[Electronic books](#)

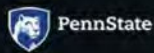
### ISBN:

1424400325

### Bibliography Note:

Includes bibliographical references and author index.

[View MARC record](#) | catkey: 20027320



Copyright ©2019 The Pennsylvania State University. All rights reserved. Except where otherwise noted, this work is subject to a [Creative Commons Attribution 4.0 license](#). Details and exceptions.

[Legal Statements](#) | [PSU Hotlines](#)

### PENN STATE UNIVERSITY LIBRARIES

[Libraries Home](#) (814) 865-6368  
[Libraries Intranet \(Staff Only\)](#)  
[Accessibility Help](#)  
[Website Feedback](#)  
[Policies and Guidelines](#)  
[Staff Directory](#)

### CONNECT WITH PENN STATE UNIVERSITY LIBRARIES

[Facebook](#)  
[Twitter](#)  
[Instagram](#)

## **APPENDIX MENDELSON07**

IEEE.org | IEEE Xplore | IEEE-SA | IEEE Spectrum | More Sites Cart Create Account Personal Sign In

**IEEE Xplore** Browse ▾ My Settings ▾ Help ▾

PENN STATE UNIVERSITY LIBRARIES Access provided by: Penn State University Sign Out

All Q

Search within Publication ADVANCED SEARCH

Browse Conferences > Annual International Conferenc... > 2006 International Conference ... ?

## Annual International Conference of the IEEE Engineering in Medicine and Biology Society (EMBC)

[Copy Persistent Link](#) [Browse Title List](#) [Sign up for Conference Alerts](#)

**Proceedings** All Proceedings Popular

2006 International Conference of the IEEE Engineering in Medicine and Biology Society

DOI: 10.1109/IEMBS10037.2006

30 Aug.-3 Sept. 2006 Volume : ▾

Search within results Q

Download PDFs ▾ | Per Page: 25 ▾ | Export ▾ | Email Selected Results ▾

Showing 251-275 of 1,651

### Refine

Author ▾

Affiliation ▾

Conference Location ▾

### Quick Links

[Search for Upcoming Conferences](#)

[IEEE Publication Recommender](#)

[IEEE Author Center](#)

Select All on Page

Sort By: Sequence ▾

**Modeling the electrode-electrolyte interface for recording and stimulating electrodes** 🔒

John B. Troy; Donald R. Cantrell; Allen Taflove; Rodney S. Ruoff  
Publication Year: 2006 , Page(s): 879 - 881  
Cited by: Papers (3)

▶ Abstract [\(html\)](#)  (134 Kb) 

**In vivo and In vitro Differences in the Charge-injection and Electrochemical Properties of Iridium Oxide Electrodes** 🔒

Stuart F. Cogan  
Publication Year: 2006 , Page(s): 882 - 885  
Cited by: Papers (23)

▶ Abstract [\(html\)](#)  (307 Kb) 

**In Vitro and In Vivo Charge Capacity of AIROF Microelectrodes** 🔒

Z. Hu; P. R. Troyk; T. P. Brawn; D. Margoliash; S. F. Cogan  
Publication Year: 2006 , Page(s): 886 - 889  
Cited by: Papers (15)

▶ Abstract [\(html\)](#)  (405 Kb) 

**Charge Injection Capacity of TiN Electrodes for an Extended Voltage Range** 🔒































Mustafa Patan; Tosha Shah; Mesut Sahin  
Publication Year: 2006 , Page(s): 890 - 892  
Cited by: Papers (5)

▶ Abstract [\(html\)](#)  (201 Kb) 





























**Optimizing Deep Brain Stimulation Parameter Selection with Detailed Models of the Electrode-Tissue Interface** 🔒

Cameron C. McIntyre; Christopher R. Butson; Christopher B. Moks; Angela M. Noecker  
Publication Year: 2006 , Page(s): 893 - 895  
Cited by: Papers (26)

▶ Abstract [\(html\)](#)  (208 Kb) 

- Effects of Nano Red Elemental Selenium on Sodium Currents in Rat Dorsal Root Ganglion Neurons**   
Huijun Yuan; Jiarui Lin; Tonghan Lan  
Publication Year: 2006 , Page(s): 896 - 899  
Cited by: Papers (1)  
[▶ Abstract](#) [\(html\)](#)  (344 Kb) 
- 
- A Non Invasive Wearable Sensor for the Measurement of Brain Temperature**   
A. Dittmar; C. Gehin; G. Delhomme; D. Boivin; G. Dumont; C. Mott  
Publication Year: 2006 , Page(s): 900 - 902  
Cited by: Papers (17) | Patents (13)  
[▶ Abstract](#) [\(html\)](#)  (317 Kb) 
- 
- Acquiring High-Rate Neural Spike Data with Hardware-Constrained Embedded Sensors**   
Shahin Farshchi; Aleksey Pesterev; Wan-Lun Ho; Jack W. Judy  
Publication Year: 2006 , Page(s): 903 - 907  
Cited by: Papers (7) | Patents (1)  
[▶ Abstract](#) [\(html\)](#)  (388 Kb) 
- 
- Wearable, Cuff-less PPG-Based Blood Pressure Monitor with Novel Height Sensor**   
Phillip A. Shaltis; Andrew Reisner; H. Harry Asada  
Publication Year: 2006 , Page(s): 908 - 911  
Cited by: Papers (37) | Patents (4)  
[▶ Abstract](#) [\(html\)](#)  (224 Kb) 
- 
- A Wearable Reflectance Pulse Oximeter for Remote Physiological Monitoring**   
Y. Mendelson; R. J. Duckworth; G. Comtois  
Publication Year: 2006 , Page(s): 912 - 915  
Cited by: Papers (52) | Patents (18)  
[▶ Abstract](#) [\(html\)](#)  (341 Kb) 
- 
- An Application of Capacitive Electrode for Detecting Electrocardiogram of Neonates and Infants**   
Tsuyoshi Kato; Akinori Ueno; Sachiyo Kataoka; Hiroshi Hoshino; Yoji Ishiyama  
Publication Year: 2006 , Page(s): 916 - 919  
Cited by: Papers (26) | Patents (1)  
[▶ Abstract](#) [\(html\)](#)  (243 Kb) 
- 
- Non-Invasive Respiration Rate Estimation Using Ultra-Wideband Distributed Cognitive Radar System**   
Yifan Chen; Erry Gunawan; Kay Soon Low; Yongmin Kim; Cheong Boon Soh; A. Rahim Leyman; Lin Lin Thi  
Publication Year: 2006 , Page(s): 920 - 923  
Cited by: Papers (9)  
[▶ Abstract](#) [\(html\)](#)  (253 Kb) 
- 
- Temporal Tracking of Coronaries in MSCTA by Means of 3D Geometrical Moments**   
S. Laguitton; C. Boldak; A. Bousse; G. Yang; C. Toumoulin  
Publication Year: 2006 , Page(s): 924 - 927  
Cited by: Papers (1)  
[▶ Abstract](#) [\(html\)](#)  (382 Kb) 
- 
- Endocardium and Epicardium Contour Modeling Based on Markov Random Fields and Active Contours**   
Lucilio Cordero-Grande; Pablo Casaseca-de-la-Higuera; Marcos Martin-Fernandez; Carlos Alberola-Lopez  
Publication Year: 2006 , Page(s): 928 - 931  
Cited by: Papers (1)  
[▶ Abstract](#) [\(html\)](#)  (254 Kb) 
- 
- Automated Pericardial Fat Quantification in CT Data**   
Alok N. Bandekar; Morteza Naghavi; Ioannis A. Kakadiaris  
Publication Year: 2006 , Page(s): 932 - 935  
Cited by: Papers (15)  
[▶ Abstract](#) [\(html\)](#)  (448 Kb) 



- Model-Based Image Reconstruction for Dynamic Cardiac Perfusion MRI from Sparse Data** 
  
 Suyash P. Awate; Edward V. R. DiBella; Tolga Tasdizen; Ross T. Whitaker
   
 Publication Year: 2006 , Page(s): 936 - 941
   
 Cited by: Papers (6) | Patents (1)
   
 ▶ Abstract (html)  (764 Kb) 
- 
- Immune Cells Detection of the In Vivo Rejecting Heart in USPIO-Enhanced Magnetic Resonance Imaging** 
  
 Hsun-Hsien Chang; Jose M. F. Moura; Yijun L. Wu; Chien Ho
   
 Publication Year: 2006 , Page(s): 942 - 945
   
 Cited by: Papers (3)
   
 ▶ Abstract (html)  (459 Kb) 
- 
- Analysis of Breathing Air Flow Patterns in Thermal Imaging** 
  
 Jin Fei; Ioannis Pavlidis
   
 Publication Year: 2006 , Page(s): 946 - 952
   
 Cited by: Papers (15) | Patents (30)
   
 ▶ Abstract (html)  (358 Kb) 
- 
- Evaluation of feature-based registration in dynamic infrared imaging for breast cancer diagnosis** 
  
 Valentina Agostini; Silvia Delsanto; Filippo Molinari; Marco Knaflitz
   
 Publication Year: 2006 , Page(s): 953 - 956
   
 Cited by: Papers (6) | Patents (15)
   
 ▶ Abstract (html)  (477 Kb) 
- 
- Segmentation and Landmark Identification in Infrared Images of the Human Body** 
  
 C.L. Herry; M. Frize; R.A. Goubran
   
 Publication Year: 2006 , Page(s): 957 - 960
   
 Cited by: Papers (6)
   
 ▶ Abstract (html)  (481 Kb) 
- 
- Field-warp registration for biomedical high-resolution thermal infrared images** 
  
 Andrea Tangherlini; Arcangelo Merla; Gian Luca Romani
   
 Publication Year: 2006 , Page(s): 961 - 964
   
 Cited by: Papers (6)
   
 ▶ Abstract (html)  (295 Kb) 
- 
- Overlay of thermal and visual medical images using skin detection and image registration** 
  
 Gerald Schaefer; Roger Tait; Shao Ying Zhu
   
 Publication Year: 2006 , Page(s): 965 - 967
   
 Cited by: Papers (11)
   
 ▶ Abstract (html)  (358 Kb) 
- 
- A biomechanical model of the pelvic cavity: first steps** 
  
 C. Rubod; M. Boukerrou; J. Rousseau; R. Viard; M. Brieu; P. Dubois
   
 Publication Year: 2006 , Page(s): 968 - 971
   
 Cited by: Papers (4) | Patents (3)
   
 ▶ Abstract (html)  (324 Kb) 
- 
- A Comparison of Adaptive and Non-Adaptive EEG Source Localization Algorithms Using a Realistic Head Model** 
  
 John P. Russell; Zoltan J. Koles
   
 Publication Year: 2006 , Page(s): 972 - 975
   
 Cited by: Papers (1)
   
 ▶ Abstract (html)  (275 Kb) 
- 
- Removal of ocular artifacts for high resolution EEG studies: a simulation study** 
  
 Laura Astolfi; Febo Cincotti; Donatella Mattia; Fabio Babiloni; Maria Grazia Marciani; Fabrizio De Vico Fallani; Marco Mattiocco; Fumikazu Miwakeichi; Yoko Yamaguchi; Pablo Martinez; Serenella Salinari; Andrea Tocci; Hovagim Bakardjian; Francois Benoit Vialatte; Andrzej Cichocki
   
 Publication Year: 2006 , Page(s): 976 - 979

#### IEEE Personal Account

[CHANGE USERNAME/PASSWORD](#)

#### Purchase Details

[PAYMENT OPTIONS](#)

[VIEW PURCHASED DOCUMENTS](#)

#### Profile Information

[COMMUNICATIONS PREFERENCES](#)

[PROFESSION AND EDUCATION](#)

[TECHNICAL INTERESTS](#)

#### Need Help?

[US & CANADA: +1 800 678 4333](#)

[WORLDWIDE: +1 732 981 0060](#)

[CONTACT & SUPPORT](#)

#### Follow



[About IEEE Xplore](#) | [Contact Us](#) | [Help](#) | [Accessibility](#) | [Terms of Use](#) | [Nondiscrimination Policy](#) | [Sitemap](#) | [Privacy & Opting Out of Cookies](#)  
A not-for-profit organization, IEEE is the world's largest technical professional organization dedicated to advancing technology for the benefit of humanity.

© Copyright 2021 IEEE - All rights reserved. Use of this web site signifies your agreement to the terms and conditions.

# **APPENDIX MENDELSON10**



## A Wearable Reflectance Pulse Oximeter for Remote Physiological Monitoring

Y. Mendelson\*, *Member, IEEE*, R. J. Duckworth, *Member, IEEE*, and G. Comtois, *Student Member, IEEE*

**Abstract**—To save life, casualty care requires that trauma injuries are accurately and expeditiously assessed in the field. This paper describes the initial bench testing of a wireless wearable pulse oximeter developed based on a small forehead mounted sensor. The battery operated device employs a lightweight optical reflectance sensor and incorporates an annular photodetector to reduce power consumption. The system also has short range wireless communication capabilities to transfer arterial oxygen saturation (SpO<sub>2</sub>), heart rate (HR), body acceleration, and posture information to a PDA. It has the potential for use in combat casualty care, such as for remote triage, and by first responders, such as firefighters.

### I. INTRODUCTION

STEADY advances in noninvasive physiological sensing, hardware miniaturization, and wireless communication are leading to the development of new wearable technologies that have broad and important implications for civilian and military applications [1]-[2]. For example, the emerging development of compact, low-power, small-size, light-weight, and unobtrusive wearable devices may facilitate remote noninvasive monitoring of vital signs from soldiers during training exercises and combat. Telemetry of physiological information via a short-range wirelessly-linked personal area network can also be useful for firefighters, hazardous material workers, mountain climbers, or emergency first-responders operating in harsh and hazardous environments. The primary goals of such a wireless mobile platform would be to keep track of an injured person's vital signs, thus readily allowing the telemetry of physiological information to medical providers, and support emergency responders in making critical and often life saving decisions in order to expedite rescue operations. Having wearable physiological monitoring could offer far-forward medics numerous advantages, including the ability to determine a casualty's condition remotely without exposing the first

responders to increased risks, quickly identifying the severity of injuries especially when the injured are greatly dispersed over large geographical terrains and often out-of-site, and continuously tracking the injured condition until they arrive safely at a medical care facility.

Several technical challenges must be overcome to address the unmet demand for long-term continuous physiological monitoring in the field. In order to design more compact sensors and improved wearable instrumentation, perhaps the most critical challenges are to develop more power efficient and low-weight devices. To become effective, these technologies must also be robust, comfortable to wear, and cost-effective. Additionally, before wearable devices can be used effectively in the field, they must become unobtrusive and should not hinder a person's mobility. Employing commercial off-the-shelf (COTS) solutions, for example finger pulse oximeters to monitor blood oxygenation and heart rate, or standard adhesive-type disposable electrodes for ECG monitoring, is not practical for many field applications because they limit mobility and can interfere with normal tasks.

A potentially attractive approach to aid emergency medical teams in remote triage operations is the use of a wearable pulse oximeter to wirelessly transmit heart rate (HR) and arterial oxygen saturation (SpO<sub>2</sub>) to a remote location. Pulse oximetry is a widely accepted method that is used for noninvasive monitoring of SpO<sub>2</sub> and HR. The method is based on spectrophotometric measurements of changes in the optical absorption of deoxyhemoglobin (Hb) and oxyhemoglobin (HbO<sub>2</sub>). Noninvasive spectrophotometric measurements of SpO<sub>2</sub> are performed in the visible (600-700nm) and near-infrared (700-1000nm) spectral regions. Pulse oximetry also relies on the detection of photoplethysmographic (PPG) signals produced by variations in the quantity of arterial blood that is associated with periodic contractions and relaxations of the heart. Measurements can be performed in either transmission or reflection modes. In transmission pulse oximetry, the sensor can be attached across a fingertip, foot, or earlobe. In this configuration, the light emitting diodes (LEDs) and photodetector (PD) in the sensor are placed on opposite sides of a peripheral pulsating vascular bed. Alternatively, in reflection pulse oximetry, the LEDs and PD are both mounted side-by-side on the same planar substrate to enable readings from multiple body locations where transillumination measurements are not feasible. Clinically, forehead reflection pulse oximetry has been used as an alternative approach to conventional transmission-based

Manuscript received April 3, 2006. This work is supported by the U.S. Army Medical Research and Materiel Command under Contract No. DAMD17-03-2-0006. The views, opinions and/or findings are those of the author and should not be construed as an official Department of the Army position, policy, or decision, unless so designated by other documentation.

\*Corresponding author – Y. Mendelson is a Professor in the Department of Biomedical Engineering, Worcester Polytechnic Institute, Worcester, MA 01609 USA (phone: 508-831-5103; fax: 508-831-5541; e-mail: ym@wpi.edu).

R. J. Duckworth is a Professor in the Department of Electrical and Computer Engineering, Worcester Polytechnic Institute, Worcester, MA 01609 USA (rjduck@ece.wpi.edu).

G. Comtois is a M. S. student in the Department of Biomedical Engineering, Worcester Polytechnic Institute, Worcester, MA 01609 USA (comtoisg@wpi.edu).

oximetry when peripheral circulation to the extremities is compromised.

Pulse oximetry was initially intended for in-hospital use on patients undergoing or recovering from surgery. During the past few years, several companies have developed smaller pulse oximeters, some including data transmission via telemetry, to further expand the applications of pulse oximetry. For example, battery-operated pulse oximeters are now attached to patients during emergency transport as they are being moved from a remote location to a hospital, or between hospital wards. Some companies are also offering smaller units with improved electronic filtering of noisy PPG signals.

Several reports described the development of a wireless pulse oximeter that may be suitable for remote physiological monitoring [3]-[4]. Despite the steady progress in miniaturization of pulse oximeters over the years, to date, the most significant limitation is battery longevity and lack of telemetric communication. In this paper, we describe a prototype forehead-based reflectance pulse oximeter suitable for remote triage applications.

## II. SYSTEM ARCHITECTURE

The prototype system, depicted in Fig. 1, consists of a body-worn pulse oximeter that receives and processes the PPG signals measured by a small ( $\phi = 22\text{mm}$ ) and lightweight (4.5g) optical reflectance transducer. The system

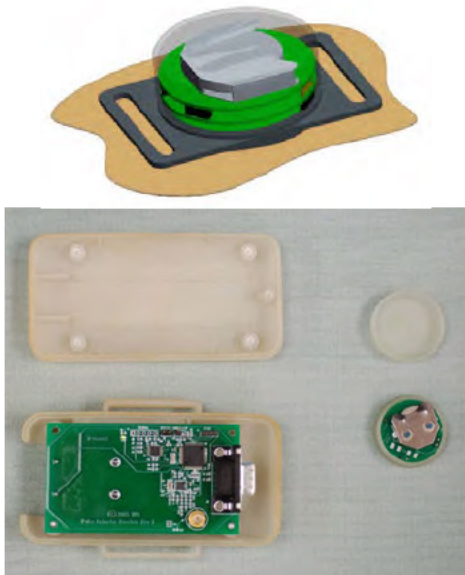


Fig. 1. (Top) Attachment of Sensor Module to the skin; (Bottom) photograph of the Receiver Module (left) and Sensor Module (right).

consists of three units: A Sensor Module, consisting of the optical transducer, a stack of round PCBs, and a coin-cell battery. The information acquired by the Sensor Module is transmitted wirelessly via an RF link over a short range to a body-worn Receiver Module. The data processed by the Receiver Module can be transmitted wirelessly to a PDA. The PDA can monitor multiple wearable pulse oximeters simultaneously and allows medics to collect vital physiological information to enhance their ability to extend more effective care to those with the most urgent needs. The

system can be programmed to alert on alarm conditions, such as sudden trauma, or physiological values out of their normal range. It also has the potential for use in combat casualty care, such as for remote triage, and for use by first responders, such as firefighters.

Key features of this system are small-size, robustness, and low-power consumption, which are essential attributes of wearable physiological devices, especially for military applications. The system block diagram (Fig. 2), is described in more detail below.

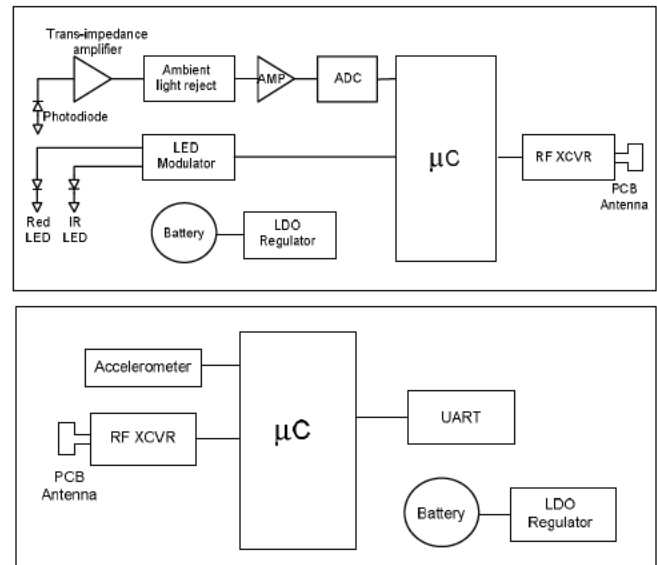


Fig. 2. System block diagram of the wearable, wireless, pulse oximeter. Sensor Module (top), Receiver Module (bottom).

*Sensor Module:* The Sensor Module contains analog signal processing circuitry, ADC, an embedded microcontroller, and a RF transceiver. The unit is small enough so the entire module can be integrated into a headband or a helmet. The unit is powered by a CR2032 type coin cell battery with 220mAh capacity, providing at least 5 days of operation.

*Receiver Module:* The Receiver Module contains an embedded microcontroller, RF transceiver for communicating with the Sensor Module, and a Universal Asynchronous Receive Transmit (UART) for connection to a PC. Signals acquired by the Sensor Module are received by the embedded microcontroller which synchronously converts the corresponding PD output to R and IR PPG signals. Dedicated software is used to filter the signals and compute  $\text{SpO}_2$  and HR based on the relative amplitude and frequency content of the reflected PPG signals. A tri-axis MEMS accelerometer detects changes in body activity, and the information obtained through the tilt sensing property of the accelerometer is used to determine the orientation of the person wearing the device.

To facilitate bi-directional wireless communications between the Receiver Module and a PDA, we used the DPAC Airborne™ LAN node module (DPAC Technologies, Garden Grove, CA). The DPAC module operates at a frequency of 2.4GHz, is 802.11b wireless compliant, and has a relatively small ( $1.6 \times 1.17 \times 0.46$  inches) footprint. The wireless module runs off a 3.7VDC and includes a built-in

TCP/IP stack, a radio, a base-band processor, an application processor, and software for a “drop-in” WiFi application. It has the advantage of being a plug-and-play device that does not require any programming and can connect with other devices through a standard UART.

**PDA:** The PDA was selected based on size, weight, and power consumption. Furthermore, the ability to carry the user interface with the medic also allows for greater flexibility during deployment. We chose the HP iPAQ h4150 PDA because it can support both 802.11b and Bluetooth™ wireless communication. It contains a modest amount of storage and has sufficient computational resources for the intended application. The use of a PDA as a local terminal also provides a low-cost touch screen interface. The user-friendly touch screen of the PDA offers additional flexibility. It enables multiple controls to occupy the same physical space and the controls appear only when needed. Additionally, a touch screen reduces development cost and time, because no external hardware is required. The data from the wireless-enabled PDA can also be downloaded or streamed to a remote base station via Bluetooth or other wireless communication protocols. The PDA can also serve to temporarily store vital medical information received from the wearable unit.

A dedicated National Instruments LabVIEW program was developed to control all interactions between the PDA and the wearable unit via a graphical user interface (GUI). One part of the LabVIEW software is used to control the flow of information through the 802.11b radio system on the PDA. A number of LabVIEW VIs programs are used to establish a connection, exchange data, and close the connection between the wearable pulse oximeter and the PDA. The LabVIEW program interacts with the Windows CE™ drivers of the PDA’s wireless system. The PDA has special drivers provided by the manufacturer that are used by Windows CE™ to interface with the 802.11b radio hardware. The LabVIEW program interacts with Windows CE™ on a higher level and allows Windows CE™ to handle the drivers and the direct control of the radio hardware.

The user interacts with the wearable system using a simple GUI, as depicted in Fig. 3.



Fig. 3. Sample PDA Graphical User Interface (GUI).

The GUI was configured to present the input and output information to the user and allows easy activation of various

functions. In cases of multiple wearable devices, it also allows the user to select which individual to monitor prior to initiating the wireless connection. Once a specific wearable unit is selected, the user connects to the remote device via the System Control panel that manages the connection and sensor control buttons. The GUI also displays the subject’s vital signs, activity level, body orientation, and a scrollable PPG waveform that is transmitted by the wearable device.

The stream of data received from the wearable unit is distributed to various locations on the PDA’s graphical display. The most prominent portion of the GUI display is the scrolling PPG waveform, shown in Fig. 3. Numerical SpO<sub>2</sub> and HR values are displayed in separate indicator windows. A separate tri-color indicator is used to annotate the subject’s activity level measured by the wearable accelerometer. This activity level was color coded using green, yellow, or red to indicate low or no activity, moderate activity, or high activity, respectively. In addition, the subject’s orientation is represented by a blue indicator that changes orientation according to body posture. Alarm limits could be set to give off a warning sign if the physiological information exceeds preset safety limits.

One of the unique features of this PDA-based wireless system architecture is the flexibility to operate in a free roaming mode. In this ad-hoc configuration, the system’s integrity depends only on the distance between each node. This allows the PDA to communicate with a remote unit that is beyond the PDA’s wireless range. The ad-hoc network would therefore allow medical personnel to quickly distribute sensors to multiple casualties and begin immediate triage, thereby substantially simplifying and reducing deployment time.

**Power Management:** Several features were incorporated into the design in order to minimize the power consumption of the wearable system. The most stringent consideration was the total operating power required by the Sensor Module, which has to drive the R and IR LEDs, process the data, and transmit this information wirelessly to the Receive Module. To keep the overall size of the Sensor Module as small as, it was designed to run on a watch style coin-cell battery.

It should be noted that low power management without compromising signal quality is an essential requirement in optimizing the design of wearable pulse oximeter. Commercially available transducers used with transmission and reflection pulse oximeters employ high brightness LEDs and a small PD element, typically with an active area ranging between 12 to 15mm<sup>2</sup>. One approach to lowering the power consumption of a wireless pulse oximeter, which is dominated by the current required to drive the LEDs, is to reduce the LED duty cycle. Alternatively, minimizing the drive currents supplied to the R and IR LEDs can also achieve a significant reduction in power consumption. However, with reduced current drive, there can be a direct impact on the quality of the detected PPGs. Furthermore, since most of the light emitted from the LEDs is diffused by the skin and subcutaneous tissues, in a predominantly forward-scattering direction, only a small fraction of the incident light is normally backscattered from the skin. In

addition, the backscattered light intensity is distributed over a region that is concentric with respect to the LEDs. Consequently, the performance of reflectance pulse oximetry using a small PD area is significantly degraded. To overcome this limitation, we showed that a concentric array of either discrete PDs, or an annularly-shaped PD ring, could be used to increase the amount of backscattered light detected by a reflectance type pulse oximeter sensor [5]-[7].

Besides a low-power consuming sensor, afforded by lowering the driving currents of the LEDs, a low duty cycle was employed to achieve a balance between low power consumption and adequate performance. In the event that continuous monitoring is not required, more power can be conserved by placing the device in an ultra low-power standby mode. In this mode, the radio is normally turned off and is only enabled for a periodic beacon to maintain network association. Moreover, a decision to activate the wearable pulse oximeter can be made automatically in the event of a patient alarm, or based on the activity level and posture information derived from the on-board accelerometer. The wireless pulse oximeter can also be activated or deactivated remotely by a medic as needed, thereby further minimizing power consumption.

### III. IN VIVO EVALUATIONS

Initial laboratory evaluations of the wearable pulse oximeter included simultaneous HR and SpO<sub>2</sub> measurements. The Sensor Module was positioned on the forehead using an elastic headband. Baseline recordings were made while the subject was resting comfortably and breathing at a normal tidal rate. Two intermittent recordings were also acquired while the subject held his breath for about 30 seconds. Fig. 4 displays about 4 minutes of SpO<sub>2</sub> and HR recordings acquired simultaneously by the sensor.

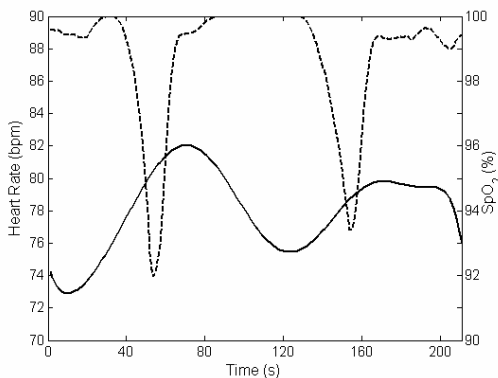


Fig. 4. Typical HR (solid line) and SpO<sub>2</sub> (dashed line) recording of two voluntary hypoxic episodes.

The pronounced drops in SpO<sub>2</sub> and corresponding increases in HR values coincide with the hypoxic events associated with the two breath holding episodes.

### IV. DISCUSSION

The emerging development of compact, low power, small size, light weight, and unobtrusive wearable devices can facilitate remote noninvasive monitoring of vital

physiological signs. Wireless physiological information can be useful to monitor soldiers during training exercises and combat missions, and help emergency first-responders operating in harsh and hazardous environments. Similarly, wearable physiological devices could become critical in helping to save lives following a civilian mass casualty. The primary goal of such a wireless mobile platform would be to keep track of an injured person's vital signs via a short-range wirelessly-linked personal area network, thus readily allowing RF telemetry of vital physiological information to command units and remote off-site base stations for continuous real-time monitoring by medical experts.

The preliminary bench testing plotted in Fig. 4 showed that the SpO<sub>2</sub> and HR readings are within an acceptable clinical range. Similarly, the transient changes measured during the two breath holding maneuvers confirmed that the response time of the custom pulse oximeter is adequate for detecting hypoxic episodes.

### V. CONCLUSION

A wireless, wearable, reflectance pulse oximeter has been developed based on a small forehead-mounted sensor. The battery-operated device employs a lightweight optical reflectance sensor and incorporates an annular photodetector to reduce power consumption. The system has short range wireless communication capabilities to transfer SpO<sub>2</sub>, HR, body acceleration, and posture information to a PDA carried by medics or first responders. The information could enhance the ability of first responders to extend more effective medical care, thereby saving the lives of critically injured persons.

### ACKNOWLEDGMENT

The authors would like to acknowledge the financial support provided by the U.S. Army Medical Research and Materiel Command referenced.

### REFERENCES

- [1] G. S. F. Ling, B. K. Day, P. Rhee, and J. M. Ecklund, "In search of technological solutions to battlefield management of combat casualties," *SPIE Conference on Battlefield Biomedical Technologies*, SPIE vol. 3712, Apr. 1999.
- [2] D. Malan, T. Fulford-Jones, M. Welsh, and S. Moulton, "CodeBlue: An ad-hoc sensor network infrastructure for emergency medical care," *International Workshop on Wearable and Implantable Body Sensor Networks*, 2004.
- [3] U. Anliker et al., "AMON: A wearable multiparameter medical monitoring and alert system," *IEEE Trans. on Information Technology in Biomedicine*, 8(4), 2004.
- [4] Y. Mendelson and V. Floroff, "A PDA based ad-hoc mobile wireless pulse oximeter," *Proc. IASTED International Conference Telehealth 2005*, Banff, Canada, 2005.
- [5] Y. Mendelson and C. J. Pujary, "Minimization of LED power consumption in the design of a wearable pulse oximeter," *IASTED International Conference BioMED 2003*, Salzburg, Austria, 2003.
- [6] Y. Mendelson and C. J. Pujary, "Measurement site and photodetector size considerations in optimizing power consumption of a wearable reflectance pulse oximeter," *Proc. of the 25<sup>th</sup> Annual International IEEE/EMBS Conference*, Cancun, Mexico, 2003.
- [7] P. Branche and Y. Mendelson, "Signal quality and power consumption of a new prototype reflectance pulse oximeter sensor," *Proc. of the 31<sup>th</sup> Annual Northeast Bioengineering Conference*, Hoboken, NJ, 2005.

## **APPENDIX MENDELSON12**

## A Wearable Reflectance Pulse Oximeter for Remote Physiological Monitoring

Y. Mendelson\*, *Member, IEEE*, R. J. Duckworth, *Member, IEEE*, and G. Comtois, *Student Member, IEEE*

**Abstract**—To save life, casualty care requires that trauma injuries are accurately and expeditiously assessed in the field. This paper describes the initial bench testing of a wireless wearable pulse oximeter developed based on a small forehead mounted sensor. The battery operated device employs a lightweight optical reflectance sensor and incorporates an annular photodetector to reduce power consumption. The system also has short range wireless communication capabilities to transfer arterial oxygen saturation (SpO<sub>2</sub>), heart rate (HR), body acceleration, and posture information to a PDA. It has the potential for use in combat casualty care, such as for remote triage, and by first responders, such as firefighters.

### I. INTRODUCTION

STEADY advances in noninvasive physiological sensing, hardware miniaturization, and wireless communication are leading to the development of new wearable technologies that have broad and important implications for civilian and military applications [1]-[2]. For example, the emerging development of compact, low-power, small-size, light-weight, and unobtrusive wearable devices may facilitate remote noninvasive monitoring of vital signs from soldiers during training exercises and combat. Telemetry of physiological information via a short-range wirelessly-linked personal area network can also be useful for firefighters, hazardous material workers, mountain climbers, or emergency first-responders operating in harsh and hazardous environments. The primary goals of such a wireless mobile platform would be to keep track of an injured person's vital signs, thus readily allowing the telemetry of physiological information to medical providers, and support emergency responders in making critical and often life saving decisions in order to expedite rescue operations. Having wearable physiological monitoring could offer far-forward medics numerous advantages, including the ability to determine a casualty's condition remotely without exposing the first

responders to increased risks, quickly identifying the severity of injuries especially when the injured are greatly dispersed over large geographical terrains and often out-of-site, and continuously tracking the injured condition until they arrive safely at a medical care facility.

Several technical challenges must be overcome to address the unmet demand for long-term continuous physiological monitoring in the field. In order to design more compact sensors and improved wearable instrumentation, perhaps the most critical challenges are to develop more power efficient and low-weight devices. To become effective, these technologies must also be robust, comfortable to wear, and cost-effective. Additionally, before wearable devices can be used effectively in the field, they must become unobtrusive and should not hinder a person's mobility. Employing commercial off-the-shelf (COTS) solutions, for example finger pulse oximeters to monitor blood oxygenation and heart rate, or standard adhesive-type disposable electrodes for ECG monitoring, is not practical for many field applications because they limit mobility and can interfere with normal tasks.

A potentially attractive approach to aid emergency medical teams in remote triage operations is the use of a wearable pulse oximeter to wirelessly transmit heart rate (HR) and arterial oxygen saturation (SpO<sub>2</sub>) to a remote location. Pulse oximetry is a widely accepted method that is used for noninvasive monitoring of SpO<sub>2</sub> and HR. The method is based on spectrophotometric measurements of changes in the optical absorption of deoxyhemoglobin (Hb) and oxyhemoglobin (HbO<sub>2</sub>). Noninvasive spectrophotometric measurements of SpO<sub>2</sub> are performed in the visible (600-700nm) and near-infrared (700-1000nm) spectral regions. Pulse oximetry also relies on the detection of photoplethysmographic (PPG) signals produced by variations in the quantity of arterial blood that is associated with periodic contractions and relaxations of the heart. Measurements can be performed in either transmission or reflection modes. In transmission pulse oximetry, the sensor can be attached across a fingertip, foot, or earlobe. In this configuration, the light emitting diodes (LEDs) and photodetector (PD) in the sensor are placed on opposite sides of a peripheral pulsating vascular bed. Alternatively, in reflection pulse oximetry, the LEDs and PD are both mounted side-by-side on the same planar substrate to enable readings from multiple body locations where transillumination measurements are not feasible. Clinically, forehead reflection pulse oximetry has been used as an alternative approach to conventional transmission-based

Manuscript received April 3, 2006. This work is supported by the U.S. Army Medical Research and Materiel Command under Contract No. DAMD17-03-2-0006. The views, opinions and/or findings are those of the author and should not be construed as an official Department of the Army position, policy, or decision, unless so designated by other documentation.

\*Corresponding author – Y. Mendelson is a Professor in the Department of Biomedical Engineering, Worcester Polytechnic Institute, Worcester, MA 01609 USA (phone: 508-831-5103; fax: 508-831-5541; e-mail: ym@wpi.edu).

R. J. Duckworth is a Professor in the Department of Electrical and Computer Engineering, Worcester Polytechnic Institute, Worcester, MA 01609 USA (rjduck@ece.wpi.edu).

G. Comtois is a M. S. student in the Department of Biomedical Engineering, Worcester Polytechnic Institute, Worcester, MA 01609 USA (comtoisg@wpi.edu).



oximetry when peripheral circulation to the extremities is compromised.

Pulse oximetry was initially intended for in-hospital use on patients undergoing or recovering from surgery. During the past few years, several companies have developed smaller pulse oximeters, some including data transmission via telemetry, to further expand the applications of pulse oximetry. For example, battery-operated pulse oximeters are now attached to patients during emergency transport as they are being moved from a remote location to a hospital, or between hospital wards. Some companies are also offering smaller units with improved electronic filtering of noisy PPG signals.

Several reports described the development of a wireless pulse oximeter that may be suitable for remote physiological monitoring [3]-[4]. Despite the steady progress in miniaturization of pulse oximeters over the years, to date, the most significant limitation is battery longevity and lack of telemetric communication. In this paper, we describe a prototype forehead-based reflectance pulse oximeter suitable for remote triage applications.

## II. SYSTEM ARCHITECTURE

The prototype system, depicted in Fig. 1, consists of a body-worn pulse oximeter that receives and processes the PPG signals measured by a small ( $\phi = 22\text{mm}$ ) and lightweight (4.5g) optical reflectance transducer. The system

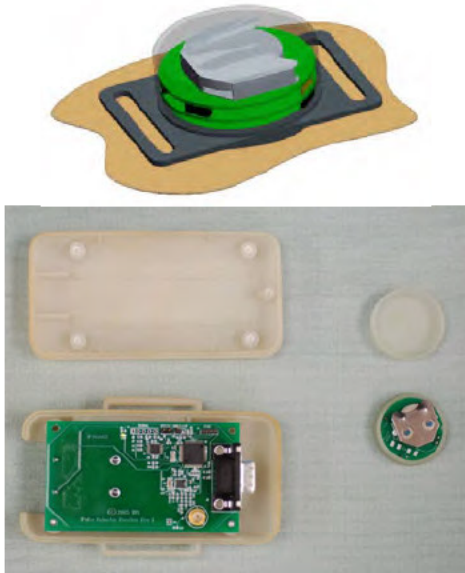


Fig. 1. (Top) Attachment of Sensor Module to the skin; (Bottom) photograph of the Receiver Module (left) and Sensor Module (right).

consists of three units: A Sensor Module, consisting of the optical transducer, a stack of round PCBs, and a coin-cell battery. The information acquired by the Sensor Module is transmitted wirelessly via an RF link over a short range to a body-worn Receiver Module. The data processed by the Receiver Module can be transmitted wirelessly to a PDA. The PDA can monitor multiple wearable pulse oximeters simultaneously and allows medics to collect vital physiological information to enhance their ability to extend more effective care to those with the most urgent needs. The

system can be programmed to alert on alarm conditions, such as sudden trauma, or physiological values out of their normal range. It also has the potential for use in combat casualty care, such as for remote triage, and for use by first responders, such as firefighters.

Key features of this system are small-size, robustness, and low-power consumption, which are essential attributes of wearable physiological devices, especially for military applications. The system block diagram (Fig. 2), is described in more detail below.

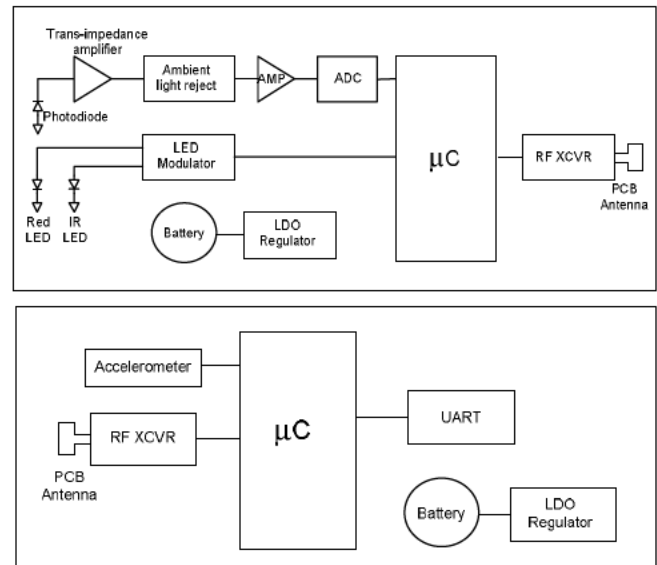


Fig. 2. System block diagram of the wearable, wireless, pulse oximeter. Sensor Module (top), Receiver Module (bottom).

**Sensor Module:** The Sensor Module contains analog signal processing circuitry, ADC, an embedded microcontroller, and a RF transceiver. The unit is small enough so the entire module can be integrated into a headband or a helmet. The unit is powered by a CR2032 type coin cell battery with 220mAh capacity, providing at least 5 days of operation.

**Receiver Module:** The Receiver Module contains an embedded microcontroller, RF transceiver for communicating with the Sensor Module, and a Universal Asynchronous Receive Transmit (UART) for connection to a PC. Signals acquired by the Sensor Module are received by the embedded microcontroller which synchronously converts the corresponding PD output to R and IR PPG signals. Dedicated software is used to filter the signals and compute  $\text{SpO}_2$  and HR based on the relative amplitude and frequency content of the reflected PPG signals. A tri-axis MEMS accelerometer detects changes in body activity, and the information obtained through the tilt sensing property of the accelerometer is used to determine the orientation of the person wearing the device.

To facilitate bi-directional wireless communications between the Receiver Module and a PDA, we used the DPAC Airborne™ LAN node module (DPAC Technologies, Garden Grove, CA). The DPAC module operates at a frequency of 2.4GHz, is 802.11b wireless compliant, and has a relatively small ( $1.6 \times 1.17 \times 0.46$  inches) footprint. The wireless module runs off a 3.7VDC and includes a built-in

TCP/IP stack, a radio, a base-band processor, an application processor, and software for a “drop-in” WiFi application. It has the advantage of being a plug-and-play device that does not require any programming and can connect with other devices through a standard UART.

**PDA:** The PDA was selected based on size, weight, and power consumption. Furthermore, the ability to carry the user interface with the medic also allows for greater flexibility during deployment. We chose the HP iPAQ h4150 PDA because it can support both 802.11b and Bluetooth™ wireless communication. It contains a modest amount of storage and has sufficient computational resources for the intended application. The use of a PDA as a local terminal also provides a low-cost touch screen interface. The user-friendly touch screen of the PDA offers additional flexibility. It enables multiple controls to occupy the same physical space and the controls appear only when needed. Additionally, a touch screen reduces development cost and time, because no external hardware is required. The data from the wireless-enabled PDA can also be downloaded or streamed to a remote base station via Bluetooth or other wireless communication protocols. The PDA can also serve to temporarily store vital medical information received from the wearable unit.

A dedicated National Instruments LabVIEW program was developed to control all interactions between the PDA and the wearable unit via a graphical user interface (GUI). One part of the LabVIEW software is used to control the flow of information through the 802.11b radio system on the PDA. A number of LabVIEW VIs programs are used to establish a connection, exchange data, and close the connection between the wearable pulse oximeter and the PDA. The LabVIEW program interacts with the Windows CE™ drivers of the PDA’s wireless system. The PDA has special drivers provided by the manufacturer that are used by Windows CE™ to interface with the 802.11b radio hardware. The LabVIEW program interacts with Windows CE™ on a higher level and allows Windows CE™ to handle the drivers and the direct control of the radio hardware.

The user interacts with the wearable system using a simple GUI, as depicted in Fig. 3.



Fig. 3. Sample PDA Graphical User Interface (GUI).

The GUI was configured to present the input and output information to the user and allows easy activation of various

functions. In cases of multiple wearable devices, it also allows the user to select which individual to monitor prior to initiating the wireless connection. Once a specific wearable unit is selected, the user connects to the remote device via the System Control panel that manages the connection and sensor control buttons. The GUI also displays the subject’s vital signs, activity level, body orientation, and a scrollable PPG waveform that is transmitted by the wearable device.

The stream of data received from the wearable unit is distributed to various locations on the PDA’s graphical display. The most prominent portion of the GUI display is the scrolling PPG waveform, shown in Fig. 3. Numerical SpO<sub>2</sub> and HR values are displayed in separate indicator windows. A separate tri-color indicator is used to annotate the subject’s activity level measured by the wearable accelerometer. This activity level was color coded using green, yellow, or red to indicate low or no activity, moderate activity, or high activity, respectively. In addition, the subject’s orientation is represented by a blue indicator that changes orientation according to body posture. Alarm limits could be set to give off a warning sign if the physiological information exceeds preset safety limits.

One of the unique features of this PDA-based wireless system architecture is the flexibility to operate in a free roaming mode. In this ad-hoc configuration, the system’s integrity depends only on the distance between each node. This allows the PDA to communicate with a remote unit that is beyond the PDA’s wireless range. The ad-hoc network would therefore allow medical personnel to quickly distribute sensors to multiple casualties and begin immediate triage, thereby substantially simplifying and reducing deployment time.

**Power Management:** Several features were incorporated into the design in order to minimize the power consumption of the wearable system. The most stringent consideration was the total operating power required by the Sensor Module, which has to drive the R and IR LEDs, process the data, and transmit this information wirelessly to the Receive Module. To keep the overall size of the Sensor Module as small as, it was designed to run on a watch style coin-cell battery.

It should be noted that low power management without compromising signal quality is an essential requirement in optimizing the design of wearable pulse oximeter. Commercially available transducers used with transmission and reflection pulse oximeters employ high brightness LEDs and a small PD element, typically with an active area ranging between 12 to 15mm<sup>2</sup>. One approach to lowering the power consumption of a wireless pulse oximeter, which is dominated by the current required to drive the LEDs, is to reduce the LED duty cycle. Alternatively, minimizing the drive currents supplied to the R and IR LEDs can also achieve a significant reduction in power consumption. However, with reduced current drive, there can be a direct impact on the quality of the detected PPGs. Furthermore, since most of the light emitted from the LEDs is diffused by the skin and subcutaneous tissues, in a predominantly forward-scattering direction, only a small fraction of the incident light is normally backscattered from the skin. In



addition, the backscattered light intensity is distributed over a region that is concentric with respect to the LEDs. Consequently, the performance of reflectance pulse oximetry using a small PD area is significantly degraded. To overcome this limitation, we showed that a concentric array of either discrete PDs, or an annularly-shaped PD ring, could be used to increase the amount of backscattered light detected by a reflectance type pulse oximeter sensor [5]-[7].

Besides a low-power consuming sensor, afforded by lowering the driving currents of the LEDs, a low duty cycle was employed to achieve a balance between low power consumption and adequate performance. In the event that continuous monitoring is not required, more power can be conserved by placing the device in an ultra low-power standby mode. In this mode, the radio is normally turned off and is only enabled for a periodic beacon to maintain network association. Moreover, a decision to activate the wearable pulse oximeter can be made automatically in the event of a patient alarm, or based on the activity level and posture information derived from the on-board accelerometer. The wireless pulse oximeter can also be activated or deactivated remotely by a medic as needed, thereby further minimizing power consumption.

### III. IN VIVO EVALUATIONS

Initial laboratory evaluations of the wearable pulse oximeter included simultaneous HR and SpO<sub>2</sub> measurements. The Sensor Module was positioned on the forehead using an elastic headband. Baseline recordings were made while the subject was resting comfortably and breathing at a normal tidal rate. Two intermittent recordings were also acquired while the subject held his breath for about 30 seconds. Fig. 4 displays about 4 minutes of SpO<sub>2</sub> and HR recordings acquired simultaneously by the sensor.

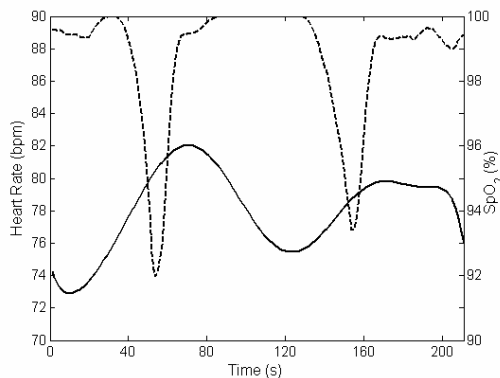


Fig. 4. Typical HR (solid line) and SpO<sub>2</sub> (dashed line) recording of two voluntary hypoxic episodes.

The pronounced drops in SpO<sub>2</sub> and corresponding increases in HR values coincide with the hypoxic events associated with the two breath holding episodes.

### IV. DISCUSSION

The emerging development of compact, low power, small size, light weight, and unobtrusive wearable devices can facilitate remote noninvasive monitoring of vital

physiological signs. Wireless physiological information can be useful to monitor soldiers during training exercises and combat missions, and help emergency first-responders operating in harsh and hazardous environments. Similarly, wearable physiological devices could become critical in helping to save lives following a civilian mass casualty. The primary goal of such a wireless mobile platform would be to keep track of an injured person's vital signs via a short-range wirelessly-linked personal area network, thus readily allowing RF telemetry of vital physiological information to command units and remote off-site base stations for continuous real-time monitoring by medical experts.

The preliminary bench testing plotted in Fig. 4 showed that the SpO<sub>2</sub> and HR readings are within an acceptable clinical range. Similarly, the transient changes measured during the two breath holding maneuvers confirmed that the response time of the custom pulse oximeter is adequate for detecting hypoxic episodes.

### V. CONCLUSION

A wireless, wearable, reflectance pulse oximeter has been developed based on a small forehead-mounted sensor. The battery-operated device employs a lightweight optical reflectance sensor and incorporates an annular photodetector to reduce power consumption. The system has short range wireless communication capabilities to transfer SpO<sub>2</sub>, HR, body acceleration, and posture information to a PDA carried by medics or first responders. The information could enhance the ability of first responders to extend more effective medical care, thereby saving the lives of critically injured persons.

### ACKNOWLEDGMENT

The authors would like to acknowledge the financial support provided by the U.S. Army Medical Research and Materiel Command referenced.

### REFERENCES

- [1] G. S. F. Ling, B. K. Day, P. Rhee, and J. M. Ecklund, "In search of technological solutions to battlefield management of combat casualties," *SPIE Conference on Battlefield Biomedical Technologies*, SPIE vol. 3712, Apr. 1999.
- [2] D. Malan, T. Fulford-Jones, M. Welsh, and S. Moulton, "CodeBlue: An ad-hoc sensor network infrastructure for emergency medical care," *International Workshop on Wearable and Implantable Body Sensor Networks*, 2004.
- [3] U. Anliker et al., "AMON: A wearable multiparameter medical monitoring and alert system," *IEEE Trans. on Information Technology in Biomedicine*, 8(4), 2004.
- [4] Y. Mendelson and V. Floroff, "A PDA based ad-hoc mobile wireless pulse oximeter," *Proc. IASTED International Conference Telehealth 2005*, Banff, Canada, 2005.
- [5] Y. Mendelson and C. J. Pujary, "Minimization of LED power consumption in the design of a wearable pulse oximeter," *IASTED International Conference BioMED 2003*, Salzburg, Austria, 2003.
- [6] Y. Mendelson and C. J. Pujary, "Measurement site and photodetector size considerations in optimizing power consumption of a wearable reflectance pulse oximeter," *Proc. of the 25<sup>th</sup> Annual International IEEE/EMBS Conference*, Cancun, Mexico, 2003.
- [7] P. Branche and Y. Mendelson, "Signal quality and power consumption of a new prototype reflectance pulse oximeter sensor," *Proc. of the 31<sup>th</sup> Annual Northeast Bioengineering Conference*, Hoboken, NJ, 2005.

## **APPENDIX MENDELSON13**



Keyword Search...

Search

Advanced search Start Over

Bookmark Share


# MARC View

```

LEADER 02475nas a2200517 a 4500
001 33348225
003 SIRSI
005 20210314090126.0
006 m fo d
007 cr n
008 990823d19851997ne br p s 0 0eng c
010 a| 2007233979
019 a| DO NOT EDIT this 360 MARC RECORD
022 a| 2214-7330 | 0748-1977 y| 0748-1977
030 a| JCMOEH
035 a| ss360mi0128570
037 b| Kluwer Academic Publishers, Spuiboulevard 50, P.O. Box 17, 3300 AA Dordrecht, The Netherlands
040 a| F#A b| eng c| F#A d| OCLCQ d| GUA d| TXA d| LGG d| OCLCQ d| OCLCF d| IUL d| OCLCQ d| UAB d| OCLCQ d| VT2 d| BWN d|
WaSeSS
042 a| pcc
050 1 4 a| R857.P36 b| I588
060 0 0 a| W1 b| JO5893ME
082 0 4 a| 610.28
130 0 a| Journal of clinical monitoring (Online)
222 0 a| Journal of clinical monitoring b| (Online)
245 1 0 a| Journal of clinical monitoring h| [electronic resource].
246 3 a| J Clin Monit
260 3| 1996-1997 : a| [Hingham, MA] ; a| [Dordrecht] : b| Kluwer Academic Publishers
260 3| 1985-1990 : a| [Boston, MA] : b| [Little, Brown and Co.], c| [1985]-©1997.
310 a| Bimonthly, b| 1994-1997
321 a| Quarterly, b| 1985-1993
362 1 a| Began with: Vol. 1, no. 1 (Jan. 1985); ceased with: vol. 13, no. 6 (Nov. 1997).
538 a| Mode of access: World Wide Web.
550 a| Official journal of: Society for Technology in Anesthesia, -Nov. 1997.
588 a| Description based on: Vol. 1, no. 1 (Jan. 1985); title from PDF article running title (SpringerLink, viewed May 7, 2012).
588 a| Final issue consulted: Vol. 13, no. 6 (Nov. 1997) (SpringerLink, viewed Dec. 17, 2007).
650 0 a| Medical care v| Periodicals.
650 2 a| Monitoring, Physiologic v| Periodicals.
650 0 a| Patient monitoring v| Periodicals.
655 0 a| Electronic journals.
710 2 a| Society for Technology in Anesthesia.
776 0 8 i| Print version: t| Journal of clinical monitoring x| 0748-1977 w| (DLC)sn 84006424 w| (OCoLC)10897663
785 1 7 t| Journal of clinical monitoring and computing (Online) x| 1573-2614 w| (DLC) 2007233984 w| (OCoLC)41569988
785 1 7 t| International journal of clinical monitoring and computing (Online) x| 2214-7314 w| (OCoLC)42209706
856 4 0 u| http://SK8E54MC2L.search.serialssolutions.com/?V=1.0&L=SK8E54MC2L&S=JCs&C=JOUROFCLIMO&T=marc
910 a| CONSER online
949 a| Electronic resource w| ASIS c| 1 i| 33348225-1001 | ONLINE m| ONLINE r| Y s| Y t| ONLINE u| 3/20/2021 o| .STAFF. 360 MARC

```

# **APPENDIX MENDELSON14**

 Covid 19 updates and more information about using the Libraries while you're remote.



Catalog

Bookmarks  Course Reserves My Account

Keyword  Search...

 Search

[Advanced search](#) [Start Over](#)

[Bookmark](#) [Share](#)



## Journal of clinical monitoring [electronic resource].

**Uniform Title:** Journal of clinical monitoring (Online)  
**Additional Titles:** J Clin Monit  
**Published:** 1996-1997 : [Hingham, MA] ; [Dordrecht] : Kluwer Academic Publishers and 1985-1990 [Boston, MA] : [Little, Brown and Co.], [1985]-©1997.  
**Additional Creators:** Society for Technology in Anesthesia  
**Access Online:** [serialssolutions.com](http://serialssolutions.com)

 ASK  
A LIBRARIAN

### Dates of Publication and/or Sequential Designation:

Began with: Vol. 1, no. 1 (Jan. 1985); ceased with: vol. 13, no. 6 (Nov. 1997).

### Subject(s):

[Medical care—Periodicals](#)  
[Monitoring, Physiologic—Periodicals](#)  
[Patient monitoring—Periodicals](#)

### Genre(s):

[Electronic journals](#)

### ISSN:

2214-7330

### Publication Frequency:

Bimonthly, 1994-1997 and Quarterly, 1985-1993

### Technical Details:

Mode of access: World Wide Web.

### Issuing Body:

Official journal of: Society for Technology in Anesthesia, -Nov. 1997.

[View MARC record](#) | catkey: 33348225



Copyright ©2019 The Pennsylvania State University. All rights reserved. Except where otherwise noted, this work is subject to a Creative Commons Attribution 4.0 license, Details and exceptions.

[Legal Statements](#) | [PSU Hotlines](#)

### PENN STATE UNIVERSITY LIBRARIES

[Libraries Home](#) (814) 865-6368  
[Libraries Intranet \(Staff Only\)](#)  
[Accessibility Help](#)  
[Website Feedback](#)  
[Policies and Guidelines](#)  
[Staff Directory](#)

### CONNECT WITH PENN STATE UNIVERSITY LIBRARIES

 Facebook  
 Twitter  
 Instagram

## **APPENDIX MENDELSON15**



Original Articles | Published: January 1991

# Skin reflectance pulse oximetry: In vivo measurements from the forearm and calf

Y. Mendelson PhD  & M. J. McGinn MSc

*Journal of Clinical Monitoring* 7, 7–12(1991) | [Cite this article](#)

183 Accesses | 15 Citations | 6 Altmetric | [Metrics](#)

Download PDF 

Sections

References

Abstract

References

Author information

Additional information

Rights and permissions

About this article

## Abstract

This study describes the results from a series of human experiments demonstrating the ability to measure arterial hemoglobin oxygen saturation ( $\text{SaO}_2$ ) from the forearm and calf using a reflectance pulse oximeter sensor. A special optical reflectance sensor that includes a heating element was interfaced to a temperature controller and a commercial Data-scope ACCUSAT pulse oximeter that was adapted for this study to perform as a reflectance pulse oximeter. The reflectance pulse oximeter sensor was evaluated in a group of 10 healthy adult volunteers during steady-state hypoxia. Hypoxia was induced by gradually lowering the inspired fraction of oxygen in the breathing gas mixture from 100 to 12%. Simultaneous  $\text{SaO}_2$  measurements obtained from the forearm and calf with two identical reflectance pulse oximeters were compared with  $\text{SaO}_2$  values measured by a finger sensor that was interfaced to a standard Datascope ACCUSAT transmittance pulse oximeter. The equations for the best-fitted linear regression lines between the percent reflectance,  $\text{SpO}_2(r)$ , and transmittance,  $\text{SpO}_2(t)$ , values in the range between 73 and 100% were  $\text{SpO}_2(r) = -7.06 + 1.09 \text{ SpO}_2(t)$  for the forearm ( $n=91, r=0.95$ ) and  $\text{SpO}_2(r) = 7.78 + 0.93 \text{ SpO}_2(t)$  for the calf ( $n=93, r=0.88$ ). The regression analysis of the forearm data revealed a mean  $\pm$  SD error of  $2.47 \pm 1.66\%$  ( $\text{SaO}_2=90-100\%$ ),  $2.35 \pm 2.45\%$  ( $\text{SaO}_2=80-89\%$ ), and  $2.42 \pm 1.20\%$  ( $\text{SaO}_2=70-79\%$ ). The corresponding regression analysis of the calf data revealed a mean  $\pm$  SD error of  $3.36 \pm 3.06\%$  ( $\text{SaO}_2=90-100\%$ ),  $3.45 \pm 4.12\%$  ( $\text{SaO}_2=80-89\%$ ), and  $2.97 \pm 2.75\%$  ( $\text{SaO}_2=70-79\%$ ). This preliminary study demonstrated the feasibility of measuring  $\text{SaO}_2$  from the forearm and calf in healthy subjects with a heated skin reflectance sensor and a pulse oximeter.

[Download](#) to read the full article text

## References

1. Mendelson Y, Kent JC, Yocum BL, Birlle MJ. Design and evaluation of a new reflectance pulse oximeter sensor. *Biomed Instrum Technol* 1988;22(4):167–173

[CAS](#) [Google Scholar](#)

2. Mendelson Y, Ochs BD. Noninvasive pulse oximetry utilizing skin reflectance photoplethysmography. *IEEE Trans Biomed Eng* 1988;35(10):798–805

[PubMed](#) [Article](#) [CAS](#) [Google Scholar](#)

3. Mendelson Y, Kent JC, Shahnarian A, et al. Evaluation of the Datascope ACCUSAT pulse oximeter in healthy adults. *J Clin Monit* 1988;4:59–63

[PubMed](#) [Article](#) [CAS](#) [Google Scholar](#)

4. Brinkman R, Ziletra WC. Determination and continuous registration of the percentage



4. Mendelson Y, Giasi R. Determination and continuous registration of the percentage oxygen saturation in clinical conditions. *Neth J Surg* 1949;1:177–183

[CAS](#) [Google Scholar](#)

5. Cohen A, Wadsworth N. A light emitting diode skin reflectance oximeter. *Med Biol Eng Comput* 1972;10:385–391

[CAS](#) [Google Scholar](#)

6. Moretti G. *Handbuch der Haut- und Geschlechtskrankheiten*. Berlin: Springer-Verlag, 1968:491–623

[Google Scholar](#)

7. Rothman S. *Physiology and biochemistry of the skin*. Chicago: University of Chicago Press, 1954:685

[Google Scholar](#)

[Download references](#) ↓

## Author information

### Affiliations

From the Department of Biomedical Engineering, Worcester Polytechnic Institute, 100 Institute Rd, 01609, Worcester, MA

Dr Y. Mendelson PhD & M. J. McGinn MSc

### Corresponding author

Correspondence to Dr Y. Mendelson PhD.

## Additional information

Financial support for this study was provided in part by the Datascope Corporation and NIH Grant R15 GM36111-01A1.

The authors would like to acknowledge the clinical assistance of Albert Shahnarian, PhD, Gary W. Welch MD, PhD, and Robert M. Giasi, MD, Department of Anesthesiology, University of Massachusetts Medical Center, Worcester, MA. We also thank Paul A. Nigromi, Datascope Corporation, Paramus, NJ, and Kevin Hines, Semiconductor Division, Analog Devices, Wilmington, MA, for technical assistance. The skillful art work by Yi Wang is also greatly appreciated.

## Rights and permissions

[Reprints and Permissions](#)

## About this article

### Cite this article

Mendelson, Y., McGinn, M.J. Skin reflectance pulse oximetry: In vivo measurements from the forearm and calf. *J Clin Monitor Comput* 7, 7–12 (1991). <https://doi.org/10.1007/BF01617892>

[Download citation](#) ↓

Received

18 September 1990

Revised

11 January 1991

Accepted

17 January 1991

10 September 1990

11 January 1991

17 January 1991

Issue Date

January 1991

DOI

<https://doi.org/10.1007/BF01617892>

## Share this article

Anyone you share the following link with will be able to read this content:

[Get shareable link](#)

Provided by the Springer Nature SharedIt content-sharing initiative

## Key words

**Blood gas analyses**

**Monitoring: oxygen**

**Measurement techniques: pulse oximetry; optical plethysmography; reflectance oximetry**

**Equipment: pulse oximeters**

Over 10 million scientific documents at your fingertips

[Academic Edition](#)

[Corporate Edition](#)

[Home](#) [Imprimatur](#) [Legal information](#) [Privacy statement](#) [California Privacy Statement](#) [How we use cookies](#) [Manage cookies/Do not sell my data](#) [Accessibility](#) [Contact us](#)

Not logged in - 132.174.254.159

Big Ten Academic Alliance Formerly (CIC) (3000133814) - The Pennsylvania State University Serials Department (8200934536)

**SPRINGER NATURE**

© 2021 Springer Nature Switzerland AG. Part of [Springer Nature](#).

## **APPENDIX MENDELSON16**

---

## SKIN REFLECTANCE PULSE OXIMETRY: IN VIVO MEASUREMENTS FROM THE FOREARM AND CALF

Y. Mendelson, PhD, and M. J. McGinn, MSc

---

Mendelson Y, McGinn MJ. Skin reflectance pulse oximetry: in vivo measurements from the forearm and calf.

J Clin Monit 1991;7:7-12

**ABSTRACT.** This study describes the results from a series of human experiments demonstrating the ability to measure arterial hemoglobin oxygen saturation ( $\text{SaO}_2$ ) from the forearm and calf using a reflectance pulse oximeter sensor. A special optical reflectance sensor that includes a heating element was interfaced to a temperature controller and a commercial Datascope ACCUSAT pulse oximeter that was adapted for this study to perform as a reflectance pulse oximeter. The reflectance pulse oximeter sensor was evaluated in a group of 10 healthy adult volunteers during steady-state hypoxia. Hypoxia was induced by gradually lowering the inspired fraction of oxygen in the breathing gas mixture from 100 to 12%. Simultaneous  $\text{SaO}_2$  measurements obtained from the forearm and calf with two identical reflectance pulse oximeters were compared with  $\text{SaO}_2$  values measured by a finger sensor that was interfaced to a standard Datascope ACCUSAT transmittance pulse oximeter. The equations for the best-fitted linear regression lines between the percent reflectance,  $\text{SpO}_2(r)$ , and transmittance,  $\text{SpO}_2(t)$ , values in the range between 73 and 100% were  $\text{SpO}_2(r) = -7.06 + 1.09 \text{SpO}_2(t)$  for the forearm ( $n = 91, r = 0.95$ ) and  $\text{SpO}_2(r) = 7.78 + 0.93 \text{SpO}_2(t)$  for the calf ( $n = 93, r = 0.88$ ). The regression analysis of the forearm data revealed a mean  $\pm$  SD error of  $2.47 \pm 1.66\%$  ( $\text{SaO}_2 = 90-100\%$ ),  $2.35 \pm 2.45\%$  ( $\text{SaO}_2 = 80-89\%$ ), and  $2.42 \pm 1.20\%$  ( $\text{SaO}_2 = 70-79\%$ ). The corresponding regression analysis of the calf data revealed a mean  $\pm$  SD error of  $3.36 \pm 3.06\%$  ( $\text{SaO}_2 = 90-100\%$ ),  $3.45 \pm 4.12\%$  ( $\text{SaO}_2 = 80-89\%$ ), and  $2.97 \pm 2.75\%$  ( $\text{SaO}_2 = 70-79\%$ ). This preliminary study demonstrated the feasibility of measuring  $\text{SaO}_2$  from the forearm and calf in healthy subjects with a heated skin reflectance sensor and a pulse oximeter.

**KEY WORDS.** Blood gas analyses. Monitoring: oxygen. Measurement techniques: pulse oximetry; optical plethysmography; reflectance oximetry. Equipment: pulse oximeters.

---

Transmittance pulse oximetry has become a widely used technique for noninvasively monitoring changes in arterial hemoglobin oxygen saturation ( $\text{SaO}_2$ ). The technique is based on the spectrophotometric analysis of the optical absorption properties of blood combined with the principle of photoplethysmography.

In transmittance pulse oximetry, which is based on tissue transillumination, sensor application in adults is limited to several specific locations on the body, such as the finger tips, ear lobes, and toes. In infants, additional monitoring sites such as the palms and the feet have been used.

Recently, a new reflectance pulse oximeter has been introduced into the market. The oximeter, which is manufactured by Ciba-Corning (Ciba Corning Diagnostics, Medfield, MA), uses a special optical reflectance sensor for specific application to the forehead. Among the advantages of this technique, as advertised by the

From the Department of Biomedical Engineering, Worcester Polytechnic Institute, 100 Institute Rd, Worcester, MA 01609.

Received Sep 18, 1989, and in revised form Jan 11, 1990. Accepted for publication Jan 17, 1990.

Address correspondence to Dr Mendelson.

company, are better reliability in critical care situations such as peripheral circulatory shutdown, less interference from ambient light, and better accuracy because measurement from the forehead is relatively unsusceptible to motion artifacts.

Currently, there are no commercially available reflectance pulse oximeters for monitoring  $\text{SaO}_2$  from locations other than the forehead. Therefore, the objective of this work was to investigate the feasibility of monitoring  $\text{SaO}_2$  with a skin reflectance pulse oximeter from two alternative and convenient locations on the body: the ventral side of the forearm and the dorsal side of the calf. Besides extending the clinical application of pulse oximetry, it appears also that reflectance pulse oximetry from peripheral tissues may have potential advantage in the assessment of local blood oxygenation after skin transplantation and regeneration following microvascular surgery.

In this article, we describe preliminary *in vivo* evaluation of a new optical reflectance sensor for noninvasive monitoring of  $\text{SaO}_2$  with a modified commercial transmittance pulse oximeter. We present the experimental evaluation of this sensor in a group of 10 healthy adult volunteers and compare  $\text{SaO}_2$  measured with the reflectance pulse oximeter sensor,  $\text{SpO}_2(\text{r})$ , with  $\text{SaO}_2$  measured noninvasively from the finger by a standard transmittance pulse oximeter sensor,  $\text{SpO}_2(\text{t})$ .

## REFLECTANCE PULSE OXIMETRY

The principle of reflectance, or backscatter, pulse oximetry is generally similar to that of transmittance pulse oximetry. Both techniques are based on the change in light absorption of tissue caused by the pulsating arterial blood during the cardiac cycle. The pulsating arterioles in the vascular bed, by expanding and relaxing, modulate the amount of light absorbed by the tissue. This rhythmic change produces characteristic photoplethysmographic waveforms, two of which are used to measure  $\text{SaO}_2$  noninvasively.

Recently, we showed that accurate noninvasive measurements of  $\text{SaO}_2$  from the forehead can be made with an unheated reflectance pulse oximeter sensor [1]. The major practical limitation of reflectance pulse oximetry is the comparatively low-level photoplethysmograms recorded from low-density vascular areas of the skin. Therefore, the feasibility of reflectance pulse oximetry depends on the ability to design an optical reflectance sensor that can reliably detect sufficiently strong reflectance photoplethysmograms from various locations on the skin.

In order to partially overcome this limitation, we have developed an optical reflectance sensor that in-

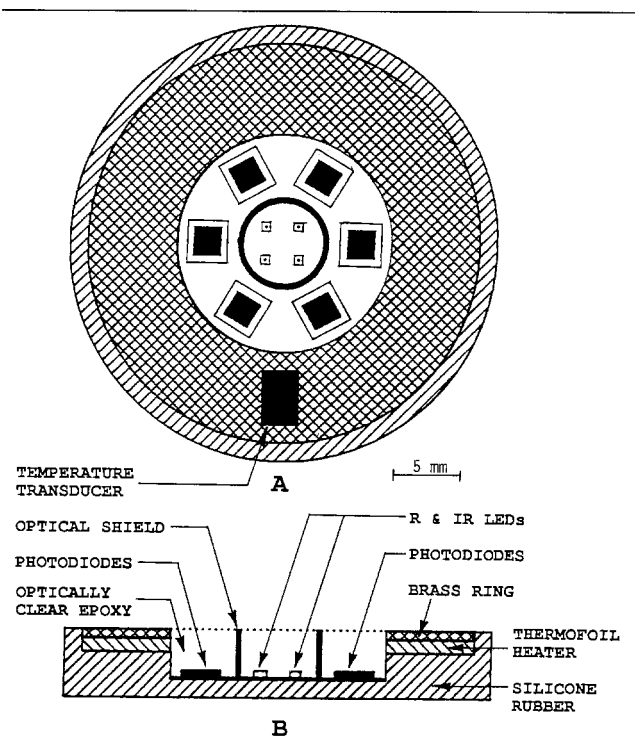


Fig 1. (A) Frontal and (B) side views of the heated skin reflectance pulse oximeter sensor. See text for explanation. R & IR LEDs = red and infrared light-emitting diodes.

cludes an array of six identical photodetectors arranged symmetrically in a hexagonal configuration surrounding two pairs of red (peak emission wavelength, 660 nm) and infrared (peak emission wavelength, 930 nm) light-emitting diodes (LEDs) [1]. In another related study, we showed that by locally heating the skin under the sensor to a temperature above  $40^\circ\text{C}$ , it is possible to achieve a four- to fivefold increase in the magnitude of the pulsatile component detected from the forearm, and thus significantly improve the detection reliability of the reflectance photoplethysmograms [2]. The new optical reflectance sensor designed for this study combines the two features described above.

## SENSOR DESIGN

The temperature-controlled optical reflectance sensor used in this study is shown in Figure 1. The major feature of the optical layout design is the multiple photodiode array, which is arranged concentric with the LEDs. This arrangement maximizes the amount of backscattered light that is detected by the sensor. The technical details related to the design and geometric

configuration of the optical components were described recently by Mendelson et al [1].

The heater consists of a ring-shaped (dimensions: 30-mm outside diameter; 15-mm inside diameter) thermofoil resistive heating element (Ocean State Thermotics, Smithfield, RI). The thermofoil heater was mounted between the surface of the optically clear epoxy, which was used to seal the optical components of the reflectance sensor, and a thin (0.005 mm) matching brass ring, which facilitates better thermal conduction to the skin. A miniature (dimensions:  $2 \times 5 \times 1$  mm) solid-state temperature transducer (AD 590, Analog Devices, Wilmington, MA) was mounted on the outer surface of the brass ring with the thermally sensitive surface facing the skin. The entire sensor assembly was potted in room-temperature vulcanizing silicone rubber to minimize heat losses to the surrounding environment. The assembled sensor weighs approximately 65 g. The sensor measures approximately 38 mm in diameter and is 15 mm thick. The heater assembly was separately interfaced to a temperature controller that was used to vary the temperature of the skin between 35 and 45°C in  $1 \pm 0.1^\circ\text{C}$  steps.

---

## SUBJECTS AND METHODS

---

### *Data Acquisition*

Each of the two heated optical reflectance sensors were separately interfaced to a temperature controller and a commercially available ACCUSAT (Datascope Corp, Paramus, NJ) pulse oximeter [3].

Two of the three ACCUSAT pulse oximeters were modified to function as reflectance pulse oximeters. The modification, which was described in a separate study [1], included the adjustment of the red and infrared LED intensities in the reflectance sensors so that the reflectance photoplethysmograms were approximately equal to transmittance photoplethysmograms measured by a standard transmittance sensor from an average size adult finger tip.

The third ACCUSAT transmittance pulse oximeter was used as a reference to measure  $\text{SpO}_2(t)$  from the finger tip. The specified accuracy of this transmittance pulse oximeter is  $\pm 2.0\%$  and  $\pm 4.0\%$  for  $\text{SaO}_2$  values ranging between 70 and 100% and 60 and 70%, respectively [3]. The three pulse oximeters were adapted to provide continuous digital readouts of the AC and DC components of the red and infrared photoplethysmograms.

Readings from each of the three pulse oximeters were acquired every 2 seconds through a standard RS-232C

serial port interface using an AT&T 6300 personal computer. The conversions of the reflectance red/infrared (R/IR) ratios measured by the two reflectance pulse oximeters to  $\text{SpO}_2(r)$  were performed by using the calibration algorithm obtained in a previous calibration study in which measurements were made with a similar nonheated sensor from the forehead [1].

### *In Vivo Study*

The ability to measure  $\text{SpO}_2(r)$  from the forearm and calf was investigated in vivo during progressive steady-state hypoxia in humans.

Measurements were acquired from 10 healthy non-smoking male adult volunteers of different ages and skin pigmentations. The study was performed in compliance with the University of Massachusetts Medical Center's review guidelines on human experimentation. Each volunteer was informed of the complete procedure as well as the possible risks associated with breathing hypoxic gas levels. Each volunteer received monetary compensation for participation in this study. The subject distribution included 1 East Indian, 3 Asians, and 2 darkly tanned and 4 lightly tanned Caucasians. Their ages ranged from 22 to 37 years old (mean  $\pm$  SD,  $27.5 \pm 4.9$  years). Measured blood hematocrits were in the range of 40 to 50.5% (mean  $\pm$  SD,  $45.7 \pm 3.2\%$ ).

All instruments were allowed to warm up for at least 30 minutes before the study. The transmittance sensor of the pulse oximeter was attached to the index finger. The reflectance sensors were attached to the ventral side of the forearm and the dorsal side of the calf by using a double-sided transparent adhesive ring. In cases where an abundance of hair prevented intimate contact between the sensors and the skin, the contact was improved by loosely wrapping the sensor and the limb with an elastic strap. The temperature of each reflectance sensor was set to 40°C and remained unchanged throughout the entire study.

A standard lead-I electrocardiogram and end-tidal carbon dioxide levels were continuously monitored by a Hewlett-Packard 78345A patient monitor (Hewlett-Packard, Andover, MA). Each subject was placed in a supine position. A face mask was tightly fitted over the subject's nose and mouth, and the subject was instructed to breathe spontaneously while we administered different gas mixtures of nitrogen and oxygen. The inspired gas mixture was supplied by a modified Heidbrink anesthesia machine (Ohio Medical Products, Madison, WI). The breathing circuit of the anesthesia machine was equipped with a carbon dioxide scrubber (soda lime). The inspired oxygen concentration was adjusted between 12 and 100% and was monitored continuously

throughout the study with an IL 408 (Instrumentation Laboratories, Lexington, MA) oxygen monitor, which was inserted in the inspiratory limb of the breathing circuit.

Steady-state hypoxia was gradually induced by lowering the inspired fraction of oxygen in the breathing gas mixture. Initially, the inspired oxygen concentration was changed in step decrements, each step producing approximately a 5% decrease in  $SpO_2(t)$  as determined from the display of the ACCUSAT transmittance pulse oximeter. The inspired oxygen was maintained at each level for at least 3 minutes until the pulse oximeter readings reached a steady level (i.e.,  $SaO_2$  fluctuations of less than  $\pm 3\%$ ). When the inspired oxygen level reached 12%, the process was reversed. Thereafter, the inspired oxygen level was increased in a similar stepwise manner to 100%. Data were recorded during both desaturation and reoxygenation.

All subjects tolerated the procedure well without adverse reactions. None of the subjects showed electrocardiographic abnormalities before or after the study. Each subject was studied for approximately 1 hour.

### Data Analysis

To avoid operator biases, the data from each pulse oximeter were acquired automatically by the computer and later subjected to the same statistical tests.

For each step change in inspired oxygen, readings from the three pulse oximeters were averaged consecutively over a period of 20 seconds. Averaged readings from the 10 subjects were pooled and a least-squares linear regression analysis was performed. Student's *t* test determined the significance of each correlation;  $p < 0.001$  was considered significant.

Although the correlation coefficient of the linear regression ( $r$ ) provides a measure of association between the  $SpO_2(r)$  and  $SpO_2(t)$  measurements, it does not provide an accurate measure of agreement between the two variables. Therefore, the measurement accuracy was estimated on the basis of the mean and standard deviations of the difference between the readings from the transmittance and reflectance pulse oximeters. The mean of the difference between the pulse oximeter measurements, which is often referred to as the bias, was used to assess whether there was a systematic over- or underestimation of one method compared with the other. The standard deviation of the bias, which is often referred to as the precision, represents the variability or random error. Finally, we computed the mean errors and standard deviations of each measurement. The mean error is defined as the absolute bias divided by the corresponding  $SpO_2(t)$  values.

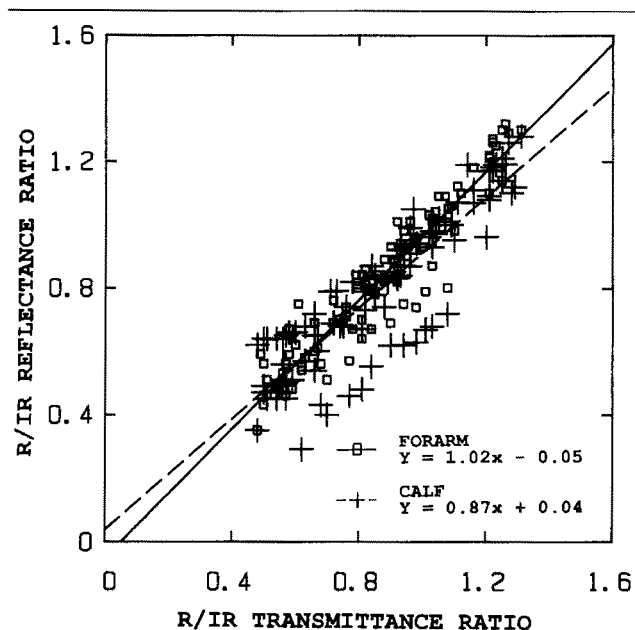


Fig 2. Comparison of red/infrared (R/IR) ratios measured by the modified reflectance pulse oximeter (y axis) and the standard transmittance pulse oximeter (x axis) during progressive steady-state hypoxia in 10 healthy subjects. The solid line represents the best-fitted linear regression line for the forearm measurements. The broken line represents the best-fitted linear regression line for the calf measurements.

## RESULTS

Normalized R/IR ratios and  $SpO_2(r)$  values measured by the reflectance pulse oximeters from the forearm and calf of the 10 subjects were compared with the normalized R/IR ratios and  $SpO_2(t)$  values measured simultaneously by the transmittance pulse oximeter from the finger. A total of 91 and 93 pairs of data points measured simultaneously from the forearm and calf, respectively, were used in the regression analysis, which provided the estimated slopes and intercepts of the linear regression lines. Each pair of data points represents a different hypoxic level.

Regression analysis of the normalized R/IR ratios measured from the reflectance pulse oximeters from the forearm and calf (y axis) versus the normalized R/IR ratios measured simultaneously by the transmittance pulse oximeter from the finger tip (x axis) is shown in Figure 2. The equations for the best-fitted linear regression lines were  $y = -0.05 + 1.02x$  ( $r = 0.94$ ,  $SEE = 0.08$ ,  $p < 0.001$ ) for the forearm and  $y = 0.04 + 0.87x$  ( $r = 0.88$ ,  $SEE = 0.11$ ,  $p < 0.001$ ) for the calf.

A comparison of  $SpO_2(r)$  readings from the reflectance pulse oximeter (y axis) and  $SpO_2(t)$  readings mea-

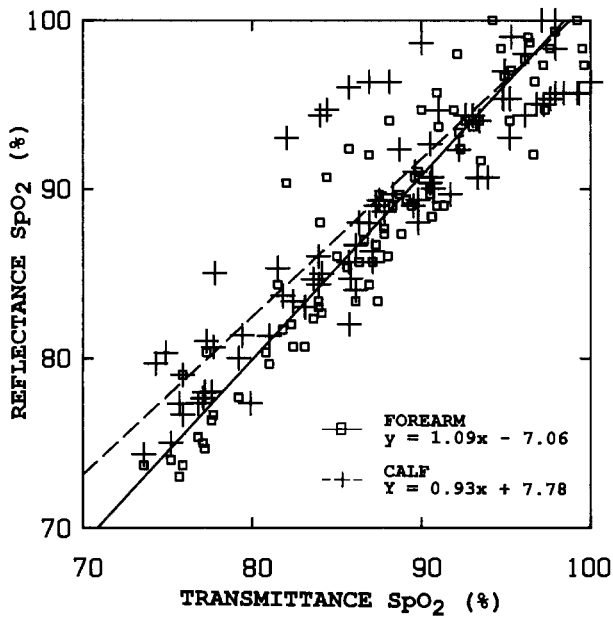


Fig 3. Comparison of percent arterial hemoglobin oxygen saturation ( $SpO_2$ ) measurements obtained from the modified reflectance pulse oximeter (y axis) and  $SpO_2$  values measured by a standard transmittance pulse oximeter (x axis) during progressive steady-state hypoxia in 10 healthy subjects. The solid line represents the best-fitted linear regression line for the forearm measurements. The broken line represents the best-fitted linear regression line for the calf measurements.

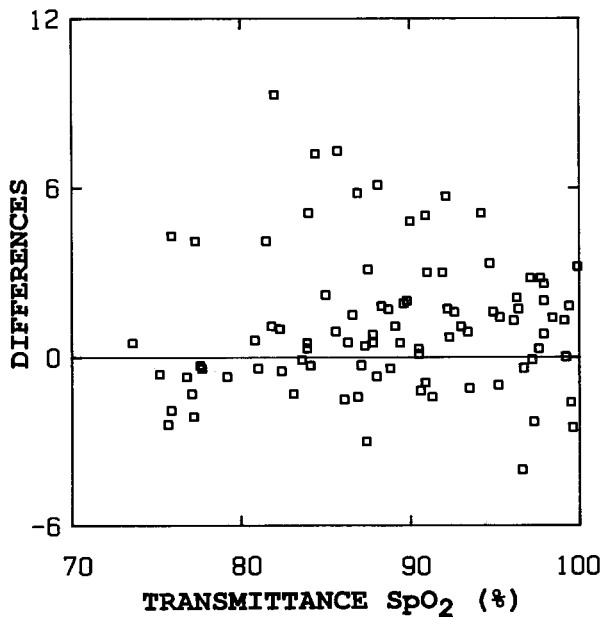


Fig 4. Mean differences between arterial hemoglobin oxygen saturation ( $SpO_2$ ) measured from the forearm by the modified reflectance pulse oximeter and the standard transmittance pulse oximeter measurements from the finger tip.

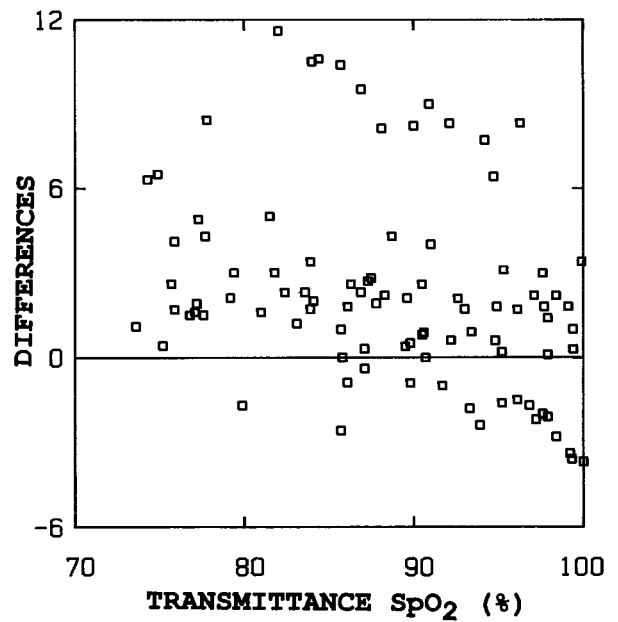


Fig 5. Mean differences between arterial hemoglobin oxygen saturation ( $SpO_2$ ) measured from the calf by the modified reflectance pulse oximeter and the standard transmittance pulse oximeter measurements from the finger tip.

Statistical Analysis of Arterial Oxygen Saturation ( $SaO_2$ ) Levels Measured from the Forearm and Calf by the Modified Reflectance Pulse Oximeters

Location/ % $SaO_2$	No. of Data Points	Mean Value (SD)	
		Difference	% Error
<b>Forearm</b>			
90-100	42	1.25 (2.55)	2.47 (1.66)
80-89	37	0.52 (2.85)	2.35 (2.45)
70-79	12	-0.82 (1.96)	2.42 (1.20)
<b>Calf</b>			
90-100	43	1.57 (4.00)	3.36 (3.06)
80-89	33	2.22 (4.00)	3.45 (4.12)
70-79	17	1.95 (2.42)	2.97 (2.75)

sured simultaneously from the transmittance pulse oximeter (x axis) is shown in Figure 3. The equations for the best-fitted linear regression lines were  $y = -7.06 + 1.09x$  ( $r = 0.95$ ,  $SEE = 2.62$ ,  $p < 0.001$ ) for the forearm and  $y = 7.78 + 0.93x$  ( $r = 0.88$ ,  $SEE = 3.73$ ,  $p < 0.001$ ) for the calf.

Figures 4 and 5 show the percent differences between  $SpO_2(r)$  and  $SpO_2(t)$ , that is,  $SpO_2(r) - SpO_2(t)$ , obtained from the forearm and calf data plotted in Figure 3, respectively. The corresponding means and standard deviations of the differences and errors for the forearm and calf measurements are summarized in the Table.



Data were summarized for three different ranges of  $SpO_2(t)$  values between 70 and 100%.

---

## DISCUSSION

---

Commercially available transmittance sensors can be used on only a limited number of peripheral locations of the body. Brinkman and Zijlstra [4] and Cohen and Wadsworth [5] showed that instead of tissue transillumination, noninvasive monitoring of  $SaO_2$  can be performed based on skin reflectance spectrophotometry. More recently, we described an improved optical reflectance sensor that was used for measuring  $SaO_2$  from the forehead with a modified commercial transmittance pulse oximeter [1].

Measuring large reflectance photoplethysmograms from sparsely vascularized areas of the skin is challenging. Differences in capillary densities between various locations on the body are known to affect the magnitude and quality of the reflected photoplethysmograms. For example, estimated average capillary density of the human forehead is approximately 127 to 149 loops/ $mm^2$ , whereas the capillary densities of the forearm and calf are approximately 35 to 51 and 41 loops/ $mm^2$ , respectively [6,7]. Furthermore, the frontal bone of the forehead provides a highly reflective surface that significantly increases the amount of light detected by the reflectance sensor. Therefore, reflected photoplethysmograms recorded from the forehead are normally larger than those recorded from the forearm and calf. Local skin heating could be used as a practical method for improving the signal-to-noise ratio of the reflected photoplethysmograms from the forearm or calf areas and thus reduce the measurement errors in reflectance pulse oximetry.

The approach presented in this article demonstrated that  $SaO_2$  can be estimated by using a heated skin reflectance sensor from the forearm and calf over a relatively wide range of  $SaO_2$  values. This technique may provide a clinically acceptable alternative to currently available transmittance pulse oximeters. In a previous study [2], we found that the ability to measure accurate  $SaO_2$  values with a reflectance skin oximeter is independent of the exact skin temperature. We noticed, however, that a minimum skin temperature of approximately 40°C is generally sufficient to detect adequately stable photoplethysmograms. Furthermore, our experience in healthy adults also has shown that at this skin temperature, the heated sensor can remain in the same location without any apparent skin damage.

Note that despite the proven advantage of local skin heating to increase skin blood flow, reflected photoplethysmograms recorded from the forearm and the calf are considerably weaker than those recorded from the

forehead. Therefore, the mean errors for the  $SpO_2(r)$  measurements from the forearm and calf are higher than the corresponding errors for similar  $SpO_2(r)$  measurements made with an unheated reflectance sensor from the forehead. For comparison, relative to  $SaO_2$  measured with a noninvasive transmittance pulse oximeter, the SEE for  $SpO_2(r)$  measurements obtained from the forehead using a similar unheated optical reflectance sensor were 1.82% [1]. The SEE obtained in this study using the heated reflectance sensor were 2.62% for the forearm and 3.73% for the calf measurements. Despite those differences, it is apparent that the degree of correlation obtained in this preliminary study is encouraging and in selected clinical applications may be acceptable. We conclude that reflectance pulse oximetry from the forearm and calf may provide a possible alternative to conventional transmittance pulse oximetry and reflectance pulse oximetry from the forehead. Further studies, however, are needed in order to compare our reflectance pulse oximeter against  $SaO_2$  measurements obtained directly from arterial blood samples. Additional work to investigate the source of variability in reflectance pulse oximetry is in progress.

---

Financial support for this study was provided in part by the Datascope Corporation and NIH Grant R15 GM36111-01A1.

The authors would like to acknowledge the clinical assistance of Albert Shahnarian, PhD, Gary W. Welch MD, PhD, and Robert M. Giasi, MD, Department of Anesthesiology, University of Massachusetts Medical Center, Worcester, MA. We also thank Paul A. Nigroni, Datascope Corporation, Paramus, NJ, and Kevin Hines, Semiconductor Division, Analog Devices, Wilmington, MA, for technical assistance. The skillful art work by Yi Wang is also greatly appreciated.

---

## REFERENCES

---

1. Mendelson Y, Kent JC, Yocum BL, Birlle MJ. Design and evaluation of a new reflectance pulse oximeter sensor. *Biomed Instrum Technol* 1988;22(4):167-173
2. Mendelson Y, Ochs BD. Noninvasive pulse oximetry utilizing skin reflectance photoplethysmography. *IEEE Trans Biomed Eng* 1988;35(10):798-805
3. Mendelson Y, Kent JC, Shahnarian A, et al. Evaluation of the Datascope ACCUSAT pulse oximeter in healthy adults. *J Clin Monit* 1988;4:59-63
4. Brinkman R, Zijlstra WG. Determination and continuous registration of the percentage oxygen saturation in clinical conditions. *Neth J Surg* 1949;1:177-183
5. Cohen A, Wadsworth N. A light emitting diode skin reflectance oximeter. *Med Biol Eng Comput* 1972;10:385-391
6. Moretti G. *Handbuch der Haut- und Geschlechtskrankheiten*. Berlin: Springer-Verlag, 1968:491-623
7. Rothman S. *Physiology and biochemistry of the skin*. Chicago: University of Chicago Press, 1954:685

# **APPENDIX QUICKSPECS01**

### Overview



- |                                     |                            |
|-------------------------------------|----------------------------|
| 1. Active Bluetooth/WLAN Indicator  | 6. Inbox Button            |
| 2. Power Button                     | 7. 5-Way Navigation Button |
| 3. LED Power/Notification Indicator | 8. Contacts Button         |
| 4. Color Display                    | 9. Calendar Button         |
| 5. iTask Button                     |                            |

### At A Glance

- Integrated WLAN 802.11b<sup>1</sup>
- Integrated Bluetooth™<sup>1</sup>
- Integrated SD expansion slot
- Microsoft® Windows® Mobile™ 2003 software for Pocket PC
- Dazzling Transflective TFT color with LED backlight display
- Removable/rechargeable battery
- Stay productive with Pocket versions of familiar applications like Microsoft Outlook, Word and Excel

**NOTE** <sup>1</sup>: A standard WLAN infrastructure, other devices enabled with Bluetooth, and a service contract with a wireless airtime provider may be required for applicable wireless communication. Wireless Internet use requires a separately purchased service contract. Check with a service provider for availability and coverage in your area. Not all web content available.

### Standard Features

#### Models

##### iPAQ Pocket PC h4150 – 64-MB SDRAM

- FA174A#ABA – US Commercial, English
- FA174A#ABC – French Canadian
- FA174A#ABG – Australia, New Zealand
- FA174A#ABU – UK, English
- FA174A#ABB – Euro English
- FA174A#ABD – German
- FA174A#ABF – French
- FA174A#ABZ – Italian
- FA174A#ABE – Spanish
- FA174A#B16 – Latin America, Spanish
- FA174A#AC4 – Brazilian Portuguese
- FA174A#ABJ – Japanese
- FA174A#UUF – APD, English
- FA174A#AB2 – S-Chinese
- FA174A#AB0 – Taiwan, T-Chinese
- FA174A#AB5 – Hong Kong, T-Chinese
- FA174A#AB1 – Korean
- FA174A#ARE – Malaysia

##### iPAQ Pocket PC h4155 – 64-MB SDRAM

- FA175A#ABA – US Retail, English

<b>Processor</b>	400 MHz Intel® Xscale™ technology-based processor	
<b>Memory</b>	<b>SDRAM</b>	64-MB (55-MB user accessible) Up to 2.8-MB iPAQ File Store (varies by SKU)
	<b>ROM</b>	32-MB
<b>Display</b>	<b>Type</b>	Transflective type TFT color with LED backlight
	<b>Number of Colors</b>	64K color (65,536 colors) 16-bit
	<b>Touch Screen</b>	Yes
	<b>Resolution (W x H)</b>	240 x 320
	<b>Viewable Image Size</b>	3.5 in (89 mm)
<b>Hardware Buttons/ Reset Buttons</b>	One power button, one recording button, one soft reset switch, four software programmable application buttons, one 5-way navigation button	
<b>Stylus</b>	One (extra stylus included in the box)	
<b>Audio</b>	Integrated microphone, speaker and one 3.5 mm headphone jack, MP3 stereo (through audio jack)	
<b>Notification Systems</b>	<b>Alarms</b>	Solid amber LED (right) - battery in unit fully charged Flashing amber LED (right) - battery in unit is charging Flashing green LED (right) - event alarm/notification Flashing green LED (left) - WLAN active Flashing blue LED (left) - Bluetooth active
	<b>Notification</b>	Sound and message on the display

### Standard Features

Cradle Interfaces	Connector	1
	Cable	1 USB cable connects to PC
	DC Jack connector for AC Adapter	1
	Additional battery charger	Charge additional slim or extended batter

---

SD Slot	Support SDIO and SD/MMC type standard
---------	---------------------------------------

---

Power Supply	<b>Battery</b>	Removable/Rechargeable 1000 mAh Lithium-Ion user swappable battery. Estimated usage time of fully charged battery up to 12 hours (no wireless, no backlight). Optional extended 1800 mAh Lithium-Ion battery available for purchase.
	<b>AC Power</b>	AC Input: 100~240 Vac, 50/60 Hz, AC Input current: 0.2 Aac max Output Voltage: 5Vdc (typical), Output Current: 2A (typical)

**NOTE:** Battery run time varies based on the usage pattern of an individual user and the configuration of the handheld. Use of internal wireless capabilities and backlight will significantly decrease battery run time.

---

Ergonomic Design Features	Instant-on/off and Backlight
	5-way Navigation button
	Touch-sensitive display for stylus
	4 programmable application launch buttons - defaults configured for Calendar, Contacts, Inbox, and iTask buttons
	Record button
	2 alarm settings
Built-in speaker	

---

HP Exclusive Applications	Bluetooth Manager
	iPAQ File Store: non-volatile storage in flash ROM (not available in Japanese, Simplified Chinese, Traditional Chinese and Korean versions)
	iPAQ Backup: utility for Backup/Restore to Main Memory, Memory Card or iPAQ File Store
	iPAQ iTask Manager: access and launch programs easily
	iPAQ Image Zone: view images and create slide shows
	Utilities: Self Test, iPAQ Audio, Power Status

---

### Standard Features

Companion CD from HP

#### APPLICATIONS

##### Full Versions

HP Web registration  
HP Mobile Print Center  
Westtek ClearVue Suite  
F-Secure FileCrypto Data Encryption  
Colligo Personal Edition  
Adobe PDF Viewer  
RealOne Player for Pocket PC  
iPresenter PowerPoint converter  
MobiMate WorldMate  
Resco File Explorer 2003 - U.S. Retail only

##### Trial Versions

Xcellenet Afaria Device Management Agent  
Margi Presenter-to-Go (requires purchase of additional hardware)  
Illum ListPro  
CommonTime Cadenza mNotes  
Resco Picture Viewer - U.S. Retail only

##### CD LINKS

NetMotion  
Avaya IP Softphone  
IP Blue VTGO!  
Cisco CallManager  
Pocket Presence Running Voice IP  
Vindigo  
Audible Manager and Audible Player (Service plan required to download and play Audible content - link)  
SingleTap  
Handango  
Pocket Backup Plus

##### Additional Documentation

Safety and Comfort Guide on PDF, and User Guide on PDF

**NOTE:** Programs may vary based on SKU. Some programs are accessed through CD links to download web sites.

---

#### Operating System

Microsoft Windows Mobile 2003 software for Pocket PC - Premium edition  
Pocket versions of Microsoft software are included (Outlook, Word, Excel and Internet Explorer for Pocket PC)

---

#### Operating System Applications

Powered by Microsoft Windows Mobile 2003 for Pocket PC  
Calendar, Contacts, Tasks, Voice Recorder, Notes, Pocket Word (with Spellchecker), Pocket Excel, Pocket Internet Explorer, Windows Media Player 9 (MP3, audio and video streaming), Calculator, Solitaire, Jawbreaker, Inbox (with Spell Checker for email), Microsoft Reader (eBooks), File Explorer, Pictures, Terminal Services Client, VPN Client, Infrared Beaming, Clock, Align Screen, Memory, Volume control, ClearType Tuner (except for Asian languages)

---

#### Additional Software and links

Outlook 2002, Microsoft ActiveSync 3.7 (Desktop device synchronization), Microsoft Reader eBooks, Links to Microsoft websites for additional downloadable applications (some programs may require purchase of additional desktop software to utilize Pocket PC versions)

---

#### Service and Support

One-year parts and labor in most regions; two-year warranty in Europe (one-year warranty for rechargeable battery pack) 90 days technical support for software in all regions. Optional HP Care Pack available in North America for Next Business Day replacement (at additional charge)

---

### Standard Features

<b>WLAN Specifications<sup>1</sup> Radio Specifications</b>	<b>RF Network Standard</b>	IEEE 802 Part 11b (802.11b)
	<b>Frequency Band</b>	2.4000 to 2.4835 GHz 2.4465 to 2.4835 GHz (France) 2.4000 to 2.497 GHz (Japan)
	<b>Antenna type</b>	Embedded Inverted F Antenna
	<b>WEP Security</b>	64/128-bit compliant to IEEE 802.11 Compliant to 802.1X
	<b>Network Architecture Models</b>	Ad-hoc (Peer to Peer) Infrastructure (Access Points Required)
	<b>Modulation Technique</b>	Direct Sequence Spread Spectrum
	<b>Modulation Schemes</b>	DBPSK, DQPSK, CCK
	<b>Receiver Sensitivity - Packet Error Rate (8E-2)</b>	11 Mbps: <-80 dBm 5.5 Mbps: <-82 dBm 2 Mbps: <-86 dBm 1 Mbps: <-89 dBm
	<b>Maximum Receive Level</b>	-10dBm (1/2/5.5/11 Mbps)
	<b>Output Power (maximum)</b>	15 dBm (limited due to FCC SARS requirements)
	<b>Power Management</b>	Radio On/Off control through Microsoft Connection icon, Power Save mode available in Power Settings
	<b>Power Consumption</b>	Transfer mode: < 380 mA, average Receive mode: < 280 mA, average
	<b>Power Saving Option</b>	802.11 Compliant Power Saving, idle mode 25 mA
	<b>Media Access Protocol Protocols Supported</b>	CSMA/CA (Collision Avoidance) with ACK TCP/IP IPX/SPX UDP
	<b>SAR</b>	1.0 mW/g
	<b>Throughput</b>	>4.5 Mbps
	<b>Operating Distance</b>	Up to 1000 feet - open sight
	<b>Certifications</b>	All necessary regulatory approvals for countries we support including: WECA Wi-Fi approval FCC (47 CFR) Part 15C, Section 15.247&15.249 ETS 300 328, ETS 301 489-1 Low Voltage Directive IEC950 UL, CSA, and CE Mark

**NOTE:** <sup>1</sup> A standard WLAN infrastructure, other devices enabled with Bluetooth, and a service contract with a wireless airtime provider may be required for applicable wireless communication. Wireless Internet use requires a separately purchased service contract. Check with a service provider for availability and coverage in your area. Not all web content available.

### Standard Features

<b>Bluetooth Specifications<sup>1</sup></b>	<b>Technology</b>	High-speed, low-power, short-range
	<b>Bluetooth specification</b>	1.1 compliant (2.4-GHz Industrial Scientific Medical Band)
	<b>System interface</b>	High-speed UART processor interface
	<b>User Interface</b>	Bluetooth Manager
	<b>Device type</b>	Class II device; up to 4 dBm transmit, typical 10 meter range
	<b>Power</b>	3.3V 5% Peak current - typical TX current at approximately 30mA - typical RX current at approximately 50 mA
	<b>Receiver sensitivity</b>	-78 dBm
	<b>Regulatory standards</b>	R&TT#-EN 300 328 and EN 300 826, UL 1950, CB Safety Scheme inclusive of EN 60950 and IEC 950, FCC Part 15 subpart C, Canadian, CE
	<b>Profile Support</b>	General Access Profile Service Discovery Application Profile Serial Port Profile Generic Object Exchange Profile File Transfer Profile Dial-Up Networking Profile LAN Access Profile Object Push Profile Personal Area Networking Profile Basic Printing Profile Hard Copy Replacement Profile (printing)
	<b>Usage Models<sup>1</sup></b>	<b>Service Discovery</b> Determine what Bluetooth devices are within range and support authorization <b>File Transfer</b> File and directory browsing and navigation on another Bluetooth device. File copying Object manipulation - including add, delete, create new folders etc. <b>Serial Port</b> Synchronization between PDAs and PCs <b>Dial Up Networking</b> Wireless link to WAN thru Bluetooth enabled cell phone <sup>1</sup> Agnostic to WAN technology Send/receive SMS messages <b>LAN Access</b> Wireless link to Corporate LAN using Bluetooth and appropriate Bluetooth access point <sup>1</sup> Corporate email, network neighborhood, access to LAN applications, file transfer, ftp, Internet browsing, etc, using TCP/IP <sup>1</sup> Access the Internet by connecting to your desktop or notebook over Bluetooth and using its network connection <sup>1</sup> <b>Generic Object Exchange and Object Push</b> Exchange business cards, tasks, documents, appointments and more <sup>1</sup> <b>Personal Area Networking</b> Collaborate, chat, play games, exchange data <sup>1</sup> Adhoc peer to peer networking <sup>1</sup> <b>Basic Printing and Hard Copy Replacement Profiles</b> Print to any HP Bluetooth enabled printer without the need for cables or specific print drivers
	<b>Certifications</b>	All necessary regulatory approvals for countries we support including: Bluetooth logo, FCC (47 CFR) Part 15C, Section 15.247&15.249 ETS 300 328, ETS 301 489-1/17 Low Voltage Directive IEC950 UL and CE Mark

**NOTE:** <sup>1</sup> A standard WLAN infrastructure, other devices enabled with Bluetooth, and a service contract with a wireless airtime provider may be required for applicable wireless communication. Wireless Internet use requires a separately purchased service contract. Check with a service provider for availability and coverage in your area. Not all web content available.



### TechSpecs

<b>System Unit</b>	<b>Dimensions (H x W x D)</b>	4.47 in x 2.78 in x 0.5 in (113.6 mm x 70.6 mm x 13.5 mm)	
	<b>Weight</b>	4.67oz (132 g)	
	<b>Operating Temperature</b>	32° to 104° F (0° to 40° C)	
	<b>Storage Temperature</b>	-4° to 140° F (-20° to 60° C)	
	<b>Operating Humidity</b>	90% RH	
	<b>Regulatory Marks</b>	Electrical	FCC Class B, UL or CSA NRTL
	Safety	C-UL, NOM	

<b>TFT Color Display</b>	<b>Number of Colors</b>	65,536 (64K 16-bit)	
	<b>Resolution (W x H)</b>	240 x 320	
	<b>Dot Pitch</b>	0.24 mm	
	<b>Viewable Image (W x H)</b>	3.5 in (89 mm)	
	<b>Display Type</b>	64K color (16-bit) transreflective type TFT color with LED	

<b>AC Adapter</b>	<b>Dimensions (H x W x D)</b>	3 x 1.9 x 1.8 in (76 x 48 x 44 mm) (including prongs)		
	<b>Cord Length (approximate)</b>	6 ft (1.83 m)		
	<b>Power Supply Ratings</b>	<b>Voltage Range</b>	100 to 240 V Switching	
		<b>Input Current</b>	0.3 A	
		<b>Input Frequency</b>	50 to 60 Hz	
		<b>Output Voltage</b>	5 VDC	
		<b>Output Current</b>	2 Amp	

### Options

**NOTE:** Optional accessories are available at additional cost.

<b>Memory/Storage</b>	64-MB SD Memory Card	253478-B21	FA134A#AC3
	128 MB SD Memory Card	253479-B21	FA135A#AC3
	256 MB SD Memory Card	287464-B21	FA136A#AC3
	512-MB SD Memory Card	344310-B21	FA184A#AC3
<b>Power</b>	1800 mAh Lithium Ion Extended Battery	343110-001	FA192A#AC3
	1000 mAh Lithium Ion Slim Battery	343111-001	FA191A#AC3
	Auto Adapter	253508-B21	FA125A#AC3
	Charger Adapter	274707-B21	FA133A#AC3
	AC Adapter		
	U.S., Canada, Latin America, Japan, Taiwan	253629-001	FA130A#ABA
	Australia	253629-011	FA130A#ABG
Europe, Brazil	253629-021	FA130A#ABB	
United Kingdom, Asia Pacific, Hong Kong	253629-031	FA130A#ABU	
<b>Synchronization</b>	Desktop Cradle	343116-001	FA188A#AC3
	USB Charge/Sync Cable		FA122A#AC3
<b>Other</b>	Stylus Three-pack	331311-B21	FA113#AC3
	Foldable Keyboard	249693-xxx	FA118A#xxx
	Micro keyboard		FA162A#AC3
<b>Performance</b>	Photosmart Mobile Camera (SDIO Camera)		FA185A#AC3
	iPAQ Navigation System (U.S. only)		FA196A#AC3
<b>Cases</b>	Nylon Case	339657-B21	FA161A#AC3
	Leather Belt Case	339656-B21	FA160A#AC3
	Custom Cases: to view and order go to: <a href="http://www.casesonline.com/">http://www.casesonline.com/</a>		



## HP iPAQ Pocket PC h4150 is a Microsoft® Windows® Powered Pocket PC

For more information on HP iPAQ Pocket PC, visit our website at <http://www.hp.com/go/iPAQ>

©2003 Hewlett-Packard Development Company, L.P.

The information in this document is subject to change without notice.









The only warranties for HP products and services are set forth in the express warranty statements accompanying such products and services. Nothing herein should be construed as constituting an additional warranty. HP shall not be liable for technical or editorial errors or omissions contained herein. Microsoft, Windows and the Windows Logo are registered trademarks or trademarks of Microsoft Corporation in the United States and/or other countries. Intel is a registered trademark of Intel Corporation in the U.S. and/or other countries.

## **APPENDIX QUICKSPECS02**

## Index of /HP/Ipaq/Retired Products/h4150

---

 [parent directory]

	Name	Size	Date Modified
	iPaq_4150_quick_specs.pdf	290 kB	11/20/03, 7:00:00 PM
	iPaq_h4000_Series_User_Guide.pdf	2.4 MB	11/20/03, 7:00:00 PM
	iPaq_h4150_1.JPG	124 kB	11/20/03, 7:00:00 PM
	iPaq_h4150_2.JPG	169 kB	11/20/03, 7:00:00 PM
	iPaq_h4150_3.JPG	375 kB	11/20/03, 7:00:00 PM
	iPaq_h4150_4.JPG	227 kB	11/20/03, 7:00:00 PM
	iPaq_h4150_with_desktop_cradle.JPG	172 kB	11/20/03, 7:00:00 PM
	iPaq_h4150_with_photomart_digital_camera.JPG	117 kB	11/20/03, 7:00:00 PM

## **APPENDIX WEBSTER01**

Welcome back! Our libraries are open with [limited hours](#), [new safety guidelines](#) and [updated services](#) including [curbside pickup](#). Please visit our [Remote Resources page](#) and our [COVID-19 page](#) for more information.



Catalog

Bookmarks 0 Course Reserves My Account

Keyword Search...

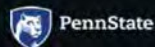
Search

Advanced search Start Over

Bookmark Share

## MARC View

LEADER 01207nam a22003258a 4500  
001 1441469  
003 SIRSI  
005 20151215023516.0  
008 971126t19971997xxk b 000 0 eng d  
010 a| 97037908  
019 a| MARS  
020 a| 0750304677 (alk. paper)  
035 a| LIAS2049620  
035 a| (OCoLC)37553776  
040 c| PSt d| WaOLN d| UtOrBLW  
050 0 0 a| QP99.3.O9 b| D47 1997  
245 0 0 a| Design of pulse oximeters / c| edited by J.G. Webster.  
264 1 a| Bristol ; a| Philadelphia : b| Institute of Physics Pub., c| [1997]  
264 4 c| ©1997  
300 a| xvi, 244 pages : b| illustrations ; c| 24 cm.  
336 a| text b| txt 2| rdacontent  
337 a| unmediated b| n 2| rdamedia  
338 a| volume b| nc 2| rdacarrier  
490 1 a| Medical science series  
504 a| Includes bibliographical references and index.  
650 0 a| Pulse oximeters x| Design and construction.  
700 1 a| Webster, John G., d| 1932-  
830 0 a| Medical science series.  
949 a| QP99.3.O9D47 1997 w| LC c| 1 i| 000032305944 d| 9/10/2015 e| 6/25/2015 i| PATERNO-4 m| UP-PAT n| 14 r| Y s| Y t| BOOK u| 4/13/2001  
949 a| QP99.3.O9D47 1997 w| LC c| 1 i| 000032031126 d| 10/14/2015 e| 6/29/2015 i| STACKS-WB m| WILKESBAR n| 2 r| Y s| Y t| BOOKFLOAT u| 4/13/2001



Copyright ©2019 The Pennsylvania State University. All rights reserved. Except where otherwise noted, this work is subject to a Creative Commons Attribution 4.0 license. Details and exceptions.

[Legal Statements](#) | [PSU Hotlines](#)

### PENN STATE UNIVERSITY LIBRARIES

[Libraries Home](#) (814) 865-6368  
[Libraries Intranet \(Staff Only\)](#)  
[Accessibility Help](#)  
[Website Feedback](#)  
[Policies and Guidelines](#)  
[Staff Directory](#)

### CONNECT WITH PENN STATE UNIVERSITY LIBRARIES

[Facebook](#)  
[Twitter](#)  
[Instagram](#)

## **APPENDIX WEBSTER02**





## **APPENDIX WEBSTER03**

Library buildings are closed to the public until further notice. The LC Catalog is available. However, Automated Call Slip service is only available to some patrons. [More](#)



# CATALOG

LC Catalog Quick Search



SEARCH OPTIONS ▾

LOGIN ▾

← Refine Your Search



1 of 1



BOOK

## Design of pulse oximeters

Full Record   MARC Tags

```
000 01331cam a2200325 a 4500
001 710330
005 20170307115139.0
008 970826s1997 enka b 001 0 eng c
906 _ |a 7 |b cbc |c orignew |d 1 |e ocip |f 19 |g y-gencatlg
925 0_ |a acquire |b 1 shelf copy |x policy default
955 _ |a pc05 to nlm 08-25-97; yn05 to ASCD 08-29-97; jc02 to cps09-03-97; bk. recd. jd00 06-29-98; CIP ver. jd25 07-15-98;
010 _ |a 97037908
020 _ |a 0750304677 (alk. paper)
035 _ |9 (DLC) 97037908
040 _ |a DNLM/DLC |c DLC |d DLC
050 00 |a QP99.3.O9 |b D47 1997
060 10 |a QY 26 D457 1997
082 00 |a 612.1/2 |2 21
245 00 |a Design of pulse oximeters / |c edited by J.G. Webster.
260 _ |a Bristol ; |a Philadelphia : |b Institute of Physics Pub., |c c1997.
300 _ |a xvi, 244 p. : |b ill. ; |c 24 cm.
440 _0 |a Medical science series
504 _ |a Includes bibliographical references and index.
650 _0 |a Pulse oximeters |x Design and construction.
650 12 |a Blood Gas Monitoring, Transcutaneous |x instrumentation.
650 12 |a Equipment Design.
700 1_ |a Webster, John G., |d 1932-
856 42 |3 Publisher description |u http://www.loc.gov/catdir/enhancements/fy0668/97037908-d.html
920 _ |a ** LC HAS REQ'D # OF SHELF COPIES **
991 _ |b c-GenColl |h QP99.3.O9 |i D47 1997 |p 00057256485 |t Copy 1 |w BOOKS
```

Request this Item

LC Find It

Item Availability



BOOK

PRINT RECORD

SAVE RECORD

EMAIL RECORD

CITE RECORD

MARCXML Record  
MODS Record

Report Record Errors  
Ask a Librarian  
Feedback

### Item Availability

CALL NUMBER      QP99.3.O9 D47 1997 FT MEADE  
Copy 2

Request in      Jefferson or Adams Building Reading Rooms - STORED OFFSITE

Status      Not Charged





## **APPENDIX YAO02**



advanced search

## Stimulating Student Learning With A Novel "In House" Pulse Oximeter Design

[Download Paper](#) | [Permalink](#)

### Conference

2005 Annual Conference

### Location

Portland, Oregon

### Publication Date

June 12, 2005

### Start Date

June 12, 2005

### End Date

June 15, 2005

### ISSN

2153-5965

### Conference Session

BME Technical Modules and Laboratories

### Page Count

14

### Page Numbers

10.1138.1 - 10.1138.14

### DOI

10.18260/1-2--14974

### Permanent URL

<https://peer.asee.org/14974>

### Download Count

120

[Request a correction](#)

### Paper Authors

Steve Warren

[author page](#)

Jason Yao

[author page](#)

[Download Paper](#) | [Permalink](#)

### Abstract

NOTE: The first page of text has been automatically extracted and included below in lieu of an abstract

Stimulating Student Learning with a Novel "In-House" Pulse Oximeter Design Jianchu Yao, M.S. and Steve Warren, Ph.D. Department of Electrical & Computer Engineering, Kansas State University Manhattan, KS 66506, USA

Abstract This paper addresses the design of a plug-and-play pulse oximeter and its application to a biomedical instrumentation laboratory and other core Electrical Engineering courses. The low- cost, microcontroller-based unit utilizes two light-emitting diodes as excitation sources, acquires reflectance data with a photodiode, and sends these raw photo-plethysmographic data to a personal computer via an RS-232 serial link. A LabVIEW interface running on the personal computer processes these raw data and stores the results to a file. The design of this pulse oximeter is unique in two ways: the excitation sources are driven just hard enough to always keep the photodiode active (meaning the sensor can be used in ambient light), and the hardware separates out the derivatives of the red and infrared photo-plethysmograms so that it can amplify the pulsatile component of each signal to fill the range of the analog-to-digital converter. Unlike commercial pulse oximeters whose packaging hides the hardware configuration from the students, the open, unpackaged design stimulates student interest and encourages dialogue with the developer; the in-house nature of the design appeals to students. Moreover, most pulse oximeters on the market are expensive and provide users with a front panel that displays only percent oxygen saturation and heart rate. This low-cost unit provides unfiltered pulsatile data, allowing students to investigate tradeoffs between different oxygen saturation calculation methods, test different filtering approaches (e.g., for motion artifact reduction), and extract other biomedical parameters (e.g., respiration rate and biometric indicators). Time-domain data from these units have been used in linear systems and scientific computing courses to teach filtering techniques, illustrate discrete Fourier transform applications, introduce time-frequency principles, and test data fitting algorithms.

1. Introduction An optical pulse oximeter measures the intensity of light passing through heterogeneous tissue and uses variations in this light intensity (primarily resulting from the fractional volume variation of arterial blood) to calculate blood oxygen saturation. Due to its non-invasive nature, high precision in its operational range, and reasonable cost, optical pulse oximetry is widely adopted as a standard patient monitoring technique. Although its foundations date back more than fifty years,<sup>1</sup> many facets of this technology still attract researchers. Current interest areas include motion artifact reduction,<sup>2, 3</sup> power consumption optimization,<sup>4</sup> low-perfusion measurements,<sup>5, 6</sup> and issues germane to various application environments (e.g., wearability for battlefield and home care monitors).<sup>7-9</sup> It is important for biomedical engineering students to understand the principles of pulse oximetry, hardware/software design issues, and signal processing approaches.

Proceedings of the 2005 American Society for Engineering Education Annual Conference & Exposition Copyright © 2005, American Society for Engineering Education

### Citation [Format](#)

Warren, S., & Yao, J. (2005, June), *Stimulating Student Learning With A Novel "In House" Pulse Oximeter Design* Paper presented at 2005 Annual Conference, Portland, Oregon, 10.18260/1-2--14974

ASEE holds the copyright on this document. It may be read by the public free of charge. Authors may archive their work on personal websites or in institutional repositories with the following citation: © 2015 American Society for Engineering Education. Other scholars may excerpt or quote from these materials with the same citation. When excerpting or quoting from Conference Proceedings, authors should, in addition to noting the ASEE copyright, list all the original authors and their institutions and name the host city of the conference. - Last updated April 1, 2015

## **APPENDIX YAO03**

# Stimulating Student Learning with a Novel “In-House” Pulse Oximeter Design

Jianchu Yao, M.S. and Steve Warren, Ph.D.  
Department of Electrical & Computer Engineering, Kansas State University  
Manhattan, KS 66506, USA

## Abstract

This paper addresses the design of a plug-and-play pulse oximeter and its application to a biomedical instrumentation laboratory and other core Electrical Engineering courses. The low-cost, microcontroller-based unit utilizes two light-emitting diodes as excitation sources, acquires reflectance data with a photodiode, and sends these raw photo-plethysmographic data to a personal computer via an RS-232 serial link. A LabVIEW interface running on the personal computer processes these raw data and stores the results to a file. The design of this pulse oximeter is unique in two ways: the excitation sources are driven just hard enough to always keep the photodiode active (meaning the sensor can be used in ambient light), and the hardware separates out the derivatives of the red and infrared photo-plethysmograms so that it can amplify the pulsatile component of each signal to fill the range of the analog-to-digital converter. Unlike commercial pulse oximeters whose packaging hides the hardware configuration from the students, the open, unpackaged design stimulates student interest and encourages dialogue with the developer; the in-house nature of the design appeals to students. Moreover, most pulse oximeters on the market are expensive and provide users with a front panel that displays only percent oxygen saturation and heart rate. This low-cost unit provides unfiltered pulsatile data, allowing students to investigate tradeoffs between different oxygen saturation calculation methods, test different filtering approaches (e.g., for motion artifact reduction), and extract other biomedical parameters (e.g., respiration rate and biometric indicators). Time-domain data from these units have been used in linear systems and scientific computing courses to teach filtering techniques, illustrate discrete Fourier transform applications, introduce time-frequency principles, and test data fitting algorithms.

## I. Introduction

An optical pulse oximeter measures the intensity of light passing through heterogeneous tissue and uses variations in this light intensity (primarily resulting from the fractional volume variation of arterial blood) to calculate blood oxygen saturation. Due to its non-invasive nature, high precision in its operational range, and reasonable cost, optical pulse oximetry is widely adopted as a standard patient monitoring technique. Although its foundations date back more than fifty years,<sup>1</sup> many facets of this technology still attract researchers. Current interest areas include motion artifact reduction,<sup>2,3</sup> power consumption optimization,<sup>4</sup> low-perfusion measurements,<sup>5,6</sup> and issues germane to various application environments (e.g., wearability for battlefield and home care monitors).<sup>7-9</sup> It is important for biomedical engineering students to understand the principles of pulse oximetry, hardware/software design issues, and signal processing approaches.



Pulse oximeter design addresses engineering areas such as optical component selection, mechanical layout, circuit design, microprocessor control, digital communication, and signal processing. Therefore, a pulse oximeter not only serves as an excellent study vehicle that allows students to learn techniques such as photoplethysmographic signal processing; it also provides a platform where students can acquire hands-on experience in practical device design. In addition, the real-time data that a pulse oximeter offers gives instructors flexibility when assigning projects and homework to students of various educational levels (graduate and undergraduate) and backgrounds (e.g., electrical engineering or biology).

Many commercial pulse oximeters display calculated parameters (i.e., percent oxygen saturation and heart rate) on their front panels, hiding the original unfiltered data from which these calculations were made. In this paper, we present an “in-house” pulse oximeter that provides raw sensor data for use in the classroom. The device is utilized in bioinstrumentation laboratory sessions, and its data provide real-world signals to other core Electrical Engineering courses.

This paper first briefly describes the theory behind photoplethysmographic (PPG) pulse oximetry. It then presents the development of a pulse oximeter, emphasizing design features that enable its application to education. These features include (a) a stand-alone pulse oximeter module with a novel circuit design, an open form-factor, and multiple signal outputs, (b) a personal computer station with a flexible, user friendly LabVIEW interface and a variety of signal processing options, and (c) the production of raw data that can be used for parameter extraction exercises. The paper describes how this device and its features have been applied in classroom environments to stimulate student learning. Several examples are introduced in detail, including (a) a pulse oximetry laboratory/lecture pair for a bioinstrumentation course sequence, (b) data sources for course projects in Linear Systems (EECE 512) and Scientific Computing (EECE 840), and (c) a platform upon which undergraduate honors research students can build. This approach can be extended to other devices and classes.

## II. Theory – Principles of Pulse Oximetry

PPG pulse oximetry relies on the fractional change in light absorption due to arterial pulsations. In a typical configuration, light at two different wavelengths illuminating one side of tissue (e.g., a finger) will be detected on the same side (reflectance mode) or the opposing side (transmission mode) after traversing the vascular tissues between the source and the detector.<sup>10</sup> When a fingertip is simplified as a hemispherical volume that is a homogenous mixture of blood (arterial and venous) and tissue, the detected light intensity is described by the Beer-Lambert law:<sup>11</sup>

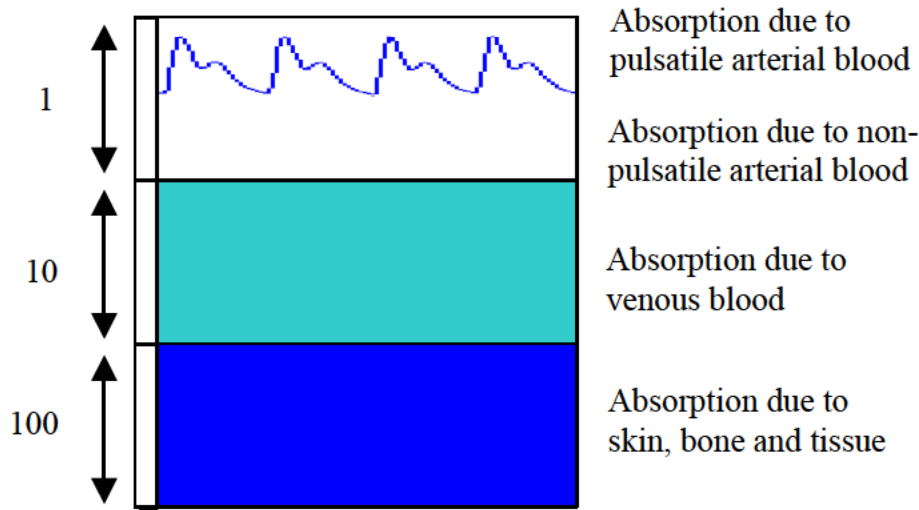
$$I_t = I_0 \left( e^{-\mu_{at}T} \right) \left( e^{-\mu_{av}V} \right) \left( e^{-\mu_{aa}A} \right) \quad (1)$$

where  $I_0$  is the incident light intensity,  $I_t$  is the light intensity detected by the photodetector, and  $\mu_{at}$ ,  $\mu_{av}$ , and  $\mu_{aa}$  are the absorption coefficients of the bloodless tissue layer, the venous blood layer, and the arterial blood layer, respectively, in units of  $\text{cm}^{-1}$ .

The heart's pumping action generates arterial pulsations that result in relative changes in arterial blood volume, represented by  $dA$ , which adds an “ac” component to the detected intensity:

$$dI_t = -I_0 \mu_{aa} \left( e^{-\mu_{at}T} \right) \left( e^{-\mu_{av}V} \right) \left( e^{-\mu_{aa}A} \right) dA \quad (2)$$

Multiple elements contribute to the attenuation of light traveling through tissue, and arterial pulsation has only a small relative effect on the amount of light detected (on the order of one percent or less; see Figure 1).



**Figure 1. Breakdown of the components in the detected photo-plethysmographic signal.<sup>12</sup>**

Dividing this change by the dc value normalizes this variation:

$$\frac{I_{ac}}{I_{dc}} = \frac{dI_t}{I_t} = -\mu_{aa} dA \quad (3)$$

The ratio of the above ratio for two wavelengths ('r' for red, 'IR' for infrared) is given by

$$R = \frac{(dI_t / I_t)_r}{(dI_t / I_t)_{IR}} = \frac{\mu_{a,r}}{\mu_{a,IR}}, \quad (4)$$

where  $\mu_{a,i}$  can be expressed as a function of  $S_a O_2$ ,<sup>13</sup> arterial oxygen saturation:

$$\mu_{a,i} = \frac{H}{v_i} [S_a O_2 \sigma_a^{100\%} + (1 - S_a O_2) \sigma_a^{0\%}] \quad (5)$$

Here,  $i = r, IR$ , while  $\sigma_a^{100\%}$  and  $\sigma_a^{0\%}$  are the wavelength-dependent optical absorption cross sections of the red blood cells containing totally oxygenated and totally deoxygenated hemoglobin, respectively. One can therefore calculate arterial oxygen saturation using

$$S_a O_2 = \frac{R \sigma_{a,IR}^{0\%} - \sigma_{a,r}^{0\%}}{(\sigma_{a,r}^{100\%} - \sigma_{a,r}^{0\%}) + R(\sigma_{a,IR}^{0\%} - \sigma_{a,IR}^{100\%})} \quad (6)$$

Equation (6) provides the desired relationship between the experimentally-determined ratio  $R$  and the arterial oxygen saturation  $S_a O_2$ . Researchers assume this relationship applies to monochromatic light sources. In reality, commonly available LEDs are used as light sources and typically have spectral widths of 20 to 50 nm. Therefore, the standard molar absorption coefficient for hemoglobin cannot be used directly in (6). Furthermore, the simplified mathematical description above only approximates a real system that incorporates

inhomogeneities and mechanical movement. Consequently, (6) is often represented empirically by fitting clinical data to the following generalized function:

$$S_a O_2 = k_1 R + k_2 \quad (7)$$

where, e.g.,  $k_1 = -25.6$ ,  $k_2 = 118.8^{14}$  or  $k_1 = -25$ ,  $k_2 = 110^{15}$

### III. Methods

#### A. Pulse Oximeter Development

As shown in the functional block diagram in Figure 2, a pulse oximeter consists of three main units: (1) an optical probe, (2) a circuit module that hosts an analog amplifier, signal conditioning element, and microcontroller, and (c) a personal computer that receives data from the circuit module and processes, displays, and stores these data.

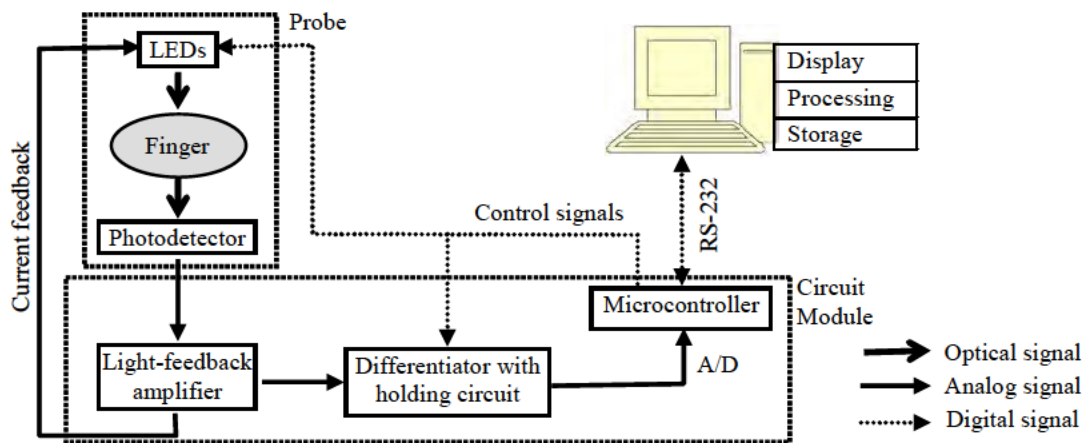


Figure 2. Functional block diagram of the pulse oximeter.

The analog portion of the pulse oximeter consists of a light-feedback amplifier and an analog differentiator with a specialized sample and hold circuit. The current feedback design adjusts the light level at the excitation LEDs such that the detected light intensity is constant, keeping the photodiode centered in its active region. To improve the stability of this feedback loop, a photodiode with smaller gain, rather than a phototransistor, is used as a photodetector. Two LEDs with wavelengths of 660 nm and 940 nm were selected as excitation sources.

As discussed earlier, the “ac” component resulting from arterial blood volume variation is very small. If A/D conversion is performed on the overall signal, this tiny “ac” component will be buried in the “huge” “dc” component after conversion. A differentiator addresses this issue. It removes the “dc” component by subtracting the previous signal voltage-level from the present signal voltage-level and amplifies this difference, yielding the “ac” component. A hold circuit is added to store voltage-levels from the previous sample cycle. The differentiator improves signal resolution by allowing one to take advantage of the full range of the A/D converter.

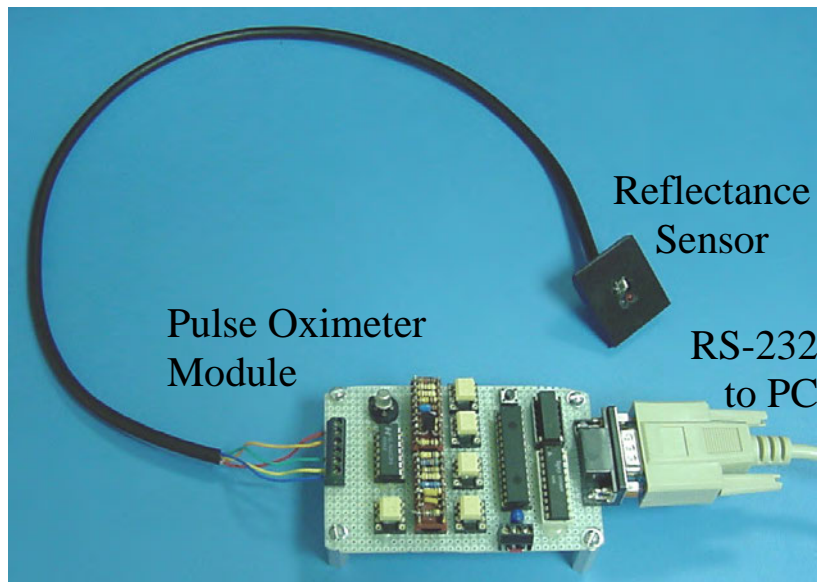
This circuitry is coordinated by a PIC microcontroller. Three output lines control the operation of the circuitry, and two A/D inputs sample the desired signal. Two outputs modulate the two light sources and switch the charging and discharging of their corresponding hold capacitors. The

other output operates the differentiator. The two A/D inputs acquire and digitize two signals: the “dc” signal when the differentiator is turned off (it is actually the original signal that includes both “dc” and “ac” components) and the amplified difference of the present and previous voltage level when the differentiator is turned on.

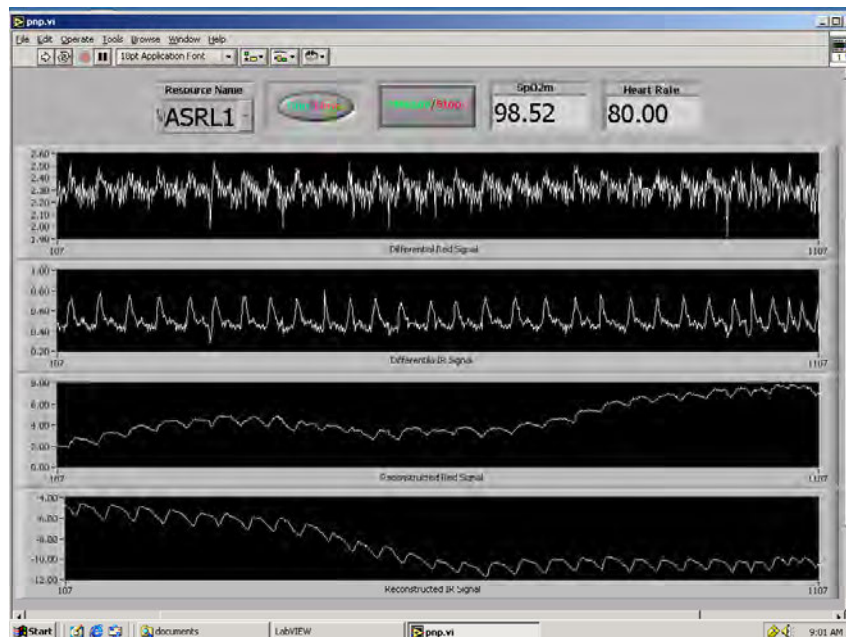
The PIC microcontroller also operates an RS-232 port to a personal computer running a LabVIEW interface. Digitized data are sent to the PC over this RS-232 interface. Because the sensor module and personal computer communicate asynchronously, and 8 bytes (two bytes for each signal) are sent in each RS-232 packet, a handshaking protocol is used to synchronize the two devices. The PC generates an acknowledgement after successfully receiving each data packet so that the pulse oximeter module can transmit the next data packet.

On the PC, LabVIEW virtual instruments (a) reconstruct the differentiated data, (b) filter the pulsatile signal with motion artifact reduction algorithms, (c) display the differentiated and reconstructed waveforms, (d) compute and display values for heart rate and blood oxygen saturation (see Figure 4), and (e) store the original and processed data to a text file for follow-up analysis. The data in the file are in columnar format:

- Column 1 – Time in milliseconds,
- Column 2 –  $d(I_{ac})_{ir}/dt$  (derivative of the near-infrared signal)
- Column 3 –  $(I_{dc})_{ir}$
- Column 4 –  $d(I_{ac})_{red}/dt$  (derivative of the red signal)
- Column 5 –  $(I_{dc})_{red}$
- Column 6 –  $(I_{ac})_{ir}/dt$  (reconstructed near-infrared signal)
- Column 7 –  $(I_{dc})_{red}$  (reconstructed red signal)



**Figure 3. Pulse oximeter module and reflectance probe.**



**Figure 4. LabVIEW virtual instrument for the pulse oximeter. In addition to heart rate and blood oxygen saturation (%), the interface displays the red and infrared derivative data (top two waveforms) and the red and infrared reconstructed data (bottom two waveforms).**

### ***B. A Pulse Oximetry Lecture/Laboratory Pair***

At Kansas State University, the 4-credit-hour Bioinstrumentation course sequence (URL: <http://www.eece.ksu.edu/~eece772/>) consists of three courses instructed by faculty from the Department of Electrical & Computer Engineering (EECE) and the Department of Anatomy and Physiology (AP). These courses are EECE 772 (Theory and Techniques of Bioinstrumentation, 2 hours), EECE 773 (Bioinstrumentation Design Laboratory, 1 hour), and AP 773 (Bioinstrumentation Laboratory, 1 hour). These courses can be taken for either undergraduate or graduate credit. The two laboratory hours provide hands-on experience and are intended to help students obtain a deeper understanding of concepts learned in lectures.

The pulse oximeter discussed earlier serves as a basis for a lecture/laboratory pair in the Bioinstrumentation course sequence. In order to improve the quality of the laboratory, the second author designed a laboratory session for AP 773 that uses the pulse oximeter developed by the first author. Four sets of devices were constructed and have been used as teaching tools in these laboratory sessions. The **learning objectives** of this laboratory (i.e., what a student should be able to do upon completion of the laboratory) are the following:

- Explain the physiological origin of a photoplethysmogram
- Describe the hardware and software components required to determine blood oxygen saturation using light-based sensors
- Calculate blood oxygen saturation given a set of red/infrared plethysmograms
- Assess the character and spectral content of the time-varying signals



- Extract physiological data from a photoplethysmogram
- Describe person-to-person variations in plethysmographic signal data
- Calculate calibration coefficients using different approaches
- Counteract the effects of mild motion artifact

During the laboratory, the class is divided into groups of 2~3 students. Each group is equipped with a collection of components: a reflectance probe, a circuit module, a serial cable, and a personal computer with the LabVIEW interface installed. The students are first taught how to use the modules properly. They then gather PPG data from their team members at different body locations and save these data to files for later signal processing.



**Figure 5. Two students acquire photoplethysmographic data in the AP 773 pulse oximetry laboratory (Fall 2002).**

These data are processed using Microsoft Excel or MATLAB. In addition to observing and analyzing time domain data, the students are also required to interpret and understand the spectral components of the signal by performing Fast Fourier Transforms (FFTs) on the data sets. They implement different methods for calculating the “ac/dc” ratios required to obtain arterial oxygen saturation. Two calculation methods are used to compute these ratios. The methods correspond to Equations 3 and 4, which supply a parameter for Equation 7. The ‘peak/valley’ method considers the peak-to-valley amplitude of the reconstructed signal as  $I_{ac}$  when calculating the “ac/dc” ratio. This method is evaluated with two different filtering techniques: a sliding average filter and a sliding median filter. The FFT method uses the spectral peaks of the red and near-infrared signals to represent  $I_{ac}$  in the calculations. The students are then asked to compare the calculation methods and choose the best one.

Students are also encouraged to experiment with other noise reduction filters. Additionally, by observing and analyzing waveforms acquired from different team members, students can realize that factors such as skin color and perfusion affect the quality of acquired PPG data. They are also asked to evaluate the differences between PPG signals acquired at different body locations (e.g., wrist, forehead, or ear lobe) that have noticeably different vascular profiles.

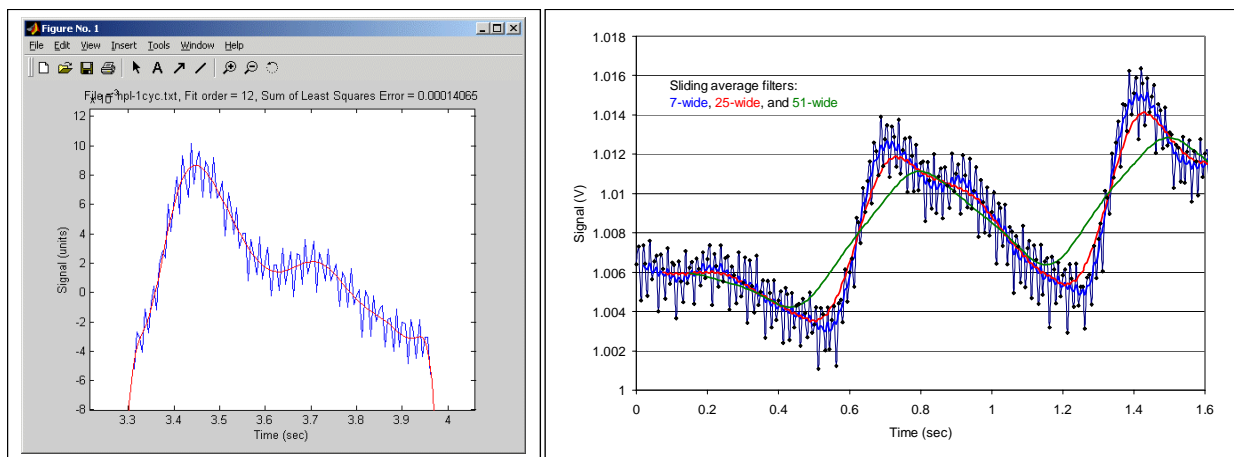
### C. Pulse Oximeter Applied to Other Educational Venues

In addition to the lecture/laboratory pair noted in the previous section, the pulse oximeter design and the signal data gathered from various implementations of this design have been applied in multiple undergraduate (*EECE 499 – Honors Research; EECE 512 – Linear Systems*) and graduate (*EECE 840 – Scientific Computing*) educational venues. The **signals** acquired from this platform have been used in the following ways:

- data for time-domain smoothing algorithms (see Figure 6),
- signals for time- and frequency-domain filtering projects (see Figure 7 and Figure 8),
- waveforms for Fourier series reconstruction projects (see Figure 9), and
- signals for time-frequency spectrogram projects (see Figure 10).

The **modules** have also been used as starting points for various undergraduate honors research projects, as depicted in Figure 11.

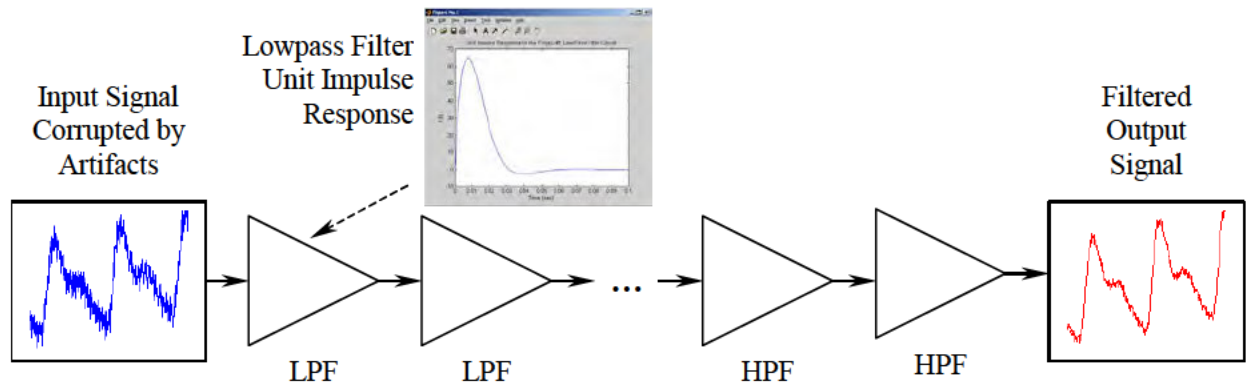
**Course Projects.** In the smoothing exercises (see Figure 6), students are asked to perform signal processing exercises to ‘smooth out’ variations in signals corrupted with noise. Two of the common techniques are illustrated here. Polynomials, by their nature, are smooth curves whose numbers of peaks and valleys correspond to the order of the polynomial. In this figure, a polynomial of order 12 provides a reasonable representation of the original data set. Note that the behavior of the fitting polynomial is unpredictable outside of the original bounds. Sliding average and median filters are also a smoothing approach that can be implemented by a young student without much programming experience (the graph on the right in Figure 6 was produced with an Excel spreadsheet). For this photoplethysmograph (sampled at 160 Hz), a 7-wide sliding window appears to provide a reasonable job of smoothing out the noise while retaining the fundamental shape of the waveform.



**Figure 6. Data smoothing algorithms (polynomial fits and sliding average filters) applied to photoplethysmographic data. These exercises were assigned in EECE 772 (Bioinstrumentation) and EECE 840 (Scientific Computing).**

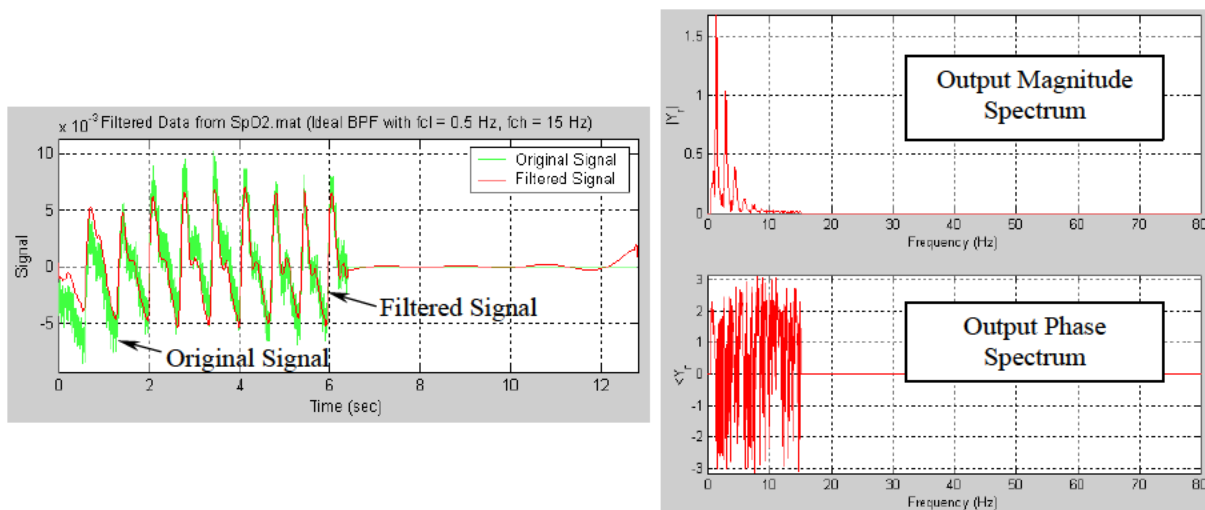
In the EECE 512 project depicted in Figure 7, a student’s code (1) loads a signal from an input ASCII text file, (2) performs a convolution (i.e., filtering operation) between the input signal and a cascade of 2<sup>nd</sup>-order Butterworth lowpass and highpass filters (which can be combined to create lowpass, highpass, or bandpass filters), (3) saves the output signal to disk, and (4) plots the original and filtered signals to the screen. Input signals for these simulations include both ideal

signals (e.g., pulses, square waves, and sinusoids) and real-world signals (e.g., biomedical signals such as electrocardiograms and light reflectance signals from the pulse oximeter modules presented here).



**Figure 7. Multi-stage filtering of photoplethysmographic data via time-domain convolution in EECE 512 (Linear Systems). Stages: 2<sup>nd</sup>-order lowpass and highpass filters.**

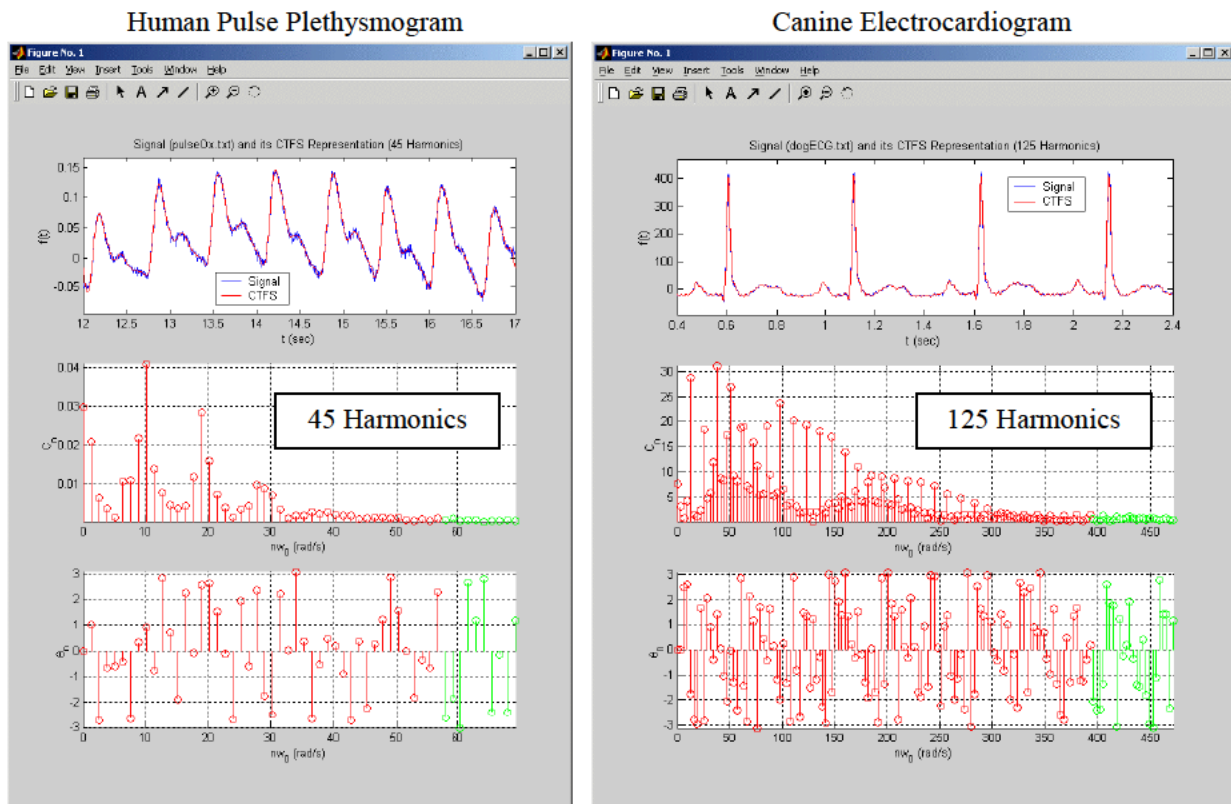
Frequency-domain filters are also an important part of a signals and systems course. In these projects, a student's program typically (1) loads an input signal from a file and calculates its Fourier transform, (2) calculates the frequency response of a filter chosen by the user, and (3) performs a frequency-domain filtering operation on the input signal: it multiplies the input signal spectrum by the spectrum of the filter and then takes the inverse Fourier transform of the result. The program then saves the input/output signals, their spectra, and the filter spectra to a set of ASCII text files and creates a plotting script that can be called by MATLAB or GNUPLOT. In the example illustrated in Figure 8, an ideal bandpass filter with a low cutoff of 0.3 Hz and a high cutoff of 15 Hz was used to remove the drift and 60 Hz noise present in the original plethysmographic signal.



**Figure 8. Frequency-domain filtering of pulsatile light reflectance data to remove signal drift and 60 Hz noise. Course: EECE 512 (Linear Systems).**

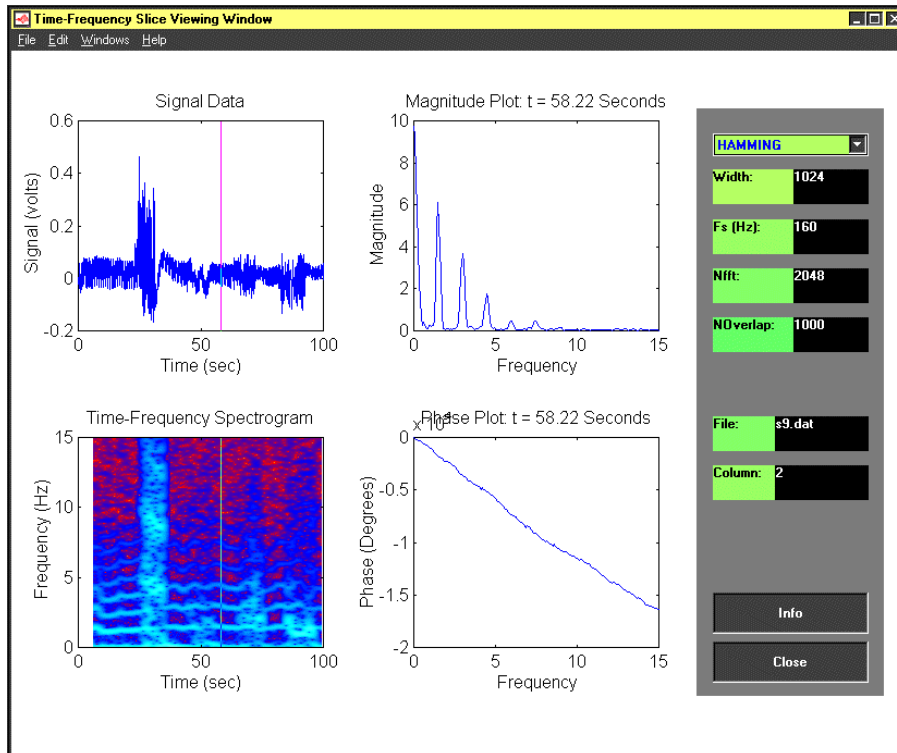


Figure 9 illustrates the use of light reflectance signals in a Fourier series project. In the left part of Figure 9, the top set of axes displays a PPG signal and its Fourier series reconstruction. The middle and bottom axes plot the magnitude and phase coefficients, respectively, that were calculated for the reconstruction. Note that 45 harmonics (or cosines with different magnitudes and phases) were required to replicate the shape of the initial signal. In the canine electrocardiogram depicted on the right hand side of the figure, 125 harmonics produced a good reconstruction. This is due to the higher frequency components present in each QRS complex.



**Figure 9. Reconstruction of biomedical signal data (human finger photoplethysmogram and canine electrocardiogram) using Fourier series. Class: EECE 512 (Linear Systems).**

It can be helpful to understand how a signal's spectral character changes as a function of time. Figure 10 presents an example of a MATLAB interface that would be written by a student in a graduate scientific computing course. In this figure, the upper left set of axes plots the time-domain plethysmogram, while the lower left set of axes displays the spectrum of the signal versus time. The plots on the right depict the magnitude and phase spectrum of the input signal at the time denoted by the vertical line that occurs at ~55 seconds (see the upper left trace). The fields on the right side of the interface depict parameters that can be chosen by the user.



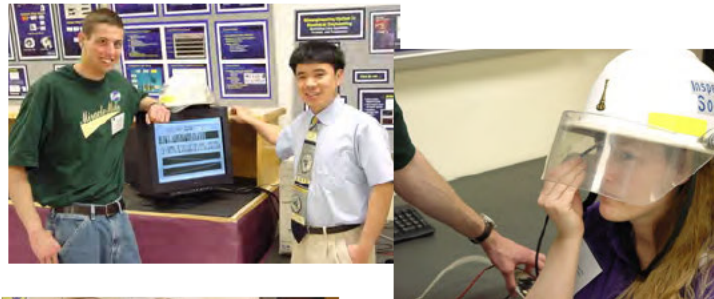
**Figure 10. Time-frequency analysis of reflectance data in EECE 840 (Scientific Computing).**

**Honors Research Projects.** The undergraduate Electrical & Computer Engineering curriculum at KSU allows high achieving students to perform research for course credit. The pulse oximeter modules presented in this paper have contributed to five EECE 499 (Honors Research) projects to date (see Figure 11). For the project shown at the top of the figure, Ben Young developed a system based upon the pulse oximeter module that acquired light reflectance data from the forehead using sensors mounted on a firefighter helmet. The goal of this project was to establish whether meaningful blood oxygen saturation measurements could be acquired continuously on an individual that needed to use their hands freely and could be exposed to dangerous levels of carbon monoxide. The second project from the top, managed by Shelly Allison and Craig Nelson, involved gathering light reflectance data from normal and hypertensive elderly subjects. These data will be analyzed for correlations between spectral behavior and the measured blood pressure of the subjects. The goal is to find a comfortable, noninvasive way to replicate the information normally provided by often painful blood pressure cuffs.

As noted in Figure 11, Jonathan Hicks investigated a method to use a patient's light reflectance data as a biometric indicator. This capability would allow a home monitoring system to authenticate the identity of a patient prior to uploading the patient's physiological data to a remote electronic patient record. The benefits of this approach are two-fold: (1) no interaction is required on the part of the patient and (2) the data are independently verified prior to submission. The plots in Figure 11 show a representative light reflectance signal for a patient and the single-period template used to represent that time-varying signal. Two other representative templates are also depicted in the figure to show how these wave shapes vary from person to person. This

method uses a statistical test to determine whether a patient's current data are similar to the single-period template stored for the patient. Finally, Austin Wareing was supported by an NSF Research Experience for Undergraduates grant to optimize the light reflectance sensor design and improve the interaction between the pulse oximeter and the host LabVIEW program. His radial sensor design and a resulting set of waveforms are depicted at the bottom of Figure 11.

Ben Young: Forehead Measurements of Blood Oxygen Saturation for Use with Fire Fighter Helmets



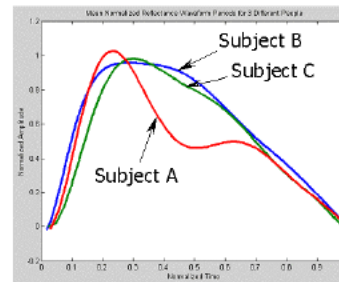
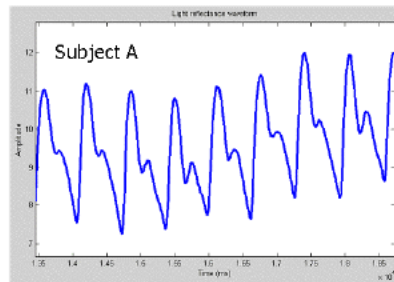
Shelly Allison and Craig Nelson: Light-Based Indicators for Hypertension



Jonathan Hicks: Photoplethysmographic Signals as Biometric Authenticators

Multi-Period Light Reflectance Waveform

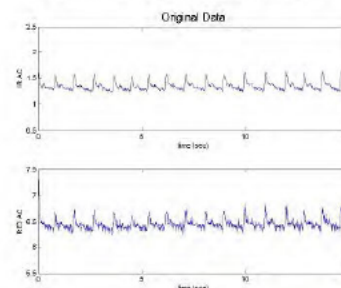
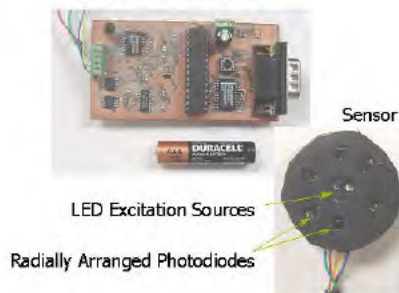
Single-Period Light Reflectance Templates



Austin Wareing: Optimization of Light Reflectance Sensors

Pulse Oximeter Module

Reflectance Data from the Thumb



**Figure 11. Honors research projects that have benefited from the pulse oximeter design.**

*Proceedings of the 2005 American Society for Engineering Education Annual Conference & Exposition  
Copyright © 2005, American Society for Engineering Education*

#### **IV. Discussion and Conclusion**

This paper presented initial efforts to apply an in-house pulse oximeter design to multiple secondary education venues. These efforts have indicated that students enjoy instructional experiences that utilize real-world devices, especially when they can manipulate elements of the design such as the signal processing algorithms that would normally be hidden from the user. The pulse oximeter modules have been used in four Fall offerings of the AP 773 laboratory (2001~2004). Because these home-grown pulse oximeters offer improved data access as compared to commercial products, instructors can experience far greater flexibility when assigning homework, which is especially appreciated when the background and educational experiences of the students vary significantly.

Each laboratory session that utilized these modules has been supported by device developers. Interactions between the device developers and the students (users) lead to experiences that are hard to replicate with packaged, off-the-shelf units. These interactions help the students appreciate the concepts discussed in lecture and allow them to become more familiar with the device development process.

As noted in the body of the paper, several other undergraduate and graduate courses have benefited from the data availability offered by these pulse oximeters. When asked, “What part of the project did you like the most” (on the survey for the Spring 2003 Linear Systems project depicted in Figure 7) one student responded, “Being able to see the ECG and pulse oximeter signals with the noise filtered out.” Many other individuals in this class of 65 students had similar opinions about working with data provided by a device in a nearby laboratory. Processing real-world signals stimulated the students’ interest the most, followed by the excitement of simply getting their code to work. The same Linear Systems student, when asked the question, “How could a project of this nature be improved?,” responded with, “More realistic signals to filter – that is what made me feel like this was a realistic project.”

The inexpensive hardware, plug-and-play features, and information-rich signals offered by these pulse oximeters have also provided starter platforms for honors students that wish to perform innovative research. These experiences not only help them to apply knowledge learned from their courses and understand recent developments; more importantly, they may also motivate these capable students to pursue careers in an expanding biomedical industry.

#### **Acknowledgements**

The authors wish to acknowledge Jerry T. Love, Sandia National Laboratories (retired), for the original design of the light feedback circuit. Portions of this material are based upon work supported by the National Science Foundation under grant BES-0093916. Opinions, findings, conclusions, or recommendations expressed in this material are those of the author(s) and do not necessarily reflect the views of the NSF. All studies addressed in this paper that involve human subjects have been approved by the Human Studies Board at Kansas State University under protocol #2211.

## References

- [1] Brinkman, R. and W. G. Zijlstra. "Determination and continuous registration of the percentage oxygen saturation in clinical conditions," *Arch. Chir. Neurol.*, vol. 1, pp. 177-183.
- [2] Swedlow, D. B. "Oximeter with motion detection for alarm modification," International Patent Application WO 94y22360 ~13, 1994, pp.
- [3] Yao, J., and S. Warren. "A Novel Algorithm to Separate Motion Artifacts from the Photoplethysmographic Signal for a Pulse Oximeter," presented at 4th Joint EMBS-BMES Conf., San Francisco, CA, 2004.
- [4] Rhee, Sokwoo, B.-H. Yang, and H. H. Asada,. "Artifact-resistant power-efficient design of finger-ring plethysmographic sensors," *IEEE Transactions on Biomedical Engineering*, vol. 48, May, pp. 795-805.
- [5] Mannheimier, P.D., J.R. Cascini, M.E. Fein, and S.L. Nierlich. "Wavelength selection for low-saturation pulse oximetry," *IEEE Transactions on Biomedical Engineering*, vol. 44, March, pp. 148 - 158.
- [6] Zonios, G., U. Shankar, and V.K. Iyer. "Pulse oximetry theory and calibration for low saturations," *IEEE Transactions on Biomedical Engineering*, vol. 51, May, pp. 818 - 822.
- [7] Warren, S., J. Yao, and G. E., Barnes. "Wearable Sensors and Component-Based Design for Home Health Care," presented at 2nd Joint EMBS-BMES Conf., Houston, TX, 2002.
- [8] Johnston, W.S., P.C. Branche, C.J. Pujary, and Y. Mendelson. "Effects of motion artifacts on helmet-mounted pulse oximeter sensors," presented at Proceedings of the IEEE 30th Annual Northeast Bioengineering Conference, 2004, 2004.
- [9] Crilly, P.B., E.T. Arakawa, D.L. Hedden, and T.L. Ferrell. "An integrated pulse oximeter system for telemedicine applications," presented at Proceedings of the IEEE Instrumentation and Measurement Technology Conference, 1997, 1997.
- [10] Bronzino, Joseph D. *IEEE Biomedical Engineering Handbook*: CRC Press, IEEE Press, 1995, 0-8493-8346-3.
- [11] Yoshiya, Y. Shimada, and K. Tanaka. "Spectrophotometric monitoring of arterial oxygen saturation in the fingertip," *Med. Biol. Eng. Comput.*, vol. 18, pp. 27-32.
- [12] Peck, Y., S. Cheang, and Peter R Smith. "An Overview of Non-Contact Photoplethysmography," *Electronic systems and control division research*, pp. 53~59.
- [13] Schmitt, J. M. "Simple photon diffusion analysis of the effects of multiple scattering on pulse oximetry," *IEEE Transaction on Biomedical Engineering*, vol. 38, December, pp. 1194-1203.
- [14] Mendelson, Yitzak, Peter W. Cheung, Michael R. Neuman, David G. Fleming, and Stephan D. Cahn. "Spectrophotometric Investigation of Pulsatile Blood Flow for Transcutaneous Reflection Oximetry," *Advances in Experimental Medicine and Biology*, vol. 159, pp. 93-102.
- [15] Love, Jerry T., S. Warren, G. R. Laguna , and T. J. Miller. " Personal Status Monitor," Sandia National Lab SAND97-0418, 1997.

## Biographical Information

Jianchu Yao is a doctoral candidate in Electrical Engineering at Kansas State University. Prior to his study at KSU, Mr. Yao worked on real-time embedded controls for five years in the continuous manufacturing processes and robotics industry. His current research interests include bioinstrumentation, sensor networking, and plug-and-play devices.

Steve Warren is an Associate Professor of Electrical & Computer Engineering at Kansas State University. He teaches courses in linear systems, computer graphics, biomedical instrumentation, and scientific computing. Dr. Warren manages the KSU *Medical Component Design Laboratory*, and his research focuses on plug-and-play, wearable systems for telemedicine.

## **APPENDIX LANDON01**

```
leader 01081cam a2200361Ia 4500
001 993402473405201
005 20150731130506.0
008 040917s2004 nju 001 0 eng d
010 ##$a 2004103154
020 ##$a0764558897 (pbk.)
035 ##$a(OCoLC)56527815
035 ##$a(NjGbs)340247-rowandb
040 ##$aCQU $cCQU $dNJG $dUtOrBLW
049 ##$aNJGA
090 ##$aQA76.76.A65 $bL25 2004
092 ##$a005.446 $bL259m
100 1#$aLandon, Bill.
245 10$aMaster visually Windows Mobile 2003 / $cby Bill Landon and Matthew Miller.
246 3#$aWindows Mobile 2003
264 #1$aHoboken, NJ : $bWiley, $c[2004]
264 #4$c@2004
300 ##$a311 pages : $billustrations ; $c23 cm.
336 ##$atext $btxt $2rdacontent
337 ##$aunmediated $bn $2rdamedia
338 ##$avolume $bnc $2rdacarrier
490 1#$aVisual read less, learn more
500 ##$a"From MaranGraphics & Wiley Publishing"--T.p.
500 ##$aIncludes index.
650 #0$aPocket computers.
700 1#$aMiller, Matthew.
710 2#$aMaranGraphics Inc.
830 #0$aVisual read less, learn more.
994 ##$aC0 $bNJG
998 ##$aUtOrBLW
```

# **APPENDIX MCPHERSON01**



# The CATALOG

Connecting Public Libraries in Allegheny County, PA

- [Your Library](#)
- [Tips & Resources](#)
- [Booklists](#)
- [Find Articles](#)
- [Interlibrary Loan](#)
- [Get a Library Card](#)

[Start Over](#)
[Add to Wish List](#)
[Regular Display](#)
[Another Search](#)

```

LEADER 0000nam 220000Ia 4500
001 69854494
003 OCoLC
005 20150415175204.0
008 060605s2006 nyua 001 0 eng d
020 0072262508 (pbk.)
040 KZT|cKZT|dQBX|dCPL|dUtoBLW
049 CPLL
082 04 004.165|222
090 QA76.5|b.M37 2006x
100 1 McPherson, Frank.
245 10 How to do everything with Windows Mobile /|cFrank
    McPherson.
246 30 Windows Mobile
250 [4th ed.].
260 New York :|bMcGraw-Hill,|c2006.
300 xviii, 414 pages :|billustrations ;|c24 cm.
336 text|btxt|2rdacontent
337 unmediated|bn|2rdamedia
338 volume|bnc|2rdacarrier
490 1 How to do everything with
500 Edition statement from p. xv.
500 Rev. ed. of: How to do everything with your pocket PC. 3rd
    ed. 2003.
500 "Covers pocket PCs, pocket PC phones, and smartphones"--
    Cover.
500 Includes index.
520 "Pocket PCs, Pocket PC Phones, and Smartphones are part of
    a series of hardware devices that run the Microsoft
    Windows CE.NET operating system and application software.
    Also in the series are the Handheld PC, Auto PC, and
    embedded devices. The combination of Windows CE.NET and
    application software is known as Windows Mobile Software
    for pocket PCs, Pocket PC Phones, and Smartphones." --
    xvii.
630 00 Microsoft Windows (Computer file)
650 0 Pocket computers.
650 0 Operating systems (Computers)
700 1 McPherson, Frank.|tHow to do everything with your pocket
    PC.
830 0 How to do everything with--
994 C0|bCPL
997 nleds
997 xasjr
997 xagap
    
```

LOCATION	CALL #	STATUS
<a href="#">Penn Hills Non-Fiction</a>	<a href="#">004.165 MCP</a>	AVAILABLE