

acid). The obtained oils or fats (triglycerides) were methylesterified, and the obtained fatty acid methyl ester mixture was analyzed by gas chromatography and found to have an arachidonic acid proportion of 40.84 wt% of the total fatty acid.

The contents of palmitic acid, stearic acid, oleic acid, linoleic acid, γ -linolenic acid and dihomo- γ -linolenic acid were 11.63%, 7.45%, 7.73%, 9.14%, 2.23% and 3.27% by weight, respectively. The arachidonic acid-containing oils or fats (triglycerides) (TGA40S) were also ethylesterified, and the fatty acid ethyl ester mixture including 40 wt% arachidonic acid ethyl ester was separated and purified by an established high-performance liquid chromatography method to obtain 99 wt% arachidonic acid ethyl ester.

Example 2 Production of triglycerides including at least 5 mole percent 8A8

After suspending 100 g of an ion-exchange resin carrier (Dowex MARATHON WBA: Dow Chemical) in 80 ml of *Rhizopus delemar* lipase aqueous solution (12.5% Talipase powder, Tanabe Pharmaceutical Co., Ltd.), 240 ml of cold acetone (-80°C) was stirred therewith and the mixture was dried under reduced pressure to obtain the immobilized lipase.

Next, 80 g of the triglycerides containing 40 wt% arachidonic acid (TGA40S) obtained in Example 1, 160 g of caprylic acid, 12 g of the aforementioned immobilized lipase and 4.8 ml of water were reacted for 48 hours at 30°C while stirring (130 rpm). Upon completion of the reaction, the reaction solution was removed to obtain the activated immobilized enzyme.

A 10 g portion of immobilized lipase (*Rhizopus delemar* lipase, carrier: Dowex MARATHON WBA) was then packed into a jacketed glass column (1.8 x 12.5 cm, 31.8 ml volume), and the reaction oils or fats comprising a mixture of the TGA40S obtained in Example 1 and caprylic

- 21 -

acid (TGA40S: caprylic acid = 1:2) was flowed through the column at a fixed speed (4 ml/h) for continuous reaction, to obtain 400 g of reaction oils or fats. The column temperature was 40-41°C. The unreacted caprylic acid and free fatty acids were removed from the obtained reaction oils or fats by molecular distillation, and then subjected to dietary oils or fats purification steps (degumming, deoxidation, deodorization, decolorizing) to obtain 8A8-containing oils or fats (triglycerides).

The 8A8 proportion of the obtained 8A8-containing oils or fats (triglycerides) was determined by gas chromatography and high-performance liquid chromatography to be 31.6 mole percent. (Incidentally, the proportions of 8P8, 8O8, 8L8, 8G8 and 8D8 were 0.6, 7.9, 15.1, 5.2 and 4.8 mole percent, respectively. The fatty acids P, O, L, G and D bonded at the triglyceride 2-position represent palmitic acid, oleic acid, linoleic acid, γ -linolenic acid and dihomogamma-linolenic acid, respectively, and therefore 8P8 represents 1,3-capryloyl-2-palmitolein-glycerol, 8O8 represents 1,3-capryloyl-2-oleoyl-glycerol, 8L8 represents 1,3-capryloyl-2-linoleoyl-glycerol, 8G8 represents 1,3-capryloyl-2-gamma-linolenoyl-glycerol and 8D8 represents 1,3-capryloyl-2-dihomogamma-linolenoyl-glycerol). Separation and purification from the obtained 8A8-containing oils or fats (triglycerides) by an established high-performance liquid chromatography method yielded 96 mole percent 8A8.

Example 3 Evaluation of learning ability effect of TGA40S by Morris water maze learning test

The experimental groups consisted of 56 two- to three-month-old male ICR mice, divided into a control diet group (27 mice) and a TGA40S-containing diet group (29 mice), with the control diet or TGA40S-containing diet shown in Table 1 being given to each group for 3 weeks. Each group was further divided into non-restrained groups (non-restrained control diet group

(13), non-restrained arachidonic acid (ARA) diet group (15)) and restrained groups (restrained control diet group (14), restrained ARA diet group (14)). The restraining was accomplished using a wire mesh
 5 restraining tube, once for a 6 hour period three weeks after the start of feeding. The control diet or TGA40S-containing diet shown in Table 1 continued to be fed to each group for the remaining experiment period. The
 10 TGA40S used for the TGA40S-containing diet was the product obtained in Example 1.

Table 1 Experimental diet

	Control diet	TGA40S-added diet
Casein (g/kg)	200	200
DL-methionine	3	3
Corn starch	150	150
Sucrose	500	500
Cellulose powder	50	50
Corn oil	50	45
Mineral AIN-76	35	35
Vitamin AIN-76	10	10
Choline bitartrate	2	2
Vitamin E	0.05	0.05
TGA40S	0	5

15 Since the daily ingestion was approximately 5 g per mouse, the daily intake of TGA40S was 25 mg per mouse. Also, since the total fatty acids bonded to the arachidonic acid-containing oils or fats (triglycerides) prepared in Example 1 included 40 wt% arachidonic acid,
 20 the daily intake of arachidonic acid was 10 mg per mouse.

The 6-hour restraint with a wire mesh restraining tube was immediately followed by a Morris water maze learning test. The Morris water maze learning test is widely used in Europe and the U.S., and is conducted by
 25 pouring water blackened with India ink into a water tank (100 cm diameter, 35 cm height) (liquid surface height: 20 cm), setting therein an escape platform of just a size to allow a mouse to stand (the escape platform is

submerged and invisible to a mouse swimming in the water tank), and then placing the mouse subject at a prescribed location of the water tank (starting point), forcing it to swim to the escape platform, in order to test its learning ability based on spatial recognition which is associated with the memory-governing hippocampus.

The water temperature was $30^{\circ}\text{C} \pm 1^{\circ}\text{C}$, each trial was limited to 120 seconds with an interval of 60 seconds between trials, and five trials were conducted each day for 5 days. The time required for the mouse to reach the escape platform (escape latency time) was recorded as the learning index. No difference was observed between the control diet mice and ARA diet mice in the absence of restraint stress. However, the mice of the control diet group which had experienced restraint stress clearly exhibited reduced learning ability compared to the non-restrained mice, whereas mice given TAG40S (arachidonic acid) exhibited the same level of learning ability as the mice without restraint stress (Fig. 1).

Thus, for the first time it has been clearly demonstrated that administration of TGA40S improves learning ability or cognitive ability which has declined as a result of stress, and that arachidonic acid exhibits an improving effect against decline in learning ability or cognitive ability as a result of stress.

Example 4 Preparation of capsules comprising arachidonic acid-containing oils or fats (triglycerides)

Water was added to 100 parts by weight of gelatin and 35 parts by weight of food additive grade glycerin for dissolution at $50\text{--}60^{\circ}\text{C}$, to prepare a gelatin coating with a viscosity of 2000 cp. Next, 0.05 wt% of vitamin E oil was combined with the arachidonic acid-containing oils or fats (triglycerides) obtained in Example 1 to prepare filling 1. Vitamin E was also added to oils or fats (triglycerides) containing 32 mole percent of the 8A8 obtained in Example 2 to prepare filling 2. Also, 50 wt% of the arachidonic acid-containing oils or fats

(triglycerides) obtained in Example 1 was combined with 50 wt% fish oil (tuna oil: the eicosapentaenoic acid and docosahexaenoic acid proportions of the total fatty acids were 5.1% and 26.5%, respectively) and then 0.05 wt% vitamin E oil was added to prepare filling 3.

Also, 80 wt% of the arachidonic acid-containing oils or fats (triglycerides) obtained in Example 1 was combined with 20 wt% fish oil (tuna oil: the eicosapentaenoic acid and docosahexaenoic acid proportions of the total fatty acids were 5.1% and 26.5%, respectively) and then 0.05 wt% vitamin E oil was added to prepare filling 4. Separately, 0.05 wt% of vitamin E oil was combined with the 99% arachidonic acid ethyl ester obtained in Example 1 to prepare filling 5. These fillings 1 to 5 were used for production of soft capsules containing 180 mg of filling per capsule, obtained by capsule molding and drying by ordinary methods.

Example 5 Use for oil infusion

After combining 400 g of the oils or fats (triglycerides) containing 96 mole percent 8A8 obtained in Example 2, 48 g of purified egg yolk lecithin, 20 g of oleic acid, 100 g of glycerin and 40 ml of 0.1 N caustic soda and dispersing the mixture with a homogenizer, distilled water for injection was added to make 4 liters. This was emulsified with a high-pressure spray emulsifier to prepare a lipid emulsion. The lipid emulsion was dispensed into plastic bags at 200 ml per bag and then subjected to high-pressure steam sterilization treatment at 121°C for 20 minutes to prepare an oil infusion.

Example 6 Use for juice

A 2 g portion of β -cyclodextrin was added to 20 ml of 20% aqueous ethanol, and then 100 mg of the arachidonic acid-containing triglycerides obtained in Example 1 (containing 0.05% vitamin E) were added thereto while stirring with a stirrer, and the mixture was incubated for 2 hours at 50°C. After room temperature

- 25 -

cooling (approximately 1 hour), stirring was continued while incubating for 10 hours at 4°C. The resulting precipitate was recovered by centrifugal separation and then washed with n-hexane and lyophilized to obtain 1.8 g
5 of a cyclodextrin clathrate compound comprising arachidonic acid-containing triglycerides. A 1 g portion of this powder was uniformly mixed into 10 L of juice to prepare a juice comprising arachidonic acid-containing triglycerides.

CLAIMS

1. A composition with a preventive or improvement effect on stress-induced brain function impairment and related symptoms or diseases, comprising arachidonic acid and/or a compound comprising arachidonic acid as a constituent fatty acid.

2. A composition according to claim 1, wherein said compound comprising arachidonic acid as a constituent fatty acid is an arachidonic acid alcohol ester, or a triglyceride, phospholipid or glycolipid wherein all or a portion of the constituent fatty acid is arachidonic acid.

3. A composition according to claim 2, wherein the triglyceride in which all or a portion of the constituent fatty acid is arachidonic acid is a triglyceride having medium chain fatty acids bonded at the 1,3-positions and arachidonic acid bonded at the 2-position.

4. A composition according to claim 3, wherein said medium chain fatty acids are selected from among C6-12 fatty acids.

5. A composition with a preventive or improvement effect on stress-induced brain function impairment and related symptoms or diseases, comprising triglycerides which include a triglyceride in which all or a portion of the constituent fatty acid is arachidonic acid.

6. A composition according to claim 5, characterized in that the arachidonic acid content of said triglycerides which include a triglyceride in which all or a portion of the constituent fatty acid is arachidonic acid, is at least 10 wt% of the total fatty acids of the triglycerides.

7. A composition according to claim 5 or 6, wherein said triglycerides which include a triglyceride in which all or a portion of the constituent fatty acid is arachidonic acid, are extracted from a microorganism belonging to the genus *Mortierella*, *Conidiobolus*, *Pythium*, *Phytophthora*, *Penicillium*, *Cladosporium*, *Mucor*,

Fusarium, Aspergillus, Rhodotorula, Entomophthora, Echinosporangium or *Saprolegnia*.

8. A composition according to any one of claims 5 to 7, wherein said triglycerides which include a triglyceride in which all or a portion of the constituent fatty acid is arachidonic acid, are triglycerides containing virtually no eicosapentaenoic acid.

9. A composition with a preventive or improvement effect on stress-induced brain function impairment and related symptoms or diseases, comprising triglycerides of which at least 5 mole percent consists of a triglyceride having medium chain fatty acids bonded at the 1,3-positions and arachidonic acid bonded at the 2-position.

10. A composition according to claim 9, wherein said medium chain fatty acids are selected from among C6-12 fatty acids.

11. A composition according to any one of claims 1 to 10, wherein said symptoms related to stress-induced brain function impairment include memory and learning ability impairment.

12. A composition according to any one of claims 1 to 10, wherein said symptoms related to stress-induced brain function impairment include cognitive ability impairment.

13. A composition according to any one of claims 1 to 10, wherein said symptoms related to stress-induced brain function impairment include depression.

14. A composition according to any one of claims 1 to 10, wherein said diseases related to stress-induced brain function impairment include melancholia.

15. A composition according to any one of claims 1 to 14, wherein said composition is a food composition or pharmaceutical composition.

16. A composition according to claim 15, characterized in that said food composition is a common food (food and drink), functional food, nutritional supplement, food for specified health uses, preterm

infant formula, term infant formula, infant food, maternal food or geriatric food.

17. A composition according to any one of claims 1 to 16, which comprises docosahexaenoic acid and/or a compound comprising docosahexaenoic acid as a constituent fatty acid.

18. A composition according to claim 17, wherein said compound comprising docosahexaenoic acid as a constituent fatty acid is a docosahexaenoic acid alcohol ester, or a triglyceride, phospholipid or glycolipid wherein all or a portion of the constituent fatty acid is docosahexaenoic acid.

19. A composition according to claim 17 or 18, characterized in that the arachidonic acid/docosahexaenoic acid ratio (by weight) in the combination of said arachidonic acid and docosahexaenoic acid is in the range of 0.1 to 15.

20. A composition according to any one of claims 1 to 19, characterized in that the amount of eicosapentaenoic acid in the composition does not exceed 1/5 of the arachidonic acid in the composition.

21. A method for production of a dietary product having a preventive or improvement effect on stress-induced brain function impairment and related symptoms or diseases, the method being characterized by adding arachidonic acid and/or a compound comprising arachidonic acid as a constituent fatty acid alone, or in combination with a dietary material containing substantially no arachidonic acid or only a slight amount thereof.

22. A method for prevention or medical treatment of stress-induced brain function impairment and related symptoms or diseases, which comprises administering arachidonic acid and/or a compound comprising arachidonic acid as a constituent fatty acid, to a patient in need of its administration.

1/1

Fig.1

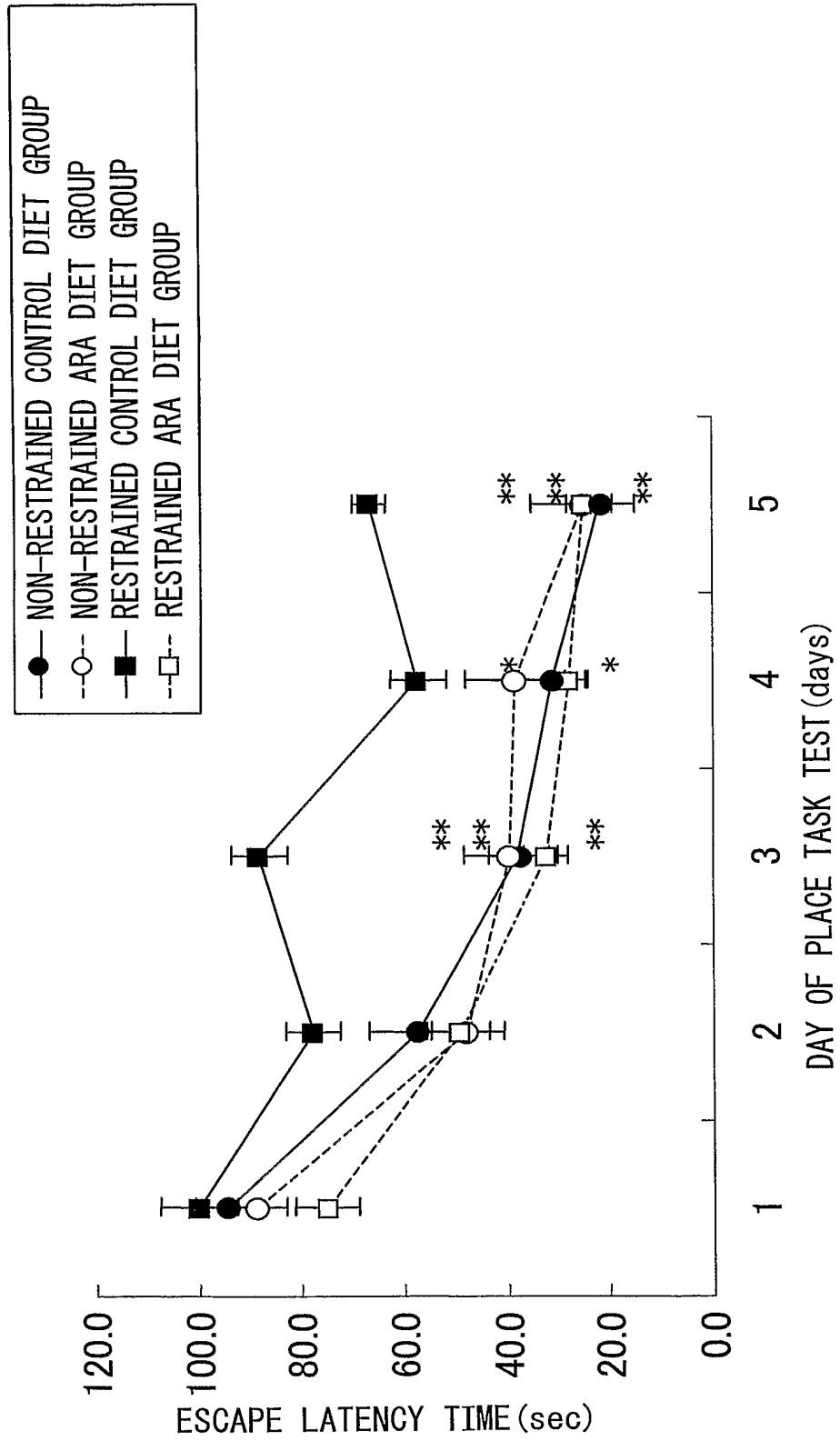

【Mean±SE, *: p<0.05, **: p<0.01 (vs. RESTRAINED-CONTROL DIET GROUP)】

INTERNATIONAL SEARCH REPORT

International Application No
PCT/JP2005/005622

A. CLASSIFICATION OF SUBJECT MATTER
IPC 7 A61K31/202 A61K31/232 A23L1/30 A61P25/00

According to International Patent Classification (IPC) or to both national classification and IPC

B. FIELDS SEARCHED

Minimum documentation searched (classification system followed by classification symbols)
IPC 7 A61K A61P A23L

Documentation searched other than minimum documentation to the extent that such documents are included in the fields searched

Electronic data base consulted during the international search (name of data base and, where practical, search terms used)

EPO-Internal, BIOSIS, EMBASE, WPI Data, PAJ

C. DOCUMENTS CONSIDERED TO BE RELEVANT

Category °	Citation of document, with indication, where appropriate, of the relevant passages	Relevant to claim No.
X	WO 2004/028529 A (SUNTORY LIMITED; AKIMOTO, KENGO; KOGA, YOSHIHIKO) 8 April 2004 (2004-04-08) claims 1-35 examples 1-8	1-22
X	EP 1 419 768 A (SUNTORY LIMITED) 19 May 2004 (2004-05-19) page 9, lines 25-32 examples 1-8	1-22
Y	WO 02/19839 A (UNIVERSITY OF MARYLAND BIOTECHNOLOGY INSTITUTE) 14 March 2002 (2002-03-14) claims 1,2	1-22
	----- -/--	

Further documents are listed in the continuation of box C.

Patent family members are listed in annex.

° Special categories of cited documents :

- "A" document defining the general state of the art which is not considered to be of particular relevance
- "E" earlier document but published on or after the international filing date
- "L" document which may throw doubts on priority claim(s) or which is cited to establish the publication date of another citation or other special reason (as specified)
- "O" document referring to an oral disclosure, use, exhibition or other means
- "P" document published prior to the international filing date but later than the priority date claimed

- "T" later document published after the international filing date or priority date and not in conflict with the application but cited to understand the principle or theory underlying the invention
- "X" document of particular relevance; the claimed invention cannot be considered novel or cannot be considered to involve an inventive step when the document is taken alone
- "Y" document of particular relevance; the claimed invention cannot be considered to involve an inventive step when the document is combined with one or more other such documents, such combination being obvious to a person skilled in the art.
- "&" document member of the same patent family

Date of the actual completion of the international search

29 June 2005

Date of mailing of the international search report

20/07/2005

Name and mailing address of the ISA

European Patent Office, P.B. 5818 Patentlaan 2
NL - 2280 HV Rijswijk
Tel. (+31-70) 340-2040, Tx. 31 651 epo nl,
Fax: (+31-70) 340-3016

Authorized officer

Young, A

INTERNATIONAL SEARCH REPORT

International Application No
PCT/JP2005/005622

C.(Continuation) DOCUMENTS CONSIDERED TO BE RELEVANT

Category °	Citation of document, with indication, where appropriate, of the relevant passages	Relevant to claim No.
Y	<p>AUGUSTE L-J ET AL: "PREVENTION OF STRESS-INDUCED EROSION GASTRITIS BY PARENTERAL ADMINISTRATION OF ARACHIDONIC ACID" JOURNAL OF PARENTERAL AND ENTERAL NUTRITION, vol. 14, no. 6, 1990, pages 615-617, XP009049858 ISSN: 0148-6071 abstract</p> <p style="text-align: center;">-----</p>	1-22

INTERNATIONAL SEARCH REPORT

International application No.
PCT/JP2005/005622

Box II Observations where certain claims were found unsearchable (Continuation of item 2 of first sheet)

This International Search Report has not been established in respect of certain claims under Article 17(2)(a) for the following reasons:

- 1. Claims Nos.:
because they relate to subject matter not required to be searched by this Authority, namely:

Although claim 22 is directed to a method of treatment of the human/animal body, the search has been carried out and based on the alleged effects of the compound/composition.
- 2. Claims Nos.:
because they relate to parts of the International Application that do not comply with the prescribed requirements to such an extent that no meaningful International Search can be carried out, specifically:
- 3. Claims Nos.:
because they are dependent claims and are not drafted in accordance with the second and third sentences of Rule 6.4(a).

Box III Observations where unity of invention is lacking (Continuation of item 3 of first sheet)

This International Searching Authority found multiple inventions in this international application, as follows:

- 1. As all required additional search fees were timely paid by the applicant, this International Search Report covers all searchable claims.
- 2. As all searchable claims could be searched without effort justifying an additional fee, this Authority did not invite payment of any additional fee.
- 3. As only some of the required additional search fees were timely paid by the applicant, this International Search Report covers only those claims for which fees were paid, specifically claims Nos.:
- 4. No required additional search fees were timely paid by the applicant. Consequently, this International Search Report is restricted to the invention first mentioned in the claims; it is covered by claims Nos.:

Remark on Protest

- The additional search fees were accompanied by the applicant's protest.
- No protest accompanied the payment of additional search fees.

INTERNATIONAL SEARCH REPORT

Information on patent family members

International Application No PCT/JP2005/005622

Patent document cited in search report	A	Publication date		Patent family member(s)	Publication date
WO 2004028529	A	08-04-2004		AU 2003267818 A1	19-04-2004
				CA 2499902 A1	08-04-2004
				EP 1542670 A1	22-06-2005
				WO 2004028529 A1	08-04-2004
EP 1419768	A	19-05-2004		JP 2003048831 A	21-02-2003
				CA 2456049 A1	20-02-2003
				EP 1419768 A1	19-05-2004
				US 2004266874 A1	30-12-2004
				CN 1561206 A	05-01-2005
				WO 03013497 A1	20-02-2003
WO 0219839	A	14-03-2002		AU 9258601 A	22-03-2002
				CA 2424570 A1	14-03-2002
				EP 1324671 A1	09-07-2003
				WO 0219839 A1	14-03-2002
				US 2002110582 A1	15-08-2002

(19) World Intellectual Property
Organization
International Bureau



(43) International Publication Date
28 April 2005 (28.04.2005)

PCT

(10) International Publication Number
WO 2005/037848 A2

- (51) International Patent Classification⁷: C07F 9/10 (74) Agents: LUZZATTO, Kfir et al.; P.O. Box 5352, 84152 Beer Sheva (IL).
- (21) International Application Number: PCT/IL2004/000957 (81) Designated States (unless otherwise indicated, for every kind of national protection available): AE, AG, AL, AM, AT, AU, AZ, BA, BB, BG, BR, BW, BY, BZ, CA, CH, CN, CO, CR, CU, CZ, DE, DK, DM, DZ, EC, EE, EG, ES, FI, GB, GD, GE, GH, GM, HR, HU, ID, IL, IN, IS, JP, KE, KG, KP, KR, KZ, LC, LK, LR, LS, LT, LU, LV, MA, MD, MG, MK, MN, MW, MX, MZ, NA, NI, NO, NZ, OM, PG, PH, PL, PT, RO, RU, SC, SD, SE, SG, SK, SL, SY, TJ, TM, TN, TR, TT, TZ, UA, UG, US, UZ, VC, VN, YU, ZA, ZM, ZW.
- (22) International Filing Date: 21 October 2004 (21.10.2004)
- (25) Filing Language: English
- (26) Publication Language: English
- (30) Priority Data: 158552 22 October 2003 (22.10.2003) IL (84) Designated States (unless otherwise indicated, for every kind of regional protection available): ARIPO (BW, GH, GM, KE, LS, MW, MZ, NA, SD, SL, SZ, TZ, UG, ZM, ZW), Eurasian (AM, AZ, BY, KG, KZ, MD, RU, TJ, TM), European (AT, BE, BG, CH, CY, CZ, DE, DK, EE, ES, FI, FR, GB, GR, HU, IE, IT, LU, MC, NL, PL, PT, RO, SE, SI, SK, TR), OAPI (BF, BJ, CF, CG, CI, CM, GA, GN, GQ, GW, ML, MR, NE, SN, TD, TG).
- (71) Applicant (for all designated States except US): ENZY-MOTEC LTD. [IL/IL]; Ramat-Gavriel Industrial Park, P.O. Box 6, 23106 Migdal HaEmek (IL).
- (72) Inventors; and
- (75) Inventors/Applicants (for US only): BEN DROR, Gai [IL/IL]; P.O. Box 126, 30835 Moshav Ofer (IL). PLATT, Dorit [IL/IL]; P.O. Box 249, 17906 Shimshit (IL). FARKASH, Orly [IL/IL]; P.O. Box 217, 17906 Shimshit (IL). ZUABI, Rassan [IL/IL]; 19320 Kfar Neen (IL). BAR-ON, Zohar [IL/IL]; 32 Yodfat Street, 21950 Karmiel (IL). SHULMAN, Avidor [IL/IL]; 29 HaGomeh Street, 36090 Kiryat Tivon (IL). PELLED, Dori [IL/IL]; 29 HaShahar Street, 45325 Hod Hasharon (IL).

Published:
— without international search report and to be republished upon receipt of that report

For two-letter codes and other abbreviations, refer to the "Guidance Notes on Codes and Abbreviations" appearing at the beginning of each regular issue of the PCT Gazette.



WO 2005/037848 A2

(54) Title: LIPIDS CONTAINING OMEGA-3 AND OMEGA-6 FATTY ACIDS

(57) Abstract: Disclosed is a lipid preparation comprising a glycerophospholipid or salt, conjugate and derivatives thereof, particularly phosphatidylserine (PS), phosphatidylcholine (PC), phosphatidylethanolamine (PE), phosphatidyl-inositol (PI), phosphatidyl-glycerol (PG) and phosphatidic acid (PA), and poly-unsaturated fatty acid (PUFA) acyl groups, particularly long-chain poly-unsaturated fatty acid (LC-PUFA) acyl groups such as omega-3 and/or omega-6 acyl groups, wherein said PUFA is covalently bound to said glycerophospholipid. The disclosed preparations possess an improved bioactivity, and are useful in the treatment of various cognitive and mental conditions and disorders and for maintenance of normal functions of brain-related systems and processes.

LIPIDS CONTAINING OMEGA-3 AND OMEGA-6 FATTY ACIDS

Field of the Invention

The present invention relates to phospholipids and polar lipids preparations which are enriched with omega-3 and/or omega-6 fatty acids covalently attached to the lipid backbone. The phospholipid preparations of the invention are particularly useful as nutraceuticals, food additives and/or pharmaceutical agents for the treatment of various conditions, in particular related to cognitive functions.

Background of the Invention

Lipids, and especially polar lipids, nitrogen containing lipids, and carbohydrate containing lipids (phospholipids, sphingosines, glycolipids, ceramides, sphingomyelins) are the major building blocks of cell membranes, tissues, etc. Additionally they play important roles in signal transduction processes and in a variety of biochemical and biosynthetic pathways.

Glycerophospholipids, lipids based on a glycerol backbone and containing a phosphate head group, are the main building blocks of cell membranes. Since most, if not all, biochemical processes involve cell membranes, the structural and physical properties of membranes in different tissues is crucial to the normal and efficient functioning of membranes in all biochemical processes.

In light of the emerging functional foods category in the area of dietary lipids many health benefits have been attributed to the consumption of certain fatty acids. For example, it has been reported in many research studies that polyunsaturated fatty acids (PUFA) of the type omega-3 and omega-6, have several health benefits on cardiovascular disease, immune disorders and inflammation, renal disorders, allergies, diabetes, and

cancer. These types of fatty acids are naturally occurring mainly in fish and algae, where they are randomly distributed on the sn-1, sn-2, and sn-3 positions of the glycerol backbone of triglycerides.

The professional literature emphasizes the importance of an adequate diet containing omega-3 fatty acids. Extensive clinical studies investigating the importance of Docosahexaenoic acid (DHA), one of the most important omega-3 fatty acids, in the brain, found that low levels of DHA are associated with depression, memory loss, dementia, and visual problems. All studies showed a dramatic improvement in the elderly brain function as blood levels of DHA increased.

Other known benefits of DHA include: lower risk of arrhythmias, reduction in the risk of sudden cardiac death, lower plasma triglyceride levels and reduced blood clotting tendency. Furthermore, DHA may have importance in the field of brain functioning enhancement, baby formula fortification, diabetics and cancer. Nutritional studies, investigating the importance of DHA in the brain, found that low levels of DHA are associated with depression, memory loss, cognitive impairment, dementia and visual problems.

The human body does not adequately synthesize DHA. Therefore it is necessary to obtain it from the diet. Humans obtain DHA from their diets, initially through the placenta, then from breast milk, and later through dietary sources, such as fish, red meats, animal organ meats and eggs. Popular fish like tuna, salmon and sardines are rich sources. Until recently, the primary source of DHA dietary supplements has been fish oils. The ability of enzymes to produce the omega-6 and omega-3 family of products of linoleic and alpha-linolenic acid declines with age. Because DHA synthesis declines with age, as we get older our need to acquire DHA directly from diet or supplements increases. In fact, several recent

publications suggested DHA to be considered as essential fatty acid [for example, Muskiet, F. *et al.* (2004) *J Nutr.* 134(1):183-6].

Because DHA is important for signal transmission in the brain, eye and nervous system, many consumers concerned with maintaining mental acuity are searching for a pure, safe way to supplement their DHA levels.

Polyunsaturated acids, in particular long chain, such as omega-3 and 6, have been shown to confer many valuable health benefits on the population. The global market for long-chain PUFAs, including the food segment, is rapidly growing.

The majority of efforts in the industry are however invested in the improvement of PUFA processing techniques and in the creation of higher concentrated grades of PUFA derivatives to accommodate dietary supplements and functional foods needs.

The academic and industrial communities are less concerned regarding the evaluation of different delivery approaches of PUFA in order to enhance their bio-availability and their efficacy in term of their known variety of health benefits. These benefits range from prevention and treatment of CVD, diabetes, cognitive disorders and/or decline, visual disorders, skin conditions, learning disorders, etc. Additionally, PUFAs have been shown to assist in the cognitive and visual development of infants.

PUFA-lipids

PS-PUFA

Phosphatidylserine, also known as PS, is a natural phospholipid with bio-functionality that has made it one of the most promising dietary supplements in the field of brain nutrition. PS and its health benefits have

been known to the scientific and nutrition communities since the 1970's. Numerous studies have been conducted in order to establish this efficacy in a variety of cognitive and mental functions. Those studies have shown that PS can improve memory, fight dementia, fight early stages of Alzheimer's disease, reduce stress and tension, improve attention span, enhance mood and fight depression, to name but few.

PS is one of the most important building blocks of cell membranes in the brain. Hence, the level of PS in brain cell membranes ensures the fluidity and structure of these membranes. The normal level ensures normal and efficient signal transduction processes, efficient glucose consumption, and other biological pathways that result in normal cognitive and mental functions.

Since PS is not abundant in human nutrition and since in many people, especially the elderly, the biosynthetic pathways responsible for the production of PS are malfunctioning, the levels of PS in the body and brain are low. This results in a variety of cognitive and mental disorders, such as depression, memory loss, short attention span, learning difficulties, etc.

The supplementation of PS in the diets of elderly people with such disorders has resulted, in many cases, in dramatic improvements of these disorders. Over the recent years, studies have shown that even younger people can benefit from dietary supplementation of PS. PS has been shown to improve the learning capabilities of students, improve memory and attention span, etc.

It is therefore an object of the present invention to provide special preparations of PS, for use mainly as nutraceuticals and as functional food additives.

PC-PUFA

As mentioned before, phospholipids are essential components of all cellular and sub-cellular membranes. Phosphatidylcholine and phosphatidylethanolamine predominate quantitatively, substantially constituting the typical bilayer configuration. Phospholipids belong to the amphipathic molecules with a water-soluble and a fat-soluble component. In the bilayer configuration the hydrophilic groups are arranged at the outer and inner side of the membrane toward the surrounding medium; the lipophilic groups, in contrast, face each other at the inner side of the bilayer configuration.

Other important constituents of biological membranes are cholesterol, glycolipids, and peripheral and integral proteins. The basic structure of biological membranes is thus a series of recurrent unities of lipid-protein complexes. The membrane is asymmetric. The function of the external (cellular) and internal (sub cellular) membrane systems depends on their composition and on the integrity of their phospholipid structure. In addition to their presence in cell membranes, phospholipids constitute structural and functional elements of the surface mono-layers of lipoproteins and of surfactants.

Of utmost importance for the function of biological membranes is their fluidity, which is decisively influenced by phospholipids. Besides the content in cholesterol and proteins and the nature and charge of the polar head groups of phospholipids in the system, membrane fluidity depends on the length of the chains of fatty acid residues in the phospholipid molecule, as well as on the number and type of pairing of their double bonds.

Phospholipids containing poly-unsaturated fatty acids supply the organism with important building blocks which improves membrane fluidity.

Studies conducted with PUFA-containing phospholipids have shown the following:

1. They are high-energy, basic, structural, and functional elements of all biological membranes, such as cells, blood corpuscles, lipoproteins, and the surfactant.
2. They are indispensable for cellular differentiation, proliferation, and regeneration.
3. They maintain and promote the biological activity of many membrane-bound proteins and receptors.
4. They play a decisive role for the activity and activation of numerous membrane-located enzymes, such as sodium-potassium-ATPase, adenylate cyclase and lipoprotein lipase.
5. They are important for the transport of molecules through membranes.
6. They control membrane-dependent metabolic processes between the intracellular and intercellular space.
7. The polyunsaturated fatty acids contained in them, such as linoleic acid, are precursors of the cytoprotective prostaglandins and other eicosanoids.
8. As choline and fatty acid donors they have an influence in certain neurological processes.
9. They emulsify fat in the gastrointestinal tract.
10. They are important emulsifiers in the bile.
11. They codetermine erythrocyte and platelet aggregation.
12. They influence immunological reactions on the cellular level.

Phospholipids containing PUFA are theoretically of importance in all those diseases in which damaged membrane structures, reduced phospholipid levels, and/or decreased membrane fluidity are present. This

hypothesis is supported by experimental and clinical investigations of various membrane-associated disorders and illnesses.

Studies on the active principle as well as pharmacological and clinical trials are available on a variety of disturbances and diseases related to membrane damages. For example, in liver diseases the hepatocyte structures are damaged by, for example, viruses, organic solvents, alcohol, medicaments, drugs, or fatty food. As a consequence, membrane fluidity and permeability may be disturbed, and membrane-dependent metabolic processes as well as membrane-associated enzyme activities may be impaired. This considerably inhibits the metabolism of the liver.

Other examples include hyperlipoproteinemia with or without atherosclerosis, hemorrhheological disturbances with an elevated cholesterol/phospholipid ratio in the membranes of platelets and red blood cells, neurological diseases, gastro intestinal inflammations, kidney diseases, and in a variety of aging symptoms.

All these very different diseases have in common comparable membrane disorders. With polyunsaturated phosphatidylcholine molecules such disorders may be positively influenced, eliminated, or even improved beyond normal due to the high content in polyunsaturated fatty acids. Following are some examples of the mechanisms that mediate this phenomenon:

1. HDL particles enriched with PUFA-containing-phosphatidylcholine are able to take up more cholesterol from low-density lipoprotein (LDL) and tissues. More cholesterol can be transported back to the liver. This action on the cholesterol reverse transport is unique. All other lipid-lowering agents reduce either the cholesterol absorption in the body or the cholesterol synthesis in the liver and its distribution to the periphery.

These substances, however, do not physiologically mobilize the cholesterol already present in the periphery.

2. The cholesterol/phospholipid ratio in membranes, platelets, and red blood cells decreases and membrane function is improved up to normalization.
3. Peroxidative reactions are reduced, damaged hepatocyte membrane structures restored, membrane fluidity and function stabilized, immunomodulation and cell protection improved, and membrane-associated liver functions enhanced.
4. With the normalization of the cholesterol/phospholipid ratio, the bile is also stabilized.
5. Due to its specific property as a surface-active emulsifier, PUFA-containing-phosphatidylcholine solubilize fat and is used in reducing the risk and treatment of fat embolism.
6. The substitution with poly-unsaturated-fatty-acids and choline may have a cytoprotective effect in the brain and activate neuronal processes.
7. Liposomes with polyunsaturated phosphatidylcholine molecules may act as drug carriers, such as of vitamin E.

Liver Disease

Experimental and clinical results support the assumption that the therapeutic application of PUFA-containing-phosphatidylcholine has protective and even curative and regenerative effects on biological membranes of sinus endothelial cells and hepatocytes. The cytoprotective effect of PUFA-containing-phosphatidylcholine has been corroborated in 7 *in vitro* and in 55 *in vivo* experiments, in which 20 different models with five different animal species were used. Types of intoxication that are known to play a role in the etiology of liver disease have mostly been applied: chemical substances, medicaments, alcohol, cholestasis, immunological phenomena, exposure to radiation, and so on.

The hepato-protective effects of PUFA-containing-phosphatidylcholine have been confirmed and were the more pronounced the earlier PUFA-containing-phosphatidylcholine was administered:

1. Structures of membranes were normal or largely normalized.
2. Fatty infiltrations and hepatocyte necrosis could be diminished or even eliminated.
3. Corresponding data were found for lipid peroxidation, transaminase and cholinesterase activity, and for serum lipids; liver cell metabolism increased.
4. The increase of RNA and protein synthesis and of the liver cell glycogen content indicated a stimulation of the liver cells.
5. Reduced collagen production, collagen/DNA ratio, and liver hydroxyproline content indicated a reduced formation of connective tissue.

The dosage of PUFA-containing-phosphatidylcholine ranged from 525 to 2,700 mg/day when administered orally, and from 500 to 3,000 mg/day in intravenous application. The duration of treatment lasted from a few weeks to up to 30 months. The main liver indications were acute hepatitis, chronic hepatitis, fatty liver, toxic liver damage, cirrhosis of the liver, and hepatic coma.

The clinical findings, showing the effectiveness of PUFA-containing-phosphatidylcholine, can be summarized generally as follows:

1. Accelerated improvement or normalization of subjective complaints, of clinical findings, and of several biochemical values
2. Better histological results as compared with the control groups
3. A shortened duration of hospitalization

Promising results were obtained also in renal disorders, chronic ambulatory peritoneal dialysis, hyperlipoproteinemia/atherosclerosis, gastrointestinal inflammation, psoriasis, and more.

Recent research studies have shown that PUFA-enriched phospholipids, isolated from rainbow trout embryos, have novel health benefits. Some of these benefits include the treatment of tumor cells, inhibition of 5-lipoxygenase activity, reduction of neutral fat levels (such as cholesterol).

There is proof that a person who receives enriched phospholipids nutritionally, these phospholipids cross the intestinal barrier and the blood-brain barrier, thus reaching the brain. Recently, investigators from Ponroy Laboratories had described an experiment in which mice lacking essential fatty acids, i.e. linoleic acid (18:2 n-6) and α -linolenic acid (18:3 n-3), which serve as the sole sources for LC-PUFA, were fed cerebral phospholipids and the quantity of phospholipids in each part of the brain measured. These phospholipids were found in the cytoplasm, in the synapses, and in other parts of the brain [Carrie *et al.*, (2000) *J. Lipid Res.* **41**, 465-472].

The utilization of phospholipids enriched with PUFA holds many potential advantages from a clinical point of view. The phospholipid may deliver the essential fatty acid to specific organs or body parts, such as the brain, and assist in the incorporation of these fatty acids in membranes. Other advantages may arise from the fact that phospholipids enriched with PUFA will not have odor problems such as found in the major current nutraceutical source, the fish oils. Furthermore, some preliminary clinical studies have shown that PUFA incorporated in phospholipids possess superior efficacy than PUFA carried by triglycerides. [Song *et al.* (2001) *Atherosclerosis*, **155**, 9-18].

Further studies have shown that the activity of DHA-rich phospholipid was different from that of DHA-rich triacylglycerol in spontaneously hypertensive rats [Irukayama-Tomobe *et al.* (2001) *Journal of Oleo*

Science, 50(12), 945-950]. Spontaneously hypersensitive rats (SHR) were fed test lipid diets for six weeks, which contained 30%-docosaehaenoic acid (DHA) phospholipid (DHA-PL) extracted from fish roe or 30%-DHA fish oil (DHA-TG). The control diet contained corn oil in the presence of test lipids. After feeding, blood pressure in the DHA-TG and DHA-PL diet groups was found significantly lower compared to the control. Serum fatty acid content of dihomo-linoleic acid (DHLnA) and Arachidonic acid (AA) of the DHA-PL diet group was significantly less than the control or DHA-TG diet group. Serum triacylglycerol, phospholipid and total cholesterol in the DHA-TG and DHA-PL diet groups were significantly less than in the control. Liver total cholesterol in DHA-PL was twice that in the DHA-TG diet group and control. The mechanism for cholesterol removal from blood by DH-PL would thus appear to differ from that by DHA-TG. Serum lipid peroxide (LPO) in the DHA-TG and DHA-PL diet groups was essentially the same as in the control.

Many PUFA-containing agents suffer from stability and quality problems due to the high degree of oxidation of the polyunsaturated fatty acids. These problems require the incorporation of antioxidants as well as the utilization of special measures which attempts to reduce this oxidation. The utilization of phospholipids as carriers of PUFA may result in enhanced stability of such products due to the anti-oxidative properties of phospholipids.

It seems that one of the most effective transport mechanism for such essential fatty acids is the attachment of these groups to phospholipid molecules. The phospholipids have been shown to pass through the blood-brain barrier and transport the DHA where it is needed.

Organoleptic concerns

PUFAs are traditionally extracted from coldwater fish. Despite the healthy image, one of the problems of consumer acceptance has been the resulting strong, fishy taste. To address this, microencapsulated forms of omega-3 have been pioneered in the last 15 years. A further step was the development of egg-containing products such as DHA-enriched mayonnaise and pasta. DHA-enriched yogurts, baked goods and broilers were also envisaged.

There is no other nutritional product or ingredient that is considered to be an agent of PUFA delivery. All current commercial products are based on the fatty acids themselves in an encapsulated form or on foods enriched with PUFA through special animal/crop feed.

It is therefore an object of the present invention to provide lipid preparations enriched with omega-3 or omega-6 fatty acids, for use mainly as nutraceuticals and as functional food additives. The composition of said preparation is such that it provides the preparation with the property of enhancing the bioavailability of PUFAs. Thus upon its consumption, preferably in the form of nutraceuticals, food additives or pharmaceutical compositions, the organism may, in the most efficient way, enjoy the benefits provided by said preparation, as will be described in detail below.

This and other objects of the invention will become apparent as the description proceeds.

Summary of the Invention

In a first aspect the present invention provides a lipid preparation, wherein said lipid is selected from glycerophospholipids and their salts, conjugates, and derivatives and any mixture thereof, and poly-

unsaturated fatty acid (PUFA) acyl groups, particularly long-chain poly-unsaturated fatty acid (LC-PUFA) acyl groups, preferably omega-3 and/or omega-6 acyl groups, at a concentration of least 5% (w/w) of total fatty acids content of said preparation, preferably more than 10% (w/w), more preferably 20-50% (w/w), wherein said PUFA is covalently bound to said lipid.

Said lipid may be a naturally occurring lipid, or a synthetic lipid. Preferably, said lipid is a glycerophospholipid in which at least some of the sn-1 or sn-2 groups of the glycerol backbone are substituted with said poly-unsaturated fatty acid (PUFA) acyl groups.

In one particular embodiment, said lipid is a glycerophospholipid of formula I:

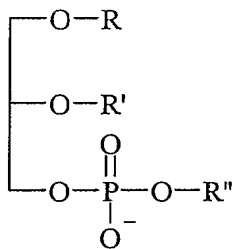

Formula (I)

wherein R'' represents a moiety selected from serine (PS), choline (PC), ethanolamine (PE), inositol (PI), glycerol (PG) and hydrogen (phosphatidic acid - PA), and R and R', which may be identical or different, independently represent hydrogen or an acyl group, wherein said acyl group is selected from saturated, mono-unsaturated or poly-unsaturated acyl groups (PUFA), particularly long-chain poly-unsaturated fatty acids (LC-PUFA), more preferably omega-3 and/or omega-6 acyl groups, and salts thereof, with the proviso that R and R' cannot simultaneously represent hydrogen, and wherein said polyunsaturated acyl groups

comprise at least 5% (w/w) of total lipid fatty acids, preferably more than 10% (w/w), and particularly 20-50% (w/w).

In one more particular embodiment of said preparation, R represents hydrogen and R' represents an acyl group. Alternatively, R' represents hydrogen and R represents an acyl group.

Considering these latter embodiments, when said acyl group is preferably an omega-3 acyl group, it may be an eicosapentaenoyl (EPA), a docosahexaenoyl (DHA) group, or linolenic omega-3 group. And, when said acyl group is preferably an omega-6 acyl group, it may be an arachidonoyl (ARA) group, or a linoleic omega-6 group. A further possibility is that said acyl group may be a linolenoyl (18:3) group.

In a yet further embodiment of the preparation of the invention, R'' may be any one of serine, choline, ethanolamine, inositol or glycerol.

In a further particular embodiment, the identity and content of R and R' are predetermined.

The preparation of the invention which comprises the compound of formula I in which R'' is serine, mimics the composition of human brain PS.

Nonetheless, the invention also refers to preparations comprising the compound of formula I in which R'' is serine, which are different from human brain PS, but still have an improved bioactivity, particularly as compared to soybean-PS. This improved bioactivity results in beneficial effects on both the learning and working memory in elderly population, in particularly in cholinergic impaired conditions like Alzheimer's disease.

The invention also relates to preparation PS preparation which mimics the human brain PS, is effective at lower dosage (2-3 fold) compared to soybean-PS, while having similar or improved bioactivity compared to soybean-PS.

The PS may be of plant, animal or microorganism source, and is enriched with PS of formula I, wherein R" represents a serine moiety.

The preparation of the invention may be further enriched with PS of formula I, characterized in having reduced or absent of fish-related organoleptic effects. Such preparation may be particularly suitable for incorporation into chocolate-containing or dairy-based food articles (including concentrated milk).

The preparation of the invention may be used in the improvement and treatment of cognitive and mental conditions and disorders as well as the maintenance of normal functions of brain-related systems and processes, preferably ADHD, aging, Alzheimer's disease, Parkinson's disease, multiple sclerosis (MS), dyslexia, depression, learning capabilities, intensity of brain waves, stress, anxiety, mental and psychiatric disorders, concentration and attention, mood, brain glucose utilization, general cognitive and mental well being, neurological disorders and hormonal disorders.

The preparation of the invention is particularly useful in enhancing the bioavailability of omega-3 and omega-6 fatty acids.

The preparation of the invention may be used in combined improvement of cognitive and mental functions together with improvement of additional health disorders or conditions. Such additional health disorders or conditions may be at least high blood cholesterol levels, high triglycerides

#

levels, high blood fibrinogen levels, HDL/LDL ratio, diabetes, metabolic syndrome, menopausal or post-menopausal conditions, hormone related disorders, vision disorders, inflammatory disorders, immune disorders, liver diseases, chronic hepatitis, steatosis, phospholipid deficiency, lipid peroxidation, dysrhythmia of cell regeneration, destabilization of cell membranes, coronary artery disease, high blood pressure, cancer, hypertension, aging, kidney disease, skin diseases, edema, gastrointestinal diseases, peripheral vascular system diseases, allergies, neurodegenerative and psychiatric diseases.

The preparation of the invention may also be used in the reduction and/or prevention of serum oxidative stress leading to atherosclerosis, cardiovascular disorders and/or coronary heart disease.

The invention further relates to nutraceutical compositions comprising a lipid preparation in accordance with the invention. The nutraceutical composition may be in the form of softgel capsules, tablets, syrups, or any other common dietary supplement delivery system.

Still further, the invention relates to functional food article comprising the lipid preparation of the invention. Such functional food article may be selected from dairy products, dairy drinks, ice-creams, bakery products, confectionary products, biscuits, soy products, pastry and bread, sauces, condiments, oils and fats, margarines, spreads, cereals, drinks and shakes, oils and fats, infant formulas, infant foods (biscuits, mashed vegetables and fruits, cereals), bars, snacks, candies and chocolate products.

In yet a further aspect, the invention relates to pharmaceutical compositions comprising the lipid preparation of the invention, and optionally further comprising at least one pharmaceutically acceptable additive, diluent or excipient. The pharmaceutical composition of the

invention may further optionally comprise at least one pharmaceutically active agent.

Brief Description of the Figures

Figure 1A-D: Performance of rats in acquisition of the spatial Morris maze task.

Latency time to platform in the three days of acquisition (2 sessions per day) of aged rats supplemented for three months with various supplements as detailed below was analyzed using video camera, with (open squares) or without (closed circles) pretreatment of 1 mg/kg of scopolamine.

Fig. 1A: Rats supplemented with MCT, $P < 0.007$.

Fig. 1B: Rats supplemented with PS- $\omega 3$, $P < 0.07$.

Fig. 1C: Rats supplemented with SB-PS, $P < 0.02$.

Fig. 1D: Rats supplemented with LC-PUFA, $P < 0.03$.

Values represent mean \pm S.E.M of four to five rats per supplement.

Abbreviations: Lat. T. , latency time; sec., seconds.

Figure 2. Performance of scopolamine-treated rats in the Morris water maze task in the spatial probe test.

This graph represents percentage of time (T.) that aged rats, supplemented for three months with MCT (open bars), PS- $\omega 3$ (solid bars), SB-PS (dotted bars) or LC-PUFA (striped bars), spent in different areas after the platform being removed, was analyzed using video camera, following pre-treatment of 1 mg/kg of scopolamine. Values represent mean \pm S.E.M of four to five rats per supplement. Significance compared to control group (MCT) * $P < 0.02$ and ** $P < 0.08$

Figure 3A-D: Performance of scopolamine-induced rats in locating the platform after its reposition.

Latency time to platform on the fifth day of the water maze test, in which the platform was repositioned between the sessions, in aged rats supplemented for three months with different supplements as specified below, was analyzed using video camera, with (open squares) or without (closed circles) pretreatment of 1 mg/kg of scopolamine.

Fig. 3A: Rats supplemented with MCT.

Fig. 3B: Rats supplemented with PS- ω 3.

Fig. 3C: Rats supplemented with SB-PS.

Fig. 3D: Rats supplemented with LC-PUFA.

Values represent mean \pm S.E.M of four to five rats per supplement.

Abbreviations: Lat. T. , latency time; sec., seconds; tr., trials.

Figure 4A-B: Phospholipid levels in rat tissues as measured using ^{31}P -NMR.

Lipids were extracted from tissues of aged rats that were supplemented for three months with MCT (open bars), PS- ω 3 (solid bars), SB-PS (dotted bars) or LC-PUFA (striped bars). Phospholipids levels were analyzed using a ^{31}P -NMR machine and the relative levels of phosphatidylcholine of the different treatments are presented.

Fig. 4A: Analysis of lipids extracted from the liver.

Fig. 4B: Analysis of lipids extracted from the brain (cortex region).

Values represent mean \pm S.D. of four to five rat tissues per supplement.

Significance compared to control group (MCT) *P<0.05 and **P<0.1.

Abbreviations: Tot. Pl., total phospholipids.

Figure 5: Parental scores of ADHD children according to behavioral rating scales.

The graph represents percentage of ADHD children that demonstrated improvement or lack of improvement in a parental view following two

months of supplementation with canola oil (open bars), DHA (solid bars) or PS- ω 3 (hatched bars). Rating includes remarks regarding behavioral tendencies at home, at school, with siblings or peers and teachers feedback. Values represent percentage of twenty to twenty-five ADHD children scores per supplement. Note that twelve parents decline to respond to the questioner and six children did not complete the supplementation period due to poor taste or severe discipline problems (mostly the control group).

Abbreviations: Improv., improvement; Marg. Improve., marginal improvement; n.c., no change; Deter., deterioration.

Figure 6: Effect of PC-DHA on the serum oxidative stress.

Apo E^o mice were fed for 10 weeks with placebo (open bars) or PC-DHA (solid bars). Serum lipid peroxide (Ser. per.) levels were measured using a spectrophotometric assay. Values represent mean \pm S.D. of 5 mice per treatment.

Detailed Description of the Invention

In a first aspect the present invention provides a lipid preparation, wherein said lipid is a glycerophospholipid, a salt, conjugate, and derivative thereof, and any mixture thereof, and poly-unsaturated fatty acid (PUFA) acyl groups, particularly long-chain poly-unsaturated fatty acid (LC-PUFA) acyl groups, preferably omega-3 and/or omega-6 acyl groups, at a concentration of least 5% (w/w) of total fatty acids content of said preparation, preferably more than 10% (w/w), more preferably 20-50% (w/w), wherein said PUFA is covalently bound to said glycerophospholipid.

Said lipid may be a naturally occurring lipid, or a synthetic lipid.

Preferably, said lipid is a glycerophospholipid in which at least some of the sn-1 or sn-2 groups of the glycerol backbone are substituted with said polyunsaturated fatty acid (PUFA) acyl groups.

In one particular embodiment, said lipid is a glycerophosphlipid of formula I:

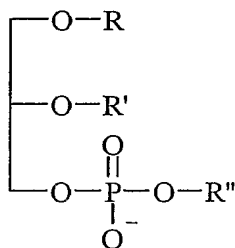

Formula (I)

wherein R'' represents a moiety selected from serine (PS), choline (PC), ethanolamine (PE), inositol (PI), glycerol (PG) and hydrogen (phosphatidic acid - PA), and R and R', which may be identical or different, independently represent hydrogen or an acyl group, wherein said acyl group is selected from saturated, mono-unsaturated or poly-unsaturated acyl groups (PUFA), particularly long-chain poly-unsaturated fatty acids (LC-PUFA), more preferably omega-3 and/or omega-6 acyl groups, and salts thereof, with the proviso that R and R' cannot simultaneously represent hydrogen, and wherein said polyunsaturated acyl groups comprise at least 5% (w/w) of total lipid fatty acids, preferably more than 10% (w/w), and particularly 20-50% (w/w).

In one more particular embodiment of said preparation, R represents hydrogen and R' represents an acyl group. Alternatively, R' represents hydrogen and R represents an acyl group.

Considering these latter embodiments, when said acyl group is preferably an omega-3 acyl group, it may be an eicosapentaenoyl (EPA), a

docosahexaenoyl (DHA) group, or linolenic omega-3 group. And, when said acyl group is preferably an omega-6 acyl group, it may be an arachidonoyl (ARA) group, or a linoleic omega-6 group. A further possibility is that said acyl group may be a linolenoyl (18:3) group.

In a yet further embodiment of the preparation of the invention, R" may be any one of serine, choline, ethanolamine, inositol or glycerol.

In a further particular embodiment, the identity and content of R and R' are predetermined.

The preparation of the invention which comprises the compound of formula I in which R" is serine, mimics the composition of human brain PS.

Nonetheless, the invention also refers to preparations comprising the compound of formula I in which R" is serine, which are different from human brain PS, but still have an improved bioactivity, particularly as compared to soybean-PS.

Traditionally, PS active ingredients used as dietary supplements were produced by the extraction of animal brains, particularly bovine brains. The PS extracted from animal brain tissues, similarly to human brain PS, has a fatty acid composition which is characterized by relatively higher levels of omega-3 moieties, compared to the levels of omega-3 found in plant phospholipids.

PS has the following structure:

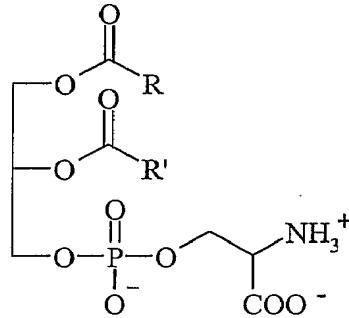

Formula II

Human brain PS is characterized by over 20-30% PS containing omega-3 fatty acyls, preferably at the *sn*-2 position of the glycerol moiety, and mainly DHA or EPA. As mentioned above, phospholipids, and PS in particular, are responsible for membrane structure and physical properties. One of the major physical properties governed by phospholipids is the fluidity of these membranes. Omega-3 fatty acids, DHA and EPA in particular, also have a crucial role in membrane fluidity in light of their unique 3D structure. Therefore, PS with omega-3 fatty acyl moieties, DHA and EPA in particular, has unique bio-functionality which cannot stem from just the basic phospholipid skeleton of this phospholipid.

Considering the risks involved with prion diseases, particularly bovine spongiform encephalopathy (BSE), as well as other disadvantages associated with ingredients obtained from animal sources, PS supplements are usually prepared using PS originating from soybean lecithin. This lecithin is enriched, usually enzymatically, with PS. This method of production results in PS with a fatty acid profile of soybean phospholipids, which is characterized by low level of omega-3 fatty acids, and almost no DHA and EPA. This PS active ingredient is also known as soybean-PS.

Although the bio-functionality of soybean-PS in the improvement of cognitive function has been shown to be similar to that of bovine-PS, it is still different from human brain PS. It is a purpose of the present invention to provide a PS ingredient with a predetermined fatty acid composition that mimics the fatty acid composition of the human brain PS.

It is a further object of the present invention to provide a PS ingredient which, while not identical to naturally occurring brain PS, is characterized by improved functionality, particularly in comparison with soybean-PS. This improved PS ingredient has a predetermined fatty acid composition.

The PS ingredient of the present invention is enriched with omega-3 fatty acyls, preferably DHA, EPA or linolenic omega-3. Furthermore, the PS of this invention is enriched with omega-3 fatty acyls covalently bonded to either or both of the *sn*-1 or *sn*-2 positions of the glycerol moiety in the PS backbone.

The present invention is also related and describes other phospholipids, such as phosphatidylcholine (PC), phosphatidylethanolamine (PE), phosphatidyl-inositol (PI), phosphatidylglycerol (PG) and phosphatidic acid (PA), enriched with omega-3 fatty acids, preferably DHA, EPA, or linolenic acid which are covalently bonded at either or both of the *sn*-1 or *sn*-2 positions of the glycerol moiety of the phospholipid. Alternatively, the phospholipids of the invention are enriched with omega-6 fatty acids.

When referring to PS in the present description, it should be taken to mean also any other lipid, such as, but not limited to, the polar lipids listed above.

In a preferred embodiment, the amount of omega-3 (particularly EPA, DHA or linolenic acid) or omega-6 (particularly ARA and linoleic acid)

fatty acids in the PS ingredient of the invention is greater than 10% at either or both of the *sn*-1 or *sn*-2 positions, preferably at the *sn*-2 position, preferably over 20% and most preferably above 40%.

As mentioned, the desired omega-3/omega-6 fatty acyls can be bonded at both or only one of the *sn*-1 and *sn*-2 positions.

The fatty acid composition of the PS preparation of this invention can have a predetermined fatty acid composition similar to or different from the fatty acid composition found in normal healthy human brain, provided it has enhanced activity, particularly compared to the activity of plant PS, for example soybean-PS.

The preparation of the omega-3/omega-6-enriched PS preparation of this invention can be enzymatic, chemical or by molecular biology methods. Briefly, the PS can be enriched with omega-3 or omega-6 moieties by enzymatic processes, e.g. enrichment of a natural phospholipid/lecithin with omega-3 fatty acids by enzymatic transesterification/esterification followed by transformation of the head group to serine (using PLD enzymes) to obtain a PS-omega-3/omega-6 conjugate. Another enzymatic pathway is to obtain a lecithin or phospholipid source which is naturally rich in omega-3 acids, such as krill phospholipids, and transform their head groups to serine. It is to be noted that the fatty acid composition of the PS obtained by this method has an omega-3 composition which is predetermined by the source of choice (fish, krill, algae, etc.). Such methods have been thoroughly described in Applicant's co-pending PCT Application claiming priority from IL158553.

The PS-omega-3/omega-6 ingredient of the present invention can also be prepared by chemical transesterification/esterification methods that will enrich the *sn*-1 and 2 positions with omega-3 or omega-6 acyl residues.

Such methods of preparation of PS-omega-3 and PS-omega-6 have been described in Applicant's co-pending PCT Application claiming priority from IL158553.

Alternatively, the PS ingredient of the present invention can be prepared by GMO (genetically modified organisms)/biotechnology methods, for example, providing phospholipids-producing organisms with omega-3 or omega-6 fatty acids to obtain phospholipids enriched with omega-3 or omega-6 PS. It may be preferred to use genetically engineered plants or microorganisms, to avoid use of animal sources.

The PS of this invention can have the omega-3 or omega-6 fatty acid composition of a specific lecithin raw material, relatively rich with omega-3 or omega-6 fatty acids, enriched with PS to yield a PS ingredient with elevated omega-3 or omega-6 fatty acids levels, compared to soybean-PS. Such is the case, for example, when phospholipids from krill are used as the starting material, as described above.

In a preferred embodiment the PS enriched with omega-3 or omega-6 can be soybean-PS or any other PS, from plant, animal, for example krill, or microorganism source. In a further preferred embodiment the omega-3 or omega-6 enrichment can be performed on a lecithin, which in turn is enriched with PS by transphosphatidylation.

It is the purpose of this invention to provide a novel PS ingredient, enriched with omega-3 fatty acids, resulting in an ingredient with improved efficacy compared to ingredients containing natural or simply enriched PS.

The improved PS preparation of this invention exhibits enhanced activity in the improvement and treatment of cognitive and mental conditions and

disorders as well as the maintenance of normal functions of brain related systems and processes. These include, but are not limited to ADHD, multiple sclerosis (MS), dyslexia, depression, learning capabilities, intensity of brain waves, stress, mental and psychiatric disorders, neurological disorders, hormonal disorders, concentration and attention, mood, brain glucose utilization, and general cognitive and mental well being.

The novel lipid preparation of this invention exhibits enhanced activity in the improvement of cognitive functions, as detailed hereunder, over omega-3 or omega-6 lipids *per se* or soybean-PS. Furthermore, under certain conditions or for all or specific disorders, the lipid preparation of the invention is effective at a dosage of less than 100 mg/day. This is lower than the current recommended daily dosage of soybean-PS (100-300mg/day) or omega-3 lipids (approx. 1-2g/day or more) currently available in the market. Nonetheless, dosages of 100-600mg/day are preferred for enhanced efficacy of the lipid preparation of the invention.

An important advantage of the PS preparation of the invention is that it exhibits multifunctional activity. This multi-functionality is exhibited by improvement in cognitive and mental functions, together with improvement of other health disorders or conditions.

The enhanced activity of this PS ingredient, as well as its multi-functionality, may arise from the unique structure of this ingredient and its influence on the physical and chemical properties of cell membranes in brain tissues as well as other organs and tissues.

The enhanced activity of this PS ingredient, as well as its multi-functionality, may also be attributed to the enhanced bioavailability of the omega-3 fatty acids, due to their incorporation in the PS skeleton. Thus,

the omega-3 fatty acids can be delivered to the brain across the blood-brain barrier, being a part of the PS molecule, which readily passes this barrier. The PS functions as a delivery platform for the fatty acids bound thereto, to various organs and tissues, thereby enhancing their bioavailability.

The additional health disorders or conditions which are affected by the multifunctional PS preparation of the invention include, but are not limited to high blood cholesterol levels, high triglycerides levels, high blood fibrinogen levels, HDL/LDL ratio, diabetes, metabolic syndrome, menopausal or post-menopausal conditions, hormone related disorders, vision disorders, inflammatory disorders, immune disorders, liver diseases, chronic hepatitis, steatosis, phospholipid deficiency, lipid peroxidation, dysrhythmia of cell regeneration, destabilization of cell membranes, coronary artery disease, high blood pressure, cancer, hypertension, aging, kidney disease, skin diseases, edema, gastrointestinal diseases, peripheral vascular system diseases, allergies, airways diseases, neurodegenerative and psychiatric diseases.

The new ingredients of the invention can be delivered and utilized in a variety of products. Such products include dietary supplements, functional foods, pharmaceutical delivery systems, etc.

The preparation of pharmaceutical compositions is well known in the art and has been described in many articles and textbooks, see e.g., Gennaro A. R. ed. (1990) *Remington's Pharmaceutical Sciences*, Mack Publishing Company, Easton, Pennsylvania, and especially pages 1521-1712 therein.

As dietary supplements, the preparations of the invention may be used in the form of soft gel capsules, tablets, syrups, and other common dietary supplements delivery systems.

As functional foods, the preparations of the invention can be incorporated and used in a variety of foods, such as dairy products, ice-creams, biscuits, soy products, pastry and bread, sauces, condiments, oils and fats, margarines, spreads, cereals, drinks and shakes, infant formulas, infant foods (biscuits, mashed vegetables and fruits, cereals), bars, snacks, candies, chocolate products.

As pharmaceutical products, the preparations of the invention can be delivered orally, intravenously, or by any other conventional or special route of administration.

The new preparations of the invention may be in the form of fluid oil, powder, granules, wax, paste, oil or aqueous emulsion, and any other form that will enable its use in the target applications.

Pharmaceutical or nutraceutical formulations comprising the PS preparation of the invention may include physiologically acceptable free flowing agents, other additives, excipients, dessicants and diluents, colorants, aroma and taste ingredients, and any ingredients that control physical, organoleptic, and other properties, as well as additional active ingredients, for example minerals, vitamins, other nutritional additives.

The utilization of omega-3 lipids in a variety of applications, and especially as ingredient of functional foods, is hindered due to their distinct fish odor. Thus, another advantage of the omega-3 enriched phospholipids ingredients of the invention is that they have reduced odor or taste of omega-3 acyl moieties, due to the covalent binding of these groups to the PS backbone. This increases the vapor pressure of these materials, hence reducing their distinct aroma. Thus, the covalent binding of the omega-3 fatty acids to the phospholipid backbone, especially PS,

alters and improves their taste properties. Moreover, the PS ingredient of the invention also offers enhanced stability to the oxidation sensitive omega-3 fatty acids. Phospholipids in general, and PS in particular, are known to act as anti-oxidants and stabilizers.

These benefits make the lipid preparation of the invention highly beneficial and important in a variety of applications and especially in functional foods, where stability, aroma and taste are fundamental requirements.

Furthermore, these novel ingredients can be formulated with additional lipids for an even enhanced bio-functionality and efficacy.

The polar lipids derivatives of PUFA, such as the PS-PUFA derivatives have exhibited high stability as a preparation and additionally in several food applications, used in the clinical trials of the present invention. The stability of these sensitive compounds is emerging from the covalent combination of phospholipids, known in the past to be used as preservatives and of the un-stable PUFA moieties.

The new ingredients of the invention can be delivered and utilized in a variety of products. Such products include dietary supplements, functional foods, pharmaceutical delivery systems, etc.

Disclosed and described, it is to be understood that this invention is not limited to the particular examples, process steps, and materials disclosed herein as such process steps and materials may vary somewhat. It is also to be understood that the terminology used herein is used for the purpose of describing particular embodiments only and not intended to be limiting since the scope of the present invention will be limited only by the appended claims and equivalents thereof.

It must be noted that, as used in this specification and the appended claims, the singular forms "a", "an" and "the" include plural referents unless the content clearly dictates otherwise.

Throughout this specification and the claims which follow, unless the context requires otherwise, the word "comprise", and variations such as "comprises" and "comprising", will be understood to imply the inclusion of a stated integer or step or group of integers or steps but not the exclusion of any other integer or step or group of integers or steps.

The following Examples are representative of techniques employed by the inventors in carrying out aspects of the present invention. It should be appreciated that while these techniques are exemplary of preferred embodiments for the practice of the invention, those of skill in the art, in light of the present disclosure, will recognize that numerous modifications can be made without departing from the spirit and intended scope of the invention.

Examples

Example 1

Methods:

Animals and diet

Male Wistar rats originated from the same colonies were obtained from Harlen. Fifty rats were randomly divided into five dietary supplemented groups, in addition to their normal diet: (i) a group fed 0.1g medium-chain triglycerides (MCT)/1ml supplement matrix (MCT group); (ii) a group fed 0.1g DHA/EPA (20/30% of total fatty acids composition, diluted with MCT to generate 30% (w/w) LC-PUFA compound) triglycerides/1ml supplement matrix (LC-PUFA group); (iii) a group fed 0.1g soybean lecithin-derived

PS (20% SB-PS w/w)/1 ml supplement matrix (SB-PS group); and (iv) a group fed 0.1g PS- ω 3 (20% PS w/w, and total LC-PUFA composition of 30%)/1 ml supplement matrix (PS group). The supplement matrices were stored at -20°C, and fresh portions were fed to the rats every day. All supplements were handled so as to minimize oxidation of the fatty acids. Rats consumed the diet and water *ad libitum*. All rats were housed in a standard environment, in which temperature was maintained at 24 \pm 0.5°C, and the relative humidity was kept at 65 \pm 5% with 12-h periods of light and dark. Body weight was measured at the beginning and the end of the treatment period.

The PS- ω 3 compound used in this study mimics the fatty acids composition of the mammalian brain PS, with respect to its DHA content (20%). Generally, in animal cells, the fatty acid composition of PS varies from tissue to tissue, but does not appear to resemble the precursor phospholipids, either because of selective utilization of specific molecular species for biosynthesis or because of re-modeling of the lipid via deacylation-reacylation reactions. In human plasma, 1-stearoyl-2-oleoyl and 1-stearoyl-2-arachidonoyl species predominate, but in brain and many other related tissues 1-stearoyl-2-docosahexaenoyl species are very abundant [O'Brien *et al.* (1964) *J Lipid Res.* 5(3):329-38]. An early work by Yabuuchi *et al.* [Yabuuchi *et al.* (1968) *J Lipid Res.* 9(1):65-7] established that the DHA content in bovine gray matter is up to 30% of the total fatty acids composition; most of the total amount of DHA was located at the sn-2 position (60%). It was the bovine brain PS that Toffano and Bruni reported in the early 1980's to be a pharmacologically active compound, which counteracts age-related changes in the central nervous system [Toffano *et al.* (1980) *Pharmacol.Res. Commun.* 12:829-845].

Behavioral testing

Water maze test, which was developed by Morris [Stewart, CA. and Morris, R.G. (1993) The water maze. In: Behavioural Neuroscience: A Practical Approach. Vol. 1 (Saghal, A., ed.), pp. 107–122. Oxford University Press, New York, NY.], uses a circular tank (137 cm diameter, 35 cm deep) constructed of opaque white plastic. It is filled with water (21–22°C) to a depth of 28 cm, and the water is rendered opaque by the addition of soluble, nontoxic white latex paint. In the place version of the maze, the rat develops a spatial map of the extra-maze cues, which it then uses to locate the platform. Thus the distance swum to the platform and the time taken in doing so should decrease over testing sessions (days) as the rat learns the location of the platform. Moreover, it is expected that if the rat has learned the location of the platform in relation to the extra-maze cues, its initial response on the probe trial will be to swim directly to the quadrant in which it expects to find the platform. Thus the distance swum (and time spent) in the target quadrant should be greater than that in the other two quadrants (excluding the start quadrant). The distance swum to the platform as well as the latency to reach the platform were monitored using the video-based tracking system. The behavioral testing was conducted during the dark cycle, when rats are normally most active.

The pool was located in a test room in which there were many extra-maze spatial cues. On the first three days, the rats were required to locate the hidden platform (15.5 cm x 15.5 cm) situated 1 cm below the surface of the water. There were two acquisition testing sessions per day, with four trials per session. On each trial, the rat was placed, facing the wall, in one of the four quadrants in the tank, and allowed to swim for a maximum of 60 seconds. Once the rat found the platform, it remained there for 5 seconds before being returned to the holding cage, which was kept warm on a heating pad. If the rat failed to find the platform in that time, it was placed on it for 5 seconds before being returned to the holding cage. Each

of the eight trials conducted each day was started from a different quadrant, with the order determined pseudorandomly (not twice from the same quadrant) and varying from day to day. The intertrial interval (ITI) was 120 seconds, counted from the end of one trial to the beginning of the next. On fourth day, followed by a session as abovementioned, the platform was removed from the tank, and a probe trial was conducted by placing the rat in the quadrant opposite to that of the platform and then allowing it to swim for 60 seconds. The day following the probe trial, the rats were tested with a session in which the maze was set up as previously described, followed by a session in which the platform was repositioned to the center of the opposite quadrant. The latency to find the platform on each trial was recorded. Scopolamine (1mg/Kg) was intraperitoneally (i.p.) administered 30 minutes before the indicated trials.

Lipid extraction and NMR analyses

At the end of the behavioral testing, the rats were anesthetized with Halothane and then decapitated. Liver and brain tissues were quickly removed and stored (at -80°C). The lipid fraction of the rat tissues were extracted using a modified version of the technique described by Bligh and Dyer 1959 [Bligh and Dyer, (1959) *Can. J. Biochem. Physiol.* **37**, 911-917]. Briefly, 500-700 mg and 300-1200 mg of liver and brain tissues, respectively, were homogenized in a solution of CDCl₃, methanol and CS-EDTA (1:2:2 v:v:v). The homogenates were further agitated using ultrasonic bath (10 min, 80°C), followed by additional vigorous shaking (20 min). The relative ratio of the phospholipids in the homogenates was measured using high-resolution ³¹P-NMR at 121.MHZ using a 7.06 Tesla General Electric spectrometer.

These homogenates were further analyzed for their fatty acids distribution. First, the lipids extracts were desalted by reverse-phase chromatography using an RP-18 column [Williams *et al.* (1980) *J.*

Neurochem.; **35**, 266–269]; diheptadecanoyl phosphatidylcholine was added as internal standard before the loading on the column. Phospholipids were separated from neutral lipids, such as cholesterol, on silica gel plates (Merck 60) developed in isohexane: ether: formic acid 80:20:2 (v:v:v). The phospholipids spot was visualized by spraying primulin solution and compared with authentic phospholipids standards. Henicasonoic methyl ester (C21:0) was added as a 2nd internal standard and the phospholipids were converted to methyl esters by mild acid hydrolysis with 1% methanolic H₂SO₄ overnight at 50°C. The fatty acids profile of the different samples was determined by gas-liquid chromatography.

Results

Anti-dementia effects of bovine brain cortex-derived PS (BC-PS) has been demonstrated by several double-blind, placebo-controlled studies, see review by [Kidd P. (1996) *Alt Med Rev.* **1**(2):70-84]. In the past decade both BC-PS and soybean lecithin transphosphatidylated PS (SB-PS) were shown to recover the scopolamine-induced amnesia in rodent, although the fatty acids composition is considerably different between these compounds [Zanotti A *et al.* (1986) *Psychopharmacology (Berl).* **90**(2):274-5.; Claro F. *et al.* (1999) *Physiol Behav.* **67**(4):551-4; Sakai M. (1996) *Nutr Sci Vitaminol. (Tokyo)* **42**(1):47-54; Furushiro M *et al.* (1997) *Jpn J Pharmacol.* **75**(4):447-50]. The means of PS administration in these studies was predominantly intravenous or intraperitoneal; although Furushiro *et al.* described also oral administration of SB-PS that antagonized amnesic effects of scopolamine. However, in the latter study the investigator used a considerable high dose of SB-PS, ranging between 60 to 240 mg/Kg.

In the presented study, rat diet was supplemented with the above-mentioned treatments (diets i, ii, iii, iv and v) for three months before the

maze test was performed. In the acquisition stage (Figure 1A-1D) there is an expected and marked increase in the latency time to find the platform after the administration of scopolamine (1mg/Kg) of all groups. Although the latency curves of MCT and PS- ω 3 groups are similar, there is a statistically smaller difference in the latency change, induced by scopolamine, in the PS- ω 3 group with respect to the latency presented by the MCT group (P-value < 0.07 Vs. P-value < 0.0007, respectively). Similarly, the groups treated with SB-PS or LC-PUFA, demonstrated a reduced effect of scopolamine on their learning curves, with respect to the MCT group (see Figure 1A-1D). Having all groups learn the task at a similar rate, resembles data presented by Blokland *et al.* [Blokland *et al.* (1999) *Nutrition* 15(10): 778-83], which showed no difference between PS obtained from different sources and the empty vehicle, in a water maze test.

What is particular to the present trial is the accelerated rate in learning the task under the scopolamine sedation. This was not demonstrated previously [Furushiro *et al.* (1997) *id ibid.*; Suzuki *et al.*, (2000) *Jpn. J. Pharmacol.* 84, 86-8]. Note that in these studies the rodent faced a different task (passive avoidance). In Suzuki *et al.* 2001 (*J. Nutr.* 131: 2951-6) the investigators utilized considerably older rats (24-25 months old) than the ones tested in the present trial. The latency time in the acquisition step was considerably longer for the aged rats compared to the young ones that were tested (eight weeks). Interestingly, although the latency time in the present trial of non-sedated rats is somewhat comparable to the younger rats tested by Suzuki *et al.* [Suzuki *et al.* (2001) *id ibid.*], the scopolamine-induced amnesia latency time in the MCT group resembles the one obtained at the described study for elderly rats. In conclusion, scopolamine induced a comparable long latency time in the control group (MCT). This effect was augmented to a different extent by long-term treatment of rats with either PS or LC-PUFA.

In the probe trial, the rats treated with PS- ω 3 showed a distinctively higher tendency than MCT-treated ones ($P < 0.085$) to be present at the zone in which the platform was located during the acquisition of the task (Figure 2), indicating that the rats had learned the spatial location of the platform. Moreover, PS- ω 3 treated rats presented a reduced tendency ($P < 0.08$) to swim in the periphery zone, but rather spent in the central zone. These latter indications, presented by the PS- ω 3 group are related to a higher adventurous characteristic and could be somewhat correlated with the open field behavior trial. Interestingly, in Blokland *et al.* [Blokland *et al.* (1999) *id ibid.*] BC-PS treated mice demonstrated a non-significant but clear tendency to be less adventurous in the open field behavior trial, by spending less time in the center area. With respect to the remarkable learning abilities demonstrated by the rats that were treated with PS- ω 3, it is interesting to compare their performance in the Morris water maze task in the spatial probe test to the one obtained by the SB-PS treated animals by Suzuki *et al* [Suzuki *et al* (2001) *id ibid.*]. Though the percent of time spent in the quadrant where the platform was located is similar (~45%), it is remarkable that the dosage in the current study was merely one third of the administration levels in Suzuki *et al* 2001 (20mg/kg vs. 60mg/kg, respectively). Indeed, in the present study there was no significant change in the time that the SB-PS (20mg/kg) treated rats spent in this quadrant when compared with the values obtained by the MCT-treated group [Fig.1C and Fig. 1A, respectively]. In summary, the PS- ω 3 treated group learning abilities were markedly higher than the control, in a considerably low level of PS administration. In addition, the rats treated with PS- ω 3 were less conservative and more adventurous in studying the maze in the absence of the platform.

Finally, the most prominent and outstanding data obtained in the present study was the response to the repositioning of the platform. All groups

presented a shorter latency in finding the platform at the first session, when compared to the one obtained by the MCT-treated group, under scopolamine sedation (Figure 3A-3D). These data suggest that LC-PUFA, and more potently PS, can attenuate scopolamine-induced amnesia, as previously presented by other studies (see selected references above).

Surprisingly, in the second session, there were no differences between the latency in finding the platform after its repositioning in all groups but the PS- ω 3 treated group. In fact, it seemed that in all treatments but the PS- ω 3 there was no learning process of the position of the platform. The PS- ω 3 group presented a remarkably different behavior; it seemed that there was no lag in the learning of the repositioned platform in the rat treated with this anti-muscarinic drug. The ability of the PS- ω 3 treated group to locate the platform after it had been repositioned seemed to be contradictory with the result obtained earlier in the spatial probe test (Fig. 2), where these rats showed preference for the third quadrant. Pearce and colleagues [Pearce *et al.* (1998) *Nature* **396**: 75-77] attempted to resolve this discrepancy, by describing two means for memorizing a specific spatial location. One is to use a cognitive map that encodes information about the geometric relationship between the object and several land marks (the cognitive map method) and the other is the use of heading vectors that specify the direction and distance from a single landmark to the object (the heading vector method). In the present test, the rats could locate the platform from the above-mentioned cues and/or from the distance and direction with respect to the walls. In the acquisition and the spatial probe test, both methods contributed to the score of finding the platform. However, in the repositioning test, the cognitive abilities which are related to the heading vector method and the short-term memory (working memory), made the difference. The heading vector method, because the distance from the wall was not effected by the repositioning (just the quadrant), and the working memory due to the

benefits in memorizing the areas already explored that enable an effective search in the pool.

It has been previously reported that the mechanism by which PS attenuates the scopolamine effect could be attributed not only to a beneficial effect on the cholinergic circuitry, but PS could also have an effect on the serotonergic neuronal system [Furushiro *et al.* (1997) *id ibid.*]. It appears that the presented data could be the result of more than one neuronal system alteration, possibly the dopaminergic. In an earlier study [Drago *et al.* (1981) *Neurobiol Aging*, 2(3):209-13], it was suggested that the alteration in the obtained behavioral changes between BC-PS treated aged rats to their control could be attributed not only to the modifications in cholinergic and serotonergic transmission, as described above, but also through affecting the catecholaminergic (like dopamine) system. In this study the facilitated acquisition of active avoidance behavior as studied in shuttle-box and pole jumping test situations, and the retention of active and passive avoidance responses were improved in the PS-treated rats. Tsakiris [Tsakiris, S. (1984) *Z Naturforsch [C]*, 39(11-12):1196-8] reported on an indirect effect of PS on the dopamine related adenylyl cyclase, through membrane fluidity mechanism. Interestingly, it has also been reported [Chalon, *et al.* (1998) *J Nutr.*; 128(12):2512-9] that enriched diet with high level of (n-3) PUFA could result in an effect on the cortical dopaminergic function. It is conceivable that the existence of LC-PUFA on the backbone of the phospholipids was highly beneficial in terms of such a multi-neurotransmitter mechanism.

The biochemical analyses of the present results in liver tissues (Fig. 4A) shows that in rats supplemented with PS for three months (SB-PS and PS- ω 3) there was a notable increase in the levels of the primer phospholipids, i.e. phosphatidylcholine (PC). These data is consistent with early observations regarding the liver and its major role in the

phospholipids uptake and the primary metabolism of most fatty acids. Wijendran and colleagues [Wijendran *et al.* (2002) *Pediatr. Res.* 51:265-272] described a study in which baboons were fed labeled LC-PUFA on the backbone of PC and triglycerides, and demonstrated that the levels of incorporation of LC-PUFA on a phospholipid backbone to the liver was higher than the extent of incorporation of LC-PUFA on the triglycerides backbone. In addition, PS levels of rats fed with PS- ω 3 were elevated in cortex tissues analyses of phospholipids distribution (Figure 4B), comparing with MCT. Interestingly, the phospholipids fatty acids profile of these cortices (Table 1) demonstrate a marked elevation in the DHA content of the rats fed with PS- ω 3 (P=0.007). Similar elevation was noted for LC-PUFA fed rats, however to a reduced extent compared with PS- ω 3 treatment (14.6 versus 17.5, respectively P=0.03) and MCT (14.6 versus 12.3, respectively P=0.02). This difference in the DHA levels between the two omega-3 groups might suggest enhanced bioavailability of DHA when it is esterified to the backbone of phospholipids rather than to triglycerides. Similar conclusions were drawn by Lemaitre-Delaunay and colleagues [Lemaitre-Delaunay *et al.* (1999) *J. Lipid Res.*; 40:1867-1874], when they had study the kinetics and metabolic fate of labeled DHA on triglycerides versus its enrichment in lysophosphatidylcholine, and by Wijendran *et al.* [Wijendran *et al.* (2002) *id ibid.*] in the above-mentioned baboons study.

Interestingly, this increase in DHA content in the cortices of both PS- ω 3 and LC-PUFA fed rats is accompanied with a statistically significant decrease in the levels of oleic acids and to somewhat lower extent of linoleic acid (Table 1) in the phospholipids fraction. Similar changes in the ratios of the fatty acids profile was demonstrated by others, by feeding rodents with dietary fats enriched with LC-PUFA [for example: Yamamoto *et al.* (1987) *J. Lipid Res.* 28: 144-151]. The SB-PS group showed a very similar profile to the MCT group.

In sum, the improved performance in the Morris water maze test of the PS- ω 3 treated rats under scopolamine sedation strongly supports the potency of PS- ω 3 as an anti-dementia and age-associated memory impairment effects. This cognitive enhancement is further supported by the biochemical evidence of the elevated phospholipids levels in the liver and brain tissues (Fig. 4A-4B), and with elevated levels of DHA attached to the phospholipids from the cortex of the PS- ω 3 fed rats.

Table 1 summarizes the effect of dietary LC-PUFA from different sources on the fatty acids profile in cerebral phospholipids from elderly Wistar rats. Fatty acids from the purified phospholipids fraction were analyzed by gas-liquid chromatography. The major fatty acids are expressed as % of total fatty acids in the phospholipids. Values represent mean \pm S.D. of four different rats per treatment. Statistical significant between different supplements and MCT group is presented as followed: * P<0.05; ** P<0.01.

Table 1

Fatty acids	MCT	LC-PUFA	SB-PS	PS- ω 3
C16:0	12.9 \pm 1.4	14.6 \pm 4.7	13.7 \pm 4.7	13.6 \pm 4.4
C16:1	1.0 \pm 0.7	1.0 \pm 0.3	1.5 \pm 0.4	1.5 \pm 0.8
C18:0	17.9 \pm 1.0	20.1 \pm 1.3*	17.2 \pm 2.8	18.0 \pm 5.5
C18:1 (n-9)	36.5 \pm 1.8	32.0 \pm 2.8*	37.0 \pm 6.8	30.7 \pm 4.1*
C18:1 (n-7)	3.7 \pm 0.5	4.3 \pm 0.2*	4.0 \pm 0.3	4.8 \pm 1.5
C18:2	7.2 \pm 0.7	4.5 \pm 0.6**	7.1 \pm 2.6	5.1 \pm 2.7
C20:1	2.5 \pm 0.5	2.9 \pm 0.8	2.1 \pm 0.4	2.3 \pm 0.3
C22:6	12.3 \pm 1.7	14.6 \pm 0.6*	12.4 \pm 3.2	17.5 \pm 2.4**
C24:1	3.4 \pm 1.0	3.3 \pm 1.3	2.8 \pm 0.9	2.0 \pm 1.2*
rest	2.7 \pm 0.1	2.8 \pm 0.4	2.1 \pm 0.9	4.5 \pm 3.0

Example 2 – PS-omega-3 in the treatment of ADHD children

Attention-deficit/hyperactivity disorder (ADHD) encompasses a broad constellation of behavioural and learning problems and its definition and

diagnosis remain controversial [Kamper (2001) *J. Pediatr.* **139**:173-4; Richardson *et al.* (2000) *Prostaglandins Leukot. Essent. Fatty Acids*, **63**(1-2):79-87]. The etiology of ADHD is acknowledged to be both complex and multi-factorial. Traditionally, ADHD is the diagnosis used to describe children who are inattentive, impulsive, and/or hyperactive. Roughly 20-25% of children with ADHD show one or more specific learning disabilities in math, reading, or spelling [Barkley, R.A. (1990) *Attention-deficit hyperactivity disorder: a handbook for diagnosis and treatment*. New York: Guilford Press]. Children with ADHD often have trouble performing academically and paying attention, and may be disorganized, have poor self-discipline, and have low self-esteem. A conservative estimate is that 3-5% of the school-age population has ADHD [American Psychiatric Association. Diagnostic and statistical manual of mental disorders. 4th ed. (DSM-IV) Washington, DC: American Psychiatric Association, 1994]. Treatments for ADHD include behavior therapy and medications, mainly methylphenidate (Ritalin™). Psychostimulant drugs and antidepressants are often used to calm children with ADHD, with an effectiveness rate of ~75% (Swanson *et al.* *Except Child* 1993; 60:154-61). The advantages of using these medications include rapid response, ease of use, effectiveness, and relative safety. Disadvantages include possible side effects, including decreased appetite and growth, insomnia, increased irritability, and rebound hyperactivity when the drug wears off [Ahmann *et al.* (1993) *Pediatrics*; **91**:1101-6]. Moreover, these medications do not address the underlying causes of ADHD. Thus, studies to elucidate the potential contributors to the behavior problems in ADHD may lead to more effective treatment strategies for some children.

Omega-3 fatty acids are specifically implicated in maintaining central nervous system function. Deficiency of n-3 fatty acids in rats and monkeys has been associated with behavioral, sensory, and neurological dysfunction [Yehuda *et al.* (1993) *Proc. Natl. Acad. Sci. USA*; **90**:10345-9;

Reisbick *et al.* (1994) *Physiol. Behav.* 55:231-9; Enslin *et al.* (1991) *Lipids*; 26:203-8]. Several studies have focused on essential fatty acid metabolism in children with ADHD [Colquhoun *et al.* (1981) *Med Hypotheses*; 7:673-679]. Children with hyperactivity have been reported to be more thirsty than normal children and have symptoms of eczema, asthma, and other allergies [Mitchell *et al.* (1987) *Clin. Pediatr.*; 26:406-11]. For example, in a cross-sectional study in 6–12-y-old boys recruited from central Indiana, it was showed that 53 subjects with ADHD had significantly lower proportions of key fatty acids in the plasma polar lipids [arachidonic acid (AA; 20:4n-6), eicosapentaenoic acid (EPA; 20:5n-3), and docosahexaenoic acid (DHA; 22:6n-3)] and in red blood cell total lipids (20:4n-6 and 22:4n-6) than did 43 control subjects [Stevens *et al.* (1995) *Am. J. Clin. Nutr.*; 62:761–8]. However, recent publications [Hirayama *et al.* (2004) *Eur. J. Clin. Nutr.*; 58(3):467-73; Voigt *et al.* (2001) *J Pediatr.*; 139(2):189-96] that investigated whether DHA supplementation would result with ameliorate the symptoms in ADHD children, suggested that careful attention should be paid as to which fatty acid(s) is used. In these studies DHA supplementation had demonstrated only marginal if any beneficial effects.

Recently, it has been suggested that one of the possible solutions to the nutrient deficiencies which are common in ADHD, could be PS supplementation [Kidd (2000) *Altern Med Rev.*; 5(5):402-28].

Method

Subjects and diet

Ninety 8-to-13-year old children diagnosed according to the DSM-IV as ADHD, were assigned randomly, in a double-blind fashion to receive PS- ω 3 (300 mg/d; containing total 450 mg/d DHA/EPA), 450 mg/d DHA/EPA or canola oil (30 per group) for two months, while not taking stimulant medication or other supplements. Characterizing the subject as ADHD included a score lower than -1.8 in the Test of Variables of Attention.

Data Analysis

At the conclusion of the trial, ADHD children were scored according to parental behavioural rating scales (Connors' Rating scale).

Results and discussion

Use of complementary therapies is particularly common among patients with chronic, incurable, or frequently relapsing conditions. For example, use of complementary and alternative medical therapies (CAM) is common in children with cancer, asthma, and cystic fibrosis. Parents or subjects who seek CAM typically do so because such therapies are more consistent with their values, are more empowering, and are perceived as more natural and less risky than conventional treatments. The majority of these patients do not abandon mainstream therapies but use herbs and other forms of CAM as adjunctive treatments. Only a minority (<40%) talk with their pediatricians about their use of CAM. Because of the stigma and side effects that accompany use of stimulant medications, many families turn to CAM to treat ADHD. Typically, only 70% of children respond to stimulants such as Ritalin™, and of those who do, approximately half report side effects from their medications. In an Australian survey of 290 families seen at a multidisciplinary referral center for ADHD, 64% had tried at least one "other therapy," most commonly dietary restriction, multivitamin supplementation, and occupational therapy [Stubberfield *et al.* (1999) *J Paediatr Child Health*;35:450-3].

In the presented study the different supplementation was formulated into a popular chocolate paste (see below). Using this matrix enable the parents to administer the treatments in a non-conventional form to their children and provided a reduced organoleptic effect characteristic of the marine-derived compounds (see below).

The parental rating survey, at the end of the treatment period, measured the attention deficit, hyperactivity and impulsivity of the children, as well as the aggression as assessed by parents, teachers, siblings and peers. The results indicate a distinctively large placebo effect. This effect is somewhat reduced if the placebo-treated ADHD children that failed to complete the study due to severe behavioral deterioration are taken into consideration. It seemed that most of these children insisted on reassigning for Ritalin™ administration. However, the present data also clearly demonstrate PS- ω 3 as a potent agent. All in all, ~70% of the parents of the PS- ω 3 treated ADHD children indicated some improvement in the behavioural score of their children, whereas 50% of these parents provided clear indications for multiple beneficial effect of the supplement on their children behavior. This prominent effect is 2.2-fold higher than the improvement obtained by placebo (~30%). Comparison of the parental scoring of LC-PUFA on ADHD children behavior with the parallel rating that followed three months of PS- ω 3 administration, point at the latter to have a higher score. While both compounds demonstrated similar extent of marginal improvement, PS- ω 3 had a marked higher rate of substantial improvement (47% versus 35%, respectively) with the lowest rates of lack or deteriorating effects (21% & 11% versus 26% and 17%, respectively). These effects of PS- ω 3 supplementation could be attributed to both enhanced bioavailability of omega-3 fatty acids and through PS well documented effects on mood, stress and anxiety.

Example 3 – Effect of PC-DHA consumption in ApoE^o mice

Methods

Animal diet

Apolipoprotein E deficient (ApoE^o) mice [Hayek T. *et al.* (1994) *Biochem. Biophys. Res. Commun.* **201**:1567-1574] at 8 weeks of age, were assigned randomly (5 mice each) to LC-PUFA enriched lecithin (30% omega-3 of total fatty acids composition; PC-DHA group) or placebo. The mice were

fed, besides the regular chow diet, once every three days with either 25 μ l PC-DHA or PBS, via oral gavage, during 10 weeks.

Each mouse consumed approximately 5 mL of water/day, and 5 g of chow/day.

Serum lipids peroxidation

Serum was diluted 1:4 in PBS. Serum susceptibility to oxidation was determined by incubating serum sample with 100mM of the free radical generating compound, 2'-2'-azobis 2'-amidinopropane hydrochloride (AAPH), which is an aqueous soluble azo compound that thermally decomposes to produce peroxy radicals at a constant rate. The formation of thiobarbituric reactive substances (TBARS) and of lipid peroxides was measured and compared to serum that was incubated under similar conditions, but without AAPH.

Results and Discussion:

ApoE^o mice are widely used as an animal model for atherosclerosis as they develop severe hypercholesterolemia and atherosclerotic lesions on a chow diet. Moreover, accelerated atherosclerosis is associated with increased lipid peroxidation of plasma lipoproteins and arterial cells in these mice [Hayek T. et al. (1994) *id ibid.*; Keidar S. (1998) *Life Sci.* **63**:1-11].

Figure 6 shows how prolonged PC-DHA consumption by ApoE^o mice resulted in a clear tendency ($P < 0.10$) to reduce the serum susceptibility to AAPH-induced oxidation by 16% (in comparison to placebo).

Organoleptic issues

The utilization of omega-3 lipids in a variety of applications, and especially as ingredient of functional foods, is hindered due to their distinct fish odor. Thus, another advantage of the omega-3 enriched phospholipids ingredients of the invention is that they have reduced odor

or taste of omega-3 acyl moieties, due to the covalent binding of these groups to the PS backbone. This increases the vapor pressure of these materials, hence reducing their distinct aroma. Thus, the covalent binding of the omega-3 fatty acids to the phospholipid backbone, especially PS, alters and improves their taste properties. Moreover, the PS ingredient of the invention also offers enhanced stability to the oxidation sensitive omega-3 fatty acids. Phospholipids in general, and PS in particular, are known to act as anti-oxidants and stabilizers.

These benefits make this novel phospholipids' preparation of the invention highly beneficial and important in a variety of applications and especially in functional foods, where stability, aroma and taste are fundamental requirements.

Furthermore, these novel ingredients can be formulated with additional lipids for an even enhanced bio-functionality and efficacy.

The starting compound used for the above-mentioned clinical trial in ADHD patients, was LC-PUFA enriched PS mixed with fish oil. Originally, this product and the control fish oil were formulated in food products like energy bars; however the responses from expert panels were categorically devastating, pointing at severe organoleptic problems. In order to overcome this taste barrier the PS- ω 3 product of the invention was de-oiled. The end-product of this process was a paste that when reformulated with either inert or dominant – organoleptic saturated fats could be easily formulated in chocolate bars, chocolate spread, chocolate coated cornflakes, low-fat dairy products or concentrated milk. Each one of these formulations had an evidently reduced organoleptic objection from both the expert panels and the trial volunteers.

47.

The polar lipids derivatives of PUFA, such as the PS-PUFA derivatives have exhibited high stability as a preparation and additionally in several food applications, used in the clinical trials of this invention. This stability, of these sensitive compounds is emerging from the covalent combination of phospholipids, known in the past to be used as preservatives and of the un-stable PUFA moieties.

The stability of a commercially prepared fish oil (omega-3 fatty acid) for laboratory rodent diet [Lytle *et al.* (1992) *Nutr Cancer*; 17(2):187-94] or as an enrichment in spreadable fats [Kolanowski *et al.* (2001) *Int J Food Sci Nutr.*; 52(6):469-76] was addressed by several studies as the public awareness towards the beneficial effects of LC-PUFA increased. A major effort was directed at maintaining the oxidative stability of the fish oil, as these fatty acids are subject to rapid and/or extensive oxidation and other chemical changes by exposure to air, light, or heat during processing or when stored for various lengths of time. The common solution presented in these studies was supplementation the fish oil matrix with antioxidants like butylated hydroxytoluene, butylated hydroxyquinone and alpha-tocopherol, or alternatively, dilution of concentrated fish oil to a limit of 1% in a saturated fats matrix. However, Song and colleagues [Song *et al.* (1997) *Biosci Biotechnol Biochem.*; 61(12):2085-8] had already evaluated the peroxidative stability of DHA-containing oils the form of phospholipids, triglycerides, and ethyl esters in the dark at 25°C in a bulk phase during 10 weeks storage. They had shown that DHA-containing oil in the form of phospholipids was more resistant to the oxidative degradation of DHA than that in the form of triglycerides and ethyl esters in a bulk phase.

The abovementioned PS- ω 3 containing products utilized for the clinical studies were tested for their shelf-life and stability in room temperature. The enriched PS- ω 3 formulated in condensed milk (1 g product per 10 ml

milk) was analyzed by ^{31}P -NMR for stability in cycles of freeze-thawing for a week, and was found to be stable. In the second phase, PS- ω 3 in a chocolate paste matrix (0.75 g product per 20 g chocolate spread) was tested for stability after two weeks storage in room temperature. This formulation also presented a stable percentage of PS, in ^{31}P -NMR analysis. In conclusion, we had been able to establish that ω -3 containing phospholipids are highly stable in room temperature, as well as in freezing-thawing cycles, as oppose to ω -3 containing triglycerides known to rapidly decay after antioxidant consumption.

Claims:

1. A lipid preparation, wherein said lipid is selected from the group consisting of a glycerophospholipid and salts, conjugates and derivatives and thereof and any mixture thereof, and poly-unsaturated fatty acid (PUFA) acyl groups, particularly long-chain poly-unsaturated fatty acid (LC-PUFA) acyl groups, preferably omega-3 and/or omega-6 acyl groups, at a concentration of least 5% (w/w) of total fatty acids content of said preparation, preferably more than 10% (w/w), more preferably 20-50% (w/w), wherein said PUFA is covalently bonded to said lipid.
2. A lipid preparation of claim 1 wherein said lipid is a naturally occurring lipid, or a synthetic lipid.
3. A lipid preparation of claim 2, wherein said lipid is a glycerophospholipid in which at least some of the sn-1 or sn-2 groups of the glycerol backbone are substituted with said poly-unsaturated fatty acid (PUFA) acyl groups.
4. A lipid preparation of any one of claims 1 to 3, wherein said lipid is a glycerophospholipid of formula I:

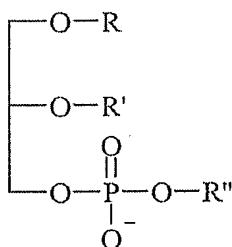

Formula I

wherein R'' represents a moiety selected from serine (PS), choline (PC), ethanolamine (PE), inositol (PI), glycerol (PG) and hydrogen (phosphatidic acid - PA), and R and R', which may be identical or different, independently represent hydrogen or an acyl group, wherein said acyl

group is selected from saturated, mono-unsaturated or poly-unsaturated acyl groups (PUFA), particularly long-chain poly-unsaturated fatty acids (LC-PUFA), more preferably omega-3 and/or omega-6 acyl groups, and salts thereof, with the proviso that R and R' cannot simultaneously represent hydrogen, and wherein said polyunsaturated acyl groups comprise at least 5% (w/w) of total lipid fatty acids, preferably more than 10% (w/w), and particularly 20-50% (w/w).

5. A preparation of claim 4, wherein R represents hydrogen and R' represents an acyl group.

6. A preparation of claim 4, wherein R' represents hydrogen and R represents an acyl group.

7. A preparation of any one of claims 4 to 6, wherein said acyl group is an omega-3 acyl group, preferably an eicosapentaenoyl (EPA), a docosahexaenoyl (DHA) group, or linolenic omega-3 group.

8. A preparation of any one of claims 4 to 6, wherein said acyl group is an omega-6 acyl group, preferably an arachidonoyl (ARA) group, or a linoleic omega-6 group.

9. A preparation of any one of claims 4 to 6, wherein said acyl group is a linolenoyl (18:3) group.

10. A preparation of any one of claims 4 to 9, wherein R' represents serine, choline, ethanolamine, inositol, glycerol, and H.

11. A preparation according to any one of claims 4 to 10, wherein the identity and content of R and R' are predetermined.

12. A preparation of claim 10, wherein R" is serine, characterized in that it mimics the composition of human brain PS.

13. A preparation of claim 10 or 12, wherein R" is serine, characterized in that it is different from human brain PS and has improved bioactivity compared to soybean-PS.

14. A PS preparation, wherein said PS is derived from any one of plant, animal or microorganism source, said preparation being enriched with PS of formula I, wherein R" represents a serine moiety.

15. A preparation of any one of claims 12 to 14, characterized in that it is effective at a lower dosage compared to soybean-PS, while having similar and/or improved bioactivity compared to soybean-PS.

16. A preparation of any one of claims 1 to 15, wherein said omega-3 or omega-6 is more stable than a omega-3 or omega-6 in the free fatty acid form, bonded to a triglyceride or as an ethyl ester.

17. A preparation of any one of claims 1 to 16, characterized in having a reduced or absent of fish-related organoleptic effects.

18. A preparation of any one of claims 1 to 17, said preparation being enriched with PS of formula I, characterized in having a reduced or absent of fish-related organoleptic effects.

19. A preparation of any one of claims 1 to 18, for use in the reduction and/or prevention of serum oxidative stress leading to atherosclerosis, cardiovascular disorders and/or coronary heart disease.

20. A preparation of any one of claims 1 to 18, for use in the improvement and treatment of cognitive and mental conditions and disorders as well as the maintenance of normal functions of brain-related systems and processes, preferably ADHD, aging, Alzheimer's disease, Parkinson's disease, multiple sclerosis (MS), dyslexia, depression, learning capabilities, intensity of brain waves, stress, anxiety, mental and psychiatric disorders, concentration and attention, mood, brain glucose utilization, general cognitive and mental well being, neurological disorders and hormonal disorders.

21. A preparation of any one of claims 1 to 18, said preparation being enriched with PS of formula I, for use in any one of the improvement and treatment of ADHD, and reducing ADHD symptoms in children.

22. A preparation of any one of claims 1 to 24, for enhancing the bioavailability of polyunsaturated fatty acids, particularly omega-3 and/or omega-6 fatty acids.

23. A preparation of any one of claims 1 to 22, for use in combined improvement of cognitive and mental functions together with improvement of additional health disorders or conditions.

24. The preparation of claim 23, wherein said additional health disorders or conditions are at least one of: high blood cholesterol levels, high triglycerides levels, high blood fibrinogen levels, HDL/LDL ratio, diabetes, metabolic syndrome, menopausal or post-menopausal conditions, hormone related disorders, vision disorders, inflammatory disorders, immune disorders, liver diseases, chronic hepatitis, steatosis, phospholipid deficiency, lipid peroxidation, dysrhythmia of cell regeneration, destabilization of cell membranes, coronary artery disease, high blood pressure, cancer, hypertension, aging, kidney disease, skin diseases,

edema, gastrointestinal diseases, peripheral vascular system diseases, allergies, neurodegenerative and psychiatric diseases.

25. A nutraceutical composition comprising a phospholipid preparation as claimed in any one of claims 1 to 24.

26. A nutraceutical composition of claim 25, in the form of softgel capsules, tablets, syrups, or any other common dietary supplement delivery system.

27. A functional food article comprising the phospholipid preparation of any one of claims 1 to 21.

28. The functional food article of claim 27, selected from dairy products, ice-creams, biscuits, soy products, bakery, pastry and bread, sauces, soups, prepared foods, frozen foods, condiments, confectionary, oils and fats, margarines, spreads, fillings, cereals, instant products, drinks and shakes, infant formulas, infant foods (biscuits, mashed vegetables and fruits, cereals), bars, snacks, candies and chocolate products.

29. A pharmaceutical composition comprising the phospholipids preparation of any one of claims 1 to 21, and optionally at least one pharmaceutically acceptable additive, diluent or excipient.

30. A pharmaceutical composition of claim 29, further optionally comprising at least one pharmaceutically active agent.

31. The preparation of any one of claims 1 to 24, wherein said PUFA has increased bioavailability to the organism when comparing to a composition comprising PUFA alone.

1/8

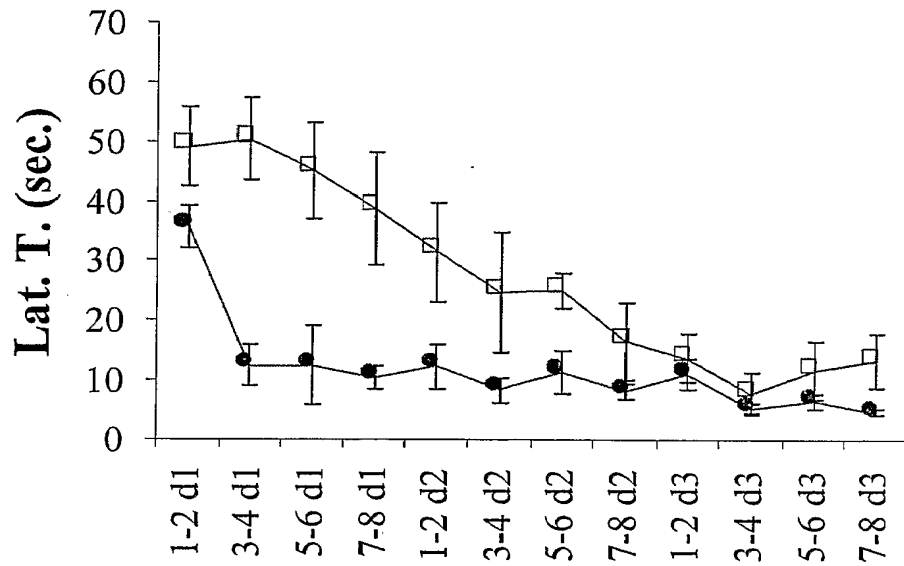

Fig. 1A

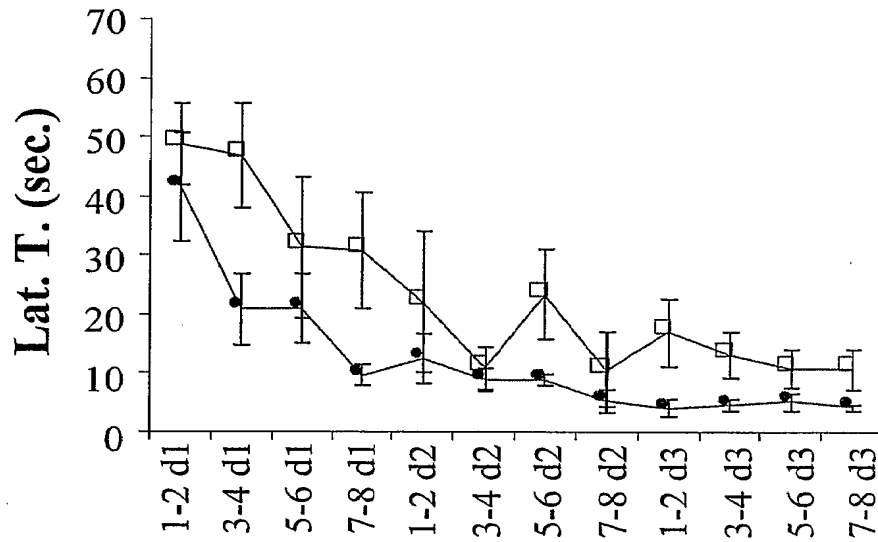

Fig. 1B

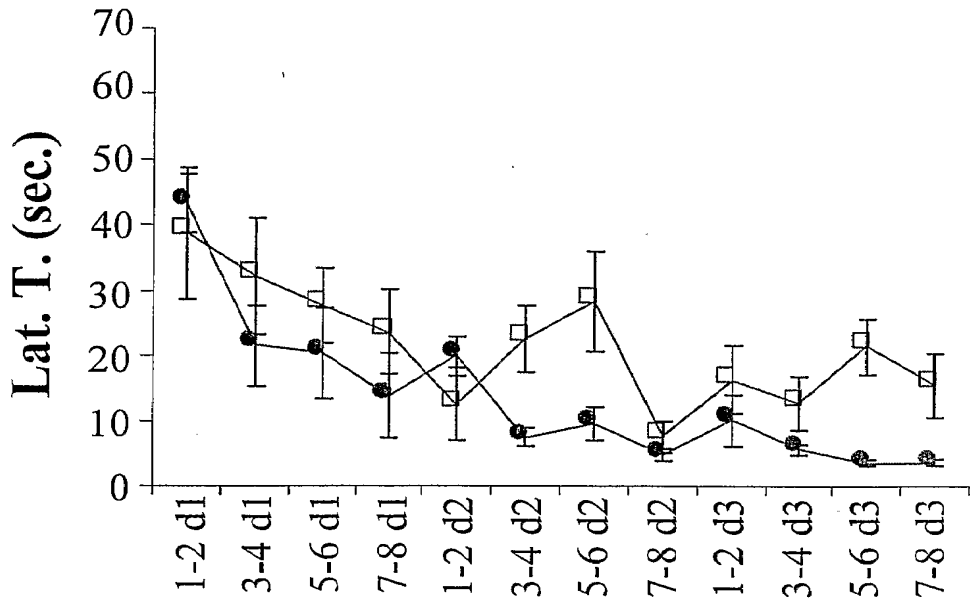

Fig. 1C

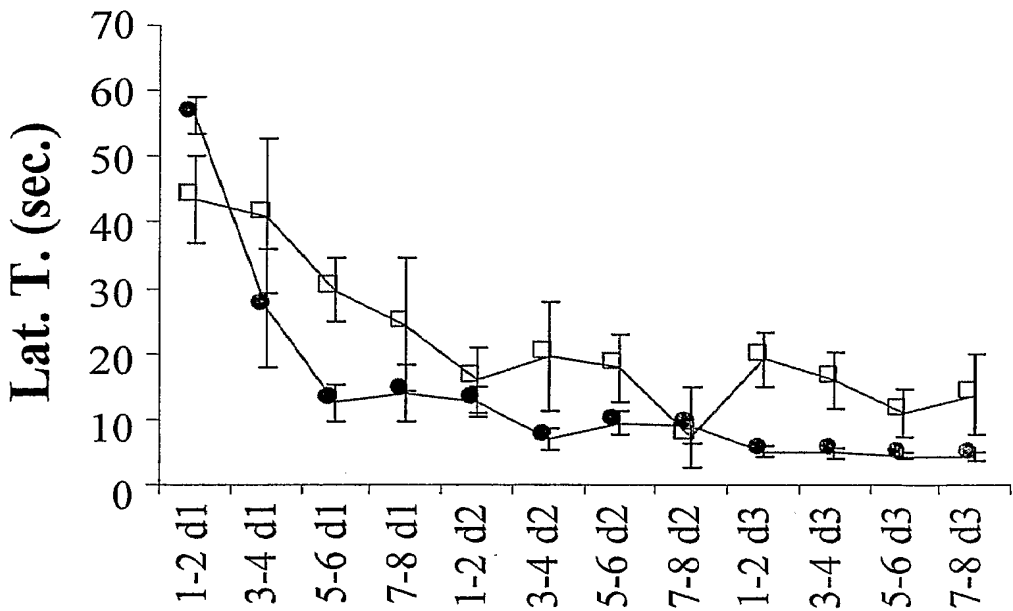

Fig. 1D

3/8

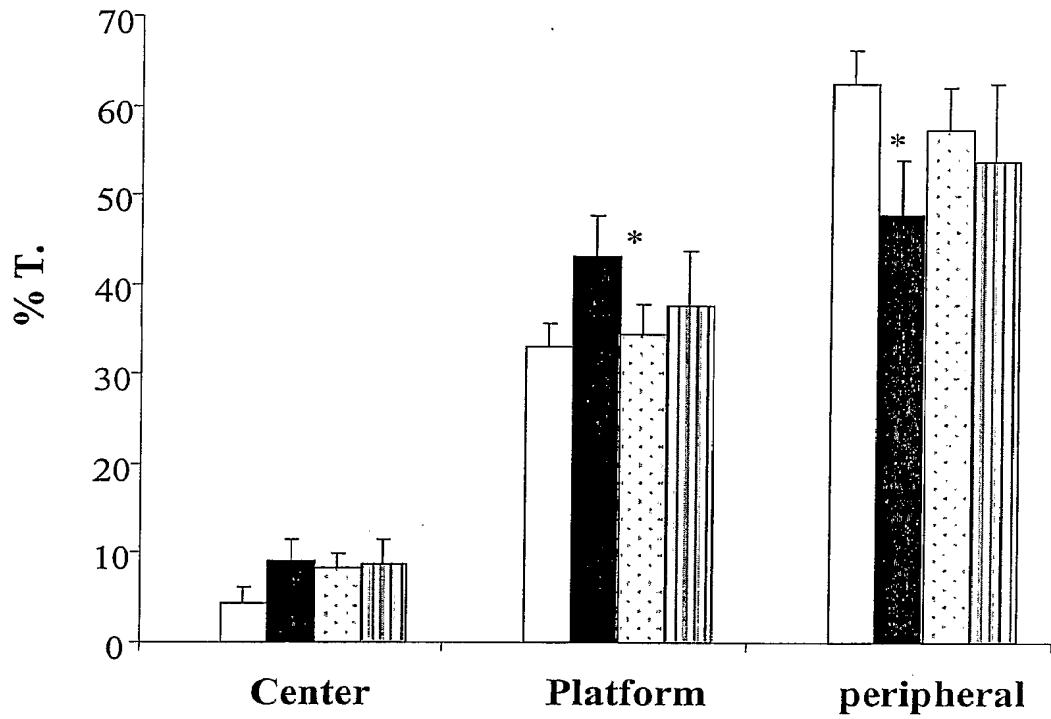

Fig. 2

4/8

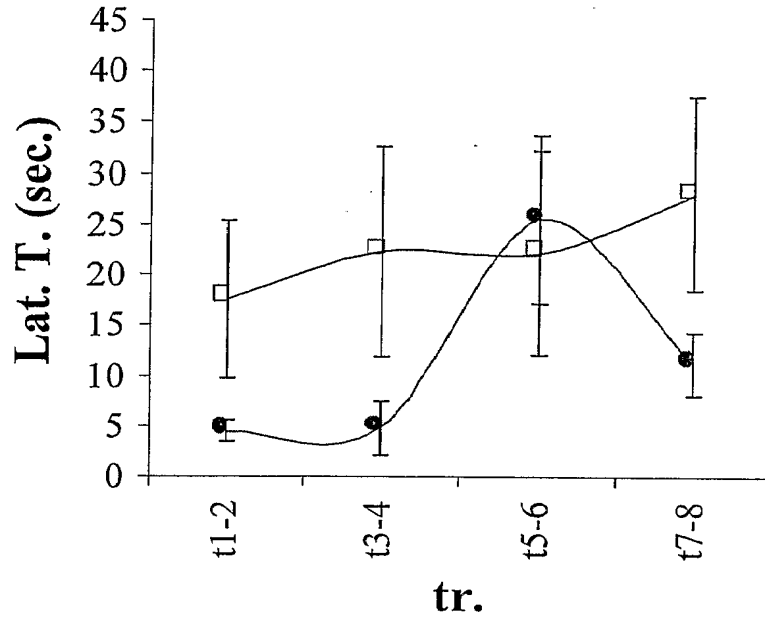

Fig. 3A

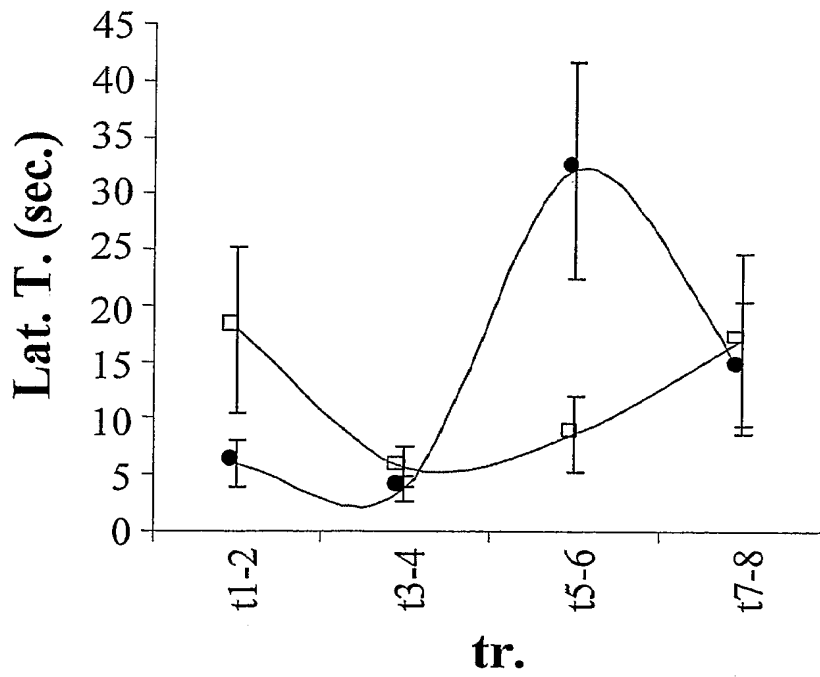

Fig. 3B

5/8

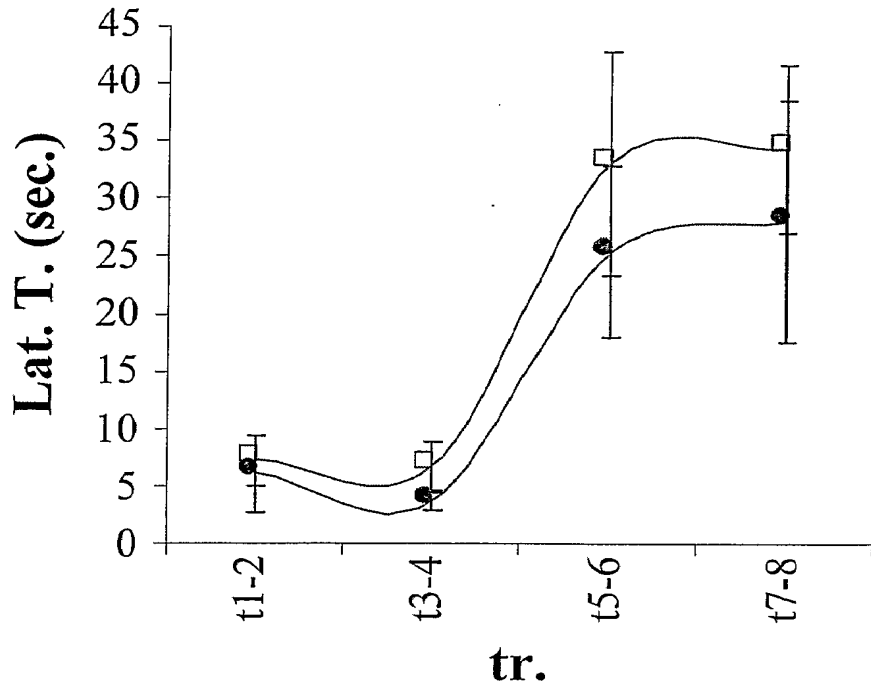

Fig. 3C

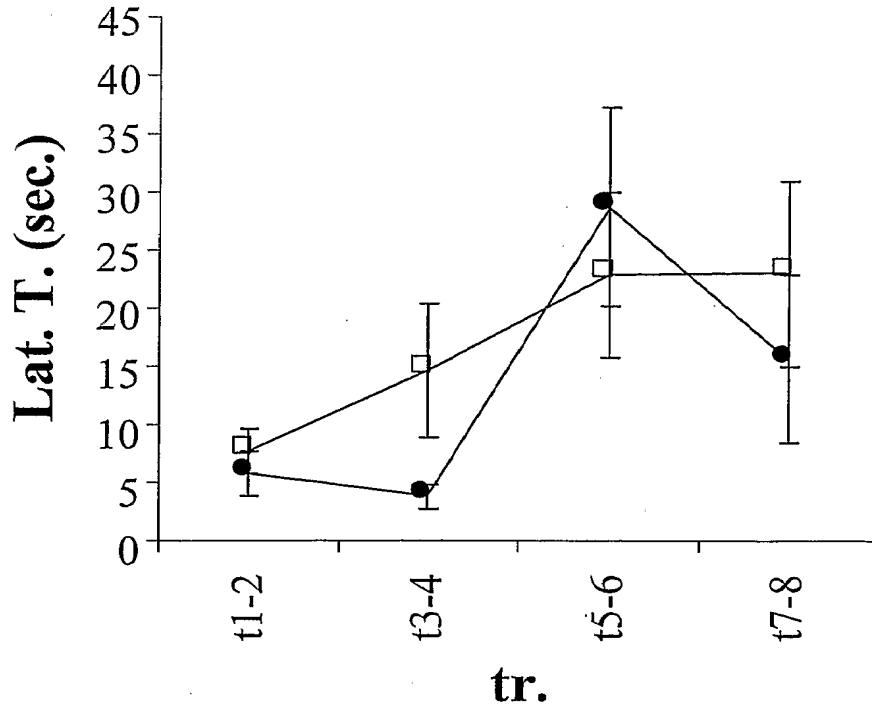

Fig. 3D

6/8

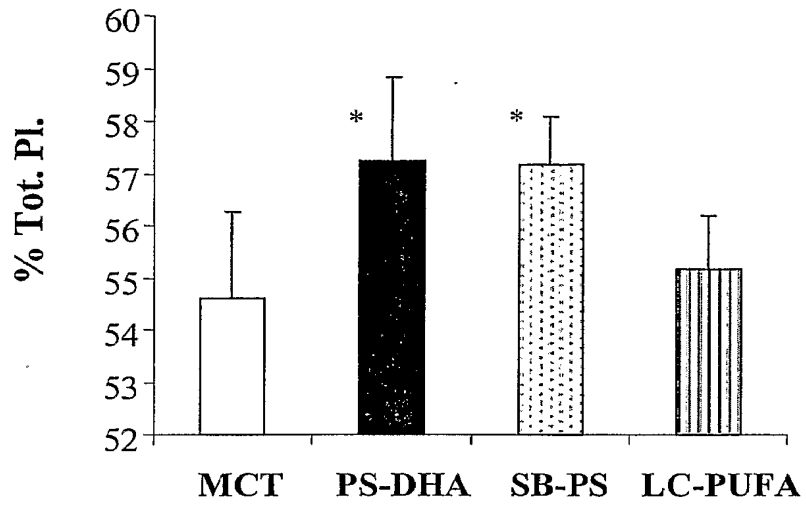

Fig. 4A

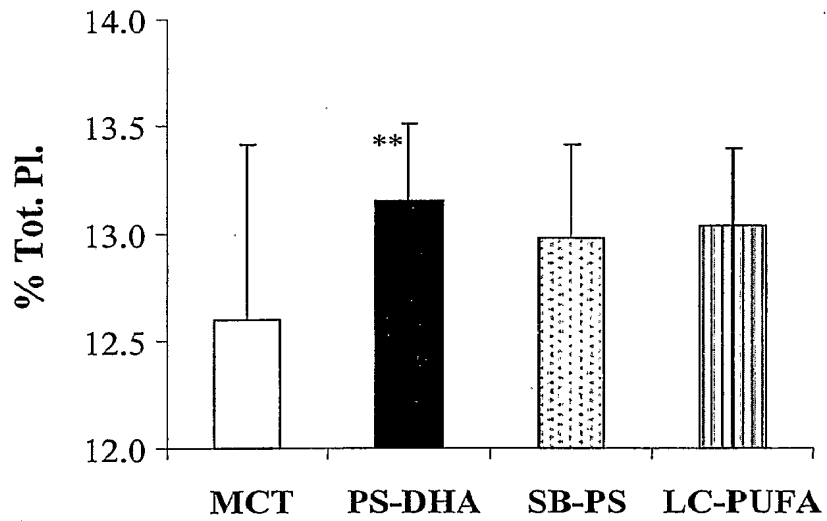

Fig. 4B

7/8

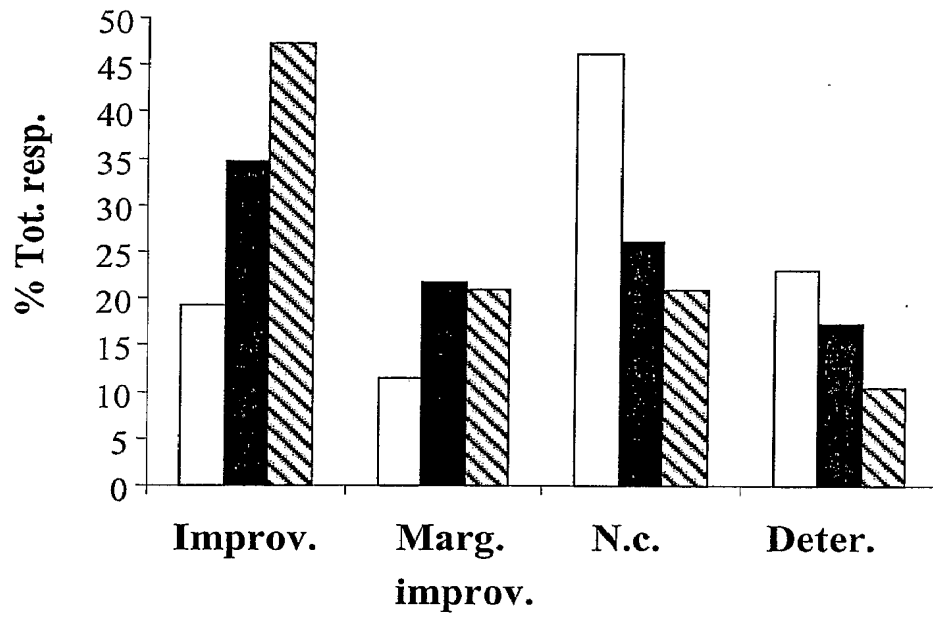

Fig. 5

8/8

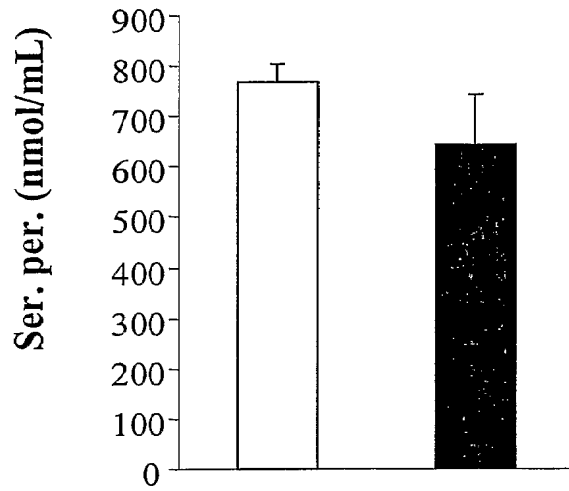

Fig. 6



(11) **EP 1 706 106 B1**

(12) **EUROPEAN PATENT SPECIFICATION**

(45) Date of publication and mention of the grant of the patent:
15.07.2009 Bulletin 2009/29

(51) Int Cl.:
A61K 31/202 (2006.01) **A61P 25/28** (2006.01)
A61P 25/08 (2006.01) **A61P 25/18** (2006.01)

(21) Application number: **05701068.8**

(86) International application number:
PCT/EP2005/000522

(22) Date of filing: **20.01.2005**

(87) International publication number:
WO 2005/070411 (04.08.2005 Gazette 2005/31)

(54) **USE OF HIGHLY CONCENTRATED COMPOSITIONS OF SELECTED N-3 FATTY ACIDS FOR THE TREATMENT OF CENTRAL NERVOUS SYSTEM DISTURBANCES**

VERWENDUNG VON HOCHKONZENTRIERTEN ZUSAMMENSETZUNGEN AUSGEWÄHLTER N-3-FETTSÄUREN ZUR BEHANDLUNG VON ERKRANKUNGEN DES ZENTRALEN NERVENSYSTEMS

UTILISATION DE COMPOSITIONS TRES CONCENTREES D'ACIDES GRAS N-3 SELECTIONNES DESTINEES AU TRAITEMENT DE TROUBLES DU SYSTEME NERVEUX CENTRAL

(84) Designated Contracting States:
AT BE BG CH CY CZ DE DK EE ES FI FR GB GR HU IE IS IT LI LT LU MC NL PL PT RO SE SI SK TR
Designated Extension States:
AL BA HR LV MK YU

(30) Priority: **21.01.2004 IT MI20040069**

(43) Date of publication of application:
04.10.2006 Bulletin 2006/40

(73) Proprietor: **Bruzzese, Tiberio**
20146 Milan (IT)

(72) Inventor: **Bruzzese, Tiberio**
20146 Milan (IT)

(74) Representative: **Mancini, Vincenzo et al**
Giambrocono & C. s.p.a.,
Via Rosolino Pilo 19/B
20129 Milano (IT)

(56) References cited:
EP-A- 0 347 056 EP-A- 0 599 576
EP-A- 0 699 437 US-B1- 6 331 568
US-B1- 6 384 077

- **MELLOR J E ET AL: "OMEGA-3 FATTY ACID SUPPLEMENTATION IN SCHIZOPHRENIC PATIENTS" HUMAN PSYCHOPHARMACOLOGY. CLINICAL AND EXPERIMENTAL, JOHN WILEY & SONS LTD, vol. 11, no. 1, 1996, pages 39-46, XP000921351 ISSN: 0885-6222 cited in the application**
- **VREUGDENHIL M ET AL: "POLYUNSATURATED FATTY ACIDS MODULATE SODIUM AND CALCIUM CURRENTS INCA1 NEURONS" PROCEEDINGS OF THE NATIONAL ACADEMY OF SCIENCES OF USA, NATIONAL ACADEMY OF SCIENCE. WASHINGTON, US, vol. 93, no. 22, 29 October 1996 (1996-10-29), pages 12559-12563, XP000616311 ISSN: 0027-8424**
- **VREUGDENHIL M ET AL: "ANTICONVULSANT PROPERTIES OF POLYUNSATURATED FATTY ACIDS" SOCIETY FOR NEUROSCIENCE ABSTRACTS, SOCIETY FOR NEUROSCIENCE, US, vol. 22, 1996, page 2106, XP000921389 ISSN: 0190-5295**
- **VOSKUYL ROB A: "Is marine fat anti-epileptogenic?" NUTRITION AND HEALTH (BERKHAMSTED, HERTFORDSHIRE) 2002, vol. 16, no. 1, 2002, pages 51-53, XP009047531 ISSN: 0260-1060**

Remarks:

The file contains technical information submitted after the application was filed and not included in this specification

Note: Within nine months of the publication of the mention of the grant of the European patent in the European Patent Bulletin, any person may give notice to the European Patent Office of opposition to that patent, in accordance with the Implementing Regulations. Notice of opposition shall not be deemed to have been filed until the opposition fee has been paid. (Art. 99(1) European Patent Convention).

EP 1 706 106 B1

Description

[0001] The invention refers to the use of highly concentrated compositions of selected n-3 fatty acids for the treatment of central nervous system disturbances. In particular, the invention concerns the use of a composition comprising do-

cosahexaenoic acid (DHA, C22:6 n-3) or DHA in admixture with eicosapentaenoic acid EPA, C20:5 n-3) both acids being under the form of their ethyle esters, in a high concentration, for the preparation of a drug for the prevention and/or treatment of the disturbances of the central nervous system (CNS), both of psychiatric relevance and of neurological type.

[0002] The expression "central nervous system disturbances" is commonly meant to indicate the cluster of convulsive symptoms usually included in the so-called epileptic syndromes, as well as to the most severe psychiatric disorders, represented by the various schizophrenia forms, by the manic-depressive syndromes, by the severe depression, and by the Alzheimer's disease and the related forms of dementia.

[0003] The term epilepsy refers to disorders of brain function characterized by periodic and unpredictable occurrence of seizures. Such seizures are constituted by transient alterations of behaviour caused by disordered, synchronous and rhythmic firing of neuronal brain populations, not induced by evident provocation.

[0004] These seizures are thought to arise from disorders of cerebral cortex, not involving other CNS structures, and their behavioural manifestations is determined by the functions served by the involved cortical site. For instance, a seizure arising from the motor cortex will induce f.i. clonic jerking of the body muscles controlled by this same region of the cortex. Epileptic seizures are defined partial, when beginning focally in a cortical site, or generalized seizures, when involving both hemispheres. A partial seizure is defined simple, if associated with preservation of consciousness, or complex in the opposite case, often due to impairment of the temporal lobe. A typical generalized epileptic seizure includes absence and tonic-clonic convulsions.

[0005] Schizophrenia is caused by a chemical imbalance in the brain induced, in its turn, by triggering causes of genetic or environmental origin (autoimmune diseases, infections during development, psychological trauma, etc.), involving- among other effects-overproduction of dopamine. There are several categories of the disease: paranoid, catatonic, disorganised, undifferentiated schizophrenia.

[0006] Patients start to get a great variety of symptoms, which anyway can reveal themselves into two typical forms: negative symptoms, such as withdrawal, apathy, depression, blunted emotions, and positive symptoms, such as hallucinations, misunderstanding of reality and of perception, disordered thinking and speech. The appearance of the disease is early, but diagnosis is complex and can take very long times.

[0007] The older drugs, typical neuroleptic drugs, essentially agents blocking cerebral dopamine, are however poorly selective and associated with heavy side effects on dopamine-related functions, including severe extrapyramidal effects, like unusual and involuntary body movements (dyskinesias, tardive dyskinesias), restlessness (akathisia), muscle spasms (dystonia), as well as impairment of cognition, reduced libido, etc; further, these drugs while moderately effective in treating positive symptoms, are quite unsuccessful on negative symptoms, as depression and apathy.

[0008] The more recent drugs, so-called atypical drugs, have a broader action spectrum and less side effects, such as the arising of involuntary movements, but are unavailable in underdeveloped countries because of their expensiveness, and are not free anyway from other effects, even highly risky (prolongation of QTC interval of ECG, weight gain, diabetic symptoms).

[0009] The syndromes of bipolar disturbances (manic-depressive disorders) and of severe unipolar depression (major depression) constitute the more severe disorders of mood or affect. They usually include disordered autonomic functioning (i.e., altered activity rhythms, sleep and appetite) and behaviour, as well as persistent abnormalities of mood and increased risk of self- destruction or suicide.

[0010] Alzheimer's disease, as other degenerative disease of CNS, all induced by progressive loss of neurons from specific regions of the brain, is characterized by marked atrophy of the cerebral cortex and loss of cortical, sub-cortical and hippocampal neurons; a parallel reduction of neurotransmitters has also been evidenced, in particular of acetylcholine, which has given rise to the cholinergic hypothesis of the disease and led to the few drugs of some limited effectiveness.

[0011] The disease produces a progressive impairment of the cognitive abilities, which is typical - but not exclusive- of the elder subject. The disease appears first as an impairment of short-term memory, but as the condition progresses additional cognitive abilities are impaired, such as the ability to calculate, exercise visual-spatial skills, and use common objects (ideo-motor apraxia), and the illness reveals itself in various forms of dementia. Later on, death often comes up from a complication of immobility, such as pneumonia.

[0012] For all mentioned pathologies, there are not valid pharmacological and clinical treatments, able to modify the progression of the disease. In all cases only symptomatic treatments are adopted, only able to alleviate the symptomatology and, if endowed with some efficacy, only effective on a very limited number of patients: for instance the standard treatments in the depression permit to obtain until a maximum of 50% reduction of score in the evaluation scale in two thirds of patients, while improvements in schizophrenia are obtained in the order of 20- 30%, and treatments in the Alzheimer's disease result to be only ineffective palliatives. Some therapeutic effects of the n-3 polyunsaturated fatty acids are already well known. For instance, IT 1,235,879, US 5,502,077 and US 5,656,667 disclose their effect on

multiple risk factors for cardiovascular illnesses, as hypertriglyceridemia, hypercholesterolemia and hypertension.

[0013] EP-A-0409903 describes the preparation of high concentration mixtures of EPA and DHA or their esters, useful in the treatment of hyperlipemia, thrombosis, myocardial infarct, platelet hyperaggregation and related vascular pathologies, as well as of acute and chronic inflammations, autoimmune syndromes, and in the tumour prevention. DHA, which is contained in high concentration in the retina, is also active on the functionality of sight, on ceroidosis and on learning and ageing processes.

[0014] WO 00/48592 discloses the use of mixtures of EPA and DHA ethyl esters for the secondary prevention of "sudden death" in patients who have already suffered a myocardial infarct.

[0015] It also results in the scientific literature that the n-3 polyunsaturated acids, particularly DHA, are contained in high concentration in the cerebral cortex (much less in the white matter), according to O'Brien JS and Sampson EL, J. Lipid Res. 6, 545, 1965, in the retina (Anderson RE, Exp. Eye Res. 10, 339, 1970), in the testis and sperm (Poulos A et al., Comp. Biochem. Physiol. 46B, 541, 1975) of all mammals, including human beings. DHA is therefore one of the most abundant components of the brain's structural lipids, in which its presence can derive only from direct ingestion or by synthesis from the dietary precursor, i.e. alpha-linolenic acid (ALA).

[0016] Among others, Neuringer M et al., J. Clin. Invest. 73, 272, 1984; Proc. Natl. Acad. Sci. USA 83, 4021, 1986, suggest that n-3 fatty acids are essential for a normal prenatal and postnatal development of retina and brain.

[0017] EP-A-0347056 discloses the use of gamma-linolenic acid (GLA, C18:3 n-6) and higher n-6 acids, and of stearidonic acid (SA, C18:4 n-3) and higher n-3 acids, for the preparation of a drug for treatment of tardive dyskinesias.

[0018] EP-A-0599576 describes the use of a combination of arachidonic acid (AA, C20:4 n-6) and DHA, acids belonging to the n-6 and n-3 series respectively, to obtain a drug effective on the negative syndrome of schizophrenia, in subjects with low levels of the two acids in the cell membranes.

[0019] US 6,331,568 discloses a method for treating schizophrenia by administration of EPA or SA, two n-3 acids, and optionally of n-6 acids. The compositions therein disclosed show a ratio of EPA or SA to DHA of not less than 3:1, 4:1, or more.

[0020] WO 00/44 361 discloses a pharmaceutical preparation containing at least 90% or more of EPA, and less than 5% of DHA for uses similar to the ones of the documents just above discussed.

[0021] US 5,120,763 and EP 0366480 disclose a composition containing 13.0-27.5% of linolenic acid (i.e. ALA, C18:3 n-3) and 87.0-72.5% of linoleic acid (i.e. LA, C18:2 n-6), useful in the treatment of Alzheimer's disease and related syndromes, while US 5,468,776 describes the same components in the more limited range of 16.7-22.2% and 83.3-77.8% respectively.

[0022] Although it is known to a certain degree that compositions comprising peculiar combinations of n-3 and/or n-6 fatty acids may have shown some effectiveness on pathologies such as schizophrenia or Alzheimer's disease, a clear indication on their activity against such pathologies cannot yet be taken from the prior art since the discussion in the scientific community is quite controversial and still open.

[0023] For instance, while Mellor et al., Human Psychopharmacology, 11, 39-46, 1996 disclosed the effectiveness of some n-3 acids, such as DHA, carrying out their experiments using a composition comprising EPA 18% and DHA 12%, in US 6,331,568 there is pointed out that such ability has to be denied on the basis of both clinical control and for biochemical reasons.

[0024] It has been now surprisingly found that some other peculiar compositions comprising n-3 fatty acids in very high concentrations are effective for the prevention and/or treatment of various and severe disorders of the central nervous system, both of neurological type and of psychiatric pertinence, as for instance epilepsy and as schizophrenia, the manic-depressive disturbances and the major depression, as well as the degenerative neuronal disorders typical of Alzheimer's disease.

[0025] The invention refers to the use of a composition comprising in a concentration expressed as % by weight of the total fatty acids weight in the composition, either

- a) DHA ethyl ester >34 and EPA ethyl ester >40, wherein EPA+DHA ethyl esters >85, or
- b) DHA ethyl ester >30 and EPA ethyl ester >44, wherein EPA+DHA ethyl esters >80, the ethyl esters of other (C20, C21, C22) n-3 acids being >3, or
- c) DHA ethyl ester >34 and EPA ethyl ester >40, wherein EPA+DHA ethyl esters >80. the total ethyl esters of n-3 acids being >90, or
- d) DHA ethyl ester >80 and EPA ethyl ester <15, wherein EPA+DHA ethyl esters >85.

for the preparation of a drug for the prevention and/or treatment of the psychiatric disturbances of the central nervous system (CNS) selected from schizophrenia, manic-depressive syndrome, major depression, and Alzheimer's disease.

[0026] Among the disturbances of CNS which can be prevented and/or treated according to the invention, there are schizophrenia (showing negative and/or positive symptoms and being either paranoid or catatonic or disorganised or undifferentiated schizophrenia), manic-depressive syndrome, major depression (including disorders of mood, behaviour

and autonomic functions correlated to activity, sleep and appetite), and Alzheimer's disease (including the various related forms of dementia).

[0027] In a preferred embodiment, the drug suitable for the use of the invention comprises essentially DHA ethyl ester and EPA ethyl ester.

[0028] Yet, according to another preferred embodiment, the composition can also comprise at least another n-3 and/or n-6 polyunsaturated and/or monounsaturated and/or saturated fatty acid, in particular the composition can comprise at least two other n-3 and/or n-6 polyunsaturated and/or monounsaturated and/or saturated fatty acids, in any ratio among themselves; the other n-3 and/or n-6 polyunsaturated and/or monounsaturated and/or saturated fatty acids are in a concentration of lower or equal to 30%.

[0029] Also the compositions reported in the European Pharmacopoeia 2000, Eu. Ph. 2000, having a content of not less than 80% of the mixture of the ethyl esters of EPA and DHA (not less than 40% and 34%, respectively) and not less than 90% total ethyl esters of n-3 polyunsaturated fatty acids, will be suitable for the use of the present invention.

[0030] All the above mentioned compositions, as well as the pharmaceutical preparations which can be derived therefrom, can be prepared according to methods known to the expert in the field, as f.i. those described in Patents US 5 130 061, WO 89/ 11 521, IT 1 235 879, DE 3 739 700, JP 02/ 25 447 (and others).

[0031] Commonly, the composition suitable for the use of the invention can be obtained by extraction, concentration and purification processes starting from natural sources, typically from fish oils or other marine source as algae (for DHA and EPA), or even from vegetable oils, f.i. seed oils (typically for ALA), as well as by means of semi-synthetic transformation processes, when required.

[0032] Together with their efficacy to the aim of the pharmaceutical and therapeutic use of the invention, the above compositions show a very high clinical tolerance, almost free from any side-effect, with exclusion of some uncommon effect on the intestinal peristalsis, and can be obtained with low production costs from natural sources, which strongly helps their diffusion in low economic potential countries, differently from the poor availability of some totally synthetic drugs.

[0033] The drug suitable for the use of the invention is preferably administered by oral route, particularly in the form of soft jelly capsules; yet, the other typical administration routes, usual in the pharmaceutical technology, are not excluded. The dose per unit includes usually 100-1000 mg of the above specified n-3 polyunsaturated fatty acids and/or derivatives and/or precursors, preferably 300-1000 mg or better 500 mg or more often 1000 mg. The mean total dose is 0.1- 5 g per day, even in intermittent administration, according to the need and advice of the physician, preferably 0.3-3 g per day or particularly 1-2 g. An effective dose meanly corresponds to 2-60 mg/kg/day.

[0034] Obviously, the drug suitable for the use of the invention can be administered also under other forms appropriate for the oral administration such as, for instance, hard oil-proof capsules or tablets wherein the fatty acids are pre-adsorbed on solid matrices.

[0035] It is also possible to use oily emulsions, syrups, drops, granulates in dispersing excipients, etc., as well as other forms able to guarantee a systemic absorption by means of other administration routes, f. i. sterile emulsions or solutions suitable for parenteral injective use, as it will be apparent to the man skilled in the art.

[0036] The drug suitable for the use of the present invention can be used alone, as a mono-therapy, or as a drug coadjuvant or auxiliary to at least another active principle or drug effective for the prevention and/or treatment of the disturbances of CNS, or can even be used in direct combination, including said at least another active principle or drug endowed with an activity similar or complementary or synergic to that one of the above defined drug suitable for the use of the invention.

[0037] Typical examples of such at least another active principle or drug to which the drug suitable for the use of the invention can be combined or can be auxiliary or coadjuvant by coadministration, are, without any limitative meaning:

- in the treatment of schizophrenia, drugs of the group of phenothiazines, thioxanthenes, dibenzoazepines, butyrophenones, indolones, phenyl- and diphenylpiperidines, etc., among them the typical neuroleptic agents as chlorpromazine, thioridazine, haloperidol, sulpiride, and pimozide, and others, and the antipsychotic "atypical" agents as clozapine, quetiapine, olanzapine, sertindole, risperidone, ziprasidone, amisulpiride and others;
- in the treatment of major depression and of manic-depressive illness, the antidepressant drugs of the group of tricyclic norepinephrine reuptake inhibitors as amitriptyline and others, of the group of serotonin reuptake inhibitors as fluoxetine, paroxetine, sertraline and others, of the group of monoamine oxidase (MAO) inhibitors as phenelzine and others, of the group of "atypical" drugs as bupropion and trazodone; the antimanic drugs as lithium salts; the drugs acting on mood and affect disorders as many antianxiety agents, including benzodiazepines and the above mentioned antidepressant and antimanic drugs as well as some anticonvulsants/antiepileptic drugs as carbamazepine and valproate;
- in the treatment of Alzheimer's disease, among the few "approach" drugs, the precursors of acetylcholine, as choline and phosphatidylcholine, and the inhibitors of catabolic enzyme (acetylcholinesterase, AChE) , as physostigmine, tacrine, donepezil/rivastigmine and galantamine, as well as memantine, more recently adopted and endowed with

a different mechanism of action.

[0038] The composition suitable for the use of the invention can also comprise a pharmaceutically acceptable diluent, and/or a vehicle, and/or a binder, and/or thickener, and/or a surfactant, as well as a lubricant, aromatizer, colorant, sweetener, stabilizer and the like, as it will be apparent to the man skilled in the art. Among the stabilizer agents, antioxidants, particularly tocopherol (vitamin E) and the like, as well as ascorbyl palmitate, hydroxytoluene, butylhydroxy-anisole and the like known in the art, are particularly preferred.

[0039] As already illustrated above, the drug comprising either a) or b) or c) or d) as above defined can be administered according to the invention either as a single drug or in fixed pharmaceutical combination with other known drugs already known to be used in the same pathologies, or even as substances coadjuvant to said known drugs, under separated administration. According to another aspect, the invention relates to a method for prevention and/or treatment of CNS disturbances, as above illustrated, in a mammal in need thereof comprising administering to the mammal a therapeutically effective dose, preferably ranging from about 2 to 60 mg/kg of the mammal body weight per day, of a drug as above described.

[0040] The following examples illustrate the invention without limiting it.

EXAMPLE 1

[0041] A few compositions of the invention are illustrated in the following Table and can be prepared according to the methods described in US 5130061 (compositions A, C, D, E), IT 1235879 (composition B), WO 89/11521 (compositions F, H, I) and DE 3739700 (composition G), and are anyway easily available even using other preparative methods (JP 02/ 25447 and several others).

[0042] The quantities indicated in the Table express percentages by weight on the total weight of fatty acids. Other n-3 acids, as well as n-6 unsaturated acids, having different length and/or unsaturation degree, monounsaturated and saturated, can be present in limited quantities. Antioxidant: alpha-tocopherol (mean < 0.3%; even much higher concentrations can be used).

	A 1)	B 1)	C 1)	D 1)	E 1)	F 1)	G 1)	H 2)	I 3)
EPA	>40	>44	>40	>35	>30	<15		>40	>50
DHA	>34	>30	>34	>30	>35	>80		>30	>30
EPA + DHA	>85	>80	>80	>70	>70	>85		>80	>80
Esters 4)		>3							
Total n-3 esters 5)			>90						
ALA							>70		

1) ethyl esters; 2) free acids; 3) sodium salts; 4) ethyl esters of other (C20, C21, C22) n-3 acids; 5) total ethyl esters of n-3 acids.

EXAMPLE 2

[0043] The compositions of the following Table, relative to soft gelatin capsules containing 1 g ethyl esters of polyunsaturated fatty acid, were prepared by methods known in the art.

	A (mg)	B (mg)	C (mg)
EPA 1)	525		>400
DHA 1)	315		>340
EPA + DHA 1)		850	>800
Total n-3 1)			>900
d-tocopherol	4 Units		4 Units
d,l-tocopherol		0.3	
Gelatine	246		246

(continued)

	A (mg)	B (mg)	C (mg)
Gelatine succinate		233	
Glycerol	118	67	118
RIO	2.27		2.27
YIO	1.27		1.27
SHB + SPHB		1.09 + 0.54	
1) ethyl esters; RIO: red iron oxide; YIO: yellow iron oxide; SHB: sodium p.hydroxybenzoate; SPHB: sodium propyl p.hydroxybenzoate.			

EXAMPLES 3-6: pharmacological activity

[0044] The effectiveness of the composition suitable for the use of the invention in the prevention and/or treatment of CNS disturbances as those above described, as well as of the possibility of their pharmaceutical and clinical use, has been demonstrated following several pharmacological tests which permitted a wide testing on small size animals (mice, rats), without the ethical implications proper of testing in humans.

[0045] A first model of experiment evaluated the protection against epileptic seizures induced by direct application of iron chloride to cerebral cortex; a second model examined the protective effect against a known convulsant chemical agent (pentylentetrazol); a third model verified the effect on the induction of epileptic seizures provoked by repeated sub-convulsive dose administration of the same chemical agent and a fourth experimental model evaluated the effect protective on the anomalous behaviour induced, in the form of irregular jumping, by the administration of dizocilpine, an analogue of phencyclidine which binds similarly to N-methyl-D-aspartate (NMDA) receptors provoking its hypo-function and inducing schizophreniform psychosis.

[0046] In some of such tests, attention has been particularly addressed to detect any activity strengthening or coadjuvant to that of other known drugs.

[0047] Male Sprague-Dawley albino rats, about two months of age and 200-240-g weight, were used in the experiments of Examples 3-5. The animals were housed at an average temperature of about 22°C and an average relative humidity of 40-50%, with artificial daily light cycles of 12 hours. In example 6, male Swiss mice weighing 22-30 g, housed in similar room conditions, were used.

EXAMPLE 3 (not encompassed by the scope of the claims)

[0048] Two groups of 15 rats were treated for 2 weeks by intraperitoneal (i.p.) route with 50 mg/kg of composition B (Example 1) containing >80% EPA and DHA ethyl esters (group 1) and with saline solution (group 2, control), respectively. At the end, all rats received a dose of 5 microlitres of 100 mM solution of FeCl₃, directly injected through unilateral left-side cannula into the anterior amygdala area. The administration of FeCl₃ into the cerebral cortex or amygdala-hippocampus complex is able to induce an epileptic focus, according to Willmore L.J., Science, 200, 1501, 1978. By prolonged direct monitoring, the number of animals protected or subject to major motor epileptic seizures are determined, as evidenced by tonic-clonic contractions of the limbs, trunk and head, lack of straightening reflex, saliva and blood discharge from the mouth.

[0049] Results: animals responding with seizures:

3/15 (group 1, treated)
14/15 (group 2, control)

EXAMPLE 4 (not encompassed by the scope of the claims)

[0050] In a preliminary experiment, the dose effective on 50% of study strain rats of a known epileptogenic agent (pentylentetrazol) injected by intraperitoneal route, has been determined, obtaining an ED50 value of approximately 70-75 mg/kg i.p.

[0051] Four groups of 10 rats each were treated daily for 2 weeks, by i.p. route, with 50 mg/kg of a composition of n-3 fatty acids having >85% of EPA and DHA ethyl esters according to Example 1, composition A (group 1), with 5 mg/kg of a known antiepileptic drug represented by clonazepam (group 2), with the same doses in combination (group 3) and

EP 1 706 106 B1

with saline solution (group 4, control). At the end, all the groups were treated with 100 mg/kg i.p. of pentylenetetrazol, and the animals underwent the following control exams:

- 1) length of latency period to the first major motor seizures (tonic- clonic contractions of the limbs, trunk and head; falling; saliva and blood discharge from the mouth); 2) number of rats responding with major motor seizures (or protected from seizure); 3) mean duration of the major motor seizure (MMS); 4) number of rats presenting minor clonic contractions (MCC), such as a sudden flexion of the forelegs or extension of the rear legs; 5) number of rats who died within 20 minutes or 5 hours after pentylenetetrazol injection.

[0052] The obtained results (mean ± standard deviation) are reported in the following Table:

Treatment groups	Latency to seizures (sec.)	Duration of seizures (sec)	Rats with MMS (n/tot)	Rats with MCC (n/tot)	Dead animals	
					<20'	<5 h
1) (n-3)	184 ± 23	22 ± 9	1/10	2/10	1/10	3/10
2) (clonazepam)	203 ± 12	25 ± 6	1/10	3/10	2/10	4/10
3) (n-3+ clonazepam)	265 ± 15	15 ± 7	0/10	1/10	0/10	2/10
4) (control)	12 ± 4	786 ± 34	9/10	1/10	10/10	0/10

[0053] It appears from such data that the pre-treatment with the composition of EPA and DHA ethyl esters is able to significantly protect the rats (about 90%) from major motor seizures induced by the administration of pentylenetetrazol. In the few animals not protected, the seizure is anyway delayed in the time and its duration is noticeably lower. Also a strong reduction of mortality during the convulsive period is noticed, with partial protection even during the post-ictal period. The effectiveness of the composition is at least similar to that of a reference drug and is noticeably potentiated if administered in combination.

EXAMPLE 5 (not encompassed by the scope of the claims)

[0054] Two groups of 10 rats each were daily treated for 2 weeks, by i.p. route, with 50 mg/kg of a composition >80% of EPA and DHA ethyl esters, according to Example 1, composition C (group 1), and with saline solution (group 2, control). At the end all the animals were administered at 15 min. intervals a series of sub-convulsive doses of pentylenetetrazol (15 mg/kg, i.p.), so determining the number of injections required to produce an attack of clonic or tonic-clonic convulsions of forelegs and hind legs, followed by loss of straightening reflex.

[0055] Results: number of sub-convulsive doses for induction of seizure (mean ± standard deviation):

- 16.35 ± 3.20 (group 1, treated)
- 3.26 ± 1.54 (group 2, control).

EXAMPLE 6

[0056] Two groups of 12 mice each were treated daily for 2 weeks, by i.p. route, with 50 mg/kg of a composition >80% of EPA and DHA ethyl esters according to Example 1, composition B (group 1), and with saline solution (group 2). At the end all the animals received by i.p. route 1 mg/kg of dizocilpine, an analogue of phencyclidine able to bind the N-methyl-D-aspartate (NMDA) receptors, inducing its hypofunction and subsequent schizophreniform psychosis. The behaviour induced in the mouse consists in eliciting irregular and intense jumping (so-called popping), and its attenuation represents a valid experimental model to identify substances able to counteract the pathophysiology of schizophrenia (Deutsch S.I. et al., Neuropsychopharmacology, 15, 37, 1996; ibidem,15,329,1996). The administration of dizocilpine was followed by monitoring for 30 minutes, and during the period the popping behaviour, i.e. the number of jumping of treated and control animals was registered by a suitable equipment.

[0057] Results: number of induced jumps:

- 45 ± 12 (group 1, treated)
- 338 ±55 (group 2, positive control).

Claims

1. Use of a composition comprising in a concentration expressed as % by weight of the total fatty acids weight in the composition, either

- 5 a) DHA ethyl ester >34 and EPA ethyl ester >40, wherein EPA+DHA ethyl esters >85, or
- b) DHA ethyl ester >30 and EPA ethyl ester >44, wherein EPA+DHA ethyl esters >80, the ethyl esters of other (C20, C21, C22) n-3 acids being >3, or
- 10 c) DHA ethyl ester >34 and EPA ethyl ester >40, wherein EPA+DHA ethyl esters >80, the total ethyl esters of n-3 acids being >90, or
- d) DHA ethyl ester >80 and EPA ethyl ester <15, wherein EPA+DHA ethyl esters >85,

for the preparation of a drug for the prevention and/or treatment of the psychiatric disturbances of the central nervous system (CNS) selected from schizophrenia, manic-depressive syndrome, major depression, and Alzheimer's disease.

- 2. Use according to claim 1, wherein schizophrenia shows negative and/or positive symptoms.
- 3. Use according to claim 1 or 2, wherein schizophrenia is paranoid, catatonic, disorganised or undifferentiated schizophrenia.
- 4. Use according to claim 1, wherein the manic-depressive syndrome and major depression include disorders of mood, behaviour and autonomic functions correlated to activity, sleep and appetite.
- 25 5. Use according to claim 1, wherein the Alzheimer's disease includes the various related forms of dementia.
- 6. Use according to any of the previous claims, wherein the composition comprises at least another n-3 and/or n-6 polyunsaturated and/or monounsaturated and/or saturated fatty acid.
- 30 7. Use according to the previous claim, wherein the composition comprises at least two 5 other n-3 and/or n-6 polyunsaturated and/or monounsaturated and/or saturated fatty acids, in any ratio among themselves.
- 8. Use according to any of the previous claims, wherein the drug is administered by oral route.
- 35 9. Use according to any of the previous claims, wherein the drug is in the form of soft gelatine capsules.
- 10. Use according to any of the previous claims, wherein the drug is administered at the dose of 0.1-5 g/day.
- 40 11. Use according to any of the previous claims, wherein the drug is administered at the dose of 0.3-3 g/day.
- 12. Use according to any of the previous claims, wherein the drug is administered at the dose of 1-2 g/day.
- 13. Use according to any of the previous claims, wherein the drug is administered separately, as a coadjuvant or an auxiliary drug, from at least another drug effective for the prevention and/or treatment of the psychiatric disturbances of CNS.
- 45 14. Use according to any of the previous claims, wherein the drug comprises at least another drug effective for the prevention and/or treatment of the psychiatric disturbances of CNS.

Patentansprüche

1. Verwendung einer Zusammensetzung, umfassend in einer Konzentration, ausgedrückt als Gewichtsprozent des Gesamtgewichts von Fettsäureethylestern in der Zusammensetzung entweder

- 55 a) DHA-ethylester >34 und EPA-ethylester >40, wobei EPA+DHA-ethylester >85, oder
- b) DHA-ethylester >30 und EPA-ethylester >44, wobei EPA+DHA-ethylester >80, die Ethylester anderer (C20, C21, C22)-(n-3)-Säuren >3 sind, oder

EP 1 706 106 B1

- c) DHA-ethylester >34 und EPA-ethylester >40, wobei EPA+DHA-ethylester >80, die Gesamtethylester von (n-3)-Säuren >90 sind, oder
d) DHA-ethylester >80 und EPA-ethylester <15, wobei EPA+DHA-ethylester >85,

- 5 zur Herstellung eines Wirkstoffs zur Prävention und/oder Behandlung der psychiatrischen Störungen des zentralen Nervensystems (ZNS), ausgewählt aus Schizophrenie, manischdepressivem Syndrom, typischer Depression und Alzheimerscher Krankheit.
- 10 2. Verwendung gemäß Anspruch 1, wobei die Schizophrenie negative und/oder positive Symptome zeigt.
3. Verwendung gemäß Anspruch 1 oder 2, wobei die Schizophrenie paranoide, katatonische, hebephrene oder un-differenzierte Schizophrenie ist.
- 15 4. Verwendung gemäß Anspruch 1, wobei das manisch-depressive Syndrom und die typische Depression Störungen von Gemüt, Verhalten und autonomen Funktionen, die mit Aktivität, Schlaf und Appetit korreliert sind, einschließen.
5. Verwendung gemäß Anspruch 1, wobei die Alzheimersche Krankheit die verschiedenen damit in Bezug stehenden Formen von Demenz einschließt.
- 20 6. Verwendung gemäß einem der vorhergehenden Ansprüche, wobei die Zusammensetzung mindestens eine andere (n-3)- und/oder (n-6)-polyungesättigte und/oder -monoungesättigte und/oder gesättigte Fettsäure umfasst.
7. Verwendung gemäß dem vorhergehenden Anspruch, wobei die Zusammensetzung mindestens zwei andere (n-3)- und/oder (n-6)-polyungesättigte und/oder -monoungesättigte und/oder gesättigte Fettsäuren in einem beliebigen Verhältnis untereinander umfasst.
- 25 8. Verwendung gemäß einem der vorherigen Ansprüche, wobei der Wirkstoff auf dem oralen Weg verabreicht wird.
9. Verwendung gemäß einem der vorherigen Ansprüche, wobei der Wirkstoff in Form weicher Gelatine kapseln vorliegt.
- 30 10. Verwendung gemäß einem der vorherigen Ansprüche, wobei der Wirkstoff in einer Dosis von 0,1 bis 5 g/Tag verabreicht wird.
11. Verwendung gemäß einem der vorherigen Ansprüche, wobei der Wirkstoff in einer Dosis von 0,3 bis 3 g/Tag verabreicht wird.
- 35 12. Verwendung gemäß einem der vorherigen Ansprüche, wobei der Wirkstoff in einer Dosis von 1 bis 2 g/Tag verabreicht wird.
- 40 13. Verwendung gemäß einem der vorherigen Ansprüche, wobei der Wirkstoff separat, als ein Coadjuvans oder ein Hilfswirkstoff, von mindestens einem anderen Wirkstoff verabreicht wird, der für die Prävention und/oder Behandlung der psychiatrischen Störungen des ZNS wirksam ist.
- 45 14. Verwendung gemäß einem der vorherigen Ansprüche, wobei der Wirkstoff mindestens einen anderen Wirkstoff umfasst, der für die Prävention und/oder Behandlung der psychiatrischen Störung des ZNS wirksam ist.

Revendications

- 50 1. Utilisation d'une composition comprenant, à une concentration exprimée en pourcentage du poids total des esters éthyliques d'acides gras présents dans la composition,
- 55 a) soit >34% d'ester éthylique de DHA et >40% d'ester éthylique d'EPA, la somme des esters éthyliques d'EPA + DHA étant supérieure à 85%,
b) soit >30% d'ester éthylique de DHA et >44% d'ester éthylique d'EPA, la somme des esters éthyliques d'EPA + DHA étant supérieure à 80% et la teneur en esters éthyliques d'autres acides n-3 (en C20, C21, C22) étant supérieure à 3%,
c) soit >34% d'ester éthylique de DHA et >40% d'ester éthylique d'EPA, la somme des esters éthyliques d'EPA

EP 1 706 106 B1

- + DHA étant supérieure à 80% et la teneur totale en esters éthyliques d'acides n-3 étant supérieure à 90%,
- d) soit >80% d'ester éthylique de DHA et <15% d'ester éthylique d'EPA, la somme des esters éthyliques d'EPA + DHA étant supérieure à 85%,

- 5 pour préparer un médicament destiné à la prévention et/ou au traitement de troubles psychiatriques du système nerveux central (SNC) choisis parmi la schizophrénie, le syndrome maniaco-dépressif, la dépression majeure et la maladie d'Alzheimer.
- 10 2. Utilisation selon la revendication 1, dans laquelle la schizophrénie présente des symptômes négatifs et/ou positifs.
3. Utilisation selon la revendication 1 ou la revendication 2, dans laquelle la schizophrénie est la schizophrénie paranoïde, catatonique, désorganisée ou indifférenciée.
- 15 4. Utilisation selon la revendication 1, dans laquelle le syndrome maniaco-dépressif et la dépression majeure comprennent des troubles de l'humeur, du comportement et des fonctions autonomes corrélés avec l'activité, le sommeil et l'appétit.
5. Utilisation selon la revendication 1, dans laquelle la maladie d'Alzheimer comprend les diverses formes de démence apparentées.
- 20 6. Utilisation selon l'une quelconque des revendications précédentes, dans laquelle la composition comprend au moins un autre acide gras n-3 et/ou n-6 polyinsaturé et/ou monoinsaturé et/ou saturé.
- 25 7. Utilisation selon l'une quelconque des revendications précédentes, dans laquelle la composition comprend au moins deux autres acides gras n-3 et/ou n-6 polyinsaturés et/ou monoinsaturés et/ou saturés selon un ratio entre eux quelconque.
8. Utilisation selon l'une quelconque des revendications précédentes, dans laquelle le médicament est administré par voie orale.
- 30 9. Utilisation selon l'une quelconque des revendications précédentes, dans laquelle le médicament se présente sous la forme de gélules en gélatine molle.
10. Utilisation selon l'une quelconque des revendications précédentes, dans laquelle le médicament est administré à la dose de 0,1 à 5 g/jour.
- 35 11. Utilisation selon l'une quelconque des revendications précédentes, dans laquelle le médicament est administré à la dose de 0,3 à 3 g/jour.
- 40 12. Utilisation selon l'une quelconque des revendications précédentes, dans laquelle le médicament est administré à la dose de 1 à 2 g/jour.
- 45 13. Utilisation selon l'une quelconque des revendications précédentes, dans laquelle le médicament est administré séparément, en tant que coadjuvant ou en tant que médicament auxiliaire, d'au moins un autre médicament efficace pour la prévention et/ou le traitement des troubles psychiatriques du SNC.
- 50 14. Utilisation selon l'une quelconque des revendications précédentes, dans laquelle le médicament comprend au moins un autre médicament efficace pour la prévention et/ou le traitement des troubles psychiatriques du SNC.
- 55

REFERENCES CITED IN THE DESCRIPTION

This list of references cited by the applicant is for the reader's convenience only. It does not form part of the European patent document. Even though great care has been taken in compiling the references, errors or omissions cannot be excluded and the EPO disclaims all liability in this regard.

Patent documents cited in the description

- IT 1235879 [0012] [0030] [0041]
- US 5502077 A [0012]
- US 5656667 A [0012]
- EP 0409903 A [0013]
- WO 0048592 A [0014]
- EP 0347056 A [0017]
- EP 0599576 A [0018]
- US 6331568 B [0019] [0023]
- WO 0044361 A [0020]
- US 5120763 A [0021]
- EP 0366480 A [0021]
- US 5468776 A [0021]
- US 5130061 A [0030] [0041]
- WO 8911521 A [0030] [0041]
- DE 3739700 [0030] [0041]
- JP 2025447 A [0030] [0041]

Non-patent literature cited in the description

- **O'Brien JS ; Sampson EL.** *J. Lipid Res.*, 1965, vol. 6, 545 [0015]
- **Anderson RE.** *Exp. Eye Res.*, 1970, vol. 10, 339 [0015]
- **Poulos A et al.** *Comp. Biochem. Physiol.*, 1975, vol. 46B, 541 [0015]
- **Neuringer M et al.** *J. Clin. Invest.*, 1984, vol. 73, 272 [0016]
- *Proc. Natl. Acad. Sci. USA*, 1986, vol. 83, 4021 [0016]
- **Mellor et al.** *Human Psychopharmacology*, 1996, vol. 11, 39-46 [0023]
- **Willmore L.J.** *Science*, 1978, vol. 200, 1501 [0048]
- **Deutsch S.I. et al.** *Neuropsychopharmacology*, 1996, vol. 15, 37 [0056]
- *NEUROPSYCHOPHARMACOLOGY*, 1996, vol. 15, 329 [0056]

(19) World Intellectual Property
Organization
International Bureau



(43) International Publication Date
4 August 2005 (04.08.2005)

PCT

(10) International Publication Number
WO 2005/070411 A1

(51) International Patent Classification⁷: A61K 31/202,
A61P 25/28, 25/08, 25/18

(21) International Application Number:
PCT/EP2005/000522

(22) International Filing Date: 20 January 2005 (20.01.2005)

(25) Filing Language: English

(26) Publication Language: English

(30) Priority Data:
MI2004A 000069 21 January 2004 (21.01.2004) IT

(71) Applicant and
(72) Inventor: BRUZZESE, Tiberio [IT/IT]; Via Frua 21/6,
I-20146 Milano (IT).

(74) Agents: MANCINI, Vincenzo et al.; Ing. A. Giambro-
cono & C. S.r.l., Via Rosolino Pilo, 19/B, I-20129 Milano
(IT).

(81) Designated States (unless otherwise indicated, for every
kind of national protection available): AE, AG, AL, AM,

AT, AU, AZ, BA, BB, BG, BR, BW, BY, BZ, CA, CH, CN,
CO, CR, CU, CZ, DE, DK, DM, DZ, EC, EE, EG, ES, FI,
GB, GD, GE, GH, GM, HR, HU, ID, IL, IN, IS, JP, KE,
KG, KP, KR, KZ, LC, LK, LR, LS, LT, LU, LV, MA, MD,
MG, MK, MN, MW, MX, MZ, NA, NI, NO, NZ, OM, PG,
PH, PL, PT, RO, RU, SC, SD, SE, SG, SK, SL, SY, TJ, TM,
TN, TR, TT, TZ, UA, UG, US, UZ, VC, VN, YU, ZA, ZM,
ZW.

(84) Designated States (unless otherwise indicated, for every
kind of regional protection available): ARIPO (BW, GH,
GM, KE, LS, MW, MZ, NA, SD, SL, SZ, TZ, UG, ZM,
ZW), Eurasian (AM, AZ, BY, KG, KZ, MD, RU, TJ, TM),
European (AT, BE, BG, CH, CY, CZ, DE, DK, EE, ES, FI,
FR, GB, GR, HU, IE, IS, IT, LT, LU, MC, NL, PL, PT, RO,
SE, SI, SK, TR), OAPI (BF, BJ, CF, CG, CI, CM, GA, GN,
GQ, GW, ML, MR, NE, SN, TD, TG).

Published:
— with international search report
— before the expiration of the time limit for amending the
claims and to be republished in the event of receipt of
amendments

For two-letter codes and other abbreviations, refer to the "Guid-
ance Notes on Codes and Abbreviations" appearing at the begin-
ning of each regular issue of the PCT Gazette.



WO 2005/070411 A1

(54) Title: USE OF HIGHLY CONCENTRATED COMPOSITIONS OF SELECTED n-3 FATTY ACIDS FOR THE TREATMENT OF CENTRAL NERVOUS SYSTEM DISTURBANCES

(57) Abstract: The use is described of a composition comprising either a) alpha-linolenic acid (ALA, C18:3 n-3) or b) docosahex-
aenoic acid (DHA, C22:6 n-3) or c) DHA in admixture with eicosapentaenoic acid (EPA, C20:5 n-3), in a ratio of 1:0.5 to 1:1.7,
respectively, and/or the pharmaceutically acceptable derivatives and/or precursors thereof; either a) or b) or c) being in a concentra-
tion not lower than 70% by weight of the total fatty acids weight in the composition, for the preparation of a drug for the prevention
and/or treatment of the disturbances of the central nervous system (CNS) such as epilepsy, schizophrenia, bipolar (manic- depressive
illness) and unipolar (major depression) psychiatric disorders, and by degenerative Alzheimer's disease and related forms of demen-
tia.

USE OF HIGHLY CONCENTRATED COMPOSITIONS OF SELECTED n-3 FATTY ACIDS FOR THE TREATMENT OF CENTRAL NERVOUS SYSTEM DISTURBANCES

* * * * *

5 The invention refers to the use of highly concentrated compositions of selected n-3 fatty acids for the treatment of central nervous system disturbances. In particular, the invention concerns the use of a composition comprising either alpha-linolenic acid (ALA, C18:3 n-3) or docosahexaenoic acid (DHA, C22:6 n-3) or DHA in admixture with eicosapentaenoic acid (EPA, C20:5 n-3) and/or the pharmaceutically acceptable derivatives and/or precursors
10 thereof, in a high concentration, for the preparation of a drug for the prevention and/or treatment of the disturbances of the central nervous system (CNS), both of psychiatric relevance and of neurological type.

The expression "central nervous system disturbances" is commonly meant to indicate the cluster of convulsive symptoms usually included in the so-called epileptic syndromes, as
15 well as to the most severe psychiatric disorders, represented by the various schizophrenia forms, by the manic-depressive syndromes, by the severe depression, and by the Alzheimer's disease and the related forms of dementia.

The term epilepsy refers to disorders of brain function characterized by periodic and unpredictable occurrence of seizures. Such seizures are constituted by transient alterations
20 of behaviour caused by disordered, synchronous and rhythmic firing of neuronal brain populations, not induced by evident provocation.

These seizures are thought to arise from disorders of cerebral cortex, not involving other CNS structures, and their behavioural manifestations is determined by the functions served by the involved cortical site. For instance, a seizure arising from the motor cortex will
25 induce f.i. clonic jerking of the body muscles controlled by this same region of the cortex. Epileptic seizures are defined partial, when beginning focally in a cortical site, or generalized seizures, when involving both hemispheres. A partial seizure is defined simple, if associated with preservation of consciousness, or complex in the opposite case, often due to impairment of the temporal lobe. A typical generalized epileptic seizure includes absence
30 and tonic-clonic convulsions.

Schizophrenia is caused by a chemical imbalance in the brain induced, in its turn, by triggering causes of genetic or environmental origin (autoimmune diseases, infections during development, psychological trauma, etc.), involving- among other effects-
overproduction of dopamine. There are several categories of the disease: paranoid,
35 catatonic, disorganised, undifferentiated schizophrenia.

Patients start to get a great variety of symptoms,, which anyway can reveal themselves into two typical forms: negative symptoms, such as withdrawal, apathy, depression, blunted emotions, and positive symptoms, such as hallucinations, misunderstanding of reality and of perception, disordered thinking and speech. The appearance of the disease is early, but
5 diagnosis is complex and can take very long times.

The older drugs, typical neuroleptic drugs, essentially agents blocking cerebral dopamine, are however poorly selective and associated with heavy side effects on dopamine-related functions, including severe extrapyramidal effects, like unusual and involuntary body movements (dyskinesias, tardive dyskinesias), restlessness (akathesia), muscle spasms
10 (dystonia), as well as impairment of cognition, reduced libido, etc; further, these drugs while moderately effective in treating positive symptoms, are quite unsuccessful on negative symptoms, as depression and apathy.

The more recent drugs, so-called atypical drugs, have a broader action spectrum and less side effects, such as the arising of involuntary movements, but are unavailable in under-
15 developed countries because of their expensiveness, and are not free anyway from other effects, even highly risky (prolongation of QTC interval of ECG, weight gain, diabetic symptoms).

The syndromes of bipolar disturbances (manic-depressive disorders) and of severe unipolar depression (major depression) constitute the more severe disorders of mood or affect. They
20 usually include disordered autonomic functioning (i.e., altered activity rhythms, sleep and appetite) and behaviour, as well as persistent abnormalities of mood and increased risk of self- destruction or suicide.

Alzheimer's disease, as other degenerative disease of CNS, all induced by progressive loss of neurons from specific regions of the brain, is characterized by marked atrophy of the
25 cerebral cortex and loss of cortical, sub-cortical and hippocampal neurons; a parallel reduction of neurotransmitters has also been evidenced, in particular of acetylcholine, which has given rise to the cholinergic hypothesis of the disease and led to the few drugs of some limited effectiveness.

The disease produces a progressive impairment of the cognitive abilities, which is typical -
30 but not exclusive- of the elder subject. The disease appears first as an impairment of short-term memory, but as the condition progresses additional cognitive abilities are impaired, such as the ability to calculate, exercise visual-spatial skills, and use common objects (ideo-motor apraxia), and the illness reveals itself in various forms of dementia. Later on, death often comes up from a complication of immobility, such as pneumonia.

35 For all mentioned pathologies, there are not valid pharmacological and clinical treatments,

able to modify the progression of the disease. In all cases only symptomatic treatments are adopted, only able to alleviate the symptomatology and, if endowed with some efficacy, only effective on a very limited number of patients: for instance the standard treatments in the depression permit to obtain until a maximum of 50% reduction of score in the evaluation scale in two thirds of patients, while improvements in schizophrenia are obtained in the order of 20- 30%, and treatments in the Alzheimer's disease result to be only ineffective palliatives.

Some therapeutic effects of the n-3 polyunsaturated fatty acids are already well known. For instance, IT 1,235,879, US 5,502,077 and US 5,656,667 disclose their effect on multiple risk factors for cardiovascular illnesses, as hypertriglyceridemia, hypercholesterolemia and hypertension.

EP-A-0409903 describes the preparation of high concentration mixtures of EPA and DHA or their esters, useful in the treatment of hyperlipemia, thrombosis, myocardial infarct, platelet hyperaggregation and related vascular pathologies, as well as of acute and chronic inflammations, autoimmune syndromes, and in the tumour prevention. DHA, which is contained in high concentration in the retina, is also active on the functionality of sight, on ceroidosis and on learning and ageing processes.

WO 00/48592 discloses the use of mixtures of EPA and DHA ethyl esters for the secondary prevention of "sudden death" in patients who have already suffered a myocardial infarct.

It also results in the scientific literature that the n-3 polyunsaturated acids, particularly DHA, are contained in high concentration in the cerebral cortex (much less in the white matter), according to O'Brien JS and Sampson EL, J. Lipid Res. 6, 545, 1965, in the retina (Anderson RE, Exp. Eye Res. 10, 339, 1970), in the testis and sperm (Poulos A et al., Comp. Biochem. Physiol. 46B, 541, 1975) of all mammals, including human beings.

DHA is therefore one of the most abundant components of the brain's structural lipids, in which its presence can derive only from direct ingestion or by synthesis from the dietary precursor, i.e. alpha-linolenic acid (ALA).

Among others, Neuringer M et al., J. Clin. Invest. 73, 272, 1984; Proc. Natl. Acad. Sci. USA 83, 4021, 1986, suggest that n-3 fatty acids are essential for a normal prenatal and postnatal development of retina and brain.

EP-A-0347056 discloses the use of gamma-linolenic acid (GLA, C18:3 n-6) and higher n-6 acids, and of stearidonic acid (SA, C18:4 n-3) and higher n-3 acids, for the preparation of a drug for treatment of tardive dyskinesias.

EP-A-0599576 describes the use of a combination of arachidonic acid (AA, C20:4 n-6) and DHA, acids belonging to the n-6 and n-3 series respectively, to obtain a drug effective on

the negative syndrome of schizophrenia, in subjects with low levels of the two acids in the cell membranes.

US 6,331,568 discloses a method for treating schizophrenia by administration of EPA or SA, two n-3 acids, and optionally of n-6 acids. The compositions therein disclosed show a
5 ratio of EPA or SA to DHA of not less than 3:1, 4:1, or more.

WO 00/44 361 discloses a pharmaceutical preparation containing at least 90% or more of EPA, and less than 5% of DHA for uses similar to the ones of the documents just above discussed.

US 5,120,763 and EP 0366480 disclose a composition containing 13.0-27.5% of linolenic
10 acid (i.e. ALA, C18:3 n-3) and 87.0-72.5% of linoleic acid (i.e. LA, C18:2 n-6), useful in the treatment of Alzheimer's disease and related syndromes, while US 5,468,776 describes the same components in the more limited range of 16.7-22.2% and 83.3-77.8% respectively.

Although it is known to a certain degree that compositions comprising peculiar
15 combinations of n-3 and/or n-6 fatty acids may have shown some effectiveness on pathologies such as schizophrenia or Alzheimer's disease, a clear indication on their activity against such pathologies cannot yet be taken from the prior art since the discussion in the scientific community is quite controversial and still open.

For instance, while Mellor et al., Human Psychopharmacology, 11, 39-46, 1996 disclosed
20 the effectiveness of some n-3 acids, such as DHA, carrying out their experiments using a composition comprising EPA 18% and DHA 12%, in US 6,331,568 there is pointed out that such ability has to be denied on the basis of both clinical control and for biochemical reasons.

It has been now surprisingly found that some other peculiar compositions comprising n-3
25 fatty acids in very high concentrations are effective for the prevention and/or treatment of various and severe disorders of the central nervous system, both of neurological type and of psychiatric pertinence, as for instance epilepsy and as schizophrenia, the manic- depressive disturbances and the major depression, as well as the degenerative neuronal disorders typical of Alzheimer's disease.

30 According to a first aspect the invention refers to the use of a composition comprising either

a) alpha-linolenic acid (ALA, C18:3 n-3) and/or the pharmaceutically acceptable derivatives and/or precursors thereof; or

b) docosahexaenoic acid (DHA, C22:6 n-3) and/or the pharmaceutically acceptable
35 derivatives and/or precursors thereof; or

c) DHA in admixture with eicosapentaenoic acid (EPA, C20:5 n-3), in a ratio of 1:0.5 to 1:1.7, preferably of 1:0.9 to 1:1.5, respectively, and/or the pharmaceutically acceptable derivatives and/or precursors thereof;

either a) or b) or c) being in a concentration not lower than 70% by weight of the total fatty acids weight in the composition, for the preparation of a drug for the prevention and/or treatment of the disturbances of the central nervous system (CNS), both of psychiatric relevance and of neurological type.

Preferably, the concentration in either a) or b) or c) is of 75% to 95%, in particular of 80% to 90%, most preferably of 85% (as a mean value).

Among the disturbances of CNS which can be prevented and/or treated according to the invention, there are epilepsy (showing partial and/or generalized seizures or simple and/or complex seizures), schizophrenia (showing negative and/or positive symptoms and being either paranoid or catatonic or disorganised or undifferentiated schizophrenia), manic-depressive syndrome, major depression (including disorders of mood, behaviour and autonomic functions correlated to activity, sleep and appetite), and Alzheimer's disease (including the various related forms of dementia).

In a preferred embodiment, the drug suitable for the use of the invention comprises essentially DHA ethyl ester and EPA ethyl ester.

Yet, according to another preferred embodiment, the composition can also comprise at least another n-3 and/or n-6 polyunsaturated and/or monounsaturated and/or saturated fatty acid, in particular the composition can comprise at least two other n-3 and/or n-6 polyunsaturated and/or monounsaturated and/or saturated fatty acids, in any ratio among themselves; the other n-3 and/or n-6 polyunsaturated and/or monounsaturated and/or saturated fatty acids are in a concentration of lower or equal to 30%.

Preferred ALA, DHA, and EPA derivative are selected among C₁-C₃ alkyl esters (preferably ethyl esters), glyceride mono-, di-, tri-esters, and salts with pharmaceutically acceptable bases, like for instance sodium hydroxide and potassium hydroxide, aminoalcohols as ethanolamine and choline, basic aminoacids as arginine and lysine. "Precursor" is herein meant to indicate any compound able to lead to ALA, DHA and EPA through in vivo transformations, f. i. through metabolic processes.

Also the compositions reported in the European Pharmacopoeia 2000, Eu. Ph. 2000, having a content of not less than 80% of the mixture of the ethyl esters of EPA and DHA (not less than 40% and 34%, respectively) and not less than 90% total ethyl esters of n-3 polyunsaturated fatty acids, will be suitable for the use of the present invention.

All the above mentioned compositions, as well as the pharmaceutical preparations which

can be derived therefrom, can be prepared according to methods known to the expert in the field, as f.i. those described in Patents US 5 130 061, WO 89/ 11 521, IT 1 235 879, DE 3 739 700, JP 02/ 25 447 (and others), herein incorporated by reference as far as their preparation is concerned.

5 Commonly, the composition suitable for the use of the invention can be obtained by extraction, concentration and purification processes starting from natural sources, typically from fish oils or other marine source as algae (for DHA and EPA), or even from vegetable oils, f.i. seed oils (typically for ALA), as well as by means of semi-synthetic transformation processes, when required.

10 Together with their efficacy to the aim of the pharmaceutical and therapeutic use of the invention, the above compositions show a very high clinical tolerance, almost free from any side-effect, with exclusion of some uncommon effect on the intestinal peristalsis, and can be obtained with low production costs from natural sources, which strongly helps their diffusion in low economic potential countries, differently from the poor availability of
15 some totally synthetic drugs.

The drug suitable for the use of the invention is preferably administered by oral route, particularly in the form of soft jelly capsules; yet, the other typical administration routes, usual in the pharmaceutical technology, are not excluded. The dose per unit includes usually 100-1000 mg of the above specified n-3 polyunsaturated fatty acids and/or
20 derivatives and/or precursors, preferably 300-1000 mg or better 500 mg or more often 1000 mg. The mean total dose is 0.1- 5 g per day, even in intermittent administration, according to the need and advice of the physician, preferably 0.3-3 g per day or particularly 1-2 g. An effective dose meanly corresponds to 2-60 mg/kg/day.

Obviously, the drug suitable for the use of the invention can be administered also under
25 other forms appropriate for the oral administration such as, for instance, hard oil-proof capsules or tablets wherein the fatty acids are pre-adsorbed on solid matrices.

It is also possible to use oily emulsions, syrups, drops, granulates in dispersing excipients, etc., as well as other forms able to guarantee a systemic absorption by means of other administration routes, f. i. sterile emulsions or solutions suitable for parenteral injective use,
30 as it will be apparent to the man skilled in the art.

The drug suitable for the use of the present invention can be used alone, as a mono-therapy, or as a drug coadjuvant or auxiliary to at least another active principle or drug effective for the prevention and/or treatment of the disturbances of CNS, or can even be used in direct combination, including said at least another active principle or drug endowed with an
35 activity similar or complementary or synergic to that one of the above defined drug suitable

for the use of the invention.

Typical examples of such at least another active principle or drug to which the drug suitable for the use of the invention can be combined or can be auxiliary or coadjuvant by co-administration, are, without any limitative meaning:

5 -in the treatment of epilepsy, carbamazepine, phenytoin, phenobarbital, primidone, valproate, gabapentin, lamotrigine, clonazepam, ethosuximide, and related structures;

 -in the treatment of schizophrenia, drugs of the group of phenothiazines, thioxanthenes, dibenzazepines, butyrophenones, indolones, phenyl- and diphenylpiperidines, etc., among them the typical neuroleptic agents as chlorpromazine, 10 thioridazine, haloperidol, sulpiride, and pimozide, and others, and the antipsychotic “atypical” agents as clozapine, quetiapine, olanzapine, sertindole, risperidone, ziprasidone, amisulpiride and others;

 -in the treatment of major depression and of manic-depressive illness, the antidepressant drugs of the group of tricyclic norepinephrine reuptake inhibitors as amitriptyline and others, of the group of serotonin reuptake inhibitors as fluoxetine, 15 paroxetine, sertraline and others, of the group of monoamine oxidase (MAO) inhibitors as phenelzine and others, of the group of “atypical” drugs as bupropion and trazodone; the antimanic drugs as lithium salts; the drugs acting on mood and affect disorders as many antianxiety agents, including benzodiazepines and the above mentioned antidepressant and antimanic drugs as well as some anticonvulsants/antiepileptic drugs as carbamazepine and 20 valproate;

 -in the treatment of Alzheimer’s disease, among the few “approach” drugs, the precursors of acetylcholine, as choline and phosphatidylcholine, and the inhibitors of catabolic enzyme (acetylcholinesterase, AChE) , as physostigmine, tacrine, 25 donepezilrivastigmine and galantamine, as well as memantine, more recently adopted and endowed with a different mechanism of action.

The composition suitable for the use of the invention can also comprise a pharmaceutically acceptable diluent, and/or a vehicle, and/or a binder, and/or thickener, and/or a surfactant, as well as a lubricant, aromatizer, colorant, sweetener, stabilizer and the like, as it will be 30 apparent to the man skilled in the art. Among the stabilizer agents, antioxidants, particularly tocopherol (vitamin E) and the like, as well as ascorbyl palmitate, hydroxytoluene, butylhydroxyanisole and the like known in the art, are particularly preferred.

As already illustrated above, the drug comprising either a) or b) or c) as above defined can be administered according to the invention either as a single drug or in fixed 35 pharmaceutical combination with other known drugs already known to be used in the same

pathologies, or even as substances coadjuvant to said known drugs, under separated administration.

According to another aspect, the invention relates to a method for prevention and/or treatment of CNS disturbances, as above illustrated, in a mammal in need thereof comprising administering to the mammal a therapeutically effective dose, preferably ranging from about 2 to 60 mg/kg of the mammal body weight per day, of a drug as above described.

The following examples illustrate the invention without limiting it.

EXAMPLE 1

A few compositions of the invention are illustrated in the following Table and can be prepared according to the methods described in US 5130061 (compositions A, C, D, E), IT 1235879 (composition B), WO 89/11521 (compositions F, H, I) and DE 3739700 (composition G), and are anyway easily available even using other preparative methods (JP 02/ 25447 and several others).

The quantities indicated in the Table express percentages by weight on the total weight of fatty acids. Other n-3 acids, as well as n-6 unsaturated acids, having different length and/or unsaturation degree, monounsaturated and saturated, can be present in limited quantities. Antioxidant: alpha-tocopherol (mean < 0.3%; even much higher concentrations can be used).

20

	A 1)	B 1)	C 1)	D 1)	E 1)	F 1)	G 1)	H 2)	I 3)
EPA	>40	>44	>40	>35	>30	<15		>40	>50
DHA	>34	>30	>34	>30	>35	>80		>30	>30
EPA + DHA	>85	>80	>80	>70	>70	>85		>80	>80
Esters 4)		>3							
Total n-3 esters 5)			>90						
ALA							>70		

1) ethyl esters; 2) free acids; 3) sodium salts; 4) ethyl esters of other (C20, C21, C22) n-3 acids; 5) total ethyl esters of n-3 acids.

EXAMPLE 2

The compositions of the following Table, relative to soft gelatin capsules containing 1 g ethyl esters of polyunsaturated fatty acid, were prepared by methods known in the art.

	A (mg)	B (mg)	C (mg)
EPA 1)	525		>400
DHA 1)	315		>340
EPA + DHA 1)		850	>800
Total n-3 1)			>900
d-tocopherol	4 Units		4 Units
d,l-tocopherol		0.3	
Gelatine	246		246
Gelatine succinate		233	
Glycerol	118	67	118
RIO	2.27		2.27
YIO	1.27		1.27
SHB + SPHB		1.09 + 0.54	

1) ethyl esters; RIO: red iron oxide; YIO: yellow iron oxide; SHB: sodium p.hydroxybenzoate; SPHB: sodium propyl p.hydroxybenzoate.

EXAMPLES 3-6: pharmacological activity

- 5 The effectiveness of the composition suitable for the use of the invention in the prevention and/or treatment of CNS disturbances as those above described, as well as of the possibility of their pharmaceutical and clinical use, has been demonstrated following several pharmacological tests which permitted a wide testing on small size animals (mice, rats), without the ethical implications proper of testing in humans.
- 10 A first model of experiment evaluated the protection against epileptic seizures induced by direct application of iron chloride to cerebral cortex; a second model examined the protective effect against a known convulsant chemical agent (pentylenetetrazol); a third model verified the effect on the induction of epileptic seizures provoked by repeated sub-convulsive dose administration of the same chemical agent and a fourth experimental
- 15 model evaluated the effect protective on the anomalous behaviour induced, in the form of irregular jumping, by the administration of dizocilpine, an analogue of phencyclidine which binds similarly to N-methyl-D-aspartate (NMDA) receptors provoking its hypo-function and inducing schizophreniform psychosis.

20 In some of such tests, attention has been particularly addressed to detect any activity strengthening or coadjuvant to that of other known drugs.

Male Sprague-Dawley albino rats, about two months of age and 200-240-g weight, were used in the experiments of Examples 3-5. The animals were housed at an average temperature of about 22°C and an average relative humidity of 40-50%, with artificial daily light cycles of 12 hours. In example 6, male Swiss mice weighing 22-30 g, housed in similar room conditions, were used.

EXAMPLE 3

Two groups of 15 rats were treated for 2 weeks by intraperitoneal (i.p.) route with 50 mg/kg of composition B (Example 1) containing >80% EPA and DHA ethyl esters (group 1) and with saline solution (group 2, control), respectively. At the end, all rats received a dose of 5 microlitres of 100 mM solution of FeCl₃, directly injected through unilateral left-side cannula into the anterior amygdala area. The administration of FeCl₃ into the cerebral cortex or amygdala-hippocampus complex is able to induce an epileptic focus, according to Willmore L.J., Science, 200, 1501, 1978. By prolonged direct monitoring, the number of animals protected or subject to major motor epileptic seizures are determined, as evidenced by tonic- clonic contractions of the limbs, trunk and head, lack of straightening reflex, saliva and blood discharge from the mouth.

Results: animals responding with seizures:

3/15 (group 1, treated)

14/15 (group 2, control)

EXAMPLE 4

In a preliminary experiment, the dose effective on 50% of study strain rats of a known epileptogenic agent (pentylentetrazol) injected by intraperitoneal route, has been determined, obtaining an ED50 value of approximately 70-75 mg/kg i.p.

Four groups of 10 rats each were treated daily for 2 weeks, by i.p. route, with 50 mg/kg of a composition of n-3 fatty acids having >85% of EPA and DHA ethyl esters according to Example 1, composition A (group 1), with 5 mg/kg of a known antiepileptic drug represented by clonazepam (group 2), with the same doses in combination (group 3) and with saline solution (group 4, control). At the end, all the groups were treated with 100 mg/kg i.p. of pentylentetrazol, and the animals underwent the following control exams:

1) length of latency period to the first major motor seizures (tonic- clonic contractions of the limbs, trunk and head; falling; saliva and blood discharge from the mouth); 2) number of rats responding with major motor seizures (or protected from seizure); 3) mean duration of the major motor seizure (MMS); 4) number of rats presenting minor clonic contractions (MCC), such as a sudden flexion of the forelegs or extension of the rear legs; 5) number of rats who died within 20 minutes or 5 hours after pentylentetrazol injection.

The obtained results (mean \pm standard deviation) are reported in the following Table:

Treatment groups	Latency to seizures (sec.)	Duration of seizures (sec)	Rats with MMS (n/tot)	Rats with MCC (n/tot)	Dead animals	
					<20'	<5 h
1) (n-3)	184 \pm 23	22 \pm 9	1/10	2/10	1/10	3/10
2) (clonazepam)	203 \pm 12	25 \pm 6	1/10	3/10	2/10	4/10
3) (n-3+ clonazepam)	265 \pm 15	15 \pm 7	0/10	1/10	0/10	2/10
4) (control)	12 \pm 4	786 \pm 34	9/10	1/10	10/10	0/10

It appears from such data that the pre-treatment with the composition of EPA and DHA ethyl esters is able to significantly protect the rats (about 90%) from major motor seizures induced by the administration of pentylenetetrazol. In the few animals not protected, the seizure is anyway delayed in the time and its duration is noticeably lower. Also a strong reduction of mortality during the convulsive period is noticed, with partial protection even during the post-ictal period. The effectiveness of the composition is at least similar to that of a reference drug and is noticeably potentiated if administered in combination.

EXAMPLE 5

Two groups of 10 rats each were daily treated for 2 weeks, by i.p. route, with 50 mg/kg of a composition >80% of EPA and DHA ethyl esters, according to Example 1, composition C (group 1), and with saline solution (group 2, control). At the end all the animals were administered at 15 min. intervals a series of sub-convulsive doses of pentylenetetrazol (15 mg/kg, i.p.), so determining the number of injections required to produce an attack of clonic or tonic-clonic convulsions of forelegs and hind legs, followed by loss of straightening reflex.

Results: number of sub-convulsive doses for induction of seizure (mean \pm standard deviation):

16.35 \pm 3.20 (group 1, treated)

3.26 \pm 1.54 (group 2, control).

EXAMPLE 6

Two groups of 12 mice each were treated daily for 2 weeks, by i.p. route, with 50 mg/kg of a composition >80% of EPA and DHA ethyl esters according to Example 1, composition B (group 1), and with saline solution (group 2). At the end all the animals received by i.p. route 1 mg/kg of dizocilpine, an analogue of phencyclidine able to bind the N-methyl-D-aspartate (NMDA) receptors, inducing its hypofunction and subsequent schizophreniform psychosis. The behaviour induced in the mouse consists in eliciting irregular and intense

jumping (so-called popping), and its attenuation represents a valid experimental model to identify substances able to counteract the pathophysiology of schizophrenia (Deutsch S.I. et al., Neuropsychopharmacology, 15, 37, 1996; ibidem,15,329,1996). The administration of dizocilpine was followed by monitoring for 30 minutes, and during the period the popping
5 behaviour, i.e. the number of jumping of treated and control animals was registered by a suitable equipment.

Results: number of induced jumps:

45 ± 12 (group 1, treated)

338 ± 55 (group 2, positive control).

CLAIMS

1. Use of a composition comprising either
 - a) alpha-linolenic acid (ALA, C18:3 n-3) and/or the pharmaceutically acceptable derivatives and/or precursors thereof; or
 - 5 b) docosahexaenoic acid (DHA, C22:6 n-3) and/or the pharmaceutically acceptable derivatives and/or precursors thereof; or
 - c) DHA in admixture with eicosapentaenoic acid (EPA, C20:5 n-3) , in a ratio of 1:0.5 to 1:1.7, respectively, and/or the pharmaceutically acceptable derivatives and/or precursors thereof;
- 10 either a) or b) or c) being in a concentration not lower than 70% by weight of the total fatty acids weight in the composition, for the preparation of a drug for the prevention and/or treatment of the disturbances of the central nervous system (CNS).
2. Use according to claim 1, wherein the disturbances of CNS are neurological and/or psychiatric disturbances.
- 15 3. Use according to claim 1 or 2, wherein the disturbances of CNS are epilepsy, schizophrenia, manic-depressive syndrome, major depression, and Alzheimer's disease.
4. Use according to the previous claim, wherein epilepsy shows partial and/or generalized seizures.
5. Use according to claim 3 or 4, wherein epilepsy shows simple and/or complex seizures.
- 20 6. Use according to claim 3, wherein schizophrenia shows negative and/or positive symptoms.
7. Use according to claim 3 or 6, wherein schizophrenia is paranoid, catatonic, disorganised or undifferentiated schizophrenia.
8. Use according to claim 3, wherein the manic-depressive syndrome and major depression
- 25 include disorders of mood, behaviour and autonomic functions correlated to activity, sleep and appetite.
9. Use according to claim 3, wherein the Alzheimer's disease includes the various related forms of dementia.
10. Use according to any of the previous claims, wherein the ratio of DHA to EPA in c) is
- 30 of 1:0.9 to 1:1.5.
11. Use according to any of the previous claims, wherein the concentration of either a) or b) or c) is of 75% to 95% by weight of the total fatty acids weight in the composition.
12. Use according to any of the previous claims, wherein the concentration of either a) or b) or c) is of 80% to 90% by weight of the total fatty acids weight in the composition.
- 35 13. Use according to any of the previous claims, wherein the concentration of either a) or b)

or c) is of 85% by weight of the total fatty acids weight in the composition.¹⁴

14. Use according to any of the previous claims, wherein the composition comprises at least another n-3 and/or n-6 polyunsaturated and/or monounsaturated and/or saturated fatty acid.

15. Use according to the previous claim, wherein the composition comprises at least two
5 other n-3 and/or n-6 polyunsaturated and/or monounsaturated and/or saturated fatty acids, in any ratio among themselves.

16. Use according to claim 14 or 15, wherein the other n-3 and/or n-6 polyunsaturated and/or monounsaturated and/or saturated fatty acids are in a concentration of lower or equal to 30%.

10 17. Use according to any of the previous claims, wherein the derivatives of ALA, DHA and EPA are selected from the group consisting of their C₁-C₃ alkyl esters, glyceride mono-, di-, tri-esters, salts with pharmaceutically acceptable bases, whereas the precursors of ALA, DHA and EPA are the compounds able to lead to them through *in vivo* transformations.

15 18. Use according to any of the previous claims, wherein the drug comprises essentially DHA ethyl ester and EPA ethyl ester.

19. Use according to any of the previous claims, wherein the drug is administered by oral route.

20. Use according to any of the previous claims, wherein the drug is in the form of soft gelatine capsules.

20 21. Use according to any of the previous claims, wherein the drug is administered at the dose of 0.1-5 g/day.

22. Use according to any of the previous claims, wherein the drug is administered at the dose of 0.3-3 g/day.

25 23. Use according to any of the previous claims, wherein the drug is administered at the dose of 1-2 g/day.

24. Use according to any of the previous claims, wherein the drug is administered separately, as a coadjuvant or an auxiliary drug, from at least another drug effective for the prevention and/or treatment of the disturbances of CNS.

30 25. Use according to any of the previous claims, wherein the drug comprises at least another drug effective for the prevention and/or treatment of the disturbances of CNS.

26. A method for prevention and/or treatment of CNS disturbances in a mammal in need thereof comprising administering to the mammal a therapeutically effective dose of a drug as defined in any of the previous claims.

35 27. A method according to the previous claim, wherein the therapeutically effective dose ranges from about 2 to 60 mg/kg of the mammal body weight per day.

28. A method according to claim 26 or 27¹⁵, wherein the CNS disturbances are epilepsy, schizophrenia, manic- depressive syndrome, major depression and Alzheimer's disease.

INTERNATIONAL SEARCH REPORT

International Application No
PCT/EP2005/000522

A. CLASSIFICATION OF SUBJECT MATTER
 IPC 7 A61K31/202 A61P25/28 A61P25/08 A61P25/18

According to International Patent Classification (IPC) or to both national classification and IPC

B. FIELDS SEARCHED
 Minimum documentation searched (classification system followed by classification symbols)
 IPC 7 A61K A61P

Documentation searched other than minimum documentation to the extent that such documents are included in the fields searched

Electronic data base consulted during the international search (name of data base and, where practical, search terms used)
 EPO-Internal, EMBASE, BIOSIS, WPI Data, PAJ

C. DOCUMENTS CONSIDERED TO BE RELEVANT

Category *	Citation of document, with indication, where appropriate, of the relevant passages	Relevant to claim No.
X	EP 0 699 437 A (PROSPA B.V) 6 March 1996 (1996-03-06) page 2, lines 9,10 page 5; example 4	1,2, 10-13, 18-23,26
X	EP 0 599 576 A (SCOTIA HOLDINGS PLC) 1 June 1994 (1994-06-01) cited in the application claims 1-6	1-3,6,7, 11-14, 17-23, 26-28

Further documents are listed in the continuation of box C. Patent family members are listed in annex.

* Special categories of cited documents :

A document defining the general state of the art which is not considered to be of particular relevance	*T* later document published after the international filing date or priority date and not in conflict with the application but cited to understand the principle or theory underlying the invention
E earlier document but published on or after the international filing date	*X* document of particular relevance; the claimed invention cannot be considered novel or cannot be considered to involve an inventive step when the document is taken alone
L document which may throw doubts on priority claim(s) or which is cited to establish the publication date of another citation or other special reason (as specified)	*Y* document of particular relevance; the claimed invention cannot be considered to involve an inventive step when the document is combined with one or more other such documents, such combination being obvious to a person skilled in the art.
O document referring to an oral disclosure, use, exhibition or other means	*Z* document member of the same patent family
P document published prior to the international filing date but later than the priority date claimed	

Date of the actual completion of the international search 2 June 2005	Date of mailing of the international search report 10/06/2005
--	--

Name and mailing address of the ISA European Patent Office, P.B. 5818 Patentlaan 2 NL - 2280 HV Rijswijk Tel. (+31-70) 340-2040, Tx. 31 651 epo nl, Fax: (+31-70) 340-3016	Authorized officer Young, A
--	------------------------------------

INTERNATIONAL SEARCH REPORT

 International Application No
 PCT/EP2005/000522

C.(Continuation) DOCUMENTS CONSIDERED TO BE RELEVANT		
Category °	Citation of document, with Indication, where appropriate, of the relevant passages	Relevant to claim No.
X	<p>MELLOR J E ET AL: "OMEGA-3 FATTY ACID SUPPLEMENTATION IN SCHIZOPHRENIC PATIENTS" HUMAN PSYCHOPHARMACOLOGY. CLINICAL AND EXPERIMENTAL, JOHN WILEY & SONS LTD, vol. 11, no. 1, 1996, pages 39-46, XP000921351 ISSN: 0885-6222 cited in the application page 40, left-hand column, paragraphs 2,3</p>	1-3,6,7, 11-13, 19-23, 26-28
Y	<p>VREUGDENHIL M ET AL: "POLYUNSATURATED FATTY ACIDS MODULATE SODIUM AND CALCIUM CURRENTS IN CA1 NEURONS" PROCEEDINGS OF THE NATIONAL ACADEMY OF SCIENCES OF USA, NATIONAL ACADEMY OF SCIENCE. WASHINGTON, US, vol. 93, no. 22, 29 October 1996 (1996-10-29), pages 12559-12563, XP000616311 ISSN: 0027-8424 page 12563, left-hand column, paragraph 3 abstract</p>	1-28
Y	<p>VREUGDENHIL M ET AL: "ANTICONVULSANT PROPERTIES OF POLYUNSATURATED FATTY ACIDS" SOCIETY FOR NEUROSCIENCE ABSTRACTS, SOCIETY FOR NEUROSCIENCE, US, vol. 22, 1996, page 2106, XP000921389 ISSN: 0190-5295 abstract</p>	1-28
Y	<p>US 6 331 568 B1 (HORROBIN DAVID FREDERICK) 18 December 2001 (2001-12-18) cited in the application column 2, paragraphs 2,3</p>	1-28
Y	<p>EP 0 347 056 A (EFAMOL HOLDINGS PLC; SCOTIA HOLDINGS PLC) 20 December 1989 (1989-12-20) cited in the application page 7; example A</p>	1-28
Y	<p>US 6 384 077 B1 (PEET MALCOLM ET AL) 7 May 2002 (2002-05-07) cited in the application claim 1</p>	1-28
Y	<p>VOSKUYL ROB A: "Is marine fat anti-epileptogenic?" NUTRITION AND HEALTH (BERKHAMSTED, HERTFORDSHIRE) 2002, vol. 16, no. 1, 2002, pages 51-53, XP009047531 ISSN: 0260-1060 the whole document</p>	1-28

INTERNATIONAL SEARCH REPORT

International application No.
PCT/EP2005/000522

Box II Observations where certain claims were found unsearchable (Continuation of item 2 of first sheet)

This International Search Report has not been established in respect of certain claims under Article 17(2)(a) for the following reasons:

1. Claims Nos.:
because they relate to subject matter not required to be searched by this Authority, namely:
Although claims 26-28 are directed to a method of treatment of the human/animal body, the search has been carried out and based on the alleged effects of the compound/composition.
2. Claims Nos.:
because they relate to parts of the International Application that do not comply with the prescribed requirements to such an extent that no meaningful International Search can be carried out, specifically:
3. Claims Nos.:
because they are dependent claims and are not drafted in accordance with the second and third sentences of Rule 6.4(a).

Box III Observations where unity of invention is lacking (Continuation of item 3 of first sheet)

This International Searching Authority found multiple inventions in this international application, as follows:

1. As all required additional search fees were timely paid by the applicant, this International Search Report covers all searchable claims.
2. As all searchable claims could be searched without effort justifying an additional fee, this Authority did not invite payment of any additional fee.
3. As only some of the required additional search fees were timely paid by the applicant, this International Search Report covers only those claims for which fees were paid, specifically claims Nos.:
4. No required additional search fees were timely paid by the applicant. Consequently, this International Search Report is restricted to the invention first mentioned in the claims; it is covered by claims Nos.:

Remark on Protest

The additional search fees were accompanied by the applicant's protest.

No protest accompanied the payment of additional search fees.

INTERNATIONAL SEARCH REPORT

Information on patent family members

International Application No
PCT/EP2005/000522

Patent document cited in search report		Publication date	Patent family member(s)	Publication date
EP 0699437	A	06-03-1996	IT 1274734 B	24-07-1997
			DE 69506642 D1	28-01-1999
			DE 69506642 T2	22-07-1999
			DE 699437 T1	07-11-1996
			EP 0699437 A1	06-03-1996
			JP 8175988 A	09-07-1996
			US 5776978 A	07-07-1998
			<hr/>	
EP 0599576	A	01-06-1994	AT 144706 T	15-11-1996
			AU 666782 B2	22-02-1996
			AU 5183093 A	09-06-1994
			AU 5232996 A	18-07-1996
			CA 2109777 A1	27-05-1994
			CN 1104494 A	05-07-1995
			DE 69305723 D1	05-12-1996
			DE 69305723 T2	03-04-1997
			DK 599576 T3	25-11-1996
			EP 0599576 A1	01-06-1994
			EP 0733360 A2	25-09-1996
			ES 2093935 T3	01-01-1997
			GR 3021692 T3	28-02-1997
			HK 114297 A	29-08-1997
			JP 6199663 A	19-07-1994
			NO 934266 A	27-05-1994
			NZ 250265 A	24-06-1997
			RU 2123844 C1	27-12-1998
			SG 47838 A1	17-04-1998
			US 5516800 A	14-05-1996
ZA 9308835 A	02-08-1994			
<hr/>				
US 6331568	B1	18-12-2001	AT 236627 T	15-04-2003
			AU 731692 B2	05-04-2001
			AU 4566797 A	11-05-1998
			BR 9713479 A	11-04-2000
			CA 2268257 A1	23-04-1998
			CN 1233955 A ,C	03-11-1999
			CZ 9901154 A3	11-08-1999
			DE 69720787 D1	15-05-2003
			DE 69720787 T2	18-03-2004
			DK 956013 T3	04-08-2003
			EP 0956013 A1	17-11-1999
			ES 2195175 T3	01-12-2003
			WO 9816216 A1	23-04-1998
			HK 1020316 A1	31-10-2003
			ID 21473 A	17-06-1999
			JP 2001503743 T	21-03-2001
			KR 2000049016 A	25-07-2000
			NO 991635 A	07-06-1999
			NZ 334852 A	25-05-2001
			PL 333423 A1	06-12-1999
PT 956013 T	29-08-2003			
SK 44899 A3	14-08-2000			
TR 9900786 T2	21-07-1999			
TW 429145 B	11-04-2001			
US 2004014810 A1	22-01-2004			
US 2004048927 A1	11-03-2004			
US 2002065319 A1	30-05-2002			
US 2003045578 A1	06-03-2003			

INTERNATIONAL SEARCH REPORT

Information on patent family members

International Application No
PCT/EP2005/000522

Patent document cited in search report	Publication date	Patent family member(s)	Publication date
US 6331568	B1	ZA 9709052 A	14-04-1998
		HU 0000419 A2	28-08-2000
<hr/>			
EP 0347056	A	20-12-1989	AT 87825 T 15-04-1993
			AU 618814 B2 09-01-1992
			AU 3597489 A 14-12-1989
			AU 633442 B2 28-01-1993
			AU 7943491 A 12-09-1991
			CA 1334004 C 17-01-1995
			DE 68905863 D1 13-05-1993
			DE 68905863 T2 26-08-1993
			EP 0347056 A1 20-12-1989
			EP 0454102 A2 30-10-1991
			ES 2053990 T3 01-08-1994
			IE 63303 B1 05-04-1995
			JP 2032017 A 01-02-1990
			JP 2796838 B2 10-09-1998
			KR 129666 B1 09-04-1998
			NZ 229423 A 28-10-1992
			NZ 239126 A 27-07-1997
			US 4977187 A 11-12-1990
	US 5120760 A 09-06-1992		
	ZA 8904380 A 28-02-1990		
<hr/>			
US 6384077	B1	07-05-2002	AU 3065700 A 18-08-2000
			BR 0007743 A 27-11-2001
			CA 2360776 A1 03-08-2000
			CN 1338929 A 06-03-2002
			CZ 20012695 A3 13-02-2002
			EE 200100387 A 17-02-2003
			EP 1148873 A2 31-10-2001
			EP 1417963 A1 12-05-2004
			WO 0044361 A2 03-08-2000
			HR 20010558 A1 31-08-2002
			HU 0105215 A2 29-05-2002
			JP 2002535355 T 22-10-2002
			MX PA01007662 A 24-06-2003
			NO 20013546 A 25-09-2001
			NZ 513172 A 31-10-2003
			SK 10392001 A3 05-02-2002
			TR 200102170 T2 21-12-2001
			US 2002077361 A1 20-06-2002
			US 2002183389 A1 05-12-2002
			US 2002193439 A1 19-12-2002
	US 2004162348 A1 19-08-2004		
	ZA 200106105 A 03-03-2003		

PATENT COOPERATION TREATY

PCT

From the INTERNATIONAL SEARCHING AUTHORITY

To:
 FRANK B. DEHN & CO.
 Attn. Golding, Louise
 St. Bride's House
 10 Salisbury Square
 London EC4Y 8JD
 GRANDE BRETAGNE

439
 File 99870
 26 MAR 2009
 Frank B. Dehn & Co.
 RECEIVED
 ANSD

NOTIFICATION OF TRANSMITTAL OF THE INTERNATIONAL SEARCH REPORT AND THE WRITTEN OPINION OF THE INTERNATIONAL SEARCHING AUTHORITY, OR THE DECLARATION

(PCT Rule 44.1)

Date of mailing (day/month/year) 26/03/2009	
Applicant's or agent's file reference 411.39.99870	FOR FURTHER ACTION See paragraphs 1 and 4 below
International application No. PCT/GB2008/002934	International filing date (day/month/year) 29/08/2008
Applicant AKER BIOMARINE ASA	

1. The applicant is hereby notified that the international search report and the written opinion of the International Searching Authority have been established and are transmitted herewith.

Filing of amendments and statement under Article 19:

The applicant is entitled, if he so wishes, to amend the claims of the International Application (see Rule 46):

When? The time limit for filing such amendments is normally two months from the date of transmittal of the International Search Report.

Where? Directly to the International Bureau of WIPO, 34 chemin des Colombettes
 1211 Geneva 20, Switzerland, Facsimile No.: (41-22) 338.82.70

For more detailed instructions, see the notes on the accompanying sheet.

2. The applicant is hereby notified that no international search report will be established and that the declaration under Article 17(2)(a) to that effect and the written opinion of the International Searching Authority are transmitted herewith.

3. **With regard to the protest** against payment of (an) additional fee(s) under Rule 40.2, the applicant is notified that:

- the protest together with the decision thereon has been transmitted to the International Bureau together with the applicant's request to forward the texts of both the protest and the decision thereon to the designated Offices.
- no decision has been made yet on the protest; the applicant will be notified as soon as a decision is made.

4. **Reminders**

Shortly after the expiration of **18 months** from the priority date, the international application will be published by the International Bureau. If the applicant wishes to avoid or postpone publication, a notice of withdrawal of the international application, or of the priority claim, must reach the International Bureau as provided in Rules 90bis.1 and 90bis.3, respectively, before the completion of the technical preparations for international publication.

The applicant may submit comments on an informal basis on the written opinion of the International Searching Authority to the International Bureau. The International Bureau will send a copy of such comments to all designated Offices unless an international preliminary examination report has been or is to be established. These comments would also be made available to the public but not before the expiration of 30 months from the priority date.

Within **19 months** from the priority date, but only in respect of some designated Offices, a demand for international preliminary examination must be filed if the applicant wishes to postpone the entry into the national phase **until 30 months** from the priority date (in some Offices even later); otherwise, the applicant must, **within 20 months** from the priority date, perform the prescribed acts for entry into the national phase before those designated Offices.

In respect of other designated Offices, the time limit of **30 months** (or later) will apply even if no demand is filed within 19 months.

See the Annex to Form PCT/IB/301 and, for details about the applicable time limits, Office by Office, see the *PCT Applicant's Guide*, Volume II, National Chapters and the WIPO Internet site.

Name and mailing address of the International Searching Authority  European Patent Office, P.B. 5818 Patentlaan 2 NL-2280 HV Rijswijk Tel. (+31-70) 340-2040, Tx. 31 651 epo nl, Fax: (+31-70) 340-3016	Authorized officer Carlos Novoa RIMFROST EXHIBIT 1024 page 2809
--	--

NOTES TO FORM PCT/ISA/220

These Notes are intended to give the basic instructions concerning the filing of amendments under article 19. The Notes are based on the requirements of the Patent Cooperation Treaty, the Regulations and the Administrative Instructions under that Treaty. In case of discrepancy between these Notes and those requirements, the latter are applicable. For more detailed information, see also the *PCT Applicant's Guide*, a publication of WIPO.

In these Notes, "Article", "Rule", and "Section" refer to the provisions of the PCT, the PCT Regulations and the PCT Administrative Instructions, respectively.

INSTRUCTIONS CONCERNING AMENDMENTS UNDER ARTICLE 19

The applicant has, after having received the international search report and the written opinion of the International Searching Authority, one opportunity to amend the claims of the international application. It should however be emphasized that, since all parts of the international application (claims, description and drawings) may be amended during the international preliminary examination procedure, there is usually no need to file amendments of the claims under Article 19 except where, e.g. the applicant wants the latter to be published for the purposes of provisional protection or has another reason for amending the claims before international publication. Furthermore, it should be emphasized that provisional protection is available in some States only (see *PCT Applicant's Guide*, Volume I/A, Annexes B1 and B2).

The attention of the applicant is drawn to the fact that amendments to the claims under Article 19 are not allowed where the International Searching Authority has declared, under Article 17(2), that no international search report would be established (see *PCT Applicant's Guide*, Volume I/A, paragraph 296).

What parts of the international application may be amended?

Under Article 19, only the claims may be amended.

During the international phase, the claims may also be amended (or further amended) under Article 34 before the International Preliminary Examining Authority. The description and drawings may only be amended under Article 34 before the International Examining Authority.

Upon entry into the national phase, all parts of the international application may be amended under Article 28 or, where applicable, Article 41.

When?

Within 2 months from the date of transmittal of the international search report or 16 months from the priority date, whichever time limit expires later. It should be noted, however, that the amendments will be considered as having been received on time if they are received by the International Bureau after the expiration of the applicable time limit but before the completion of the technical preparations for international publication (Rule 46.1).

Where not to file the amendments?

The amendments may only be filed with the International Bureau and not with the receiving Office or the International Searching Authority (Rule 46.2).

Where a demand for international preliminary examination has been/is filed, see below.

How?

Either by cancelling one or more entire claims, by adding one or more new claims or by amending the text of one or more of the claims as filed.

A replacement sheet must be submitted for each sheet of the claims which, on account of an amendment or amendments, differs from the sheet originally filed.

All the claims appearing on a replacement sheet must be numbered in Arabic numerals. Where a claim is cancelled, no renumbering of the other claims is required. In all cases where claims are renumbered, they must be renumbered consecutively (Section 205(b)).

The amendments must be made in the language in which the international application is to be published.

What documents must/may accompany the amendments?

Letter (Section 205(b)):

The amendments must be submitted with a letter.

The letter will not be published with the international application and the amended claims. It should not be confused with the "Statement under Article 19(1)" (see below, under "Statement under Article 19(1)").

The letter must be in English or French, at the choice of the applicant. However, if the language of the international application is English, the letter must be in English; if the language of the international application is French, the letter must be in French.

NOTES TO FORM PCT/ISA/220 (continued)

The letter must indicate the differences between the claims as filed and the claims as amended. It must, in particular, indicate, in connection with each claim appearing in the international application (it being understood that identical indications concerning several claims may be grouped), whether

- (i) the claim is unchanged;
- (ii) the claim is cancelled;
- (iii) the claim is new;
- (iv) the claim replaces one or more claims as filed;
- (v) the claim is the result of the division of a claim as filed.

The following examples illustrate the manner in which amendments must be explained in the accompanying letter:

1. [Where originally there were 48 claims and after amendment of some claims there are 51]:
"Claims 1 to 29, 31, 32, 34, 35, 37 to 48 replaced by amended claims bearing the same numbers; claims 30, 33 and 36 unchanged; new claims 49 to 51 added."
2. [Where originally there were 15 claims and after amendment of all claims there are 11]:
"Claims 1 to 15 replaced by amended claims 1 to 11."
3. [Where originally there were 14 claims and the amendments consist in cancelling some claims and in adding new claims]:
"Claims 1 to 6 and 14 unchanged; claims 7 to 13 cancelled; new claims 15, 16 and 17 added." or
"Claims 7 to 13 cancelled; new claims 15, 16 and 17 added; all other claims unchanged."
4. [Where various kinds of amendments are made]:
"Claims 1-10 unchanged; claims 11 to 13, 18 and 19 cancelled; claims 14, 15 and 16 replaced by amended claim 14; claim 17 subdivided into amended claims 15, 16 and 17; new claims 20 and 21 added."

"Statement under article 19(1)" (Rule 46.4)

The amendments may be accompanied by a statement explaining the amendments and indicating any impact that such amendments might have on the description and the drawings (which cannot be amended under Article 19(1)).

The statement will be published with the international application and the amended claims.

It must be in the language in which the international application is to be published.

It must be brief, not exceeding 500 words if in English or if translated into English.

It should not be confused with and does not replace the letter indicating the differences between the claims as filed and as amended. It must be filed on a separate sheet and must be identified as such by a heading, preferably by using the words "Statement under Article 19(1)."

It may not contain any disparaging comments on the international search report or the relevance of citations contained in that report. Reference to citations, relevant to a given claim, contained in the international search report may be made only in connection with an amendment of that claim.

Consequence if a demand for international preliminary examination has already been filed

If, at the time of filing any amendments and any accompanying statement, under Article 19, a demand for international preliminary examination has already been submitted, the applicant must preferably, at the time of filing the amendments (and any statement) with the International Bureau, also file with the International Preliminary Examining Authority a copy of such amendments (and of any statement) and, where required, a translation of such amendments for the procedure before that Authority (see Rules 55.3(a) and 62.2, first sentence). For further information, see the Notes to the demand form (PCT/IPEA/401).

If a demand for international preliminary examination is made, the written opinion of the International Searching Authority will, except in certain cases where the International Preliminary Examining Authority did not act as International Searching Authority and where it has notified the International Bureau under Rule 66.1*bis*(b), be considered to be a written opinion of the International Preliminary Examining Authority. If a demand is made, the applicant may submit to the International Preliminary Examining Authority a reply to the written opinion together, where appropriate, with amendments before the expiration of 3 months from the date of mailing of Form PCT/ISA/220 or before the expiration of 22 months from the priority date, whichever expires later (Rule 43*bis*.1(c)).

Consequence with regard to translation of the international application for entry into the national phase

The applicant's attention is drawn to the fact that, upon entry into the national phase, a translation of the claims as amended under Article 19 may have to be furnished to the designated/elected Offices, instead of, or in addition to, the translation of the claims as filed.

For further details on the requirements of each designated/elected Office, see the *PCT Applicant's Guide*, Volume II.

PATENT COOPERATION TREATY

PCT

INTERNATIONAL SEARCH REPORT

(PCT Article 18 and Rules 43 and 44)

Applicant's or agent's file reference 411.39.99870	FOR FURTHER ACTION see Form PCT/ISA/220 as well as, where applicable, item 5 below.	
International application No. PCT/GB2008/002934	International filing date (day/month/year) 29/08/2008	(Earliest) Priority Date (day/month/year) 29/08/2007
Applicant AKER BIOMARINE ASA		

This international search report has been prepared by this International Searching Authority and is transmitted to the applicant according to Article 18. A copy is being transmitted to the International Bureau.

This international search report consists of a total of 8 sheets.

It is also accompanied by a copy of each prior art document cited in this report.

1. Basis of the report

a. With regard to the **language**, the international search was carried out on the basis of:

- the international application in the language in which it was filed
- a translation of the international application into _____, which is the language of a translation furnished for the purposes of international search (Rules 12.3(a) and 23.1(b))

b. This international search report has been established taking into account the **rectification of an obvious mistake** authorized by or notified to this Authority under Rule 91 (Rule 43.6bis(a)).

c. With regard to any **nucleotide and/or amino acid sequence** disclosed in the international application, see Box No. I.

2. **Certain claims were found unsearchable** (See Box No. II)

3. **Unity of invention is lacking** (see Box No III)

4. With regard to the **title**,

- the text is approved as submitted by the applicant
- the text has been established by this Authority to read as follows:

5. With regard to the **abstract**,

- the text is approved as submitted by the applicant
- the text has been established, according to Rule 38.2(b), by this Authority as it appears in Box No. IV. The applicant may, within one month from the date of mailing of this international search report, submit comments to this Authority

6. With regard to the **drawings**,

- a. the figure of the **drawings** to be published with the abstract is Figure No. _____
 - as suggested by the applicant
 - as selected by this Authority, because the applicant failed to suggest a figure
 - as selected by this Authority, because this figure better characterizes the invention
- b. none of the figures is to be published with the abstract

A. CLASSIFICATION OF SUBJECT MATTER

INV. A23J1/04 A23K1/10 A23K1/18 A23L1/30 C11B1/10
 A23J7/00 C07F9/10 A61K35/60

According to International Patent Classification (IPC) or to both national classification and IPC

B. FIELDS SEARCHED

Minimum documentation searched (classification system followed by classification symbols)
 A23J A23K A23L C11B C07F A61K

Documentation searched other than minimum documentation to the extent that such documents are included in the fields searched

Electronic data base consulted during the international search (name of data base and, where practical, search terms used)

EPO-Internal, FSTA, WPI Data

C. DOCUMENTS CONSIDERED TO BE RELEVANT

Category*	Citation of document, with indication, where appropriate, of the relevant passages	Relevant to claim No.
X	DATABASE FSTA [Online] INTERNATIONAL FOOD INFORMATION SERVICE (IFIS), FRANKFURT-MAIN, DE; 1974, YANASE M: "Modification of a Russian method for separation of heat-coagulated protein from Antarctic krill." XP002501559 Database accession no. 76-1-11-r0645 abstract & BULLETIN OF THE TOKAI REGIONAL FISHERIES RESEARCH LABORATORY ((TOKAI-KU SUISAN KENKYUSHO KENKYU HOKOKU)), 1974,	1-15
A	WO 2007/080514 A (KRILL AS [DK]; ALFA LAVAL COPENHAGEN AS [DK]; LARSEN PETER MOSE [DK];) 19 July 2007 (2007-07-19) the whole document ----- -/--	1-15

Further documents are listed in the continuation of Box C.

See patent family annex.

* Special categories of cited documents:

- *A* document defining the general state of the art which is not considered to be of particular relevance
- *E* earlier document but published on or after the international filing date
- *L* document which may throw doubts on priority claim(s) or which is cited to establish the publication date of another citation or other special reason (as specified)
- *O* document referring to an oral disclosure, use, exhibition or other means
- *P* document published prior to the international filing date but later than the priority date claimed

- *T* later document published after the international filing date or priority date and not in conflict with the application but cited to understand the principle or theory underlying the invention
- *X* document of particular relevance; the claimed invention cannot be considered novel or cannot be considered to involve an inventive step when the document is taken alone
- *Y* document of particular relevance; the claimed invention cannot be considered to involve an inventive step when the document is combined with one or more other such documents, such combination being obvious to a person skilled in the art.
- *G* document member of the same patent family

Date of the actual completion of the international search

11 March 2009

Date of mailing of the international search report

26/03/2009

Name and mailing address of the ISA/

European Patent Office, P.B. 5818 Patentlaan 2
 NL - 2280 HV Rijswijk
 Tel. (+31-70) 340-2040,
 Fax: (+31-70) 340-3016

Authorized officer

RIMROST EXHIBIT 1024 page 2813

C(Continuation). DOCUMENTS CONSIDERED TO BE RELEVANT

Category*	Citation of document, with indication, where appropriate, of the relevant passages	Relevant to claim No.
A	JP 02 215351 A (TAIYO FISHERY CO LTD) 28 August 1990 (1990-08-28) abstract	1-15
X	----- US 2004/241249 A1 (SAMPALIS TINA [CA]) 2 December 2004 (2004-12-02) page 2, paragraph 25 - paragraph 84; examples page 1, paragraph 18 - paragraph 24	21-27, 48-51
X	----- TOU JANET C ET AL: "Krill for human consumption: nutritional value and potential health benefits." NUTRITION REVIEWS FEB 2007, vol. 65, no. 2, February 2007 (2007-02), pages 63-77, XP002518830 ISSN: 0029-6643 the whole document	21-27, 48-51
X	----- WO 86/06082 A (MATCON RADGIVENDE ING FIRMA [DK]) 23 October 1986 (1986-10-23) page 9, line 31 - line 36; example	21-27, 50,51

INTERNATIONAL SEARCH REPORT

International application No.
PCT/GB2008/002934

Box No. II Observations where certain claims were found unsearchable (Continuation of item 2 of first sheet)

This international search report has not been established in respect of certain claims under Article 17(2)(a) for the following reasons:

1. Claims Nos.:
because they relate to subject matter not required to be searched by this Authority, namely:

2. Claims Nos.:
because they relate to parts of the international application that do not comply with the prescribed requirements to such an extent that no meaningful international search can be carried out, specifically:

3. Claims Nos.:
because they are dependent claims and are not drafted in accordance with the second and third sentences of Rule 6.4(a).

Box No. III Observations where unity of invention is lacking (Continuation of item 3 of first sheet)

This International Searching Authority found multiple inventions in this international application, as follows:

see additional sheet

1. As all required additional search fees were timely paid by the applicant, this international search report covers all searchable claims.
2. As all searchable claims could be searched without effort justifying an additional fees, this Authority did not invite payment of additional fees.
3. As only some of the required additional search fees were timely paid by the applicant, this international search report covers only those claims for which fees were paid, specifically claims Nos.:
1-15, 21-27, 48-51(partly)
4. No required additional search fees were timely paid by the applicant. Consequently, this international search report is restricted to the invention first mentioned in the claims; it is covered by claims Nos.:

Remark on Protest

- The additional search fees were accompanied by the applicant's protest and, where applicable, the payment of a protest fee.
- The additional search fees were accompanied by the applicant's protest but the applicable protest fee was not paid within the time limit specified in the invitation.
- No protest accompanied the payment of additional search fees.

FURTHER INFORMATION CONTINUED FROM PCT/ISA/ 210

This International Searching Authority found multiple (groups of) inventions in this international application, as follows:

1. claims: 1-15

A process for preparing phospholipid compositions from biological material comprising phospholipids and proteins comprising:
mixing said biological material with water to increase the temperature of said biological material to about 25 to 80 deg. C to form a first solid phase and a first aqueous phase comprising said phospholipids and proteins;
separating said first solid phase from said first aqueous phase; and
separating a protein and phospholipid fraction from said first aqueous phase.

2. claim: 16

An aqueous phase composition obtainable by the process of 1.

3. claims: 17, 48-51(partly)

A coagulate meal obtainable by the process of claim 9.

4. claims: 18, 48-51(partly)

A coagulate oil obtainable by the process of claim 10.

5. claims: 19, 48-51(partly)

A retentate concentrate obtainable by the process of claim 13.

6. claims: 20, 48-51(partly)

A retentate oil obtainable by the process of claim 14.

7. claims: 21-27, 48-51(partly)

A krill composition comprising from about 0.01 to about 200 mg/kg astaxanthin, from about 45% to about 65% fat w/w, and about 20% to 50% protein w/w, wherein said fat comprises omega-3 fatty acid residues.

8. claims: 28, 48-51(partly)

FURTHER INFORMATION CONTINUED FROM PCT/ISA/ 210

A krill composition comprising from about 10% to about 20% protein w/w, about 15% to about 30% fat w/w, and from about 0.01 mg/kg to about 200 mg/kg astaxanthin.

9. claims: 29-31, 48-51(partly)

A krill meal comprising from about 65% to about 75% protein w/w (dry matter) , from about 10% to about 25% fat w/w (dry matter), and from about 1 to about 200 mg/kg astaxanthin (wet base).

10. claims: 32, 48-51(partly)

A krill oil composition comprising greater than about 1500 mg/kg total esterified astaxanthin, wherein said esterified astaxanthin comprises from about 25 to 35% astaxanthin monoester on a w/w basis and from about 50 to 70% astaxanthin diester on a w/w basis, and greater than about 20 mg/kg free astaxanthin.

11. claims: 33, 48-51(partly)

A krill composition comprising from about 3% to about 10% protein w/w, about 8% to about 20% dry matter w/w, and about 4% to about 10% fat w/w.

12. claims: 34, 48-51(partly)

A krill coagulum meal comprising, 50-75% fat w/w, 30-50% protein w/w, and 1 to 200 mg/kg astaxanthin, wherein said fat comprises 15 to 30 g/100 g fat omega-3 fatty acid residues and 35 to 60g /100 g fat phosphatidylcholine.

13. claims: 35-40

A system for processing of marine biomass comprising: a mixer for mixing marine biomass and water to form a mixture having a defined temperature, wherein said mixture has a first solid phase and a first liquid phase.

14. claim: 41

A krill composition 50-75% fat w/w, .30-50% protein w/w, and 1 to 200 mg/kg astaxanthin, wherein said fat comprises 15 to 30 g/100 g fat omega-3 fatty acid residues and 35 to 60g /100 g fat phosphatidylcholine, and less than about 1 mg/100g trimethyl amine, volatile nitrogen, or 1g/100g lysophosphatidylcholine or combination thereof.

FURTHER INFORMATION CONTINUED FROM PCT/ISA/ 210

15. claims: 42-44

A process for processing of marine biomass comprising:
providing a marine biomass and a mixer for mixing marine
biomass and water to form a mixture having a defined
temperature, wherein said mixture comprises a first solid
phase and a first liquid phase.

16. claims: 45-47

A system for processing of marine biomass comprising:
a ship;
a trawl net towable from said ship, wherein said trawl net
is configured to catch a marine biomass;
a mixer for mixing said marine biomass and water to form a
mixture having a defined temperature, wherein said mixture
has a first solid phase and a first liquid phase.

Patent document cited in search report		Publication date		Patent family member(s)	Publication date
WO 2007080514	A	19-07-2007	AR	059659 A1	23-04-2008
JP 2215351	A	28-08-1990	JP	2909508 B2	23-06-1999
US 2004241249	A1	02-12-2004	US	2007098808 A1	03-05-2007
WO 8606082	A	23-10-1986	AR	242592 A1	30-04-1993
			AU	5694686 A	05-11-1986
			DK	166285 A	13-10-1986
			EP	0217887 A1	15-04-1987
			ES	8706170 A1	16-08-1987
			IN	165452 A1	21-10-1989
			IS	3090 A7	13-10-1986
			NO	865015 A	11-12-1986
			PT	82378 A	01-05-1986

From the
INTERNATIONAL SEARCHING AUTHORITY

PCT

To:

see form PCT/ISA/220

WRITTEN OPINION OF THE
INTERNATIONAL SEARCHING AUTHORITY
(PCT Rule 43bis.1)

Date of mailing
(day/month/year) see form PCT/ISA/210 (second sheet)

Applicant's or agent's file reference
see form PCT/ISA/220

FOR FURTHER ACTION
See paragraph 2 below

International application No. PCT/GB2008/002934	International filing date (day/month/year) 29.08.2008	Priority date (day/month/year) 29.08.2007
--	--	--

International Patent Classification (IPC) or both national classification and IPC
INV. A23J1/04 A23K1/10 A23K1/18 A23L1/30 C11B1/10 A23J7/00 C07F9/10 A61K35/60

Applicant
AKER BIOMARINE ASA

1. This opinion contains indications relating to the following items:

- Box No. I Basis of the opinion
- Box No. II Priority
- Box No. III Non-establishment of opinion with regard to novelty, inventive step and industrial applicability
- Box No. IV Lack of unity of invention
- Box No. V Reasoned statement under Rule 43bis.1(a)(i) with regard to novelty, inventive step or industrial applicability; citations and explanations supporting such statement
- Box No. VI Certain documents cited
- Box No. VII Certain defects in the international application
- Box No. VIII Certain observations on the international application

2. FURTHER ACTION

If a demand for international preliminary examination is made, this opinion will usually be considered to be a written opinion of the International Preliminary Examining Authority ("IPEA") except that this does not apply where the applicant chooses an Authority other than this one to be the IPEA and the chosen IPEA has notified the International Bureau under Rule 66.1bis(b) that written opinions of this International Searching Authority will not be so considered.

If this opinion is, as provided above, considered to be a written opinion of the IPEA, the applicant is invited to submit to the IPEA a written reply together, where appropriate, with amendments, before the expiration of 3 months from the date of mailing of Form PCT/ISA/220 or before the expiration of 22 months from the priority date, whichever expires later.

For further options, see Form PCT/ISA/220.

3. For further details, see notes to Form PCT/ISA/220.

<p>Name and mailing address of the ISA:</p>  <p>European Patent Office D-80298 Munich Tel. +49 89 2399 - 0 Fax: +49 89 2399 - 4465</p>	<p>Date of completion of this opinion</p> <p>see form PCT/ISA/210</p>	<p>Authorized Officer</p> <p>Smeets, Dieter</p> <p>Telephone No. +49 89 2399-7492</p>
---	---	---

RIMFROST EXHIBIT 1024



Box No. I Basis of the opinion

1. With regard to the **language**, this opinion has been established on the basis of:
 - the international application in the language in which it was filed
 - a translation of the international application into , which is the language of a translation furnished for the purposes of international search (Rules 12.3(a) and 23.1 (b)).
2. This opinion has been established taking into account the **rectification of an obvious mistake** authorized by or notified to this Authority under Rule 91 (Rule 43bis.1(a))
3. With regard to any **nucleotide and/or amino acid sequence** disclosed in the international application and necessary to the claimed invention, this opinion has been established on the basis of:
 - a. type of material:
 - a sequence listing
 - table(s) related to the sequence listing
 - b. format of material:
 - on paper
 - in electronic form
 - c. time of filing/furnishing:
 - contained in the international application as filed.
 - filed together with the international application in electronic form.
 - furnished subsequently to this Authority for the purposes of search.
4. In addition, in the case that more than one version or copy of a sequence listing and/or table relating thereto has been filed or furnished, the required statements that the information in the subsequent or additional copies is identical to that in the application as filed or does not go beyond the application as filed, as appropriate, were furnished.
5. Additional comments:

Box No. III Non-establishment of opinion with regard to novelty, inventive step and industrial applicability

The questions whether the claimed invention appears to be novel, to involve an inventive step (to be non obvious), or to be industrially applicable have not been examined in respect of

- the entire international application
- claims Nos. 16-20, 28-47, 48-51(partly)

because:

- the said international application, or the said claims Nos. relate to the following subject matter which does not require an international search (*specify*):
- the description, claims or drawings (*indicate particular elements below*) or said claims Nos. are so unclear that no meaningful opinion could be formed (*specify*):
- the claims, or said claims Nos. are so inadequately supported by the description that no meaningful opinion could be formed (*specify*):
- no international search report has been established for the whole application or for said claims Nos. 16-20, 28-47, 48-51(partly)
- a meaningful opinion could not be formed without the sequence listing; the applicant did not, within the prescribed time limit:
 - furnish a sequence listing on paper complying with the standard provided for in Annex C of the Administrative Instructions, and such listing was not available to the International Searching Authority in a form and manner acceptable to it.
 - furnish a sequence listing in electronic form complying with the standard provided for in Annex C of the Administrative Instructions, and such listing was not available to the International Searching Authority in a form and manner acceptable to it.
 - pay the required late furnishing fee for the furnishing of a sequence listing in response to an invitation under Rules 13ter.1(a) or (b).
- a meaningful opinion could not be formed without the tables related to the sequence listings; the applicant did not, within the prescribed time limit, furnish such tables in electronic form complying with the technical requirements provided for in Annex C-bis of the Administrative Instructions, and such tables were not available to the International Searching Authority in a form and manner acceptable to it.
- the tables related to the nucleotide and/or amino acid sequence listing, if in electronic form only, do not comply with the technical requirements provided for in Annex C-bis of the Administrative Instructions.
- See Supplemental Box for further details

Box No. IV Lack of unity of invention

1. In response to the invitation (Form PCT/ISA/206) to pay additional fees, the applicant has, within the applicable time limit:
- paid additional fees
 - paid additional fees under protest and, where applicable, the protest fee
 - paid additional fees under protest but the applicable protest fee was not paid
 - not paid additional fees
2. This Authority found that the requirement of unity of invention is not complied with and chose not to invite the applicant to pay additional fees.
3. This Authority considers that the requirement of unity of invention in accordance with Rule 13.1, 13.2 and 13.3 is
- complied with
 - not complied with for the following reasons:
see separate sheet
4. Consequently, this report has been established in respect of the following parts of the international application:
- all parts.
 - the parts relating to claims Nos. 1-15, 21-27, 48-51(partly)

Box No. V Reasoned statement under Rule 43bis.1(a)(i) with regard to novelty, inventive step or industrial applicability; citations and explanations supporting such statement

1. Statement

Novelty (N)	Yes: Claims	<u>21-27</u>
	No: Claims	<u>1-15, 48-51</u>
Inventive step (IS)	Yes: Claims	
	No: Claims	<u>1-15, 21-27, 48-51</u>
Industrial applicability (IA)	Yes: Claims	<u>1-15, 21-27, 48-51</u>
	No: Claims	

2. Citations and explanations

see separate sheet

Re Item IV.

The separate inventions are:

Claims 1-15

A process for preparing phospholipid compositions from biological material comprising phospholipids and proteins comprising:

mixing said biological material with water to increase the temperature of said biological material to about 25 to 80 °C to form a first solid phase and a first aqueous phase comprising said phospholipids and proteins;

separating said first solid phase from said first aqueous phase; and

separating a protein and phospholipid fraction from said first aqueous phase.

Claim 16

An aqueous phase composition obtainable by the process of 1.

Claims 17, 48-51 (partly)

A coagulate meal obtainable by the process of claim 9.

Claim 18, 48-51 (partly)

A coagulate oil obtainable by the process of claim 10.

Claims 19, 48-51 (partly)

A retentate concentrate obtainable by the process of claim 13.

Claims 20, 48-51 (partly)

A retentate oil obtainable by the process of claim 14.

Claims 21-27, 48-51 (partly)

A krill composition comprising from about 0.01 to about 200 mg/kg astaxanthin, from about 45% to about 65% fat w/w, and about 20% to 50% protein w/w, wherein said fat comprises omega-3 fatty acid residues.

Claims 28, 48-51 (partly)

A krill composition comprising from about 10% to about 20% protein w/w, about 15% to about 30% fat w/w, and from about 0.01 mg/kg to about 200 mg/kg astaxanthin.

Claims 29-31, 48-51 (partly)

A krill meal comprising from about 65% to about 75% protein w/w (dry matter), from about 10% to about 25% fat w/w (dry matter), and from about 1 to about 200 mg/kg astaxanthin (wet base).

Claims 32, 48-51 (partly)

A krill oil composition comprising greater than about 1500 mg/kg total esterified astaxanthin, wherein said esterified astaxanthin comprises from about 25 to 35%

astaxanthin monoester on a w/w basis and from about 50 to 70% astaxanthin diester on a w/w basis, and greater than about 20 mg/kg free astaxanthin.

Claims 33, 48-51 (partly)

A krill composition comprising from about 3% to about 10% protein w/w, about 8% to about 20% dry matter w/w, and about 4% to about 10% fat w/w.

Claims 34, 48-51 (partly)

A krill coagulum meal comprising, 50-75% fat w/w, 30-50% protein w/w, and 1 to 200 mg/kg astaxanthin, wherein said fat comprises 15 to 30 g/100 g fat omega-3 fatty acid residues and 35 to 60g /100 g fat phosphatidylcholine.

Claims 35-40

A system for processing of marine biomass comprising:
a mixer for mixing marine biomass and water to form a mixture having a defined temperature, wherein said mixture has a first solid phase and a first liquid phase.

Claim 41

A krill composition 50-75% fat w/w, 30-50% protein w/w, and 1 to 200 mg/kg astaxanthin, wherein said fat comprises 15 to 30 g/100 g fat omega-3 fatty acid residues and 35 to 60g /100 g fat phosphatidylcholine, and less than about 1 mg/100g trimethyl amine, volatile nitrogen, or 1g/100g lysophosphatidylcholine or combinations thereof.

Claims 42-44

A process for processing of marine biomass comprising:
providing a marine biomass and a mixer for mixing marine biomass and water to form a mixture having a defined temperature, wherein said mixture comprises a first solid phase and a first liquid phase.

Claims 45-47

A system for processing of marine biomass comprising:
a ship;
a trawl net towable from said ship, wherein said trawl net is configured to catch a marine biomass;
a mixer for mixing said marine biomass and water to form a mixture having a defined temperature, wherein said mixture has a first solid phase and a first liquid phase.

They are not so linked as to form a single general inventive concept (Rule 13.1 PCT) for the following reasons:

The only common feature linking independent claims 1, 16-21, 28, 29, 32, 33, 34, 35, 41, 42, 45, 48-51 is "biological material". This feature is not new, see, e.g. WO2007080514.

Consequently, the groups of claims as defined above are not linked by common or corresponding special technical features and define 16 different inventions not linked by a single general inventive concept.

The application, hence does not meet the requirements of unity of invention as defined in Rules 13.1 and 13.2 PCT.

Re Item V.

0 As only some of the required additional search fees were timely paid by the applicant, this written opinion covers only those claims for which fees were paid, namely

- i) Invention 1: claims 1-15
- ii) Invention 7: claims 21-27, 48-51 (partly)

1 Reference is made to the following documents:

- D1: DATABASE FSTA [Online] INTERNATIONAL FOOD INFORMATION SERVICE (IFIS), FRANKFURT-MAIN, DE; 1974, YANASE M: "Modification of a Russian method for separation of heat-coagulated protein from Antarctic krill." XP002501559 Database accession no. 76-1-11-r0645
- D2: WO 2007/080514 A (KRILL AS [DK]; ALFA LAVAL COPENHAGEN AS [DK]; LARSEN PETER MOSE [DK];) 19 July 2007 (2007-07-19)
- D3: JP 02 215351 A (TAIYO FISHERY CO LTD) 28 August 1990 (1990-08-28)
- D4: US 2004/241249 A1 (SAMPALIS TINA [CA]) 2 December 2004 (2004-12-02)
- D5: TOU JANET C ET AL: "Krill for human consumption: nutritional value and potential health benefits." NUTRITION REVIEWS FEB 2007, vol. 65, no. 2, February 2007 (2007-02), pages 63-77, XP002518830 ISSN: 0029-6643
- D6: WO 86/06082 A (MATCON RADGIVENDE ING FIRMA [DK]) 23 October 1986 (1986-10-23)

2 Invention 1: Claims 1-15

2.1 Novelty (Art. 33(1) and (2) PCT)

First, the following important objections with respect to the clarity (Art. 6 PCT) of the claims are made:

The terms "phospholipid composition" and "protein and phospholipid fraction" used in claim 1 are unclear as it left open how much phospholipid a composition should contain to be considered as a "phospholipid composition".

The description of the present application only provides support for krill as the biological material. A generalisation of the method to any biological material as in claim 1 is therefore not allowable.

It is also clear from the examples that the formation of the coagulate is essential to the definition of the invention. Since independent claim 1 does not contain this feature it does not meet the requirement following from Article 6 PCT taken in combination with Rule 6.3(b) PCT that any independent claim must contain all the technical features essential to the definition of the invention.

Anyway, even if the subject-matter of dependent claims 2 and 5 was incorporated into claim 1 in order to overcome the objection with respect to Art. 6 PCT, D1 would anticipate the subject-matter of this claim.

Document D1 discloses a process for preparing a coagulate comprising the following steps:

- i) mixing frozen krill with water at 45 °C to form a first solid phase and a first aqueous phase;
- ii) separating said first solid phase from said first liquid phase;
- iii) heating the liquid fraction to 95 °C to coagulate the protein
- iv) separating the coagulate from the aqueous phase.

It is pointed out that the obtained coagulate *implicitly* comprises protein and phospholipids as the process steps of claim 1 of the present application are identical to the process steps described in D1.

Thus, D1 is novelty destroying for the subject-matter of claims 1,2,4,5 and 6.

2.2 Inventive Step (Art. 33(1) and (3) PCT)

The question whether the application involves an inventive step is only of

relevance once novelty of the independent claim has been established and the requirements of Art. 6 PCT are met.

However, the subject-matter of the other dependent claims, insofar as not directly disclosed in D1, appears to relate to constructional features, obvious for the skilled person.

3 Invention 2: claims 21-27, 48-51(partly)

3.1 Novelty (Art. 33(1) and (2) PCT

The expression "krill composition" in claim 21 is interpreted as requiring at least 1 of the ingredients of the composition originating from krill.

Formal novelty of independent claim 21 is acknowledged as none of the available prior art discloses a composition according to independent claim 21 on file.

Claims 22-27 are dependent on claim 21 and as such also meet the requirements of the PCT with respect to novelty and inventive step.

Claims 48-51 refer to compositions (pharmaceuticals, supplements, feeds, foods) *comprising* the composition according to claim 21. This means that the actual concentration of astaxanthin, fat, protein and omega-3 fatty acid residues in the compositions according to claims 48-51 is not defined. Indeed, the concentration of (some of) these ingredients in the compositions according to these claims can increase with respect to the composition of claim 21 (if further sources of fat, protein and/or astaxanthin are added) or decrease with respect to the composition of claim 21 (if no further sources of fat, protein and/or astaxanthin are added).

In other words, the essential features of claims 48-51 are:

a composition suitable as a pharmaceutical, supplement, food or feed comprising a fat with omega-3 fatty acid residues, protein and astaxanthin, wherein at least a part of at least one of the ingredients is derived from krill.

Thus, D4 is considered to anticipate the subject-matter of claims 48-51 as it discloses a krill extract comprising krill oil, astaxanthin, and protein. As can be seen from said document, krill oil comprises high amounts of omega-3 fatty acid residues. The composition can also comprise a pharmaceutical carrier and is suitable as a pharmaceutical, supplement, food and feed.

D5 relates to the health benefits of krill and discloses that krill is a good source of

omega-3 fatty acids, high quality protein and astaxanthin. This document therefore also anticipates the subject-matter of claims 48-51.

D6 is of relevance for the subject-matter of claims 50 and 51 as it suggests using krill oil comprising high amounts of astaxanthin for the preparation of fodder for salmon. Salmon feed implicitly comprises protein.

3.2 Inventive Step (Art. 33(1) and (3) PCT)

The subject-matter of claims 21-27 is not considered to involve an inventive step for the following reasons:

Krill is known to be a good source of oil rich in omega-3 fatty acids, astaxanthin, protein, phospholipids etc. (see, e.g. D4 and D5).

The subject-matter of claim 21 differs from these documents in that a particular combination of ranges of concentrations of fat, protein and astaxanthin is specified.

However, this particular combination does not solve any technical problem. The description of the present application does not disclose a surprising effect related to this composition.

Therefore, the subject-matter of independent claim 21 cannot be considered as involving an inventive step.

The same reasoning applies for dependent claims 22-27.

Possible steps after receipt of the international search report (ISR) and written opinion of the International Searching Authority (WO-ISA)

General information

For all international applications filed on or after 01/01/2004 the competent ISA will establish an ISR. It is accompanied by the WO-ISA. Unlike the former written opinion of the IPEA (Rule 66.2 PCT), the WO-ISA is not meant to be responded to, but to be taken into consideration for further procedural steps. This document explains about the possibilities.

Amending claims under Art. 19 PCT

Within 2 months after the date of mailing of the ISR and the WO-ISA the applicant may file amended claims under Art. 19 PCT directly with the International Bureau of WIPO. The PCT reform of 2004 did not change this procedure. For further information please see Rule 46 PCT as well as form PCT/ISA/220 and the corresponding Notes to form PCT/ISA/220.

Filing a demand for international preliminary examination

In principle, the WO-ISA will be considered as the written opinion of the IPEA. This should, in many cases, make it unnecessary to file a demand for international preliminary examination. If the applicant nevertheless wishes to file a demand this must be done before expiry of 3 months after the date of mailing of the ISR/ WO-ISA or 22 months after priority date, whichever expires later (Rule 54bis PCT). Amendments under Art. 34 PCT can be filed with the IPEA as before, normally at the same time as filing the demand (Rule 66.1 (b) PCT).

If a demand for international preliminary examination is filed and no comments/amendments have been received the WO-ISA will be transformed by the IPEA into an IPRP (International Preliminary Report on Patentability) which would merely reflect the content of the WO-ISA. The demand can still be withdrawn (Art. 37 PCT).

Filing informal comments

After receipt of the ISR/WO-ISA the applicant may file informal comments on the WO-ISA directly with the International Bureau of WIPO. These will be communicated to the designated Offices together with the IPRP (International Preliminary Report on Patentability) at 30 months from the priority date. Please also refer to the next box.

End of the international phase

At the end of the international phase the International Bureau of WIPO will transform the WO-ISA or, if a demand was filed, the written opinion of the IPEA into the IPRP, which will then be transmitted together with possible informal comments to the designated Offices. The IPRP replaces the former IPER (international preliminary examination report).

Relevant PCT Rules and more information

Rule 43 PCT, Rule 43bis PCT, Rule 44 PCT, Rule 44bis PCT, PCT Newsletter 12/2003, OJ 11/2003, OJ 12/2003

Bitte beachten Sie, dass angeführte Nichtpatentliteratur (wie z. B. wissenschaftliche oder technische Dokumente) je nach geltendem Recht dem Urheberrechtsschutz und/oder anderen Schutzarten für schriftliche Werke unterliegen könnte. Die Vervielfältigung urheberrechtlich geschützter Texte, ihre Verwendung in anderen elektronischen oder gedruckten Publikationen und ihre Weitergabe an Dritte ist ohne ausdrückliche Zustimmung des Rechtsinhabers nicht gestattet.

Veillez noter que les ouvrages de la littérature non-brevets qui sont cités, par exemple les documents scientifiques ou techniques, etc., peuvent être protégés par des droits d'auteur et/ou toute autre protection des écrits prévue par les législations applicables. Les textes ainsi protégés ne peuvent être reproduits ni utilisés dans d'autres publications électroniques ou imprimées, ni rediffusés sans l'autorisation expresse du titulaire du droit d'auteur.

Please be aware that cited works of non-patent literature such as scientific or technical documents or the like may be subject to copyright protection and/or any other protection of written works as appropriate based on applicable laws. Copyrighted texts may not be copied or used in other electronic or printed publications or re-distributed without the express permission of the copyright holder.

Attachments can contain viruses that may harm your computer. Attachments may not display correctly.

Docketing Email Account

From: Sara Kidd [skidd@frankbdehn.com] **Sent:** Tue 4/7/2009 8:49 AM
To: Docketing Email Account
Cc: J. Mitchell Jones
Subject: Your Ref: NATNUT-30102 FBD Ref: 439.99870 International (PCT) Patent Application No. PCT/GB2008/002934 (WO2009/027692)
Attachments: 99870 2009-04-06 - Letter to Casimir Jones enc ISR.doc(857KB) ISR & WO_001.pdf(1MB) XP-002501559_001.pdf(37KB) 02215351_001.pdf(51KB) XP-002518830_001.pdf(1MB) WO 2007_080514_001.pdf(1MB) JP 2-215351_001.pdf(333KB) US 2004_0241249_001.pdf(829KB) WO 86_06082_001.pdf(1002KB) PCT-IB-308.pdf(85KB)

Dear Sirs

International (PCT) Patent Application No. PCT/GB2008/002934 (WO2009/027692)
Aker BioMarine ASA
A new method for making krill meal

Please see the attachments.

Yours faithfully
 Frank B Dehn & Co

Sara Kidd

<<99870 2009-04-06 - Letter to Casimir Jones enc ISR.doc>> <<ISR & WO_001.pdf>> <<XP-002501559_001.pdf>> <<02215351_001.pdf>> <<XP-002518830_001.pdf>> <<WO 2007_080514_001.pdf>> <<JP 2-215351_001.pdf>> <<US 2004_0241249_001.pdf>> <<WO 86_06082_001.pdf>> <<PCT-IB-308.pdf>>

Telephone +44 (0)20 7632 7200 Facsimile +44 (0)20 7353 8895

Frank B. Dehn & Co.
 St. Bride's House
 10 Salisbury Square
 London
 EC4Y 8JD
 UK

This e-mail and any attachments may contain confidential and privileged information. If you are not the intended recipient, please notify the sender immediately by return e-mail, delete this e-mail and destroy any copies. Any dissemination or use of this information by a person other than the intended recipient is unauthorized and may be illegal.

PATENT COOPERATION TREATY

PCT

From the INTERNATIONAL SEARCHING AUTHORITY

To: FRANK B. DEHN & CO. Attn: Golding, Louise St. Bride's House 10 Salisbury Square London EC4Y 8JD GRANDE BRETAGNE		INVITATION TO PAY ADDITIONAL FEES AND WHERE APPLICABLE, PROTEST FEE (PCT Article 17(3)(a) and Rule 40.1 and 40.2(e))	
Applicant's or agent's file reference 411.39.99870		PAYMENT DUE within ONE MONTH from the above date of mailing	
International application No. PCT/GB2008/002934		International filing date (day/month/year) 29/08/2008	
Applicant AKER BIOMARINE ASA			

408 99870
 File _____
 26 JAN 2009
 Frank B. Dehn & Co.
 RECEIVED
 ANSD (day/month/year)
 22/01/2009

- This International Searching Authority
 - considers that there are 16 (number of) inventions claimed in the international application covered by the claims indicated on an extra sheet:
 - therefore considers that **the international application does not comply with the requirements of unity of invention** (Rules 13.1, 13.2 and 13.3) for the reasons indicated on an extra sheet:
 - has carried out a partial international search (see Annex) will establish the international search report on those parts of the international application which relate to the invention first mentioned in claims Nos.:
 see extra sheet
 - will establish the international search report on the other parts of the international application only if, and to the extent to which, additional fees are paid.
- Consequently, the applicant is hereby **invited to pay**, within the time limit indicated above, the amount indicated below:

EUR 1.700,00	x	15	=	EUR 25.500
Fee per additional invention		number of additional inventions		currency/total amount of additional fees
- The applicant is informed that, according to Rule 40.2(c), **the payment of any additional fee may be made under protest**, i.e., a reasoned statement to the effect that the international application complies with the requirement of unity of invention or that the amount of the required additional fee is excessive, where applicable, subject to the payment of a protest fee.
 Where the applicant pays additional fees under protest, the applicant is hereby invited, within the time limit indicated above, to pay a protest fee (Rule 40.2(e)) in the amount of EUR 750,00 (currency/amount)
 Where the applicant has not, within the time limit indicated above, paid the required protest fee, the protest will be considered not to have been made and the International Searching Authority will so declare.
- Claim(s) Nos. _____ have been found to be unsearchable under Article 17(2)(b) because of defects under Article 17(2)(a) and therefore have not been included with any invention.

Name and mailing address of the International Searching Authority  European Patent Office, P.B. 5818 Patentlaan 2 NL-2280 HV Rijswijk Tel. (+31-70) 340-2040, Tx. 31 651 epo nl, Fax: (+31-70) 340-3016	Authorized officer Carlos Novoa	DUE DATES NOTED 22/2/09
--	------------------------------------	-------------------------------

**Annex to Form PCT/ISA/206
COMMUNICATION RELATING TO THE RESULTS
OF THE PARTIAL INTERNATIONAL SEARCH**

International Application No
PCT/GB2008/002934

1. The present communication is an Annex to the invitation to pay additional fees (Form PCT/ISA/206). It shows the results of the international search established on the parts of the international application which relate to the invention first mentioned in claims Nos.:
- see 'Invitation to pay additional fees'
2. This communication is not the international search report which will be established according to Article 18 and Rule 43.
3. If the applicant does not pay any additional search fees, the information appearing in this communication will be considered as the result of the international search and will be included as such in the international search report.
4. If the applicant pays additional fees, the international search report will contain both the information appearing in this communication and the results of the international search on other parts of the international application for which such fees will have been paid.

C. DOCUMENTS CONSIDERED TO BE RELEVANT

Category °	Citation of document, with indication, where appropriate, of the relevant passages	Relevant to claim No.
X	<p>DATABASE FSTA [Online] INTERNATIONAL FOOD INFORMATION SERVICE (IFIS), FRANKFURT-MAIN, DE; 1974, YANASE M: "Modification of a Russian method for separation of heat-coagulated protein from Antarctic krill." XP002501559 Database accession no. 76-1-11-r0645 abstract & BULLETIN OF THE TOKAI REGIONAL FISHERIES RESEARCH LABORATORY ((TOKAI-KU SUISAN KENKYUSHO KENKYU HOKOKU)), 1974,</p>	1-15
A	<p>WO 2007/080514 A (KRILL AS [DK]; ALFA LAVAL COPENHAGEN AS [DK]; LARSEN PETER MOSE [DK];) 19 July 2007 (2007-07-19) the whole document</p>	1-15
A	<p>JP 02 215351 A (TAIYO FISHERY CO LTD) 28 August 1990 (1990-08-28) abstract</p>	1-15

Further documents are listed in the continuation of box C.

Patent family members are listed in annex.

° Special categories of cited documents:

- "A" document defining the general state of the art which is not considered to be of particular relevance
- "E" earlier document but published on or after the international filing date
- "L" document which may throw doubts on priority claim(s) or which is cited to establish the publication date of another citation or other special reason (as specified)
- "O" document referring to an oral disclosure, use, exhibition or other means
- "P" document published prior to the international filing date but later than the priority date claimed

- "T" later document published after the international filing date or priority date and not in conflict with the application but cited to understand the principle or theory underlying the invention
- "X" document of particular relevance; the claimed invention cannot be considered novel or cannot be considered to involve an inventive step when the document is taken alone
- "Y" document of particular relevance; the claimed invention cannot be considered to involve an inventive step when the document is combined with one or more other such documents, such combination being obvious to a person skilled in the art.
- "&" document member of the same patent family

This International Searching Authority found multiple (groups of) inventions in this international application, as follows:

1. claims: 1-15

A process for preparing phospholipid compositions from biological material comprising phospholipids and proteins comprising:
mixing said biological material with water to increase the temperature of said biological material to about 25 to 80 deg. C to form a first solid phase and a first aqueous phase comprising said phospholipids and proteins;
separating said first solid phase from said first aqueous phase; and
separating a protein and phospholipid fraction from said first aqueous phase.

2. claim: 16

An aqueous phase composition obtainable by the process of 1.

3. claims: 17, 48-51(partly)

A coagulate meal obtainable by the process of claim 9.

4. claims: 18, 48-51(partly)

A coagulate oil obtainable by the process of claim 10.

5. claims: 19, 48-51(partly)

A retentate concentrate obtainable by the process of claim 13.

6. claims: 20, 48-51(partly)

A retentate oil obtainable by the process of claim 14.

7. claims: 21-27, 48-51(partly)

A krill composition comprising from about 0.01 to about 200 mg/kg astaxanthin, from about 45% to about 65% fat w/w, and about 20% to 50% protein w/w, wherein said fat comprises omega-3 fatty acid residues.

8. claims: 28, 48-51(partly)

A krill composition comprising from about 10% to about 20% protein w/w, about 15% to about 30% fat w/w, and from about 0.01 mg/kg to about 200 mg/kg astaxanthin.

9. claims: 29-31, 48-51(partly)

A krill meal comprising from about 65% to about 75% protein w/w (dry matter), from about 10% to about 25% fat w/w (dry matter), and from about 1 to about 200 mg/kg astaxanthin (wet base).

10. claims: 32, 48-51(partly)

A krill oil composition comprising greater than about 1500 mg/kg total esterified astaxanthin, wherein said esterified astaxanthin comprises from about 25 to 35% astaxanthin monoester on a w/w basis and from about 50 to 70% astaxanthin diester on a w/w basis, and greater than about 20 mg/kg free astaxanthin.

11. claims: 33, 48-51(partly)

A krill composition comprising from about 3% to about 10% protein w/w, about 8% to about 20% dry matter w/w, and about 4% to about 10% fat w/w.

12. claims: 34, 48-51(partly)

A krill coagulum meal comprising, 50-75% fat w/w, 30-50% protein w/w, and 1 to 200 mg/kg astaxanthin, wherein said fat comprises 15 to 30 g/100 g fat omega-3 fatty acid residues and 35 to 60g /100 g fat phosphatidylcholine.

13. claims: 35-40

A system for processing of marine biomass comprising: a mixer for mixing marine biomass and water to form a mixture having a defined temperature, wherein said mixture has a first solid phase and a first liquid phase.

14. claim: 41

A krill composition 50-75% fat w/w, 30-50% protein w/w, and 1 to 200 mg/kg astaxanthin, wherein said fat comprises 15 to 30 g/100 g fat omega-3 fatty acid residues and 35 to 60g /100 g fat phosphatidylcholine, and less than about 1 mg/100g trimethyl amine, volatile nitrogen, or 1g/100g lysophosphatidylcholine or combinations thereof.

15. claims: 42-44

A process for processing of marine biomass comprising:
providing a marine biomass and a mixer for mixing marine
biomass and water to form a mixture having a defined
temperature, wherein said mixture comprises a first solid
phase and a first liquid phase.

16. claims: 45-47

A system for processing of marine biomass comprising:
a ship;
a trawl net towable from said ship, wherein said trawl net
is configured to catch a marine biomass;
a mixer for mixing said marine biomass and water to form a
mixture having a defined temperature, wherein said mixture
has a first solid phase and a first liquid phase.

The only common feature linking independent claims 1, 16-21, 28, 29, 32, 33, 34, 35, 41, 42, 45, 48-51 is "biological material". This feature is not new, see, e.g. W02007080514

Consequently, the inventions 1-16 as defined above are not linked by a single general inventive concept. Therefore, the requirement of unity of invention referred to in Rule 13.1 PCT is not fulfilled.

Patent Family Annex

Information on patent family members

International Application No

PCT/GB2008/002934

Patent document cited in search report	Publication date	Patent family member(s)	Publication date
WO 2007080514 A	19-07-2007	AR 059659 A1	23-04-2008
JP 2215351 A	28-08-1990	JP 2909508 B2	23-06-1999

Important Information

General:

- The **claims cannot be changed** at this point in the procedure, the transmitted report is **not** the international search report (see Art. 19 PCT).
- Any payment has to be made **directly** to this ISA, payments to other entities will not be accepted.
- In case of a **total of more than 2 inventions** found: when paying please **specify exactly** which claims should be searched (unless you pay for all inventions found)
- An **extension of the set time limit** cannot be granted.

Payment by cheque (not accepted as of 01/04/2008):

- The **date to be considered as the date on which the payment is made** is the **date of receipt of the cheque at the EPO**, provided that the cheque is **met**.
- Copies of cheques sent by fax or by mail are not considered to be a valid payment.
- The fees shall be paid in euro, no equivalents in other currencies.
- No payments by cheque shall be accepted as of 01/04/2008 (date of receipt at the EPO).

Payment or transfer to a bank account:

- The **date to be considered as the date on which the payment is made** is the date on which the amount of the payment or the transfer is **actually entered** in a bank account or Giro account held by the EPO.
- The fees shall be paid in euros, no equivalents in other currencies, all charges to be carried by the applicant
- For a list of accounts held by the EPO please see http://www.european-patent-office.org/epo/new/bank_euro.pdf

Payment by deposit account with the EPO:

- The **date to be considered as the date on which the payment is made** is the date that the **authorisation** to deduct fees from the deposit account is **received at the EPO**.

Note: If you don't have a deposit account with the EPO yourself you might want to consider using the account of an associate as a safe and quick way of paying.

Payments by credit card are not possible.

Payments under protest (one-step procedure under Rule 40 PCT as of 13/12/2007):

- For general information on the protest procedure at ISA/EP, please refer to the Special Edition No. 3 of the OJ of the EPO 2007, pages 140-145, http://www.european-patent-office.org/epo/pubs/oj007/08_07/special_edition_3_epc_2000_decisions.pdf
- Any protest will **only be accepted if**, within the time limit set in the invitation, the additional fees for each invention to be searched **and** the protest fee are paid.
- The protest has to be **accompanied by a technical reasoning**.

Bitte beachten Sie, dass angeführte Nichtpatentliteratur (wie z. B. wissenschaftliche oder technische Dokumente) je nach geltendem Recht dem Urheberrechtsschutz und/oder anderen Schutzarten für schriftliche Werke unterliegen könnte. Die Vervielfältigung urheberrechtlich geschützter Texte, ihre Verwendung in anderen elektronischen oder gedruckten Publikationen und ihre Weitergabe an Dritte ist ohne ausdrückliche Zustimmung des Rechtsinhabers nicht gestattet.

Veillez noter que les ouvrages de la littérature non-brevets qui sont cités, par exemple les documents scientifiques ou techniques, etc., peuvent être protégés par des droits d'auteur et/ou toute autre protection des écrits prévue par les législations applicables. Les textes ainsi protégés ne peuvent être reproduits ni utilisés dans d'autres publications électroniques ou imprimées, ni rediffusés sans l'autorisation expresse du titulaire du droit d'auteur.

Please be aware that cited works of non-patent literature such as scientific or technical documents or the like may be subject to copyright protection and/or any other protection of written works as appropriate based on applicable laws. Copyrighted texts may not be copied or used in other electronic or printed publications or re-distributed without the express permission of the copyright holder.

© FSTA / IFIS

- AN** - 76-1-11-r0645 FSTA
- TI** - Modification of a Russian method for separation of heat-coagulated protein from Antarctic krill
- AB** - A modified version of a Russian method for preparation of heat-coagulated krill protein is described. Frozen krill are autolysed with an equal vol. of water for 2 h at 45C, and pressed to separate the solid residue from the liquid. The liquid fraction is then heated at 95C for 15 min to coagulate the proteins, and centrifuged to separate the protein from the remaining extract. Yields of residue, protein fraction and extract were 10.4, 40.3 and 45% respectively; corresponding values for a non-autolysed sample were 70.3, 9.0 and 16.5% respectively. Data are given for DM, protein, fat and ash concn. and N distribution in the 3 fractions from krill samples autolysed for 0, 1, 2, 3, or 4 h. ((From En summ.))
- IW** - Proteins (unconventional); krill proteins, manufacture of heat coagulated
- Krill; manufacture of heat coagulated krill proteins
- Heating; krill proteins, manufacture of heat coagulated
- PUB** - Bulletin of the Tokai Regional Fisheries Research Laboratory ((Tokai-ku Suisan Kenkyusho Kenkyu Hokoku))
- 1974
- AU** - Yanase M
- IRN** - ISBN 84-00-04248-4
- DT** - J Journal
- TFT** - R - Fish & marine products

(19) World Intellectual Property Organization
International Bureau



(43) International Publication Date
19 July 2007 (19.07.2007)

PCT

(10) International Publication Number
WO 2007/080514 A2

- (51) International Patent Classification:
C11B 1/10 (2006.01) *C11B 3/00* (2006.01)
- (21) International Application Number:
PCT/IB2007/000098
- (22) International Filing Date: 15 January 2007 (15.01.2007)
- (25) Filing Language: English
- (26) Publication Language: English
- (30) Priority Data:
PA 2006 00057 13 January 2006 (13.01.2006) DK
60/758,956 13 January 2006 (13.01.2006) US
- (71) Applicants (for all designated States except US): **KRILL A/S** [DK/DK]; c/o Novi A/S, Bredgade 56, DK-1260 København K (DK). **ALFA LAVAL COPENHAGEN A/S** [DK/DK]; Oil and Protein Technology, Maskinvej 5, DK-2860 Søborg (DK).
- (72) Inventors; and
- (75) Inventors/Applicants (for US only): **LARSEN, Peter, Mose** [DK/DK]; Valmuearken 16, DK-5260 Odense S (DK). **FEY, Stephen, John** [GB/DK]; Middelfartvej 469, DK-5491 Blommenslyst (GB). **BREUNING, Jesper** [DK/DK]; Mikkeltorg Park 30, 2.tv, DK-2970 Hørsholm (DK). **LUDVIGSEN, Bent** [DK/DK]; Valmuehaven 53, DK-2765 Smørum (DK).
- (74) Agent: **BUDDE, SCHOU & OSTENFELD A/S**; Vester Søgade 10, DK-1601 Copenhagen V (DK).

- (81) Designated States (unless otherwise indicated, for every kind of national protection available): AE, AG, AL, AM, AT, AU, AZ, BA, BB, BG, BR, BW, BY, BZ, CA, CH, CN, CO, CR, CU, CZ, DE, DK, DM, DZ, EC, EE, EG, ES, FI, GB, GD, GE, GH, GM, GT, HN, HR, HU, ID, IL, IN, IS, JP, KE, KG, KM, KN, KP, KR, KZ, LA, LC, LK, LR, LS, LT, LU, LV, LY, MA, MD, MG, MK, MN, MW, MX, MY, MZ, NA, NG, NI, NO, NZ, OM, PG, PH, PL, PT, RO, RS, RU, SC, SD, SE, SG, SK, SL, SM, SV, SY, TJ, TM, TN, TR, TT, TZ, UA, UG, US, UZ, VC, VN, ZA, ZM, ZW.
- (84) Designated States (unless otherwise indicated, for every kind of regional protection available): ARIPO (BW, GH, GM, KE, LS, MW, MZ, NA, SD, SL, SZ, TZ, UG, ZM, ZW), Eurasian (AM, AZ, BY, KG, KZ, MD, RU, TJ, TM), European (AT, BE, BG, CH, CY, CZ, DE, DK, EE, ES, FI, FR, GB, GR, HU, IE, IS, IT, LT, LU, LV, MC, NL, PL, PT, RO, SE, SI, SK, TR), OAPI (BF, BJ, CF, CG, CI, CM, GA, GN, GQ, GW, ML, MR, NE, SN, TD, TG).

Declarations under Rule 4.17:

- as to applicant's entitlement to apply for and be granted a patent (Rule 4.17(ii))
- as to the applicant's entitlement to claim the priority of the earlier application (Rule 4.17(iii))

Published:

- without international search report and to be republished upon receipt of that report

[Continued on next page]

(54) Title: A METHOD FOR THE EXTRACTION OF LIPID FRACTIONS FROM KRILL

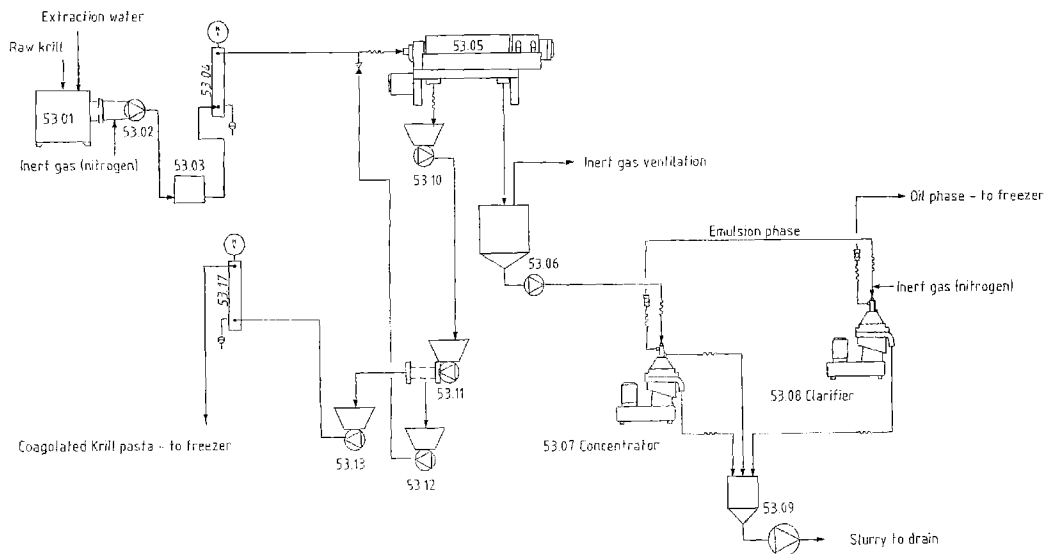

(57) Abstract: According to the present disclosure there is provided a method for extracting lipid fractions from krill, wherein freshly captured krill is ground to produce a slurry, which is gently heated to a temperature below 90°C for less than 45 minutes, whereafter the liquid into an aqueous phase and a krill oil phase from which a krill oil extract is derived without the use of organic solvents. Moreover there is also provided a pharmaceutical composition for the treatment of thrombosis in a patient comprising an effective amount of a krill oil extract.

WO 2007/080514 A2

(19) World Intellectual Property Organization
International Bureau



(43) International Publication Date
19 July 2007 (19.07.2007)

PCT

(10) International Publication Number
WO 2007/080514 A2

- (51) International Patent Classification:
C11B 1/10 (2006.01) C11B 3/00 (2006.01)
- (21) International Application Number:
PCT/IB2007/000098
- (22) International Filing Date: 15 January 2007 (15.01.2007)
- (25) Filing Language: English
- (26) Publication Language: English
- (30) Priority Data:
PA 2006 00057 13 January 2006 (13.01.2006) DK
60/758,956 13 January 2006 (13.01.2006) US
- (71) Applicants (for all designated States except US): KRILL A/S [DK/DK]; c/o Novi A/S, Bredgade 56, DK-1260 København K (DK). ALFA LAVAL COPENHAGEN A/S [DK/DK]; Oil and Protein Technology, Maskinvej 5, DK-2860 Søborg (DK).
- (72) Inventors; and
- (75) Inventors/Applicants (for US only): LARSEN, Peter, Mose [DK/DK]; Valmuearken 16, DK-5260 Odense S (DK). FEY, Stephen, John [GB/DK]; Middelfartvej 469, DK-5491 Blommenslyst (GB). BREUNING, Jesper [DK/DK]; Mikkelborg Park 30, 2.tv, DK-2970 Hørsholm (DK). LUDVIGSEN, Bent [DK/DK]; Valmuehaven 53, DK-2765 Smørum (DK).
- (74) Agent: BUDDE, SCHOU & OSTENFELD A/S; Vester Søgade 10, DK-1601 Copenhagen V (DK).

- (81) Designated States (unless otherwise indicated, for every kind of national protection available): AE, AG, AL, AM, AT, AU, AZ, BA, BB, BG, BR, BW, BY, BZ, CA, CH, CN, CO, CR, CU, CZ, DE, DK, DM, DZ, EC, EE, EG, ES, FI, GB, GD, GE, GH, GM, GT, HN, HR, HU, ID, IL, IN, IS, JP, KE, KG, KM, KN, KP, KR, KZ, LA, LC, LK, LR, LS, LT, LU, LV, LY, MA, MD, MG, MK, MN, MW, MX, MY, MZ, NA, NG, NI, NO, NZ, OM, PG, PH, PL, PT, RO, RS, RU, SC, SD, SE, SG, SK, SL, SM, SV, SY, TJ, TM, TN, TR, TT, TZ, UA, UG, US, UZ, VC, VN, ZA, ZM, ZW.
- (84) Designated States (unless otherwise indicated, for every kind of regional protection available): ARIPO (BW, GH, GM, KE, LS, MW, MZ, NA, SD, SL, SZ, TZ, UG, ZM, ZW), Eurasian (AM, AZ, BY, KG, KZ, MD, RU, TJ, TM), European (AT, BE, BG, CH, CY, CZ, DE, DK, EE, ES, FI, FR, GB, GR, HU, IE, IS, IT, LT, LU, LV, MC, NL, PL, PT, RO, SE, SI, SK, TR), OAPI (BF, BJ, CF, CG, CI, CM, GA, GN, GQ, GW, ML, MR, NE, SN, TD, TG).

Declarations under Rule 4.17:

- as to applicant's entitlement to apply for and be granted a patent (Rule 4.17(ii))
- as to the applicant's entitlement to claim the priority of the earlier application (Rule 4.17(iii))

Published:

- without international search report and to be republished upon receipt of that report

[Continued on next page]

(54) Title: A METHOD FOR THE EXTRACTION OF LIPID FRACTIONS FROM KRILL

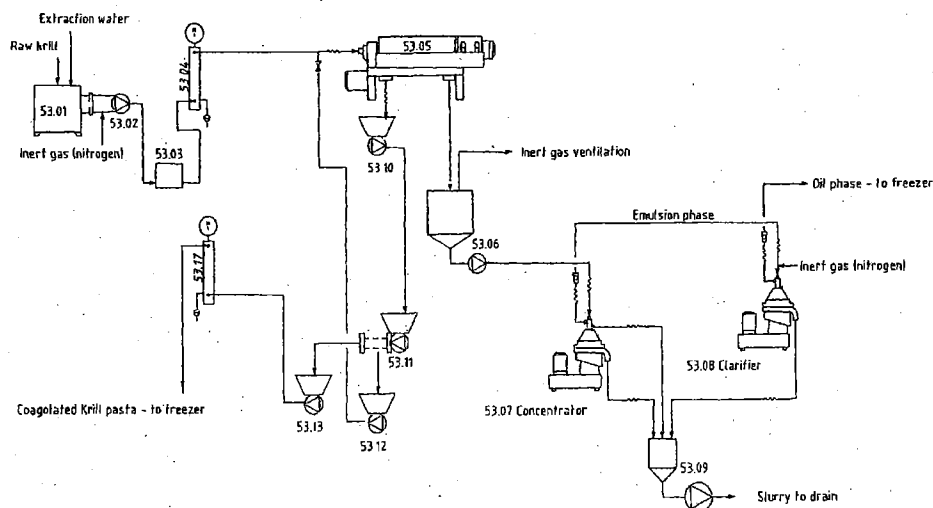

(57) Abstract: According to the present disclosure there is provided a method for extracting lipid fractions from krill, wherein freshly captured krill is ground to produce a slurry, which is gently heated to a temperature below 90°C for less than 45 minutes, whereafter the liquid into an aqueous phase and a krill oil phase from which a krill oil extract is derived without the use of organic solvents. Moreover there is also provided a pharmaceutical composition for the treatment of thrombosis in a patient comprising an effective amount of a krill oil extract.

WO 2007/080514 A2



For two-letter codes and other abbreviations, refer to the "Guidance Notes on Codes and Abbreviations" appearing at the beginning of each regular issue of the PCT Gazette.

A METHOD FOR THE EXTRACTION OF LIPID FRACTIONS FROM KRILL

FIELD OF THE INVENTION

- 5 This invention relates to a novel method and equipment for extracting lipid fractions from marine and aquatic animals such as krill, Calanus, fish and sea mammals, which method does not utilize high temperatures and/or organic solvent and thus preserves valuable components in the extracted animal material.

10 BACKGROUND OF THE INVENTION

- Marine and aquatic animal oils and fractions thereof contain various therapeutic agents. For example, it is reported that various marine and aquatic animal oils have anti-inflammatory properties. Marine and aquatic animal oils are also reported as
15 helpful in reducing the incidence of cardiovascular disease. Also, some marine and aquatic animal oils are reported as suppressing the development of certain forms of lupus and renal diseases. As a further example, krill may be used as a source of enzymes for debridement of ulcers and wounds or to facilitate food digestion. Also marine and aquatic oils contain various antioxidants, which may have potential
20 therapeutic properties.

- Krill is the common name for small, shrimp-like crustaceans that swarm in dense shoals, especially in Antarctic waters. It is one of the most important food sources (especially protein) for fish, some kind of birds and especially for baleen whales. Krill is
25 also a good source of omega-3 fatty acid, which are well known for their beneficial effects on human health.

- It is known in the art to use krill and/or marine enzymes for the treatment of a great variety of diseases in human and animals such as infections, inflammations, cancers,
30 HIV/AIDS, pain, polyps, warts, haemorrhoids, plaque, wrinkles, thin hair, allergic itch, anti-adhesion, eye disease, acne, cystic fibrosis and immune disorders including autoimmune diseases and cancer.

- It is also known in the art that krill and/or marine oils may be used for the treatment of
35 autoimmune lupus and other autoimmune diseases and can also be used for treating cardiovascular diseases.

Various methods for extracting marine and aquatic animal oils are known. For example, it is known to extract fish oil using organic solvents such as hexane and ethanol. It is also known to measure the fat content in fish muscle tissue using solvents such as acetone.

5

U.S. Pat. No. 4,331,695 describes a method using pressurized solvents which are gaseous at room temperature, such as propane, butane or hexane. The extraction is performed at preferred temperatures of 15 to 80° C on shredded vegetable or finely divided animal products. The extracted oils are then made to precipitate under high
10 pressure and elevated temperatures of 50 to 200° C. However, hexane is a poor extraction solvent for marine animals such as krill. Furthermore, the high temperatures used in the precipitation step negatively alters the lipids.

Canadian Patent Application 2,115,571 describes a method for extracting oils from
15 various brown and red algae species. The method provides, for example, extraction using nearly pure ethanol for 40 hours.

U.S. Pat. No. 5,006,281 describes a method for extracting oil from marine and aquatic animals such as fish. The marine and aquatic animal is first treated with an antioxidant
20 compound, finely divided and centrifuged to separate the oil phase from the aqueous phase and solid phase. The oil phase is then further treated with antioxidant to remove undesirable odour or taste.

Canadian Patent 1,098,900 describes a method for extracting oils from krill. The
25 method involves emulsifying fresh or defrosted krill in an aqueous medium. The oil fraction is recovered by centrifugation.

Folch published in J. Biol. Chem. 226: 497-509 in 1957 an article entitled "A simple method for the isolation and purification of total lipids from animal tissues" proposes an
30 extraction method using chloroform and methanol. This method is not commercially feasible because of the toxicity of the solvents involved.

However, most of the krill oil extract used for these treatments has only conserved its
35 omega-3 fatty acids as active ingredients, which is a very small part of all the active ingredients of the krill itself. This fact dramatically reduces the potential of the krill and/or marine oil as a treatment for human diseases.

There is an increasing demand for treatments using products derived from a natural source, therefore, it would be highly desirable to be provided with a krill and/or marine extract having an enhanced potential for prevention and/or treatment and/or management of disease.

5

US Patent 6,800,299 discloses a method for extracting lipid fractions from marine and aquatic animal material by acetone extraction. The resulting non-soluble and particulate fraction is preferably subjected to an additional solvent extraction with an alcohol, preferably ethanol, isopropanol or t-butanol or an ester of acetic acid, preferably ethyl acetate to achieve extraction of the remaining soluble lipid fraction from the marine and aquatic animal material. The remaining non-soluble particulate content is also recovered since it is enriched in proteins and contains a useful amount of active enzymes. Also provided herein is a krill extract. It is reported that these marine and aquatic animal oils have anti-inflammatory properties. Marine and aquatic animal oils are also reported as helpful in reducing the incidence of cardiovascular disease. As a further example the patent mentions that krill may be used as a source of enzymes for debridement of ulcers and wounds or to facilitate food digestion.

WO02102394A2 discloses a process for the preparation of a krill oil extract, which process includes the steps of placing krill and/or marine material in a ketone solvent to achieve extraction of the soluble lipid fraction from the krill; then separating the liquid and solid contents; then recovering a first lipid rich fraction from the liquid contents by evaporation of the solvent present in the liquid contents; then placing the solid contents in an organic solvent to achieve extraction of the remaining soluble lipid fraction from the krill material; then separating the liquid and solid contents; then recovering a second lipid rich fraction by evaporation of the solvent from the liquid contents; and finally recovering the solid contents. Diseases that can be treated and/or prevented by using the krill oil extract are *inter alia* cardiovascular diseases. In this respect it is mentioned that the Krill oil has been shown to decrease cholesterol *in vivo*, inhibit platelet adhesion and plaque formation and reduce vascular endothelial inflammation in a patient.

Canadian Patent 1,098,900 describes a method for extracting oils and producing proteins from krill comprising emulsification of lipids of krill in an aqueous medium, separation of the emulsion of lipids from the krill mass, alkaline extraction of proteins from the krill mass, separation of the protein extract produced from chitin integuments,

and finally separation of protein from the protein extract. The document mentions that krill is a prospective source of food and other practically useful products such as chitin and lipids which find wide application in different branches, such as food industry, textile, and medicine.

5

WO03011873A2 discloses a phospholipid extract from *inter alia* krill, with therapeutic properties, such as those essential for the maintenance of a healthy cardiovascular system. The phospholipid extract comprises a variety of phospholipids, fatty acid, metals and a novel flavonoid. The method for the preparation of this extract is
10 generally carried out by a method similar to the one described in US Patent 6,800,299 (see above; and utilises organic solvents), which procedure produces two successive lipid fractions and a dry residue enriched in protein, including active enzymes.

WO8401715A1 and WO09533471A1 disclose various aspects of so-called krill
15 enzymes, which are water-soluble. It is mentioned that in krill a mixture of different enzymes exists, such as e.g. proteinases (with acidic and neutral-to-alkaline pH-optima), peptidases (exo- and endopeptidases), lipases, phospholipases, amylases and other carbohydrate degrading enzymes, phosphatases nucleases, nucleotidases and esterases. The proteolytic (trypsin-like) activity existing in a water extract from krill
20 has been studied and described. WO09533471A1 disclose the use of one or more krill enzymes for the manufacture of an intravasal pharmaceutical composition for thrombolysis in a mammal host.

As appears from the above cited prior art current available technology for production of
25 marine oils are usually based on a thermal process such as those used in the fish meal process, and in some particular cases on a solvent extraction method, such as hexane extraction or similar highly effective solvent. However the solvent method which is necessary to get the optimum oil quality, cannot be implemented on a fishing vessel,. In addition the most active solvents are not suitable for pharmaceutical
30 processing.

Thus, the prior art disclose extraction methods involving the use of organic solvents or high temperatures or both – none of which are optimal from the point of view of the biological activity of the oil.

35

SUMMARY OF THE INVENTION

In accordance with the present invention there is provided a novel marine lipid extract obtainable by a process with following characteristics:

5

- Processing temperature below 60 °C, and more precisely with an optimum processing just under 27 °C.
- Mechanical and physical disruption of the lipid cell membrane to facilitate low temperature extraction.
- Processing takes place under inert gas to prevent oxidation or denaturation of fat and proteins
- Intermediate processing tanks kept at a minimum level to reduce residence time.
- The oil is frozen immediately after recovery to stabilize it.

10

15

In accordance with the present invention, there is provided a novel lipid extract obtainable by the process of the present invention. The novel lipid extract is derived from marine raw materials found in any marine environment around the world, for example, for krill, the Antarctic ocean (*euphasia superba*), the Pacific ocean (*euphasia pacifica*), the Atlantic ocean, the Indian ocean, in particular coastal regions of Mauritius Island and/or Reunion Island of Madagascar, Canadian West Coast, Japanese Coast, St-Lawrence Gulf and Fundy Bay, but other sources of marine raw materials obviously exist.

20

25

The present invention describes a method for extracting lipid fractions from marine raw materials, said method comprising the steps of:

- Feeding freshly captured raw material into a grinder to produce a slurry comprising particles of less than 5 mm prior to further processing
- Ultra sound disintegration of cell membranes to expose the marine oil without heating the slurry appreciably
- Heating the slurry gently to a temperature below 60°C, preferably between 25°C and 27°C
- Separating the solid material from the liquid
- Separating the liquid into an aqueous phase and a lipid phase

30

35

wherein the extraction does not involve the use of organic solvents or temperatures above 60°C, and each process step takes place in an inert gas environment.

Additionally according to the present invention there is provided a apparatus for
5 performing the process of the invention.

DETAILED DESCRIPTION OF THE INVENTION

10 Specifically, according to a first aspect of the present invention there is provided a method for extracting lipid fractions from marine raw materials, such as krill, said method comprising the steps of:

- supplying an inert gas (e.g. nitrogen) to reduce or exclude oxygen
- placing the raw material in a grinder to mechanically disrupt fat cell
15 membranes
- ultra sound sonication of the grinded material to facilitate extraction of the soluble lipid fraction;
- separating the liquid and solid components;
- recovering a lipid rich fraction from the liquid component;

20 wherein the extraction is performed at a temperature below 60 °C, preferably below 30°C, and does not involve the use of organic solvents.

Specifically, according to a second aspect of the present invention there is provided an apparatus for carrying out the method of the present invention comprising

- 25 • means for grinding and ultra sound sonication of the marine raw material,
- means for extracting the majority of the liquid fraction of the material,
- means for recovering the light phase of the liquid fraction,
- means for recovering a concentrated marine lipid,
- means for accumulating remaining solid components and subsequently pressing
30 residue liquid therefrom,
- means for returning the additional extracted liquid to means for recovering the additional lipid extract

Example 1

Preparation of the lipid extract of the present invention.

5

The invented process may be performed with an apparatus comprising one or more of components referred to in Figure 1, and in particular:

- | | | |
|----|--------|---|
| 10 | 53.01. | Grinding of the product and addition of extraction water –
Max. 5 mm holeplate grinder. |
| | 53.02. | Feed pump for ultra sound sonicator, Contherm and
decanter. |
| | 53.03. | Heavy duty ultrasound sonication to disintegrate cell
membrane. |
| 15 | 53.04. | Contherm scraped heat exchanger - Temperature
condition by heating to maximum 30 °C |
| | 53.05. | Decanter centrifuge for extracting liquid. |
| | 53.06. | Feed pump for separator |
| | 53.07. | Concentrator centrifuge to recover emulsified fat phase |
| 20 | 53.08. | Clarifying centrifuge to recover the clean marine oil |
| | 53.09. | Slurry pump for heavy and sludge phases from centrifuges |
| | 53.10. | Solid phase pump |
| | 53.11. | High pressure dewatering press – applying a pressure of
minimum 15 bar to press residual liquid from product |
| 25 | 53.12. | Pump to return additional extracted liquid to a process step
prior to the decanter |
| | 53.13. | Press cake pump |
| | 53.14. | Contherm pasturising the press cake before freezing. |

30 A preferred embodiment comprises at least:

- means for grinding (53.01) and ultra sound sonication of (53.03) the marine raw material,
- means for extracting the majority of the liquid fraction of the material (53.05),
- 35 • means for recovering the light phase of the liquid fraction (53.07),
- means for recovering a concentrated marine lipid (53.08),

- means for accumulating (53.09, 53.10) remaining solid components and subsequently pressing residue liquid therefrom (53.11), and
- means for returning (53.12) the additional extracted liquid to means for recovering the additional lipid extract (53.07).

5

Preferably the entire process is carried out under an inert atmosphere, such as nitrogen or helium.

The inventors have also envisaged that the present invention may be carried out by
10 applying supercritical CO₂ extraction.

CLAIMS

1. A method for extracting lipid fractions from marine raw materials, such as krill, said method comprising the steps of:
- 5 • placing the raw material in a grinder to mechanically disrupt fat cell membranes;
- Ultra sound sonication of the ground material to facilitate extraction of the soluble lipid fraction;
- separating the liquid and solid components;
- 10 • recovering a lipid rich fraction from the liquid component;
- recovering a protein rich cake;
- wherein the extraction is performed at a temperature below 60 °C and does not involve the use of organic solvents.
- 15 2. A method as in claim 1, wherein separating the liquid and solid components is effected by techniques selected from the group consisting of mechanical pressure, filtration, centrifugation and sedimentation.
3. A method as in claim 1, wherein the extraction is performed at a temperature
- 20 between 25°C and 27°C.
4. A method as in claim 1, wherein the extraction is performed under an inert atmosphere.
- 25 5. A marine lipid extract obtainable by a method according to any one of claims 1 to 4.
6. A method according to any one of claims 1 to 4, wherein the marine raw material is krill.
- 30 7. A krill oil extract obtainable by a method according to claim 6.
8. An apparatus for carrying out the method of any one of the claims 1 to 4 comprising
- means for grinding (53.01) and ultra sound sonication of (53.03) the marine raw material,
- 35 • means for extracting the majority of the liquid fraction of the material (53.05),
- means for recovering the light phase of the liquid fraction (53.07),

- means for recovering a concentrated marine lipid (53.08)
 - means for accumulating (53.09, 53.10) remaining solid components and subsequently pressing residue liquid therefrom (53.11), and
 - means for returning (53.12) the additional extracted liquid to means for recovering
- 5 the additional lipid extract (53.07).

9. An apparatus for carrying out the method of any one of the claims 1 to 4 comprising:

- Feed pump for ultra sound sonicator, Contherm and decanter,
- 10 • Heavy duty ultrasound sonication to disintegrate cell membrane,
- Contherm scraped heat exchanger - Temperature condition by heating to maximum 30 °C,
- Decanter centrifuge for extracting liquid,
- Feed pump for separator,
- 15 • Concentrator centrifuge to recover emulsified fat phase,
- Clarifying centrifuge to recover the clean marine oil,
- Slurry pump for heavy and sludge phases from centrifuges,
- Solid phase pump,
- High pressure dewatering press – applying a pressure of minimum 15 bar to press
- 20 residual liquid from product,
- Pump to return additional extracted liquid to a process step prior to the decanter,
- Press cake pump, and
- Contherm pasturising the press cake before freezing.

25 10. An apparatus according to claim 8 or 9, wherein the method is carried out under an inert atmosphere.

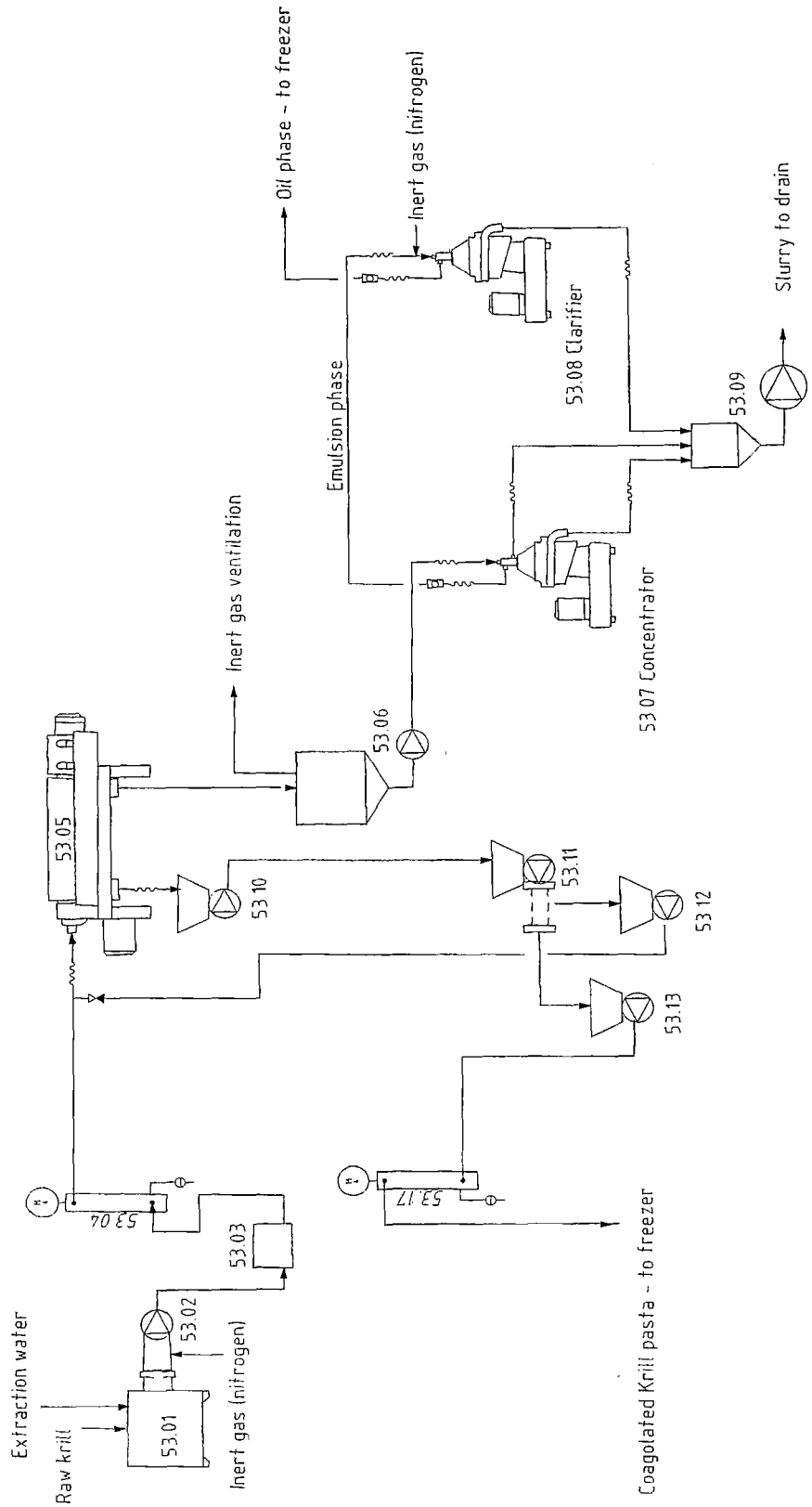
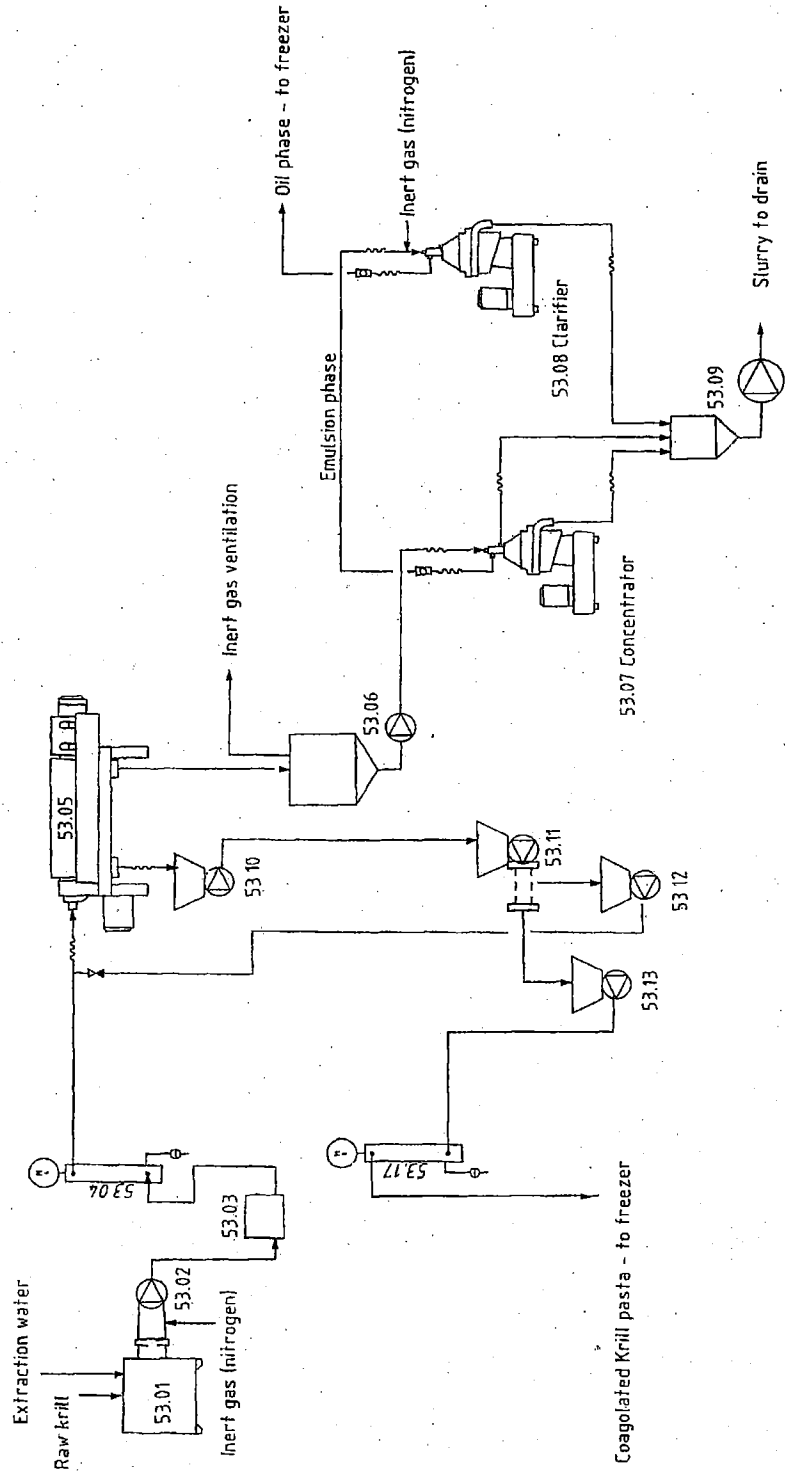

Figure 1

Figure 1



EUROPEAN PATENT OFFICE

Patent Abstracts of Japan

PUBLICATION NUMBER : 02215351
PUBLICATION DATE : 28-08-90

APPLICATION DATE : 14-02-89
APPLICATION NUMBER : 01034846

APPLICANT : TAIYO FISHERY CO LTD;

INVENTOR : NONAKA MICHIO;

INT.CL. : A23J 7/00 A23L 1/30 A23L 1/33 A61K 31/685 A61K 37/22

TITLE : METHOD FOR COLLECTING KRILL PHOSPHOLIPID AND FUNCTIONAL FOOD AND NERVE FUNCTION IMPROVING AGENT HAVING NERVE FUNCTION IMPROVING EFFECT

ABSTRACT : PURPOSE: To obtain an useful phospholipid in high purity by fractionating an ethanol extracted total lipid of fresh krill dehydrated by vacuum freeze drying method to specific two ingredients using an absorption column chromatography and further isolating these ingredients using a fraction collector.

CONSTITUTION: A fresh krill is dehydrated to $\leq 6\%$ water content using a vacuum freeze drying method. Then the dried krill is homogenized with ethanol to extract total lipid. The ethanol is removed as much as possible from the total lipid and the extracted total lipid is fractionated to soluble fraction and insoluble fraction using an acetone based solvent or hexane based solvent as eluate and then the solvent is cleaned from the insoluble fraction to give a crude phospholipid. Then the crude phospholipid is fractionated to phosphatidyl choline and phosphatidyl ethanolamine with an absorption column chromatography using ethanol based solvent, acetone based solvent or hexane based solvent as an eluate. Then each phospholipid ingredient is isolated therefrom in a high purity of about 90-95% by a fraction collector.

COPYRIGHT: (C)1990,JPO&Japio

⑩ 日本国特許庁 (JP)

⑪ 特許出願公開

⑫ 公開特許公報 (A) 平2-215351

⑬ Int. Cl.³ 識別記号 庁内整理番号 ⑭ 公開 平成2年(1990)8月28日
 A 23 J 7/00 6712-4B
 A 23 L 1/30 8114-4B
 1/33 A 2114-4B*
 B

審査請求 未請求 請求項の数 3 (全6頁)

⑮ 発明の名称 オキアミリン脂質の分取方法及び脳機能改善効果を有する機能性食品と脳機能改善剤

⑯ 特 願 平1-34846

⑰ 出 願 平1(1989)2月14日

⑱ 発 明 者 丸 山 一 輝 東京都中央区月島3丁目2番9号 大洋漁業株式会社大洋研究所内

⑲ 発 明 者 西 川 正 純 東京都中央区月島3丁目2番9号 大洋漁業株式会社大洋研究所内

⑳ 発 明 者 木 村 省 二 東京都中央区月島3丁目2番9号 大洋漁業株式会社大洋研究所内

㉑ 出 願 人 大洋漁業株式会社 東京都千代田区大手町1丁目1番2号

㉒ 代 理 人 弁理士 大津 洋夫

最終頁に続く

明 細 書

1. 発明の名称

オキアミリン脂質の分取方法及び脳機能改善効果を有する機能性食品と脳機能改善剤

2. 特許請求の範囲

(1) 生オキアミを真空凍結乾燥法により脱水したうえ、エタノールで総脂質を抽出し、得られた総脂質を、エタノール系溶媒、アセトン系溶媒、またはヘキサン系溶媒のいずれかを溶離液となし、シリカゲルを充填剤として、吸着カラムクロマトグラフィーを用いてホスファチジルコリンとホスファチジルエタノールアミンを分離し、これをフラクションコレクターにより単離するようにしたことを特徴とするオキアミリン脂質の分取方法。

(2) オキアミより単離したホスファチジルコリンもしくはホスファチジルエタノールアミンまたはこれらの誘導体のうち少なくとも一種以上を有効成分として食品基材に混入させるようにしたことを特徴とする脳機能改善効果を有する機能性食品。

品。

(3) オキアミより単離したホスファチジルコリンもしくはホスファチジルエタノールアミンまたはこれらの誘導体のうち少なくとも一種以上を有効成分として含有し構成させるようにしたことを特徴とする脳機能改善剤。

3. 発明の詳細な説明

「産業上の利用分野」

本発明は、オキアミからリン脂質を分離抽出する方法、特に、生体内において重要な生理活性を示すホスファチジルコリン及びホスファチジルエタノールアミンを単離する方法であり、こうして分取されたホスファチジルコリン及びホスファチジルエタノールアミン等が、食品としてまたは薬品として利用可能なものである点に特徴を有する技術に関する。

「従来技術」

最近、高齢化社会を迎えて、老人性痴呆症が大

きな社会問題になっている。老人性痴呆症は、神経系の障害を原因として起こるアルツハイマー型痴呆症と、脳血管障害を原因として起こる脳血管性痴呆症との二つの型に大別できる。前者のアルツハイマー型痴呆症の場合には、脳内の神経化学的な変化として、神経伝達物質であるアセチルコリンの生産が著しく低下していることが知られており、この病気の予防や治療法として、低下したコリン系の代謝を補給することにより生理機能を回復せんとすることが行なわれている。例えば、PCT特許出願公表昭56-500374号「レシチンを投与することにより病気を治療するための方法および組成物」、特開昭59-167514号「脳機能亢進剤組成物」、特開昭60-214734号「神経障害及び走化の治療組成物および治療方法」等がそれである。

即ち、コリン含有リン脂質であるホスファチジルコリンを摂取することにより、脳内にアセチルコリンを供給し、これによりアルツハイマー型痴呆症やその他の神経障害の予防と治療が期待され

ている。溶性区分と不溶性区分に分ける。当該アセトン可溶性区分には中性脂質、コレステロール、遊離脂肪酸等が分画されており、またアセトン不溶性区分にはリン脂質が分画されている。そこで、次に、アセトン不溶性区分を90%エタノールで処理して、アルコールに溶けるホスファチジルコリンと不溶性のホスファチジルエタノールアミンとを得る。

「発明が解決しようとする問題点」

しかし、上記のような、大豆を原料としたリン脂質の精製法の場合には、得られるホスファチジルコリン及びホスファチジルエタノールアミンとも純度が70%~80%程度であり、90%以上の高純度の精製物を得ることはなかなか困難であった。また、上記のように、クロロホルムメタノールを使用する方法は、いかに精製分画しても有害成分が残留している恐れがあるため、食品には使用しにくいという問題があった。

本発明者は、オキアミが豊富な蛋白質資源とし

ている。

また、リン脂質の一種であるホスファチジルエタノールアミンはS-アデノシルメチオンニンからのメチル基移転反応によりホスファチジルコリンに変換される。従って、当該ホスファチジルエタノールアミンもアルツハイマー型痴呆症やその他の神経障害の予防と治療剤としての利用が期待されている。

本発明者は、特に、グリセリン脂質である、これらホスファチジルコリン及びホスファチジルエタノールアミンといったリン脂質に注目し、これを食品や薬品の原料として利用が可能な状態で工業的に分取する方法を研究開発せんとしたものである。

従来、天然物からリン脂質を工業的に精製する場合の原料といえば大豆が一般的であり、大豆リン脂質は主に健康食品等として、商品化されている。従来大豆リン脂質精製法は、まず原料大豆をクロロホルム・メタノール系の溶媒で総脂質を抽出し、次に当該総脂質をアセトンで分画し、可

で注目されているが、腐敗し易く、水分が多過ぎることから保存と運送にコストがかかり過ぎるとして、その有効な利用法が確立していないこと、また、オキアミにはリン脂質が多く含まれているが、この有効成分であるリン脂質に着目して付加価値が高く経済性のある高機能性食品または医薬品等に利用しようとする技術開発が、いまだなされていないことに気が付いた。

そこで本発明者は、未利用の水産資源であるオキアミを原料として、これから有用なリン脂質を高純度で得ることができれば、オキアミの有効利用法として非常に有益であると考え、その精製法の研究開発を進め、完成したのが本発明である。

即ち、本発明は、オキアミを原料として、総脂質を分画し、得られた総脂質から高純度のホスファチジルコリン及びホスファチジルエタノールアミン等を精製単離することを特徴とする分取方法と、そうして得られた生理活性物質を用いて脳機能改善効果を有する機能性食品及び脳機能改善剤として利用する技術である。

「問題点を解決する手段」

本発明は、上記問題点を解決するため、次のような手段を採用したものである。

本発明は、生オキアミを真空凍結乾燥法により脱水したうえ、エタノールで総脂質を抽出し、得られた総脂質を、エタノール系溶媒、アセトン系溶媒、またはヘキサン系溶媒のいずれかを溶離液となし、シリカゲルを充填剤として、吸着カラムクロマトグラフィーを用いてリン脂質を分画し、これをフラクションコレクターにより単離するようになったことを特徴とするオキアミリン脂質の分取方法である。

第一工程：船内急速凍結生オキアミのブロック中には、90%以上が水分であるため、脱水方法が問題になる。そこで本発明では、吸着カラムクロマトグラフィーを用いた分取の前処理として、真空凍結乾燥装置を用いて脱水し乾燥オキアミとする。このとき水分含量が6%以下になるように脱水乾燥するのが望ましい。すると、水溶性蛋白質のエタノール抽出物への混入が抑制できるの

アミンなどのオキアミリン脂質を分取する方法である。

次は、上記の方法でオキアミより単離した高純度のホスファチジルコリンもしくはホスファチジルエタノールアミンがいずれも脳機能を改善する生理機能活性物質であるところに着目し、当該オキアミより単離した高純度のホスファチジルコリンもしくはホスファチジルエタノールアミンまたはこれらの誘導体のうち少なくとも一種以上を有効成分として食品基材に混入させるようにして脳機能改善効果を有する機能性食品とする。

また、オキアミより単離したホスファチジルコリンもしくはホスファチジルエタノールアミンまたはこれらの誘導体のうち少なくとも一種以上を有効成分として含有させるようにして脳機能改善剤となす。ここで、脳機能改善剤は、錠剤、カプセル、顆粒、液状などの形態として、薬品化することができるものである。

「作用」

で、分別成分の純度を高めることができる。

第二工程：第一工程により得られた乾燥オキアミをエタノールでホモジナイズして総脂質を抽出する。

第三工程：次に総脂質からエタノールを出来るだけ除去したうえ、アセトン系溶媒、またはヘキサン系溶媒のいずれかを溶離液となし、可溶区分と不溶区分とに分画する。例えば、アセトン系溶媒の場合には、リン脂質の大部分は不溶区分にあるので、これから溶媒を洗浄すれば、粗リン脂質が得られる。

第四工程：この粗リン脂質をエタノール系溶媒、アセトン系溶媒、またはヘキサン系溶媒のいずれかを溶離液となし、吸着カラムクロマトグラフィーを用いてホスファチジルコリンやホスファチジルエタノールアミンに分画し、これからフラクションコレクターにより各リン脂質成分を90%以上95%前後の高純度にて単離する。

本発明は、以上のようにして高純度のホスファチジルコリンもしくはホスファチジルエタノール

アルツハイマー型痴呆症の場合には、脳内の神経化学的な変化として、神経伝達物質であるアセチルコリンの生産が著しく低下していることが知られており、この病気の予防や治療法として、低下したコリン系の代謝を補給することにより生理機能を回復せんとすることが行なわれている。

特に、人の場合、コリンまたはコリンに解離する天然産出化合物レシチンを経口投与した場合、脳アセチルコリンの合成および放出を増進するのに十分な容量の血液コリン量の増加をもたらすと同時に、脳脊髄液のコリン量も増加する生理機能のあることが解っている。

従って、オキアミからリン脂質であるホスファチジルコリンをいかに効率良く、しかも安全性を保って抽出するか、それを食品または薬剤として摂取することにより、脳内にアセチルコリンを供給し、これによりアルツハイマー型痴呆症やその他の神経障害の予防と治療を期待しようとするのが本発明である。

「実施例」

以下、本発明を実施例に基づき詳細に説明する。

<実施例1.>

船内急速凍結生オキアミ20Kgを真空乾燥装置を用いて水分含量4%前後になるまで乾燥させて乾燥オキアミ2.2Kgを得た。この原料である乾燥オキアミの脂質組成をイアトロスキャン法で分析した結果は、表1.の通りであった。

次に、こうして得た乾燥オキアミ2kgをエタノール40kgでホモジナイズして総脂質の抽出を行なった。その後、再抽出はエタノール20kgと同様に行なった。

抽出物である総脂質を濃縮して、できるだけエタノールを除去した後、当該総脂質をアセトンに溶解し、可溶区分と不溶区分に分画する。すると大部分のリン脂質は不溶区分に区画される。そこで、当該不溶区分に分画された物質にアセトン洗浄を数回繰り返して、粗リン脂質408gを得た。

20mlを自動注入した。溶離液はエタノール100%を流速30ml/minで流し、カラム恒温槽は40℃で、ピーク検出は紫外線吸収検出器(205μm)を用いてモニターしたところ、第1図に示したクロマトグラムが得られたので、最初のピークの分画区分をAとし、2番目の大きなピークの分画区分をBとしてフラクションコレクターを用いて分取した。分画区分Bのホスファチジルコリンの純度はイアトロスキャン法で分析したところ98%以上であった。1バッチのサイクルタイムは30分で、原料溶液を30分毎に自動充填して100サイクルで約50時間要して、乾燥オキアミ2kgから高純度ホスファチジルコリンを約239g分取した。

また、分画区分Aから同様に純度95%以上の高純度のホスファチジルエタノールアミンを約45g分取した。

<実施例2.>

ウエクスラー方式の記憶ないし知能指数試験を

表1. 乾燥オキアミの脂質組成

脂質組成	重量%
ホスファチジルコリン	31.1
ホスファチジルエタノールアミン	7.5
トリグリセリド	43.2
遊離脂肪酸	6.5
その他	5.7

次に、前記粗リン脂質400gをエタノールに2000mlに溶解し、全自動分取型高速液体クロマトグラフィーに装着した分取カラム(カラム長さ×カラム径:50cm×50mm、断面積19.6cm²)に粒径10μmの球状シリカゲル(吸着剤)を充填したものに、1バッチ当たり

したところ記憶指数123であった記憶喪失にかかっている患者に、オキアミのから第1実施例にて分取した高純度ホスファチジルコリン(純度98%)を6週間に渡って1日3回食事毎に10gづつ食品に混入して経口投与した。

試験治療前と高純度ホスファチジルコリン摂取終了の6週間後に、患者からコリン測定用血液資料を採取しておき、血漿資料を分離し、凍結し、そしてそのコリン含量について慣用の放射性酵素法により分析した。その結果は、試験治療前採取した血液中の血漿コリン量が13.4±1.2ナノモル/mlであったのに対し、高純度ホスファチジルコリン投与から4時間後に得られた血液中の血漿コリン量が31.3±2.5ナノモル/mlに増加していた(P<0.01)。

しかも、高純度ホスファチジルコリン摂取の6週間後には、患者の記憶指数は、142に向上していた。

「効果」

特開平2-215351(5)

第1請求項に係る保護を受けようとする発明は、未利用の水産資源であるオキアミを原料として、これから有用なホスファチジルコリン及びホスファチシラエタノールアミンを90%以上という高純度で精製単離することができる分取方法である。この分取方法は、精製単離成分が高純度であるというだけでなく、その精製過程において、毒性を持った溶剤などが一切使用されていないので、安全性が高く、食品や薬品などにも安心して利用できる点に特徴がある。

また、第2請求項、第3請求項に係る特許を受けようとする発明は、そうして得られたオキアミン脂質であるホスファチジルコリン及びホスファチシラエタノールアミンには、アルツハイマー病の予防と治療が期待できる脳機能を改善するという生理機能を有しているため、これを利用して脳機能改善効果を有する機能性食品及び脳機能改善剤となすことができる。

第1図は本発明に係るクロマトグラムが得られた組成成分の分画表である。

特許出願人 大洋漁業株式会社

代理人 弁理士 大津 洋 夫



4. 図面の簡単な説明

第1図

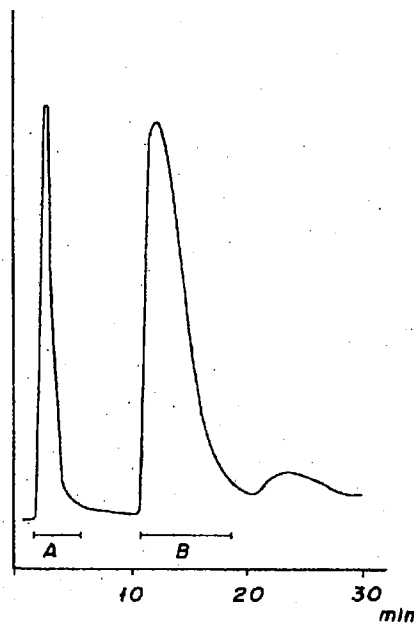

特開平2-215351(6)

第1頁の続き

④Int. Cl.⁵

A 61 K 31/685
37/22

識別記号

AAM

庁内整理番号

7431-4C
8615-4C

⑦発 明 者 野 中 道 夫 東京都中央区月島3丁目2番9号 大洋漁業株式会社大洋
研究所内

Bull. Tokai Reg. Fish. Res. Lab., No.78, June 1974*

Modification of Russian Method for Separating Heat Coagulated Protein from Antarctic Krill

Masaaki YANASE

Abstract: The Antarctic krill *Euphausia superba* seems to be a promising resource as human food, but being the size small and the carapace which occupies nearly 30% of the whole body can be problems on processing. A method proposed by Russian workers to solve the problems was modified and the yields of the products were found much improved. The procedures were: frozen krill instead of fresh-caught one on which the Russians have worked was autolysed with equal volume of water at 45°C for two hours, pressed to separate the residue from the liquid. The liquid was then heated at 95°C for 15 min to coagulate the proteins, and it was centrifuged to separate the protein fraction, which also abounds in fat, from the remaining extract.

Calculating on dry based yields for the residue, protein fraction and extract were found for the non-autolysed sample 70.3, 9.0 and 16.5% respectively, and for the autolysed sample 10.4, 49.3 and 45% respectively. Total nitrogen was found distributing in the above three fractions 70.9, 4.7 and 17.3% for the non-autolysed sample, and 7.1, 28.3 and 53.4% for the autolysed sample.

It may seem from the above data that the yield of protein in the protein fraction for the autolysed sample is not large, but by correcting the amount of chitin nitrogen in the residue and extractive nitrogen in the extract the distribution of protein nitrogen for the residue, protein fraction and extract are calculated to be 2.0, 56.8 and 3.5% respectively.

It is widely known that the factor which hinders the large scale consumption of Antarctic krill (*euphausia superba*) is its carapace. The shell makes up approximately one third of its bodyweight¹⁾. In general, in crustaceans, the cephalothorax and abdomen sections of the shell can be removed by hand or mechanically, but for the krill, which has a 3-5cm body length, this process is difficult to carry out. For that reason, the krill are often used with the shell still attached, in the same way as sakura shrimp (*sergia lucens*), but using them in this way has a limited appeal, which probably restricts their consumption level. Therefore, in order for raw material to be processed from the krill for large-scale consumption as a universally useful food source there is a need to be able to harvest the internal parts by removing the shell efficiently.

In Soviet²⁾ processing on board boats, fresh krill are first compressed and centrifuged so that the liquid is separated from a residue containing the shells, then the liquid is heated, after which it is centrifuged and is separated into the main constituent which is a heat-coagulated protein and a top layer which is the extract. This protein part is rich in proteins and fats, it has a paste form which resembles cheese in appearance which, as

* Received 10th June, 1974, Tokai Region Fisheries Research Laboratory no. 547

well as being able to be used as it is in all kinds of cooking, may be used as a raw material to be added to processed cheeses, fish pastes and a wide range of other uses. The extract can be concentrated and used as flavouring, and the residue used as food for domestic animals. However, this method is reported as yielding 43% solids as residue, 37% proteins and 18% extract, so the greater part of the yield is limited to the residue.

Based on the Soviet method noted above for separating the protein portion of the krill, the author sought a method which would decrease the yield of the residue and increase the yield of the protein. As a result, he found that this could be achieved by autolysis under uniform digestion conditions.

Test materials and method

Materials: Antarctic Krill, with a body length of 25-45mm, harvested on 12th January 1973 by the Antarctic Ocean Fisheries Resources Development Centre at coordinates of 59° – 40' S, 53° – 05' S. The krill were frozen on board the boat for 7 hours at a temperature of -34°C, stored for 2 months at -27°C to -28.5°C, then transported inland where they were stored for 4 months at -25°C to -27°C, and 5 months at -40°C.

Autolysis: The abovementioned frozen krill test material was used whole without being crushed. 100g of the test material was weighed out into a beaker, 100cc water added and then it was heated for 4 hours in a constant 45°C heat bath¹⁾, and autolysed for intervals of 1, 2, 3, 4 hours whilst being stirred. For the control, water was added to krill test material, which was immediately crushed and dried.

Separating residue, protein, extract: following the Soviet method and performed in the following manner. The autolysed substance was filtered through two sheets of gauze, and then compressed by wringing by hand. The filtrate and wrung out liquid were collected and combined (the “liquid”). The residue was rinsed with approximately double its volume of water, recompressed and collected. Next, the liquid was simmered at approximately 95°C for 15 minutes, and the heat coagulated protein settled to the bottom. The main part, the settled heat coagulated protein (the “protein”), was separated from the top extract layer by centrifugal separation (5000rpm). The protein was collected after rinsing with approximately double its volume of water.

The rinsing liquid from the residue and the protein were discarded, but the rinsing liquid from the residue in the control contained a large amount of undissolved solids so heat coagulated protein was recovered from this liquid and added to the protein portion.

Quantities of the various products: the solids from each of the various samples, the residue, protein and extract, were removed and measured. The solid content was 97%, 55% and 30%, respectively. These solids were dried.

The protein nitrogen of the dry matter, crude protein, fat and ash, was measured using a trichloroacetic acid precipitation method, in the same way as shown in the previous data on protein nitrogen³⁾.

Chitin – there is no established method for quantifying chitin in natural substances or the chitin in samples prepared from natural substances. The author tentatively used the following gravimetric method. Samples equivalent to 0.05-0.35g of their dry substance were weighed out into a 15cc centrifuge tube, and a fat removal process was carried out on each using 10cc alcohol and 10cc acetone. Then, 10cc water was added and they were heated in an autoclave at 120°C for 1 hour. After removing the hot liquid solute fraction, they were heated twice with 5cc of 5% KOH at 120°C for 4 hours, and after rinsing with a sufficient amount of water, the residue was judged to be chitin. Removal of the liquid portion during this process was carried out by centrifugal separation (3000rpm).

Test Results

The quantity of residue, protein and extract yielded after autolysing the krill for 0-4hrs, compressing it and heating it, was measured, and then the constituent amount of dry matter, raw protein, fat and ash in each of these fractions was measured. Then the yield quantity for these components within each of the three fractions was calculated. The results are shown in Table 1. Fig 1 shows the change in the yield (expressed as a percentage of the amount of each component in the original material) for each component in each of the three fractions over the digestion time.

As shown in Table 1 and Fig. 1, at the start of the autolysis process, out of all the components, the protein component in the residue fraction is clearly decreased. This is as a result of the rapid progression of the digestion process, since digestion is marked in the initial stages. The effect of the autolysis in decreasing each component in the residue fraction is due to the migration of those components to the protein or extract fraction, thus achieving an increase in their yields in the protein and extract fractions. Up until 2 hours digestion time, the yield of each component in both the protein and extract fractions, excluding fat, is greatly increased. Thereafter, in contrast with the yields in the extract fraction which continue to increase gradually, the yields in the protein fraction gradually decrease. For the fat component, the yield increase in the protein fraction is more striking than for the other components up to 2 hours into digestion time, whereas the fat yield in the extract fraction is always extremely low.

Table 1. Yields and analysis for autolysed krill products.*

Autolysis time	Fraction	Yield g	Dry matter		Crude protein**		Fat		Ash	
			Content %	Yield g	Content %	Yield g	Content %	Yield g	Content %	Yield g
0 hr (Control)	Re	75.5	21.8	16.45	59.9	9.86	10.6	1.74	11.7	1.93
	Pr	18.2	11.5	2.10	31.7	0.66	36.8	0.64	7.14	0.15
	Ex	100.4	3.84	3.85	62.2	2.40	0.57	0.02	19.7	0.76
	total	194.1 (97.1)		22.42 (95.8)		12.92 (92.9)		2.40 (80.0)		2.84 (93.1)
1 hr	Re	34.6	24.9	8.62	61.4	5.23	7.99	0.68	11.0	1.03
	Pr	36.5	19.2	7.09	32.8	2.30	30.4	2.14	9.09	0.64
	Ex	122.2	5.85	7.14	67.5	4.82	0.61	0.04	16.0	1.14
	total	193.3 (96.7)		22.76 (97.2)		12.40 (89.2)		2.86 (95.3)		2.81 (92.1)
2 hr	Re	7.9	31.0	2.44	40.5	0.99	3.26	0.98	23.9	0.59
	Pr	44.3	21.3	9.44	41.8	3.94	29.8	2.82	9.33	0.86
	Ex	144.4	7.30	10.54	70.4	7.42	0.42	0.03	12.3	1.30
	total	196.6 (98.8)		22.42 (95.8)		12.35 (88.8)		2.94 (97.7)		2.77 (90.8)
3 hr	Re	6.0	30.9	1.62	35.9	0.65	1.89	0.03	28.5	0.54
	Pr	48.3	18.6	8.98	35.3	3.17	31.4	2.52	9.40	0.84
	Ex	145.6	7.44	10.84	72.7	7.38	0.24	0.03	12.5	1.35
	total	199.9 (100)		21.64 (92.5)		11.70 (84.2)		2.88 (95.0)		2.74 (89.8)
4 hr	Re	5.7	31.5	1.86	35.6	0.64	2.09	0.04	27.6	0.49
	Pr	42.1	20.9	8.80	35.8	3.16	30.7	2.70	9.50	0.84
	Ex	149.5	7.49	11.20	71.5	8.00	0.36	0.04	12.4	1.38
	total	197.3 (98.7)		21.80 (93.2)		11.80 (84.9)		2.78 (92.6)		2.71 (88.5)
Original** material		200		23.4		13.9		3.00		3.05

* Whole body of krill was autolysed for different hours, separated into pressed residue (Re), heat coagulated protein from the liquid portion (Pr) and the remaining extract (Ex). Contents for crude protein, fat and ash were calculated on dry basis. Figures in parentheses are % to the original amounts.

** frozen whole krill 100g + water 100g

*** Crude protein, N x 6.25

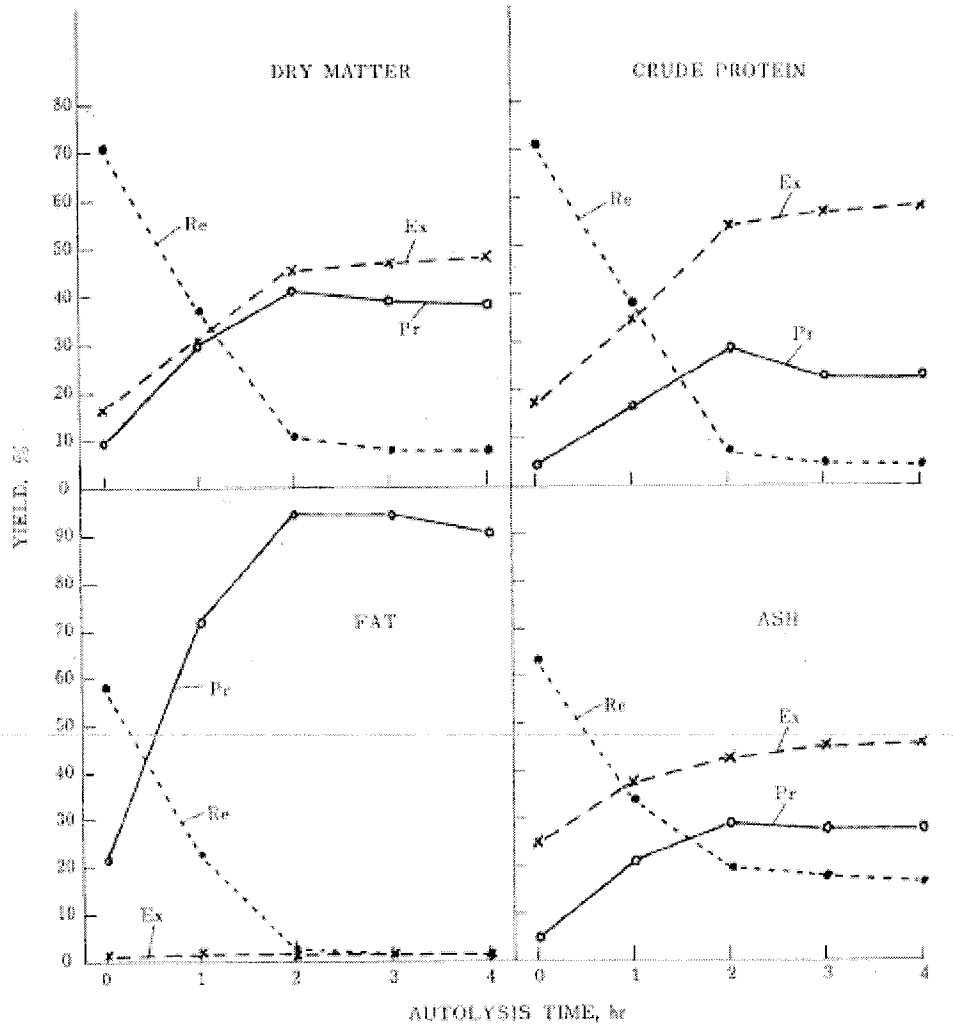

Fig. 1. Changes in the yields in autolysed krill products.*

* See footnote of Table 1. Yields are expressed as % to the original amounts.

From the results above and within the scope of this experiment, it is clear that two hours digestion time meets the objective of decreasing the yields in the residue fraction and increasing the yields in the protein fraction.

However, crude protein yields of 28.3% in the protein fraction and 53.4% in the extract fraction are still far from attainable. This is probably due to the fact that there water soluble nitrogen compounds are naturally present in the krill and also that, due to the autolysis process, insoluble proteinous matter is partly dispersed into the added water. For that reason, protein nitrogen distribution was examined both in the samples that were autolysed for 2 hours and in the original material. When measuring protein nitrogen in chitinous samples it is necessary to correct the nitrogen originating from the chitin. Therefore, when apparent protein nitrogen was measured in the samples, chitin was measured at the same time and the nitrogen in the chitin (chitin nitrogen content was set at 6.9%) was subtracted from the visible protein nitrogen. These results are shown in Table 2.

Table 2. Distribution of chitin and protein nitrogen in the two hours autolysed krill products.*

Fraction	Chitin**			Protein*** N content	Chitin**** N content	Corrected protein N		
	Content %	Yield				Content mg%	Yield	
		g	%	mg	%			
Re	50.0	1.22	70.1	4,274	3,450	824	20	2.0
Pr	1.58	0.149	8.5	4,032	169	3,923	370	36.8
Ex	trace	trace	trace	330	trace	330	35	3.5
Original material	7.44	1.74	100	4,808	513	4,295	1,005	100

* See footnote of Table 1. Contents of the components were calculated on dry basis.

** Each sample was extracted twice with 5% KOH solution at 120°C, 1 hr, and the residue was regarded as chitin.

*** trichloroacetic acid precipitable N

**** chitin x 0.069

Conclusion

Comparing the results of the control test in this study with results from the Soviet method, the yields for residue, protein and extract in this study were 70%, 0.9% and 16.5%, respectively, and reported yields using the Soviet method were 43%, 37% and 18%, respectively, so there is a large gap between the two sets of results. The origin of this difference, as shown earlier in this report, is that the original material used in this case was frozen as opposed to fresh. Furthermore, aside from the fact that the samples used in this study were whole rather than crushed, there is a probably a difference between the methods in terms of the amount of pressure used to compress the material. So, as a matter of course, it is to be expected that the results of the study in increasing the protein yield and decreasing the residue yield through autolysis could be realised under the conditions of the Soviet method.

The main components of the protein fraction are protein and then fat. Krill fat, similar to whale oils and fish oils, is rich in unsaturated fatty acids^{4,5}). Accordingly, the stability of this fat requires further investigation, so that an appropriate storage method can be established for the protein portion, based on the results of such investigation.

Summary

Frozen krill and equal amounts of added water were autolysed at 45°C, then, based on the Soviet method, the material was compressed and the liquid separated from the residue, the liquid was heated at 95°C for 15 minutes and centrifuged to separate the main component, the protein fraction, made up of heat coagulated protein and fat, from the supernatant layer – the extract. The initial stages of autolysis demonstrated a marked effect in decreasing the yield of residue and increasing the yield of protein.

Through the process of autolysing the material for 2 hours before processing, the residue, protein and extract yields found in the control were changed from 70.3%, 9.0% and

16.5%, to 10.4%, 40.3% and 45%. The yields of crude protein found in the control were changed from 70.9%, 4.7% and 7.3% to 7.1%, 28.3% and 53.4%. When the protein nitrogen yield was examined and corrected for nitrogen originating from chitins, the yields of the three autolysed processed fractions became 2.0%, 36.8% and 3.5%.

References

- 1) Yanase, M.: Bulletin of Tokai Fisheries Research Laboratory, 65, 59-66 (1971).
- 2) Krychkova, N. I.: *Rybnoe Khozyaistvo*, 46, 11, 53-56 (1970).
U.S. Government Research and Development Reports, 71, 5, 40 (1971).
- 3) Yanase, M.: Bulletin of Tokai Fisheries Research Laboratory, 77, 97-102 (1974).
- 4) Hansen, R.P. and Meiklen, S.M.: *J. Sci. Fd Agric.*, 21, 203-206 (1970).
- 5) Sidhu, G.S., Montgomery, W.A., Holloway, G.L., Johnson, A.R. and Walker, D.M: *J. Sci. Fd Agric.*, 21, 293-296 (1970).

自己消化を利用する、オキアミ熱凝固たん白の 分離に関するソ連法の改変

築瀬正明

Modification of Russian Method for Separating Heat Coagulated Protein from Antarctic Krill

Masaaki YANASE

Abstract: The Antarctic krill *Euphausia superba* seems to be a promising resource as human food, but being the size small and the carapace which occupies nearly 30% of the whole body can be problems on processing. A method proposed by Russian workers to solve the problems was modified and the yields of the products were found much improved. The procedures were: frozen krill instead of fresh-caught one on which the Russians have worked was autolysed with equal volume of water at 45°C for two hours, pressed to separate the residue from the liquid. The liquid was then heated at 95°C for 15 min to coagulate the proteins, and it was centrifuged to separate the protein fraction, which also abounds in fat, from the remaining extract.

Calculating on dry based yields for the residue, protein fraction and extract were found for the non-autolysed sample 70.3, 9.0 and 16.5% respectively, and for the autolysed sample 10.4, 40.3 and 45% respectively. Total nitrogen was found distributing in the above three fractions 70.9, 4.7 and 17.3% for the non-autolysed sample, and 7.1, 28.3 and 53.4% for the autolysed sample.

It may seem from the above data that the yield of protein in the protein fraction for the autolysed sample is not large, but by correcting the amount of chitin nitrogen in the residue and extractive nitrogen in the extract the distribution of protein nitrogen for the residue, protein fraction and extract are calculated to be 2.0, 36.8 and 3.5% respectively.

南氷洋産オキアミ (*Euphausia superba*) の大量消費を図る上で障害となっているのは甲殻の存在である。体重の中で甲殻の占める割合は約3割に達する。¹⁾ 一般のえび類では頭胸部、腹部の甲殻を手や機械により除去できるが、体長が3~5cmのオキアミに対してはこの処理は行い難い。このためオキアミはサクラエビと同様に甲殻をつけたまま利用されることが多いが、この利用形態では嗜好上の制約から消費量には限度があるように思う。そこでオキアミより大量消費が期待できる汎用性ある食品ないしはその素材を製造するためには、甲殻部を効率的に除去して肉質部を採取する工夫が必要となる。

ソ連²⁾ では船上における処理加工として生鮮オキアミを先ず圧搾または遠心分離して甲殻を含む残渣と液汁に分離し、次に液汁を加熱の後遠心分離して熱凝固たん白質を主体とするたん白部と上層のエキスとに分別している。このたん白部はたん白質と共に脂肪に富み、ペースト状でチーズに似た外観があり、そのまま

もろもろの料理に用いられる外、素材としてプロセスチーズ、練製品などに加えられ、用途が広い。一方、エキスは濃縮して調味料に、残渣は家畜の飼料に用いられる。ところでこの方法による各部の収量は固形分として残渣 43%、たん白部 37%、エキス 18% と報告され、最も大きな収量を占めるのは残渣である。

著者はオキアミたん白質の分離にかかわる上記ソ連法について、残渣収量を減少せしめ、たん白部収量を増大せしめる方法を追求し、この結果前処理として原料を自己消化する時、一定の消化条件ではこの目的を達し得ることを認めた。

実験材料及び方法

材料 原料オキアミは海洋水産資源開発センターが昭和48年1月12日、59°—40' S, 23°—05' W の地点で採集した体長 25~45 mm のものである。船内で -34°C, 7 時間で凍結し、-27°C~-28.5°C に 2 カ月保ち、内地に到着してより -25°C~-27°C に 4 カ月、-40°C に 5 カ月保管した。

自己消化 上記オキアミの凍結試料を磨砕せずに使用した。ビーカーにこの試料 100g を秤量し、水 100cc を添加後恒温槽中 45°C¹⁾ で 1, 2, 3, 4 の各時間攪拌しつつ自己消化せしめる。対照ではオキアミ試料に水を添加後、直ちに下記の圧搾操作を行った。

残渣、たん白部、エキスの分別 ソ連法に準じ次のように実施した。各自己消化物をガーゼ 2 枚を用いて濾過の後、手絞りにより圧搾する。濾液と搾汁を合せて採取し（これを液汁と呼ぶ）、残渣は約 2 倍量の水を用いて水洗、再び圧搾して採取する。次に液汁を約 95°C で 15 分間蒸気加熱し、熱凝固性たん白質を沈でんせしめる。遠心分離 (5,000 rpm) により、この熱凝固たん白を主体とする沈でん部分（これをたん白部とする）と上層のエキスとに分離する。たん白部は約 2 倍量の水で水洗の後採取した。

なお残渣及びたん白部の各洗じょう液はいずれも廃棄したが、対照における残渣の洗じょう液には不溶固形分が特に多かったため、これより熱凝固たん白を回収したたん白部に加えた。

諸成分の定量 残渣、たん白部、エキスの各試料は固形分を除く諸成分の測定に先立ち、固形分含量がそれぞれ 97%, 55%, 30% 程度になるように乾燥した。

固形分、粗たん白質、脂肪、灰分、たん白窒素——前報²⁾と同様であって、たん白 N はトリクロール酢酸を用いる沈でん法によった。

キチン——自然物またはこれに準ずる試料中のキチンの定量に関しては確立された方法がないようである。著者は暫定的に次の重量法を用いた。乾燥物として 0.05~0.35g に相当する供試料を 15cc 遠濾管に秤量し、アルコール 10cc 及びアセトン 10cc による脱脂操作をそれぞれ行い、次に水 10cc を加え 120°C で 1 時間オートクレーブ中に加熱して熱水可溶分を除いた後、5% KOH 5cc による 120°C, 4 時間の加熱を 2 回行い、十分に水洗の後乾燥して得た残渣をキチンとする。これらの操作に伴う液体部分の除去は遠心分離 (3,000 rpm) によった。

実験結果

オキアミ原料を 0~4 時間自己消化の後、圧搾、加熱して取得した残渣、たん白部、エキスについて取得重量並びに固形分、粗たん白質、脂肪、灰分の含量を測定し、かつ三部におけるそれら成分の収量を算出した。この結果を Table 1 に示す。また Fig. 1 に消化時間による三部における各成分の収量（使用原料中の各成分量に対する%）の変化を図示する。

Table 1, Fig. 1 から判るように自己消化処理は残渣中のたん白質を初め各成分の収量をいずれも著しく減少せしめる。その効果は消化が進む程大きい。消化の初期段階において顕著である。自己消化の結果減少した残渣中の各成分は、その分だけたん白部またはエキスに移行する訳であるが、たん白部とエキスではこれら収量の増減に相違がある。消化時間 2 時間まではたん白部、エキス共に脂肪を除く各成分の収量が激

Table 1. Yields and analysis for autolysed krill products.*

Autolysis time	Fraction	Yield g	Dry matter		Crude protein***		Fat		Ash	
			Content %	Yield g	Content %	Yield g	Content %	Yield g	Content %	Yield g
0 hr (Control)	Re	75.5	21.8	16.46	59.9	9.86	10.6	1.74	11.7	1.93
	Pr	18.2	11.5	2.10	31.7	0.66	30.8	0.64	7.14	0.15
	Ex	100.4	3.84	3.86	62.2	2.40	0.57	0.02	19.7	0.76
	total	194.1 (97.1)		22.42 (95.8)		12.92 (92.9)		2.40 (80.0)		2.84 (93.1)
1 hr	Re	34.6	24.9	8.62	61.4	5.28	7.89	0.68	11.9	1.03
	Pr	36.5	19.2	7.00	32.8	2.30	30.4	2.14	9.09	0.64
	Ex	122.2	5.85	7.14	67.5	4.82	0.61	0.04	16.0	1.14
	total	193.3 (96.7)		22.76 (97.2)		12.40 (89.2)		2.86 (95.3)		2.81 (92.1)
2 hr	Re	7.9	31.0	2.44	40.5	0.99	3.26	0.08	23.9	0.59
	Pr	44.3	21.3	9.44	41.8	3.94	29.8	2.82	9.33	0.88
	Ex	144.4	7.30	10.54	70.4	7.42	0.42	0.03	12.3	1.30
	total	196.6 (98.3)		22.42 (95.8)		12.35 (88.8)		2.93 (97.7)		2.77 (90.8)
3 hr	Re	6.0	30.3	1.82	35.9	0.65	1.89	0.03	29.5	0.54
	Pr	48.3	18.6	8.98	35.3	3.17	31.4	2.82	9.40	0.84
	Ex	145.6	7.44	10.84	72.7	7.38	0.24	0.03	12.5	1.36
	total	199.9 (100)		21.64 (92.5)		11.70 (84.2)		2.88 (96.0)		2.74 (89.8)
4 hr	Re	5.7	31.5	1.80	35.6	0.64	2.00	0.04	27.6	0.49
	Pr	42.1	20.9	8.80	35.8	3.16	30.7	2.70	9.50	0.84
	Ex	149.5	7.49	11.20	71.5	8.00	0.36	0.04	12.4	1.38
	total	197.3 (98.7)		21.80 (93.2)		11.80 (84.9)		2.78 (92.6)		2.71 (88.8)
Original** material			23.4		13.9		3.00		3.05	

* Whole body of krill was autolysed for different hours, separated into pressed residue (Re), heat coagulated protein from the liquid portion (Pr) and the remaining extract (Ex). Contents for crude protein, fat and ash were calculated on dry basis. Figures in parentheses are % to the original amounts.

** frozen whole krill 100g + water 100g

*** Crude protein, N x 6.25

より10.4%, 40.3%, 45%に, 粗たん白質の取量は対照の70.9%, 4.7%, 17.3%より7.1%, 28.3%, 53.4%に変化した。但しキチンに由来するNを補正したたん白Nの取量で見ると, 自己消化処理三部は2.0%, 36.8%, 3.5%となる。

文 献

- 1) 築瀬正明: 東海区水研報, 65, 59-66 (1971).
- 2) KRYCHKOVA, N. I.: *Rybnoe Khozyaistvo*, 46, 11, 53-56 (1970).
U. S. Government Research and Development Reports, 71, 5, 40 (1971).
- 3) 築瀬正明: 東海区水研報, 77, 97-102 (1974).
- 4) HANSEN, R. P. and MEIKLEN, S. M.: *J. Sci. Fd Agric.*, 21, 203-206 (1970).
- 5) SIDHU, G. S., MONTGOMERY, W. A., HOLLOWAY, G. L., JOHNSON, A. R. and WALKER, D. M.: *J. Sci. Fd Agric.*, 21, 293-296 (1970).

WO 2007/080514
 Cited in Court.
 PCT Case

INTERNATIONAL SEARCH REPORT

International application No
 PCT/IB2007/000098

A. CLASSIFICATION OF SUBJECT MATTER
 INV. C11B1/10 C11B3/00

According to International Patent Classification (IPC) or to both national classification and IPC

B. FIELDS SEARCHED

Minimum documentation searched (classification system followed by classification symbols)
 C11B

Documentation searched other than minimum documentation to the extent that such documents are included in the fields searched

Electronic data base consulted during the international search (name of data base and, where practical, search terms used)

EPO-Internal

C. DOCUMENTS CONSIDERED TO BE RELEVANT

Category*	Citation of document, with indication, where appropriate, of the relevant passages	Relevant to claim No.
A	CA 1 098 900 A1 (INST ELEMENTOORGANICHESKIKH SO; VNII RYBNOGO KHOZYAISTVA I) 7 April 1981 (1981-04-07) cited in the application page 3	1-7
A	BR 8 701 265 A (GUILLOT BERNARD RENE [FR]) 29 December 1987 (1987-12-29) the whole document	1-10
A	GB 921 537 A (MARIO MERONI) 20 March 1963 (1963-03-20) the whole document	1-8
A	GB 2 097 014 A (BAIKOFF EUGENE MARC ALEXANDRE) 27 October 1982 (1982-10-27) the whole document	
	-/--	

Further documents are listed in the continuation of Box C.

See patent family annex.

* Special categories of cited documents:

- *A* document defining the general state of the art which is not considered to be of particular relevance
- *E* earlier document but published on or after the international filing date
- *L* document which may throw doubts on priority claim(s) or which is cited to establish the publication date of another citation or other special reason (as specified)
- *O* document referring to an oral disclosure, use, exhibition or other means
- *P* document published prior to the international filing date but later than the priority date claimed

- *T* later document published after the international filing date or priority date and not in conflict with the application but cited to understand the principle or theory underlying the invention
- *X* document of particular relevance; the claimed invention cannot be considered novel or cannot be considered to involve an inventive step when the document is taken alone
- *Y* document of particular relevance; the claimed invention cannot be considered to involve an inventive step when the document is combined with one or more other such documents, such combination being obvious to a person skilled in the art.
- *Z* document member of the same patent family

Date of the actual completion of the international search

26 June 2007

Date of mailing of the international search report

03/07/2007

Name and mailing address of the ISA/

European Patent Office, P.B. 5818 Patentlaan 2
 NL - 2280 HV Rijswijk
 Tel. (+31-70) 340-2040, Tx. 31 651 epo nl,
 Fax: (+31-70) 340-3016

Authorized officer

Popa, Marian

INTERNATIONAL SEARCH REPORT

International application No
PCT/IB2007/000098

C(Continuation). DOCUMENTS CONSIDERED TO BE RELEVANT		
Category*	Citation of document, with indication, where appropriate, of the relevant passages	Relevant to claim No.
A	US 6 800 299 B1 (BEAUDOIN ADRIEN [CA] ET AL) 5 October 2004 (2004-10-05) cited in the application the whole document	

Form PCT/ISA/210 (continuation of second sheet) (April 2005)

INTERNATIONAL SEARCH REPORT

Information on patent family members

International application No

PCT/IB2007/000098

Patent document cited in search report	Publication date	Publication date	Patent family member(s)	Publication date
CA 1098900	A1	07-04-1981	NONE	
BR 8701265	A	29-12-1987	CN	87102848 A
			DE	3764011 D1
			EG	18006 A
			EP	0243220 A1
			FR	2596060 A1
			GR	3000992 T3
			IN	171343 A1
			JP	62232499 A
			OA	8502 A
			PT	84522 A
			ZA	8702035 A
				13-01-1988
				06-09-1990
				30-06-1991
				28-10-1987
				25-09-1987
				10-12-1991
				19-09-1992
				12-10-1987
				29-07-1988
				01-04-1987
				26-08-1987
GB 921537	A	20-03-1963	NONE	
GB 2097014	A	27-10-1982	PH	17793 A
				13-12-1984
US 6800299	B1	05-10-2004	AU	765464 B2
			AU	6455299 A
			BR	9914699 A
			CA	2251265 A1
			WO	0023546 A1
			CN	1324394 A
			EP	1123368 A1
			JP	2002527604 T
			NO	20011915 A
			PL	347396 A1
			RU	2236441 C2
			UA	75029 C2
			ZA	200103235 A
				18-09-2003
				08-05-2000
				10-07-2001
				21-04-2000
				27-04-2000
				28-11-2001
				16-08-2001
				27-08-2002
				21-06-2001
				08-04-2002
				20-09-2004
				17-09-2001
				20-06-2002

JMJ

PATENT COOPERATION TREATY

From the INTERNATIONAL SEARCHING AUTHORITY

PCT

To:
 Jones, J. Mitchell
 CASIMIR JONES, S.C.
 2275 Deming Way, Suite 310
 Middleton, WI 53562
 ETATS-UNIS D'AMERIQUE

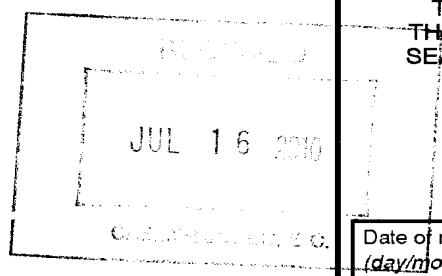

NOTIFICATION OF TRANSMITTAL OF
 THE INTERNATIONAL SEARCH REPORT AND
 THE WRITTEN OPINION OF THE INTERNATIONAL
 SEARCHING AUTHORITY, OR THE DECLARATION

(PCT Rule 44.1)

Date of mailing (day/month/year)	13 July 2010 (13-07-2010)
Applicant's or agent's file reference AKBM-30844/WO-1	FOR FURTHER ACTION See paragraphs 1 and 4 below
International application No. PCT/IB2010/000512	International filing date (day/month/year) 25 February 2010 (25-02-2010)
Applicant AKER BIOMARINE ASA	

- The applicant is hereby notified that the international search report and the written opinion of the International Searching Authority have been established and are transmitted herewith.
Filing of amendments and statement under Article 19:
 The applicant is entitled, if he so wishes, to amend the claims of the International Application (see Rule 46):
When? The time limit for filing such amendments is normally two months from the date of transmittal of the International Search Report.
Where? Directly to the International Bureau of WIPO, 34 chemin des Colombettes
 1211 Geneva 20, Switzerland, Facsimile No.: (41-22) 338.82.70
For more detailed instructions, see the notes on the accompanying sheet.
- The applicant is hereby notified that no international search report will be established and that the declaration under Article 17(2)(a) to that effect and the written opinion of the International Searching Authority are transmitted herewith.
- With regard to any protest** against payment of (an) additional fee(s) under Rule 40.2, the applicant is notified that:
 - the protest together with the decision thereon has been transmitted to the International Bureau together with the applicant's request to forward the texts of both the protest and the decision thereon to the designated Offices.
 - no decision has been made yet on the protest; the applicant will be notified as soon as a decision is made.
- Reminders**
 Shortly after the expiration of **18 months** from the priority date, the international application will be published by the International Bureau. If the applicant wishes to avoid or postpone publication, a notice of withdrawal of the international application, or of the priority claim, must reach the International Bureau as provided in Rules 90bis.1 and 90bis.3, respectively, before the completion of the technical preparations for international publication.
 The applicant may submit comments on an informal basis on the written opinion of the International Searching Authority to the International Bureau. The International Bureau will send a copy of such comments to all designated Offices unless an international preliminary examination report has been or is to be established. These comments would also be made available to the public but not before the expiration of 30 months from the priority date.
 Within **19 months** from the priority date, but only in respect of some designated Offices, a demand for international preliminary examination must be filed if the applicant wishes to postpone the entry into the national phase **until 30 months** from the priority date (in some Offices even later); otherwise, the applicant must, **within 20 months** from the priority date, perform the prescribed acts for entry into the national phase before those designated Offices.
 In respect of other designated Offices, the time limit of **30 months** (or later) will apply even if no demand is filed within 19 months.
 See the Annex to Form PCT/IB/301 and, for details about the applicable time limits, Office by Office, see the *PCT Applicant's Guide*, National Chapters.

ARTICLE 19
 AMEND
 9-13-10
 JP

Name and mailing address of the International Searching Authority  European Patent Office, P.B. 5818 Patentlaan 2 NL-2280 HV Rijswijk Tel. (+31-70) 340-2040 Fax: (+31-70) 340-3016	Authorized officer
---	--------------------

NOTES TO FORM PCT/ISA/220

These Notes are intended to give the basic instructions concerning the filing of amendments under article 19. The Notes are based on the requirements of the Patent Cooperation Treaty, the Regulations and the Administrative Instructions under that Treaty. In case of discrepancy between these Notes and those requirements, the latter are applicable. For more detailed information, see also the *PCT Applicant's Guide*.

In these Notes, "Article", "Rule", and "Section" refer to the provisions of the PCT, the PCT Regulations and the PCT Administrative Instructions, respectively.

INSTRUCTIONS CONCERNING AMENDMENTS UNDER ARTICLE 19

The applicant has, after having received the international search report and the written opinion of the International Searching Authority, one opportunity to amend the claims of the international application. It should however be emphasized that, since all parts of the international application (claims, description and drawings) may be amended during the international preliminary examination procedure, there is usually no need to file amendments of the claims under Article 19 except where, e.g. the applicant wants the latter to be published for the purposes of provisional protection or has another reason for amending the claims before international publication. Furthermore, it should be emphasized that provisional protection is available in some States only (see *PCT Applicant's Guide*, Annex B).

The attention of the applicant is drawn to the fact that amendments to the claims under Article 19 are not allowed where the International Searching Authority has declared, under Article 17(2), that no international search report would be established (see *PCT Applicant's Guide*, International Phase, paragraph 296).

What parts of the international application may be amended?

Under Article 19, only the claims may be amended.

During the international phase, the claims may also be amended (or further amended) under Article 34 before the International Preliminary Examining Authority. The description and drawings may only be amended under Article 34 before the International Examining Authority.

Upon entry into the national phase, all parts of the international application may be amended under Article 28 or, where applicable, Article 41.

When?

Within 2 months from the date of transmittal of the international search report or 16 months from the priority date, whichever time limit expires later. It should be noted, however, that the amendments will be considered as having been received on time if they are received by the International Bureau after the expiration of the applicable time limit but before the completion of the technical preparations for international publication (Rule 46.1).

Where not to file the amendments?

The amendments may only be filed with the International Bureau and not with the receiving Office or the International Searching Authority (Rule 46.2).

Where a demand for international preliminary examination has been/is filed, see below.

How?

Either by cancelling one or more entire claims, by adding one or more new claims or by amending the text of one or more of the claims as filed.

A replacement sheet or sheets containing a complete set of claims in replacement of all the claims previously filed must be submitted.

Where a claim is cancelled, no renumbering of the other claims is required. In all cases where claims are renumbered, they must be renumbered consecutively in Arabic numerals (Section 205(a)).

The amendments must be made in the language in which the international application is to be published.

What documents must/may accompany the amendments?

Letter (Section 205(b)):

The amendments must be submitted with a letter.

The letter will not be published with the international application and the amended claims. It should not be confused with the "Statement under Article 19(1)" (see below, under "Statement under Article 19(1)").

The letter must be in English or French, at the choice of the applicant. However, if the language of the international application is English, the letter must be in English; if the language of the international application is French, the letter must be in French.

NOTES TO FORM PCT/ISA/220 (continued)

The letter must indicate the differences between the claims as filed and the claims as amended. It must, in particular, indicate, in connection with each claim appearing in the international application (it being understood that identical indications concerning several claims may be grouped), whether

- (i) the claim is unchanged;
- (ii) the claim is cancelled;
- (iii) the claim is new;
- (iv) the claim replaces one or more claims as filed;
- (v) the claim is the result of the division of a claim as filed.

The following examples illustrate the manner in which amendments must be explained in the accompanying letter:

1. [Where originally there were 48 claims and after amendment of some claims there are 51]:
"Claims 1 to 29, 31, 32, 34, 35, 37 to 48 replaced by amended claims bearing the same numbers; claims 30, 33 and 36 unchanged; new claims 49 to 51 added."
2. [Where originally there were 15 claims and after amendment of all claims there are 11]:
"Claims 1 to 15 replaced by amended claims 1 to 11."
3. [Where originally there were 14 claims and the amendments consist in cancelling some claims and in adding new claims]:
"Claims 1 to 6 and 14 unchanged; claims 7 to 13 cancelled; new claims 15, 16 and 17 added."
"Claims 7 to 13 cancelled; new claims 15, 16 and 17 added; all other claims unchanged."
4. [Where various kinds of amendments are made]:
"Claims 1-10 unchanged; claims 11 to 13, 18 and 19 cancelled; claims 14, 15 and 16 replaced by amended claim 14; claim 17 subdivided into amended claims 15, 16 and 17; new claims 20 and 21 added."

"Statement under article 19(1)" (Rule 46.4)

The amendments may be accompanied by a statement explaining the amendments and indicating any impact that such amendments might have on the description and the drawings (which cannot be amended under Article 19(1)).

The statement will be published with the international application and the amended claims.

It must be in the language in which the international application is to be published.

It must be brief, not exceeding 500 words if in English or if translated into English.

It should not be confused with and does not replace the letter indicating the differences between the claims as filed and as amended. It must be filed on a separate sheet and must be identified as such by a heading, preferably by using the words "Statement under Article 19(1)."

It may not contain any disparaging comments on the international search report or the relevance of citations contained in that report. Reference to citations, relevant to a given claim, contained in the international search report may be made only in connection with an amendment of that claim.

Consequence if a demand for international preliminary examination has already been filed

If, at the time of filing any amendments and any accompanying statement, under Article 19, a demand for international preliminary examination has already been submitted, the applicant must preferably, at the time of filing the amendments (and any statement) with the International Bureau, also file with the International Preliminary Examining Authority a copy of such amendments (and of any statement) and, where required, a translation of such amendments for the procedure before that Authority (see Rules 55.3(a) and 62.2, first sentence). For further information, see the Notes to the demand form (PCT/IPEA/401).

If a demand for international preliminary examination is made, the written opinion of the International Searching Authority will, except in certain cases where the International Preliminary Examining Authority did not act as International Searching Authority and where it has notified the International Bureau under Rule 66.1bis(b), be considered to be a written opinion of the International Preliminary Examining Authority. If a demand is made, the applicant may submit to the International Preliminary Examining Authority a reply to the written opinion together, where appropriate, with amendments before the expiration of 3 months from the date of mailing of Form PCT/ISA/220 or before the expiration of 22 months from the priority date, whichever expires later (Rule 43bis.1(c)).

Consequence with regard to translation of the international application for entry into the national phase

The applicant's attention is drawn to the fact that, upon entry into the national phase, a translation of the claims as amended under Article 19 may have to be furnished to the designated/elected Offices, instead of, or in addition to, the translation of the claims as filed.

For further details on the requirements of each designated/elected Office, see the *PCT Applicant's Guide*, National Chapters.

PATENT COOPERATION TREATY

PCT

INTERNATIONAL SEARCH REPORT

(PCT Article 18 and Rules 43 and 44)

Applicant's or agent's file reference AKBM-30844/WO-1	FOR FURTHER ACTION		see Form PCT/ISA/220 as well as, where applicable, item 5 below.
International application No. PCT/IB2010/000512	International filing date (day/month/year) 25/02/2010	(Earliest) Priority Date (day/month/year) 26/02/2009	
Applicant AKER BIOMARINE ASA			

This international search report has been prepared by this International Searching Authority and is transmitted to the applicant according to Article 18. A copy is being transmitted to the International Bureau.

This international search report consists of a total of 4 sheets.

It is also accompanied by a copy of each prior art document cited in this report.

1. **Basis of the report**

a. With regard to the **language**, the international search was carried out on the basis of:

- the international application in the language in which it was filed
 a translation of the international application into _____, which is the language of a translation furnished for the purposes of international search (Rules 12.3(a) and 23.1(b))

b. This international search report has been established taking into account the **rectification of an obvious mistake** authorized by or notified to this Authority under Rule 91 (Rule 43.6bis(a)).

c. With regard to any **nucleotide and/or amino acid sequence** disclosed in the international application, see Box No. I.

2. **Certain claims were found unsearchable** (See Box No. II)

3. **Unity of invention is lacking** (see Box No III)

4. With regard to the **title**,

- the text is approved as submitted by the applicant
 the text has been established by this Authority to read as follows:

5. With regard to the **abstract**,

- the text is approved as submitted by the applicant
 the text has been established, according to Rule 38.2(b), by this Authority as it appears in Box No. IV. The applicant may, within one month from the date of mailing of this international search report, submit comments to this Authority

6. With regard to the **drawings**,

- a. the figure of the **drawings** to be published with the abstract is Figure No. _____
 as suggested by the applicant
 as selected by this Authority, because the applicant failed to suggest a figure
 as selected by this Authority, because this figure better characterizes the invention
- b. none of the figures is to be published with the abstract

INTERNATIONAL SEARCH REPORT

International application No
PCT/IB2010/000512

A. CLASSIFICATION OF SUBJECT MATTER
 INV. A23L1/325 A23D9/013 A23L1/275 A61K35/56
 ADD.

According to International Patent Classification (IPC) or to both national classification and IPC

B. FIELDS SEARCHED
 Minimum documentation searched (classification system followed by classification symbols)
 A23L A23D A61K

Documentation searched other than minimum documentation to the extent that such documents are included in the fields searched

Electronic data base consulted during the international search (name of data base and, where practical, search terms used)
 EPO-Internal, WPI Data, FSTA, BIOSIS, EMBASE

C. DOCUMENTS CONSIDERED TO BE RELEVANT

Category*	Citation of document, with indication, where appropriate, of the relevant passages	Relevant to claim No.
X —	WO 2008/117062 A1 (AKER BIOMARINE ASA [NO]; GOLDING LOUISE [GB]; BRUHEIM INGE [NO]; GRIIN) 2 October 2008 (2008-10-02) the whole document -----	1-14, 17
X	WO 2007/080515 A1 (AKER BIOMARINE ASA [NO]; LARSEN PETER MOSE [DK]; FEY STEPHEN JOHN [DK]) 19 July 2007 (2007-07-19) page 3, paragraph 4 - page 5, paragraph 1; claims 1-28; example 1 -----	16
X,P	WO 2009/027692 A2 (AKER BIOMARINE ASA [NO]; GOLDING LOUISE [GB]; OEISTEIN HOESTMARK [NO];) 5 March 2009 (2009-03-05) the whole document ----- -/--	1-17

Further documents are listed in the continuation of Box C.

See patent family annex.

* Special categories of cited documents :

"A" document defining the general state of the art which is not considered to be of particular relevance	"T" later document published after the international filing date or priority date and not in conflict with the application but cited to understand the principle or theory underlying the invention
"E" earlier document but published on or after the international filing date	"X" document of particular relevance; the claimed invention cannot be considered novel or cannot be considered to involve an inventive step when the document is taken alone
"L" document which may throw doubts on priority claim(s) or which is cited to establish the publication date of another citation or other special reason (as specified)	"Y" document of particular relevance; the claimed invention cannot be considered to involve an inventive step when the document is combined with one or more other such documents, such combination being obvious to a person skilled in the art.
"O" document referring to an oral disclosure, use, exhibition or other means	"&" document member of the same patent family
"P" document published prior to the international filing date but later than the priority date claimed	

Date of the actual completion of the international search 24 June 2010	Date of mailing of the international search report 13/07/2010
Name and mailing address of the ISA/ European Patent Office, P.B. 5818 Patentlaan 2 NL - 2280 HV Rijswijk Tel. (+31-70) 340-2040, Fax: (+31-70) 340-3016	Authorized officer Korb, Margit

INTERNATIONAL SEARCH REPORT

International application No
PCT/IB2010/000512

C(Continuation). DOCUMENTS CONSIDERED TO BE RELEVANT		
Category*	Citation of document, with indication, where appropriate, of the relevant passages	Relevant to claim No.
A	<p>YAMAGUCHI K ET AL: "SUPERCRITICAL CARBON DIOXIDE EXTRACTION OF OILS FROM ANTARCTIC KRILL" JOURNAL OF AGRICULTURAL AND FOOD CHEMISTRY, AMERICAN CHEMICAL SOCIETY, US LNKD- DOI:10.1021/JF00071A034, vol. 34, no. 5, 1 January 1986 (1986-01-01), pages 904-907, XP001183110 ISSN: 0021-8561 the whole document</p>	1-17
A	<p>TAKAICHI S ET AL: "Fatty acids of astaxanthin esteres in krill determined by mild mass spectrometry" COMPARATIVE BIOCHEMISTRY AND PHYSIOLOGY. PART B, BIOCHEMISTRY AND MOLECULAR BIOLOGY, ELSEVIER, OXFORD, GB LNKD- DOI:10.1016/S1096-4959(03)00209-4, vol. 136, 1 January 2003 (2003-01-01), pages 317-322, XP008110880 ISSN: 1096-4959 the whole document</p>	1-17

INTERNATIONAL SEARCH REPORT

Information on patent family members

International application No
PCT/IB2010/000512

Patent document cited in search report	Publication date	Patent family member(s)	Publication date
WO 2008117062 A1	02-10-2008	AU 2008231570 A1 CA 2682068 A1 EP 2144618 A1 US 2008274203 A1	02-10-2008 02-10-2008 20-01-2010 06-11-2008
WO 2007080515 A1	19-07-2007	AR 059012 A1	05-03-2008
WO 2009027692 A2	05-03-2009	AU 2008291978 A1 CA 2697730 A1 EP 2190298 A2 US 2009061067 A1	05-03-2009 05-03-2009 02-06-2010 05-03-2009

PATENT COOPERATION TREATY

From the
INTERNATIONAL SEARCHING AUTHORITY

PCT

To:

see form PCT/ISA/220

**WRITTEN OPINION OF THE
INTERNATIONAL SEARCHING AUTHORITY
(PCT Rule 43bis.1)**

Date of mailing
(day/month/year) see form PCT/ISA/210 (second sheet)

Applicant's or agent's file reference
see form PCT/ISA/220

FOR FURTHER ACTION
See paragraph 2 below

International application No.
PCT/B2010/000512

International filing date (day/month/year)
25.02.2010

Priority date (day/month/year)
26.02.2009

International Patent Classification (IPC) or both national classification and IPC
INV. A23L1/325 A23D9/013 A23L1/275 A61K35/56

Applicant
AKER BIOMARINE ASA

1. This opinion contains indications relating to the following items:

- Box No. I Basis of the opinion
- Box No. II Priority
- Box No. III Non-establishment of opinion with regard to novelty, inventive step and industrial applicability
- Box No. IV Lack of unity of invention
- Box No. V Reasoned statement under Rule 43bis.1(a)(i) with regard to novelty, inventive step and industrial applicability; citations and explanations supporting such statement
- Box No. VI Certain documents cited
- Box No. VII Certain defects in the international application
- Box No. VIII Certain observations on the international application

2. FURTHER ACTION

If a demand for international preliminary examination is made, this opinion will usually be considered to be a written opinion of the International Preliminary Examining Authority ("IPEA") except that this does not apply where the applicant chooses an Authority other than this one to be the IPEA and the chosen IPEA has notified the International Bureau under Rule 66.1bis(b) that written opinions of this International Searching Authority will not be so considered.

If this opinion is, as provided above, considered to be a written opinion of the IPEA, the applicant is invited to submit to the IPEA a written reply together, where appropriate, with amendments, before the expiration of 3 months from the date of mailing of Form PCT/ISA/220 or before the expiration of 22 months from the priority date, whichever expires later.

For further options, see Form PCT/ISA/220.

3. For further details, see notes to Form PCT/ISA/220.

Name and mailing address of the ISA:



European Patent Office
D-80298 Munich
Tel. +49 89 2399 - 0
Fax: +49 89 2399 - 4465

Date of completion of
this opinion

see form
PCT/ISA/210

Authorized Officer

Korb, Margit

Telephone No. +49 89 2399-8639



Box No. I Basis of the opinion

1. With regard to the **language**, this opinion has been established on the basis of:
 - the international application in the language in which it was filed
 - a translation of the international application into , which is the language of a translation furnished for the purposes of international search (Rules 12.3(a) and 23.1 (b)).
2. This opinion has been established taking into account the **rectification of an obvious mistake** authorized by or notified to this Authority under Rule 91 (Rule 43bis.1(a))
3. With regard to any **nucleotide and/or amino acid sequence** disclosed in the international application, this opinion has been established on the basis of a sequence listing filed or furnished:
 - a. (means)
 - on paper
 - in electronic form
 - b. (time)
 - in the international application as filed
 - together with the international application in electronic form
 - subsequently to this Authority for the purposes of search
4. In addition, in the case that more than one version or copy of a sequence listing has been filed or furnished, the required statements that the information in the subsequent or additional copies is identical to that in the application as filed or does not go beyond the application as filed, as appropriate, were furnished.
5. Additional comments:

Box No. V Reasoned statement under Rule 43bis.1(a)(i) with regard to novelty, inventive step or industrial applicability; citations and explanations supporting such statement

1. Statement

Novelty (N)	Yes: Claims	
	No: Claims	<u>1-17</u>
Inventive step (IS)	Yes: Claims	
	No: Claims	<u>1-17</u>
Industrial applicability (IA)	Yes: Claims	<u>1-17</u>
	No: Claims	

2. Citations and explanations

see separate sheet

Box No. VI Certain documents cited

1. Certain published documents (Rules 43*bis*.1 and 70.10)
and / or
2. Non-written disclosures (Rules 43*bis*.1 and 70.9)
see form 210

Re Item V

Reasoned statement with regard to novelty, inventive step or industrial applicability; citations and explanations supporting such statement

1 Reference is made to the following documents:

D1: WO 2008/117062

D2: WO 2007/080515

- 2 D1 (cf. claims 1-59) discloses krill oil compositions comprising high amounts of phospholipids, astaxanthin, omega-3 fatty acids. However, D1 does not explicitly mention that the oil composition has Newtonian fluidity at 25 °C as stated in claim 1. D1 (example 5) mentions the successful encapsulation of exemplified oil products into soft gels. Furthermore D1 reads "During the encapsulation it was observed that any further increase in phospholipids and thereby viscosity will make it very difficult to encapsulate the final product." As D1 does not mention any non-Newtonian fluidity behaviour and as the components and its amounts defined in claim 1 are considered essential for the viscosity of the claimed extracted oil and as these components in amounts are also present in the D1 krill oil compositions, it is considered that the requirement of the physical parameter Newtonian fluidity as defined in claim 1 is met also for the D1 krill oil compositions .
Hence D1 takes away novelty from claim 1 (Art. 33(2) PCT).
The particular range of viscosity as defined in claims 6 and 8 is not mentioned in D1 but the same conclusions are made with respect to claims 6 and 8, i.e. the same components in the amounts as required for the claimed extracted oil leads inevitably to the viscosity defined in claims 6 and 8. Thus it is considered that D1 appears also to take away novelty from said claims 6 and 8 (Art. 33(2) PCT). The dependent product claims 2-5, 7, 9-14 and 17 are also not considered novel over D1 (Art. 33(2) PCT).
The claimed products do also not involve an inventive step over D1 (Art. 33(3) PCT).
- 3 D2 (cf. p.1, paragraph 1, example 1, fig. 1) discloses a method of extracting lipid fractions from krill without using high temperatures (max. below 40 °C) and/or organic solvents. D2 is focused on krill oil extraction but is silent on

astaxanthin. D2 does also not disclose an extraction step of oil from the phospholipid and protein concentrate.

The D1 krill oil is extracted from denatured krill meal by supercritical fluid extraction and with polar organic solvent in a two-stage process. However, an extraction of oil from krill by the process as defined in claim 16 is not disclosed in D1.

- 4 The process for producing a krill oil according to claim 16 is not in consistency with the description (Art. 6 PCT). The description discloses numerous of embodiments for the process inter alia a heating step of the first aqueous phase at a temperature sufficient to form a phospholipid-protein coagulate or phospholipid-protein precipitate (compare e.g p.5, l.1-3, p.3, l.21-22) whereas claim 16 defines heating said first aqueous phase to produce a phospholipid and a protein concentrate. The starting material other than krill as exemplified in the description (cf. p.3, l.24-27) and further process steps (compare with e.g. p.5, last paragraph onwards) are not defined/covered by claim 16. The term "about" in context with ranges stated in the claims and throughout the description detracts also from the general clarity of the claims (Art. 6 PCT).
- 5 It is considered that the general gist of the present application is to avoid any high temperatures and organic solvents when extracting oil from krill. As D2 already discloses no organic solvents and gentle conditions, in particular temperature conditions and as D2 (p.9, last paragraph but one) discloses also the presence of minute amounts of proteins in krill oil, it appears obvious for the skilled person to produce a phospholipid and protein concentrate from the aqueous phase by a heating step and then to extract the oil from the phospholipid and protein concentrate. Thus the claimed process does not involve an inventive step over D2 (Art. 33(3) PCT).

Re Item VI

Certain documents cited

Application No Patent No	Publication date (day/month/year)	Filing date (day/month/year)	Priority date (valid claim) (day/month/year)
WO 2009/027692	05.03.2009	29.08.2008	29.08.2007

Document P1: WO 2009/027692 , although not constituting prior art within the meaning of Rule 64(1)(b) PCT, appears to disclose all the features of claims 1-17 and therefore appears to be pertinent for the assessment of novelty of the present claims under Rule 70.10 PCT.

The applicant's attention is drawn to the fact that P1 could be furthermore considered relevant for the assessment of novelty, depending on national law, upon entering the regional phase, e.g. before the EPO.

Possible steps after receipt of the international search report (ISR) and written opinion of the International Searching Authority (WO-ISA)

General information

For all international applications filed on or after 01/01/2004 the competent ISA will establish an ISR. It is accompanied by the WO-ISA. Unlike the former written opinion of the IPEA (Rule 66.2 PCT), the WO-ISA is not meant to be responded to, but to be taken into consideration for further procedural steps. This document explains about the possibilities.

Amending claims under Art. 19 PCT

Within 2 months after the date of mailing of the ISR and the WO-ISA the applicant may file amended claims under Art. 19 PCT directly with the International Bureau of WIPO. The PCT reform of 2004 did not change this procedure. For further information please see Rule 46 PCT as well as form PCT/ISA/220 and the corresponding Notes to form PCT/ISA/220.

Filing a demand for international preliminary examination

In principle, the WO-ISA will be considered as the written opinion of the IPEA. This should, in many cases, make it unnecessary to file a demand for international preliminary examination. If the applicant nevertheless wishes to file a demand this must be done before expiry of 3 months after the date of mailing of the ISR/ WO-ISA or 22 months after priority date, whichever expires later (Rule 54bis PCT). Amendments under Art. 34 PCT can be filed with the IPEA as before, normally at the same time as filing the demand (Rule 66.1 (b) PCT).

If a demand for international preliminary examination is filed and no comments/amendments have been received the WO-ISA will be transformed by the IPEA into an IPRP (International Preliminary Report on Patentability) which would merely reflect the content of the WO-ISA. The demand can still be withdrawn (Art. 37 PCT).

Filing informal comments

After receipt of the ISR/WO-ISA the applicant may file informal comments on the WO-ISA directly with the International Bureau of WIPO. These will be communicated to the designated Offices together with the IPRP (International Preliminary Report on Patentability) at 30 months from the priority date. Please also refer to the next box.

End of the international phase

At the end of the international phase the International Bureau of WIPO will transform the WO-ISA or, if a demand was filed, the written opinion of the IPEA into the IPRP, which will then be transmitted together with possible informal comments to the designated Offices. The IPRP replaces the former IPER (international preliminary examination report).

Relevant PCT Rules and more information

Rule 43 PCT, Rule 43bis PCT, Rule 44 PCT, Rule 44bis PCT, PCT Newsletter 12/2003, OJ 11/2003, OJ 12/2003

Bitte beachten Sie, dass angeführte Nichtpatentliteratur (wie z. B. wissenschaftliche oder technische Dokumente) je nach geltendem Recht dem Urheberrechtsschutz und/oder anderen Schutzarten für schriftliche Werke unterliegen könnte. Die Vervielfältigung urheberrechtlich geschützter Texte, ihre Verwendung in anderen elektronischen oder gedruckten Publikationen und ihre Weitergabe an Dritte ist ohne ausdrückliche Zustimmung des Rechtsinhabers nicht gestattet.

Veillez noter que les ouvrages de la littérature non-brevets qui sont cités, par exemple les documents scientifiques ou techniques, etc., peuvent être protégés par des droits d'auteur et/ou toute autre protection des écrits prévue par les législations applicables. Les textes ainsi protégés ne peuvent être reproduits ni utilisés dans d'autres publications électroniques ou imprimées, ni rediffusés sans l'autorisation expresse du titulaire du droit d'auteur.

Please be aware that cited works of non-patent literature such as scientific or technical documents or the like may be subject to copyright protection and/or any other protection of written works as appropriate based on applicable laws. Copyrighted texts may not be copied or used in other electronic or printed publications or re-distributed without the express permission of the copyright holder.

- Bligh, E. G.; Dyer, W. J. *Can. J. Biochem. Physiol.* 1959, 37, 911.
 Brannolte, H. D.; Mangold, H. K.; Stahl, E. *Chem. Phys. Lipids* 1983, 33, 297.
 Brogle, H. *Chem. Ind.* 1982, 19, 385.
 Friedrich, J. P.; List, G. R. *J. Agric. Food Chem.* 1982, 30, 192.
 Hannay, J. B.; Hogarth, J. *Proc. R. Soc. London* 1879, 29, 324.
 Hubert, P.; Vitzthum, O. G. *Angew. Chem., Int. Ed. Engl.* 1978, 17, 710.
 Kaufmann, W.; Biernoth, G.; Frade, E.; Merk, W.; Precht, D.; Timmen, H. *Milchwissenschaft* 1982, 37, 92.
 Krukonia, V. *JAOCS* 1984, 61, 698.
 Miki, W.; Toriu, N.; Kondo, Y.; Murakami, M.; Yamaguchi, K.; Konosu, S.; Satake, M.; Fujita, T. *Bull. Jpn. Soc. Fish.* 1983, 49, 1417.
 Mori, M.; Hikichi, S. *Rep. Cent. Res. Lab. Nippon Suisan Co.* 1976, No. 11, 12.
 Needleman, P.; Raz, A.; Mikea, S. M.; Ferrandelli, J. A.; Sprecher, H. *Proc. Natl. Acad. Sci. U.S.A.* 1979, 76, 944.
 Paul, P. F.; Wise, W. S. *The Principles of Gas Extraction*; Mills and Boon, Ltd.: London, England, 1971.
 Stahl, E.; Schutz, E.; Manglod, H. K. *J. Agric. Food Chem.* 1980, 28, 1153.
 Wilke, G. *Angew. Chem., Int. Ed. Engl.* 1978, 17, 701.
 Yamaguchi, K.; Miki, W.; Toriu, N.; Kondo, Y.; Murakami, M.; Konosu, S.; Satake, M.; Fujita, T. *Bull. Jpn. Soc. Sci. Fish.* 1983, 49, 1411.
 Zosel, K. *Ger. Pat.* 2 005 243, 1974.
 Zosel, K. *Angew. Chem., Int. Ed. Engl.* 1978, 17, 701.

Received for review December 9, 1985. Revised manuscript received April 2, 1986. Accepted April 22, 1986.

Isolation of Estrogens in Bovine Plasma and Tissue Extracts Using Alumina and Ion-Exchange Microcolumns

Marjorie B. Medina* and Daniel P. Schwartz

Estrogens (estradiol, estrone) in picogram quantities can be isolated quantitatively from bovine plasma and tissue extracts by a simple procedure. Bovine plasma (0.1–1.0 mL) was extracted with either acetone or ether while tissues (1 g) were extracted with acetone. Extracts were passed through two disposable plastic tubes vertically arranged in tandem. The top column (5-mL pipet tip) contained 1–1.5 g of dry basic alumina and removed interfering substances. The bottom column (transfer pipet) contained 0.3–1.0 g of wet anion-exchange resin in the phosphate form and trapped the estrogens through their phenolic hydroxyl group. The estrogens were then eluted with acetic acid in acetone following a thorough washing of the columns. Recoveries greater than 95% were obtained when extracts of bovine plasma and tissue extracts of liver, kidney, and heart were spiked with either tritiated 17β -estradiol or estrone. This technique offers the advantages of simplicity, rapidity, and accuracy over traditional methods employed routinely in the purification of estrogens.

INTRODUCTION

Partial purification of estrogens extracted from animal tissues and fluids is necessary prior to most methods of quantitation. The methods currently employed in routine analysis of estrogens such as paper chromatography (Shutt, 1969), Sephadex LH-20 (Sjovall and Nystrom, 1968; Murphy, 1970; Mikhail et al., 1970; Murphy and Diez D'Aux, 1975), and Celite column cleanup (Korenman et al., 1969; Abraham et al., 1970) are tedious with reported recoveries of only 65–85%. Aqueous solutions of estrogens had also been purified by ion exchange (Järvenpää et al., 1979) with reported recoveries of 50–90%. Covey and co-workers (1984) also used an anion-exchange resin for purification of diethylstilbestrol and dienestrol.

This paper describes a relatively simple and rapid technique that can quantitatively isolate the estrogens (estradiol, estrone) from acetone extracts of bovine blood plasma and tissues for subsequent chromatographic analysis. This study is a preliminary report on the development of screening methods to detect and measure residues of estrogens in the blood and edible tissues of food-producing animals given growth-promoting hormones

Table I. Column Conditions for Isolation of [3 H]Estradiol Added to Bovine Plasma and Tissue Extracts Using the Alumina Ion-Exchange Columns

sample	extr appl to col, mL	basic alumina, g	resin suspensn, mL
A. Bovine Plasma (mL)			
acetone extractn			
0.1	2	1.0 (3) ^a	1.0 (2) ^b
0.5	4	1.0 (3)	2.0 (3)
1.0	8	1.5 (5)	3.0 (4)
1.0	8 ^c	1.5 (5)	3.0 (4)
ether extractn			
1.0	4	1.0 (3)	1.0 (2)
B. Bovine Tissues (1 g/8 mL of Acetone)			
liver	2	1.0 (3)	2.0 (3)
muscle	2	1.0 (3)	2.0 (3)
heart	2	1.0 (3)	2.0 (3)
kidney	2	1.0 (3)	2.0 (3)

^a Total volume 95% acetone (mL) to wash alumina column.
^b Total volume 10% HOAc in acetone (mL) to elute [3 H]estradiol.
^c Plasma/acetone mixture added directly to column with glass wool on top of alumina bed.

Eastern Regional Research Center, Agricultural Research Service, U.S. Department of Agriculture, Philadelphia, Pennsylvania 19118.

such as 17β -estradiol and to ascertain their absence such that safe and wholesome food can be delivered to consumers.

This article not subject to U.S. Copyright. Published 1988 by the American Chemical Society

RIMFROST EXHIBIT 1024 page 2893

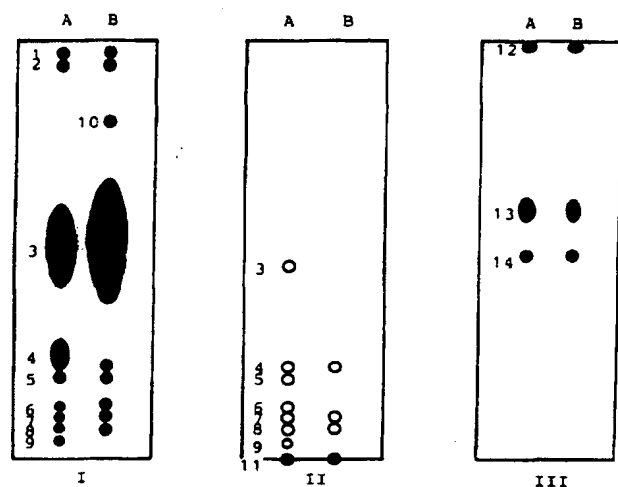

Figure 2. Thin-layer chromatograms of krill oils extracted with supercritical carbon dioxide (I) and the residual lipids (II and III): A, freeze-dried krill; B, krill meal. Stationary phase: silica gel 60F₂₅₄ in chromatograms I-III. Mobile phase: petroleum ether-diethyl ether-acetic acid (90:10:1) in chromatograms I and II; chloroform-methanol-water (65:25:4) in chromatogram III. Identification: 50% H₂SO₄ in chromatograms I and II; Dragendorff reagent in chromatogram III.

Table III. Fatty Acid Composition of Oils Extracted from Krill Samples with Supercritical Carbon Dioxide^a

fatty acid	freeze-dried krill	krill meal	fatty acid	freeze-dried krill	krill meal
12:0	0.25	0.28	18:4	1.98	3.21
14:0	17.42	19.08	20:1	1.82	1.86
15:0	0.28	0.21	20:3	0.15	0.09
16:0	22.05	18.78	20:4 ω 6 +	1.08	0.55
16:1	11.78	16.30	22:1		
17:1	1.09	1.70	20:4 ω 3	0.32	0.30
18:0	1.47	1.33	20:5	11.36	6.62
18:1	21.37	22.40	22:5	0.20	0.18
18:2	2.24	3.56	22:6	4.44	2.71
18:3	0.30	0.26	24:1	0.32	0.42
			unidentified	0.08	0.16

^a Conditions of extraction: 250 kg/cm², 60 °C.

veloped with petroleum ether-diethyl ether-acetic acid (90:10:1), indicating that the residual lipids were composed almost exclusively of polar lipids together with denatured and polymerized lipids. Furthermore, as shown in chromatogram III, when the residual lipids were developed using chloroform-methanol-water (65:25:4) and visualized with Dragendorff reagent, at least three orange-red spots (12-14) of phospholipids were detected. These results confirmed that the SC-CO₂ extraction of krill samples yielded only nonpolar undenatured oils, as mentioned above.

Table III shows the fatty acid compositions of the oils extracted with SC-CO₂ at a pressure of 250 kg/cm² and a temperature of 60 °C. Essentially no differences were noticed in the fatty acid compositions of the oils extracted under other conditions. Whereas the main fatty acids were 14:0, 16:0, 16:1, 18:1, and 20:5 in oils of both freeze-dried krill and krill meal, significant differences were found between krill meal and freeze-dried krill oils in the 16:1, 20:5, and 22:6 acids.

Table IV shows the content and composition of carotenoids in the oils extracted with SC-CO₂ from the

Table IV. Content and Composition of Carotenoids in Oils Extracted from Freeze-Dried Krill with Supercritical Carbon Dioxide

carotenoid	temp of extractn, °C		
	40	60	80
total content, mg/100 g oil	43.5-50.4	19.1-24.3	7.0-8.7
composition, %			
astaxanthin diester	48-58	78-83	<i>b</i>
astaxanthin monoester	33-44	13-15	<i>b</i>
astaxanthin	5-7	3-4	<i>b</i>
unidentified	0-2	1	<i>b</i>

^a Pressure: 250 kg/cm². ^b Unable to be determined due to decomposition.

freeze-dried krill at a fixed pressure of 250 kg/cm² and stepwise increase of temperatures. In previous papers (Yamaguchi et al., 1983; Miki et al., 1983), we reported that the carotenoids of the Antarctic krill consist almost exclusively of astaxanthin and its esters and that their stabilities against heat and organic solvents are in the order of astaxanthin diester, astaxanthin monoester, and astaxanthin. It is evident that the astaxanthin tends to be decomposed according to their instabilities during extraction with SC-CO₂. Although Zosel (1978) pointed out that SC-CO₂ is suitable for the isolation of thermally labile substances because of its low critical temperature, the above finding indicates that some compounds like astaxanthin could be unstable under high pressures of SC-CO₂ at a temperature, for example 80 °C, that never induces the decomposition of astaxanthin under atmospheric pressure (Miki et al., 1983). Attention should be paid to this fact in the extraction of natural products with SC-CO₂.

In spite of such a disadvantage, we proved that SC-CO₂ is effective in obtaining nonpolar lipids from Antarctic krill by a simple, one-step extraction that excludes the phospholipids that have hampered the utilization of krill oils. In this connection, several workers (Stahl et al., 1980; Friedrich and List, 1982) have reported the removal of polar lipids from seed oils with SC-CO₂, but the reason why polar lipids can be removed with SC-CO₂ has not yet been elucidated.

As shown in Table III, the oils extracted from krill samples with SC-CO₂ contained fairly high proportions of eicosapentaenoic acid (EPA), which is known as a medically useful substance (Needleman et al., 1979). Recently, Krukoni (1984) reported that, by using SC-CO₂ for the fractionation of fish oils, EPA could be concentrated to 15% from 8%. Used in this manner, SC-CO₂ extraction will produce useful substances from aquatic organisms.

Abbreviations Used: SC-CO₂, supercritical carbon dioxide; EPA, eicosapentaenoic acid.

ACKNOWLEDGMENT

We are indebted to Dr. Y. Miyake, Director of the Central Research Institute of Iwatani & Co., Ltd., and Dr. T. Fujita, Director of the Central Research Laboratory of Nippon Suisan Kaisha, Ltd., for their valuable advice. Thanks are also due to N. Ando and K. Kajiyama, Iwatani & Co., Ltd., for their help in SC-CO₂ extraction experiments. We also thank Professor George J. Flick, Department of Food Science and Technology, Virginia Polytechnic Institute and State University, for his review of this paper.

Registry No. EPA, 1553-41-9; CO₂, 124-38-9; astaxanthin, 472-61-7.

LITERATURE CITED

Association of Official Analytical Chemists, Inc. *Official Methods of Analysis of the Association of Official Analytical Chemists*, 14th ed.; AOAC: Washington, DC, 1984.

Table I. Proximate Composition of Krill Samples (as Percentage of Total)

	frozen krill	freeze-dried krill	krill mean
moisture	77.7	7.83	1.75
protein ^a	14.0	52.0	60.7
fat	3.01	16.7	11.5
ash	2.74	12.2	13.4
total	97.5	88.7	87.4

^aTotal nitrogen was multiplied by 6.25.

Table II. Yields of Oils Extracted from Krill Samples with Supercritical Carbon Dioxide

sample	extractn condn ^a	amt, g/100 g sample			rec, ^c %
		extr oil	resid lipid ^b	total lipid ^b	
freeze-dried krill	250/40	11.2	7.6		95
	250/60	11.7	7.9	19.7	98
	250/80	11.5	8.1		99
krill meal	250/40	4.5	8.1		84
	250/60	4.1	9.0	16.2	81
	250/80	4.0	8.4		77
	400/40	4.0	9.0		80

^aPressure, kg/cm²/temperature, °C. ^bMeasured by the Bligh-Dyer method. ^cRecovery = [extr oil + resid lipid]/total lipid × 100.

After saponification and then esterification with boron trifluoride-methanol complex, the fatty acid composition of the oils was determined by GLC with a Shimadzu GC-5A gas chromatograph using a glass column (2 m × 3 mm) packed with 10% DEGS on Celite 545 (80-100 mesh) at a temperature of 200 °C, with nitrogen carrier gas at a flow rate of 25 mL/min. The temperature of the detector and injection port was 250 °C.

The composition of carotenoids in the SC-CO₂-extracted oils and in the residual lipids was analyzed by the method reported by Yamaguchi et al. (1983).

RESULTS AND DISCUSSION

Table I shows the proximate compositions of the krill samples. Total recoveries of components of the freeze-dried krill and the krill meal were rather low, because of the application of the Soxhlet method with diethyl ether for the extraction of lipid. The lipid of krill, which contains high proportions of polyunsaturated fatty acids and phospholipids (Mori and Hikichi, 1976), deteriorates rapidly and diethyl ether insoluble lipid increases when krill is dehydrated or treated at high temperatures. In this connection, the lipid content of the krill meal was found to be 16.2% when measured by the method of Bligh and Dyer (1959) with chloroform-methanol. Furthermore, the low recoveries in the freeze-dried krill and the krill meal may be also accounted for by chitin, contents of which should be higher than that in the frozen krill.

Figure 1 presents the SC-CO₂ extraction curves with time of oils from the freeze-dried krill and krill meal with SC-CO₂ at 250 kg/cm² and 80 °C. For freeze-dried krill, extraction of oil practically terminated in 3-4 h and after the use of 2-3 kg of CO₂ at a flow rate of about 0.6 kg/h. Extraction of the krill meal oil, however, ceased after 2-3 h and the use of 1-2 kg of CO₂. Reproducibility in the experiments was very high.

Table II shows the yields of oils extracted with SC-CO₂ under different conditions. In every sample the extracted oil was fluid and bright red from carotenoids. When the temperature was increased from 40 to 60 and 80 °C at a fixed pressure of 250 kg/cm² and when the pressure was increased from 250 to 400 kg/cm² at a fixed temperature of 40 °C, yields of extracted oils remained almost constant.

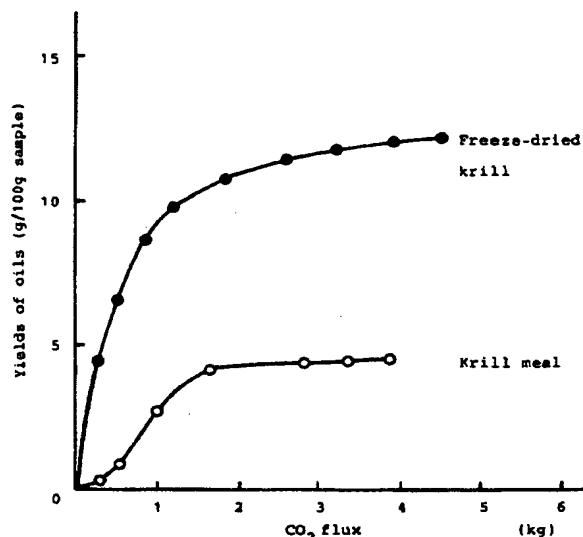

Figure 1. Extraction curves of krill oils with supercritical carbon dioxide at 250 kg/cm² and 80 °C.

In this connection, Brogle (1982) reported that the solvent power of SC-CO₂ for organic substances is highly dependent on its pressure and temperature; at low pressures, around 100 kg/cm², solvent power drops with rising temperatures, and at pressures higher than approximately 150 kg/cm², its solvent power increases. For the krill samples, however, the amounts of extracted oils were almost constant regardless of pressures and temperatures examined. That is, even under the lowest temperature/pressure combination (250 kg/cm² and 40 °C), nearly all oils extractable with SC-CO₂ were recovered. Further, yields of krill meal oil were one-third of those of freeze-dried krill oil. The lower yields from meal oil are probably attributable to the fact that the oil of the krill meal was in part deteriorated by oxidation or polymerization to such an extent that only limited extraction occurred with SC-CO₂. Judging from this result, we think that SC-CO₂ extraction is suitable method to obtain undenatured oils from meals of marine origin.

To determine the composition of the extracted oils, we partitioned them by chromatography on a silica gel column using a mobile phase of chloroform and methanol. Approximately 100% of the oils from both krill samples was recovered in the fraction eluted with chloroform, proving that the oils extracted with SC-CO₂ were composed exclusively of nonpolar lipids with practically no polar lipids. Figure 2 shows TLC patterns of the oils extracted with SC-CO₂ and the residual lipids. By co-TLC with standard reagents, the main component of the extracted oils was found to be triglycerides (spot 3) and the minor components were identified as hydrocarbon (1), cholesteryl ester (2), free fatty acids (4), diglycerides (5), cholesterol (7), monoglycerides (8), and carotenoids (6 and 9), as illustrated in chromatogram I. In addition, a small amount of a nonpolar lipid (spot 10) was found to be present in the oil from the krill meal, but it remained unidentified. The free fatty acid content of the oil from the krill meal was lower than that of the freeze-dried krill. Because of their rapid deterioration, some of free fatty acids in the meal should have been denatured during manufacture and storage of the meal.

As shown in chromatogram II, trace amounts of some nonpolar lipids (spots 3-9) were observed, but almost all the residual lipids (spot 11) were not affected when de-

Hawks, S. N.; Collins, W. K. *Principles of Flue-Cured Tobacco*; North Carolina State University: Raleigh, NC, 1983; p 233.
 Leffingwell, J. C. *Rec. Adv. Tob. Sci.* 1976, 2, 1.
 Lloyd, R.; Miller, C.; Roberts, D.; Giles, J.; Dickerson, J.; Nelson, N.; Rix, C.; Ayers, P. *Tobacco Sci.* 1976, 20, 40.
 Rodgers, J. D.; Mitchum, A. R. *Rec. Adv. Tob. Sci.* 1976, 2, 112.

Seltmann, H. *Proceedings of the 5th International Tobacco Science Congress*, 1970, 77.
 Seltmann, H. *Beitr. Tabforsch. Int.* 1980, 10, 120.

Received for review November 18, 1985. Accepted April 1, 1986.

Supercritical Carbon Dioxide Extraction of Oils from Antarctic Krill

Katsumi Yamaguchi,* Masahiro Murakami, Hiroshi Nakano, Shoji Konosu, Tsunehiko Kokura, Hiroshi Yamamoto, Masahiko Kosaka, and Kazuhiko Hata

Supercritical carbon dioxide extraction of the Antarctic krill yielded oils that were composed solely of nonpolar lipids, largely triglycerides, without phospholipids. The extracted oils were fluid and of red color due to astaxanthin, which tended to be decomposed at temperatures higher than 60 °C and a fixed pressure of 250 kg/cm². Analyses of the fatty acids showed a comparatively high proportion of eicosapentaenoic acid (11%). These results indicate that supercritical carbon dioxide is effective in obtaining nonpolar lipids from the krill by only one-step extraction and in excluding phospholipids that interfere with the utilization of krill oils.

Organic solvent extraction of oils from raw materials is a well-developed technology. However, after the extraction process, further purification steps are generally required to remove impurities and gum-forming compounds from the extracted oil, especially in foodstuffs intended for human use.

In recent years supercritical fluid extraction has received much attention, though its fundamental principles were known over 100 years ago (Hannay and Hogarth, 1879). The theory and practice of the supercritical fluid extraction process have been reviewed by Paul and Wise (1971), who predicted its application to foods, pharmaceuticals, fine chemicals, petrochemicals, mineral extraction, and fuel- and waste-processing technologies. Various kinds of supercritical fluids have been studied (Wilke, 1978), but most work done so far has used carbon dioxide as the extractant. Carbon dioxide has the advantages of nontoxicity, incom-bustibility, low critical temperature (31 °C) and pressure (75 kg/cm²), and low price, all of which meet the recent energy and health concerns.

The application of supercritical carbon dioxide (SC-CO₂) extraction to foods has had limited success, as exemplified by decaffeination of green coffee beans in large-scale industrial plants (Zosel, 1974) and production of hop extract (Hubert and Vitzthum, 1978). Further, SC-CO₂ has been used to extract oils from soybean (Friedrich and List, 1982), coconut palm (Brannolte et al., 1983), butter (Kaufmann et al., 1983), etc. Applications of SC-CO₂ extraction to animal sources, in particular seafoods, are still more limited.

Lipids of aquatic organisms are generally rich in highly unsaturated fatty acids and phospholipids, which are readily deteriorated. The Antarctic krill, *Euphausia superba*, possesses an especially high proportion of phospholipids (Mori and Hikichi, 1976), which hampers the

effective utilization of krill oils. We applied SC-CO₂ extraction to krill samples and proved that the extracted oils were composed solely of nonpolar lipids without contamination by phospholipids and their deteriorated lipids.

The present paper deals with the extraction and characterization of the extracted oils and residual lipids.

Materials and Methods Commercial preparations by Nippon Suisan Kaisha, Ltd., of frozen Antarctic krill and its meal were sampled. A freeze-dried sample was prepared by lyophilization of frozen krill. The samples were kept below -25 °C until used. Standard commercial preparations of lipid reagent were used without further purification.

Proximate composition of the samples was analyzed according to the AOAC procedures (No. 7.003, 7.009, 7.015, and 7.060; 1984).

The extraction with SC-CO₂ was carried out using a test plant instrument manufactured by Mitsubishi Kakoki, Co., Ltd. This equipment has a 75-mL extraction vessel with upper limits of pressure and temperature of 500 kg/cm² and 100 °C, respectively.

Ground freeze-dried krill (20 g) and krill meal (25 g) were put into the extraction vessel, gaseous CO₂ of which pressure was increased to a supercritical state by a pressure pump was introduced, and extraction was carried out at different pressures and temperatures. Gaseous CO₂ of commercial purity (Iwatani & Co., Ltd.) was used. Average flow rate was 0.6 kg/h. The extracted oils were measured gravimetrically.

The fractionation of the oils (150 mg) was carried out on a column (1 × 8.5 cm) using silica gel (Wakogel C-200, 100-200 mesh) and 50 mL of chloroform and then 50 mL of methanol. The eluted oils were measured gravimetrically after evaporation of the solvent.

The method of Bligh and Dyer (1959) was applied to the extraction of whole lipids from the krill samples and the residues after SC-CO₂ extraction. After evaporation of the solvent, the oils and lipids were measured gravimetrically.

The oils and lipids extracted with SC-CO₂ and by the method of Bligh and Dyer (1959) were analyzed by TLC on silica gel 60F₂₅₄ (Merk, 0.25 mm thick) with petroleum ether-diethyl ether-acetic acid (90:10:1) or chloroform-methanol-water (65:25:4) as solvents and 50% aqueous sulfuric acid or Dragendorff reagent as indicator.

Laboratory of Marine Biochemistry, Faculty of Agriculture, The University of Tokyo, Bunkyo-ku, Tokyo 113, Japan (K.Y., M.M., H.N., S.K.); Iwatani & Company, Limited, Higashi-ku, Osaka 541, Japan (T.K., H.Y.); Osaka Hydrogen Industries, Limited, Amagasaki 660, Japan (M.K.); and Central Research Laboratory, Nippon Suisan Kaisha, Limited, Hachioji, Tokyo 192, Japan (K.H.).



ELSEVIER

Comparative Biochemistry and Physiology Part B 136 (2003) 317–322

XP008110880

CBP

www.elsevier.com/locate/cbpb

Fatty acids of astaxanthin esters in krill determined by mild mass spectrometry

Shinichi Takaichi^{a,*}, Kumi Matsui^b, Masahisa Nakamura^b, Mizuho Muramatsu^c,
Satoshi Hanada^c

^aBiological Laboratory, Nippon Medical School, Kosugi-cho, Nakahara, Kawasaki 211-0063, Japan

^bDepartment of Biology, School of Education, Waseda University, Nishiwaseda, Shinjuku 169-8050, Japan

^cNational Institute of Advanced Industrial Science and Technology (AIST), Tsukuba 305-8566, Japan

Received 17 April 2003; received in revised form 2 July 2003; accepted 3 July 2003

Abstract

Krill is a major source of astaxanthin, which has strong antioxidant activity. Fractions with astaxanthin monoesters and diesters of Antarctic krill *Euphausia superba* were isolated. Astaxanthin esters were separated by C18-HPLC depending on the number of carbons and double bonds of esterified fatty acid(s). Small amounts of other lipids remained in the samples, but relative molecular masses of carotenoid esters could be measured by field desorption mass spectrometry without fragmentation and interference from contaminant lipids. The fatty acids were determined by calculation of difference between astaxanthin and astaxanthin esters. Only five kinds of fatty acids, dodecanoate, tetradecanoate, hexadecanoate, hexadecenoate and octadecenoate, were detected. Fast atom bombardment mass spectrometry and secondary ion mass spectrometry showed similar spectra. The fatty acid composition in astaxanthin esters was different from those in krill lipids. Therefore, determination of fatty acids in carotenoid esters by a combination of HPLC elution profile and mild mass spectrometry is found to be a useful tool.

© 2003 Elsevier Inc. All rights reserved.

Keywords: Astaxanthin; Astaxanthin ester; Carotenoid ester; *Euphausia superba*; Fatty acid; Krill; Mass spectrometry

1. Introduction

Antarctic krill are crustaceans with large biomass in the Southern Ocean and a good source of poly-unsaturated fatty acids, such as eicosapentaenoate (C20:5) and docosahexaenoate (C22:6) (Bottino, 1975; Phleger et al., 2002).

Astaxanthin is a strong antioxidant (Palozza and Krinsky, 1992), and it mainly distributes in the carapace of crustacean, the integuments of marine fish, the yeast *Phaffia* and green alga *Haemato-*

coccus sp. (Goodwin, 1980, 1984). Major carotenoids of krill are astaxanthin and its mono- and di-esters (Yamaguchi et al., 1983; Maoka et al., 1985; Foss et al., 1987). In krill, astaxanthin and its esters consist of three stereoisomers; (3*R*,3'*R*)-astaxanthin (60–70%) exists as a major component along with (3*R*,3'*S*;*meso*)-astaxanthin (10–20%) and (3*S*,3'*S*)-astaxanthin (10–20%) (Maoka et al., 1985; Foss et al., 1987). The (3*S*,3'*S*)-form may be oxidized from (3*R*,3'*R*)-zeaxanthin, which is synthesized by plants in nature. The origin of the *R*-configuration of astaxanthin isomers in krill is still obscure. Although astaxanthin esters are known to be major carotenoids in marine animals,

*Corresponding author. Tel.: 81-44-733-3584; fax: +81-44-722-1231.

E-mail address: takaichi@nms.ac.jp (S. Takaichi).

fatty acid compositions of astaxanthin esters in krill have not been investigated.

In this study, astaxanthin esters in krill were analyzed by field desorption mass spectrometry (FD-MS). The esterified fatty acids could be determined in spite of small amounts of other lipids remaining in the samples.

2. Materials and methods

2.1. Samples and purification

Antarctic krill *Euphausia superba* was purchased in local markets. Carotenoids and lipids were extracted several times from the carapace of krill by acetone, and extracts were evaporated to dryness. The extract was dissolved in *n*-hexane and loaded on a column of Toyopearl DEAE-650M (Tosoh, Japan), and the carotenoids and neutral lipids were eluted with *n*-hexane/acetone (8:2, v/v), while polar lipids remained on the column (Takaichi et al., 2001). The carotenoid fraction was loaded on a column of silica gel 60 (1.07734; Merck, Germany), neutral lipids were eluted with *n*-hexane, a red band was eluted with *n*-hexane/acetone (9:1, v/v), the next red band was with *n*-hexane/acetone (8:2, v/v) and a final red band with *n*-hexane/acetone (7:3, v/v). Each red band was further purified by KC18 TLC (Whatman, USA) developed with methanol and by silica gel TLC (1.13748; Merck) developed with *n*-hexane/acetone (8:2, v/v), and finally each carotenoid ester was collected from HPLC described below.

The HPLC system was equipped with a μ -Bondapak C18 column (8×100 mm, RCM type; Waters, USA), and eluted with methanol (2.0 ml/min). The absorption spectra of carotenoids were measured by an MCPD-3600 photodiode array detector (Otsuka Electronics, Japan) attached to the HPLC apparatus (Takaichi and Ishidsu, 1992).

2.2. Analysis of carotenoid esters

Relative molecular masses of carotenoids and carotenoid esters were measured by field desorption mass spectrometry (FD-MS), M-2500 double-focusing gas chromatograph-mass spectrometer (Hitachi, Japan) equipped with a field-desorption apparatus (Takaichi, 1993). Secondary ion mass spectrometry (SI-MS) and fast atom bombardment mass spectrometry (FAB-MS) were obtained from

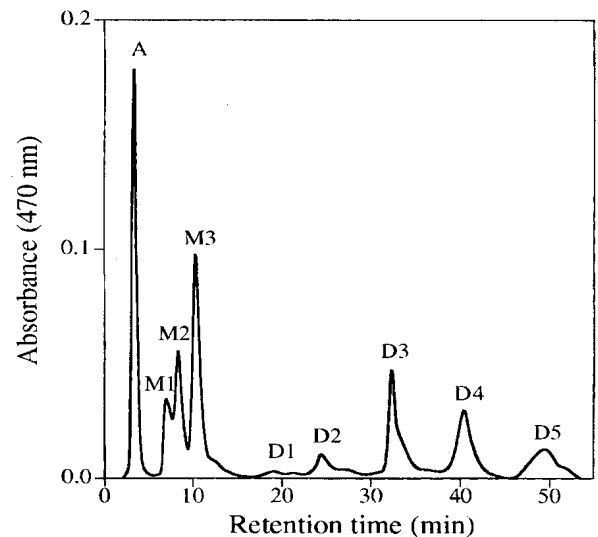

Fig. 1. HPLC elution profile of carotenoids extracted from Antarctic krill *Euphausia superba*. See the text for details of the chromatographic conditions. A, M1–3 and D1–5 indicate the HPLC peaks, and the peak numbers are referred to in the text and figures.

the M-2500 and a JMS-HX/HX110A mass spectrometer (JEOL, Japan), respectively, using *m*-nitrobenzyl alcohol as a matrix.

The fatty acid moieties of the carotenoid esters and krill lipids were converted to fatty acid methyl esters by treatment with 5% HCl in methanol solution at 60 °C for 20 min (Takaichi and Ishidsu, 1992). The fatty acid methyl esters were then analyzed by a gas chromatograph/mass spectrometer (M7200A GC/3DQMS system; Hitachi) equipped with a DB-5ms capillary column (J&W Scientific, USA) coated with (5%-phenyl)-methylpolysiloxane as described previously (Takaichi et al., 2001).

3. Results

3.1. Carotenoids and composition

Fig. 1 shows a C18-HPLC elution profile of carotenoids extracted from Antarctic krill. Peaks A, M1–3 and D1–5 corresponded to the third, the second and the first red bands obtained from the silica gel column.

The carotenoid in peak A was identified as astaxanthin based on the same retention time on HPLC and the same absorption spectrum with

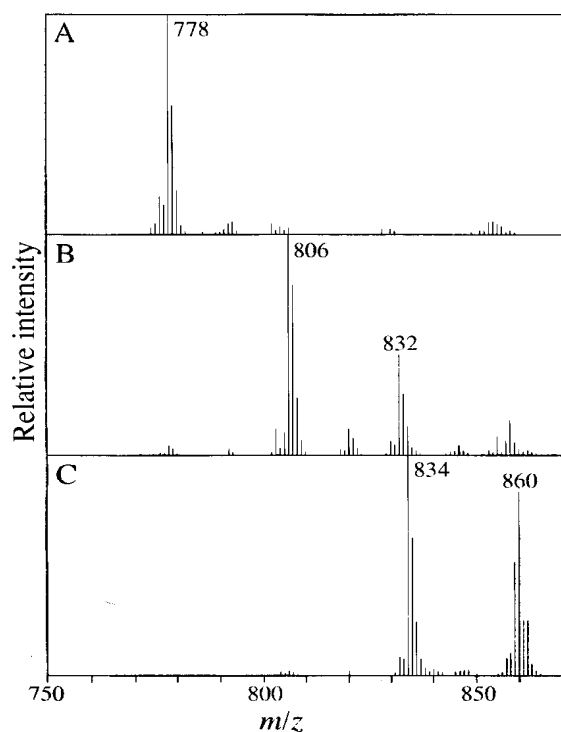

Fig. 2. FD-MS spectra of astaxanthin monoesters in the peaks M1 (a), M2 (b) and M3 (c) in Fig. 1.

authentic astaxanthin (Roche, Switzerland) and the relative molecular mass of 596.

All the HPLC peaks showed similar absorption spectra with astaxanthin in the HPLC eluent of methanol. By methanolysis of the carotenoid esters with HCl in methanol solution, carotenoid was liberated, and identified as astaxanthin as described above. From the retention times on HPLC, the second group (M1–3, Fig. 1) and the third group (D1–5) were astaxanthin monoesters and astaxanthin diesters, respectively. The composition was astaxanthin (20%), astaxanthin monoesters (34%) and astaxanthin diesters (46%).

3.2. Astaxanthin monoesters

The peaks M1, M2 and M3 were collected from HPLC. The major relative molecular mass of the peak M1 analyzed by FD-MS was 778 (Fig. 2a). Those of the peak M2 were 806 and 832 (Fig. 2b) and the peak M3 were 834 and 860 (Fig. 2c). Recognized fragment peaks corresponding to carotenoid and fatty acid moieties were not found

in the low-mass region, and many mass peaks in Fig. 2 might be due to impurities. Similar mass spectra were obtained by SI-MS and FAB-MS (data not shown). The relative molecular masses of carotenoid esters were easily determined under these mild mass spectrometry conditions in spite of the presence of lipids, while detection of the carotenoid moiety of the carotenoid esters was difficult by these methods due to the absence of fragmentation. Since SI-MS and FAB-MS require a matrix of *m*-nitrobenzyl alcohol, there are many mass peaks derived from the matrix, whereas FD-MS needs no matrixes and is more suitable for analysis of the relative molecular masses.

The fatty acid moiety was calculated from the difference of the relative molecular masses of astaxanthin and astaxanthin esters. The mass of 778 in peak M1 (Fig. 2a) corresponded to astaxanthin dodecanoate (C12:0) monoester. Similarly, those of 806, 832, 834 and 860 corresponded to astaxanthin tetradecanoate (C14:0), hexadecanoate (C16:0) and octadecanoate (C18:1) monoesters, respectively. Two peaks on this HPLC system contained two astaxanthin monoesters. The peak M2 contained astaxanthin C14:0 and C16:1 monoesters and the peak M3 contained astaxanthin C16:0 and C18:1 monoesters. The HPLC peak areas of M1, M2 and M3 (Fig. 1) were 17, 29 and 54%, respectively. The compositions of two astaxanthin monoesters in the peaks M2 and M3 were calculated from intensities of the mass peaks (Fig. 2b and c). The composition of astaxanthin monoesters were thus calculated to be 17, 20, 9, 29 and 25% of C12:0, C14:0, C16:1, C16:0 and C18:1, respectively.

The fatty acid moieties of the astaxanthin monoester fraction (M1–3) were converted into fatty acid methyl esters, and analyzed by GC. The major fatty acids were C16:0 (76%) and C18:1 (20%), and the trace amount of other fatty acids were also found. HPLC elution profile reflects esterified fatty acids of astaxanthin esters. When all of the fatty acid detected by GC described above was bound to astaxanthin as astaxanthin monoesters, HPLC elution profile was different from Fig. 1. This meant the astaxanthin monoester fraction (M1–3) contained other lipids, which could not be detected by FD-MS.

3.3. Astaxanthin diesters

The major relative molecular masses in peak D5 (Fig. 1) were 1072, 1098 and 1124 (Fig. 3). In

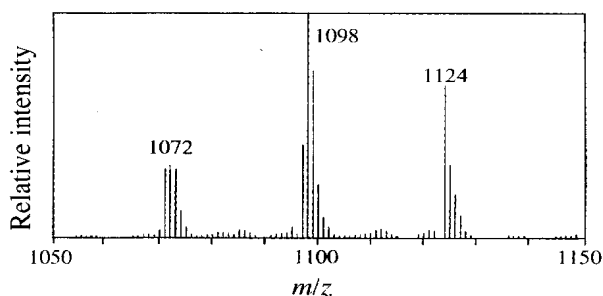

Fig. 3. FD-MS spectra of astaxanthin diesters in the peak D5 in Fig. 1.

the case of 1072, the sum of the carbon number of fatty acids was 32 and the sum of double bond was zero. This corresponds to two C16:0. Similarly, for 1098, the carbon number was 34 and the double bond was one, and the two fatty acids could be C16:0 and C18:1. For 1124, the carbon number was 36 and the double bond was two, corresponding to two C18:1. Consequently, peak D5 contained astaxanthin C16:0 and C18:1 diesters. The major relative molecular masses in peak D4 were 1044, 1070 and 1096. For 1070, two pairs could be possible, C14:0 and C18:1, and C16:0 and C16:1 diesters. Those of 1044 and 1096 corresponded to C14:0 and C16:0, and C16:1 and C18:1 diesters, respectively. In the peak D3, 1016 corresponded to two C14:0, and C12:0 and C16:0 diesters, 1042 to C14:0 and C16:1, and C12:0 and C18:1 diesters and 1068 to two C16:1 diester. In the peak D2, 988 corresponded to C12:0 and C14:0 diester, and 1014 to C12:0 and C16:1 diester. Since the content of the peak D1 was too small to collect from HPLC, we could not measure the relative molecular masses, but this peak might contain astaxanthin C12:0 diester from the retention time on HPLC.

The HPLC peak areas of D1, D2, D3, D4 and D5 (Fig. 1) were 3, 12, 33, 28 and 24%, respectively. When the fatty acids of the astaxanthin diester fraction (D1–5) were analyzed by GC, they were C14:0 (42%), C16:1 (6%), C16:0 (46%), C18:1 (4%) and some minors. This composition did not reflect the HPLC elution profile, and consequently, the astaxanthin diester fraction might contain other lipids. Poly-unsaturated fatty acids were not found in astaxanthin esters based on HPLC elution profile and FD-MS analysis.

4. Discussion

The presence of astaxanthin esters in animals, especially in marine, is well known (Goodwin, 1984). We found astaxanthin (20%), astaxanthin monoesters (34%) and astaxanthin diesters (46%) from Antarctic krill *E. superba*. Most carotenoids in krill have been reported as astaxanthin, and similar compositions have been reported for krill *E. superba* (Renstrøm and Liaaen-Jensen, 1981; Yamaguchi et al., 1983; Maoka et al., 1985; Foss et al., 1987).

Fatty acids of carotenoid esters have not been studied much in animals. We found that only five kinds of fatty acids, C12:0, C14:0, C16:0, C16:1 and C18:1, were esterified to astaxanthin esters in the krill. Although poly-unsaturated fatty acids were not found in astaxanthin esters, major fatty acids in the cellular lipids of krill was C14:0 (17%), C16:0 (26%), C16:1 (16%), C18:1 (8%), C20:5 (26%) and C22:6 (7%). Similar fatty acid compositions have been reported (Bottino, 1975; Phleger et al., 2002).

Carotenoid esters occur in algae, fruits and petals of higher plants, and animals and are not found in bacteria (Goodwin, 1980, 1984). Acetate (C2:0) is common among algal carotenoids, e.g. fucoxanthin and peridinin. In siphonaxanthin ester of green-algae, 2-*trans*-tetradecenoate (C14:1) is usually a specific and sole fatty acid esterified, but recently, other specific fatty acids have been found (Yoshii et al., 2002). Bacteria such as *Rhodococcus*, *Halorhodospira* and *Heliorestis* contain carotenoid glucoside esters, whose fatty acids are only a few specific ones (Takaichi et al., 1990, 2001, 2003; Niggli and Pfander, 1999). In these, HPLC elution profiles showed few peaks corresponding to each carotenoid ester or carotenoid glucoside ester (Takaichi et al., 1990; Yoshii et al., 2002). Carotenoid esters of plants, such as lutein diesters from marigold petals, capsantin and capsorubin esters from red bell peppers and carotenoid esters in orange peels and concentrates (Zonta et al., 1987; Philip and Chen, 1988; Wingerath et al., 1996), have many fatty acids. In these, HPLC elution profiles showed many carotenoid ester peaks.

Contamination of carotenoid esters with other lipids affects fatty acid composition analyzed by GC. Indeed, the fatty acid composition of the astaxanthin monoester fraction (M1–3, Fig. 1) in

krill determined by HPLC and FD-MS was different from that by GC in this study.

In this study, we could determine some fatty acids in astaxanthin esters by FD-MS without fragmentation. FD-MS has been reported to show only a molecular ion without fragmentation for carotenoids, carotenoid glucoside and carotenoid glucoside esters (Takaichi, 1993). SI-MS and FAB-MS showed similar spectra. Therefore, these methods are useful tools for determination of fatty acids in carotenoid esters containing small amounts of lipid impurities, and can be useful for carotenoid ester analysis in animals and fruits, which contain large amounts of lipids. Carbon numbers and sum of double bonds can be calculated for carotenoid diesters, while determination of carbon number of each individual fatty acid is impossible by this method. Therefore, other spectroscopic methods are necessary for fully understanding all the astaxanthin esters.

Major fatty acids among 11 different from astaxanthin monoesters and diesters in shrimp *Pandalus borealis* was C16:1, C18:1, docosenoate (C22:1) and C22:6 (Renström and Liaaen-Jensen, 1981). In this case, the fatty acid composition of the purified astaxanthin esters was analyzed by GC. Major fatty acids in total phospholipids in eyes of *P. borealis* were C16:0, C18:1, C20:5 and C22:6 (Bell and Dick, 1990).

From the red crab langostilla *Pleuroncodes planipes*, one astaxanthin monoester fraction and three astaxanthin diester fractions were purified from silica gel TLC (Coral-Hinostrza and Bjerkeng, 2002). Separation of astaxanthin diesters reflects the different esterified fatty acids, but the fatty acid composition analyzed by GC was similar to each other.

Concerning biosynthesis of astaxanthin esters, an esterase must be present. This esterase can esterify both sides of astaxanthin to produce astaxanthin monoesters and diesters, and only five fatty acids appear to be substrates.

Acknowledgments

We thank Dr T. Maoka of Kyoto Pharmaceutical University for the analysis of the FAB-MS spectra.

References

Bell, M.V., Dick, J.R., 1990. The fatty acid composition of phospholipids from the eyes of the northern deepwater

- prawn, *Pandalus borealis*. Biochem. Soc. Trans. 18, 907–908.
- Bottino, N.R., 1975. Lipid composition of two species of Antarctic krill: *Euphausia superba* and *E. crystallorophias*. Comp. Biochem. Physiol. B 50, 479–484.
- Coral-Hinostrza, G., Bjerkeng, B., 2002. Astaxanthin from the red crab langostilla (*Pleuroncodes planipes*): optical R/S isomers and fatty acid moieties of astaxanthin esters. Comp. Biochem. Physiol. B 133, 437–444.
- Goodwin, T.W., 1980. The Biochemistry of the Carotenoids, Vol. 1 Plants. 2nd Ed. Chapman and Hall, New York.
- Goodwin, T.W., 1984. The Biochemistry of the Carotenoids, Vol. II Animals. 2nd Ed. Chapman and Hall, New York.
- Foss, P., Renström, B., Liaaen-Jensen, S., 1987. Natural occurrence of enantiomeric and meso astaxanthin: 7. Crustaceans including zooplankton. Comp. Biochem. Physiol. B 86, 313–314.
- Maoka, T., Katsuyama, M., Kaneko, N., Matsuno, T., 1985. Stereochemical investigation of carotenoids in the Antarctic krill *Euphausia superba*. Bull. Jpn. Soc. Sci. Fish. 51, 1671–1673.
- Niggli, U.A., Pfander, H., 1999. Carotenoid glycosides and glycosyl esters. In: Ikan, R. (Ed.), Naturally Occurring Glycosides. Wiley & Sons Ltd, Chichester, pp. 125–145.
- Palozza, P., Krinsky, N.I., 1992. Antioxidant effects of carotenoids in vivo and in vitro: an overview. Methods Enzymol. 213, 403–420.
- Philip, T., Chen, T.-S., 1988. Separation and quantitative analysis of some carotenoid fatty acid esters of fruits by liquid chromatography. J. Chromatogr. 435, 113–126.
- Phleger, C.F., Nelson, M.M., Mooney, B.D., Nicholes, P.D., 2002. Interannual and between species comparison of the lipids, fatty acids and sterols of Antarctic krill from the US AMLR Elephant Island survey area. Comp. Biochem. Physiol. B 131, 733–747.
- Renström, B., Liaaen-Jensen, S., 1981. Fatty acid composition of some esterified carotenols. Comp. Biochem. Physiol. B 69, 625–627.
- Takaichi, S., 1993. Usefulness of field desorption mass spectrometry in determining molecular masses of carotenoids, natural carotenoid derivatives and their chemical derivatives. Org. Mass Spectrom. 28, 785–788.
- Takaichi, S., Ishitsu, J., 1992. Carotenoid glycoside ester from *Rhodococcus rhodochrous*. Methods Enzymol. 213, 366–374.
- Takaichi, S., Seki, T., Ishitsu, J., Fukuda, S., 1990. Carotenoid pigments from *Rhodococcus rhodochrous* RNMS1: two monocyclic carotenoids, a carotenoid monoglycoside and carotenoid glycoside monoesters. Argic. Biol. Chem. 54, 1931–1937.
- Takaichi, S., Maoka, T., Hanada, S., Imhoff, J.F., 2001. Dihydroxylcopene diglycoside diesters: a novel class of carotenoids from the phototrophic purple sulfur bacteria *Halorhodospira abdelmalekii* and *Halorhodospira halochloris*. Arch. Microbiol. 175, 161–167.
- Takaichi, S., Oh-oka, H., Maoka, T., Jung, D.O., Madigan, M.T., 2003. Novel carotenoid glucoside esters from alkaliphilic heliobacteria. Arch. Microbiol. 179, 95–100.

- Wingerath, T., Stahl, W., Kirsch, D., Kaufmann, R., Sies, H., 1996. Fruit juice carotenol fatty acid esters and carotenoids as identified by matrix-assisted laser desorption ionization (MALDI) mass spectrometry. *J. Agric. Food Chem.* 44, 2006–2013.
- Yamaguchi, K., Miki, W., Toriu, N., Kondo, Y., Murakami, M., Konosu, S., et al., 1983. The composition of carotenoid pigments in the Antarctic krill *Euphausia superba*. *Bull. Jpn. Soc. Sci. Fish.* 49, 1411–1415.
- Yoshii, Y., Takaichi, S., Maoka, T., Hanada, S., Inoue, I., 2002. Characterization of two unique carotenoid fatty acid esters from *Pterosperma cristatum* (Prasinophyceae, Chlorophyta). *J. Phycol.* 38, 297–303.
- Zonta, F., Stancher, B., Marletta, G.P., 1987. Simultaneous high-performance liquid chromatographic analysis of free carotenoids and carotenoid esters. *J. Chromatogr.* 403, 207–215.

(19) World Intellectual Property Organization
International Bureau



(43) International Publication Date
2 October 2008 (02.10.2008)

PCT

(10) International Publication Number
WO 2008/117062 A1

- (51) International Patent Classification:
A61K 35/60 (2006.01)
- (21) International Application Number:
PCT/GB2008/001080
- (22) International Filing Date: 28 March 2008 (28.03.2008)
- (25) Filing Language: English
- (26) Publication Language: English
- (30) Priority Data:

60/920,483	28 March 2007 (28.03.2007)	US
60/975,058	25 September 2007 (25.09.2007)	US
60/983,446	29 October 2007 (29.10.2007)	US
61/024,072	28 January 2008 (28.01.2008)	US

[AU/AU]; Pyrmont Bridge Road, Camperdown, SYdney, NSW 2050 (AU). **MANCINELLI, Daniele** [NO/NO]; Grimvegen 14, N-6150 Orsta (NO).

(74) Agent: **GOLDING, Louise**; Frank B. Dehn & Co., St Bride's House, 10 Salisbury Square, London EC4Y 8JD (GB).

(81) Designated States (unless otherwise indicated, for every kind of national protection available): AE, AG, AL, AM, AO, AT, AU, AZ, BA, BB, BG, BH, BR, BW, BY, BZ, CA, CH, CN, CO, CR, CU, CZ, DE, DK, DM, DO, DZ, EC, EE, EG, ES, FI, GB, GD, GE, GH, GM, GT, HN, HR, HU, ID, IL, IN, IS, JP, KE, KG, KM, KN, KP, KR, KZ, LA, LC, LK, LR, LS, LT, LU, LY, MA, MD, ME, MG, MK, MN, MW, MX, MY, MZ, NA, NG, NI, NO, NZ, OM, PG, PH, PL, PT, RO, RS, RU, SC, SD, SE, SG, SK, SL, SM, SV, SY, TJ, TM, TN, TR, TT, TZ, UA, UG, US, UZ, VC, VN, ZA, ZM, ZW.

(71) Applicant (for all designated States except US): **AKER BIOMARINE ASA** [NO/NO]; Fjordalléen 16, PO BOX 1423 Vika, N-0115 Oslo (NO).

(84) Designated States (unless otherwise indicated, for every kind of regional protection available): ARIPO (BW, GH, GM, KE, LS, MW, MZ, NA, SD, SL, SZ, TZ, UG, ZM, ZW), Eurasian (AM, AZ, BY, KG, KZ, MD, RU, TJ, TM), European (AT, BE, BG, CH, CY, CZ, DE, DK, EE, ES, FI, FR, GB, GR, HR, HU, IE, IS, IT, LT, LU, LV, MC, MT, NL, NO, PL, PT, RO, SE, SI, SK, TR), OAPI (BF, BJ, CF, CG, CI, CM, GA, GN, GQ, GW, ML, MR, NE, SN, TD, TG).

(71) Applicant (for GB only): **GOLDING, Louise** [GB/GB]; Frank B. Dehn & Co., St Bride's House, 10 Salisbury Square, London EC4Y 8JD (GB).

- (72) Inventors; and
- (75) Inventors/Applicants (for US only): **BRUHEIM, Inge** [NO/NO]; Martavegen 6 A, N-6100 Volda (NO). **GRIINARI, Mikko** [FI/FI]; Kultarinnantie 1B, FIN-02660 Espoo (FI). **TILSETH, Snorre** [NO/NO]; Fantottasen 27 A, N-5027 Bergen (NO). **BANNI, Sebastiano** [IT/IT]; Viale Poetto 98, I-09126 Cagliari (IT). **COHN, Jeffrey**

Published:
— with international search report
— before the expiration of the time limit for amending the claims and to be republished in the event of receipt of amendments

(54) Title: BIOEFFECTIVE KRILL OIL COMPOSITIONS

(57) Abstract: This invention discloses new krill oil compositions characterized by having high amounts of phospholipids, astaxanthin esters and/or omega-3 contents. The krill oils are obtained from krill meal using supercritical fluid extraction in a two stage process. Stage 1 removes the neutral lipid by extracting with neat supercritical CO₂ or CO₂ plus approximately 5% of a co-solvent. Stage 2 extract the actual krill oils by using supercritical CO₂ in combination with approximately 20% ethanol. The krill oil materials obtained are compared with commercially available krill oil and found to be more bioeffective in a number of areas such as anti-inflammation, anti-oxidant effects, improving insulin resistances and improving blood lipid profile.



WO 2008/117062 A1

BIOEFFECTIVE KRILL OIL COMPOSITIONS

FIELD OF THE INVENTION

This invention relates to extracts from Antarctic krill that comprise bioactive fatty
5 acids.

BACKGROUND OF THE INVENTION

In the Southern Ocean, off the coast of Antarctica, Antarctic krill (*Euphausia superba*)
can be found in large quantities, ranging from 300-500 million metric tons of biomass. It
10 feeds on phytoplankton during the short Antarctic summer. During winter, however, its food
supply is limited to ice algae, bacteria, marine detritus as well as depleting body protein for
energy.

In order to isolate the krill oil from the krill, solvent extraction methods have been
used. See, e.g., WO 00/23546. Krill lipids have been extracted by placing the material in a
15 ketone solvent (e.g. acetone) in order to extract the lipid soluble fraction. This method
involves separating the liquid and solid contents and recovering a lipid rich fraction from the
liquid fraction by evaporation. Further processing steps include extracting and recovering by
evaporation the remaining soluble lipid fraction from the solid contents by using a solvent
such as ethanol. See, e.g., WO 00/23546. The compositions produced by these methods are
20 characterized by containing at least 75 µg/g astaxanthin, preferably 90 µg/g astaxanthin.
Another krill lipid extract disclosed contained at least 250 µg/g canastaxanthin, preferably 270
µg/g canastaxanthin.

Krill oil compositions have been described as being effective for decreasing
cholesterol, inhibiting platelet adhesion, inhibiting artery plaque formation, preventing
25 hypertension, controlling arthritis symptoms, preventing skin cancer, enhancing transdermal
transport, reducing the symptoms of premenstrual symptoms or controlling blood glucose
levels in a patient. See, e.g., WO 02/102394. In yet another application, a krill oil
composition has been disclosed comprising a phospholipid and/or a flavonoid. The
phospholipid content in the krill lipid extract could be as high as 60% w/w and the EPA/DHA
30 content as high as 35% (w/w). See, e.g., WO 03/011873.

Furthermore, nutraceuticals, pharmaceuticals and cosmetics comprising the
phospholipid extract were disclosed. Previously, it was also shown that supercritical fluid
extraction using neat CO₂ could be used to prevent the extraction of phospholipids in order to
extract the neutral lipid fraction from krill, which comprised of esterified and free astaxanthin.

See, e.g., Yamaguchi et al., *J. Agric. Food Chem.* (1986), 34(5), 904-7. Supercritical fluid extraction with solvent modifier has previously been used to extract marine phospholipids from salmon roe, but has not been previously used to extract phospholipids from krill meal. See, e.g., Tanaka et al., *J. Oleo Sci.* (2004), 53(9), 417-424.

5 The methods described above rely on the processing of frozen krill that are transported from the Southern Ocean to the processing site. This transportation is both expensive and can result in degradation of the krill starting material. Data in the literature showing a rapid decomposition of the oil in krill explains why some krill oil currently offered as an omega-3 supplement in the marketplace contains very high amounts of partly decomposed
10 phosphatidylcholine and also partly decomposed glycerides. Saether et al., *Comp. Biochem Phys. B* 83B(1): 51-55 (1986). The products offered also contain high levels of free fatty acids.

What is needed in the art are methods for processing krill that do not require transport of frozen krill material over long distances and the products produced by those methods.

15

SUMMARY OF THE INVENTION

In a first aspect of the invention is a composition characterized by comprising at least 65% (w/w) phospholipids.

20 In another aspect of the invention is a composition obtained from aquatic or marine sources, characterized by comprising 65% (w/w) phospholipids.

In yet another aspect of the invention is a composition obtained from krill, characterized by comprising at least 65% (w/w) phospholipids.

In another aspect of the invention is a composition obtained from krill, characterized by comprising at least 65% (w/w) phospholipids and at least 39% omega-3 fatty acids (w/w).

25 In yet another aspect of the invention is a composition obtained from krill, characterized by comprising at least 65% (w/w) phospholipids, at least 39% omega-3 fatty acids (w/w) and at least 580 mg/kg astaxanthin esters.

In another aspect of the invention is a composition obtained from krill, characterized by comprising at least 39% omega-3 fatty acids (w/w) and at least 580 mg/kg astaxanthin
30 esters.

In yet another aspect of the invention is a composition obtained from krill, characterized by comprising at least 65% (w/w) phospholipids and at least 580mg/kg astaxanthin esters.

In yet another aspect, the present invention provides a krill oil effective for reducing insulin resistance, improving blood lipid profile, reducing inflammation or reducing oxidative stress.

In some embodiments, the present invention provides compositions comprising: from
5 about 3% to 10% ether phospholipids on a w/w basis; from about 35% to 50% non-ether
phospholipids on w/w basis, so that the total amount of ether phospholipids and non-ether
phospholipids in the composition is from about 48% to 60% on a w/w basis;
from about 20% to 45% triglycerides on a w/w basis; and from about 400 to about 2500
mg/kg astaxanthin. In some embodiments, the ether phospholipids are selected from the
10 group consisting of alkylacylphosphatidylcholine, lyso-alkylacylphosphatidylcholine,
alkylacylphosphatidylethanolamine, and combinations thereof. In some embodiments, the
ether lipids are greater than 90% alkylacylphosphatidylcholine. In some embodiments, the
non-ether phospholipids are selected from the group consisting of phosphatidylcholine,
phosphatidylserine, phosphatidylethanolamine and combinations thereof. In some
15 embodiments, krill oil composition comprises a blend of lipid fractions obtained from krill. In
some preferred embodiments, krill is *Euphausia superba*, although other krill species also find
use in the present invention. Other krill species include, but are not limited to *E. pacifica*, *E.*
frigida, *E. longirostris*, *E. triacantha*, *E. vallentini*, *Meganyctiphanes norvegica*, *Thysanoessa*
raschii and *Thysanoessa inermis*. In some embodiments, the compositions comprise from
20 about 25% to 30% omega-3 fatty acids as a percentage of total fatty acids and wherein from
about 80% to 90% of said omega-3 fatty acids are attached to said phospholipids. In some
embodiments, the present invention provides a capsule containing the foregoing compositions.

In further embodiments, the present inventions provide compositions comprising: from
about 3% to 10% ether phospholipids on a w/w basis; and from about 400 to about 2500
25 mg/kg astaxanthin. In some embodiments, the compositions further comprise from about
35% to 50% non-ether phospholipids on w/w basis, so that the total amount of ether
phospholipids and non-ether phospholipids in the composition is from about 38% to 60% on a
w/w basis. In some embodiments, the compositions further comprise from about 20% to 45%
triglycerides on a w/w basis. In some embodiments, the ether phospholipids are selected from
30 the group consisting of alkylacylphosphatidylcholine, lyso-alkylacylphosphatidylcholine,
alkylacylphosphatidylethanolamine, and combinations thereof. In some embodiments, the
ether lipids are greater than 90% alkylacylphosphatidylcholine. In some embodiments, the
non-ether phospholipids are selected from the group consisting of phosphatidylcholine,
phosphatidylserine, phosphatidylethanolamine and combinations thereof. In some

embodiments, krill oil composition comprises a blend of lipid fractions obtained from krill. In some preferred embodiments, krill is *Euphausia superba*, although other krill species also find use in the present invention. Other krill species include, but are not limited to *E. pacifica*, *E. frigida*, *E. longirostris*, *E. triacantha*, *E. vallentini*, *Meganyctiphanes norvegica*, *Thysanoessa*
5 *raschii* and *Thysanoessa inermis*. In some embodiments, the compositions comprise about 25% to 30% omega-3 fatty acids as a percentage of total fatty acids and wherein from about 80% to 90% of said omega-3 fatty acids are attached to said phospholipids. In some embodiments, the present invention provides a capsule containing the foregoing compositions.

In some embodiments, the present invention provides a composition comprising at
10 least 65% (w/w) of phospholipids, said phospholipids characterized in containing at least 35% omega-3 fatty acid residues. In some preferred embodiments, the composition is derived from a marine or aquatic biomass. In some further preferred embodiments, the composition is derived from krill. In some embodiments, the composition comprises less than 2% free fatty acids. In some embodiments, composition comprises less than 10% triglycerides. In some
15 preferred embodiments, the phospholipids comprise greater than 50% phosphatidylcholine. In some embodiments, the composition comprises at least 500 mg/kg astaxanthin esters. In some embodiments, the composition comprises at least 500 mg/kg astaxanthin esters and at least 36% (w/w) omega-3 fatty acids. In some embodiments, the composition comprises less than about 0.5g/100g total cholesterol. In some embodiments, the composition comprises less
20 than about 0.45% arachidonic acid (w/w).

In some embodiments, the present invention provides a krill lipid extract comprising at least 500, 100, 1500, 2000, 2100, or 2200 mg/kg astaxanthin esters and at least 36% (w/w) omega-3 fatty acids. In further embodiments, the present invention provides a krill lipid
25 extract comprising at least 100 mg/kg astaxanthin esters, at least 20% (w/w) omega-3 fatty acids, and less than about 0.45% arachidonic acid (w/w).

In some embodiments, the present invention provides methods comprising administering the foregoing compositions to a subject in an amount effective for reducing insulin resistance, reducing inflammation, improving blood lipid profile and reducing oxidative stress.

In some embodiments, the present invention provides a krill lipid extract comprising
30 greater than about 80% triglycerides and greater than about 90, 100, 500, 1000, 1500, 200, 2100 or 2200 mg/kg astaxanthin esters. In some embodiments, the krill lipid extract is characterized in containing from about 5% to about 15% omega-3 fatty acid residues. In some embodiments, the krill lipid extract is characterized in containing less than about 5%

phospholipids. In some embodiments, the krill lipid extract is characterized in comprising from about 5% to about 10% cholesterol.

In some embodiments, the present invention provides a krill meal composition comprising less than about 50g/kg total fat. In some embodiments, the krill meal composition
5 comprises from about 5 to about 20 mg/kg astaxanthin esters. In some embodiments, the krill meal composition comprises greater than about 65% protein. In some embodiments, the krill meal composition of comprises greater than about 70% protein. In some further embodiments, the present invention provides an animal feed comprising the krill meal composition.

10 In some embodiments, the present invention provides methods of increasing flesh coloration in an aquatic species comprising feeding said aquatic species a composition comprising the krill meal described above. In some embodiments, the present invention provides methods of increasing growth and overall survival rate of aquatic species by feeding the krill meal described above.

15 In some embodiments, the present invention provides methods of producing krill oil comprising: a) providing krill meal; and b) extracting oil from said krill meal. In some embodiments, the krill meal is produced by heat-treating krill. In some embodiments, the krill meal is stored prior to the extraction step. In some embodiments, the extracting step comprises extraction by supercritical fluid extraction. In some embodiments, the supercritical
20 fluid extraction is a two step process comprising a first extraction step with carbon dioxide and a low concentration of a co-solvent (e.g., from about 1-10% co-solvent) and a second extraction step with carbon dioxide and a high concentration of a co-solvent (e.g., from about 10-30% co-solvent). In preferred embodiments, the co-solvent is a C₁-C₃ monohydric alcohol, preferably ethanol. In some embodiments, the present invention provides oil
25 produced by the foregoing method.

In some embodiments, the present invention provides methods of production of krill oil comprising: a) providing fresh krill; b) treating said fresh krill to denature lipases and phospholipases in said fresh krill to provide a denatured krill product; and c) extracting oil
30 heating of said fresh krill. In some embodiments, the denaturation step comprises heating said fresh krill after grinding. In some embodiments, the methods further comprise storing said denatured krill product at room temperature or below between the denaturation step and the extraction step. In some embodiments, the enzyme denaturation step is achieved by application of heat. In some embodiments, the extraction step comprises use of supercritical

carbon dioxide, with or without use of a polar modifier. In some embodiments, the extraction step comprises use of ethanol. In some embodiments, the extraction step is comprises ethanol extraction followed by acetone to precipitation of phospholipids. In some embodiments, the denatured krill product is a meal. In some embodiments, the present invention provides oil
5 produced by the foregoing method.

In some embodiments, the present invention provides a composition comprising oil extracted from krill having a phosphatidylcholine content of greater than about 50% (w/w). In some embodiments, the oil has a phosphatidylcholine content of greater than about 70% (w/w). In some embodiments, the oil has a phosphatidylcholine content of greater than about
10 80% (w/w). In some embodiments, the composition comprises less than 2% free fatty acids. In some embodiments, the composition comprises less than 10% triglycerides. In some embodiments, the composition comprises at least 500 mg/kg astaxanthin esters. In some embodiments, the composition comprises less than about 0.45% arachidonic acid (w/w).

In some embodiments, the present invention provides composition comprising
15 odorless krill oil. In some embodiments, the odorless krill oil comprises less than about 10 mg/kg (w/w) trimethylamine. In some further embodiments, the present invention provides an odorless krill oil produced by the method comprising: extracting a neutral krill oil from a krill oil containing material by supercritical fluid extraction to provide a deodorized krill material, wherein said neutral krill oil contains odor causing compounds and extracting a
20 polar krill oil from said deodorized krill material by supercritical fluid extraction with a polar entrainer to provide an essentially odorless krill oil.

In some embodiments, the present invention provides a composition comprising krill oil containing less than about 70 micrograms/kilogram (w/w) astaxanthin esters. In some
25 embodiments, the compositions comprise less than about 50 micrograms/kilogram (w/w) astaxanthin esters. In some embodiments, the compositions comprise less than about 20 micrograms/kilogram (w/w) astaxanthin esters. In some embodiments, the compositions comprise less than about 5 micrograms/kilogram (w/w) astaxanthin esters.

In some embodiments, the present invention provides a krill oil produced by the process comprising: pumping fresh krill from a trawl onto a ship, heating the krill to provide a
30 krill material, and extracting oil from the krill material.

In further embodiments, the present invention provides a blended krill oil composition comprising: from about 45% to 55% w/w phospholipids; from about 20% to 45% w/w triglycerides; and from about 400 to about 2500 mg/kg astaxanthin. In some embodiments, the blended krill oil product comprises a blend of lipid fractions obtained from *Euphausia*

superba. In some embodiments, the composition comprises from about 25% to 30% omega-3 fatty acids as a percentage of total fatty acids and wherein from about 80% to 90% of said omega-3 fatty acids are attached to said phospholipids.

In still other embodiments, the present invention provides a *Euphausia superba* krill oil composition comprising: from about 30% to 60% w/w phospholipids; from about 20% to 50% triglycerides; from about 400 to about 2500 mg/kg astaxanthin; and from about 20% to 35% omega-3 fatty acids as a percentage of total fatty acids in said composition, wherein from about 70% to 95% of said omega-3 fatty acids are attached to said phospholipids.

In still further embodiments, the present invention provides a dietary supplement comprising encapsulated *Euphausia superba* krill oil comprising from about 30% to 60% w/w phospholipids; from about 20% to 50% triglycerides; from about 400 to about 2500 mg/kg astaxanthin; and from about 20% to 35% omega-3 fatty acids as a percentage of total fatty acids in said composition, wherein from about 70% to 95% of said omega-3 fatty acids are attached to said phospholipids.

In some embodiments, the present invention provides methods of making a *Euphausia superba* krill oil composition comprising: contacting *Euphausia superba* with a polar solvent to provide a polar extract comprising phospholipids; contacting *Euphausia superba* with a neutral solvent to provide a neutral extract comprising triglycerides and astaxanthin; combining said polar extract and said neutral extract to provide *Euphausia superba* krill oil comprising from about 30% to 60% w/w phospholipids; from about 20% to 50% triglycerides; from about 400 to about 2500 mg/kg astaxanthin; and from about 20% to 35% omega-3 fatty acids as a percentage of total fatty acids in said composition, wherein from about 70% to 95% of said omega-3 fatty acids are attached to said phospholipids. In some embodiments, the methods further comprise the step of encapsulating the *Euphausia superba* krill oil. In some embodiments, the present invention provides a *Euphausia superba* krill oil produced by the methods described above.

In some embodiments, the present invention provides methods of producing a dietary supplement comprising: contacting *Euphausia superba* with a polar solvent to provide an polar extract comprising phospholipids; contacting *Euphausia superba* with a neutral solvent to provide a neutral extract comprising triglycerides and astaxanthin; combining said polar extract and said neutral extract to provide *Euphausia superba* krill oil comprising from about 30% to 60% w/w phospholipids; from about 20% to 50% triglycerides; from about 400 to about 2500 mg/kg astaxanthin; and from about 20% to 35% omega-3 fatty acids as a percentage of total fatty acids in said composition, wherein from about 70% to 95% of said

omega-3 fatty acids are attached to said phospholipids; and encapsulating said *Euphausia superba* krill oil.

In some embodiments, the present invention provides methods of reducing diet-induced hyperinsulinemia, insulin insensitivity, muscle mass hypertrophy, serum adiponectin reduction or hepatic steatosis comprising in a subject exposed to a high fat diet: administering to said subject exposed to a high fat diet an effective amount of a krill oil composition under conditions such that a condition selected from the group consisting of diet-induced hyperinsulinemia, insulin insensitivity, muscle mass hypertrophy, serum adiponectin reduction and hepatic steatosis is reduced. The present invention is not limited to any particular krill oil composition. In some embodiments, the krill oil composition is a *Euphausia superba* krill oil composition. The present invention is not limited to any particular formulation of krill oil. In some embodiments, the krill oil composition is encapsulated. In some preferred embodiments, the effective amount of a krill oil composition is from 0.2 grams to 10 grams of said krill oil composition. In some embodiments, the krill oil composition comprises: from about 45% to 55% w/w phospholipids; from about 20% to 45% w/w triglycerides; and from about 400 to about 2500 mg/kg astaxanthin. In some embodiments, the krill oil composition comprises a blend of lipid fractions obtained from *Euphausia superba*. In some embodiments, the krill oil composition comprises from about 25% to 30% omega-3 fatty acids as a percentage of total fatty acids and wherein from about 80% to 90% of said omega-3 fatty acids are attached to said phospholipids. In some embodiments, the krill oil composition comprises from about 30% to 60% w/w phospholipids; from about 20% to 50% triglycerides; from about 400 to about 2500 mg/kg astaxanthin; and from about 20% to 35% omega-3 fatty acids as a percentage of total fatty acids in said composition, and wherein from about 70% to 95% of said omega-3 fatty acids are attached to said phospholipids.

In some embodiments, the present invention provides methods of reducing diet-induced hyperinsulinemia, insulin insensitivity, muscle mass hypertrophy, serum adiponectin reduction or hepatic steatosis comprising in a subject consuming a high fat diet or a normal fat diet: administering to said subject consuming a high fat diet or a normal fat diet an effective amount of a krill oil composition under conditions such that a condition selected from the group consisting of diet-induced hyperinsulinemia, insulin insensitivity, muscle mass hypertrophy, serum adiponectin reduction and hepatic steatosis is reduced. The present invention is not limited to any particular krill oil composition. In some embodiments, the krill oil composition is a *Euphausia superba* krill oil composition. The present invention is not

limited to any particular formulation of krill oil. In some embodiments, the krill oil composition is encapsulated. In some preferred embodiments, the effective amount of a krill oil composition is from 0.2 grams to 10 grams of said krill oil composition. In some embodiments, the krill oil composition comprises: from about 45% to 55% w/w phospholipids; from about 20% to 45% w/w triglycerides; and from about 400 to about 2500 mg/kg astaxanthin. In some embodiments, the krill oil composition comprises a blend of lipid fractions obtained from *Euphausia superba*. In some embodiments, the krill oil composition comprises from about 25% to 30% omega-3 fatty acids as a percentage of total fatty acids and wherein from about 80% to 90% of said omega-3 fatty acids are attached to said phospholipids. In some embodiments, the krill oil composition comprises from about 30% to 60% w/w phospholipids; from about 20% to 50% triglycerides; from about 400 to about 2500 mg/kg astaxanthin; and from about 20% to 35% omega-3 fatty acids as a percentage of total fatty acids in said composition, and wherein from about 70% to 95% of said omega-3 fatty acids are attached to said phospholipids.

In some embodiments, the present invention provides methods of inducing diuresis in a subject comprising: administering to said subject an effective amount of a krill oil composition under conditions such that diuresis is induced. In some embodiments, the present invention provides methods of increasing muscle mass in a subject, comprising: administering to said subject an effective amount of a krill oil composition under conditions such that muscle mass is increased. In some embodiments, the present invention provides methods of decreasing protein catabolism in a subject, comprising: administering to said subject an effective amount of a krill oil composition under conditions such that protein catabolism is decreased. In some embodiments, the present invention provides methods of decreasing lipid content in the heart of a subject, comprising: administering to said subject an effective amount of a krill oil composition under conditions such that lipid content in the heart of the subject is decreased. In some embodiments, the present invention provides methods of decreasing lipid content in the liver of a subject, comprising: administering to said subject an effective amount of a krill oil composition under conditions such that lipid content in the liver of the subject is decreased.

DESCRIPTION OF THE FIGURES

Figure 1. ³¹P NMR analysis of polar lipids in krill oil.

Figure 2. Blood lipid profiles in Zucker rats fed different forms of omega-3 fatty acids (TAG = FO, PL1 = NKO and PL2 = Superba).

Figure 3. Plasma glucose concentration in Zucker rats fed different forms of omega-3 fatty acids.

Figure 4. Plasma insulin concentration in Zucker rats fed different forms of omega-3 fatty acids.

5 Figure 5. Estimated HOMA-IR values in Zucker rats fed different forms of omega-3 fatty acids.

Figure 6. The effect of dietary omega-3 fatty acids on TNF α production by peritoneal macrophages.

Figure 7. The effect of dietary omega-3 fatty acids on lipid accumulation in the liver.

10 Figure 8. The effect of dietary omega-3 fatty acids on lipid accumulation in the muscle.

Figure 9. The effect of dietary omega-3 fatty acids on lipid accumulation in the heart.

Figure 10. Relative concentrations of DHA in the brain in Zucker rats supplemented with omega-3 fatty acids.

15 Figure 11. Mean group body weights (g) in the collagen-induced male DBA/1 arthritic mice. B - PL2 is the krill oil group. * p<0.05, significantly different from Group A (Positive Control - Fish Oil) and Group C (Control).

Figure 12. Body weight for the various treatment groups.

Figure 13. Muscle weight for the various treatment groups.

20 Figure 14. Muscle to body weight ratio for the various treatment groups.

Figure 15. Serum adiponectin levels (ng/ml) for the various treatment groups.

Figure 16. Serum insulin levels for the various treatment groups.

Figure 17. Blood glucose (mmol/l) levels in the various treatment groups.

Figure 18. HOMA-IR values for the various treatment groups.

25 Figure 19. Liver triglyceride levels (μ mol/g) for the various treatment groups.

DEFINITIONS

30 As used herein, "phospholipid" refers to an organic compound having the following general structure:

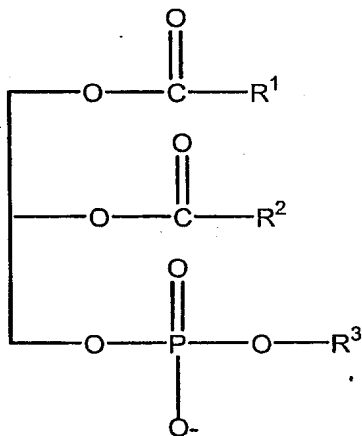

wherein R1 is a fatty acid residue, R2 is a fatty acid residue or -OH, and R3 is a -H or nitrogen containing compound choline (HOCH₂CH₂N⁺(CH₃)₃OH), ethanolamine (HOCH₂CH₂NH₂), inositol or serine. R1 and R2 cannot simultaneously be OH. When R3 is an -OH, the compound is a diacylglycerophosphate, while when R3 is a nitrogen-containing compound, the compound is a phosphatide such as lecithin, cephalin, phosphatidyl serine or plasmalogen.

An "ether phospholipid" as used herein refers to a phospholipid having an ether bond at position 1 the glycerol backbone. Examples of ether phospholipids include, but are not limited to, alkylacylphosphatidylcholine (AAPC), lyso-alkylacylphosphatidylcholine (LAAPC), and alkylacylphosphatidylethanolamine (AAPE). A "non-ether phospholipid" is a phospholipid that does not have an ether bond at position 1 of the glycerol backbone.

As used herein, the term omega-3 fatty acid refers to polyunsaturated fatty acids that have the final double bond in the hydrocarbon chain between the third and fourth carbon atoms from the methyl end of the molecule. Non-limiting examples of omega-3 fatty acids include, 5,8,11,14,17-eicosapentaenoic acid (EPA), 4,7,10,13,16,19-docosahexanoic acid (DHA) and 7,10,13,16,19-docosapentanoic acid (DPA).

As used herein, astaxanthin refers to the following chemical structure:

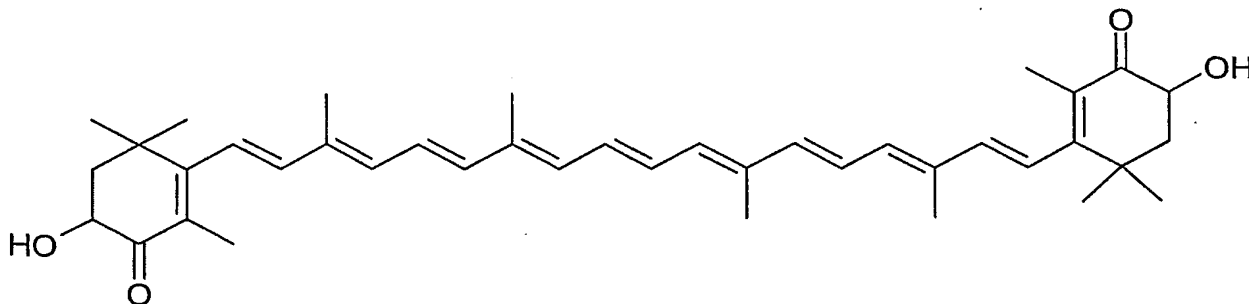

20

As used herein, astaxanthin esters refer to the fatty acids esterified to OH group in the astaxanthin molecule.

As used herein, the term w/w (weight/weight) refers to the amount of a given substance in a composition on weight basis. For example, a composition comprising 50% w/w phospholipids means that the mass of the phospholipids is 50% of the total mass of the composition (i.e., 50 grams of phospholipids in 100 grams of the composition, such as an oil).

DETAILED DESCRIPTION OF THE INVENTION

This invention discloses novel krill oil compositions characterized by containing high levels of astaxanthin, phospholipids, included an enriched quantities of ether phospholipids, and omega-3 fatty acids. The krill oils compositions are extracted from krill meal using supercritical fluid extraction (SFE) with a co-solvent modifier. The krill meal has been processed on board a ship in Antarctica using live krill as starting material in order to ensure the highest possible quality of the krill meal. The krill oils are extracted from the krill meal in two stages, in step 1 the neutral fraction is extracted using neat supercritical CO₂ or in combination with 5% ethanol. The neutral fraction consisted mostly of triglycerides and cholesterol. In stage 2, the polar lipids (phospholipids) are extracted by adding at least 20% ethanol to the supercritical CO₂ extraction medium.

The present invention provides methods to avoid decomposition of glycerides and phospholipids in krill oil and compositions produced by those methods. The product obtained by these new methods is virtually free of enzymatically decomposed oil constituents. The solution to the problem is to incorporate a protein denaturation step on fresh krill prior to use of any extraction technology. Denaturation can be achieved by thermal stress or by other means. After denaturation, the oil can be extracted by an optional selection of nonpolar and polar solvents including use of supercritical carbon dioxide. Krill is adapted to a very efficient nutrient digestion at very low temperatures. Therefore the enzymes are sensitive to heat and the step of applying thermal denaturation of lipases and phospholipases does not imply use of very high temperatures. Surprisingly, it has been found that the use of mild denaturation conditions can greatly enhance the quality of krill oil.

Additionally, a major obstacle of several processes of extraction is the cost of removing water. This is particularly true for methods feasible for extraction of highly unsaturated lipids where freeze drying has been regarded as the method of choice to avoid oxidative breakdown of lipids. However, the lipids in krill are surprisingly stable against

oxidative deterioration. Therefore, a process including moderate use of heat in the water removing process is feasible provided that the enzymes have been inactivated.

A. Krill Processing

5 The present invention provides methods for processing freshly caught krill at the site of capture and preferably on board a ship. After processing on board, the krill can be further subjected to extraction processes on board the ship or at a remote location away from the ship. The processing steps described herein also allow for the storage of krill material, preferably a krill meal for from about 1,2, 3, 4, 5, 6, 8, 9, 10, 11, or 12 months to about 24 to 36 months
10 prior to processing.

In some preferred embodiments, freshly caught krill is first subjected to a protein denaturation step. The present invention is not limited to any particular method of protein denaturation. In some embodiments, the denaturation is accomplished by application of chemicals, heat, or combinations thereof. In some embodiments, freshly caught krill is wet
15 pressed to obtain oil and meal. In some embodiments, the meal is then heated to a temperature of about 50°C to about 100°C for about 20 minutes to about an hour, preferably about 40 minutes to denature the proteins. In some embodiments, this material is then pressed to yield a press cake. When this method is used on krill, only a small amount of oil is released. Most of the oil is still present in the denatured meal. In some embodiments, antioxidants such as
20 ethoxyquin or Vitamin E are added to the meal. However, as shown in the examples, the resulting meal is surprisingly stable. The stability can only partly be explained by addition of an antioxidant to the meal. This antioxidant can, after extraction of the oil from denatured meal, be removed by further processing steps. Alternatively the oil can be extracted rather shortly after production of the meal without any addition of antioxidant in the process.
25 Further, storage conditions at a low to very low temperature can be applied if addition of antioxidant is not desired.

Krill oil extracted from denatured krill meal by supercritical fluid extraction even 19 months after the production of the meal contained virtually no decomposed phospholipids. This product turned out to be substantially different from samples of krill oil available in the
30 market today. Previously described commercial krill processing procedures utilize krill that has been frozen immediately after catching followed by freeze drying and extraction at low temperatures. However, these processes only yield a suitable product if the time the krill is kept frozen is very short or the temperature is extremely low (-60° to -80°C). However, data provided herein clearly shows that if a step of denaturation of the proteins is added in front of

an optional extraction method, an excellent krill oil can be produced even after a long time of storage. This methodology also opens up for use of alternative methods to remove water prior to extraction, which in turn has a great impact on costs in full scale operation. If a long time of storage is desired, the denatured material should preferably be stored at low temperature preferably at -20°C.

In some embodiments, krill oil is extracted from the denatured krill meal. In some embodiments, the krill oil is extracted by contacting the krill meal with ethanol. In some embodiments, krill is then extracted with a ketone solvent such as acetone. In other embodiments, the krill oil is extracted by one or two step supercritical fluid extraction. In some embodiments, the supercritical fluid extraction uses carbon dioxide and neutral krill oil is produced. In some embodiments, the supercritical fluid extraction uses carbon dioxide with the addition of a polar entrainer, such as ethanol, to produce a polar krill oil. In some embodiments, the krill meal is first extracted with carbon dioxide followed by carbon dioxide with a polar entrainer, or vice versa. In some embodiments, the krill meal is first extracted with CO₂ supplemented with a low amount of a polar co-solvent (e.g., from about 1% to about 10%, preferably about 5%) such as a C₁-C₃ monohydric alcohol, preferably ethanol, followed by extraction with CO₂ supplemented with a high amount of a polar co-solvent (from about 10% to about 30%, preferably about 23%) such as such a C₁-C₃ monohydric alcohol, preferably ethanol, or vice versa. Surprisingly, it has been found that use of a low amount of polar solvent in the CO₂ as an entrainer facilitates the extraction of neutral lipid components and astaxanthin in a single step. Use of the high of polar solvent as an entrainer in the other step facilitates extraction of ether phospholipids, as well as non-ether phospholipids.

The present invention is distinguished from previously described krill oil products, such as those described in U.S. Pat. No. 6,800,299 or WO 03/011873 and Neptune brand krill oil, by having substantially higher levels of non-ether phospholipids, ether phospholipids, and astaxanthin. The krill oils of the present invention also have unexpected and superior properties as compared to previously available krill oils. In particular, the krill oil of the present invention has been demonstrated to reduce blood LDL cholesterol levels, improve DHA transfer to the brain as well as reduce lipid accumulation in the liver and muscle while the previously described krill oil compositions do not have such a properties. Accordingly, in some embodiments, the present invention provides a krill oil composition, preferably a *Euphausia superba* krill oil composition, comprising from about 40% to about 60% w/w phospholipids, preferably from about 45% to 55% w/w phospholipids and from about 300 mg/kg astaxanthin to about 2500 mg/kg astaxanthin, preferably from about 1000 to about

2200 mg/kg astaxanthin, more preferably from about 1500 to about 2200 mg/kg astaxanthin. In some preferred embodiments, the compositions comprise greater than about 1000, 1500, 1800, 1900, 2000, or 2100 mg/kg astaxanthin. In some preferred embodiments, the krill oil compositions of the present invention comprise from about 1%, 2%, 3% or 4% to about 8%, 10%, 12% or 15% w/w ether phospholipids or greater than about 4%, 5%, 6%, 7%, 8%, 9% or 10% ether phospholipids. In some embodiments the ether phospholipids are preferably alkylacylphosphatidylcholine, lyso-alkylacylphosphatidylcholine, alkylacylphosphatidylethanolamine or combinations thereof. In some embodiments, the krill oil compositions comprise from about 1%, 2%, 3% or 4% to about 8%, 10%, 12% or 15% w/w ether phospholipids and from about 30%, 33%, 40%, 42%, 45%, 48%, 50%, 52%, 54%, 55% 56%, 58% to about 60% non-ether phospholipids so that the total amount of phospholipids (both ether and non-ether phospholipids) ranges from about 40% to about 60%. One of skill in the art will recognize that the range of 40% to 60% total phospholipids, as well as the other ranges of ether and non-ether phospholipids, can include other values not specifically listed within the range.

In further embodiments, the compositions comprise from about 20% to 45% w/w triglycerides; and from about 400 to about 2500 mg/kg astaxanthin. In some embodiments, the compositions comprise from about 20% to 35%, preferably from about 25% to 35%, omega-3 fatty acids as a percentage of total fatty acids in the composition, wherein from about 70% to 95%, or preferably from about 80% to 90% of the omega-3 fatty acids are attached to the phospholipids. In some embodiments, the present invention provides encapsulated *Euphausia superba* krill oil compositions. In some embodiments, the present invention provides a method of making a *Euphausia superba* krill oil composition comprising contacting *Euphausia superba* with a polar solvent to provide a polar extract comprising phospholipids, contacting *Euphausia superba* with a neutral solvent to provide a neutral extract comprising triglycerides and astaxanthin, and combining said polar extract and said neutral extract to provide the *Euphausia superba* krill oils described above. In some embodiments, fractions from polar and non-polar extractions are combined to provide a final product comprising the desired ether phospholipids, non-ether phospholipids, omega-3 moieties and astaxanthin. In other embodiments, the present invention provides methods of making a *Euphausia superba* (or other krill species) krill oil comprising contacting a *Euphausia superba* preparation such as *Euphausia superba* krill meal under supercritical conditions with CO₂ containing a low amount of a polar solvent such as ethanol to extract neutral lipids and astaxanthin; contacting meal remaining from the first extraction step under

supercritical conditions with CO₂ containing a high amount of a polar solvent such as ethanol to extract a polar lipid fraction containing ether and non-ether phospholipids; and then blending the neutral and polar lipid extracts to provide the compositions described above.

The krill oil extracted by the methods of the present invention contains few enzymatic
5 breakdown products. Examples of the krill oil compositions of the present invention are provided in Tables 9-24. In some embodiments, the present invention provides a polar krill oil comprising at least 65% (w/w) of phospholipids, wherein the phospholipids are characterized in containing at least 35% omega-3 fatty acid residues. The present invention is not limited to the presence of any particular omega-3 fatty acid residues in the krill oil
10 composition. In some preferred embodiments, the krill oil comprises EPA and DHA residues. In some embodiments, the krill oil compositions comprise less than about 5%, 4%, 3% or preferably 2% free fatty acids on a weight/weight (w/w) basis. In some embodiments, the krill oil compositions comprise less than about 25%, 20%, 15%, 10% or 5% triglycerides (w/w). In some embodiments, the krill oil compositions comprise greater than about 30%,
15 40%, 45%, 50%, 55%, 60%, or 65% phosphatidyl choline (w/w). In some embodiments, the krill oil compositions comprise greater than about 100, 200, 300, 400, or 500 mg/kg astaxanthin esters and up to about 700 mg/kg astaxanthin esters. In some embodiments, the present invention provides krill oil compositions comprising at least 500, 1000, 1500, 2000, 2100, or 2200 mg/kg astaxanthin esters and at least 36% (w/w) omega-3 fatty acids. In some
20 embodiments, the krill oil compositions of the present invention comprise less than about 1.0g/100g, 0.5g/100g, 0.2g/100g or 0.1g/100g total cholesterol. In some embodiments, the krill oil compositions of the present invention comprise less than about 0.45

In some embodiments, the present invention provides a neutral krill oil extract comprising greater than about 70%, 75% 80%, 85% or 90% triglycerides. In some
25 embodiments, the krill oil compositions comprise from about 50 to about 2500 mg/kg astaxanthin esters. In some embodiments, the krill oil compositions comprise from about 50, 100, 200, or 500 to about 750, 1000, 1500 or 2500 mg/kg astaxanthin esters. In some embodiments, the compositions comprise from about 1% to about 30% omega-3 fatty acid residues, and preferably from about 5%-15% omega-3 fatty acid residues. In some
30 embodiments, the krill oil compositions comprise less than about 20%, 15%, 10% or 5% phospholipids.

In some embodiments, the present invention provides krill oil containing less than about 70, 60, 50, 40, 30, 20, 10, 5 or 1 micrograms/kilogram (w/w) astaxanthin esters. In some embodiments, the krill oil is clear or only has a pale red color. In some embodiments,

the low-astaxanthin krill oil is obtained by first extracting a krill material, such as krill oil, by supercritical fluid extraction with neat carbon dioxide. It is contemplated that this step removes astaxanthin from the krill material. In some embodiments, the krill material is then subjected to supercritical fluid extraction with carbon dioxide and a polar entrainer such as ethanol, preferably about 20% ethanol. The oil extracted during this step is characterized in containing low amounts of astaxanthin. In other embodiments, krill oil comprising astaxanthin is extracted by countercurrent supercritical fluid extraction with neat carbon dioxide to provide a low-astaxanthin krill oil.

In some embodiments, the present invention provides krill oil that is substantially odorless. By substantially odorless it is meant that the krill oil lacks an appreciable odor as determined by a test panel. In some embodiments, the substantially odorless krill oil comprises less than about 10, 5 or 1 milligrams/kilogram trimethylamine. In some preferred embodiments, the odorless krill oil is produced by first subjecting krill material to supercritical fluid extraction with neat carbon dioxide to remove odor causing compounds such as trimethylamine, followed by extraction with carbon dioxide with a polar entrainer such as ethanol.

In some embodiments, the present invention provides a delipidated krill meal produced after extraction of lipids from the krill meal. In some embodiments, the delipidated krill meal comprises krill protein. In some embodiments, the delipidated krill meal comprises less than about 200, 150, 120, 100, 75, 65, 60, 55, or 50 g/kg total fat. In some embodiments, the delipidated krill meal comprises from about 1 to about 100 mg/kg astaxanthin esters, and preferably from about 5 to about 20 mg/kg astaxanthin esters. In some embodiments, the delipidated krill meal comprises greater than about 60%, 65%, 70% or 75% krill protein. In some embodiments, the present invention provides animal feeds comprising the delipidated krill meal. In some embodiments, the animal feed is a fish feed or aquatic organism feed, such as shrimp feed, crab feed, or crawfish feed. In preferred embodiments, the krill meal is incorporated into complete ration for the target organism. In preferred embodiments, the feed is provided in pelleted form. In many instances, compounds such as astaxanthin are removed during delipidation. The methods of the present invention provide a delipidated krill meal that retains significant amounts of astaxanthin. Accordingly, in some embodiments, the present invention provides methods of feeding aquatic organisms, comprising providing to the aquatic organism a feed comprising the delipidated krill meal described above. In other embodiments, the present invention provides methods of increasing flesh coloration in an

aquatic species comprising feeding the aquatic species a comprising the delipidated krill meal described above.

B. Compositions Containing Krill Oil

5 In some embodiments, the compositions of this invention (such as those described in the preceding sections) are contained in acceptable excipients and/or carriers for oral consumption. The actual form of the carrier, and thus, the composition itself, is not critical. The carrier may be a liquid, gel, gelcap, capsule, powder, solid tablet (coated or non-coated), tea, or the like. The composition is preferably in the form of a tablet or capsule and most
10 preferably in the form of a soft gel capsule. Suitable excipient and/or carriers include maltodextrin, calcium carbonate, dicalcium phosphate, tricalcium phosphate, microcrystalline cellulose, dextrose, rice flour, magnesium stearate, stearic acid, croscarmellose sodium, sodium starch glycolate, crospovidone, sucrose, vegetable gums, lactose, methylcellulose, povidone, carboxymethylcellulose, corn starch, and the like (including mixtures thereof).
15 Preferred carriers include calcium carbonate, magnesium stearate, maltodextrin, and mixtures thereof. The various ingredients and the excipient and/or carrier are mixed and formed into the desired form using conventional techniques. The tablet or capsule of the present invention may be coated with an enteric coating that dissolves at a pH of about 6.0 to 7.0. A suitable enteric coating that dissolves in the small intestine but not in the stomach is cellulose acetate
20 phthalate. Further details on techniques for formulation for and administration may be found in the latest edition of Remington's Pharmaceutical Sciences (Maack Publishing Co., Easton, PA).

The dietary supplement may comprise one or more inert ingredients, especially if it is desirable to limit the number of calories added to the diet by the dietary supplement. For
25 example, the dietary supplement of the present invention may also contain optional ingredients including, for example, herbs, vitamins, minerals, enhancers, colorants, sweeteners, flavorants, inert ingredients, and the like. For example, the dietary supplement of the present invention may contain one or more of the following: ascorbates (ascorbic acid, mineral ascorbate salts, rose hips, acerola, and the like), dehydroepiandrosterone (DHEA), Fo-
30 Ti or Ho Shu Wu (herb common to traditional Asian treatments), Cat's Claw (ancient herbal ingredient), green tea (polyphenols), inositol, kelp, dulse, bioflavonoids, maltodextrin, nettles, niacin, niacinamide, rosemary, selenium, silica (silicon dioxide, silica gel, horsetail, shavegrass, and the like), spirulina, zinc, and the like. Such optional ingredients may be either naturally occurring or concentrated forms.

In some embodiments, the dietary supplements further comprise vitamins and minerals including, but not limited to, calcium phosphate or acetate, tribasic; potassium phosphate, dibasic; magnesium sulfate or oxide; salt (sodium chloride); potassium chloride or acetate; ascorbic acid; ferric orthophosphate; niacinamide; zinc sulfate or oxide; calcium pantothenate; copper gluconate; riboflavin; beta-carotene; pyridoxine hydrochloride; thiamin mononitrate; folic acid; biotin; chromium chloride or picolonate; potassium iodide; sodium selenate; sodium molybdate; phylloquinone; vitamin D3; cyanocobalamin; sodium selenite; copper sulfate; vitamin A; vitamin C; inositol; potassium iodide. Suitable dosages for vitamins and minerals may be obtained, for example, by consulting the U.S. RDA guidelines.

In further embodiments, the compositions comprise at least one food flavoring such as acetaldehyde (ethanal), acetoin (acetyl methylcarbinol), anethole (parapropenyl anisole), benzaldehyde (benzoic aldehyde), N butyric acid (butanoic acid), d or l carvone (carvol), cinnamaldehyde (cinnamic aldehyde), citral (2,6 dimethyloctadien 2,6 al 8, gera nial, neral), decanal (N decylaldehyde, capraldehyde, capric aldehyde, caprinaldehyde, aldehyde C 10), ethyl acetate, ethyl butyrate, 3 methyl 3 phenyl glycidic acid ethyl ester (ethyl methyl phenyl glycidate, strawberry aldehyde, C 16 aldehyde), ethyl vanillin, geraniol (3,7 dimethyl 2,6 and 3,6 octadien 1 ol), geranyl acetate (geraniol acetate), limonene (d , l , and dl), linalool (linalol, 3,7 dimethyl 1,6 octadien 3 ol), linalyl acetate (bergamol), methyl anthranilate (methyl 2 aminobenzoate), piperonal (3,4 methylenedioxy benzaldehyde, heliotropin), vanillin, alfalfa (Medicago sativa L.), allspice (Pimenta officinalis), ambrette seed (Hibiscus abelmoschus), angelic (Angelica archangelica), Angostura (Galipea officinalis), anise (Pimpinella anisum), star anise (Illicium verum), balm (Melissa officinalis), basil (Ocimum basilicum), bay (Laurus nobilis), calendula (Calendula officinalis), (Anthemis nobilis), capsicum (Capsicum frutescens), caraway (Carum carvi), cardamom (Elettaria cardamomum), cassia, (Cinnamomum cassia), cayenne pepper (Capsicum frutescens), Celery seed (Apium graveolens), chervil (Anthriscus cerefolium), chives (Allium schoenoprasum), coriander (Coriandrum sativum), cumin (Cuminum cyminum), elder flowers (Sambucus canadensis), fennel (Foeniculum vulgare), fenugreek (Trigonella foenum graecum), ginger (Zingiber officinale), horehound (Marrubium vulgare), horseradish (Armoracia lapathifolia), hyssop (Hyssopus officinalis), lavender (Lavandula officinalis), mace (Myristica fragrans), marjoram (Majorana hortensis), mustard (Brassica nigra, Brassica juncea, Brassica hirta), nutmeg (Myristica fragrans), paprika (Capsicum annum), black pepper (Piper nigrum), peppermint (Mentha piperita), poppy seed (Papayer somniferum), rosemary (Rosmarinus officinalis), saffron (Crocus sativus), sage (Salvia officinalis), savory (Satureia hortensis, Satureia

montana), sesame (*Sesamum indicum*), spearmint (*Mentha spicata*), tarragon (*Artemisia dracunculus*), thyme (*Thymus vulgaris*, *Thymus serpyllum*), turmeric (*Curcuma longa*), vanilla (*Vanilla planifolia*), zedoary (*Curcuma zedoaria*), sucrose, glucose, saccharin, sorbitol, mannitol, aspartame. Other suitable flavoring are disclosed in such references as Remington's
5 Pharmaceutical Sciences, 18th Edition, Mack Publishing, p. 1288-1300 (1990), and Furia and Pellanca, Fenaroli's Handbook of Flavor Ingredients, The Chemical Rubber Company, Cleveland, Ohio, (1971), known to those skilled in the art.

In other embodiments, the compositions comprise at least one synthetic or natural food coloring (e.g., annatto extract, astaxanthin, beet powder, ultramarine blue, canthaxanthin,
10 caramel, carotenal, beta carotene, carmine, toasted cottonseed flour, ferrous gluconate, ferrous lactate, grape color extract, grape skin extract, iron oxide, fruit juice, vegetable juice, dried algae meal, tagetes meal, carrot oil, corn endosperm oil, paprika, paprika oleoresin, riboflavin, saffron, tumeric, tumeric and oleoresin).

In still further embodiments, the compositions comprise at least one phytonutrient
15 (e.g., soy isoflavonoids, oligomeric proanthcyanidins, indol 3 carbinol, sulforaphane, fibrous ligands, plant phytosterols, ferulic acid, anthocyanocides, triterpenes, omega 3/6 fatty acids, conjugated fatty acids such as conjugated linoleic acid and conjugated linolenic acid, polyacetylene, quinones, terpenes, catechins, gallates, and quercetin). Sources of plant phytonutrients include, but are not limited to, soy lecithin, soy isoflavones, brown rice germ,
20 royal jelly, bee propolis, acerola berry juice powder, Japanese green tea, grape seed extract, grape skin extract, carrot juice, bilberry, flaxseed meal, bee pollen, ginkgo biloba, primrose (evening primrose oil), red clover, burdock root, dandelion, parsley, rose hips, milk thistle, ginger, Siberian ginseng, rosemary, curcumin, garlic, lycopene, grapefruit seed extract, spinach, and broccoli.

In still other embodiments, the compositions comprise at least one vitamin (e.g.,
25 vitamin A, thiamin (B1), riboflavin (B2), pyridoxine (B6), cyanocobalamin (B12), biotin, ascorbic acid (vitamin C), retinoic acid (vitamin D), vitamin E, folic acid and other folates, vitamin K, niacin, and pantothenic acid). In some embodiments, the particles comprise at least one mineral (e.g., sodium, potassium, magnesium, calcium, phosphorus, chlorine, iron,
30 zinc, manganese, flourine, copper, molybdenum, chromium, selenium, and iodine). In some particularly preferred embodiments, a dosage of a plurality of particles includes vitamins or minerals in the range of the recommended daily allowance (RDA) as specified by the United States Department of Agriculture. In still other embodiments, the particles comprise an amino

acid supplement formula in which at least one amino acid is included (e.g., l-carnitine or tryptophan).

C. Uses of Krill Oil

5 Previously, it was disclosed that omega-3 fatty acids have anti-inflammatory properties. See, e.g., Calder. *Am. J. Clin. Nutr.* 83 (2006) 1505S. In addition, in it was disclosed that a phospholipid emulsion derived from a marine and/or synthetic origin comprising polyunsaturated fatty acids have anti-inflammatory and/or immuno-suppressive effects. See, e.g., 5,434,183. An embodiment of this invention is a krill oil composition
10 effective for reducing inflammation i.e. reducing the levels of TNF- α , IL-1 beta, IL-6, IL-10, TGF beta and fibrinogen in the blood.

Type 2 diabetes is a metabolic disorder characterized by impaired glycemic control (high blood glucose levels). In type 2 diabetes, it is the tissue wide insulin resistance that contributes to the development of the disease. Strategies reducing insulin resistance or
15 improving tissue sensitivity to insulin are recognized as beneficial in preventing type 2 diabetes. In healthy humans, a 3-week supplementation with fish oil (1.1 g EPA/d and 0.7 g DHA/d) decreased the insulin response to an oral glucose load by 40%. Omega-3 PUFA dietary enrichment resulted in lower glucose oxidation, higher fat oxidation, and increased glycogen storage; the glycemic response was unchanged, however, which indicates an
20 improved sensitivity to insulin. In another embodiment of this invention is a krill oil composition effective for reducing the insulin resistance.

Krill oil has not been disclosed as being effective in treating one of the most important life style problems of modern societies, i.e., excess weight gain and obesity. Excess adipose tissue mass (overweight and obesity) is associated with low grade inflammation in adipose
25 tissue and in the whole body reflecting the inflammatory mediators "spilling over" from fat tissue. Trayhurn et al., *Br. J. Nutrition* (2004), 92(3), 347-355. Inflammation appears to be an important link between obesity and metabolic syndrome/type-II diabetes as well as cardiovascular disease. Libby et al., *J. Amer. Coll. Card.* (2006), 48(9, Suppl. A), A33-A46. Thus, excess adipose tissue is an unhealthy condition. Weight reduction will improve the
30 inflammatory condition, but persistent weight reduction is difficult to achieve. Omega-3 fatty acid supplementation may alleviate the inflammatory condition in adipose tissue and thus ideally complement the principal strategies of weight reduction i.e. low calorie diet and exercise. There are clinical studies in humans that demonstrate that omega-3 enhance the effect of very low calorie diet and exercise in reducing body fat mass. Kunesova et al.,

Physiological research / Academia Scientiarum Bohemoslovaca (2006), 55(1), 63-72.

Although diet and exercise regime may fail to result in consistent decrease in weight in long term, the effect of omega-3 fatty acids alleviating the inflammatory condition in the adipose tissue may persist generating a condition that can be described as "healthy adipose tissue".

5 Previously, it was shown that dietary omega-3 fatty acids can be used to reduce inflammation in adipose tissue without influencing level of obesity. Todoric et al., *Diabetologia* (2006), 49(9), 2109-2119. Reduction in adipose tissue inflammation was demonstrated by an increase in circulating levels of adiponectin. Adiponectin is an adipose tissue derived anti-inflammatory hormone. Results on the treatment of obese people with omega-3 fatty acids to
10 alleviate circulating levels of inflammatory markers are inconclusive. Trebble et al., *Br. J. Nutrition* (2003), 90(2), 405-412. However, duration of these studies may not have been sufficient given the slow turnover of adipose tissue in humans. Itoh et al. found that 1.8 g/d of EPA increased adiponectin, a marker of adipose tissue derived inflammation, in a group of overweight subjects with metabolic syndrome. Itoh et al., *Arteriosclerosis, Thrombosis, and*
15 *Vascular Biology* (2007), 27(9), 1918-1925.

An embodiment of the invention is the use of krill oil to increase serum adiponectin levels. Adiponectin is a protein hormone that modulates a number of metabolic processes, including glucose regulation and fatty acid catabolism. Adiponectin is exclusively secreted from adipose tissue into the bloodstream and is very abundant in plasma relative to many
20 hormones. Levels of the hormone are inversely correlated with body mass index (BMI). The hormone plays a role in alleviating the metabolic dysregulation that may result in type 2 diabetes, obesity, atherosclerosis and non-alcoholic fatty liver disease (NAFLD). Díez et al., *Eur. J. Endocrinol.* 148 (3): 293-300; Ukkola et al., *J. Mol. Med.* 80 (11): 696-702.

Another embodiment of the invention is to use krill oil in an overweight and obese
25 subjects for alleviating diet induced adipose tissue dysfunction and diet induced changes in the lipid metabolism.

In further embodiments, krill oil is effective in reducing risk factors of type 2 diabetes such as hyperinsulinemia and insulin resistance and cardiovascular disease risk factors in overweight subjects. In addition this invention discloses that krill oil is effective in preventing
30 accumulation of fat in muscles and in the liver (liver steatosis).

It is well known in the art that the obese Zucker rat is a useful rat model to study metabolic Syndrome X and non-insulin dependent diabetes mellitus, including glucose tolerance, insulin resistance and hyperinsulinaemia. It has also been shown previously that astaxanthin is a powerful antioxidant, useful for prevention of oxidative stress in vivo and in

Zucker rats using vitamin E. See, e.g., Aoi et al., (2003). *Antioxidants & Redox Signaling*. 5(1):139-44; Laight et al., *Eur. J. Pharmacol.* 377 (1999) 89.

In yet another embodiment of the invention is a krill oil composition effective of improving the blood lipid profile by increasing the HDL cholesterol levels, decreasing the LDL cholesterol and triglyceride levels. Hence the novel krill oil composition is effective for treating metabolic syndrome. Metabolic syndrome is defined as the coexistence of 3 or more components selected from the group: abdominal obesity, high serum triglyceride levels, low HDL levels, elevated blood pressure and high fasting plasma glucose levels.

In another embodiment of the invention, the krill oil compositions are found to be effective and safe for the treatment of metabolic syndrome in humans.

In still other embodiments, the krill oil compositions of the present invention find use in increasing or inducing diuresis. In some embodiments, the krill oil compositions of the present invention find use in decreasing protein catabolism and increasing the muscle mass of a subject.

In some embodiments, the kill oil composition of the present invention find use in the treatment of fatty heart disease and non-alcoholic fatty acid liver disease. Thus, the krill oil compositions are useful for decreasing the lipid content of the heart and/or liver and/or muscle of a subject.

In yet another embodiment of the invention is a method to increase the transfer of DHA to the brain.

EXAMPLE 1

Antarctic krill (*Euphausia superba*) was captured and brought on board alive, before it was processed into krill meal, an oil (asta oil) and stickwater. The composition and properties of the krill meal was monitored during the processing and compared to a commercial competitor (Table 1 and 2). Furthermore, the amino acid composition of the krill meal and stickwater was determined (Table 3), showing that krill meal is a suitable feed source for to be used in aquaculture due to the presences of all the essential amino acids teleost fish require. During the krill meal processing a neutral oil (asta oil) is recovered, the chemical composition of the asta oil is shown in Tables 4 and 5.

Table 1. Composition of products from the processing line

	Round frozen krill	After decanter	After drier	Konstruktor Koshkin (Ukranian)
--	--------------------	----------------	-------------	--------------------------------

				vessel)
Protein	13,5 g/100 g	20,9 g/100 g	58,5 g/100 g	60,2 g/100 g
Moisture	76,3 g/100 g	65,6 g/100 g	9,1 g/100 g	9,6 g/100 g
Lipid (Folch)	8,6 g/100 g	10 g/100 g	21,8 g/100 g	21,4 g/100 g
Free fatty acids	29,8 g/100 g	25,3 g/100 g	24,8 g/100 g	23,3 g/100 g
Total astaxanthin	53,3 mg/kg	81,3 mg/kg	145 mg/kg	126 mg/kg

Table 2. Lipid class composition in products from the processing line

Crude protein	Round frozen krill (g/100 g)	After decanter (g/100 g)	After drier (g/100 g)	Konstruktor Koshkin (Ukranian vessel) (g/100 g)
Wax ester/cholesterol ester	2,5	3,0	1,9	3,3
Triglycerides/pigments	30,2	33,7	29,3	32,2
Free fatty acids	15,1	2,5	9,0	5,9
Monoglycerides	3,9	Nd	1,3	Nd
PE	6,6	10,4	7,9	6,3
PS	1,2	1,6	1,4	2,7
PI	1,9	2,0	2,1	3,5
PC	28	35,9	32,0	32,1
Sphingomyeline/lyso PC	2,0	0,5	3,0	3,0

Nd= not detected

5 **Table 3.** Amino acids in krill meal and stick water

Amino acid	Total in meal (g/100 g protein)	Free in meal (g/100g protein)	Free in stickwater (g/100 g protein)
Aspartic acid	10,5	0,02	0,22
Glutamic acid	13,5	0,007	0,51
Hydroxiprolin	<0,5	<0,001	<0,05
Serine	4,2	0,02	0,13
Glycine	4,4	0,18	3,28
Histidine	2,1	<0,01	<0,05
Arginine	6,7	0,56	4,86
Threonine	4,1	<0,01	0,22
Alanine	5,4	0,08	0,87
Proline	3,8	0,53	2,32

Tyrosine	4,0	0,01	0,2
Valine	5,0	0,02	0,13
Methionine	2,9	<0,01	0,12
Isoleucine	5,0	0,02	0,1
Leucine	7,8	0,14	0,19
Phenylalanine	4,4	0,01	0,1
Lysine	7,8	0,02	0,27
Cysteine/Cystine	1,4	<0,01	<0,05
Thryptophan	1,1	<0,02	<0,05
Creatinine		<0,01	<0,05
Asparagine		<0,01	0,05
Glutamine		<0,01	<0,05
3-aminopropanoic acid		0,5	8,99
Taurine		0,5	8,52
4-aminobutanoic acid		<0,01	<0,05
Citrulline		0,04	0,14
Carnosine		<0,01	<0,05
Anserine		<0,01	<0,05
Ornithine		0,02	1,04

3-aminopropanoic acid is also known as β -alanine

4-aminobutanoic acid is also known as γ -aminobutyric acid or GABA

Table 4. Composition and quality parameters of asta oil.

Moisture	0,14 g/100 g
Insoluble impurities	0,02 g/100 g
Unsaponifiable matter	1,5 g/100 g
Nitrogen	0,5 g/100 g
Free fatty acids	0,3 g/100 g
Peroxide value	<2 meq peroxide/kg oil
Ansidine value	<1
Phosphorous	23 mg/kg
Phospholipids	575 mg/kg
Astaxanthin	1245 mg/kg

5

10

Table 5. Fatty acid composition of the asta oil

Fatty Acid	Asta oil
File	
C4:0	0,00
C6:0	0,00
C8:0	0,00
C10:0	0,00
C12:0	0,00
C14:0	17,5
C14:1	0,00
C15:0	0,00
C16:0	19,3
C16:1	9,7
C18:0	1,2
C18:1	22,6
C18:2N6	1,4
C18:3N6	0,1
C18:3N3	0,7
C18:4N3	3,0
C20:0	0,1
C20:1	1,3
C20:2N6	<0,1
C20:3N6	0,1
C20:4N6	0,1
C20:3N3	<0,1
C20:4N3	0,2
C20:5N3 (EPA)	5,6
C22:0	0,1
C22:1	0,3
C22:2N6	0,0
C22:4N6	<0,1
C22:5N6	0,00
C22:5N3	0,2
C22:6N3 (DHA)	2,00
C24:1	0,03
Total	88,4
Saturated	38,0
Monounsaturated	33,9
Polyunsaturated	16,4
Total	88,4
Omega-3	11,9
Omega-6	1,6

EXAMPLE 2

The krill meal obtained in example 1 was then ethanol extracted according to the method disclosed in JP02215351. The results showed that around 22% fat from the meal could be extracted, somewhat lower than was extracted using Folch (25%). Table 6 shows the fatty acid composition of the krill meal and the krill oil extracted from the meal using ethanol. Table 7 shows the composition and properties of the krill meal and products before and after extraction, whereas table 8 shows the lipid composition.

Table 6. Fatty acid distribution in krill meal (g/100 g lipid) and the ethanol extracted krill oil.

Fatty Acid	Krill meal	EtOH KO
File		
C4:0	0,00	
C6:0	0,00	
C8:0	0,00	
C10:0	0,00	
C12:0	0,00	
C14:0	7,8	6,4
C14:1	0,00	
C15:0	0,00	
C16:0	15,8	14,7
C16:1	5,1	4,2
C18:0	0,9	0,7
C18:1	13,4	11,8
C18:2N6	1,1	1,2
C18:3N6	0,1	0,1
C18:3N3	0,4	0,4
C18:4N3	1,1	0,1
C20:0	0,1	0,1
C20:1	0,8	0,6
C20:2N6	<0,1	<0,1
C20:3N6	0,1	<0,1
C20:4N6	0,2	0,2
C20:3N3	<0,1	<0,1
C20:4N3	0,2	0,2
C20:5N3 (EPA)	10,5	10,4
C22:0	<0,1	<0,1
C22:1	0,5	0,4
C22:2N6	<0,1	<0,1
C22:4N6	<0,1	
C22:5N6	0,00	
C22:5N3	0,2	
C22:6N3 (DHA)	5,4	4,8
C24:1	0,03	

Saturated	24,6	21,9
Monounsaturated	19,9	17,0
Polyunsaturated	21,0	19,4
Total	65,5	58,2
Omega-3	18,2	17,0
Omega-6	1,3	

Table 7. Composition and properties of the krill meal and products after extraction

	Krill meal	Delipidated krill meal	EtOH extracted krill oil
Crude protein	586 g/kg	735 g/kg	
Fat (Folch)	250 g/kg	30 g/kg	
Moisture/ethanol	71 g/kg	134 g/kg	85 g/kg
Astaxanthin esters	144 mg/kg	10 mg/kg	117 mg/kg
Diesters	110 mg/kg	8,5 mg/kg	117 mg/kg
Monoesters	33 mg/kg	1,8 mg/kg	37 mg/kg
Biological digestible protein	854 g/kg protein	870 g/kg protein	
Flow number	4,8	1,9	
NH ₃	9 mg N/100 g	0	3 mg N/100 g
TMA	2 mg N/100 g	0	70 mg N/100 g
TMAO	125 mg N/100 g	0	456 mg N/100 g

5 **Table 8.** Lipid class distribution

	Krill meal	Delipidated krill meal	EtOH extracted KO
Cholesterol ester	3,5		
TG	32,7	37,4	31,1
FFA	7,8	14,1	16,0
Cholesterol	9,1	8,0	12,6
DG	1,1		3,3
MG	3,7		
Sphingolipid			2,8
PE	6,5	2,5	2,7
Cardiolipin		4,2	
PI	1,1	11,0	
PS	1,4		

PC	28,6	20,2	25,3
LPC	2,9	2,6	6,2
Total polar lipids	40,6	40,5	36,9
Total neutral lipids	54,2	59,5	63,1

EXAMPLE 3

The krill meal obtained in example 1 was then subjected to a supercritical fluid extraction method in two stages. During stage 1, 12.1% fat (neutral krill oil) was removed using neat CO₂ only at 300 bars, 60° C and for 30 minutes. In stage 2, the pressure was increased to 400 bar and 20% ethanol was added (v/v) for 90 minutes. This resulted in further extraction of 9% polar fat which hereafter is called polar krill oil. The total fatty acid composition of the polar krill oil, the neutral krill oil and a commercial product obtained from Neptune Biotech (Laval, Quebec, Canada) are listed in Table 9. In addition the fatty acid composition for the phospholipids (Table 10), the neutral lipids (Table 11), the free fatty acids, diglycerides (Table 12), triglycerides, lyso-phosphatidylcholine (LPC) (Table 13), phosphatidylcholine (PC), phosphatidylethanolamine (PE) (Table 14), phosphatidylinositol (PI) and phosphatidylserine (PS) (Table 15) are shown. Table 16 shows the level of astaxanthin and cholesterol for the different fractions.

Table 9. Total fatty acids compositions of the krill oil products (% (w/w))

Fatty Acid	Total Fatty Acids		
	Neutral KO	Polar KO	NKO
File			
C4:0	0,00	0,00	0,00
C6:0	0,00	0,00	0,00
C8:0	0,00	0,00	0,00
C10:0	0,00	0,00	0,00
C12:0	0,47	0,04	0,24
C14:0	22,08	3,28	12,48
C14:1	0,33	0,01	0,17
C15:0	0,58	0,36	0,52
C16:0	27,03	29,25	23,25
C16:1	0,07	0,01	8,44
C18:0	1,72	1,03	1,42
C18:1	30,29	13,57	18,92
C18:2N6	2,10	1,96	1,71
C18:3N6	0,30	0,21	0,00
C18:3N3	0,69	1,02	1,32
C18:4N3	0,05	1,81	3,50

C20:0	0,06	0,00	0,05
C20:1	1,87	0,80	1,16
C20:2N6	0,05	0,05	0,05
C20:3N6	0,22	0,73	0,04
C20:4N6	0,00	0,00	0,49
C20:3N3	0,09	0,09	0,06
C20:4N3	0,24	0,51	0,33
C20:5N3 (EPA)	7,33	29,88	16,27
C22:0	0,01	0,06	0,05
C22:1	0,64	1,78	0,82
C22:2N6	0,00	0,00	0,00
C22:4N6	0,00	0,00	0,07
C22:5N6	0,00	0,03	0,00
C22:5N3	0,21	0,67	0,36
C22:6N3 (DHA)	3,51	12,61	8,17
C24:0	0,05	0,00	0,01
C24:1	0,03	0,25	0,11
Total	100,00	100,00	100,00
Saturated	52,00	34,01	38,01
Monounsaturated	33,22	16,43	29,61
Polyunsaturated	14,77	49,56	32,37
Total	100,00	100,00	100,00
Omega-3	12,11	46,58	30,02
Omega-6	2,67	2,98	2,35

Table 10. Fatty acid composition of the phospholipid fraction (% (w/w)).

Fatty Acid	Total Phospholipid		
	Neutral KO	Polar KO	Neptune KO
File			
C4:0	0,00	0,00	0,00
C6:0	0,00	0,00	0,00
C8:0	0,00	0,00	0,00
C10:0	0,00	0,00	0,00
C12:0	0,00	0,00	0,00
C14:0	0,01	0,00	0,00
C14:1	0,42	0,01	0,01
C15:0	2,52	0,00	0,00
C16:0	4,73	35,78	32,81
C16:1	0,19	0,17	0,19
C18:0	6,31	1,18	1,55
C18:1	38,40	15,58	13,54
C18:2N6	4,18	2,16	1,90
C18:3N6	0,18	0,22	0,19
C18:3N3	1,02	1,05	1,48

C18:4N3	3,08	1,62	2,15
C20:0	0,27	0,00	0,07
C20:1	2,55	1,02	0,78
C20:2N6	0,19	0,06	0,06
C20:3N6	0,00	0,14	0,10
C20:4N6	0,57	0,62	0,64
C20:3N3	0,43	0,08	0,09
C20:4N3	0,17	0,45	0,42
C20:5N3 (EPA)	20,58	25,53	26,47
C22:0	0,14	0,06	0,00
C22:1	0,00	2,09	1,94
C22:2N6	0,25	0,71	0,85
C22:4N6	0,44	0,00	0,03
C22:5N6	0,11	0,00	0,00
C22:5N3	0,00	0,60	0,63
C22:6N3 (DHA)	10,93	10,30	13,34
C24:0	1,77	0,30	0,37
C24:1	0,59	0,28	0,38
Total	100,00	100,00	100,00
Saturated	15,74	37,32	34,81
Monounsaturated	42,14	19,15	16,84
Polyunsaturated	42,12	43,53	48,34
Total	100,00	100,00	100,00
Omega-3	36,22	39,62	44,56
Omega-6	5,91	3,90	3,78

Table 11. Fatty acid composition of the total neutral lipid fraction (% (w/w)).

Fatty Acid	Total neutral lipid		
	Neutral KO	Polar KO	Neptune KO
File			
C4:0	0,00	0,00	0,00
C6:0	0,00	0,00	0,00
C8:0	0,00	0,00	0,00
C10:0	0,00	0,00	0,00
C12:0	0,00	0,00	0,00
C14:0	20,35	11,31	18,44
C14:1	0,30	0,29	0,25
C15:0	0,53	1,53	0,62
C16:0	23,79	0,49	24,11
C16:1	12,42	5,22	11,86
C18:0	1,54	3,27	1,67
C18:1	26,81	33,09	23,82

C18:2N6	1,68	2,37	1,79
C18:3N6	0,20	0,23	0,25
C18:3N3	0,59	0,62	0,03
C18:4N3	0,03	1,27	0,05
C20:0	0,07	0,00	0,06
C20:1	1,63	1,41	1,39
C20:2N6	0,04	0,00	0,05
C20:3N6	0,18	0,94	0,01
C20:4N6	0,00	0,00	0,00
C20:3N3	0,09	0,00	0,01
C20:4N3	0,18	0,41	0,23
C20:5N3 (EPA)	5,88	19,26	9,68
C22:0	0,02	0,00	0,03
C22:1	0,56	0,60	0,53
C22:2N6	0,00	0,00	0,00
C22:4N6	0,00	0,00	0,04
C22:5N6	0,01	0,00	0,00
C22:5N3	0,17	0,27	0,22
C22:6N3 (DHA)	2,74	17,22	4,64
C24:0	0,15	0,00	0,17
C24:1	0,03	0,21	0,06
Total	100,00	100,00	100,00
Saturated	46,45	16,60	45,10
Monounsaturated	41,75	40,82	37,91
Polyunsaturated	11,80	42,59	16,99
Total	100,00	100,00	100,00
Omega-3	9,68	39,05	14,86
Omega-6	2,11	3,54	2,14

Table 12. Fatty acid composition of the diglyceride and free fatty acids (% (w/w)).

Fatty Acid	Diglycerides			Free fatty acids		
	Neutral KO	Polar KO	Neptune KO	Neutral KO	Polar KO	Neptune KO
File						
C4:0	0,00	0,00	0,00	0,00	0,00	0,00
C6:0	0,00	0,00	0,00	0,00	0,00	0,00
C8:0	0,00	0,00	0,00	0,00	0,00	0,00
C10:0	0,00	0,00	0,00	0,00	0,00	0,00
C12:0	0,00	0,00	0,00	0,00	0,00	0,00
C14:0	13,85	14,35	12,22	5,86	7,19	5,45
C14:1	0,18	0,00	0,17	0,05	0,00	0,08
C15:0	0,49	1,08	0,66	0,46	1,60	0,45
C16:0	23,68	35,24	25,81	28,30	29,37	21,12
C16:1	9,49	6,80	0,09	3,27	3,08	4,91
C18:0	1,56	3,63	1,89	1,13	2,43	0,99

C18:1	23,67	19,85	23,82	14,50	14,77	17,41
C18:2N6	1,79	0,21	1,90	1,69	0,97	1,86
C18:3N6	0,17	0,00	0,01	0,14	0,00	0,22
C18:3N3	0,69	0,00	1,19	0,85	0,00	1,34
C18:4N3	1,92	0,00	2,75	1,30	0,00	2,72
C20:0	0,00	0,00	0,00	0,00	0,00	0,00
C20:1	1,09	0,00	1,01	0,48	0,00	0,57
C20:2N6	0,00	0,00	0,00	0,00	0,00	0,00
C20:3N6	0,13	0,00	0,00	0,08	0,00	0,05
C20:4N6	0,45	0,00	0,64	0,78	0,00	1,43
C20:3N3	0,00	0,00	0,00	0,00	0,00	0,00
C20:4N3	0,35	0,00	0,43	0,39	0,00	0,43
C20:5N3 (EPA)	14,03	9,80	18,00	24,33	23,57	25,36
C22:0	0,18	0,00	0,10	0,00	0,00	0,05
C22:1	0,41	0,00	0,57	0,80	0,69	0,37
C22:2N6	0,28	0,00	0,50	0,46	0,00	0,54
C22:4N6	0,00	0,00	0,00	0,00	0,00	0,00
C22:5N6	0,00	0,00	0,00	0,00	0,00	0,00
C22:5N3	0,20	0,00	0,27	0,34	0,00	0,32
C22:6N3 (DHA)	4,74	9,04	7,53	14,31	16,33	13,95
C24:0	0,64	0,00	0,42	0,49	0,00	0,39
C24:1	0,00	0,00	0,00	0,00	0,00	0,00
Total	100,00	100,00	100,00	100,00	100,00	100,00
Saturated	40,40	54,30	41,10	36,24	40,59	28,45
Monounsaturated	34,84	26,64	25,66	19,09	18,54	23,34
Polyunsaturated	24,77	19,06	33,24	44,67	40,87	48,22
Total	100,00	100,00	100,00	100,00	100,00	100,00
Omega-3	21,95	18,85	30,18	41,51	39,90	44,13
Omega-6	2,82	0,21	3,05	3,15	0,97	4,09

Table 13. Fatty acid composition of the triglyceride and lyso-phosphatidylcholine fractions (% (w/w)).

Fatty Acid	Triglycerides			Lyso PC		
	Neutral KO	Polar KO	Neptune KO	Neutral KO	Polar KO	Neptune KO
File						
C4:0	0,00	0,00	0,00	0,00	0,00	0,00
C6:0	0,00	0,00	0,00	0,00	0,00	0,00
C8:0	0,00	0,00	0,00	0,00	0,00	0,00
C10:0	0,00	0,00	0,00	0,00	0,00	0,00
C12:0	0,00	0,00	0,00	0,00	0,00	0,00
C14:0	23,06	26,65	25,13	19,38	4,27	2,87
C14:1	0,36	0,93	0,36	0,00	0,08	0,00

C15:0	0,56	2,64	0,78	0,00	0,52	0,45
C16:0	23,17	4,93	27,80	41,00	44,14	30,56
C16:1	13,68	11,58	0,04	0,00	1,84	2,24
C18:0	1,52	3,12	1,99	0,76	1,59	1,32
C18:1	27,83	34,39	27,92	6,65	14,24	11,29
C18:2N6	1,64	2,05	1,92	0,00	1,75	2,07
C18:3N6	0,20	0,00	0,30	0,00	0,00	0,06
C18:3N3	0,51	0,00	0,00	7,95	0,67	1,75
C18:4N3	1,99	0,00	4,83	0,00	1,11	2,46
C20:0	0,06	0,00	0,08	0,00	0,00	0,00
C20:1	1,67	0,00	1,76	0,00	0,52	0,00
C20:2N6	0,04	0,00	0,05	0,00	0,00	0,00
C20:3N6	0,05	0,00	0,01	0,00	0,00	0,54
C20:4N6	0,00	0,00	0,00	0,00	0,40	0,00
C20:3N3	0,05	0,00	0,07	0,00	0,00	0,00
C20:4N3	0,11	0,00	0,17	0,00	0,31	0,55
C20:5N3 (EPA)	2,10	7,97	4,44	0,00	18,59	28,48
C22:0	0,02	0,00	0,04	0,00	0,00	0,00
C22:1	0,37	0,00	0,42	0,00	1,46	0,91
C22:2N6	0,00	0,00	0,00	0,00	0,00	0,00
C22:4N6	0,01	0,00	0,01	0,00	0,00	0,00
C22:5N6	0,00	0,00	0,01	0,00	0,00	0,00
C22:5N3	0,10	0,00	0,16	0,00	0,41	0,62
C22:6N3 (DHA)	0,67	3,97	1,42	24,26	7,79	13,82
C24:0	0,26	1,78	0,26	0,00	0,32	0,00
C24:1	0,00	0,00	0,03	0,00	0,00	0,00
Total	100,00	100,00	100,00	100,00	100,00	100,00
Saturated	48,64	39,12	56,08	61,14	50,83	35,21
Monounsaturated	43,90	46,89	30,52	6,65	18,14	14,44
Polyunsaturated	7,45	13,99	13,41	32,20	31,02	50,35
Total	100,00	100,00	100,00	100,00	100,00	100,00
Omega-3	5,51	11,94	11,11	32,20	28,87	47,69
Omega-6	1,94	2,05	2,30	0,00	2,15	2,66

Table 14. Fatty acid composition of the phosphatidylcholine and the phosphatidylserine fractions (% (w/w)).

Fatty Acid	PC			PS		
	Neutral KO	Polar KO	Neptune KO	Neutral KO	Polar KO	Neptune KO
File						
C4:0	0,00	0,00	0,00	0,00	0,00	0,00
C6:0	0,00	0,00	0,00	0,00	0,00	0,00
C8:0	0,00	0,00	0,00	0,00	0,00	0,00

C10:0	0,00	0,00	0,00	0,00	0,00	0,00
C12:0	0,00	0,00	0,00	0,00	0,00	0,00
C14:0	0,75	3,29	2,77	7,60	9,52	2,31
C14:1	2,07	0,04	0,02	0,00	0,00	0,00
C15:0	1,34	0,00	0,00	3,83	0,00	0,00
C16:0	16,65	31,92	29,83	30,44	43,61	19,49
C16:1	0,96	0,01	0,17	9,96	3,47	2,79
C18:0	1,33	1,06	1,33	2,08	3,34	2,24
C18:1	34,34	13,55	11,16	0,00	7,37	11,87
C18:2N6	10,55	2,27	1,90	0,00	0,00	0,00
C18:3N6	1,44	0,25	0,20	0,00	0,00	0,00
C18:3N3	2,49	1,19	1,54	0,00	0,00	0,00
C18:4N3	2,38	1,92	2,41	0,00	0,00	0,00
C20:0	2,79	0,03	0,05	0,00	0,00	0,00
C20:1	2,42	0,82	0,74	0,00	0,00	0,00
C20:2N6	0,56	0,05	0,06	0,00	0,00	0,00
C20:3N6	0,67	0,13	0,09	0,00	0,00	0,00
C20:4N6	1,85	0,61	0,56	0,00	0,00	0,00
C20:3N3	3,94	0,07	0,06	0,00	0,00	0,33
C20:4N3	4,32	0,50	0,46	0,00	0,00	0,00
C20:5N3 (EPA)	1,08	29,85	30,09	25,84	15,81	16,35
C22:0	0,00	0,05	0,02	0,00	0,00	0,00
C22:1	2,77	0,00	1,87	0,00	0,00	0,00
C22:2N6	0,00	0,81	0,97	0,00	0,00	0,00
C22:4N6	0,00	0,01	0,02	0,00	0,00	0,00
C22:5N6	1,49	0,01	0,00	0,00	0,00	0,00
C22:5N3	1,48	0,67	0,68	0,00	0,00	0,00
C22:6N3 (DHA)	0,00	10,53	12,49	20,25	16,89	44,63
C24:0	2,34	0,10	0,18	0,00	0,00	0,00
C24:1	0,00	0,25	0,34	0,00	0,00	0,00
Total	100,00	100,00	100,00	100,00	100,00	100,00
Saturated	25,19	36,46	34,18	43,95	56,47	24,04
Monounsaturated	42,56	14,67	14,29	9,96	10,84	14,65
Polyunsaturated	32,25	48,87	51,53	46,09	32,69	61,31
Total	100,00	100,00	100,00	100,00	100,00	100,00
Omega-3	15,69	44,73	47,73	46,09	32,69	61,31
Omega-6	16,56	4,13	3,81	0,00	0,00	0,00

Table 15. Fatty acid composition of the phosphatidylinositol and phosphatidylethanolamine fractions (% (w/w)).

Fatty Acid	PI			PE		
	Neutral KO	Polar KO	Neptune KO	Neutral KO	Polar KO	Neptune KO
File						
C4:0	0,00	0,00	0,00	0,00	0,00	0,00
C6:0	0,00	0,00	0,00	0,00	0,00	0,00
C8:0	0,00	0,00	0,00	0,00	0,00	0,00
C10:0	0,00	0,00	0,00	0,00	0,00	0,00
C12:0	0,00	0,00	0,00	0,00	0,00	0,00
C14:0	11,15	5,82	5,72	14,42	4,60	0,83
C14:1	3,03	0,66	0,00	0,00	0,00	0,10
C15:0	5,86	1,95	3,18	0,00	1,30	0,23
C16:0	37,02	30,66	31,39	35,91	31,21	18,38
C16:1	18,05	2,24	1,16	0,00	1,51	0,75
C18:0	6,72	2,83	5,56	12,72	16,70	1,84
C18:1	18,15	24,77	14,23	36,96	19,91	18,45
C18:2N6	0,00	2,67	0,00	0,00	2,62	0,85
C18:3N6	0,00	0,00	0,00	0,00	0,00	0,00
C18:3N3	0,00	0,00	0,00	0,00	0,00	0,33
C18:4N3	0,00	0,00	0,00	0,00	0,00	0,00
C20:0	0,00	0,00	0,00	0,00	0,00	0,00
C20:1	0,00	0,00	0,00	0,00	0,00	0,00
C20:2N6	0,00	0,00	0,00	0,00	0,00	0,00
C20:3N6	0,00	0,00	0,00	0,00	0,00	1,15
C20:4N6	0,00	0,00	0,00	0,00	0,00	0,00
C20:3N3	0,00	0,00	0,00	0,00	0,00	0,00
C20:4N3	0,00	0,00	0,00	0,00	0,00	0,00
C20:5N3 (EPA)	0,00	17,60	20,45	0,00	10,76	21,26
C22:0	0,00	0,00	0,00	0,00	0,00	0,00
C22:1	0,00	0,00	0,00	0,00	0,00	0,00
C22:2N6	0,00	0,00	0,00	0,00	0,00	0,00
C22:4N6	0,00	0,00	0,00	0,00	0,00	0,00
C22:5N6	0,00	0,00	0,00	0,00	0,00	0,00
C22:5N3	0,00	0,00	0,00	0,00	0,00	0,67
C22:6N3 (DHA)	0,00	10,79	18,32	0,00	11,39	35,16
C24:0	0,00	0,00	0,00	0,00	0,00	0,00
C24:1	0,00	0,00	0,00	0,00	0,00	0,00
Total	100,00	100,00	100,00	100,00	100,00	100,00
Saturated	60,76	41,26	45,84	63,04	53,81	21,28
Monounsaturated	39,24	27,67	15,39	36,96	21,42	19,30
Polyunsaturated	0,00	31,07	38,77	0,00	24,77	59,42
Total	100,00	100,00	100,00	100,00	100,00	100,00

Omega-3	0,00	28,40	38,77	0,00	22,15	57,43
Omega-6	0,00	2,67	0,00	0,00	2,62	1,99

Table 16. Compositional data for the novel krill oil composition obtained and NKO krill oil.

Compounds	Neptune KO	Ethanol extracted KO	Polar KO	Neutral KO
Astaxanthin esters	472 mg/kg	117 mg/kg	580 mg/kg	98 mg/kg
Astaxanthin free	11 mg/kg	< 1 mg/kg	<1 mg/kg	<1 mg/kg
Total cholesterol	1 g/100g	12 g/100g	< 0,5 g/100g	5,7 g/100g

5

EXAMPLE 4

Neutral lipids were extracted from krill meal (138 kg) using SFE with neat CO₂ (solvent ratio 25 kg/kg) at 500 bar and 75 °C. The neutral lipids were fractionated at 200 bar (75 °C) and at 60 bar (35 °C) at separator S1 and S2, respectively. The extract obtained in S1 (19,6 kg) were characterized and the results can be found in Tables 17A-C. The extract in table S2 (0,4 kg) were rich in water and were not further used. Next, the polar lipids were extracted using CO₂ at 500 bar, 20% ethanol and at a temperature of 75 °C. Using a solvent ratio of 32 (kg/kg) and collecting an extract of 18,2 kg using a separator at 60 bars and 35°C. The polar lipids were collected and analyzed (Tables 18A-C). Next, the polar lipids were mixed in a 50/50 ratio with the neutral lipids collected from S1 before finally the ethanol was removed carefully by evaporation. The product obtained was red and transparent. If the ethanol is removed before the mixing if the fractions a transparent product is not obtained. The composition of the 50/50 red and transparent product can be found in Tables 19A-C.

Table 17A Fatty acid composition of the extract collected in S1

Fatty acid	Unit	Amount
14:0	g/100g	18,4
16:0	g/100g	22,2
18:0	g/100g	1,5
16:1 n-7	g/100g	10,9
18:1 (n-9) + (n-7) + (n-5)	g/100g	25,6

20:1 (n-9) + (n-7)	g/100g	1,8
22:1 (n-11) + (n-9) + (n-7)	g/100g	0,5
16:2 (n-4)	g/100g	1,3
16:4 (n-1)	g/100g	1,2
18:2 n-6	g/100g	1,3
18:3 n-3	g/100g	0,8
18:4 n-3	g/100g	2,9
20:5 n-3	g/100g	4,1
22:6 n-4	g/100g	1,7

Table 17B. Lipid class composition of the extract collected in S1

Lipid	Unit	Amount
Triacylglycerol	g/100g	84
Diacylglycerol	g/100g	0,7
Free fatty acids	g/100g	1,5
Cholesterol	g/100g	2,7
Cholesterol esters	g/100g	0,9

Table 17C. Miscellaneous analysis of the extract in S1.

Compound	Unit	Amount
Free astaxanthin	mg/kg	4,3
Astaxanthin esters	mg/kg	462
Trimethylamin	mg N/100 g	<1
Trimethylamineoxide	mg N/100 g	2

5

Table 18A Fatty acid composition of the extract collected after CO₂ and 20% ethanol in S1.

Fatty acid	Unit	Amount
14:0	g/100g	1,3
16:0	g/100g	13,8
18:0	g/100g	0,6
16:1 n-7	g/100g	0,9
18:1 (n-9) + (n-7) + (n-5)	g/100g	6,5
20:1 (n-9) + (n-7)	g/100g	0,6

22:1 (n-11) + (n-9) + (n-7)	g/100g	0,1
16:2 (n-4)	g/100g	<0,1
16:4 (n-1)	g/100g	<0,1
18:2 n-6	g/100g	0,8
18:3 n-3	g/100g	0,6
18:4 n-3	g/100g	1,0
20:5 n-3	g/100g	14,7
22:6 n-4	g/100g	6,5

Table 18B. Lipid class composition of the extract collected after CO₂ and 20% ethanol in S1.

Lipid	Unit	Amount
Triacylglycerol	g/100g	<0,5
Cholesterol	g/100g	<0,5
Phosphatidylethanolamine	g/100g	1,6
Phosphatidylcholine	g/100g	67
Lyso-phosphatidylcholine	g/100g	4,4

Table 18C. Miscellaneous analysis of the extract in S1.

Compound	Unit	Amount
Trimethylamin	mg N/100 g	422
Trimethylamineoxide	mg N/100 g	239

5

Table 19A Fatty acid composition of the final blended product obtained in Example 4 in S1.

Fatty acid	Unit	Amount
14:0	g/100g	9,7
16:0	g/100g	18,5
18:0	g/100g	1,0
16:1 n-7	g/100g	5,8
18:1 (n-9) + (n-7) + (n-5)	g/100g	16,0
20:1 (n-9) + (n-7)	g/100g	1,2
22:1 (n-11) + (n-9) + (n-7)	g/100g	1,0
16:2 (n-4)	g/100g	0,3
16:4 (n-1)	g/100g	<0,1

18:2 n-6	g/100g	1,0
18:3 n-3	g/100g	0,8
18:4 n-3	g/100g	2,1
20:5 n-3	g/100g	10,7
22:6 n-4	g/100g	4,7

Table 19B. Lipid class composition of the final blended product obtained in Example 4.

Lipid ¹	Unit	Amount
Triacylglycerol	g/100g	53
Diacylglycerol	g/100g	1,3
Free fatty acids	g/100g	0,5
Cholesterol	g/100g	0,6
Cholesterol esters	g/100g	<0,5
Phosphatidylethanolamine	g/100g	<1
Phosphatidylcholine	g/100g	42
Lyso-phosphatidylcholine	g/100g	5,9

Table 19C. Miscellaneous analysis of the final blended product obtained in example 4.

Compound	Unit	Amount
Free astaxanthin	mg/kg	1,1
Astaxanthin esters	mg/kg	151
Trimethylamin	mg N/100 g	109
Trimethylamineoxide	mg N/100 g	80

5

EXAMPLE 5

The asta oil obtained in example 1 was blended with the polar lipids obtained in example 4 in a ratio of 46:54 (v/v). Next the ethanol was removed by evaporation and a dark red and transparent product was obtained. The product was analyzed and the results can be found in Tables 20A-C. Furthermore, the product was encapsulated into soft gels successfully. During the encapsulation it was observed that any further increase in phospholipids and thereby viscosity will make it very difficult to encapsulate the final product.

10

Table 20A Fatty acid composition of the final blended product obtained in Example 5.

Fatty acid	Unit	Amount
14:0	g/100g	8,2
16:0	g/100g	17,7
18:0	g/100g	1,0
16:1 n-7	g/100g	4,9
18:1 (n-9) + (n-7) + (n-5)	g/100g	14,9
20:1 (n-9) + (n-7)	g/100g	1,1
22:1 (n-11) + (n-9) + (n-7)	g/100g	1,0
16:2 (n-4)	g/100g	0,4
16:4 (n-1)	g/100g	<0,1
18:2 n-6	g/100g	1,2
18:3 n-3	g/100g	0,8
18:4 n-3	g/100g	1,8
20:5 n-3	g/100g	10,6
22:6 n-4	g/100g	4,8

Table 20B. Lipid class composition of the final blended product obtained in Example 5.

Lipid	Unit	Amount
Triacylglycerol	g/100g	41
Diacylglycerol	g/100g	0,8
Free fatty acids	g/100g	1,2
Cholesterol	g/100g	0,4
Cholesterol esters	g/100g	0,3
Phosphatidylethanolamine	g/100g	0,6
Phosphatidylcholine	g/100g	51
Lyso-phosphatidylcholine	g/100g	<0,5
Total polar lipids	g/100g	52,4
Total neutral lipids	g/100g	43,6

5 **Table 20C.** Miscellaneous analysis of the final blended product obtained in Example 5

Compound	Unit	Amount
Free astaxanthin	mg/kg	12

Astaxanthin esters	mg/kg	1302
Trimethylamin	mg N/100 g	193
Trimethylamineoxide	mg N/100 g	1,7

EXAMPLE 6

Fresh krill was pumped from the harvesting trawl directly into an indirect steam cooker, and heated to 90C. Water and a small amount of oil were removed in a screw press before ethoxyquin (antioxidant) was added and the denatured meal was dried under vacuum at a temperature not exceeding 80C. After 19 months storage in room temperature, a sample of the denatured meal was extracted in two steps with supercritical CO₂ in laboratory scale at a flow rate of 2ml/min at 100C and a pressure of 7500 psi. In the second step 20% ethanol was added to the CO₂. The two fractions collected were combined and analyzed by HPLC using ELS detection. The phosphatidylcholine was measured to 42.22% whereas the partly decomposed phosphatidylcholine was 1.68%. This data strongly contrasts the data obtained by analysis of a krill oil sample in the marketplace that showed a content of 9.05% of phosphatidylcholine and 4.60% of partly decomposed phosphatidylcholine.

EXAMPLE 7

Krill lipids were extracted from krill meal (a food grade powder) using supercritical fluid extraction with co-solvent. Initially, 300 bar pressure, 333°K and 5% ethanol (ethanol:CO₂, w/w) were utilized for 60 minutes in order to remove neutral lipids and astaxanthin from the krill meal. Next, the ethanol content was increased to 23% and the extraction was maintained for 3 hours and 40 minutes. The extract was then evaporated using a falling film evaporator and the resulting krill oil was finally filtered. The product obtained was then analyzed and the results can be found in Table 21.

Table 21. Analysis of the krill oil obtained using supercritical fluid extraction.

Parameter	Value
Ethanol	1.11% w/w
Water Content	2.98 % w/w
C20:5 n-3 (EPA)	19.9
C22:6 n-3 (DHA)	11.3
Total Omega 3	35.7
Total Omega 6	3.0
Total Phospholipids	50.55 wt%
Ratio Omega3-PL/Total Omega 3	77.6 % w/w
Ratio EPA- PL/Total EPA	84.4 %w/w

Ratio DHA-PL/Total DHA	74.7 %w/w
Triglycerides	25.9 g/100g
Astaxanthin	2091 mg/kg
Peroxide Value	<0.1

EXAMPLE 8

Krill oil was prepared according to the method described in example 7 extracting from the same krill meal. The oil was subjected to ^{31}P NMR analysis for the identification and quantification of the various forms of phospholipids. The analysis was performed according to the following methods: Samples (20 – 40 mg) were weighed into 1.5 ml centrifuge tubes. Next, NMR detergent (750 μl -10% Na cholate, 1% EDTA, pH 7.0 in $\text{H}_2\text{O}+\text{D}_2\text{O}$, 0.3 g L-1 PMG internal standard) was added. Next, the tube was placed in a oven at 60°C and periodically shaken/sonicated until completely dispersed. The solution was then transferred to a 5 ml NMR tube for analysis. Phosphorus NMR spectra were recorded on the two-channel Bruker Avance300 with the following instrument settings: spectrometer frequency 121.498MHz, sweep width 24,271 Hz, 64,000 data points, 30 degree excitation pulse, 576 transients were normally taken, each with an 8 second delay time and f.i.d. acquisition time of 1.35 sec. Spectra were processed with a standard exponential weighting function with 0.2 Hz line broadening before Fourier transformation.

Peaks were identified using known chemical shifts. Deacylation of samples with monomethylamine was also used on two samples for confirmation of peak identity and to achieve better peak resolution. Example spectra are presented in Figure 1. Peak area integration gave relative molar amounts of each lipid class. Weight percent values were calculated using molecular masses calculated from a krill sample fatty acid profile (average chain length = 18.6). Total PL levels were calculated from the PMG internal standard peak. The quantification of the phospholipids are shown in table 25 for both the raw material, the final product and for a commercially available krill oil (Neptune Krill Oil). The main polar ether lipids of the krill meal are alkylacylphosphatidylcholine (AAPC) at 7-9 % of total polar lipids, lyso-alkylacylphosphatidylcholine (LAAPC) at 1 % of total polar lipids (TPL) and alkylacylphosphatidyl-ethanolamine (AAPE) at < 1 % of TPL.

Table 22: Phospholipid profiles

	<u>Type B krill powder</u>	<u>NK O</u>	<u>Krill Oil obtained in Example 7</u>
PC	66.0	68.6	75.3
AAPC	12.0	7.0	13.0
PI			
1LPC	1.2	1.3	0.4
PS			
2LPC	7.4	13.8	2.9
LAAPC	2.2	1.2	0.9
PE	6.0	3.4	3.4
AAPE			1.5
SM			
GPC		1.3	
DHSM			
NAPE		3.4	
CL	5.3		2.1
LPE			0.5
LCL			
% PL in powder or lipid sample	8.3	30.0	47.9

Analysis has been carried out on the fatty acid and ether/alcohol profiles of the AAPC. The following results are presented in Table 23.

Table 23. Fatty acid profile of the alkylacylphosphatidylcholine.

AAPC fatty acid composition	AAPC alcohol composition	alcohol %
20:5(n-3) – 46.9%;	16:0	47.6
22:6(n-3) – 36.1%;	18:1	17.8
18:1(n-9) – 4.6%	16:1	14.1
22:5(n-3) – 2.6%	14:0	10
20:4(n-6) – 1.9%	18:0	8.6
21:5(n-3) – 1.5%	18:2	5.1
18:2(n-6) – 0.9%	17:0	4.4
16:1(n-9) – 0.8%	15:0-i	2.1
16:0 – 0.7%	15:0	1.7
phytanic – 0.6%	20:1	1.4
18:3(n-3) – 0.5%	15:0-a	1.3

18:4(n-3) – 0.4% 18:0-i 0.4
18:1(n-7) – 0.4%
24:1 – 0.4%
14:0 – 0.3%

The rest of alcohols (i17:0, etc.), were less than 0.3% each. Only part of 20:1 was confirmed by GC-MS. Alcohol moieties composition of Krill AAPC was determined (identification was performed in the form of 1-alkyl-2,3-diTMS glycerols on GC-MS, % of total fatty alcohols were obtained by GC with FID). Ten other fatty acids were all below 0.3
5 % by mass.

EXAMPLE 9

The purpose of this experiment was to investigate the effect of different omega-3 fatty acid sources on metabolic parameters in the Zucker rat. The Zucker rat is a widely used model
10 of obesity and insulin resistance. Obesity is due to a mutation in the leptin receptor which impairs the regulation of intake. Omega-3 sources compared in this study were fish oil (FO) and two types of krill oil. The krill oil were either from a commercial supplier (Neptune Krill oil) or prepared according to example 7 (SuperbaTM). Four groups of rats (n = 6 per group) were fed *ad lib* either a control diet (CTRL) or a diet supplemented with a source of omega-3
15 fatty acids (FO, NKO, Superba). All diets supplied same amount of dietary fatty acids, oleic acid, linoleic acid and linolenic acid. Omega-3 diets (FO, NKO and SuperbaTM) were additionally balanced for EPA and DHA content. The Zucker rats were 4 wk old at the start of the study with average initial weight of 250 g. At this stage the Zucker rats can be characterized as being pre-diabetic. Rats were fed the test diets for 4 wk after which they were
20 sacrificed and blood and tissue samples were collected. Data presented in the following figures are means ± SE. This example shows that supplementation of the Zucker rat with krill oil prepared as in example 7 results in an improvement of metabolic parameters characteristic of the obesity induced type two diabetic condition. The effect induced by the novel krill oil is often more pronounced than the effect of FO an in several cases greater than the effect
25 induced by NKO. Specifically, the effects of the two types of krill oil differentiated with respect to the reduction of blood LDL cholesterol levels as well as lipid accumulation in the liver and muscle (Figure 2-9). Furthermore, the efficacy of transfer of DHA from the diet to the brain tissue was greatest with the krill oil prepared as in example 7 (Figure 10).

30

EXAMPLE 11

This example describes the effect of the supplementation of human diets with krill oil, fish oil (positive control), or a negative control oil (no omega-3 fatty acids) on blood urea nitrogen (BUN).

BUN measures the amount of nitrogen in the blood that comes from urea. BUN is used as a measure of renal function. Serum creatinine is, however, considered to be a more specific measure of renal function. In this study, krill oil decreased BUN by 11.8% while creatinine levels were unchanged. Thus, it is likely that the decrease in BUN is due to some other effect than improved renal function. BUN decreases if krill oil induced diuresis i.e. excretion of urine (diuretic effect).

BUN also decreases if body protein catabolism is reduced. Protein catabolism is a normal feature of body protein turnover. Many tissues express high protein turnover rates. For example the gastrointestinal system expresses high rates of protein turnover. In growing animals a reduction in GI protein catabolism improves weight gain. Mice supplemented with krill oil grew at a faster rate than mice supplemented with fish oil or control diet (Figure 11).

Table 24. The effect on blood urea nitrogen in humans for the different treatment groups.

20

	Control n = 23	Krill Oil n = 24	Menhaden oil n = 25	p
BUN, mg/dL				
Baseline	11.5 (7.8, 13.8)	11.5 (9.5, 13.5)	11.5 (9.5, 14.0)	0.523
Δ from baseline, %	11.0 (-14.3, 26.1)	-11.8 (-20.0, 1.5)	9.1 (-9.1, 35.7)	0.014r
Creatinine, mg/dL				
Baseline	0.9 (0.7, 0.9)	0.9 (0.7, 0.9)	0.8 (0.8, 1.0)	0.952r
(r)				
Δ from baseline, %	0.0 (-9.6, 2.9)	0.0 (-2.0, 5.9)	0.0 (-5.9, 6.7)	0.416

30

EXAMPLE 12

The purpose of this experiment was to investigate the effect of dietary krill oil on metabolic parameters in high-fat fed mice and to compare the effect of dietary krill oil with that of fish oil containing the same amount of omega-3 fatty acids. Four groups of C57BL/6

35

mice (n = 10 per group) were fed 1) chow (N), 2) high fat diet comprising 21% butter fat and 0.15% cholesterol (HF), 3) high fat diet + krill oil (HFKO) or 4) high fat diet + fish oil (HFFO). Treatment 3 contained 2.25% (w/w) krill oil as prepared in example 5 (except that the astaxanthin content was 500 ppm) which were equivalent to 0.36% omega-3 fatty acids.

5 Treatment 4 also contained 0.36% omega-3 fatty acids obtained from regular 18-12 fish oil. The diets were fed to the mice for 7 weeks with free access to drinking water. Data represented in this example means \pm SE. Columns not sharing a common letter are significantly different ($P < 0.05$) by ANOVA followed by Tukey's multiple comparison test. N = normal chow diet (n = 10); HF = high-fat diet (n = 10); HFFO = high-fat diet

10 supplemented with fish oil (n = 9); HFKO = high-fat diet supplemented with krill oil (n = 8). The data are presented in Figures 18-25.

This example shows that supplementation of high-fat fed mice with krill oil results in an amelioration of diet-induced hyperinsulinemia, insulin resistance, increase in muscle lipid content (measured as a change in muscle mass), serum adiponectin reduction and hepatic

15 steatosis. These potentially beneficial atheroprotective effects were similar or greater than those achieved with a supplement containing a comparable level of omega-3 fatty acids (Figure 12-19).

CLAIMS

- 5 1. A composition comprising:
from about 3% to 10% ether phospholipids on a w/w basis; and
from about 400 to about 2500 mg/kg astaxanthin.
2. The composition of claim 1, further comprising from about 35% to 50% non-ether
10 phospholipids on w/w basis, so that the total amount of ether phospholipids and non-ether
phospholipids in the composition is from about 38% to 60% on a w/w basis.
3. The composition of claim 1 or claim 2, further comprising from about 20% to 45%
triglycerides on a w/w basis.
- 15 4. The composition of any one of claims 1 to 3, wherein said ether phospholipids are
selected from the group consisting of alkylacylphosphatidylcholine, lyso-
alkylacylphosphatidylcholine, alkylacylphosphatidylethanolamine, and combinations thereof.
- 20 5. The composition of any one of claims 1 to 4, wherein said ether lipids are greater than
90% alkylacylphosphatidylcholine.
6. The composition of any one of claims 1 to 5, wherein said non-ether phospholipids are
selected from the group consisting of phosphatidylcholine, phosphatidylserine,
25 phosphatidylethanolamine and combinations thereof.
7. The composition of any one of claims 1 to 6, wherein said composition comprises a
blend of lipid fractions obtained from *Euphausia superba*.
- 30 8. The composition of any one of claims 1 to 7, wherein said composition comprises
from about 25% to 40% omega-3 fatty acids as a percentage of total fatty acids and wherein
from about 80% to 90% of said omega-3 fatty acids are attached to said phospholipids.

9. The composition of claim 1, further characterized in comprising at least 65% (w/w) of phospholipids, said phospholipids characterized in containing at least 35% omega-3 fatty acid residues.
- 5 10. The composition of any one of claims 1 to 9, wherein the composition is derived from a marine or aquatic biomass.
11. The composition of any one of claims 1 to 9, wherein the composition is derived from krill.
- 10 12. The composition of any one of claims 1 to 11, wherein said composition comprises less than 2% free fatty acids.
13. The composition of any one of claims 1 to 12, further characterized in that said phospholipids comprise greater than 50% phosphatidylcholine (w/w).
- 15 14. The composition of any one of claims 1 to 12, further characterized in that said phospholipids comprise greater than 70% phosphatidylcholine (w/w).
- 20 15. The composition of any one of claims 1 to 12, further characterized in that said phospholipids comprise greater than 80% phosphatidylcholine (w/w).
16. The composition of any one of claims 1 to 15, further characterized in comprising at least 36% (w/w) omega-3 fatty acids.
- 25 17. The composition of any one of claims 1 to 16, further characterized in comprising less than about 0.5g/100g total cholesterol.
18. The composition of any one of claims 1 to 17, further characterized in comprising less than about 0.45% arachidonic acid (w/w).
- 30 19. The composition of any one of claims 1 to 18, further characterized in being free from acetone.

20. The compositions of any one of claims 1 to 19, wherein said composition is odorless.
21. The composition of any one of claims 1 to 20, wherein said composition comprises less than about 10 mg/kg (w/w) trimethylamine.
- 5
22. A composition as claimed in claim 1 wherein said composition is a *Euphausia superba* krill oil composition comprising:
- from about 3% to about 10% w/w ether phospholipids;
 - from about 27% to 50% w/w non-ether phospholipids so that the amount of total
 - 10 phospholipids in the composition is from about 30% to 60% w/w;
 - from about 20% to 50% w/w triglycerides;
 - from about 400 to about 2500 mg/kg astaxanthin; and
 - from about 20% to 35% omega-3 fatty acids as a percentage of total fatty acids in said
 - 15 composition, wherein from about 70% to 95% of said omega-3 fatty acids are attached to said phospholipids.
23. A capsule containing the composition of any one of claims 1 to 22.
24. A dietary supplement comprising the composition of any one of claims 1 to 22.
- 20
25. A composition as claimed in any one of claims 1 to 22 for the prevention or treatment of diet-induced hyperinsulinemia, insulin insensitivity, muscle mass hypertrophy, serum adiponectin reduction or hepatic steatosis.
- 25
26. A composition as claimed in any one of claims 1 to 22 for inducing diuresis.
27. A composition as claimed in any one of claims 1 to 22 for increasing muscle mass.
28. A composition as claimed in any one of claims 1 to 22 for decreasing protein
- 30 catabolism.
29. A composition as claimed in any one of claims 1 to 22 for prevention or treatment of fatty heart.

30. A composition as claimed in any one of claims 1 to 22 for prevention or treatment of fatty liver.
31. A composition as claimed in any one of claims 1 to 22 for prevention or treatment of insulin resistance, inflammation, blood lipid profile and oxidative stress.
32. A process for producing krill oil comprising:
a) providing a denatured krill product; and
b) extracting oil from said denatured krill product.
33. The process of claim 32, wherein said denatured krill product is produced by
a) providing fresh krill;
b) treating said fresh krill to denature lipases and phospholipases in said fresh krill to provide a denatured krill product; and
c) extracting oil from said denatured krill product.
34. The process of claim 33 in which the denaturation step comprises heating of said fresh krill.
35. The process of claim 33 in which the denaturation step comprises heating said fresh krill after grinding.
36. The process of any one of claims 32 to 35, further comprising storing said denatured krill product at room temperature or below between the denaturation step and the extraction step.
37. The process of any one of claims 32 to 36, wherein the enzyme denaturation step is achieved by application of heat.
38. The process of any one of claims 32 to 36, wherein said denatured krill product is a krill meal.
39. The process of claim 38, wherein said krill meal is stored prior to said extraction step.

40. The process of any one of claims 32 to 39, wherein the extraction step comprises use of supercritical carbon dioxide, with or without use of a polar modifier.

41. The process of claim 40, wherein said supercritical fluid extraction is a two step process comprising a first extraction step with carbon dioxide and from 1 to 10% of a co-solvent and a second extraction with carbon dioxide and from 10-30% of a co-solvent, wherein said co-solvent is a C₁-C₃ monohydric alcohol.

42. The process of any one of claims 32 to 41, wherein the extraction step comprises the use of ethanol.

43. The process of any one of claims 32 to 42, wherein the extraction step comprises ethanol extraction followed by acetone whereby to precipitate phospholipids.

44. A process for making a composition as claimed in claim 1 comprising:
contacting *Euphausia superba* with a polar solvent to provide a polar extract comprising phospholipids;
contacting *Euphausia superba* with a neutral solvent to provide a neutral extract comprising triglycerides and astaxanthin;
combining said polar extract and said neutral extract to provide *Euphausia superba* krill oil comprising from about 3% to about 10% w/w ether phospholipids; from about 27% to 50% w/w non-ether phospholipids so that the amount of total phospholipids in the composition is from about 30% to 60% w/w; from about 20% to 50% w/w triglycerides; from about 400 to about 2500 mg/kg astaxanthin; and from about 20% to 35% omega-3 fatty acids as a percentage of total fatty acids in said composition, wherein from about 70% to 95% of said omega-3 fatty acids are attached to said phospholipids.

45. The process of any one of claims 32 to 44, further comprising encapsulating said krill oil.

46. An oil produced by the processes of any one of claims 32 to 44.

47. A krill lipid extract comprising greater than about 80% triglycerides and greater than about 90 mg/kg astaxanthin esters.

48. The krill lipid extract of claim 47, characterized in containing from about 5% to about 15% omega-3 fatty acid residues.

5 49. The krill lipid extract of claim 47 or claim 48, characterized in containing less than about 5% phospholipids.

50. The krill lipid extract of any one of claims 47 to 49, characterized in comprising from about 5% to about 10% cholesterol.

10

51. A krill meal composition comprising less than about 50g/kg total fat.

52. The krill meal composition of claim 51 comprising from about 5 to about 20 mg/kg astaxanthin esters.

15

53. The krill meal composition of claims 51 or 52 comprising greater than about 65% protein.

20

54. The krill meal composition of any one of claims 51 to 53 comprising greater than about 70% protein.

55. An animal feed comprising the krill meal of any one of claims 51 to 54.

25

56. Use of the krill meal composition of any one of claims 51 to 54 to increase flesh coloration in an aquatic species.

57. Use of the krill meal composition of any one of claims 51 to 54 to increase growth and overall survival rate of aquatic species.

30

58. An odorless krill oil produced by the method comprising:
extracting a neutral krill oil from a krill oil containing material by supercritical fluid extraction to provide a deodorized krill material, wherein said neutral krill oil contains odor causing compounds; and

extracting a polar krill oil from said deodorized krill material by supercritical fluid extraction with a polar entrainer to provide an essentially odorless krill oil.

59. A krill oil produced by the process comprising:

5 pumping fresh krill from a trawl onto a ship, heating the krill to provide a krill material, and extracting oil from the krill material.

10

FIGURE 1

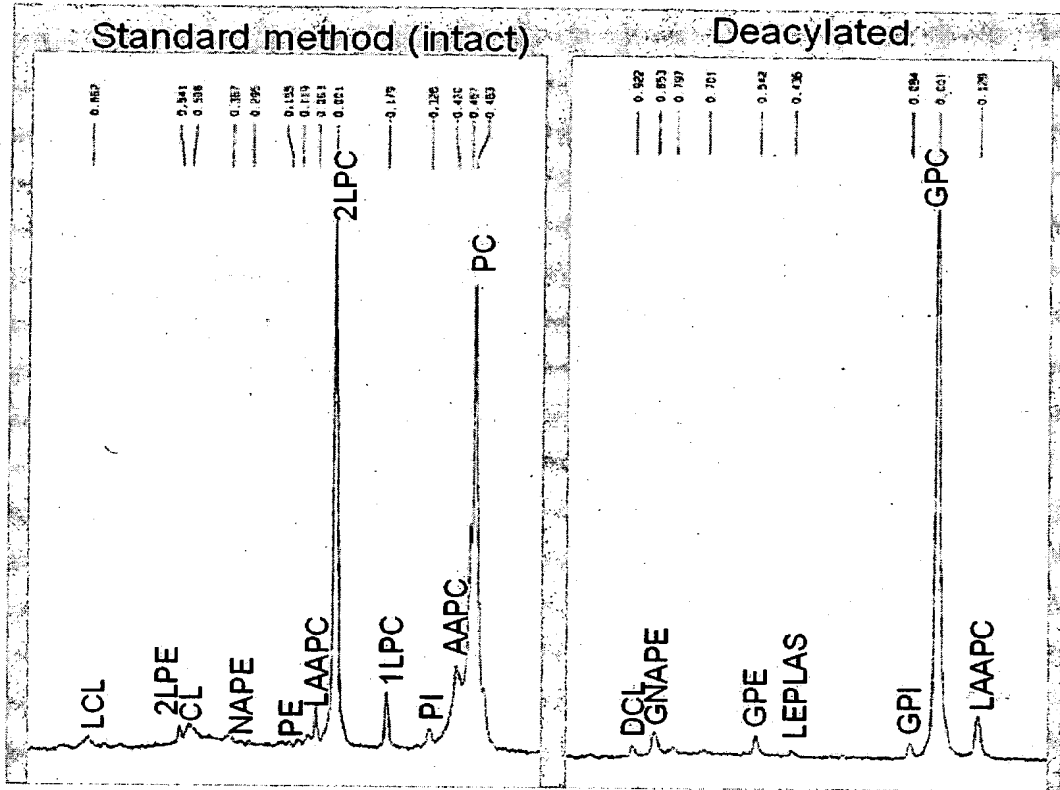

FIGURE 2

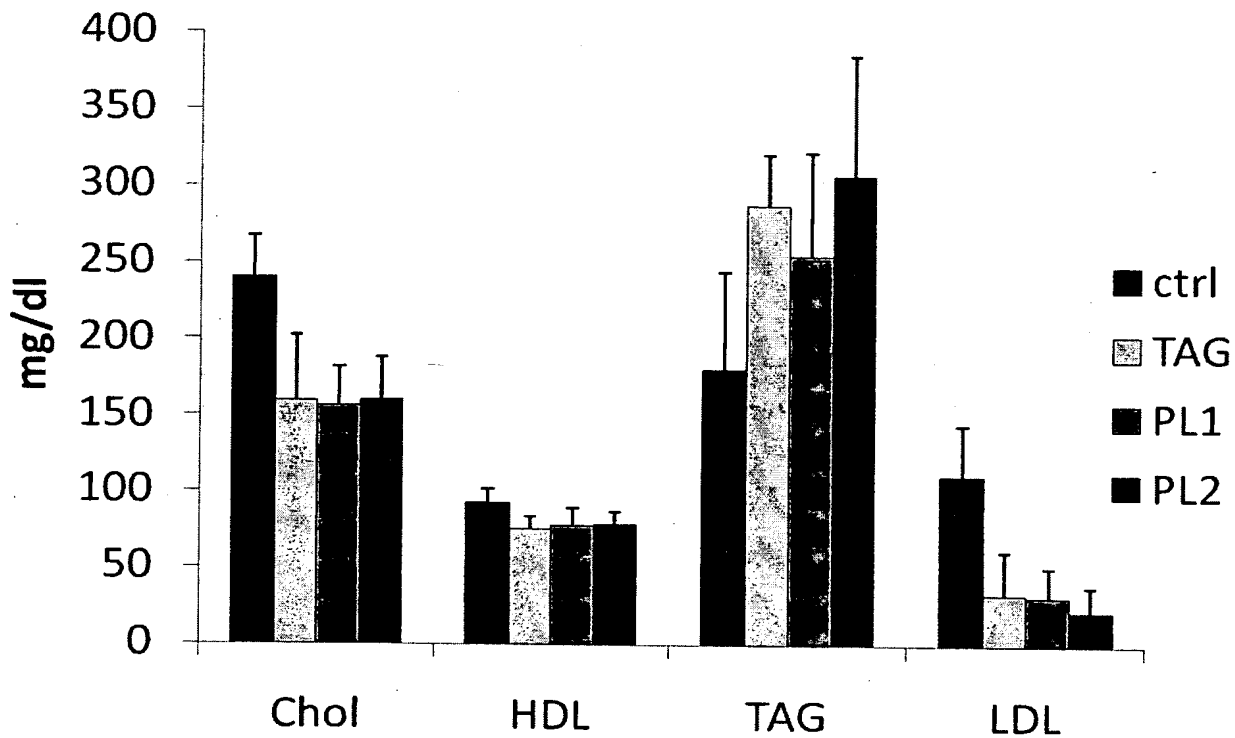

FIGURE 3

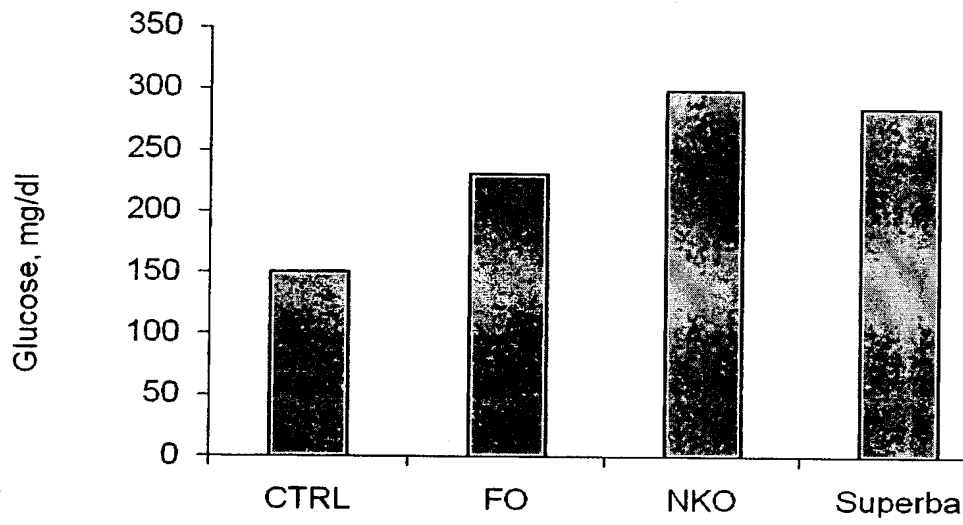

FIGURE 4

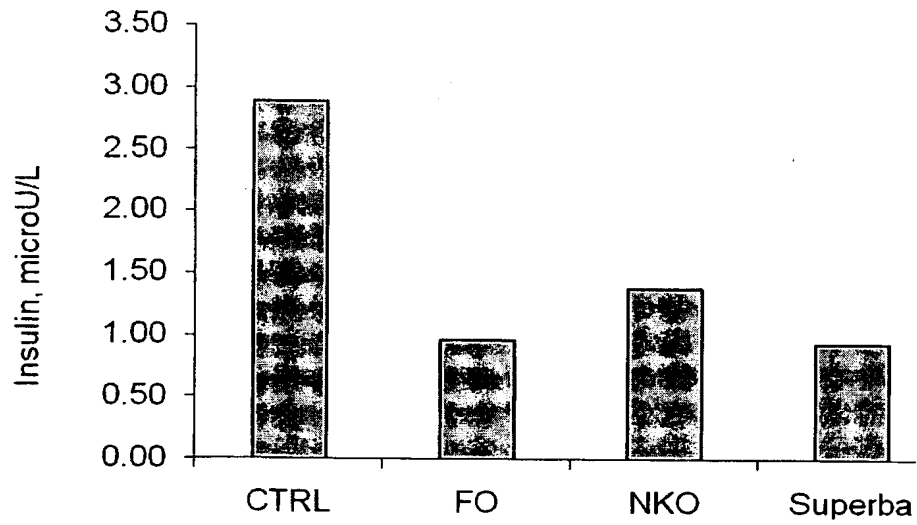

FIGURE 5

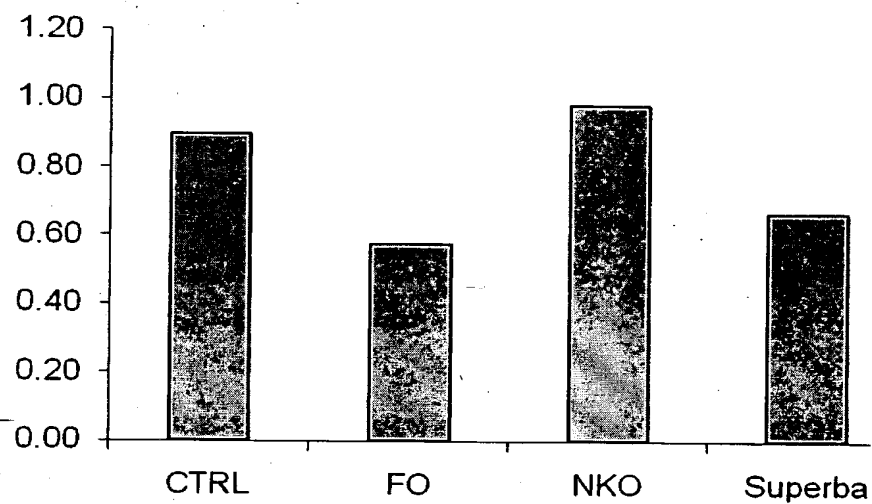

FIGURE 6

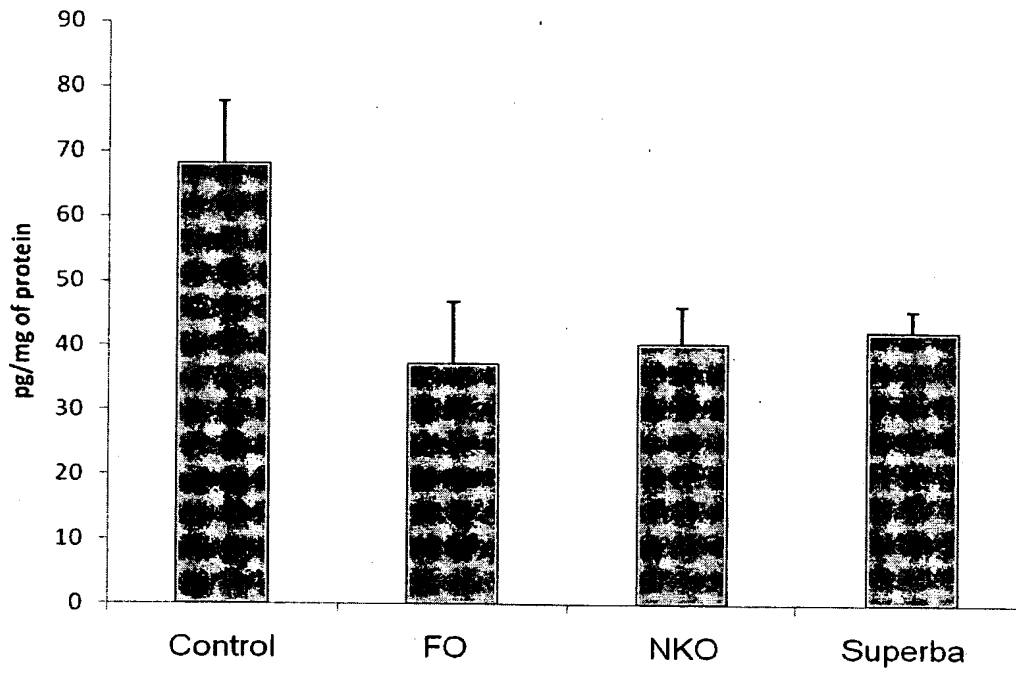

FIGURE 7

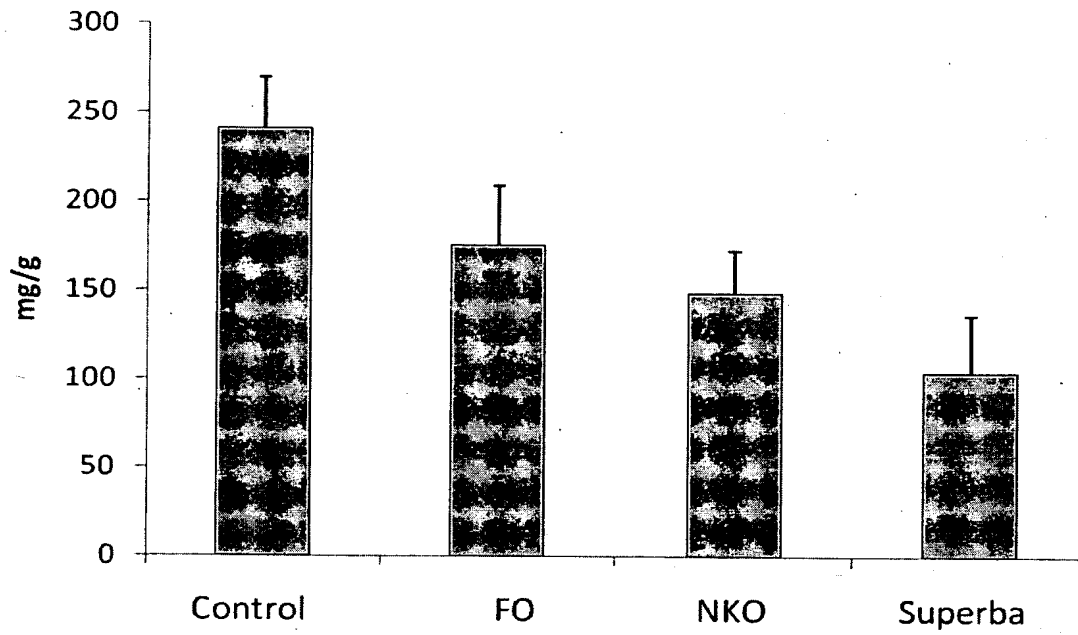

FIGURE 8

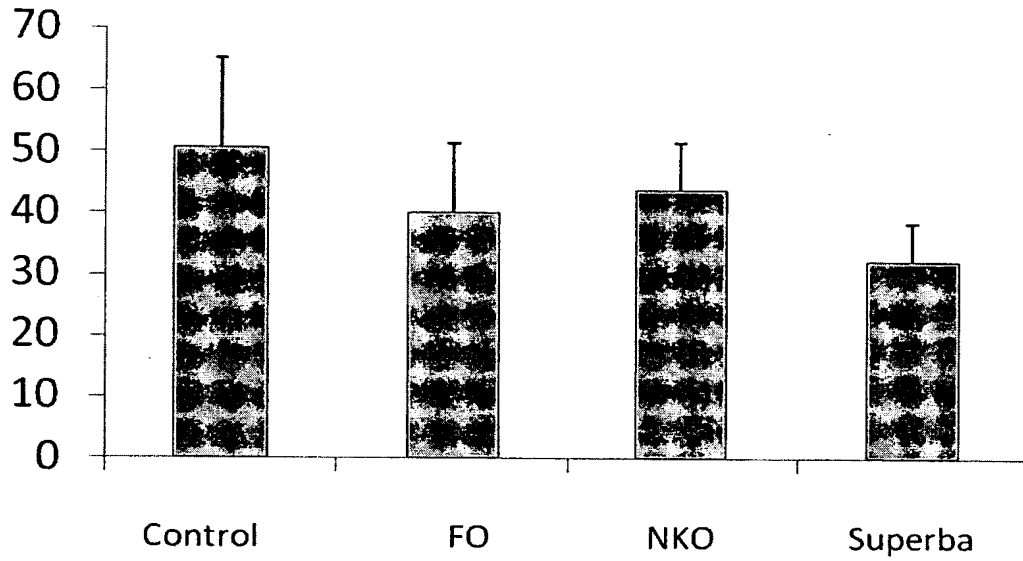
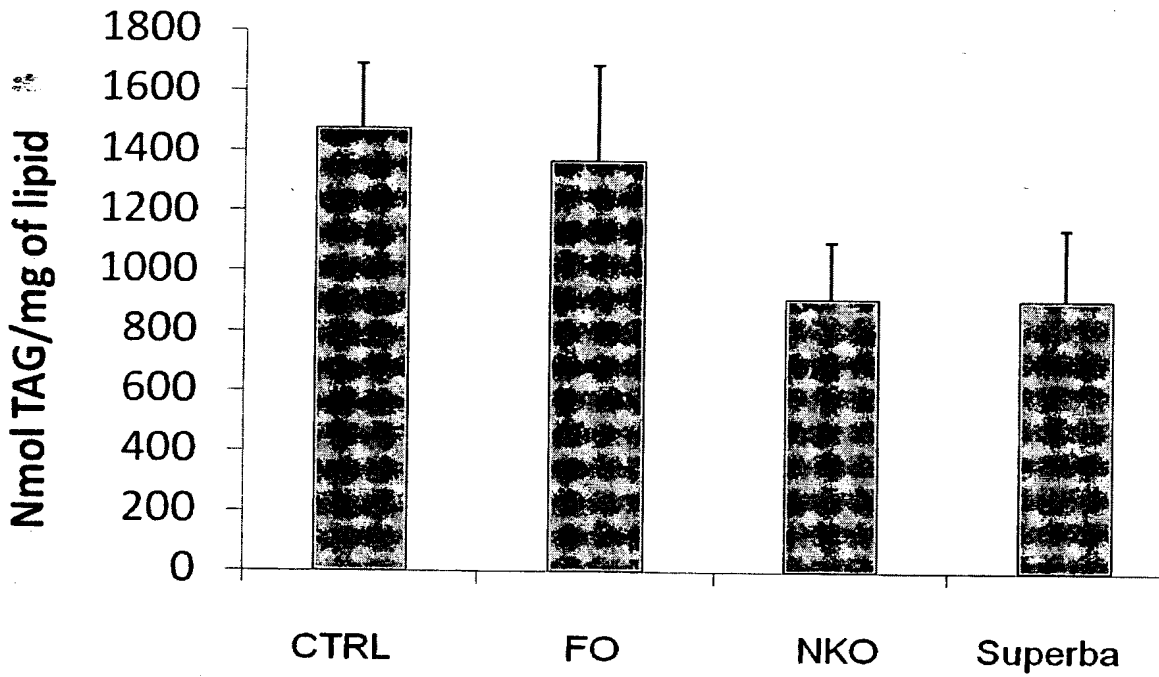
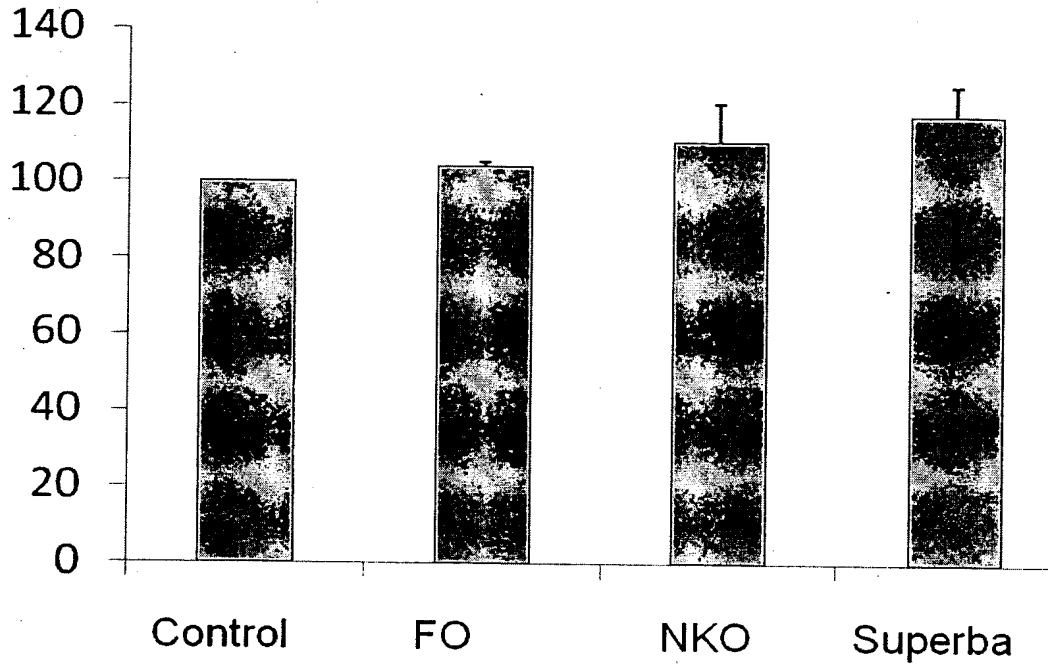

FIGURE 9



10/19

FIGURE 10



11/19

FIGURE 11

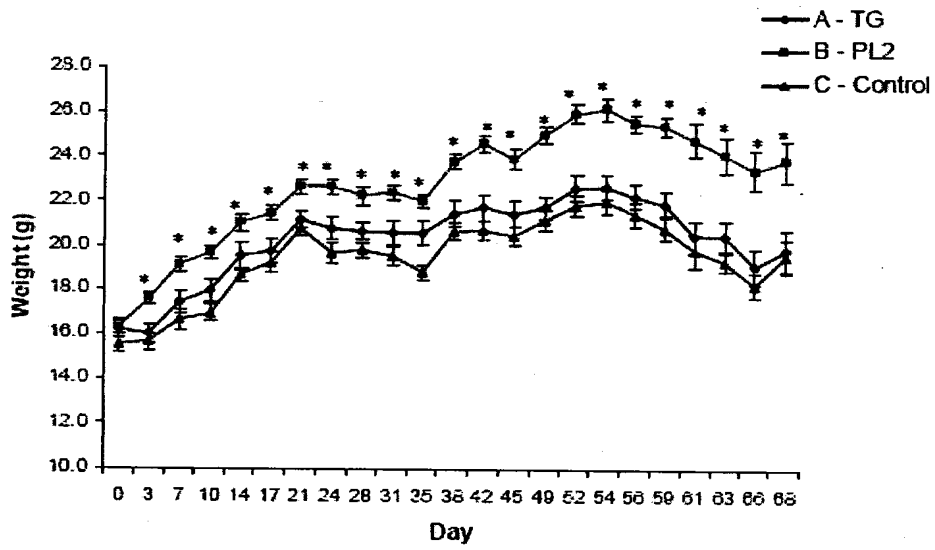

12/19

FIGURE 12

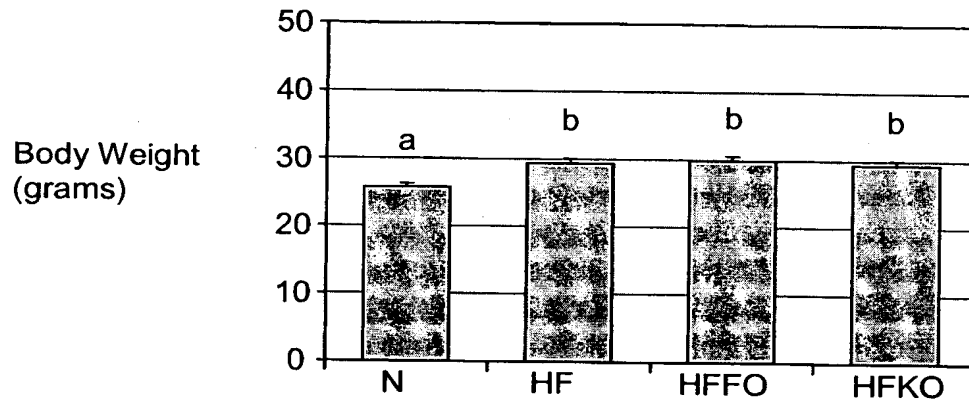

FIGURE 13

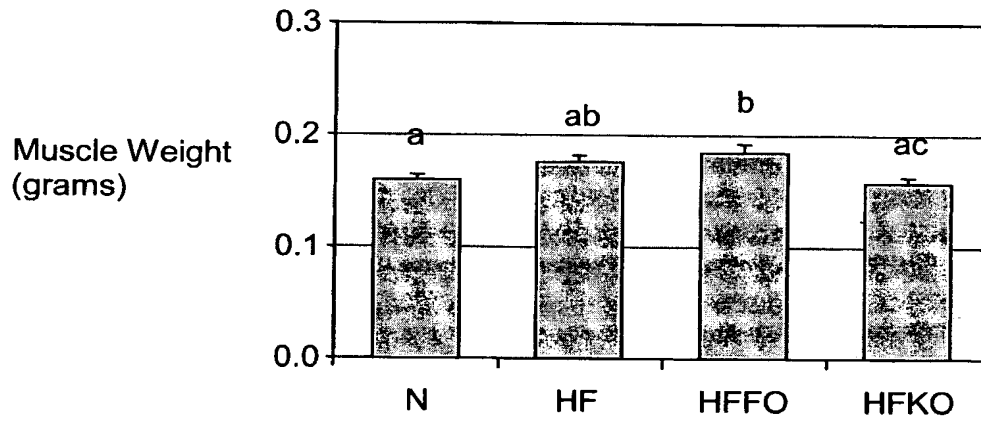

FIGURE 14

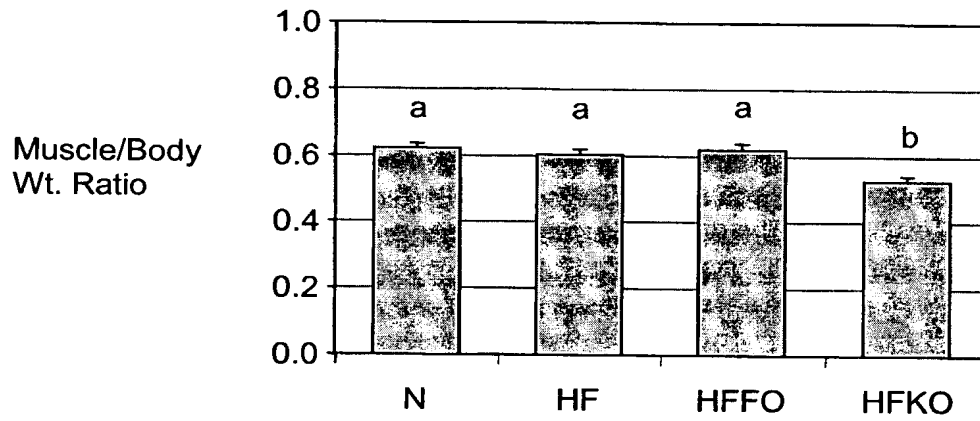

FIGURE 15

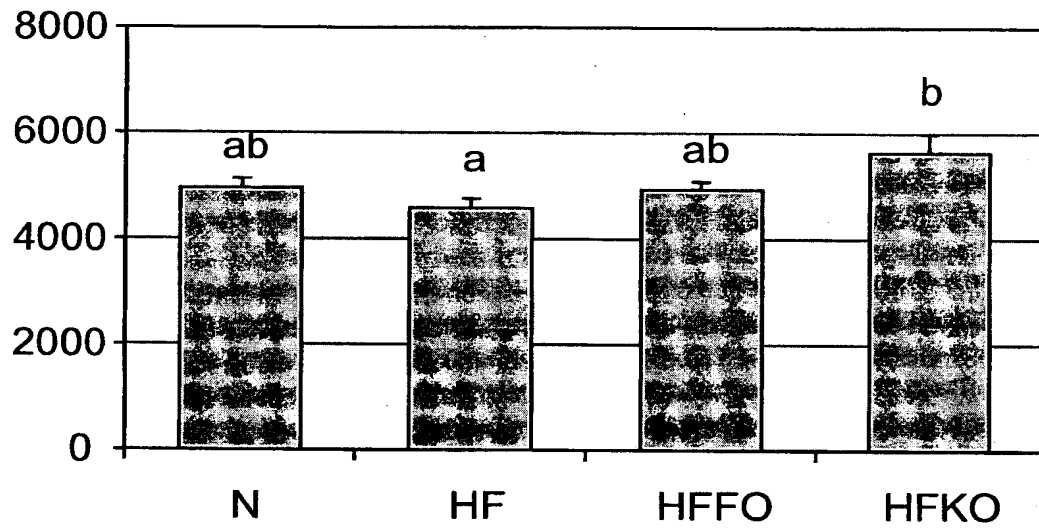

FIGURE 16

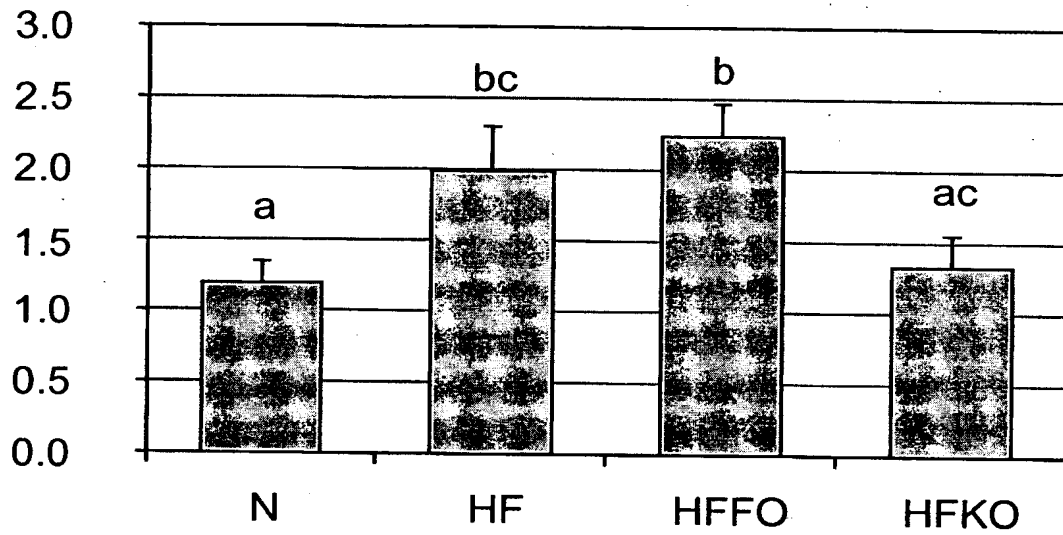

FIGURE 17

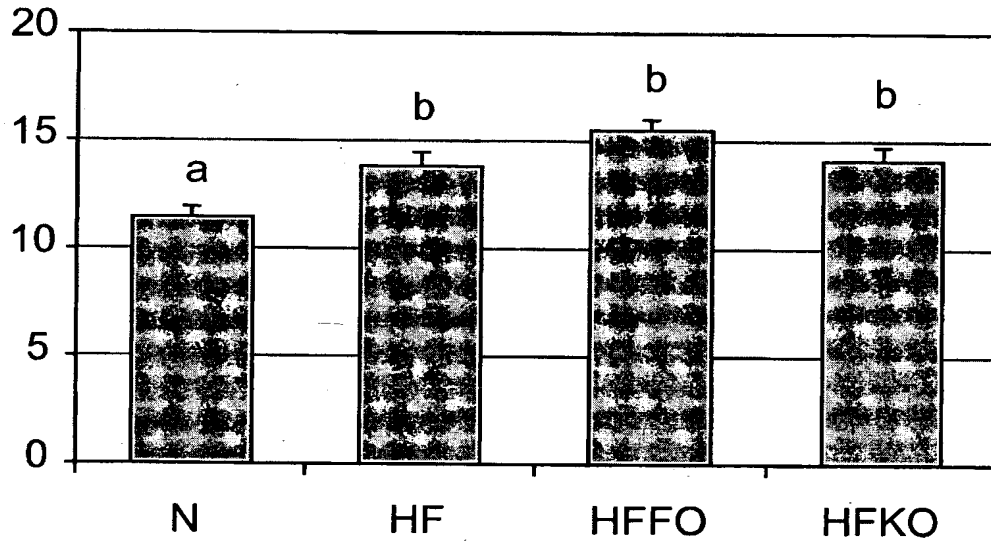

FIGURE 18

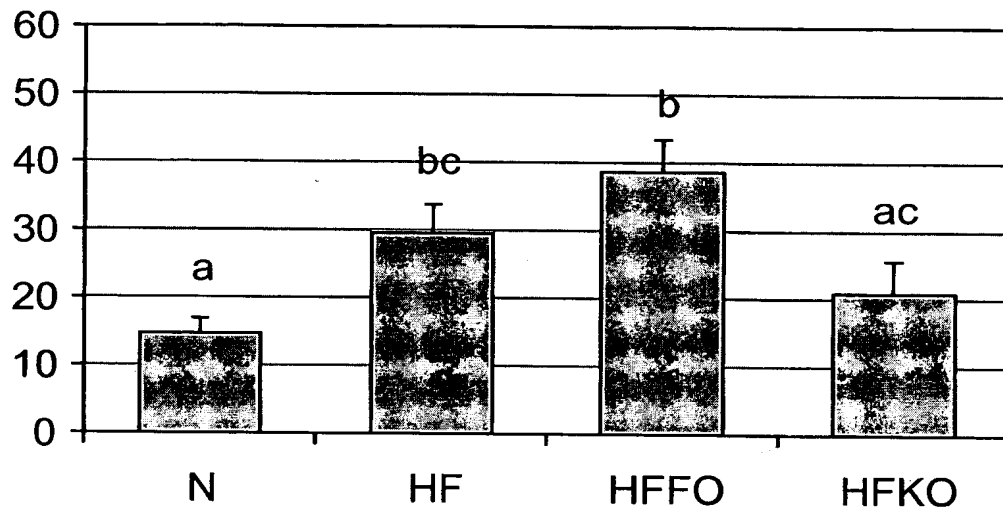
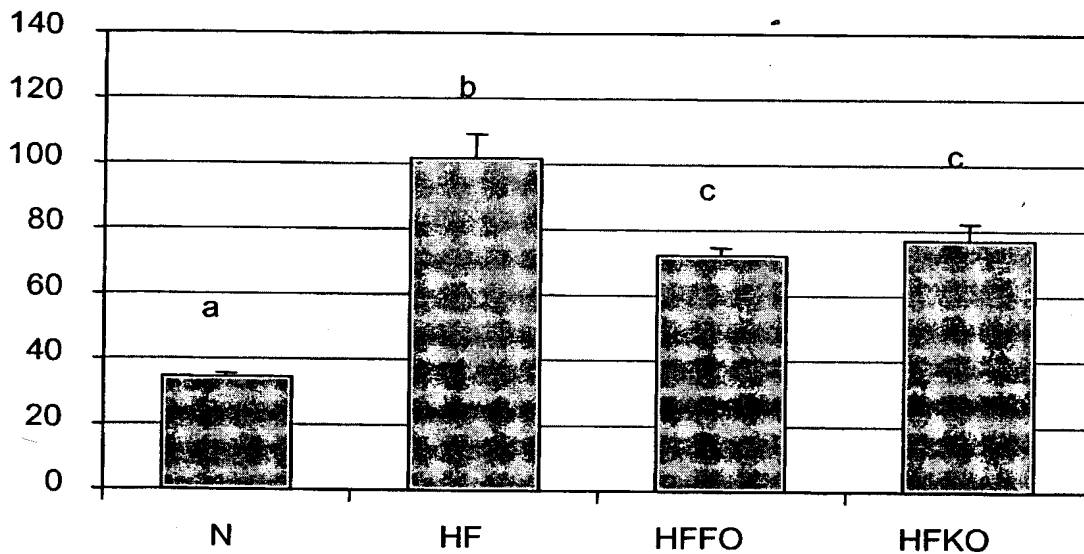

FIGURE 19



INTERNATIONAL SEARCH REPORT

International application No
PCT/GB2008/001080

A. CLASSIFICATION OF SUBJECT MATTER
INV. A61K35/60

According to International Patent Classification (IPC) or to both national classification and IPC

B. FIELDS SEARCHED

Minimum documentation searched (classification system followed by classification symbols)
A61K

Documentation searched other than minimum documentation to the extent that such documents are included in the fields searched

Electronic data base consulted during the international search (name of data base and, where practical, search terms used)
EPO-Internal, WPI Data

C. DOCUMENTS CONSIDERED TO BE RELEVANT

Category*	Citation of document, with indication, where appropriate, of the relevant passages	Relevant to claim No.
A	WO 02/102394 A (NEPTUNE TECHNOLOGIES & BIORESS [CA]; SAMPALIS TINA [CA]) 27 December 2002 (2002-12-27) cited in the application the whole document	1-31
A	US 4 119 619 A (ROGOZHIN SERGEI VASILIEVICH ET AL) 10 October 1978 (1978-10-10) the whole document	32-49, 59
A	WO 00/23546 A (UNIV SHERBROOKE [CA]; BEAUDOIN ADRIEN [CA]; MARTIN GENEVIEVE [CA]) 27 April 2000 (2000-04-27) the whole document	32-49, 59

Further documents are listed in the continuation of Box C.

See patent family annex.

* Special categories of cited documents:

- *A* document defining the general state of the art which is not considered to be of particular relevance
- *E* earlier document but published on or after the international filing date
- *L* document which may throw doubts on priority claim(s) or which is cited to establish the publication date of another citation or other special reason (as specified)
- *O* document referring to an oral disclosure, use, exhibition or other means
- *P* document published prior to the international filing date but later than the priority date claimed

- *T* later document published after the international filing date or priority date and not in conflict with the application but cited to understand the principle or theory underlying the invention
- *X* document of particular relevance; the claimed invention cannot be considered novel or cannot be considered to involve an inventive step when the document is taken alone
- *Y* document of particular relevance; the claimed invention cannot be considered to involve an inventive step when the document is combined with one or more other such documents, such combination being obvious to a person skilled in the art.
- *Z* document member of the same patent family

Date of the actual completion of the international search

16 July 2008

Date of mailing of the international search report

24/07/2008

Name and mailing address of the ISA/
European Patent Office, P.B. 5818 Patentlaan 2
NL - 2280 HV Rijswijk
Tel. (+31-70) 340-2040, Tx. 31 651 epo nl,
Fax: (+31-70) 340-3016

Authorized officer
Engl, Brigitte

INTERNATIONAL SEARCH REPORT

International application No
PCT/GB2008/001080

C(Continuation). DOCUMENTS CONSIDERED TO BE RELEVANT

Category*	Citation of document, with indication, where appropriate, of the relevant passages	Relevant to claim No.
A	EP 1 127 497 A (NIPPON SUISAN KAISHA LTD [JP]) 29 August 2001 (2001-08-29) the whole document	51-57
X	YAMAGUCHI K ET AL: "Supercritical carbon dioxide extraction of oils from antarctic krill" JOURNAL OF AGRICULTURAL AND FOOD CHEMISTRY, AMERICAN CHEMICAL SOCIETY. WASHINGTON, US, vol. 34, 1 January 1986 (1986-01-01), pages 904-907, XP002430955 ISSN: 0021-8561 the whole document	58

INTERNATIONAL SEARCH REPORT

Information on patent family members

International application No PCT/GB2008/001080

Patent document cited in search report		Publication date	Patent family member(s)	Publication date
WO 02102394	A	27-12-2002	CA 2449898 A1	27-12-2002
			CN 1516592 A	28-07-2004
			EP 1406641 A2	14-04-2004
			JP 2004534800 T	18-11-2004
US 4119619	A	10-10-1978	ES 465066 A1	01-09-1978
			FR 2373972 A1	13-07-1978
			JP 53101400 A	04-09-1978
WO 0023546	A	27-04-2000	AT 391763 T	15-04-2008
			AU 765464 B2	18-09-2003
			AU 6455299 A	08-05-2000
			BR 9914699 A	10-07-2001
			CA 2251265 A1	21-04-2000
			CN 1324394 A	28-11-2001
			EP 1123368 A1	16-08-2001
			JP 2002527604 T	27-08-2002
			NO 20011915 A	21-06-2001
			PL 347396 A1	08-04-2002
			RU 2236441 C2	20-09-2004
			UA 75029 C2	17-09-2001
			US 6800299 B1	05-10-2004
			ZA 200103235 A	20-06-2002
EP 1127497	A	29-08-2001	AU 6230399 A	22-05-2000
			CA 2345418 A1	11-05-2000
			CN 1324219 A	28-11-2001
			WO 0025608 A1	11-05-2000
			JP 2000139419 A	23-05-2000
			NO 20011590 A	11-06-2001

(19) World Intellectual Property Organization
International Bureau



(43) International Publication Date
19 July 2007 (19.07.2007)

PCT

(10) International Publication Number
WO 2007/080515 A1

(51) International Patent Classification:

A61P 7/02 (2006.01) C11B 1/14 (2006.01)
A61P 9/10 (2006.01) A23L 1/30 (2006.01)
A61P 9/14 (2006.01) A23D 9/00 (2006.01)
C11B 1/02 (2006.01)

(21) International Application Number:

PCT/IB2007/000099

(22) International Filing Date: 15 January 2007 (15.01.2007)

(25) Filing Language: English

(26) Publication Language: English

(30) Priority Data:

PA 2006 00058 13 January 2006 (13.01.2006) DK
US 60/758,957 13 January 2006 (13.01.2006) US
US 60/777,630 28 February 2006 (28.02.2006) US

(71) Applicant (for all designated States except US): AKER
BIOMARINE ASA [NO/NO]; Fjordalléen 16, P.O. Box
1423 Vika, N-0115 Oslo (NO).

(72) Inventors; and

(75) Inventors/Applicants (for US only): LARSEN, Peter,
Mose [DK/DK]; Valmuemarken 16, DK-5260 Odense S
(DK). FEY, Stephen, John [GB/DK]; Middelfartvej 469,
DK-5491 Blommenslyst (GB).

(74) Agent: BUDDE, SCHOU & OSTENFELD A/S; Vester
Søgade 10, DK-1601 Copenhagen V (DK).

(81) Designated States (unless otherwise indicated, for every
kind of national protection available): AE, AG, AL, AM,
AT, AU, AZ, BA, BB, BG, BR, BW, BY, BZ, CA, CH, CN,
CO, CR, CU, CZ, DE, DK, DM, DZ, EC, EE, EG, ES, FI,
GB, GD, GE, GH, GM, GT, HN, HR, HU, ID, IL, IN, IS,
JP, KE, KG, KM, KN, KP, KR, KZ, LA, LC, LK, LR, LS,
LT, LU, LV, LY, MA, MD, MG, MK, MN, MW, MX, MY,
MZ, NA, NG, NI, NO, NZ, OM, PG, PH, PL, PT, RO, RS,
RU, SC, SD, SE, SG, SK, SL, SM, SV, SY, TJ, TM, TN,
TR, TT, TZ, UA, UG, US, UZ, VC, VN, ZA, ZM, ZW.

(84) Designated States (unless otherwise indicated, for every
kind of regional protection available): ARIPO (BW, GH,
GM, KE, LS, MW, MZ, NA, SD, SL, SZ, TZ, UG, ZM,
ZW), Eurasian (AM, AZ, BY, KG, KZ, MD, RU, TJ, TM),
European (AT, BE, BG, CH, CY, CZ, DE, DK, EE, ES, FI,
FR, GB, GR, HU, IE, IS, IT, LT, LU, LV, MC, NL, PL, PT,
RO, SE, SI, SK, TR), OAPI (BF, BJ, CF, CG, CI, CM, GA,
GN, GQ, GW, ML, MR, NE, SN, TD, TG).

Declarations under Rule 4.17:

— as to applicant's entitlement to apply for and be granted a
patent (Rule 4.17(ii))

[Continued on next page]

(54) Title: THROMBOSIS PREVENTING KRILL EXTRACT

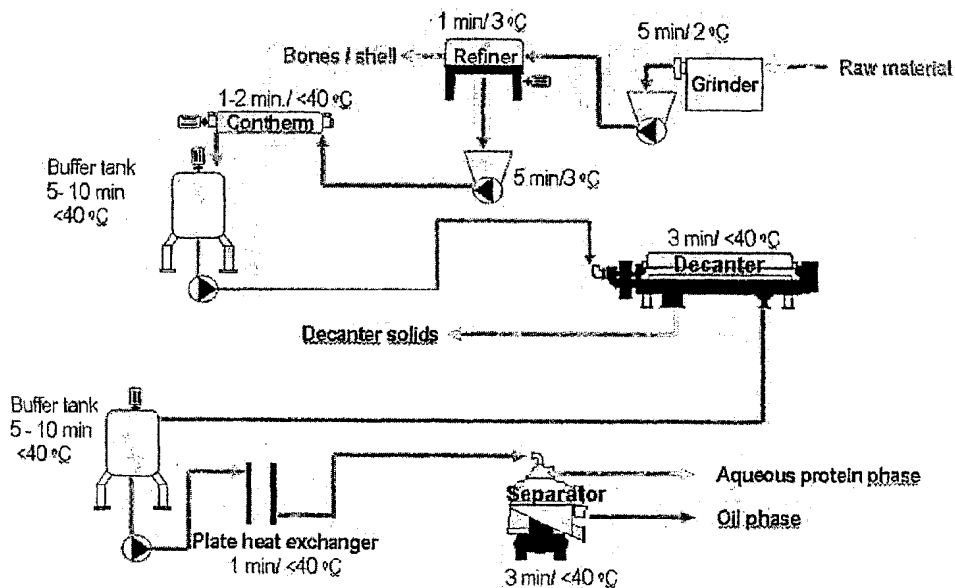

(57) Abstract: In accordance with the present disclosure there is provided a novel marine lipid extract obtainable by a process wherein processing temperature below 60 °C; mechanical and physical disruption of the lipid cell membrane to facilitate low temperature extraction; processing takes place under inert gas to prevent oxidation or denaturation of fat and proteins; intermediate processing tanks kept at a minimum level to reduce residence time; and the oil is frozen immediately after recovery to stabilize it.

WO 2007/080515 A1



- *as to the applicant's entitlement to claim the priority of the earlier application (Rule 4.17(iii))*

Published:

- *with international search report*
- *before the expiration of the time limit for amending the claims and to be republished in the event of receipt of amendments*

For two-letter codes and other abbreviations, refer to the "Guidance Notes on Codes and Abbreviations" appearing at the beginning of each regular issue of the PCT Gazette.

THROMBOSIS PREVENTING KRILL EXTRACT

FIELD OF THE INVENTION

This invention relates to novel extracts derived from krill, which can prevent and/or treat thrombosis. This invention also relates to a method for the extraction of lipid fractions from krill in order to obtain the novel extracts of the present invention. More specifically, the invention relates to an improved method of extracting lipid fractions without using high temperatures and/or organic solvents.

BACKGROUND OF THE INVENTION

Krill is the common name for small, shrimp-like crustaceans that swarm in dense shoals, especially in Antarctic waters. It is one of the most important food sources (especially protein) for fish, some kind of birds and especially for baleen. Krill is also a good source of omega-3 fatty acids, which are well known for their beneficial effects on human health.

It is known in the art to use krill and/or marine enzymes for the treatment of a great variety of diseases in human and animals such as infections, inflammations, cancers, HIV/AIDS, pain, polyps, warts, hemorrhoids, plaque, wrinkles, thin hair, allergic itch, anti-adhesion, eye disease, acne, cystic fibrosis and immune disorders including autoimmune diseases and cancer.

It is also known in the art that krill and/or marine oils may be used for the treatment of autoimmune murine lupus and other autoimmune diseases and can also be used for treating cardiovascular diseases.

However, most of the krill oil extracts used for these treatments has only conserved its omega-3 fatty acids as active ingredients, which is a very small part of all the active ingredients of the krill itself. This fact dramatically reduces the potential of the krill and/or marine oil as a treatment for these diseases.

There is an increasing demand for treatments using products derived from a natural source, therefore, it would be highly desirable to be provided with a krill and/or marine extract having an enhanced potential for prevention and/or treatment and/or management of disease.

US Patent 6,800,299 discloses a method for extracting lipid fractions from marine and aquatic animal material by acetone extraction. The resulting non-soluble and particulate fraction is preferably subjected to an additional solvent extraction with an alcohol, preferably ethanol,

isopropanol or t-butanol or an ester of acetic acid, preferably ethyl acetate to achieve extraction of the remaining soluble lipid fraction from the marine and aquatic animal material. The remaining non-soluble particulate content is also recovered since it is enriched in proteins and contains a useful amount of active enzymes. Also provided herein is a krill extract. It is reported that these marine and aquatic animal oils have anti-inflammatory properties. Marine and aquatic animal oils are also reported as helpful in reducing the incidence of cardiovascular disease. As a further example the patent mentions that krill may be used as a source of enzymes for debridement of ulcers and wounds or to facilitate food digestion.

WO02102394A2 discloses a process for the preparation of a krill oil extract, which process includes the steps of placing krill and/or marine material in a ketone solvent to achieve extraction of the soluble lipid fraction from the krill; then separating the liquid and solid contents; then recovering a first lipid rich fraction from the liquid contents by evaporation of the solvent present in the liquid contents; then placing the solid contents in an organic solvent to achieve extraction of the remaining soluble lipid fraction from the krill material; then separating the liquid and solid contents; then recovering a second lipid rich fraction by evaporation of the solvent from the liquid contents; and finally recovering the solid contents. Diseases that can be treated and/or prevented by using the krill oil extract are *inter alia* cardiovascular diseases. In this respect it is mentioned that the Krill oil has been shown to decrease cholesterol *in vivo*, inhibit platelet adhesion and plaque formation and reduce vascular endothelial inflammation in a patient.

Canadian Patent 1,098,900 describes a method for extracting oils and producing proteins from krill comprising emulsification of lipids of krill in an aqueous medium, separation of the emulsion of lipids from the krill mass, alkaline extraction of proteins from the krill mass, separation of the protein extract produced from chitin integuments, and finally separation of protein from the protein extract. The document mentions that krill is a prospective source of food and other practically useful products such as chitin and lipids which find wide application in different branches, such as food industry, textile, and medicine.

WO03011873A2 discloses a phospholipid extract from *inter alia* krill, with therapeutic properties, such as those essential for the maintenance of a healthy cardiovascular system. The phospholipid extract comprises a variety of phospholipids, fatty acid, metals and a novel flavonoid. The method for the preparation of this extract is generally carried out by a method similar to the one described in US Patent 6,800,299 (see above; includes organic solvents),

which procedure produces two successive lipid fractions and a dry residue enriched in protein, including active enzymes.

WO8401715A1 and WO09533471A1 disclose various aspects of so-called krill enzymes, which are water-soluble. It is mentioned that in krill a mixture of different enzymes exists, such as e.g. proteinases (with acidic and neutral-to-alkaline pH-optima), peptidases (exo- and endopeptidases), lipases, phospholipases, amylases and other carbohydrate degrading enzymes, phosphatases nucleases, nucleotidases and esterases. The proteolytic (trypsin-like) activity existing in a water extract from krill has been studied and described. WO09533471A1 disclose the use of one or more krill enzymes for the manufacture of an intravasal pharmaceutical composition for thrombolysis in a mammal host.

The potential of krill oil to prevent thrombosis has been disclosed in the prior art; however such a preventive effect has so far only been ascribed to the presence of powerful antioxidants and the special composition of poly-unsaturated fatty acids. The present inventors have surprisingly found that krill oil prepared by a novel process, which is from a physical-chemical point of view very gentle to the krill material due to relatively low temperature and no use of organic solvents, comprises other therapeutically valuable components than known from conventional krill oil extracts as well as other known fish oil; such components include inter alia high molecular (MWt > 200 kDa) hydrophobic proteins.

SUMMARY OF THE INVENTION

In accordance with the present invention there is provided a novel krill oil extract for the prevention and/or treatment of thrombosis.

The general extraction method of the present invention will now be described. The starting material, consisting of freshly harvested and preferably finely divided krill material, is subjected to extraction, for about two hours and preferably overnight. However, extraction time is not critical to the yield of lipid extraction. To facilitate extraction, it is preferable to use particles of less than 0.5 mm in diameter. Extraction is preferably conducted under inert atmosphere and at a temperature in the order of about 5° C or less. The inventors have also envisaged that the present invention may be carried out by applying supercritical CO₂ extraction.

Preferably, the beginning of the extraction will be conducted under agitation for about 10 to 40

minutes, preferably 20 minutes. The solubilized lipid fractions are separated from the solid material by standard techniques including, for example, filtration, centrifugation or sedimentation. Filtration is preferably used.

DETAILED DESCRIPTION OF THE INVENTION

In accordance with the present invention, there is provided a novel krill extract for prevention and/or treatment and/or therapy of thrombosis.

The novel oil extract is derived from krill found in any marine environment around the world, for example, the Antarctic ocean (*euphasia superba*), the Pacific ocean (*euphasia pacifica*), the Atlantic ocean, the Indian ocean, in particular coastal regions of Mauritius Island and/or Reunion Island of Madagascar, Canadian West Coast, Japanese Coast, St-Lawrence Gulf and Fundy Bay, and this oil extract is a lipid fraction.

According to a first aspect of the present invention there is provided a method for extracting lipid fractions from krill, said method comprising the steps of:

- placing the krill material in a blender to mechanically disrupt fat cell membranes;
- separating the liquid and solid components;
- recovering a lipid rich fraction from the liquid component;

wherein the extraction is performed quickly at a temperature below 60 °C and does not involve the use of organic solvents.

According to another aspect of the present invention there is provided a method for extracting lipid fractions from krill, said method comprising the steps of:

- Feeding freshly captured krill into a grinder to produce a slurry
- Heating the slurry gently to a temperature below 90°C for less than 45 minutes
- Separating the solid material from the liquid
- Separating the liquid into an aqueous phase and a krill oil phase

wherein the extraction does not involve the use of organic solvents.

According to the invention there is also provided a pharmaceutical composition for the treatment of thrombosis in a patient comprising an effective amount of a krill oil extract obtainable by a method according to the present invention.

EXAMPLES

As used herein, the term omega-3 fatty acid refers to polyunsaturated fatty acids that have the final double bond in the hydrocarbon chain between the third and fourth carbon atoms from the methyl end of the molecule. Non-limiting examples of omega-3 fatty acids include, but are not limited to 5,8,11,14,17-eicosapentaenoic acid (EPA), 4,7,10,13,16,19-docosahexanoic acid (DHA) and 7,10,13,16,19-docosapentanoic acid (DPA).

Example 1

Preparation of the krill oil extract of the present invention (see also Fig 1).

Preparation of the krill oil

The method of preparation is a continuous flow process and so the times given represent the average time that the material is in each stage of the process and the temperatures are typical (and may vary by $\pm 3^{\circ}\text{C}$).

1. The freshly captured krill are fed into the grinder together with process water and shredded at 2°C for 5 minutes.
2. This is then fed into a refiner which separates the chitin shell from the slurry (1 minute, 3°C).
3. The slurry is then passed into a heat exchanger and warmed gently up to a temperature about 35°C (max below 40°C) (1-2 minutes) and then stored in a buffer tank for 5 to 10 minutes. All subsequent processes occur at temperatures below 40°C .
4. A centrifugal decanter is then used to separate the solid material from the liquid (3 minutes).
5. The liquid fraction is then stored in a buffer tank for 5 to 10 minutes.
6. The temperature of the liquid is adjusted to 35°C using a countercurrent plate heat exchanger (1 minute).
7. The liquid is then separated into an aqueous phase and a krill oil phase.

Preparation of the stock solution of krill oil

1. Autoclave glycerol (analytical quality) and leave to cool to room temperature
2. Mix 100 μ L of krill oil with 1000 μ L autoclaved glycerol
3. Shake mixture for 6 min. on a minibead beater (Biospec. Products, USA) at room temperature
4. Add 900 μ L diluted CPD solution (Compoflex[®], Fresenius HemoCare 61348 Bad Hamburg, Germany containing: citric acid monohydrate 3.27g, Sodium citrate dihydrate 26.3g, sodium dihydrogen phosphate dehydrate 2.51g, glucose monohydrate 25.3g made up to 1L).
5. Shake mixture for 6 min. on minibead beater 4 times at room temperature

Preparation of the dilute solutions of krill oil

1. The stock is diluted sequentially (1:10), shaking for 6 minutes at each dilution.
2. Immediately before use, shake mixture for 6 min. on a minibead beater at room temperature

Preparation of the stock solution of CPD Glycerol control solution

1. Mix 100 μ L of diluted CPD solution with 1000 μ L autoclaved glycerol
2. Shake mixture for 6 min. on minibead beater at room temperature
3. Add 900 μ L diluted CPD solution
4. Shake mixture for 6 min. on minibead beater 2 times at room temperature
5. Repeat 4. immediately before use

Example 2

Effect of the krill oil extract of the present invention on the aggregation time of thrombocytes.

Preparation of human blood

Blood samples were taken from normal subjects. 3.8 mm plastic tubes containing 0.38 ml 0.129M sodium citrate buffer (CPD buffer, pH 5.5) were used to store the blood. The buffered blood was then mixed with the krill or fish oil to achieve a final oil concentration varying from 5×10^{-2} to 5×10^{-18} Vol%. The blood cells were treated with krill or fish oil for 60 minutes before aggregation tests were performed.

Blood aggregation time

The thrombocyte aggregation tests were performed with a PFA 100 aggregometer (Dade Bering), which is a microprocessor controlled apparatus with single test vials. The unit comprises a small reservoir, a capillary and a membrane, which is covered with 2 mg genuine, type 1 collagen and 50 mg adenosin-5'-diphosphate (ADP). The blood is pipetted directly into the reservoir and aspirated through a capillary with a diameter of 200 μm with a constant negative pressure resulting in high shear stress. The capillary ends with a membrane having an aperture with a diameter of 150 μm . The thrombocytes are then activated by collagen and ADP. Upon aggregation the blood flow is stopped due to clogging, which is referred to as closing time. The test automatically stops after 300 seconds. The normal value is between 62.5 – 120.5 seconds for ADP.

Determination of anti-aggregation effect

Dilute krill oil solutions were added to whole human blood samples and allowed to react in accordance with the following steps:

1. Serial dilutions of the krill oil or other oils under investigation were added to the human blood samples and gently shaken for 1 hour at room temperature on a "HETO-blood turner" at a rotational speed of 10 rpm.
2. Exactly 800 μL of the blood-oil sample were placed in the reaction cartridge (DADE PFA collagen/epitest cartridge containing 4 μg epinephrine bitartrate and 2 μg type 1 equine collagen). The blood was then allowed to clot at 37°C for up to 300 seconds (preset instrument maximum).
3. Measurements were read from the display and printed out recorded

Figure 2 shows the effects of various oils on the rate of aggregation of human whole blood.

Samples of human whole blood are aggregated at the start and end of every experiment ("Start blood" and "End blood" on the abscissa) to determine the rate of blood aggregation for the donor. As an additional control carried out just after and just before the start and end whole blood aggregation determinations, an aliquot of the vehicle is added and the aggregation determination is repeated ("Start Glycerol/CPD" and "End Glycerol/CPD"). These controls are performed to ensure that the ability of the blood to aggregate does not change during the experimentation (see the trend line for the glycerol/CPD points). Between these control experiments, the blood is treated (as described in the text) with various concentrations of the different oils for 1hr before its ability to aggregate is determined. Dotted line - fish oil; dashed

line a commercially available krill oil; solid line krill oil prepared in the manner disclosed here. The graph shows typical data from a single patient.

As can be seen in Figure 2, the fish oil can be diluted to a concentration of only about 1×10^{-4} before it loses its effect. A commercially available krill oil can be diluted to about 5×10^{-6} before it loses its effect (i.e. it is about 500 times more effective than fish oil). Krill oil prepared in the manner described here can be diluted to a concentration of about 5×10^{-12} before it loses its effect. This is a million times more effective than the existing krill oil preparations and five hundred million times better than fish oil (note that the abscissa is a logarithmic scale).

Figure 3 (graph 1) shows the inhibiting effect of krill oil on the aggregation of thrombocytes in blood samples from 6 subjects. It also appears that the effect varies from subject to subject; and furthermore blood from one of the subjects was not influenced at all by the presence of krill oil.

In Figure 4 (graph 2) the effect of krill oil C on blood from the same subject was analysed twice with a 21 day interval. The effect of krill oil C on the aggregation of thrombocytes is significant; however it must be concluded that the difference in the concentration required to achieve a significant inhibition varies with more than 10^{-3} Vol%.

Example 3

Comparison of krill oils and fish oils with respect to the effect on blood aggregation

These experiments serve to demonstrate that the krill oil obtainable by the process of the present invention prevents formation of thrombosis (based on the same experimental procedure as laid down in Examples 1 and 2) to a higher degree than known krill oils and other fish oils.

The experiments include 2 fish oils as well as 3 different krill oils:

- Krill oil A: Krill caught in large nets and subjected to a long process time
- Krill oil B: Krill caught in smaller nets and subjected to a short process time
- Krill oil C: Krill sucked up and processed very rapidly (in accordance with the present invention)
- Fish oil A: Newly cold pressed cod fish oil
- Fish oil B: Pikasol (OTC registered natural pharmaceutical containing concentrated Omega-3 rich fish oil; contains 62% omega-3 fatty acids, mainly EPA and DHA; Pikasol is produced from highly refined fish oil from the cleanest oceans in the world)

The oils are dissolved in a 1:1 mixture with glycerol and CPD (Gly/CPD-mixture). Every single dilution is performed with the Gly/CPD-mixture to ensure that the glycerol concentration remains constant about 5×10^{-3} Vol%.

It is known that the quality of krill oil may vary considerably due to the way the krill material has been "caught". As discussed above the prior envisages that the amount of phospholipids, omega-3 and omega-6 polyunsaturated fatty acids and various antioxidants is responsible for the therapeutic effects attributable to krill oil. As appears from Fig 5 (graph 3) the three krill oils have very different effects on the aggregation. Surprisingly, the different effects could not be ascribed to differences in the amount of e.g. polyunsaturated fatty acids. On the contrary it appeared (based on 2D gel electrophoresis) that 5 proteins were present in Krill oil C (according to the present invention) but only in minute amounts in krill oil B and not traceable in krill oil A. This observation stems with the fact that many proteins in krill are extremely sensible for proteolytic degradation, which starts right after the krill has been caught.

As already mentioned the therapeutic effect of antioxidants and polyunsaturated fatty acids from fish oil on cardiovascular diseases is well known. Accordingly, the present inventors have compared the effect the effect of Krill oil C and fish oils A and B with respect to their ability to prevent thrombocyte formation (verified with the above described aggregation test). Fig 6 (graph 4) demonstrates that Krill oil C (according to the present invention) has a far more pronounced inhibitory effect on the thrombocyte aggregation than is the case with the fish oils.

Conclusions drawn from Examples 1-3

Based on the experimental evidence provided so far the following conclusions may be drawn:

- Krill oil prepared by the process according to the present invention has a strong inhibitory effect on human thrombocyte aggregation in blood samples,
- The difference between the intensity of the effect may possibly be ascribed to certain proteins of the krill oil, and
- There is a substantial difference between how blood from different subjects responds to the krill oil with respect to aggregation time, however it may validly said that the krill oil obtained with the process of the present invention is far more effective than krill oils and fish oils obtained by traditional high temperature/solvent extraction methods.

Example 4

Phospholipids are to be extracted from the solid fraction obtained in example 1 (step 4) using ethanol. After removal of the ethanol, the phospholipids are to be mixed with the krill oil phase obtained from the liquid fraction in example 1 (step 7) into a krill oil composition. The anti-thrombotic effects of this krill oil composition are to be compared with other krill oil products extracted with organic solvents by investigating the effect on the aggregation time of thrombocytes in-vitro. The krill oil products (mixtures of krill triglycerides and krill phospholipids) for this comparison are to be extracted from krill or krill meal using organic solvents as described in US 6,800,299. It is to be observed that the anti-thrombotic effects of the krill oil composition obtained by the methods described herein are superior to any krill oil product extracted with organic solvents such as acetone.

Example 5

The krill oil compositions tested in example 4, the krill oil extracted obtained in example 1 (step 7), krill oil obtained using organic solvents and a control are to be administered in humans (in-vivo) for a period of 5 weeks. Diets are to contain approximately 38% of energy as fat excluding the lipid in the supplement. Around 2 g of each product are to be administered in a way that preserves the biological effect of the krill oil. Non-limiting examples of administration are oral, sublingual or transdermal. After termination of the experiment, ex vivo and in vitro platelet aggregation, and variables of coagulation, fibrinolysis, and hematology are to be evaluated. Ex vivo platelet aggregation time are to be measured by filtragometry and in vitro platelet aggregation induced by collagen and ADP measured by PFA 100 aggregometer. Variables of coagulation (factor VII amidolytic activity and concentrations of fibrinogen and prothrombin fragment 1 and 2) and fibrinolysis [plasminogen activator inhibitor (PAI) activity

and concentrations of tissue plasminogen activator (tPA)/PAI-1 complexes] are to be determined by standard methods. It is to be observed that the subjects treated with the krill oil composition described in example 4 and the krill lipid extract obtained in example 1 (step 7) show superior anti-thrombotic activity than subjects treated with krill oil compositions obtained using organic solvents and control. Prevention of thrombosis is linked to prevention of myocardial infarction and stroke. Hence, the krill oil composition described in example 4 and example 1 (Step 7) can be used to prevent these pathologies.

CLAIMS

1. A method for extracting lipid fractions from krill, said method comprising the steps of:

- placing the krill material in a grinder or blender to mechanically disrupt cell membranes;
- separating the liquid and solid components;
- recovering a lipid rich fraction from the liquid component;

wherein the extraction is performed at a temperature below 60 °C and does not involve the use of organic solvents.

2. A method as in claim 1, wherein separating the liquid and solid components is effected by techniques selected from the group consisting of mechanical pressing, filtration, centrifugation and sedimentation.

3. A method as in claim 1, wherein the extraction is performed at a temperature below 27°C, preferably below 15°C, more preferably below 5°C.

4. A krill oil extract obtainable by a method according to any one of claims 1 to 3.

5. A krill oil extract according to claim 4 for use as a medicament.

6. A pharmaceutical composition comprising the krill oil extract of claim 4.

7. A pharmaceutical composition for the treatment of thrombosis in a patient comprising an effective amount of a krill oil extract obtainable by a method according to any one of claims 1 to 3 in association with a pharmaceutically acceptable carrier.

8. The composition of claim 7, further comprising at least one of compounds selected from the group consisting of glycerol, dimethyl-sulphoxide (DMSO), linoleic acid, alpha-linoleic acid, arachidonic acid, oleic acid, palmitic acid, palmitoleic acid, stearic acid, cholesterol, triglycerides, monoglycerides, all-trans retinal, canthexanthin, carotene, zinc, selenium, sodium, potassium and calcium.

9. Use of the krill oil extract obtainable by the method of any one of claims 1-3 for the production of a medicament for decreasing development of thrombosis in a patient.

10. A composition for inhibiting platelet adhesion and plaque formation in arteries of a patient comprising an effective amount of krill oil extract in association with a pharmaceutically acceptable carrier, wherein said krill oil extract is obtainable from a method according to any one of claims 1 to 3.

11. A krill oil extract obtainable by a method comprising the steps of:

- Feeding freshly captured krill into a grinder to produce a slurry
- Heating the slurry gently to a temperature below 90°C in less than 45 minutes
- Separating the solid material from the liquid
- Separating the liquid into an aqueous phase and a krill oil phase wherein the extraction does not involve the use of organic solvents.

12. A food product comprising the krill oil extract of claim 4.

13. An animal feed comprising the krill oil extract of claim 4.

14. A food supplement comprising the krill oil extract of claim 4.

15. A composition comprising the krill oil extract of claim 4 and phospholipids, said phospholipids having the following structure:

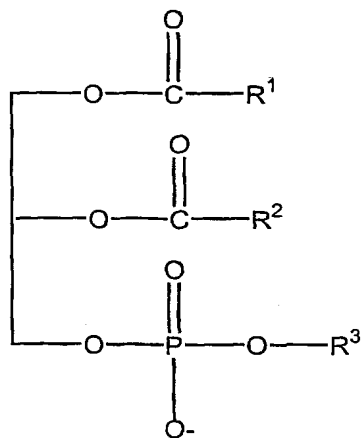

wherein R1 is a fatty acid, R2 is a fatty acid, and R3 is selected from the group consisting of H or choline, ethanolamine, inositol or serine.

16. The composition in claim 15, wherein at least 1% (w/w) of the said fatty acids are unsaturated fatty acids.

17. The composition in claim 15, wherein at least 1% (w/w) of the said fatty acids are omega-3 fatty acids.
18. A food product comprising the composition in any of the claims 15 to 17.
19. An animal feed comprising the composition in any of the claims 15 to 17
20. A food supplement comprising the composition in any of the claims 15 to 17.
21. A pharmaceutical comprising the composition in any of the claims 15 to 17.
22. A method of preventing platelet adhesion in a patient comprising administering to said patient a therapeutically effective amount of the composition in any of the claims 15 to 21.
23. A method for preventing stroke or heart attack in a patient comprising administering to said patient a therapeutically effective amount of the composition in any of the claims 15 to 21.
24. A method of preventing platelet adhesion and plaque formation in a patient comprising administering to said patient a therapeutically effective amount of krill oil, wherein said krill oil is obtained without organic solvent extraction.
25. A method of preventing platelet adhesion and plaque formation in a patient comprising administering to said patient a therapeutically effective amount of krill oil composition, wherein said krill oil composition comprises triglyceride, phospholipid and protein fractions.
26. The method of claim 25, wherein said protein fraction comprises high molecular weight hydrophobic proteins.
27. A composition comprising a krill oil extract isolated from krill comprising triglyceride, phospholipid and protein fractions.
28. A pharmaceutical comprising the composition of claim 27.

Figure 1

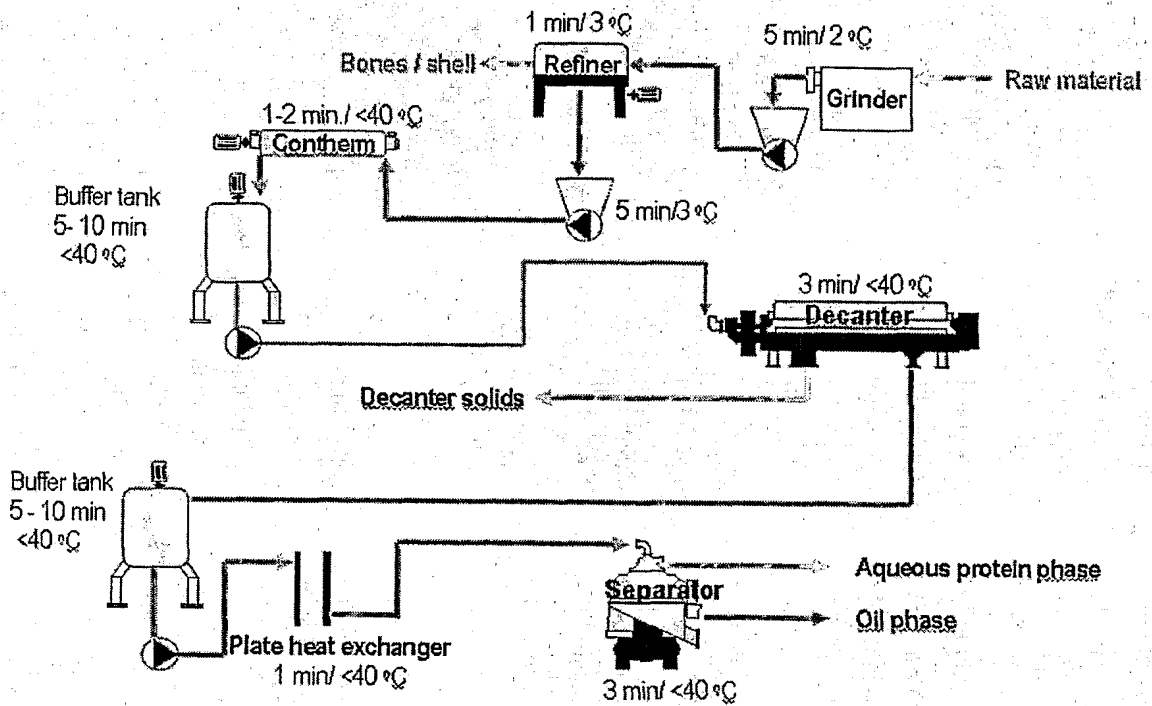
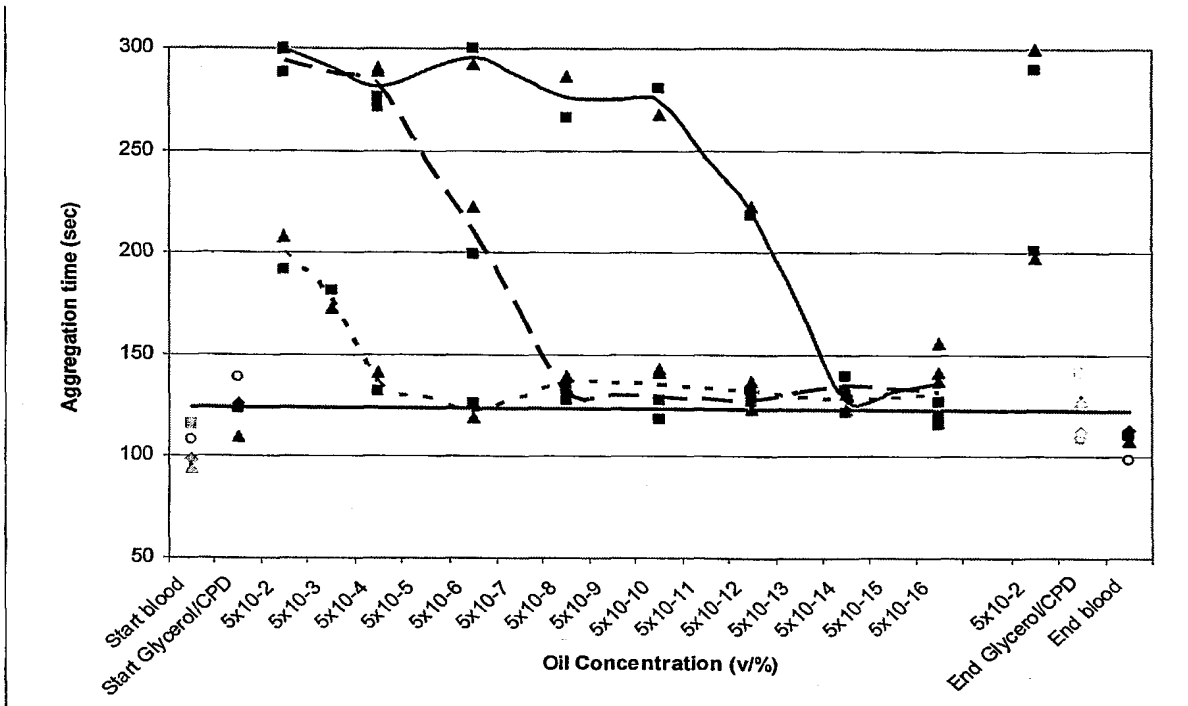

Figure 2



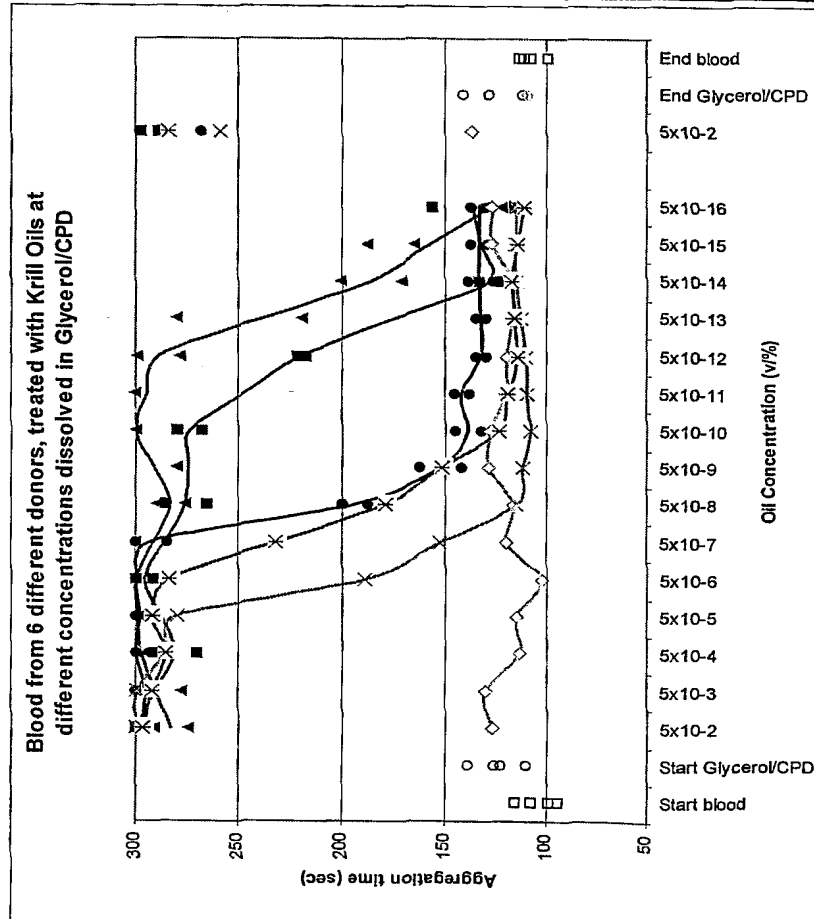
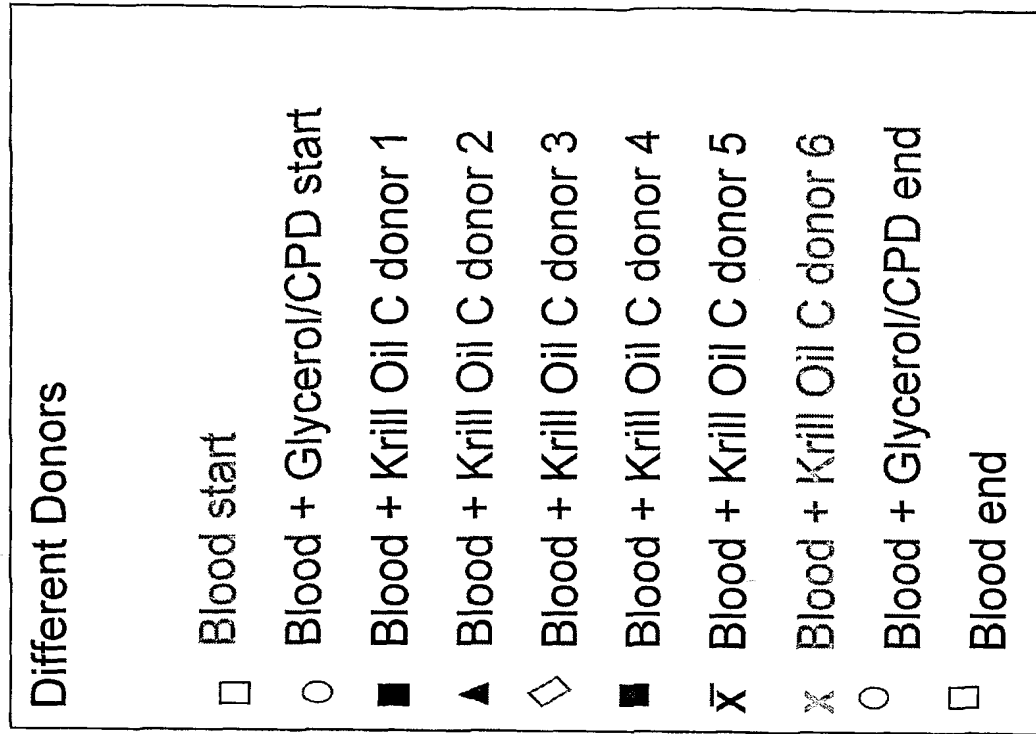

Figure 3

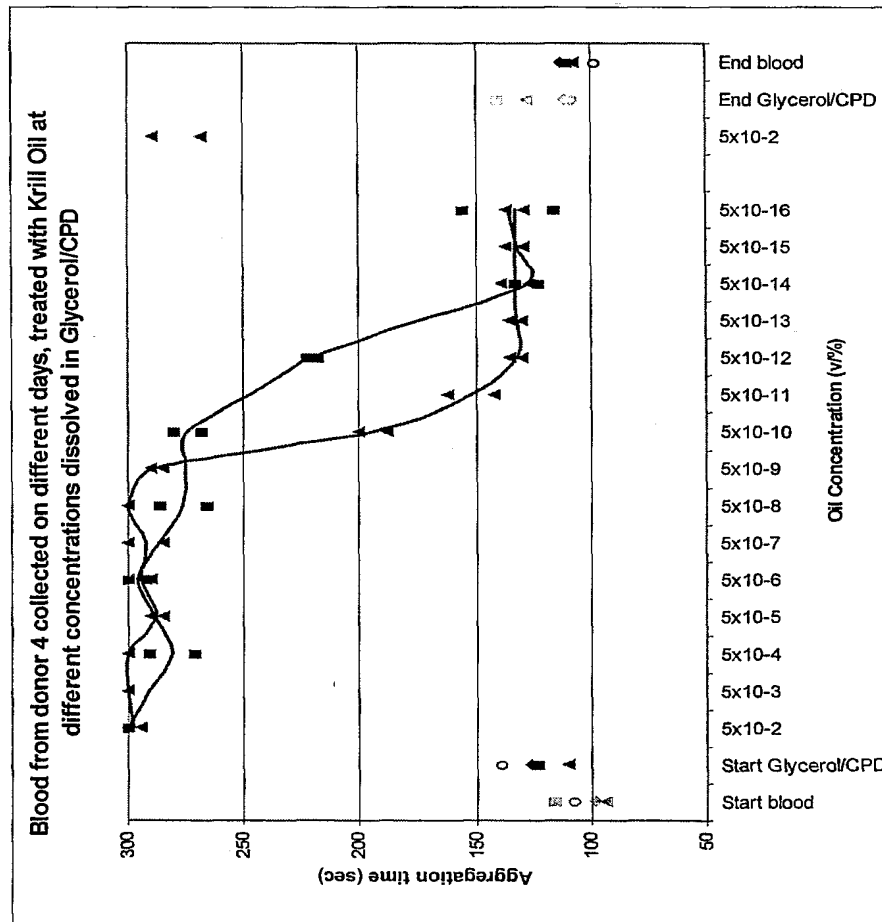
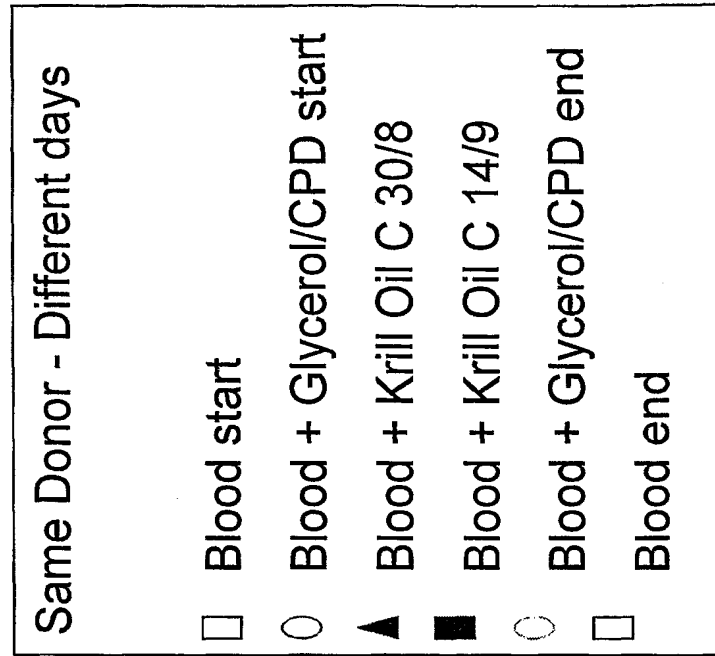

Figure 4

Figure 5

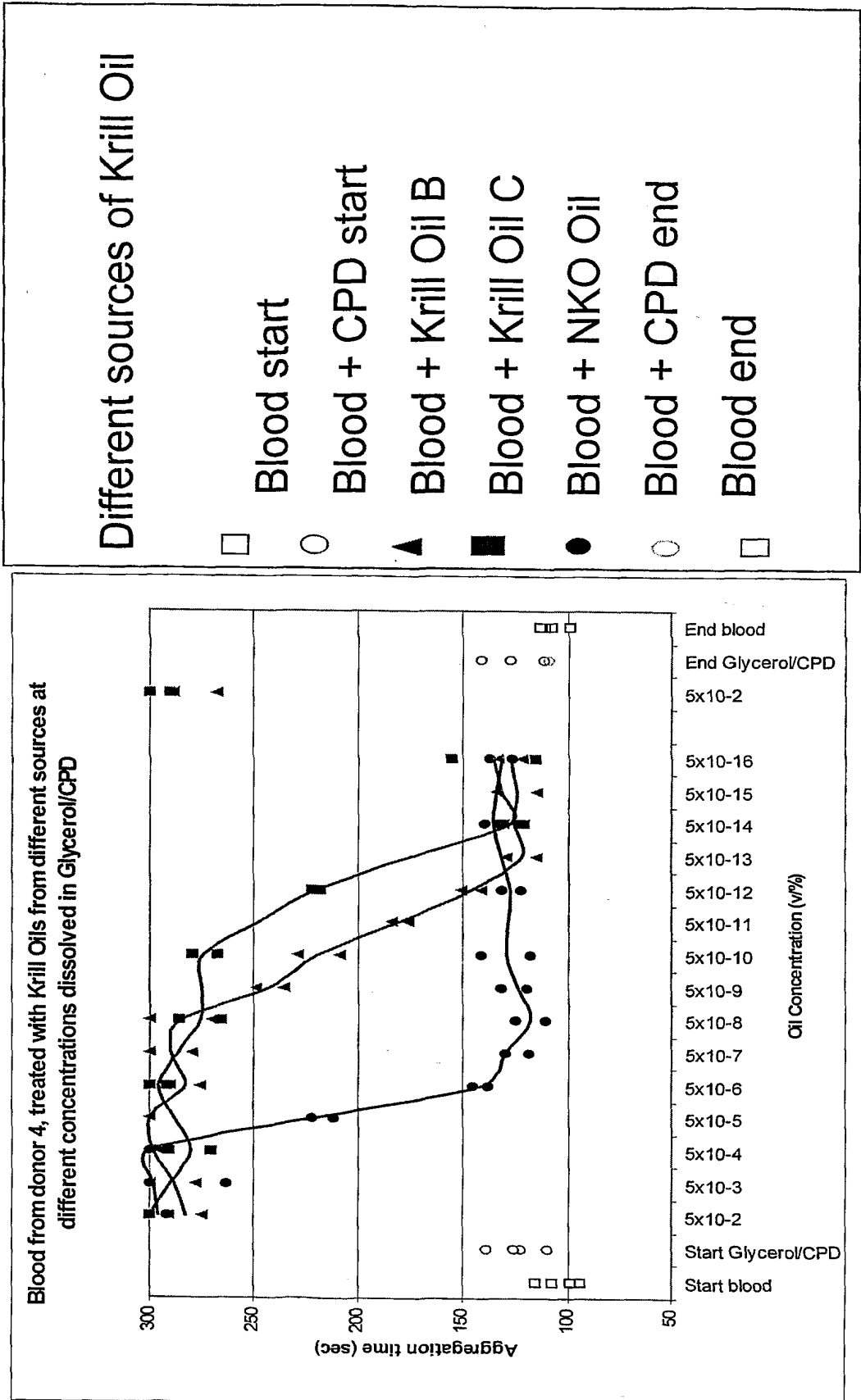
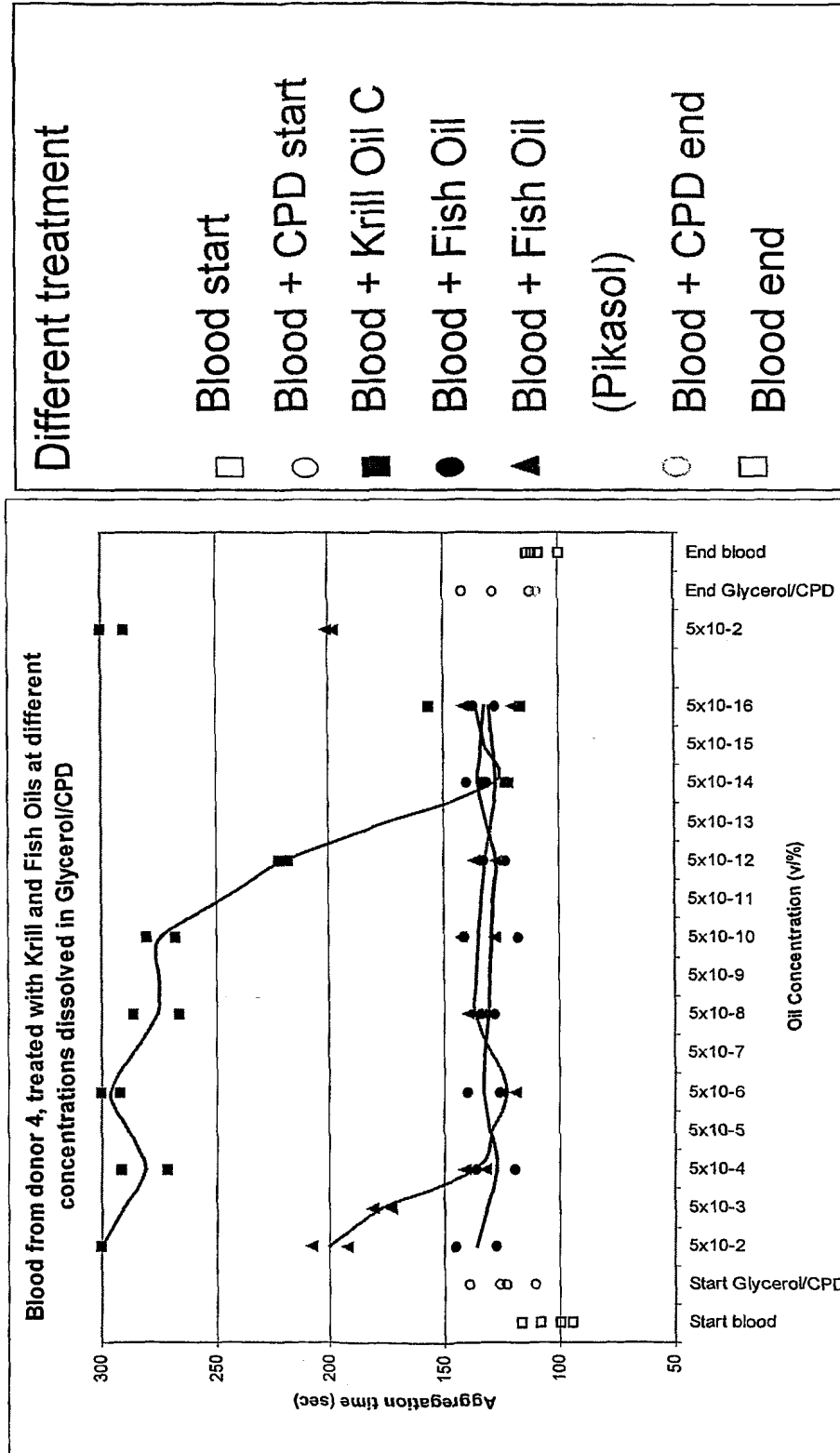

Figure 6



INTERNATIONAL SEARCH REPORT

International application No
PCT/IB2007/000099

A. CLASSIFICATION OF SUBJECT MATTER
 INV. A61P7/02 A61P9/10 A61P9/14 C11B1/02 C11B1/14
 A23L1/30 A23D9/00

According to International Patent Classification (IPC) or to both national classification and IPC

B. FIELDS SEARCHED
 Minimum documentation searched (classification system followed by classification symbols)
 C11B A23L A61P A23D

Documentation searched other than minimum documentation to the extent that such documents are included in the fields searched

Electronic data base consulted during the international search (name of data base and, where practical, search terms used)
 EPO-Internal, CHEM ABS Data, WPI Data, FSTA, BIOSIS

C. DOCUMENTS CONSIDERED TO BE RELEVANT

Category*	Citation of document, with indication, where appropriate, of the relevant passages	Relevant to claim No.
X	US 4 036 993 A (IKEDA IZUMI ET AL) 19 July 1977 (1977-07-19) example 2	1-8, 10-21, 27,28
X	DE 30 38 190 A1 (ALFA LAVAL AB [SE]) 23 April 1981 (1981-04-23) page 7, paragraph 2 - page 9, paragraph 2	1-8, 10-21, 27,28
X	WO 2005/075613 A (BEAUDOIN ADRIEN [CA]) 18 August 2005 (2005-08-18) page 6, paragraph 2 table 9	1-8, 10-21, 27,28
	----- -/--	

Further documents are listed in the continuation of Box C. See patent family annex.

* Special categories of cited documents :

- *A* document defining the general state of the art which is not considered to be of particular relevance
- *E* earlier document but published on or after the international filing date
- *L* document which may throw doubts on priority claim(s) or which is cited to establish the publication date of another citation or other special reason (as specified)
- *O* document referring to an oral disclosure, use, exhibition or other means
- *P* document published prior to the international filing date but later than the priority date claimed
- *T* later document published after the international filing date or priority date and not in conflict with the application but cited to understand the principle or theory underlying the invention
- *X* document of particular relevance; the claimed invention cannot be considered novel or cannot be considered to involve an inventive step when the document is taken alone
- *Y* document of particular relevance; the claimed invention cannot be considered to involve an inventive step when the document is combined with one or more other such documents, such combination being obvious to a person skilled in the art.
- *&* document member of the same patent family

Date of the actual completion of the international search 25 April 2007	Date of mailing of the international search report 15/05/2007
--	--

Name and mailing address of the ISA/ European Patent Office, P.B. 5818 Patentlaan 2 NL - 2280 HV Rijswijk Tel. (+31-70) 340-2040, Tx. 31 651 epo nl, Fax: (+31-70) 340-3016	Authorized officer Rooney, Kevin
---	---

INTERNATIONAL SEARCH REPORT

International application No

PCT/IB2007/000099

C(Continuation). DOCUMENTS CONSIDERED TO BE RELEVANT

Category*	Citation of document, with indication, where appropriate, of the relevant passages	Relevant to claim No.
X	DATABASE CA [Online] CHEMICAL ABSTRACTS SERVICE, COLUMBUS, OHIO, US; 1989, PIVOVAROV, P. P. ET AL: "Electronic spectra of oil-based extracts from krill" XP002430957 retrieved from STN Database accession no. 1989:593160 abstract & IZVESTIYA VYSSHIKH UCHEBNYKH ZAVEDENII, PISHCHEVAYA TEKHNLOGIYA, (3), 72-4 CODEN: IVUPA8; ISSN: 0579-3009, 1989, -----	1-8, 10-21, 27,28
X	URAKAZE M ET AL: "INFUSION OF EMULSIFIED TRIEICOSAPENTAENOYL-GLYCEROL INTO RABBITS. - THE EFFECTS ON PLATELET AGGREGATION, POLYMORPHONUCLEAR LEUKOCYTE ADHESION, AND FATTY ACID COMPOSITION IN PLASMA AND PLATELET PHOSPHOLIPIDS" THROMBOSIS RESEARCH, TARRYTOWN, NY, US, vol. 44, no. 5, 1986, pages 673-682, XP000650534 ISSN: 0049-3848 the whole document -----	1-25,27, 28
X	WO 02/102394 A (NEPTUNE TECHNOLOGIES & BIORESS [CA]; SAMPALIS TINA [CA]) 27 December 2002 (2002-12-27) the whole document -----	22-25
X	YAMAGUCHI, K., ET AL.: "Supercritical carbon dioxide extraction of oils from antarctic krill" JOURNAL OF AGRICULTURAL AND FOOD CHEMISTRY., vol. 34, 1986, pages 904-907, XP002430955 USAMERICAN CHEMICAL SOCIETY. WASHINGTON. the whole document -----	1-8, 10-21, 27,28
X	US 2004/241249 A1 (SAMPALIS TINA [CA]) 2 December 2004 (2004-12-02) example 1 -----	1-25,27, 28
A	BUNEA, R., EL FARRAH, K., AND DEUTSCH, L.: "Evaluation of the effects of neptune krill oil on the clinical course of hyperlipidemia" ALTERNATIVE MEDICINE REVIEW, vol. 9, no. 4, 2004, pages 420-428, XP002430956 USTHORNE RESEARCH INC., SANDPOINT, the whole document -----	1-28

-/--

INTERNATIONAL SEARCH REPORT

International application No
PCT/IB2007/000099

C(Continuation). DOCUMENTS CONSIDERED TO BE RELEVANT

Category*	Citation of document, with indication, where appropriate, of the relevant passages	Relevant to claim No.
A	WO 95/33471 A (M D SERV EUROP S A [FR]; HELLGREN LARS [SE]; MOHR VIGGO [NO]; VINCENT) 14 December 1995 (1995-12-14) the whole document -----	26
A	WO 03/000061 A (TRANSUCRANIA S A [ES]; PIVOVAROV PAVEL PETROVICH [ES]; PIVOVAROV EUGEN) 3 January 2003 (2003-01-03) the whole document -----	1-28
A	DATABASE WPI Week 198810 Derwent Publications Ltd., London, GB; AN 1988-068398 XP002430959 & JP 63 023819 A (KAO CORP) 1 February 1988 (1988-02-01) abstract -----	1-28

INTERNATIONAL SEARCH REPORT

International application No.
PCT/IB2007/000099

Box II Observations where certain claims were found unsearchable (Continuation of item 2 of first sheet)

This International Search Report has not been established in respect of certain claims under Article 17(2)(a) for the following reasons:

1. Claims Nos.: _____
because they relate to subject matter not required to be searched by this Authority, namely:

Although claims 22-26 are directed to a method of treatment of the human/animal body, the search has been carried out and based on the alleged effects of the compound/composition.
2. Claims Nos.: _____
because they relate to parts of the International Application that do not comply with the prescribed requirements to such an extent that no meaningful International Search can be carried out, specifically:
3. Claims Nos.: _____
because they are dependent claims and are not drafted in accordance with the second and third sentences of Rule 6.4(a).

Box III Observations where unity of invention is lacking (Continuation of item 3 of first sheet)

This International Searching Authority found multiple inventions in this international application, as follows:

1. As all required additional search fees were timely paid by the applicant, this International Search Report covers all searchable claims.
2. As all searchable claims could be searched without effort justifying an additional fee, this Authority did not invite payment of any additional fee.
3. As only some of the required additional search fees were timely paid by the applicant, this International Search Report covers only those claims for which fees were paid, specifically claims Nos.:
4. No required additional search fees were timely paid by the applicant. Consequently, this International Search Report is restricted to the invention first mentioned in the claims; it is covered by claims Nos.:

Remark on Protest

- The additional search fees were accompanied by the applicant's protest.
- No protest accompanied the payment of additional search fees.

INTERNATIONAL SEARCH REPORT

Information on patent family members

International application No
PCT/IB2007/000099

Patent document cited in search report	Publication date	Patent family member(s)	Publication date
US 4036993	A	19-07-1977	CA 1068542 A1 24-12-1979
			FR 2308320 A1 19-11-1976
			JP 932246 C 14-11-1978
			JP 51125773 A 02-11-1976
			JP 53007508 B 18-03-1978
			NO 753131 A 26-10-1976
			SU 727109 A3 05-04-1980
DE 3038190	A1	23-04-1981	JP 56064767 A 02-06-1981
			NO 803050 A 13-04-1981
			SE 431502 B 13-02-1984
			SE 7908433 A 12-04-1981
WO 2005075613	A	18-08-2005	EP 1727882 A1 06-12-2006
			US 2005192634 A1 01-09-2005
WO 02102394	A	27-12-2002	CA 2449898 A1 27-12-2002
			CN 1516592 A 28-07-2004
			EP 1406641 A2 14-04-2004
			JP 2004534800 T 18-11-2004
US 2004241249	A1	02-12-2004	NONE
WO 9533471	A	14-12-1995	AU 7278094 A 04-01-1996
WO 03000061	A	03-01-2003	NONE
JP 63023819	A	01-02-1988	NONE

(19) World Intellectual Property Organization
International Bureau



(43) International Publication Date
5 March 2009 (05.03.2009)

PCT

(10) International Publication Number
WO 2009/027692 A2

(51) International Patent Classification:

A23J 1/04 (2006.01) C11B 1/10 (2006.01)
A23K 1/10 (2006.01) A23J 7/00 (2006.01)
A23K 1/18 (2006.01) C07F 9/10 (2006.01)
A23L 1/30 (2006.01)

(21) International Application Number:

PCT/GB2008/002934

(22) International Filing Date: 29 August 2008 (29.08.2008)

(25) Filing Language: English

(26) Publication Language: English

(30) Priority Data:

60/968,765 29 August 2007 (29.08.2007) US

(71) Applicant (for all designated States except US): **AKER BIOMARINE ASA** [NO/NO]; Fjordalleen 16, PO BOX 1423 Vika, N-0115 Oslo (NO).

(71) Applicant (for GB only): **GOLDING, Louise** [GB/GB]; Frank B. Dehn & Co., St Bride's House, 10 Salisbury Square, London EC4Y 8JD (GB).

(72) Inventors; and

(75) Inventors/Applicants (for US only): **ØISTEIN, Høstmark** [NO/NO]; Skalevikveien 23, N-5178 Loddefjord

(NO). **SNORRE, Tilseth** [NO/NO]; Fantoftsasen 27A, N-5072 Bergen (NO).

(74) Agents: **GOLDING, Louise** et al.; FRANK B. DEHN & CO., St Bride's House, 10 Salisbury Square, London EC4Y 8JD (GB).

(81) Designated States (unless otherwise indicated, for every kind of national protection available): AE, AG, AL, AM, AO, AT, AU, AZ, BA, BB, BG, BH, BR, BW, BY, BZ, CA, CH, CN, CO, CR, CU, CZ, DE, DK, DM, DO, DZ, EC, EE, EG, ES, FI, GB, GD, GE, GH, GM, GT, HN, HR, HU, ID, IL, IN, IS, JP, KE, KG, KM, KN, KP, KR, KZ, LA, LC, LK, LR, LS, LT, LU, LY, MA, MD, ME, MG, MK, MN, MW, MX, MY, MZ, NA, NG, NI, NO, NZ, OM, PG, PH, PL, PT, RO, RS, RU, SC, SD, SE, SG, SK, SL, SM, ST, SV, SY, TJ, TM, TN, TR, TT, TZ, UA, UG, US, UZ, VC, VN, ZA, ZM, ZW.

(84) Designated States (unless otherwise indicated, for every kind of regional protection available): ARIPO (BW, GH, GM, KE, LS, MW, MZ, NA, SD, SL, SZ, TZ, UG, ZM, ZW), Eurasian (AM, AZ, BY, KG, KZ, MD, RU, TJ, TM), European (AT, BE, BG, CH, CY, CZ, DE, DK, EE, ES, FI, FR, GB, GR, HR, HU, IE, IS, IT, LT, LU, LV, MC, MT, NL, NO, PL, PT, RO, SE, SI, SK, TR), OAPI (BF, BJ, CF, CG, CI, CM, GA, GN, GQ, GW, ML, MR, NE, SN, TD, TG).

Published:

— without international search report and to be republished upon receipt of that report



WO 2009/027692 A2

(54) Title: A NEW METHOD FOR MAKING KRILL MEAL

(57) Abstract: A new method for krill meal production has been developed using a two step cooking process. In the first step the proteins and phospholipids are removed from the krill and precipitated as a coagulum. In the second stage the krill without phospholipids are cooked. Following this, residual fat and astaxanthin are removed from the krill using mechanical separation methods. A novel krill meal product with superior nutritional and technical properties is prepared.

A new method for making krill meal

FIELD OF THE INVENTION

The invention relates to processing crustaceans such as krill to provide oil and meal products, and in particular to the production of oils containing astaxanthin and phospholipids comprising omega-3 fatty acid moieties and meal rich in astaxanthin.

BACKGROUND OF THE INVENTION

Krill is a small crustacean which lives in all the major oceans world-wide. For example, it can be found in the Pacific Ocean (*Euphausia pacifica*), in the Northern Atlantic (*Meganyctiphanes norvegica*) and in the Southern Ocean off the coast of Antarctica (*Euphausia superba*). Krill is a key species in the ocean as it is the food source for many animals such as fish, birds, sharks and whales. Krill can be found in large quantities in the ocean and the total biomass of Antarctic krill (*E. superba*) is estimated to be in the range of 300-500 million metric tons. Antarctic krill feeds on phytoplankton during the short Antarctic summer. During winter, however, its food supply is limited to ice algae, bacteria, marine detritus as well as depleting body protein for energy. Virtue et al., Mar. Biol. 126, 521-527. For this reason, the nutritional values of krill vary during the season and to some extent annually. Phleger et al., Comp. Biochem. Physiol. 131B (2002) 733. In order to accommodate variations in food supply, krill has developed an efficient enzymatic digestive apparatus resulting in a rapid breakdown of the proteins into amino acids. Ellingsen et al., Biochem. J. (1987) 246, 295-305. This autoproteolysis is highly efficient also post mortem, making it a challenge to catch and store the krill in a way that preserves the nutritional quality of the krill. Therefore, in order to prevent the degradation of krill the enzymatic activity is either reduced by storing the krill at low temperatures or the krill is made into a krill meal.

During the krill meal process the krill is cooked so that all the active enzymes are denatured in order to eliminate all enzymatic activity. Krill is rich in phospholipids which act as emulsifiers. Thus it is more difficult to separate water, fat and proteins using mechanical separation methods than it is in a regular fish meal production line. In addition, krill becomes solid, gains weight and loose liquid more easily when mixed with hot water. Eventually this may lead to a gradual build up of coagulated krill proteins in the cooker and a non-continuous operation due to severe clogging problems. In order to alleviate this, hot steam must be added directly into the cooker. This operation is energy demanding and may also result in a degradation of unstable bioactive components in the krill such as omega-3 fatty acids,

phospholipids and astaxanthin. The presence of these compounds, make krill oil an attractive source as a food supplement, a functional food products and a pharmaceutical for the animal and human applications.

Omega-3 fatty acids have recently been shown to have potential effect of preventing cardiovascular disease, cognitive disorders, joint disease and inflammation related diseases such as rheumatoid arthritis. Astaxanthin is a strong antioxidant and may therefore assist in promoting optimal health. Hence, there is a need for a method of processing krill into a krill meal at more gentle conditions which prevents the degradation of these valuable bioactive compounds.

SUMMARY OF THE INVENTION

The invention relates to processing crustaceans such as krill to provide oil and meal products, and in particular to the production of oils and other lipid extracts containing astaxanthin and phospholipids comprising omega-3 fatty acid moieties and meal rich in astaxanthin.

In some embodiments, the present invention provides compositions comprising less than about 150, 100, 10, 5, 2 or 1 mg/kg astaxanthin or from about 0.1 to about 1, 2, 5, 10 or 200 mg/kg astaxanthin, preferably endogenous, naturally occurring astaxanthin, from about 20% to about 50%, 15% to 45%, or 25% to 35% phospholipids on a w/w basis, and about 15% to 60%, about 20% to 50%, or about 25% to 40% protein on a w/w basis, wherein said phospholipids comprise omega-3 fatty acid residues. In some embodiments, the composition comprises a lipid fraction having an omega-3 fatty acid content of from about 5% to about 30%, from 10% to about 30%, or from about 12% to about 18% on a w/w basis. In some embodiments, the phospholipids comprise greater than about 60%, 65%, 80%, 85% or 90% phosphatidylcholine on a w/w basis. In some embodiments, the phospholipids comprise less than about 15%, 10%, 8% or 5% ethanolamine on a w/w basis. In some embodiments, the compositions comprise from about 1% to 10%, preferably 2% to 8%, and most preferably about 2% to 6% alkylacylphosphatidylcholine. In some embodiments, the compositions comprise from about 40% to about 70% triacylglycerol on a w/w basis. In further embodiments, the compositions comprise less than about 1% cholesterol. In some embodiments, the protein comprises from about 8% to about 14% leucine on a w/w basis and from about 5% to 11% isoleucine on a w/w basis.

In some embodiments, the present invention comprises an aqueous phase and a solid phase, said solid phase comprising from about 20% to about 40% phospholipids on a w/w

basis, and about 20% to 50% protein on a w/w basis, wherein said phospholipids comprise from about 10% to about 20% omega-3 fatty acid residues.

In other embodiments, the present invention provides krill compositions comprising astaxanthin, a protein fraction, and a lipid fraction, wherein said lipid fraction comprises less than about 10%, 5% or 3% phospholipids on a w/w basis. In some embodiments, the phospholipids comprise less than about 15%, 10% or 5% phosphatidylcholine on a w/w basis.

In some embodiments, the present invention provides a krill meal comprising astaxanthin and from about 8 % to about 31 % lipids, preferably from about 8% to about 10 or 18 % lipids, wherein said lipids comprises greater than about 80% neutral lipids on a w/w basis. In some embodiments, the krill meal comprises less than about 15%, 10%, 5%, 3% or 1% phospholipids. In some embodiments, the phospholipids comprise less than about 15%, 10% or 5% phosphatidylcholine on a w/w basis.

In some embodiments, the present invention provides methods of preparing a phospholipid composition from biological material or biomass comprising: mixing said biological material or biomass with water at a suitable temperature to form a solid phase and an aqueous phase comprising phospholipids and proteins; separating said solid phase from said aqueous phase; heating said aqueous phase at a temperature sufficient to form a phospholipid-protein precipitate; and separating said phospholipid-protein precipitate from said aqueous phase. In some embodiments, the present invention provides a phospholipid-protein precipitate obtained by using the foregoing method. In some embodiments, the biological material or biomass is krill. In other embodiments, the biological material or biomass is selected from crabs, shrimp, calanus, plankton, crayfish, eggs or other phospholipid containing biological materials or biomass. In some embodiments, the methods further comprise the step of forming a meal from said solid phase. In some embodiments, the step of forming a meal comprises: heating the solid phase in the presence of water; separating fat and protein in said solid phase; and drying said protein to form a meal. In some embodiments, the processes further comprise the steps of pressing and drying the coagulum to form a coagulum meal. In some embodiments, the drying is by hot air or steam. In some embodiments, the present invention provides a phospholipid-protein precipitate obtained by using the foregoing method. In some embodiments, the present invention provides a composition comprising a krill solid phase according to the foregoing methods. In some embodiments, the present invention provides a krill meal obtained by the foregoing methods.

In some embodiments, the present invention provides processes comprising: extracting a first lipid fraction from a krill biomass; extracting a second lipid fraction from a krill

biomass; and blending said first lipid fraction and said second lipid fraction to provide a krill lipid composition having a desired composition. In some embodiments, the one or more of the extracting steps are performed in the absence of substantial amounts of organic solvents. In some embodiments, the first lipid fraction is extracted by: mixing krill with water at a suitable temperature to form a solid phase and an aqueous phase comprising phospholipids and protein; separating said solid phase from said aqueous phase; heating said aqueous phase at a temperature sufficient to form a phospholipid-protein precipitate; separating said phospholipid-protein precipitate from said aqueous phase; and separating said phospholipids from said protein. In some embodiments, the second lipid fraction is extracted by: heating the solid phase in the presence of water; and separating fat and protein in said solid phase. In some embodiments, the first lipid fraction comprises a phospholipid fraction comprising greater than about 90% phosphatidylcholine on a w/w basis. In some embodiments, the second lipid fraction comprises greater than about 80% neutral lipids on a w/w basis.

In some embodiments, the present invention provides processes of producing a phospholipid composition from biological material or biomass comprising: mixing said biological material or biomass with water to increase the temperature of said biological material to about 25 to 80 °C , preferably to about 50 to 75 °C, and most preferably to about 60 to 75 °C to form a first solid phase and a first aqueous phase comprising phospholipids and proteins; separating said first solid phase from said first aqueous phase; and separating a protein and phospholipid fraction from said first aqueous phase. In some embodiments, the biomass is heated to the first temperature for at least 3 minutes, preferably from about 3 minutes to 60 minutes, more preferably from about 3 minutes to 20 minutes, and most preferably from about 3 minutes to 10 minutes. The present invention is not limited to the use of any particular biological materials or biomass. In some embodiments, the biological material is a marine biomass. In some preferred embodiments, the biological material or biomass comprises krill crabs, shrimp, calanus, plankton, crayfish, eggs or other phospholipid containing biological materials or biomass. The present invention is not limited to the use of any particular type of krill. In some embodiments, the krill is fresh, while in other embodiments, the krill is frozen. In some embodiments, the krill is of the species *Euphausia superba*. In some embodiments, the step of separating a protein and phospholipid fraction from said first aqueous phase comprises heating said first aqueous phase at a temperature sufficient to form a phospholipid-protein coagulate and separating said phospholipid-protein coagulate from said aqueous phase. In some embodiments, the processes utilize a second heating step. In some embodiments, the first aqueous phase is heated to over 80 °C, preferably

to about 80 to 120 °C, and most preferably to about 90 to 100 °C. In some embodiments, the krill milk is held at these temperatures for from about 1 minute to about 60 minutes, preferably about 1 minute to about 10 minutes, and most preferably for about 2 minutes to 8 minutes. In some embodiments, the heating is at atmospheric pressure, while in other
5 embodiments, the pressure is greater than atmospheric pressure. In some embodiments, the processes further comprise the step of pressing said phospholipid-protein coagulate to form a coagulate liquid phase and a coagulate press cake. In some embodiments, the processes further comprise drying said coagulate press cake to form a coagulate meal. In some
10 embodiments, the processes further comprise extracting a coagulate oil from said coagulate meal. In some embodiments, the processes further comprise the steps of pressing and drying the coagulum to form a coagulum meal. In some embodiments, the drying is by hot air or steam.

In some embodiments, the step of separating a protein and phospholipid fraction from said first aqueous phase comprises filtration of said aqueous phase to provide a phospholipid-
15 protein retentate comprising proteins and phospholipids. In some embodiments, filtration is via membrane filtration. In some embodiments, the filtration comprises filtering said aqueous phase through a microfilter with a pore size of from about 50 to 500 nm. In some embodiments, the processes further comprise the step of dewatering said phospholipid-protein retentate to form a retentate liquid phase and a retentate concentrate. In some
20 embodiments, the processes further comprise the step of removing water from said retentate concentrate so that said retentate concentrate is microbially stable. In some embodiments, the processes further comprise the step of extracting a retentate oil from said retentate concentrate. In some embodiments, the processes further comprise the step of heating said first solid phase and then pressing said first solid phase to form a first press cake and a second liquid phase. In some
25 embodiments, the processes further comprise the step of drying said first press cake to provide a first krill meal. In some embodiments, the processes further comprise the steps of heating said second liquid phase and then separating said second liquid phase to provide a first krill oil and stickwater. In some embodiments, the stickwater is evaporated and added to said first press cake, and a meal is formed from said evaporated stickwater and said first press cake to
30 provide a second krill meal. In some embodiments, the second liquid phase is heated to over 80 °C, preferably to about 80 to 120 °C, and most preferably to about 90 to 100 °C prior to said separation. In some embodiments, the processes further comprise the step of combining the previously described coagulate oil or the retentate oil and the first krill oil to provide a blended oil. In other embodiments, the coagulate oil, retentate oil, or oil pressed from the first

solid phase are combined with the coagulate meal or retentate. In further embodiments, the processes of the present invention comprise the further step of supplementing the meals or oils produced as described above with additional proteins, phospholipids, triglycerides, fatty acids, and/or astaxanthin to produce an oil or meal with a desired defined composition. As such, a person of skill in the art will readily recognize that the processes described above serve as a starting point for producing compositions that are further supplemented in subsequent process steps to produce a desired composition, such a composition containing elevated levels of proteins, lipids or astaxanthin. In some embodiments, the present invention provides the lipid-protein composition produced by the foregoing processes. In some embodiments, the present invention provides the coagulate meal produced by the foregoing processes. In some embodiments, the present invention provides the coagulate oil produced by the foregoing processes. In some embodiments, the present invention provides the retentate meal produced by the foregoing processes. In some embodiments, the present invention provides the retentate oil produced by the foregoing processes. In some embodiments, the present invention provides the krill meal produced by the foregoing processes. In some embodiments, the present invention provides a krill oil produced by the foregoing processes. In some embodiments, the present invention provides a blended oil produced by the foregoing processes. In some embodiments, the compositions of the present invention are supplemented with additional proteins, phospholipids, triglycerides, fatty acids, and/or astaxanthin to produce an oil or meal with a desired defined composition. As such, a person of skill in the art will readily recognize that the compositions described above serve as a starting point for producing compositions that are further supplemented in subsequent process steps to produce a desired composition, such a composition containing elevated levels of proteins, lipids or astaxanthin.

In some embodiments, the present invention provides processes comprising: heating a krill biomass to about 25 to 80 °C, preferably to about 50 to 75 °C, and most preferably to about 60 to 75 °C; separating said krill biomass into solid and liquid phases; extracting a first lipid fraction from said solid phase; extracting a second lipid fraction from said liquid phases; and blending said first lipid fraction and said second lipid fraction to provide a krill lipid composition having a desired composition. In some embodiments, the extracting steps are performed in the absence of substantial amounts of organic solvents. In some embodiments, the first lipid fraction comprises a phospholipid fraction comprising greater than about 90% phosphatidylcholine on a w/w basis. In some embodiments, the second lipid fraction comprises greater than about 80% neutral lipids on a w/w basis.

In some embodiments, the present invention provides krill compositions comprising from about 0.01 to about 200 mg/kg astaxanthin, from about 45% to about 65% fat w/w, and about 20% to 50% protein w/w, wherein said fat comprises omega-3 fatty acid residues. In some embodiments, the fat has an omega-3 fatty acid content of from about 10% to 30 %, preferably 15% to about 25% on a w/w basis. In some embodiments, the fat comprises from about 20% to about 50% phospholipids w/w, wherein said phospholipids comprise greater than about 65% phosphatidylcholine w/w and from about 1% to about 10% alkylacylphosphatidylcholine. In some embodiments, the phospholipids comprise less than about 10% ethanolamine on a w/w basis. In some embodiments, the fat comprises from about 40% to about 70% triacylglycerol w/w. In some embodiments, the compositions further comprise less than about 1% cholesterol. In some embodiments, the protein comprises from about 8% to about 14% leucine on a w/w basis and from about 5% to 11% isoleucine on a w/w basis.

In some embodiments, the present invention provides krill compositions comprising from about 10% to about 20% protein w/w, about 15% to about 30% fat w/w, and from about 0.01 to about 200 mg/kg astaxanthin. In some embodiments, the fat has an omega-3 fatty acid content of from about 10% to about 30% on a w/w basis. In some embodiments, the fat comprises from about 30% to about 50% phospholipids w/w. In some embodiments, the phospholipids comprise greater than about 65% phosphatidylcholine w/w. In some embodiments, the phospholipids comprise less than about 10% ethanolamine on a w/w basis. In some embodiments, the fat comprises from about 40% to about 70% triacylglycerol w/w. In some embodiments, the compositions comprise less than about 1% cholesterol. In some embodiments, the protein comprises from about 7% to about 13% leucine on a w/w basis and from about 4% to 10% isoleucine on a w/w basis.

In some embodiments, the present invention provides krill meal press cakes comprising from about 65% to about 75% protein w/w (dry matter) , from about 10% to about 25% fat w/w (dry matter), and from about 1 to about 200 mg/kg astaxanthin (wet base). In some embodiments, the fat comprises greater than about 30% neutral lipids and greater than about 30% phospholipids on a w/w basis. In some embodiments, the fat comprises from about 50 to about 60% neutral lipids w/w and from about 40% to about 55% polar lipids w/w. In some embodiments, the protein comprises from about 5% to about 11% leucine w/w and from about 3% to about 7% isoleucine w/w.

In some embodiments, the present invention provides krill meals comprising from about 65% to about 75% protein w/w (dry matter) , from about 10% to about 25% fat w/w

(dry matter), and from about 1 to about 200 mg/kg astaxanthin (wet base). In some embodiments, the fat comprises greater than about 30% neutral lipids and greater than about 30% phospholipids on a w/w basis. In some embodiments, the fat comprises from about 50 to about 60% neutral lipids w/w and from about 40% to about 55% polar lipids w/w. In some
5 embodiments, the polar lipids comprise greater than about 90% phosphatidyl choline w/w. In some embodiments, the polar lipids comprise less than about 10% phosphatidyl ethanolamine w/w. In some embodiments, the protein comprises from about 5% to about 11% leucine w/w and from about 3% to about 7% isoleucine w/w.

In some embodiments, the present invention provides krill oil compositions
10 comprising greater than about 1500 mg/kg total esterified astaxanthin, wherein said esterified astaxanthin comprises from about 25 to 35% astaxanthin monoester on a w/w basis and from about 50 to 70% astaxanthin diester on a w/w basis, and greater than about 20 mg/kg free astaxanthin.

In some embodiments, the present invention provides krill compositions comprising
15 from about 3% to about 10% protein w/w, about 8% to about 20% dry matter w/w, and about 4% to about 10% fat w/w. In some embodiments, the fat comprises from about 50% to about 70% triacylglycerol w/w. In some embodiments, the fat comprises from about 30% to about 50% phospholipids w/w. In some embodiments, the phospholipids comprise greater than about 90% phosphatidyl choline w/w. In some embodiments, the fat comprises from about
20 10% to about 25% n-3 fatty acids. In some embodiments, the fat comprises from about 10% to about 20% EPA and DHA.

In some embodiments, the krill compositions of the present invention are supplemented with additional proteins, phospholipids, triglycerides, fatty acids, and/or astaxanthin to produce an oil or meal with a desired defined composition. As such, a person
25 of skill in the art will readily recognize that the krill compositions described above serve as a starting point for producing compositions that are further supplemented in subsequent process steps to produce a desired composition, such a composition containing elevated levels of proteins, lipids or astaxanthin.

The meal and oil compositions of the present invention described above are
30 characterized in containing low levels, or being substantially free of many volatile compounds that are commonly found in products derived from marine biomass. In some embodiments, the meals and oils of the present invention are characterized as being substantially free of one or more of the following volatile compounds: acetone, acetic acid, methyl vinyl ketone, 1-penten-3-one, n-heptane, 2-ethyl furan, ethyl propionate, 2-methyl-2-pentenal, pyridine,

acetamide, toluene, N,N-dimethyl formamide, ethyl butyrate, butyl acetate, 3-methyl-1,4-heptadiene, isovaleric acid, methyl pyrazine, ethyl isovalerate, N,N-dimethyl acetamide, 2-heptanone, 2-ethyl pyridine, butyrolactone, 2,5-dimethyl pyrazine, ethyl pyrazine, N,N-dimethyl propanamide, benzaldehyde, 2-octanone, β -myrcene, dimethyl trisulfide, trimethyl
5 pyrazine, 1-methyl-2-pyrrolidone. In other embodiments, the meals and oils of the present invention are characterized in containing less than 1000, 100, 10, 1 or 0.1 ppm (alternatively less than 10 mg/100g, preferably less than 1 mg/100 g and most preferably less than 0.1 mg/100 g) of one or more of the following volatile compounds: acetone, acetic acid, methyl vinyl ketone, 1-penten-3-one, n-heptane, 2-ethyl furan, ethyl propionate, 2-methyl-2-pentenal,
10 pyridine, acetamide, toluene, N,N-dimethyl formamide, ethyl butyrate, butyl acetate, 3-methyl-1,4-heptadiene, isovaleric acid, methyl pyrazine, ethyl isovalerate, N,N-dimethyl acetamide, 2-heptanone, 2-ethyl pyridine, butyrolactone, 2,5-dimethyl pyrazine, ethyl pyrazine, N,N-dimethyl propanamide, benzaldehyde, 2-octanone, β -myrcene, dimethyl trisulfide, trimethyl pyrazine, 1-methyl-2-pyrrolidone. In further embodiments, the
15 compositions of the present invention are characterized in comprising less than 10 mg/100g, and preferably less than 1mg/100 g (dry weight) of trimethylamine (TMA), trimethylamine oxide (TMAO) and/or lysophosphatidylcholine.

In some embodiments, the present invention provides systems for processing of marine biomass comprising: a mixer for mixing marine biomass and water to form a mixture
20 having a defined temperature, wherein said mixture has a first solid phase and a first liquid phase. In some embodiments, the water is heated and said defined temperature of said mixture is from about 25 to 80 °C, preferably to about 50 to 75 °C, and most preferably to about 60 to 75 °C. In some embodiments, the systems further comprise a separator in fluid communication with said mixer for separating said first solid phase and said first liquid phase.
25 In some embodiments, the first separator is a filter. In some embodiments, the systems further comprise a first heater unit in fluid communication with said first separator, wherein said first heater unit heats said first liquid phase to a defined temperature. In some embodiments, the defined temperature is about 80°C to about 100°C, preferably 90°C to about 100°C, most preferably 95°C to about 100°C. In some embodiments, the systems further comprise a
30 microfilter in fluid communication with said mixer, wherein said liquid phase is separated into a retentate phase and a permeate phase by said microfilter. In some embodiments, the systems further comprise a prefilter in line with said microfilter. In some embodiments, the prefilter is a sieve. In some embodiments, the water is heated and said defined temperature of said mixture is from about 25 to 80 °C, preferably to about 50 to 75 °C, and most preferably to

about 60 to 75 °C. In some embodiments, the systems further comprise a first separator in fluid communication with said mixer for separating said first solid phase and said first liquid phase. In some embodiments, the first separator is a filter.

In some embodiments, the present invention provides krill compositions comprising
5 from about 10% to about 20% protein w/w, about 15% to about 30% fat w/w, from about 0.01% to about 200 mg/kg astaxanthin, and less than about 1 mg/100g trimethyl amine, trimethyl amine, volatile nitrogen, or 1g/100g lysophosphatidylcholine or combinations thereof. In some embodiments, the fat has an omega-3 fatty acid content of from about 10% to about 25% on a w/w basis. In some embodiments, the fat comprises from about 35% to
10 about 50% phospholipids w/w. In some embodiments, the phospholipids comprise greater than about 90% phosphatidylcholine w/w. In some embodiments, the phospholipids comprise less than about 10% ethanolamine on a w/w basis. In some embodiments, the fat comprises from about 40% to about 60% triacylglycerol w/w. In some embodiments, the compositions further comprise less than about 1% cholesterol. In some embodiments, the protein comprises
15 from about 7% to about 13% leucine on a w/w basis and from about 4% to 10% isoleucine on a w/w basis.

In some embodiments, the present invention provides processes for processing of marine biomass comprising: providing a marine biomass and a mixer for mixing marine biomass and water to form a mixture having a defined temperature, wherein said mixture
20 comprises a first solid phase and a first liquid phase. In some embodiments, the defined temperature of said mixture is from about 25 to 80 °C, preferably to about 50 to 75 °C, and most preferably to about 60 to 75 °C. In some embodiments, the processes further comprise the steps of separating said liquid phase from said solid phase, and heating said liquid phase to about 80°C to about 100°C, preferably 90°C to about 100°C, most preferably 95°C to about
25 100°C, to produce a coagulate. In some embodiments, the coagulate comprises proteins and lipids. In some embodiments, the coagulate is separated from residual liquid by filtering.

In some embodiments, the present invention provides systems for processing of marine biomass comprising: a ship; a trawl net towable from said ship, said trawl net configured to catch the marine biomass; and a mixer for mixing said marine biomass and
30 water to form a mixture having a defined temperature, wherein said mixture has a first solid phase and a first liquid phase. In some embodiments, the marine biomass is krill. In some embodiments, the krill is fresh krill and the trawl and ship are configured to deliver the fresh krill to the mixer. In some embodiments, system comprises a pump to transfer the biomass from the krill to the ship. In some embodiments, the system comprises a microfilter in fluid

communication with said mixer, wherein said microfilter separates said first solid phase and said first liquid phase. In some embodiments, the marine biomass is krill. In some embodiments, the krill is fresh krill.

In some embodiments, the present invention provides a pharmaceutical composition
5 comprising one or more of the compositions described above in combination with a
pharmaceutically acceptable carrier. In some embodiments, the present invention provides a
food product comprising one or of the foregoing compositions. In some embodiments, the
present invention provides a dietary supplement comprising one or more of the foregoing
compositions. In some embodiments, the present invention provides an animal feed
10 comprising one or more of the foregoing compositions.

DESCRIPTION OF THE FIGURES

Figure 1 shows an overview of the process of making krill meal with a two stage
cooking process.

15 Figure 2 is a graph of the Permeate flux as function of dry matter of the retentate (%
(°Brix).

Figure 3 is a graph of Average Flux as function of dry matter in retentate.

Figure 4 is a GC of the neutral fraction extracted from krill coagulate.

Figure 5 is a GC analysis of the neutral fraction extracted from krill coagulate.

20 Figure 6 is a GC of the polar fraction extracted from krill coagulate.

Figure 7 is a GC analysis of the polar fraction extracted from krill coagulate.

DEFINITIONS

25

As used herein, "phospholipid" refers to an organic compound having the following
general structure:

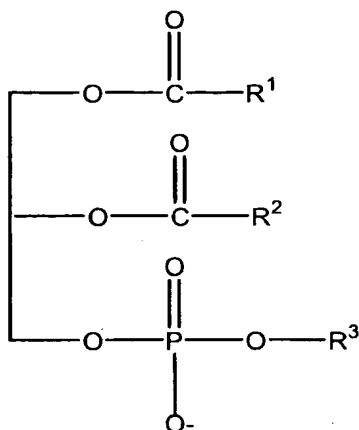

wherein R1 is a fatty acid residue, R2 is a fatty acid residue or -OH, and R3 is a -H or nitrogen containing compound choline (HOCH₂CH₂N⁺(CH₃)₃OH), ethanolamine (HOCH₂CH₂NH₂), inositol or serine. R1 and R2 cannot simultaneously be OH. When R3 is an -OH, the compound is a diacylglycerophosphate, while when R3 is a nitrogen-containing compound, the compound is a phosphatide such as lecithin, cephalin, phosphatidyl serine or plasmalogen.

An "ether phospholipid" as used herein refers to a phospholipid having an ether bond at position 1 the glycerol backbone. Examples of ether phospholipids include, but are not limited to, alkylacylphosphatidylcholine (AAPC), lyso-alkylacylphosphatidylcholine (LAAPC), and alkylacylphosphatidylethanolamine (AAPE). A "non-ether phospholipid" is a phospholipid that does not have an ether bond at position 1 of the glycerol backbone.

As used herein, the term omega-3 fatty acid refers to polyunsaturated fatty acids that have the final double bond in the hydrocarbon chain between the third and fourth carbon atoms from the methyl end of the molecule. Non-limiting examples of omega-3 fatty acids include, 5,8,11,14,17-eicosapentaenoic acid (EPA), 4,7,10,13,16,19-docosahexanoic acid (DHA) and 7,10,13,16,19-docosapentanoic acid (DPA).

As used herein, astaxanthin refers to the following chemical structure:

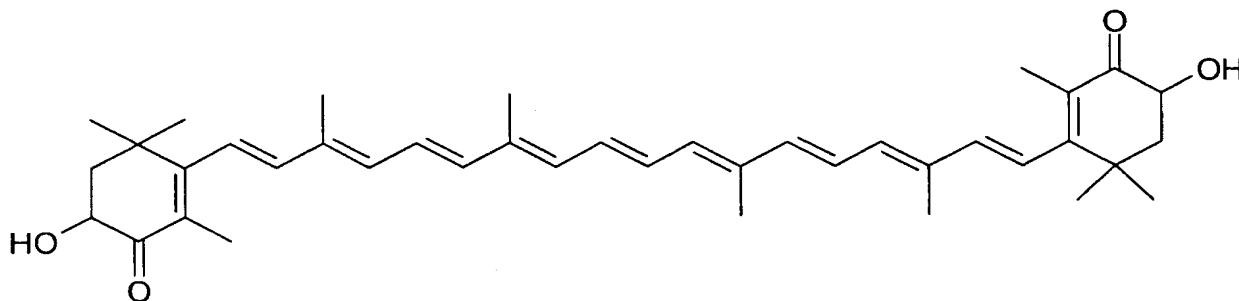

20

As used herein, astaxanthin esters refer to the fatty acids esterified to OH group in the astaxanthin molecule.

As used herein, the term w/w (weight/weight) refers to the amount of a given substance in a composition on weight basis. For example, a composition comprising 50% w/w phospholipids means that the mass of the phospholipids is 50% of the total mass of the composition (i.e., 50 grams of phospholipids in 100 grams of the composition, such as an oil).

As used herein, the term "fresh krill" refers to krill that is has been harvested less than about 12, 6, 4, 2 or preferably 1 hour prior to processing. "Fresh krill" is characterized in that products made from the fresh krill such as coagulum comprise less than 1 mg/100g TMA, volatile nitrogen or Trimethylamine oxide-N, alone or in combination, and less than 1g/100 g lysophosphatidylcholine.

DETAILED DESCRIPTION OF THE INVENTION

The invention relates to processing crustaceans such as krill to provide oil and meal products, and in particular to the production of oils containing astaxanthin and phospholipids comprising omega-3 fatty acid moieties and meal rich in astaxanthin. In some embodiments, the present invention provides systems and methods for the continuous processing of fresh or frozen krill into useful products, including krill oil, krill meal, and a krill protein/phospholipid coagulum.

Previous processes for treating marine biomasses such as krill have utilized a single high temperature treatment to provide a proteinaceous product. Pat No. SU220741; "Removing fats from the protein paste "Okean". Gulyaev and Bugrova, Konservnaya i Ovoshchesushil'naya Promyshlennost (1976), (4), 37-8; Amino acid composition of protein-coagulate in krill. Nikolaeva, VNIRO (1967), 63 161-4. However, these methods result in a product with a relatively low lipid content. The present invention describes a process in which the marine biomass such as krill is first heated at moderate temperatures to provide an aqueous phase which is subsequently heated at a higher temperature. This process provides a novel protein-lipid composition that has a higher lipid content than previously described compositions produced from marine biomasses. The compositions of the present invention are further distinguished from other krill oil supplements marketed for human use in that the described compositions are, in some embodiments, provided as solids or powders comprising a combination of krill lipids, including krill phospholipids and krill triglycerides, and krill-derived protein. These solids/powders may preferably be provided in capsules, gel capsules, or as tablets or caplets.

In some embodiments, the present invention provides solvent-free methods to produce a phospholipid-containing composition from a biomass such as krill, crabs, Calanus, plankton, eggs, crayfish, shrimp and the like without using organic solvents. In some embodiments, the biomass (preferably krill, freshly harvested or frozen) is heated to a temperature in the range of 25 to 80°C, preferably 40 to 75°C, and most preferably 60 to 75°C in order to dissolve/disperse lipids and proteins from the krill into the water phase, which is called krill milk. In some embodiments, the biomass is heated to and held at this first temperature for at least 3 minutes, preferably from about 3 minutes to 60 minutes, more preferably from about 3 minutes to 20 minutes, and most preferably from about 3 minutes to 10 minutes. In some embodiments, the processes then utilize a second heating step. The proteins and phospholipids are precipitated out of the water phase produced from the first heating step by heating the krill milk (after removal of the krill solids) to a temperature of greater than about 80°C, preferably 80 to 120°C, most preferably 95 to 100°C. In some embodiments, the krill milk is held at these temperatures for from about 1 minute to about 60 minutes, preferably about 1 minute to about 10 minutes, and most preferably for about 2 minutes to 8 minutes. The water phase may be heated at atmospheric pressure, or the water phase may be heated in a closed system at an elevated pressure so that the temperature can be increased above 100°C. Accordingly, in some embodiments, the heating is at atmospheric pressure, while in other embodiments, the pressure is greater than atmospheric pressure. The precipitate formed (hereafter called a coagulum) can be isolated and characterized. In some embodiments, the processes further comprise the steps of pressing and drying the coagulum to form a coagulum meal. In some embodiments, the drying is by hot air or steam.

The solid phase (e.g., krill solids) is preferably used to make a krill meal which also has a novel composition. In other embodiments, the krill milk is microfiltrated. The solid phase produced by microfiltration (called the retentate) is similar to that of the coagulum. Data show that the coagulum and retentate are low in cholesterol. In some embodiments, the retentate and coagulum are substantially free of cholesterol. In some embodiments, the retentate and coagulum comprise less than 1% cholesterol, preferably less than 0.1% cholesterol. This is a novel method to remove at least a portion of the lipids, such as phospholipids, from the krill. Removal of lipids from krill has previously required solvent extraction using liquids such as ethanol or other polar solvents. Solvent extraction is time-consuming and may also result in loss of material and is therefore not wanted. The krill used to separate out the coagulum had been stored frozen for 10 months prior to the experimentation. It is believed that due to the release of proteolytic enzyme activity during a

freezing/thawing process, more protein can be expected to be solubilized based on the processing of frozen krill than from fresh krill.

In some embodiments, the present invention provides systems and processes for processing a marine biomass. In preferred embodiments, the marine biomass is krill, preferably the Antarctic krill *Euphausia superba*. Other krill species may also be processed using the systems and processes of the present invention. In some embodiments, the krill is processed in a fresh state as defined herein. In some embodiments, the krill is processed on board a ship as described below within 12, 10, 8, 6, 4, or preferably 2 hours of catching the krill. In some embodiments, the krill is processed on board a ship within 1 or preferably 0.5 hours of catching the krill. In some embodiments, the ship tows a trawl that is configured to catch krill. The krill is then transferred from the trawl to the ship and processed. In some embodiments, the trawl comprises a pump system to pump the freshly caught krill from the trawl to the ship so that the krill can be processed in a fresh state. In preferred embodiments, the pump system comprises a tube that extends below the water the trawl and a pumping action is provided by injecting air into the tube below the waterline so that the krill is continuously drawn or pumped from the trawl, through the tube and on board the ship. Preferred trawling systems with pumps are described in PCT Applications WO 07/108702 and WO 05/004593, incorporated herein by reference.

Some embodiments of the systems and processes of the present invention are shown in Figure 1. As shown in Figure 1, fresh or frozen is krill is mixed in mixer with a sufficient amount of hot water from water heater to increase the temperature of the krill mass to approximately 40 to 75°C, preferably 50 to 75 °C, more preferably 60 to 75 °C, and most preferably about 60 to 70 °C. Many different types of water heaters are useful in the present invention. In some embodiments, the water heater is a steam heated kettle, while in other embodiments, the water heater is a scraped surface heat exchanger. The heated mass is then separated into liquid (krill milk) and krill solid fractions in a filter. In some embodiments, the separation is performed by sieving through a metal sieve. After separation, the krill milk is heated to approximately 90°C to 100°C, preferably to about 95°C to 100°C in a heater. Any type of suitable water or liquid heater may be used. In preferred embodiments, the heater is a scraped surface heat exchanger. This heating step produced a solid fraction (the coagulum described above) and a liquid fraction. In some preferred embodiments, the separator utilizes a filter as previously described. The present invention is not limited to the use of any particular type of filter. In some embodiments, the filter is a woven filter. In some embodiments, the filter comprises polymeric fibers. The coagulum is introduced into a

dewaterer. In some embodiments, the dewaterer is a press such as screw press. Pressing produces a liquid fraction and a press cake. The press cake is dried in a drier to produce coagulum meal.

5 The solid krill fraction is introduced into a dewaterer for dewatering. In some embodiments, the dewaterer is a press such as screw press. Pressing produces a press cake and a liquid fraction. The press cake is dried in a drier, such as an air drier or steam drier, to provide krill meal. The liquid fraction is centrifuged to produce a neutral krill oil containing high levels of astaxanthin and stickwater. In preferred embodiments, the stick water is added back into the krill press cake to make a full meal, including the various components of the
10 stick water such as soluble proteins, amino acids, etc.

In alternative embodiments, the krill milk can be treated by microfiltration instead of by heating to form a coagulum. The krill milk is introduced into a microfilter. Microfiltration produces a fraction called a retentate and a liquid permeate. The retentate is concentrated by evaporation under vacuum to stability, water activity <0.5 Aw. Membrane filtration of
15 cooking liquid is preferably performed at about 70 °C with a filter having a pore size of about 10 nm to about 1000nm, more preferably about 50 to about 500 nm, and most preferably about 100 nm. An exemplary filter is the P19-40 100 nm ZrO₂ membrane. In some embodiments, the liquid fraction is prefiltered prior to microfiltration. In preferred embodiments, the prefilter is a roto-fluid sieve (air opening 100 μm).

20 In yet another embodiment of the invention is a novel and more efficient method of preparing krill meal. By removing the coagulum, the krill meal process is less susceptible to clogging problems and the use of hot steam in the cooker can be avoided. The data disclosed show the coagulum contains a high percentage of phospholipids, hence the separation of the fat in the new krill meal process can be obtained using mechanical methods as in standard fish
25 meal processes. In fact, the separation of fat from the meal is important. Ideally, the krill meal should have a low fat value in order to have satisfactory technical properties. Mechanically separating the fat from the meal will result in a neutral oil rich in astaxanthin. If the neutral oil rich in astaxanthin stays in the meal, the astaxanthin may be degraded during the drying.

In some embodiments, the present invention provides a krill coagulate and retentate
30 compositions. The compositions are characterized in containing a combination of protein and lipids, especially phospholipids. In preferred embodiments, the compositions are solids or powders and are provided as a meal. In some embodiments, the compositions comprise from about 20% to about 50% protein w/w, preferably about 30% to 40% protein w/w, and about 40% to 70% lipids w/w, preferably about 50% to 65% lipids w/w, so that the total amount of

proteins and lipids in the compositions of from 90 to 100%. In some embodiments, the lipid fraction contains from about 10 g to 30 g omega-3 fatty acid residues per 100 g of lipid, preferably about 15 g to 25 g omega-3 fatty acids residues per 100 g lipids (i.e., from 10 to 30% or preferably from 15 to 25% omega-3 residues expressed w/w as a percentage of total lipids in the composition). In some embodiments, the lipid fraction of the composition comprises from about 25 to 50 g polar lipids per 100 g lipids (25 to 50% w/w expressed as percentage of total lipids), preferably about 30 to 45 g polar lipids per 100 g total lipids (30 to 45% w/w expressed as percentage of total lipids), and about 50 to 70 g nonpolar lipids per 100 g lipids (50 to 70% w/w expressed as percentage of total lipids), so that the total amount of polar and nonpolar lipids is 90 to 100% of the lipid fraction. In some embodiments, the phospholipids comprise greater than about 60% phosphatidylcholine on a w/w basis. In some embodiments, the phospholipids comprise less than about 10% ethanolamine on a w/w basis. In some embodiments, the compositions comprise from about 20% to about 50% triacylglycerol on a w/w basis. In some embodiments, the compositions comprise less than about 1% cholesterol. In some embodiments, the protein fraction comprises from about 8% to about 14% leucine on a w/w basis and from about 5% to 11% isoleucine on a w/w basis. In some embodiments, the compositions comprise less than about 200, 10, 5 or 1 mg/kg naturally occurring or endogenous astaxanthin. In some embodiments, the compositions comprise from about 0.01 to about 200 mg/kg naturally-occurring astaxanthin. It will be recognized that the astaxanthin content of the composition can be increased by adding in astaxanthin from other (exogenous) sources, both natural and non-natural. Likewise, the compositions can be supplemented with exogenous proteins, triglycerides, phospholipids and fatty acids such as omega-3 fatty acids to produce a desired composition.

In yet another embodiment of the invention is a pre-heated krill composition. Non-limiting examples of the pre-heated krill composition is a krill composition comprising lipids with less than 10% or 5% phospholipids, and in particular phosphatidylcholine.

In yet another embodiment of the invention is a novel krill meal product produced from the solid phase left after the first heating step (i.e., the heating step at below 80 C). The krill meal has good nutritional and technical qualities such as a high protein content, low fat content and has a high flow number. Unexpectedly, the ratios of polar lipids to neutral lipids and EPA to DHA is substantially enhanced as compared to normal krill meal. In some embodiments, the krill meals comprise from about 60% to about 80% protein on a w/w basis, preferably from about 70% to 80% protein on a w/w basis, from about 5% to about 20% fat on a w/w basis, and from about 1 to about 200 mg/kg astaxanthin, preferably from about 50 to

about 200 mg/kg astaxanthin. In some embodiments, the fat comprises from about 20 to 40% total neutral lipids and from about 50 to 70% total polar lipids on a w/w basis (total lipids). In some embodiments, the ratio of polar to neutral lipids in the meal is from about 1.5:1 to 3:1, preferably about 1.8:1 to 2.5:1, and most preferably from about 1.8:1 to 2.2:1. In some
5 embodiments, the fat comprises from about 20% to 40% omega-3 fatty acids, preferably about 20% to 30% omega-3 fatty acids. In some embodiments, the ratio of EPA:DHA is from about 1.8:1 to 1:0.9, preferably from about 1.4:1 to 1:1.

In still other embodiments, the present invention provides oil produced by the processes described above. In some embodiments, the oils comprise greater than about 1800
10 mg/kg total esterified astaxanthin, wherein said esterified astaxanthin comprises from about 25 to 35% astaxanthin monoester on a w/w basis and from about 50 to 70% astaxanthin diester on a w/w basis, and less than about 40 mg/kg free astaxanthin.

The compositions of the present invention are highly palatable humans and other animals. In particular the oil and meal compositions of the present invention are characterized
15 as containing low levels of undesirable volatile compounds or being substantially free of many volatile compounds that are commonly found in products derived from marine biomass. In some embodiments, the meals and oils of the present invention are characterized as being substantially free of one or more of the following volatile compounds: acetone, acetic acid, methyl vinyl ketone, 1-penten-3-one, n-heptane, 2-ethyl furan, ethyl propionate, 2-methyl-2-
20 pentenal, pyridine, acetamide, toluene, N,N-dimethyl formamide, ethyl butyrate, butyl acetate, 3-methyl-1,4-heptadiene, isovaleric acid, methyl pyrazine, ethyl isovalerate, N,N-dimethyl acetamide, 2-heptanone, 2-ethyl pyridine, butyrolactone, 2,5-dimethyl pyrazine, ethyl pyrazine, N,N-dimethyl propanamide, benzaldehyde, 2-octanone, β -myrcene, dimethyl trisulfide, trimethyl pyrazine, 1-methyl-2-pyrrolidone. In other embodiments, the meals and
25 oils of the present invention are characterized in containing less than 1000, 100, 10, 1 or 0.1 ppm (alternatively less than 10 mg/100g, preferably less than 1 mg/100 g and most preferably less than 0.1 mg/100 g) of one or more of the following volatile compounds: acetone, acetic acid, methyl vinyl ketone, 1-penten-3-one, n-heptane, 2-ethyl furan, ethyl propionate, 2-
30 methyl-2-pentenal, pyridine, acetamide, toluene, N,N-dimethyl formamide, ethyl butyrate, butyl acetate, 3-methyl-1,4-heptadiene, isovaleric acid, methyl pyrazine, ethyl isovalerate, N,N-dimethyl acetamide, 2-heptanone, 2-ethyl pyridine, butyrolactone, 2,5-dimethyl pyrazine, ethyl pyrazine, N,N-dimethyl propanamide, benzaldehyde, 2-octanone, β -myrcene, dimethyl trisulfide, trimethyl pyrazine, 1-methyl-2-pyrrolidone. In further embodiments, the compositions of the present invention are characterized in comprising less than 10 mg/100g,

and preferably less than 1mg/100 g (dry weight) of trimethylamine (TMA), trimethylamine oxide (TMAO) and/or lysophosphatidylcholine.

In some embodiments, the compositions of this invention (such as those described in the preceding sections) are contained in acceptable excipients and/or carriers for oral consumption. In some embodiments, the present invention provides a pharmaceutical composition one or more of the foregoing compositions in combination with a pharmaceutically acceptable carrier. The actual form of the carrier, and thus, the composition itself, is not critical. The carrier may be a liquid, gel, gelcap, capsule, powder, solid tablet (coated caplet or non-coated), tea, or the like. The composition is preferably in the form of a tablet or capsule and most preferably in the form of a soft gel capsule. Suitable excipient and/or carriers include maltodextrin, calcium carbonate, dicalcium phosphate, tricalcium phosphate, microcrystalline cellulose, dextrose, rice flour, magnesium stearate, stearic acid, croscarmellose sodium, sodium starch glycolate, crospovidone, sucrose, vegetable gums, lactose, methylcellulose, povidone, carboxymethylcellulose, corn starch, and the like (including mixtures thereof). Preferred carriers include calcium carbonate, magnesium stearate, maltodextrin, and mixtures thereof. The various ingredients and the excipient and/or carrier are mixed and formed into the desired form using conventional techniques. The tablet or capsule of the present invention may be coated with an enteric coating that dissolves at a pH of about 6.0 to 7.0. A suitable enteric coating that dissolves in the small intestine but not in the stomach is cellulose acetate phthalate. Further details on techniques for formulation for and administration may be found in the latest edition of Remington's Pharmaceutical Sciences (Maack Publishing Co., Easton, PA).

The dietary supplement may comprise one or more inert ingredients, especially if it is desirable to limit the number of calories added to the diet by the dietary supplement. For example, the dietary supplement of the present invention may also contain optional ingredients including, for example, herbs, vitamins, minerals, enhancers, colorants, sweeteners, flavorants, inert ingredients, and the like. For example, the dietary supplement of the present invention may contain one or more of the following: ascorbates (ascorbic acid, mineral ascorbate salts, rose hips, acerola, and the like), dehydroepiandrosterone (DHEA), Fo-Ti or Ho Shu Wu (herb common to traditional Asian treatments), Cat's Claw (ancient herbal ingredient), green tea (polyphenols), inositol, kelp, dulse, bioflavonoids, maltodextrin, nettles, niacin, niacinamide, rosemary, selenium, silica (silicon dioxide, silica gel, horsetail, shavegrass, and the like), spirulina, zinc, and the like. Such optional ingredients may be either naturally occurring or concentrated forms.

In some embodiments, the dietary supplements further comprise vitamins and minerals including, but not limited to, calcium phosphate or acetate, tribasic; potassium phosphate, dibasic; magnesium sulfate or oxide; salt (sodium chloride); potassium chloride or acetate; ascorbic acid; ferric orthophosphate; niacinamide; zinc sulfate or oxide; calcium pantothenate; copper gluconate; riboflavin; beta-carotene; pyridoxine hydrochloride; thiamin mononitrate; folic acid; biotin; chromium chloride or picolonate; potassium iodide; sodium selenate; sodium molybdate; phyloquinone; vitamin D3; cyanocobalamin; sodium selenite; copper sulfate; vitamin A; vitamin C; inositol; potassium iodide. Suitable dosages for vitamins and minerals may be obtained, for example, by consulting the U.S. RDA guidelines.

In further embodiments, the compositions comprise at least one food flavoring such as acetaldehyde (ethanal), acetoin (acetyl methylcarbinol), anethole (parapropenyl anisole), benzaldehyde (benzoic aldehyde), N butyric acid (butanoic acid), d or l carvone (carvol), cinnamaldehyde (cinnamic aldehyde), citral (2,6 dimethyloctadien 2,6 al 8, gera nial, neral), decanal (N decylaldehyde, capraldehyde, capric aldehyde, caprinaldehyde, aldehyde C 10), ethyl acetate, ethyl butyrate, 3 methyl 3 phenyl glycidic acid ethyl ester (ethyl methyl phenyl glycidate, strawberry aldehyde, C 16 aldehyde), ethyl vanillin, geraniol (3,7 dimethyl 2,6 and 3,6 octadien 1 ol), geranyl acetate (geraniol acetate), limonene (d , l , and dl), linalool (linalol, 3,7 dimethyl 1,6 octadien 3 ol), linalyl acetate (bergamol), methyl anthranilate (methyl 2 aminobenzoate), piperonal (3,4 methylenedioxy benzaldehyde, heliotropin), vanillin, alfalfa (Medicago sativa L.), allspice (Pimenta officinalis), ambrette seed (Hibiscus abelmoschus), angelic (Angelica archangelica), Angostura (Galipea officinalis), anise (Pimpinella anisum), star anise (Illicium verum), balm (Melissa officinalis), basil (Ocimum basilicum), bay (Laurus nobilis), calendula (Calendula officinalis), (Anthemis nobilis), capsicum (Capsicum frutescens), caraway (Carum carvi), cardamom (Elettaria cardamomum), cassia, (Cinnamomum cassia), cayenne pepper (Capsicum frutescens), Celery seed (Apium graveolens), chervil (Anthriscus cerefolium), chives (Allium schoenoprasum), coriander (Coriandrum sativum), cumin (Cuminum cyminum), elder flowers (Sambucus canadensis), fennel (Foeniculum vulgare), fenugreek (Trigonella foenum graecum), ginger (Zingiber officinale), horehound (Marrubium vulgare), horseradish (Armoracia lapathifolia), hyssop (Hyssopus officinalis), lavender (Lavandula officinalis), mace (Myristica fragrans), marjoram (Majorana hortensis), mustard (Brassica nigra, Brassica juncea, Brassica hirta), nutmeg (Myristica fragrans), paprika (Capsicum annum), black pepper (Piper nigrum), peppermint (Mentha piperita), poppy seed (Papayer somniferum), rosemary (Rosmarinus officinalis), saffron (Crocus sativus), sage (Salvia officinalis), savory (Satureia hortensis, Satureia

montana), sesame (*Sesamum indicum*), spearmint (*Mentha spicata*), tarragon (*Artemisia dracunculus*), thyme (*Thymus vulgaris*, *Thymus serpyllum*), turmeric (*Curcuma longa*), vanilla (*Vanilla planifolia*), zedoary (*Curcuma zedoaria*), sucrose, glucose, saccharin, sorbitol, mannitol, aspartame. Other suitable flavoring are disclosed in such references as Remington's
5 Pharmaceutical Sciences, 18th Edition, Mack Publishing, p. 1288-1300 (1990), and Furia and Pellanca, Fenaroli's Handbook of Flavor Ingredients, The Chemical Rubber Company, Cleveland, Ohio, (1971), known to those skilled in the art.

In other embodiments, the compositions comprise at least one synthetic or natural food coloring (e.g., annatto extract, astaxanthin, beet powder, ultramarine blue, canthaxanthin,
10 caramel, carotenal, beta carotene, carmine, toasted cottonseed flour, ferrous gluconate, ferrous lactate, grape color extract, grape skin extract, iron oxide, fruit juice, vegetable juice, dried algae meal, tagetes meal, carrot oil, corn endosperm oil, paprika, paprika oleoresin, riboflavin, saffron, tumeric, tumeric and oleoresin).

In still further embodiments, the compositions comprise at least one phytonutrient
15 (e.g., soy isoflavonoids, oligomeric proanthcyanidins, indol 3 carbinol, sulforaphane, fibrous ligands, plant phytosterols, ferulic acid, anthocyanocides, triterpenes, omega 3/6 fatty acids, conjugated fatty acids such as conjugated linoleic acid and conjugated linolenic acid, polyacetylene, quinones, terpenes, catechins, gallates, and quercitin). Sources of plant phytonutrients include, but are not limited to, soy lecithin, soy isoflavones, brown rice germ,
20 royal jelly, bee propolis, acerola berry juice powder, Japanese green tea, grape seed extract, grape skin extract, carrot juice, bilberry, flaxseed meal, bee pollen, ginkgo biloba, primrose (evening primrose oil), red clover, burdock root, dandelion, parsley, rose hips, milk thistle, ginger, Siberian ginseng, rosemary, curcumin, garlic, lycopene, grapefruit seed extract, spinach, and broccoli.

In still other embodiments, the compositions comprise at least one vitamin (e.g.,
25 vitamin A, thiamin (B1), riboflavin (B2), pyridoxine (B6), cyanocobalamin (B12), biotin, ascorbic acid (vitamin C), retinoic acid (vitamin D), vitamin E, folic acid and other folates, vitamin K, niacin, and pantothenic acid). In some embodiments, the particles comprise at least one mineral (e.g., sodium, potassium, magnesium, calcium, phosphorus, chlorine, iron,
30 zinc, manganese, flourine, copper, molybdenum, chromium, selenium, and iodine). In some particularly preferred embodiments, a dosage of a plurality of particles includes vitamins or minerals in the range of the recommended daily allowance (RDA) as specified by the United States Department of Agriculture. In still other embodiments, the particles comprise an amino

acid supplement formula in which at least one amino acid is included (e.g., l-carnitine or tryptophan).

In further embodiments, the present invention provide animal feeds comprising one or more the compositions described in detail above. The animal feeds preferably form a ration for the desired animal and is balanced to meet the animals nutritional needs. The compositions may be used in the formulation of feed or as feed for animals such as fish, including fish fry, poultry, cattle, pigs, sheep, shrimp and the like.

EXAMPLE 1

Four portions of krill were analysed for dry matter, fat, and protein. Most of the variation in the composition can be expected to be due to variation in the sampling. To include the effect of variation in storage time after thawing, raw material samples were also taken at different times during the working day. The observed variation in raw material input is inherent in all calculations of fat, dry matter and protein distributions based on the reported examples.

Table 1. Composition of krill (g/100 g)

	Dry matter	Fat	Fat free dry matter	Protein
Krill 1	21,40	7,80	13,60	11,80
Krill 2	22,13	7,47	14,66	12,96
Krill 3	23,78	7,44	16,34	14,60
Krill 4	23,07	7,55	15,52	13,83
Mean	22,60	7,57	15,03	13,30
SD	1,04	0,16	1,17	1,20
RSD	4,6 %	2,2 %	7,8 %	9,0 %

EXAMPLE 2

In this example a novel method for preparing krill meal was investigated. 800 g of preheated water (95-100 °C) and 200g of frozen krill (0 °C) were mixed in a cooker (cooker 1) at a temperature of 75 °C for 6 minutes. Next, the heated krill and the hot water were

separated by filtration. The preheated krill was further cooked (cooker 2) by mixing with 300 g hot water (95 °C) in a kitchen pan and kept at 90 °C for 2 minutes before separation over a sieve (1,0 × 1,5 mm opening). The heated krill was separated from the liquid and transferred to a food mixer and cut for 10 seconds. The disintegrated hot krill was added back to the hot water and centrifuged at 8600 × g (RCF average) for 10 minutes. The supernatant corresponding to a decanter liquid (DI) was decanted off. The liquid from cooking step 1 was heated to 95-100 °C to coagulate the extracted protein. The coagulum was separated over a sieve (1.0 × 1.5 mm opening) and a weight of 40 g was found. Figure 1 shows an overview of the process of making krill meal with a two stage cooking process.

10

EXAMPLE 3

The total volatile nitrogen (TVN), trimethylamine (TMA) and trimethylamine oxide (TMAO) content were determined in the four products from the cooking test in example 2 (Table 2). The krill was fresh when frozen, so no TMA was detected in the products. The results show that TMAO is evenly distributed in the water phase during cooking of krill.

15

Table 2. Distribution of total volatile nitrogen (TVN), trimethylamine (TMA) and trimethylamine oxide (TMAO) in the products from the cooking procedure.

Products from test no.	10	Krill	Coagulum from cooker	Coagulate d cooker liquid	Decante r solids	Decante r liquid	SUM
Weight (wb)	g	200	97,6	711,1	90,3	294,7	
Dry matter	g/100 g	21,4	14,2	1,0	22,2	0,9	
Analytical values							
Total volatile nitrogen	mg N/100 g	8	1,3	1,2	2,3	1	
Trimethylamine-N	mg N/100 g	<1	<1	<1	<1	<1	
Trimethylamine oxid-N	mg N/100 g	107	19,2	13,5	10,4	13,1	
Quantities							
Total volatile nitrogen	mg N	15,0	1,3	8,5	2,1	2,9	14,8
Trimethylamine-N	mg N	-	-	-	-	-	-

Trimethylamine oxid-N	mg N	214	18,7	96,0	9,4	38,6	163
Distribution							
Total volatile nitrogen	% of input	100 %	8 %	57 %	14 %	20 %	99 %
Trimethylamine-N	% of input						
Trimethylamine oxid-N	% of input	100 %	9 %	45 %	4 %	18 %	76 %

In addition, fat, dry matter and astaxanthin were determined in the products (Table 3). It was observed that the major part of the astaxanthin in the krill was found in the press cake (Table 3). Only a minor part is found in the coagulum which contains more than 60 % of the lipid in the krill raw material. The cooking procedure with leaching of a protein-lipid emulsion increases the concentration of astaxanthin in the remaining fat. The results also show that the water free coagulum contains approximately 40% dry matter and 60% fat. The dry matter consist of mostly protein.

Table 3. Distribution of astaxanthin in the products from the cooking procedure.

Products from test no.	10	Krill	Coagulum from cooker	Coagulate d cooker liquid	Decante r solids	Decante r liquid	SUM
Weight (wb)	g	200	97,6	711,1	90,3	294,7	
Fat	g/100 g	7,8	10,3	0,1	5,3	0,2	
Fat free dry matter	g/100 g	13,6	3,9	0,9	16,9	0,8	
Analytical values							
Fri Astaxanthin	mg/kg	3	<1	<1	4,5	<1	
Astaxanthin esters	mg/kg	33	1,2	<0,02	59	0,18	
Conc. in lipid							
Fri Astaxanthin	mg/kg lipid	38	-	-	85	-	
Astaxanthin esters	mg/kg lipid	423	12	-	1111	113	
Quantities							
Free Astaxanthin	mg	0,6	-	-	0,4	-	0,4
Astaxanthin esters	mg	6,6	0,1	-	5,3	0,1	6,2
Distribution							
Free Astaxanthin	% of	100 %	-	-	68 %	-	68 %

	input						
	% of						
Astaxanthin esters	input	100 %	2 %	-	81 %	1 %	83 %

The coagulum from the cooking experiment in Example 2 were analysed for lipid classes. The coagulum lipid was dominated by triacylglycerol and phosphatidyl choline with a small quantity of phosphatidyl ethanolamine (Table 4).

5 Table 4. Distribution of lipid classes in the coagulum from cooking experiments.

Experiment		Krill	Coagulum F5	Coagulum F6
Fat (Bligh & Dyer)	g/100 g sample	7,8	11,8	9,9
Triacylglycerol	g/100 g fat	47	40	50
Diacylglycerol	g/100 g fat	<0,5	1	0,7
Monocylglycerol	g/100 g fat	<1	<1	<1
Free fatty acids	g/100 g fat	12	0,2	0,4
Cholesterol	g/100 g fat	0,3	<0,3	<0,3
Cholesterol esters	g/100 g fat	0,8	<0,3	<0,3
Phosphatidyl ethanolamine	g/100 g fat	5,3	2,3	2,2
Phosphatidyl inositol	g/100 g fat	<1	<1	<1
Phosphatidyl serine	g/100 g fat	<1	<1	<1
Phosphatidyl choline	g/100 g fat	33	43,1	42,3
Lyso-Phosphatidyl choline	g/100 g fat	2,4	<1	<1
Total polar lipids	g/100 g fat	41,3	45,5	44,5
Total neutral lipids	g/100 g fat	61,0	41,3	51,2
Sum lipids	g/100 g fat	102,3	86,8	95,7

The proportion of phosphatidyl choline increased from 33 % in krill to 42 – 46 % in the coagulum. The other phospholipids quantified, phosphatidyl ethanolamine and lyso-phosphatidyl choline, had lower concentrations in the coagulum than in krill. The free fatty acids were almost absent in the coagulum.

10

The cooking time in test F5 was 6.75 min, in test F6 it was 4.00 min. The results in Table 4 show no dependence of the distribution of the lipid classes with the cooking time.

The amino acid composition of the coagulum is not much different the amino acid composition in krill. There seems to be a slight increase in the apolar amino acids in the coagulum compared to krill (Table 5). For a protein to have good emulsion properties it is the distribution of amino acids within the protein that is of importance more than the amino acid composition.

Table 5. Amino acids in coagulum from cooking Example 2.

		Coagulum F 10-2 mar/apr 2007	Coagulum 70-100°C 24.06.2006	Krill 24.06.2006
Aspartic acid	g/100 g protein	8,8	10,8	7,8
Glutamic acid	g/100 g protein	10,1	11,6	10,7
Hydroxiprolin	g/100 g protein	<0,10	<0,10	<0,10
Serine	g/100 g protein	4,3	4,6	3,0
Glycine	g/100 g protein	3,7	3,4	4,1
Histidine	g/100 g protein	1,7	1,6	1,6
Arginine	g/100 g protein	4,4	4,4	5,7
Threonine	g/100 g protein	5,2	5,6	3,4
Alanine	g/100 g protein	4,7	4,6	4,7
Proline	g/100 g protein	4,2	4,3	3,9
Tyrosine	g/100 g protein	4,3	4,7	2,7
Valine	g/100 g protein	6,4	6,6	4,2
Methionine	g/100 g protein	2,1	2,1	2,4
Isoleucine	g/100 g protein	8,0	8,5	4,5
Leucine	g/100 g protein	10,8	11,6	6,7

Phenylalanine	g/100 g protein	4,3	4,3	3,6
Lysine	g/100 g protein	7,5	8,2	6,2
Cysteine/Cystine	g/100 g protein	0,75		
Tryptophan	g/100 g protein	0,63		
Sum amino acids		91,9	96,9	75,2
Polar amino acids		47 %	48 %	51 %
Apolar amino acids		53 %	52 %	49 %

The fatty acid profile of the coagulum is presented in Table 6. The content of EPA (20:5) is about 12.4 g/100 g extracted fat and the content of DHA (22:6) is about 5.0 g/100 g extracted fat.

5 Table 6. Fatty acid content of coagulum

Fatty acid	Unit	Amount
14:0	g/100 extracted fat	11,5
16:0	g/100 extracted fat	19,4
18:0	g/100 extracted fat	1,1
20:0	g/100 extracted fat	<0,1
22:0	g/100 extracted fat	<0,1
16:1 n-7	g/100 extracted fat	7,0
18:1 (n-9) + (n-7) + (n-5)	g/100 extracted fat	18,4
20:1 (n-9) + (n-7)	g/100 extracted fat	1,3
22:1 (n-11) + (n-9) + (n-7)	g/100 extracted fat	0,8
24:1 n-9	g/100 extracted fat	0,1
16:2 n-4	g/100 extracted fat	0,6
16:3 n-4	g/100 extracted fat	0,2
16:4 n-4	g/100 extracted fat	<0,1
18:2 n-6	g/100 extracted fat	1,2
18:3 n-6	g/100 extracted fat	0,1
20:2 n-6	g/100 extracted fat	<0,1
20:3 n-6	g/100 extracted fat	<0,1
20:4 n-6	g/100 extracted fat	0,2
22:4 n-6	g/100 extracted fat	<0,1
18:3 n-3	g/100 extracted fat	0,8
18:4 n-3	g/100 extracted fat	2,5
20:3 n-3	g/100 extracted fat	<0,1
20:4 n-3	g/100 extracted fat	0,4
20:5 n-3	g/100 extracted fat	12,4
21:5 n-3	g/100 extracted fat	0,4

22:5 n-3	g/100 extracted fat	0,3
22:6 n-3	g/100 extracted fat	5,0

EXAMPLE 4

5 To evaluate the two stage cooking process described above, a laboratory scale test was performed. The tests are described below.

Materials and methods

10 **Raw material.** Frozen krill were obtained by Aker Biomarine and 10 tons were stored at Norway Pelagic, Bergen, and retrieved as required. The krill was packed in plastic bags in cardboard boxes with 2×12.5 kg krill. The boxes with krill were placed in a single layer on the floor of the process plant the day before processing. By the time of processing the krill varied from + 3 °C to -3 °C.

Analytical methods.

15 **Protein, Kjeldahl's method:** Nitrogen in the sample is transformed to ammonium by dissolution in concentrated sulfuric acid with copper as catalyst. The ammonia is liberated in a basic distillation and determined by titration, (ISO 5983:1997(E), Method A 01). Uncertainty: 1 %.

20 **Protein, Combustion:** Liberation of nitrogen by burning the sample at high temperature in pure oxygen. Detection by thermal conductivity. Percent protein in the sample is calculated by a multiplication of analysed percent nitrogen and a given protein factor, (AOAC Official Method 990.03, 16th ed. 1996, Method A 25).

Moisture: Determination of the loss in mass on drying at 103 °C during four hours (ISO 6496 (1999). Method A 04). Uncertainty: 4 %.

25 **Ash:** Combustion of organic matter at 550 °C. The residue remaining after combustion is defined as the ash content of the sample. (ISO 5984:2002. Method A 02). Uncertainty: 3 %.

Fat, Ethyl acetate extraction: Absorption of moisture in wet sample by sodium sulphate, followed by extraction of fat by ethyl acetate (NS 9402, 1994 (modified calculation). Method A 29).

30 **Fat, Soxhlet:** Extraction of fat by petroleum ether. Mainly the content of triglycerides is determined, (AOCS Official Method Ba 3-38 Reapproved 1993. Method A 03).

Fat, Bligh and Dyer: Extraction of fat by a mixture of chloroform, methanol, and water in the proportion 1:2:0.8 which build a single phase system. Addition of chloroform and water gives a chloroform phase with the lipids and a water/methanol phase. The lipids are determined in an aliquot of the chloroform phase after evaporation and weighing. The extraction includes both triglycerides and phospholipids. (E.G. Bligh & W.J. Dyer: A rapid method of total lipid extraction and purification. *Can.J.Biochem.Physiol.* Vol 37 (1959). Methode A 56).

Astaxanthin: Extraction with ethanol and di-chloromethane. Polar products are removed by open column chromatography on silica gel. Isomers are separated on normal phase HPLC on Si 60 column and detection at 470 nm. (Schierle J. & Härdi W. 1994. Determination of stabilized astaxanthin in Carophyll® Pink, premixes and fish feeds. Edition 3. Revised Supplement to: Hoffman P, Keller HE, Schierle J., Schuep W. Analytical methods for vitamins and carotenoids in feed. Basel: Department of Vitamin Research and Development, Roche. Method A 23)

Moisture in oil: Determination of actual water content of fats and oils by titration with Karl Fischer reagent, which reacts quantitatively with water, (AOCS Official Method CA 2e-84. Reapproved 1993. Method A 13).

Dry matter in stick water during processing is correlated to refract meter which gives ° Brix. Amino acids were determined as urea derivatives by reversed phase HPLC with fluorescence detection. (Cohen S. A. and Michaud D. P., Synthesis of a Fluorescent Derivatizing Reagent, 6-Aminoquinolyl-N-Hydroxysuccinimidyl Carbamate, and Its Application for the Analysis of Hydrolysate Amino Acids via High-Performance Liquid Chromatography. *Analytical Biochemistry* **211**, 279-287, 1993. Method A42). TVB-N, TMA-N and TMAO-N were determined in a 6% trichloro-acetic acid extract by micro diffusion and titration. (Conway, E. I., and A. Byrne. An absorption apparatus for the micro determination of certain volatile substances. *Biochem. J.* 27:419-429, 1933, and Larsen, T, SSF rapport nr. A-152, 1991). Fatty acids were determined by esterifying the fatty acids to methyl esters, separate the esters by GLC, and quantify by use of C23:0 fatty acid methyl ester as internal standard.(AOCS Official Method Ce 1b-89, Method A 68). Lipids were separated by HPLC and detected with a Charged Aerosol Detector. Vitamins A, D and E were analysed at AnalyCen, Kambo.

Results and discussion

Raw material of krill. Table 7 gives the results of analysis of the raw material of the krill that was used in the pilot trials. Besides the first trial, the same shipment of krill was used for all trials. The dry matter was about 21-22 %, fat 6 %, protein 13-14 %, salt 1 % pH, total volatile nitrogen (TVN) 18 mgN/100g, trimethylamine (TMA) 4 mg N/100g and trimethylamineoxide (TMAO) 135 mg N/100g. Compared to fish pH, TMAO and salt (Cl⁻) is high for krill.

Table 7. Analysis of raw krill on wet base (wb)

Sample:	Raw material of krill									
Analysis:	Dry matter	Fat, B&D	Protein	Ash	Salt	pH	TVN	TMA	TMAO	
Date:	g/100 g	g/100 g	g/100 g	g/100 g	g/100 g		mg N/100 g	mg N/100 g	mg N/100 g	Marks
07.08.2007	22,8	7,1	13,5	2,5						Saga Sea 04.07.06 Lot. L1
18.09.2007	21,3	6,0								
04.10.2007	21,6	6,3	13,5							Krillråstoff CO5S
04.10.2007	20,5	5,9	12,8							Krillråstoff AO6S
25.10.2007	22,1	6,0	13,9	2,9	1,1	7,4	20,8	5,8	128,3	Krillråstoff CO5S
25.10.2007	21,3	6,0	13,2	2,7	1,1	7,4	15,0	2,3	140,6	Krillråstoff AO6S
22.11.2007	21,9	5,9				7,8	17,9	3,5	123,7	
Average	21,6	6,2	13,5	2,7	1,1	7,4	17,9	4,0	134,5	

Table 8 gives the analysis of raw krill on dry base. If these figures are multiplied with 0.93 it will give the figures on meal base with 7 % water.

Table 8 Analysis of raw krill on dry base (db)

Sample:	Raw material of krill								
Analysis:	Dry matter	Fat, B&D	Protein	Ash	Salt	TVN	TMA	TMAO	
Date:	g/100 g	g/100 g	g/100 g	g/100 g	g/100 g	mg N/100 g	mg N/100 g	mg N/100 g	
07.08.2007	100	31,1	59,2	11,0					
18.09.2007	100	28,2		0,0					
04.10.2007	100	29,2	62,5	0,0					
04.10.2007	100	28,8	62,4	0,0					
25.10.2007	100	27,1	62,9	13,1	5,0	94,1	26,1	580,5	
25.10.2007	100	28,2	62,0	12,7	5,2	70,6	10,9	660,2	
22.11.2007	100	26,9				81,7	16,0	564,8	
Average	100	28,5	62,5	12,3	5,1	82,4	18,5	620,4	

Separation of coagulum and pressing for krill oil. 99 kg krill was processed by adding batches of 20 kg krill to 80 l of water at 95 °C in a steam heated kettle (200 l). The steam on the kettle was closed, and the krill and water were gently mixed manually for 3 minutes, and the mixed temperature became 75 °C (heating step no. 1). The heated krill was separated from the water by sieving. Sieved preheated krill (75°C) was added 20 kg hot water and heated to 85 °C within a minute, (heating step 2). The krill was sieved again and feed into the press. The liquid from step1 (krill milk) was coagulated at 95 °C. All the krill was cooked and the press liquid was separated for oil. From 99 kg krill about 0.5 kg of unpolished krill oil

was separated from the press liquid. Tables 9 and 10 provide an analysis of cooked krill after first cooking step on wet base and dry base.

Table 9 Analysis of cooked krill on wet base (wb)

Sample:	Cooked krill							
Analysis:	Dry matter	Fat, B&D	Protein	Ash	pH	TVN	TMA	TMAO
Date:	g/100 g	g/100 g	g/100 g	g/100 g		mg N/100 g	mg N/100 g	mg N/100 g
07.08.2007	20,2	4,7	13,5	2,2				
18.09.2007	19,8	4,6						
25.10.2007	15,2	3,2	10,3	2,0	8,2	10,5	3,5	75,4

Table 10 Analysis of cooked krill on dry base (db)

Sample:	Cooked krill						
Analysis:	Dry matter	Fat, B&D	Protein	Ash	TVN	TMA	TMAO
Date:	g/100 g	g/100 g	g/100 g	g/100 g	mg N/100 g	mg N/100 g	mg N/100 g
07.08.2007	100,0	23,3	66,8	10,9			
18.09.2007	100	23,2					
25.10.2007	100	21,1	67,8	13,2	69,3	23,1	496,3

Compared to raw krill (Table 8) there is a reduction in dry matter for cooked krill. The fat content in dry matter is reduced because of the fat in the krill milk which is separated from the cooked krill. The content of protein is increased on dry base, but the ash seems to be at the same level. TMAO in the krill is reduced and is found in the cooking liquid.

Micro filtration. The krill milk (70 °C) from step 1 was coagulated at > 95 °C and separated from the liquid through microfiltration (Soby Miljøfilter). Coagulum was then pressed in a press and dried. Tables 11 and 12 gives analyses of coagulum on wet base and dry base. The dry matter of the coagulum was between 12.8 and 16.7 %. On dry base the fat content about 60 % and TMAO 340 mg N/100 g. The dry matter of the coagulum increased to 34-38 % by pressing. The fat content also increased on dry base (Table 13), but the TMAO was reduced to 145 mg N/100 g. After washing the press cake with 1 part water to 1 part press cake of coagulum and then press again, the TMAO was reduced to 45 mg N/100g on dry base (Table 18).

Table 11 Analysis of coagulum on wet base (wb)

Sample:	Coagulum						
Analysis:	Dry matter	Fat, B&D	Protein	Ash	TVN	TMA	TMAO
Date:	g/100 g	g/100 g	g/100 g	g/100 g	mg N/100 g	mg N/100 g	mg N/100 g
10.10.2007	12,8	7,9					
25.10.2007	14,3	8,3	5,4	1,0	5,9	2,3	48,6
31.10.2007	16,7	9,3	6,2				
Average	14,6	8,5	5,8				

Table 12 Analysis of coagulum on dry base (db)

Sample:	Coagulum						
Analysis:	Dry matter	Fat, B&D	Protein	Ash	TVN	TMA	TMAO
Date:	g/100 g	g/100 g	g/100 g	g/100 g	mg N/100 g	mg N/100 g	mg N/100 g
10.10.2007	100	61,7					
25.10.2007	100	58,0	37,8	7,0	41,0	16,4	340,1
31.10.2007	100	55,7	37,1				
Average	100	58,5	37,4				

5

Table 13 Analysis of press cake from coagulum on wet base

Sample:	Press cake of coagulum						Raw krill	Coagulum	Coagulum PK
Analysis:	Dry matter	Fat, B&D	TVN	TMA	TMAO	worked up	perss cake	per kg raw krill	
Date:	g/100 g	g/100 g	mg N/100 g	mg N/100 g	mg N/100 g	kg	kg	kg/kg	
22.11.2007	38,8	23,6	7,9	4,5	56,1	1000	54,2	0,0542	
11.12.2007	33,8	22,5	3,4	0	45,3	500	21,92	0,0438	
11.12.2007*	33,6	21,3	0	0	15,3	500	15	0,0300	

*) After 1 wash (Press cake : water = 1:1)

10 **Membrane filtration.** Another way to collect the lipids from the krill milk is to separate by membrane filtration. For this to be possible the milk must not coagulate, but be brought to the membrane filter from the sieve (heating step no. 1).

15 Before the krill milk could enter the membrane filter the milk is pre-filtrated, which was done by the sieve (100 µm). The opening of the micro-filter was 100 nm. 80 kg krill was processed by starting by 80 kg water (95 °C) and 20 kg krill into the kettle as described. For
20 for the first 2 batches of krill clean water was used (160 kg), but for the last 2 batches permeate from the membrane filter was used instead of water. The membrane filtration was followed with a refract meter calibrated for sugar solution (°Brix). The Brix-value is near the dry matter concentration in the process liquids. The flux value for the filter at about 60 °C was
350 l/m²/h for retentate with 7.8 °Brix (refract meter) and reduced to 290 l/m²/h when the Brix value increased to 9.9 °. The Brix value for the permeate was only 1 ° due to high

dilution when the amount to be filtered is small. See Figures 2 and 3. The permeate was golden and transparent.

All permeate was evaporated in a kettle to > 65 ° Brix. Retentate, 2 liter, was evaporated in a laboratory evaporator at 70 °C and 12 mm Hg. At 27.5 °Brix the retentate was still flowing well. As the concentration continued the retentate became more and more viscous, first as a paste and finely to a dry mass. The concentrated retentate (27 °Brix), permeate (> 65 °Brix) and dry retentate were analyzed and the results are given in Table 14 on sample base (% wb) and Table 15 on dry matter base (% db) (sample no 1, 2 and 3). A sample of coagulum was dried as for the retentate (sample no 4).

Table 14 Analysis of concentrate from retentate, permeate and coagulum on wet base (wb)

	Dry matter	Fat (polar+apolar) Bligh & Dyer	Crude Protein	Ash	TVN	TMA	TMAO	Water activity 25 °C
Sample	% wb	% wb	% wb	% wb	mg N/100g wb	mg N/100g wb	mg N/100g wb	aw
No. 1 Concentrate of retentat	26,0	16,3	9,5	1,6	5,7	<1	99	0,978
No. 2 Consentrate of permeat	72,7	1,0	51,1	24,7	138	110	1 157	0,385
No. 3 Vakuum dried retentate	64,9	39,3	24	4,1	12,8	29,4	196	0,875
No. 4 Vakuum died coagulum	60,3	37,1	20,9	4,4	52,9	28,1	216	0,912

Table 15 Analysis of concentrate from retentate, permeate and coagulum on dry matter base (db)

	Dry matter	Fat (polar+apolar) Bligh & Dyer	Crude Protein	Ash	TVN	TMA	TMAO
Sample	% db	% db	% db	% db	mg N/100g db	mg N/100g db	mg N/100g db
No. 1 Concentrate of retentat	100,0	62,7	36,5	6,2	21,9	<1	382
No. 2 Consentrate of permeat	100,0	1,4	70,3	34,0	190	152	1 592
No. 3 Vakuum dried retentate	100,0	60,6	37,0	6,3	19,7	45,3	302
No. 4 Vakuum died coagulum	100,0	61,5	34,7	7,3	87,7	46,6	358

These results indicate that micro filtration of krill milk was promising and is an alternative to coagulate the krill milk. The protein portion was high in taurine. The content of fat, protein, ash and TMAO were almost similar between retentate and coagulum. Permeate can be concentrated to 70 % dry matter and will have a water activity below 0.4 at 25 °C which means that it can be stored at ambient temperature.

Press cake and press liquid. Tables 16 and 17 provide an analysis of press cake on wet and dry base from the different trials. The average amount of press cake per kg raw krill was found to be 0.23 kg. The dry matter of the press cake was between 44 and 48 %. The fat content in dry matter was reduced from 21 % before to 15-20 % after pressing. This will give a press cake meal from 14 to 18.5 % fat, about 67 % protein and 7 % moisture. TMAO was

reduced from about 500 mg N/100g dry matter in cooked krill to 95mg N/100g dry matter in the press cake.

Table 16 Analysis on wet base (wb) of press cake and calculations

Sample:	Press cake						Raw krill	Press cake	Kg press cake
Analysis:	Dry matter	Fat, B&D	Protein	TVN	TMA	TMAO	worked up		per kg raw krill
Date:	g/100 g	g/100 g	g/100 g	mg N/100 g	mg N/100 g	mg N/100 g	kg	kg	kg/kg
18.09.2007	48,1	8,0					327	90	0,28
04.10.2007	47,9	7,0	34,8						
10.10.2007	44,8	9,3					250	55	0,22
31.10.2007	47,4	7,2	33,8				709	143	0,20
22.11.2007	44,4	8,1		8,4	2,1	42,2	1000	226	0,23
11.12.2007	43,8	7,3		5,6	2,2	46,7	500	117	0,23
Average:	46,1	7,8	34,3	7	2,2	44,5			0,23

5

Table 17 Analysis on dry base (db) of press cake

Press cake					
Dry matter	Fat, B&D	Protein	TVN	TMA	TMAO
g/100 g	g/100 g	g/100 g	mg N/100 g	mg N/100 g	mg N/100 g
100	16,6				
100	14,6	72,7			
100	20,8				
100	15,2	71,3			
100	18,2		18,9	4,7	95,0
100	16,7		12,8	5,0	106,6
100	17,0	72,0	15,9	4,9	100,8

Oil was produced from the krill solids by centrifugation. Table 18. The oil was almost free for water and the content of astaxanthin was quite high (1.8 g/kg).

10

Table 18 Analysis of krill oil

		Date:	Date:
Tricanter oil (krill oil)		31.10.2007	22.11.2007
Astaxanthin, Free	mg/kg	22	29
Trans	mg/kg	12	14
9-cis	mg/kg	2,3	3,2
13-cis	mg/kg	5,4	7,8
Astaxanthin, Esters	mg/kg	1802	1785
Diester	mg/kg	1142	1116
Monoester	mg/kg	660	669
Astaxanthin - total	mg/kg	1824	1814
Water, Karl F.	g/100 g	0,17	0,04
FFA	g/100 g		0,9
Vitamin A	IE/kg		602730
Vitamin D3	IE/kg		<1000
Vitamin E (alfa-tokoferol)	mg/kg		630

Table 19 Analysis of press cake from coagulum on dry base

Sample:	Press cake of coagulum				
Analysis:	Dry matter	Fat, B&D	TVN	TMA	TMAO
Date:	g/100 g	g/100 g	mg N/100 g	mg N/100 g	mg N/100 g
22.11.2007	100	60,8	20,4	11,6	144,6
11.12.2007	100	66,6	10,1	0,0	134,0
11.12.2007*	100	63,4	0,0	0,0	45,5

*) After 1 wash (Press cake : water = 1:1)

The yield of coagulum press cake was about 5 % of raw krill. The compositions of coagulum and retentate from micro filtration is compared in Table 20. There was hardly any difference between the products from the two process alternatives. Press cake of coagulum was dried, and Table 21 gives the analysis of the coagulum and final coagulum meal. The proximate composition based on dry matter did not change during drying, and the amino acid composition and fatty acid composition is near identical. There was some loss of phospholipids during drying. This is most probable caused by oxidation of fatty acids, but other chemical modification of the phospholipids may also be of consequence.

Table 20 Analysis of Retentate from micro filtration and Coagulum

		Retentat 25.10.07	Coagulum 25.10.07
Protein	g/100 g	5,8	5,4
Dry matter	g/100 g	13,5	14,3
Ash	g/100 g	1,1	1,0
Fat (B&D)	g/100 g	7,3	8,3
pH		8,5	
TFN	mg N/100 g	5,9	5,9
TMA	mg N/100 g	2,3	2,3
TMAO	mg N/100 g	61,0	48,6
Lipid classes:			
Triacylglycerol	g/100 g extracted fat	59,0	51
Diacylglycerol	g/100 g extracted fat	1,3	1
Monocylglycerol	g/100 g extracted fat	<1	<1
Free fatty acids	g/100 g extracted fat	3,8	3,2
Cholesterol	g/100 g extracted fat	<0,5	<0,5
Cholesterol esters	g/100 g extracted fat	1,0	0,8
Phosphatidyl ethanolamine	g/100 g extracted fat	1,8	3
Phosphatidyl inositol	g/100 g extracted fat	<1	<1
Phosphatidyl serine	g/100 g extracted fat	<1	<1
Phosphatidyl choline	g/100 g extracted fat	35,0	40
Lyso-Phosphatidyl choline	g/100 g extracted fat	0,8	1,2
Total polar lipids	g/100 g extracted fat	37,6	44,2
Total neutral lipids	g/100 g extracted fat	67,1	56,0
Sum lipids	g/100 g extracted fat	103,4	100,2
Fatty acid composition:			
14:0	g/100 g extracted fat	10,6	10,4
16:0	g/100 g extracted fat	16,4	16,2
18:0	g/100 g extracted fat	1,1	1,2
20:0	g/100 g extracted fat	0,1	0,1
22:0	g/100 g extracted fat	<0,1	<0,1
16:1 n-7	g/100 g extracted fat	6,3	6,4
18:1 (n-9)+(n-7)+(n-5)	g/100 g extracted fat	15,5	15,4
20:1 (n-9)+(n-7)	g/100 g extracted fat	1,1	1,1
22:1 (n-11)+(n-9)+(n-7)	g/100 g extracted fat	0,6	0,5
24:1 n-9	g/100 g extracted fat	0,1	0,1
16:2 n-4	g/100 g extracted fat	0,5	0,5
16:3 n-4	g/100 g extracted fat	0,2	0,2
18:2 n-6	g/100 g extracted fat	1,4	1,4
18:3 n-6	g/100 g extracted fat	0,2	0,2
20:2 n-6	g/100 g extracted fat	0,1	0,1
20:3 n-6	g/100 g extracted fat	0,1	0,1
20:4 n-6	g/100 g extracted fat	0,3	0,3
22:4 n-6	g/100 g extracted fat	<0,1	<0,1
18:3 n-3	g/100 g extracted fat	0,7	0,7
18:4 n-3	g/100 g extracted fat	1,7	1,7
20:3 n-3	g/100 g extracted fat	<0,1	<0,1
20:4 n-3	g/100 g extracted fat	0,3	0,3
20:5 n-3 (EPA)	g/100 g extracted fat	10,5	10,3
21:5 n-3	g/100 g extracted fat	0,3	0,3
22:5 n-3	g/100 g extracted fat	0,5	0,4
22:6 n-3 (DHA)	g/100 g extracted fat	5,1	5,0
Sum saturated fat acides	g/100 g extracted fat	28,2	27,9
Sum monoene fat acides	g/100 g extracted fat	23,6	23,4
Sum PUFA (n-6) fat acides	g/100 g extracted fat	2,1	2
Sum PUFA (n-3) feat acides	g/100 g extracted fat	19,1	18,7
Sum PUFA fat acides total	g/100 g extracted fat	21,9	21,4
Sum fat acides total	g/100 g extracted fat	73,7	72,7
EPA/DHA		2,1	2,1

Table 21 Analysis of Coagulum press cake and meal dried in a Rotadisc dryer on wet and dry base

		Coagulum press cake 22.11.2007	Coagulum meal 22.11.2007	Coagulum press cake 22.11.2007	Coagulum meal 22.11.2007
Analysis:		wb	wb	db	db
Protein	g/100 g	14,6	35,3	37,6	37,4
Moisture	g/100 g	61,2	5,7	0,0	0,0
Fat B&D	g/100 g	23,6	55,1	60,8	58,4
Ash	g/100 g		5,9		6,3
TMA	mg N/100 g	4,5	7	11,6	7
TMAO	mg N/100 g	56,1	140	144,6	148
Fatty acid composition:					
14:0	g/100 g extracted fat	10,4	10,4		
16:0	g/100 g extracted fat	17	17		
18:0	g/100 g extracted fat	1,2	1,2		
20:0	g/100 g extracted fat	0,1	0,1		
22:0	g/100 g extracted fat	0,1	0,1		
16:1 n-7	g/100 g extracted fat	6,4	6,4		
18:1 (n-9)+(n-7)+(n-5)	g/100 g extracted fat	15,2	15,3		
20:1 (n-9)+(n-7)	g/100 g extracted fat	1,1	1,1		
22:1 (n-11)+(n-9)+(n-7)	g/100 g extracted fat	0,5	0,6		
24:1 n-9	g/100 g extracted fat	0,1	0,1		
16:2 n-4	g/100 g extracted fat	0,5	0,5		
16:3 n-4	g/100 g extracted fat	0,2	0,2		
18:2 n-6	g/100 g extracted fat	1,5	1,4		
18:3 n-6	g/100 g extracted fat	0,2	0,2		
20:2 n-6	g/100 g extracted fat	0,1	0,1		
20:3 n-6	g/100 g extracted fat	<0,1	<0,1		
20:4 n-6	g/100 g extracted fat	0,3	0,3		
22:4 n-6	g/100 g extracted fat	<0,1	<0,1		
18:3 n-3	g/100 g extracted fat	0,7	0,7		
18:4 n-3	g/100 g extracted fat	1,7	1,7		
20:3 n-3	g/100 g extracted fat	<0,1	<0,1		
20:4 n-3	g/100 g extracted fat	0,4	0,4		
20:5 n-3 (EPA)	g/100 g extracted fat	10,9	10,5		
21:5 n-3	g/100 g extracted fat	0,3	0,3		
22:5 n-3	g/100 g extracted fat	0,3	0,3		
22:6 n-3 (DHA)	g/100 g extracted fat	5,3	5,1		
Sum saturated fat acides	g/100 g extracted fat	28,7	28,7		
Sum monoene fat acides	g/100 g extracted fat	23,3	23,3		
Sum PUFA (n-6) fat acides	g/100 g extracted fat	2	2		
Sum PUFA (n-3) feat acides	g/100 g extracted fat	19,7	19		
Sum PUFA fat acides total	g/100 g extracted fat	22,4	21,7		
Sum fat acides total	g/100 g extracted fat	74,4	73,8		
Amino acids:					
Aspartic acid	g/100 g protein	10,5	10,5		
Glutamic acid	g/100 g protein	11,2	11,6		
Hydroxiproline	g/100 g protein	<0,10	<0,10		
Serine	g/100 g protein	4,3	4,2		
Glycine	g/100 g protein	4	4		
Histidine	g/100 g protein	2	1,9		
Arginine	g/100 g protein	4,8	4,7		
Threonine	g/100 g protein	4,9	4,9		
Alanine	g/100 g protein	4,8	4,9		
Proline	g/100 g protein	4,2	4,1		
Tyrosine	g/100 g protein	3,7	3,5		
Valine	g/100 g protein	6	5,9		
Methionine	g/100 g protein	2,4	2,4		
Isoleucine	g/100 g protein	6,9	6,7		
Leucine	g/100 g protein	9,6	9,4		
Phenylalanine	g/100 g protein	4,5	4,4		
Lysine	g/100 g protein	7,7	7,6		
Sum AA	g/100 g protein	91,5	90,7		
Lipid classes:					
Triacylglycerol	g/100 g extracted fat	48	63		
Diacylglycerol	g/100 g extracted fat	1,2	1,3		
Monocylglycerol	g/100 g extracted fat	<1	<1		
Free fatty acids	g/100 g extracted fat	3,2	3,1		
Cholesterol	g/100 g extracted fat	1,2	<0,5		
Cholesterol esters	g/100 g extracted fat	0,5	0,9		
Phosphatidyl ethanolamine	g/100 g extracted fat	3,1	1,1		
Phosphatidyl inositol	g/100 g extracted fat	<1	<1		
Phosphatidyl serine	g/100 g extracted fat	<1	<1		
Phosphatidyl choline	g/100 g extracted fat	38	34		
Lyso-Phosphatidyl choline	g/100 g extracted fat	1,2	<1		
Total polar lipids	g/100 g extracted fat	42	34,8		
Total neutral lipids	g/100 g extracted fat	54,6	67,9		
Sum lipids	g/100 g extracted fat	96,7	103,6		

Krill meal. Final krill meal was produced. Press cake and press cake with stick water concentrate were dried in a hot air dryer or steam drier. Table 22.

Table 22 Analysis of krill meal from

		Forberg Air dried Press cake meal of krill	Forberg Air dried Krill meal with stickwater	Rota disc. Steam dried Krill meal with stickwater
Date: 22.11.2007				
Wet base:				
Protein	g/100 g	66,4	63,6	66,3
Moisture	g/100 g	5,9	7,1	3,7
Fat Soxhlet	g/100 g	8,7	10,4	
Fat B&D	g/100 g	15,9	15,6	15,2
Ash	g/100 g	9,8	13,0	13,4
Salt	g/100 g	1,3	4,3	4,4
Water sol. protein	g/100 g prot.	11,1	28,0	27,1
pH		8,6	8,3	
TVN	mg N/100 g	18,8	39,9	38,6
TMA	mg N/100 g	11,1	22,2	29,8
TMAO	mg N/100 g	109,7	442,1	399,5
Dry matter base:				
Protein	g/100 g db	70,6	68,5	
Fat Soxhlet	g/100 g db	9,2	11,2	
Fat B&D	g/100 g db	16,9	16,8	15,8
Ash	g/100 g db	10,4	14,0	
Salt	g/100 g db	1,4	4,6	
TVN	mg N/100 g db	20,0	42,9	40,1
TMA	mg N/100 g db	11,8	23,9	30,9
TMAO	mg N/100 g db	116,6	475,9	414,9
Astaxanthin on wet base:				
Astaxanthin, Free	mg/kg	4,6	3,6	<1
Trans	mg/kg	2,5	1,9	<1
9-cis	mg/kg	0,4	0,4	<1
13-cis	mg/kg	1,3	0,9	<1
Astaxanthin, Esters	mg/kg	112,0	100	58,0
Diester	mg/kg	80,0	72,0	50,0
Monoester	mg/kg	32,0	27,0	8,1
Astaxanthin - total	mg/kg	116,6	103,6	58,0
Astaxanthin on fat base:				
Astaxanthin, Fritt	mg/kg fat	28,9	23,1	<7
Trans	mg/kg fat	15,7	12,2	<7
9-cis	mg/kg fat	2,5	2,6	<7
13-cis	mg/kg fat	8,2	5,8	<7
Astaxanthin, Estere	mg/kg fat	704,4	641,0	381,6
Diester	mg/kg fat	503,1	461,5	328,9
Monoester	mg/kg fat	201,3	173,1	53,3
Astaxanthin - totalt	mg/kg fat	733,3	664,1	381,6
Amino acids:				
Aspartic acid	g/100 g protein	10,6	9,2	9,2
Glutamic acid	g/100 g protein	14,1	12,4	12,3
Hydroxiprolin	g/100 g protein	<0,5	<0,5	0,1
Serine	g/100 g protein	4,2	3,7	3,8
Glycine	g/100 g protein	4,4	4,4	4,5
Histidine	g/100 g protein	2,3	1,9	1,9
Arginine	g/100 g protein	6,6	6,0	6,1
Threonine	g/100 g protein	4,3	3,7	4,1
Alanine	g/100 g protein	5,4	4,9	5,3
Proline	g/100 g protein	3,7	4,1	4
Tyrosine	g/100 g protein	4,4	3,1	4,7
Valine	g/100 g protein	5,1	4,4	4,5
Methionine	g/100 g protein	3,2	2,7	2,7
Isoleucine	g/100 g protein	5,3	4,5	4,5
Leucine	g/100 g protein	8,0	6,9	6,9
Phenylalanine	g/100 g protein	4,6	3,9	4
Lysine	g/100 g protein	8,2	7,0	6,6
Sum AA	g/100 g protein	94,4	82,8	85,2
Lipide classes:				
Triacylglycerol	g/100 g extracted fat		41,0	63
Diacylglycerol	g/100 g extracted fat		1,7	1,3
Monocylglycerol	g/100 g extracted fat		<1	<1
Free fatty acids	g/100 g extracted fat		8,8	3,1
Cholesterol	g/100 g extracted fat		2,4	<0,5
Cholesterol esters	g/100 g extracted fat		<0,5	0,9
Phosphatidyl ethanolamine	g/100 g extracted fat		3,6	1,1
Phosphatidyl inositol	g/100 g extracted fat		<1	<1
Phosphatidyl serine	g/100 g extracted fat		<1	<1
Phosphatidyl choline	g/100 g extracted fat		43,0	34
Lyso-Phosphatidyl choline	g/100 g extracted fat		1,1	<1
Total polar lipids	g/100 g extracted fat		47,2	34,8
Total neutral lipids	g/100 g extracted fat		54,2	67,9
Sum lipids	g/100 g extracted fat		101,4	103,6

EXAMPLE 5

Coagulum meal produced as described in Example 4 was extracted using lab scale SFE. 4,885g of coagulum (freeze dried over night) via a two step extraction: 1) SFE: CO₂, 500 Bar, 60°C, 70min at a medium flow rate of 1,8ml/min of CO₂; 2) SFE: CO₂+15%EtOH, 500 Bar, 60°C, 70min at a medium flow rate of 2,5ml/min of CO₂+EtOH. The first step extracted 1,576g of extracted neutral fraction (NF). As shown in Figures 4 and 5, the analysis at HPLC show lower than the detectable limit content on PL in the NF. It was extracted about 32.25% of the total material. Table 29 provides the peak areas of the components of the neutral fraction as determined by GC.

Table 29.

Rel.Area %	Peakname	Ret.Time min	Area mV*min	Height mV	Rel.Area %
0,29	n.a.	17,455	0,2864	2,271	0,29
19,49	C14:0	24,073	19,0301	105,696	19,49
21,16	C16:0	32,992	20,6601	88,859	21,16
11,99	C16:1	36,197	11,7032	48,125	11,99
3,5	n.a.	37,28	3,4166	14,344	3,5
1,57	n.a.	43,331	1,5375	6,141	1,57
15,6	n.a.	46,425	15,2285	58,605	15,6
8,81	n.a.	46,873	8,5983	30,65	8,81
0,93	n.a.	50,499	0,9055	3,164	0,93
1,56	n.a.	51,292	1,5216	5,746	1,56
1,67	n.a.	57,312	1,6281	4,78	1,67
2,03	n.a.	60,985	1,98	6,963	2,03
0,02	n.a.	67,761	0,0189	0,116	0,02
0,11	n.a.	68,833	0,1066	0,423	0,11
0,11	n.a.	71,705	0,1028	0,497	0,11
0,08	n.a.	74,053	0,0806	0,398	0,08
3,92	C20:5 EPA	74,489	3,826	12,07	3,92
0,11	n.a.	80,519	0,1095	0,48	0,11
0,08	C22:5 DPA	85,369	0,0785	0,41	0,08
1,3	C22:6 DHA	87,787	1,2719	4,253	1,3

The second step extracted a polar fraction of 1,023g corresponding to 20,95% of the total material. The polar fraction consisted mostly of PL and just less than 1% TG. See Figures 6 and 7. Table 30 provides the peak areas of the components of the polar fraction as determined by GC.

5

Table 30.

Rel.Area %	Peakname	Ret.Time min	Area mV*min	Height mV	Rel.Area %
2,87	C14:0	24,025	4,8099	28,243	2,87
28,5	C16:0	33,084	47,7079	182,756	28,5
1,82	C16:1	36,155	3,0402	13,166	1,82
1,13	n.a.	43,304	1,8848	8,208	1,13
3,89	n.a.	46,336	6,5129	27,429	3,89
5,46	n.a.	46,852	9,1467	35,825	5,46
2,15	n.a.	51,265	3,6015	14,095	2,15
1,6	n.a.	57,121	2,6735	7,213	1,6
1,72	n.a.	60,944	2,8832	10,686	1,72
2,03	n.a.	68,259	3,3913	8,025	2,03
30,09	C20:5 EPA	74,599	50,3768	163,312	30,09
12,11	C22:6 DHA	87,832	20,2774	68,714	12,11

- 10 The coagulate was dried over night with a weight loss of about 5,53% w/w. The total extracted was about 53,2% of the starting weight of the dried material.

EXAMPLE 6

- 15 Freshly harvested krill were processed into coagulum on board the ship either 10 minutes or six hours post harvest. The coagulum produced from both the 10 minute post harvest krill and the 6 hour post harvest krill contained less than 1mg/100g volatile nitrogen, less than 1 mg/100 g trimethylamine (TMA), and less than 1g/100g lysophosphatidylcholine. This can be compared to the coagulum produced from frozen krill in Example 4 above, which contained higher levels of volatile nitrogen, and lysophosphatidylcholine. The methods of the invention which utilize freshly harvested krill provide krill products that are characterized in
20 being essentially free of TMA, volatile nitrogen, and lysophosphatidylcholine.

EXAMPLE 7

Coagulum meal, 250 g, and krill oil were mixed in a kitchen mixer. The aim was to add 300 – 500 mg astaxanthin/kg coagulum meal. If the oil contains 1500 mg astaxanthin/kg krill oil, at least 200 g oil should be added to one kg of coagulum meal. The flow of the meal was markedly reduced by addition of 10 % oil, and the oil came off on the packaging when the addition of oil was increased to 14 and 20 %. 3.5 kg coagulum from was thawed and milled on a Retsch ZM1 with a 2 mm sieve. The quantity of milled powder was 2.96 kg. The 2.96 kg dried coagulum was added 300 g krill oil in three portions. The knives in the mixer (Stephan UM12) were to far from the bottom to give a good mixing, so the mixture was mixed by hand and mixer intermittently. The astaxanthin content in the final mixture was 40 % lower than calculated. New analyses of astaxanthin were performed on the oil and on the fortified meal. The krill oil had been stored in a cold room at 3 °C for 4 months, and the astaxanthin content in the oil did not change during this storage . A new sample were drawn from the fortified meal after 4 weeks frozen storage, and the astaxanthin content was the same in both samples (Table 31).

Table 31. Composition of steam dried coagulum fortified with 10 % krill oil.

		Analysed Meal with oil	Calculated Meal with oil	New analysis Krill oil	New analysis Meal with oil
Dry matter	g/100 g	98.0	99.2		
Protein	g/100 g		33.6		
Fat (B&D)	g/100 g	58.9	60.7		
Ash	g/100 g		5.9		
Water soluble protein	g/100 g protein		15.8		
TFN	mg N/100 g		10		
TMA	mg N/100 g		10		
TMAO	mg N/100 g		113		
Astaxanthin, Free	mg/kg	2.5	4.9	27	2.8
Trans	mg/kg	1.4	2.5	14	1.5
9-cis	mg/kg	0.35	0.6	3.1	0.4
13-cis	mg/kg	0.57	1.2	6.2	0.7
Astaxanthin, Esters	mg/kg	193	338	1805	197
Diester	mg/kg	126	216	1128	127
Monoester	mg/kg	67	122	677	70
Astaxanthin - total	mg/kg	196	343	1832	200
Astaxanthin, Free	mg/kg lipid	4.2	8.1		
Trans	mg/kg lipid	2.4	4.2		
9-cis	mg/kg lipid	0.6	1.0		

13-cis	mg/kg lipid	1.0	2.0
Astaxanthin, Esters	mg/kg lipid	328	556
Diester	mg/kg lipid	214	356
Monoester	mg/kg lipid	114	200
Astaxanthin - total	mg/kg lipid	332	564
<hr/>			
Ffa	g/100 g extracted fat		4.4
<hr/>			
Total polar lipids	g/100 g extracted fat		39.7
Total neutral lipids	g/100 g extracted fat		60.1

The astaxanthin content in fortified coagulum meal is 58 % of the amount in the ingredients. This reduction in astaxanthin takes place during mixing of dried coagulum and krill oil, and indicate that dried coagulum is easily oxidized.

5 Example 8

The dried coagulum meal was extracted by supercritical fluid extraction. The extracted oil was analyzed as presented in Tables 32-34.

10 Table 32. Lipid composition

Phosphatidylcholine	34 g/100 g lipid
Phosphatidylethanolamine	1,3 g/100 g lipid
Triglycerides	48 g/100 g lipid
Cholesterol	n.d.
Free fatty acids	1,0 g/100 g lipid

Table 33. Fatty acid profile

Total saturated fatty acids	26,3 g/100 g lipid
Total omega-3 fatty acids	18,1 g/100 g lipid
Total fatty acids	67,3 g/100 g lipid

Table 34. Miscellaneous properties

Astaxanthin	130 mg/kg
TMAO	87 mg N/100 g

TMA	<1 mg N/100 g
Viscosity at 25°C	61 mPa s

Example 9

- 5 Coagulum meal prepared as described above was administered to two human subjects and absorption of the product was determined by measuring omega-3 fatty acids in total lipids and in phospholipids in plasma. Subject 1 consumed 8g of coagulum in combination with yoghurt, whereas subject 2 consumed 8g of krill oil without yoghurt. The data is presented in Tables 35 (Subject 1) and 36 (Subject 2).

10

Table 35

Time (h)	C20:5 W3 (EPA)	C22:5 W3 (DPA)	C22:6 W3(DHA)
0	0.117	0.062	0.267
0.5	0.118	0.063	0.270
1	0.113	0.061	0.260
1.5	0.117	0.064	0.272
2	0.116	0.063	0.271
2.5	0.119	0.063	0.271
3	0.123	0.065	0.281
3.5	0.122	0.063	0.275
4	0.123	0.063	0.275
5	0.141	0.065	0.294
6	0.153	0.064	0.286
7	0.154	0.062	0.277
8	0.165	0.063	0.292
10	0.167	0.063	0.291
12	0.163	0.061	0.275
16	0.169	0.062	0.301
24	0.173	0.074	0.323

Table 36

Time (h)	C20:5 W3 (EPA)	C22:5 W3 (DPA)	C22:6 W3(DHA)
0	0.146	0.052	0.260
0.5	0.142	0.052	0.260
1	0.146	0.054	0.268
1.5	0.142	0.053	0.263
2	0.145	0.054	0.267
2.5	0.140	0.053	0.258

3	0.143	0.054	0.264
3.5	0.155	0.056	0.278
4	0.155	0.055	0.277
5	0.179	0.057	0.295
6	0.217	0.057	0.316
7	0.204	0.057	0.304
8	0.211	0.060	0.320
10	0.187	0.057	0.293
12	0.171	0.054	0.272
16	0.166	0.052	0.272
24	0.169	0.061	0.290

These data show that absorption patterns of the coagulum and krill oil are different for the two subjects. The EPA pattern in subject 1 (coagulum) shows that a high EPA level is maintained over a long time despite the fact that coagulum contains less lipid than the krill oil. The coagulum has also enriched the circulating PL pool which could be an indication of absorption/incorporation of krill oil fatty acids in PL form. We have previously observed that krill oil is more efficient in enriching tissue lipid fatty acid profiles than fish oil. These data indicate that coagulum is even more bioeffective than krill oil.

10

Example 10.

The phospholipid content of the retentate was further analyzed by NMR. Table 37 provides the results.

15

Table 37.

Phospholipid	% (w/w)
Phosphatidylcholine	16,5
Alkylacylphosphatidylcholine	1,7
Lyso-alkylacylphosphatidylcholine	0,28
2-lysophosphatidylcholine	0,52
Phosphatidylethanolamine	0,59
N-acylphosphatidylethanolamine	3,6
Total phospholipid	23,23

Example 11

This example provides an analysis of the volatile compounds in oil extracted from krill meal and oil extracted from coagulum meal. Table 38. Briefly, oil was extracted by SFE from regular krill meal or meal prepared from coagulum as described above. The oil prepared from coagulum meal had substantially reduced amounts of volatile compounds as compared to the oil prepared from regular krill meal. In particular, 1-penten-3-one was detected in oil prepared from regular krill meal and was absent in oil prepared from coagulum meal. 1-pentene-3-one have previously been identified has a key marker of fishy and metallic off-flavor in fish oil and fish oil enriched food products (Jacobsen et al., J. Agric Food Chem, 2004, 52, 1635-1641).

Table 38.

Compound	TIC peak area (Krill oil extracted from krill meal using SFE)	Description	TIC peak area (Krill oil extracted from coagulum using SFE)	Description
dimethyl amine	180403283		22848535	
trimethyl amine	255213688	old fish, strong bad	49040416	old fish
Ethanol	394615326	fresh	1426886614	vodka, ethanol
Acetone	875959		0	
acetic acid	36136270	weak smell	0	
methyl vinyl ketone	515892		0	
2-butanone	2807131	sweet	23124362	
ethyl acetate	6231705		404501	
1- [dimethylamino]- 2-propanone	23316404		15380603	
1-penten-3-one	5627101	rubbery	0	weak dishcloth

n-heptane	291386		0	
2-ethyl furan	1640866	weak sweet	0	
ethyl propionate	909959		0	
2-methyl-2-pentenal	6996219		0	
Pyridine	2085743		0	
Acetamide	6169014	pleasant	0	
Toluene	4359806		0	
N,N-dimethyl formamide	177968590	garden hose, mint	0	garden hose
ethyl butyrate	1122805		0	
2-ethyl-5-methyl furan	1550476	good, flower	427805	
butyl acetate	306001		856292	
3-methyl-1,4-heptadiene	1617339		0	weak smell, rubber
Isovaleric acid	1528541	foot sweat, weak	0	
methyl pyrazine	1335979	peculiar	0	
ethyl isovalerate	1043918	fruity	0	fruity
N,N-dimethyl acetamide	9895351		0	smell, solvent
2-heptanone	7397187	blue cheese	0	
2-ethyl pyridine	317424		0	
Butyrolactone	652076	butter, pleasant	0	
2,5-dimethyl pyrazine	2414087		0	
ethyl pyrazine	1909284	metallic	0	soft
N,N-dimethyl propanamide	1160830	unpleasant	0	
Benzaldehyde	3134653		0	
2-octanone	2068169	disgusting	0	
β -myrcene	2618870		0	

dimethyl trisulfide	3279406	sewer	0	
n-decane	1851488		331629	
trimethyl pyrazine	4186679	unpleasant	0	
1-methyl-2-pyrrolidone	9577873		0	
Eucalyptol	0	peppermint	868411	
Asetofenoni	1146348	smell, pleasant	350688	

Example 12

Krill meal produced by the traditional process (Tables 39-42) was compared with krill meal produced from the solid fraction remaining after removal of krill milk (Tables 43-46).

5

Table 39

14:0	g/100g total fat	8,3	
16:0	g/100g total fat	15,4	
18:0	g/100g total fat	1,0	
20:0	g/100g total fat	<0,1	
22:0	g/100g total fat	<0,1	
16:1 n-7	g/100g total fat	4,7	
18:1 (n-9)+(n-7)+(n-5)	g/100g total fat	13,5	
20:1 (n-9)+(n-7)	g/100g total fat	0,9	
22:1 (n-11)+(n-9)+(n-7)	g/100g total fat	0,6	
24:1 n-9	g/100g total fat	0,1	
16:2 n-4	g/100g total fat	0,6	
16:3 n-4	g/100g total fat	0,3	
18:2 n-6	g/100g total fat	1,1	
18:3 n-6	g/100g total fat	0,1	
20:2 n-6	g/100g total fat	<0,1	
20:3 n-6	g/100g total fat	<0,1	
20:4 n-6	g/100g total fat	0,3	
22:4 n-6	g/100g total fat	<0,1	
18:3 n-3	g/100g total fat	0,8	
18:4 n-3	g/100g total fat	1,8	
20:3 n-3	g/100g total fat	<0,1	
20:4 n-3	g/100g total fat	0,4	
20:5 n-3	g/100g total fat	11,3	
21:5 n-3	g/100g total fat	0,4	
22:5 n-3	g/100g total fat	0,3	
22:6 n-3	g/100g total fat	6,5	

Table 40

* Fat Bligh & Dyer	%	22,8		
Sum saturated fatty acids	g/100g total fat	24,7		
Sum monounsaturated fatty acids	g/100g total fat	19,8		
Sum PUFA (n-6)	g/100g total fat	1,6		
Sum PUFA (n-3)	g/100g total fat	21,5		
Sum PUFA	g/100g total fat	24,0		
Sum fatty acids total	g/100g total fat	68,5		

5 Table 41

Triacylglycerol	g/100g total fat	46		
Diacylglycerol	g/100g total fat	1,0		
Monoacylglycerol	g/100g total fat	<1		
Free fatty acids	g/100g total fat	4,4		
Cholesterol	g/100g total fat	1,6		
Cholesterol ester	g/100g total fat	0,8		
Phosphatidylethanolamine	g/100g total fat	4,6		
Phosphatidylinositol	g/100g total fat	<1		
Phosphatidylserine	g/100g total fat	<1		
Phosphatidylcholine	g/100g total fat	37		
Lyso-Phosphatidylcholine	g/100g total fat	2,0		
Total polar lipids	g/100g total fat	36,2		
Totale neutral lipids	g/100g total fat	54,0		
Total sum lipids	g/100g total fat	96,2		

Table 42

Protein Kjeldahl (N*6,25)	%	60,9		
Total	%	92,7		
Salt (NaCl)	%	2,9		
Trimethylamine-N	Mg N/100 gram	4		
Trimethylaminoxide-N	Mg N/100 gram	149		
Free Astaxanthin	Mg/kg	<1		
Astaxanthin ester	Mg/kg	122		

10

Table 43

14:0	g/100g total fat	5,0		
16:0	g/100g total fat	13,9		
18:0	g/100g total fat	0,8		
20:0	g/100g total fat	<0,1		
22:0	g/100g total fat	<0,1		
16:1 n-7	g/100g total fat	3,0		
18:1 (n-9)+(n-7)+(n-5)	g/100g total fat	11,4		
20:1 (n-9)+(n-7)	g/100g total fat	0,5		
22:1 (n-11)+(n-9)+(n-7)	g/100g total fat	0,4		
24:1 n-9	g/100g total fat	0,1		
16:2 n-4	g/100g total fat	0,4		
16:3 n-4	g/100g total fat	0,2		
18:2 n-6	g/100g total fat	1,2		
18:3 n-6	g/100g total fat	0,1		
20:2 n-6	g/100g total fat	0,1		
20:3 n-6	g/100g total fat	0,1		
20:4 n-6	g/100g total fat	0,4		
22:4 n-6	g/100g total fat	<0,1		
18:3 n-3	g/100g total fat	0,7		
18:4 n-3	g/100g total fat	1,2		
20:3 n-3	g/100g total fat	0,1		
20:4 n-3	g/100g total fat	0,3		
20:5 n-3	g/100g total fat	13,1		
21:5 n-3	g/100g total fat	0,3		
22:5 n-3	g/100g total fat	0,3		
22:6 n-3	g/100g total fat	10,0		

Table 44

* Fat Bligh & Dyer	%	10,2		
Sum saturated fatty acids	g/100g total fat	19,7		
Sum monounsaturated fatty acids	g/100g total fat	15,3		
Sum PUFA (n-6)	g/100g total fat	1,8		
Sum PUFA (n-3)	g/100g total fat	26,1		
Sum PUFA	g/100g total fat	28,5		
Sum fatty acids	g/100g total fat	63,5		

Table 45

5

Triacylglycerol	g/100g total fat	25		
Diacylglycerol	g/100g total fat	0,7		
Monoacylglycerol	g/100g total fat	<1		
Free fatty acids	g/100g total fat	0,9		
Cholesterol	g/100g total fat	3,1		
Cholesterol ester	g/100g total fat	<0,5		
Phosphatidylethanolamine	g/100g total fat	12,8		
Phosphatidylinositol	g/100g total fat	<1		
Phosphatidylserine	g/100g total fat	<1		
Phosphatidylcholine	g/100g total fat	49		
Lyso-Phosphatidylcholine	g/100g total fat	1,3		
Total polar lipid	g/100g total fat	63,2		
Total neutral lipid	g/100g total fat	29,7		
Total sum lipid	g/100g total fat	92,9		

Table 46

Protein Kjeldahl (N*6,25)	%	73,9		
Total	%	90,2		
Salt (NaCl)	%	1,9		
Trimethylamine-N	Mg N/100 gram	7		
Trimethylaminoxide-N	Mg N/100 gram	224		
Free Astaxanthin	Mg/kg	2,8		
Astaxanthin ester	Mg/kg	89		

10

CLAIMS

- 5 1. A process for preparing phospholipid compositions from biological material comprising phospholipids and proteins comprising:
- mixing said biological material with water to increase the temperature of said biological material to about 25 to 80 °C to form a first solid phase and a first aqueous phase comprising said phospholipids and proteins;
- 10 separating said first solid phase from said first aqueous phase; and
- separating a protein and phospholipid fraction from said first aqueous phase.
2. The process of claim 1, wherein said biological material is krill.
3. The process of claims 2, wherein said krill is freshly harvested.
4. The process of claim 2, wherein said krill is frozen.
- 15 5. The process of claims 1 to 4, wherein said separating a protein and phospholipid fraction from said first aqueous phase comprises heating said first aqueous phase at a temperature sufficient to form a phospholipid-protein coagulate and separating said phospholipid-protein coagulate from said aqueous phase.
6. The process of claim 5, wherein said first aqueous phase is heated to greater than 80
- 20 °C to provide said phospholipid-protein coagulate.
7. The process of claim 5 or claim 6, further comprising the step of pressing said phospholipid-protein coagulate to form a coagulate liquid phase and a coagulate press cake.
8. The process of claims 5 to 7, further comprising the step of washing said phospholipid-protein coagulate.
- 25 9. The process of claim 7 or claim 8, further comprising drying said coagulate press cake to form a coagulate meal.

10. The process of claim 9, further comprising extracting a coagulate oil from said coagulate meal.
11. The process of any of claims 1 to 4, wherein said separating a protein and phospholipid fraction from said first aqueous phase comprises filtration of said aqueous phase
5 to provide a phospholipid-protein retentate comprising proteins and phospholipids.
12. The process of claim 11, wherein said filtration is via membrane filtration.
13. The process of claim 11 or claim 12, further comprising the step of dewatering said phospholipid-protein retentate to form a retentate liquid phase and a retentate concentrate.
14. The process of claim 13, further comprising extracting a retentate oil from said
10 retentate concentrate.
15. The process of claims 1 to 14, further comprising the step of supplementing the protein and phospholipid fraction with additional proteins, lipids, astaxanthin and combinations thereof.
16. An aqueous phase composition obtainable by the process of 1.
- 15 17. A coagulate meal obtainable by the process of claim 9.
18. A coagulate oil obtainable by the process of claim 10.
19. A retentate concentrate obtainable by the process of claim 13.
20. A retentate oil obtainable by the process of claim 14.
21. A krill composition comprising from about 0.01 to about 200 mg/kg astaxanthin, from
20 about 45% to about 65% fat w/w, and about 20% to 50% protein w/w, wherein said fat comprises omega-3 fatty acid residues.
22. The composition of Claim 21, wherein said fat has an omega-3 fatty acid content of from about 10% to about 30% on a w/w basis.

25

23. The composition of claim 21 or claim 22, wherein said fat comprises from about 20% to about 50% phospholipids w/w, wherein said phospholipids comprise greater than about 65% phosphatidylcholine w/w and from about 2% to 10% alkylacylphosphatidylcholine w/w.

5 24. The composition of claim 23, wherein said phospholipids comprise less than about 10% ethanolamine on a w/w basis.

25. The composition of Claims 21 to 24, wherein said fat comprises from about 40% to about 70% triacylglycerol w/w.

10

26. The composition of Claims 21 to 25, comprising less than about 1% cholesterol.

27. The composition of Claims 21 to 26, wherein said protein comprises from about 8% to about 14% leucine on a w/w basis and from about 5% to 11% isoleucine on a w/w basis.

15

28. A krill composition comprising from about 10% to about 20% protein w/w, about 15% to about 30% fat w/w, and from about 0.01mg/kg to about 200 mg/kg astaxanthin.

20 29. A krill meal comprising from about 65% to about 75% protein w/w (dry matter), from about 10% to about 25% fat w/w (dry matter), and from about 1 to about 200 mg/kg astaxanthin (wet base).

30. A krill meal as claimed in claim 29, wherein said meal is dried and supplemented with stickwater.

25

31. A krill meal as claimed in claim 30, wherein said meal is steam dried.

30 32. A krill oil composition comprising greater than about 1500 mg/kg total esterified astaxanthin, wherein said esterified astaxanthin comprises from about 25 to 35% astaxanthin monoester on a w/w basis and from about 50 to 70% astaxanthin diester on a w/w basis, and greater than about 20 mg/kg free astaxanthin.

33. A krill composition comprising from about 3% to about 10% protein w/w, about 8% to about 20% dry matter w/w, and about 4% to about 10% fat w/w.

34. A krill coagulum meal comprising,
50-75% fat w/w, 30-50% protein w/w, and 1 to 200 mg/kg astaxanthin, wherein said
fat comprises 15 to 30 g/100 g fat omega-3 fatty acid residues and 35 to 60g /100 g fat
5 phosphatidylcholine.
35. A system for processing of marine biomass comprising:
a mixer for mixing marine biomass and water to form a mixture having a defined
temperature, wherein said mixture has a first solid phase and a first liquid phase.
10
36. The system of claim 35, wherein said water is heated and said defined temperature of
said mixture is from about 50°C to about 70°C.
37. The system of claim 35 or 36, further comprising a separator in fluid communication
15 with said mixer for separating said first solid phase and said first liquid phase.
38. The system of claims 35 to 37, further comprising a first heater unit in fluid
communication with said first separator, wherein said first heater unit heats said first liquid
phase to a defined temperature.
20
39. The system of claim 38, wherein said defined temperature is about 95°C to about
100°C.
40. The system of claim 35, further comprising a microfilter in fluid communication with
25 said mixer, wherein said liquid phase is separated into a retentate phase and a permeate phase
by said microfilter.
41. A krill composition 50-75% fat w/w, 30-50% protein w/w, and 1 to 200 mg/kg
astaxanthin, wherein said fat comprises 15 to 30 g/100 g fat omega-3 fatty acid residues and
30 35 to 60g /100 g fat phosphatidylcholine, and less than about 1 mg/100g trimethyl amine,
volatile nitrogen, or 1g/100g lysophosphatidylcholine or combinations thereof.
42. A process for processing of marine biomass comprising:

providing a marine biomass and a mixer for mixing marine biomass and water to form a mixture having a defined temperature, wherein said mixture comprises a first solid phase and a first liquid phase.

- 5 43. The process of claim 42, wherein said defined temperature of said mixture is from about 70 to about 75°C.
44. The process of claim 43, further comprising the steps of separating said liquid phase from said solid phase, and heating said liquid phase to about 90 to about 100°C to produce a
10 coagulate comprising proteins and phospholipids.
45. A system for processing of marine biomass comprising:
a ship;
a trawl net towable from said ship, wherein said trawl net is configured to catch a
15 marine biomass;
a mixer for mixing said marine biomass and water to form a mixture having a defined temperature, wherein said mixture has a first solid phase and a first liquid phase.
46. The system of claim 45, comprising a
20 microfilter in fluid communication with said mixer, wherein said microfilter separates said first solid phase and said first liquid phase.
47. The system of claims 45 or 46, wherein ship said mixer is fed with fresh krill.
- 25 48. A pharmaceutical composition comprising a composition as described in claims 17 to 34 and a pharmaceutical carrier.
49. A dietary supplement comprising a composition as described in claims 17 to 34.
- 30 50. An animal feed comprising a composition as described in claims 17 to 34.
51. A food product comprising a composition as described in claims 17 to 34.

FIGURE 1

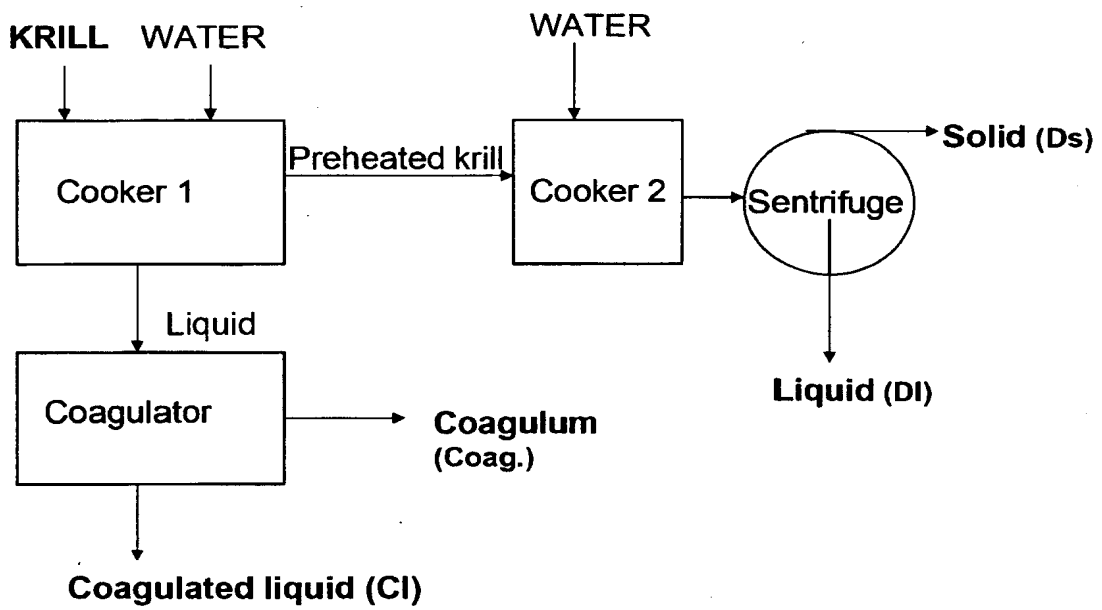

FIGURE 2

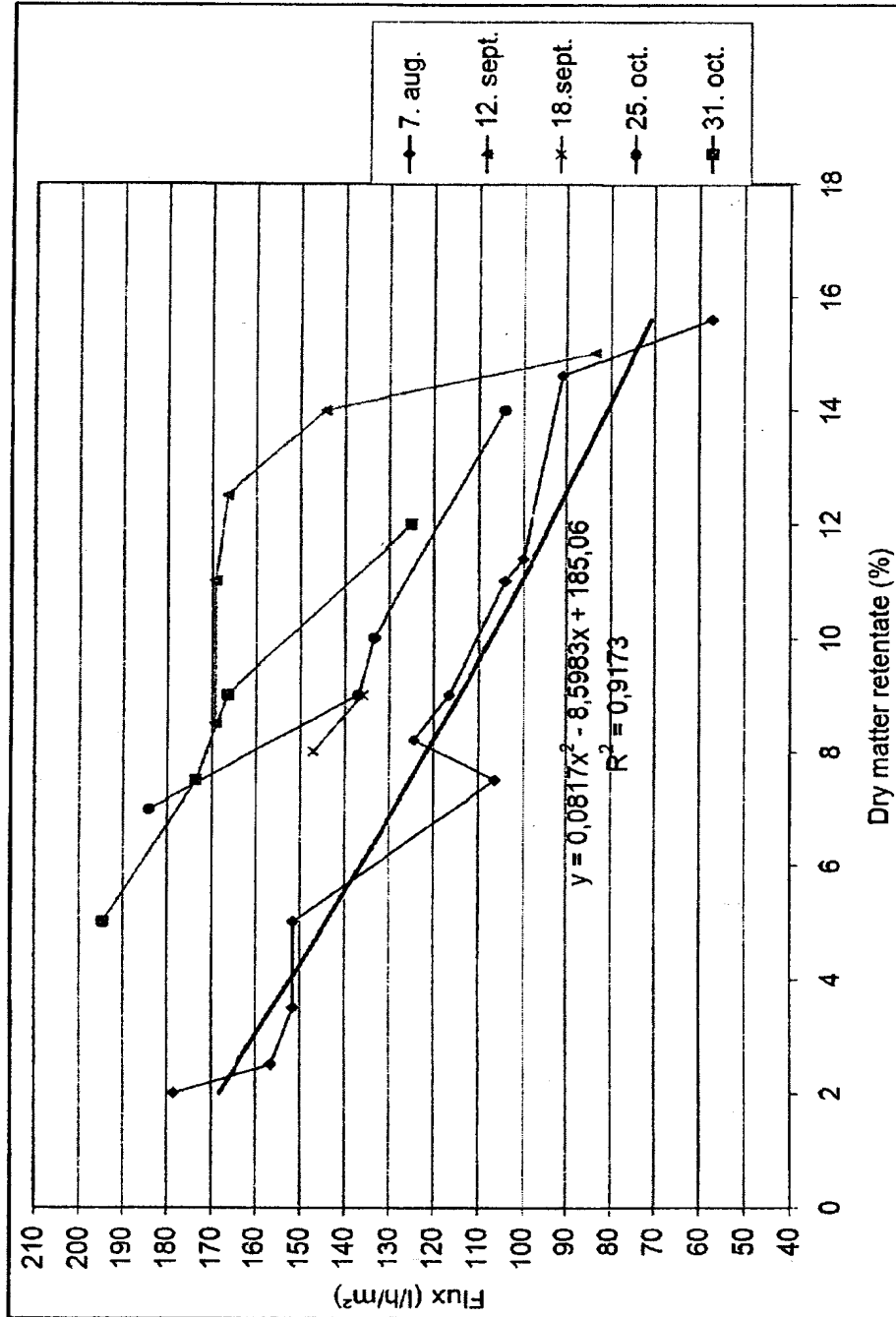

FIGURE 3

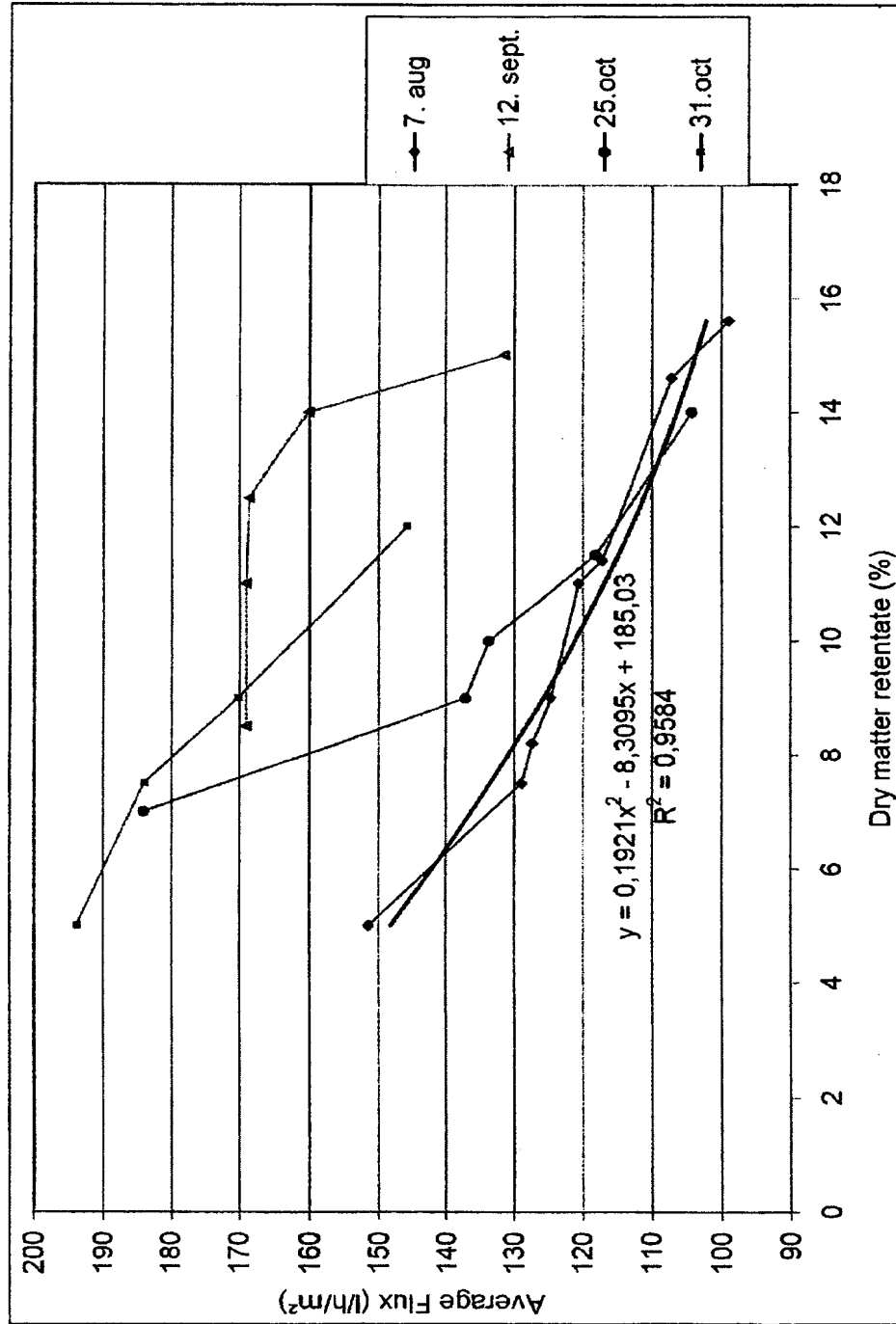
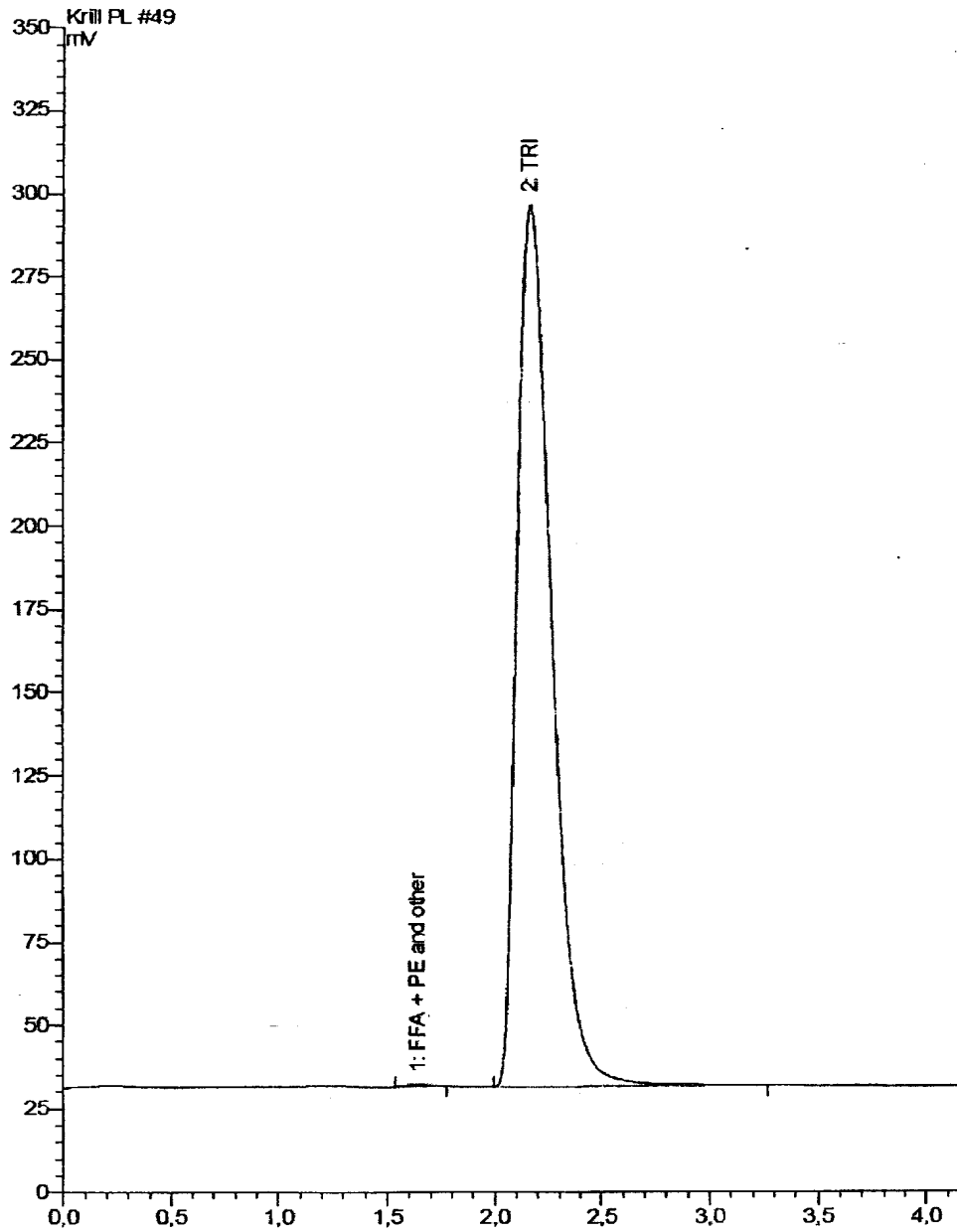
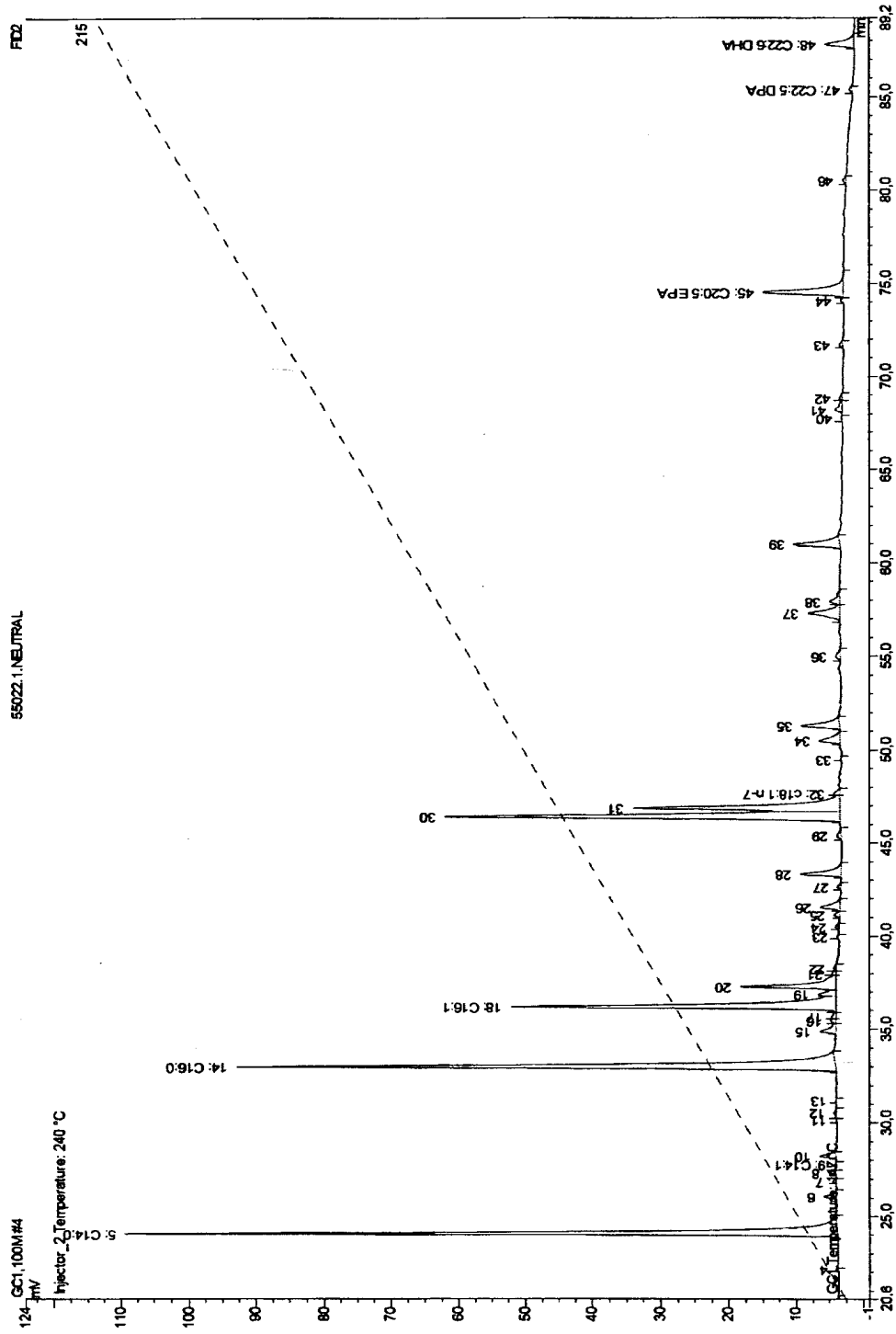

FIGURE 4



5/7

FIGURE 5



6/7

FIGURE 6

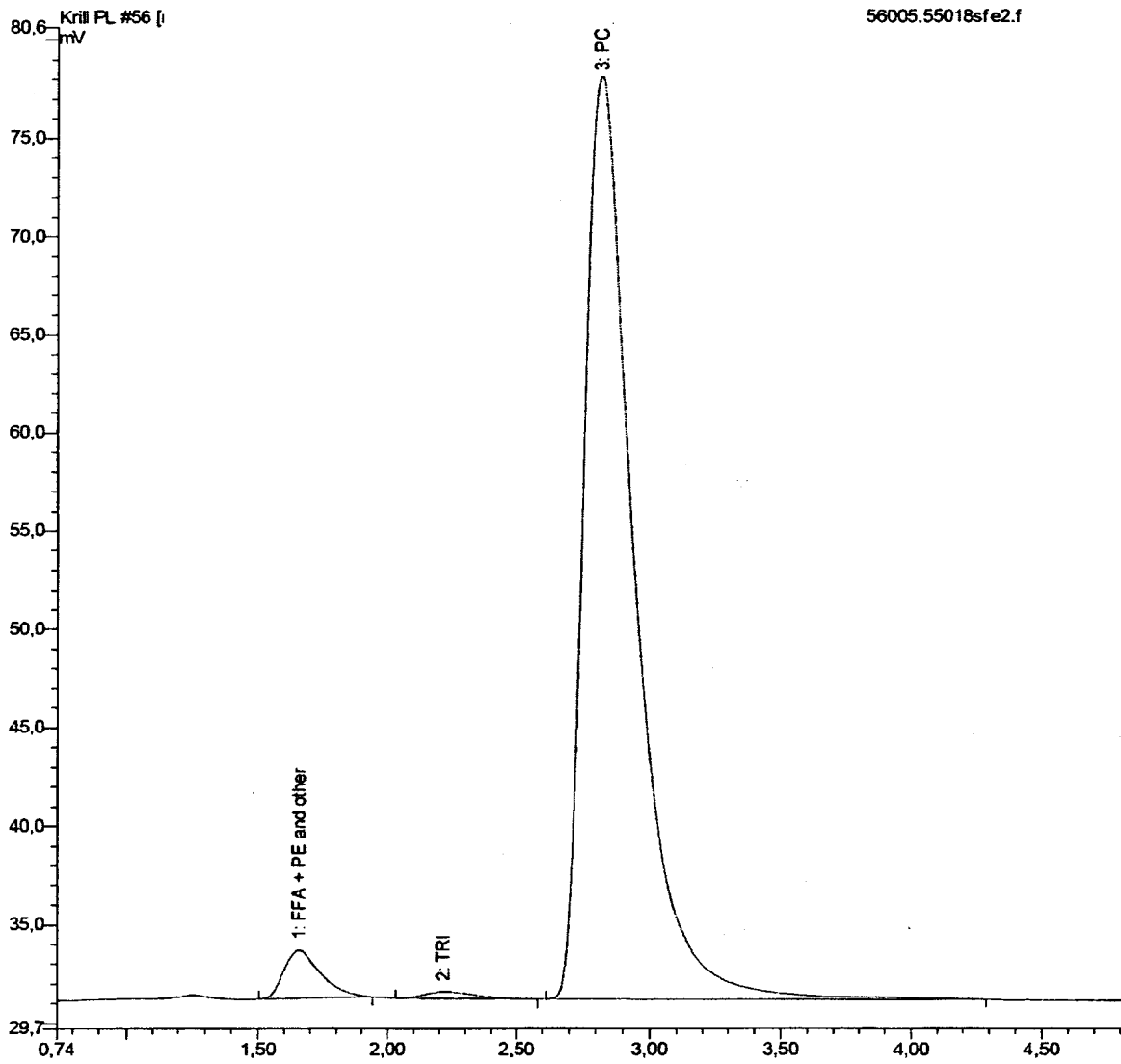

7/7

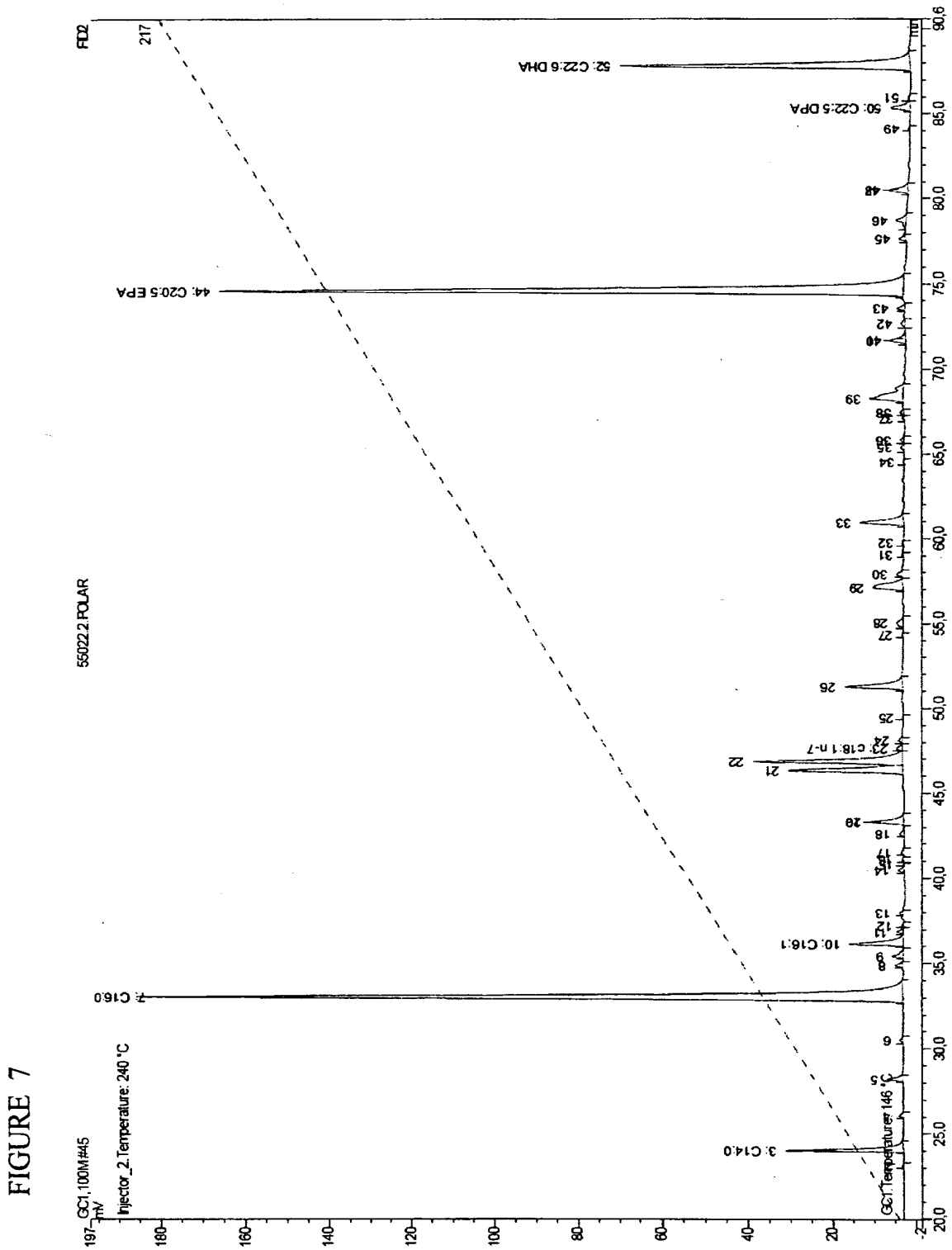

FIGURE 7

(19) World Intellectual Property Organization
International Bureau



(43) International Publication Date
5 March 2009 (05.03.2009)

PCT

(10) International Publication Number
WO 2009/027692 A3

(51) International Patent Classification:

A23J 1/04 (2006.01) C11B 1/10 (2006.01)
A23K 1/10 (2006.01) A23J 7/00 (2006.01)
A23K 1/18 (2006.01) C07F 9/10 (2006.01)
A23L 1/30 (2006.01) A61K 35/60 (2006.01)

(21) International Application Number:

PCT/GB2008/002934

(22) International Filing Date: 29 August 2008 (29.08.2008)

(25) Filing Language: English

(26) Publication Language: English

(30) Priority Data:

60/968,765 29 August 2007 (29.08.2007) US

(71) Applicant (for all designated States except US): **AKER BIOMARINE ASA** [NO/NO]; Fjordalleen 16, PO BOX 1423 Vika, N-0115 Oslo (NO).

(71) Applicant (for GB only): **GOLDING, Louise** [GB/GB]; Frank B. Dehn & Co., St Bride's House, 10 Salisbury Square, London EC4Y 8JD (GB).

(72) Inventors; and

(75) Inventors/Applicants (for US only): **ØISTEIN, Høstmark** [NO/NO]; Skalevikveien 23, N-5178 Loddefjord (NO). **SNORRE, Tilseth** [NO/NO]; Fantoftsasen 27A, N-5072 Bergen (NO).

(74) Agents: **GOLDING, Louise** et al.; FRANK B. DEHN & CO., St Bride's House, 10 Salisbury Square, London EC4Y 8JD (GB).

(81) Designated States (unless otherwise indicated, for every kind of national protection available): AE, AG, AL, AM, AO, AT, AU, AZ, BA, BB, BG, BH, BR, BW, BY, BZ, CA, CH, CN, CO, CR, CU, CZ, DE, DK, DM, DO, DZ, EC, EE, EG, ES, FI, GB, GD, GE, GH, GM, GT, HN, HR, HU, ID, IL, IN, IS, JP, KE, KG, KM, KN, KP, KR, KZ, LA, LC, LK, LR, LS, LT, LU, LY, MA, MD, ME, MG, MK, MN, MW, MX, MY, MZ, NA, NG, NI, NO, NZ, OM, PG, PH, PL, PT, RO, RS, RU, SC, SD, SE, SG, SK, SL, SM, ST, SV, SY, TJ, TM, TN, TR, TT, TZ, UA, UG, US, UZ, VC, VN, ZA, ZM, ZW.

(84) Designated States (unless otherwise indicated, for every kind of regional protection available): ARIPO (BW, GH, GM, KE, LS, MW, MZ, NA, SD, SL, SZ, TZ, UG, ZM, ZW), Eurasian (AM, AZ, BY, KG, KZ, MD, RU, TJ, TM), European (AT, BE, BG, CH, CY, CZ, DE, DK, EE, ES, FI, FR, GB, GR, HR, HU, IE, IS, IT, LT, LU, LV, MC, MT, NL, NO, PL, PT, RO, SE, SI, SK, TR), OAPI (BF, BJ, CF, CG, CI, CM, GA, GN, GQ, GW, ML, MR, NE, SN, TD, TG).

Published:

- with international search report
- before the expiration of the time limit for amending the claims and to be republished in the event of receipt of amendments

(88) Date of publication of the international search report: 14 May 2009



WO 2009/027692 A3

(54) Title: A NEW METHOD FOR MAKING KRILL MEAL

(57) Abstract: A new method for krill meal production has been developed using a two step cooking process. In the first step the proteins and phospholipids are removed from the krill and precipitated as a coagulum. In the second stage the krill without phospholipids are cooked. Following this, residual fat and astaxanthin are removed from the krill using mechanical separation methods. A novel krill meal product with superior nutritional and technical properties is prepared.

INTERNATIONAL SEARCH REPORT

International application No
PCT/GB2008/002934

A. CLASSIFICATION OF SUBJECT MATTER
 INV. A23J1/04 A23K1/10 A23K1/18 A23L1/30 C11B1/10
 A23J7/00 C07F9/10 A61K35/60

According to International Patent Classification (IPC) or to both national classification and IPC

B. FIELDS SEARCHED

Minimum documentation searched (classification system followed by classification symbols)
 A23J A23K A23L C11B C07F A61K

Documentation searched other than minimum documentation to the extent that such documents are included in the fields searched

Electronic data base consulted during the international search (name of data base and, where practical, search terms used)

EPO-Internal, FSTA, WPI Data

C. DOCUMENTS CONSIDERED TO BE RELEVANT

Category*	Citation of document, with indication, where appropriate, of the relevant passages	Relevant to claim No.
X	DATABASE FSTA [Online] INTERNATIONAL FOOD INFORMATION SERVICE (IFIS), FRANKFURT-MAIN, DE; 1974, YANASE M: "Modification of a Russian method for separation of heat-coagulated protein from Antarctic krill." XP002501559 Database accession no. 76-1-11-r0645 abstract & BULLETIN OF THE TOKAI REGIONAL FISHERIES RESEARCH LABORATORY ((TOKAI-KU SUISAN KENKYUSHO KENKYU HOKOKU)), 1974,	1-15
A	WO 2007/080514 A (KRILL AS [DK]; ALFA LAVAL COPENHAGEN AS [DK]; LARSEN PETER MOSE [DK];) 19 July 2007 (2007-07-19) the whole document	1-15

Further documents are listed in the continuation of Box C.

See patent family annex.

- * Special categories of cited documents :
- *A* document defining the general state of the art which is not considered to be of particular relevance
 - *E* earlier document but published on or after the international filing date
 - *L* document which may throw doubts on priority claim(s) or which is cited to establish the publication date of another citation or other special reason (as specified)
 - *O* document referring to an oral disclosure, use, exhibition or other means
 - *P* document published prior to the international filing date but later than the priority date claimed
 - *T* later document published after the international filing date or priority date and not in conflict with the application but cited to understand the principle or theory underlying the invention
 - *X* document of particular relevance; the claimed invention cannot be considered novel or cannot be considered to involve an inventive step when the document is taken alone
 - *Y* document of particular relevance; the claimed invention cannot be considered to involve an inventive step when the document is combined with one or more other such documents, such combination being obvious to a person skilled in the art.
 - *G* document member of the same patent family

Date of the actual completion of the international search 11 March 2009	Date of mailing of the international search report 26/03/2009
--	--

Name and mailing address of the ISA/ European Patent Office, P.B. 5618 Patentlaan 2 NL - 2280 HV Rijswijk Tel. (+31-70) 340-2040, Fax: (+31-70) 340-3016	Authorized officer Smeets, Dieter
--	--

INTERNATIONAL SEARCH REPORT

International application No
PCT/GB2008/002934

C(Continuation). DOCUMENTS CONSIDERED TO BE RELEVANT

Category*	Citation of document, with indication, where appropriate, of the relevant passages	Relevant to claim No.
A	JP 02 215351 A (TAIYO FISHERY CO LTD) 28 August 1990 (1990-08-28) abstract	1-15
X	----- US 2004/241249 A1 (SAMPALIS TINA [CA]) 2 December 2004 (2004-12-02) page 2, paragraph 25 - paragraph 84; examples page 1, paragraph 18 - paragraph 24 -----	21-27, 48-51
X	TOU JANET C ET AL: "Krill for human consumption: nutritional value and potential health benefits." NUTRITION REVIEWS FEB 2007, vol. 65, no. 2, February 2007 (2007-02), pages 63-77, XP002518830 ISSN: 0029-6643 the whole document -----	21-27, 48-51
X	WO 86/06082 A (MATCON RADGIVENDE ING FIRMA [DK]) 23 October 1986 (1986-10-23) page 9, line 31 - line 36; example -----	21-27, 50,51

INTERNATIONAL SEARCH REPORT

International application No.
PCT/GB2008/002934

Box No. II Observations where certain claims were found unsearchable (Continuation of item 2 of first sheet)

This international search report has not been established in respect of certain claims under Article 17(2)(a) for the following reasons:

- 1. Claims Nos.:
because they relate to subject matter not required to be searched by this Authority, namely:

- 2. Claims Nos.:
because they relate to parts of the international application that do not comply with the prescribed requirements to such an extent that no meaningful international search can be carried out, specifically:

- 3. Claims Nos.:
because they are dependent claims and are not drafted in accordance with the second and third sentences of Rule 6.4(a).

Box No. III Observations where unity of invention is lacking (Continuation of item 3 of first sheet)

This International Searching Authority found multiple inventions in this international application, as follows:

see additional sheet

- 1. As all required additional search fees were timely paid by the applicant, this international search report covers allsearchable claims.

- 2. As all searchable claims could be searched without effort justifying an additional fees, this Authority did not invite payment of additional fees.

- 3. As only some of the required additional search fees were timely paid by the applicant, this international search report covers only those claims for which fees were paid, specifically claims Nos.:

1-15, 21-27, 48-51(partly)

- 4. No required additional search fees were timely paid by the applicant. Consequently, this international search report is restricted to the invention first mentioned in the claims; it is covered by claims Nos.:

Remark on Protest

- The additional search fees were accompanied by the applicant's protest and, where applicable, the payment of a protest fee.
- The additional search fees were accompanied by the applicant's protest but the applicable protest fee was not paid within the time limit specified in the invitation.
- No protest accompanied the payment of additional search fees.

INTERNATIONAL SEARCH REPORT

International Application No. PCT/GB2008 /002934

FURTHER INFORMATION CONTINUED FROM PCT/ISA/ 210

This International Searching Authority found multiple (groups of) inventions in this international application, as follows:

1. claims: 1-15

A process for preparing phospholipid compositions from biological material comprising phospholipids and proteins comprising:
mixing said biological material with water to increase the temperature of said biological material to about 25 to 80 deg. C to form a first solid phase and a first aqueous phase comprising said phospholipids and proteins;
separating said first solid phase from said first aqueous phase; and
separating a protein and phospholipid fraction from said first aqueous phase.

2. claim: 16

An aqueous phase composition obtainable by the process of 1.

3. claims: 17, 48-51(partly)

A coagulate meal obtainable by the process of claim 9.

4. claims: 18, 48-51(partly)

A coagulate oil obtainable by the process of claim 10.

5. claims: 19, 48-51(partly)

A retentate concentrate obtainable by the process of claim 13.

6. claims: 20, 48-51(partly)

A retentate oil obtainable by the process of claim 14.

7. claims: 21-27, 48-51(partly)

A krill composition comprising from about 0.01 to about 200 mg/kg astaxanthin, from about 45% to about 65% fat w/w, and about 20% to 50% protein w/w, wherein said fat comprises omega-3 fatty acid residues.

8. claims: 28, 48-51(partly)

FURTHER INFORMATION CONTINUED FROM PCT/ISA/ 210

A krill composition comprising from about 10% to about 20% protein w/w, about 15% to about 30% fat w/w, and from about 0.01 mg/kg to about 200 mg/kg astaxanthin.

9. claims: 29-31, 48-51(partly)

A krill meal comprising from about 65% to about 75% protein w/w (dry matter) , from about 10% to about 25% fat w/w (dry matter), and from about 1 to about 200 mg/kg astaxanthin (wet base).

10. claims: 32, 48-51(partly)

A krill oil composition comprising greater than about 1500 mg/kg total esterified astaxanthin, wherein said esterified astaxanthin comprises from about 25 to 35% astaxanthin monoester on a w/w basis and from about 50 to 70% astaxanthin diester on a w/w basis, and greater than about 20 mg/kg free astaxanthin.

11. claims: 33, 48-51(partly)

A krill composition comprising from about 3% to about 10% protein w/w, about 8% to about 20% dry matter w/w, and about 4% to about 10% fat w/w.

12. claims: 34, 48-51(partly)

A krill coagulum meal comprising, 50-75% fat w/w, 30-50% protein w/w, and 1 to 200 mg/kg astaxanthin, wherein said fat comprises 15 to 30 g/100 g fat omega-3 fatty acid residues and 35 to 60g /100 g fat phosphatidylcholine.

13. claims: 35-40

A system for processing of marine biomass comprising: a mixer for mixing marine biomass and water to form a mixture having a defined temperature, wherein said mixture has a first solid phase and a first liquid phase.

14. claim: 41

A krill composition 50-75% fat w/w, 30-50% protein w/w, and 1 to 200 mg/kg astaxanthin, wherein said fat comprises 15 to 30 g/100 g fat omega-3 fatty acid residues and 35 to 60g /100 g fat phosphatidylcholine, and less than about 1 mg/100g trimethyl amine, volatile nitrogen, or 1g/100g lysophosphatidylcholine or combinations thereof.

FURTHER INFORMATION CONTINUED FROM PCT/ISA/ 210

15. claims: 42-44

A process for processing of marine biomass comprising:
providing a marine biomass and a mixer for mixing marine
biomass and water to form a mixture having a defined
temperature, wherein said mixture comprises a first solid
phase and a first liquid phase.

16. claims: 45-47

A system for processing of marine biomass comprising:
a ship;
a trawl net towable from said ship, wherein said trawl net
is configured to catch a marine biomass;
a mixer for mixing said marine biomass and water to form a
mixture having a defined temperature, wherein said mixture
has a first solid phase and a first liquid phase.

INTERNATIONAL SEARCH REPORT

Information on patent family members

International application No
PCT/GB2008/002934

Patent document cited in search report	Publication date	Patent family member(s)	Publication date
WO 2007080514 A	19-07-2007	AR 059659 A1	23-04-2008
JP 2215351 A	28-08-1990	JP 2909508 B2	23-06-1999
US 2004241249 A1	02-12-2004	US 2007098808 A1	03-05-2007
WO 8606082 A	23-10-1986	AR 242592 A1	30-04-1993
		AU 5694686 A	05-11-1986
		DK 166285 A	13-10-1986
		EP 0217887 A1	15-04-1987
		ES 8706170 A1	16-08-1987
		IN 165452 A1	21-10-1989
		IS 3090 A7	13-10-1986
		NO 865015 A	11-12-1986
		PT 82378 A	01-05-1986

WO 2007/080514
 Cited in Court.
 PCT Case

INTERNATIONAL SEARCH REPORT

International application No
 PCT/IB2007/000098

A. CLASSIFICATION OF SUBJECT MATTER INV. C11B1/10 C11B3/00		
According to International Patent Classification (IPC) or to both national classification and IPC		
B. FIELDS SEARCHED Minimum documentation searched (classification system followed by classification symbols) C11B		
Documentation searched other than minimum documentation to the extent that such documents are included in the fields searched		
Electronic data base consulted during the international search (name of data base and, where practical, search terms used) EPO-Internal		
C. DOCUMENTS CONSIDERED TO BE RELEVANT		
Category*	Citation of document, with indication, where appropriate, of the relevant passages	Relevant to claim No.
A	CA 1 098 900 A1 (INST ELEMENTOORGANICHESKIKH SO; VNII RYBNOGO KHOZYAISTVA I) 7 April 1981 (1981-04-07) cited in the application page 3	1-7
A	BR 8 701 265 A (GUILLOT BERNARD RENE [FR]) 29 December 1987 (1987-12-29) the whole document	1-10
A	GB 921 537 A (MARIO MERONI) 20 March 1963 (1963-03-20) the whole document	1-8
A	GB 2 097 014 A (BAIKOFF EUGENE MARC ALEXANDRE) 27 October 1982 (1982-10-27) the whole document	
	-/--	
<input checked="" type="checkbox"/> Further documents are listed in the continuation of Box C.		
<input checked="" type="checkbox"/> See patent family annex.		
* Special categories of cited documents :		
A document defining the general state of the art which is not considered to be of particular relevance *E* earlier document but published on or after the international filing date *L* document which may throw doubts on priority claim(s) or which is cited to establish the publication date of another citation or other special reason (as specified) *O* document referring to an oral disclosure, use, exhibition or other means *P* document published prior to the international filing date but later than the priority date claimed		*T* later document published after the international filing date or priority date and not in conflict with the application but cited to understand the principle or theory underlying the invention *X* document of particular relevance; the claimed invention cannot be considered novel or cannot be considered to involve an inventive step when the document is taken alone *Y* document of particular relevance; the claimed invention cannot be considered to involve an inventive step when the document is combined with one or more other such documents, such combination being obvious to a person skilled in the art. *&* document member of the same patent family
Date of the actual completion of the international search 26 June 2007		Date of mailing of the international search report 03/07/2007
Name and mailing address of the ISA/ European Patent Office, P.B. 5818 Patentlaan 2 NL - 2280 HV Rijswijk Tel. (+31-70) 340-2040, Tx. 31 651 epo nl, Fax: (+31-70) 340-3016		Authorized officer Popa, Marian

INTERNATIONAL SEARCH REPORT

International application No
PCT/IB2007/000098

C(Continuation). DOCUMENTS CONSIDERED TO BE RELEVANT		
Category*	Citation of document, with indication, where appropriate, of the relevant passages	Relevant to claim No.
A	US 6 800 299 B1 (BEAUDOIN ADRIEN [CA] ET AL) 5 October 2004 (2004-10-05) cited in the application the whole document	

Form PCT/ISA/210 (continuation of second sheet) (April 2005)

INTERNATIONAL SEARCH REPORT

Information on patent family members

International application No

PCT/IB2007/000098

Patent document cited in search report	Publication date	Patent family member(s)	Publication date
CA 1098900	A1	07-04-1981	NONE
BR 8701265	A	29-12-1987	CN 87102848 A 13-01-1988 DE 3764011 D1 06-09-1990 EG 18006 A 30-06-1991 EP 0243220 A1 28-10-1987 FR 2596060 A1 25-09-1987 GR 3000992 T3 10-12-1991 IN 171343 A1 19-09-1992 JP 62232499 A 12-10-1987 OA 8502 A 29-07-1988 PT 84522 A 01-04-1987 ZA 8702035 A 26-08-1987
GB 921537	A	20-03-1963	NONE
GB 2097014	A	27-10-1982	PH 17793 A 13-12-1984
US 6800299	B1	05-10-2004	AU 765464 B2 18-09-2003 AU 6455299 A 08-05-2000 BR 9914699 A 10-07-2001 CA 2251265 A1 21-04-2000 WO 0023546 A1 27-04-2000 CN 1324394 A 28-11-2001 EP 1123368 A1 16-08-2001 JP 2002527604 T 27-08-2002 NO 20011915 A 21-06-2001 PL 347396 A1 08-04-2002 RU 2236441 C2 20-09-2004 UA 75029 C2 17-09-2001 ZA 200103235 A 20-06-2002