

- 42 -

50. Method as in claim 43 wherein said product is subject to digestion between approximately 0-70 degrees Celsius.

5 51. Method of producing a concentrated krill hydrolysate comprising the steps of harvesting, digesting and evaporating the krill hydrolysate to provide a partial hydrolysis for a predetermined time and temperature so as to enhance the nutrient characteristics of said krill.

10

52. Method of producing a dry krill premix or feedstuff comprising the steps of producing a predetermined amount of concentrated krill hydrolysate, producing a predetermined amount of dry matter and mixing  
15 said concentrated krill hydrolysate and said dry carrier matter and co-drying said mixture.

54. Method as in claim 52 wherein the dry matter is selected from the group of vegetable and/or  
20 vegetable and/or animal protein meals and by products.

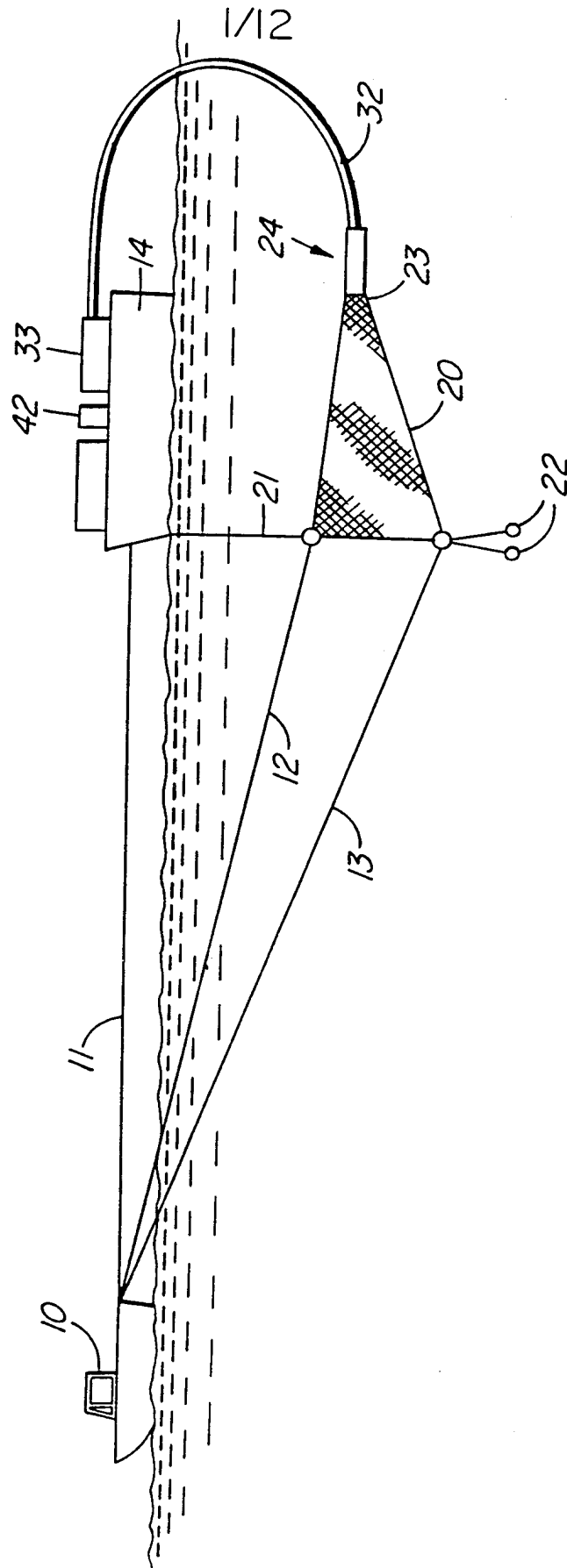

FIG. 1A

2/12

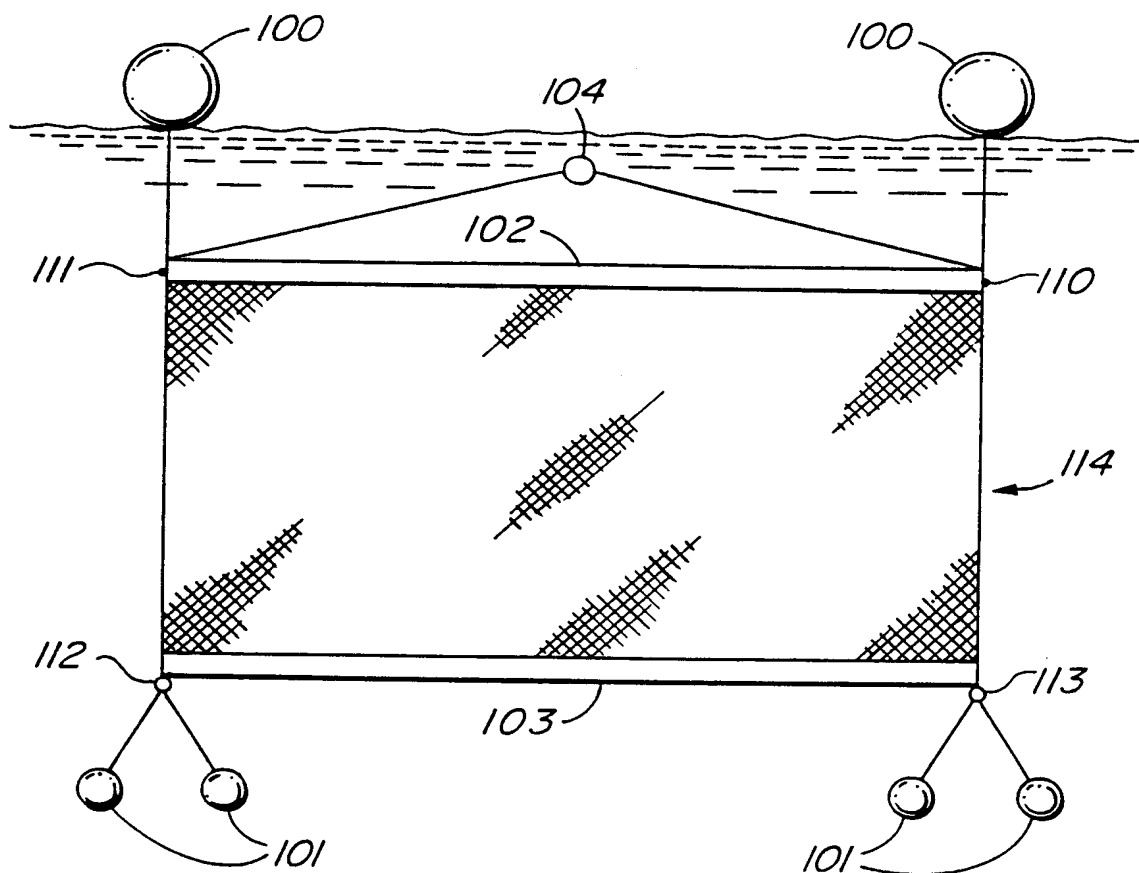

FIG. 1B

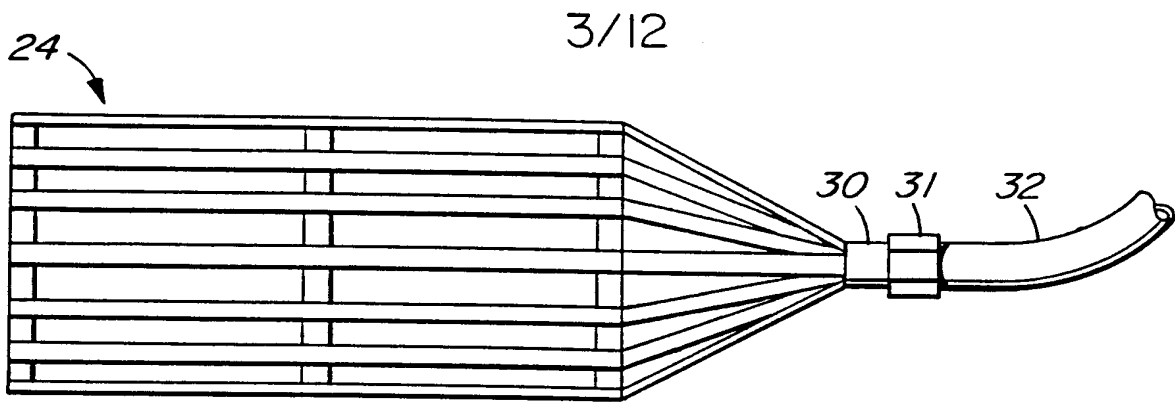

FIG. 2A

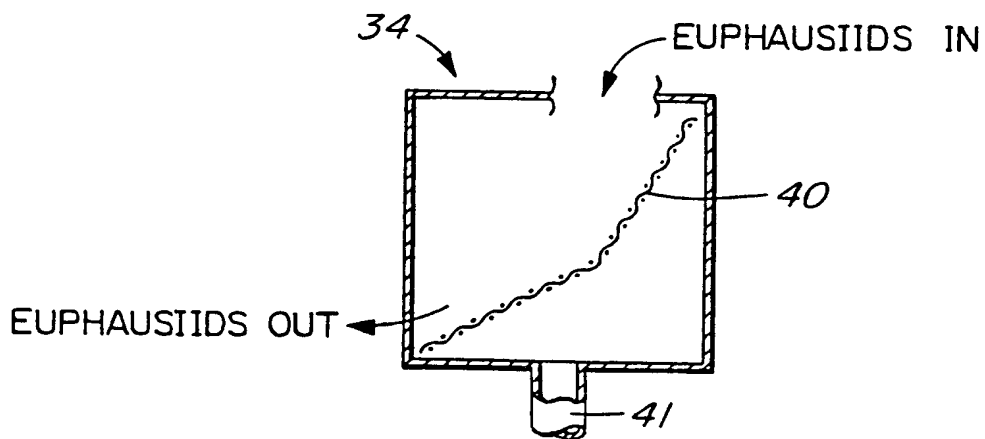

FIG. 2B

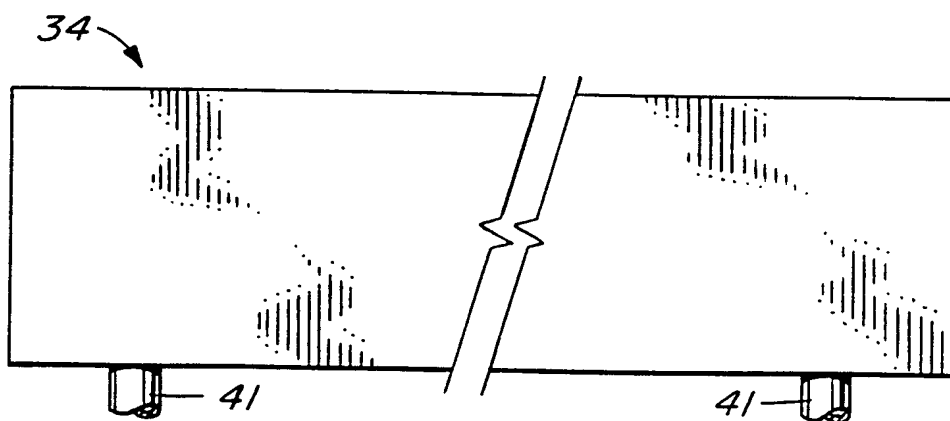

FIG. 2C



4/12

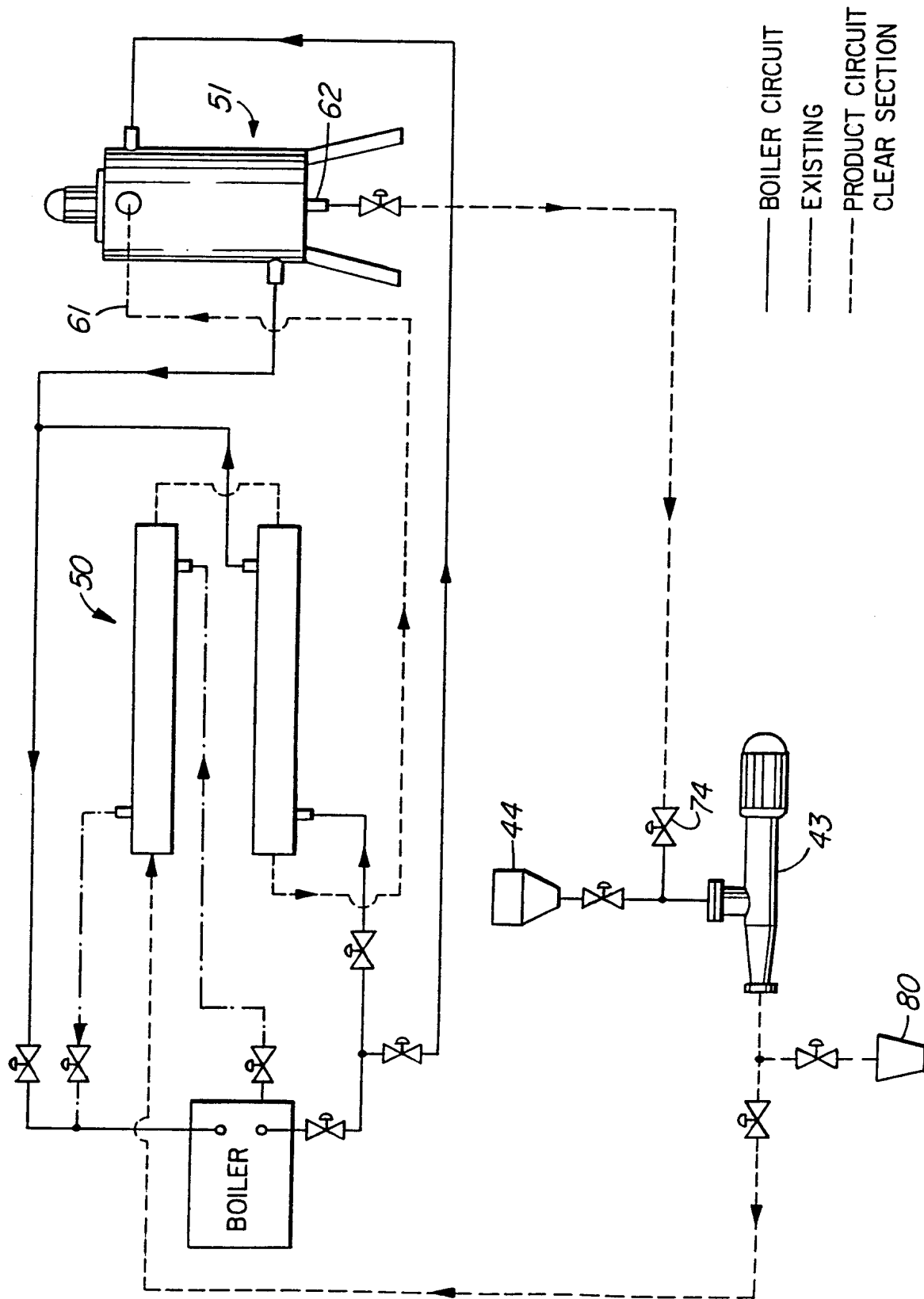

FIG. 3

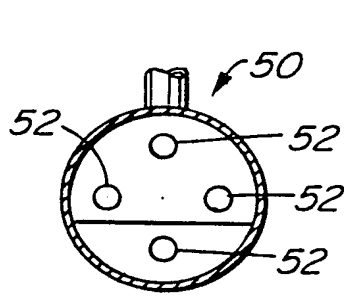

FIG. 4A

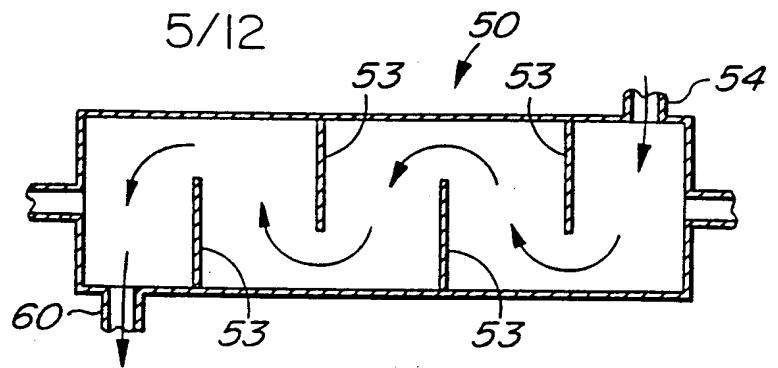

FIG. 4B

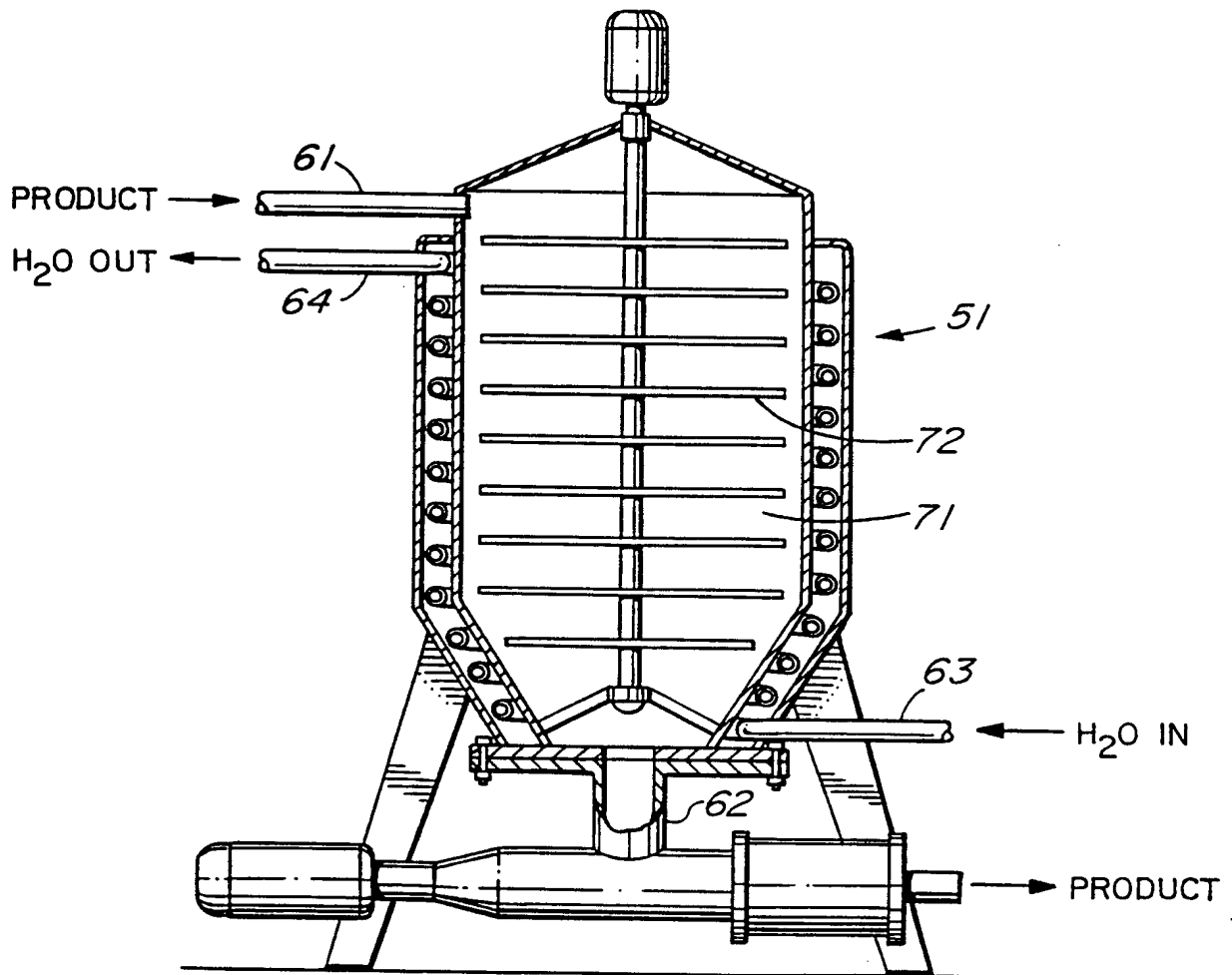

FIG. 5

6/12

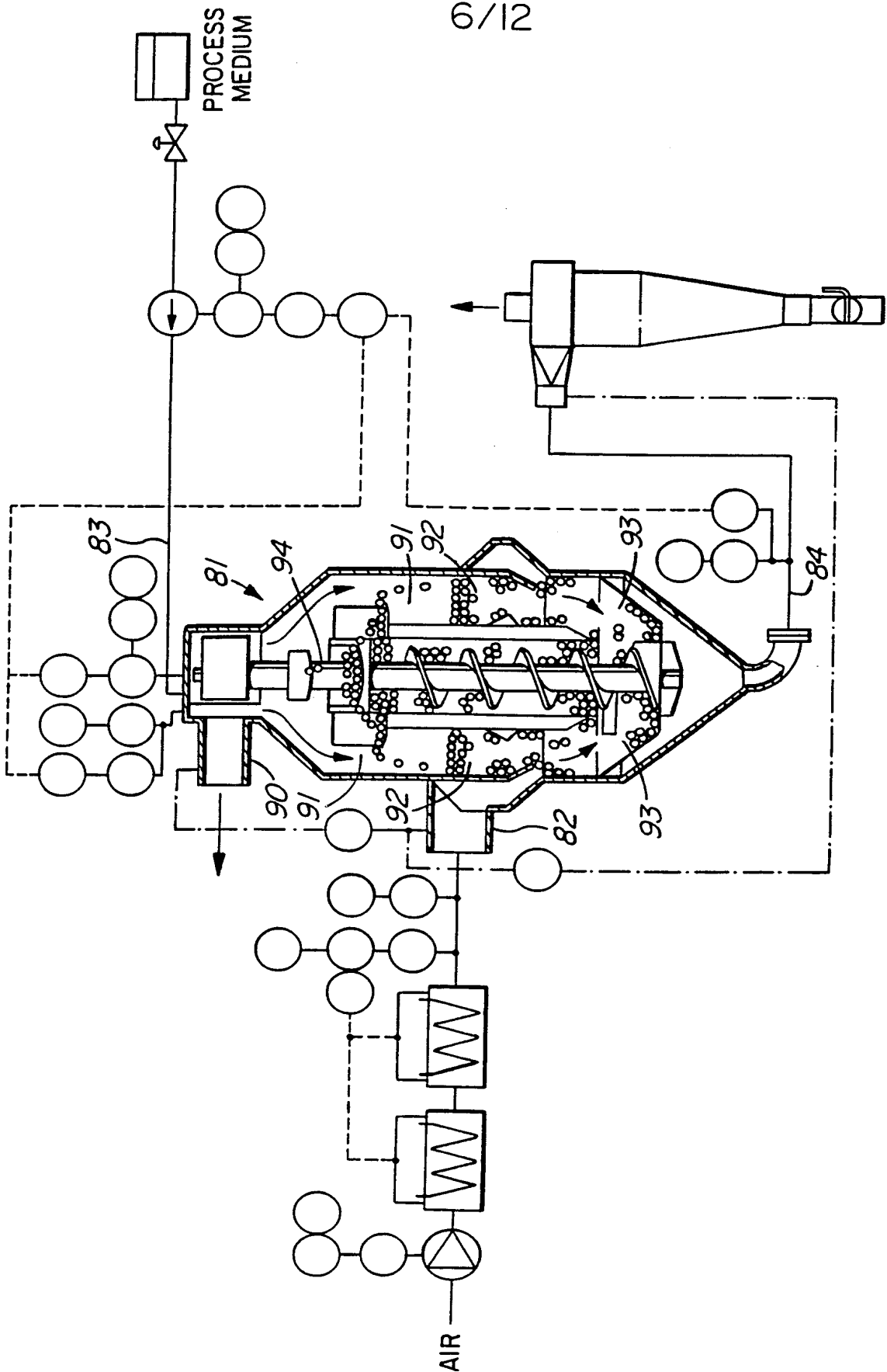

FIG. 6

7/12

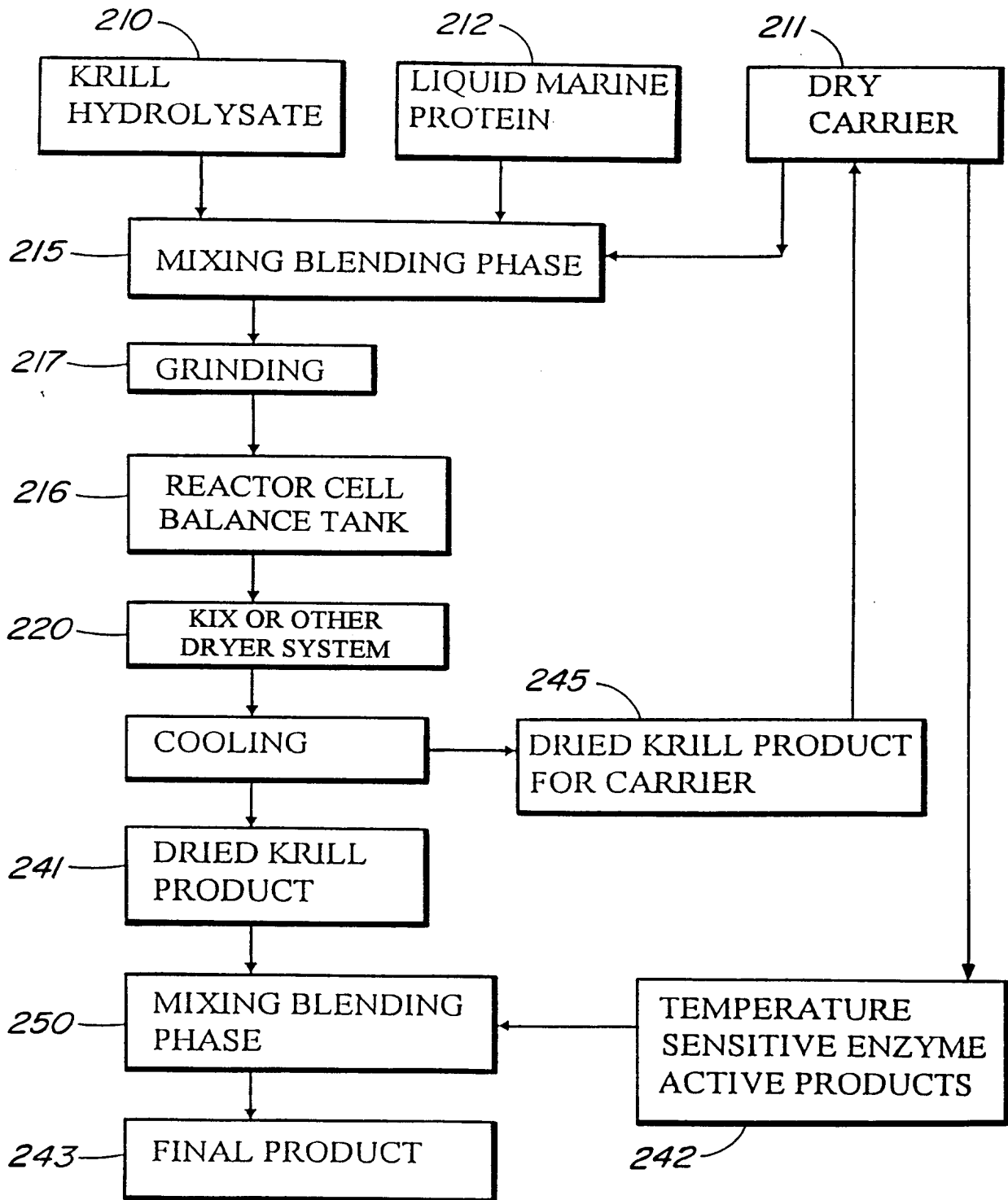

FIG. 7

8/12

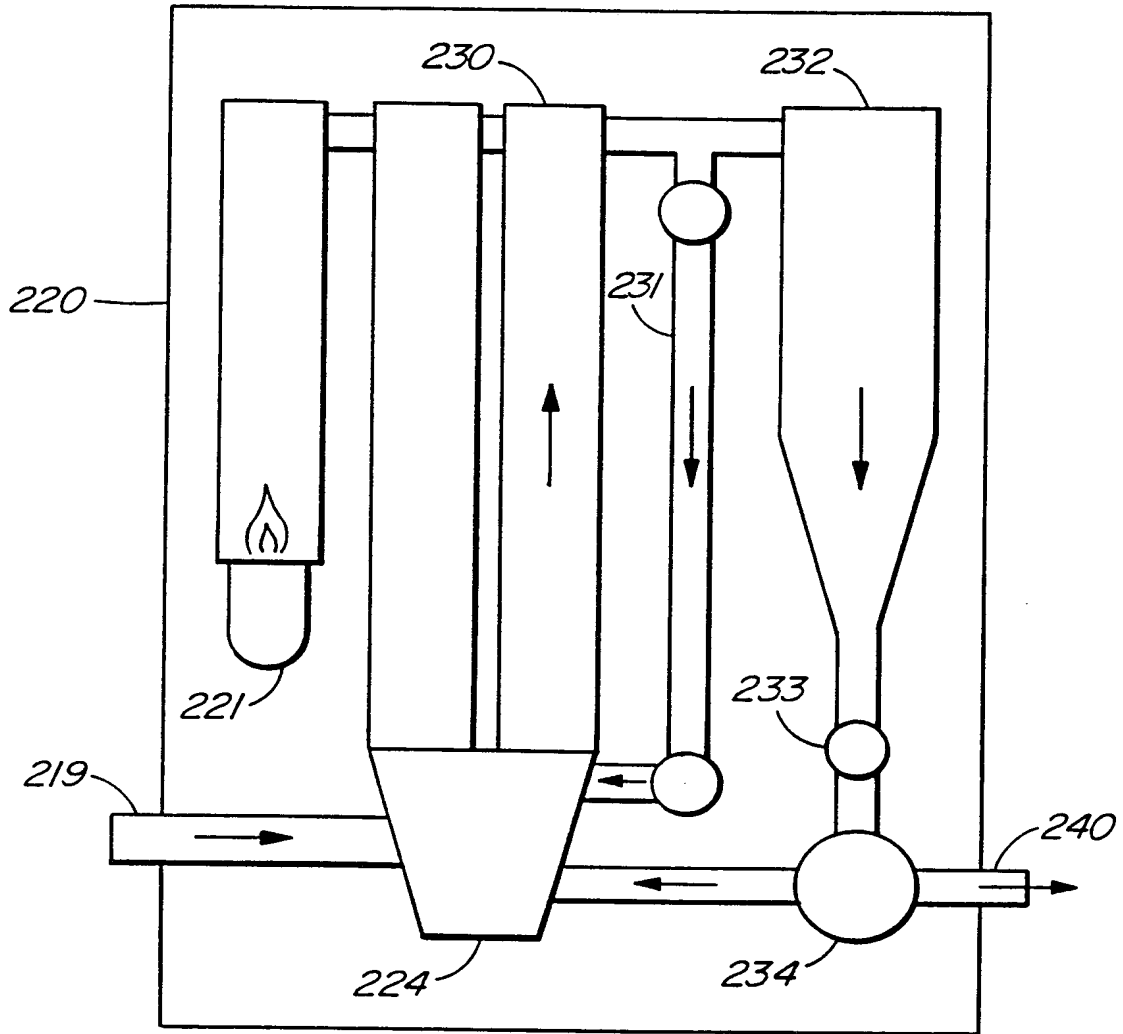

FIG. 8

9/12

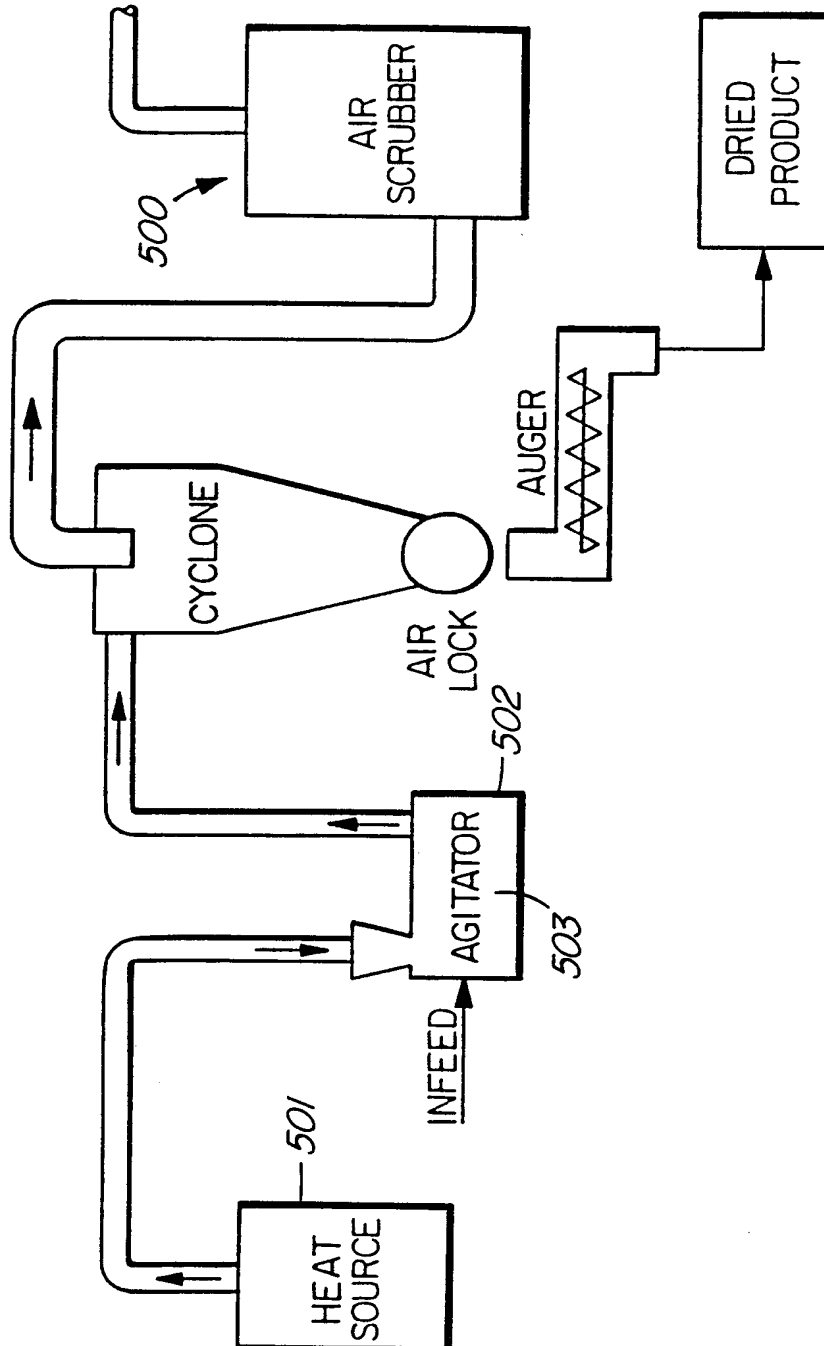

FIG. 9

10/12

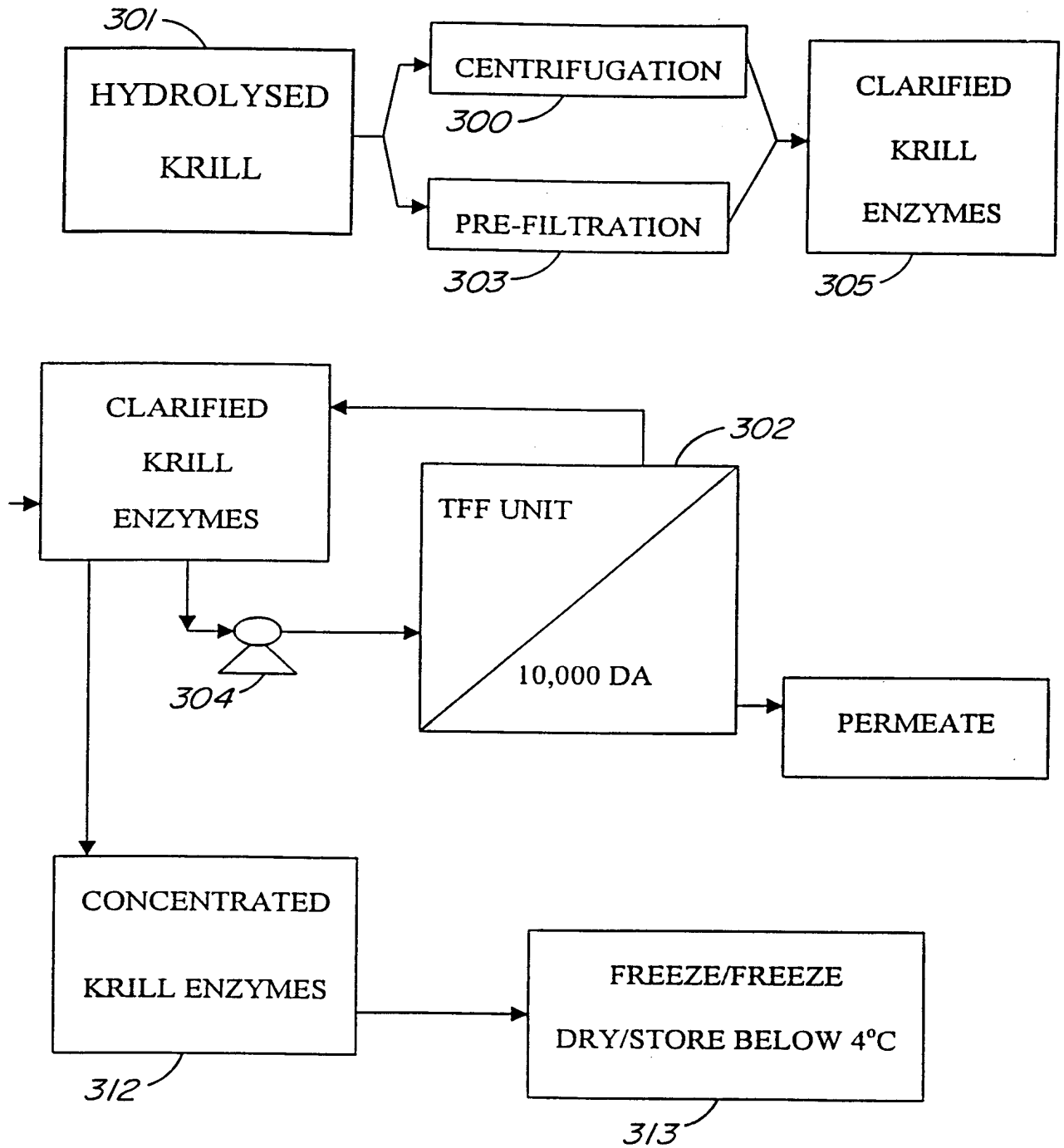

FIG. 10

11/12

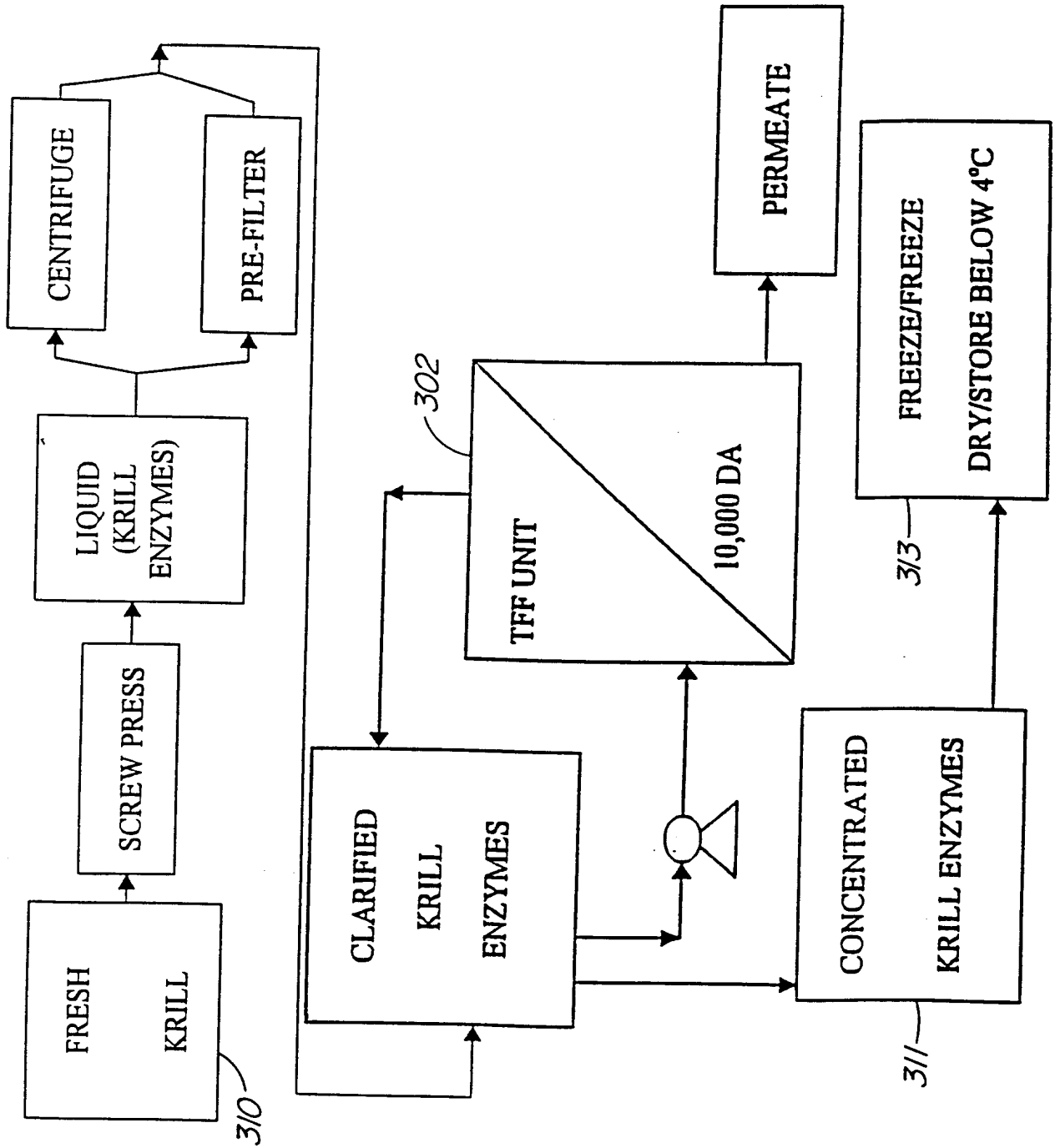

FIG. 11



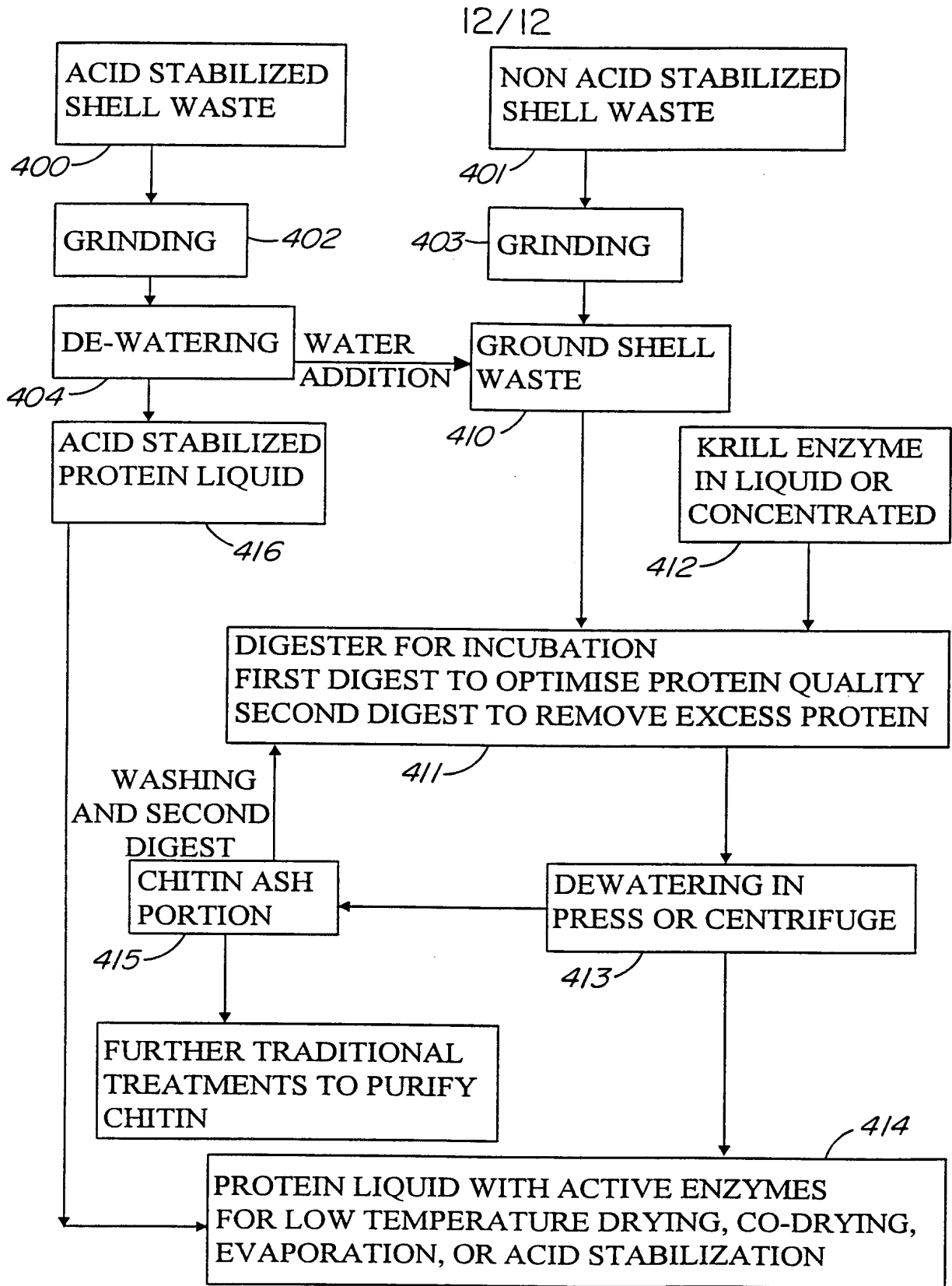

FIG. 12

# INTERNATIONAL SEARCH REPORT

International Application No

PCT/CA 99/00075

**A. CLASSIFICATION OF SUBJECT MATTER**

IPC 6    A23K1/10    A23K1/16    A23K1/18    A23J1/04    A23N17/00  
           C12N9/00

According to International Patent Classification (IPC) or to both national classification and IPC

**B. FIELDS SEARCHED**

Minimum documentation searched (classification system followed by classification symbols)

IPC 6    A23K    A23J    C12N

Documentation searched other than minimum documentation to the extent that such documents are included in the fields searched

Electronic data base consulted during the international search (name of data base and, where practical, search terms used)

**C. DOCUMENTS CONSIDERED TO BE RELEVANT**

Category °	Citation of document, with indication, where appropriate, of the relevant passages	Relevant to claim No.
P, X	WO 98 34498 A (BIOZYME SYSTEMS INC ; SAXBY DAVID J (CA); SPENCE JOHN A (CA); ALOIS) 13 August 1998 see the whole document ---	1-54
X	DATABASE WPI Section Ch, Week 8447 Derwent Publications Ltd., London, GB; Class C03, AN 84-293719 XP002070859 & SU 1 084 005 A (N BASSIN FISHING IND) , 7 April 1984 see abstract ---	1, 20, 52
X	WO 95 22893 A (SPECIALTY MARINE FEEDS INC) 31 August 1995 see page 15, line 19 - page 17, line 19 see claims 11-28, 30-46 ---	51
	-/--	

Further documents are listed in the continuation of box C.

Patent family members are listed in annex.

° Special categories of cited documents :

- "A" document defining the general state of the art which is not considered to be of particular relevance
- "E" earlier document but published on or after the international filing date
- "L" document which may throw doubts on priority claim(s) or which is cited to establish the publication date of another citation or other special reason (as specified)
- "O" document referring to an oral disclosure, use, exhibition or other means
- "P" document published prior to the international filing date but later than the priority date claimed

- "T" later document published after the international filing date or priority date and not in conflict with the application but cited to understand the principle or theory underlying the invention
- "X" document of particular relevance; the claimed invention cannot be considered novel or cannot be considered to involve an inventive step when the document is taken alone
- "Y" document of particular relevance; the claimed invention cannot be considered to involve an inventive step when the document is combined with one or more other such documents, such combination being obvious to a person skilled in the art.
- "&" document member of the same patent family

Date of the actual completion of the international search

9 June 1999

Date of mailing of the international search report

29/06/1999

Name and mailing address of the ISA

European Patent Office, P.B. 5818 Patentlaan 2  
 NL - 2280 HV Rijswijk  
 Tel. (+31-70) 340-2040, Tx. 31 651 epo nl,  
 Fax: (+31-70) 340-3016

Authorized officer

Dekeirel, M

# INTERNATIONAL SEARCH REPORT

International Application No PCT/CA 99/00075
---

C.(Continuation) DOCUMENTS CONSIDERED TO BE RELEVANT		
Category	Citation of document, with indication, where appropriate, of the relevant passages	Relevant to claim No.
X	WO 89 01031 A (PHARMACIA AB) 9 February 1989 see page 5, paragraph 2 see page 7, paragraph 1 see examples 1-3 see claim 1	29-34, 41
A	---	35-40
X	WO 89 10960 A (PHARMACIA AB) 16 November 1989 see page 8, last paragraph see page 11, paragraph 3 - paragraph 5 see page 14, paragraph 3 see page 27, paragraph 4 see claims 1,7,17	42,43
X	WO 90 05026 A (AKT CONSULTANTS) 17 May 1990 see figure 1	21,27
A	PATENT ABSTRACTS OF JAPAN vol. 017, no. 315 (C-1071), 16 June 1993 & JP 05 030923 A (RIKEN VITAMIN CO LTD), 9 February 1993 see abstract	1,20,52
A	DATABASE WPI Section Ch, Week 9602 Derwent Publications Ltd., London, GB; Class D13, AN 96-018544 XP002070860 & RU 2 034 492 C (TROITSKII B N) , 10 May 1995 see abstract	1,20,52
	-----	

# INTERNATIONAL SEARCH REPORT

Information on patent family members

International Application No

PCT/CA 99/00075

Patent document cited in search report	A	Publication date	Patent family member(s)	Publication date
WO 9834498	A	13-08-1998	CA 2197137	A 07-08-1998
			AU 5976698	A 26-08-1998
WO 9522893	A	31-08-1995	CA 2134515	A 28-04-1996
			AU 1802695	A 11-09-1995
			CN 1146709	A 02-04-1997
			EP 0758842	A 26-02-1997
			FI 963343	A 27-08-1996
			JP 10500004	T 06-01-1998
WO 8901031	A	09-02-1989	AT 124085	T 15-07-1995
			AU 2259788	A 01-03-1989
			DE 3854050	D 27-07-1995
			EP 0393035	A 24-10-1990
			JP 2504465	T 20-12-1990
WO 8910960	A	16-11-1989	NONE	
WO 9005026	A	17-05-1990	AU 4518389	A 28-05-1990
			CA 2002193	A 03-05-1990
			DK 158990	A 22-08-1990
			EP 0403608	A 27-12-1990
			GR 89100729	A 31-12-1990
			PT 92192	A, B 31-05-1990
			US 5105560	A 21-04-1992



## INTERNATIONAL APPLICATION PUBLISHED UNDER THE PATENT COOPERATION TREATY (PCT)

(51) International Patent Classification <sup>7</sup> : <b>C11B 1/10, C12N 9/64</b>	<b>A1</b>	(11) International Publication Number: <b>WO 00/23546</b>  (43) International Publication Date: 27 April 2000 (27.04.00)
<p>(21) International Application Number: PCT/CA99/00987</p> <p>(22) International Filing Date: 21 October 1999 (21.10.99)</p> <p>(30) Priority Data: 2,251,265 21 October 1998 (21.10.98) CA</p> <p>(71) Applicant (for all designated States except US): UNIVERSITE DE SHERBROOKE [CA/CA]; University Boulevard, Sherbrooke, Quebec J1K 2R1 (CA).</p> <p>(72) Inventors; and (75) Inventors/Applicants (for US only): BEAUDOIN, Adrien [CA/CA]; 748, boulevard des Vétérans, Rock Forest, Quebec J1N 1Z7 (CA). MARTIN, Geneviève [CA/CA]; 797, McManamy, Sherbrooke, Quebec J1H 2N1 (CA).</p> <p>(74) Agents: DUBUC, Jean, H. et al.; Goudreau Gage Dubuc &amp; Martineau Walker, The Stock Exchange Tower, Suite 3400, P.O. Box 242, 800 Place Victoria, Montreal, Quebec H4Z 1E9 (CA).</p>	<p>(81) Designated States: AE, AL, AM, AT, AU, AZ, BA, BB, BG, BR, BY, CA, CH, CN, CR, CU, CZ, DE, DK, DM, EE, ES, FI, GB, GD, GE, GH, GM, HR, HU, ID, IL, IN, IS, JP, KE, KG, KP, KR, KZ, LC, LK, LR, LS, LT, LU, LV, MA, MD, MG, MK, MN, MW, MX, NO, NZ, PL, PT, RO, RU, SD, SE, SG, SI, SK, SL, TJ, TM, TR, TT, TZ, UA, UG, US, UZ, VN, YU, ZA, ZW, ARIPO patent (GH, GM, KE, LS, MW, SD, SL, SZ, TZ, UG, ZW), Eurasian patent (AM, AZ, BY, KG, KZ, MD, RU, TJ, TM), European patent (AT, BE, CH, CY, DE, DK, ES, FI, FR, GB, GR, IE, IT, LU, MC, NL, PT, SE), OAPI patent (BF, BJ, CF, CG, CI, CM, GA, GN, GW, ML, MR, NE, SN, TD, TG).</p> <p><b>Published</b> <i>With international search report. Before the expiration of the time limit for amending the claims and to be republished in the event of the receipt of amendments.</i></p>	
(54) Title: METHOD OF EXTRACTING LIPIDS FROM MARINE AND AQUATIC ANIMAL TISSUES		
(57) Abstract		
<p>Provided herein is a method for extracting lipid fractions from marine and aquatic animal material by acetone extraction. The resulting non-soluble and particulate fraction is preferably subjected to an additional solvent extraction with an alcohol, preferably ethanol, isopropanol or <i>t</i>-butanol or an ester of acetic acid, preferably ethyl acetate to achieve extraction of the remaining soluble lipid fraction from the marine and aquatic animal material. The remaining non-soluble particulate contents is also recovered since it is enriched in proteins and contains a useful amount of active enzymes. Also provided herein is a krill extract.</p>		

**FOR THE PURPOSES OF INFORMATION ONLY**

Codes used to identify States party to the PCT on the front pages of pamphlets publishing international applications under the PCT.

<b>AL</b>	Albania	<b>ES</b>	Spain	<b>LS</b>	Lesotho	<b>SI</b>	Slovenia
<b>AM</b>	Armenia	<b>FI</b>	Finland	<b>LT</b>	Lithuania	<b>SK</b>	Slovakia
<b>AT</b>	Austria	<b>FR</b>	France	<b>LU</b>	Luxembourg	<b>SN</b>	Senegal
<b>AU</b>	Australia	<b>GA</b>	Gabon	<b>LV</b>	Latvia	<b>SZ</b>	Swaziland
<b>AZ</b>	Azerbaijan	<b>GB</b>	United Kingdom	<b>MC</b>	Monaco	<b>TD</b>	Chad
<b>BA</b>	Bosnia and Herzegovina	<b>GE</b>	Georgia	<b>MD</b>	Republic of Moldova	<b>TG</b>	Togo
<b>BB</b>	Barbados	<b>GH</b>	Ghana	<b>MG</b>	Madagascar	<b>TJ</b>	Tajikistan
<b>BE</b>	Belgium	<b>GN</b>	Guinea	<b>MK</b>	The former Yugoslav Republic of Macedonia	<b>TM</b>	Turkmenistan
<b>BF</b>	Burkina Faso	<b>GR</b>	Greece	<b>ML</b>	Mali	<b>TR</b>	Turkey
<b>BG</b>	Bulgaria	<b>HU</b>	Hungary	<b>MN</b>	Mongolia	<b>TT</b>	Trinidad and Tobago
<b>BJ</b>	Benin	<b>IE</b>	Ireland	<b>MR</b>	Mauritania	<b>UA</b>	Ukraine
<b>BR</b>	Brazil	<b>IL</b>	Israel	<b>MW</b>	Malawi	<b>UG</b>	Uganda
<b>BY</b>	Belarus	<b>IS</b>	Iceland	<b>MX</b>	Mexico	<b>US</b>	United States of America
<b>CA</b>	Canada	<b>IT</b>	Italy	<b>NE</b>	Niger	<b>UZ</b>	Uzbekistan
<b>CF</b>	Central African Republic	<b>JP</b>	Japan	<b>NL</b>	Netherlands	<b>VN</b>	Viet Nam
<b>CG</b>	Congo	<b>KE</b>	Kenya	<b>NO</b>	Norway	<b>YU</b>	Yugoslavia
<b>CH</b>	Switzerland	<b>KG</b>	Kyrgyzstan	<b>NZ</b>	New Zealand	<b>ZW</b>	Zimbabwe
<b>CI</b>	Côte d'Ivoire	<b>KP</b>	Democratic People's Republic of Korea	<b>PL</b>	Poland		
<b>CM</b>	Cameroon	<b>KR</b>	Republic of Korea	<b>PT</b>	Portugal		
<b>CN</b>	China	<b>KZ</b>	Kazakstan	<b>RO</b>	Romania		
<b>CU</b>	Cuba	<b>LC</b>	Saint Lucia	<b>RU</b>	Russian Federation		
<b>CZ</b>	Czech Republic	<b>LI</b>	Liechtenstein	<b>SD</b>	Sudan		
<b>DE</b>	Germany	<b>LK</b>	Sri Lanka	<b>SE</b>	Sweden		
<b>DK</b>	Denmark	<b>LR</b>	Liberia	<b>SG</b>	Singapore		
<b>EE</b>	Estonia						

## METHOD OF EXTRACTING LIPIDS FROM MARINE AND AQUATIC ANIMAL TISSUES

### BACKGROUND OF THE INVENTION

5 This invention relates to the extraction of lipid fractions from marine and aquatic animals such as krill, *Calanus*, fish and sea mammals. More specifically, this invention relates to an improved method of extracting lipid fractions by dehydration with solvents and recovering a solid residue rich in active enzymes.

10 Lipid fractions obtained from marine and aquatic animals such as krill, *Calanus*, fish and sea mammals have various applications:

#### Medical applications

15 Marine and aquatic animal oils and fractions thereof contain various therapeutic agents. For example, it is reported that various marine and aquatic animal oils have anti-inflammatory properties. Marine and aquatic animal oils are also reported as helpful in reducing the incidence of cardiovascular disease. Also, some marine and aquatic animal oils are reported as suppressing the development of certain forms of lupus and renal diseases. As a further example, krill may be used as a source of enzymes for debridement of ulcers and wounds or to facilitate food digestion. Also  
20 marine and aquatic oils contain various antioxidants, which may have potential therapeutic properties.

#### Nutraceuticals

25 Considering the beneficial effects of omega-3 fatty acids, oils from krill, *Calanus* and fish could be used as dietary supplements to human diet. These fatty acids are essential for proper development of the brain and the eye. Marine and aquatic animal oils are also rich in liposoluble vitamins A, D and E and carotenoids.

#### Cosmetics

Various marine and aquatic animal oils are used for the production of moisturizing creams.

### Fish farming

Among the lipids found in krill, *Calanus* and fish, high concentrations of fatty acids 20:5 (eicosapentaenoic acid) and 22:6 (docosahexaenoic acid) are present. These fatty acids are essential nutrients and are beneficial as fish feed. Furthermore, these essential nutrients are carried over in human diet by eating the fish grown on such diets.

### Animal feed

Animal feed diets rich in omega-3 fatty acids may increase the level of unsaturated fatty acids and decrease cholesterol levels of meat. This property is already exploited in the poultry industry to improve the quality of eggs.

Various methods for extracting marine and aquatic animal oils are known. For example, it is known to extract fish oil using organic solvents such as hexane and ethanol. It is also known to measure the fat content in fish muscle tissue using solvents such as acetone.

USP 4,331,695 describes a method using pressurized solvents which are gaseous at room temperature, such as propane, butane or hexane. The extraction is performed at preferred temperatures of 15 to 80°C on shredded vegetable or finely divided animal products. The extracted oils are then made to precipitate under high pressure and elevated temperatures of 50 to 200°C. However, hexane is a poor extraction solvent for marine animals such as krill. Furthermore, the high temperatures used in the precipitation step negatively alters the lipids.

Canadian Patent Application 2,115,571 describes a method for extracting oils from various brown and red algae species. The method provides for example Soxhlet extraction using nearly pure ethanol for 40 hours.

USP 5,006,281 describes a method for extracting oil from marine and aquatic animals such as fish. The marine and aquatic animal is first treated with an antioxidant compound, finely divided and centrifuged to separate the oil phase from



the aqueous phase and solid phase. The oil phase is then further treated with antioxidant to remove undesirable odour or taste.

Canadian Patent 1,098,900 describes a method for extracting oils from krill. The method involves emulsifying fresh or defrosted krill in an aqueous medium. The oil fraction is recovered by centrifugation.

Folch in the article published in the year 1957 in J. biol. Chem. 226: 497-509 "A simple method for the isolation and purification of total lipids from animal tissues" proposes an extraction method using chloroform and methanol. This method is not commercially feasible because of the toxicity of the solvents involved.

However, prior art processes are generally commercially unfeasible or provide low quantitative yields. Thus, it is an object of the present invention to provide an improved marine and aquatic animal oil extraction method allowing recovery of a valuable lipid fraction and separate recovery of a valuable protein rich solid residue that comprises active enzymes.

Other objects and further scope of applicability of the present invention will become apparent from the detailed description given hereinafter. It should be understood, however, that this detailed description, while indicating preferred embodiments of the invention, is given by way of illustration only, since various changes and modifications within the spirit and scope of the invention will become apparent to those skilled in the art.

#### **BRIEF DESCRIPTION OF THE DRAWINGS**

Figure 1. Gas-liquid chromatography of fatty acids from dry krill (chloroform-methanol)

Figure 2. Gas-liquid chromatography of fatty acids from dry krill (acetone)

Figure 3. Gas-liquid chromatography of fatty acids from frozen krill (acetone)

Figure 4. Gas-liquid chromatography of fatty acids from frozen krill (ethanol)

Figure 5. Gas-liquid chromatography of fatty acids from frozen krill (*t*-butanol)

Figure 6. Gas-liquid chromatography of fatty acids from frozen krill (ethyl acetate)

Figure 7. Thin-layer chromatography of neutral lipids of *Calanus* sp. and *M. norvegica*

5 Figure 8. Thin-layer chromatography of neutral lipids of *E. pacifica*

Figure 9. Thin-layer chromatography of neutral lipids of *M. schmitti*

Figure 10. Thin-layer chromatography of neutral lipids of *G. galeus*

Figure 11. Thin-layer chromatography of neutral lipids of Angel Shark

Figure 12. Thin-layer chromatography of phospholipids of *Calanus* sp. and  
10 *M. norvegica*

Figure 13. Thin-layer chromatography of phospholipids of *E. pacifica*

Figure 14. Thin-layer chromatography of phospholipids of *M. schmitti*

Figure 15. Thin-layer chromatography of phospholipids of *G. galeus*

Figure 16. Thin-layer chromatography of phospholipids of Angel Shark

15 Figure 17. Influence of the volume of acetone on lipid extraction (*E. pacifica*)

Figure 18. Influence of incubation time in acetone on lipid extraction  
(*E. pacifica*)

Figure 19. Influence of the volume of ethanol on lipid extraction (*E. pacifica*)

Figure 20. Influence of incubation time in ethanol on lipid extraction  
20 (*T. raschii*)

### **DETAILED DESCRIPTION OF THE PREFERRED EMBODIMENT**

Before describing the present invention in detail, it is to be understood that the invention is not limited in its application to the process details described herein. The  
25 invention is capable of other embodiments and of being practised in various ways. It is also to be understood that the phraseology or terminology used herein is for the purpose of description and not limitation.

The method of the invention comprises suspending freshly collected marine and  
30 aquatic material in acetone. Lipids are extracted with a ketone such as acetone. This allows a rapid dehydration of animal tissue and a migration of the lipid fraction to the solvent. The dry residue is a valuable product rich in active enzymes.

In a preferred embodiment, the extraction is carried out by successive acetone and alcohol treatments. Preferred alcohols are isopropanol, and *t*-butanol. The alcohol may also be substituted with an ester of acetic acid such as ethyl acetate. The procedure produces two successive lipid fractions and a dry residue enriched in protein, including active enzymes. Recovery of total lipids is comparable to the Folch et al. (1957) procedure reported in the background of the invention. It has been tested with krill, *Calanus*, fish and shark tissues.

Surprisingly, it was found that successive extraction treatments as proposed by the present invention has a better yield in lipid extraction than single solvent system extractions. The extraction using two successive solvents which starts with a ketone such as acetone is especially advantageous since the acetone, in effect, dehydrates the animal tissue. Having the animal tissue in dehydrated form greatly facilitates the extraction process with the second solvent, alcohol or an ester of acetic acid such as ethyl acetate.

In the case of zooplankton such as krill and *Calanus* and in the case of fish-filleting by-products such as fish viscera, it is noted that extraction with acetone alone may be sufficient to allow a cost-effective recovery of lipid fractions and separate recovery of a dry solid product rich in proteins including active enzymes.

The general extraction method of the present invention will now be described. The starting material consisting of freshly harvested and preferably finely divided marine and aquatic animal material is subjected to acetone extraction, for at about two hours and preferably overnight. However extraction time is not critical to the yield of lipid extraction. To facilitate extraction, it is preferable to use particles of less than 5mm in diameter. Extraction is preferably conducted under inert atmosphere and at a temperature in the order of about 5°C or less.

Preferably, the beginning of the extraction will be conducted under agitation for about 10 to 40 minutes, preferably 20 minutes. Although extraction time is not critical, it

was found that a 2 hour extraction with 6:1 volume ratio of acetone to marine and aquatic animal material is best.

5 The solubilized lipid fractions are separated from the solid material by standard techniques including, for example, filtration, centrifugation or sedimentation. Filtration is preferably used.

10 After separation by filtration on an organic solvent resistant filter (metal, glass or paper) the residue is optionally washed with pure acetone, preferably two volumes (original volume of material) to recover yet more lipids. The combined filtrates are evaporated under reduced pressure. Optionally, flash evaporation or spray drying may be used. The water residue obtained after evaporation is allowed to separate from the oil phase (fraction I) at low temperature.

15 The solid residue collected on the filter is suspended and extracted with alcohol, such as ethanol, isopropanol, *t*-butanol or alternatively with ethyl acetate, preferably two volumes (original volume of material). The filtrate is evaporated leaving a second fraction of lipids (identified as fraction II). Although the extraction period is not critical, it was found that an extraction time of about 30 minutes is sufficient at  
20 temperatures below about 5°C.

Temperature of the organic solvents, except *t*-butanol, and temperature of the sample are not critical parameters, but it is preferable to be as cold as possible. However, in the case of *t*-butanol which is solid at room temperature, it is important  
25 to warm it before using it and to perform the extraction at 25 °C immediately.

#### Comparative examples

30 To compare the efficiency of the extraction process, a classical technique (Folch et al. 1957) using chloroform and methanol was applied to krill. This method is the reference for measuring efficiency of the extraction process. Another comparison has been made with a technique using hexane as the extraction solvent. Lipid recovery

was estimated by suspending lipid fractions in small volumes of their original solvents and measuring by gravimetry small aliquots after evaporation.

5 For all examples provided herein, the method of the present invention involving acetone extraction followed by extraction with a second solvent (ethyl acetate, for example) gave a translucent oil having appearance and properties more attractive than any oil obtained by the classical technique of Folch et al. (1957).

10 To analyze lipid composition, 780 µg of each extract was loaded on silica-gel plates and fractionated by thin layer chromatography, TLC (Bowyer et al. 1962) with the following solvents. Neutral lipids: hexane, ethyl ether, acetic acid (90:10:1, v/v) and phospholipids: chloroform, methanol, water (80:25:2, v/v). Fatty acid composition of *E. pacifica* was analyzed by gas liquid chromatography, GLC (Bowyer et al. 1962, see bibliography) including some modifications to the original technique: 2h at 65°C  
15 instead of 1h at 80°C, three washes with hexane instead of two and no wash with water.

To get rid of traces of organic solvents, lipid fractions I and II are warmed to about 125°C for about 15 minutes under inert atmosphere.

20 Fat was analyzed according to the American Oil Chemist's Society (AOCS). The following criteria have been used to analyze the lipids extracted: saponification and Wijs iodine indexes and moisture-volatile matter levels. Cholesterol content has also been determined by the method of Plummer 1987 (see bibliography). The same  
25 analyzes and others have been made by an independent laboratory under Professor Robert Ackman's supervision (Canadian Institute of Fisheries Technology, DalTech, Dalhousie University, Halifax, Nova Scotia, Canada). This includes Wijs iodine index, peroxide and anisidine values, lipid class composition, fatty acid composition, free fatty acid FAME, cholesterol, tocopherol, all-*trans* retinol, cholecalciferol,  
30 asthaxanthin and canthaxantin contents.

Table 1 shows that higher levels of lipids are extracted from dry krill by acetone followed by ethanol as compared to the classical procedure of Folch et al. (1957).

5 Table 2 shows the results of lipid extraction from frozen *Euphausia pacifica*, a species of krill from Pacific Ocean. Assuming an eighty percent content of water, the lipid content is comparable to dry krill as shown in Table 1. Isopropanol, *t*-butanol and ethyl acetate, as solvent for the second extraction, give a yield less important than ethanol, but are not necessarily less effective in lipid recovery since ethanol carries more impurities than isopropanol, *t*-butanol or ethyl acetate. Then, they can  
10 be used as second solvent after acetone as well. Variations between results from acetone extractions are mainly due to the water-oil separations. These separations are influenced by the quantity of residual acetone in the water-oil solution after acetone evaporation. This quantity of acetone varies from an experiment to another, because the evaporation system used at a small scale is less reproducible (at the  
15 industrial scale, the evaporation step will be optimized). Single solvents have also been tested to extract the totality of lipids from krill. This shows that ethyl acetate (1,37% extraction rate), as hexane (0,23% extraction rate) are not good solvents, compared to acetone alone (1,86% extraction rate, and even greater extraction rates with an efficient acetone evaporation system).

20

One of the main advantages of the procedure is the removal of bacteria from extracts (lipid fraction and solid protein-rich material). Indeed, samples of *E. pacifica* incubated in different ratios of acetone at 4°C for 112 days have been inoculated on NA medium containing Bacto™ beef extract 0,3%, Bacto™ peptone 0,5% and Bacto™  
25 agar 1,5% (Difco Laboratories, Detroit, USA) then incubated at room temperature or 4°C for 18 days. No significant bacterial growth was observed at a ratio of 1 volume of acetone per gram of krill. At higher proportions of acetone (2 volumes and 5 volumes), there was no bacterial growth at all, which means that acetone preserves krill samples. Acetone is known as an efficient bactericidal and viricidal agent  
30 (Goodman et al. 1980).

Table 3 shows the yield of lipids from *M. norvegica*. The percentage of lipids (3,67%) is comparable to the one obtained with *E. pacifica* (3,11%) shown in Table 2. Variations can be attributable to diet and time (season) of collection, which are different for those two species.

5

Table 4 shows the influence of grinding on the efficiency of extraction of *M. norvegica* lipids. These extractions were carried out under optimal conditions and show the definite advantage of the procedure over the classical method (4,46 % versus 3,30 %). It also shows that grinding may be an important factor when the species is large (4,46% versus 3,53 %).

10

Table 5 reports on lipid extraction from *Calanus*. Considerable quantities of lipids were obtained. Some variations in *Calanus* species composition may explain the variations between experiments 1 and 2 (8,22 % and 10,90 % of fresh weight).

15

Tables 6-8 report the total amount of lipids extracted from fish tissue. The method of the present invention was demonstrated on mackerel, trout and herring. The method was demonstrated on peripheral tissues (mainly muscles) and viscera. Advantageously, the present method would permit the recovery of valuable lipid fractions from parts of fish that are usually wasted after the withdrawal of fillets of the fish. Those fish tissues not used after the transformation of the fish for human consumption could be stored in acetone, and lipids extracted therefrom in accordance with the present invention even if the method Folch [1957] recovers more lipid than our method. Indeed small amounts of lipids from mackerel (0.52% from viscera and 1,45% from tissues) have been extracted by the method of Folch after a first extraction with acetone and ethanol as described in the present invention. Comparative extractions with the method described in the present invention carried out in parallel with the method of Folch on trout and herring show superior recovery with the latter. However, it is noteworthy that the Folch method can not be applied for the recovery of lipids for commercial uses (because of toxicity).

20

25

30

In Tables 9 to 11, are shown results of lipids extraction from shark liver tissues. There is no marked difference in results between techniques within a species. Table 12 shows the fatty acid composition of krill oil (*e. pacifica*) following extraction in various solvents.

5

Tables 13 shows some characteristics features of fraction I (acetone) and fraction II (alcohol or ethyl acetate) for krill oil (*e. pacifica*). First, the saponification index of fraction I (130,6) indicates that this fraction contains fatty acids with longer chains, compared to fraction II (185,7). The Wijs iodine index of fraction I shows that this

10

fraction contains high levels of polyunsaturated fatty acids. As compared to olive oil which has an index of 81.1. It explains why fraction I is liquid at room temperature. It is well known that unsaturated fatty acids have a fusion point inferior to the one of their saturated homologues. The same observations are made for fraction II which has a iodine index of 127,2. The fatty acid composition shown in Table 12 corroborates these iodine indexes: fraction I has a high percentage (30,24%) of polyunsaturated fatty acids (pentaenes+hexaenes) and so fraction II (22,98%). Finally, Table 13 shows also that fraction I is comprised of 10,0% of volatile matter and humidity after evaporation of the solvent. For the same test, the fraction II gives a value of 6,8%. To get rid of traces of solvents, it is important to briefly heat (to

15

20

Results on krill oils obtained in accordance with the method of the present invention (fraction I extracted with acetone and fraction II extracted with ethyl acetate) are provided in Tables 13, 14, 15, 16, 17 and 18. It is noteworthy to mention that in

25

30



(astaxanthin and canthaxanthin). These compounds are indicative of favourable pharmaceutical or cosmetological properties of the krill extract whereby high levels of carotenoids indicate excellent transdermal migration characteristics. Thus, krill extract is a good candidate for transdermal delivery of medicines.

5

Table 19 shows the best mode of the method in accordance with the present invention for lipid extraction of aquatic animal tissues.

10

Table 20 shows that the enzyme activity of the solid fraction is maintained following the method of the present invention. Indeed, the demonstration was completed for solid krill residue obtained after successive acetone and ethyl acetate extraction. Proteolytic activities were measured by the liberation of amino groups by spectrophotometric assay using o-phthalaldehyde as reagent. Protein concentrations were measured by the Bradford method. Soluble proteins were extracted with water and added to a 10% lactoserum protein concentrate obtained by ultrafiltration. At the end of incubation at 37°C in 50mM potassium phosphate buffer, trichloroacetic acid was added and the amount of NH<sub>3</sub> group was measured in the supernatant according to the method of Church et al. [1983, J Dairy Sci 66: 1219-1227].

20

Figures 1 to 6 show chromatograms of fatty acid composition of *E. pacifica* lipids. On each of them, high proportions of 20:5 and 22:6 fatty acids (characteristic of marine and aquatic oils) are noticeable and represented by two distinct peaks. Data are shown in Table 12.

25

Variations in lipid patterns of neutral lipids (from Figure 7 to Figure 11) from one species to another are attributable to the differences in food sources. Within a species (*E. pacifica*, for example) there is no marked variation between lipid patterns obtained from different techniques of lipid extraction. Concerning phospholipids (Figure 12 to Figure 16), the opposite is observed: variations are explained by the different extraction processes of lipids since the same species do not lead to the same lipid pattern. Lipids from shark species (extracted by the mentioned methods)

30

and commercial cod-liver oil (sample available from Uniprix drugstores, Province of Québec, Canada) are mainly composed of neutral lipids as opposed to phospholipids.

5 The influence of the volume of solvent and incubation time on the efficiency of the acetone to extract lipids from *E. pacifica* is illustrated in Figures 17 and 18, respectively. A ratio of 1:6 (w/v) produced optimal yield with near complete extraction after 2h. The second extraction step has been experimented with ethanol. The volume of this solvent does not appear to be critical since the same yield was  
10 obtained with different volumes of ethanol (Figure 19), but incubations time in ethanol should be at least 30 minutes as indicated by the results on Figure 20.

One of the inventors, Dr. Adrien Beaudoin, has ingested the different lipid fractions of krill. No side effect profile was observed.

15 Although the invention has been described above with respect with one specific form, it will be evident to a person skilled in the art that it may be modified and refined in various ways. It is therefore wished to have it understood that the present invention should not be limited in scope, except by the terms of the following claims.

20 Demonstration that krill residue, obtained after acetone and ethyl acetate extraction, contains enzyme proteolytic activities. Proteolytic activities were measured by the liberation of amino groups by spectrophotometric assay using *o*-phthaldialdehyde as reagent. Protein concentrations were measured by the Bradford method.

25 The enzyme source was the residue obtained after acetone and ethyl acetate extractions of lipids. Soluble proteins were extracted with water and added to a 10% lactoserum protein concentrate obtained by ultrafiltration.

30 At the end of incubation at 37°C in 50 mM potassium phosphate buffer, trichloroacetic acid was added and the amount of NH<sub>3</sub> groups were measured in the supernatant according to Church and al. 1983.

**BIBLIOGRAPHY**

- 5 Bowyer, D.E., Leat, W.M.F., Howard, A.N. and Gresham, G.A. 1962. The determination of the fatty acid composition of serum lipids separated by thin-layer chromatography; and a comparison with column chromatography. BBA. 70: 423-431.
- 10 Chandrasekar, B., Troyer, D.A., Venkatraman, J.T. and Fernandes, G. 1996. Tissue specific regulation of transforming growth factor beta by omega-3 lipid-rich krill oil in autoimmune murine lupus. Nutr Res. 16(3): 489-503.
- 15 Christensen, M.S., Hoy, C-E. and Redgrave, T.G. 1994. Lymphatic absorption of *n*-3 polyunsaturated fatty acids from marine oils with different intramolecular fatty acid distributions. BBA. 1215: 198-204.
- 20 Church, F.C., Swaisgood, H.E., Porter, D.H. and Catignani, G.L. 1983. Spectrophotometric assay using *o*- Phthaldialdehyde for determination of proteolysis in milk and isolated milk proteins. J Dairy Sci. 66: 1219-1227.
- 25 Difco laboratories. 1984. Difco Manual Dehydrated Culture Media and Reagents for Microbiology. 10<sup>th</sup> ed. Detroit.
- 30 Folch, J., Lees, M. and Sloane-Stanley, G.H. 1957. A simple method for the isolation and purification of total lipids from animal tissues. J. biol. Chem. 226: 497-509.
- 35 Goodman Gilman, A., Goodman, L.L. and Gilman, A. 1980. The Pharmacological Basis of Therapeutics. 6<sup>th</sup> ed. Collier Macmillan Canada Ltd, Toronto.
- 40 Harwood, H.J. and Geyer, R.P. 1964. Biology Data Book. The Federation of American Societies for Experimental Biology, Washington.
- 45 Hellgren, L., Karlstam, B., Mohr, V. and Vincent, J. 1991. Krill enzymes. A new concept for efficient debridement of necrotic ulcers. Int J Dermatol. 30(2): 102-103

Plummer, D.T. 1987. An introduction to practical biochemistry. 3<sup>th</sup> ed. McGraw-Hill Book Company, London.

Rawn, J.D. 1990. Traité de biochimie. De Boeck-Wesmael, Bruxelles.

5

Runge, J.A. and Joly, P. 1994. Rapport sur l'état des invertébrés en 1994: 7:0 Zooplancton (Euphausiacés et *Calanus*) de l'Estuaire et du Golfe du Saint-Laurent.

Sargent, J.R. 1997. Fish oils and human diet. Br J Nutr.78 Suppl 1: S5-S13.

10

**TABLE 1. EXTRACTION OF DRY KRILL LIPIDS (*E. pacifica*)**

<u>Exp. No.</u>	<u>Technique</u>	<u>Yield (%)</u>	<u>Total (%)</u>	<u>Mean (%) ± s.d.</u>
5	acetone <sup>a)</sup> ethanol <sup>b)</sup>	8,00	<b>15,60</b>	<b>20,49±3,95</b>
		7,60		
10	"	19,70	<b>26,60</b>	
		6,90		
15	"	8,15	<b>19,35</b>	
		11,20		
20	"	6,80	<b>20,40</b>	
		13,60		
5-	chlor : MeOH <sup>c)</sup>		<b>15,50</b>	
6-	"		<b>14,90</b>	
				<b>15,20±0,30</b>

Determinations in triplicates (variation < 5 %).

<sup>a)</sup> :Extraction made with a sample-solvent ratio of 1:9 (w/v), no incubation.

<sup>b)</sup> :Extraction made with a sample-solvent ratio of 1:4 (w/v), incubated 1 night at 4°C, following a first extraction with acetone.

<sup>c)</sup> :Folch et al. 1957.

**TABLE 2. EXTRACTION OF FROZEN KRILL LIPIDS (*E. pacifica*)**

<u>Exp. No.</u>	<u>Technique</u>	<u>Yield (%)</u>	<u>Total (%)</u>	<u>Mean (%) ± s.d.</u>
35	acetone <sup>a)</sup> ethanol <sup>b)</sup>	1,17	<b>2,40</b>	<b>3,11±0,91</b>
		1,23		
40	"	3,05	<b>4,14</b>	
		1,09		
45	"	1,53	<b>2,79</b>	
		1,26		
50	acetone <sup>a)</sup> isopropanol <sup>b)</sup>	2,45	<b>3,15</b>	
		0,70		
50	"	1,80	<b>2,60</b>	
		0,80		
50	"	1,60	<b>2,40</b>	
		0,80		
				<b>2,72±0,39</b>

**TABLE 2 (continued). EXTRACTION OF FROZEN KRILL LIPIDS (*E. pacifica*)**

	<u>Exp. No.</u>	<u>Technique</u>	<u>Yield (%)</u>	<u>Total (%)</u>	<u>Mean (%) ± s.d.</u>
5	7-	acetone <sup>a)</sup> <i>t</i> -butanol <sup>c)</sup>	2,15 0,47	<b>2,62</b>	
10	8-	"	2,11 0,40	<b>2,51</b>	
	9-	"	2,37 0,45	<b>2,82</b>	
15	10-	acetone <sup>a)</sup> ethyl acetate <sup>b)</sup>	2,28 0,21	<b>2,49</b>	<b>2,65±0,16</b>
20	11-	"	1,09 0,16	<b>1,25</b>	
	12-	"	2,54 0,09	<b>2,63</b>	<b>2,12±0,76</b>
25	13-	combined acetone-ethanol <sup>d)</sup>		<b>3,28</b>	
	14-	"		<b>3,02</b>	
30	15-	"		<b>3,25</b>	<b>3,18±0,14</b>
	16-	ethyl acetate <sup>e)</sup>		<b>1,32</b>	
35	17-	"		<b>1,49</b>	
	18-	"		<b>1,31</b>	<b>1,37±0,10</b>
40	19-	hexane <sup>e)</sup>		<b>0,31</b>	
	20-	"		<b>0,18</b>	
	21-	"		<b>0,20</b>	
45	22-	chlor:MeOH <sup>f)</sup>		<b>2,37</b>	<b>0,23±0,07</b>

**TABLE 2 (continued). EXTRACTION OF FROZEN KRILL LIPIDS (*E. pacifica*)**

<u>Exp. No.</u>	<u>Technique</u>	<u>Yield (%)</u>	<u>Total (%)</u>	<u>Mean (%) ± s.d.</u>
5	23-	"	<b>2,07</b>	
	24-	"	<b>2,62</b>	
				<b>2,35±0,28</b>

10 Determinations in triplicates (variation < 5 %).

a) :Extraction made with a sample-solvent ratio of 1:6 (w/v), incubated 2 h at 4°C.

b) :Extraction made with a sample-solvent ratio of 1:2 (w/v), incubated 30 min at 4°C, following a first extraction with acetone.

15 c) :Extraction made with a sample-solvent ratio of 1:2 (w/v), incubated 30 min at 25°C, following a first extraction with acetone.

d) :Extraction made with a sample-acetone-ethanol ratio of 1:5:5 (w/v/v), incubated 2 h at 4°C.

e) :Extraction made with a sample-solvent ratio of 1:9 (w/v), incubated 2 h at 4°C.

f) : Folch et al. 1957.

20

**TABLE 3. EXTRACTION OF FROZEN KRILL LIPIDS(*M. norvegica*)**

<u>Exp. No.</u>	<u>Technique</u>	<u>Yield (%)</u>	<u>Total (%)</u>	<u>Mean (%) ± s.d.</u>
25	1-	acetone <sup>a)</sup>	1,82	
		ethanol <sup>b)</sup>	1,82	<b>3,64</b>
	2-	"	1,15	
			2,35	<b>3,50</b>
30	3-	"	1,68	
			2,19	<b>3,87</b>
				<b>3,67±0,15</b>

35 Determinations in triplicates (variation < 5 %).

a) :Extraction made with a sample-solvent ratio of 1:9 (w/v), incubated 1 night at 4°C.

b) :Extraction made with a sample-solvent ratio of 1:4 (w/v), incubated 1 h at 4°C, following a first extraction with acetone.

**TABLE 4. INFLUENCE OF GRINDING ON EXTRACTION OF FROZEN KRILL LIPIDS (*M. norvegica*)**

Exp. No.	Technique	Krill ground before 1 <sup>st</sup> extraction	Yield (%)	Total (%)
5	acetone <sup>a)</sup> ethanol <sup>b)</sup>	yes	3,10 1,07	4,17
10		no	2,14 1,39	3,53
	"	yes	3,32 1,14	4,46
15	chlor : MeOH <sup>c)</sup>	yes		3,30
	"	yes		3,26

Determinations in triplicates (variation < 5 %).

- 20 <sup>a)</sup> :Extraction made with a sample-solvent ratio of 1:6, incubated 2 h at 4°C.
- <sup>b)</sup> :Extraction made with a sample-solvent ratio of 1:2, incubated 30 min at 4°C, following a first extraction with acetone.
- <sup>c)</sup> :Folch et al. 1957.

**TABLE 5. EXTRACTION OF FROZEN *Calanus* LIPIDS (*Calanus* sp.)**

Exp. No.	Technique	Yield (%)	Total (%)	Mean (%) ± s.d.
30	acetone <sup>a)</sup> ethanol <sup>b)</sup>	6,18 2,04	<b>8,22</b>	<b>9,56±1,34</b>
		8,64 2,26		
35	"			

Determinations in triplicates (variation < 5 %).

- 40 <sup>a)</sup> :Extraction made with a sample-solvent ratio of 1:9 (w/v), incubated 1 night at 4°C.
- <sup>b)</sup> :Extraction made with a sample-solvent ratio of 1:4 (w/v), incubated 1 h at 4°C, following a first extraction with acetone.



**TABLE 6. EXTRACTION OF FRESH FISH LIPIDS (Mackerel)**

<u>Exp. No.</u>	<u>Technique</u>	<u>Yield (%)</u>	<u>Total (%)</u>
5	1- viscera fish 1	acetone <sup>a)</sup> ethanol <sup>b)</sup>	6,11 0,59 <b>6,70</b>
	2- tissues fish 1	"	3,78 0,91 <b>4,69</b>
10	3- viscera fish 2	"	10,46 0,57 <b>11,03</b>
15	4- issues fish 2	"	6,65 1,41 <b>8,06</b>
	5- viscera fish 3	"	8,39 0,66 <b>9,05</b>
20	6- tissues fish 3	"	5,27 0,97 <b>6,24</b>
	7- viscera fish 4	"	8,47 0,69 <b>9,16</b>
25	8- tissues fish 4	"	8,40 1,02 <b>9,42</b>
30	9- viscera fish 1	chlor:MeOH <sup>c)</sup>	<b>0,52</b>
	10- tissues fish 1	"	<b>1,45</b>

35 <sup>a)</sup>:Extraction made with a sample-solvent ratio of 1:9 (w/v), incubation time:

- fish 1 viscera: 4h, fish 1 tissues: 23h
- fish 2 viscera: 23h45, fish 2 tissues: 45h30
- fish 3 viscera: 8 days 2h20, fish 3 tissues: 8 days 22h30
- fish 4 viscera: 17 days 23h, fish 4 tissues: 18 days 2h25.

40 <sup>b)</sup>:Extraction made with a sample-solvent ratio of 1:4 (w/v), incubated 1h at 4°C, following a first extraction with acetone.

<sup>c)</sup>:Folch et al. 1957, following extractions with acetone, then ethanol.

**TABLE 7. EXTRACTION OF FRESH FISH LIPIDS (Trout)**

<u>Exp. No.</u>	<u>Technique</u>	<u>Yield (%)</u>	<u>Total (%)</u>
5	1- viscera	acetone <sup>a)</sup> ethanol <sup>b)</sup>	34,70 2,18 <b>36,88</b>
	2- tissues	"	5,53 1,17 <b>6,70</b>
10	3- viscera	chlor:MeOH <sup>c)</sup>	<b>39,81</b>
	4- tissues	"	<b>14,93</b>

15 Determinations in triplicates (variation < 5 %).

<sup>a)</sup> :Extraction made with a sample-solvent ratio of 1:9 (w/v), incubated 1 night at 4°C.

<sup>b)</sup> :Extraction made with a sample-solvent ratio of 1:4 (w/v), incubated 1 h at 4°C, following a first extraction with acetone.

<sup>c)</sup> :Folch et al. 1957.

20

**TABLE 8. EXTRACTION OF FRESH FISH LIPIDS (Herring)**

<u>Exp. No.</u>	<u>Technique</u>	<u>Yield (%)</u>	<u>Total (%)</u>
25	1-tissues and viscera	acetone <sup>a)</sup> ethanol <sup>b)</sup>	2,09 0,68 <b>2,77</b>
30	2-tissues and viscera	chlor:MeOH <sup>c)</sup>	<b>5,95</b>

Determination in triplicates (variation < 5 %).

<sup>a)</sup> :Extraction made with a sample-solvent ratio of 1:9 (w/v), incubated 1 night at 4°.

<sup>b)</sup> :Extraction made with a sample-solvent ratio of 1:4 (w/v), incubated 1 h at 4°C, following a first extraction with acetone.

<sup>c)</sup> :Folch et al. 1957.

35

**TABLE 9. EXTRACTION OF FRESH SHARK LIVER LIPIDS (M. schmitti)**

<u>Exp. No.</u>	<u>Technique</u>	<u>Yield (%)</u>	<u>Total (%)</u>
40	1-	acetone <sup>a)</sup> ethyl acetate <sup>b)</sup>	36,39 4,48 <b>40,87</b>
45	2-	ethyl acetate <sup>c)</sup>	<b>36,68</b>
	3-	chlor : MeOH <sup>d)</sup>	<b>41,86</b>

Determinations in triplicates (variations <5 %).

<sup>a)</sup> :Extraction made with a sample-solvent ratio of 1:9 (w/v), incubated 2h at 4°C.

<sup>b)</sup> :Extraction made with a sample-solvent ratio of 1:2 (w/v), incubated 30 min at 4°C, following a first extraction with acetone.

<sup>c)</sup> :Extraction made with a sample-solvent ratio of 1 :9 (w/v), incubated 2h at 4°C.

<sup>d)</sup> :Folch et al. 1957.

50

**TABLE 10. EXTRACTION OF FRESH SHARK LIVER LIPIDS (*G. galeus*).**

<u>Exp. No.</u>	<u>Technique</u>	<u>Yield (%)</u>	<u>Total (%)</u>
5	1- acetone <sup>a)</sup>	21,39	<b>26,66</b>
	ethyl acetate <sup>b)</sup>	5,27	
	2- ethyl acetate <sup>c)</sup>		<b>25,89</b>
10	3- chlor : MeOH <sup>d)</sup>		<b>29,99</b>

Determinations in triplicates (variations <5 %).

<sup>a)</sup> :Extraction made with a sample-solvent ratio of 1:9 (w/v), incubated 2h at 4°C.

<sup>b)</sup> :Extraction made with a sample-solvent ratio of 1:2 (w/v), incubated 30 min at 4°C, following a first extraction with acetone.

<sup>c)</sup> :Extraction made with a sample-solvent ratio of 1 :9 (w/v), incubated 2h at 4°C.

<sup>d)</sup> :Folch et al. 1957.

**TABLE 11. EXTRACTION OF FRESH SHARK LIVER LIPIDS (Angel Shark)**

<u>Exp. No.</u>	<u>Technique</u>	<u>Yield (%)</u>	<u>Total (%)</u>
25	1- acetone <sup>a)</sup>	19,23	<b>28,21</b>
	ethyl acetate <sup>b)</sup>	8,98	
	2- ethyl acetate <sup>c)</sup>		<b>39,22</b>
30	3- chlor : MeOH <sup>d)</sup>		<b>39,23</b>

Determinations in triplicates (variations <5 %).

<sup>a)</sup> :Extraction made with a sample-solvent ratio of 1:9 (w/v), incubated 2h at 4°C.

<sup>b)</sup> :Extraction made with a sample-solvent ratio of 1:2 (w/v), incubated 30 min at 4°C, following a first extraction with acetone.

<sup>c)</sup> :Extraction made with a sample-solvent ratio of 1 :9 (w/v), incubated 2h at 4°C.

<sup>d)</sup> :Folch et al. 1957.

**TABLE 12. FATTY ACID COMPOSITION (*E. pacifica*)**

<u>Solvent</u>	<u>Saturated</u>	<u>Unsaturated Mono</u>	<u>Di</u>	<u>Poly</u>	<u>H-Poly</u>	<u>Unidentified</u>
chlo-meth	26.18	22.54	1.91	3.23	26.34	19.8
45 acetone	21.4	22.18	1.75	3.7	24.52	26.46
acetone	19.09	22.11	2.03	3.48	30.24	23.03
50 ethanol	28.07	22.92	2.14	3.07	27.78	16.03
t-butanol	32.63	24.96	1.86	2.86	17.86	19.83
ethyl acetate	22.68	25.77	2.17	2.88	22.98	23.51

Data expressed in percentage of total fatty acids (%).

**TABLE 13. CHARACTERISTICS OF KRILL OIL (*E. pacifica*)**

		independent laboratory <sup>a)</sup>	handbook <sup>b)</sup>
5	<u>Saponification index</u>		
	Fraction I <sup>c)</sup>	130,6	---
	Fraction II <sup>d)</sup>	185,7	---
	Olive oil	192,0 <sup>e)</sup>	189,7
10	<u>Wijs iodine index</u>		
	Fraction I <sup>c)</sup>	185,2	172,5
	Fraction II <sup>d)</sup>	127,2	139,2
15	Olive oil	85,3 <sup>e)</sup>	---
	<u>Cholesterol content (%)</u>		
	Fraction I <sup>c)</sup>	2,1	1,9
20	Fraction II <sup>d)</sup>	3,7	3,0
	Olive oil	0,2 <sup>e)</sup>	---
	<u>Volatile matter and moisture levels (%)</u>		
	Fraction I <sup>c)</sup>	10,0	---
25	Fraction II <sup>d)</sup>	6,8	---
	<u>Peroxide value (meq peroxide/kg oil)</u>		
	Fraction I <sup>c)</sup>	---	0,0
30	Fraction II <sup>d)</sup>	---	0,0
	<u>p-Anisidine value (g<sup>-1</sup> absorption)</u>		
	Fraction I <sup>c)</sup>	---	0,1
35	Fraction II <sup>d)</sup>	---	5,5

<sup>a)</sup> : Professor Robert Ackman's laboratory, Canadian Institute of Fisheries Technology, Halifax, Nova Scotia.

40 <sup>b)</sup> : Harwood and Geyer 1964.

<sup>c)</sup> : Extraction made with a sample-acetone ratio of 1:6 (w/v), incubated 2h at 4°C.

<sup>d)</sup> : Extraction made with a sample-ethyl acetate ratio of 1:2 (w/v), incubated 30 min at 4°C, following a first extraction with acetone.

<sup>e)</sup> : Extra virgin olive oil cold compressed from Bertolli <sup>TM</sup>.

45

**TABLE 14. LIPID CLASS COMPOSITION OF KRILL OIL (AREA %) (*E. pacifica*)**

<u>Triglycerides</u>		
5	Fraction I <sup>a)</sup>	19,0±0,7
	Fraction II <sup>b)</sup>	66,5± 2,3
<u>Hydrocarbons</u>		
10	Fraction I <sup>a)</sup>	trace
	Fraction II <sup>b)</sup>	1,3± 0,1
<u>Free fatty acids</u>		
15	Fraction I <sup>a)</sup>	23,7± 1,1
	Fraction II <sup>b)</sup>	20,3± 0,3
<u>Monoglycerides</u>		
20	Fraction I <sup>a)</sup>	1,4± 0,3
	Fraction II <sup>b)</sup>	0,5± 0,1
<u>Phospholipids or other polar material</u>		
25	Fraction I <sup>a)</sup>	54,1± 6,1
	Fraction II <sup>b)</sup>	8,5 ±1,6

Data from Professor Robert Ackman's laboratory, Canadian Institute of Fisheries Technology, Halifax, Nova Scotia.

30 <sup>a)</sup> : Extraction made with a sample-acetone ratio of 1:6 (w/v), incubated 2h at 4°C.

<sup>b)</sup> : Extraction made with a sample-ethyl acetate ratio of 1:2 (w/v), incubated 30 min at 4°C, following a first extraction with acetone.

**TABLE 15. FATTY ACID COMPOSITION OF KRILL OIL (WT/WT%) (*E. pacifica*)**

Fatty acids	<u>Fraction I <sup>a)</sup></u>	<u>Fraction II <sup>b)</sup></u>
40 12 :0	0,0	0,1
13 :0	0,2	0,1
ISO 14 :0	0,4	0,6
14:0	4,2	7,6
ISO 15:0	0,5	0,7
ANT 15:0	0,2	0,2
45 15:0	0,6	1,0
ISO 16:0	0,2	0,3
ANT 16:0	0,2	0,2
16:0	14,1	21,6
7MH	0,6	0,9
50 ANT 17:0	0,1	0,3
17:0	2,8	3,7
18:0	1,0	1,6
20:0	0,1	0,3
Saturates	25,2	39,2
55		

**TABLE 15 (continued). FATTY ACID COMPOSITION OF KRILL OIL (WT/WT%)  
(*E. pacifica*)**

	<u>Fatty acids</u>	<u>Fraction I <sup>a)</sup></u>	<u>Fraction II <sup>b)</sup></u>
5	14:1	0,4	0,5
	15:1	0,1	0,2
	16:1 n-7	6,6	7,8
	16:1 n-5	0,6	0,2
10	17:1	0,6	0,7
	18:1 n-9	8,0	9,8
	18:1 n-7	4,2	5,6
	18:1 n-5	0,1	0,1
	20:1 n-9	0,3	0,4
15	20:1 n-7	0,3	0,4
	20:1 n-5	0,3	0,4
	22:1 n-11 +13	0,1	0,2
	Monoenes	21,6	26,3
20	16:2 n-6	0,6	1,2
	16:2 n-4	1,3	1,3
	18:2 n-7	0,1	0,2
	18:2 n-6	2,0	1,8
	18:2 n-4	0,1	0,1
25	20:2 NMID	0,2	0,2
	20:2 n-6	0,1	0,1
	Dienes	4,4	4,9
30	16:3 n-4	1,4	1,2
	18:3 n-6	0,4	0,3
	18:3 n-4	0,2	0,2
	18:3 n-3	3,2	3,0
	18:3 n-1	0,1	0,1
35	20:3 n-3	0,1	0,1
	Trienes	5,4	4,9
	16:4 n-3	0,9	0,7
	16:4 n-1	1,0	0,8
40	18:4 n-3	9,2	7,4
	18:4 n-1	0,1	0,0
	20:4 n-6	0,7	0,5
	20:4 n-3	0,7	0,3
	Tetraenes	12,6	9,7
45	20:5 n-3	17,4	8,6
	21:5 n-3	0,7	0,5
	22:5 n-6	0,2	0,1
	22:5 n-3	0,5	0,3
50	Pentaenes	18,8	9,5

**TABLE 15 (continued). FATTY ACID COMPOSITION OF KRILL OIL (WT/WT%)  
(*E. pacifica*)**

	<u>Fatty acids</u>	<u>Fraction I <sup>a)</sup></u>	<u>Fraction II <sup>b)</sup></u>
5	22:6 n-3 Hexaenes	13,2	6,6
10	Iodine value calculated	214,8	145,1

Data from Professor Robert Ackman's laboratory, Canadian Institute of Fisheries Technology, Halifax, Nova Scotia.

<sup>a)</sup> : Extraction made with a sample-acetone ratio of 1:6 (w/v), incubated 2h at 4°C.

15 <sup>b)</sup> : Extraction made with a sample-ethyl acetate ratio of 1:2 (w/v), incubated 30 min at 4°C, following a first extraction with acetone.

**TABLE 16. KRILL LIPID FREE FATTY ACID FAME (WT/WT%) (*E. pacifica*)**

	<u>Fatty acids</u>	<u>Fraction I <sup>a)</sup></u>	<u>Fraction II <sup>b)</sup></u>
20	12:0	0,5	0,1
	13:0	0,2	0,0
25	ISO 14:0	0,2	0,2
	14:0	1,3	2,6
	ISO 15:0	0,3	0,3
	ANT 15:0	0,1	0,1
	15:0	0,2	0,5
30	ISO 16:0	0,1	0,2
	ANT 16:0	0,2	0,1
	16:0	3,3	10,6
	7MH	0,6	0,8
	ANT 17:0	0,2	0,2
35	Phytanic	0,2	0,0
	17:0	0,5	0,8
	18:0	0,2	0,6
	20:0	0,3	0,2
	22:0	0,0	0,1
40	Saturates	8,4	17,4
	14:1	0,2	0,2
	15:1	0,2	0,1
	16:1 n-9	0,5	0,0
45	16:1 n-7	5,2	6,8
	16:1 n-5+17:0	0,1	0,1
	17:1	0,6	0,7
	18:1 n-9	7,0	11,4
	18:1 n-7	4,9	9,3
50	18:1 n-5	0,1	0,3
	20:1 n-11	0,2	0,3
	20:1 n-9	0,1	0,3
	22:1 n-11+13	0,1	0,2
	24:1 n-9	0,0	0,1
55	Monoenes	19,2	29,8

**TABLE 16 (continued). KRILL LIPID FREE FATTY ACID FAME (WT/WT%) (*E. pacifica*)**

	<u>Fatty acids</u>	<u>Fraction I <sup>a)</sup></u>	<u>Fraction II <sup>b)</sup></u>
5	16:2 n-6	0,4	0,9
	16:2 n-4	1,2	1,0
	18:2 n-7	0,1	0,2
	18:2 n-6	2,4	2,6
	18:2 n-4	0,1	0,1
10	20:2 n-6	0,1	0,1
	Dienes	4,3	4,9
15	16:3 n-4+17:1	1,4	0,9
	16:3 n-3+18:0	0,2	0,5
	18:3 n-6	0,4	0,3
	18:3 n-4	0,1	0,1
	18:3 n-3	3,3	3,4
	18:3 n-1	0,1	0,1
20	20:3 n-6	0,1	0,1
	20:3 n-3	0,1	0,2
	Trienes	5,7	5,6
25	16:4 n-3	0,6	0,3
	16:4 n-1	1,0	0,6
	18:4 n-3	9,8	6,2
	18:4 n-1	0,1	0,1
	20:4n-6	1,7	1,4
30	20:4 n-3	0,6	0,5
	22:4 n-3	0,3	0,3
	Tetraenes	14,1	9,4
35	18:5 n-3	0,2	0,1
	20:5 n-3	26,4	17,4
	21:5 n-3	0,9	0,6
	22:5 n-6	0,0	0,1
	22:5 n-3	0,7	0,5
	Pentaenes	28,2	18,7
40	22:6 n-3	20,5	14,4
	Hexaenes	20,5	14,4
45	Iodine value calculated	291,6	220,3

Data from Professor Robert Ackman's laboratory, Canadian Institute of Fisheries Technology, Halifax, Nova Scotia.

<sup>a)</sup> : Extraction made with a sample-acetone ratio of 1:6 (w/v), incubated 2h at 4°C.

<sup>b)</sup> : Extraction made with a sample-ethyl acetate ratio of 1:2 (w/v), incubated 30 min at 4°C, following a first extraction with acetone.

50



**TABLE 17. TOCOPHEROL, ALL-*trans* RETINOL AND CHOLECALCIFEROL CONTENT IN KRILL OIL (*E. pacifica*)**

	<u>alpha-tocopherol by HPLC (IU)</u>	
5	Fraction I <sup>a)</sup>	0,91
	Fraction II <sup>b)</sup>	0,83
	<u>gamma-tocopherol by HPLC µg/g</u>	
10	Fraction I <sup>a)</sup>	Tr
	Fraction II <sup>b)</sup>	Tr
	<u>delta-tocopherol by HPLC µg/g</u>	
15	Fraction I <sup>a)</sup>	N.D.
	Fraction II <sup>b)</sup>	N.D.
	<u>all-<i>trans</i> retinol by HPLC (IU)</u>	
	Fraction I <sup>a)</sup>	395,57
	Fraction II <sup>b)</sup>	440,47
20	<u>cholecalciferol by HPLC (IU)</u>	
	Fraction I <sup>a)</sup>	N.D.
	Fraction II <sup>b)</sup>	N.D.

25 Data from Professor Robert Ackman's laboratory, Canadian Institute of Fisheries Technology, Halifax, Nova Scotia.

Data expressed per gram of krill oil.

<sup>a)</sup> : Extraction made with a sample-acetone ratio of 1:6 (w/v), incubated 2h at 4°C.

<sup>b)</sup> : Extraction made with a sample-ethyl acetate ratio of 1:2 (w/v), incubated 30 min at 4°C, following a first extraction with acetone.

30 TR = trace

N.D. = not detected

Conversion : Vitamin

alpha-tocopherol

mg/g oil x 1,36 = International Unit

All-*trans* retinol

µg/g ÷ 0,3 = International Unit

35

**TABLE 18. ASTAXANTHIN AND CANTHAXANTHIN CONTENT OF KRILL OIL (*E. pacifica*)**

	<u>Asthaxantin (µg/g oil)</u>	
40	Fraction I <sup>a)</sup>	93,1
	Fraction II <sup>b)</sup>	121,7
	<u>Canthaxanthin (µg/g oil)</u>	
45	Fraction I <sup>a)</sup>	270,4
	Fraction II <sup>b)</sup>	733,0

50 Data from Professor Robert Ackman's laboratory, Canadian Institute of Fisheries Technology, Halifax, Nova Scotia.

<sup>a)</sup> : Extraction made with a sample-acetone ratio of 1:6 (w/v), incubated 2h at 4°C.

<sup>b)</sup> : Extraction made with a sample-ethyl acetate ratio of 1:2 (w/v), incubated 30 min at 4°C, following a first extraction with acetone.

55

**TABLE 19. OPTIMAL CONDITIONS FOR LIPID EXTRACTION OF AQUATIC ANIMAL TISSUES (suggested procedure)**

	<u>STEP</u>	<u>CONDITIONS</u>
5	Grinding (if particles > 5mm)	4°C
	Lipid extraction	sample-acetone ratio of 1:6 (w/v) 2h (including swirling 20 min) 4°C
10	Filtration	organic solvent resistant filter under reduced pressure
15	Washing	sample-acetone ratio of 1:2 (w/v) pure and cold acetone
	Filtration	organic solvent resistant filter under reduced pressure
20	Evaporation	under reduced pressure
	Oil-water separation	4°C
25	Lipid extraction	<u>sample: ethyl acetate</u> ratio of 1:2 (w/v) <sup>a)</sup> pure <u>ethyl acetate</u> 30 min 4°C <sup>b)</sup>
30	Filtration	organic solvent resistant filter under reduced pressure
	Evaporation	under reduced pressure
35	<sup>a)</sup> : Ethanol can be replaced by isopropanol, <i>t</i> -butanol or ethyl acetate. <sup>b)</sup> : 25 °C when using <i>t</i> -butanol.	

**TABLE 20: PROTEOLYTIC ACTIVITY OF KRILL RESIDU USING LACTOSERUM AS THE SUBSTRATE, AT 37 °C, PH 7.0 FOR A RATIO ENZYME:SUBSTRATE OF 1:43**

	<u>Time (min)</u>	<u>Amino acids released (µmoles)</u>	<u>Enzymatic rate (µmoles/min)</u>	<u>Specific enzymatic activity (µmoles/min/mg*)</u>
45	15	28.76	1.917	0.164
	30	43.74	0.999	0.125
	170	98.51	0.322	0.050
	255	177.26	0.308	0.060

\* total quantity of enzymes in hydrolysis media

We claim:

1. A method for extracting lipid fractions from marine and aquatic animal material, said method comprising the steps of:
  - 5 (a) placing marine and aquatic animal material in a ketone solvent, preferably acetone to achieve extraction of the soluble lipid fraction from said marine and aquatic animal material;
  - (b) separating the liquid and solid contents;
  - 10 (c) recovering a first lipid rich fraction from the liquid contents by evaporation of the solvent present in the liquid contents;
  - (d) placing said solid contents in an organic solvent selected from the group of solvents consisting of alcohol, preferably ethanol, isopropanol or *t*-butanol and esters of acetic acid, preferably ethyl acetate to achieve extraction of the remaining soluble lipid fraction from said  
15 marine and aquatic animal material;
  - (e) separating the liquid and solid contents;
  - (f) recovering a second lipid rich fraction by evaporation of the solvent from the liquid contents;
  - 20 (g) recovering the solid contents.
2. A method as in claim 1 wherein during step (a), the solvent and animal material are homogenized.
3. A method as in claim 1 wherein during step (d), the solvent and solid contents  
25 are homogenized.
4. A method as in any of claims 1 to 3 wherein steps (b) and (d) are conducted under inert gas atmosphere.
- 30 5. A method as in any of claims 1 to 4 wherein steps (b) and (e) are effected by techniques selected from filtration, centrifugation and sedimentation.

6. A method as in any of claims 1 to 5 wherein steps (c) and (f) are effected by techniques selected from vacuum evaporation, flash evaporation and spray drying.
- 5 7. A method as in any of claims 1 to 6 wherein after step (b) and before step (c), the method additionally comprises the intervening step of washing the solid contents with the solvent and adding the resulting washing solution to the liquid contents of step (b).
- 10 8. A method as in any of claims 1 to 7 wherein after step (e) and before step (f), the method additionally comprises the intervening step of washing the solid contents with the organic solvent selected in step (d).
- 15 9. A method as in any of claims 1 to 8 wherein prior to step (a) the marine and aquatic animal material is finely divided, preferably to an average particle size of 5mm or less.
- 20 10. A method as in claims 1 to 9 wherein steps (a) and (b) are conducted at solvent temperatures of about 5°C or less.
- 25 11. A method as in claims 1 to 10 wherein said marine and aquatic animal is zooplankton.
12. A method as in claim 11 wherein said zooplankton is krill.
13. A method as in claim 12 wherein said zooplankton is *Calanus*.
- 30 14. A method as in claims 1 to 10 wherein said marine and aquatic animal is fish filleting by-products.

15. A method for extracting lipid fractions from marine and aquatic animal material selected from zooplankton and fish filleting by-products, preferably viscera, said method comprising the steps of:
- 5 (a) placing said animal material in a ketone solvent, preferably acetone to achieve extraction of the soluble lipid fraction from said marine and aquatic animal material;
- (b) separating the liquid and solid contents;
- (c) recovering a lipid rich fraction from the liquid contents by evaporation of the solvent present in the liquid contents;
- 10 (d) recovering the solid contents.
16. A method as in claim 15 wherein the animal material is krill.
17. A method as in claim 15 wherein the animal material is *Calanus*.
- 15 18. A method as in claims 15 to 17 wherein during step (a), the solvent and animal material are homogenized.
19. A method as in any of claims 15 to 18 wherein steps (b) and (d) are  
20 conducted under inert gas atmosphere.
20. A method as in any of claims 15 to 19 wherein step (b) is effected by techniques selected from filtration, centrifugation and sedimentation.
- 25 21. A method as in any of claims 15 to 20 wherein step (c) is effected by techniques selected from vacuum evaporation, flash evaporation and spray drying.
- 30 22. A method as in any of claims 15 to 21 wherein after step (b) and before step (c), the method additionally comprises the intervening step of washing the solid contents with the solvent and adding the resulting washing solution to the liquid contents of step (b).

23. A method as in any of claims 15 to 22 wherein prior to step (a) the marine and aquatic animal material is finely divided, preferably to an average particle size of 5mm or less.
- 5 24. A method as in claims 15 to 23 wherein steps (a) and (b) are conducted at solvent temperatures of about 5°C or less.
25. A krill lipid extract characterized in that the carotenoid content in asthaxanthin is at least about 75 and preferably at least about 90:g/g of krill extract.
- 10 26. A krill lipid extract characterized in that the carotenoid content in canthaxanthin is as least about 250 µg/g and preferably at least about 270 µg/g of krill extract.
- 15 27. A method of lipid extraction as in claims 1 or 15 wherein the solid contents recovered in the last step consists of a dehydrated residue containing active enzymes.

1/20

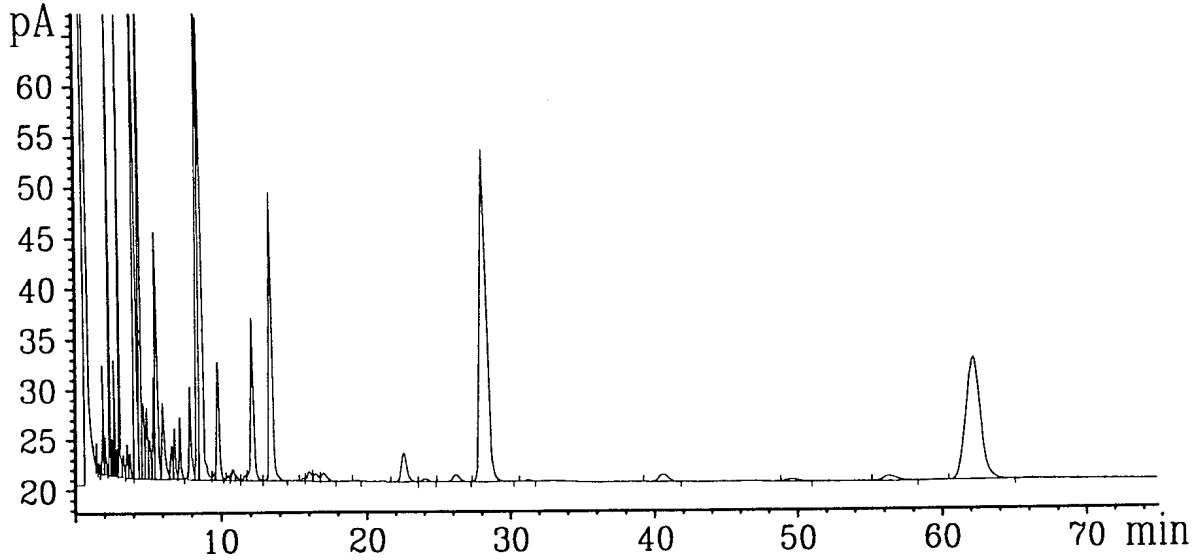
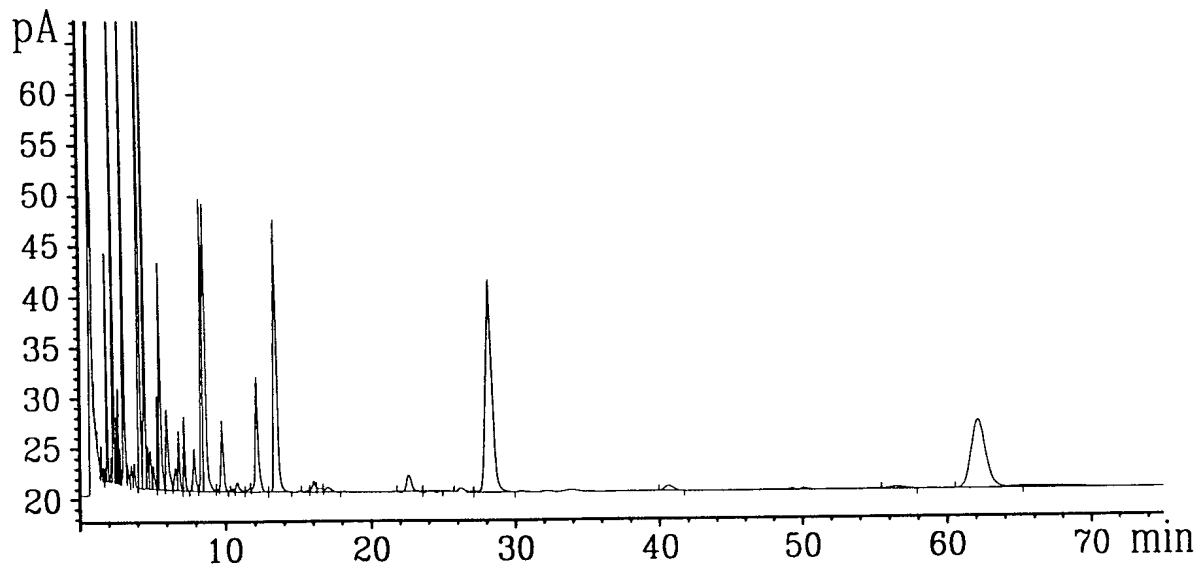

FIG - 1

1.263		4.521 - 16:1	11.637
1.455 - 12:0		4.684	12.145 - 18:3
1.625		4.891 - 16:1tr	13.458
1.812		5.121	15.626 - 20:0
1.876		5.426	16.045
2.056		5.570	16.482 - 20:1
2.173		6.037	17.017 - 20:1(cis11)
2.331 - 14:0		6.662	19.344 - 20:2
2.505		6.871	22.606 - 20:4(6,10,14,18)
2.591 - 14:1		7.235	24.103
2.682		7.925 - 18:0	26.247
2.802		8.439 - 18:1	28.287
2.855		8.640 - 18:1tr	31.295
3.078 - std 15:0		9.544	40.655
3.309		9.801 - 18:2	49.721
3.586		10.491	56.373
3.810		10.825	62.225
4.176 - 16:0		11.042	

2/20



1.217	3.806	9.786 - 18:2
1.264	4.157 - 16:0	10.484
1.454 - 12:0	4.515 - 16:1	10.813
1.624	4.680	11.590
1.812	4.891 - 16:1tr	12.136 - 18:3
1.876	5.028	13.447
2.055	5.109	15.623 - 20:0
2.171	5.421	16.025
2.330 - 14:0	5.562	16.466 - 20:1
2.505	6.031	17.021 - 20:1 (cis11)
2.591 - 14:1	6.642	22.585 - 20:4 (6,10,14,18)
2.680	6.870	24.100
2.800	7.230	26.217
2.854	7.910 - 18:0	28.241
3.077 - std 15:0	8.419 - 18:1	40.622
3.306	8.622 - 18:1tr	56.417
3.585	9.529	62.086



3/20

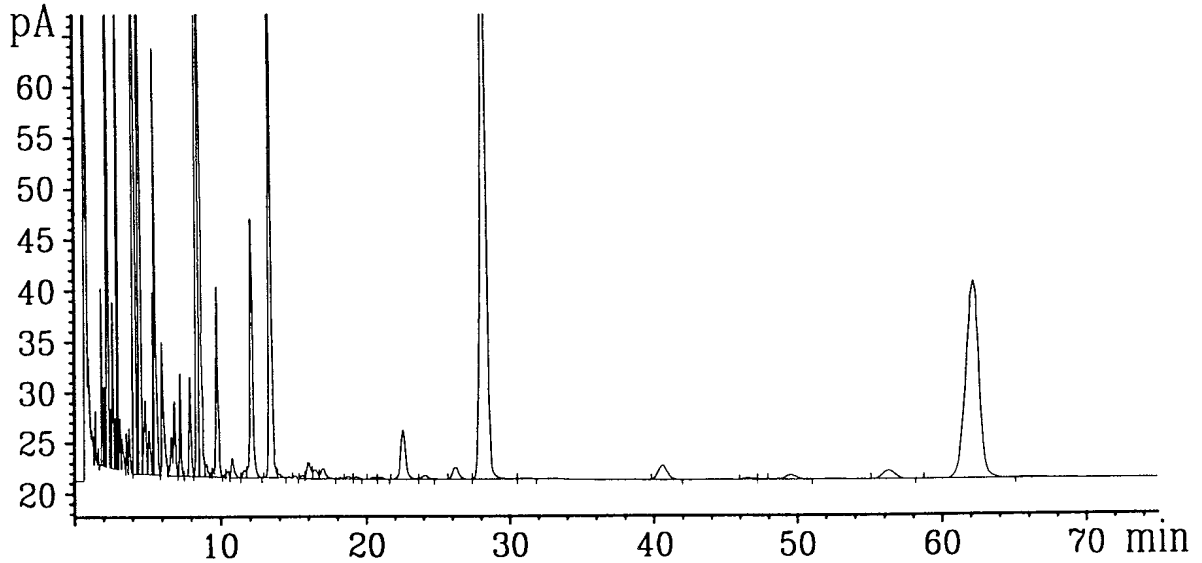

FIG - 3

1.216	4.520 - 16:1	13.457
1.262	4.683	13.943
1.454 - 12:0	4.884 - 16:1tr	15.053
1.624	5.030	15.572 - 20:0
1.811	5.111	16.016
1.875	5.420	16.486 - 20:1
2.016	5.561	16.999 - 20:1(cis11)
2.054	6.031	18.762
2.174	6.642	19.303 - 20:2
2.330 - 14:0	6.868	20.474
2.505	7.226	21.027 - 20:3
2.589 - 14:1	7.908 - 18:0	22.575 - 20:4 (6,10,14,18)
2.679	8.444 - 18:1	24.071
2.799	8.639 - 18:1tr	26.215
2.854	9.005	28.333
2.981	9.536	31.180
3.074 - std 15:0	9.788 - 18:2	40.560
3.304	10.267	46.595
3.580	10.481	49.513
3.804	10.807	56.292
4.169 - 16:0	11.626	62.250
4.296	12.140 - 18:3	

4/20

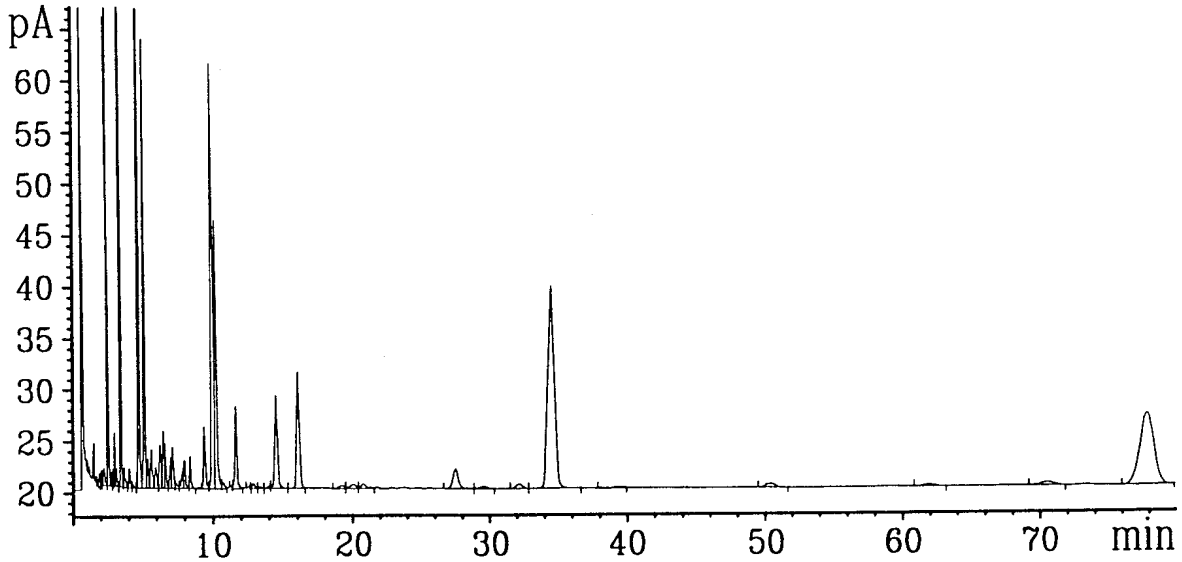

FIG - 4

1.552 - 12:0	5.675 - 16:1tr	12.888
1.749	5.964	13.388
1.968	6.284	14.017
2.095	6.533	14.524 - 18:3
2.262	6.655	16.107
2.485	7.009	19.275 - 20:0
2.582 - 14:0	7.159	20.112 - 20:1 (cis11)
2.784	7.440	20.781 - 20:1
2.886 - 14:1	7.874	27.553
3.004	8.019	29.529
3.145	8.462	32.161
3.478 - std 15:0	9.411 - 18:0	34.614
3.720	10.000 - 18:1	39.240
4.088	10.249 - 18:1tr	50.374
4.325	10.716	61.892
4.793 - 16:0	11.357	70.568
5.196 - 16:1	11.647 - 18:2	77.894
5.406	12.519	

5/20

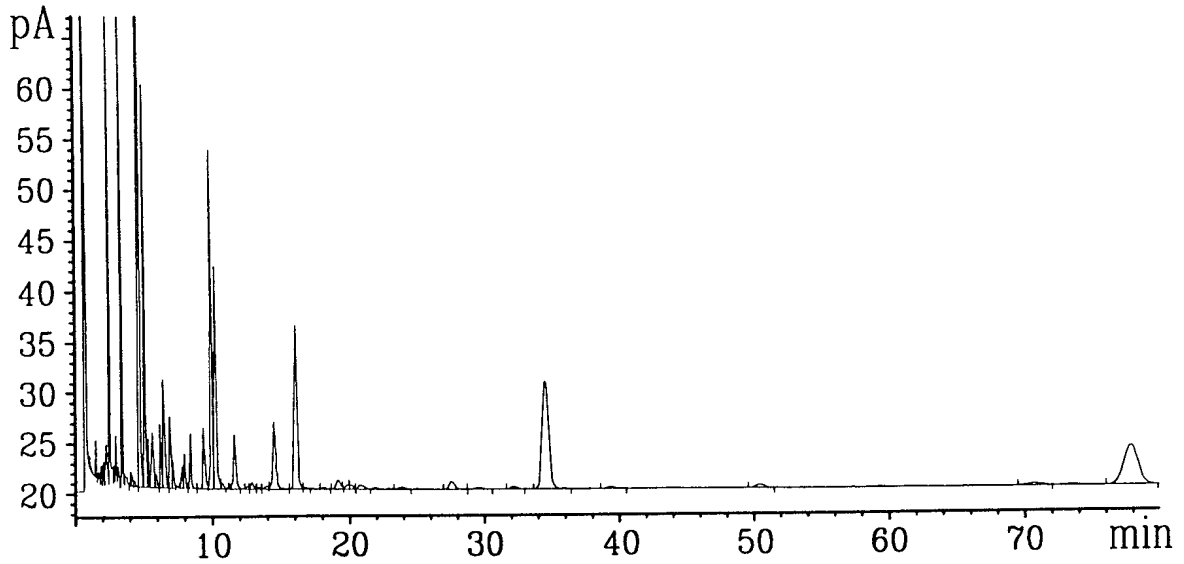
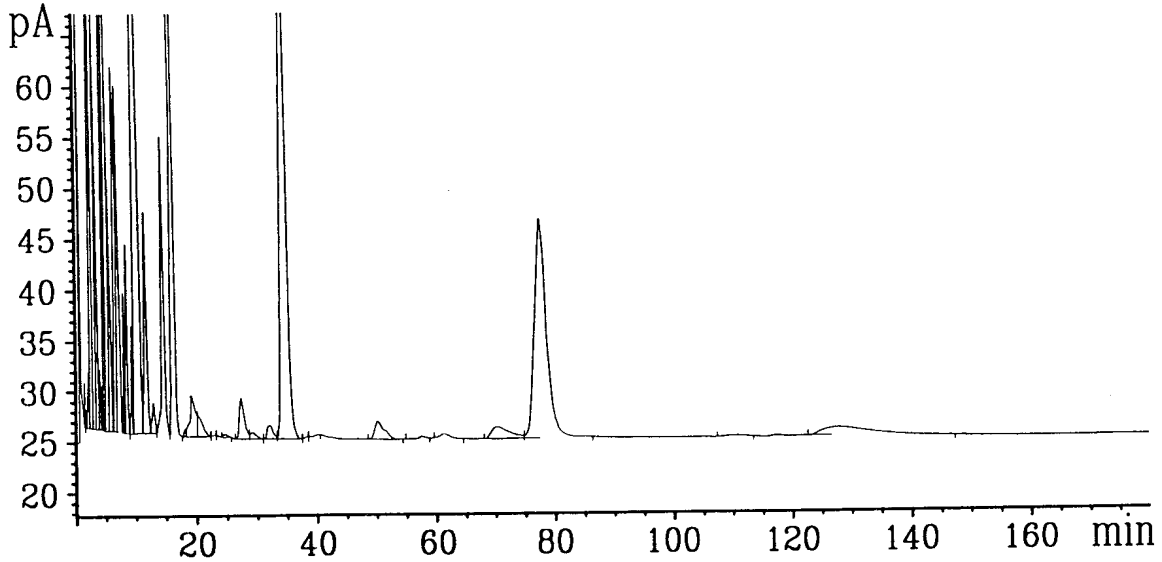

FIG. 5

1.556 - 12:0	5.977	14.540 - 18:3
1.753	6.294	16.133
1.972	6.546	16.805
2.104	7.020	18.131
2.304	7.166	19.154 - 20:0
2.590 - 14:0	7.889	19.875
2.892 - 14:1	8.030	20.099 - 20:1(cis11)
3.012	8.473	20.820 - 20:1
3.153	9.425 - 18:0	23.903
3.485 - std 15:0	10.010 - 18:1	27.583
3.710	10.260 - 18:1tr	29.570
4.096	10.735	32.195
4.203	11.394	34.597
4.333	11.661 - 18:2	39.334
4.800 - 16:0	12.540	50.452
5.206 - 16:1	12.909	70.660
5.417	13.402	77.895 - 24:0
5.711 - 16:1tr	14.010	

6/20



77.8 - 6

1.564 - 12:0	8.025	34.677
1.762	8.485	38.373 - 22:0
1.977	9.360 - 18:0	40.163
2.080	9.407	50.157
2.273	10.147 - 18:1tr	57.532
2.591 - 14:0	11.618 - 18:2	61.436
2.887 - 14:1	12.858	70.271
3.008	14.515 - 18:3	77.784 - 24:0
3.470 - std 15:0	16.162	110.694
4.108	18.077	127.696
4.341	19.355 - 20:1	
4.803 - 16:0	20.182 - 20:4 (cis11)	
5.210 - 16:1tr	20.311	
5.683	23.205 - 20:2	
6.292	24.678	
6.514	27.411 - 20:4 (6,10,14,18)	
7.030	29.307	
7.810	31.990	

7/20

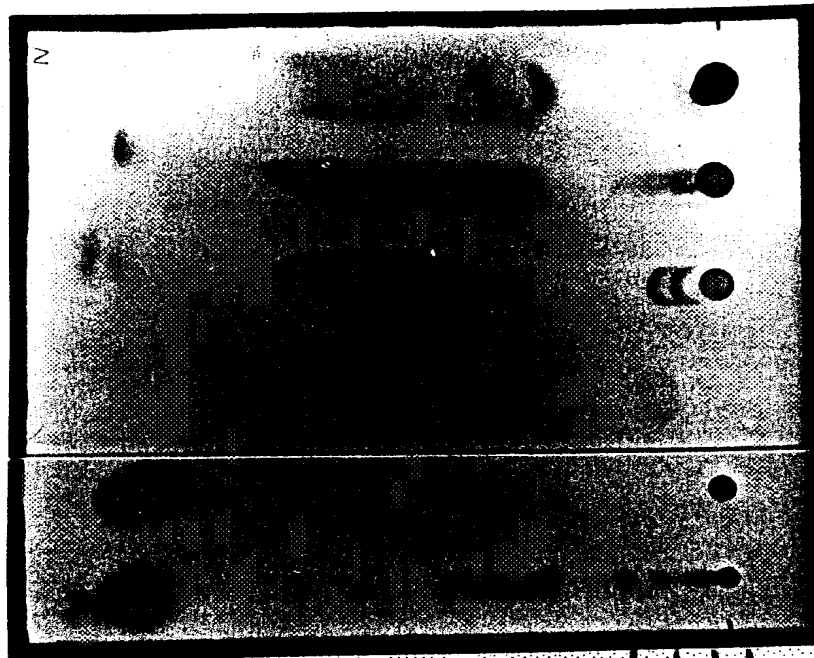

Cholesterol esters

Methyl esters

Triglycerides

Free fatty acids

Cholesterol

Diglycerides

Monoglycerides

Origin

FIG. 7

8/20

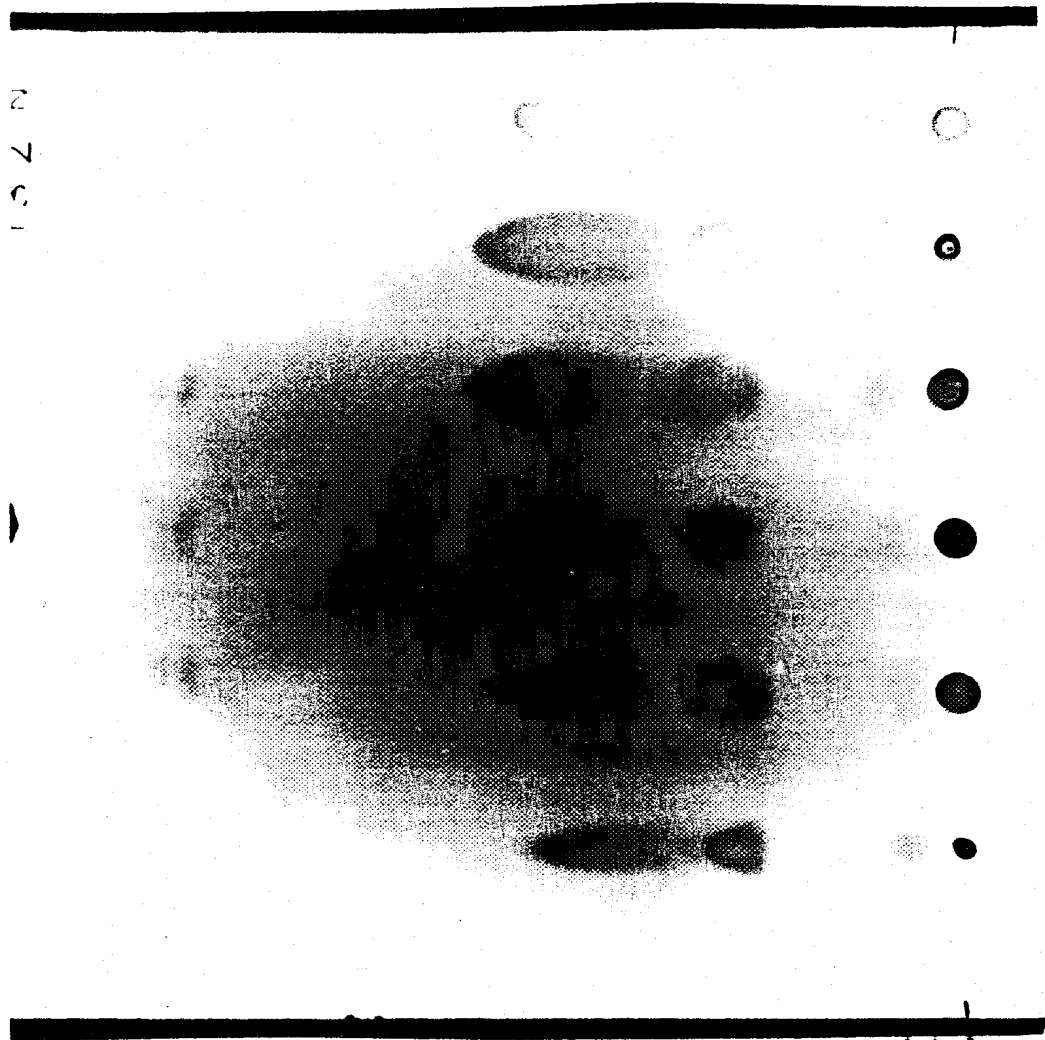

Cholesterol esters  
Methyl esters

Triglycerides

Free fatty acids  
Cholesterol

Diglycerides

Monoglycerides

Origin

9/20

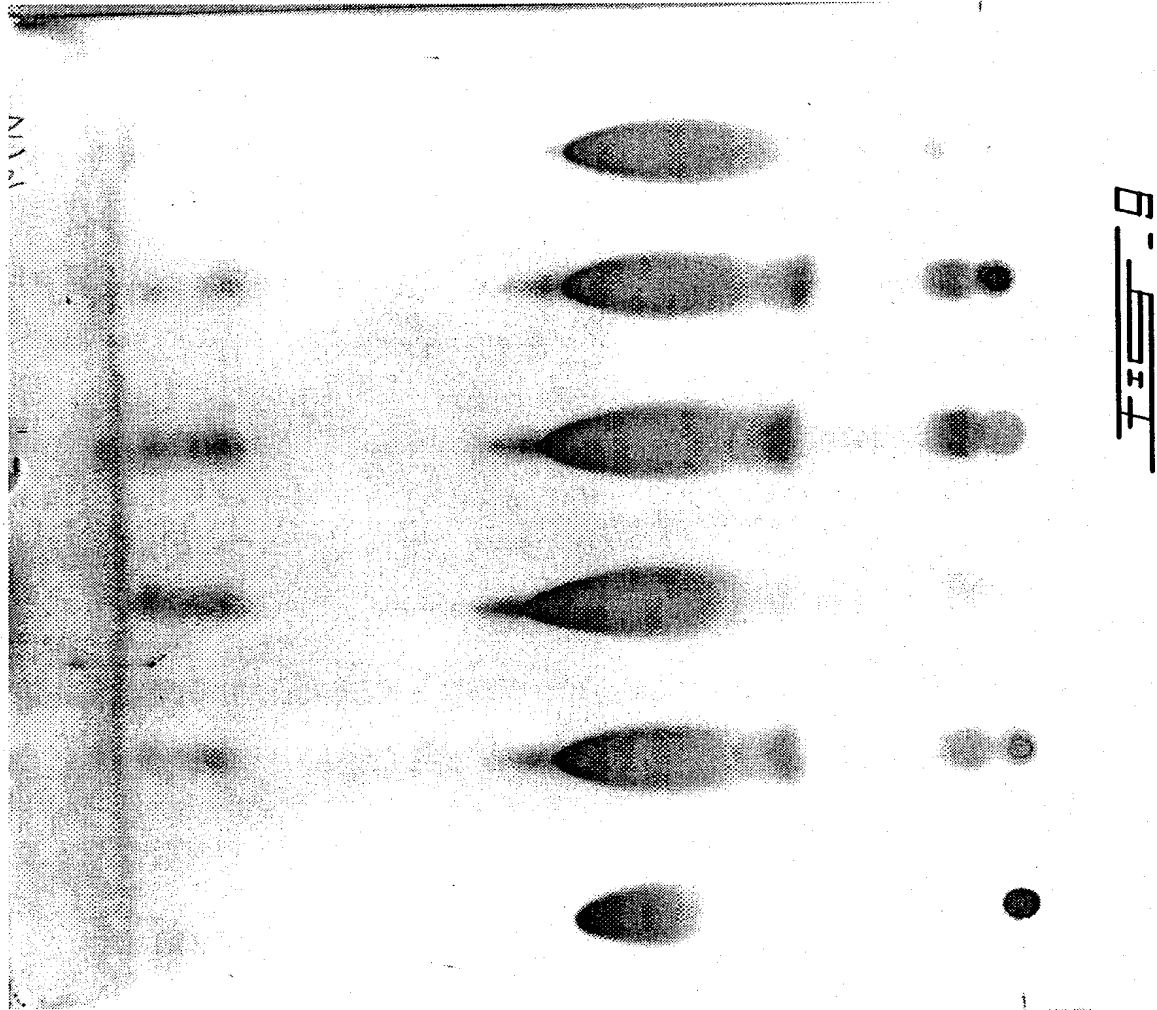

A B

C

D

E

F

G

H

I

10/20

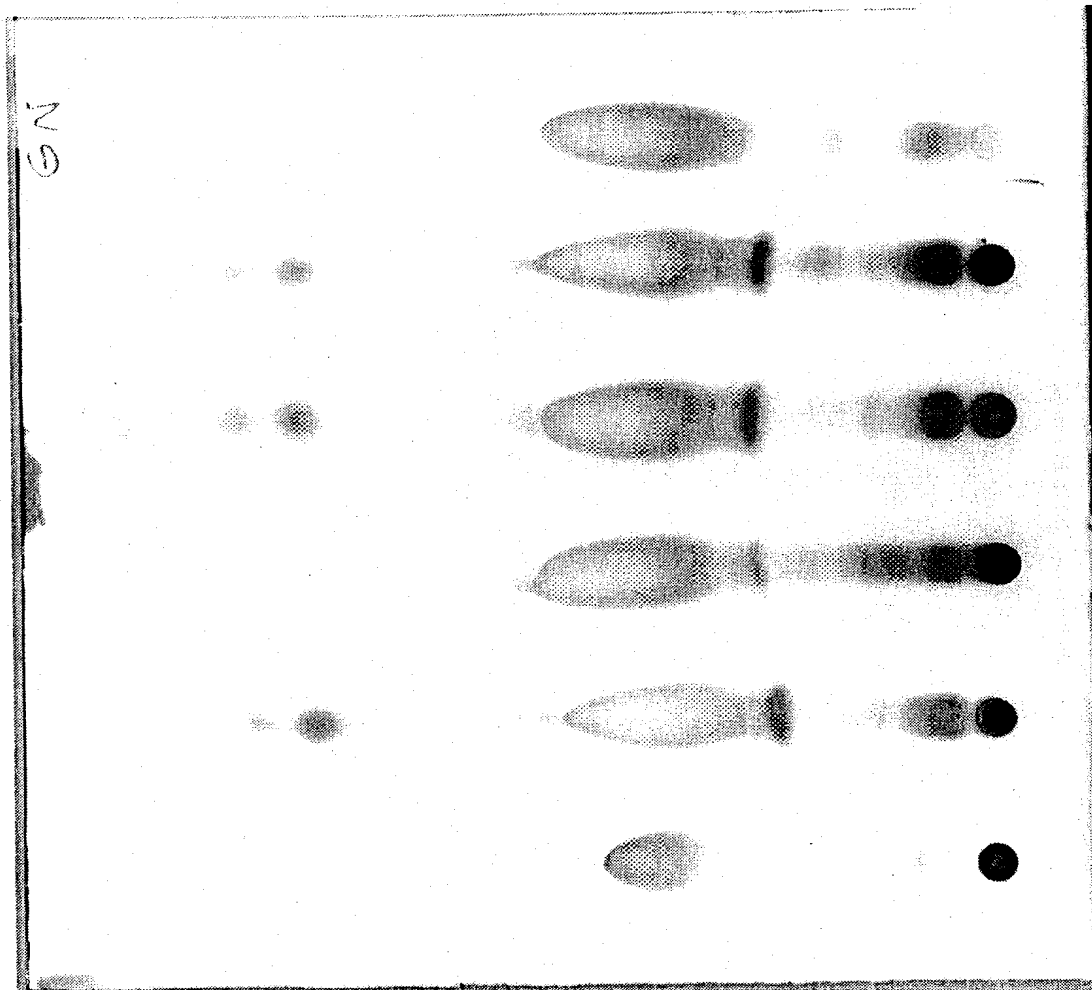

GN

10-10

A B C D E F G H I



11/20

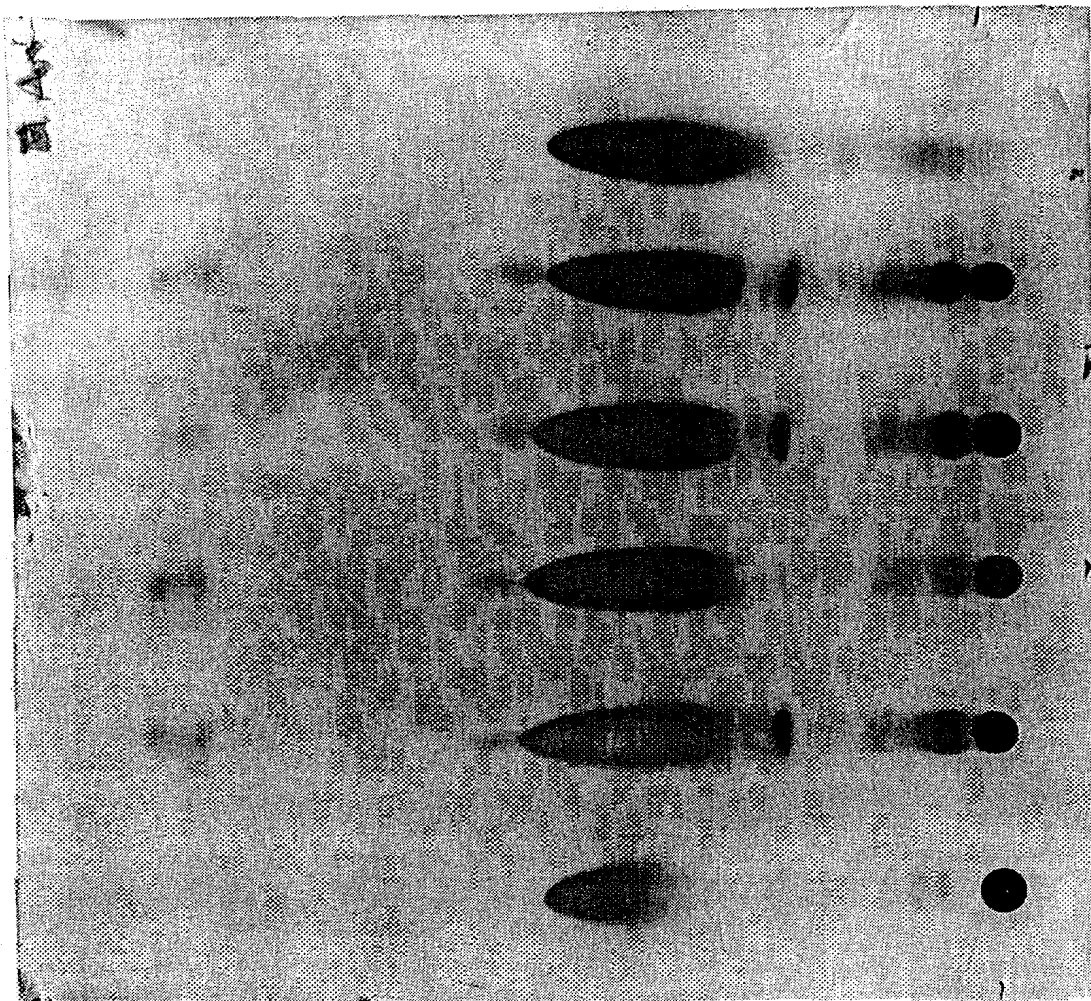

11-11

A B

C

D E F G I

12/20

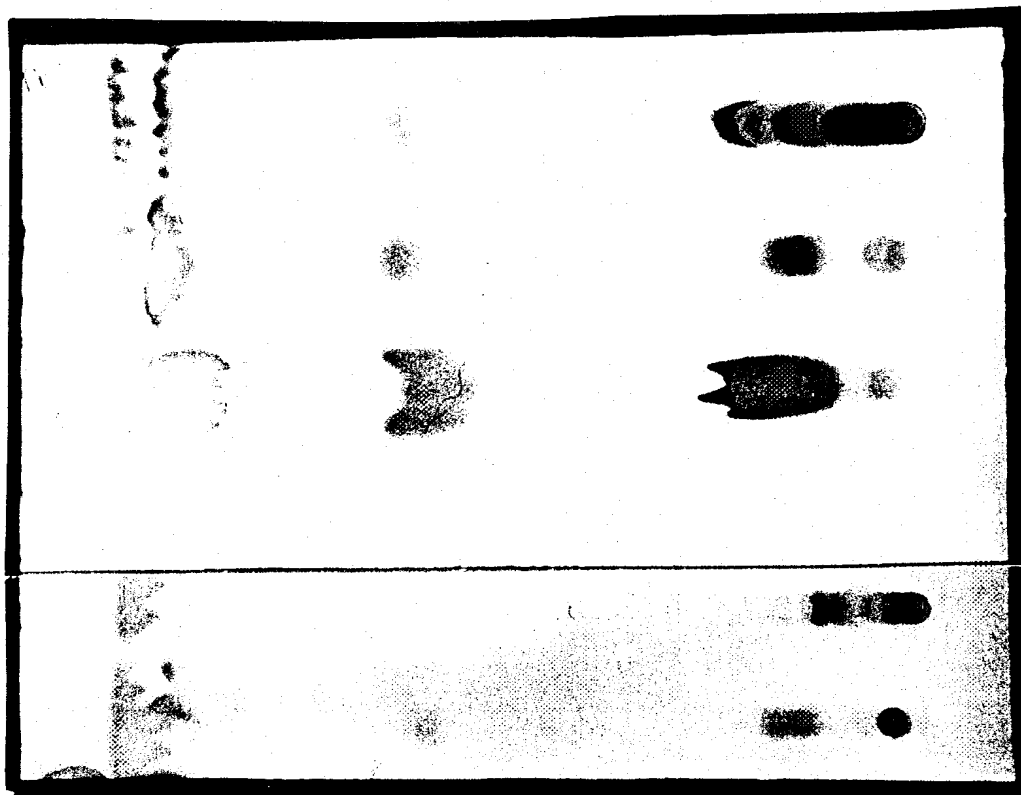

Neutral lipids

Cephalin

Lecithin  
Sphingomyelin  
Lysolecithin  
Origin

FIG. 12

13/20

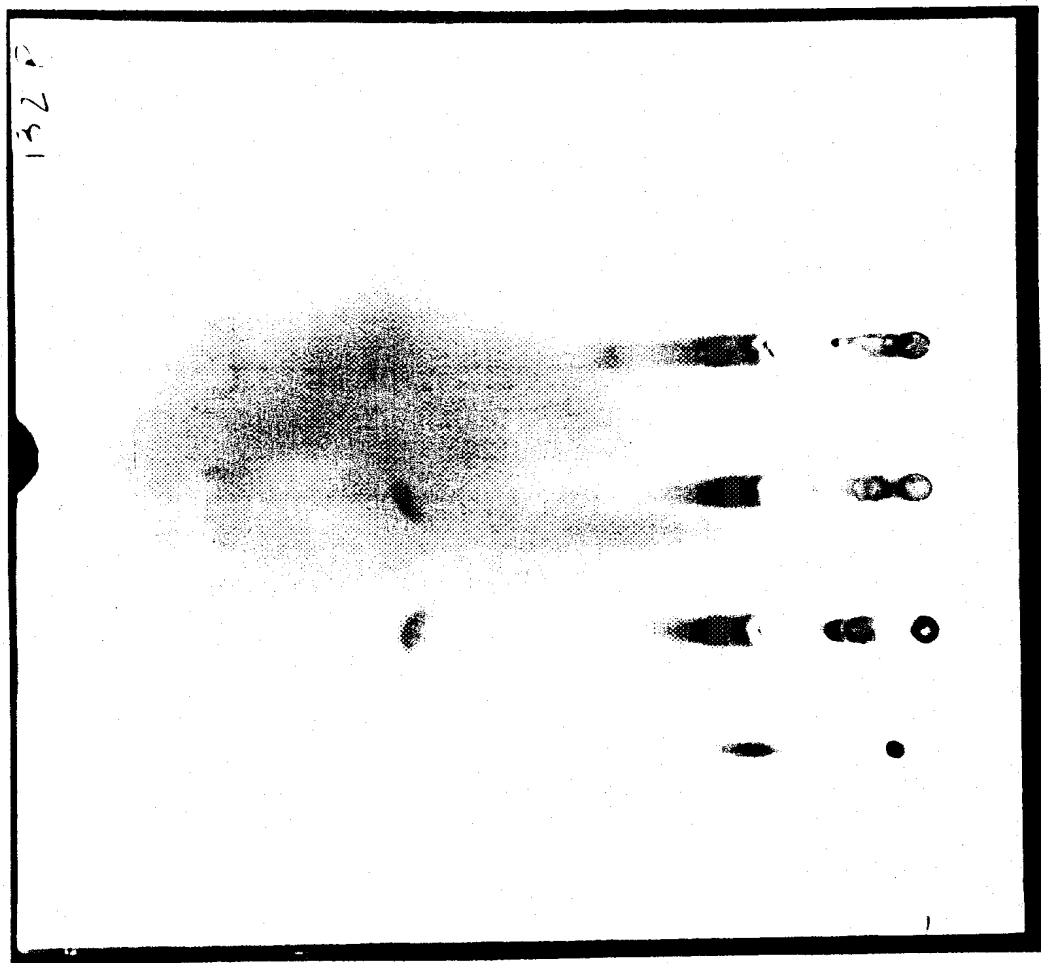

Neutral lipids

Cephalin

Lecithin  
 Sphingomyelin  
 Lysolecithin  
 Origin

132 P

14/20

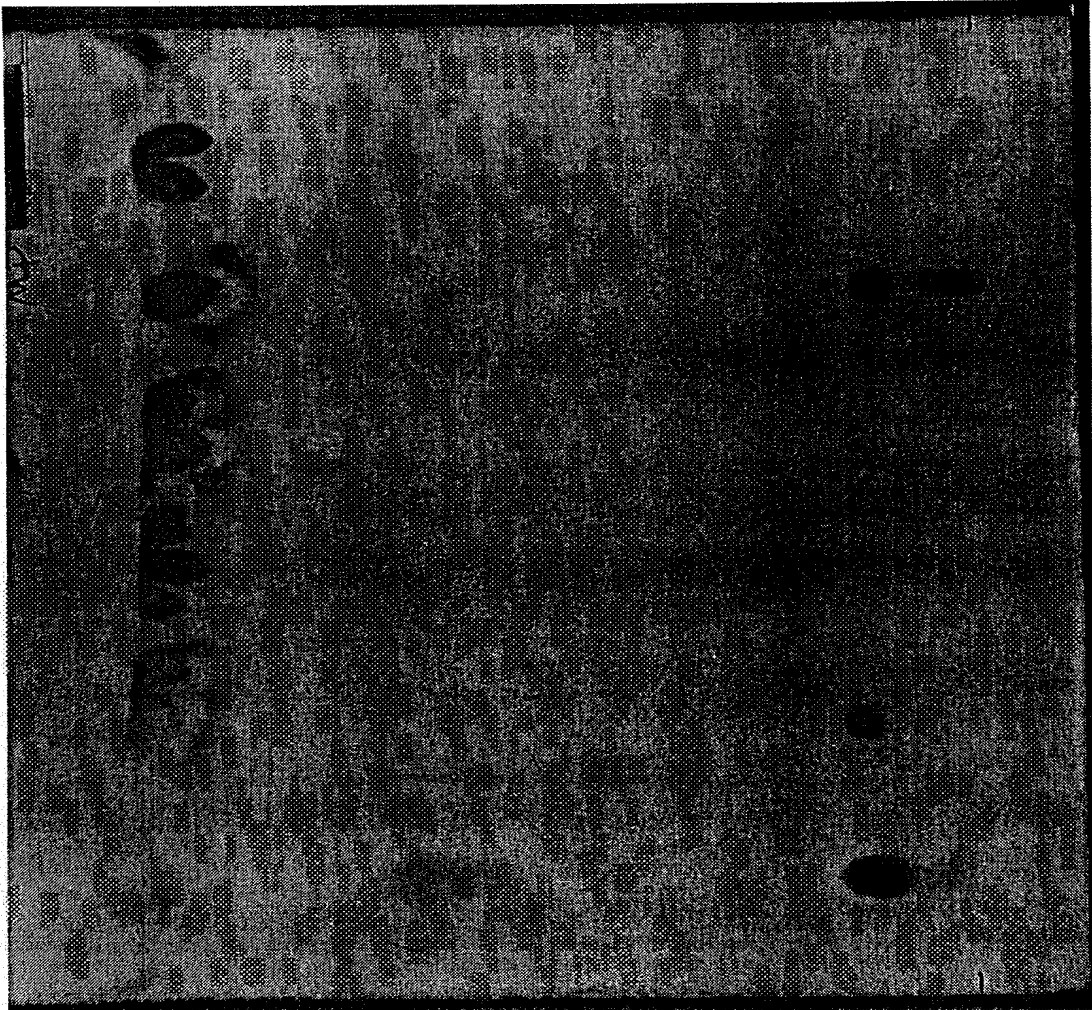

14

A

B

// //  
C D E F

15/20

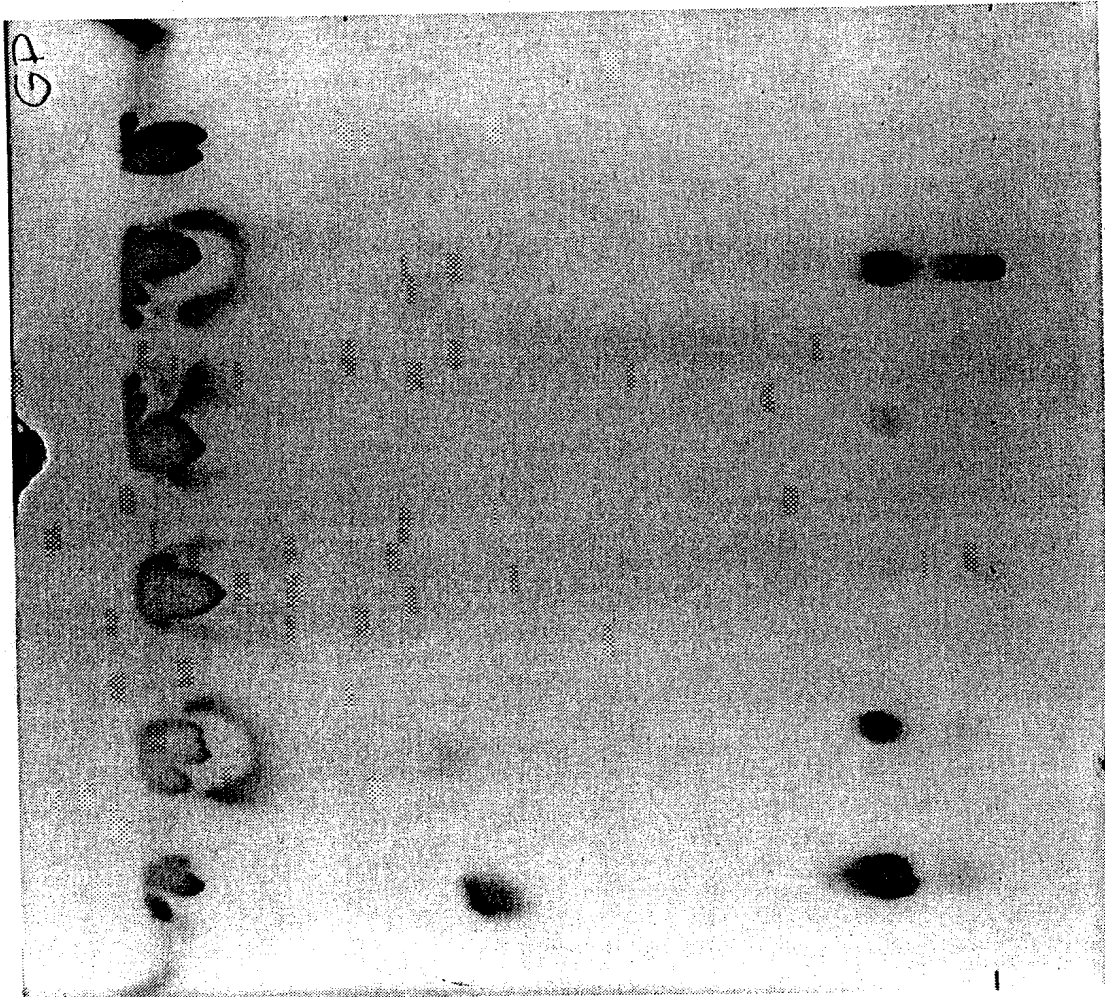

15

A

B

|||  
O D W L

16/20

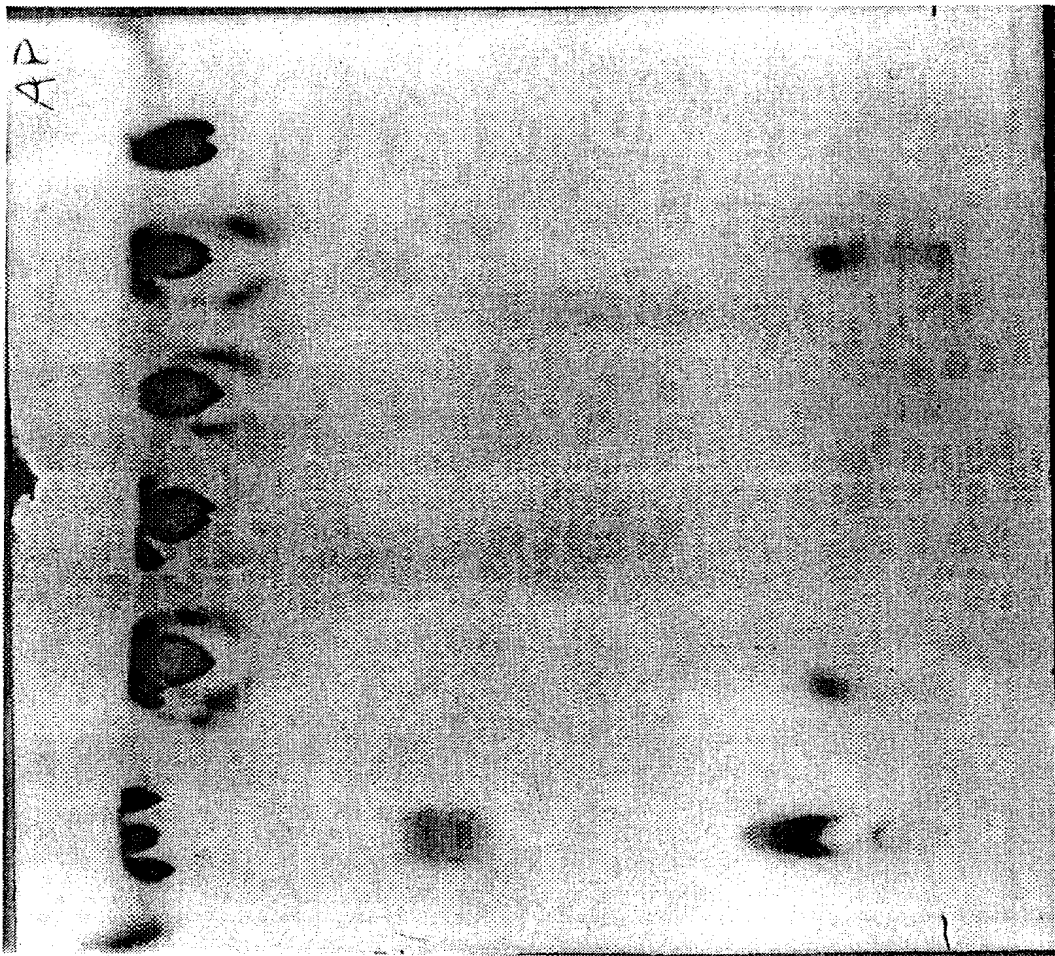

A

B

C D E F

17/20

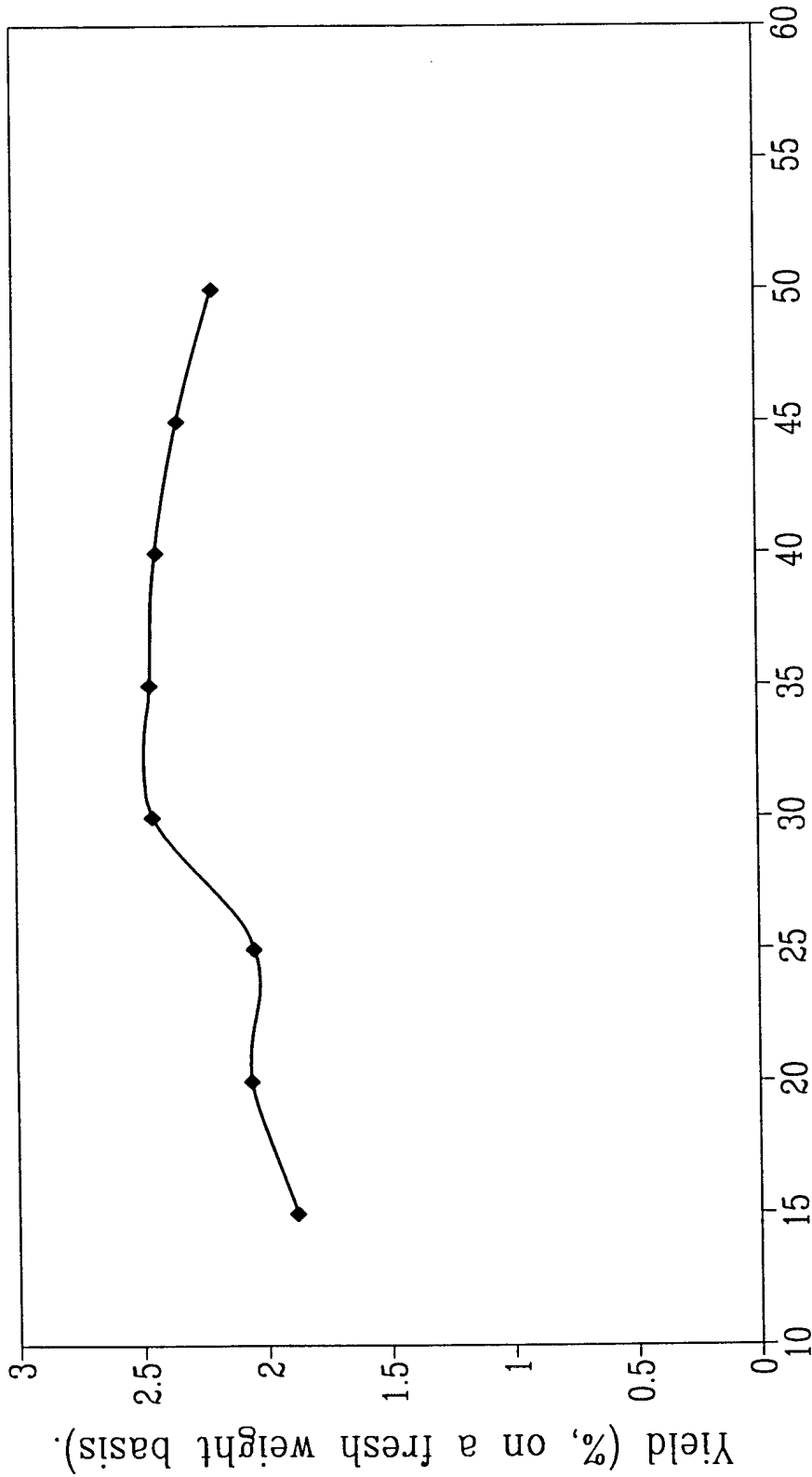

Volume of acetone (mL).

Incubation time of 2 h.

Determinations in triplicates (variation less than 5 %).

FIG - 17

18/20

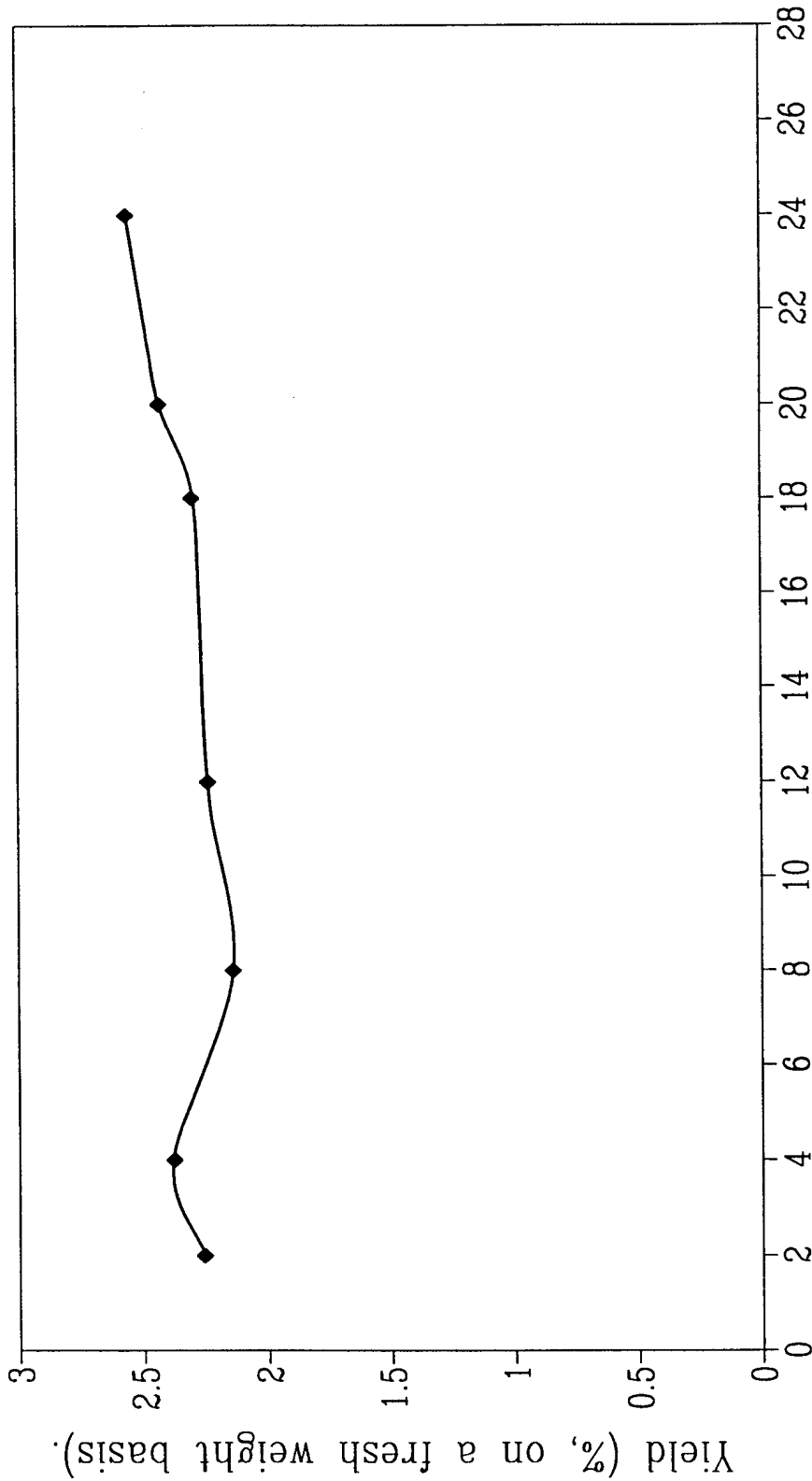

Incubation time in acetone (h).  
Sample-acetone ratio of 1:9 (w/v).  
Determinations in triplicates (variation less than 5 %).

FE8-18



19/20

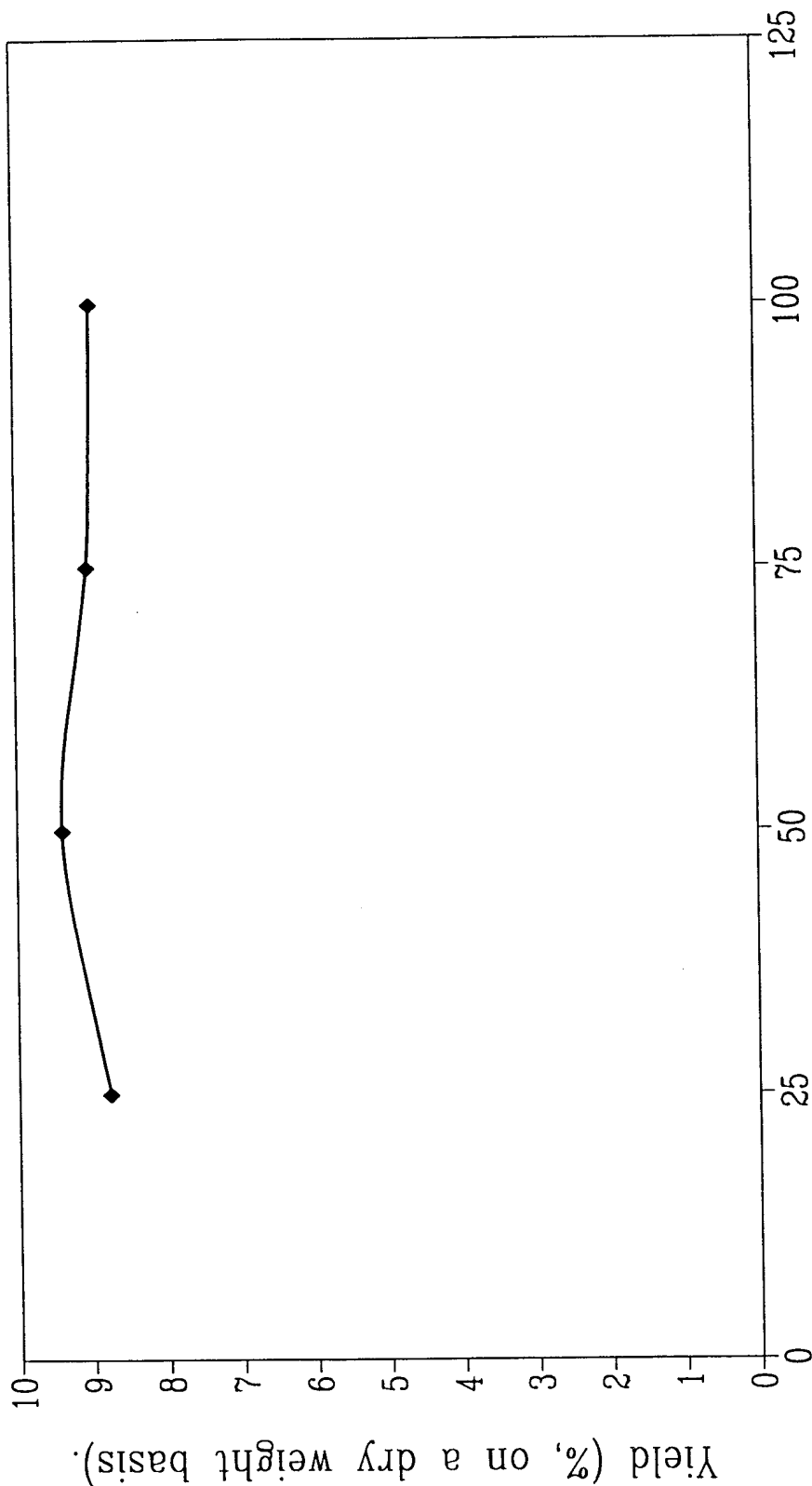

Volume of ethanol (mL).  
Incubation time of 30 min.

Determinations in triplicates (variation less than 5 %).

19

20/20

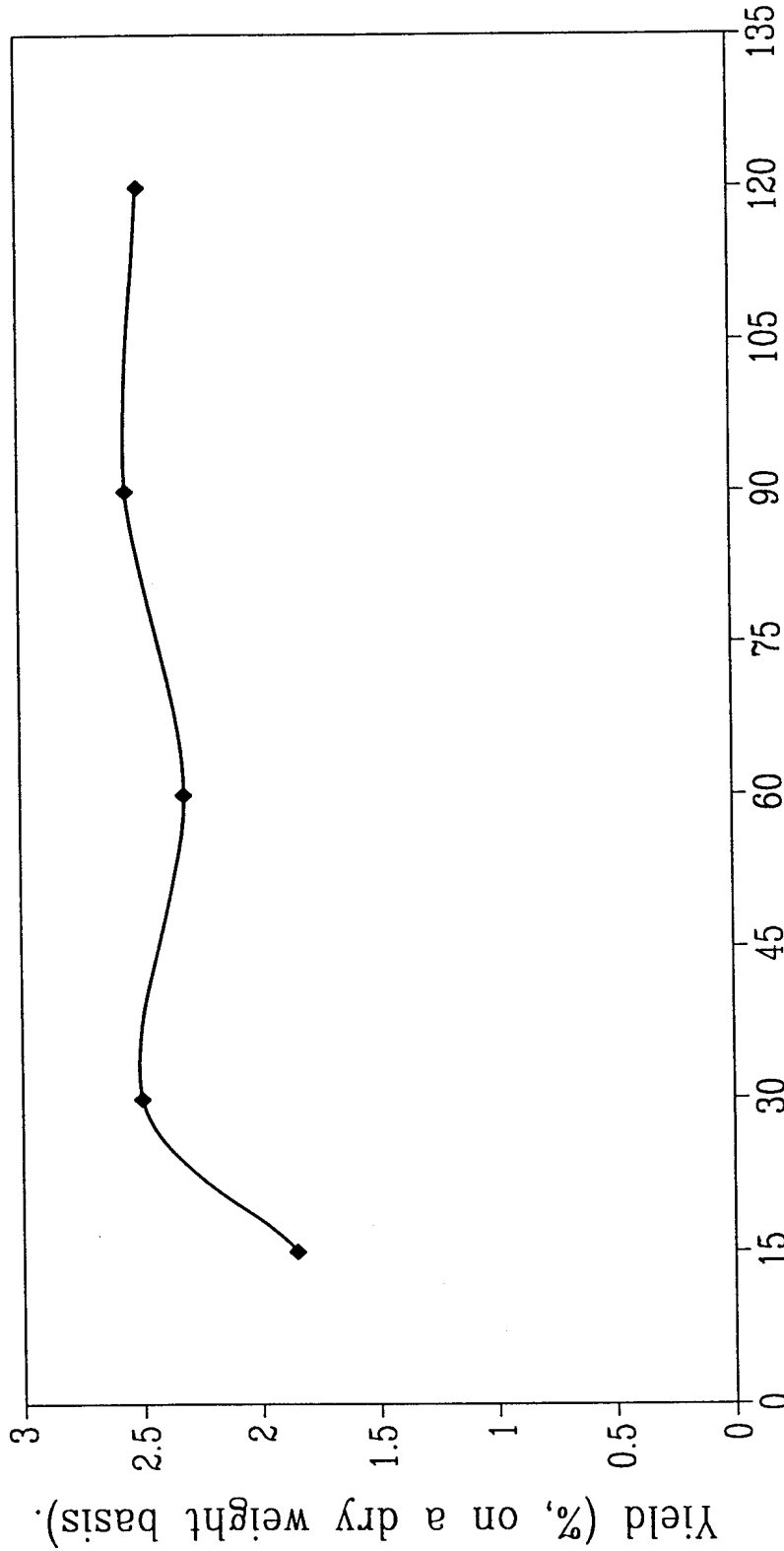

Incubation time in ethanol (min).

Sample-ethanol ratio of 1:4 (w/v).

Determinations in triplicates (variation less than 5 %).

20/20

# INTERNATIONAL SEARCH REPORT

International Application No

PCT/CA 99/00987

**A. CLASSIFICATION OF SUBJECT MATTER**  
 IPC 7 C11B1/10 C12N9/64

According to International Patent Classification (IPC) or to both national classification and IPC

**B. FIELDS SEARCHED**

Minimum documentation searched (classification system followed by classification symbols)  
 IPC 7 C11B C12N

Documentation searched other than minimum documentation to the extent that such documents are included in the fields searched

Electronic data base consulted during the international search (name of data base and, where practical, search terms used)

**C. DOCUMENTS CONSIDERED TO BE RELEVANT**

Category *	Citation of document, with indication, where appropriate, of the relevant passages	Relevant to claim No.
X	PATENT ABSTRACTS OF JAPAN vol. 1996, no. 12, 26 December 1996 (1996-12-26) - & JP 08 198754 A (YAKULT HONSHA CO LTD), 6 August 1996 (1996-08-06) abstract	1, 2, 5, 14, 15, 18, 20
Y	---	27
Y	WO 84 01715 A (HELLGREN LARS G I ; MOHR VIGGO (NO); VINCENT JAN GUSTAV (SE)) 10 May 1984 (1984-05-10) page 7, line 29 - line 31 examples 1,2	27
	---	
	-/--	

Further documents are listed in the continuation of box C.

Patent family members are listed in annex.

\* Special categories of cited documents :

- "A" document defining the general state of the art which is not considered to be of particular relevance
- "E" earlier document but published on or after the international filing date
- "L" document which may throw doubts on priority claim(s) or which is cited to establish the publication date of another citation or other special reason (as specified)
- "O" document referring to an oral disclosure, use, exhibition or other means
- "P" document published prior to the international filing date but later than the priority date claimed

- "T" later document published after the international filing date or priority date and not in conflict with the application but cited to understand the principle or theory underlying the invention
- "X" document of particular relevance; the claimed invention cannot be considered novel or cannot be considered to involve an inventive step when the document is taken alone
- "Y" document of particular relevance; the claimed invention cannot be considered to involve an inventive step when the document is combined with one or more other such documents, such combination being obvious to a person skilled in the art.
- "&" document member of the same patent family

Date of the actual completion of the international search

31 January 2000

Date of mailing of the international search report

28/02/2000

Name and mailing address of the ISA

European Patent Office, P.B. 5818 Patentlaan 2  
 NL - 2280 HV Rijswijk  
 Tel. (+31-70) 340-2040, Tx. 31 651 epo nl,  
 Fax: (+31-70) 340-3018

Authorized officer

Dekeirel, M

## INTERNATIONAL SEARCH REPORT

Inter. Appl. Application No  
PCT/CA 99/00987

C.(Continuation) DOCUMENTS CONSIDERED TO BE RELEVANT		
Category °	Citation of document, with indication, where appropriate, of the relevant passages	Relevant to claim No.
X	<p>DATABASE WPI Section Ch, Week 197845 Derwent Publications Ltd., London, GB; Class C03, AN 1978-80681A XP002129262 -&amp; JP 53 112195 A (NIPPON PAINT CO LTD), 30 September 1978 (1978-09-30) abstract</p>	15
X	<p>PATENT ABSTRACTS OF JAPAN vol. 009, no. 160 (C-289), 4 July 1985 (1985-07-04) -&amp; JP 60 035057 A (SANEI KAGAKU KOGYO KK), 22 February 1985 (1985-02-22) abstract</p>	15, 16, 25
X	<p>PATENT ABSTRACTS OF JAPAN vol. 016, no. 249 (C-0948), 8 June 1992 (1992-06-08) -&amp; JP 04 057853 A (CHLORINE ENG CORP LTD; OTHERS: 01), 25 February 1992 (1992-02-25) abstract</p>	25
Y		26
Y	<p>EP 0 732 378 A (NIPPON OIL CO LTD) 18 September 1996 (1996-09-18) column 1, line 37 - line 47 column 4, line 49 - line 53</p>	26
X	<p>DATABASE WPI Section Ch, Week 197633 Derwent Publications Ltd., London, GB; Class D13, AN 1976-62648X XP002129263 -&amp; JP 51 076467 A (KYOWA HAKKO KOGYO), 2 July 1976 (1976-07-02) abstract</p>	25, 26
X	<p>CHEMICAL ABSTRACTS, vol. 98, no. 21, 23 May 1983 (1983-05-23) Columbus, Ohio, US; abstract no. 177859, RAA, JAN ET AL.: "Isolation of astaxanthin from crayfish or shrimp waste for use as a coloring agent in fish feed" page 531; column 2; XP002129261 abstract -&amp; NO 147 365 B 20 December 1982 (1982-12-20)</p>	25
	-/--	

INTERNATIONAL SEARCH REPORT

International Application No  
PCT/CA 99/00987

C.(Continuation) DOCUMENTS CONSIDERED TO BE RELEVANT		
Category °	Citation of document, with indication, where appropriate, of the relevant passages	Relevant to claim No.
A	<p>PATENT ABSTRACTS OF JAPAN vol. 009, no. 059 (C-270), 15 March 1985 (1985-03-15) -&amp; JP 59 196032 A (FUMIO NISHIKAWA; OTHERS: 02), 7 November 1984 (1984-11-07) abstract</p> <p style="text-align: center;">———</p>	27

INTERNATIONAL SEARCH REPORT

Information on patent family members

Int: onal Application No  
PCT/CA 99/00987

Patent document cited in search report		Publication date	Patent family member(s)	Publication date
JP 08198754	A	06-08-1996	NONE	
WO 8401715	A	10-05-1984	AT 42111 T AU 573730 B AU 2204183 A BR 8307587 A CA 1220740 A DK 308684 A EP 0107634 A FI 842555 A,B, JP 1934186 C JP 5262665 A JP 6062994 B JP 5017209 B JP 59501908 T NO 842497 A US 4963491 A ZA 8307888 A SE 8302268 A US 4801451 A	15-04-1989 23-06-1988 22-05-1984 25-09-1984 21-04-1987 22-06-1984 02-05-1984 25-06-1984 26-05-1995 12-10-1993 17-08-1994 08-03-1993 15-11-1984 21-06-1984 16-10-1990 26-09-1984 23-10-1984 31-01-1989
JP 53112195	A	30-09-1978	NONE	
JP 60035057	A	22-02-1985	JP 1383716 C JP 61052183 B	09-06-1987 12-11-1986
JP 04057853	A	25-02-1992	JP 2963152 B	12-10-1999
EP 0732378	A	18-09-1996	JP 8253695 A CA 2171780 A NO 961074 A	01-10-1996 17-09-1996 17-09-1996
JP 51076467	A	02-07-1976	JP 1000118 C JP 52048191 B	30-05-1980 08-12-1977
NO 147365	B	28-05-1982	NO 803582 A,B, DK 515581 A	28-05-1982 28-05-1982
JP 59196032	A	07-11-1984	NONE	

<b>INFORMATION DISCLOSURE STATEMENT BY APPLICANT</b> ( Not for submission under 37 CFR 1.99)	Application Number	12057775
	Filing Date	2008-03-28
	First Named Inventor	Inge Bruheim, et al.
	Art Unit	1651
	Examiner Name	Susan Marie Hanley
	Attorney Docket Number	NATNUT-14409/US-5/ORD

U.S.PATENTS							Remove
Examiner Initial*	Cite No	Patent Number	Kind Code <sup>1</sup>	Issue Date	Name of Patentee or Applicant of cited Document	Pages,Columns,Lines where Relevant Passages or Relevant Figures Appear	
	1						

If you wish to add additional U.S. Patent citation information please click the Add button. Add

U.S.PATENT APPLICATION PUBLICATIONS							Remove
Examiner Initial*	Cite No	Publication Number	Kind Code <sup>1</sup>	Publication Date	Name of Patentee or Applicant of cited Document	Pages,Columns,Lines where Relevant Passages or Relevant Figures Appear	
	1						

If you wish to add additional U.S. Published Application citation information please click the Add button. Add

FOREIGN PATENT DOCUMENTS								Remove
Examiner Initial*	Cite No	Foreign Document Number <sup>3</sup>	Country Code <sup>2</sup> j	Kind Code <sup>4</sup>	Publication Date	Name of Patentee or Applicant of cited Document	Pages,Columns,Lines where Relevant Passages or Relevant Figures Appear	T <sup>5</sup>
	1	2000/25608	WO		2000-05-11	NIPPON SUISAN KAISHA, LTD.		<input type="checkbox"/>
	2	2000/38708	WO		2000-07-06	PHAIRSON MEDICAL INC.		<input type="checkbox"/>
	3	2002/102394	WO		2002-12-27	NEPTUNE TECHNOLOGIES & BIORESS		<input type="checkbox"/>

**INFORMATION DISCLOSURE  
STATEMENT BY APPLICANT**  
( Not for submission under 37 CFR 1.99)

Application Number		12057775
Filing Date		2008-03-28
First Named Inventor	Inge Bruheim, et al.	
Art Unit		1651
Examiner Name	Susan Marie Hanley	
Attorney Docket Number	NATNUT-14409/US-5/ORD	

4	2003/011873	WO		2003-02-13	NEPTUNE TECHNOLOGIES & BIORESSOURCES INC.	<input type="checkbox"/>
5	2005/004393	WO		2005-01-13	KONIN-KLIJKE PHILIPS ELECTRONICS N.V.	<input type="checkbox"/>
6	2005/037848	WO		2005-04-28	ENZYMOTEC LTD.	<input type="checkbox"/>
7	2005/038037	WO		2005-04-28	ENZYMOTEC INC.	<input type="checkbox"/>
8	2007/080514	WO		2007-07-19	KRILL A/S	<input type="checkbox"/>
9	2007/080515	WO		2007-07-19	AKER BIOMARINE ASA	<input type="checkbox"/>
10	2007/108702	WO		2007-09-27	AKER SEAFOODS HOLDING AS	<input type="checkbox"/>
11	2008/006607	WO		2008-01-17	NATTOPHARMA ASA	<input type="checkbox"/>
12	2008/117062	WO		2008-10-02	AKER BIOMARINE ASA	<input type="checkbox"/>
13	2009/027692	WO		2009-03-05	AKER BIOMARINE ASA	<input type="checkbox"/>
14	2001/028526	WO		2001-04-26	TRUFFINI & REGGE FARMACEUTICI	<input type="checkbox"/>



**INFORMATION DISCLOSURE  
STATEMENT BY APPLICANT**  
( Not for submission under 37 CFR 1.99)

Application Number		12057775
Filing Date		2008-03-28
First Named Inventor	Inge Bruheim, et al.	
Art Unit		1651
Examiner Name	Susan Marie Hanley	
Attorney Docket Number	NATNUT-14409/US-5/ORD	

15	2004/047554	WO		2004-06-10	PHARES PHARM RES NV	<input type="checkbox"/>
16	0973532	EP		2005-09-07	I.B.R ISRAELI BIOTECHNOLOGY RESEARCH LTD.	<input type="checkbox"/>
17	1123368	EP		2008-04-09	UNIVERSITE DE SHERBROOKE	<input type="checkbox"/>
18	1292294	EP		2009-03-18	ACCERA, INC.	<input type="checkbox"/>
19	2001/082928	WO		2001-11-08	HENDERSON	<input type="checkbox"/>
20	2003/013497	WO		2003-02-20	SUNTORY LIMITED	<input type="checkbox"/>
21	1419768	EP		2009-01-07	NEPTUNE TECHNOLOGIES & BIORESSOURCES, INC.	<input type="checkbox"/>
22	1385500	EP		2010-07-28	YEDA RESEARCH AND DEVELOPMENT CO. LTD	<input type="checkbox"/>
23	2002/083122	WO		2002-10-24	YEDA RESEARCH AND DEVELOPMENT CO. LTD	<input type="checkbox"/>
24	1392623	EP		2004-03-03	MARTEK BIOSCIENCES BOULDER CORPORATION	<input type="checkbox"/>
25	2002/092540	WO		2002-11-21	MARTEK BIOSCIENCES BOULDER CORPORATION	<input type="checkbox"/>

**INFORMATION DISCLOSURE  
STATEMENT BY APPLICANT**  
( Not for submission under 37 CFR 1.99)

Application Number		12057775
Filing Date		2008-03-28
First Named Inventor	Inge Bruheim, et al.	
Art Unit	1651	
Examiner Name	Susan Marie Hanley	
Attorney Docket Number	NATNUT-14409/US-5/ORD	

26	1406641	EP		2009-01-07	NEPTUNE TECHNOLOGIES & BIORESSOURCES, INC.		<input type="checkbox"/>
27	2005/070411	WO		2005-08-04	BRUZZESE		<input type="checkbox"/>
28	1542670	EP		2005-06-22	SUNTORY LIMITED	Identical to WO2004028529	<input type="checkbox"/>
29	2004/028529	WO		2004-04-08	SUNTORY LIMITED		<input type="checkbox"/>
30	1743531	EP		2007-01-17	NIPPON SUISAN KAISHA, LTD		<input type="checkbox"/>
31	1631280	EP		2008-03-08	BTG INTERNATIONAL LIMITED		<input type="checkbox"/>
32	2004/100943	WO		2004-11-25	BTG INTERNATIONAL LIMITED		<input type="checkbox"/>
33	1660071	EP		2006-05-31	BTG INTERNATIONAL LIMITED		<input type="checkbox"/>
34	2005/018632	WO		2005-03-03	BTG INTERNATIONAL LIMITED		<input type="checkbox"/>
35	2006/030552	WO		2006-03-23	SUNTORY LIMITED		<input type="checkbox"/>
36	1689413	EP		2006-08-16	ENZYMOTEC LTD.		<input type="checkbox"/>

**INFORMATION DISCLOSURE  
STATEMENT BY APPLICANT**  
( Not for submission under 37 CFR 1.99)

Application Number	12057775
Filing Date	2008-03-28
First Named Inventor	Inge Bruheim, et al.
Art Unit	1651
Examiner Name	Susan Marie Hanley
Attorney Docket Number	NATNUT-14409/US-5/ORD

37	1706106	EP		2009-07-15	BRUZZESE	<input type="checkbox"/>
----	---------	----	--	------------	----------	--------------------------

If you wish to add additional Foreign Patent Document citation information please click the Add button

**NON-PATENT LITERATURE DOCUMENTS**

Examiner Initials*	Cite No	Include name of the author (in CAPITAL LETTERS), title of the article (when appropriate), title of the item (book, magazine, journal, serial, symposium, catalog, etc), date, pages(s), volume-issue number(s), publisher, city and/or country where published.	T <sup>5</sup>
	1	TAKAICHI et al., 2003, "Fatty Acids of astaxanthin esters in krill determined by mild mass spectrometry", Comparative Biochemistry and Physiology Part B, Biochemistry and Molecular Biology, Elsevier, Oxford, Vol. 136, 1 January 2003, p. 317-322;	<input type="checkbox"/>
	2	TANAKA et al., 2004, "Extraction of Phospholipids from Salmon Roe with Supercritical Carbon Dioxide and an Entrainer", J. Oleo Sci, 53(9): 417-424	<input type="checkbox"/>
	3	TANAKA et al., 2005, "Extraction of Phospholipids from Unused Natrual Resources with Supercritical Carbon Dioxide and an Entrainer", Journal of Oleo Science, Vol. 54(11): 569-576	<input type="checkbox"/>
	4	TODORIC et al., 2006, "Adipose tissue inflammation induced by high-fat diet in obese diabetic mice is prevented by n-3 polyunsaturated fatty acids", Diabetologia, 49(9): 2109-2119	<input type="checkbox"/>
	5	TOU et al., 2007, "Krill for human consumption: nutritional value and potential health benefits.", Nutrition Rev 65 (2):63-77	<input type="checkbox"/>
	6	TRAYHURN et al., 2004, "Adipokines: inflammation and the pleiotropic role of white adipose tissue", Br. J. Nutrition, 92(3): 347-355	<input type="checkbox"/>
	7	TREBBLE et al., 2003, "Inhibition of tumour necrosis factor-alpha and interleukin 6 production by mononuclear cells following dietary fish-oil supplementation in healthy men and response to antioxidant co-supplementation", Br. J. Nutrition, 90(2): 405-412	<input type="checkbox"/>
	8	UKKOLA et al., 2002, "Adiponectin: a link between excess adiposity and associated comorbidities?", J. Mol. Med., 80 (11): 696-702	<input type="checkbox"/>

**INFORMATION DISCLOSURE  
STATEMENT BY APPLICANT**  
( Not for submission under 37 CFR 1.99)

Application Number		12057775
Filing Date		2008-03-28
First Named Inventor	Inge Bruheim, et al.	
Art Unit	1651	
Examiner Name	Susan Marie Hanley	
Attorney Docket Number	NATNUT-14409/US-5/ORD	

9	VAN DER VEEN et al., 1971 "The Lipids of Krill (Euphausia Species) and Red Crab (Pleuroncodes Planipes)", Lipids, 6(7): 481-485	<input type="checkbox"/>
10	VIRTUE, et al. 1996, Reproductive trade-off in male Antarctic krill, Euphausia superba", Marine Biology, Volume 126, Number 3, Pages 521-527	<input type="checkbox"/>
11	YAMAGUCHI et al., 1983, "The Composition of Carotenoid Pigments in the Antarctic Krill Euphausia superba", Bulletin of the Japanese Society of Scientific Fisheries, 49(9): 1411-1415	<input type="checkbox"/>
12	YAMAGUCHI et al., 1986, "Supercritical Carbon Dioxide Extraction Of Oils From Antarctic Krill," Journal Of Agricultural And Food Chemistry, vol. 34, pp. 904-907	<input type="checkbox"/>
13	YANASE M; 1974, "Modification of a Russian method for separation of heat-coagulated protein from Antarctic krill", Database FSTA (online); International Food Information Service (IFIS); FRANKFURT-MAIN, DE	<input type="checkbox"/>
14	YEN et al., 1994, "Effect of dietary omega-3 and omega-6 fatty acid sources on PUVA-induced cutaneous toxicity and tumorogenesis in the hairless mouse", Arch. Dermatol. Res., 286(6): 331-6	<input type="checkbox"/>
15	DATABASE WPI Week 200682, Thomson Scientific, London, GB, 2006	<input type="checkbox"/>
16	ENGLISH ABSTRACT; JP 2003-531857; See abstract from corresponding WO 2001/082928 filed herewith	<input type="checkbox"/>
17	ENGLISH ABSTRACT; JP 2004-525180; See abstract from corresponding WO 2002/083122 filed herewith	<input type="checkbox"/>
18	ENGLISH ABSTRACT; JP 2006-528233; See abstract from corresponding WO 2004/100943 filed herewith	<input type="checkbox"/>
19	ENGLISH ABSTRACT; JP 2007-502805; See abstract from corresponding WO 2005/018632 filed herewith	<input type="checkbox"/>

<b>INFORMATION DISCLOSURE STATEMENT BY APPLICANT</b> ( Not for submission under 37 CFR 1.99)	Application Number	12057775
	Filing Date	2008-03-28
	First Named Inventor	Inge Bruheim, et al.
	Art Unit	1651
	Examiner Name	Susan Marie Hanley
	Attorney Docket Number	NATNUT-14409/US-5/ORD

20	ENGLISH ABSTRACT; JP 2007-509131; See abstract from corresponding WO 2005/037848 filed herewith	<input type="checkbox"/>
21	ENGLISH ABSTRACT; JP 2007-518764; See abstract from corresponding WO 2005/070411 filed herewith	<input type="checkbox"/>
22	ENGLISH ABSTRACT; JP 2004-536059; See abstract from corresponding WO 2002/09254 filed herewith	<input type="checkbox"/>
23	ENGLISH ABSTRACT; JP 2006-502196; See abstract from corresponding WO 2004/028529 filed herewith	<input type="checkbox"/>

If you wish to add additional non-patent literature document citation information please click the Add button

**EXAMINER SIGNATURE**

Examiner Signature		Date Considered	
--------------------	--	-----------------	--

\*EXAMINER: Initial if reference considered, whether or not citation is in conformance with MPEP 609. Draw line through a citation if not in conformance and not considered. Include copy of this form with next communication to applicant.

<sup>1</sup> See Kind Codes of USPTO Patent Documents at [www.USPTO.GOV](http://www.USPTO.GOV) or MPEP 901.04. <sup>2</sup> Enter office that issued the document, by the two-letter code (WIPO Standard ST.3). <sup>3</sup> For Japanese patent documents, the indication of the year of the reign of the Emperor must precede the serial number of the patent document. <sup>4</sup> Kind of document by the appropriate symbols as indicated on the document under WIPO Standard ST.16 if possible. <sup>5</sup> Applicant is to place a check mark here if English language translation is attached.

<b>INFORMATION DISCLOSURE STATEMENT BY APPLICANT</b> ( Not for submission under 37 CFR 1.99)	Application Number	12057775
	Filing Date	2008-03-28
	First Named Inventor	Inge Bruheim, et al.
	Art Unit	1651
	Examiner Name	Susan Marie Hanley
	Attorney Docket Number	NATNUT-14409/US-5/ORD

**CERTIFICATION STATEMENT**

Please see 37 CFR 1.97 and 1.98 to make the appropriate selection(s):

That each item of information contained in the information disclosure statement was first cited in any communication from a foreign patent office in a counterpart foreign application not more than three months prior to the filing of the information disclosure statement. See 37 CFR 1.97(e)(1).

**OR**

That no item of information contained in the information disclosure statement was cited in a communication from a foreign patent office in a counterpart foreign application, and, to the knowledge of the person signing the certification after making reasonable inquiry, no item of information contained in the information disclosure statement was known to any individual designated in 37 CFR 1.56(c) more than three months prior to the filing of the information disclosure statement. See 37 CFR 1.97(e)(2).

- See attached certification statement.
- The fee set forth in 37 CFR 1.17 (p) has been submitted herewith.
- A certification statement is not submitted herewith.

**SIGNATURE**

A signature of the applicant or representative is required in accordance with CFR 1.33, 10.18. Please see CFR 1.4(d) for the form of the signature.

Signature	/J. Mitchell Jones/	Date (YYYY-MM-DD)	2011-03-03
Name/Print	J. Mitchell Jones	Registration Number	44,174

This collection of information is required by 37 CFR 1.97 and 1.98. The information is required to obtain or retain a benefit by the public which is to file (and by the USPTO to process) an application. Confidentiality is governed by 35 U.S.C. 122 and 37 CFR 1.14. This collection is estimated to take 1 hour to complete, including gathering, preparing and submitting the completed application form to the USPTO. Time will vary depending upon the individual case. Any comments on the amount of time you require to complete this form and/or suggestions for reducing this burden, should be sent to the Chief Information Officer, U.S. Patent and Trademark Office, U.S. Department of Commerce, P.O. Box 1450, Alexandria, VA 22313-1450. **DO NOT SEND FEES OR COMPLETED FORMS TO THIS ADDRESS. SEND TO: Commissioner for Patents, P.O. Box 1450, Alexandria, VA 22313-1450.**

## Privacy Act Statement

The Privacy Act of 1974 (P.L. 93-579) requires that you be given certain information in connection with your submission of the attached form related to a patent application or patent. Accordingly, pursuant to the requirements of the Act, please be advised that: (1) the general authority for the collection of this information is 35 U.S.C. 2(b)(2); (2) furnishing of the information solicited is voluntary; and (3) the principal purpose for which the information is used by the U.S. Patent and Trademark Office is to process and/or examine your submission related to a patent application or patent. If you do not furnish the requested information, the U.S. Patent and Trademark Office may not be able to process and/or examine your submission, which may result in termination of proceedings or abandonment of the application or expiration of the patent.

The information provided by you in this form will be subject to the following routine uses:

1. The information on this form will be treated confidentially to the extent allowed under the Freedom of Information Act (5 U.S.C. 552) and the Privacy Act (5 U.S.C. 552a). Records from this system of records may be disclosed to the Department of Justice to determine whether the Freedom of Information Act requires disclosure of these records.
2. A record from this system of records may be disclosed, as a routine use, in the course of presenting evidence to a court, magistrate, or administrative tribunal, including disclosures to opposing counsel in the course of settlement negotiations.
3. A record in this system of records may be disclosed, as a routine use, to a Member of Congress submitting a request involving an individual, to whom the record pertains, when the individual has requested assistance from the Member with respect to the subject matter of the record.
4. A record in this system of records may be disclosed, as a routine use, to a contractor of the Agency having need for the information in order to perform a contract. Recipients of information shall be required to comply with the requirements of the Privacy Act of 1974, as amended, pursuant to 5 U.S.C. 552a(m).
5. A record related to an International Application filed under the Patent Cooperation Treaty in this system of records may be disclosed, as a routine use, to the International Bureau of the World Intellectual Property Organization, pursuant to the Patent Cooperation Treaty.
6. A record in this system of records may be disclosed, as a routine use, to another federal agency for purposes of National Security review (35 U.S.C. 181) and for review pursuant to the Atomic Energy Act (42 U.S.C. 218(c)).
7. A record from this system of records may be disclosed, as a routine use, to the Administrator, General Services, or his/her designee, during an inspection of records conducted by GSA as part of that agency's responsibility to recommend improvements in records management practices and programs, under authority of 44 U.S.C. 2904 and 2906. Such disclosure shall be made in accordance with the GSA regulations governing inspection of records for this purpose, and any other relevant (i.e., GSA or Commerce) directive. Such disclosure shall not be used to make determinations about individuals.
8. A record from this system of records may be disclosed, as a routine use, to the public after either publication of the application pursuant to 35 U.S.C. 122(b) or issuance of a patent pursuant to 35 U.S.C. 151. Further, a record may be disclosed, subject to the limitations of 37 CFR 1.14, as a routine use, to the public if the record was filed in an application which became abandoned or in which the proceedings were terminated and which application is referenced by either a published application, an application open to public inspections or an issued patent.
9. A record from this system of records may be disclosed, as a routine use, to a Federal, State, or local law enforcement agency, if the USPTO becomes aware of a violation or potential violation of law or regulation.

## Electronic Acknowledgement Receipt

<b>EFS ID:</b>	9582207
<b>Application Number:</b>	12057775
<b>International Application Number:</b>	
<b>Confirmation Number:</b>	1945
<b>Title of Invention:</b>	BIOEFFECTIVE KRILL OIL COMPOSITIONS
<b>First Named Inventor/Applicant Name:</b>	Inge Bruheim
<b>Customer Number:</b>	72960
<b>Filer:</b>	John Mitchell Jones/Stephanie Filandrinos
<b>Filer Authorized By:</b>	John Mitchell Jones
<b>Attorney Docket Number:</b>	NATNUT-14409/US-5/ORD
<b>Receipt Date:</b>	08-MAR-2011
<b>Filing Date:</b>	28-MAR-2008
<b>Time Stamp:</b>	16:05:41
<b>Application Type:</b>	Utility under 35 USC 111(a)

### Payment information:

Submitted with Payment	no
------------------------	----

### File Listing:

Document Number	Document Description	File Name	File Size(Bytes)/ Message Digest	Multi Part /.zip	Pages (if appl.)
1	Foreign Reference	WO2000025608.pdf	771099 <small>2c26ec188e0358b77a754365f20c721ee73a c56b</small>	no	20

### Warnings:

### Information:



2	Foreign Reference	WO2000038708.pdf	2884255	no	66
			544f900eec13857a550a132975130e80b7566b79		
<b>Warnings:</b>					
<b>Information:</b>					
3	Foreign Reference	WO2002102394.pdf	1342022	no	37
			64278b1332a334cea66406bf2f1ab7b3f359afea		
<b>Warnings:</b>					
<b>Information:</b>					
4	Foreign Reference	WO2003011873.pdf	2762253	no	72
			8b7b2eb5bf8203598eb277a2b44d340efabf5499		
<b>Warnings:</b>					
<b>Information:</b>					
5	Foreign Reference	WO2005004393.pdf	747909	no	20
			48a04f5bde12778b00d14fd7f09c21f4c75cete7		
<b>Warnings:</b>					
<b>Information:</b>					
6	Foreign Reference	WO2005037848.pdf	2543757	no	62
			db94464a07ac6e98b90d2581c5164ad0af8799cc		
<b>Warnings:</b>					
<b>Information:</b>					
7	Foreign Reference	WO2005038037.pdf	1997461	no	45
			741fcd66e049ec3d3130113a64cdd9364fd02ecf		
<b>Warnings:</b>					
<b>Information:</b>					
8	Foreign Reference	WO2007080514.pdf	508337	no	13
			9fc08416ed7de4cf6c28b102a3f9727ecc6b146		
<b>Warnings:</b>					
<b>Information:</b>					
9	Foreign Reference	WO2007080515.pdf	1126336	no	27
			f107d460359dfa9680c803b00531e826d95c6e72		
<b>Warnings:</b>					
<b>Information:</b>					
10	Foreign Reference	WO2007108702.pdf	633051	no	19
			7df3e09ce9c7b79e643247018a3937588f709431		
<b>Warnings:</b>					
<b>Information:</b>					

11	Foreign Reference	WO2008006607.pdf	1452260	no	35
			d386394188ab80ac9a601598588d8bb5c515f13c6		
<b>Warnings:</b>					
<b>Information:</b>					
12	Foreign Reference	WO2008117062.pdf	3936244	no	77
			3958f201ee284e0c78014d5cf3df3e4a0b71fe9f		
<b>Warnings:</b>					
<b>Information:</b>					
13	Foreign Reference	WO2009027692.pdf	2775488	no	63
			93b34eb412fd4046b296fdd825e2c85f87cdd8aa		
<b>Warnings:</b>					
<b>Information:</b>					
14	Foreign Reference	WO2001028526A2.pdf	255236	no	12
			c8d44ae6d7089a2d30f387d14917b17ad5b90df2		
<b>Warnings:</b>					
<b>Information:</b>					
15	Foreign Reference	WO2004047554A1.pdf	872223	no	28
			cd3689e43f036c27c3d8622245b5850f7647cba		
<b>Warnings:</b>					
<b>Information:</b>					
16	Foreign Reference	EP0973532.pdf	513646	no	53
			fa30a7292b34ea1857feeab3af4dbd2388893362		
<b>Warnings:</b>					
<b>Information:</b>					
17	Foreign Reference	EP1123368A1.pdf	1196869	no	46
			3fb790c9c9f29b9ca1188d0e94fee120f0bd368a		
<b>Warnings:</b>					
<b>Information:</b>					
18	Foreign Reference	EP1292294B1.pdf	173009	no	15
			292ff4c0c1ab2e5d596215c6b73b4da08c652973		
<b>Warnings:</b>					
<b>Information:</b>					
19	Foreign Reference	WO2001082928A1.pdf	757986	no	26
			373e31e8df2cd6db97799e83ac02a1189d57911d		
<b>Warnings:</b>					
<b>Information:</b>					

20	Foreign Reference	WO2003013497A1.pdf	1591580	no	52
			5371c23087e57a5a6500cba48c7f0d09952adfb		
<b>Warnings:</b>					
<b>Information:</b>					
21	Foreign Reference	EP1419768A1.pdf	315262	no	24
			463d8e6587f8e27f1ba2affc2067fb45f74ee04f		
<b>Warnings:</b>					
<b>Information:</b>					
22	Foreign Reference	EP1385500B1.pdf	339484	no	15
			a5ccc1d0557fa115ed4faf2cb5f80a70bc6348c		
<b>Warnings:</b>					
<b>Information:</b>					
23	Foreign Reference	WO2002083122A1.pdf	780480	no	34
			1052c595a0a69b0ace1fc926a2d65d80815cbe41		
<b>Warnings:</b>					
<b>Information:</b>					
24	Foreign Reference	EP1392623A1.pdf	681339	no	20
			633b081c60bf4c53161b6ec63a07ba5cc29652cd		
<b>Warnings:</b>					
<b>Information:</b>					
25	Foreign Reference	WO2002092540A1.pdf	610826	no	20
			4a652924cb97bea4892ccc491ebffae9c42dc3b		
<b>Warnings:</b>					
<b>Information:</b>					
26	Foreign Reference	EP1406641B1.pdf	113611	no	13
			004634ecf6dfca9cb183a0516f0bc45157009422		
<b>Warnings:</b>					
<b>Information:</b>					
27	Foreign Reference	WO2004028529A1.pdf	1045643	no	45
			91bb974c5ff568ca026b78eaa90f8c2fd28ec1f5		
<b>Warnings:</b>					
<b>Information:</b>					
28	Foreign Reference	EP1743531A1.pdf	158888	no	10
			616db06974999391bb1ee2c56499ce2f6ff038ab		
<b>Warnings:</b>					
<b>Information:</b>					

29	Foreign Reference	EP1631280A1.pdf	1021731	no	45
			76d52b19f72280cda63c8c1f27369853f121f12c		
<b>Warnings:</b>					
<b>Information:</b>					
30	Foreign Reference	WO2004100943A1.pdf	924244	no	45
			21eaa0f46c229627866dbdfc067658399d386b56		
<b>Warnings:</b>					
<b>Information:</b>					
31	Foreign Reference	EP1660071A1.pdf	2492248	no	90
			3c87cfd386adf83ff53b8d156a4b416d3071578a		
<b>Warnings:</b>					
<b>Information:</b>					
32	Foreign Reference	WO2005018632A1.pdf	2261077	no	90
			515e3e21879541f58d1e9c15be88efe6a395c041		
<b>Warnings:</b>					
<b>Information:</b>					
33	Foreign Reference	WO2006030552A1.pdf	797495	no	34
			cb8e14ad89401f6f37201fa758f68c8d32d62422		
<b>Warnings:</b>					
<b>Information:</b>					
34	Foreign Reference	EP1689413A2.pdf	1664922	no	62
			884276fe5584ea452bc4ff6b990b27ec9eeef119		
<b>Warnings:</b>					
<b>Information:</b>					
35	Foreign Reference	EP1706106B1.pdf	117358	no	11
			9c308261dd5cb5e37daaf1285f8e9025ebd872cc		
<b>Warnings:</b>					
<b>Information:</b>					
36	Foreign Reference	WO2005070411A1.pdf	675061	no	21
			ab4264ff7eadff450c7eaf4f66a40c88ab4f5af0		
<b>Warnings:</b>					
<b>Information:</b>					
37	Information Disclosure Statement (IDS) Filed (SB/08)	14409US5updated_IDS2.pdf	614821	no	9
			a37d41284286e645a0ab95e1977deedd9871886d		
<b>Warnings:</b>					
<b>Information:</b>					

A U.S. Patent Number Citation or a U.S. Publication Number Citation is required in the Information Disclosure Statement (IDS) form for autoloading of data into USPTO systems. You may remove the form to add the required data in order to correct the Informational Message if you are citing U.S. References. If you chose not to include U.S. References, the image of the form will be processed and be made available within the Image File Wrapper (IFW) system. However, no data will be extracted from this form. Any additional data such as Foreign Patent Documents or Non Patent Literature will be manually reviewed and keyed into USPTO systems.

38	NPL Documents	TAKAICHI2003CompBiochemP hys.pdf	358463 0a4d9c6f1245fa03b71abcd6a3ad417e8a59 4d5a	no	6
<b>Warnings:</b>					
<b>Information:</b>					
39	NPL Documents	Tanaka2004JOleoSci.pdf	542717 f73801737eab08d017ad863acf04ca3447b da20d	no	8
<b>Warnings:</b>					
<b>Information:</b>					
40	NPL Documents	TODORIC2006.pdf	381710 0d9e5b8b5e45c270648d375b8ac836f3416 a3a06	no	11
<b>Warnings:</b>					
<b>Information:</b>					
41	NPL Documents	TOU2007NutritionReviews.pdf	1858857 e830a85754f9a22b4be86f95492c587dcd3 2ac50	no	17
<b>Warnings:</b>					
<b>Information:</b>					
42	NPL Documents	TRAYHURN2004.pdf	215158 43b2264d362691f32cd0be5a958b522e97d fb7ab	no	9
<b>Warnings:</b>					
<b>Information:</b>					
43	NPL Documents	TREBBLE2003.pdf	117657 08bd0d1ae7579c6d9c3ea527d4d3d35deac 097b2	no	8
<b>Warnings:</b>					
<b>Information:</b>					
44	NPL Documents	UKKOLA2002JMolMed.pdf	1230587 445f52fefec78b57fc9d920b54d812ca4382 9947	no	9
<b>Warnings:</b>					
<b>Information:</b>					
45	NPL Documents	VanderVeen1971.pdf	156749 1624d5e0afbc73c7ebe9e6e13ca33a55763 7ec7e	no	7

**Warnings:**

The page size in the PDF is too large. The pages should be 8.5 x 11 or A4. If this PDF is submitted, the pages will be resized upon entry into the Image File Wrapper and may affect subsequent processing

<b>Information:</b>					
46	NPL Documents	VIRTUE1996MarineBiology.pdf	692488 313186fd0b6c9940d20e80c1530934656d93c4c2	no	9
<b>Warnings:</b>					
<b>Information:</b>					
47	NPL Documents	Yamaguchi1986JAgFoodChem904-907.pdf	486703 09513f7b267892805c71d6d5515f1434a54b12ce	no	4
<b>Warnings:</b>					
<b>Information:</b>					
48	NPL Documents	YANASE1974.pdf	831028 a7d207496c89be11ce2b2af2fa1346f40425ba11	no	11
<b>Warnings:</b>					
<b>Information:</b>					
49	NPL Documents	DATABASE2006WPIWeekThomson.pdf	37556 7a541ee3bd9dd8b241f289fea1904a07a2524184	no	1
<b>Warnings:</b>					
<b>Information:</b>					
50	NPL Documents	Yamaguchi1983ScientificFishes1411-1415.pdf	2105650 051fbaac091991741140be1999eeff318dffdbaf	no	6
<b>Warnings:</b>					
<b>Information:</b>					
51	NPL Documents	TANAKA2005JOleoSci.pdf	1985743 2e84a6b465e5cbbeab2c6c06e235aa857e57788d	no	8
<b>Warnings:</b>					
<b>Information:</b>					
<b>Total Files Size (in bytes):</b>			54456577		

**This Acknowledgement Receipt evidences receipt on the noted date by the USPTO of the indicated documents, characterized by the applicant, and including page counts, where applicable. It serves as evidence of receipt similar to a Post Card, as described in MPEP 503.**

**New Applications Under 35 U.S.C. 111**

**If a new application is being filed and the application includes the necessary components for a filing date (see 37 CFR 1.53(b)-(d) and MPEP 506), a Filing Receipt (37 CFR 1.54) will be issued in due course and the date shown on this Acknowledgement Receipt will establish the filing date of the application.**

**National Stage of an International Application under 35 U.S.C. 371**

**If a timely submission to enter the national stage of an international application is compliant with the conditions of 35 U.S.C. 371 and other applicable requirements a Form PCT/DO/EO/903 indicating acceptance of the application as a national stage submission under 35 U.S.C. 371 will be issued in addition to the Filing Receipt, in due course.**

**New International Application Filed with the USPTO as a Receiving Office**

**If a new international application is being filed and the international application includes the necessary components for an international filing date (see PCT Article 11 and MPEP 1810), a Notification of the International Application Number and of the International Filing Date (Form PCT/RO/105) will be issued in due course, subject to prescriptions concerning national security, and the date shown on this Acknowledgement Receipt will establish the international filing date of the application.**



PCT

特許協力条約に基づいて公開された国際出願

<p>(51) 国際特許分類6 A23L 1/33</p>	<p>A1</p>	<p>(11) 国際公開番号 WO00/25608</p> <p>(43) 国際公開日 2000年5月11日(11.05.00)</p>
<p>(21) 国際出願番号 PCT/JP99/05892</p> <p>(22) 国際出願日 1999年10月26日(26.10.99)</p> <p>(30) 優先権データ 特願平10/311730 1998年11月2日(02.11.98) JP</p> <p>(71) 出願人 (米国を除くすべての指定国について) 日本水産株式会社 (NIPPON SUISAN KAISHA, LTD.)[JP/JP] 〒100-0004 東京都千代田区大手町二丁目6番2号 Tokyo, (JP)</p> <p>(72) 発明者 ; および (75) 発明者 / 出願人 (米国についてののみ) 吉富文司(YOSHITOMI, Bunji)[JP/JP] 〒192-0906 東京都八王子市北野町559-6 日本水産株式会社 中央研究所内 Tokyo, (JP) 重松良明(SHIGEMATU, Yoshiaki)[JP/JP] 〒100-0004 東京都千代田区大手町2-6-2 日本水産株式会社内 Tokyo, (JP)</p> <p>(74) 代理人 弁理士 須藤阿佐子(SUDOU, Asako) 〒184-0002 東京都小金井市梶野町5-6-3-103 Tokyo, (JP)</p>		<p>(81) 指定国 AU, CA, CN, KR, NO, NZ, US, 欧州特許 (AT, BE, CH, CY, DE, DK, ES, FI, FR, GB, GR, IE, IT, LU, MC, NL, PT, SE)</p> <p>添付公開書類 国際調査報告書</p>

(54) Title: DRY KRILL POWDER

(54) 発明の名称 オキアミ乾燥粉粒体

(57) Abstract

A dry krill powder wherein deterioration of lipids can be sufficiently prevented without resort to any antioxidant. The dry krill powder is characterized by containing all of the krill components. The proteases contained in the krill material have been completely inactivated. Heating is the only means for denaturing the proteins and inactivating the proteases contained in the krill material. The production process involves no chemical treatment for eliminating moisture or inactivating or inhibiting the proteases. Moreover, the process is free from the formation of waste liquor. This production process comprises lightly dehydrating caught krill, then grinding the same and drying by heating. Namely, the moisture contained in the krill is inactivated exclusively by heating so as to broaden the application range and, moreover, impart a high keeping quality. Thus, this production is a so-called zero-mission performance free from any waste.

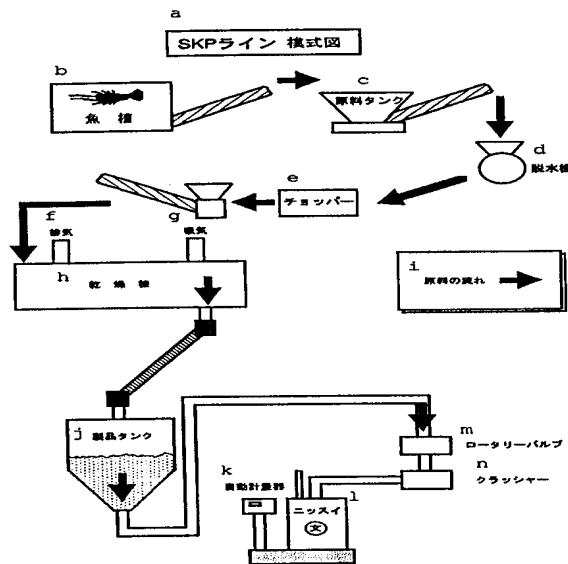

- |                      |                       |
|----------------------|-----------------------|
| a ... SKP LINE MODEL | h ... DRYER           |
| b ... FISH TANK      | i ... MATERIAL FLOW   |
| c ... MATERIAL TANK  | j ... PRODUCT TANK    |
| d ... DEHYDRATOR     | k ... AUTOMATIC METER |
| e ... CHOPPER        | l ... NISSUI          |
| f ... DISCHARGE GAS  | m ... ROTARY VALVE    |
| g ... INTAKE GAS     | n ... CRUSHER         |



(57)要約

抗酸化剤を使わなくとも十分に脂質劣化を防止できるオキアミ乾燥粉粒体の提供。

オキアミの全成分を含有することを特徴とするオキアミ乾燥粉粒体。原料オキアミ由来の蛋白分解酵素が完全に失活している。原料オキアミ蛋白質の変性や蛋白質分解酵素の失活に加えられる手段が加熱のみである。製造工程において水分除去や蛋白分解酵素失活や阻害の目的で何らの薬品処理がなく、しかも廃液の発生が全くない製造方法により製造される。当該製造方法は、漁獲したオキアミを軽く脱水し、これを破碎してから加熱乾燥する工程からなる製造方法である。つまり加熱のみによりオキアミから水分のみを失活させ、その利用用途を拡大し、さらに保存性までも付与せしめたもので、いわゆる廃棄物の発生がないゼロミッションを実現した製法、製品である。

PCTに基づいて公開される国際出願のパンフレット第一頁に掲載されたPCT加盟国を同定するために使用されるコード(参考情報)

AE	アラブ首長国連邦	DM	ドミニカ	KZ	カザフスタン	RU	ロシア
AL	アルバニア	EE	エストニア	LC	セントルシア	SD	スーダン
AM	アルメニア	ES	スペイン	LI	リヒテンシュタイン	SE	スウェーデン
AT	オーストラリア	FI	フィンランド	LK	スリランカ	SG	シンガポール
AU	オーストラリア	FR	フランス	LR	リベリア	SI	スロヴェニア
AZ	アゼルバイジャン	GA	ガボン	LS	レソト	SK	スロヴァキア
BA	ボスニア・ヘルツェゴビナ	GB	英国	LT	リトアニア	SL	シエラ・レオネ
BB	バルバドス	GD	グレナダ	LU	ルクセンブルグ	SN	セネガル
BE	ベルギー	GE	グルジア	LV	ラトヴィア	SZ	スワジランド
BF	ブルキナ・ファソ	GH	ガーナ	MA	モロッコ	TD	チャード
BG	ブルガリア	GM	ガンビア	MC	モナコ	TG	トーゴ
BJ	ベナン	GN	ギニア	MD	モルドヴァ	TJ	タジキスタン
BR	ブラジル	GW	ギニア・ビサウ	MG	マダガスカル	TZ	タンザニア
BY	ベラルーシ	GR	ギリシャ	MK	マケドニア旧ユーゴスラヴィア共和国	TM	トルクメニスタン
CA	カナダ	HR	クロアチア	ML	マリ	TR	トルコ
CF	中央アフリカ	HU	ハンガリー	MN	モンゴル	TT	トリニダード・トバゴ
CG	コンゴ	ID	インドネシア	MR	モーリタニア	UA	ウクライナ
CH	スイス	IE	アイルランド	MW	マラウイ	UG	ウガンダ
CI	コートジボアール	IL	イスラエル	MX	メキシコ	US	米国
CM	カメルーン	IN	インド	NE	ニジェール	UZ	ウズベキスタン
CN	中国	IS	アイスランド	NL	オランダ	VN	ヴェトナム
CR	コスタ・リカ	IT	イタリア	NO	ノルウェー	YU	ユーゴスラビア
CU	キューバ	JP	日本	NZ	ニュージーランド	ZA	南アフリカ共和国
CY	キプロス	KE	ケニア	PL	ポーランド	ZW	ジンバブエ
CZ	チェッコ	KG	キルギスタン	PT	ポルトガル		
DE	ドイツ	KR	北朝鮮	RO	ルーマニア		
DK	デンマーク	KR	韓国				

## 明 細 書

オキアミ乾燥粉粒体

5

## 技術分野

本発明はオキアミの全成分を含有する抗酸化剤を使わなくとも十分に脂質劣化を防止できるオキアミ乾燥粉粒体に関する。

10

## 背景技術

15

オキアミは主に北極および南極海域に生息する動物プランクトンで、現在までに約80数種類が知られている。この中でナンキョクオキアミは南極海に生息し、その資源量は膨大であることから、昭和40年代の後半から50年代にかけてその資源や漁法の開発調査および利用加工法が盛に研究された。

20

オキアミは栄養価の点で魚肉や畜肉に比べて遜色はないが利用加工上いくつか問題が存在する。その中の一つが急速な鮮度低下である。漁獲直後のオキアミを放置しておくと、気温が0℃付近の低温下でも1～2時間で頭胸部の黒変が進行する。さらにオキアミの頭胸部の殻は外圧に対して非常に弱く、漁獲時の衝撃で容易に破壊され、内臓に存在する酵素が流出し、筋肉を分解する。これらの現象はいずれもオキアミに存在する酸素の作用で前者はチロシナーゼ、後者はプロテアーゼと考えられている。

25

このためオキアミの加工に際してこれらの酸素を失活もしくは不活化させる必要がある。つまり漁獲後直ちに $-40^{\circ}\text{C}$ 以下に急速凍結し、酸素を不活化させ保存するか、もしくは $80^{\circ}\text{C}$ 以上に加熱し、酸素を失活させる必要があった。

5 既存の製品で急速凍結後、冷凍保管するものはオキアミの生冷凍品や生むき身品、加熱後、冷凍保管するものはオキアミボイル品、そして加熱、乾燥後、常温保管するものはオキアミミールであった。これらの製品の処理工程別の分類および製品別の特徴や改善点を整理して表1、表2に示した。

10

既存の製品はそれぞれの用途で利用されているが、これらの製品は南氷洋かた日本まで運ばれているため、その運賃が製品価格に大いに影響する。このためオキアミの持つ特性を引き出し、付加価値を濃縮した製品が望まれている。

15

表 1

処理	処理目的	製品例
急速凍結、冷凍保管	酸素不活性	生冷凍品、生むき身品
加熱処理、冷凍保管	酵素失活	ボイル品
加熱乾燥処理、常温保管	酵素失活	ミール

20

25

表 2

製品例	特徴	改善を望まれる点
5 生冷凍品、 生むき身品	生オキアミの風味、食感がある。	高水分および酵素活性が残存しているために冷凍保管、流通が必要。 解凍時に酵素が活性化し、品質が低下する。ドリップ流出。
10 ボイル品	加熱により酵素が失活し、蛋白質の安定性があり、肉感がある。	煮蒸時の風味、呈味成分の流出。 高水分のためコールドチェーンが必要。
15 ミール	加熱により酵素が失活し、蛋白質の安定性がある。 水分が低いために常温保管可能である。	加熱時の蛋白質変性による消化性の低下。 水溶性成分が脱水上澄み(ステイックウォーター)に流出する。

オキアミの蛋白分解酵素を阻害し、蛋白原料として利用する方法として特開昭57-11876号公報に記載の発明がある。当該方法はオキアミペーストをアルコール変性することにより蛋白質の固定(変性)と酵素の変性を同時に行った後、水洗してアルコールを除去するものであるが、以下の問題点がある。

1、水洗時にアルコールと共に未変性の水溶性蛋白質や低分子の蛋白質が同時に除去される。

2、水洗時にアルコールと共に旨味に関与する遊離アミノ酸、エキス

成分も除去される。

3、水洗時にアルコールと共に極性脂質が除去される。オキアミの脂質はその大部分がリン脂質で、高度不飽和脂肪酸に富んでおり、これを除去することになる。

5 4、アルコールの回収、再利用は可能であるが、コストがかかる。これらのことより当該方法の実用性には疑問が残る。

10 また、海老の乾燥造粒方法として特開平8-298967号公報に記載の発明がある。これは生海老をミンチ装置ですり身状となし、それを攪拌加熱して乾燥物を得るものである。

15 当該公報に示された実施例によると先ず原料の海老を搗り身状にする。ここで記載されている搗り身状とは原料の海老を完全にすり潰した状態のみならず、細かく切断した状態のものも含めている。具体的には挽肉等を製造するミンチ装置を用いてこの処理を行っており、その記載によると最大の粒度、つまり粗挽き状態は2mm角程度とされている。この様な処理をされた原料を加熱乾燥に供し、乾燥造粒物を得るのであるが、オキアミ特有の性状から、加熱乾燥機に供しても非常に乾燥し難いと推定される。

20

#### 発明の開示

すなわち、我々の研究によるとオキアミを上記と同様の処理を行うとオキアミに含まれる脂質、蛋白質および水分が乳化状態となり、加熱乾燥機に供しても非常に乾燥し難いことが分かっている。これは前述のようにオキアミの脂質の大部分が極性脂質であることで余計に乳化性に富んでいることに関係している。つまり乳化により水分が構造的に安定化

25

し、加熱により容易に蒸発しないからである。

また、搗り身状にすることによりオキアミ内臓由来の強い蛋白分解酵素活性が発現し、さらに搗り身処理時の昇温により酵素活性が高まり、オキアミ蛋白質の分解が促進され、ひいては呈味性の低下に結びつく。

5 さらに搗り身状の原料を加熱乾燥機に供すると機器の加熱面と接触し、徐々に皮膜が成長し、ついには接触面に付着した原料に焦げ付く現象が見られる。この現象の防止策としては機器の加熱面を常に攪拌羽等で接擦する必要があるが、機器の構造や精度から、さらに加熱による機器の膨張等の影響により加熱面と攪拌羽の間隔を一定に保つことは非常に難  
10 しく、結果として原料の焦げの発生は避けられず、これらによる風味の悪化や消化性の低下の原因となる。

そこで、本発明は貴重な水産資源であるオキアミを用いてオキアミ由来の酵素活性を完全に失活させ、さらにオキアミ由来成分の全てを有し、しかも保存性に優れた粉粒状のオキアミの製造方法ならびに当該粉粒状  
15 オキアミを提供することを目的としたものである。

本発明は、オキアミの全成分を含有することを特徴とするオキアミ乾燥粉粒体を要旨としている。オキアミの全成分を含有することにより抗酸化剤を使わなくとも十分に脂質劣化を防止できる機能を持たせたものである。上記のオキアミ乾燥粉粒体は、原料オキアミ由来の蛋白分解酵素が完全に失活しており、したがって本発明は、原料オキアミ由来の蛋白分解酵素が完全に失活しており、かつ、オキアミの全成分を含有することを特徴とするオキアミ乾燥粉粒体である。原料オキアミ蛋白質の変性や蛋白分解酵素の失活に加えられる手段が加熱のみであり、したが  
20 って本発明は、原料オキアミ蛋白質の変性や蛋白分解酵素の失活に加えられる手段が加熱のみである製造方法により得られた、原料オキアミ  
25

由来の蛋白分解酵素が完全に失活しており、かつ、オキアミの全成分を含有することを特徴とするオキアミ乾燥粉粒体である。

5 本願発明の上記のオキアミ乾燥粉粒体は、製造工程において水分除去や蛋白分解酵素失活や阻害の目的で何らの薬品処理がなく、しかも廃液の発生が全くない製造方法により製造される。当該製造方法は、漁獲したオキアミを軽く脱水し、これを破碎してから加熱乾燥する工程からなる製造方法である。

10 このオキアミ乾燥粉粒体は製造工程において薬品等による何らの化学的処理を加えられておらず、唯一加熱のみが加えられている。また工程中に廃液の発生する箇所は存在しない。つまり加熱のみによりオキアミから水分のみを失活させ、その利用用途を拡大し、さらに保存性までも付与せしめたもので、いわゆる廃棄物の発生がないゼロミッションを実現した製法、製品である。

15 この製造方法は漁獲されているオキアミから海水分を抜き、破碎した後、加熱乾燥する工程からなる。従来より行われているミールの製造工程においては先ずオキアミと同量の水でオキアミを煮熟した後、固液分離する。固形分は乾燥機にて加熱乾燥する。固液分離する際に得られた液体分はスティックウォーターと呼ばれ、別途保管される。このためオキアミミールには本発明品に比べ水溶性の成分が少なく、例えばエキス等における呈味性や養魚飼料等における摂餌誘引性に欠ける点があった。また、煮熟工程と加熱乾燥工程の2工程における加熱により蛋白質が過度に加熱変性し、消化率が低下する場合もある。

25 先にオキアミの種類については80数種類あることを述べたが、本発

明を実施するにあたりオキアミの種類は限定されない。またアミ類についても利用可能である。

ここでは現在、産業的に利用されているナンキョクオキアミ (Euphasia superba) を主に用いた。

5 以下、製造工程について説明する。

原料オキアミは漁獲後、直ちに魚槽に移される。その後、体表に付着している海水などを除去するために脱水機に供される。特に脱水機の種類は限定しないが、オキアミは外殻が非常にもろく、40～140 g /  
10  $\text{cm}^2$ の圧力で容易に破壊され、体成分が流出する。そのため脱水機はオキアミに過度の物理的負荷を与えない機種が望ましい。

脱水されたオキアミは加熱乾燥に際して熱効率を改善するために粉碎処理に供される。粉碎に用いる機材については特に限定はしない。粉碎の粒度に関しては原料オキアミをその外殻や筋組織が残る程度の粗挽き  
15 状からペースト状までいずれも限定はしないが、本発明では前述した理由により、1.5～2.5 cm角程度の粒度としている。この処理には挽肉等を作成するのに用いられている公知のミンチ装置を用い、目皿を変更することにより粗挽き肉状からペースト状まで対応している。

粉碎されたオキアミは加熱乾燥に供される。この工程も用いる機種は  
20 特に限定はしない。例えば蒸気式ディスクドライヤー等の公知の加熱乾燥機を使用できるが、加熱時間、加熱温度、攪拌の度合い等を調整できるものが望ましい。つまり天然資源であるオキアミの体成分は季節により変化するため、これらに対応して一定の品質の製品を得るためである。

25 また加熱時間および加熱温度に関してはオキアミの筋肉蛋白質および内在する蛋白分解酵素を加熱変性し、さらに保存性を考慮し水分を10



5 %以下に低下させることを考慮して設定する。この場合も高温、長時間加熱乾燥は避け、先に述べた条件を満たすのに必要最低限の処理を行う。過度の加熱は蛋白質の極度の変性による消化率の低下、オキアミ由来の天然色素アスタキサンチンの減少、ビタミン類の減少、そして脂質の酸化につながる。また加熱不足であると内在する蛋白分解酵素の活性が残存し、品質低下の引き金となりうる。また水分が10数%以上であるとカビ発生の原因となる。

乾燥後のオキアミは殻も非常に脆くなっているため粉碎機により任意の粒度容易に粉碎可能である。

10 本発明品の用途は養魚用飼料においては魚粉に代わる主原料として、また食品用途においてはエビ風味調味料として練り製品等に混合して使用可能である。

15 従来技術の欄で述べた問題は原料を揃り身状にすることに起因するため、我々は原料オキアミを魚体長の2～3割（約1.5～2.5cm角程度）に切断してから加熱乾燥機に供している。このことにより原料の乳化が防止され、乾燥効率が高まり、されに内臓由来の強い蛋白分解酵素活性も抑制されることで呈味に対する悪影響が減じられ、さらに加熱面への付着が防止されることで適切な加熱が可能となり、品質の向上に大きく寄与した。

20 さらにこの方法で得られたオキアミ乾燥物が粒径が大きく、また原料の形状をよく維持しているために食品等に利用してもその形状を活かした製品を得ることが可能である。また本発明によるオキアミ乾燥物は必要に応じて簡単に粉碎ができ、所望の粒度とすることができる。

25 よって本発明は特開平8-298967号公報に記載の発明とは異なる工程により異なった品質の乾燥物を得るものといえる。

生オキアミおよび本発明品の残存蛋白分解酵素活性を第1図に示す。

これはアゾカゼインを基質として各反応時間毎の残存蛋白分解酵素活性を440nmの吸光度を指標として示した。これによると生オキアミの残存蛋白分解酵素活性は反応時間の経過と共に高くなっているが、本発明品の残存蛋白分解酵素活性はほとんど変化せず、このことから本発明品には蛋白分解酵素が残存しておらず、製造工程において完全に失活しており、貯蔵保管中の品質劣化の可能性が低いことが示唆された。

10 本発明品の保存性について以下の表に示す。

これは本発明品にミール等の抗酸化剤として最も一般的なエトキシキン添加した区と添加していない区の2つの区を設け、37℃に2カ月間保管したときの品質の変化を脂質の劣化を指標として比較したものである。エトキシキン添加区には保存中の変化の差を明らかにするためエトキシキン300ppmと通常の添加量の2倍の量を添加した。

15 これによると1カ月目までは抗酸化剤無添加区および抗酸化剤添加区における脂質の変化には大きな変化は見られなかった。また2カ月目においては抗酸化剤無添加区の方が抗酸化剤添加区より若干酸化が進行しているが、大きな差は認められない。

20 脂質の劣化を示す指標についてはいくつかあるが、オキアミの脂質、特に抽出精製したものについては保存中に過酸化価はほとんど上昇せず、カルボニル価のみが上昇することが知られており、一般の魚油等の劣化とは酸化物生成、分解反応の進行速度が違うことが指摘されている。

25

表 3

	酸価		過酸化物価		カルボニル価	
	抗酸化剤 なし* 1	抗酸化剤 あり* 2	抗酸化剤 なし	抗酸化剤 あり	抗酸化剤 なし	抗酸化剤 あり
保存スタート	18.1	19.2	1.8	4.1	67.6	60.5
37℃1ヶ月	21.9	22.6	6.0	7.0	75.6	81.3
37℃2ヶ月	21.3	23.6	10.7	6.2	93.5	78.6

5 \* 1 : エトキシシン無添加

\* 2 : エトキシシン300ppm添加

15 また、本発明品と本発明品からオキアミ由来の水溶性成分を完全に除去したものでは保存中にその脂質の劣化速度が明らかに異なる現象が見られた。この原因物質については不明であるが、オキアミ由来の水溶性成分に何らかの抗酸化作用があると考えられている。このため本発明品のごとくオキアミの全成分を濃縮した製品は抗酸化剤を使わなくとも充分に脂質劣化を防止できる特徴があると思われる。

20

25

表 4

	過酸化物価		カルボニル価	
	本発明品	水溶性画分除去品	本発明品	水溶性画分除去品
保存スタート	0	0	69.5	87.7
30℃ 1ヶ月	0	0	53.9	71.7
30℃ 3ヶ月	0	0	63.0	76.9
30℃ 6ヶ月	6.9	10.5	89.1	142.3
30℃12ヶ月	11.8	20.7	127.1	202.6

#### 図面の簡単な説明

第1図は、生オキアミおよび本発明品の残存蛋白分解酵素活性を示す図面である。第2図は、本発明品の生産ラインの模式図である。

#### 発明を実施するための最良の形態

本願発明の詳細を実施例で説明する。本願発明はこれら実施例によって何ら限定されるものではない。

#### 実施例 1

1. オキアミ乾燥プラント装置および生産の流れ。

第2図に示すとおり、生産の流れの概略は、魚槽からオキアミ供給装置にて原料タンクへまず原料オキアミを送り、そこから適宜原料を脱水機に供給する。脱水機ではオキアミに含まれている海水分のみ脱水することを基本として考えているが原料によって水分量が異なることも予想

され、また、乾燥機の処理能力によっては脱水率を上げるように絞りの調整を行う。脱水後の原料はチョッパーで粗砕した後で乾燥機へ送る。原料は蒸気で加熱された乾燥機の中で煮熟し、さらに乾燥し、所定の水分に達した所で、乾燥終了として排出する。乾燥粉末は製品タンクに送られ、ロータリーバルブ、クラッシャー等を経て所定の重量迄自動的に袋詰めされる。

これまでのミールの製造工程は、生オキアミ→煮熟→遠心分離または固液分離→固形分→乾燥→粉碎→包装である。遠心分離工程で液体分は除去されるが、その中に有用成分が含まれおりそれが投棄されていた。ミールはある面では滓を乾燥したものであるといいかえることができる。

これに対して、本発明品を製造するための方法は、生オキアミ→周辺水分除去→煮熟→乾燥→粉碎→包装と簡単な流れとなっている。遠心分離工程がなく、煮熟、乾燥の工程で酵素を失活させオキアミ成分を熱変性安定化し、本来含有するオキアミ成分を外部に投棄することなく製品とする。装置的には、上記オキアミ乾燥装置の特徴は、デカンターやプレスによる原料を煮熟した後の絞り工程を省いたものであり、クッカーとドライヤーが一体になっていること等従来のミール装置と異なっている。

## 2. 成分分析値

本発明品の成分分析値を表5に示した。比較のために従来製法によるオキアミミールの値も示した。特に本発明では食味における呈味性や養魚飼料等における摂餌誘引性に深く関与する遊離アミノ酸量が従来のオキアミミールの2倍強含まれている。

原料を煮熟した後の絞り工程が省かれたことにより、呈味成分の流失による損失がなく良いフレーバーのものが得られる、廃液のほとんど出

ない製品の歩留まりがよい製造方法となっていることに基づく結果であると推定される。

表 5

	オキアミール	本発明品
水分	6.5	8.3
粗蛋白質(遊離アミノ酸)	64.0(2.9)	65.1(7.54)
粗脂肪	7.0	7.0
粗灰分	16.7	18.0
粗繊維	3.2	2.1

#### 産業上の利用可能性

貴重な水産資源であるオキアミを体成分の流出による損失が全くなく、完全有効利用する方法を提供することができる。得られたオキアミ乾燥粉粒体はオキアミ由来の全成分を含み、しかもオキアミ特有の強力な酵素活性を失活させているため、飼料分野はもとより、食品分野においても幅広く利用することができる。

## 請 求 の 範 囲

1. オキアミの全成分を含有することを特徴とするオキアミ乾燥粉粒体。
- 5 2. 原料オキアミ由来の蛋白分解酵素が完全に失活している請求項1のオキアミ乾燥粉粒体。
3. 原料オキアミ蛋白質の変性や蛋白質分解酵素の失活に加えられる手段が加熱のみである製造方法による請求項1または2のオキアミ乾燥粉粒体。
- 10 4. 製造工程において水分除去や蛋白分解酵素失活や阻害の目的で何らの薬品処理がなく、しかも廃液の発生が全くない製造方法による請求項1、2または3のオキアミ乾燥粉粒体。
- 15 5. 漁獲したオキアミを軽く脱水し、これを破碎してから加熱乾燥する工程からなる製造方法による請求項1ないし4のいずれかのオキアミ乾燥粉粒体。

20

25

# 第1図

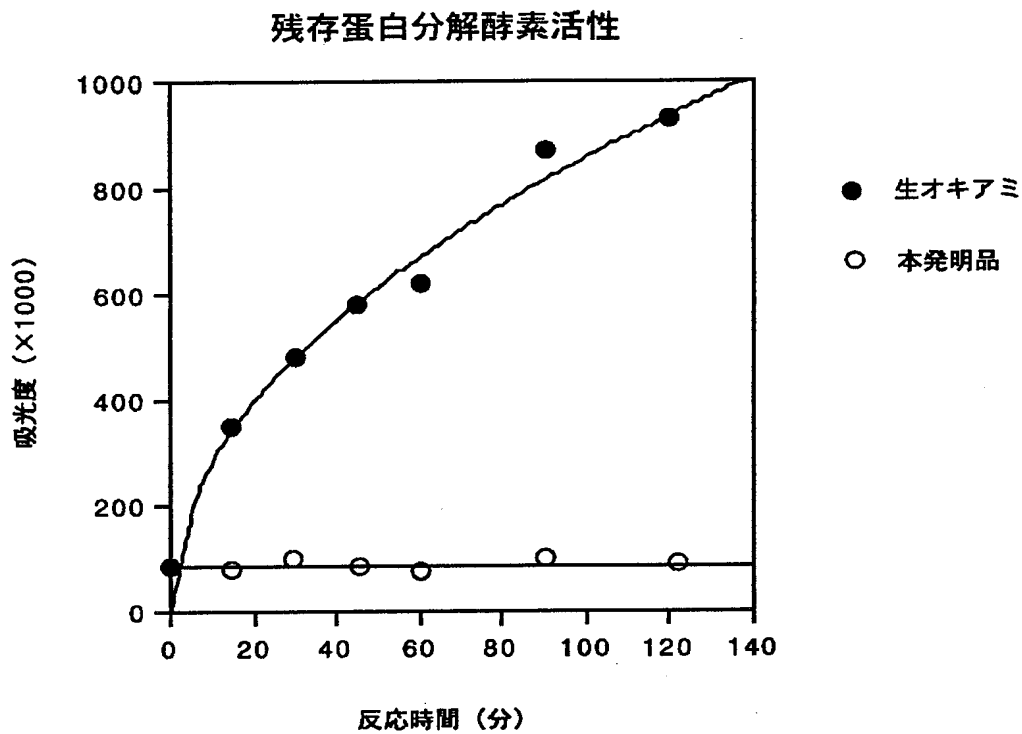



# 第2図

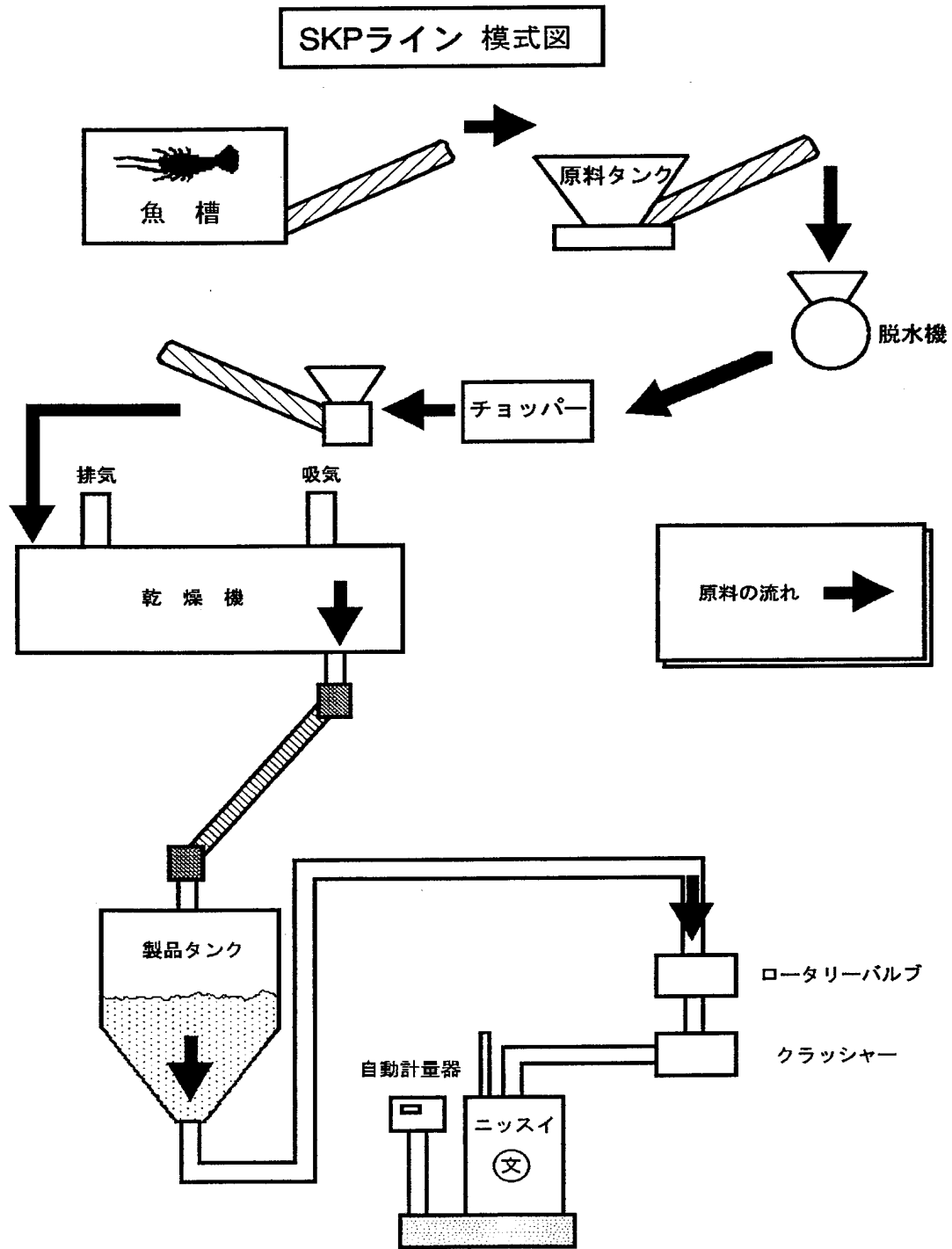

INTERNATIONAL SEARCH REPORT

International application No.

PCT/JP99/05892

A. CLASSIFICATION OF SUBJECT MATTER  
Int.Cl<sup>6</sup> A23L1/33

According to International Patent Classification (IPC) or to both national classification and IPC

B. FIELDS SEARCHED

Minimum documentation searched (classification system followed by classification symbols)  
Int.Cl<sup>6</sup> A23L1/33

Documentation searched other than minimum documentation to the extent that such documents are included in the fields searched

Electronic data base consulted during the international search (name of data base and, where practicable, search terms used)

C. DOCUMENTS CONSIDERED TO BE RELEVANT

Category*	Citation of document, with indication, where appropriate, of the relevant passages	Relevant to claim No.
X	JP, 51-22855, A (Daigo Takamura), 23 February, 1976 (23.02.76), Claims; column 3, the second line from the bottom to column4, line 2 (Family: none)	1-4
Y		5
Y	JP, 4-304862, A (Kabushiki Kaisha Nichiro), 28 October, 1992 (28.10.92), Claim 1 (Family: none)	1

Further documents are listed in the continuation of Box C.

See patent family annex.

\* Special categories of cited documents:

- "A" document defining the general state of the art which is not considered to be of particular relevance
- "E" earlier document but published on or after the international filing date
- "L" document which may throw doubts on priority claim(s) or which is cited to establish the publication date of another citation or other special reason (as specified)
- "O" document referring to an oral disclosure, use, exhibition or other means
- "P" document published prior to the international filing date but later than the priority date claimed

- "T" later document published after the international filing date or priority date and not in conflict with the application but cited to understand the principle or theory underlying the invention
- "X" document of particular relevance; the claimed invention cannot be considered novel or cannot be considered to involve an inventive step when the document is taken alone
- "Y" document of particular relevance; the claimed invention cannot be considered to involve an inventive step when the document is combined with one or more other such documents, such combination being obvious to a person skilled in the art
- "&" document member of the same patent family

Date of the actual completion of the international search  
12 November, 1999 (12.11.99)

Date of mailing of the international search report  
24 November, 1999 (24.11.99)

Name and mailing address of the ISA/  
Japanese Patent Office

Authorized officer

Facsimile No.

Telephone No.

A. 発明の属する分野の分類 (国際特許分類 (IPC)) Int.Cl <sup>6</sup> A 2 3 L 1 / 3 3		
B. 調査を行った分野 調査を行った最小限資料 (国際特許分類 (IPC)) Int.Cl <sup>6</sup> A 2 3 L 1 / 3 3		
最小限資料以外の資料で調査を行った分野に含まれるもの		
国際調査で使用した電子データベース (データベースの名称、調査に使用した用語)		
C. 関連すると認められる文献		
引用文献の カテゴリー*	引用文献名 及び一部の箇所が関連するときは、その関連する箇所の表示	関連する 請求の範囲の番号
X Y	J P, 5 1 - 2 2 8 5 5, A (高村大五), 2 3. 2 月. 1 9 7 6 (2 3. 0 2. 7 6), 特許請求の範囲, 第 3 欄下から 2 行目 - 第 4 欄上から 2 行目, (ファミリーなし)	1 - 4 5
Y	J P, 4 - 3 0 4 8 6 2, A (株式会社ニチロ), 2 8. 1 0 月. 1 9 9 2 (2 8. 1 0. 9 2), 特許請求の範囲第 1 項, (ファミ リーなし)	1
<input type="checkbox"/> C 欄の続きにも文献が列挙されている。 <span style="margin-left: 200px;"><input type="checkbox"/> パテントファミリーに関する別紙を参照。</span>		
* 引用文献のカテゴリー 「A」 特に関連のある文献ではなく、一般的技術水準を示すもの 「E」 国際出願日前の出願または特許であるが、国際出願日以後に公表されたもの 「L」 優先権主張に疑義を提起する文献又は他の文献の発行日若しくは他の特別な理由を確立するために引用する文献 (理由を付す) 「O」 口頭による開示、使用、展示等に言及する文献 「P」 国際出願日前で、かつ優先権の主張の基礎となる出願		
の日の後に公表された文献 「T」 国際出願日又は優先日後に公表された文献であって出願と矛盾するものではなく、発明の原理又は理論の理解のために引用するもの 「X」 特に関連のある文献であって、当該文献のみで発明の新規性又は進歩性がないと考えられるもの 「Y」 特に関連のある文献であって、当該文献と他の 1 以上の文献との、当業者にとって自明である組合せによって進歩性がないと考えられるもの 「&」 同一パテントファミリー文献		
国際調査を完了した日 1 2. 1 1. 9 9	国際調査報告の発送日 2 4. 1 1. 9 9	
国際調査機関の名称及びあて先 日本国特許庁 (ISA/J P) 郵便番号 1 0 0 - 8 9 1 5 東京都千代田区霞が関三丁目 4 番 3 号	特許庁審査官 (権限のある職員) 吉田 一朗	4 N   2 1 1 4  電話番号 0 3 - 3 5 8 1 - 1 1 0 1 内線 3 4 4 8



INTERNATIONAL APPLICATION PUBLISHED UNDER THE PATENT COOPERATION TREATY (PCT)

<p>(51) International Patent Classification <sup>7</sup> : <b>A61K 38/43, 38/46, 39/395</b></p>	<p><b>A1</b></p>	<p>(11) International Publication Number: <b>WO 00/38708</b> (43) International Publication Date: 6 July 2000 (06.07.00)</p>
<p>(21) International Application Number: PCT/US99/30818 (22) International Filing Date: 23 December 1999 (23.12.99) (30) Priority Data: 60/114,147 24 December 1998 (24.12.98) US (71) Applicant: PHAIRSON MEDICAL INC. [US/US]; 602 The Chambers, Chelsea Harbor, London SW10 0XF (GB). (72) Inventors: FRANKLIN, Richard, L.; 39 Dymock Street, London SW6 3ET (GB). ST. PIERRE, Yves; 531 Boul. des-Prairies, Laval, Quebec (CA). (74) Agents: BLOOM, Allen et al.; Dechert Price &amp; Rhoads, Princeton Pike Corporate Center, P.O. Box 5218, Princeton, NJ 08543 (US).</p>	<p>(81) Designated States: AE, AL, AM, AT, AU, AZ, BA, BB, BG, BR, BY, CA, CH, CN, CU, CZ, DE, DK, EE, ES, FI, GB, GD, GE, GH, GM, HR, HU, ID, IL, IN, IS, JP, KE, KG, KP, KR, KZ, LC, LK, LR, LS, LT, LU, LV, MD, MG, MK, MN, MW, MX, NO, NZ, PL, PT, RO, RU, SD, SE, SG, SI, SK, SL, TJ, TM, TR, TT, UA, UG, UZ, VN, YU, ZA, ZW, ARIPO patent (GH, GM, KE, LS, MW, SD, SL, SZ, TZ, UG, ZW), Eurasian patent (AM, AZ, BY, KG, KZ, MD, RU, TJ, TM), European patent (AT, BE, CH, CY, DE, DK, ES, FI, FR, GB, GR, IE, IT, LU, MC, NL, PT, SE), OAPI patent (BF, BJ, CF, CG, CI, CM, GA, GN, GW, ML, MR, NE, SN, TD, TG).</p> <p><b>Published</b> <i>With international search report. Before the expiration of the time limit for amending the claims and to be republished in the event of the receipt of amendments.</i></p>	

(54) Title: TREATMENT AND PREVENTION OF IMMUNE REJECTION REACTIONS

(57) Abstract

Provided, among other things, is a method of preventing or ameliorating transplantation rejection reactions comprising treating the donor tissue with a rejection reaction preventing or ameliorating effective amount of a hydrolase that is effective to reduce the amount of one or more cell surface adhesion molecules.

**FOR THE PURPOSES OF INFORMATION ONLY**

Codes used to identify States party to the PCT on the front pages of pamphlets publishing international applications under the PCT.

<b>AL</b>	Albania	<b>ES</b>	Spain	<b>LS</b>	Lesotho	<b>SI</b>	Slovenia
<b>AM</b>	Armenia	<b>FI</b>	Finland	<b>LT</b>	Lithuania	<b>SK</b>	Slovakia
<b>AT</b>	Austria	<b>FR</b>	France	<b>LU</b>	Luxembourg	<b>SN</b>	Senegal
<b>AU</b>	Australia	<b>GA</b>	Gabon	<b>LV</b>	Latvia	<b>SZ</b>	Swaziland
<b>AZ</b>	Azerbaijan	<b>GB</b>	United Kingdom	<b>MC</b>	Monaco	<b>TD</b>	Chad
<b>BA</b>	Bosnia and Herzegovina	<b>GE</b>	Georgia	<b>MD</b>	Republic of Moldova	<b>TG</b>	Togo
<b>BB</b>	Barbados	<b>GH</b>	Ghana	<b>MG</b>	Madagascar	<b>TJ</b>	Tajikistan
<b>BE</b>	Belgium	<b>GN</b>	Guinea	<b>MK</b>	The former Yugoslav Republic of Macedonia	<b>TM</b>	Turkmenistan
<b>BF</b>	Burkina Faso	<b>GR</b>	Greece			<b>TR</b>	Turkey
<b>BG</b>	Bulgaria	<b>HU</b>	Hungary	<b>ML</b>	Mali	<b>TT</b>	Trinidad and Tobago
<b>BJ</b>	Benin	<b>IE</b>	Ireland	<b>MN</b>	Mongolia	<b>UA</b>	Ukraine
<b>BR</b>	Brazil	<b>IL</b>	Israel	<b>MR</b>	Mauritania	<b>UG</b>	Uganda
<b>BY</b>	Belarus	<b>IS</b>	Iceland	<b>MW</b>	Malawi	<b>US</b>	United States of America
<b>CA</b>	Canada	<b>IT</b>	Italy	<b>MX</b>	Mexico	<b>UZ</b>	Uzbekistan
<b>CF</b>	Central African Republic	<b>JP</b>	Japan	<b>NE</b>	Niger	<b>VN</b>	Viet Nam
<b>CG</b>	Congo	<b>KE</b>	Kenya	<b>NL</b>	Netherlands	<b>YU</b>	Yugoslavia
<b>CH</b>	Switzerland	<b>KG</b>	Kyrgyzstan	<b>NO</b>	Norway	<b>ZW</b>	Zimbabwe
<b>CI</b>	Côte d'Ivoire	<b>KP</b>	Democratic People's Republic of Korea	<b>NZ</b>	New Zealand		
<b>CM</b>	Cameroon			<b>PL</b>	Poland		
<b>CN</b>	China	<b>KR</b>	Republic of Korea	<b>PT</b>	Portugal		
<b>CU</b>	Cuba	<b>KZ</b>	Kazakstan	<b>RO</b>	Romania		
<b>CZ</b>	Czech Republic	<b>LC</b>	Saint Lucia	<b>RU</b>	Russian Federation		
<b>DE</b>	Germany	<b>LI</b>	Liechtenstein	<b>SD</b>	Sudan		
<b>DK</b>	Denmark	<b>LK</b>	Sri Lanka	<b>SE</b>	Sweden		
<b>EE</b>	Estonia	<b>LR</b>	Liberia	<b>SG</b>	Singapore		

## TREATMENT AND PREVENTION OF IMMUNE REJECTION REACTIONS

The present application claims the priority of Provisional Patent Application No. 5 60/114,147, filed 24 December 1998.

The present invention relates to a treatments to prevent immune rejection reactions, such as graft vs. host disease (GVHD), with a hydrolase effective to remove cell surface adhesion molecules involved in triggering such immune reactions. One embodiment uses a krill-derived multifunctional enzyme and a family of crustacean and 10 fish derived enzymes having substantial structural or functional similarity to the multifunctional enzyme derived from antarctic krill. Another particularly preferred enzyme is an Atlantic cod (*Gadus morhua*) trypsin, particularly that described *European J. Biochem.* 180: 85-94, 1989 and Protein Resource/GenBank Accession No. S03570.

The aquatic or other enzymes that are substantially or functional structurally 15 similar to the krill-derived multifunctional enzyme have the same utility as the krill enzyme. In particular, these enzymes are useful for treating viral infections and other disorders, as outlined for example in U.S. Patent Application Nos. 08/486,820, 08/338,501 (filed November 22, 1994) and U.S. Patents 5,945,102 and 5,958,406.

A WO 96/00082 application of Cortecs Limited describes treating T-cells with 20 bromelain to affect intracellular phosphorylation reactions. The mechanism is said to probably be blockage of "tyrosine phosphorylation of proteins including MAP kinase." The claims of the WO 96/00082 application recite preventing or treating tissue rejection, but no example or protocol for doing so is described. Using antibodies to CD3e and CD28, the authors concluded that "the removal of cell surface molecules by bromelain 25 treatment was not responsible for the reduced cytokine mRNA observed," though *increases* in CD3e and CD28 binding observed "may have contributed" to a proliferative response observed.

A Döring et al., *J. Immunol.* 154: 4842-4850, 1995 article ("Döring") describes the effects of two enzymes found in sputum from cystic fibrosis patients on CD4 and 30 CD8. The enzymes are polymorphonuclear leukocyte-derived proteinase elastase and cathepsin G. Exposure to the polymorphonuclear leukocyte-derived proteinase elastase apparently reduced the cytotoxic response of a T-cell clone. The authors speculate that the effect helps limit tissue damage from the sustained inflammation found in the lungs

of cystic fibrosis patients. Döring does not disclose any treatment of tissue rejection reactions.

Gaciong et al., *Transplantation Proceedings* 28: 3439-3440, 1996 assert that systemic administration of a mixture of bromelain, pancreatic trypsin and a glucoside  
5 reduces immune-mediated arteriosclerosis in rat model, where the rats received transplants of allogeneic abdominal aortas. Gaciong et al. describe no tissue-targeted method of preventing or ameliorating transplantation rejection.

#### SUMMARY OF THE INVENTION

The invention provides a method of preventing or ameliorating transplantation  
10 rejection reactions comprising treating the donor tissue with a rejection reaction preventing or ameliorating effective amount of a hydrolase (which can be a mixture of hydrolases), such as a protease. Without limiting the invention to theory, one indication that a hydrolase is appropriate for use in the invention is that such hydrolase is effective to reduce (e.g., remove, destroy, inactivate or disable) the amount of one or more cell  
15 surface adhesion molecules. For example, the invention can comprise selecting an hydrolase that is effective to induce tolerance in an immune cell to an antigen or cell to which the immune cell was previously reactive. Or, the invention can comprise selecting a hydrolase (or an appropriate mix of hydrolases) that disrupts signal 2 mediators of an immune cell or signal 1 mediators (or both). In one preferred embodiment, the invention  
20 can comprise selecting a hydrolase (or an appropriate mixture of hydrolases) that disrupts signal 2 mediators, while leaving in place signal 1. Alternatively, the invention can comprise selecting a hydrolase that removes, destroys, inactivates or disables at least 60% of the cell surface adhesion molecules involved in mediating signal 2 for which a purified krill-derived multifunctional enzyme ("PHM protease," as described, for  
25 example, in U.S. Patents 5,945,102 and 5,958,406) or cod trypsin removes, destroys, inactivates or disables at least 60%. Preferably, the amount of such cell surface adhesion molecules removed, destroyed, inactivated or disabled is an amount greater than or within 10% of the amount removed, destroyed, inactivated or disabled by PHM or cod trypsin. The method can comprise treating the donor tissue *ex vivo*.

30 In one embodiment, the hydrolase employed is more effective on a molar basis in preventing or ameliorating donor tissue rejection than is the krill multifunctional enzyme. For example, the hydrolase employed is more effective in removing one or more of CD4, CD8, CD25 (IL-2 alpha receptor chain), CD28, ICAM-1 (CD54), CD152

(also known as CTLA-4), GP39 (also known as CD154, CD40 ligand or CD40L), an integrin, CD40 and CD80 (also known as B7) than is the krill multifunctional enzyme. Or the hydrolase is more effective than papain, or bromelain, or mammalian trypsin. For example, the hydrolase employed is more effective in removing one or more of CD28, 5 ICAM-1 (CD54), GP39 (CD154), an integrin, CD40 and CD80 than is the krill multifunctional enzyme. In another example, the hydrolase employed is more effective in removing CD28 than is one or more of the krill multifunctional enzyme. In another example, the hydrolase employed is more effective in removing ICAM-1 (CD54) than is one or more of the krill multifunctional enzyme. In another example, the hydrolase 10 employed is more effective in removing an integrin than is one or more of the krill multifunctional enzyme. In another example, the hydrolase employed is more effective in removing an LFA-1 (also known as  $\alpha$ L or CD11a) than is the krill multifunctional enzyme. In another example, the hydrolase employed is more effective in removing GP39 (CD154) than is one or more of the krill multifunctional enzyme.

15 In one embodiment of the method described above, the preventing or ameliorating transplantation rejection reactions comprises treating a donor source of immune cells (lymphocytes such as T-cells or B-cells) with a rejection preventing or ameliorating effective amount of a hydrolase that is effective to reduce the amount of one or more cell surface adhesion molecules, or preventing or ameliorating transplantation 20 rejection. The method can comprise contacting the treated immune cells, which cells are obtained from a recipient animal, with second cells of a donor animal; and transplanting a tissue from the donor animal to the recipient animal

The invention also provides a method of preventing or ameliorating transplantation rejection reactions comprising: treating a donor source of immune cell 25 (e.g., lymphocyte) *precursor* cells (such as from bone marrow) with a rejection preventing or ameliorating effective amount of a hydrolase, and administering the treated lymphocyte precursor cells to a recipient.

The invention further provides a method of preventing or ameliorating transplantation rejection reactions comprising: isolating from a source of immune cells 30 taken from a donor (a) a fraction enriched in mature T-cells and (b) a fraction containing immune cell precursor cells; treating the mature T-cells of fraction (a) with a rejection preventing or ameliorating effective amount of a hydrolase; and administering the



mature T-cells of fraction (a) and fraction (b) to a recipient. In one embodiment, the hydrolase treated mature T-cells are contacted with cells of fraction (b) prior to administration to the recipient.

The invention still further provides a method of preventing or ameliorating  
5 transplantation rejection reactions comprising: treating a source of immune cells taken from a recipient or donor (for example where the recipient does not have an immune system) with a rejection preventing or ameliorating effective amount of a hydrolase; incubating the treated source of immune cells with a donor organ, tissue or cell type; transplanting the donor organ, tissue or cell type into the recipient; and administering the  
10 treated cells into the recipient. In one embodiment, the treated cells include mature T-cells.

The invention also provides a method of preventing or ameliorating allergic or autoimmune reactions comprising: treating a source of immune cells taken from a treatment subject or donor (for example where the recipient does not have an immune  
15 system) with an allergic or autoimmune reaction preventing or ameliorating effective amount of a hydrolase; exposing the immune cells to an antigen that induces the allergic reaction or which contains autoimmune epitopes; and restoring the treated and exposed immune cells to the treatment subject.

In one embodiment, the invention provides a method of preventing or  
20 ameliorating allergic, autoimmune or transplantation rejection reactions with a hydrolase, comprising: identifying the hydrolase or mixture of hydrolases as a hydrolase or mixture of hydrolases with a relative selective preference for disabling signal 2 and/or signal 1, or effective for inducing tolerance in immune cells to a substance or to a cell; treating immune cells with the hydrolase or mixture of hydrolases; and administering the treated  
25 cells to a mammal. Alternatively, the hydrolase can be selected on the basis of specificity for cell surface adhesion molecules.

The invention further provides (a) methods relating to certain conditions using effective amounts of hydrolase, (b) compositions for use in such methods, (c) pharmaceutical compositions containing effective amounts of hydrolase for use in such  
30 methods, and (d) uses of the hydrolase composition for manufacturing a medicament for use in such methods. The methods are include:

- treating a tissue, body fluid or composition of cells to remove or inactivate a cell adhesion component comprising, wherein the enzyme is administered to the tissue, body fluid or composition of cells, preferably a cell-adhesion component removing or inactivating effective amount or an immune rejection inhibiting amount of the enzyme is administered, wherein preferably the tissue, body fluid or composition of cells is treated extra-corporeally, although they may also be treated *in situ* in an animal; or
  - treating or prophylactically preventing HIV infection, preferably administering an HIV infection treating or preventing effective amount of the enzyme
- 10 The method comprises administering a composition comprising a hydrolase described above.

The invention further provides (a) methods for treating or prophylactically preventing a cell-cell or cell-virus adhesion syndrome comprising administering an anti-adhesion effective amount of a hydrolase effective to remove or inactivate a cellular or viral acceptor or receptor adhesion component that is involved in the cell-cell or cell-virus adhesion, (b) compositions or substances for use in such methods, (c) pharmaceutical compositions containing effective amounts of enzyme for use in such methods, and (d) uses of the enzyme composition for manufacturing a medicament for use in such methods. Preferably, the syndrome comprises inflammation, shock, tumor metastases, autoimmune disease, transplantation rejection reactions or microbial infections. Preferably, (a) the syndrome is selected from the group consisting of graft versus host disease, organ or tissue transplantation rejection, autoimmune disease and associated conditions, microbial infection, immune disorder, cystic fibrosis, COPD, atherosclerosis, cancer, asthma, septic shock, toxic shock syndrome, conjunctivitis, reperfusion injury and pain, and (b) a cell surface adhesion molecule, associated with the cell-cell or cell-virus adhesion syndrome, is removed or inactivated by the administered hydrolase, where the cell surface adhesion molecule can be selected from the group consisting of ICAM-1 (also know as CD54), ICAM-2 (also known as CD102), VCAM-1, CD3, CD4, CD8, CD11, CD18, CD28, CD29D, CD31, CD44, CD 49, CD62L, CD102, GP39 (CD154), integrins (e.g., of  $\beta$ -1 subfamily {e.g.,  $\beta$ -1 (CD29) with  $\alpha$ 1 (CD49a),  $\alpha$ 2 (CD49b),  $\alpha$ 3 (CD49c),  $\alpha$ 4 (CD49d),  $\alpha$ 5 (CD49e),  $\alpha$ 6 (CD49f) or  $\alpha$ V (CD51), of  $\beta$ -2 subfamily (e.g.,  $\beta$ -2 (CD11a) with  $\alpha$ L (CD11b),  $\alpha$ M (CD ) or  $\alpha$ X (CD11c), or of  $\beta$ -3

subfamily (e.g.,  $\beta$ -3 (CD61) with  $\alpha$ V (CD51) or  $\alpha$ 11b (CD41),  $\beta$ -4 (CD104) with  $\alpha$ 6 (CD49f),  $\beta$ -5 with  $\alpha$ V (CD51),  $\beta$ -P with  $\alpha$ 4 (CD49d)} and asialo GM1 ceramide.

The invention further provides a pharmaceutical composition for removing or inactivating a cell-surface adhesion molecule comprising a cell-surface adhesion  
5 molecule removing or inactivating effective amount of a hydrolase. Such hydrolases include a number of enzymes such as cod trypsin and other hydrolases, including, as one specific example, proteases with multiple classes of proteolytic activity such as the multifunctional enzyme having: activity comprising at least one of a chymotrypsin, trypsin, collagenase, elastase or exo peptidase activity; a molecular weight between  
10 about 20 kd and about 40 kd as determined by SDS PAGE; and substantial homology to the krill-derived multifunctional hydrolase. Such compositions typically include a pharmaceutically acceptable diluent or carrier.

The invention still further provides a pharmaceutical composition for treating or prophylactically preventing a cell-cell or cell-virus adhesion syndrome comprising a cell-  
15 cell or cell-virus adhesion syndrome treating or preventing effective amount of a composition comprising a hydrolase. For example, in some embodiments the hydrolase is multifunctional enzyme having: activity comprising at least one of a chymotrypsin, trypsin, collagenase, elastase or exo peptidase activity; a molecular weight between about 20 kd and about 40 kd as determined by SDS PAGE; and substantial homology to  
20 the krill-derived multifunctional hydrolase. Such compositions typically include a pharmaceutically acceptable diluent or carrier.

In a preferred embodiment, HIV-infected patients are treated to slow the progression of the associated diseases by the process of (1) isolating T-cells from the patient, (2) treating the T-cells with a hydrolase effective to remove CD4, and (3)  
25 injecting the T-cells into the patient.

In one aspect, the method of extra-corporeally treating a tissue, body fluid or composition of cells to remove cell adhesion components reduces the immune rejection of a tissue, body fluid or composition of cells that is transplanted from one individual to another. In another aspect, such treatments remove or inactivate the cell adhesion  
30 components found in the treated tissue, body fluid or composition of cells involved in a microbial infection.

In some specific embodiments, the invention relates to a hydrolase having multifunctional activity comprising at least one of a chymotrypsin, trypsin, collagenase, elastase or exo peptidase activity, a molecular weight between about 20 kd and about 40 kd as determined by SDS PAGE, and substantial homology to krill-derived

5 multifunctional hydrolase. Preferably, the enzyme has a molecular weight of from about 26 kd to about 32 kd as determined by SDS (sodium dodecyl sulfate) polyacrylamide gel electrophoresis ("PAGE"), more preferably about 29 kd. Preferably, the enzyme has an N-terminal sequence comprising: I-V-G-G-X-E/D-B-X-X-X-X-Z/B'-P-Z/H-Q-B-X-B'/Z, wherein X is any amino acid, Z is an aromatic amino acid, B is an amino acid

10 having a C1 to C6 alkyl side chain, and B' is leucine or isoleucine. More preferably, all amino acids represented by X, Z or B are natural amino acids. Preferably, the enzyme has an N-terminal sequence comprising: I-V-G-G-X-E/D-B wherein X is any amino acid, B is an amino acid having a C1 to C6 alkyl side chain. Preferably, the enzyme is the krill-derived multifunctional hydrolase. Thus, in one embodiment, the N-terminal

15 sequence is I-V-G-G-X-E-V-T-P-H-A-Y-P-W-Q-V-G-L-F-I-D-D-M-Y-F (SEQ ID NO. 20). Preferably, the enzyme has the N-terminal sequence: I-V-G-G-N/M-E-V-T-P-H-A-Y-P-W-Q-V-G-L-F-I-D-D-M-Y-F (SEQ ID NO. 1).

In these specific embodiments, preferably, the multifunctional enzyme of the invention has at least two of the identified proteolytic activities, more preferably at least

20 three, still more preferably at least four. Yet more preferably, the enzyme has all of the identified proteolytic activities. Preferably, the multifunctional enzyme has substantial anti cell-cell and cell-virus adhesion activity. Preferably, the multifunctional enzyme has substantial homology with the krill-derived multifunctional hydrolase.

In another aspect of this specific embodiment, the multifunctional enzyme shall

25 include an amino acid sequence having at least about 70% identity with a "reference sequence" described below, more preferably at least about 80% identity, still more preferably at least about 90% identity, yet still more preferably at least about 95% identity. The krill-derived multifunctional hydrolase can be the multifunctional enzyme. The reference sequence is (i) the amino acid 64-300 sequence of SEQ ID NO:21, or (i) a

30 sequence which is that of the amino acid 64-300 sequence of SEQ ID NO:21 except that it has

one or more of the amino acid substitutions found in the amino acid 1-185 sequence of SEQ ID NO:22,

one or more of the amino acid substitutions found in the amino acid 72-178 sequence of SEQ ID NOS:23 or 24,  
one or more of the amino acid substitutions found in the amino acid 1-211 sequence of SEQ ID NO:25,  
5 one or more of the amino acid substitutions found in the amino acid 66-302 sequence of SEQ ID NO:26, or  
has asparagine or lysine at a residue corresponding to residue 68 of SEQ ID NO:21,

wherein identity is calculated by (a) aligning the sequences as described below and  
10 determining, over the entire length corresponding to the reference sequence, the average number of substitutions, deletions or insertions for every 100 amino acids of the reference sequence, with this number corresponding to percent identity; or (b) the method of Needleman and Wunch, using the parameters set forth in Version 2 of DNASIS.

15 Preferably, the hydrolase is selectively reactive with cell-surface receptors such as proteins or glycolipids. Preferably, the hydrolase is substantially purified. In some embodiments, the hydrolase has a purity with respect to macromolecules of at least about 90%, more preferably least about 95%, more preferably about 97%, still more preferably about 99%, yet more preferably 99.7% with respect to macromolecules. For the  
20 purposes of this application, "substantially pure" shall mean about 60% purity.

The invention also provides a pharmaceutical composition comprising the multifunctional enzyme of claim 1 and a pharmaceutically acceptable diluent or carrier.

#### **BRIEF DESCRIPTION OF THE DRAWINGS**

25 **Figures 1A and 1B:** Survival of (C57BL/6 x DBA/2)BDFI recipients of semi-allogeneic C57BL/6 bone marrow cells mixed with PHM-treated C57BL/6 splenocytes.

**Figure 2:** Survival of (C57BL/6 x DBA/2)BDFI recipients of semi-allogeneic C57BL/6 bone marrow cells mixed with protease-treated C57BL/6 splenocytes.

**Figure 3 (3A-3C)** shows the effects of cod trypsin of PHM incubations on surface  
30 markers.

**Figures 4 and 5** show the effects of various hydrolases on a number of cell surface adhesion molecules.

### DETAILED DESCRIPTION

It has now been established that the multifunctional enzyme and other hydrolases effectively remove or inactivate certain cell-surface adhesion molecules, such as ICAM-1 (CD54), ICAM-2 (CD102), VCAM-1, CD4, CD8, CD28, CD31, CD11a, CD49d, other integrin component chains, CD44, the asialo GM1 ceramide, CD40 and CD80 without affecting cell viability. This adhesion site removal or inactivation phenomenon is believed to provide at least a partial explanation for effectiveness against many, though probably not all, of the indications against which, for example, the multifunctional enzyme is effective.

Again not wishing to be limited by any particular theory, the anti-CD4 cell surface adhesion molecule activity of the multifunctional enzyme is believed to be responsible, at least in part, for the enzyme's HIV-transmission inhibitory activity. The HIV infective pathway utilizes the CD4 cell-surface molecule. *See*, Lentz, "Molecular Interaction of Viruses with Host-Cell Receptors," in *Adhesion Molecules*, Wegner, Ed., Academic Press, 1994, pp. 223-251 at p. 229.

Studies on the destruction or inactivation of cell surface molecules on T-cell exposed to as little as 10 µg/ml of the krill hydrolase for four hours at 37°C have determined that: CD3 and CD90 show little or no change; CD28, CD49, CD29D, CD18 and CD11 are significantly destroyed or inactivated, about 25% to about 40% reduction detectable antigen; ICAM-1 (CD54), ICAM-2 (CD102), CD44, CD31, CD62L (L-selectin), CD4, and CD8 are substantially destroyed or inactivated, generally about 70% to about 100% reduction in detectable antigen. Additionally, antibodies against asialo GM-1 have indicated reductions in the immunologically detectable amount of this ceramide in the membranes of lung epithelial cells following exposure to the multifunctional enzyme of the invention. Further, such treatment of lung epithelial cells with the krill hydrolase reduces the level attachment of *Pseudomonas* bacteria to the lung epithelial cells.

Further studies have established that hydrolases of interest remove certain cell surface molecules that are believed to contribute to the signal 2 pathway for activation of T-cells, these cell surface molecules include one or more of CD4, CD8, CD28, and CD154, while having substantially less effect on the T-cell receptor (TcR), which is involved in the signal 1 pathway for activation of T-cells. While not wishing to be

limited to theory, it is believed that hydrolases that substantially interfere with the signal 2 pathway or another accessory pathway (e.g., remove, destroy, inactivate or disable at least 60% of at least one CD4, CD8, CD28, or CD154) but do not substantially interfere with the signal 1 pathway (e.g., no more than 50% of TcR is removed, destroyed, inactivated or disabled) are effective in the immune rejection embodiments of the invention. It is believed that, for immune cells subjected to such differential disruption in pathways, exposure to certain substances initiates processes that lead to tolerance against immune reactions to those substances. See, e.g., Kuby, *Immunology*, Third Edition, W.H. Freeman & Co. 1997; Waldmann, "Transplantation Tolerance — Where Do We Stand," *Nature Med.* 5(11): 1245-1248, 1999. Prior work has indicated that intervention in signal 2, while signal 1 is activated, drives T-cells into an anergic state. The present inventors have shown that such selective disabling of signaling molecules can be done with hydrolases selected to have the appropriate selectivity in removing, destroying, inactivating or disabling cell surface molecules.

It is believed that the above discussed adhesion molecules and others will prove to play a role in a number of other diseases for which the multifunctional enzyme is an effective treatment or preventative agent. As described further in Example 4, it has now been shown that treatments with hydrolases are effective to treat, prevent or reduce the severity of GVHD.

For the purposes of this application, the terms listed below shall have the following meaning:

- **adhesion molecule:** a molecule found on the surface of a cell involved, directly or indirectly, in transmitting signals to the cell.
- **cell-cell or cell-virus adhesion syndrome:** a disease in which a receptor or acceptor cell adhesion component plays a role in the etiology of the disease, for instance by playing a role in the development, transmission, growth or course of the disease.
- **hydrolase:** an enzyme that degrades bonds formed by dehydration reactions such as amide, ester, or ether bonds. The term encompasses, but is not limited to, proteases such as trypsin and chymotrypsin.
- **identity:** "Identity," as known in the art, is a relationship between two or more polypeptide sequences or two or more polynucleotide sequences, as the case may be, as determined by comparing the sequences. In the art, "identity" also means the degree of sequence

relatedness between polypeptide or polynucleotide sequences, as the case may be, as determined by the match between strings of such sequences. "Identity" can be readily calculated by known methods, including but not limited to those described in (Computational Molecular Biology, Lesk, A.M., ed., Oxford University Press, New York, 5 1988; Biocomputing: Informatics and Genome Projects, Smith, D.W., ed., Academic Press, New York, 1993; Computer Analysis of Sequence Data, Part I, Griffin, A.M., and Griffin, H.G., eds., Humana Press, New Jersey, 1994; Sequence Analysis in Molecular Biology, von Heinje, G., Academic Press, 1987; and Sequence Analysis Primer, Gribskov, M. and Devereux, J., eds., M Stockton Press, New York, 1991; and Carillo, H., and 10 Lipman, D., SIAM J. Applied Math., 48: 1073 (1988). Preferred methods to determine identity are designed to give the largest match between the sequences tested. Thus, a contiguous portion of a polypeptide can be tested against the reference sequence described above and aligned to give the highest match taking into account that non-matched pairs and non-matched gap sequences are scored against identity, with the each non-matched 15 pairing scoring and each non-matched gap residue or nucleotide reducing the identity, prior to normalization to a percent scale, by -1.

Thus, one of the simplest ways to describe polypeptide sequences that are related, as by high identity, is set forth below for a 95% identity example. In this case the test sequence includes a contiguous segment that is the reference amino acid sequence 20 described above, or is identical with the reference sequence except that, over the entire length corresponding to the reference sequence, the amino acid sequence has an average of up to five substitutions, deletions or insertions for every 100 amino acids of the reference sequence.

Moreover, methods to determine identity are codified in publicly available 25 computer programs. Computer program methods to determine identity between two sequences include, but are not limited to, the GCG program package (Devereux, J., et al., Nucleic Acids Research 12(1): 387 (1984)), BLASTP, BLASTN, and FASTA (Altschul, S.F. et al., J. Molec. Biol. 215: 403-410 (1990)). The BLAST X program is publicly available from NCBI and other sources (BLAST Manual, Altschul, S., et al., NCBI NLM 30 NIH Bethesda, MD 20894; Altschul, S., et al., J. Mol. Biol. 215: 403-410 (1990)). The method of Needleman and Wunch, using the parameters set forth in Version 2 of DNASIS can also be used. Additionally, the well known Smith Waterman algorithm can be used to determine identity.



Alternatively, Parameters for polypeptide sequence comparison include the following:

- Algorithm: Needleman and Wunsch, J. Mol Biol. 48: 443-453 (1970);
- Comparison matrix: BLOSSUM62 from Hentikoff and Hentikoff, Proc. Natl. Acad. Sci. USA. 89:10915-10919 (1992);
- Gap Penalty: 12; and
- Gap Length Penalty: 4

A program useful with these parameters is publicly available as the "gap" program from Genetics Computer Group, Madison WI. The aforementioned parameters are the default parameters for peptide comparisons (along with no penalty for end gaps).

By way of example, a polypeptide sequence of the present invention may be identical to the reference sequence, that is it may be 100% identical, or it may include up to a certain integer number of amino acid alterations as compared to the reference sequence such that the percent identity is less than 100% identity. Such alterations are selected from the group consisting of at least one amino acid deletion, substitution, including conservative and non-conservative substitution, or insertion, and wherein said alterations may occur at the amino- or carboxy-terminal positions of the reference polypeptide sequence or anywhere between those terminal positions, interspersed either individually among the amino acids in the reference sequence or in one or more contiguous groups within the reference sequence.

• **immune disorder:** any disorder caused by an immune reaction to foreign substances, tissues or cells or to autologous or transplanted tissue. The term encompasses autoimmune diseases.

• **immune cell:** a lymphocyte, such as a B-cell or T-cell, or a precursor cell to a lymphocyte.

• **krill-derived multifunctional hydrolase:** a multifunctional enzyme having the same sequence as the enzyme isolated from krill having the properties of the protein described in Examples 1B, 1C and 1D. This enzyme is also referred to as the "krill multifunctional hydrolase" or the "krill multifunctional enzyme" or the "krill-derived multifunctional enzyme."

• **macromolecule:** for determining purity, this means a biological polymer such as a protein, nucleic acid or carbohydrate of molecular weight greater than about 1000.

- **multifunctional enzyme:** an enzyme having activity comprising at least one of a chymotrypsin, trypsin, collagenase, elastase or exo peptidase activity, a molecular weight between about 20 kd and about 40 kd, and substantial homology to krill-derived multifunctional hydrolase.
- 5 • **multifunctional enzyme derived from fish or crustacean:** refers to an enzyme having the same sequence as an enzyme isolated from fish or crustacean.
- **protein:** for the purpose of determining purity, this means a polypeptide of molecular weight greater than about 1000.
- **reactive with a cell-surface protein or glycolipid:** means removes, destroys,  
10 inactivates or disables the detectable presence of the cell-surface molecule, by whatever mechanism.
- **reactive with a cellular or viral acceptor or receptor adhesion component:** means removes, destroys, inactivates or disables a cell's or a virus' ability to interact with a cell, virus, ligand, group or molecule, regardless of the mechanism.
- 15 • **SDS-PAGE:** means polyacrylamide gel electrophoresis of proteins in the presence of sodium dodecyl sulfate.
- **selectively reactive with a cell-surface protein:** means removes, destroys, inactivates or disables certain cell-surface proteins on the surface of a cell but not others.
- **substantial homology:** at least about 60% sequence homology.
- 20 • **systemic administration:** an administration of a biological agent, such as the multifunctional enzyme, designed deliver the agent to the blood or other circulatory system (such as the lymphatic system) of an animal.
- **tolerance:** a state of unresponsiveness of an immune cell upon encountering an antigen or cell.
- 25 • **units of activity:** Hydrolases have unit activity according to a recognized assay for the particular type of hydrolase, and is typically defined as the amount of enzyme that catalyzes the hydrolysis of 1  $\mu\text{mol}$  of substrate per minute at 25°C. For the chymotrypsin activity of a hydrolase, succinyl-ala-ala-pro-phe-*p*-nitroanilide (Sigma Chemical Co., St. Louis, MO) is the substrate, and hydrolysis is monitored via the  
30 absorbance change at 410 nm. The extinction coefficient,  $\epsilon$ , of *p*-nitroanilide is 8800  $\text{M}^{-1}\text{cm}^{-1}$ , thus the multiplication factor to convert dA/minute into U/minute of sample is

5.68, when 20  $\mu$ l of sample is used. For the trypsin activity of a hydrolase, the substrate is CBZ-GRpNA.

When HL60 cells (promyelocyte cells believed to give rise to T-cells, derived from an acute progranulocytic leukemia) are pretreated with the krill multifunctional hydrolase, their binding to TNF $\alpha$  stimulated endothelial cells is inhibited by more than about 60%. Preferably, treatment of HL60 or endothelial cells with the multifunctional enzyme of the invention will inhibit HL60 cell binding to TNF $\alpha$  stimulated endothelial cells by at least about 20%, more preferably at least about 40%, still more preferably at least about 60%, yet more preferably at least about 80%. Alternately, the multifunctional enzyme will preferably have at least about 30% of the adhesion-inhibiting activity of the krill-derived multifunctional hydrolase. More preferably, the multifunctional enzyme shall have at least about 60% of the adhesion inhibiting activity of the krill-derived multifunctional hydrolase, still more preferably at least about 80%, yet more preferably at least about 100%.

15 Transplantation; Autoimmune and Allergic Reactions

Studies on bone marrow transplantation provide an illustration of the effect of hydrolase treatments in treating, inhibiting or preventing an immune rejection, in this case GVHD. GVHD typically involves the donor cells attacking the host, instead of the host attacking the donor tissue. Bone marrow transplantation (BMT) is used in conjunction with treatments of a number of cancers, particularly treatments that damage or destroy cell types found in blood, such as treatments of life-threatening hematologic malignancies. However, the threat of severe graft-vs.-host disease (GVHD) remains a major obstacle, impeding widespread application of bone marrow transplantation. Acute and chronic GVHD develops in a significant proportion of transplant recipients and represents a major cause of morbidity and mortality after bone marrow transplantation between imperfectly matched individuals (i.e., allogeneic transplantation). Efforts to prevent GVHD should reduce morbidity and mortality of transplantation, and enhance the long term outcome of a transplant. GVHD is a T-cell mediated disease affecting multiple organ systems. The risk of death due to GVHD can be reduced by depleting the T-cell population in the marrow inoculum used in bone marrow transplantation, or by using immunosuppressive drugs, such as FK506 or rapamycin (see for review, Blazar et al., 1997). Others have shown that a short course of high dose IL-2 administered at the

time of bone marrow transplantation can protect against GVHD mortality in mice (Sykes et al., 1990; Abraham et al., 1992). Treatment with a protective course of IL-12 also inhibit GVHD, as IL-12 reduces the kinetics of T-cell expansion (Sykes et al., 1995). In most of these strategies, however, extensive treatments ancillary to  
5 transplantation are necessary, and can lead to adverse consequences.

Recent strategies against GVHD have evolved around the concept of inducing immune tolerance in T-cells. In the late 1980's, Jenkins and Schwartz demonstrated that to get full activation, T-cells must receive two signals: one through the T cell receptor (TcR), and a second signal delivered by accessory molecules, such as CD28, which bind  
10 to their counter receptors expressed at the surface of antigen presenting cells (APC) (reviewed in Schwartz et al., 1997). Activation of T cells through the TcR in absence of the second signal not only fails to activate T cells, but to the contrary induces a state of unresponsiveness (i.e., anergy). Close interactions between cells also play a crucial role in allorecognition as such interactions facilitate the binding of the TcR to the allo-MHC,  
15 and of the accessory receptor to its counter ligand. Indeed, integrins like LFA-1 ( $\alpha$ L or CD11a, which associates with CD18) expressed on T cells bind to a counter ligand (ICAM-1, i.e., CD54) on the antigen presenting cell to increase the avidity of the interaction between a T-cell the antigen presenting cell (Dustin et al., 1991; St-Pierre et al., 1991). Consistent with this model is the observation that blocking LFA-1/ICAM-1  
20 interactions with antibodies prevents GVHD only partially, but such blockade significantly increases the efficacy of other blocking antibodies specific for other accessory molecules in inducing a state of anergy in T-cells during GVHD (Blazar et al., 1995; Cavazzana-Calvo et al., 1996).

Treatment of immune cells with hydrolases significantly affects key cell surface  
25 adhesion molecules implicated in the delivery of activation signals. It has now been found that CD4, CD8, and other cell adhesion molecules, are among the most sensitive cell surface adhesion molecules to proteolysis. *Ex vivo* treatment of donor T-cells with hydrolase prior to engraftment is believed to block these activation signals and significantly reduce the severity of GVHD. The present work reports the results of two  
30 series of experiments in which lethal GVHD was prevented by treatment of mature T-cells with hydrolase (*see*, Example 4). In one experiment, both the krill multifunctional enzyme and a Cod-derived trypsin were effective. In the other experiment, the Cod

trypsin was more effective, probably reflecting the faster digestion kinetics observed with this enzyme.

It is important to note that the protection induced by *ex vivo* treatment of splenocytes with hydrolases was obtained by treating spleen cells of the donor.

5 Hydrolase treatment of spleen cells is believed (without limitation to theory) to prevent full activation of allogeneic T-cells, inducing a state of tolerance that is transferred to bone marrow T-cells and their precursors through the immune mechanism known as “infectious tolerance” (Cobbold and Waldmann, 1998). Thus, the results reported herein have significant impact not only in GVHD resulting from bone marrow transplant, but on  
10 solid organ transplantation as well. *Ex vivo* treatment of recipients T-cells with hydrolase, followed by exposure to allogeneic donor MHC, is believed to induce a state of tolerance in these T-cells that is propagated systemically upon re-injection into the recipient. In some embodiments, exposure to donor MHC is conducted *in vitro* (i.e., also *ex vivo*).

15 Without limitation to theory, it is believed that the transplantation rejection inhibition seen with the present invention can be explained if the hydrolase-treated immune-mediating cells, when brought into contact with the cells or substances which would trigger immune responses, instead begin the process of acquiring tolerance for such cells or substances. When treated cells are reintroduced into a recipient, such  
20 acquired tolerance is believed to be transmitted to other immune cells.

When immune cells are treated and contacted with other immune reaction mediating cells prior to administration to a patient, such contacting is, for example, conducted under appropriate conditions for maintaining metabolically active immune reaction mediating cells for, for example, from a few minutes to a few hours, preferably  
25 from about 1 hour to about 4 hours.

In the invention, immune reaction mediating cells are treated with hydrolase, exposed to a preparation which would trigger the immune response sought to be avoided, and reintroduced into a treatment subject. Such hydrolase treatment is typically *ex vivo*, and the exposure is preferably conducted *ex vivo*. Such *ex vivo* exposing (i.e.,  
30 contacting) is, for example, conducted under appropriate conditions for maintaining metabolically active immune reaction mediating cells for, for example, from a few minutes to a few hours, preferably from about 1 hour to about 4 hours.

Examples of autoimmune-associated antigen preparations include, without limitation, myelin sheath preparations, myelin basic protein and preparations of one or more types of collagen. Antigen preparations can be used, for example, in the treatment of multiple sclerosis, irritable bowel disease (including Crohn's Disease and ulcerative colitis), pernicious anemia, juvenile onset diabetes, thyroiditis, systemic lupus erythematosus (SLE), scleroderma, polyarteritis nodosa and other vasculitides, myasthenia gravis, motor neuron disease, encephlomyelitis, subacute sclerosing pan-encephalitis, Goodpasture's Syndrome, haemolytic anemia, thrombocytopenia, pemphigus vulgaris and bullous pemphigoid. Other examples of autoimmune diseases and examples of allergies can be found in standard texts on allergies or immunology, such as Roitt, *Essential Immunology*, Eighth Edition, Blackwell Scientific Publications, Oxford, 1994.

Transplantation or tolerizing protocols according to the invention include:

1.	Contacting first cells which are immune cells from a recipient animal with second cells or immunogens to which one seeks to induce tolerance, where the first cells or the second cells are immune cells that are treated with hydrolase, administering the first cells to the recipient animal, and, if appropriate, transplanting tissue from the animal source of the second cells to the recipient; and
2.	Contacting first cells which are immune cells from a donor animal with second cells, wherein the first cells or second cells comprise antigens to which one seeks to induce tolerance, where the first cells or the second cells are immune cells that are treated with hydrolase, administering the first cells to a recipient animal, and, if appropriate, transplanting tissue form the animal source of the second cells to the recipient.

The cells contacted with the treated immune cells can be the tissue to be transplanted. Typically, the immune cells are administered some time before transplantation, such as 12, 24, 48, 72 hours. The second cells can also be treated with the hydrolase.

Preferably, the tolerized cells are T-cells. Thus, in one embodiment, the T-cells are tolerized by contact with T-cell depleted cells, preferably immune cells. The T-cells can then be isolated from the tolerizing mixture of cells by an affinity binding protocol or

cell sorting with appropriate cell-specific antibody reagents. For example, Thy-1 (CD90) antibodies tagged with a magnetically susceptible material can be used to isolate T-cells by by magnetic separation.

5 Exemplary Hydrolases

A wide variety of hydrolases are believed to be applicable. These include metalloproteinases (such as matrix metalloproteinases, including human fibroblast collagenase, interstitial collagenase, stromelysin, gelatinase A, gelatinase B, adamalysins, microbial metalloproteinases and the like), elastases, trypsin, 10 chymotrypsins, other serine proteinases, and the like. Such hydrolases include hydrolases of aquatic origin, as described herein. Other applicable hydrolases are believed to include, for example, mammalian and non-mammalian trypsin, mammalian and non-mammalian chymotrypsins, mammalian and non-mammalian elastases, papains, bromelains, mammalian and non-mammalian collagenases, subtilisins and mammalian 15 and non-mammalian cathepsins (such as cathepsin B, C, D or G). Further enzymes include mixtures of digestive enzymes from Atlantic cod (e.g., trypsin, chymotrypsin, elastase and collagenase), chymotrypsins for Atlantic cod (see, Aseirsson and Bjarnason, *Comp. Biochem. Physiol.* 99B:327-335, 1991; Guthmundsdottir et al., *Biochem. Biophys. Acta.* 1219:211-214, 1994), elastase from Atlantic cod (Aseirsson and 20 Bjarnason, *Biochem. Biophys. Acta.* 1164:91-100, 1993), a mixture of serine proteinase-type collagenases from Atlantic cod (see, Kristjansson et al., *Comp. Biochem. Physiol. B Biochem. Mol. Biol.* 110:707-717, 1995), trypsin from Atlantic cod (Aseirsson et al., *Eur. J. Biochem.* 180:85-94, 1989), collagenase from *Uca pugilator* (Tsu et al., *J. Biol. Chem.* 269:19565-19572, 1994), and other hydrolases described herein.

25 In certain embodiments of the invention, the hydrolase used is not, at least in effective amounts, bromelain, or, in some embodiments, an enzyme component of bromelain. Bromelain is an enzyme-containing extract from pineapple, particularly pineapple stem. Also in certain embodiments, the hydrolase used is not, at least in effective amounts, polymorphonuclear leukocyte-derived proteinase elastase or cathepsin 30 G. Further, in certain embodiments the hydrolase used is not, at least in effective amounts, papain, or mammalian pancreatic trypsin, or a mixture of these enzymes. Papain is an enzyme extracted from papaya.

### Signal 2 and Signal 1 Pathways

Preferably, a hydrolase exposed to immune cells removes, destroys, inactivates or disables at least 60%, 75%, 85%, 90%, 95%, 98% or 99% of at least one of CD4, CD8, a CD11, CD25, CD28, a CD49, CD152 and CD154. These molecules are involved in the signal 2 pathway. Preferably, the hydrolases removes, destroys, inactivates or disables a significant portion of (a) CD4 and CD8, (b) CD4 and CD28, (c) CD4 and CD154, (d) CD4, CD8 and CD28, (e) CD4, CD8 and CD154, (f) CD4, CD28 and CD154, (g) CD4, CD8, CD28 and CD154, (h) CD8 and CD28, (i) CD8 and CD154, (j) CD8, CD28 and CD154, or (k) CD28 and CD154. In certain preferred embodiments, the hydrolases removes, destroys, inactivates or disables a significant portion of (a) CD4 and CD8, (d) CD4, CD8 and CD28, (e) CD4, CD8 and CD154 or (g) CD4, CD8, CD28 and CD154.

Preferably, no more than 50%, 35%, 20% or 10% of TcR, which is associated with signal 1, is removed, destroyed, inactivated or disabled by contacting a hydrolase with the immune cells. Preferably, no more than 50%, 35%, 20% or 10% of CD3, which is associated with signal 1, is removed, destroyed, inactivated or disabled by contacting a hydrolase with the immune cells.

### Mixtures of Hydrolases

In certain embodiments, a mixture of two or more hydrolases is used to provide the removing, destroying, inactivating or disabling activity, i.e., induce tolerance, or the signal 2 disrupting activity. The mixture can be selected on the basis of mixing a second (or third, etc.) hydrolase that is more effective against given cell surface adhesion molecule than another hydrolase in the mixture.

### Co-Administration of Antibodies

In one embodiment of the invention, the effects of hydrolase treatment is supplemented with the use of antibodies to specific cell adhesion molecules. This approach can be used for example to alter the kinetics of cell surface effects or supplement effects against certain cell adhesion molecules. For example, the hydrolase selected could be very effective against certain of the targeted cell surface adhesion molecules, but less effective against others. In this case, the antibodies, which are preferably monoclonal, are used to target the cell surface adhesion molecules against which the hydrolase is less effective. Or, the selected hydrolase can be effective against targeted cell surface adhesion molecules, but a further effect can be achieved with the antibodies. The antibodies can be monovalent (e.g., Fab fragments), especially as to a given



cell surface target (such that an antibody monovalent as to a cell surface adhesion molecule has another binding pocket with another specificity).

Appropriate targets for antibody blockade include CD4, CD8, CD25 (IL-2 receptor alpha chain), CD28, CD152 (CTLA-4), integrins, CD154, CD40 and CD80.

5           Antibody sources for use in this aspect of the invention include: Boehringer Mannheim, LaVal, Quebec; GIBCO, New York; PharMingen, San Diego, CA; Wako Bioproducts, Richmond, VA. The antibodies are contacted with the cells in sufficient amounts, and preferably some excess, to bind the available targeted cell surface adhesion molecules.

#### 10    Administration of Hydrolase

For topical treatments, a suitable dose of hydrolase per application ranges from about  $0.1 \mu\text{g}/\text{cm}^2$  to about  $1 \text{ mg}/\text{cm}^2$ , preferably from about  $1 \mu\text{g}/\text{cm}^2$  (for example, using about  $10 \mu\text{g}/\text{ml}$ ) to about  $1 \text{ mg}/\text{cm}^2$  (for example, using about  $10 \text{ mg}/\text{ml}$ ), more preferably from about  $5 \mu\text{g}/\text{cm}^2$  (for example, using about  $50 \mu\text{g}/\text{ml}$ ) to about  $100 \mu\text{g}/\text{cm}^2$  (for example, using about  $1 \text{ mg}/\text{ml}$ ), yet more preferably from about  $10 \mu\text{g}/\text{cm}^2$  to about  $250 \mu\text{g}/\text{cm}^2$ , still yet more preferably from about  $10 \mu\text{g}/\text{cm}^2$  (for example, using about  $100 \mu\text{g}/\text{ml}$ ) to about  $50 \mu\text{g}/\text{cm}^2$  (for example, about  $500 \mu\text{g}/\text{ml}$ ). For systemic treatments, dosages will generally be selected to maintain a serum level of hydrolase between about  $0.1 \mu\text{g}/100\text{cc}$  and about  $5 \mu\text{g}/100\text{cc}$ , preferably between about  $0.5 \mu\text{g}/100\text{cc}$  and about  $2.0 \mu\text{g}/100\text{cc}$ . In an alternative measure of preferred systemic administration amounts, preferably from about  $0.1 \text{ mg}/\text{kg}$  to about  $10 \text{ mg}/\text{kg}$ , more preferably about  $1 \text{ mg}/\text{kg}$ , will be administered (although toxicology in animal models suggests that amounts even in excess of  $25 \text{ mg}/\text{kg}$  can be used). For ocular treatments, a suitable dose of hydrolase per application ranges from about  $0.01 \text{ mg}$  per eye to about  $5 \text{ mg}$  per eye, preferably from about  $0.1 \text{ mg}$  per eye to about  $2.0 \text{ mg}$  per eye. For vaginal and urinary tract treatments, suitable flushing/ instillation solutions of the hydrolase will generally have concentrations from about  $1 \mu\text{g}/\text{ml}$  to about  $15 \text{ mg}/\text{ml}$ , preferably from about  $100 \mu\text{g}/\text{ml}$  to about  $3 \text{ mg}/\text{ml}$ . For oral treatments, suitable mouthwash solutions will generally have concentration of hydrolase from about  $1 \text{ mg}/\text{ml}$  to about  $15 \text{ mg}/\text{ml}$  preferably from about  $2 \text{ mg}/\text{ml}$  to about  $10 \text{ mg}/\text{ml}$ . Lozenges will typically contain from about  $100 \mu\text{g}$  to about  $10 \text{ mg}$  of hydrolase. Aerosols will generally be made from solutions having enzyme concentrations from about  $0.1 \text{ mg}/\text{ml}$  to about  $15 \text{ mg}/\text{ml}$ ,

preferably from about 1 mg/ml to about 10 mg/ml. Generally, from about 0.1 ml to about 2 ml of aerosol will be applied to the airways of the patient, preferably from about 0.5 ml to about 1.0 ml. For scar and keloid treatments, generally between about 0.1 mg and about 5 mg of hydrolase will be injected into each cm<sup>2</sup> of the lesion, preferably from about 0.5 mg to about 3 mg. For treating adhered connective tissue or joints, generally between about 0.5 mg and about 10 mg of hydrolase will be injected interstitially at the adhesion, preferably between about 1 mg and about 5 mg. For all treatments, the enzyme composition will generally be applied from about 1 to about 10 times per day, preferably from about 2 to about 5 times per day. These values, of course, will vary with a number of factors including the type and severity of the disease, and the age, weight and medical condition of the patient, as will be recognized by those of ordinary skill in the medical arts. It is believed that substantially higher doses can be used without substantial adverse effect.

For treating immune disorders, the composition may be applied systemically or in a manner adapted to target the affected tissue or cells, or a tissue or cells implicated in the disorder can be treated extra-corporeally.

For organ transplants or other *ex vivo* treatments, the organ, tissue or cells to be transplanted will preferably be bathed in a solution of the hydrolase for between about 10 minutes and about 5 hours. The enzyme solution will preferably contain between about 0.01 mg/ml or 0.5U/ml and about 25 mg/ml or 1,250U/ml of the hydrolase, and in certain embodiment preferably, between about 0.5 mg/ml or 25U/ml and about 5 mg/ml and about 250U/ml. After transplantation, the hydrolase can be administered systemically using the conditions described above. For treating bone marrow or other sources of cells found in the blood, particularly those containing T-cells or T-cell precursors, the cells are preferably treated with an amount and time of treatment effective to reduce, remove or inactivate at least one cell surface protein by at least about 50%, more preferably by at least about 80%.

The hydrolase of the invention is administered orally, topically, rectally, vaginally, by instillation (for instance into the urinary tract or into fistulas), by pulmonary route by use of an aerosol, by application of drops to the eye, or systemically, such as parenterally, including, for example, intramuscularly, subcutaneously, intraperitoneally, intraarterially or intravenously. The multifunctional enzyme is

administered alone, or it is combined with a pharmaceutically-acceptable carrier or excipient according to standard pharmaceutical practice. For the oral mode of administration, the hydrolase is used in the form of tablets, capsules, lozenges, chewing gum, troches, powders, syrups, elixirs, aqueous solutions and suspensions, and the like.

5 In the case of tablets, carriers that is used include lactose, sodium citrate and salts of phosphoric acid. Various disintegrants such as starch, and lubricating agents such as magnesium stearate and talc, are commonly used in tablets. For oral administration in capsule form, useful diluents are lactose and high molecular weight polyethylene glycols. If desired, certain sweetening and/or flavoring agents are added. For parenteral

10 administration, sterile solutions of the hydrolase are usually prepared, and the pHs of the solutions are suitably adjusted and buffered. For intravenous use, the total concentration of solutes should be controlled to render the preparation isotonic. For ocular administration, ointments or droppable liquids may be delivered by ocular delivery systems known to the art such as applicators or eye droppers. Such compositions can

15 include mucomimetics such as hyaluronic acid, chondroitin sulfate, hydroxypropyl methylcellulose or polyvinyl alcohol, preservatives such as sorbic acid, EDTA or benzylchromium chloride, and the usual quantities of diluents and/or carriers. For pulmonary administration, diluents and/or carriers will be selected to be appropriate to allow the formation of an aerosol. For topical administrations, the hydrolase is typically

20 administered in aqueous form or in a hydrogel. A preferred hydrogel comprises an aqueous suspension of from about 1% (w/v) to about 10% of low molecular weight hydrolyzed starch.

Suppository forms of the hydrolase are useful for vaginal, urethral and rectal administrations. Such suppositories will generally be constructed of a mixture of

25 substances that is solid at room temperature but melts at body temperature. The substances commonly used to create such vehicles include theobroma oil, glycerinated gelatin, hydrogenated vegetable oils, mixtures of polyethylene glycols of various molecular weighty and fatty acid esters of polyethylene glycol. *See*, Remington's Pharmaceutical Sciences, 16th Ed., Mack Publishing, Easton, PA, 1980, pp. 1530-1533

30 for further discussion of suppository dosage forms. Analogous gels or cremes can be used for vaginal, urethral and rectal administrations.

Numerous administration vehicles will be apparent to those of ordinary skill in the art, including without limitation slow release formulations, liposomal formulations and polymeric matrices.

For adhesion disorders, the cells or viruses involved can include, without  
5 limitation, endothelial cells, lymphocytes, including T-cells, tumor cells, microbial cells, viruses, including HIV and herpes. Adhesion processes are believed to be involved in tissue invasion, for instance, by immune cells, microbes, and tumor cells.

Preferred hydrolases are proteases. Particularly preferred is the multifunctional enzyme of the invention.

10 Generally, the hydrolase will be administered in an effective amount. An effective amount is an amount effective to either (1) reduce the symptoms of the disease sought to be treated, (2) induce a pharmacological change relevant to treating the disease sought to be treated, (3) inhibit or prevent infection or re-infection by an infective agent,  
15 disease treatable by blocking a cell adhesion phenomenon).

Humans are the preferred subjects for treatment. However, the hydrolases can be used in many veterinary contexts to treat animals, preferably to treat mammals, as will be recognized by those of ordinary skill in light of the present disclosure.

The adhesion of HL60 cells (a human lymphocyte cell line) to endothelial cells is  
20 believed to model a mechanism for tumor cell invasion and infection more generally. This adhesion is stimulated by tumor necrosis factor ("TNF ") and inhibited by antibodies to the E-selectin antigen on HL60 cells. E-selectin is a cell surface adhesion protein that appears to bind to a sialated carbohydrate. See, Bevilacqua et al., *Science* (1989) 243:1160.

25 Preparations of the multifunctional enzyme are active even when not purified to homogeneity. Preparations are described, for example, in WO 96/24371 (Phairson Medical) and WO 98/08863 (Phairson Medical).

Isolations and partial sequences of various fish or crustacean hydrolases have been reported. A number of such reports are identified in Table 1, below.

30

**Table 1 - Sequence Reports**

<i>Panaeus vanameli</i> 1		
	Sequence reported:	Van Wormoudt et al., <i>Comp Biochem. Physiol.</i> , 103B: 675-680, 1992 and Sellos and Wormhoudt, <i>FEBS</i> , 39: 219-224, 1992.
	Reported activities:	chymotryptic
	Apparent MW:	25kd
<i>Panaeus vanameii</i> 2		
	Sequence reported:	Van Wormoudt et al., <i>Comp Biochem. Physiol.</i> , 103B: 675-680, 1992.
	Reported activities:	chymotryptic (tryptic)
	Apparent MW:	25kd
<i>Panaeus monodon</i> tryptic (shrimp)		
	Sequence reported:	Lu et al., <i>Biol. Chem. Hoppe-Seyler</i> , 371: 851-859, 1990.
	Reported activities:	tryptic
	Apparent MW:	27kd
	Ph optimum:	7.4 - 8.0
	Pi:	2.4
<i>Panaeus monodon</i> chymotryptic - 1 (shrimp)		
	Sequence reported:	Tsai et al., <i>Biochem et Biophys. Acta</i> , 1080: 59-67, 1991
	Reported activities:	chymotryptic collagenase
	Apparent MW:	27-28kd
<i>Panaeus monodon</i> chymotryptic - 2		
	Sequence reported:	Tsai et al., <i>Biochem. et Biophys. Acta</i> , 1080: 59-67, 1991
	Reported activities:	chymotryptic collagenase
	Apparent MW:	25-26kd
<i>Uca pubilator</i> (Fiddler Crab) 1		
	Sequence reported:	Tsai et al., <i>Biochem. et Biophys. Acta</i> , 1080: 59-67, 1991
	Reported activities:	chymotryptic
	Apparent MW:	25kd
	Ph optimum	8.0 - 8.5

<i>Uca pugilator</i> II		
	Sequence reported:	Grant et al., <i>Biochemistry</i> , 19: 4653-4659, 1980.
	Reported activities:	chymotryptic collagenase tryptic elastase
	Apparent MW:	25kd
	pI:	8.0 - 8.5
<i>Kamchatka crab (at least four proteases)</i>		
	Sequence Reported:	Klimova et al., <i>Biochem. Biophys. Res. Commun.</i> <b>166</b> : 1411-1420, 1990
	Reported Activities:	tryptic collagenase
	Apparent MW:	23-26kd
Crayfish Protease		
	Sequence reported:	Titani et al., <i>Biochemistry</i> , 22: 1459-1465,

The sequence of the first 25 amino acids of the Krill derived multifunctional enzyme is I-V-G-G-N/M-E-V-T-P-H-A-Y-P-(W)-Q-V-G-L-F-I-D-D-M-Y-F (SEQ ID NO. 1). The parentheses indicate a weak recovery of the 14th amino acid and "N/M" indicates heterogeneity at the 5th position. A comparison of the N-terminal 20 to 25 amino acid sequences of various serine hydrolases is presented in Table 2, below.

Table 2 - N-Terminal Sequences

Species	SEQ ID NO	Sequence
<i>Penaeus vanameii</i> 1 (shrimp)	3	I V G G V E A T P H S W P H Q A A L F I D D M Y F
<i>Penaeus vanameii</i> 2	4	I V G G V E A T P H S X P H Q A A L F I
<i>P. monodon</i> , trypt. (shrimp)	5	I V G G T A V T P G E F P Y Q L S F Q D S I E G V
<i>P. monodon</i> , chym. 1	6	I V G G V E A V P G V W P Y Q A A L F I I D M Y F
<i>P. monodon</i> , chym. 2	7	I V G G V E A V P H S W P Y Q A A L F I I D M Y F
<i>Uca pugilator</i> I (crab)	8	I V G G V E A V P N S W P H Q A A L F I D D M Y F

<u>Species</u>	<u>SEQ ID NO</u>	<u>Sequence</u>
Uca pugilator II	9	I V G G Q D A T P G Q F P Y Q L S F Q D
King crab	10	I V G G Q E A S P G S W P ? Q V G L F
Kamchatka I crab	11	I V G G Q E A S P G S W P X Q V G L F F
	IIA 12	I V G G T E V T P G E I P Y Q L S L Q D
	IIB 13	I V G G T E V T P G E I P Y Q L S F Q D
	IIC 14	I V G G S E A T S G Q F P Y Q X S F Q D
Crayfish	15	I V G G T D A T L G E F P Y Q L S F Q N
krill Enzyme	1	I V G G N E V T P H A Y P W Q V G L F I D D M Y F
	2	I V G G M E V T P H A Y P W Q V G L F I D D M Y F
Bovine chymotrypsn	16	I V N G E D A V P G S W P W Q V S L Q D
Salmon	17	I V G G Y E C K A Y S Q A Y Q V S L N S G Y H Y C
Atlant. Cod I*	18	I V G G Y E C T K H S Q A H Q V S L N S G Y H
Atlant. Cod II*	19	I V G G Y E C T R H S Q A H Q V S L N S G Y H
Atlant. Cod Tryspin	27	I V G G Y Q C E A H S Q A H Q V S L N S G Y H Y C G G S L I N W V V S A A

\*Both of these enzymes are trypsins; see, Gudmundsdottir et al., *Eur. J. Biochem.* **217**: 1091-1097, 1993.

X = unknown or undefined.

5

It will be apparent to those of ordinary skill that the enzyme can be manufactured by recombinant means. For instance, the sequences recited herein can be used as the basis of oligonucleotide probes for screening expression or genomic libraries to isolate the complete structural gene. See, e.g., Suggs et al., *Proc. Natl. Acad. Sci. USA*, 78:

10 6613, 1981 or Berent et al., *BioTechniques*, 3: 208, 1985. Alternately, known protein sequences can be used to design primers for use in PCR-based amplification of nucleic acid encoding a multifunctional enzyme. See generally, *Molecular Cloning: A Laboratory Manual*, second edition, Cold Spring Harbor, 1989 and *PCR Protocols, A Guide to Methods and Applications*, edited by Michael et al., Academic Press, 1990.

15 Once fully identified, these structural genes can be edited and appropriately inserted into expression vectors by methods known to the art. In particular, recombinant means can follow the guidance found in WO 98/08863 (Phairson Medical).

These structural genes can be altered by mutagenesis methods such as that described by Adelman et al., *DNA*, 2: 183, 1983 or through the use of synthetic nucleic acid strands. The products of mutant genes can be readily tested for multifunctional enzymatic activity. Conservative mutations are preferred. Such conservative mutations

5 include mutations that switch one amino acid for another within one of the following groups:

1. Small aliphatic, nonpolar or slightly polar residues: Ala, Ser, Thr, Pro and Gly;
2. Polar, negatively charged residues and their amides: Asp, Asn, Glu and  
10 Gln;
3. Polar, positively charged residues: His, Arg and Lys;
4. Large aliphatic, nonpolar residues: Met, Leu, Ile, Val and Cys; and
5. Aromatic residues: Phe, Tyr and Trp.

A preferred listing of conservative substitutions is the following:

15

Original Residue	Substitution
Ala	Gly, Ser
Arg	Lys
Asn	Gln, His
Asp	Glu
Cys	Ser
Gln	Asn
Glu	Asp
Gly	Ala, Pro
His	Asn, Gln
Ile	Leu, Val
Leu	Ile, Val
Lys	Arg, Gln, Glu
Met	Leu, Tyr, Ile
Phe	Met, Leu, Tyr
Ser	Thr
Thr	Ser
Trp	Tyr
Tyr	Trp, Phe
Val	Ile, Leu

The types of substitutions selected can be based on the analysis of the frequencies of amino acid substitutions between homologous proteins of different species developed by Schulz et al., *Principles of Protein Structure*, Springer-Verlag, 1978, pp. 14-16, on the

20 analyses of structure-forming potentials developed by Chou and Fasman, *Biochemistry*



13, 211, 1974 or other such methods reviewed by Schulz et al, *Principles in Protein Structure*, Springer-Verlag, 1978, pp. 108-130, and on the analysis of hydrophobicity patterns in proteins developed by Kyte and Doolittle, *J. Mol. Biol.* 157: 105-132, 1982.

Krill, including without limitation krill of the genuses *Euphausia* (such as 5 *superba*, *crystallorhynchus*, *frigida*, *triacantha*, *vellantini*, *lougistrostris*, *lucens*, *similis*, *spinifera*, *recurva* and the like), *Meganyctiphanes* (such as *norvegica* and the like) and *Tysanoessa* (such as *macrura*, *vicina*, *gregaria* and the like), are a preferred source of the multifunctional enzyme.

#### **Example 1 - In Vitro Binding of HL60 Cells to Endothelial Cells**

10 Endothelial cells were first passaged onto 96 well plates at a given concentration. The endothelial cells used in the experiment are described in Edgell et al., *Proc. Natl. Acad. Sci. USA* (1983) 80:3734. The cells were incubated at 37°C under a DMEM cell culture medium containing 10% fetal calf serum and under a 5% CO<sub>2</sub> atmosphere. Then, the medium was removed and replaced with 100 µl (microliter) of a suspension of 15 200,000 HL60 cells (a human lymphocyte cell line, available from the European Cell Culture Bank under ECACC Accession No. 85011431) in RPMI medium containing 10% fetal calf serum. The cells were incubated for 30 minutes. After this, the medium was removed and the adherent cells were washed two times with DMEM medium. The relative adherence of the HL60 cells was measured by measuring the difference in 20 optical density at 450nm between the plates on which the cells were co-incubated and plates having endothelial cells alone.

The effect of TNF $\alpha$  was measured by adding TNF $\alpha$  at 1500 units/ml to the endothelial cells 4 hours before the incubation with HL60 cells. The effect of antibody to E-selectin was measured by adding 25µg/ml of monoclonal antibody BBAZ (R&D 25 Systems Europe, Oxford, England) to the HL60 cells. The results of the experiments were:

Expt. No.	HL60 Cells	Endothelial Cells	Absorbance*
1	no treatment	no treatment	0.324
2	no treatment	pretreated with TNF $\alpha$	0.444
3	added in the presence of mAb to E-selectin	pretreated with TNF $\alpha$	0.357

\*increase over absorbance of endothelial cells alone

The effects of the krill multifunctional hydrolase on this system were measured by:

- 5 1. measuring the effect of adding to the endothelial cells 92.3  $\mu$ g/ml krill multifunctional hydrolase (prepared as in Example 1C of WO 96/24371 (Phairson Medical)) together with the HL60 cells;
2. after pretreating the endothelial cells with TNF for 2 hours, adding 92.3  $\mu$ g/ml krill multifunctional hydrolase and incubating for 2
- 10 more hours prior to the addition of HL60 cells; or
3. pretreating the HL60 cells with 92.3  $\mu$ g/ml krill multifunctional hydrolase prior to adding the HL60 cells to the plates of endothelial cells.

The results of these experiments were as follows:

Expt. No.	HL60 Cells	Endoth Cells	Absorbance*
4	Multifunctional enzyme added simultaneously with cells	pretreated with TNF $\alpha$	0.425
5	no treatment	Four hours pretreatment: 0-4h TNF $\alpha$ 2-4h multifunctional enzyme	0.247
6	pretreated with multifunctional enzyme for 2h	pretreated with TNF $\alpha$	0.160
7	pretreated with multifunctional enzyme for 2h	Four hours pretreatment: 0-4h TNF $\alpha$ 2-4h multifunctional enzyme	0.059

15

\*increase over absorbance of endothelial cells alone.

To confirm these results, the number of adhering HL60 cells were counted by removing them from the plate and counting the cells. The number of HL60 cells was determined by subtracting the cell numbers for control plates having only endothelial cells. These counting results mirrored the optical density results, as follows:

5

EXPERIMENT	HL60 CELL NUMBER
1	32,590
2	43,990
3	35,730
4	42,190
5	25,280
6	17,010

These adherence studies show that krill hydrolase destroyed the cell-surface ligand and acceptor molecules that facilitate cell-adhesion.

**Example 2- Activity Against Certain Cell-Surface Adhesion Molecules**

10

Freshly isolated T-cells from the thymus of a C57BL/6 mouse were washed three times with serum-free medium. 1 ml aliquots of the cells containing  $5 - 10 \times 10^6$  cells were treated at 37°C for 4 hours with 0, 100 or 500 µg/ml of the krill-derived multifunctional hydrolase prepared according to Example 1B dissolved in serum-free medium. Resulting cells were labeled with one of fluorescent antibodies identified

15

below:

Antibody	Source
CD4-PE	Boehringer Mannheim, Laval, Quebec
CD8-Red613	GIBCO, Long Island, New York
ICAM-1	PharMingen, San Diego, CA
ICAM-2	PharMingen, San Diego, CA
CD44	PharMingen, San Diego, CA
H-2K	PharMingen, San Diego, CA

The amount of antibody binding was determined using a fluorescence-activated cell sorter. From the results, it was determined that the order of sensitivity to inactivation or removal by the hydrolase was CD4, CD8 < ICAM-2 (CD102) < CD44 < ICAM-1  
 20 (CD54) < H-2K. Using these same methods with appropriate cells, including endothelial cells, including the s-end-1 endothelial cell line (Kinashi et al., *J. Leukocyte Biol.* 57: 168, 1995) and T-cells isolated from the thymuses of C57BL/6 mice, it was determined

that the VCAM-1, CD28, CD 31 and asialo GM1 ceramide markers are sensitive to the hydrolase. The antibodies used to make these determinations were:

Antibody Specificity	Source
VCAM-1	PharMingen, San Diego, CA
CD28	PharMingen, San Diego, CA
CD31	PharMingen, San Diego, CA
asialoGM1	Wako Bioproducts, Richmond, VA

In some cases, binding was detected with a labeled second antibody, for instance, binding of the asialo GM1 antibody was detected with FITC-labeled Fab fragments that were specific for rabbit IgG (heavy and light chains), which was obtained from Caltag Laboratories, San Francisco, CA.

**Example 3 - Timecourse of Cell Surface Recovery of Adhesion Molecules**

O-11.10 T-cell hybrids (this cell line is described by Shimonkevitz et al., *J. Experimental Med.* 158: 303, 1983) were treated with 500 µg/ml of the krill-derived multifunctional hydrolase prepared as described in Example 1B of WO 96/24371 (Phairson Medical) and tested for the CD4 marker as described in Example 2. Immediately after the treatment, well less than 1% of the amount of CD4 found in the controls was found on the hydrolase-treated cells. 48 hours later, the levels in treated cells were the same as those in untreated cells.

**Example 4 - GVHD and Bone Marrow Transplantation**

*Materials and Methods*

*Mice*

Female C57BL/6 (H-2<sup>b</sup>), DBA/2 (H-2<sup>k</sup>), and (C57BL/6 x DBA/2)F<sub>1</sub> mice (abbreviated BDF1 mice, H-2<sup>b,k</sup>) were purchased from Charles River Laboratories (St-Constant, Quebec, Canada). Animals were housed microisolator cages at the Institut Arnaud Frappier specific-pathogen free facility. At the time of bone marrow transplantation, donors and recipients were 6 to 8 weeks of age in the first series of experiments, and 5 to 10 weeks of age in the second series of experiments.

*Bone marrow transplantation (BMT)*

Recipients were given a single dose of 700 r total body irradiation 2-4 hours before transplantation from a <sup>60</sup>Co irradiator. Irradiated recipients received, as a source of T-cells, a single intravenous injection via the tail vein of 5 x 10<sup>6</sup> bone marrow cells and 5 x 10<sup>6</sup> spleen cells. Spleens, femurs, and tibias were aseptically collected from

5 euthanized donors and placed in ice-cold Hank's balanced salt solution (HBSS). Spleens were pressed through sterile wire mesh to obtain single cell suspensions which were further treated with Tris-buffered ammonium chloride or sterile distilled water (hypotonic lysis) to eliminate erythrocytes. Bone marrow cells were flushed with a  
5 needle and a syringe from femoral and tibial cavities of donor mice and collected. All cell suspensions were washed twice with HBSS before use.

*Treatment of spleen cells with proteases*

In some experiments, spleen cells were treated with proteases prior to injection in irradiated recipients. The purified krill-derived multifunctional enzyme ("PHM  
10 protease") was obtained from Phairson Medical Ltd (Batch No. PS-3; London, England) in a freeze-dried form and reconstituted with sterile serum-free RPMI medium. Cod trypsin was obtained in a liquid form from Dr. Jon Bjarnason (University of Iceland) (Lot NO. 27.11.95) and had a specific activity of 173 U/mg (CBZ-GRpNA hydrolyzing activity). The enzyme was dialyzed against 1 L of serum-free RPMI stored in frozen  
15 aliquots. Papain was obtained from Sigma (St. Louis, MO). In the first series of experiments, donor C57BL/6 spleen cells were treated with 50 µg/ml of PHM in serum-free RPMI medium for 2 h at 37°C, whereas DBA/2 cells were treated with 20 µg/ml of PHM in serum-free RPMI medium for 2 h at 37°C. In the second series of experiments, donor C57BL/6 spleen cells were treated with 20 µg/ml of protease (e.g. cod trypsin,  
20 papain, or PHM) in serum-free RPMI medium for 1 h at 37°C. Controls included spleen cells incubated without proteases in serum-free RPMI for the same period of time at 37°C. Cells were then washed twice in serum-free medium and counted using Trypan blue staining,

*Flow cytometry*

25 Spleen cells from C57BL/6 mice were stained with saturating amount of PE-labeled anti-CD4 (Pharmingen, San Diego, CA) and Red-613-labeled anti-CD8 antibodies (GIBCO-BRL, Mississauga, Ont, Canada) obtained commercially. The stained cells were analyzed on a Coulter XL-MCL laser flow cytometer (Hialeah, FL).

*Experimental design*

30 The experiments were designed to investigate the impact of protease treatment of splenocytes on the prevention of lethal GVHD. Donor cells from C57BL/6 (H-2<sup>b</sup>), or DBA/2 (H-2<sup>k</sup>), were injected in semi-allogeneic BDF1 (H-2<sup>b,k</sup>) recipients. In this model,

rejection of the bone marrow graft is not possible as H-2<sup>b</sup> or H-2<sup>k</sup> cells are recognized as self by the BDF1 recipients. GVHD is induced either upon allorecognition of H-2<sup>k</sup> antigens expressed by the antigen presenting cells of the recipients following injection of C57BL/6 (H-2<sup>b</sup>) donor T-cells, or upon allorecognition of H-2<sup>b</sup> antigens on the antigen presenting cells of the recipients following injection of DBA/2 (H-2<sup>k</sup>) donor T-cells. In this model of GVHD, mature donor T-cells are mixed with the bone marrow inoculum since the number of donor T-cells in the marrow inoculum is insufficient to induce reproducible and acute GVHD (Ushiyama et al. 1995). Since all nucleated cells express H-2 antigens, the attack of the donor T-cells can be severe, and kill the animals (acute GVHD). Sometimes depending on the H-2 mismatch between donor and recipients, the GVH reaction is mild, and does not kill the recipients (e.g. chronic GvHD). Mice were observed periodically for clinical signs of the disease, and their weight measured twice a week.

### Results

*The first-series of experiments:*

PHM can cleave several cell surface adhesion molecules from the surface of T lymphocyte cell lines in vitro, including CD4, CD8, CD62L, CD54, and others. Thus, PHM can cleave receptors from the surface of freshly isolated splenocytes of C57BL/6. The cleavage of the CD4 and CD8 molecules by PHM was dose-dependent. When PHM is used at concentrations above 20 µg/ml, we found that PHM completely removed the expression of CD4 or CD8 from the surface of splenocytes. Splenocytes from C57BL/6 mice were incubated with the indicated concentrations of PHM for 1 h at 37°C in serum-free RPMI medium. Cells were then stained with specific antibodies to CD4 or CD8, and analyzed by laser flow cytometry.

Since PHM can remove any expression of CD4 or CD8 at the surface of splenocytes, and since both CD4 and CD8 have been reported to play a key role in the induction of GVHD, the question of whether *ex vivo* treatment of lymphoid cells with PHM could reduce the adverse effect of GVHD in a murine model of severe GVHD was investigated. In the first series of experiments, a group (n = 6) of lethally irradiated BDF1 (C57BL/6 x DBA/2, H-2<sup>b,k</sup>) recipients were reconstituted with 5 x10<sup>6</sup> bone marrow and 5 x 10<sup>7</sup> splenocytes from C57BL/6 (H-2<sup>b</sup>) mice. In this model, spleen cells were added to the bone marrow inoculum since there is often not enough T-cells in the

bone marrow to induce severe GVHD. Under these conditions, BDF1 recipients reconstituted with C57BL/6 bone marrow cells and splenocytes did not survive allogeneic BMT, as most of recipients died within 4 weeks post-transfer (untreated group, Figure 1A). In contrast, C57BL/6 inoculums of bone marrow cells + splenocytes  
5 from did not induce a GVH reaction when inoculated into histocompatible, lethally irradiated C57BL/6 recipients (syngeneic control, Figure 1A). *Ex vivo* treatment of C57BL/6 splenocytes with PHM (50 µg/ml for 2 h at 37°C) was sufficient to prevent, at least partially, the ability of splenocytes to induce lethal GVHD in BDF1 recipients. Whereas BDF1 recipients receiving normal C57BL/6 splenocytes died within 4 weeks  
10 post-transfer, most of the recipients (4/6) receiving PHM-treated splenocytes mixed with BMC survived up to 60 days post-transfer. In Figure 1, controls included recipients receiving untreated semi-allogeneic splenocytes (untreated) and recipients receiving syngeneic PHM-treated (50 µg/ml for 2 h at 37°C) splenocytes (Syngeneic + PHM.). Figure 1B illustrates mean survival times (MST) of the three different groups of  
15 recipients.

GVHD is associated with severe weight loss. BDF1 recipients receiving C57BL/6 bone marrow mixed with splenocytes suffered irreversible and severe weight loss while recipients receiving histocompatible bone marrow inoculum occasionally lost some weight shortly after the transfer due to the irradiation, but subsequently showed  
20 signs of recovery as indicated by a continuous gain of weight. BDF1 recipients reconstituted with C57BL/6 bone marrow cells and the PHM-treated splenocytes also recovered from the initial weight loss associated with the irradiation then underwent a period of gradual weight loss between day 15 and they 30. After day 30, however, these BDF1 recipients started to fully recover and most of these recipients survived and gained  
25 weight. For these results, weights of individual mice were monitored twice a week for each BDF1 recipient receiving C57BL/6 semi-allogeneic bone marrow cells mixed with (A) untreated splenocytes, (B) PHM-treated splenocytes, or (C) syngeneic, PHM-treated splenocytes.

In murine models of GVHD, it is sometimes difficult to accurately predict the  
30 onset of GVHD, irrespective of the level of histocompatibility between donors and recipients. In the above experiments, the combination of C57BL/6 with BDF1 recipients was indeed a good model of GVHD. To obtain a second model of GVH, we also

reconstituted the BDF1 recipients with DBA/2 bone marrow cells mixed with DBA/2 splenocytes with a similar inoculum of bone marrow cells and splenocytes. However, reconstitution of DBF1 recipients with DBA/2 BMC did not lead to an acute and lethal GVHD. Only one BDF1 recipients died after bone marrow graft. Again, in this model, a temporary weight loss was observed shortly (< 10 days), but all recipients survived and showed continuous gain of weight thereafter.

*The second series of experiments:*

Since CD4 and CD8 play a crucial role as accessory signals in the T-cell response to allogeneic antigens, treatment of splenocytes with PHM could prevent lethal GVHD by removing all cell surface expression of both receptors at the surface of the treated splenocytes prior to the transfer. To gain further insight into this possibility, a second series of experiments were conducted using three proteases: cod trypsin, PHM and papain. Whereas both cod trypsin and PHM can efficiently cleave CD4 and CD8, papain cannot cleave either receptor efficiently.

Lethally irradiated BDF1 recipients were therefore reconstituted as in the first series of experiments, i.e. using  $5 \times 10^6$  bone marrow and  $5 \times 10^7$  splenocytes. Additional experiments with the spleen of C57BL/6 donor mice showed that efficient cleavage of CD4 and CD8 at their surface could be obtained using a milder treatment of splenocytes with proteases. Thus, the time of incubation with proteases was lowered from 2 h to 1 h, keeping the temperature of incubation at 37°C, and the dose of proteases for *ex vivo* treatment was lowered to 20 µg/ml. Again treatment of splenocytes with a protease significantly reduced the mortality associated with histoincompatible engraftment (Figure 2). At four weeks post-transfer, most of the recipients having received an inoculum of splenocytes treated with a protease had a significantly higher percentage of survival as compared to those reconstituted with untreated splenocytes. The most significant effect was observed with treatment using cod trypsin, as most of the BDF1 mice reconstituted with cod trypsin-treated splenocytes survived the histoincompatible bone marrow graft from C57BL/6 donors. At day 43 post transfer, most of the these BDF1 recipients had stabilized their weight, while some show significant gain of weight.

In the current experiments, lethal GVHD has been prevented. Engraftment has been demonstrated, confirming the indication of successful engraftment that follows



from the observation that irradiated recipients that do not receive a bone marrow graft die within one week post-transplantation.

**Example 5 - T-Cell Proliferation in Response to Mitogen**

Peripheral blood mononuclear cells (PBMCs) were isolated from human blood.

5 1 X 10<sup>5</sup> PBMCs per well were incubated for 72 h at 37°C in medium supplemented with 10% human serum under 5% CO<sub>2</sub>, in the presence of various dilutions of phyto-haemagglutinin (PHA) in the presence (or absence) of a dilution of cod trypsin (diluted 1:100 or more from a 173 U/ml stock solution). At 54 h, the wells were pulsed with <sup>3</sup>H-thymidine. After cell harvest, <sup>3</sup>H uptake was measured, with each experimental

10 point determined from triplicate cultures. The result was that a dose-responsive diminishment in <sup>3</sup>H uptake was seen, with the diminishment first apparent at the 1:1000 dilution and with the 1:100 dilution showing negligible uptake.

A parallel experiment with PHM at best a small effect, but later analysis showed that the starting dilution corresponded to about the 1:10,000 dilution of cod trypsin, such

15 that no effect would have been expected.

**Example 6 - T-Cell Proliferation to Alloantigen (Mixed Lymphocyte Reaction)**

1 X 10<sup>4</sup> PBMCs (responders) per well were incubated with 1 X 10<sup>5</sup> irradiated allogeneic PBMCs (stimulators). The responder PBMCs and stimulator PBMCs were isolated from the blood of different humans. Cells were incubated under the culture

20 conditions of Example 5 for six days in the presence or absence of cod trypsin (various dilutions). Again a <sup>3</sup>H-thymidine pulse was used to generate an uptake indicator of mitogenic activity. The results, from triplicate wells, showed a dose response, with the first significant reduction seen at a 1:10,000 dilution, with the 1:100 dilution showing negligible <sup>3</sup>H uptake.

25 **Example 7 - Skin Transplantation in Murine Model**

*First Protocol*

Preparation of Balb/c cells: Spleen cells are harvested, red blood cells removed, and T-cell depleted by magnetic separation with anti-Thy-1 (CD90) antibodies (an antigen specifically expressed on all T cells). T-cell-depleted Balb/c stimulator cells

30 (containing mostly B cells and macrophages, and some dendritic cells, and few NK cells) are resuspended in serum-free RPMI (Russell Park Memorial Institute) at 2 x 10<sup>6</sup> cells /ml. PHM or cod trypsin (1, 5, 50 µg/ml final concentration) is added and cells

incubated for 2 hours at 37°C. The reaction with the protease is stopped by adding fetal calf serum (FCS - 10% final concentration). Cells are added to a F-25 flask ( $10^6$  cells/0.5 ml/6.1 cm, i.e. equivalent to 106/24-well plate). An aliquot of cells is used to confirm cleavage by flow cytometric analysis with anti-B7 and anti-CD40 antibodies.

- 5 Controls include stimulator cells incubated in serum-free medium without PHM.

Preparation of C3H cells: Spleen cells (N.B. 15% of spleen cells are T cells) are harvested as a source of T-cells, red blood cells are removed. Cells are counted and added to F-25 flasks containing PHM-treated C3H stimulator cells at given ratios of 1:1. Cells are incubated for 24 hours at 37°C.

- 10 Separation of *ex vivo* tolerized T cells from co-culture: all T-cells from co-culture are isolated using antibodies to Thy-1 (CD90) by magnetic separation (since both CD4 and CD8 are responsible for tolerization (Blazar et al., 1996)). This procedure allows isolation of C3H-T cells away from Balb/c stimulator cells. T-cells are washed twice with PBS to remove any trace of PHM, and the cell concentration adjusted to  
15 108/ml.

- Induction of tolerance: Recipient C3H mice are injected iv with 1, 10, and  $100 \times 10^6$  donor cells. Challenge with tail skin from Balb/c mice are done 24, 48 or 72 hours later. Skin transplant, as is known in the art, includes cutting the tails of donor animals, cleaning and trimming the skin (3-4 grafts within a tail), preparing the recipient  
20 (anaesthesia), trimming a graft bed, and suturing. Inhibition of rejection is measured 10-12 days post-transplant.

#### Second Protocol

- Preparation of C3H cells: Spleen cells are harvested, red blood cells removed, and T-cell depleted by magnetic separation with anti-Thy-1 (CD90) antibodies (an  
25 antigen specifically expressed on all T cells). T-cell-depleted stimulator cells (containing mostly B cells and macrophages, and some dendritic cells, and few NK cells) are resuspended in serum-free RPMI (Russell Park Memorial Institute) at  $2 \times 10^6$  cells/ml. PHM or cod trypsin (1, 5, 50  $\mu\text{g/ml}$  final concentration) is added and cells incubated for 2 hours at 37°C. The reaction with the protease is stopped by adding fetal calf serum  
30 (FCS - 10% final concentration). Cells are added to a F-25 flask ( $10^6$  cells/0.5 ml/6.1 cm, i.e. equivalent to 106/24-well plate). An aliquot of cells is used to confirm cleavage by flow cytometric analysis with anti-B7 and anti-CD40 antibodies. Controls include stimulator cells incubated in serum-free medium without PHM.

Preparation of Balb/c cells: Spleen cells (N.B. 15% of spleen cells are T cells) are harvested as a source of T-cells, red blood cells are removed. Cells are counted and added to F-25 flasks containing PHM-treated C3H stimulator cells at given ratios of 1:1. Cells are incubated for 24 hours at 37°C.

5 Separation of *ex vivo* tolerized T cells from co-culture: all T-cells from co-culture are isolated using antibodies to Thy-1 (CD90) by magnetic separation (since both CD4 and CD8 are responsible for tolerization (Blazar et al., 1996)). This procedure allows isolation of Balb/c T-cells away from C3H stimulator cells. T-cells are washed twice with PBS to remove any trace of PHM, and the cell concentration adjusted to  
10 108/ml.

Induction of tolerance: Recipient C3H mice are injected iv with 1, 10, and 100 x 10<sup>6</sup> T-cells. Challenge with tail skin from Balb/c mice are done 24, 48 or 72 hours later. Skin transplant, as is known in the art, includes cutting the tails of donor animals, cleaning and trimming the skin (3-4 grafts within a tail), preparing the recipient  
15 (anaesthesia), trimming a graft bed, and suturing. Inhibition of rejection is measured 10-12 days post-transplant.

#### **Example 8 - Effect of Serum**

1 X 10<sup>5</sup> PBMCs per well were incubated for 72 h at 37°C in in medium supplemented with 10% human serum under 5% CO<sub>2</sub>, in the presence of an appropriate  
20 dilution of PHA (selected based on Example 5) in the presence (or absence) of cod trypsin (diluted 1:100) and 0%, 1%, 2%, 5% or 10% human AB serum. The wells were pulsed with <sup>3</sup>H-thymidine. After cell harvest, <sup>3</sup>H uptake was measured, with each experimental point determined from triplicate cultures. The result was that 1% or 2% serum nearly doubled the hydrolase-induced inhibition of the mitogenic response, while  
25 5% or 10% serum nearly halved the hydrolase-induced inhibition of the mitogenic response.

#### **Example 9 - Removal of Cell-Surface Proteins**

Human PBMCs per incubation were incubated at 37°C for 5 h in the presence or absence of 6 µg/ml PHM or 200 µg/ml cod trypsin. The effects of these treatments on  
30 various surface markers were measured by flow cytometry with fluorescently labeled antibodies and summarized by percent of cells having the marker and median fluorescence. **Figure 3A** shows the results for CD3, CD4 and CD8, with open squares

representing the results with no enzyme, open triangles for the cod trypsin treatment, and open circles for the PHM treatment. The results for CD25 and CD28 are in **Figure 3B**; for CD11a, CD49a and CD54 in **Figure 3C**.

#### **Example 10 - Protease Comparisons**

5 Aliquots of T-lymphocytes ( $2 \times 10^6$ ) were incubated in 0.5 ml of RPMI 1640 culture medium at 37°C for 2 h in the presence of 2 mcg/ml or 20 mcg/ml of a protease. After incubation, the protease was removed by washing the cells using low speed centrifugation. The effects on surface molecules was quantitated with fluorescent-labeled monoclonal antibodies and fluorescence measured on individual cells by flow  
10 cytometry. The quantity is derived from 10,000 cells per measurement. The 2 mcg/ml results are shown in **Figure 4** for CD62L (panel A), CD8 (panel B), CD54 (panel C), CD11a (panel D), CD102 (panel E), CD4 (panel F) and CD31 (panel G). The proteases were:

<u>Enzyme</u>	<u>Source</u>
PHIM	see, U.S. Patents 5,945,102 and 5,958,406
Kamchatka protease	Anawa, Wangen, Switzerland
Cod chymotrypsin	Atlantic cod, see, Aseirsson and Bjarnason, <i>Comp. Biochem. Physiol.</i> 99B:327-335, 1991
Cod trypsin	Atlantic cod, see, <i>European J. Biochem.</i> 180: 85-94, 1989
Cod collagenase 3	Atlantic cod, see, Aseirsson and Bjarnason, <i>Comp. Biochem. Physiol.</i> 99B:327-335, 1991
Cod cryotin IV	Atlantic cod, see, Professor Bjarnason, Univ. of Ra
Cod elastase	Atlantic cod, see, Aseirsson and Bjarnason, <i>Biochem. Biophys. Acta.</i> 1164:91-100, 1993
Papain	Sigma Chemical, St. Louis
Bromelain	Sigma Chemical, St. Louis
Subtilisin	Sigma Chemical, St. Louis
Tunisin	Gaiker, Zamudio, Spain
Collagenase F	Sigma Chemical, St. Louis

15 The 20 mcg/ml results are shown in panels A-G of **Figure 5**.

#### References

- Abraham VS, et al. Mechanism of protection from graft-versus-host disease mortality by IL-2, III. Early reductions in donor T-cell subsets and expansion of a CD3+CD4-  
20 CD8-cell population. *J. Immunol.* 1992 Jun 15;148(12):3746-52.

- Blazar BR, et al. Coblockade of the LFA1:ICAM and CD28/CTLA4:B7 pathways is a highly effective means of preventing acute lethal graft-versus-host disease induced by fully major histocompatibility complex-disparate donor grafts. *Blood*. 1995 May 1;85(9):2607-18.
- 5 • Blazar BR, et al. Recent advances in graft-versus-host disease (GVHD) prevention. *Immunol Rev*. 1997 Jun;157:79-109. Review.
- Cavazzana-Calvo M, et al. A phase II trial of partially incompatible bone marrow transplantation for high-risk acute lymphoblastic leukaemia in children: prevention of graft rejection with anti- LFA-1 and anti-CD2 antibodies. Societe Francaise de  
10 Greffe de Moelle Osseuse. *Br. J. Haematol*. 1996 Apr;93(1):131-8.
- Cobbold S, et al. Infectious tolerance. *Curr. Opin. Immunol*. 1998 Oct;10(5):518-24.
- Dustin ML, et al. Role of lymphocyte adhesion receptors in transient interactions and cell locomotion. *Ann. Rev. Immunol*. 1991;9:27-66. Review.
- Schwartz RH. T-cell clonal anergy. *Curr. Opin. Immunol*. 1997 Jun;9(3):351-7.  
15 Review.
- St-Pierre Y, et al. Characterization of the signaling function of MHC class II molecules during antigen presentation by B cells. *J. Immunol*. 1991 Nov 1; 147(9):2875-82.
- Sykes M, et al. Interleukin 2 prevents graft-versus-host disease while preserving the  
20 graft-versus-leukemia effect of allogeneic T-cells. *Proc. Natl. Acad. Sci. USA*. 1990 Aug;87(15):5633-7.
- Sykes M et al. IL-12 inhibits murine graft-versus-host disease. *Blood*. 1995 Sep 15;86(6):2429-38.
- Ushiyama C, et al. Anti-IL-4 antibody prevents graft-versus-host disease in mice after  
25 bone marrow transplantation. The IgE allotype is an important marker of graft-versus-host disease. *J. Immunol*. 1995 Mar 15;154(6):2687-96.

The protein sequences described herein and in documents identified herein have been carefully sequenced. However, those of ordinary skill will recognize that nucleic  
30 acid sequencing technology can be susceptible to inadvertent error. Those of ordinary skill in the relevant arts are capable of validating or correcting these sequences based on the ample description herein of methods of isolating the nucleic acid sequences in

question, and such modifications that are made readily available by the present disclosure are encompassed by the present invention. Furthermore, those sequences reported herein are believed to define functional biological macromolecules within the invention whether or not later clarifying studies identify sequencing errors. Moreover, 5 please note that sequences recited in the Sequence Listing below as "DNA" or under some other apparently restrictive nomenclature, represent an exemplification of the invention, since those of ordinary skill will recognize that such sequences can be usefully employed in polynucleotides in general, including ribopolynucleotides.

All publications and references, including but not limited to patents and patent 10 applications, cited in this specification are herein incorporated by reference in their entirety as if each individual publication or reference were specifically and individually indicated to be incorporated by reference herein as being fully set forth. Any patent application to which this application claims priority is also incorporated by reference herein in its entirety in the manner described above for publications and references.

15 While this invention has been described with an emphasis upon preferred embodiments, it will be obvious to those of ordinary skill in the art that variations in the preferred devices and methods may be used and that it is intended that the invention may be practiced otherwise than as specifically described herein. Accordingly, this invention includes all modifications encompassed within the spirit and scope of the invention as 20 defined by the claims that follow.

What is claimed:

1. A method of preventing or ameliorating transplantation rejection reactions, where the transplantation can be of immune cells or another tissue, the method comprising:
  - 5 treating a source of immune cells with a rejection preventing or ameliorating effective amount of a hydrolase or mixture of hydrolases; and administering the treated immune cells to a recipient animal.
2. The method of preventing or ameliorating transplantation rejection  
10 reactions of claim 1, further comprising:
  - contacting the treated immune cells, which cells are obtained from a recipient animal, with second cells of a donor animal; and
  - transplanting a tissue from the donor animal to the recipient animal.
3. The method of preventing or ameliorating transplantation rejection  
15 reactions of claim 1, further comprising:
  - administering the immune cells with a cell surface adhesion molecule binding effective amount of an antibody that binds one of CD4, CD8, CD25 (IL-2  
receptor alpha chain), CD28, CD152 (CTLA-4), an integrin, CD154,  
20 CD40 and CD80.
4. The method of preventing or ameliorating transplantation rejection  
reactions of claim 1 comprising:
  - 25 isolating from a source of immune cells taken from a donor (a) a fraction enriched in mature T-cells and (b) a fraction containing immune cell precursor cells;
  - treating the mature T-cells of fraction (a) with a rejection preventing or ameliorating effective amount of a hydrolase or mixture of hydrolases; and
  - 30 administering the mature T-cells of fraction (a) and the cells of fraction (b) to a recipient.

5. The method of claim 4, wherein the hydrolase treated mature T-cells are contacted with cells of fraction (b) prior to administration to the recipient.

6. A method of preventing or ameliorating allergic, autoimmune or  
5 transplantation rejection reactions comprising:  
treating a source of immune cells taken from a recipient with an allergic,  
autoimmune or transplantation rejection preventing or ameliorating  
effective amount of a hydrolase or mixture of hydrolases;  
contacting the treated source of immune cells with cells from the donor animal or  
10 with a substance that induces the allergic reaction or which contains  
autoimmune epitopes;  
transplanting the donor organ into the recipient; and  
administering the treated cells into the recipient.

7. The method of claim 6, wherein the treated cells include mature T-cells.

8. The method of claim 6, further comprising  
administering the treated immune cells with a cell surface adhesion molecule  
binding effective amount of an antibody that binds one of CD4, CD8,  
20 CD25 (IL-2 receptor alpha chain), CD28, CD152 (CTLA-4), an integrin,  
CD154, CD40 and CD80.

9. A method of preventing or ameliorating allergic, autoimmune or  
transplantation rejection reactions with a hydrolase, comprising:  
25 identifying the hydrolase or mixture of hydrolases as a hydrolase or mixture of  
hydrolases (a) effective to induce tolerance in immune cells to a substance  
against which the immune cells were previously reactive, or (b) with a  
relative selective preference for disabling signal 2 and/or signal 1;  
treating immune cells or immune cell precursors with the hydrolase or mixture of  
30 hydrolases; and  
administering the treated cells to a mammal.



10. The method of claim 9, wherein the hydrolase has a relative selective preference for removing, destroying, inactivating or disabling at least one of at least one of CD4, CD8, CD25, CD28, ICAM-1 (CD54), CD152, an integrin, CD154, CD40 and CD80 over removing, destroying, inactivating or disabling TcR.

5

11. The method of claim 9, wherein the hydrolase has a relative selective preference for removing, destroying, inactivating or disabling at least one of at least one CD4, CD8, CD28, ICAM-1 (CD54), CD11a, CD49d and CD154 over removing, destroying, inactivating or disabling TcR.

10

12. The method of claim 9, wherein the hydrolase has a relative selective preference for removing, destroying, inactivating or disabling at least two of CD4, CD8, CD28 and CD154 over removing, destroying, inactivating or disabling TcR.

15

13. A method of identifying a hydrolase for use in preventing or ameliorating allergic, autoimmune or transplantation rejection reactions, comprising:

identifying a relative selective preference of one or more hydrolases for removing, destroying, inactivating or disabling at least one of CD4, CD8, CD25, CD28, ICAM-1 (CD54), CD152, an integrin, CD154, CD40 and CD80 in contrast to removing, destroying, inactivating or disabling TcR; and

20

selecting a hydrolase or mixture of hydrolases with a relative selective preference for removing, destroying, inactivating or disabling at least one of CD4, CD8, CD25, CD28, ICAM-1 (CD54), CD152, an integrin, CD154, CD40 and CD80 in contrast to removing, destroying, inactivating or disabling TcR.

25

14. A method of preventing or ameliorating transplantation rejection reactions comprising treating the donor tissue with a rejection reaction preventing or ameliorating effective amount of a hydrolase or mixture of hydrolases, wherein the hydrolase or mixture of hydrolases employed is more effective on a molar basis in preventing or ameliorating donor tissue rejection than is the krill multifunctional enzyme.

30

15. The method of claim 14, further comprising treating the donor tissue *ex vivo*.

16. The method of claim 14, wherein the hydrolase or mixture of hydrolases  
5 employed is more effective in removing, destroying, inactivating or disabling one or more of CD4, CD8, CD25, CD28, ICAM-1 (CD54), CD152, an integrin, CD154, CD40 and CD80 than is the krill multifunctional enzyme.

17. The method of claim 14, wherein the hydrolase or mixture of hydrolases  
10 employed is more effective in removing, destroying, inactivating or disabling one or more of CD4, CD8, CD28, ICAM-1 (CD54), an integrin, CD154, than is the krill multifunctional enzyme.

18. A method of preventing or ameliorating transplantation rejection reactions  
15 comprising treating a donor source of immune cells with a rejection preventing or ameliorating effective amount of a hydrolase or mixture of hydrolases, wherein the hydrolase or mixture of hydrolases employed is more effective on a molar basis in preventing or ameliorating donor tissue rejection than is the krill multifunctional enzyme.

20

19. The method of claim 18, wherein the hydrolase or mixture of hydrolases  
employed is more effective in removing, destroying, inactivating or disabling one or more of CD4, CD8, CD25, CD28, ICAM-1 (CD54), CD152, an integrin and GP39 (CD154) than is the krill multifunctional enzyme.

25

Figure 1A

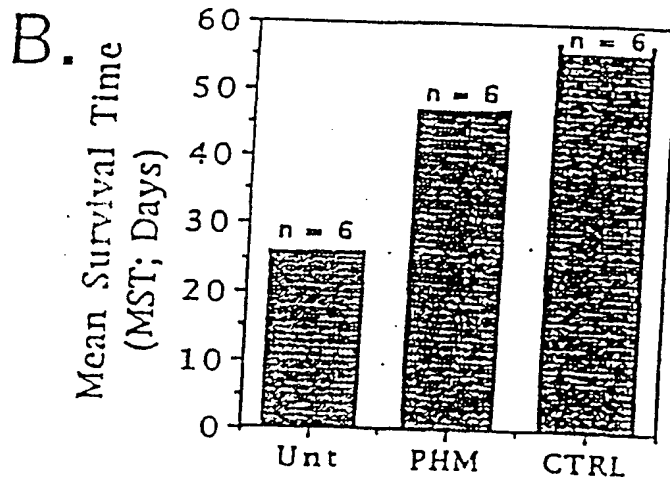
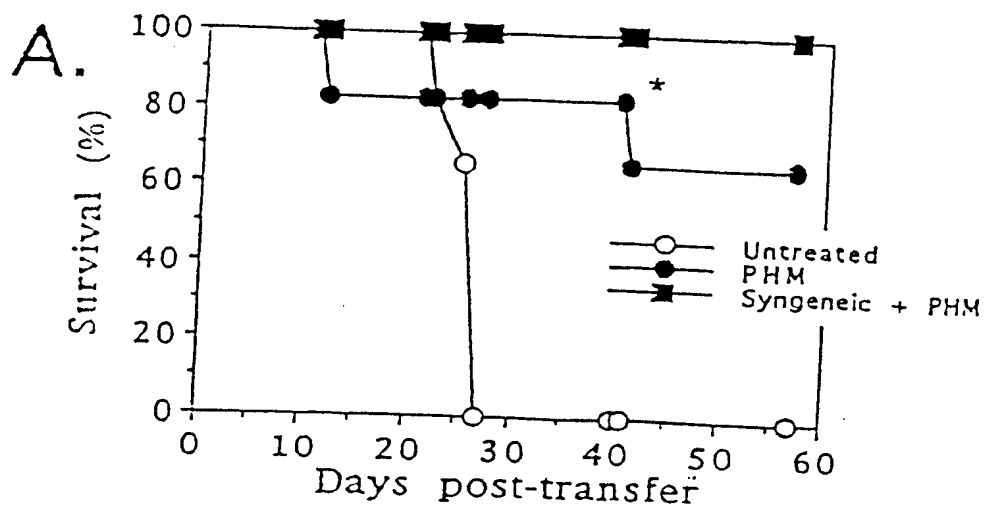

Figure 1B

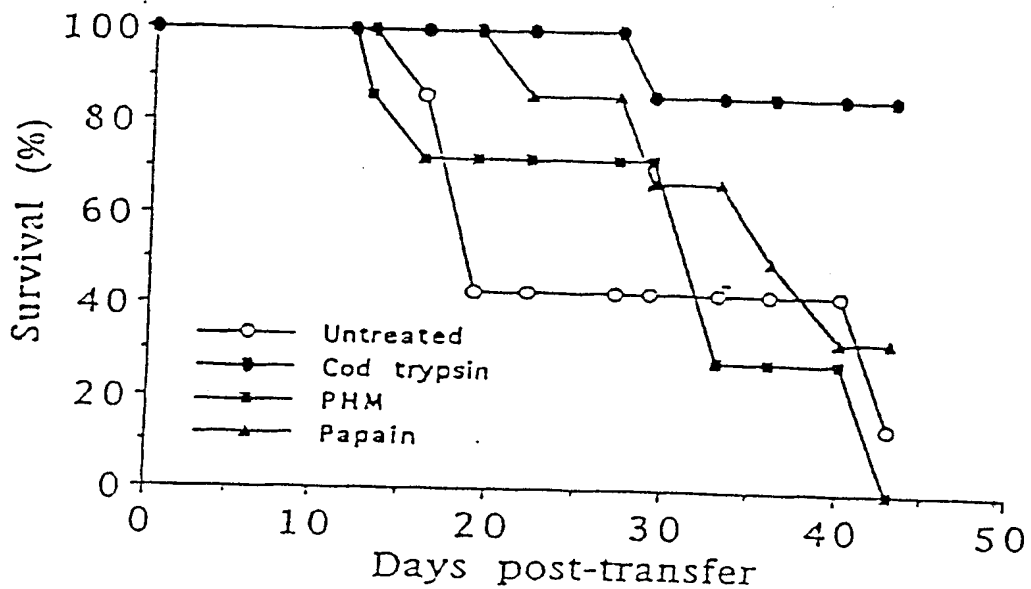

Figure 2

# CD3, CD4, CD8

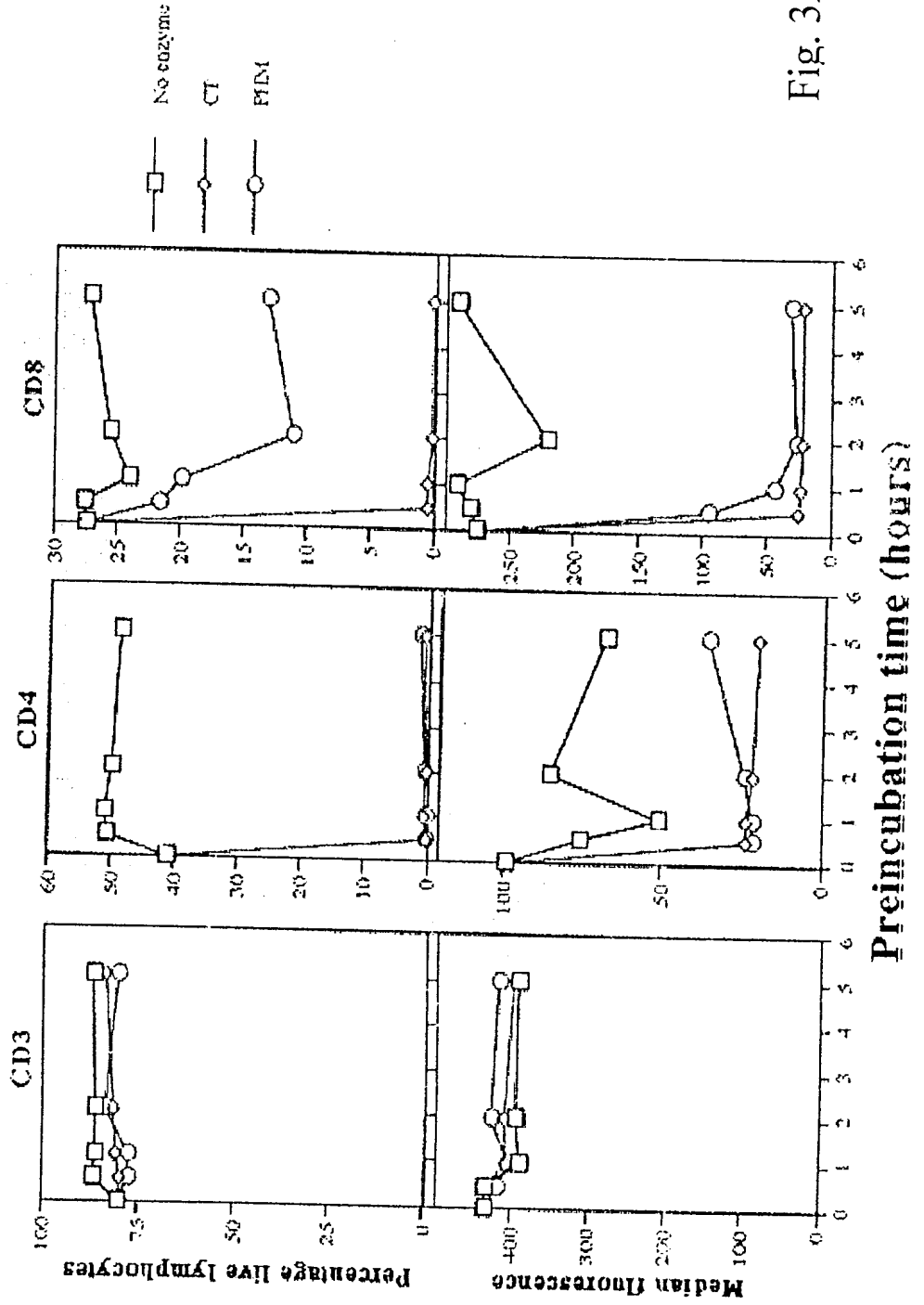

Fig. 3A

Pharison Medical

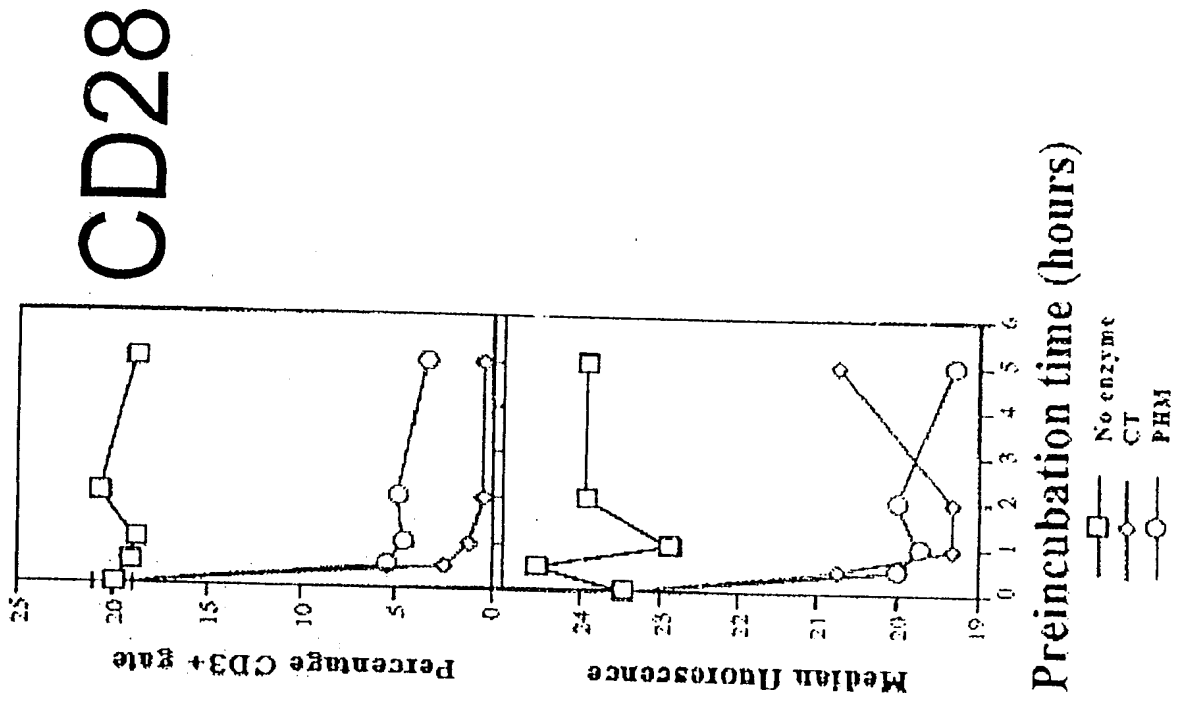

Fig. 3B

Phairson Medical

Phairson Medical

# CD11a, CD49d, CD54

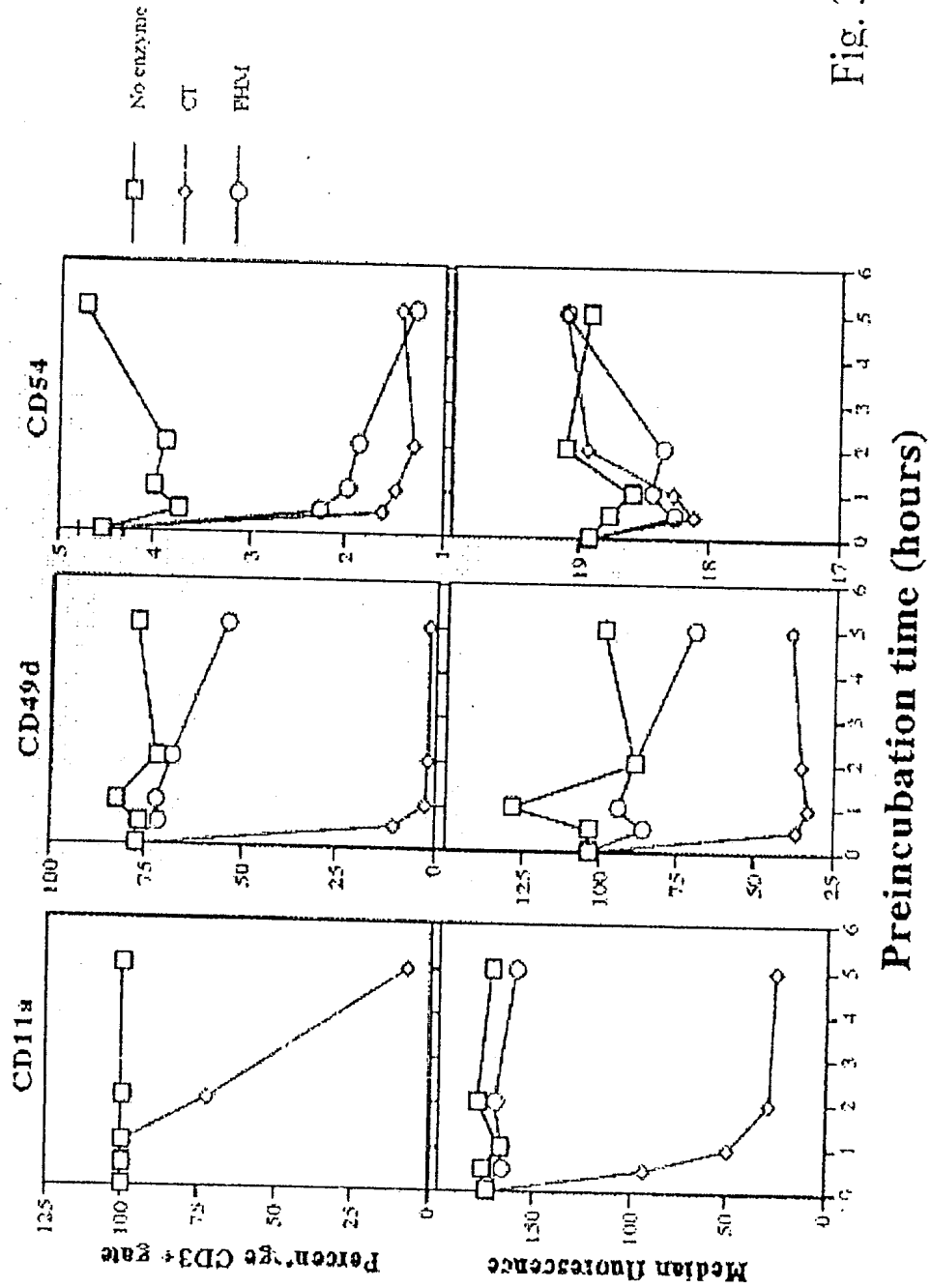

Fig. 3C

Phairson Medical

Figure 1: Cleavage of murine cell surface receptors at a dose of 2 µg/ml.

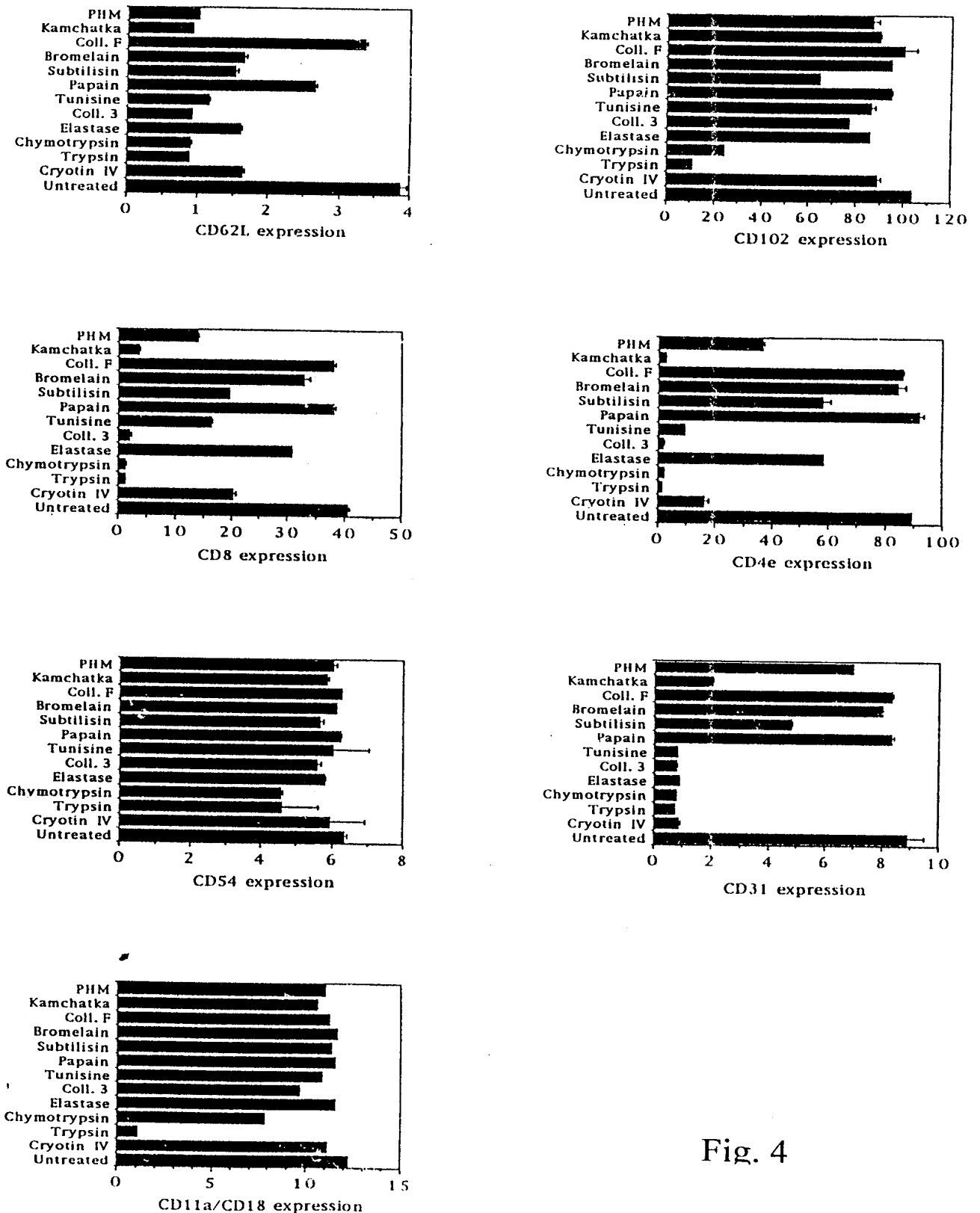

Fig. 4



Figure 2: Cleavage of murine cell surface receptors at a dose of 10 µg/ml.

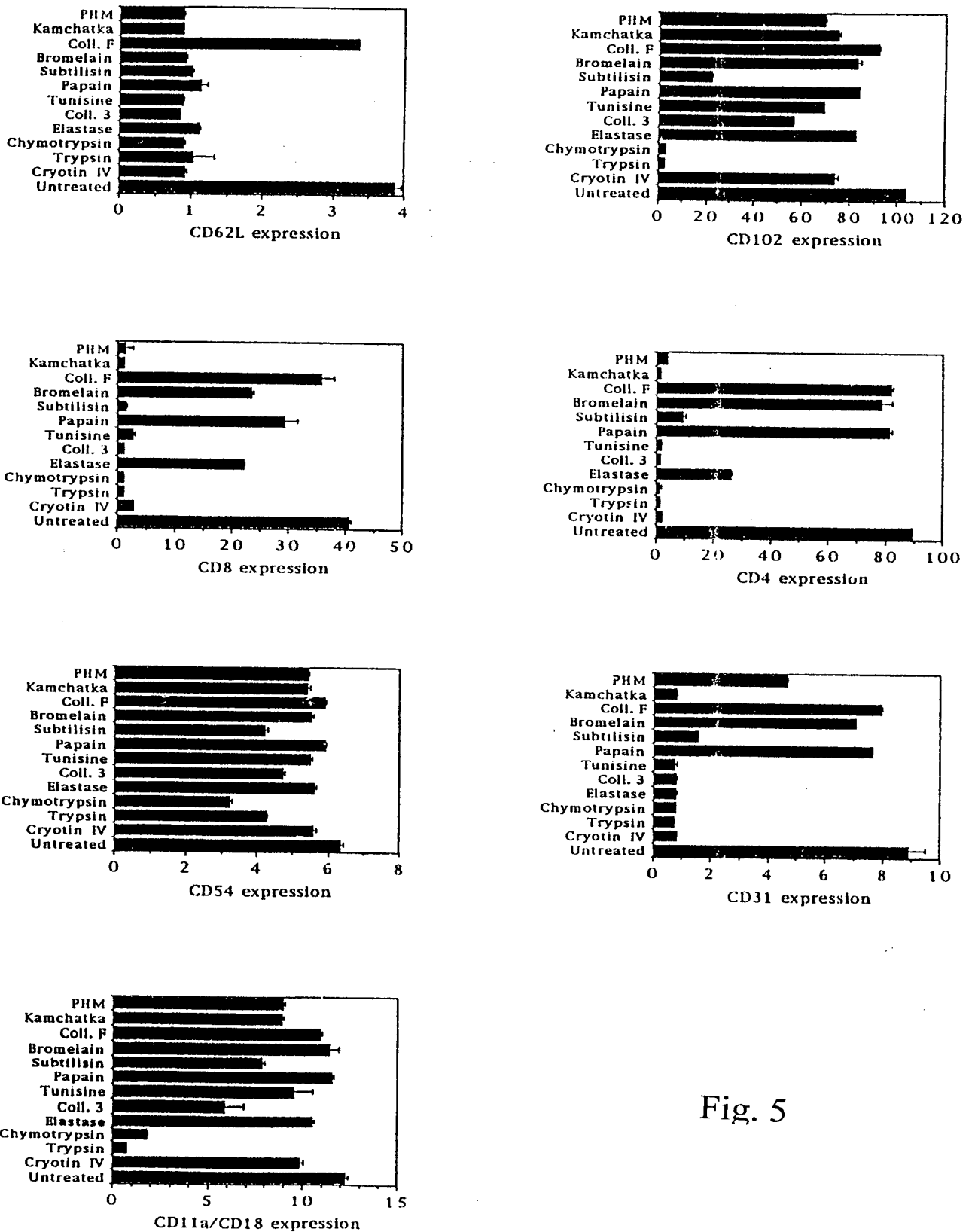

Fig. 5

## A - 1

## SEQUENCE LISTING

<110> Richard L. Franklin  
 Yves St. Pierre

<120> Treatment and Prevention of Immune  
 Rejection Reactions

<130> 314572-104A

<160> 27

<170> FastSEQ for Windows Version 4.0

<210> 1  
 <211> 25  
 <212> PRT  
 <213> Euphasia superba

<400> 1  
 Ile Val Gly Gly Asn Glu Val Thr Pro His Ala Tyr Pro Trp Gln Val  
 1 5 10 15  
 Gly Leu Phe Ile Asp Asp Met Tyr Phe  
 20 25

<210> 2  
 <211> 25  
 <212> PRT  
 <213> Euphasia superba

<400> 2  
 Ile Val Gly Gly Met Glu Val Thr Pro His Ala Tyr Pro Trp Gln Val  
 1 5 10 15  
 Gly Leu Phe Ile Asp Asp Met Tyr Phe  
 20 25

<210> 3  
 <211> 25  
 <212> PRT  
 <213> Penaeus vanameii

<400> 3  
 Ile Val Gly Gly Val Glu Ala Thr Pro His Ser Trp Pro His Gln Ala  
 1 5 10 15  
 Ala Leu Phe Ile Asp Asp Met Tyr Phe  
 20 25

<210> 4  
 <211> 20  
 <212> PRT  
 <213> Penaeus vanameii

<220>  
 <221> VARIANT  
 <222> (12)...(12)

<221> VARIANT

A - 2

<222> (1)...(20)

<223> Xaa = Any Amino Acid

<400> 4

Ile Val Gly Gly Val Glu Ala Thr Pro His Ser Xaa Pro His Gln Ala  
 1 5 10 15  
 Ala Leu Phe Ile  
 20

<210> 5

<211> 25

<212> PRT

<213> Penaeus monodon

<400> 5

Ile Val Gly Gly Thr Ala Val Thr Pro Gly Glu Phe Pro Tyr Gln Leu  
 1 5 10 15  
 Ser Phe Gln Asp Ser Ile Glu Gly Val  
 20 25

<210> 6

<211> 25

<212> PRT

<213> Penaeus monodon

<400> 6

Ile Val Gly Gly Val Glu Ala Val Pro Gly Val Trp Pro Tyr Gln Ala  
 1 5 10 15  
 Ala Leu Phe Ile Ile Asp Met Tyr Phe  
 20 25

<210> 7

<211> 25

<212> PRT

<213> Penaeus monodon

<400> 7

Ile Val Gly Gly Val Glu Ala Val Pro His Ser Trp Pro Tyr Gln Ala  
 1 5 10 15  
 Ala Leu Phe Ile Ile Asp Met Tyr Phe  
 20 25

<210> 8

<211> 25

<212> PRT

<213> Uca pugilator

<400> 8

Ile Val Gly Gly Val Glu Ala Val Pro Asn Ser Trp Pro His Gln Ala  
 1 5 10 15  
 Ala Leu Phe Ile Asp Asp Met Tyr Phe  
 20 25

<210> 9

<211> 20

<212> PRT

<213> Uca pugilator

<400> 9

A - 3

Ile Val Gly Gly Gln Asp Ala Thr Pro Gly Gln Phe Pro Tyr Gln Leu  
 1 5 10 15  
 Ser Phe Gln Asp  
 20

<210> 10  
 <211> 19  
 <212> PRT  
 <213> King crab

<220>  
 <221> VARIANT  
 <222> (14)...(14)

<221> VARIANT  
 <222> (1)...(19)  
 <223> Xaa = Any Amino Acid

<400> 10  
 Ile Val Gly Gly Gln Glu Ala Ser Pro Gly Ser Trp Pro Xaa Gln Val  
 1 5 10 15  
 Gly Leu Phe

<210> 11  
 <211> 20  
 <212> PRT  
 <213> Kamchatka

<220>  
 <221> VARIANT  
 <222> (14)...(14)

<221> VARIANT  
 <222> (1)...(20)  
 <223> Xaa = Any Amino Acid

<400> 11  
 Ile Val Gly Gly Gln Glu Ala Ser Pro Gly Ser Trp Pro Xaa Gln Val  
 1 5 10 15  
 Gly Leu Phe Phe  
 20

<210> 12  
 <211> 20  
 <212> PRT  
 <213> Kamchatka

<400> 12  
 Ile Val Gly Gly Thr Glu Val Thr Pro Gly Glu Ile Pro Tyr Gln Leu  
 1 5 10 15  
 Ser Leu Gln Asp  
 20

<210> 13  
 <211> 20  
 <212> PRT  
 <213> Kamchatka

A - 4

<400> 13  
 Ile Val Gly Gly Thr Glu Val Thr Pro Gly Glu Ile Pro Tyr Gln Leu  
 1 5 10 15  
 Ser Phe Gln Asp  
 20

<210> 14  
 <211> 20  
 <212> PRT  
 <213> Kamchatka

<220>  
 <221> VARIANT  
 <222> (16)...(16)

<221> VARIANT  
 <222> (1)...(20)  
 <223> Xaa = Any Amino Acid

<400> 14  
 Ile Val Gly Gly Ser Glu Ala Thr Ser Gly Gln Phe Pro Tyr Gln Xaa  
 1 5 10 15  
 Ser Phe Gln Asp  
 20

<210> 15  
 <211> 20  
 <212> PRT  
 <213> Cray fish

<400> 15  
 Ile Val Gly Gly Thr Asp Ala Thr Leu Gly Glu Phe Pro Tyr Gln Leu  
 1 5 10 15  
 Ser Phe Gln Asn  
 20

<210> 16  
 <211> 20  
 <212> PRT  
 <213> Bovine

<400> 16  
 Ile Val Asn Gly Glu Asp Ala Val Pro Gly Ser Trp Pro Trp Gln Val  
 1 5 10 15  
 Ser Leu Gln Asp  
 20

<210> 17  
 <211> 25  
 <212> PRT  
 <213> Salmon

<400> 17  
 Ile Val Gly Gly Tyr Glu Cys Lys Ala Tyr Ser Gln Ala Tyr Gln Val  
 1 5 10 15  
 Ser Leu Asn Ser Gly Tyr His Tyr Cys  
 20 25

<210> 18

A - 5

<211> 23  
 <212> PRT  
 <213> Atlantic cod

<400> 18  
 Ile Val Gly Gly Tyr Glu Cys Thr Lys His Ser Gln Ala His Gln Val  
 1 5 10 15  
 Ser Leu Asn Ser Gly Tyr His  
 20

<210> 19  
 <211> 23  
 <212> PRT  
 <213> Atlantic cod

<220>  
 <221> VARIANT  
 <222> (1)...(23)  
 <223> Xaa = Any Amino Acid

<400> 19  
 Ile Val Gly Gly Xaa Glu Val Thr Pro His Ala Tyr Pro Trp Gln Val  
 1 5 10 15  
 Gly Leu Phe Ile Asp Asp Met  
 20

<210> 20  
 <211> 25  
 <212> PRT  
 <213> Euphasia superba

<220>  
 <221> VARIANT  
 <222> (5)...(5)  
 <221> VARIANT  
 <222> (1)...(25)  
 <223> Xaa = Any Amino Acid

<400> 20  
 Ile Val Gly Gly Xaa Glu Val Thr Pro His Ala Tyr Pro Trp Gln Val  
 1 5 10 15  
 Gly Leu Phe Ile Asp Asp Met Tyr Phe  
 20 25

<210> 21  
 <211> 300  
 <212> PRT  
 <213> Euphasia superba

<400> 21  
 Leu Leu Leu Ala Leu Val Ala Ala Ala Ser Ala Ala Glu Trp Arg Trp  
 1 5 10 15  
 Gln Phe Arg His Pro Thr Val Thr Pro Asn Pro Arg Ala Lys Asn Pro  
 20 25 30  
 Phe Arg Val Thr Lys Ser Ser Pro Val Gln Pro Pro Ala Val Arg Gly  
 35 40 45  
 Thr Lys Ala Val Glu Asn Cys Gly Pro Val Ala Pro Arg Asn Lys Ile  
 50 55 60

A - 6

Val Gly Gly Met Glu Val Thr Pro His Ala Tyr Pro Trp Gln Val Gly  
 65 70 75 80  
 Leu Phe Ile Asp Asp Met Tyr Phe Cys Gly Gly Ser Ile Ile Ser Asp  
 85 90 95  
 Glu Trp Val Leu Thr Ala Ala His Cys Met Asp Gly Ala Gly Phe Val  
 100 105 110  
 Glu Val Val Met Gly Ala His Ser Ile His Asp Glu Thr Glu Ala Thr  
 115 120 125  
 Gln Val Arg Ala Thr Ser Thr Asp Phe Phe Thr His Glu Asn Trp Asn  
 130 135 140  
 Ser Phe Thr Leu Ser Asn Asp Leu Ala Leu Ile Lys Met Pro Ala Pro  
 145 150 155 160  
 Ile Glu Phe Asn Asp Val Ile Gln Pro Val Cys Leu Pro Thr Tyr Thr  
 165 170 175  
 Asp Ala Ser Asp Asp Phe Val Gly Glu Ser Val Thr Leu Thr Gly Trp  
 180 185 190  
 Gly Lys Pro Ser Asp Ser Ala Phe Gly Ile Ala Glu Gln Leu Arg Glu  
 195 200 205  
 Val Asp Val Thr Thr Ile Thr Thr Ala Asp Cys Gln Ala Tyr Tyr Gly  
 210 215 220  
 Ile Val Thr Asp Lys Ile Leu Cys Ile Asp Ser Glu Gly Gly His Gly  
 225 230 235 240  
 Ser Cys Asn Gly Asp Ser Gly Gly Pro Met Asn Tyr Val Thr Gly Gly  
 245 250 255  
 Val Thr Gln Thr Arg Gly Ile Thr Ser Phe Gly Ser Ser Thr Gly Cys  
 260 265 270  
 Glu Thr Gly Tyr Pro Asp Gly Tyr Thr Arg Val Thr Ser Tyr Leu Asp  
 275 280 285  
 Trp Ile Glu Ser Asn Thr Gly Ile Ala Ile Asp Pro  
 290 295 300

<210> 22  
 <211> 185  
 <212> PRT  
 <213> Euphasia

<400> 22  
 Met Gly Ala His Ser Ile His Asp Asp Thr Glu Ala Ser Arg Val Ser  
 1 5 10 15  
 Ala Thr Ser Thr Asp Phe Phe Thr His Glu Asn Trp Asn Ser Phe Thr  
 20 25 30  
 Leu Thr Asn Asp Leu Ala Leu Ile Lys Met Pro Ala Pro Ile Glu Phe  
 35 40 45  
 Thr Pro Glu Ile Gln Pro Val Cys Leu Pro Ser Tyr Thr Asp Ala Ala  
 50 55 60  
 Asp Asp Phe Ile Gly Glu Ser Val Val Leu Thr Gly Trp Gly Arg Asp  
 65 70 75 80  
 Ser Asp Ala Ala Ser Gly Ile Ser Glu Leu Leu Arg Glu Val His Val  
 85 90 95  
 Thr Thr Ile Ser Thr Ala Asp Cys Gln Ala Tyr Tyr Gly Ile Val Thr  
 100 105 110  
 Asp Lys Ile Leu Cys Ile Ser Ser Glu Asp Gly His Gly Ser Cys Asn  
 115 120 125  
 Gly Asp Ser Gly Gly Pro Met Asn Tyr Val Thr Gly Gly Val Thr Gln  
 130 135 140  
 Thr Arg Gly Ile Thr Ser Phe Gly Ser Ser Thr Gly Cys Glu Thr Gly  
 145 150 155 160  
 Tyr Pro Asp Gly Tyr Thr Arg Val Thr Ser Tyr Leu Asp Trp Ile Glu  
 165 170 175

A - 7

Ser Asn Thr Gly Ile Ala Ile Asp Ala  
 180 185

<210> 23  
 <211> 178  
 <212> PRT  
 <213> Euphasia

<400> 23

Pro Gly Arg Ser Arg Ile Ala Leu Leu Leu Ala Leu Val Ala Ala Thr  
 1 5 10 15  
 Ala Ser Ala Ser Glu Trp Arg Trp Gln Phe Arg His Pro Thr Val Thr  
 20 25 30  
 Pro Asn Pro Arg Ala Asn Asn Pro Phe Arg Pro Ser Lys Val Ala Pro  
 35 40 45  
 Val Gln Pro Pro Ala Val Arg Gly Thr Lys Ala Val Glu Asn Cys Gly  
 50 55 60  
 Pro Val Ala Pro Lys Asn Lys Ile Val Gly Gly Gln Glu Val Thr Pro  
 65 70 75 80  
 His Ala Tyr Pro Trp Gln Val Gly Leu Phe Ile Asp Asp Met Tyr Phe  
 85 90 95  
 Cys Gly Gly Ser Ile Ile Ser Glu Asp Trp Val Leu Thr Ala Ala His  
 100 105 110  
 Cys Val Asp Gly Ala Gly Phe Val Glu Val Val Met Gly Ala His Ser  
 115 120 125  
 Ile His Asp Asp Thr Glu Ala Ser Arg Ile Ser Ala Thr Ser Thr Asp  
 130 135 140  
 Phe Phe Thr His Glu Asn Trp Asn Ser Phe Thr Leu Thr Asn Asp Leu  
 145 150 155 160  
 Ala Leu Ile Lys Met Pro Ala Pro Ile Glu Phe Thr Pro Glu Ile Gln  
 165 170 175  
 Pro Val

<210> 24  
 <211> 178  
 <212> PRT  
 <213> Euphasia

<400> 24

Pro Gly Arg Ser Arg Ile Ala Leu Leu Leu Ala Leu Val Ala Ala Thr  
 1 5 10 15  
 Ala Ser Ala Ser Glu Trp Arg Trp Gln Phe Arg His Pro Thr Val Thr  
 20 25 30  
 Pro Asn Pro Arg Ala Asn Asn Pro Phe Arg Pro Ser Lys Val Ala Pro  
 35 40 45  
 Val Gln Pro Pro Ala Val Arg Gly Thr Lys Ala Val Glu Asn Cys Gly  
 50 55 60  
 Pro Val Ala Pro Lys Asn Lys Ile Val Gly Gly Gln Glu Val Thr Pro  
 65 70 75 80  
 His Ala Tyr Pro Trp Gln Val Gly Leu Phe Ile Asp Asp Met Tyr Phe  
 85 90 95  
 Phe Gly Gly Ser Ile Ile Ser Glu Asp Trp Val Val Thr Ala Arg His  
 100 105 110  
 Cys Met Asp Gly Arg Gly Phe Val Glu Val Val Met Gly Ala His Ser  
 115 120 125  
 Ile Leu Asp Asp Thr Glu Ala Ser Arg Met Ser Ala Thr Ser Thr Asp  
 130 135 140  
 Phe Phe Thr His Glu Asn Trp Asn Ser Phe Thr Leu Thr Asn Asp Leu



A - 8

145					150					155				160	
Ala	Leu	Ile	Lys	Met	Pro	Ala	Pro	Ile	Glu	Phe	Thr	Pro	Glu	Ile	Gln
				165					170					175	
Pro	Val														

<210> 25  
 <211> 211  
 <212> PRT  
 <213> Euphasia

<400> 25

His	Ala	Tyr	Pro	Trp	Gln	Val	Gly	Leu	Phe	Ile	Asp	Asp	Met	Tyr	Phe
1				5					10					15	
Cys	Gly	Gly	Ser	Ile	Ile	Ser	Asp	Glu	Trp	Val	Leu	Thr	Ala	Ala	His
			20					25					30		
Cys	Met	Asp	Gly	Ala	Gly	Phe	Val	Glu	Val	Val	Met	Gly	Ala	His	Ser
		35					40					45			
Ile	His	Asp	Glu	Thr	Glu	Ala	Thr	Gln	Val	Arg	Ala	Thr	Ser	Thr	Asp
	50					55				60					
Phe	Phe	Thr	His	Glu	Asn	Trp	Asn	Ser	Phe	Thr	Leu	Ser	Asn	Asp	Leu
65					70					75					80
Ala	Leu	Ile	Lys	Met	Pro	Ala	Pro	Ile	Glu	Phe	Asn	Asp	Val	Ile	Gln
				85					90					95	
Pro	Val	Cys	Leu	Pro	Thr	Tyr	Thr	Asp	Ala	Ser	Asp	Asp	Phe	Val	Gly
			100					105					110		
Glu	Ser	Val	Thr	Leu	Thr	Gly	Trp	Gly	Lys	Pro	Ser	Asp	Ser	Ala	Phe
		115						120					125		
Gly	Ile	Ala	Glu	Gln	Leu	Arg	Glu	Val	Asp	Val	Thr	Thr	Ile	Thr	Thr
	130					135						140			
Ala	Asp	Cys	Gln	Ala	Tyr	Tyr	Gly	Ile	Val	Thr	Asp	Lys	Ile	Leu	Cys
145					150					155					160
Ile	Asp	Ser	Glu	Gly	Gly	His	Gly	Ser	Cys	Asn	Gly	Asp	Ser	Gly	Gly
				165					170					175	
Pro	Met	Asn	Tyr	Val	Thr	Gly	Gly	Val	Thr	Gln	Thr	Arg	Gly	Ile	Thr
			180					185					190		
Ser	Phe	Gly	Ser	Ser	Thr	Gly	Cys	Glu	Thr	Gly	Tyr	Pro	Asp	Asn	Tyr
		195					200						205		
Thr	Arg	Val													
	210														

<210> 26  
 <211> 302  
 <212> PRT  
 <213> Euphasia

<400> 26

Ile	Ala	Leu	Leu	Leu	Ala	Leu	Val	Ala	Ala	Thr	Ala	Ser	Ala	Ser	Glu
1				5					10					15	
Trp	Arg	Trp	Gln	Phe	Arg	His	Pro	Thr	Val	Thr	Pro	Asn	Pro	Arg	Ala
			20					25					30		
Asn	Asn	Pro	Phe	Arg	Pro	Ser	Lys	Val	Ala	Pro	Val	Gln	Pro	Pro	Ala
		35					40					45			
Val	Arg	Gly	Thr	Lys	Ala	Val	Pro	Asn	Cys	Gly	Gln	Ser	Lys	Ser	Thr
	50					55					60				
Lys	Ile	Val	Gly	Gly	Gly	Glu	Val	Thr	Pro	His	Ala	Tyr	Pro	Trp	Gln
65					70					75					80
Val	Gly	Leu	Phe	Ile	Asp	Asp	Met	Tyr	Phe	Cys	Gly	Gly	Ser	Ile	Ile
				85					90					95	

A - 9

Ser Glu Asp Trp Val Leu Thr Ala Ala His Cys Met Asp Gly Ala Gly  
 100 105 110  
 Phe Val Glu Val Val Met Gly Ala His Lys Ile His Asp Asp Thr Glu  
 115 120 125  
 Ala Ser Arg Val Ser Ala Ile Ser Thr Asp Phe Phe Thr His Glu Asn  
 130 135 140  
 Trp Asn Ser Phe Leu Leu Thr Asn Asp Leu Ala Leu Ile Lys Met Pro  
 145 150 155 160  
 Ala Pro Ile Ala Phe Thr Asp Glu Ile Gln Pro Val Cys Leu Pro Thr  
 165 170 175  
 Tyr Thr Asp Ser Asp Asp Asp Phe Val Gly Glu Ser Val Thr Leu Thr  
 180 185 190  
 Gly Trp Gly Arg Ala Ser Asp Ser Ala Ser Gly Ile Ser Glu Val Leu  
 195 200 205  
 Arg Glu Val Asp Val Thr Thr Ile Thr Thr Ala Asp Cys Gln Ala Tyr  
 210 215 220  
 Tyr Gly Ile Val Thr Asp Lys Ile Leu Cys Ile Asp Ser Glu Gly Gly  
 225 230 235 240  
 His Gly Ser Cys Asn Gly Asp Ser Gly Gly Pro Met Asn Tyr Val Thr  
 245 250 255  
 Gly Gly Val Thr Gln Thr Arg Gly Ile Thr Ser Phe Gly Ser Ser Thr  
 260 265 270  
 Gly Cys Glu Thr Gly Tyr Pro Asp Gly Tyr Thr Arg Val Thr Ser Tyr  
 275 280 285  
 Leu Asp Trp Ile Glu Ser Asn Thr Gly Ile Ala Ile Asp Pro  
 290 295 300

<210> 27  
 <211> 37  
 <212> PRT  
 <213> Atlantic cod

<400> 27  
 Ile Val Gly Gly Tyr Gln Cys Glu Ala His Ser Gln Ala His Gln Val  
 1 5 10 15  
 Ser Leu Asn Ser Gly Tyr His Tyr Cys Gly Gly Ser Leu Ile Asn Trp  
 20 25 30  
 Val Val Ser Ala Ala  
 35

# INTERNATIONAL SEARCH REPORT

International application No.  
PCT/US99/30818

**A. CLASSIFICATION OF SUBJECT MATTER**

IPC(7) : A61K 38/43, 38/46, 39/395

US CL : Please See Extra Sheet.

According to International Patent Classification (IPC) or to both national classification and IPC

**B. FIELDS SEARCHED**

Minimum documentation searched (classification system followed by classification symbols)

U.S. : 424/94.1, 94.6, 130.1., 133.1, 141.1, 143.1, 144.1, 153.1, 154.1, 173.1

Documentation searched other than minimum documentation to the extent that such documents are included in the fields searched

Electronic data base consulted during the international search (name of data base and, where practicable, search terms used)

DIALOG, BIOSIS, CA, EMBASE, MEDLINE, USPAT

search terms: hydrolase, krill, phm protease, trypsin, papain, cd4, cd8, cd25, cd28, ctla-4, cd40, cd40 ligand, cd80, b7

**C. DOCUMENTS CONSIDERED TO BE RELEVANT**

Category*	Citation of document, with indication, where appropriate, of the relevant passages	Relevant to claim No.
Y	US 5,747,037 A (NOELLE ET AL.) 05 May 1998, see entire document.	1-19
Y	US 5,747,034 A (DE BOER ET AL.) 05 May 1998, see entire document.	1-19
Y	US 5,756,096 A (NEWMAN ET AL.) 26 May 1998, see entire document.	1-19
Y	WO 98/38291 A1 (CORTECS LIMITED) 03 September 1998, see entire document.	1-19

Further documents are listed in the continuation of Box C.       See patent family annex.

<p>* Special categories of cited documents:</p> <p>"A" document defining the general state of the art which is not considered to be of particular relevance</p> <p>"E" earlier document published on or after the international filing date</p> <p>"L" document which may throw doubts on priority claim(s) or which is cited to establish the publication date of another citation or other special reason (as specified)</p> <p>"O" document referring to an oral disclosure, use, exhibition or other means</p> <p>"P" document published prior to the international filing date but later than the priority date claimed</p>	<p>"T" later document published after the international filing date or priority date and not in conflict with the application but cited to understand the principle or theory underlying the invention</p> <p>"X" document of particular relevance; the claimed invention cannot be considered novel or cannot be considered to involve an inventive step when the document is taken alone</p> <p>"Y" document of particular relevance; the claimed invention cannot be considered to involve an inventive step when the document is combined with one or more other such documents, such combination being obvious to a person skilled in the art</p> <p>"&amp;" document member of the same patent family</p>
--	---

Date of the actual completion of the international search 30 MARCH 2000	Date of mailing of the international search report <b>26 APR 2000</b>
--	--

Name and mailing address of the ISA/US Commissioner of Patents and Trademarks Box PCT Washington, D.C. 20231 Facsimile No. (703) 305-3230	Authorized officer PHILLIP GAMBEL  Telephone No. (703) 308-0196
---	--

**INTERNATIONAL SEARCH REPORT**

International application No.  
PCT/US99/30818

C (Continuation). DOCUMENTS CONSIDERED TO BE RELEVANT		
Category*	Citation of document, with indication, where appropriate, of the relevant passages	Relevant to claim No.
Y	KRADIN et al. Antigen-independent Binding of T-Cells by Dendritic Cells and Alveolar Macrophages in the Rat. AM. REV. RESPIR. DIS. 1989, Volume 139, pages 207-211, see entire document.	1-19
Y	MANNHALTER et al. Modulation of Antigen-Induced T Cell Proliferation by $\alpha_2$ M-Trypsin Complexes. J. Immunol. 15 April 1996, Volume 136, No. 8, pages 2792-2799, see entire document.	1-19

# INTERNATIONAL SEARCH REPORT

International application No.  
PCT/US99/30818

## A. CLASSIFICATION OF SUBJECT MATTER:

US CL :

424/94.1, 94.6, 130.1., 133.1, 141.1, 143.1, 144.1, 153.1, 154.1, 173.1

(19) World Intellectual Property Organization  
International Bureau



(43) International Publication Date  
27 December 2002 (27.12.2002)

PCT

(10) International Publication Number  
WO 02/102394 A2

(51) International Patent Classification<sup>7</sup>: A61K 35/60, 31/23

(21) International Application Number: PCT/CA02/00843

(22) International Filing Date: 7 June 2002 (07.06.2002)

(25) Filing Language: English

(26) Publication Language: English

(30) Priority Data: 60/298,383 18 June 2001 (18.06.2001) US

(71) Applicant (for all designated States except US): NEPTUNE TECHNOLOGIES & BIORESSOURCES INC. [CA/CA]; 500, boulevard St-Martin Ouest, Bureau 500, Laval, Québec H7M 3Y2 (CA).

(72) Inventor; and

(75) Inventor/Applicant (for US only): SAMPALIS, Tina [CA/CA]; 1348 Elisabeth Blvd, Laval, Québec H7W 3J8 (CA).

(74) Agents: OGILVY RENAULT et al.; Suite 1600, 1981 McGill College Avenue, Montreal, Québec H3A 2Y3 (CA).

(81) Designated States (national): AE, AG, AL, AM, AT, AU, AZ, BA, BB, BG, BR, BY, BZ, CA, CH, CN, CO, CR, CU, CZ, DE, DK, DM, DZ, EC, EE, ES, FI, GB, GD, GE, GH, GM, HR, HU, ID, IL, IN, IS, JP, KE, KG, KP, KR, KZ, LC, LK, LR, LS, LT, LU, LV, MA, MD, MG, MK, MN, MW, MX, MZ, NO, NZ, OM, PH, PL, PT, RO, RU, SD, SE, SG, SI, SK, SL, TJ, TM, TN, TR, TT, TZ, UA, UG, US, UZ, VN, YU, ZA, ZM, ZW.

(84) Designated States (regional): ARIPO patent (GH, GM, KE, LS, MW, MZ, SD, SL, SZ, TZ, UG, ZM, ZW), Eurasian patent (AM, AZ, BY, KG, KZ, MD, RU, TJ, TM), European patent (AT, BE, CH, CY, DE, DK, ES, FI, FR, GB, GR, IE, IT, LU, MC, NL, PT, SE, TR), OAPI patent (BF, BJ, CF, CG, CI, CM, GA, GN, GQ, GW, ML, MR, NE, SN, TD, TG).

**Published:**

— without international search report and to be republished upon receipt of that report

For two-letter codes and other abbreviations, refer to the "Guidance Notes on Codes and Abbreviations" appearing at the beginning of each regular issue of the PCT Gazette.

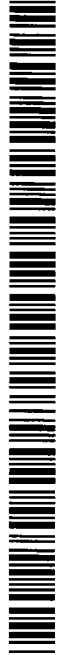

WO 02/102394 A2

(54) Title: KRILL AND/OR MARINE EXTRACTS FOR PREVENTION AND/OR TREATMENT OF CARDIOVASCULAR DISEASES, ARTHRITIS, SKIN CANCER, DIABETES, PREMENSTRUAL SYNDROME AND TRANSDERMAL TRANSPORT

(57) Abstract: The present invention relates to a method of treatment and/or prevention of cardiovascular disease, rheumatoid arthritis, skin cancer, premenstrual syndrome, diabetes and transdermal transport enhancement. The method comprises the administration of a therapeutically effective amount of krill and/or marine oil to a patient. The present invention also relates to a composition for the treatment and/or prevention of these diseases.

**Krill and/or marine extracts for prevention and/or treatment of cardiovascular diseases, arthritis, skin cancer, diabetes, premenstrual syndrome and transdermal transport.**

**BACKGROUND OF THE INVENTION**

Field of the Invention

This invention relates to multi-therapeutic extracts derived from krill and/or marine, which can prevent and/or treat several diseases.

Description of Prior Art

Krill is the common name for small, shrimp-like crustaceans, however not shrimp, that swarm in dense shoals, especially in Antarctic waters. It is one of the most important food source for fish, some kind of birds and especially for baleen whales as being an important source of protein. Krill is also a good source of omega-3 fatty acid, which are well known for their health benefits.

It is known in the art to use krill and/or marine enzymes for the treatment of a great variety of diseases in human and animals such as infections, inflammations, cancers, HIV/AIDS, pain, polyps, warts, hemorrhoids, plaque, wrinkles, thin hairs, allergic itch, anti-adhesion, eye disease, acne, cystic fibrosis and immune disorders including autoimmune disease and cancer.

It is also known in the art that krill and/or marine oil may be used for the treatment of autoimmune murine lupus and other autoimmune diseases and can also be used for treating cardiovascular diseases.

However, the krill and/or marine oil used for these treatments has only conserved its omega-3 fatty acids as active ingredients, which is a very small part of all the active ingredients of the krill and/or marine itself. This fact reduces the potential of the krill and/or marine oil as a treatment for these diseases.

There is an increasing demand for treatments using products derived from a natural source, therefore, it would be highly desirable to be provided with a krill and/or marine extract having an enhanced potential for prevention and/or treatment and/or management of disease.

### **SUMMARY OF THE INVENTION**

In accordance with the present invention there is provided a method of prevention, therapy and/or treatment of several disease, the method comprising the administration of a therapeutically effective amount of krill and/or marine oil to a patient.

In a preferred embodiment of the present invention the krill and/or marine oil is obtained from a process comprising the steps of:

(a) placing krill and/or marine material in a ketone solvent, preferably acetone to achieve extraction of the soluble lipid fraction from the marine and/or aquatic animal material;

(b) separating the liquid and solid contents;

(c) recovering a first lipid rich fraction from the liquid contents by evaporation of the solvent present in the liquid contents;

(d) placing the solid contents in an organic solvent selected from the group of solvents consisting of alcohol, preferably ethanol, isopropanol or t-butanol and esters of acetic acid, preferably ethyl acetate to achieve extraction of the remaining soluble lipid fraction from the marine and/or aquatic material;

(e) separating the liquid and solid contents;

(f) recovering a second lipid rich fraction by evaporation of the solvent from the liquid contents; and

(g) recovering the solid contents.

In a preferred embodiment of the present invention, the krill and/or marine oil comprises Eicosapentanoic acid, Docosahexanoic acid, Phosphatidylcholine, Phosphatidylinositol, Phosphatidylserine, Phosphatidylethanolamine, Sphingomyelin, a-tocopherol, all-trans retinol, Astaxanthin and flavonoid.

In another embodiment of the present invention, the krill and/or marine oil comprises Eicosapentanoic acid, Docosahexanoic acid, Linolenic acid, Alpha-linolenic acid, Linoleic acid, Arachidonic acid, Oleic



acid, palmitic acid, palmitoleic acid, stearic acid, nervonic acid, Phosphatidylcholine, Phosphatidylinositol, Phosphatidylserine, Phosphatidylethanolamine, Sphingomyelin, Cholesterol, Triglycerides, Monoglycerides,  $\alpha$ -tocopherol, all-trans retinol, Astaxanthin, Canthaxanthin,  $\beta$ -carotene, flavonoid, Zinc, Selenium, sodium, potassium and calcium.

In another embodiment of the present invention, the krill and/or marine oil comprises Eicosapentanoic acid, Docosahexanoic acid, Linolenic acid, Alpha-linolenic acid, Linoleic acid, Arachidonic acid, Oleic acid, palmitic acid, palmitoleic acid, stearic acid, Phosphatidylcholine, Phosphatidylinositol, Phosphatidylserine, Phosphatidylethanolamine, Sphingomyelin, Cholesterol, Triglycerides, Monoglycerides,  $\alpha$ -tocopherol, all-trans retinol, Astaxanthin, Canthaxanthin,  $\beta$ -carotene, Zinc and Selenium.

The diseases that can be treated and/or prevented by the method of the present invention are cardiovascular diseases, arthritis, skin cancer, diabetes, premenstrual syndrome and transdermal transport enhancement.

In accordance with the present invention there is also provided a composition for the treatment and/or prevention and/or therapy of the previously mentioned diseases, the composition comprising a therapeutically effective amount of krill and/or marine oil in association with a pharmaceutically acceptable carrier.

In accordance with the present invention, it is further provided the use of krill and/or marine oil for the treatment and/or prevention and/or therapy of the previously mentioned diseases.

In accordance with the present invention, it is also provided the use of krill and/or marine oil for the manufacture of a medicament for the treatment and/or prevention and/or therapy of the previously mentioned diseases.

### DETAILED DESCRIPTION OF THE INVENTION

In accordance with the present invention, there is provided krill and/or marine extract for prevention and/or treatment and/or therapy of several diseases.

A multi-therapeutic oil extract free of enzyme is derived from krill and/or marine, found in any marine environment around the world, for example, the Antarctic ocean (*euphasia superba*), the Pacific ocean (*euphasia pacifica*), the Atlantic ocean, the Indian ocean, in particular coastal regions of Mauritius Island and/or Reunion Island of Madagascar, Canadian West Coast, Japanese Coast, St-Lawrence Gulf and Fundy Bay, and this oil extract is a free fatty acid lipid fraction.

The extraction process can be described as the following:

(a) Placing marine and/or aquatic krill and/or marine in a ketone solvent, preferably acetone, to achieve the extraction of grease from the krill and/or marine;

(b) Separating the liquid and the solid phases;

(c) Recovering a lipid rich fraction from the liquid phase obtained at step (b) by evaporation of the solvent present in the liquid phase;

(d) Placing the solid phase in an organic solvent, which can be alcohol, preferably ethanol, isopropanol or t-butanol, or esters of acetic acid, preferably ethyl acetate. This in order to extract the remaining soluble lipid fraction from the solid phase;

(e) Separating the liquid and the solid phases; and

(f) Recovering a lipid rich fraction from the liquid phase obtained at step (e) by evaporation of the solvent present in the liquid phase.

The active components of the enzyme-free krill and/or marine oil extract are:

#### **lipids**

i) Omega-3:

i. Eicosapentanoic acid: >8g/100g

ii. Docosahexanoic acid: >2g/100g

iii. Linolenic acid: >0.10g/100g

iv. Alpha-linolenic acid: >0.3g/100g

In the preferred embodiment of the present invention, the Omega-3 are found in more than 30g/100g.

ii) Omega-6: i. Linoleic acid: >0.9g/100g

ii. Arachidonic acid: <0.45g/100g, preferably < 0.6g/100g

iii) Omega-9: i. Oleic acid: >5g/100g

iv) palmitic acid: >10g/100g

v) palmitoleic acid: 0.08g/100g

vi) stearic acid: > 0.5g/100g

#### **Phospholipids**

Phosphatidylcholine: >4.5g/100g

Phosphatidylinositol: >107mg/100g

Phosphatidylserine: >75 mg/100g

Phosphatidylethanolamine: >0.5g/100g

Sphingomyelin: >107mg/100g

#### **Neutral lipids**

Cholesterol: <3g/100g

Triglycerides: <55g/100g

Monoglycerides: >0.5g/100g

In another embodiment of the present invention, the neutral lipids of the krill and/or marine extract also comprises:

Diglycerides: >0.5g/100g

#### **Antioxydants**

$\alpha$ -tocopherol (vitamin E): >1.0 IU/100g

all-trans retinol (vitamin A): >1500 IU/100g

$\beta$ -carotene: > 3000  $\mu$ g/100 ml

**Pigments**

Astaxanthin: >20 mg/100g

Canthaxanthin: > 2 mg/100g

**Metals**

Zinc: >0.1 mg/100g

Selenium: >0.1 mg/100g

In another embodiment of the present invention, the krill and/or marine extract also comprises:

Flavonoids: >0.5mg/100g

Sodium: < 500mg/100g

Calcium: >0.1mg/100g

Potassium: > 50mg/100g

Aluminum: < 8.5mg/100g

Protein: > 4g/100g

Moisture and volatile matter: <0.8%

After characterization of the krill and/or marine oil extract, it was determined that the extract contains less than 25 ppm of solvent residue from the extraction process.

The oil has the following stability indexes:

Peroxide value: < 0.1(mEq/kg)

Oil Stability index: < 0.1 after 50 hours at 97.8°C

Saponification index: 70-180

Iodine value:60-130%

The present invention will be more readily understood by referring to the following examples which are given to illustrate the invention rather than to limit its scope.

### Example 1

#### **Cardiovascular disease prevention and/or treatment**

Krill and/or marine oil has been shown to decrease cholesterol *in vivo*. It also inhibits platelet adhesion and plaque formation and reduces vascular endothelial inflammation in a patient. It can offer hypertension prophylaxis. It prevents oxidation of low-density lipoprotein. It may have an inhibitory effect on the secretion of VLDL due to increased intracellular degradation of apo B-100. It also offers a post-myocardial infarction prophylaxis because of its ability to decrease CIII apolipoprotein B, to decrease CIII non-apolipoprotein B lipoproteins and to increase antithrombin III levels. Krill and/or marine oil is suitable for prophylactic usage against cardiovascular disease in human where cardiovascular disease relates to coronary artery disease, hyperlipidemia, hypertension, ischemic disease (relating to angina, myocardial infarction, cerebral ischemia, shock without clinical or laboratory evidence of ischemia, arrhythmia)

To evaluate the effects of krill and/or marine oil on the course of arteriosclerotic coronary artery disease and hyperlipidemia, a study was performed (prospective clinical trial, statistical significance  $p < 0.05$ ) with patients with known hyperlipidemia.

A group of 13 patients took krill and/or marine oil concentrate gelules. Both fish oil and krill and/or marine oil contained equal amounts of omega-3 fatty acids. Recommended dosage is of 1 to 6 capsules per day, each capsule containing 800 mg of oil. In this study, each patient took 6 capsules per day.

The patients were tested for LDL, HDL, Triglycerides, vital signs, CBC, SGOT/SGPT,  $\gamma$ -GT, ALP, Urea, Creatine, Glucose,  $K^+$ ,  $Na^+$ ,  $Ca^{2+}$  and total indirect bilirubin cholesterol before treatment and also at 2 months.

Table 1 is showing the results obtained from the previously described tests:

**Table 1**  
**Paired Samples Test**

Paired Differences								
Parameter tested	Mean	SD.	Std. Error Mean	95% Confidence Interval of the Difference		t-value	df	Sig. (2-tailed)
				Lower	Upper			
Cholesterol	.4954	.55800	.15476	.1582	.8326	3.201	12	.008
Triglycerides	.3538	.54543	.15127	.0242	.6834	2.339	12	.037
HDL	-.2108	.29859	.08281	-.3912	-.0303	-2.545	12	.026
LDL	.2846	.47333	.13128	-.0014	.5706	2.168	12	.051
Chol / HDL	.3600	.53446	.14823	.0370	.6830	2.429	12	.032

From the above, it was shown that a daily uptake of 1 to 4.8 g of krill extract was providing to the patients a cholesterol decrease in the range of 15%, a triglycerides decrease in the range of 15%, a HDL increase in the range of 8%, a LDL decrease in the range of 13% and a Cholesterol/HDL ratio decrease of 14%.

This shows that an uptake of krill extract has a beneficial effect on patient suffering from hyperlipidemia, which is known to be the primary causative factor of atherosclerosis.

### **Example 2** **Arthritis treatment**

Krill and/or marine oil offers symptomatic relief for Arthritis where arthritis relates to adult arthritis, Still's disease, polyarticular or pauciarticular juvenile rheumatoid arthritis, rheumatoid arthritis, osteoarthritis because it has been shown that it provides a clinical improvement in decreasing the number of tender joints and of analgesics consumed daily by decreasing the production of Interleukin-8 and Interleukin-1 in human patients. Patients with a bleeding tendency or severe psychiatric disease were excluded from the study.

To evaluate the effects of krill and/or marine oil supplementation on the clinical course of osteoarthritis, a study was performed (prospective clinical trial, statistical significance  $p < 0.05$ ) with patients diagnosed with and treated for osteoarthritis which is Active class I, II or III and having

treatment with NSAIDs and/or analgesics for at least 3 months before enrollment.

A group of 13 patients took krill and/or marine oil concentrate capsules at a daily rate of 6 capsules of 800mg krill oil per capsule. The recommended dosage varies between 1 and 4.8 grams of pure krill extract per day. Patients were asked to follow a normal healthy diet consisting of 20% fat (less than 10% animal fat), 40% protein and 40% carbohydrates.

The inclusion criteria for the study are being aged between 50 and 65 years, both genders being admissible, having a clinical diagnosis of primary osteoarthritis (mild to moderate) 6 to 12 months prior to study enrollment including pain and stiffness, radiographic confirmation of illness prior to enrollment. It also include evidence of measurable symptoms of OA for at least 3 months prior to study enrollment requiring the use of acetaminophen, anti-inflammatory agents or opioid analgesics. Patients were asked to stop the use of all "pain-killers" the week prior to initiation of the trial for wash-out purposes.

The Exclusion criteria were a severe osteoarthritis, unavoidable sustained use of NSAID's, aspirin or other medicines for anti-inflammatory use, use of topical analgesics within 4 weeks of randomization visit, steroid injection into either knee within past 3 months, initiation of physical therapy or muscle conditioning within 3 months, seafood allergies, use of anticoagulants or salicylates, alcohol consumption exceeding 3 mixed drinks per day, concurrent medical/arthritis disease that could confound or interfere with the evaluation of pain, prior surgery (including arthroscopy) of either knee, a known "secondary" cause of osteoarthritis.

Evaluation was based on daily dose of NSAIDs and/or analgesics and/or SAARDs, number of painful joints, number or swollen joints, duration of morning stiffness, visual analog scale (0-100) WOMACscale and SF36. Preliminary results have been obtained after 2 months. The number of NSAIDs and/or analgesics and/or SAARDs required for daily functioning has been recorded at initiation and at 2 months after initiation.

Results shown at Table 2 demonstrate the effect of an uptake of krill extract on the relief of arthritis.

**Table 2**

	Frequency	%	Valid %	Cumulative %
<b>No change</b>	3	23.1	23.1	23.1
<b>Pain relief</b>	10	76.9	76.9	100.0
<b>Total</b>	13	100.0	100.0	

This shows that ten out of 13 (76.9%) people reported a significant pain relief and improvement of flexibility of large joints (lower back, knees, shoulders)

**Example 3****Skin Cancer Prophylaxis**

Krill and/or marine oil has been shown to be a skin cancer prophylactic because of its retinol anti-carcinogenic effect, Astaxanthin anti-carcinogenic effect and its phopholipid anti-carcinogenic effect.

To evaluate the photoprotective potential of krill and/or marine oil against UVB-induced skin cancer, a study was performed on nude mice, preferably on C57BL6 Nude Congenic Mice - B6NU-T (heterozygotes) because of their proven susceptibility to skin cancer.

Groups were formed as follows: 48 fish oil: 16 with oral supplementation (po) 16 with local application, 16 with po and local application; 48 krill and/or marine oil: 16 with po, 16 with local application, 16 with po and local application. In order to establish efficacy of krill and/or marine oil for the prevention of skin cancer, the test was conducted as a randomized blind controlled trial (statistical significance  $p < 0.05$ ). Half of the mice have been treated orally or topically or both with oil containing 100% by weight krill and/or marine oil and the other half have been treated the same way with fish oil.

Nutrition was fat-free chow for the first week and was modified accordingly with the assigned group as described below for the following 2-20 weeks in the quantity of 1 ml of oil per day.

The mice were divided in six groups as follows:

Group A: fat-free chow with supplementation of fish oil (20% of total calories)



Group B: fat-free chow (100% of calories) + local application of fish oil 2 times per day

Group C: fat free chow with supplementation of fish oil (20% of total calories) + local application of soy oil 2 times per day

Group D: fat-free chow with supplementation of krill and/or marine oil (20% of total calories)

Group E: fat free chow (100% of calories) + local application of krill and/or marine oil 2 times per day

Group F: fat-free chow with supplementation or krill and/or marine oil (20% of total calories) + local application of krill and/or marine oil 2 times per day

The mice had been submitted to UVB radiation using a fluorescent test lamp, emission spectrum 270-400 nm during weeks 2-20. The assay were performed during 30 minutes of UVB exposure per day and the test lamp was at a distance of 30 cm from the mice. At the end of the 20 weeks, or when malignant tumors had formed, mice were anesthetized with ether and sacrificed. Skin was examined blind by pathologists for signs of carcinogenesis.

The following tables (Tables 3-8) are showing the results obtained about the incidence of cancer when ultra-violet radiations are administered to mice's skin during 5 weeks.

**Table 3**  
**Krill extract Oral uptake**

		Frequency	Percent	Valid Percent	Cumulative Percent
Valid	Benign	14	87.5	87.5	87.5
	Cancer	2	12.5	12.5	100.0
	Total	16	100.0	100.0	

**Table 4**

**Control Oral uptake**

		Frequency	Percent	Valid Percent	Cumulative Percent
Valid	Benign	14	87.5	87.5	87.5
	Cancer	2	12.5	12.5	100.0
	Total	16	100.0	100.0	

**Table 5**

**Krill extract topical uptake**

		Frequency	Percent	Valid Percent	Cumulative Percent
Valid	BENIGN	16	100.0	100.0	100.0

**Table 6**

**Control topical uptake**

		Frequency	Percent	Valid Percent	Cumulative Percent
Valid	BENIGN	5	31.3	31.3	31.3
	Cancer	11	68.8	68.8	100.0
	Total	16	100.0	100.0	

**Table 7**

**Krill extract topical and oral uptake**

		Frequency	Percent	Valid Percent	Cumulative Percent
Valid	BENIGN	16	100.0	100.0	100.0

**Table 8****Control topical and oral uptake**

		Frequency	Percent	Valid Percent	Cumulative Percent
Valid	BENIGN	10	62.5	62.5	62.5
	Cancer	6	37.5	37.5	100.0
	Total	16	100.0	100.0	

The results obtained shows that both oral and topical use of krill oil is effective for the protection of the skin against the harmful effects fo UVB radiation induced skin cancer.

**Example 4****Transdermal transport in therapeutic applications**

Krill and/or marine oil enhances transdermal transportation as a substrate for dermatological topical therapeutic applications. It may be used in dermatological treatments via creams, ointments, gels, lotions and oils. It may also be used in various therapeutic applications such as relating to anesthetic, corticosteroids, anti-inflammatory, antibiotic and ketolytic functions.

To evaluate the efficacy of krill and/or marine oil as a substrate for topical treatments and the speed of transdermal absorption of krill and/or marine alone or as a substrate, a study was performed as a randomized blind controlled trial on C57BL6 nude Congenic Mice - B6NU-T (heterozygotes).

The results appearing in tables 5 and 6 are showing that topical treatment with krill oil faciliate the absorption of retinol and other antioxydants through the dermis which in turn result in significant photoprotective potential which in turn results in 100% protection from UVB induced skin cancer. In contrast, fish oil application with all-trans retinol resulted in 68.8% incidence of cancer.

**Example 5**

**Transdermal Transport for dermatological topical cosmetic applications**

Krill and/or marine oil can be used to enhance transdermal transportation as a substrate for dermatological topical cosmetic applications where cosmetic applications relate to skin hydration, anti-wrinkle, keratolytics, peeling and mask via creams, ointments, gels, lotions or oils.

To evaluate the effects of Krill and/or marine oil in aging and facial wrinkles, a study was conducted as a prospective clinical trial on patients concerned about facial dryness and wrinkles. Those patients had no prognosis severely limited by other dermatological or non-dermatological condition, bleeding tendency or severe psychiatric disease.

13 Healthy caucasian women with facial dryness or wrinkles have been included in this study. Women have been asked to take 6 capsules a day, each capsule containing 800 mg of krill extract. The recommended daily dosage is of about 1 to 4.8 g of krill extract.

Table 9 shows results obtained on skin hydration following the method previously described.

**Table 9**  
**Changes in skin hydration**

	Frequency	%	Valid %	Cumulative %
<b>No change</b>	4	30.8	30.8	30.8
<b>Hydration</b>	9	69.2	69.2	100.0
<b>Total</b>	13	100.0	100.0	

The results of the pilot study after 2 months indicate that nine out of 13 (69.2%) people reported a significant improvement of the hydration, texture and elasticity of the skin (face, hands and arms) in human patients.

Moreover, these results are also indicative that krill extract is useful for anti-wrinkle treatment. The mechanism of all-trans retinol, which is included in the krill oil, as an anti-wrinkle works as follows:

- Regeneration and distinctive anti-inflammatory effects
- Improve blood irrigation
- Increases the epidermis regeneration by increasing the rate of cell division and turnover
- Accelerates the differentiation of keratin
- Regenerates the collagen
- Allows cells in the top layer of the skin, which are always being replaced, to mature more normally than untreated sun-damaged cells
- Reduces the activation of enzymes that break down the proteins collagen and elastin that provide structural support for the skin.

The results obtained with krill extract administered on a patient's skin show that the krill extract is having an anti-wrinkle effect by increasing the hydration and the mechanism above described.

#### **Example 6**

#### **Premenstrual syndrome**

Table 10 shows results obtained from the use of krill oil to reduce the pain and mood changes associated with premenstrual syndrome in women. Krill oil extract was administered to 7 women during 2 months. The women were taking 6 capsules of krill extract per day, each capsule containing 800 mg of krill oil. A recommended daily intake of krill oil is of about 1 to 4.8 grams. All participants were advised to continue with their usual nutrition habits and to refrain from initiating any restrictions in their diet. No serious side effects were reported.

All women enrolled reported noticeable emotional and/or physical discomfort 7 to 10 days prior to menstruation. A self-assessment visual analogue scale validated for the assessment of the premenstrual syndrome, ranging from 0 (no symptoms) to 10 (unbearable) was used as a primary outcome in order to evaluate the effect of krill extract on premenstrual discomfort.

Data analysis has been reported on 60% of the women participating in the study who have completed a two months regimen. The

majority of the women (73.3%) showed a clinically significant reduction in both emotional and physical distress prior to menstruation (see Table 10).

**Table 10**

**Frequency distribution of the effect of krill extract on premenstrual syndrome symptomatology**

PMS symptoms	Frequency %	Valid %	Cumulative %
No change	26.7	26.7	26.7
Positive	73.3	73.3	100.0
Total	100.0	100.0	

**Example 7**

**Diabetes**

8 human patients were taking krill extract at the dosage of 6 capsules a day, each capsule containing 800 mg of krill extract, during 2 months. A recommended daily intake of krill oil is of about 1 to 4.8 grams. The Table 11 is showing the variation in the glucose tested for the patients after 2 months.

**Table 11**

**Variation in glucose in patients**

Paired Differences							
Parameter tested	Mean	SD.	Std. Error Mean	95% Confidence Interval of the Difference	t-value	df	Sig. (2-tailed)
Glucose	.5778	.60369	.20123	.1137 - 1.0418	2.871	8	.021

A blood glucose decrease of 20% was obtained for the patients taking krill extract, which shows that an uptake of krill extract is controlling blood glucose content and therefore controlling diabetes in human patients.

While the invention has been described in connection with specific embodiments thereof, it will be understood that it is capable of further modifications and this application is intended to cover any variations, uses, or adaptations of the invention following, in general, the principles of the invention and including such departures from the present disclosure as come within known or customary practice within the art to which the invention pertains and as may be applied to the essential features hereinbefore set forth, and as follows in the scope of the appended claims.

**WHAT IS CLAIMED IS:**

1. A composition for decreasing cholesterol in a patient comprising an effective amount of krill and/or marine oil in association with a pharmaceutically acceptable carrier, wherein said krill and/or marine oil is obtained from a process comprising the steps of:

a) placing krill and/or marine material in a ketone solvent, preferably acetone to achieve extraction of the soluble lipid fraction from said marine and/or aquatic animal material;

b) separating the liquid and solid contents;

c) recovering a first lipid rich fraction from the liquid contents by evaporation of the solvent present in the liquid contents;

d) placing said solid contents in an organic solvent selected from the group of solvents consisting of alcohol, preferably ethanol, isopropanol or t-butanol and esters of acetic acid, preferably ethyl acetate to achieve extraction of the remaining soluble lipid fraction from said marine and/or aquatic animal material;

e) separating the liquid and solid contents;

f) recovering a second lipid rich fraction by evaporation of the solvent from the liquid contents; and

g) recovering the solid contents.

2. A composition for decreasing cholesterol in a patient comprising an effective amount of krill and/or marine oil in association with a pharmaceutically acceptable carrier, wherein said krill and/or marine oil comprises Eicosapentanoic acid, Docosahexanoic acid, Phosphatidylcholine, Phosphatidylinositol, Phosphatidylserine, Phosphatidylethanolamine, Sphingomyelin,  $\alpha$ -tocopherol, Astaxanthin, and flavonoid.

3. The composition of claim 2, further comprising at least one of the group consisting of Linoleic acid, Alpha-linoleic acid, arachidonic acid, oleic acid, palmitic acid, palmitoleic acid, stearic acid, cholesterol,



triglycerides, monoglycerides, all-trans retinol, canthaxanthin,  $\beta$ -carotene, zinc, selenium, nervonic acid, sodium, potassium and calcium.

4. A method of decreasing cholesterol in a patient, said method comprising administering an effective amount of the composition of any one of claims 1-3 to said patient.

5. The method of claim 4, wherein said administering is effected orally.

6. The method of claim 4, wherein said krill and/or marine extract is administered in a quantity in a range of 1 to 4.8 grams per day.

7. The method of claim 6, wherein said quantity is 4.8 grams.

8. Use of the composition of any one of claims 1-3 for decreasing cholesterol in a patient.

9. Use of the composition of any one of claims 1-3 for the production of a medicament for decreasing cholesterol in a patient.

10. A composition for inhibiting platelet adhesion and plaque formation in arteries of a patient comprising an effective amount of krill and/or marine oil in association with a pharmaceutically acceptable carrier, wherein said krill and/or marine oil is obtained from a process comprising the steps of:

a) placing krill and/or marine material in a ketone solvent, preferably acetone to achieve extraction of the soluble lipid fraction from said marine and/or aquatic animal material;

b) separating the liquid and solid contents;

c) recovering a first lipid rich fraction from the liquid contents by evaporation of the solvent present in the liquid contents;

d) placing said solid contents in an organic solvent selected from the group of solvents consisting of alcohol, preferably ethanol, isopropanol or t-butanol and esters of acetic acid, preferably ethyl acetate to achieve extraction of the remaining soluble lipid fraction from said marine and/or aquatic animal material;

e) separating the liquid and solid contents;

f) recovering a second lipid rich fraction by evaporation of the solvent from the liquid contents; and

g) recovering the solid contents.

11. A composition for inhibiting platelet adhesion and plaque formation in arteries of a patient comprising an effective amount of krill and/or marine oil in association with a pharmaceutically acceptable carrier, wherein said krill and/or marine oil comprises Eicosapentanoic acid, Docosahexanoic acid, Phosphatidylcholine, Phosphatidylinositol, Phosphatidylserine, Phosphatidylethanolamine, Sphingomyelin,  $\alpha$ -tocopherol, Astaxanthin, and flavonoid.

12. The composition of claim 11, further comprising at least one of the group consisting of Linoleic acid, Alpha-linoleic acid, arachidonic acid, oleic acid, palmitic acid, palmitoleic acid, stearic acid, cholesterol, triglycerides, monoglycerides, all-trans retinol, canthaxanthin,  $\beta$ -carotene, zinc, selenium, nervonic acid, sodium, potassium and calcium.

13. A method of inhibiting platelet adhesion and plaque formation in arteries of a patient, said method comprising administering an effective amount of the composition of any one of claims 11-12 to said patient.

14. The method of claim 13, wherein said administering is effected orally.

15. The method of claim 13, wherein said krill and/or marine extract is administered in a quantity in a range of 1 to 4.8 grams per day.

16. The method of claim 15, wherein said quantity is 4.8 grams.

17. Use of the composition of any one of claims 11-13 for inhibiting platelet adhesion and plaque formation in arteries of a patient.

18. Use of the composition of any one of claims 11-13 for the production of a medicament for inhibiting platelet adhesion and plaque formation in arteries of a patient.

19. A prophylactic composition for preventing hypertension in a patient comprising a prophylactic effective amount of krill and/or marine oil in association with a pharmaceutically acceptable carrier, wherein said krill and/or marine oil is obtained from a process comprising the steps of:

a) placing krill and/or marine material in a ketone solvent, preferably acetone to achieve extraction of the soluble lipid fraction from said marine and/or aquatic animal material;

b) separating the liquid and solid contents;

c) recovering a first lipid rich fraction from the liquid contents by evaporation of the solvent present in the liquid contents;

d) placing said solid contents in an organic solvent selected from the group of solvents consisting of alcohol, preferably ethanol, isopropanol or t-butanol and esters of acetic acid, preferably ethyl acetate to achieve extraction of the remaining soluble lipid fraction from said marine and/or aquatic animal material;

e) separating the liquid and solid contents;

f) recovering a second lipid rich fraction by evaporation of the solvent from the liquid contents; and

g) recovering the solid contents.

20. A prophylactic composition for prevention of hypertension in a patient comprising a prophylactic effective amount of krill and/or marine oil in association with a pharmaceutically acceptable carrier, wherein said krill and/or marine oil comprises Eicosapentanoic acid, Docosahexanoic acid, Phosphatidylcholine, Phosphatidylinositol, Phosphatidylserine, Phosphatidylethanolamine, Sphingomyelin,  $\alpha$ -tocopherol, Astaxanthin, and flavonoid.

21. The composition of claim 20, further comprising at least one of the group consisting of Linoleic acid, Alpha-linoleic acid, arachidonic acid, oleic acid, palmitic acid, palmitoleic acid, stearic acid, cholesterol, triglycerides, monoglycerides, all-trans retinol, canthaxanthin,  $\beta$ -carotene, zinc, selenium, nervonic acid, sodium, potassium and calcium.

22. A method of preventing hypertension in a patient, said method comprising administering a prophylactic effective amount of the composition of any one of claims 19-21 to said patient.

23. The method of claim 22, wherein said administering is effected orally.

24. The method of claim 22, wherein said krill and/or marine extract is administered in a quantity in a range of 1 to 4.8 grams per day.
25. The method of claim 24, wherein said quantity is 4.8 grams.
26. Use of the composition of any one of claims 19-21 for preventing hypertension in a patient.
27. Use of the composition of any one of claims 19-21 for the production of a medicament for preventing hypertension in a patient.
28. A therapeutical composition for symptomatic controlling or treating arthritis comprising a therapeutically effective amount of krill and/or marine oil in association with a pharmaceutically acceptable carrier, wherein said krill and/or marine oil is obtained from a process comprising the steps of:
- a) placing krill and/or marine material in a ketone solvent, preferably acetone to achieve extraction of the soluble lipid fraction from said marine and/or aquatic animal material;
  - b) separating the liquid and solid contents;
  - c) recovering a first lipid rich fraction from the liquid contents by evaporation of the solvent present in the liquid contents;
  - d) placing said solid contents in an organic solvent selected from the group of solvents consisting of alcohol, preferably ethanol, isopropanol or t-butanol and esters of acetic acid, preferably ethyl acetate to achieve extraction of the remaining soluble lipid fraction from said marine and/or aquatic animal material;
  - e) separating the liquid and solid contents;
  - f) recovering a second lipid rich fraction by evaporation of the solvent from the liquid contents; and
  - g) recovering the solid contents.
29. The composition of claim 28, wherein said arthritis is selected from the group consisting of rheumatoid arthritis and osteoarthritis.
30. A therapeutical composition for symptomatic controlling or treating arthritis comprising a therapeutically effective amount of krill and/or

marine oil in association with a pharmaceutically acceptable carrier, wherein said krill and/or marine oil comprises Eicosapentanoic acid, Docosahexanoic acid, Phosphatidylcholine, Phosphatidylinositol, Phosphatidylserine, Phosphatidylethanolamine, Sphingomyelin,  $\alpha$ -tocopherol, Astaxanthin, and flavonoid.

31. The composition of claim 30, further comprising at least one of the group consisting of Linoleic acid, Alpha-linoleic acid, arachidonic acid, oleic acid, palmitic acid, palmitoleic acid, stearic acid, cholesterol, triglycerides, monoglycerides, all-trans retinol, canthaxanthin,  $\beta$ -carotene, zinc, selenium, nervonic acid, sodium, potassium and calcium.

32. The composition of claim 30, wherein said arthritis is selected from the group consisting of rheumatoid arthritis and osteoarthritis.

33. A method for symptomatic controlling or treating arthritis in a patient, said method comprising administering a therapeutically effective amount of the composition of any one of claims 29-32 to said patient.

34. The method of claim 33, wherein said administering is effected orally.

35. The method of claim 33, wherein said krill and/or marine extract is administered in a quantity in a range of 1 to 4.8 grams per day.

36. The method of claim 35, wherein said quantity is 4.8 grams.

37. Use of the composition of any one of claims 29-32 for symptomatic controlling or treating rheumatoid arthritis in a patient.

38. Use of the composition of any one of claims 29-32 for the production of a medicament for symptomatic controlling or treating rheumatoid arthritis in a patient.

39. A prophylactic composition for prevention of skin cancer in a patient comprising a prophylactic effective amount of krill and/or marine oil in association with a pharmaceutically acceptable carrier, wherein said krill and/or marine oil is obtained from a process comprising the steps of:

a) placing krill and/or marine material in a ketone solvent, preferably acetone to achieve extraction of the soluble lipid fraction from said marine and/or aquatic animal material;

- b) separating the liquid and solid contents;
- c) recovering a first lipid rich fraction from the liquid contents by evaporation of the solvent present in the liquid contents;
- d) placing said solid contents in an organic solvent selected from the group of solvents consisting of alcohol, preferably ethanol, isopropanol or t-butanol and esters of acetic acid, preferably ethyl acetate to achieve extraction of the remaining soluble lipid fraction from said marine and/or aquatic animal material;
- e) separating the liquid and solid contents;
- f) recovering a second lipid rich fraction by evaporation of the solvent from the liquid contents; and
- g) recovering the solid contents.

40. A prophylactic composition for prevention of skin cancer in a patient comprising a prophylactic effective amount of krill and/or marine oil in association with a pharmaceutically acceptable carrier, wherein said krill and/or marine oil comprises Eicosapentanoic acid, Docosahexanoic acid, Phosphatidylcholine, Phosphatidylinositol, Phosphatidylserine, Phosphatidylethanolamine, Sphingomyelin,  $\alpha$ -tocopherol, Astaxanthin, and flavonoid.

41. The composition of claim 40, further comprising at least one of the group consisting of Linoleic acid, Alpha-linoleic acid, arachidonic acid, oleic acid, palmitic acid, palmitoleic acid, stearic acid, cholesterol, triglycerides, monoglycerides, all-trans retinol, canthaxanthin,  $\beta$ -carotene, zinc, selenium, nervonic acid, sodium, potassium and calcium.

42. A method of prevention of skin cancer, said method comprising administering a therapeutically or a prophylactic effective amount of the composition of any one of claims 39-41 to a patient.

43. The method of claim 42, wherein said administering is effected orally.

44. The method of claim 42, wherein said krill and/or marine extract is administered in a quantity in a range of 1 to 4.8 grams per day.

45. The method of claim 44, wherein said quantity is 4.8 grams.

46. Use of the composition of any one of claims 39-41 for preventing skin cancer in a patient.

47. Use of the composition of any one of claims 39-41 for the production of a medicament for preventing skin cancer in a patient.

48. A composition for enhancing transdermal transportation for dermatological topical therapeutic applications in a patient comprising an enhancing effective amount of krill and/or marine oil in association with a pharmaceutically acceptable carrier, wherein said krill and/or marine oil is obtained from a process comprising the steps of:

a) placing krill and/or marine material in a ketone solvent, preferably acetone to achieve extraction of the soluble lipid fraction from said marine and/or aquatic animal material;

b) separating the liquid and solid contents;

c) recovering a first lipid rich fraction from the liquid contents by evaporation of the solvent present in the liquid contents;

d) placing said solid contents in an organic solvent selected from the group of solvents consisting of alcohol, preferably ethanol, isopropanol or t-butanol and esters of acetic acid, preferably ethyl acetate to achieve extraction of the remaining soluble lipid fraction from said marine and/or aquatic animal material;

e) separating the liquid and solid contents;

f) recovering a second lipid rich fraction by evaporation of the solvent from the liquid contents; and

g) recovering the solid contents.

49. A composition for enhancing transdermal transportation for dermatological topical therapeutic applications in a patient comprising an enhancing effective amount of krill and/or marine oil in association with a pharmaceutically acceptable carrier, wherein said krill and/or marine oil comprises Eicosapentanoic acid, Docosahexanoic acid, Phosphatidylcholine, Phosphatidylinositol, Phosphatidylserine,

Phosphatidylethanolamine, Sphingomyelin,  $\alpha$ -tocopherol, Astaxanthin, and flavonoid.

50. The composition of claim 49, further comprising at least one of the group consisting of Linoleic acid, Alpha-linoleic acid, arachidonic acid, oleic acid, palmitic acid, palmitoleic acid, stearic acid, cholesterol, triglycerides, monoglycerides, all-trans retinol, canthaxanthin,  $\beta$ -carotene, zinc, selenium, nervonic acid, sodium, potassium and calcium.

51. A method for enhancing transdermal transportation for dermatological topical therapeutic applications in a patient, said method comprising administering an enhancing effective amount of the composition of any one of claims 48-50 to said patient.

52. The method of claim 51, wherein said administering is effected orally and/or topically.

53. The method of claim 51, wherein said krill and/or marine extract is administered in a quantity in a range of 1 to 4.8 grams per day.

54. The method of claim 53, wherein said quantity is 4.8 grams.

55. Use of the composition of any one of claims 48-50 for enhancing transdermal transportation for dermatological topical therapeutic applications in a patient.

56. Use of the composition of any one of claims 48-50 for the production of a medicament for enhancing transdermal transportation for dermatological topical therapeutic applications in a patient.

57. A composition for enhancing transdermal transportation for dermatological cosmetic applications in a patient comprising an enhancing effective amount of krill and/or marine oil in association with a pharmaceutically acceptable carrier, wherein said krill and/or marine oil is obtained from a process comprising the steps of:

a) placing krill and/or marine material in a ketone solvent, preferably acetone to achieve extraction of the soluble lipid fraction from said marine and/or aquatic animal material;

b) separating the liquid and solid contents;



c) recovering a first lipid rich fraction from the liquid contents by evaporation of the solvent present in the liquid contents;

d) placing said solid contents in an organic solvent selected from the group of solvents consisting of alcohol, preferably ethanol, isopropanol or t-butanol and esters of acetic acid, preferably ethyl acetate to achieve extraction of the remaining soluble lipid fraction from said marine and/or aquatic animal material;

e) separating the liquid and solid contents;

f) recovering a second lipid rich fraction by evaporation of the solvent from the liquid contents; and

g) recovering the solid contents.

58. A composition for enhancing transdermal transportation for dermatological cosmetic applications in a patient comprising an enhancing effective amount of krill and/or marine oil in association with a pharmaceutically acceptable carrier, wherein said krill and/or marine oil comprises Eicosapentanoic acid, Docosahexanoic acid, Phosphatidylcholine, Phosphatidylinositol, Phosphatidylserine, Phosphatidylethanolamine, Sphingomyelin,  $\alpha$ -tocopherol, Astaxanthin, and flavonoid.

59. The composition of claim 58, further comprising at least one of the group consisting of Linoleic acid, Alpha-linoleic acid, arachidonic acid, oleic acid, palmitic acid, palmitoleic acid, stearic acid, cholesterol, triglycerides, monoglycerides, all-trans retinol, canthaxanthin,  $\beta$ -carotene, zinc, selenium, nervonic acid, sodium, potassium and calcium.

60. A method for enhancing transdermal transportation for dermatological cosmetic applications, said method comprising administering an enhancing effective amount of the composition of any one of claims 57-59 to a patient.

61. The method of claim 60, wherein said administering is effected orally and/or topically.

62. The method of claim 60, wherein said krill and/or marine extract is administered in a quantity in a range of 1 to 4.8 grams per day.

63. The method of claim 62, wherein said quantity is 4.8 grams.
64. Use of the composition of any one of claims 57-59 for enhancing transdermal transportation for dermatological cosmetic applications in a patient.
65. Use of the composition of any one of claims 57-59 for the production of a medicament for enhancing transdermal transportation for dermatological cosmetic applications in a patient.
66. A composition for reducing premenstrual syndrome's symptoms in a patient comprising an enhancing effective amount of krill and/or marine oil in association with a pharmaceutically acceptable carrier, wherein said krill and/or marine oil is obtained from a process comprising the steps of:
- a) placing krill and/or marine material in a ketone solvent, preferably acetone to achieve extraction of the soluble lipid fraction from said marine and/or aquatic animal material;
  - b) separating the liquid and solid contents;
  - c) recovering a first lipid rich fraction from the liquid contents by evaporation of the solvent present in the liquid contents;
  - d) placing said solid contents in an organic solvent selected from the group of solvents consisting of alcohol, preferably ethanol, isopropanol or t-butanol and esters of acetic acid, preferably ethyl acetate to achieve extraction of the remaining soluble lipid fraction from said marine and/or aquatic animal material;
  - e) separating the liquid and solid contents;
  - f) recovering a second lipid rich fraction by evaporation of the solvent from the liquid contents; and
  - g) recovering the solid contents.
67. A composition for reducing premenstrual syndrome's symptoms in a patient comprising an enhancing effective amount of krill and/or marine oil in association with a pharmaceutically acceptable carrier, wherein said krill and/or marine oil comprises Eicosapentanoic acid, Docosahexanoic acid, Phosphatidylcholine, Phosphatidylinositol,

Phosphatidylserine, Phosphatidylethanolamine, Sphingomyelin,  $\alpha$ -tocopherol, Astaxanthin, and flavonoid.

68. The composition of claim 67, further comprising at least one of the group consisting of Linoleic acid, Alpha-linoleic acid, arachidonic acid, oleic acid, palmitic acid, palmitoleic acid, stearic acid, cholesterol, triglycerides, monoglycerides, all-trans retinol, canthaxanthin,  $\beta$ -carotene, zinc, selenium, nervonic acid, sodium, potassium and calcium.

69. A method for reducing premenstrual syndrome's symptoms in a patient, said method comprising administering an enhancing effective amount of the composition of any one of claims 66-68 to said patient.

70. The method of claim 69, wherein said administering is effected orally.

71. The method of claim 69, wherein said krill and/or marine extract is administered in a quantity in a range of 1 to 4.8 grams per day.

72. The method of claim 71, wherein said quantity is 4.8 grams.

73. Use of the composition of any one of claims 66-68 for reducing premenstrual syndrome's symptoms in a patient.

74. Use of the composition of any one of claims 66-68 for the production of a medicament for reducing premenstrual syndrome's symptoms in a patient.

75. A composition for controlling blood glucose level in a patient comprising an enhancing effective amount of krill and/or marine oil in association with a pharmaceutically acceptable carrier, wherein said krill and/or marine oil is obtained from a process comprising the steps of:

a) placing krill and/or marine material in a ketone solvent, preferably acetone to achieve extraction of the soluble lipid fraction from said marine and/or aquatic animal material;

b) separating the liquid and solid contents;

c) recovering a first lipid rich fraction from the liquid contents by evaporation of the solvent present in the liquid contents;

d) placing said solid contents in an organic solvent selected from the group of solvents consisting of alcohol, preferably ethanol, isopropanol or t-butanol and esters of acetic acid, preferably ethyl acetate to achieve extraction of the remaining soluble lipid fraction from said marine and/or aquatic animal material;

e) separating the liquid and solid contents;

f) recovering a second lipid rich fraction by evaporation of the solvent from the liquid contents; and

g) recovering the solid contents.

76. A composition for controlling blood glucose level in a patient comprising an enhancing effective amount of krill and/or marine oil in association with a pharmaceutically acceptable carrier, wherein said krill and/or marine oil comprises Eicosapentanoic acid, Docosahexanoic acid, Phosphatidylcholine, Phosphatidylinositol, Phosphatidylserine, Phosphatidylethanolamine, Sphingomyelin,  $\alpha$ -tocopherol, Astaxanthin, and flavonoid.

77. The composition of claim 76, further comprising at least one of the group consisting of Linoleic acid, Alpha-linoleic acid, arachidonic acid, oleic acid, palmitic acid, palmitoleic acid, stearic acid, cholesterol, triglycerides, monoglycerides, all-trans retinol, canthaxanthin,  $\beta$ -carotene, zinc, selenium, nervonic acid, sodium, potassium and calcium.

78. A method for controlling blood glucose level in a patient, said method comprising administering an enhancing effective amount of the composition of any one of claims 75-77 to said patient.

79. The method of claim 78, wherein said administering is effected orally.

80. The method of claim 78, wherein said krill and/or marine extract is administered in a quantity in a range of 1 to 4.8 grams per day.

81. The method of claim 80, wherein said quantity is 4.8 grams.

82. Use of the composition of any one of claims 75-77 for controlling blood glucose level in a patient.

83. Use of the composition of any one of claims 75-77 for the production of a medicament for controlling blood glucose level in a patient.

(19) World Intellectual Property Organization  
International Bureau



(43) International Publication Date  
27 December 2002 (27.12.2002)

PCT

(10) International Publication Number  
WO 02/102394 A3

- (51) International Patent Classification<sup>7</sup>: A61K 35/60, 31/23
- (21) International Application Number: PCT/CA02/00843
- (22) International Filing Date: 7 June 2002 (07.06.2002)
- (25) Filing Language: English
- (26) Publication Language: English
- (30) Priority Data: 60/298,383 18 June 2001 (18.06.2001) US
- (71) Applicant (for all designated States except US): NEPTUNE TECHNOLOGIES & BIORESSOURCES INC. [CA/CA]; 500, boulevard St-Martin Ouest, Bureau 500, Laval, Québec H7M 3Y2 (CA).
- (72) Inventor; and
- (75) Inventor/Applicant (for US only): SAMPALIS, Tina [CA/CA]; 1348 Elisabeth Blvd, Laval, Québec H7W 3J8 (CA).
- (74) Agents: OGILVY RENAULT et al.; Suite 1600, 1981 McGill College Avenue, Montreal, Québec H3A 2Y3 (CA).
- (81) Designated States (national): AE, AG, AL, AM, AT, AU, AZ, BA, BB, BG, BR, BY, BZ, CA, CH, CN, CO, CR, CU, CZ, DE, DK, DM, DZ, EC, EE, ES, FI, GB, GD, GE, GH, GM, HR, HU, ID, IL, IN, IS, JP, KE, KG, KP, KR, KZ, LC, LK, LR, LS, LT, LU, LV, MA, MD, MG, MK, MN, MW, MX, MZ, NO, NZ, OM, PH, PL, PT, RO, RU, SD, SE, SG, SI, SK, SL, TJ, TM, TN, TR, TT, TZ, UA, UG, US, UZ, VN, YU, ZA, ZM, ZW.
- (84) Designated States (regional): ARIPO patent (GH, GM, KE, LS, MW, MZ, SD, SL, SZ, TZ, UG, ZM, ZW), Eurasian patent (AM, AZ, BY, KG, KZ, MD, RU, TJ, TM), European patent (AT, BE, CH, CY, DE, DK, ES, FI, FR, GB, GR, IE, IT, LU, MC, NL, PT, SE, TR), OAPI patent (BF, BJ, CF, CG, CI, CM, GA, GN, GQ, GW, ML, MR, NE, SN, TD, TG).
- Published:**  
— with international search report  
— before the expiration of the time limit for amending the claims and to be republished in the event of receipt of amendments
- (88) Date of publication of the international search report: 10 April 2003
- For two-letter codes and other abbreviations, refer to the "Guidance Notes on Codes and Abbreviations" appearing at the beginning of each regular issue of the PCT Gazette.



WO 02/102394 A3

(54) Title: KRILL AND/OR MARINE EXTRACTS FOR PREVENTION AND/OR TREATMENT OF CARDIOVASCULAR DISEASES, ARTHRITIS, SKIN CANCER, DIABETES, PREMENSTRUAL SYNDROME AND TRANSDERMAL TRANSPORT

(57) Abstract: The present invention relates to a method of treatment and/or prevention of cardiovascular disease, rheumatoid arthritis, skin cancer, premenstrual syndrome, diabetes and transdermal transport enhancement. The method comprises the administration of a therapeutically effective amount of krill and/or marine oil to a patient. The present invention also relates to a composition for the treatment and/or prevention of these diseases.

INTERNATIONAL SEARCH REPORT

International Application No

PCT/CA 02/00843

A. CLASSIFICATION OF SUBJECT MATTER  
 IPC 7 A61K35/60 A61K31/23

According to International Patent Classification (IPC) or to both national classification and IPC

B. FIELDS SEARCHED

Minimum documentation searched (classification system followed by classification symbols)  
 IPC 7 A61K

Documentation searched other than minimum documentation to the extent that such documents are included in the fields searched

Electronic data base consulted during the International search (name of data base and, where practical, search terms used)

C. DOCUMENTS CONSIDERED TO BE RELEVANT

Category *	Citation of document, with indication, where appropriate, of the relevant passages	Relevant to claim No.
X	WO 00 23546 A (BEAUDOIN ADRIEN ;UNIV SHERBROOKE (CA); MARTIN GENEVIEVE (CA)) 27 April 2000 (2000-04-27)  page 1, line 12 -page 2, line 10; claim 1 -----	1,4-10, 19,28, 29,32, 39,48, 57,66,75

Further documents are listed in the continuation of box C.

Patent family members are listed in annex.

\* Special categories of cited documents :

- "A" document defining the general state of the art which is not considered to be of particular relevance
- "E" earlier document but published on or after the international filing date
- "L" document which may throw doubts on priority claim(s) or which is cited to establish the publication date of another citation or other special reason (as specified)
- "O" document referring to an oral disclosure, use, exhibition or other means
- "P" document published prior to the international filing date but later than the priority date claimed

- "T" later document published after the international filing date or priority date and not in conflict with the application but cited to understand the principle or theory underlying the invention
- "X" document of particular relevance; the claimed invention cannot be considered novel or cannot be considered to involve an inventive step when the document is taken alone
- "Y" document of particular relevance; the claimed invention cannot be considered to involve an inventive step when the document is combined with one or more other such documents, such combination being obvious to a person skilled in the art.
- "&" document member of the same patent family

Date of the actual completion of the international search

17 September 2002

Date of mailing of the international search report

03.02.03

Name and mailing address of the ISA  
 European Patent Office, P.B. 5818 Patentlaan 2  
 NL - 2280 HV Rijswijk  
 Tel. (+31-70) 340-2040, Tx. 31 651 epo nl,  
 Fax: (+31-70) 340-3016

Authorized officer

REMPROST & Co EXHIBIT 1024 page 1561

# INTERNATIONAL SEARCH REPORT

International application No.  
PCT/CA 02/00843

## Box I Observations where certain claims were found unsearchable (Continuation of item 1 of first sheet)

This International Search Report has not been established in respect of certain claims under Article 17(2)(a) for the following reasons:

1.  Claims Nos.:  
because they relate to subject matter not required to be searched by this Authority, namely:  

Although claims 4-7 are directed to a method of treatment of the human body, the search has been carried out and based on the alleged effects of the composition.
2.  Claims Nos.:  
because they relate to parts of the International Application that do not comply with the prescribed requirements to such an extent that no meaningful International Search can be carried out, specifically:
3.  Claims Nos.:  
because they are dependent claims and are not drafted in accordance with the second and third sentences of Rule 6.4(a).

## Box II Observations where unity of invention is lacking (Continuation of item 2 of first sheet)

This International Searching Authority found multiple inventions in this international application, as follows:

1.  As all required additional search fees were timely paid by the applicant, this International Search Report covers all searchable claims.
2.  As all searchable claims could be searched without effort justifying an additional fee, this Authority did not invite payment of any additional fee.
3.  As only some of the required additional search fees were timely paid by the applicant, this International Search Report covers only those claims for which fees were paid, specifically claims Nos.:
4.  No required additional search fees were timely paid by the applicant. Consequently, this International Search Report is restricted to the invention first mentioned in the claims; it is covered by claims Nos.:  

1, 10, 19, 28, 29, 32, 39, 48, 57, 66, 75 (partly) and 4-9 (partly)

### Remark on Protest

- The additional search fees were accompanied by the applicant's protest.
- No protest accompanied the payment of additional search fees.



INTERNATIONAL SEARCH REPORT  
Information on patent family members

International Application No  
PCT/CA 02/00843

Patent document cited in search report	Publication date	Patent family member(s)	Publication date
WO 0023546 A	27-04-2000	AU 6455299 A	08-05-2000
		BR 9914699 A	10-07-2001
		CN 1324394 T	28-11-2001
		EP 1123368 A	16-08-2001
		JP 2002527604 T	27-08-2002
		NO 20011915 A	21-06-2001
		PL 347396 A	08-04-2002

-----

Hello Amy - Regarding US Patent Application Serial No. 11/156,516 (Duke Reference No. 2304 (IM-Collingsworth); Our Reference No. DUKE 9961), please note that a Restriction Requirement issued on January 9, 2007 requiring a Response by June 9, 2007. The pending claim set and the Restriction Requirement are attached to this email. In the Restriction Requirement, the Examiner restricted the pending claim set into the following 9 groups:

1. Claims 1 to 7, drawn to a method that employs a REEP1 protein;
2. Claims 1 to 7, drawn to a method that employs a RTP1 protein;
3. Claims 1 to 7, drawn to a method that employs a RTP2 protein;
4. Claims 8 to 11, drawn to a cell line comprising heterologous gene encoding a REEP1 protein;
5. Claims 8 to 11, drawn to a cell line comprising heterologous gene encoding a RTP1 protein;
6. Claims 8 to 11, drawn to a cell line comprising heterologous gene encoding a RTP2 protein;
7. Claims 12 to 15, drawn to a method of screening compounds for REEP1;
8. Claims 16 to 20, drawn to a method of screening compounds for RTP1; and
9. Claims 16 to 20, drawn to a method of screening compounds for RTP2;

Moreover, if Group 2, 5, or 8 is chosen, a single species of RTP1 must be selected (e.g., one of RTP1, RTP2, RTP1-A, RTP1-B, RTP1-C, RTP1-D, and RTP1-E, RTP1-A1, RTP1-D1, RTP1-D2, and RTP1-D3). Please let me know if you would like us to contact Dr. Matsunami. Please feel free to contact Dave Casimir or me with any questions or comments. We look forward to hearing from you.

(19) World Intellectual Property Organization  
International Bureau



(43) International Publication Date  
13 February 2003 (13.02.2003)

PCT

(10) International Publication Number  
**WO 03/011873 A2**

- (51) International Patent Classification<sup>7</sup>: C07F 9/02
- (21) International Application Number: PCT/CA02/01185
- (22) International Filing Date: 29 July 2002 (29.07.2002)
- (25) Filing Language: English
- (26) Publication Language: English
- (30) Priority Data:  
60/307,842 27 July 2001 (27.07.2001) US
- (71) Applicant (for all designated States except US): **NEPTUNE TECHNOLOGIES & BIORESSOURCES INC.** [CA/CA]; 500, St-Martin Boulevard West, Suite 550, Laval, Québec H7M 3Y2 (CA).
- (72) Inventor; and
- (75) Inventor/Applicant (for US only): **SAMPALIS, Fotini** [CA/CA]; 1348 Elizabeth Boulevard, Laval, Quebec H7W 3J8 (CA).
- (74) Agents: **SABET, Sohrab** et al.; Smart & Biggar, 1000 de la Gauchetière Ouest, Suite 3400, Montréal, Quebec H3B 4W5 (CA).
- (81) Designated States (national): AE, AG, AL, AM, AT, AU, AZ, BA, BB, BG, BR, BY, BZ, CA, CH, CN, CO, CR, CU, CZ, DE, DK, DM, DZ, EC, EE, ES, FI, GB, GD, GE, GH, GM, HR, HU, ID, IL, IN, IS, JP, KE, KG, KP, KR, KZ, LC, LK, LR, LS, LT, LU, LV, MA, MD, MG, MK, MN, MW, MX, MZ, NO, NZ, OM, PH, PL, PT, RO, RU, SD, SE, SG, SI, SK, SL, TJ, TM, TN, TR, TT, TZ, UA, UG, US, UZ, VN, YU, ZA, ZM, ZW.
- (84) Designated States (regional): ARIPO patent (GH, GM, KE, LS, MW, MZ, SD, SL, SZ, TZ, UG, ZM, ZW), Eurasian patent (AM, AZ, BY, KG, KZ, MD, RU, TJ, TM), European patent (AT, BE, BG, CH, CY, CZ, DE, DK, EE, ES, FI, FR, GB, GR, IE, IT, LU, MC, NL, PT, SE, SK, TR), OAPI patent (BF, BJ, CF, CG, CI, CM, GA, GN, GQ, GW, ML, MR, NE, SN, TD, TG).
- Published: — without international search report and to be republished upon receipt of that report

[Continued on next page]

(54) Title: NATURAL MARINE SOURCE PHOSPHOLIPIDS COMPRISING FLAVONOIDS, POLYUNSATURATED FATTY ACIDS AND THEIR APPLICATIONS

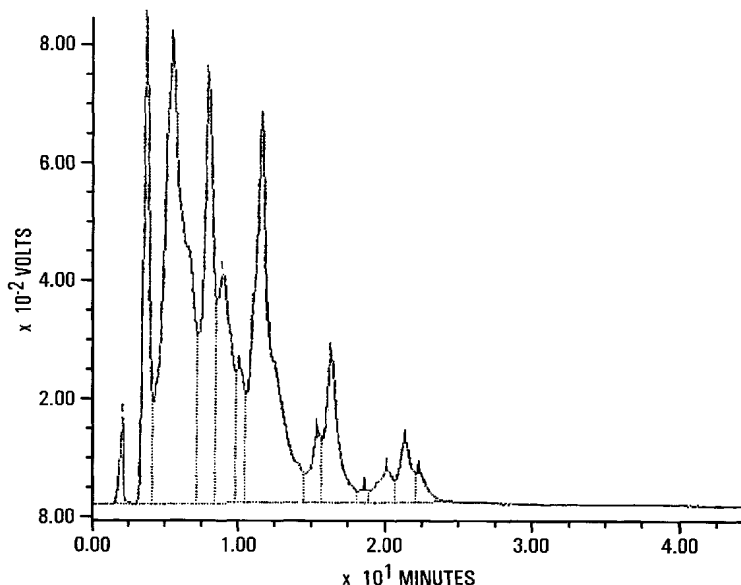

(57) Abstract: A phospholipid extract from a marine or aquatic biomass possesses therapeutic properties. The phospholipid extract comprises a variety of phospholipids, fatty acid, metals and a novel flavonoid.



WO 03/011873 A2



---

*For two-letter codes and other abbreviations, refer to the "Guidance Notes on Codes and Abbreviations" appearing at the beginning of each regular issue of the PCT Gazette.*

- 1 -

NATURAL MARINE SOURCE PHOSPHOLIPIDS COMPRISING FLAVONOIDS,  
POLYUNSATURATED FATTY ACIDS AND THEIR APPLICATIONS

Cross-Reference to Related Application

This application claims the benefit of United States  
5 Provisional Patent Application Serial No. 60/307,842, filed  
July 27, 2001, which is incorporated herein by reference in its  
entirety.

Field of the Invention

The present invention is directed to nutraceutical,  
10 pharmaceutical or cosmetic compositions, particularly to  
phospholipid compositions derived from natural marine or  
aquatic sources.

Background of the Invention

United States Patent No. 5,434,183 issued on July 18,  
15 1995 describes a phospholipid emulsion derived from marine  
and/or synthetic origin comprising polyunsaturated fatty acids  
and having anti-inflammatory and immunosuppressive effects and  
which promotes normal brain or retinal development and  
function. U.S. 5,434,183 does not disclose the presence of  
20 flavonoids or nervonic acid (a mono-unsaturated fatty acid) in  
the composition.

JP 2215351, published on August 28, 1990, discloses a  
method for extracting and purifying phospholipids from fresh  
krill. Krill is lyophilized and then extracted with ethanol to  
25 produce an extract which is fractionated by absorption column  
chromatography to produce high purity phosphatidyl choline and  
phosphatidyl ethanolamine. There is no disclosure of a  
phospholipid extract comprising a flavonoid or nervonic acid.

WO 00/23546, published on April 27, 2000, discloses methods for extracting lipid fractions from marine and aquatic animal material by acetone extractions. The resulting non-soluble and particulate fraction is further solvent extracted with ethanol or ethylacetate to achieve further lipid extractions.

Summary of the Invention

In one aspect, the invention provides novel phospholipids, wherein the two fatty acids chains of the phospholipid are occupied by eicosapentanoic acid (EPA) and docosahexanoic acid (DHA) simultaneously, within the same molecule, i.e.: a phospholipid of the general formula (I):

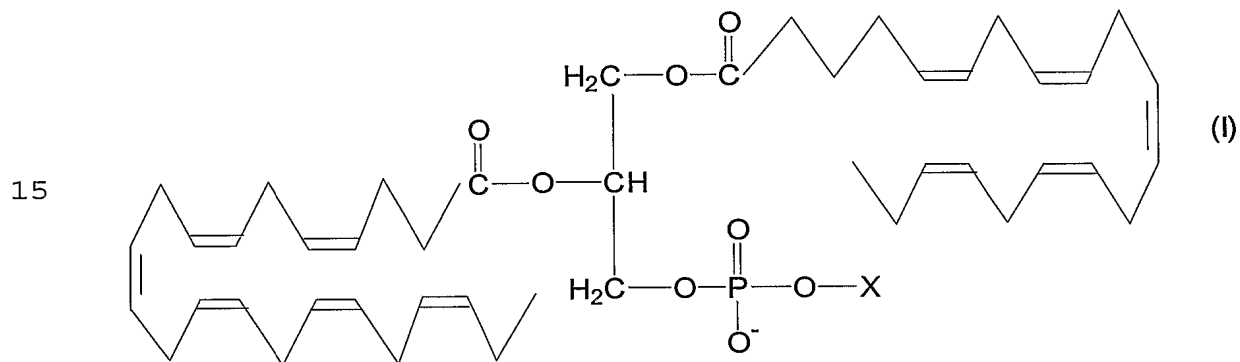

wherein X represents a moiety normally found in a phospholipid.

In a further aspect, the invention provides a novel flavonoid compound (II):

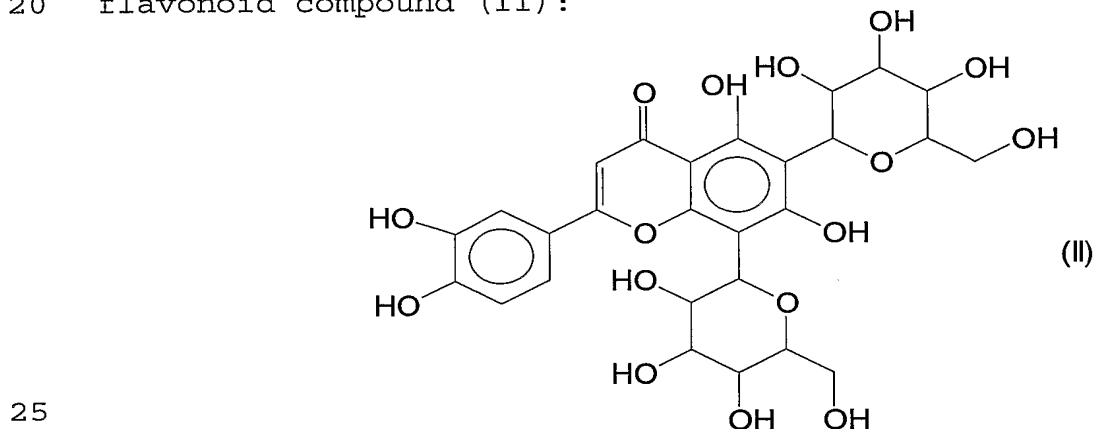

- 3 -

The novel phospholipids and the novel flavonoid compound are derived from an extract from a marine or aquatic biomass.

There is also provided a phospholipid extract  
5 comprising the above noted phospholipids and flavonoid compound derived from a marine or aquatic biomass. The extract and the components are useful in the prevention or treatment of a variety of disease states and for the aesthetic enhancement of an animal, including human, body. Pharmaceutical,  
10 nutraceutical and cosmetic compositions containing the extract and uses thereof are also within the invention, as are commercial packages contain the compositions of the invention.

#### Detailed Description of the Invention

##### 1. Phospholipids

15 Phospholipids are complex lipids containing phosphorus. The phosphatides, known as phospholipids, are usually divided into groups on the basis of compounds from which they are derived. In addition to two chains of fatty acids they contain phosphoric acid, glycerol and nitrogenous  
20 bases such as choline. Important phospholipids are phosphatidylcholine (PC), phosphatidylethanolamine (PE) and phosphatidylinositol (PI). Their nature as amphiphilic molecules provides them with unique physicochemical properties. Their function as the principle components of cell membranes  
25 makes phospholipids essential for all vital cell processes. They are widespread as secretory and structural components of the body and can mimic or enhance natural physiological processes.

- 4 -

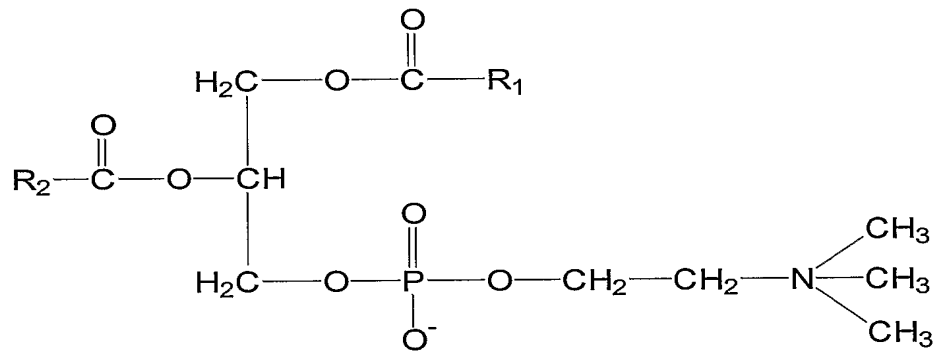

5

Phosphatidylcholine – common structure  
 $R_1$  and  $R_2$  are fatty acid residues,  
 different for each molecular species

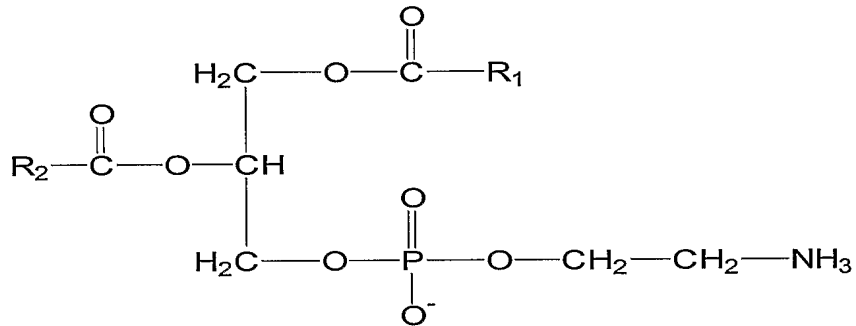

10

Phosphatidylethanolamine – common structure

$R_1$  and  $R_2$  are fatty acid residues,  
 different for each molecular species

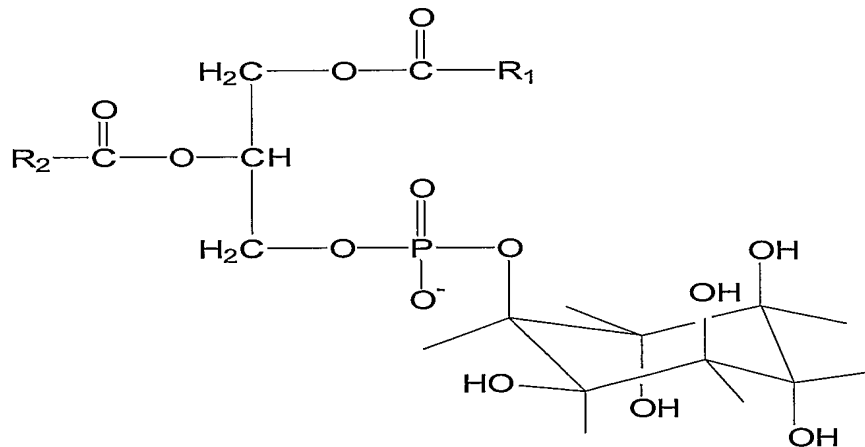

15

Phosphatidylinositol – common structure  
 $R_1$  and  $R_2$  are fatty acid residues,  
 different for each molecular species

20



- 5 -

Phospholipid production may be either synthetic or through extraction from natural tissues. The chief source of commercial natural phospholipids are soybean, egg yolk and cows (brain and liver). Since an individual phospholipid may  
5 contain a variety of fatty acid residues, it may be described as pure only with this limitation in mind. Naturally occurring essential polyunsaturated fatty acids can contribute to the activation of cellular metabolism. The main fatty acid found in phospholipid products is linoleic acid (C18:2n6), present in  
10 soybean at more than 65%. The longest chain polyunsaturated fatty acids found in commercially available phospholipids either as preparations or individually are 20:4 among the eicosanoids, known as arachidonic acid, and 22:6 known as docosahexanoic acid.

15 Arachidonic acid is a fatty acid that is found as part of phospholipid membranes, generally as part of phosphatidylcholine and phosphatidylinositol. Adverse cellular stimuli will activate enzymes (phospholipase) that cleave arachidonic acid from the phospholipid backbone in the cell  
20 membrane. Arachidonic acid, which serves as the precursor for prostaglandins and prostacyclin (PGs, PGI<sub>2</sub>) and thromboxane (TXs), can then be metabolized by one of two major pathways: the cyclooxygenase (COX) pathway or the lipoxygenase pathway. The COX pathway products, PGG<sub>2</sub> and PGH<sub>2</sub>, can then be acted upon  
25 by thromboxane synthase (in platelets) or prostacyclin synthase (in endothelium) to form TXs or PGI<sub>2</sub>, respectively. Arachidonic acid can also be acted upon by 5-lipoxygenase, primarily in leukocytes, to form leukotrienes (LTs). One or more of these metabolites can mediate all the signs and symptoms associated  
30 with arachidonic acid, i.e. inflammatory disease and pain.

Platelets, leukocytes, smooth muscle, and endothelium can produce vasoactive substances, products of arachidonic acid metabolism such as prostaglandins (PGs), prostacyclin (PGI<sub>2</sub>),

- 6 -

leukotrienes (LTs), and thromboxanes (TXs). These substances can either act as vasodilators or as vasoconstrictors. PGI<sub>2</sub> is essential in vascular function since it inhibits platelet adhesion to the vascular endothelium and has significant vasodilatation qualities. Damaged endothelial cells cannot produce PGI<sub>2</sub>, making the vessel more susceptible to thrombosis and vasospasm. Thromboxanes and leukotrienes serve a vascular function during inflammation, generally producing vasoconstriction. Prostaglandins have a vascular role during inflammation, and also play a more subtle role in normal flow regulation, most notably as modulators of other control mechanisms. Prostaglandins have both vasoconstrictor and vasodilator activities. Leukotrienes and prostaglandins can also increase the endothelial membrane permeability thus promoting edema during inflammation. Arachidonic acid is naturally present in most phospholipid mixtures or emulsions available today.

Nervonic acid (C24:1) is also called selacholeic acid or tetracosenic acid. Nervonic acid is the predominant nutrient of white matter in glucoside, which is quantitatively contained in nerve tissue and white matter. The absence of nervonic acid may result in cerebral lesion, fatigue, hypodynamia, amentia, and senile dementia. Nervonic acid, tetracosenic acid in another name, is monounsaturated, non-oxidable/decomposed and absorptive. It is called a rare tonic as it is rare existent in nature. It may be obtained in small quantities by extracting from cerebral chondriosome. Therefore, the substance is far below the demand of human body. In foreign countries, nervonic acid mainly comes from shark brain and oil.

- 7 -

## 1.1 Phosphatidylinositol Clinical Applications

Recent advances in nutritional and biochemical research have documented inositol as an important dietary and cellular constituent. Functions of phosphatidylinositol in biological membranes include the regulation of cellular responses to external stimuli and/or nerve transmission as well as the mediation of enzyme activity through interactions with various specific proteins (1).

Inositol has been identified as an important dietary and cellular constituent. Biochemical functions:

- a. Regulation of cellular responses to external stimuli
- b. mediation of enzyme activity.

Phosphoinositide composition of the central nervous system cell membranes are fatty-acid enriched and consist primarily of phosphatidylinositol (PI), phosphatidylinositol-4-phosphate (PIP), and phosphatidylinositol-4,5-biphosphate (PIP<sub>2</sub>). Once the membrane is stimulated, phospholipase C is activated and consequently inositol triphosphate along with diacylglycerol is produced. PI is used as a precursor for phosphatidylinositol-3-phosphate and 3,4,5-triphosphate (2).

Active transport carriers, calcium pumps in the cell membrane itself, and in the endoplasmic reticulum, keep cytoplasmic calcium concentration very low. Usually the calcium concentration inside the cytoplasm is 5,000-10,000 times less than the concentration in the extracellular fluid. This endoplasmic store of calcium can be accessed upon stimulation by inositol. Inositol triphosphate is released from the cell membrane and travels through the cytoplasm until it reaches the endoplasmic reticulum. This inositol then releases the sequestered calcium, which can go on to mediate

- 8 -

the release of neurotransmitters in response to depolarization (3).

In addition to releasing endoplasmic reticulum calcium, inositol functions as the major central nervous system non-nitrogenous osmoregulator. Modulation of this inositol pool is regulated in response to states of high or low osmolalities. The inositol pool is supplied via a sodium/inositol transporter, a sodium dependent active transport system, and a passive low affinity transporter (4,5).

10 Numerous non-inositol receptors have been identified in the central nervous system that can potentially interact with the inositol signaling system. Most of these receptors are linked to the G proteins and produce inositol-1,4,5-triphosphate as second messengers. These receptors can be found in nearly every human organ system. The potential interactions between these receptors and their agonists are responsible for regulation of the body on a day-to-day basis. In view of the complexity of these systems and their actions, a perfect balance is required for regulation of the signaling systems.

20 Theoretically, an imbalance of inositol concentration could potentially affect the development and function of one or all of these receptors. Cholinergic receptors are located in the liver, heart, stomach, and lungs. Serotonin and glutamine receptors are found mostly in the central nervous system (CNS) tissues. Adrenergic receptors are present in various tissues including CNS, vascular tissues, and heart. Histaminergic receptors are predominantly found in the lungs and stomach.

## Clinical Applications

A change in CNS availability of inositol may produce altered brain signaling and eventually lead to the development of neurological disorders.

### 5 a. Depression:

The pathophysiology of depression is believed to be linked to a deficiency of neurotransmitters at post-synaptic receptor sites. According to the catecholamine theory, the deficiency is in the amount of norepinephrine; in the  
10 indolamine theory the deficiency is in the amount of serotonin. Receptors linked to the inositol signalling system include serotonin (5HT2a and 5HT2b) and norepinephrine (alpha 1a, 1b, and 1d).

In 1978, Barkai et al demonstrated depressed patients  
15 had significantly decreased cerebrospinal fluid (CSF) levels of inositol as compared to healthy patients (6). In 1993 this theory was expanded to conclude that administration of high-dose inositol could increase CSF levels by as much as 70 percent (7). This led to the study of inositol for treatment  
20 of depression (8,9). In 1995 Levine et al completed a double-blind study for treatment of depression using inositol at a dose of 12 grams daily compared to placebo. Patients receiving inositol showed significant improvement in depression as ranked by the Hamilton Depression Rating Scale (33.4 +/- 6 versus .6  
25 +/- 10). Another important observation was the absence of manic episodes in the bipolar patients treated with inositol. This lack of manic episodes may suggest that when the signalling system is not overactive, addition of inositol will not increase the signalling system's activity (10,11). It can  
30 be concluded that inositol is effective in managing the clinical manifestations of depression.

- 10 -

## b. Panic Disorder:

Benjamin et al expanded the clinical use of inositol by evaluating its effectiveness in panic disorder (12). This was an eight week double-blind, crossover study whereby patients were treated with inositol daily for four weeks and then crossed over to the other study arm. Improvement was assessed using patient diaries, the Marks-Matthews Phobia Scale, the Hamilton Anxiety Rating Scale, and the Hamilton Depression Scale. The frequency and severity of panic attacks and the severity of agoraphobia declined significantly more after inositol than after placebo (a decrease from 10 attacks per week to 3 per week in the treated group compared to a decrease from 10 to 6 in the placebo group). The authors conclude inositol's efficacy and safety, and the fact that inositol is a natural component of the human diet, make it a potentially attractive therapeutic agent for panic disorder.

## c. Obsessive Compulsive Disorder (OCD):

Since the phosphatidylinositol cycle, as a second messenger is known to affect several neurotransmitters, including serotonin receptors, inositol was studied for treatment in OCD in a double-blind, placebo controlled, crossover trial. Thirteen patients were treated for six weeks. There was a significant improvement at week six during the inositol period when compared to placebo period. There were no side-effects reported during the study period (1).

## d. Alzheimer's Disease (AD):

Although the role of aluminum in AD is still speculative at best, the presence of aluminosilicates at the core of senile plaques in diseased neurons is a consistent feature found in the CNS of AD patients during autopsy. It is known that aluminum inhibits the incorporation of inositol into

- 11 -

phospholipids and the hydrolysis of the phosphoinositides by binding to one of two specific phosphate groups. This binding of phosphate and aluminum affects the calcium releasing effects of the cell. The resulting profound disturbance of the phosphatidylinositol second messenger system may account for neuronal malfunction and eventual cell death (13).

Since the potential role of aluminum as a causative agent for cell death may be affected by the deregulation of calcium concentration, possibly due to inositol depletion, supplementation with inositol may produce positive CNS effects. Recent data suggests the loss of PI second messenger system target sites and IP3 receptors may add to cognitive impairment and the failure of conventional therapies in AD. Therefore, supplementation of inositol to replenish the diminished PI system may be beneficial in the treatment of AD (13-20).

In 1996 Barak et al completed a double-blind, controlled, crossover study of six grams inositol daily compared to placebo for 30 days in 11 Alzheimer's patients. Patients in the study were diagnosed with dementia of the AD type as classified by DSM - IIIR and aged 65 years or older. The Cambridge Mental Disorder of the Elderly Examination (CAMDEX) was used as the basic assessment parameter and was administered upon admission into the study. Included in CAMDEX is part A: patient's present physical and mental state, part B: Cognitive Subscale of CAMDEX (CAMCOG), part C: interviewers observations, and part D: physical examination. CAMCOG was repeated at two, four, six, and eight weeks. Participants scored 80 or less on the CAMCOG examination and their symptoms of depression were not severe (21).

Patients were excluded from the study if they had a history of psychiatric, alcohol, and/or drug addiction disorders, or abnormalities in baseline laboratory values

- 12 -

(blood count, electrolytes, liver or kidney functions, VDRL, or CT scan) not consistent with AD. Patients with additional neurologic, metabolic, endocrinologic disorders, or presence of internal disease that grossly impaired brain functioning were also excluded.

Subjects were given either three grams inositol or placebo in the morning and again in the evening. After four weeks patients were crossed over into the other arm (inositol or placebo) for an additional four weeks. Only benzodiazepines were allowed during the study period (15 mg of oxazepam or equivalent), provided the patient was receiving it on study entry.

Analysis of the improvement scores of all patients who completed the study showed inositol increased the total CAMCOG score from a baseline of 31.36 +/- 20.90 to 40.09 +/- 24.54, while the placebo group increased from baseline of 35.9 +/- 25.96 to 39.27 +/- 25. The authors concluded only two of the eight subscales (language and orientation) showed significant improvement with inositol.

Inositol's proposed mechanism of action in the CNS does not include direct manipulation with either pre- or post-receptors. However, it may indirectly affect the relationship between receptor and agonist. By mediating the physiochemical characteristics of the M1 pre-synaptic receptor (solubility, osmolality, etc.), inositol may alter the binding site and influence the signaling that occurs as a result.

## 1.2 Aging

Phosphatidylcholine rich in polyunsaturated fatty acids is indispensable for cellular differentiation, proliferation and regeneration. The physiologic functions of these phospholipids are related to the morphology of the



- 13 -

biological membranes, the incorporation of these molecules into membranes and thus the maintenance of intact cell membranes.

The current study was designed to investigate the effects of Polyunsaturated phosphatidylcholine on age-related hearing loss by evaluating its ability to preserve mitochondrial function, protect mitochondrial DNA from oxidative damage and preserve auditory sensitivity (22).

Harlan-Fischer 344 rats, 18-20 months of age, were used as the experimental subjects.

The subjects were caged individually and maintained at 21 to 22° C in a 12:12 light-dark cycle b.

A dose of 300mg/kg/day of Polyunsaturated phosphatidylcholine was supplemented to each subject, by adding it to the oral diet.

The animals were divided randomly into two groups (n = 7 for each group). Group-1 served as the control, and group-2 as the experimental group.

At the onset of the study, Auditory Brainstem Responses were obtained to measure baseline hearing thresholds in all subjects.

Age-associated changes in hearing sensitivities were then recorded at two-month intervals for six months.

In order to assess age-related changes in mitochondrial function, mitochondrial membrane potentials were studied using flow cytometry. For this purpose, peripheral blood was obtained from each subject at the beginning and at the end of the protocol.

At the conclusion, the subjects were euthanized (according to NIH protocol), and tissue samples were obtained

- 14 -

from brain and cochlea (stria vascularis and auditory nerve) to study mitochondrial DNA deletion associated with aging. This was achieved by amplifying the specific common aging mitochondrial deletion by Polymerase Chain Reaction. DNA  
5 quantification was performed. The data obtained for each protocol was compared between the two groups and analyzed using ANOVA.

The effects of Polyunsaturated phosphatidylcholine on age-related hearing loss demonstrate a gradual age-associated  
10 decline in hearing sensitivities at all the frequencies tested (3, 6, 9, 12 and 18 kHz).

There was a statistically significant preservation of hearing noted in the treated subjects at all frequencies, which was observed at four and six months of treatment.

15 Overall, there was a continued decline in hearing in the control subjects and a statistically significant protective effect of Polyunsaturated phosphatidylcholine on the experimental subjects ( $p < .005$ ).

Mitochondrial membrane potentials were recorded by  
20 flow cytometry as a measure of the uptake of Rhodamine 123 by mitochondria.

The mean fluorescence intensity (MFI) in group-1 subjects measured 3190 and 2100 at the beginning and end of the study, respectively.

25 This, approximately, 30% decline in membrane potential with time was statistically significant ( $p = 0.003$ ).

Conversely, the MFI in the experimental group remained essentially unchanged at 2990 from 3165 at the beginning of the study.

- 15 -

This difference between the control and treated groups was statistically significant ( $p < 0.05$ ), demonstrating the protective effect of polyunsaturated phosphatidylcholine supplementation on mitochondrial membrane potential.

5            Phospholipids are integral structural components of all biological membranes with polyunsaturated phosphatidylcholine and phosphatidylethanolamine being the predominant types, quantitatively. They constitute the phospholipid bilayer structure of cellular membranes, which is  
10 responsible for membrane stability and cellular function. Polyunsaturated phosphatidylcholine maintains and promotes the activity of several membrane bound proteins and enzymes, including Na-K ATPase, adenylate cyclase and glutathione reductase. They are also known to be precursors of  
15 cytoprotective agents such as eicosanoids, prostaglandins and antioxidants.

The results of these studies suggest that polyunsaturated phosphatidylcholine and phosphatidylethanolamine may protect mitochondrial function by  
20 preserving the age-related decline in mitochondrial membrane potentials and hence their activity. The observation that there was less mitochondrial DNA damage in the treated group may explain the effect of preservation of hearing loss associated with aging, by the ability of polyunsaturated  
25 phosphatidylcholine and phosphatidylethanolamine to specifically up-regulate cochlear mitochondrial function. There are many studies demonstrating the effects of mitochondrial metabolites on cognition and aging (22-33). Additionally, recent work has shown that acetyl-L-carnitine and -lipoic acid  
30 delay the progression of age-related hearing loss by protecting cochlear mitochondrial DNA from oxidative damage (34). These results support the membrane hypothesis of aging and provide further evidence to support this theory as a possible

- 16 -

explanation for age-related hearing loss. Thus, PPC may be one of many rational approaches to consider for the purpose of membrane preservation, enhanced mitochondrial function, reduction of age-associated mitochondrial DNA damage and  
5 slowing of some of the aging processes.

### 1.3 Effect of phosphoglycolipid extract (NT factor) on normal and cancerous cells

Reduced levels of phospholipids in normal cells can limit metabolic activity and limit available energy.

10 Phospholipids, as part of the membrane structure:

i. maintain membrane integrity

ii. regulate enzyme activities and membrane transport processes through changes in membrane fluidity (Spector 1981, 1985)

15 iii. Signal transduction utilizes phosphatidylcholine and phosphatidylinositol for the production of diacyl-glycerol (DAG) by phospholipase C (Berridge 1989) and for the production of inositol triphosphate (IP3) (Ranan 1990, Michell 1988, Margolis 1990).

20 iv. One of the choline phospholipids (1-alkyl-2 acetyl-SN-glycerol-3-phosphocholine) is the substrate for the synthesis of platelet activating factor (Synder 1989).

v. The arachidonic acid found as part of the structure of choline or inositol phospholipid is utilized for the production  
25 of prostaglandin and leukotriene (Nordoy 1990).

vi. The choline of phosphatidylcholine may be used in neural tissue for the synthesis of acetylcholine (Blusztain 1987)

vii. Phosphoglycolipid improves cell maintenance and metabolic activity of normal cells.

- 17 -

viii. Phosphatidylcholine derivatives disrupt cancer cells at concentrations that do not affect normal cells.

ix. Phosphatidylcholine is selectively cytotoxic to cancer cells in vitro (Hoffman 1986, Harmann 1986, Berger 1984).

5           a. Such compounds inhibit HL60 leukemic cells at a dosage that has no effect on normal human marrow cells, the tissue from which the leukemic cells are derived.

          b. Normal cells were able to tolerate 4 times higher dosage than the leukemic cells during 24 hours incubation with  
10 the phospholipid preparation (Berdel 1986).

          c. There was up to a 5-fold difference in sensitivity between the normal and tumor cells with breast, ovarian, and lung cancer cells, as well as with mesothelioma cells (Namba 1993).

#### 15 1.4 Imaging

Polyunsaturated phospholipids are known to be important with regard to the biological functions of essential fatty acids, for example, involving neural tissues such as the brain and retina. The NMR spectra of polyunsaturated bilayers  
20 are dramatically different from those of less unsaturated phospholipid bilayers. MD simulations can aid in interpreting the complex NMR spectra of polyunsaturated bilayers, in conjunction with electron density profiles determined from small-angle X-ray diffraction studies. This work clearly  
25 demonstrates preferred helical and angle-iron conformations of the polyunsaturated chains in liquid-crystalline bilayers, which favor chain extension while maintaining bilayer flexibility. The presence of relatively long, extended fatty acyl chains may be important for solvating the hydrophobic  
30 surfaces of integral membrane proteins, such as rhodopsin. In

- 18 -

addition, the polyallylic DHA chains have a tendency to adopt back-bended (hairpin-like) structures, which increase the interfacial area per lipid. Finally, the material properties have been analyzed in terms of the response of the bilayer to mechanical stress. Simulated bilayers of phospholipids containing docosahexaenoic acid were less sensitive to the applied surface tension than were saturated phospholipids, possibly implying a decrease in membrane elasticity (area elastic modulus, bending rigidity). The above features distinguish DHA-containing lipids from saturated or nonunsaturated lipids and may be important for their biological modes of action.

#### 1.5 In Summary

The functions of the phospholipids are multiple and different for each phospholipid:

- a. Sphingosine and carbohydrate containing lipids are mainly concentrated in nervous tissues.
- b. The hydrophilic and hydrophobic parts of the phospholipid molecule allow them to function as emulsifying agents in order to maintain the proper colloidal state of protoplasm.
- c. Phospholipids aid the transport of triglycerides through the liver, especially during mobilization from adipose tissue.
- d. Phospholipids and their metabolites play an important role in intracellular signalling, for example via phosphatidylinositol specific phospholipase C, phospholipase D or phosphatidylinositol-kinases.
- e. Through their concentration in cell membranes they may somehow be involved in the transport of hydrophobic constituents into and out of cells.

- 19 -

f. Phospholipids affect brain function in two substantial ways: (Cohen B.M., Babb S.M., Yurgelun-Todd D., et al. *Brain choline uptake and cognitive function in middle age. Biol. Psych.* 1997;41:90S.)

- 5           a. The membranes of brain cells depend on phospholipids as part of their structure. Phosphatidylserine (PS) is concentrated in the cell membranes of the brain.
- 10           b. Phospholipids are required for the production of neurotransmitters.
- c. Choline is a component of the neurotransmitter acetylcholine. Without adequate levels of acetylcholine, the brain can't store or retrieve information efficiently.
- 15           d. Lower choline levels in the brain are an underlying factor for age-related cognitive disorders.
- e. Patients submitted to increased choline uptake show significant improvement in their ability to recall information and perform on memory retention tests, suggesting a causal relationship between poor choline status and cognition.
- 20

g. Phosphatidylserine (PS) in Dementia-Related Diseases:

- 25           a. Dementia is the deterioration of mental function, particularly affecting memory, concentration, and judgment.
- b. A frequent cause of dementia is Alzheimer's disease.
- 30           c. The first double-blind trial of PS for Alzheimer's disease was published about a decade ago. (Delwaide P.J., et al. *Double-blind randomized controlled study of phosphatidylserine in demented subjects. Acta Neur. Scand.* 1986;73:136-140.) In this study, 35 Alzheimer's patients were either given a placebo or 300 mg. per day of PS for six weeks. The PS group showed significant improvement after this short-term supplementation period.
- 35           d. More recently, a large double-blind study of 494 elderly patients with symptoms of cognitive decline compared a placebo to 300 mg. per day of PS for six months. (Cenacchi T., Bertoldin T., Farina C., et al. *Cognitive decline in the elderly: A double-blind, placebo-controlled multicenter study on efficacy of phosphatidylserine administration. Aging Clin.*
- 40
- 45

- 20 -

- 5                   *Exp. Res. 1993;5:123-133.* ) Memory and learning of the PS-treated group was significantly improved over the placebo group, as well as certain emotional and behavior components of Alzheimer's disease.
- 10           e.       Supplements of PS have also shown impressive results in older populations with memory impairment unrelated to Alzheimer's disease. (*Crook T.H., et al. Effects of phosphatidylserine in age-associated memory impairment. Neurology 1991;41:644-649.*) Three months of taking 300 mg. of PS daily, in one study, reversed the decline of memory function in a group of 149 patients. The memory function of these men and women
- 15                   initially averaged that of a typical 64 years old. After taking PS supplements, the average memory function was 52 years old -- a mental gain of 12 years.
- 20    h.    Restoring and Preserving Liver Function:
- a.    While the phospholipid PS dominates in the mental function arena, the phospholipid phosphatidylcholine (PC) is the major player for
- 25                   liver health.
- b.    PC protects the liver against damage from alcoholism, pharmaceuticals, pollutant substances, viruses, and other toxic influences, most of which operate by damaging cell
- 30                   membranes.
- c.    Many of the studies using PC supplements to aid recovery of the liver are based on 800 mg. per day (taken with meals). (*Kidd P.M. Phosphatidylcholine: A superior protectant against liver damage. Alt. Med. Rev. 1996; 1:258-274.*) Although PC is a source of choline, studies reviewed by Dr. Kidd suggest that PC is superior to choline; in fact choline in its pure form may be detrimental to the liver's recovery from toxic
- 35                   overload (such as in alcoholism). As a lipotropic, choline transports fats within the body, while inadequate choline intake might result in an unhealthy accumulation of fat in the
- 40                   liver. (*Newberne P.M., Nauss K.M., and de Camargo J.L. Lipotropes, immunocompetence, and cancer. Cancer Res. 1983;43:2426S-2434S.*)
- 45



## 2. Flavonoids

Flavonoids are polyphenolic compounds ubiquitous in nature. They are categorized into isoflavones, anthocyanidins, flavans, flavonols, flavones, citrus flavonoids, hesperidin, 5 chalcones, catechins, rutin, and flavanones. Essential flavonoids, such as quercetin in onions and genistein in soy are actually considered subcategories rather than independent categories. Over 4,000 flavonoids have been identified in 10 fruits, vegetables and beverages (tea, coffee, beer, wine and fruit drinks). Even though they have a similar molecular structure between them, their functions are different from each other. Flavonoids have been shown to have antibacterial, anti-inflammatory, antiallergic, antimutagenic, antiviral, antineoplastic, anti-thrombotic, and vasodilatory activity. 15 Quercetin has been proven to block the "sorbitol pathway" which is directly associated with diabetes as well as to prevent LDL-cholesterol oxidative damage, which is essential for the maintenance of a healthy cardiovascular system.

Flavonoids are found in a wide range of fruits and 20 vegetables. For example, Quercetin (a flavonol in vegetables, fruit and onions), Xanthohumol (a prenylated chalcone in beer), Isoxanthohumol (a prenylated flavanone in beer), Genistein (an isoflavone in soy), Chalconaringenin (a non-prenylated chalcone in citrus fruits) and Naringenin (a non-prenylated flavanone in 25 citrus fruits).

In plants flavonoids have very well defined functions. First, the accumulation of pigment in flower petals, seeds and leaves. Flowers, as pollinators, must attract pollen carriers. Second, they protect plants from UV damage, 30 by absorbing UV at the epidermal layer. Third, they protect the plants against insects and pathogens.

- 22 -

The flavonoid biosynthetic pathway is one of the best understood plant secondary metabolism pathways (1992, Gerats). The key enzymes are phenylalanine-ammonia lyase and chalcone synthase. Phenylalanine-ammonia lyase converts phenylalanine into cinnamic acid as it controls the total flow of carbons into phenolics which is shown to be the limiting step in this pathway (1974, Creasy). Another key enzyme of the flavonoid pathway is the chalcone synthase. It condenses three molecules of malonyl-CoA with one molecule p-coumaroyl-CoA to form a C<sub>15</sub> intermediate, naringenin chalcone, with a R stereochemistry at the 2<sup>nd</sup> carbon. Chalcone isomerase, transforms the intermediate into the first flavonoid of the pathway, 2S-flavonone (naringenin). This reaction is part of all major flavonoid biosynthesis pathways. Chalcone synthase and chalcone isomerase form a complex ensuring the right stereochemistry (1996, Lyster).

The structural components of flavonoids include two benzene rings on either side of a 3-carbon ring. Different combinations of hydroxyl groups, sugars, oxygens, and methyl groups attached to these structures create the various categories of flavonoids mentioned above. The capacity of flavonoids to act as an antioxidant depends upon their biochemical structure, and more specifically, the position of the hydroxyl groups. Epicatechin gallate, epigallocatechin gallate, luteolin and quercetin exhibit the highest antioxidant activity, followed by epigallocatechin, gallic acid, epicatechin, catechin, rutin, and dihydroquercetin. It is worth noting at this point that the only difference between quercetin or luteolin (the most potent) and dihydroquercetin (the least potent) is the double bond between the second (2<sup>nd</sup>) and third (3<sup>rd</sup>) carbons on the center (C) ring. The presence of this double bond significantly increases the antioxidant activity of the flavonoid. Antioxidant activity can be

increased with the addition of another hydroxyl group on the B or C ring.

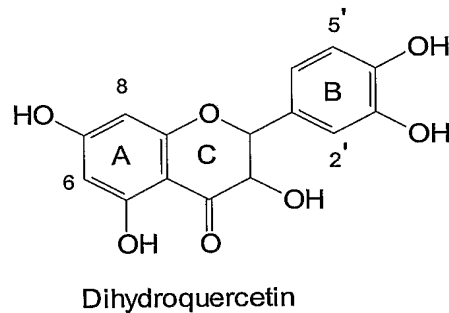
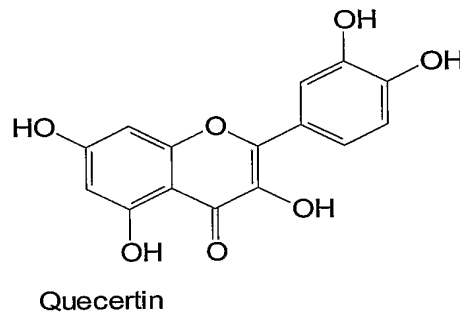
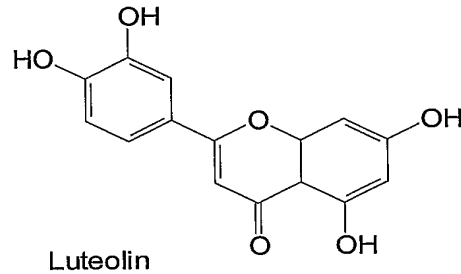

15           The potent antioxidant activity of flavonoids seems to be the most important function of flavonoids, responsible for many of the above mentioned health benefits.

The flavonoids most recognised by scientists until today are:

20   Quercetin and quercetin chalcone

Quercetin chalcone, is quercetin with an opened C ring and the oxygen found in the C-ring of quercetin converted into a hydroxyl group. Quercetin is mainly found in tea and even more in green tea.

- 24 -

### Oligomeric Proanthocyanidins

Oligomeric proanthocyanindins are oligomeric flavonoids, usually dimers and trimers, based on the flavan-3-ol, or catechin, molecule, sometimes attached to gallic acid. They are found in the bark of pine trees, in grape seeds and skins, in peanut skins, cranberries, tea, and other sources.

### Ginkgo Biloba Extract

Ginkgo biloba extracts contain 24% ginkgo flavone glycosides and 6% terpenes. They are extracted from the eldest living tree species, Ginkgo Biloba. Scientific research suggests that the beneficial constituents of ginkgo biloba extracts are quercetin and myricetin.

### Luteolin

Luteolin is a flavonoid found in the same foods as apigenin (vegetables and fruits). Scientific research has shown that luteolin and quercetin can inhibit platelet activating factor and suppress the inflammatory response induced by allergens.

Flavonoids have been studied for the last 60 years. Their antioxidant activity is accepted as a scientific fact. Epidemiological, clinical, and laboratory research on flavonoids demonstrates the use of flavonoids in the prevention and/or treatment of cardiovascular disease, cancer, inflammatory conditions, asthma, peridontal disease, liver disease, cataracts and macular degeneration. Until today there has never been a flavonoid extracted from anything other than a plant, vegetable, fruit or algae.

- 25 -

### 3. Preparation of Extracts

The phospholipid extract of the present invention may be extracted from a variety of marine or aquatic biomass sources. Preferred sources of the phospholipid composition are crustaceans, in particular, zooplankton. A particularly preferred zooplankton is Krill. Krill can be found in any marine environment around the world. For example, the Antarctic Ocean (where the krill is Euphasia superba), the Pacific Ocean (where the krill is Euphasia pacifica), the Atlantic Ocean and the Indian Ocean all contain krill habitats. In particular, the coastal regions of Mauritius Island and/or Reunion Island off Madagascar, the Canadian West Coast, the Japanese Coast, the Gulf of St. Lawrence and the Bay of Fundy are krill habitats.

The phospholipid extract of the present invention is preferably a product of initial processing of the biomass. As such, the phospholipids are extracted from the biomass grease as opposed to the oil, the oil being a product of subsequent processing steps of a biomass. Since the phospholipid extract is derived from the biomass grease, the viscosity of the phospholipid extract tends to be higher than extracts from biomass oils. The extract has a very high natural stability with a peroxide value of zero or approaching zero and a good Oil Stability Index of less than about 0.2 Meq/kg after 20 or more hours. Table 1 below details the stability of the extract.

- 26 -

TABLE 1

<u>Stability indexes of the extract after 50 hours at 97.8°C</u>	
Peroxide value (mEq/kg)	<0.1
Oil Stability Index (after 50 hours) at 97.8°C (mEq/kg)	<0.1
Saponification Index	70-180
Iodine Index (%)	60-130

Phospholipids are generally present in the extract in an amount of at least 40% w/w, preferably at least 45% w/w.

5 More preferably, the amount of phospholipid is from about 45-60% w/w. A variety of types of phospholipids may be present in the extract. These include phosphatidylethanolamine, phosphatidylinositol, phosphatidylserine, phosphatidylcholine and sphingomyelin.

10 The phospholipid extract preferably further comprises a number of other components. The extract may also comprise fatty acids, antioxidants and/or metals.

Fatty acids found in the phospholipid extract may be saturated, monounsaturated or polyunsaturated fatty acids.

15 Polyunsaturated fatty acids are particularly preferred, the omega-3 and omega-6 fatty acids being most preferred. In particular, docosahexaenoic acid (DHA), eicosapentaenoic acid (EPA), myristic acid, myristoleic acid, lignoceric acid, linolenic acid, alpha linolenic acid, nervonic acid, linoleic  
20 acid, oleic acid, stearic acid, palmitic acid and palmitoleic acid are present in significant quantities. Arachidonic acid content of the extract is generally very low to non-existent despite the presence of phosphatidyl inositol and phosphatidyl serine. Other lipid components that may be present in the  
25 extract include monoglycerides, triglycerides and/or cholesterol.

Table 2 below details the fatty acid compositions of the phospholipids of the extract.

TABLE 2

5 The fatty acid composition of the extract of the phospholipids

Fatty Acids	Total PL FA%	PC FA%	PE FA%
C14:0 MYRISTIC	2.04	1.70	0.7
C14:1 MYRISTOLEIC	1.22		
C15:0 PENTADECANOIC	0.2	0.30	0.3
C16:0 PALMITIC	24.08	26.50	23.9
C16:1 PALMITOLEIC	2.24	2.30	0.7
C18:0 STEARIC	1.02	1.30	2.9
C18:1 OLEIC	9.18	11.90	24.1
C18:2n6 LINOLEIC	1.63	2.30	0.8
C18:3n6 GLA	1.02	0.30	
C18:3n3 ALA	1.02	1.30	
C18:4n3 OTA	1.84	2.00	0.3
C20:0 ARACHIDIC			
C20:1 cis-11-EICOSENOIC	0.41	0.60	0.7
C20:2n6 EICOSADIENOIC			
C20:3n6 METHYL ETA		0.20	
<b>C20:4n6 ARACHIDONIC</b>	<b>0.61</b>	<b>0.70</b>	<b>0.6</b>
C20:3n3 Homo-γ-LINOLENIC			
C20:4n3			
<b>C20:5n3 EPA</b>	<b>27.35</b>	<b>31.90</b>	<b>12.9</b>
C22:0 BEHENIC			
C22:1 ERUCIC	1.22	1.50	
C22:2n6			
C22:4n6			
C22:5n6 METHYL DPA			
C22:5n3 DPA		1.00	
<b>C22:6n3 DHA</b>	<b>24.9</b>	<b>14.20</b>	<b>32.1</b>
C24:0 LIGNOCERIC			
C24:1 NERVONIC			
Total	100.0	100	100

Compared to phospholipids existing in the market today, the extract phospholipids:

- 10 a. achieve a superior profile;
- b. have the highest quantities of polyunsaturated fatty acids;
- c. have the highest quantities of DHA;
- d. are the only phospholipids that contain EPA; and
- 15 e. are the only phospholipids that contain a combination of EPA and DHA on the same molecule.

- 28 -

PL = phospholipid  
FA = fatty acid  
PC = phosphatidylcholine  
PE = phosphatidylethanolamine

5

Free fatty acids are present in the extract in an amount of at least 4% w/w and preferably at least 5% w/w.

Polyunsaturated fatty acids, in particular omega-3 fatty acids, preferably make up at least 15% w/w, more preferably at least 40% w/w, and even more preferably at least 45% w/w, of the total lipids in the extract. DHA and EPA are generally the largest component of the fatty acids and preferably account for at least 32% w/w, more preferably at least 35% or 37%, of the total lipid content of the extract.

15

Table 3 below details the fatty acid composition of the total lipids of the extract.



TABLE 3

Fatty acid composition of total lipids of the extract

<u>Sample</u>	<u>%</u>
Fatty Acid Composition	
C14:0	≥3.00
C14:1	≥0.01
C15:0	≥0.3
C16:0	≥20.00
C16:1	≥3.25
C18:0	≥1.00
C18:1	≥10.00
C18:2n6	≥2.00
C18:3n6 GLA	≥0.04
C18:3n3 ALA	≥0.01
C18:4n3	≥1.50
C20:0	≥0.05
C20:1	≥1.00
C20:2n6	≥0.05
C20:3n6	≥0.05
C20:4n6	≤0.50
C20:3n3	≥0.01
C20:4n3	≥0.20
C20:5n3 EPA	≥25.00
C22:0	≥0.01
C22:1	≥1.50
C22:2n6	≥0.03
C22:4n6	≥0.01
C22:5n6	≥0.01
C22:5n3 DPA	≥0.50
C22:6n3 DHA	≥10.00
C24:0	≥0.01
C24:1	≥0.05

5

Table 4 below also details the fatty acid composition of the total lipids of the extract.

TABLE 4

10

Fatty acid composition of total lipids of the extract

Saturated (g/100g lipid)	≥22.00
Monounsaturated (g/100g lipid)	≥11.00
Polyunsaturated (g/100g lipid)	≥35.00
Omega-3 (g/100g lipid)	≥30.00
Omega-6 (g/100g lipid)	≥1.00

Antioxidants present in the extract may include vitamin A (for example, all-trans retinol), vitamin E (for example, alpha-tocopherol), beta-carotene, astaxanthin (mainly esterified but non-esterified may be present), canthaxanthin and/or flavonoids. Antioxidants are preferably present in the extract in an amount of at least 20 and preferably at least 200 mg/100 ml.

Table 5 below details the lipids and other compounds (non-metal) of the extract.

10

TABLE 5

Lipid composition, vitamins A and E, pigments and flavonoids of the extract

Monoglycerides (MG) (g/100g sample)	≥0.7
Triglycerides (TG) (g/100g sample)	≥3.00
Free Fatty Acids (FFA) (g/100g sample)	≥5.00
Cholesterol (g/100g sample)	≤2.00
Total Phospholipids (PL) (g/100g sample)	≥40.00
Phosphatidyl Ethanolamine (PE) (g/100g sample)	≥2.50
Phosphatidyl Inositol (PI) (g/100g sample)	≥0.20
Phosphatidyl Serine (PS) (g/100g sample)	≥0.20
Phosphatidyl Choline (PC) (g/100g sample)	≥35.00
Sphingomyelin (g/100g sample)	≥0.50
Vitamin A (µg/100 ml)	≥1,400
Vitamin E (µg/100 ml)	≥15
Beta-Carotene (µg/100 ml)	≥1,600
Astaxanthin (mg/100 ml)	≥10
Canthaxanthin (mg/100ml)	≥10
Flavonoid (mg/100ml)	≥7.0

15

The metals present in the extract are preferably zinc and selenium. Zinc is preferably present in an amount of at least 0.05 mg/100g of extract while selenium is generally present in an amount of less than 3 mg/100g of extract.

20

Table 6 below details the metals content of the extract.

TABLE 6

Metal composition and solvent residue of the extract mixture

Zinc (mg/100g)	>0.1
Selenium (mg/100g)	<2
Solvent residue	<25 ppm

5

Table 7 below details the physiochemical characteristics of the extract.

TABLE 7

10

Physiochemical characteristics of the extract

Color	Red
Viscosity (cPs)	<1300
Odor	Fish

15

Extraction of the phospholipid composition from the biomass is generally carried out by a method similar to the one described in commonly owned PCT publication number WO 00/23546, published on April 27, 2000, the disclosure of which is incorporated herein by reference. The extraction is generally carried out by successive acetone and alcohol treatments. For the extraction of the instant application, the preferred

20

treatment involves the use of >60% acetone in the first extraction followed by extraction with a mixture of organic solvents at 65-95%/45-50% preferably acetone, ethyl acetate/ethanol mixture. The most preferred extraction solvent system is 100% acetone in the first extraction followed with a

25

95%/5% ethyl acetate/ethanol mixture. However, other ketones can also be used in combination with or in place of acetone. The alcohol can be other than ethanol, e.g., isopropanol or t-butanol. The acetate may also vary. Further, the ratio of alcohol to acetate may vary widely from 100:0 to 0:100. The

30

procedure produces two successive lipid fractions and a dry residue enriched in protein, including active enzymes.

- 32 -

Preferably, freshly harvested and finely divided marine and aquatic animal material is subjected to acetone extraction, for at least about two hours and preferably overnight. However, extraction time is not critical to the yield of lipid extracted. Particle sizes of comminuted crustacean less than 5 mm are preferred. The extraction is preferably conducted under an inert atmosphere and at a temperature of about 5 degrees Celsius or less. The mixture may be agitated during extraction and a volume ratio of about 6:1 of acetone to biomass is generally most preferred.

The solubilized lipid fraction is separated from the solid starting material by known techniques, for example, by filtration, centrifugation or sedimentation. Filtration is preferred. The residue is optionally washed with acetone to recover more lipid and the acetone removed by flash evaporation or spray drying. Water residue is allowed to separate from the lipid extract at low temperature.

The solid residue left on the filter from the initial extraction is suspended and extracted with 95/5 ethyl acetate/ethanol, preferably two volumes (original volume of material). The filtrate is evaporated yielding a second fraction of lipids. Extraction period is not critical although it is preferred to extract for about 30 minutes at a temperature below about 5 degrees Celsius.

Each phospholipid is subdivided into multiple categories depending on the fatty acids that are attached to the molecule. The biological activity, bioavailability as well as the value of phospholipids is determined by the purity and the source:

- 33 -

## a. Purity:

i. Optimal purity of the phospholipid or flavonoid of the invention is at least 99% by weight. The purity of the phospholipid or flavonoid after extraction from the krill may vary, but will normally be in the range of at least 90% to 100% of the/or mixture of phospholipid compound(s). Usually, the purity will be at least 95%. Preferably, the purity will be at least 96%, 97% or 98%. More preferably, the purity will be at least 99.5%. Most preferably, the purity will be at least 99.9%. By "purity" is meant that the phospholipid or flavonoid of the invention is isolated from other phospholipids, flavonoids, or components of the extract, to the weight percent specified. Isolation may be performed by e.g. HPLC. For example, a phospholipid that is 99% pure, contains less than 1% by weight of any material other than the specified phospholipid.

ii. Higher bioavailability and efficacy is achieved with higher purity.

iii. Phospholipid market value is directly analogous to the purity achieved for the final product.

## b. Source and fatty acid content:

i. The types of fatty acids attached to the phospholipid is widely dependent upon the source.

ii. Plant source phospholipids contain mainly palmitic acid (16:0), stearic acid (18:0), vaccenic acid (18:1), linoleic acid (18:2) or alpha-linoleic acid (18:3).

iii. Animal source phospholipids contain a higher percentage of longer-chain fatty acids with higher degree of unsaturation like homo-gamma-linoleic acid (20:3),

arachidonic acid (20:4), behenic acid (22:0) and docosahexanoic acid -DHA (22:6).

iv. Neptune Krill Oil™ (the present invention) phospholipids contain high quantities of eicosapentanoic acid -EPA (20:5) and docosahexanoic acid -DHA (22:6). Their fatty acid profile closely resembles that of human brain phospholipids.

v. The efficacy in human health and the value of phospholipids increases directly analogous to the length of the fatty acid chain and the degree of unsaturation. Therefore, phospholipids with more polyunsaturated fatty acids attached to them are more efficacious and of higher value.

vi. Arachidonic acid, although polyunsaturated, has been proven to predispose to inflammatory disease. Hence, moderate quantities are preferred.

vii. DHA and EPA are the two most active polyunsaturated fatty acids in the human body, contributing to all health benefits associated with omega-3 fatty acids.

viii. The highest quantities of polyunsaturated fatty acids contained in the phospholipids in the market today are:

a.	Arachidonic acid	:30.1%
b.	Homo-gamma-linolenic acid	:9.0%
c.	DHA	:8.4%

4. Pharmaceutical, nutraceutical and cosmetic compositions

The phospholipid extract of the present invention may be used with or without other additives. Preferably, no other additives are used. However, if other additives are used, pharmaceutical or nutraceutical formulations may be made by

- 35 -

methods known in the art. For example, the compositions of the present invention may be formulated in a conventional manner using one or more pharmaceutically or nutraceutically acceptable carriers. Thus, the extract may be formulated for oral administration. For oral administration, the pharmaceutical or nutraceutical compositions may take the form of, for example, tablets or capsules prepared by conventional means with pharmaceutically or nutraceutically acceptable excipients such as binding agents (e.g., pregelatinised maize starch, polyvinylpyrrolidone or hydroxypropyl methylcellulose); filters (e.g., lactose, microcrystalline cellulose or calcium phosphate); lubricants (e.g., magnesium stearate, talc or silica); disintegrants (e.g., potato starch or sodium starch glycollate); or wetting agents (e.g., sodium lauryl sulphate). The tablets may be coated by methods well known in the art. Liquid preparations for oral administration may take the form of, for example, solutions, syrups or suspensions, or they may be presented as a dry product for constitution with water or other suitable vehicle before use. Such liquid preparations may be prepared by conventional means with pharmaceutically or nutraceutically acceptable additives such as suspending agents (e.g., sorbitol syrup, methyl cellulose or hydrogenated edible fats); emulsifying agents (e.g., lecithin or acacia); non-aqueous vehicles (e.g., almond oil, oily esters or ethyl alcohol); and preservatives (e.g., methyl or propyl p-hydroxybenzoates or sorbic acid).

When the phospholipid extract of the inventions is used as a nutraceutical, it can be in the form of foods, beverages, energy bars, sports drinks, supplements or other forms all as are known in the art.

As noted above, the phospholipid extract of the invention is also useful in cosmetic preparations, e.g.,

- 36 -

moisturizing creams, sun-block products and other topical cosmetic products as known in the art.

The phospholipid extract of the present invention may be used in the treatment or prevention of a variety of disease states including: liver disease; chronic hepatitis; steatosis; liver fibrosis; alcoholism; malnutrition; chronic parenteral nutrition; phospholipid deficiency; lipid peroxidation; disarrhythmia of cell regeneration; destabilization of cell membranes; coronary artery disease caused by hypercholesterolemia; high blood pressure; menopausal or post-menopausal conditions; cancer, e.g., skin cancer; hypertension; aging; benign prostatic hyperplasia; kidney disease; edema; skin diseases; gastrointestinal diseases; peripheral vascular system diseases (e.g. leg ulcers); pregnancy toxemia; and neurodegenerative and psychiatric diseases (e.g. Parkinson's, Alzheimer's, autism, attention deficit disorder, learning disorders, mood disorders, bipolar depression, multiple sclerosis, muscular dystrophy).

The extracts are also useful for targeting tumors and can be used in conjunction with radioisotopes for diagnosing central nervous system tumors. The extract can also be used to reduce local fat deposits and reducing visible cellulite. The extract can also be used in aesthetics such as breast enlargement by acting on the lobular tissue of the breast and by increasing hydration of the breast.

As noted above, the present invention provides novel phospholipids derived from a marine or aquatic biomass. The novel phospholipids have the general formula (I):



- 37 -

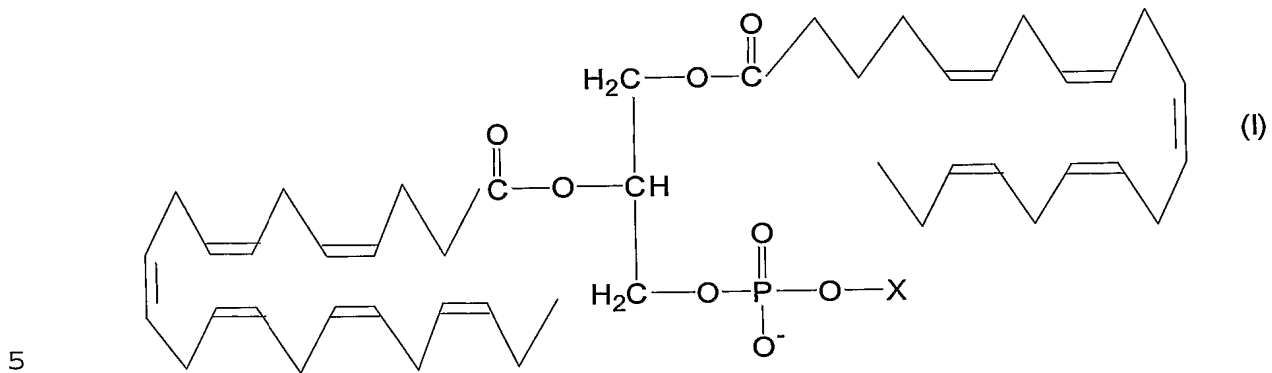

wherein X represents a moiety normally found in phospholipids, e.g.,  $-\text{CH}_2\text{CH}_2\text{N}(\text{CH}_3)_3$ ,  $\text{CH}_2\text{CH}_2\text{NH}_3$  or

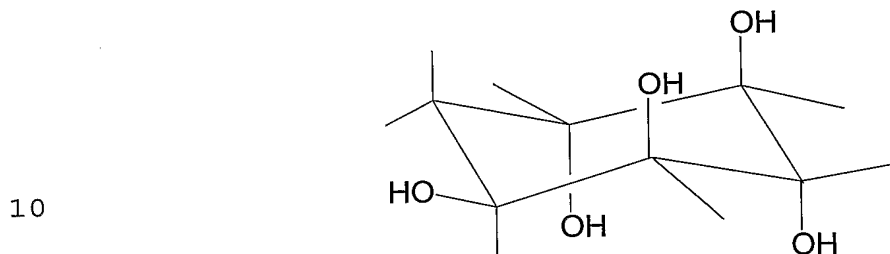

for phosphatidylcholine, phosphatidylethanolamine or phosphatidylinositol, respectively.

15 The left hand acid residue is derived from docosahexanoic acid (DHA) [C22:6n3]. The right hand acid residue is derived from eicosapentaenoic acid (EPA) [C20:5n3].

These novel phospholipids have all of the uses noted above for phospholipids in pharmaceutical, nutraceutical and cosmetic compositions.

20 As noted above, the present invention also provides a novel flavonoid compound derived from a marine or aquatic biomass. The novel flavonoid compound has the formula (II):

- 38 -

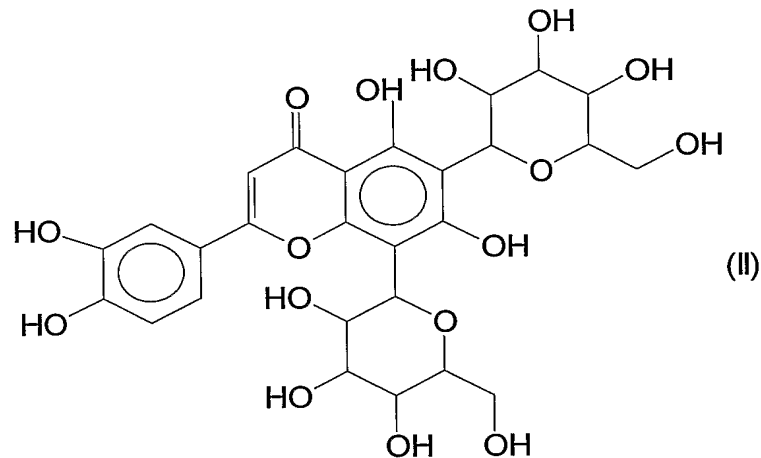

The novel flavonoid is an antioxidant and thus is useful in the pharmaceutical, nutraceutical and cosmetic compositions of the invention.

10 As used herein and in the claims, where the term "about" is used with a numerical value, the numerical value may vary by at least  $\pm 50\%$ . Preferably, the variation will be  $\pm 40\%$  or  $\pm 30\%$  and more preferably  $\pm 20\%$  or  $\pm 10\%$ . Even more preferred variations are in the range  $\pm 5\%$ ,  $\pm 4\%$ ,  $\pm 3\%$  or  $\pm 2\%$ . Most preferably, the variation is in the range of  $\pm 1\%$ .

15 Brief Description of the Drawings

Figs. 1 to 3 are chromatograms of the product of Example 1.

Fig. 4 is a mass spectrograph for characterizing the novel flavonoid compound (II).

20 The invention is further illustrated by the following non-limiting examples.

The extraction of the phospholipids for Example 1 was as described above for krill extractions.

Examples*Materials and Methods*

For analysis of lipids, samples were dissolved in solvent and standards were added. Lipid classes were isolated using silica gel and quantified. Fatty acid composition of total lipids and individual phospholipids was determined by gas chromatography. Pigments were measured by reversed phase high performance liquid chromatography.

Example 1

This example illustrates the isolation and molecular characterization of the phospholipids from the extract.

**Sample #804 molecular species determination**

The sample contains large amounts of phospholipids, mainly:

PC (438.48 mg/g lipid)  
PE (183.15 mg/g lipid)

Preliminary results were obtained only for these two phospholipid fractions.

**METHODS****Separation of main phospholipid fractions**

To obtain large quantities of PC and PE, separation was done by Thin Layer Chromatography (TLC) and bands identity was confirmed by HPLC.

**Diacylglycerol formation**

Both fractions (PC and PE) were incubated with phospholipase C, the enzyme which removes choline phosphate

from PC and ethanolamine phosphate from PE. The remaining diacylglycerols were extracted with ethyl ether.

**Benzoate derivatization**

Each mixture of diacylglycerols needed to be derivatized (using benzoic anhydride and 4-dimethyl-aminopyridine) to make further separation possible. In a parallel experiment, derivatization was done for three standard authentic diacylglycerols, dilinolein, diolein and dipalmitin.

**Subclass separation**

A preliminary separation of diacylglycerols derivatives into subclasses was done by TLC. Diacylglycerol derivatives obtained from PC and from PE separated into two major bands (#3 and #4). Additional bands #2 were also visible very close to the start. Only bands #3 and #4 were processed further because their localization corresponded to the localization of main band #2 obtained for a mixture of standards (benzoate derivatives of dilinolein, diolein and dipalmitin).

Example TLC plate separation

# 3		
#2	#4 (Rf = 0.37)	#4 (Rf = 0.37)
	#3 (Rf = 0.25)	#3 (Rf = 0.25)
	#2	#2
<b>Start Std mix</b>	<b>Start PC</b>	<b>Start PE</b>

20

HPLC fractionation

- 41 -

Bands #3 and #4 obtained for PC and PE were eluted and further separated into individual diacylglycerol species by HPLC. To confirm a number of peaks for the subsequent GC analysis, each peak was collected and separately re-run on  
5 HPLC.

Number of confirmed peaks:

For PC band #3, nine peaks were identified and confirmed.  
For PC band #4, nine peaks were identified and confirmed.  
For PE band #3, eight peaks were identified and confirmed.  
10 For PE band #4, eight peaks were identified and confirmed.

See Figure 1.

#### **Hydrolysis, methyl ester derivatization and GC analysis**

For both PC and PE, all confirmed peaks obtained from HPLC separation of band #3 were hydrolyzed and fatty acid  
15 profiles were determined by GC after conversion into methyl esters. Peak identity was assessed by mass spectrometry. Fatty acid profiles were compared to those obtained for intact PC and PE fractions subjected to hydrolysis and methylation.

#### **Results**

20 The peak surface areas calculated for fatty acid molecular species in selected fractions are summarized in Table 8. The peak fatty acid areas for intact PC and PE fraction are in Table 9. The representative Gas Chromatography profiles for an individual fraction and for intact phospholipid (PC) are  
25 presented in Table 10.

The Gas Chromatography profiles obtained for individual peaks were only partly consistent with profiles obtained for intact PC. They contained only 5-6 major peaks while Gas Chromatography profiles of intact phospholipids

consist of much higher number of peaks. Among the 5-6 peaks consistently found in molecular species profiles, only two had identity confirmed by mass spectrometry (C16:0 and C18:0). Among the remaining three peaks, one did not correspond to any fatty acid and two had retention times identical to those of authentic omega-3 fatty acids, EPA and DHA.

The C16:0 peak was prominent in all individual molecular species profiles and was also prominent in the intact phospholipid fractions. For the C18:0 peak, its proportions found in individual peaks were relatively high. Oleic acid (C18:1) was found at high levels in both PC and PE fatty acid profile.

TABLE 8

Molecular species peak areas obtained for selected fractions.

15

Fraction	C16:0	C18:0	EPA	RT 48.33	DHA
PC band #3 F1	205.27	57.79	42.76	103.83	62.07
PC band #3 F2	21.39	8.87	0	71.96	7.11
PC band #3 F3	58.74	17.70	0	45.64	14.75
PC band #3 F4	93.41	9.72	0	44.31	9.19
PC band #3 F5	19.87	9.67	4.56	46.89	3.96
PC band #3 F6	15.26	10.34	12.45	59.86	14.29
PC band #3 F7	28.32	10.93	30.70	56.83	25.12
PC band #3 F8	6.39	4.49	0	84.24	11.89
PC band #3 F9	14.65	8.21	8.60	58.95	28.22
PE band #3 F2	4.50	10.79	0	77.68	9.19
PE band #3 F3	26.85	22.14	14.45	49.62	21.76
PE band #3 F4	13.08	22.45	28.70	62.11	29.43
PE band #3 F5	22.42	20.34	11.06	100.79	30.61
PE band #3 F6	3.05	6.13	4.93	54.88	7.28

TABLE 9

Selected fatty acid peak areas of intact PC and PE

	C16:0	C18:0	C18:1	EPA	Un-identified	DHA
Retention time	15.80	21.66	22.36+22.63	39.68	48.34	53.59
PC	1141.36	35.75	257.99	642.50	68.61	192.22
PE	166.43	20.45	87.75	59.77	110.27	109.63

5

See Fig. 2

TABLE 10

The representative GC profiles for an individual fraction and for intact phospholipid (PE)

10

CH	PKNO	TIME	AREA	HEIGHT	MK	IDNO	CONC
1	5	0.826	17654310	1368301	E		21.8397
	13	2.637	11027760	1352920	E		13.6422
	14	2.916	2167386	203115	E		2.6812
	15	3.15	597812	87264	V		0.7395
	22	4.408	667991	60799	V		0.8264
	29	7.063	7293939	290768			9.0231
	30	8.397	144489	13997			0.1787
	32	9.933	32467398	1384059	E		40.1646
	33	10.252	8166303	661493	V		10.1023
	43	14.451	348072	20030			0.4306
	44	14.813	102126	9975			0.1263
	45	15.12	198366	21561			0.2454
<b>TOTAL</b>			<b>80835952</b>	<b>5474282</b>			<b>100</b>

See Fig. 3

Example 2

15 UVB-Induced Skin Cancer

Objectives

To evaluate the photoprotective potential of krill extract against UVB-induced skin cancer.

Study Design

Randomized control trial

Statistical significance  $p < 0.05$

Study Phase

5 Pre-clinical

Experimental Animals

Type: Nude Mice

Strain: C57BL6 Nude Congenic Mice - B6NU -T (heterozygotes)

10 (Preference of specific type because of proven susceptibility to skin cancer).

Study Protocol

Number of nude mice = 96

Randomization groups: 48 placebo: 16 per os

16 local application

15 16 per os and local application

48 krill extract: 16 per os

16 local application

16 per os and local application

20 In order to establish efficacy of krill extract for the prevention of skin cancer, the test was conducted as a randomized double blind controlled trial (both the pathologist and the research assistant were blind). Half of the mice were treated orally or topically or both with extract containing 100% by weight of krill extract and the other half underwent



- 45 -

the same method of treatment with a placebo. The groups were divided as follows:

Nutrition: Week 1: fat-free chow

Week 2-20: according to group

5 Experimental Design:

The mice were divided in six groups as follows:

Group A: fat-free chow with supplementation of soy extract  
(20% of total calories)

10 Group B: fat-free chow (100% of calories) + local application  
of soy extract 2 times per day

Group C: fat-free chow with supplementation of soy extract  
(20% of total calories) + local application of soy extract 2  
times per day

15 Group D: fat-free chow with supplementation of krill extract  
(20% of total calories)

Group E: fat-free chow (100% of calories) + local application  
of krill extract 2 times per day

20 Group F: fat-free chow with supplementation of krill extract  
(20% of total calories) + local application of krill extract 2  
times per day

Week 2-20: UVB radiation using a fluorescent test lamp,  
emission spectrum 270 - 400 nm.

Week 3-20: liquid from blisters formed is examined for PGE2  
levels

Week 3-20: mice are anaesthetized with ether and sacrificed when malignant tumours have formed or at the end of the 20 weeks.

5 Skin is examined by pathologist for signs of carcinogenesis.

The results are shown in the following Table 11.

TABLE 11

Application	Frequency of cancer	
	Krill Oil Frequency %	Placebo Frequency %
Oral	13	69.3
Topical	0	63.8
Oral & Topical	0	37.5

10

In conclusion, the results of the present study demonstrate that both oral and topical krill extract maybe effectively used for the protection of skin against the harmful effects of UVB radiation including skin cancer.

15 Example 3

This example illustrates the use of the present krill extract in improving dyslexia and abnormal motor function in a 7 year old girl.

20 2g per day of the krill extract were given to a year old girl suffering from dyslexia and abnormal motor function. After 1.5 months, she showed:

- Increased learning ability (blind observation by psychologist)
- Improved motor function (moderate ice skating)
- Improved social skills
- Improved speech

25

Accordingly, the krill extract has beneficial neurological properties.

- 47 -

All publications cited in this specification are herein incorporated by reference as if each individual publication were specifically and individually indicated to be incorporated by reference. The citation of any publication is  
5 for its disclosure prior to the filing date and should not be construed as an admission that the present invention is not entitled to antedate such publication by virtue of prior invention.

Although the foregoing invention has been described  
10 in some detail by way of illustration and example for purposes of clarity of understanding, it is readily apparent to those of ordinary skill in the art in light of the teachings of this invention that certain changes and modifications may be made thereto without departing from the spirit or scope of the  
15 appended claims.

References

1. Lisa Colodny, Pharm D. and Ronald L. Hoffman, M.D. *Altern Med Rev* 1998;3(6):432-447.
- 5 2. Vandal R. Role of inositol in the treatment of psychiatric disorders. *CNS Drugs* 1997;7:6-16.
3. Gill DL, Ghosh TK, Mullaney JM. Calcium signaling mechanisms in endoplasmic reticulum activated by inositol 1,4,5 triphosphate and GTP. *Cell Calcium* 1989;10:363-374.
- 10 4. Parthasarathy L, Vadnal R, Parthasarathy R, et al. Biochemical and molecular properties of lithium-sensitive myo-inositol monophosphatase. *Life Sci* 1994;54:1127-1142.
- 15 5. Kitamura H, Yamauchi A, Sugiura T, et al. Inhibition of myo-inositol transport causes acute renal failure with selective medullary injury in the rat. *Kidney Int* 1998;53:146-153.
6. Barkai A, Dunner D, Gross H, et al. Reduced myo-inositol levels in cerebrospinal fluid from patients with affective disorder. *Biol Psychiatry* 1978;13:65-72.
- 20 7. Levine J, Rapaport A, Lev L, et al. Inositol treatment raises CSF inositol levels. *Brain Research* 1993;627:168-169.
8. Levine J. Controlled trials of inositol in psychiatry. *Eur Neuropsychopharmacol* 1997;7:147-155.
- 25 9. Cohen H, Kotler M, Kaplan Z, et al. Inositol has behavioral effects with adaptation after chronic administration. *J Neural Transm* 1997;104:299-305.
10. Levine J, Barak Y, Gonzalves M, et al. Double-blind, controlled trial of inositol treatment of depression. *Am J Psychiatry* 1995;152:792-794.
- 30 11. Levine J, Barak Y, Kofman O, et al. Follow-up and relapse of an inositol study of depression. *Isr J Psychiatry Relat Sci* 1995;32:14-21.
- 35 12. Benjamin J, Levine J, Fux M, et al. Double-blind, placebo-controlled, crossover trial of inositol treatment for panic disorder. *Am J Psychiatry* 1995;15:1084-1086.
13. Birchall J, Chappell J. Aluminum, chemical physiology, and Alzheimer's disease. *Lancet* 1988;29:1008-1010.

14. Cheng D, Ren H, Tang X. Huperzine A. A novel promising acetylcholinesterase inhibitor. *Neuroreport* 1996;8:97-101.
15. Kawakami Y, Inoue A, Kawai T, et al. The rationale for E2020 as a potent acetylcholinesterase inhibitor. *Bioorg Med Chem* 1996;4:1429-1446.
16. Knopman D, Schneider L, Davis K, et al. Long term tacrine (Cognex) treatment: effects on nursing home placement and mortality, tacrine study group. *Neurology* 1996;47:166-167.
17. Mohr E, Nair N, Sampson M, et al. Treatment of Alzheimer's disease with sabeluzole: functional and structural correlates. *Clin Neuropharmacol* 1997;20:338-345.
18. Rogers S, Friedhoff L. The efficacy and safety of donepezil in patients with Alzheimer's disease: results of a US multicentre, randomized, double-blind, placebo-controlled trial. The donepezil study group. *Dementia* 1996;7:293-303.
19. Schneider L, Farlow M, Pogoda J. Potential role for estrogen replacement in the treatment of Alzheimer's dementia. *Am J Med* 1997;103:46S-50S.
20. Van Dyck C, Lin C, Robinson R, et al. The acetylcholine releaser linopiridine increases parietal regional cerebral blood flow in Alzheimer's disease. *Psychopharmacology* 1997;132:217-226.
21. Barak Y, Levine J, Glasman A, et al. Inositol treatment of Alzheimer's disease: a double blind, cross-over placebo controlled trial. *Prog Neuropsychopharmacol Biol Psychiatry* 1996;20:729-735.
22. Michael D. Seidman, MD., FACS Polyunsaturated Phosphatidylcholine in NT Factor™ Improves Mitochondrial Function, Auditory Sensitivity and May Slow Some Aspects of the Aging Processes. *Anti-aging Medical News*, winter 2001-01.
23. Imperato A, Ramacci MT, Angelucci L. Acetyl L-carnitine enhances acetylcholine release in the striatum and hippocampus of awake freely moving rats. *Neuroscience letters*. 1989: 107(1-3): 251-255.
24. Ghirardi O, Milano S, Ramacci MT, Angelucci L. Effects of acetyl L-carnitine chronic treatment on discrimination models in aged rats. *Physiol. Behav.* 1988;44(6): 769-773.
25. Caprioli A, Ghirardi O, Ramacci MT, Angelucci L. Age-dependent deficits in radial maze performance in the rat:

- 50 -

- effect of chronic treatment with acetyl L-carnitine. Prog. in Neuropsychopharmacol. Biol. Psychiatr. 1990;14(3):3 59-369.
- 5 26. Bast A and Haenen GRMM. Interlay between lipoic acid and glutathione in the protection against microsomal lipid peroxidation. Biochem. Biophys. Acta. 1988; 963: 558-561.
27. Suzuki YJ, Aggarwal B, Packer L. Alpha-lipoic acid is a potent inhibitor of NFkB activation in human Tcells. Biochem. Biophys. Res. Commun. 1992; 189:1709-1715.
- 10 28. Kagan VE, Shvedova A, Serbinova E, Khan S, Swanson C, Poweel R, Packer L. Dihydrolipoic acid: A universal antioxidant both in the membrane and in the aqueous phase. Biochem Pharmacol. 1992; 44: 1637-1649.
- 15 29. Devasagayam TP, Subramanian M, Pradhan DS, Sies H. Chemical Biological Interactions. 1993; 86: 79-92.
30. Gadaleta MN, Petruzalla V, Daddabbo L, et al. Mitochondrial DNA transcription and translation in aged rat. Effect of acetyl-L-carnitine. Ann.N.Y. Acad. Sci. 1994; 717: 150-160.
- 20 31. Paradies G, Ruggiero FM, Petrosillo G, Gadaleta MN, Quaglieriello E. Carnitine-acylcarnitine translocase activity in cardiac mitochondria from aged rats: the effect of acetyl-L-carnitine. Mech. of aging and develop. 1995; 84(2):103-112.
- 25 32. Aureli T, Miccheli A, Ricciolini R, Di Cocco M, et al. Aging brain: effect of acetyl L-carnitine treatment on rat brain energy and phospholipid metabolism. A study by <sup>31</sup>P and <sup>1</sup>H NMR spectroscopy. Brain Research. 1990; 526(1):108-112.
- 30 33. Sebinova E, Khwaja S, Reznick AZ, Packer L. Thiocctic acid protects against ischemia-reperfusion injury in the isolated perfused Langendorif heart. Free Rad. Res. Commun. 1994; 17: 49-58.
- 35 34. Seidman MD, Khan MJ, Bai U, Shirwany N, Quirk WS. Biologic Activity of Mitochondrial Metabolites on Aging and Age-Related Hearing Loss. Am. J. Otol. 2000;21:161-167.

CLAIMS:

1. A phospholipid of the general formula (I):

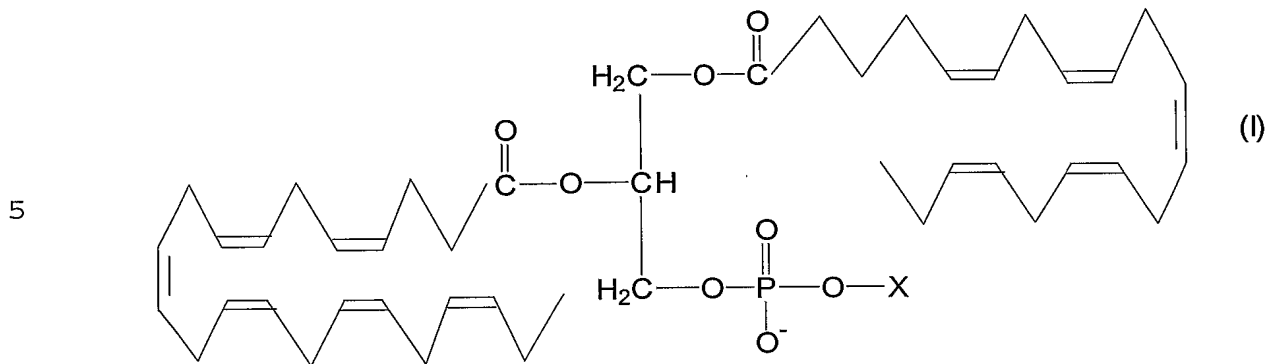

wherein X represents a moiety normally found in a phospholipid.

10 2. A phospholipid of the general formula (I) as defined in claim 1, wherein X is  $-\text{CH}_2\text{CH}_2\text{NH}_3$ ,  $-\text{CH}_2\text{CH}_2\text{N}(\text{CH}_3)_3$  or

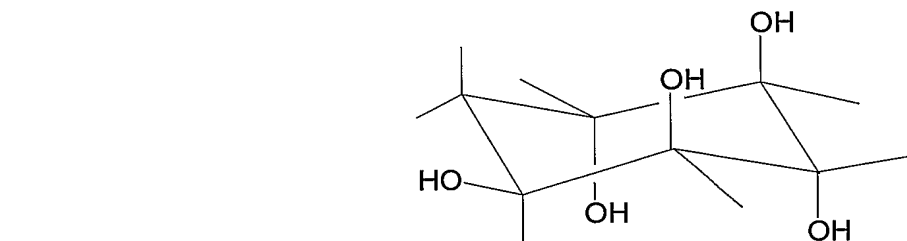

3. The flavonoid of formula (II):

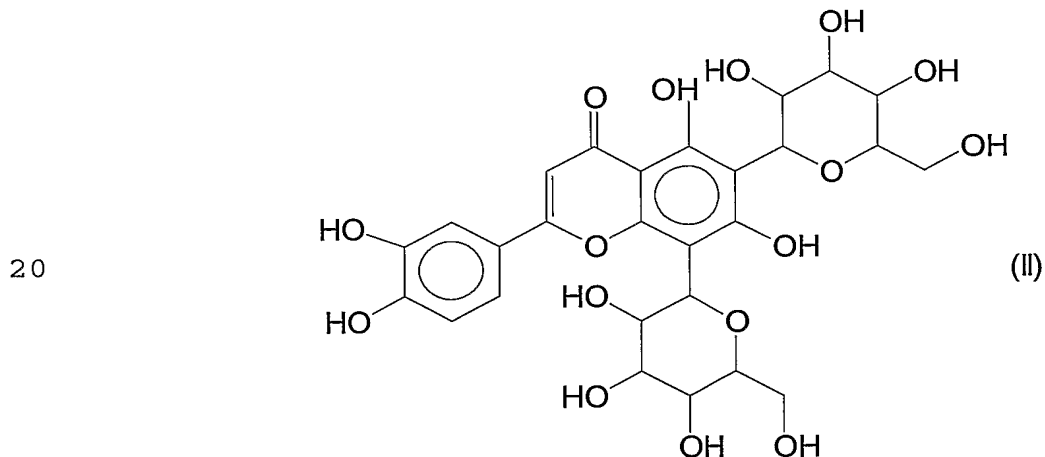

- 52 -

4. A phospholipid extract derived from a marine or aquatic biomass, comprising phospholipids, wherein at least one phospholipid is as defined in claim 1 or 2.
5. A phospholipid extract as defined in claim 4,  
5 wherein the biomass is crustaceans.
6. A phospholipid extract as defined in claim 4,  
wherein the biomass is zooplankton.
7. A phospholipid extract as defined in claim 6,  
wherein the zooplankton is krill.
- 10 8. A phospholipid extract as defined in any one of  
claims 4 to 7, wherein the extract is derived from initial  
processing of the biomass.
9. A phospholipid extract as defined in claim 8,  
wherein the extract is derived from the biomass grease.
- 15 10. A phospholipid extract as defined in any one of  
claims 4 to 9, comprising at least about 40% w/w  
phospholipids.
11. A phospholipid extract as defined in claim 10,  
comprising at least about 45% w/w phospholipids.
- 20 12. A phospholipid extract as defined in claim 11,  
comprising from about 45 to 60% w/w phospholipids.
13. A phospholipid extract as defined in any one of  
claims 4 to 12, comprising phosphatidylcholine,  
phosphatidylethanolamine, phosphatidylinositol,  
25 phosphatidylserine, sphingomyelin or a mixture thereof.
14. A phospholipid extract as defined in any one of  
claims 4 to 13, wherein the phospholipids comprise  
saturated, monounsaturated or polyunsaturated fatty acids.



- 53 -

15. A phospholipid extract as defined in claim 14, wherein the polyunsaturated fatty acids are selected from the group consisting of omega-3 and omega-6 fatty acids.

16. A phospholipid extract as defined in claim 14,  
5 wherein the polyunsaturated fatty acids are selected from the group consisting of docosahexaenoic acid (DHA), eicosapentaenoic acid (EPA), myristic acid, myristoleic acid, lignoceric acid, linolenic acid, alpha linolenic acid, nervonic acid, linoleic acid, oleic acid, stearic acid,  
10 palmitic acid and palmitoleic acid.

17. A phospholipid extract as defined in any one of claims 4 to 16, wherein the phospholipids further comprise an additional lipid component.

18. A phospholipid extract as defined in claim 17,  
15 wherein the additional lipid component is a monoglyceride, triglyceride, cholesterol or a mixture thereof.

19. A phospholipid extract as defined in any one of claims 4 to 18, further comprising at least about 4% w/w of free fatty acids.

20 20. A phospholipid extract as defined in claim 14, comprising at least about 5% w/w of free fatty acids.

21. A phospholipid extract as defined in any one of claims 4 to 20, wherein polyunsaturated fatty acids comprise at least about 15% w/w of the total lipids in the extract.

25 22. A phospholipid extract as defined in claim 21, wherein polyunsaturated fatty acids comprise at least about 40% w/w of the total lipids in the extract.

- 54 -

23. A phospholipid extract as defined in claim 22, wherein polyunsaturated fatty acids comprise at least about 45% w/w of the total lipids in the extract.

24. A phospholipid extract as defined in claims 21, 22  
5 or 23, wherein the polyunsaturated fatty acids are omega-3 fatty acids.

25. A phospholipid extract as defined in any one of claims 4 to 24, wherein DHA and EPA comprise at least about 32% w/w of the total lipids in the extract.

10 26. A phospholipid extract as defined in claim 25, wherein DHA and EPA comprise at least about 35% w/w of the total lipids in the extract.

27. A phospholipid extract as defined in any one of claims 4 to 26, further comprising an antioxidant.

15 28. A phospholipid extract as defined in claim 27, wherein the antioxidant comprises 20 mg/100 ml of the extract.

29. A phospholipid extract as defined in claim 27 or 28, wherein the antioxidant is selected from the group  
20 consisting of vitamin A, vitamin E, beta-carotene, astaxanthin, canthaxanthin, flavonoids and a mixture thereof.

30. A phospholipid extract as defined in claim 29, wherein the vitamin A is all-trans retinol, the vitamin E is  
25 alpha-tocopherol, the astaxanthin is mainly esterified and the flavonoids comprise the flavonoid of claim 3.

31. A phospholipid extract as defined in any one of claims 1 to 30, further comprising a metal.

- 55 -

32. A phospholipid extract as defined in claim 31, wherein the metal is zinc, selenium or a mixture thereof.

33. A phospholipid extract as defined in claim 32, wherein the zinc comprises at least 0.05 mg/100g of the extract and the selenium comprises less than 3mg/100g of the extract.

34. A phospholipid extract as defined in any one of claims 4 to 33, wherein the fatty acid composition of the lipids in the extract is about:

10

Fatty Acids	Total PL FA%	PC FA%	PE FA%
C14:0 MYRISTIC	2	2	0.7
C14:1 MYRISTOLEIC	1		
C15:0 PENTADECANOIC	0.2	0.3	0.3
C16:0 PALMITIC	24	27	24
C16:1 PALMITOLEIC	2	2	0.7
C18:0 STEARIC	1	1	3
C18:1 OLEIC	9	12	24
C18:2n6 LINOLEIC	2	2	0.8
C18:3n6 GLA	1	0.3	
C18:3n3 ALA	1	1	
C18:4n3 OTA	2	2	0.3
C20:0 ARACHIDIC			
C20:1 cis-11-EICOSENOIC	0.5	0.6	0.7
C20:2n6 EICOSADIENOIC			
C20:3n6 METHYL ETA		0.2	
<b>C20:4n6 ARACHIDONIC</b>	<b>0.6</b>	<b>0.7</b>	<b>0.6</b>
C20:3n3 Homo- $\gamma$ -LINOLENIC			
C20:4n3			
<b>C20:5n3 EPA</b>	<b>27</b>	<b>32</b>	<b>13</b>
C22:0 BEHENIC			
C22:1 ERUCIC	1	1.5	
C22:2n6			
C22:4n6			
C22:5n6 METHYL DPA			
C22:5n3 DPA		1.00	
<b>C22:6n3 DHA</b>	<b>25</b>	<b>14</b>	<b>32</b>
C24:0 LIGNOCERIC			
C24:1 NERVONIC			
Total	100.0	100	100

35. A phospholipid extract as defined in claim 34, wherein the total fatty acid composition of all the lipids in the extract is about:

Sample	%
Fatty Acid Composition	
C14:0	≥3.00
C14:1	≥0.01
C15:0	≥0.3
C16:0	≥20.00
C16:1	≥3.25
C18:0	≥1.00
C18:1	≥10.00
C18:2n6	≥2.00
C18:3n6 GLA	≥0.04
C18:3n3 ALA	≥0.01
C18:4n3	≥1.50
C20:0	≥0.05
C20:1	≥1.00
C20:2n6	≥0.05
C20:3n6	≥0.05
C20:4n6	≤0.50
C20:3n3	≥0.01
C20:4n3	≥0.20
C20:5n3 EPA	≥25.00
C22:0	≥0.01
C22:1	≥1.50
C22:2n6	≥0.03
C22:4n6	≥0.01
C22:5n6	≥0.01
C22:5n3 DPA	≥0.50
C22:6n3 DHA	≥10.00
C24:0	≥0.01
C24:1	≥0.05

5

36. A phospholipid extract as defined in claim 35, wherein the total fatty acid composition of all the lipids further is about:

Saturated (g/100g lipid)	≥22.00
Monounsaturated (g/100g lipid)	≥11.00
Polyunsaturated (g/100g lipid)	≥35.00
Omega-3 (g/100g lipid)	≥30.00
Omega-6 (g/100g lipid)	≥1.00

- 57 -

37. A phospholipid extract as defined in any one of claims 4 to 36, comprising about:

Monoglycerides (MG) (g/100g sample)	$\geq 0.7$
Triglycerides (TG) (g/100g sample)	$\geq 3.00$
Free Fatty Acids (FFA) (g/100g sample)	$\geq 5.00$
Cholesterol (g/100g sample)	$\leq 2.00$
Total Phospholipids (PL) (g/100g sample)	$\geq 40.00$
Phosphatidyl Ethanolamine (PE) (g/100g sample)	$\geq 2.50$
Phosphatidyl Inositol (PI) (g/100g sample)	$\geq 0.20$
Phosphatidyl Serine (PS) (g/100g sample)	$\geq 0.20$
Phosphatidyl Choline (PC) (g/100g sample)	$\geq 35.00$
Sphingomyelin (g/100g sample)	$\geq 0.50$
Vitamin A ( $\mu\text{g}/100 \text{ ml}$ )	$\geq 1,400$
Vitamin E ( $\mu\text{g}/100 \text{ ml}$ )	$\geq 15$
Beta-Carotene ( $\mu\text{g}/100 \text{ ml}$ )	$\geq 1,600$
Astaxanthin (mg/100 ml)	$\geq 10$
Canthaxanthin (mg/100ml)	$\geq 10$
Flavonoid (mg/100ml)	$> 7.0$

5 38. A pharmaceutical composition comprising a phospholipid extract as defined in any one of claims 4 to 37, and a pharmaceutically acceptable carrier, diluent or excipient.

10 39. A nutraceutical composition comprising a phospholipid extract as defined in any one of claims 4 to 37.

40. A cosmetic composition comprising a phospholipid extract as defined in any one of claims 4 to 37.

15 41. Use of a phospholipid extract as defined in any one of claims 4 to 37, for preparing a medicament.

- 58 -

42. Use of a phospholipid extract as defined in any one of claims 4 to 37, for preparing a nutraceutical composition.

43. Use of a phospholipid extract as defined in any one of claims 4 to 37, for preparing a cosmetic.

44. Use of a phospholipid extract as defined in any one of claims 4 to 37, for the prevention or treatment of a disease or disorder.

45. Use of claim 44, wherein the disease or disorder is liver disease, chronic hepatitis, steatosis, liver fibrosis, alcoholism, malnutrition, chronic parenteral nutrition, phospholipid deficiency, lipid peroxidation, disarrhythmia of cell regeneration, destabilization of cell membranes, coronary artery disease caused by hypercholesterolemia, high blood pressure, menopausal or post-menopausal conditions, cancer, hypertension, ageing, benign prostatic hyperplasia, kidney disease, edema, skin diseases, gastrointestinal diseases, peripheral vascular system diseases, pregnancy toxemia and neurodegenerative and psychiatric diseases.

46. Use of claim 45, wherein the peripheral vascular system disease is ulcers, and the neurodegenerative or psychiatric disease is Parkinson's, Alzheimer's, autism, attention deficit disorder, learning disorders, mood disorders, bipolar depression, multiple sclerosis or muscular dystrophy.

47. Use of claim 45, wherein the cancer is skin cancer and the use of the extract is oral or topical.

48. Use of claim 44, wherein the disease or disorder is dyslexia and abnormal motor function.

- 59 -

49. Use of a phospholipid extract as defined in any one of claims 4 to 37, in conjunction with a radioisotope for diagnosing or targeting tumors.

50. Use of claim 49, wherein the tumors are central  
5 nervous system tumors.

51. Use of a phospholipid extract as defined in any one of claims 4 to 37, for reducing local fat deposits and for reducing visible cellulite.

52. Use of a phospholipid extract as defined in any  
10 one of claims 4 to 37, for aesthetic enhancement.

53. Use of claim 52, wherein the aesthetic enhancement is breast enlargement.

54. A commercial package, comprising: a  
pharmaceutical, nutraceutical or cosmetic composition as  
15 defined in claim 38, 39 or 40; and instructions associated therewith for use of the pharmaceutical, nutraceutical or cosmetic compositions.

1/4

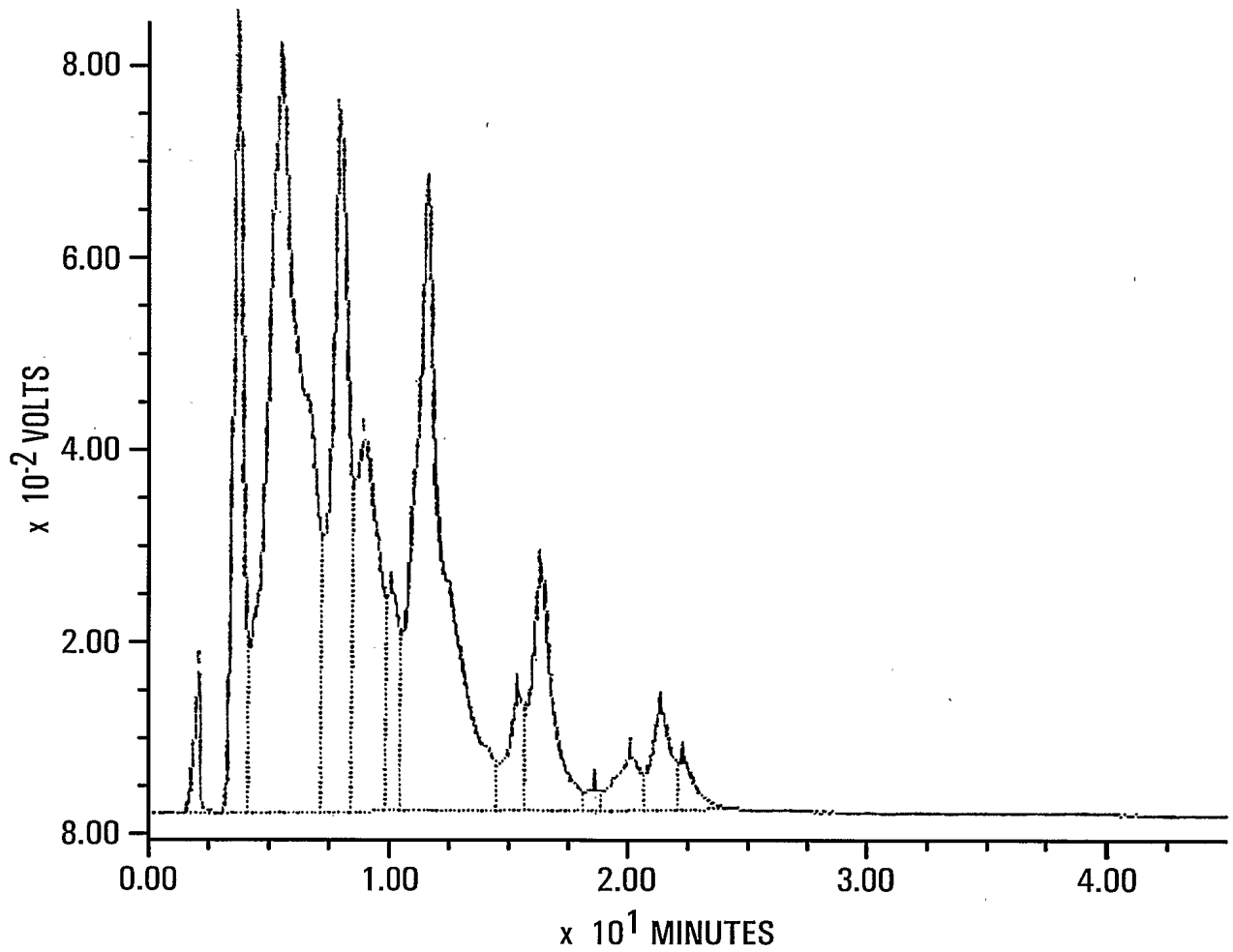

**Fig. 1**



2/4

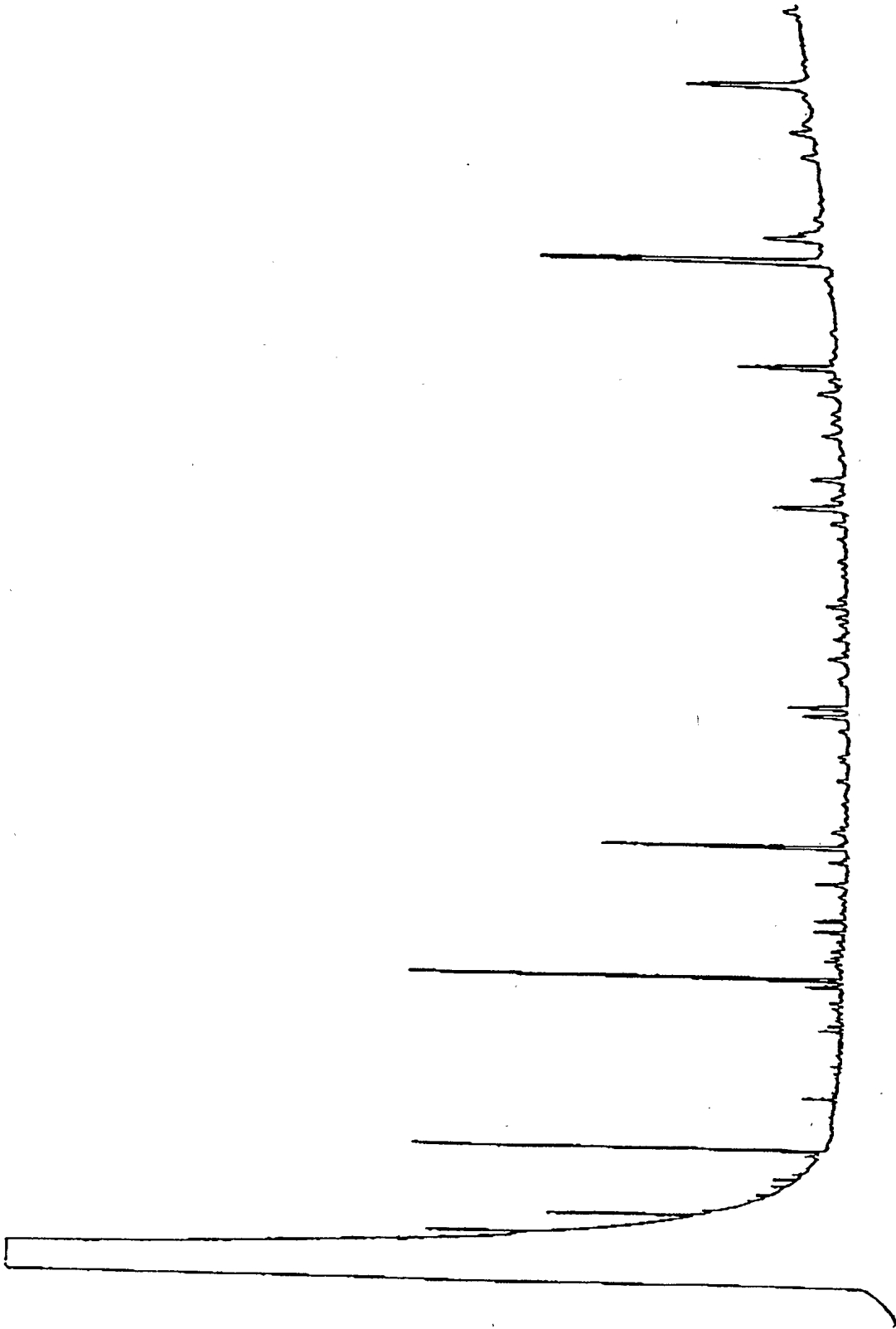

Fig. 2

3/4

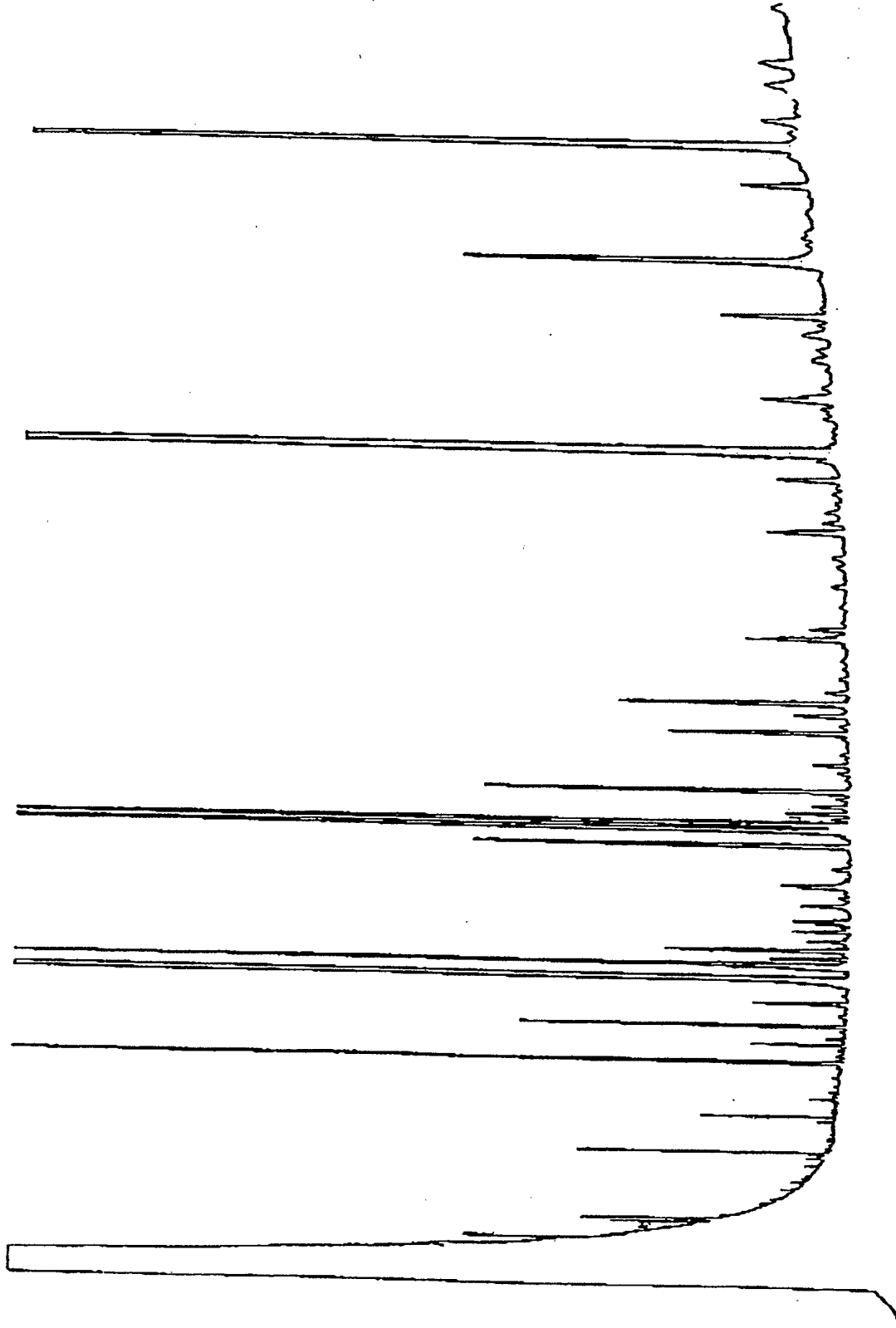

Fig. 3

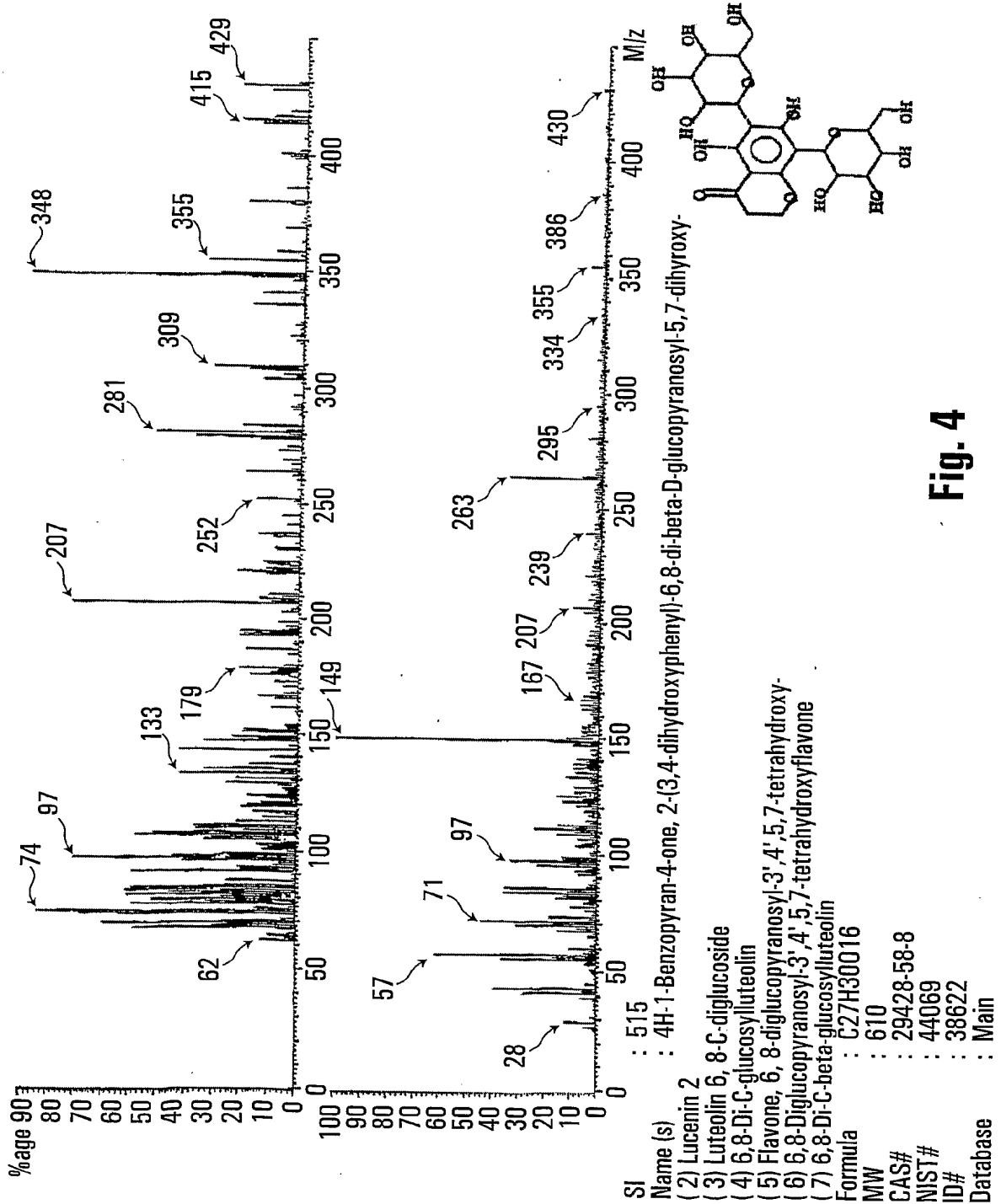

Fig. 4

(12) INTERNATIONAL APPLICATION PUBLISHED UNDER THE PATENT COOPERATION TREATY (PCT)

(19) World Intellectual Property Organization  
International Bureau



(43) International Publication Date  
13 February 2003 (13.02.2003)

PCT

(10) International Publication Number  
**WO 03/011873 A3**

(51) International Patent Classification<sup>7</sup>: C07F 9/10, C07D 407/14, A23J 7/00, A61K 31/683, 31/685, A61P 25/00, 35/00, A61K 7/00, C11B 1/10

(21) International Application Number: PCT/CA02/01185

(22) International Filing Date: 29 July 2002 (29.07.2002)

(25) Filing Language: English

(26) Publication Language: English

(30) Priority Data:  
60/307,842 27 July 2001 (27.07.2001) US

(71) Applicant (for all designated States except US): **NEPTUNE TECHNOLOGIES & BIORESSOURCES INC.** [CA/CA]; 500, St-Martin Boulevard West, Suite 550, Laval, Québec H7M 3Y2 (CA).

(72) Inventor; and

(75) Inventor/Applicant (for US only): **SAMPALIS, Fotini** [CA/CA]; 1348 Elizabeth Boulevard, Laval, Quebec H7W 3J8 (CA).

(74) Agents: **SABET, Sohrab** et al.; Smart & Biggar, 1000 de la Gauchetière Ouest, Suite 3400, Montréal, Quebec H3B 4W5 (CA).

(81) Designated States (national): AE, AG, AL, AM, AT, AU, AZ, BA, BB, BG, BR, BY, BZ, CA, CH, CN, CO, CR, CU, CZ, DE, DK, DM, DZ, EC, EE, ES, FI, GB, GD, GE, GH, GM, HR, HU, ID, IL, IN, IS, JP, KE, KG, KP, KR, KZ, LC, LK, LR, LS, LT, LU, LV, MA, MD, MG, MK, MN, MW, MX, MZ, NO, NZ, OM, PH, PL, PT, RO, RU, SD, SE, SG, SI, SK, SL, TJ, TM, TN, TR, TT, TZ, UA, UG, US, UZ, VN, YU, ZA, ZM, ZW.

(84) Designated States (regional): ARIPO patent (GH, GM, KE, LS, MW, MZ, SD, SL, SZ, TZ, UG, ZM, ZW), Eurasian patent (AM, AZ, BY, KG, KZ, MD, RU, TJ, TM), European patent (AT, BE, BG, CH, CY, CZ, DE, DK, EE, ES, FI, FR, GB, GR, IE, IT, LU, MC, NL, PT, SE, SK, TR), OAPI patent (BF, BJ, CF, CG, CI, CM, GA, GN, GQ, GW, ML, MR, NE, SN, TD, TG).

**Published:**

- with international search report
- before the expiration of the time limit for amending the claims and to be republished in the event of receipt of amendments

(88) Date of publication of the international search report:  
1 May 2003

For two-letter codes and other abbreviations, refer to the "Guidance Notes on Codes and Abbreviations" appearing at the beginning of each regular issue of the PCT Gazette.



**WO 03/011873 A3**

(54) Title: NATURAL MARINE SOURCE PHOSPHOLIPIDS COMPRISING FLAVONOIDS, POLYUNSATURATED FATTY ACIDS AND THEIR APPLICATIONS

(57) Abstract: A phospholipid extract from a marine or aquatic biomass possesses therapeutic properties. The phospholipid extract comprises a variety of phospholipids, fatty acid, metals and a novel flavonoid.

INTERNATIONAL SEARCH REPORT

International Application No  
PCT/CA 02/01185

A. CLASSIFICATION OF SUBJECT MATTER

IPC 7 C07F9/10 C07D407/14 A23J7/00 A61K31/683 A61K31/685  
A61P25/00 A61P35/00 A61K7/00 C11B1/10

According to International Patent Classification (IPC) or to both national classification and IPC

B. FIELDS SEARCHED

Minimum documentation searched (classification system followed by classification symbols)  
IPC 7 C07F C07D A23J A61K A61P C11B

Documentation searched other than minimum documentation to the extent that such documents are included in the fields searched

Electronic data base consulted during the international search (name of data base and, where practical, search terms used)

CHEM ABS Data, EPO-Internal

C. DOCUMENTS CONSIDERED TO BE RELEVANT

Category °	Citation of document, with indication, where appropriate, of the relevant passages	Relevant to claim No.
X	HOSOKAWA, MASASHI ET AL: "Conversion to Docosahexaenoic Acid-Containing Phosphatidylserine from Squid Skin Lecithin by Phospholipase D-Mediated Transphosphatidylation" JOURNAL OF AGRICULTURAL AND FOOD CHEMISTRY (2000), 48(10), 4550-4554, October 2000 (2000-10), XP002219096 the whole document	1,2,4-37
X	HENDERSON, R. J. ET AL: "Lipid composition of the pineal organ from rainbow trout (Oncorhynchus mykiss)" LIPIDS (1994), 29(5), 311-17, 1994, XP008009561 table 4, first compound	1,2,4-37
	-/--	

Further documents are listed in the continuation of box C.

Patent family members are listed in annex.

° Special categories of cited documents :

- "A" document defining the general state of the art which is not considered to be of particular relevance
- "E" earlier document but published on or after the international filing date
- "L" document which may throw doubts on priority claim(s) or which is cited to establish the publication date of another citation or other special reason (as specified)
- "O" document referring to an oral disclosure, use, exhibition or other means
- "P" document published prior to the international filing date but later than the priority date claimed

- "T" later document published after the international filing date or priority date and not in conflict with the application but cited to understand the principle or theory underlying the invention
- "X" document of particular relevance; the claimed invention cannot be considered novel or cannot be considered to involve an inventive step when the document is taken alone
- "Y" document of particular relevance; the claimed invention cannot be considered to involve an inventive step when the document is combined with one or more other such documents, such combination being obvious to a person skilled in the art.
- "&" document member of the same patent family

Date of the actual completion of the international search

1 November 2002

Date of mailing of the international search report

20 02 2003

Name and mailing address of the ISA

European Patent Office, P.B. 5818 Patentlaan 2  
NL - 2280 HV Rijswijk  
Tel. (+31-70) 340-2040, Tx. 31 651 epo nl,  
Fax: (+31-70) 340-3016

Authorized officer

BESLIER, L

## C.(Continuation) DOCUMENTS CONSIDERED TO BE RELEVANT

Category *	Citation of document, with indication, where appropriate, of the relevant passages	Relevant to claim No.
X	BELL, M. V. ET AL: "Molecular species composition of the major diacyl glycerophospholipids from muscle, liver, retina and brain of cod (Gadus morhua)" LIPIDS (1991), 26(8), 565-73, 1991, XP008009562 table 1, compound 2; table 2, compound 1; table 3, compound 1; table 4, compound 1 ---	1,2,4-37
X	WIEGAND, REX D. ET AL: "Phospholipid molecular species of frog rod outer segment membranes" EXP. EYE RES. (1983), 37(2), 159-73, 1983, XP008009560 table VIII, see polyenes ---	1,2,4-37
X	WO 97 39759 A (BRIGHAM AND WOMEN'S HOSPITAL) 30 October 1997 (1997-10-30) the whole document ---	1,2,38, 41,44-46
Y	EP 0 609 078 A (SCOTIA HOLDINGS PLC) 3 August 1994 (1994-08-03) the whole document ---	1-54
Y	WO 00 23546 A (UNIVERSITÉ DE SHERBROOKE) 27 April 2000 (2000-04-27) cited in the application the whole document ---	1-54
Y	WO 92 21335 A (KABI PHARMACIA AB) 10 December 1992 (1992-12-10) cited in the application the whole document -----	1-54

INTERNATIONAL SEARCH REPORT

International application No.  
PCT/CA 02/01185

**Box I Observations where certain claims were found unsearchable (Continuation of item 1 of first sheet)**

This International Search Report has not been established in respect of certain claims under Article 17(2)(a) for the following reasons:

- 1.  Claims Nos.:  
because they relate to subject matter not required to be searched by this Authority, namely:
  
- 2.  Claims Nos.:  
because they relate to parts of the International Application that do not comply with the prescribed requirements to such an extent that no meaningful International Search can be carried out, specifically:
  
- 3.  Claims Nos.:  
because they are dependent claims and are not drafted in accordance with the second and third sentences of Rule 6.4(a).

**Box II Observations where unity of invention is lacking (Continuation of item 2 of first sheet)**

This International Searching Authority found multiple inventions in this international application, as follows:

see additional sheet

- 1.  As all required additional search fees were timely paid by the applicant, this International Search Report covers all searchable claims.
  
- 2.  As all searchable claims could be searched without effort justifying an additional fee, this Authority did not invite payment of any additional fee.
  
- 3.  As only some of the required additional search fees were timely paid by the applicant, this International Search Report covers only those claims for which fees were paid, specifically claims Nos.:
  
- 4.  No required additional search fees were timely paid by the applicant. Consequently, this International Search Report is restricted to the invention first mentioned in the claims; it is covered by claims Nos.:

1, 2, 4-54

**Remark on Protest**

- The additional search fees were accompanied by the applicant's protest.
- No protest accompanied the payment of additional search fees.

FURTHER INFORMATION CONTINUED FROM PCT/ISA/ 210

This International Searching Authority found multiple (groups of) inventions in this international application, as follows:

1. Claims: 1,2,4-54

Phospholipid compounds of formula (I), phospholipid extracts derived from a marine or aquatic biomass comprising at least one compound of formula (I) as well as the pharmaceutical, nutraceutical and cosmetic use of such phospholipid extracts.

2. Claim : 3

A flavonoid derivative of formula (II)



INTERNATIONAL SEARCH REPORT

Information on patent family members

International Application No

PCT/CA 02/01185

Patent document cited in search report	Publication date	Patent family member(s)	Publication date
WO 9739759 A	30-10-1997	AU 2738497 A	12-11-1997
EP 609078 A	03-08-1994	AU 671329 B	22-08-1996
		AU 5474994 A	04-08-1994
		CA 2114349 A	28-07-1994
		CN 1097124 A	11-01-1995
		JP 6293785 A	21-10-1994
		NO 940288 A	28-07-1994
		NZ 250768 A	21-12-1995
		SG 49749 A	15-06-1998
		US 5466841 A	14-11-1995
		ZA 9400587 A	09-09-1994
WO 0023546 A	27-04-2000	AU 6455299 A	08-05-2000
		BR 9914699 A	10-07-2001
		CN 1324394 T	28-11-2001
		EP 1123368 A	16-08-2001
		JP 2002527604 T	27-08-2002
		NO 20011915 A	21-06-2001
		PL 347396 A	08-04-2002
WO 9221335 A	10-12-1992	AT 216227 T	15-05-2002
		AU 657969 B	30-03-1995
		AU 1910192 A	08-01-1993
		CA 2109611 A	10-12-1992
		DE 69232564 D	23-05-2002
		DE 69232564 T	26-09-2002
		EP 0660708 A	05-07-1995
		ES 2174833 T	16-11-2002
		IE 921477 A	02-12-1992
		JP 6508123 T	14-09-1994
		NZ 242697 A	25-02-1994
		PT 100524 A,B	31-08-1993
		SG 64864 A	16-01-2001
		US 5434183 A	18-07-1995

CORRECTED VERSION

(19) World Intellectual Property Organization  
International Bureau



(43) International Publication Date  
13 February 2003 (13.02.2003)

PCT

(10) International Publication Number  
WO 03/011873 A3

(51) International Patent Classification<sup>7</sup>: C07F 9/10, C07D  
407/14, A23J 7/00, A61K 31/683, 31/685, A61P 25/00,  
35/00, A61K 7/00, C11B 1/10

CZ, DE, DK, DM, DZ, EC, EE, ES, FI, GB, GD, GE, GH,  
GM, HR, HU, ID, IL, IN, IS, JP, KE, KG, KP, KR, KZ, LC,  
LK, LR, LS, LT, LU, LV, MA, MD, MG, MK, MN, MW,  
MX, MZ, NO, NZ, OM, PH, PL, PT, RO, RU, SD, SE, SG,  
SI, SK, SL, TJ, TM, TN, TR, TT, TZ, UA, UG, US, UZ,  
VN, YU, ZA, ZM, ZW.

(21) International Application Number: PCT/CA02/01185

(22) International Filing Date: 29 July 2002 (29.07.2002)

(25) Filing Language: English

(26) Publication Language: English

(30) Priority Data:  
60/307,842 27 July 2001 (27.07.2001) US

(84) Designated States (*regional*): ARIPO patent (GH, GM,  
KE, LS, MW, MZ, SD, SL, SZ, TZ, UG, ZM, ZW),  
Eurasian patent (AM, AZ, BY, KG, KZ, MD, RU, TJ, TM),  
European patent (AT, BE, BG, CH, CY, CZ, DE, DK, EE,  
ES, FI, FR, GB, GR, IE, IT, LU, MC, NL, PT, SE, SK,  
TR), OAPI patent (BF, BJ, CF, CG, CI, CM, GA, GN, GQ,  
GW, ML, MR, NE, SN, TD, TG).

(71) Applicant (*for all designated States except US*): NEP-  
TUNE TECHNOLOGIES & BIORESSOURCES INC.  
[CA/CA]; 500, St-Martin Boulevard West, Suite 550,  
Laval, Québec H7M 3Y2 (CA).

Published:  
— with international search report

(72) Inventor; and

(75) Inventor/Applicant (*for US only*): SAMPALIS, Fotini  
[CA/CA]; 1348 Elizabeth Boulevard, Laval, Quebec H7W  
3J8 (CA).

(88) Date of publication of the international search report:  
1 May 2003

(74) Agents: SABET, Sohrab et al.; Smart & Biggar, 1000 de  
la Gauchetière Ouest, Suite 3400, Montréal, Quebec H3B  
4W5 (CA).

(48) Date of publication of this corrected version:  
7 August 2003

(81) Designated States (*national*): AE, AG, AL, AM, AT, AU,  
AZ, BA, BB, BG, BR, BY, BZ, CA, CH, CN, CO, CR, CU,

(15) Information about Correction:  
see PCT Gazette No. 32/2003 of 7 August 2003, Section II

*For two-letter codes and other abbreviations, refer to the "Guidance Notes on Codes and Abbreviations" appearing at the beginning of each regular issue of the PCT Gazette.*



WO 03/011873 A3

(54) Title: NATURAL MARINE SOURCE PHOSPHOLIPIDS COMPRISING FLAVONOIDS, POLYUNSATURATED FATTY ACIDS AND THEIR APPLICATIONS

(57) Abstract: A phospholipid extract from a marine or aquatic biomass possesses therapeutic properties. The phospholipid extract comprises a variety of phospholipids, fatty acid, metals and a novel flavonoid.

(19) World Intellectual Property Organization  
International Bureau



(43) International Publication Date  
13 January 2005 (13.01.2005)

PCT

(10) International Publication Number  
WO 2005/004393 A1

(51) International Patent Classification<sup>7</sup>: H04L 12/18, 12/56

(21) International Application Number: PCT/IB2004/051066

(22) International Filing Date: 30 June 2004 (30.06.2004)

(25) Filing Language: English

(26) Publication Language: English

(30) Priority Data: 03101998.7 3 July 2003 (03.07.2003) EP

(71) Applicant (for all designated States except US): KONINKLIJKE PHILIPS ELECTRONICS N.V. [NL/NL]; Groenewoudseweg 1, NL-5621 BA Eindhoven (NL).

(72) Inventor; and

(75) Inventor/Applicant (for US only): KEVENAAR, Thomas, A., M. [NL/NL]; c/o Prof. Holstlaan 6, NL-5656 AA Eindhoven (NL).

(74) Agent: GROENENDAAL, Antonius, W., M.; Prof. Holstlaan 6, NL-5656 AA Eindhoven (NL).

(81) Designated States (unless otherwise indicated, for every kind of national protection available): AE, AG, AL, AM, AT, AU, AZ, BA, BB, BG, BR, BW, BY, BZ, CA, CH, CN, CO, CR, CU, CZ, DE, DK, DM, DZ, EC, EE, EG, ES, FI, GB, GD, GE, GH, GM, HR, HU, ID, IL, IN, IS, JP, KE, KG, KP, KR, KZ, LC, LK, LR, LS, LT, LU, LV, MA, MD, MG, MK, MN, MW, MX, MZ, NA, NI, NO, NZ, OM, PG, PH, PL, PT, RO, RU, SC, SD, SE, SG, SK, SL, SY, TJ, TM, TN, TR, TT, TZ, UA, UG, US, UZ, VC, VN, YU, ZA, ZM, ZW.

(84) Designated States (unless otherwise indicated, for every kind of regional protection available): ARIPO (BW, GH, GM, KE, LS, MW, MZ, NA, SD, SL, SZ, TZ, UG, ZM, ZW), Eurasian (AM, AZ, BY, KG, KZ, MD, RU, TJ, TM), European (AT, BE, BG, CH, CY, CZ, DE, DK, EE, ES, FI, FR, GB, GR, HU, IE, IT, LU, MC, NL, PL, PT, RO, SE, SI, SK, TR), OAPI (BF, BJ, CF, CG, CI, CM, GA, GN, GQ, GW, ML, MR, NE, SN, TD, TG).

Declaration under Rule 4.17:

— as to applicant's entitlement to apply for and be granted a patent (Rule 4.17(ii)) for the following designations AE, AG, AL, AM, AT, AU, AZ, BA, BB, BG, BR, BW, BY, BZ, CA, CH, CN, CO, CR, CU, CZ, DE, DK, DM, DZ, EC, EE, EG, ES, FI, GB, GD, GE, GH, GM, HR, HU, ID, IL, IN, IS, JP, KE, KG, KP, KR, KZ, LC, LK, LR, LS, LT, LU, LV, MA,

[Continued on next page]

(54) Title: SECURE INDIRECT ADDRESSING

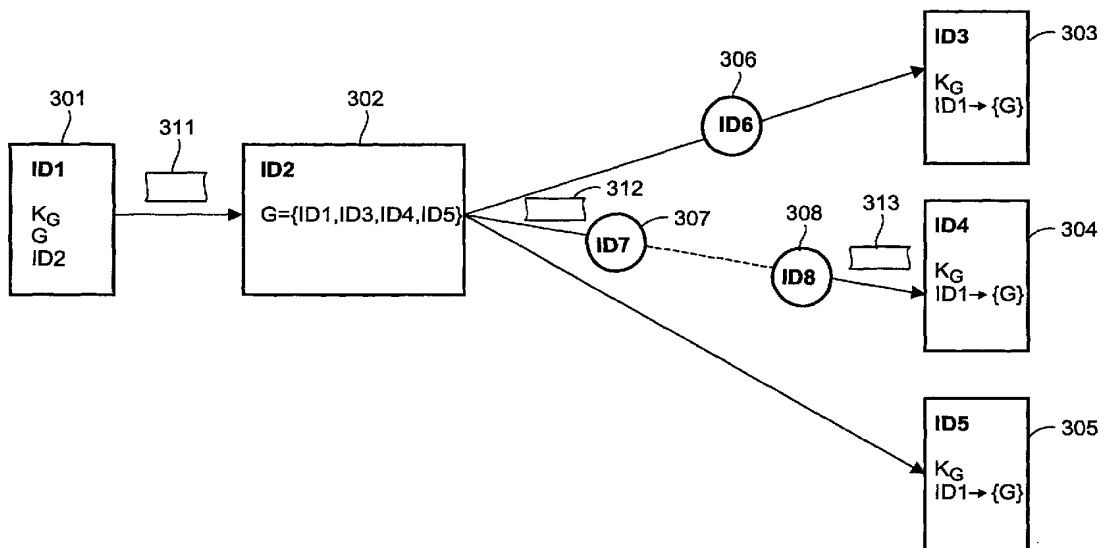

(57) Abstract: An efficient solution for secure implementation of indirect addressing (IA) is described. IA may be used, for example, in networks of which the routing algorithms are not capable of multicast but also contain very constrained devices that, although requiring multicast, are not capable of repeated unicast. This ID is useful in wireless networks containing low-power low-cost devices.



WO 2005/004393 A1



MD, MG, MK, MN, MW, MX, MZ, NA, NI, NO, NZ, OM, PG, PH, PL, PT, RO, RU, SC, SD, SE, SG, SK, SL, SY, TJ, TM, TN, TR, TT, TZ, UA, UG, UZ, VC, VN, YU, ZA, ZM, ZW, ARIPO patent (BW, GH, GM, KE, LS, MW, MZ, NA, SD, SL, SZ, TZ, UG, ZM, ZW), Eurasian patent (AM, AZ, BY, KG, KZ, MD, RU, TJ, TM), European patent (AT, BE, BG, CH, CY, CZ, DE, DK, EE, ES, FI, FR, GB, GR, HU, IE, IT, LU, MC, NL, PL, PT, RO, SE, SI, SK, TR), OAPI patent (BF, BJ, CF, CG, CI, CM, GA, GN, GQ, GW, ML, MR, NE, SN, TD, TG)

**Published:**

— with international search report

*For two-letter codes and other abbreviations, refer to the "Guidance Notes on Codes and Abbreviations" appearing at the beginning of each regular issue of the PCT Gazette.*

## Secure indirect addressing

The invention relates to a method of communicating a communication fragment. The invention further relates to the corresponding sender device, router device, receiver device, system, and signal implementing this method.

In communication networks often the distinction is made between unicast, 5 multicast and broadcast. Unicast is the situation where a single device (the sender device) sends a message to a single other device (the receiver device). In multicast, the sender device sends a message to a number (more than one, but not all) of receiver devices, while in broadcast, the sender device sends a message to all devices in the network.

While nearly all networks contain routing algorithms that support unicast, this 10 is not always the case for multicast. When the routing algorithms do not support multicast and a single device still wants to address several devices, multicast can be achieved by repeated unicast.

However, the sender device might not be able or allowed to do repeated unicast due to, for example, power or cost constraints. An example is a wireless control 15 network used to control lights in large public spaces. Here a single, cheap light switch must be capable of switching more than, say, 50 lights. It is obvious that many more application examples can be found.

A solution to this problem can be found in indirect addressing (IA). where a second device (the router device) is available in the vicinity of the sender device. The sender 20 device will then send a single message to the router device which will subsequently perform repeated unicast.

However, problems are related to the security aspects of IA. For example, the application running on the sender device might want to encrypt its message using a cryptographic key  $K_G$  known only to members of a group  $G$ . Further the sender device might 25 want to apply a Message Integrity Code (MIC) on parts of the communication such as its own address  $ID_1$  and the destination address  $G$  in the message also using  $K_G$ . The result is that only the members of  $G$  (but *not* the router device) can read the message and receiving devices can verify if indeed the message is intended for them and if it was sent by the sender device  $ID_1$ .

Communication protocols are commonly described using a layered, OSI-like stack. Part of this stack are, from bottom to top, the physical layer (PHY), the medium access control layer (MAC), the network layer (NWK) and the application layer (APL). Frames exchanged between equal layers on different devices consist of a *header* and a *payload*. A  
5 frame at level  $n$  in the stack is physically sent as the payload of a frame at layer  $n-1$ . The abbreviations to identify some of the fields in these headers are as follows: SRC for source address, DEST for destination address, and INF for information field.

A straightforward but inefficient solution to the problem would be to have the application layer compute a MIC on the message, and on its destination address and on its  
10 source address using the group key  $K_G$ .

The NWK layer will then also add the NWK-DEST and NWK-SRC addresses, as they are usually required by the routing algorithms. It might further compute an additional MIC on these two NWK addresses. As compared to the solutions given above this will result in more overhead (one or two more addresses) and one additional MIC to be sent which  
15 makes this solution less efficient. A second drawback is that the APL level is concerned with verifying address information, a task which more naturally belongs at a lower layer.

It is therefore an object of the invention to provide a method that improves the efficiency of indirect addressing while providing security.

This object is realized by a method of communicating a communication  
20 fragment, the communication fragment comprising a first target address reference referring to a group of at least one receiver device, comprising the steps of: - a sender device adding a cryptographic message integrity code to protect at least part of the communication fragment, - the sender device transmitting the protected communication fragment to a router device, - the router device, for at least one receiver device in the group of target devices, modifying the  
25 first target address reference into an address of the at least one receiver device, while maintaining the unchanged cryptograph message integrity code, and subsequently forwarding the modified protected communication fragment to the at least one receiver device, - the at least one receiver device receiving the modified protected communication fragment, - the at least one receiver device restoring the original protected communication fragment in order to  
30 allow verification of the original protected communication fragment using the message integrity code.

For security reasons, the addressing information should be protected with a MIC using the key  $K_G$ . However, the router device should be able to change the addressing information in order to do repeated unicast. Obviously, since  $G$  is protected by the MIC, it

cannot simply be substituted by a target address to do repeated unicast: when the receiver device receives the communication fragment with the substituted address and it checks the MIC, it will find a mismatch because the protected information should contain G and not the receiver device ID. As a result, it will probably ignore the message.

5                   The sender device therefore indicates the usage of indirect addressing by for example setting a special IA bit field in the message. (Alternatively, the router device may indicate the usage of indirect addressing by for example setting a special IA bit field in the message, after detecting, for example because the target address is a group identity, that indirect addressing is used). The addresses MAC-DEST and MAC-SRC indicate that a  
10 message is sent from ID1 to ID2. The addresses NWK-DEST and NWK-SRC indicate that the final destination of the message is all the members in G (possibly except ID1 itself) and that the message was sent by ID1. The NWK-INF field further indicates that the message is used in the context of indirect addressing (IA=1) and the application on ID1 encrypted the string m using the group key  $K_G$  (indicated by  $E_{K_G}(m)$ ).

15                   On receipt of the message from the sender device, the router device notices that it is an IA message by inspecting the IA bit in the NWK-INF field and it will perform a multiple unicast to all the members of group G (possibly except the sender device ID1). From its routing information (e.g. routing tables), the router device knows that a way to reach the receiver device is sending it to intermediate nodes. The router changes, for each receiver  
20 device, the NWK-DEST field from the entry G to the address of the receiver device ID, as intermediate hops are not aware of a group identity G and the unicast routing algorithms need a single, known device address as a final destination. Note further that, because of the replacement, the MIC and the protected information are no longer consistent. The receiver device upon receiving the message will replace the modified information, for example the  
25 receiver device ID by the group ID, and is subsequently able to verify the MIC. The receiver device should know the identity of all devices in G in order to perform this action. An alternative solution is that the sender device or the router device copies the group identity G somewhere in the communication fragment, for example in the NWK-INF field in the NWK frame. This way the receiver devices do not have to store the link between device identities  
30 and group identities and they can still substitute the group identity in the NWK-DEST field before verifying the MIC. In addition, multiple overlapping groups are supported in this manner.

The advantage of this solution is that the sender device only requires storing a very limited amount of information, and sending very short and few communication

fragments. The activities of the router device (ID2) and intermediate hops are independent of the fact if the message by the sender device (here ID1) is secured or not. Only the group members and (of course) the router device need to be aware of indirect addressing; the intermediate nodes between the router device and the receiver devices are not aware of the indirect addressing mode. The router device need not be trusted with application data.

An advantageous implementation of the method according to the invention is described in claim 2. Use of a single bit field IA to indicate the use of the indirect addressing mode is simple and efficient.

An advantageous implementation of the method according to the invention is described in claim 4. Using a single common key both to encrypt the message content and to generate or verify the MIC results in an efficient implementation.

An advantageous implementation of the method according to the invention is described in claim 5. The receiver device attempts multiple substitutions of the target address reference by the groups the receiver device is a member of. This way, the receiver device is able to find the group identity for which the MIC matches. This alleviates the need to add the group identity in the communication fragment, therefore optimizing the communication fragment length.

An advantageous implementation of the method according to the invention is described in claim 6. This implementation allows the receiver device to restore the communication fragment without local information or without having to perform multiple attempts to find the matching group identity by storing or copying the original first target address reference into the modified protected communication fragment.

The sender device, router device, receiver device, system, and signal according to the invention are characterized as described in claims 7-11.

These and other aspects of the invention will be further described by way of example and with reference to the schematic drawings in which:

Fig. 1 shows an exploded view of a message at the MAC layer for a four-layer protocol stack,

Fig. 2 shows a schematic example of indirect addressing,

Fig. 3 shows a detailed example of indirect addressing, and

Fig. 4 shows the message formats on the MAC level during indirect addressing



Throughout the figures, same reference numerals indicate similar or corresponding features. Some of the features indicated in the drawings are typically implemented in software, and as such represent software entities, such as software modules  
5 or objects.

Communication protocols are commonly described using a layered, OSI-like stack. An example stack comprises, from bottom to top, the physical layer (PHY), the medium access control layer (MAC), the network layer (NWK) and the application layer (APL). Frames exchanged between equal layers on different devices consist of a *header* and  
10 a *payload* and a frame at level  $n$  in the stack is physically sent as the payload of a frame at layer  $n-1$ . Thus, considering the top three layers in this four-layer protocol stack, Fig. 1 illustrates a message 100 sent by the MAC layer.

In many cases there is a close relation between the addresses at the APL layer and at the NWK layer which makes it possible to leave out duplicated address information in  
15 the APL layer in order to arrive at an efficient solution. Address information at the NWK layer can usually not be omitted because it is required by the routing algorithms. Because the APL addresses are usually equal to the NWK addresses or can be derived easily, they are not always present in order to reduce the size of the message.

The INF fields contain information for a receiving device on the different  
20 layers on what kind of information is present in the rest of the message and how it should be treated. For example, the MAC-INF field might indicate that the MAC-PAYLOAD is encrypted. This will show to the receiving device that it must first decrypt the payload before dealing with it further. Also, the NWK-INF field might indicate that the received frame is generated in the context of indirect addressing and should be treated accordingly.

25 Indirect addressing is schematically depicted in Fig. 2. ID1, sender device 201, member of the group  $G=\{ID1, ID3, ID4, ID5\}$ , sends a message 211 containing the final destination address  $G$ , its own address ID1 and a string  $m$  (i.e. the actual information to be sent to the group) to ID2, the router device 202. When ID2 receives the message and notices that the message coming from ID1 is intended for the group  $G$ , it will forward the message to  
30 ID3 203, ID4 204 and ID5 205 whose addresses it found in, for example, a pairing table 212.

As a security measure, the application running on ID1 generating the string  $m$ , might want to encrypt  $m$  using a cryptographic key  $K_G$  known only to members of  $G$ . Further it might want to apply a Message Integrity Code (MIC) on its own address ID1 and the destination address  $G$  in the message also using  $K_G$ . The result of these security measures is

that only the members of G (but *not* the router device) can read the message and receiving devices can verify if indeed the message is intended for them and if it was sent by ID1.

As the router device ID2 is not trusted by ID1, ID2 has no access to the key  $K_G$ . However, the router node should be able to change the addressing information on the  
5 NWK level in order to perform repeated unicast. Since G is protected by the MIC, it cannot simply be substituted by ID3, ID4 and ID5 to do repeated unicast: when the receiving devices ID3, ID4 and ID5 check the MIC, they will find a mismatch because the protected information should contain G and not ID3, ID4 or ID5, respectively. As a result, they will ignore the message.

10 As illustrated in Fig. 3, ID1 knows the cryptographic group key  $K_G$ , the identity of the group G (but not necessarily the addresses of all the group members) and the address of its router device ID2. Router device ID2 knows or is able to retrieve the addresses of all the members of G.

ID1 sends the message 301 to the router ID2 302 that, on the MAC level, will  
15 look like the message 401 in Fig. 4 where, as compared to Fig. 1, fields that are not relevant in the current explanation are omitted for clarity. The addresses MAC-DEST and MAC-SRC indicate that a message is sent from ID1 to ID2. The addresses NWK-DEST and NWK-SRC indicate that the final destination of the message is all members of G (possibly except ID1 itself) and that the message was sent by ID1. The NWK-INF field further indicates that it  
20 concerns a message in the context of indirect addressing ( $IA=1$ ) and the application on ID1 encrypted the string  $m$  using the group key  $K_G$  (indicated by  $E_{K_G}(m)$ ) in APL-PAYLOAD. A dark gray background in a message means that its content is protected by a MIC using  $K_G$ . As an alternative solution, the application on the sender device ID1 can decide not to encrypt  $m$  but only do add a MIC. In this case,  $E_{K_G}(m)$  in message 401 will be replaced by  $m$ .

25 On receipt of the message from sender device ID1 301, router device ID2 302 notices that it is an IA message by inspecting the IA bit in the NWK-INF field and it will perform a multiple unicast to all the members of G 303,304,305 (again, possibly except ID1). In an alternative implementation, on receipt of a message from a sender device, the router device, rather than checking the IA bit in the NWK-INF field, can also check the NWK-  
30 DEST field to conclude that the sender device sent an IA message.

Subsequently, the router device substitutes in the NWK-DEST field the value G by ID3, ID4 and ID5, respectively, hereby ignoring the resulting inconsistency between the information protected by the MIC and the MIC itself. The router is allowed to make other

modifications to the protected information as long as the receiver devices are capable of undoing the modifications before verifying the MIC.

As an example, the unicast message from ID2 to ID4 is described. From its routing information (e.g. routing tables), ID2 knows that a way to reach ID4 is sending it to ID7 after which multiple hops might follow, as indicated in Fig. 3. The message ID2 sends to ID7 on the MAC level will then look like message 402 in Fig. 4. In the NWK-DEST field the entry G is replaced by ID4, because intermediate hops are not aware of a group identity G and the unicast routing algorithms need a single, known device address as a final destination. Because of this replacement, the MIC and the protected information are no longer consistent which is indicated by the striped/light gray background of the NWK-DEST field.

After possibly more hops, a message 313 finally ends up at ID4. If the one but last hop address was ID8 (see Fig. 3), the message looks like message 403. If ID4 knows the identity of all devices in G it can receive a message from (indicated by ID1 → {G} in Fig. 3), then, by inspecting the NWK-SRC field in the received message, ID4 can obtain the group identity G. Before verifying the MIC on the message using  $K_G$ , it will replace ID4 in the NWK-DEST field by G.

Although this solution is very efficient in simple situations, there will be problems in more complicated situations. It might be, for example, that both ID1 and ID4 are a member of G but also of a different group G' in which ID1 is also a sender device. Upon receipt of a message, ID4 is not sure if it should replace ID4 in the NWK-DEST field by G or by G' because it will have stored ID1 → {G, G'}. Clearly ID4 can try all the group identities in the list belonging to ID1 until a recomputed MIC matches the MIC in the message. An alternative solution is that ID copies the group identity G in the NWK frame, for example in the NWK-INF field. This way the receiver devices do not have to store the link between device identities and group identities and they can still substitute the group identity in the NWK-DEST field before verifying the MIC. The cost is that in this case, the messages to be sent will be longer.

As an alternative solution to storing G in the NWK frame, the receiver device can attempt multiple substitutions of the target address reference by the groups the receiver device and sender device are a member of. This way, the receiver device is able to find the group identity for which the MIC matches. This alleviates the need to add the group identity in the communication fragment, therefore optimizing the communication fragment length.

The advantages of the method according to the invention are as summarized below. The sender device only requires storing a very limited amount of information. The

activities of the router device (ID2) and intermediate hops are independent of the fact if the message by the sender device (here ID1) is secured or not. Only the group members and (of course) the router device are aware of a group G. There is only one bit overhead in the messages (the IA bit in the NWK-INF field). The receiver devices have to store the links  
5 between device IDs and group IDs, which can be done efficiently. The router device need not be trusted with application data.

It is clear to a person skilled in the art that minor modifications to the solutions presented above still constitute the same solutions.

For example, to further reduce the size of the message from sender device ID1  
10 to router device ID2, the identity of the router (ID2) might be omitted if it is clear from context. Receiving a message from ID1, the router might deduce from context that it must forward the message to the group G. This reduces even further the required amount of storage on the sender device and the length of the message to be sent by the sender device.

As a second example, to further reduce the size of the message from sender  
15 device ID1 to router device ID2, the sender device identity ID1 can be omitted from the group definition on the router device (here  $G=\{ID1, ID3, ID4, ID5\}$ ), if the router device is only acting as router for a single device in G (in this case ID1),

Alternatives are possible. In the description above, "comprising" does not  
20 exclude other elements or steps, "a" or "an" does not exclude a plurality, and a single processor or other unit may also fulfill the functions of several means recited in the claims.

## CLAIMS:

1. Method of communicating a communication fragment (211), the communication fragment comprising a first target address reference referring to a group of at least one receiver device (203), comprising the steps of:
  - a sender device (201) adding a cryptographic message integrity code to protect  
5 at least part of the communication fragment,
  - the sender device transmitting the protected communication fragment to a router device (202),
  - the router device, for at least one receiver device in the group of target devices, modifying the first target address reference into an address of the at least one receiver device,  
10 while maintaining the unchanged cryptograph message integrity code, and subsequently forwarding the modified protected communication fragment (213) to the at least one receiver device,
  - the at least one receiver device receiving the modified protected communication fragment,
  - 15 - the at least one receiver device restoring the original protected communication fragment in order to allow verification of the original protected communication fragment using the message integrity code.
2. Method according to claim 1, wherein the first communication fragment  
20 comprises a bit field IA to indicate whether indirect addressing is used.
3. Method according to claim 1, wherein the sender device and the at least one receiver device share a common cryptographic key, and where the cryptographic message integrity code is computable and verifiable only by using the common cryptographic key.  
25
4. Method according to claim 3, wherein the common cryptographic key is used to encrypt the message content.

5. Method according to claim 1, wherein the at least one receiver device restores the original protected communication fragment by substituting the first target address reference with each of the group identities that comprises the sender device to determine for which of the group identities the message integrity code matches.

5

6. Method according to claim 1, wherein

- the router device, in the step of modifying the first target address reference, stores the first target address reference in the modified protected communication fragment, and

10 - the at least one receiver device restores the original protected communication fragment using the stored first target address reference in the modified protected communication fragment in order to allow verification of the message integrity code.

7. Sender device (201) being arranged to transmit a communication fragment

15 through a router device (202) towards a receiver device (203), the communication fragment (211) comprising a first target address reference referring to a group of at least one receiver device, the sender device comprising:

- protecting means (221) being arranged to add a cryptographic message integrity code to protect at least part of the communication fragment, and

20 - transmitting means (222) being arranged to transmit the communication fragment to a router device that is not able to modify the cryptographic message integrity code.

8. Router device (202) being arranged to route a communication fragment (211)

25 from a sender device towards a receiver device, the communication fragment comprising a first target address reference referring to a group of at least one receiver device, the router device comprising:

- receiving means (223) being arranged to receive the communication fragment, comprising a first address reference referring to a group of at least one receiver device, the first communication fragment at least partly being protected by a MIC,

30

- modifying means (224) being arranged to modify the communication fragment, by replacing the group of at least one receiver device by a reference referring to the at least one receiver device, while maintaining the original MIC, and

- transmitting means (225) to transmit the modified communication fragment (213) to the at least one receiver device.

9. Receiver device (203) being arranged to receive a modified communication  
5 fragment (213) originating from a transmitter device through a router device, the modified communication fragment being derived from a communication fragment (211) comprising a first target address reference referring to a group of at least one receiver device, the receiver device comprising:

- receiving means (226) being arranged to receive the modified communication  
10 fragment,
- restoring means (227) being arranged to restore the original communication fragment that was used to compute the cryptographic message integrity code, and
- verification means (228) being arranged to verify the cryptographic message integrity code.

15

10. System (200) for communication comprising a sender device (201), router device (202), and receiver device (203) as described in claims 7, 8 and 9.

11. Signal for secure indirect addressing, comprising a modified communication  
20 fragment (213) according to the method of claim 1.

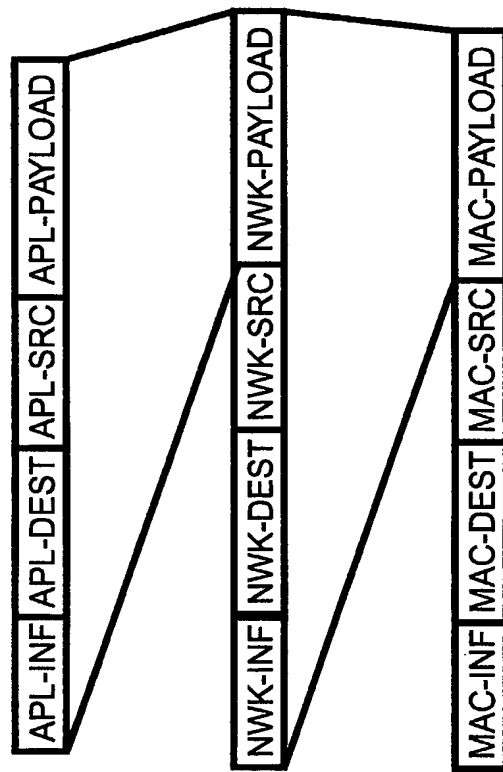

100

FIG.1



2/4

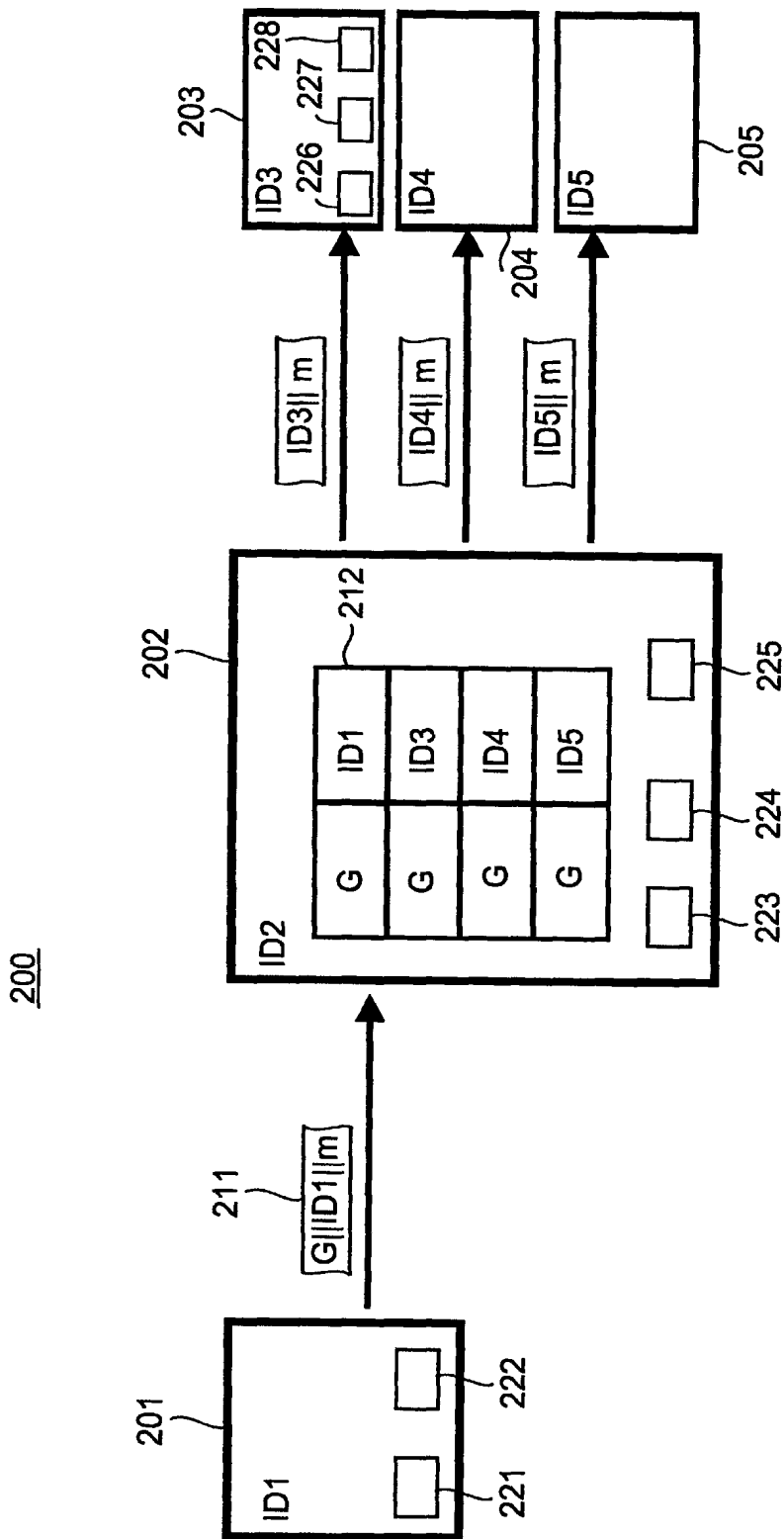

FIG.2

3/4

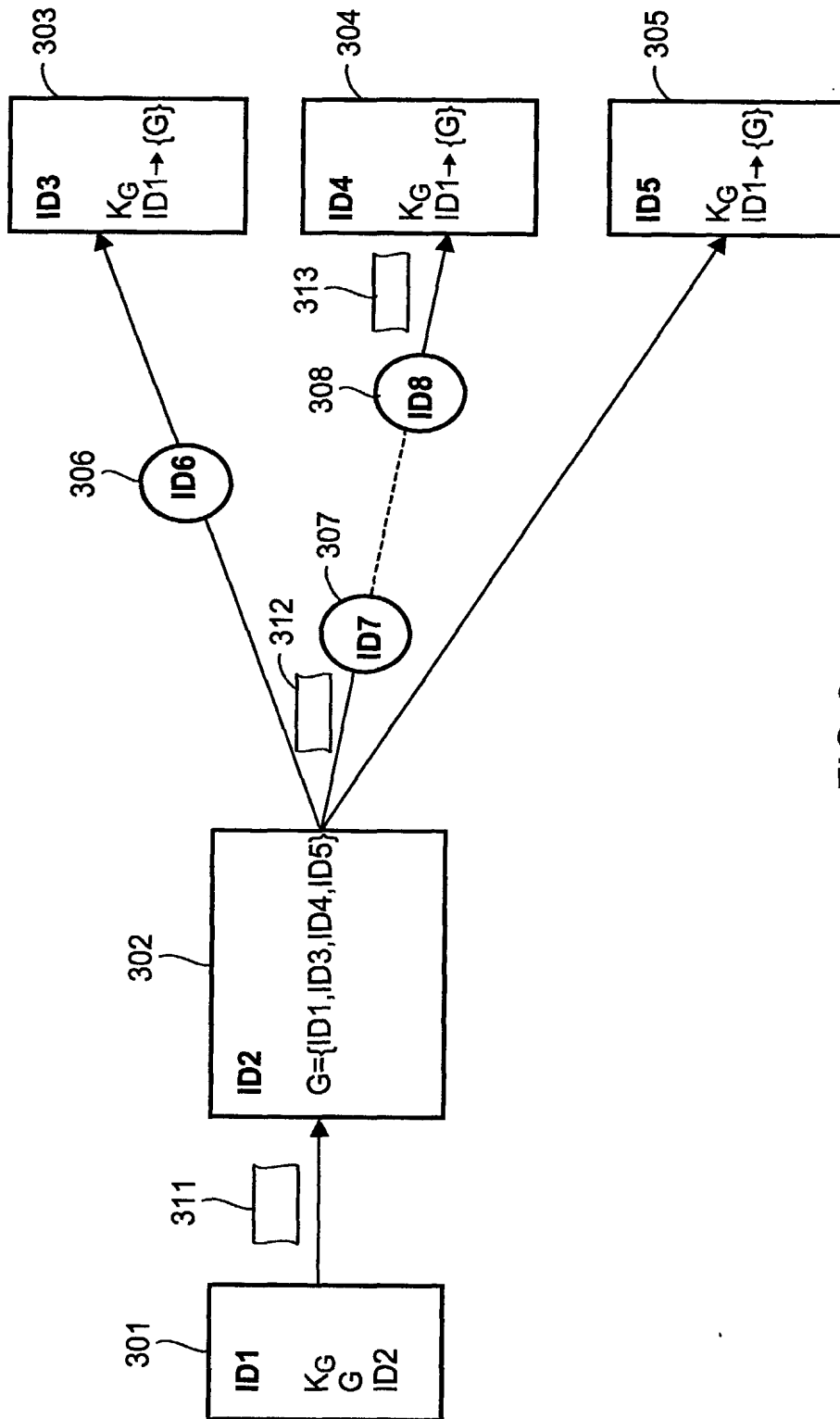

FIG.3

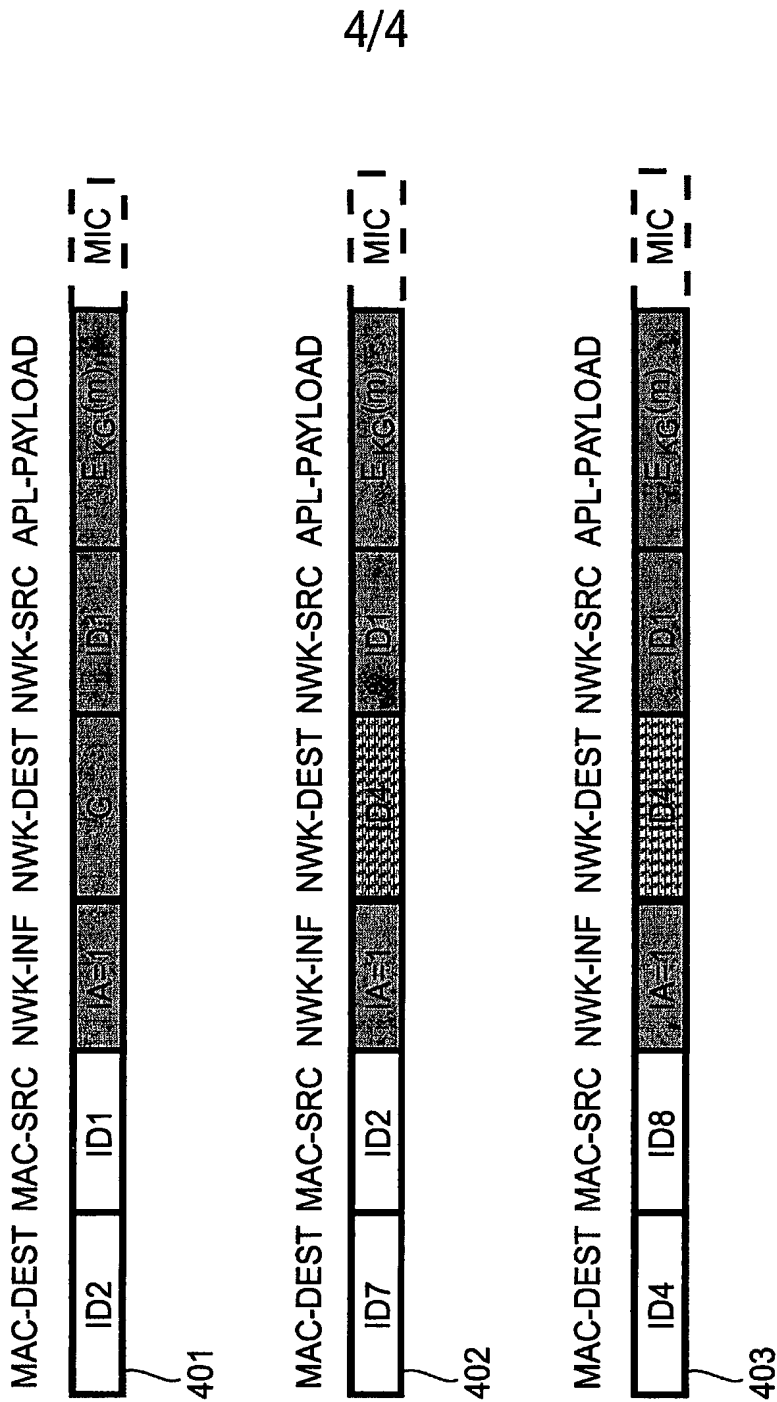

FIG.4

# INTERNATIONAL SEARCH REPORT

International Application No

PCT/IB2004/051066

**A. CLASSIFICATION OF SUBJECT MATTER**  
 IPC 7 H04L12/18 H04L12/56

According to International Patent Classification (IPC) or to both national classification and IPC

**B. FIELDS SEARCHED**  
 Minimum documentation searched (classification system followed by classification symbols)  
 IPC 7 H04L

Documentation searched other than minimum documentation to the extent that such documents are included in the fields searched

Electronic data base consulted during the international search (name of data base and, where practical, search terms used)  
 EPO-Internal

**C. DOCUMENTS CONSIDERED TO BE RELEVANT**

Category °	Citation of document, with indication, where appropriate, of the relevant passages	Relevant to claim No.
X	WO 00/62503 A (HARDJONO THOMAS P ; NORTEL NETWORKS LTD (US)) 19 October 2000 (2000-10-19) page 5, line 9 - page 9, line 10; figures 1,2	7
X	EP 0 902 569 A (AT & T CORP) 17 March 1999 (1999-03-17) paragraphs '0004! - '0009!; figure 1 ----- -/--	8

Further documents are listed in the continuation of box C.       Patent family members are listed in annex.

° Special categories of cited documents :

<p>*A* document defining the general state of the art which is not considered to be of particular relevance</p> <p>*E* earlier document but published on or after the international filing date</p> <p>*L* document which may throw doubts on priority claim(s) or which is cited to establish the publication date of another citation or other special reason (as specified)</p> <p>*O* document referring to an oral disclosure, use, exhibition or other means</p> <p>*P* document published prior to the international filing date but later than the priority date claimed</p>	<p>*T* later document published after the international filing date or priority date and not in conflict with the application but cited to understand the principle or theory underlying the invention</p> <p>*X* document of particular relevance; the claimed invention cannot be considered novel or cannot be considered to involve an inventive step when the document is taken alone</p> <p>*Y* document of particular relevance; the claimed invention cannot be considered to involve an inventive step when the document is combined with one or more other such documents, such combination being obvious to a person skilled in the art.</p> <p>*G* document member of the same patent family</p>
--	--

Date of the actual completion of the international search  <b>4 October 2004</b>	Date of mailing of the international search report  <b>11/10/2004</b>
--	---

Name and mailing address of the ISA European Patent Office, P.B. 5818 Patentlaan 2 NL - 2280 HV Rijswijk Tel. (+31-70) 340-2040, Tx. 31 651 epo nl. Fax: (+31-70) 340-3016	Authorized officer  <b>Kreppel, J</b>
--	---

INTERNATIONAL SEARCH REPORT

International Application No  
PCT/IB2004/051066

C.(Continuation) DOCUMENTS CONSIDERED TO BE RELEVANT		
Category °	Citation of document, with indication, where appropriate, of the relevant passages	Relevant to claim No.
A	<p>KRUUS P S ET AL: "Techniques and issues in multicast security"  MILITARY COMMUNICATIONS CONFERENCE, 1998.  MILCOM 98. PROCEEDINGS., IEEE BOSTON, MA,  USA 18-21 OCT. 1998, NEW YORK, NY,  USA,IEEE, US,  18 October 1998 (1998-10-18), pages  1028-1032, XP010307977  ISBN: 0-7803-4506-1  Chapter "SECURITY SERVICES"  -----</p>	1-11

**INTERNATIONAL SEARCH REPORT**

Information on patent family members

International Application No  
PCT/IB2004/051066

Patent document cited in search report		Publication date		Patent family member(s)	Publication date
WO 0062503	A	19-10-2000	US	6643773 B1	04-11-2003
			AU	4346800 A	14-11-2000
			CA	2372114 A1	19-10-2000
			EP	1171972 A2	16-01-2002
			WO	0062503 A2	19-10-2000
-----					
EP 0902569	A	17-03-1999	US	6259701 B1	10-07-2001
			CA	2245979 A1	11-03-1999
			EP	0902569 A1	17-03-1999
-----					

(19) World Intellectual Property  
Organization  
International Bureau



(43) International Publication Date  
28 April 2005 (28.04.2005)

PCT

(10) International Publication Number  
WO 2005/037848 A2

- (51) International Patent Classification<sup>7</sup>: C07F 9/10 (74) Agents: LUZZATTO, Kfir et al.; P.O. Box 5352, 84152 Beer Sheva (IL).
- (21) International Application Number: PCT/IL2004/000957 (81) Designated States (unless otherwise indicated, for every kind of national protection available): AE, AG, AL, AM, AT, AU, AZ, BA, BB, BG, BR, BW, BY, BZ, CA, CH, CN, CO, CR, CU, CZ, DE, DK, DM, DZ, EC, EE, EG, ES, FI, GB, GD, GE, GH, GM, HR, HU, ID, IL, IN, IS, JP, KE, KG, KP, KR, KZ, LC, LK, LR, LS, LT, LU, LV, MA, MD, MG, MK, MN, MW, MX, MZ, NA, NI, NO, NZ, OM, PG, PH, PL, PT, RO, RU, SC, SD, SE, SG, SK, SL, SY, TJ, TM, TN, TR, TT, TZ, UA, UG, US, UZ, VC, VN, YU, ZA, ZM, ZW.
- (22) International Filing Date: 21 October 2004 (21.10.2004)
- (25) Filing Language: English
- (26) Publication Language: English
- (30) Priority Data: 158552 22 October 2003 (22.10.2003) IL (84) Designated States (unless otherwise indicated, for every kind of regional protection available): ARIPO (BW, GH, GM, KE, LS, MW, MZ, NA, SD, SL, SZ, TZ, UG, ZM, ZW), Eurasian (AM, AZ, BY, KG, KZ, MD, RU, TJ, TM), European (AT, BE, BG, CH, CY, CZ, DE, DK, EE, ES, FI, FR, GB, GR, HU, IE, IT, LU, MC, NL, PL, PT, RO, SE, SI, SK, TR), OAPI (BF, BJ, CF, CG, CI, CM, GA, GN, GQ, GW, ML, MR, NE, SN, TD, TG).
- (71) Applicant (for all designated States except US): ENZY-MOTEC LTD. [IL/IL]; Ramat-Gavriel Industrial Park, P.O. Box 6, 23106 Migdal HaEmek (IL).
- (72) Inventors; and
- (75) Inventors/Applicants (for US only): BEN DROR, Gai [IL/IL]; P.O. Box 126, 30835 Moshav Ofer (IL). PLATT, Dorit [IL/IL]; P.O. Box 249, 17906 Shimshit (IL). FARKASH, Orly [IL/IL]; P.O. Box 217, 17906 Shimshit (IL). ZUABI, Rassan [IL/IL]; 19320 Kfar Neen (IL). BAR-ON, Zohar [IL/IL]; 32 Yodfat Street, 21950 Karmiel (IL). SHULMAN, Avidor [IL/IL]; 29 HaGomeh Street, 36090 Kiryat Tivon (IL). PELLED, Dori [IL/IL]; 29 HaShahar Street, 45325 Hod Hasharon (IL).

**Published:**  
— without international search report and to be republished upon receipt of that report

For two-letter codes and other abbreviations, refer to the "Guidance Notes on Codes and Abbreviations" appearing at the beginning of each regular issue of the PCT Gazette.

(54) Title: LIPIDS CONTAINING OMEGA-3 AND OMEGA-6 FATTY ACIDS

(57) Abstract: Disclosed is a lipid preparation comprising a glycerophospholipid or salt, conjugate and derivatives thereof, particularly phosphatidylserine (PS), phosphatidylcholine (PC), phosphatidylethanolamine (PE), phosphatidyl-inositol (PI), phosphatidyl-glycerol (PG) and phosphatidic acid (PA), and poly-unsaturated fatty acid (PUFA) acyl groups, particularly long-chain poly-unsaturated fatty acid (LC-PUFA) acyl groups such as omega-3 and/or omega-6 acyl groups, wherein said PUFA is covalently bound to said glycerophospholipid. The disclosed preparations possess an improved bioactivity, and are useful in the treatment of various cognitive and mental conditions and disorders and for maintenance of normal functions of brain-related systems and processes.



WO 2005/037848 A2

## LIPIDS CONTAINING OMEGA-3 AND OMEGA-6 FATTY ACIDS

### **Field of the Invention**

The present invention relates to phospholipids and polar lipids preparations which are enriched with omega-3 and/or omega-6 fatty acids covalently attached to the lipid backbone. The phospholipid preparations of the invention are particularly useful as nutraceuticals, food additives and/or pharmaceutical agents for the treatment of various conditions, in particular related to cognitive functions.

### **Background of the Invention**

Lipids, and especially polar lipids, nitrogen containing lipids, and carbohydrate containing lipids (phospholipids, sphingosines, glycolipids, ceramides, sphingomyelins) are the major building blocks of cell membranes, tissues, etc. Additionally they play important roles in signal transduction processes and in a variety of biochemical and biosynthetic pathways.

Glycerophospholipids, lipids based on a glycerol backbone and containing a phosphate head group, are the main building blocks of cell membranes. Since most, if not all, biochemical processes involve cell membranes, the structural and physical properties of membranes in different tissues is crucial to the normal and efficient functioning of membranes in all biochemical processes.

In light of the emerging functional foods category in the area of dietary lipids many health benefits have been attributed to the consumption of certain fatty acids. For example, it has been reported in many research studies that polyunsaturated fatty acids (PUFA) of the type omega-3 and omega-6, have several health benefits on cardiovascular disease, immune disorders and inflammation, renal disorders, allergies, diabetes, and



cancer. These types of fatty acids are naturally occurring mainly in fish and algae, where they are randomly distributed on the sn-1, sn-2, and sn-3 positions of the glycerol backbone of triglycerides.

The professional literature emphasizes the importance of an adequate diet containing omega-3 fatty acids. Extensive clinical studies investigating the importance of Docosahexaenoic acid (DHA), one of the most important omega-3 fatty acids, in the brain, found that low levels of DHA are associated with depression, memory loss, dementia, and visual problems. All studies showed a dramatic improvement in the elderly brain function as blood levels of DHA increased.

Other known benefits of DHA include: lower risk of arrhythmias, reduction in the risk of sudden cardiac death, lower plasma triglyceride levels and reduced blood clotting tendency. Furthermore, DHA may have importance in the field of brain functioning enhancement, baby formula fortification, diabetics and cancer. Nutritional studies, investigating the importance of DHA in the brain, found that low levels of DHA are associated with depression, memory loss, cognitive impairment, dementia and visual problems.

The human body does not adequately synthesize DHA. Therefore it is necessary to obtain it from the diet. Humans obtain DHA from their diets, initially through the placenta, then from breast milk, and later through dietary sources, such as fish, red meats, animal organ meats and eggs. Popular fish like tuna, salmon and sardines are rich sources. Until recently, the primary source of DHA dietary supplements has been fish oils. The ability of enzymes to produce the omega-6 and omega-3 family of products of linoleic and alpha-linolenic acid declines with age. Because DHA synthesis declines with age, as we get older our need to acquire DHA directly from diet or supplements increases. In fact, several recent

publications suggested DHA to be considered as essential fatty acid [for example, Muskiet, F. *et al.* (2004) *J Nutr.* 134(1):183-6].

Because DHA is important for signal transmission in the brain, eye and nervous system, many consumers concerned with maintaining mental acuity are searching for a pure, safe way to supplement their DHA levels.

Polyunsaturated acids, in particular long chain, such as omega-3 and 6, have been shown to confer many valuable health benefits on the population. The global market for long-chain PUFAs, including the food segment, is rapidly growing.

The majority of efforts in the industry are however invested in the improvement of PUFA processing techniques and in the creation of higher concentrated grades of PUFA derivatives to accommodate dietary supplements and functional foods needs.

The academic and industrial communities are less concerned regarding the evaluation of different delivery approaches of PUFA in order to enhance their bio-availability and their efficacy in term of their known variety of health benefits. These benefits range from prevention and treatment of CVD, diabetes, cognitive disorders and/or decline, visual disorders, skin conditions, learning disorders, etc. Additionally, PUFAs have been shown to assist in the cognitive and visual development of infants.

#### PUFA-lipids

##### PS-PUFA

Phosphatidylserine, also known as PS, is a natural phospholipid with bio-functionality that has made it one of the most promising dietary supplements in the field of brain nutrition. PS and its health benefits have

been known to the scientific and nutrition communities since the 1970's. Numerous studies have been conducted in order to establish this efficacy in a variety of cognitive and mental functions. Those studies have shown that PS can improve memory, fight dementia, fight early stages of Alzheimer's disease, reduce stress and tension, improve attention span, enhance mood and fight depression, to name but few.

PS is one of the most important building blocks of cell membranes in the brain. Hence, the level of PS in brain cell membranes ensures the fluidity and structure of these membranes. The normal level ensures normal and efficient signal transduction processes, efficient glucose consumption, and other biological pathways that result in normal cognitive and mental functions.

Since PS is not abundant in human nutrition and since in many people, especially the elderly, the biosynthetic pathways responsible for the production of PS are malfunctioning, the levels of PS in the body and brain are low. This results in a variety of cognitive and mental disorders, such as depression, memory loss, short attention span, learning difficulties, etc.

The supplementation of PS in the diets of elderly people with such disorders has resulted, in many cases, in dramatic improvements of these disorders. Over the recent years, studies have shown that even younger people can benefit from dietary supplementation of PS. PS has been shown to improve the learning capabilities of students, improve memory and attention span, etc.

It is therefore an object of the present invention to provide special preparations of PS, for use mainly as nutraceuticals and as functional food additives.

### PC-PUFA

As mentioned before, phospholipids are essential components of all cellular and sub-cellular membranes. Phosphatidylcholine and phosphatidylethanolamine predominate quantitatively, substantially constituting the typical bilayer configuration. Phospholipids belong to the amphipathic molecules with a water-soluble and a fat-soluble component. In the bilayer configuration the hydrophilic groups are arranged at the outer and inner side of the membrane toward the surrounding medium; the lipophilic groups, in contrast, face each other at the inner side of the bilayer configuration.

Other important constituents of biological membranes are cholesterol, glycolipids, and peripheral and integral proteins. The basic structure of biological membranes is thus a series of recurrent unities of lipid-protein complexes. The membrane is asymmetric. The function of the external (cellular) and internal (sub cellular) membrane systems depends on their composition and on the integrity of their phospholipid structure. In addition to their presence in cell membranes, phospholipids constitute structural and functional elements of the surface mono-layers of lipoproteins and of surfactants.

Of utmost importance for the function of biological membranes is their fluidity, which is decisively influenced by phospholipids. Besides the content in cholesterol and proteins and the nature and charge of the polar head groups of phospholipids in the system, membrane fluidity depends on the length of the chains of fatty acid residues in the phospholipid molecule, as well as on the number and type of pairing of their double bonds.

Phospholipids containing poly-unsaturated fatty acids supply the organism with important building blocks which improves membrane fluidity.

Studies conducted with PUFA-containing phospholipids have shown the following:

1. They are high-energy, basic, structural, and functional elements of all biological membranes, such as cells, blood corpuscles, lipoproteins, and the surfactant.
2. They are indispensable for cellular differentiation, proliferation, and regeneration.
3. They maintain and promote the biological activity of many membrane-bound proteins and receptors.
4. They play a decisive role for the activity and activation of numerous membrane-located enzymes, such as sodium-potassium-ATPase, adenylate cyclase and lipoprotein lipase.
5. They are important for the transport of molecules through membranes.
6. They control membrane-dependent metabolic processes between the intracellular and intercellular space.
7. The polyunsaturated fatty acids contained in them, such as linoleic acid, are precursors of the cytoprotective prostaglandins and other eicosanoids.
8. As choline and fatty acid donors they have an influence in certain neurological processes.
9. They emulsify fat in the gastrointestinal tract.
10. They are important emulsifiers in the bile.
11. They codetermine erythrocyte and platelet aggregation.
12. They influence immunological reactions on the cellular level.

Phospholipids containing PUFA are theoretically of importance in all those diseases in which damaged membrane structures, reduced phospholipid levels, and/or decreased membrane fluidity are present. This

hypothesis is supported by experimental and clinical investigations of various membrane-associated disorders and illnesses.

Studies on the active principle as well as pharmacological and clinical trials are available on a variety of disturbances and diseases related to membrane damages. For example, in liver diseases the hepatocyte structures are damaged by, for example, viruses, organic solvents, alcohol, medicaments, drugs, or fatty food. As a consequence, membrane fluidity and permeability may be disturbed, and membrane-dependent metabolic processes as well as membrane-associated enzyme activities may be impaired. This considerably inhibits the metabolism of the liver.

Other examples include hyperlipoproteinemia with or without atherosclerosis, hemorrheological disturbances with an elevated cholesterol/phospholipid ratio in the membranes of platelets and red blood cells, neurological diseases, gastro intestinal inflammations, kidney diseases, and in a variety of aging symptoms.

All these very different diseases have in common comparable membrane disorders. With polyunsaturated phosphatidylcholine molecules such disorders may be positively influenced, eliminated, or even improved beyond normal due to the high content in polyunsaturated fatty acids. Following are some examples of the mechanisms that mediate this phenomenon:

1. HDL particles enriched with PUFA-containing-phosphatidylcholine are able to take up more cholesterol from low-density lipoprotein (LDL) and tissues. More cholesterol can be transported back to the liver. This action on the cholesterol reverse transport is unique. All other lipid-lowering agents reduce either the cholesterol absorption in the body or the cholesterol synthesis in the liver and its distribution to the periphery.

These substances, however, do not physiologically mobilize the cholesterol already present in the periphery.

2. The cholesterol/phospholipid ratio in membranes, platelets, and red blood cells decreases and membrane function is improved up to normalization.
3. Peroxidative reactions are reduced, damaged hepatocyte membrane structures restored, membrane fluidity and function stabilized, immunomodulation and cell protection improved, and membrane-associated liver functions enhanced.
4. With the normalization of the cholesterol/phospholipid ratio, the bile is also stabilized.
5. Due to its specific property as a surface-active emulsifier, PUFA-containing-phosphatidylcholine solubilize fat and is used in reducing the risk and treatment of fat embolism.
6. The substitution with poly-unsaturated-fatty-acids and choline may have a cytoprotective effect in the brain and activate neuronal processes.
7. Liposomes with polyunsaturated phosphatidylcholine molecules may act as drug carriers, such as of vitamin E.

#### Liver Disease

Experimental and clinical results support the assumption that the therapeutic application of PUFA-containing-phosphatidylcholine has protective and even curative and regenerative effects on biological membranes of sinus endothelial cells and hepatocytes. The cytoprotective effect of PUFA-containing-phosphatidylcholine has been corroborated in 7 *in vitro* and in 55 *in vivo* experiments, in which 20 different models with five different animal species were used. Types of intoxication that are known to play a role in the etiology of liver disease have mostly been applied: chemical substances, medicaments, alcohol, cholestasis, immunological phenomena, exposure to radiation, and so on.

The hepato-protective effects of PUFA-containing-phosphatidylcholine have been confirmed and were the more pronounced the earlier PUFA-containing-phosphatidylcholine was administered:

1. Structures of membranes were normal or largely normalized.
2. Fatty infiltrations and hepatocyte necrosis could be diminished or even eliminated.
3. Corresponding data were found for lipid peroxidation, transaminase and cholinesterase activity, and for serum lipids; liver cell metabolism increased.
4. The increase of RNA and protein synthesis and of the liver cell glycogen content indicated a stimulation of the liver cells.
5. Reduced collagen production, collagen/DNA ratio, and liver hydroxyproline content indicated a reduced formation of connective tissue.

The dosage of PUFA-containing-phosphatidylcholine ranged from 525 to 2,700 mg/day when administered orally, and from 500 to 3,000 mg/day in intravenous application. The duration of treatment lasted from a few weeks to up to 30 months. The main liver indications were acute hepatitis, chronic hepatitis, fatty liver, toxic liver damage, cirrhosis of the liver, and hepatic coma.

The clinical findings, showing the effectiveness of PUFA-containing-phosphatidylcholine, can be summarized generally as follows:

1. Accelerated improvement or normalization of subjective complaints, of clinical findings, and of several biochemical values
2. Better histological results as compared with the control groups
3. A shortened duration of hospitalization

Promising results were obtained also in renal disorders, chronic ambulatory peritoneal dialysis, hyperlipoproteinemia/atherosclerosis, gastrointestinal inflammation, psoriasis, and more.



Recent research studies have shown that PUFA-enriched phospholipids, isolated from rainbow trout embryos, have novel health benefits. Some of these benefits include the treatment of tumor cells, inhibition of 5-lipoxygenase activity, reduction of neutral fat levels (such as cholesterol).

There is proof that a person who receives enriched phospholipids nutritionally, these phospholipids cross the intestinal barrier and the blood-brain barrier, thus reaching the brain. Recently, investigators from Ponroy Laboratories had described an experiment in which mice lacking essential fatty acids, i.e. linoleic acid (18:2 n-6) and  $\alpha$ -linolenic acid (18:3 n-3), which serve as the sole sources for LC-PUFA, were fed cerebral phospholipids and the quantity of phospholipids in each part of the brain measured. These phospholipids were found in the cytoplasm, in the synapses, and in other parts of the brain [Carrie *et al.*, (2000) *J. Lipid Res.* **41**, 465-472].

The utilization of phospholipids enriched with PUFA holds many potential advantages from a clinical point of view. The phospholipid may deliver the essential fatty acid to specific organs or body parts, such as the brain, and assist in the incorporation of these fatty acids in membranes. Other advantages may arise from the fact that phospholipids enriched with PUFA will not have odor problems such as found in the major current nutraceutical source, the fish oils. Furthermore, some preliminary clinical studies have shown that PUFA incorporated in phospholipids possess superior efficacy than PUFA carried by triglycerides. [Song *et al.* (2001) *Atherosclerosis*, **155**, 9-18].

Further studies have shown that the activity of DHA-rich phospholipid was different from that of DHA-rich triacylglycerol in spontaneously hypertensive rats [Irukayama-Tomobe *et al.* (2001) *Journal of Oleo*

*Science*, 50(12), 945-950]. Spontaneously hypersensitive rats (SHR) were fed test lipid diets for six weeks, which contained 30%-docosahexaenoic acid (DHA) phospholipid (DHA-PL) extracted from fish roe or 30%-DHA fish oil (DHA-TG). The control diet contained corn oil in the presence of test lipids. After feeding, blood pressure in the DHA-TG and DHA-PL diet groups was found significantly lower compared to the control. Serum fatty acid content of dihomo-linoleic acid (DHLnA) and Arachidonic acid (AA) of the DHA-PL diet group was significantly less than the control or DHA-TG diet group. Serum triacylglycerol, phospholipid and total cholesterol in the DHA-TG and DHA-PL diet groups were significantly less than in the control. Liver total cholesterol in DHA-PL was twice that in the DHA-TG diet group and control. The mechanism for cholesterol removal from blood by DH-PL would thus appear to differ from that by DHA-TG. Serum lipid peroxide (LPO) in the DHA-TG and DHA-PL diet groups was essentially the same as in the control.

Many PUFA-containing agents suffer from stability and quality problems due to the high degree of oxidation of the polyunsaturated fatty acids. These problems require the incorporation of antioxidants as well as the utilization of special measures which attempts to reduce this oxidation. The utilization of phospholipids as carriers of PUFA may result in enhanced stability of such products due to the anti-oxidative properties of phospholipids.

It seems that one of the most effective transport mechanism for such essential fatty acids is the attachment of these groups to phospholipid molecules. The phospholipids have been shown to pass through the blood-brain barrier and transport the DHA where it is needed.

Organoleptic concerns

PUFAs are traditionally extracted from coldwater fish. Despite the healthy image, one of the problems of consumer acceptance has been the resulting strong, fishy taste. To address this, microencapsulated forms of omega-3 have been pioneered in the last 15 years. A further step was the development of egg-containing products such as DHA-enriched mayonnaise and pasta. DHA-enriched yogurts, baked goods and broilers were also envisaged.

There is no other nutritional product or ingredient that is considered to be an agent of PUFA delivery. All current commercial products are based on the fatty acids themselves in an encapsulated form or on foods enriched with PUFA through special animal/crop feed.

It is therefore an object of the present invention to provide lipid preparations enriched with omega-3 or omega-6 fatty acids, for use mainly as nutraceuticals and as functional food additives. The composition of said preparation is such that it provides the preparation with the property of enhancing the bioavailability of PUFAs. Thus upon its consumption, preferably in the form of nutraceuticals, food additives or pharmaceutical compositions, the organism may, in the most efficient way, enjoy the benefits provided by said preparation, as will be described in detail below.

This and other objects of the invention will become apparent as the description proceeds.

**Summary of the Invention**

In a first aspect the present invention provides a lipid preparation, wherein said lipid is selected from glycerophospholipids and their salts, conjugates, and derivatives and any mixture thereof, and poly-

unsaturated fatty acid (PUFA) acyl groups, particularly long-chain polyunsaturated fatty acid (LC-PUFA) acyl groups, preferably omega-3 and/or omega-6 acyl groups, at a concentration of least 5% (w/w) of total fatty acids content of said preparation, preferably more than 10% (w/w), more preferably 20-50% (w/w), wherein said PUFA is covalently bound to said lipid.

Said lipid may be a naturally occurring lipid, or a synthetic lipid. Preferably, said lipid is a glycerophospholipid in which at least some of the sn-1 or sn-2 groups of the glycerol backbone are substituted with said polyunsaturated fatty acid (PUFA) acyl groups.

In one particular embodiment, said lipid is a glycerophospholipid of formula I:

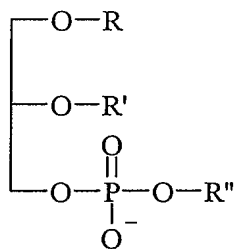

Formula (I)

wherein R'' represents a moiety selected from serine (PS), choline (PC), ethanolamine (PE), inositol (PI), glycerol (PG) and hydrogen (phosphatidic acid - PA), and R and R', which may be identical or different, independently represent hydrogen or an acyl group, wherein said acyl group is selected from saturated, mono-unsaturated or poly-unsaturated acyl groups (PUFA), particularly long-chain poly-unsaturated fatty acids (LC-PUFA), more preferably omega-3 and/or omega-6 acyl groups, and salts thereof, with the proviso that R and R' cannot simultaneously represent hydrogen, and wherein said polyunsaturated acyl groups

comprise at least 5% (w/w) of total lipid fatty acids, preferably more than 10% (w/w), and particularly 20-50% (w/w).

In one more particular embodiment of said preparation, R represents hydrogen and R' represents an acyl group. Alternatively, R' represents hydrogen and R represents an acyl group.

Considering these latter embodiments, when said acyl group is preferably an omega-3 acyl group, it may be an eicosapentaenoyl (EPA), a docosahexaenoyl (DHA) group, or linolenic omega-3 group. And, when said acyl group is preferably an omega-6 acyl group, it may be an arachidonoyl (ARA) group, or a linoleic omega-6 group. A further possibility is that said acyl group may be a linolenoyl (18:3) group.

In a yet further embodiment of the preparation of the invention, R'' may be any one of serine, choline, ethanolamine, inositol or glycerol.

In a further particular embodiment, the identity and content of R and R' are predetermined.

The preparation of the invention which comprises the compound of formula I in which R'' is serine, mimics the composition of human brain PS.

Nonetheless, the invention also refers to preparations comprising the compound of formula I in which R'' is serine, which are different from human brain PS, but still have an improved bioactivity, particularly as compared to soybean-PS. This improved bioactivity results in beneficial effects on both the learning and working memory in elderly population, in particular in cholinergic impaired conditions like Alzheimer's disease.

The invention also relates to preparation PS preparation which mimics the human brain PS, is effective at lower dosage (2-3 fold) compared to soybean-PS, while having similar or improved bioactivity compared to soybean-PS.

The PS may be of plant, animal or microorganism source, and is enriched with PS of formula I, wherein R" represents a serine moiety.

The preparation of the invention may be further enriched with PS of formula I, characterized in having reduced or absent of fish-related organoleptic effects. Such preparation may be particularly suitable for incorporation into chocolate-containing or dairy-based food articles (including concentrated milk).

The preparation of the invention may be used in the improvement and treatment of cognitive and mental conditions and disorders as well as the maintenance of normal functions of brain-related systems and processes, preferably ADHD, aging, Alzheimer's disease, Parkinson's disease, multiple sclerosis (MS), dyslexia, depression, learning capabilities, intensity of brain waves, stress, anxiety, mental and psychiatric disorders, concentration and attention, mood, brain glucose utilization, general cognitive and mental well being, neurological disorders and hormonal disorders.

The preparation of the invention is particularly useful in enhancing the bioavailability of omega-3 and omega-6 fatty acids.

The preparation of the invention may be used in combined improvement of cognitive and mental functions together with improvement of additional health disorders or conditions. Such additional health disorders or conditions may be at least high blood cholesterol levels, high triglycerides

#

levels, high blood fibrinogen levels, HDL/LDL ratio, diabetes, metabolic syndrome, menopausal or post-menopausal conditions, hormone related disorders, vision disorders, inflammatory disorders, immune disorders, liver diseases, chronic hepatitis, steatosis, phospholipid deficiency, lipid peroxidation, dysrhythmia of cell regeneration, destabilization of cell membranes, coronary artery disease, high blood pressure, cancer, hypertension, aging, kidney disease, skin diseases, edema, gastrointestinal diseases, peripheral vascular system diseases, allergies, neurodegenerative and psychiatric diseases.

The preparation of the invention may also be used in the reduction and/or prevention of serum oxidative stress leading to atherosclerosis, cardiovascular disorders and/or coronary heart disease.

The invention further relates to nutraceutical compositions comprising a lipid preparation in accordance with the invention. The nutraceutical composition may be in the form of softgel capsules, tablets, syrups, or any other common dietary supplement delivery system.

Still further, the invention relates to functional food article comprising the lipid preparation of the invention. Such functional food article may be selected from dairy products, dairy drinks, ice-creams, bakery products, confectionary products, biscuits, soy products, pastry and bread, sauces, condiments, oils and fats, margarines, spreads, cereals, drinks and shakes, oils and fats, infant formulas, infant foods (biscuits, mashed vegetables and fruits, cereals), bars, snacks, candies and chocolate products.

In yet a further aspect, the invention relates to pharmaceutical compositions comprising the lipid preparation of the invention, and optionally further comprising at least one pharmaceutically acceptable additive, diluent or excipient. The pharmaceutical composition of the

invention may further optionally comprise at least one pharmaceutically active agent.

### **Brief Description of the Figures**

#### **Figure 1A-D: Performance of rats in acquisition of the spatial Morris maze task.**

Latency time to platform in the three days of acquisition (2 sessions per day) of aged rats supplemented for three months with various supplements as detailed below was analyzed using video camera, with (open squares) or without (closed circles) pretreatment of 1 mg/kg of scopolamine.

Fig. 1A: Rats supplemented with MCT,  $P < 0.007$ .

Fig. 1B: Rats supplemented with PS-  $\omega 3$ ,  $P < 0.07$ .

Fig. 1C: Rats supplemented with SB-PS,  $P < 0.02$ .

Fig. 1D: Rats supplemented with LC-PUFA,  $P < 0.03$ .

Values represent mean  $\pm$  S.E.M of four to five rats per supplement.

Abbreviations: Lat. T. , latency time; sec., seconds.

#### **Figure 2. Performance of scopolamine-treated rats in the Morris water maze task in the spatial probe test.**

This graph represents percentage of time (T.) that aged rats, supplemented for three months with MCT (open bars), PS-  $\omega 3$  (solid bars), SB-PS (dotted bars) or LC-PUFA (striped bars), spent in different areas after the platform being removed, was analyzed using video camera, following pre-treatment of 1 mg/kg of scopolamine. Values represent mean  $\pm$  S.E.M of four to five rats per supplement. Significance compared to control group (MCT) \*  $P < 0.02$  and \*\*  $P < 0.08$



**Figure 3A-D: Performance of scopolamine-induced rats in locating the platform after its reposition.**

Latency time to platform on the fifth day of the water maze test, in which the platform was repositioned between the sessions, in aged rats supplemented for three months with different supplements as specified below, was analyzed using video camera, with (open squares) or without (closed circles) pretreatment of 1 mg/kg of scopolamine.

Fig. 3A: Rats supplemented with MCT.

Fig. 3B: Rats supplemented with PS-  $\omega$ 3.

Fig. 3C: Rats supplemented with SB-PS.

Fig. 3D: Rats supplemented with LC-PUFA.

Values represent mean  $\pm$  S.E.M of four to five rats per supplement.

Abbreviations: Lat. T. , latency time; sec., seconds; tr., trials.

**Figure 4A-B: Phospholipid levels in rat tissues as measured using  $^{31}\text{P}$ -NMR.**

Lipids were extracted from tissues of aged rats that were supplemented for three months with MCT (open bars), PS-  $\omega$ 3 (solid bars), SB-PS (dotted bars) or LC-PUFA (striped bars). Phospholipids levels were analyzed using a  $^{31}\text{P}$ -NMR machine and the relative levels of phosphatidylcholine of the different treatments are presented.

Fig. 4A: Analysis of lipids extracted from the liver.

Fig. 4B: Analysis of lipids extracted from the brain (cortex region).

Values represent mean  $\pm$  S.D. of four to five rat tissues per supplement.

Significance compared to control group (MCT) \*P<0.05 and \*\*P<0.1.

Abbreviations: Tot. Pl., total phospholipids.

**Figure 5: Parental scores of ADHD children according to behavioral rating scales.**

The graph represents percentage of ADHD children that demonstrated improvement or lack of improvement in a parental view following two

months of supplementation with canola oil (open bars), DHA (solid bars) or PS-  $\omega$ 3 (hatched bars). Rating includes remarks regarding behavioral tendencies at home, at school, with siblings or peers and teachers feedback. Values represent percentage of twenty to twenty-five ADHD children scores per supplement. Note that twelve parents decline to respond to the questioner and six children did not complete the supplementation period due to poor taste or severe discipline problems (mostly the control group).

Abbreviations: Improv., improvement; Marg. Improve., marginal improvement; n.c., no change; Deter., deterioration.

**Figure 6: Effect of PC-DHA on the serum oxidative stress.**

Apo E<sup>0</sup> mice were fed for 10 weeks with placebo (open bars) or PC-DHA (solid bars). Serum lipid peroxide (Ser. per.) levels were measured using a spectrophotometric assay. Values represent mean  $\pm$  S.D. of 5 mice per treatment.

**Detailed Description of the Invention**

In a first aspect the present invention provides a lipid preparation, wherein said lipid is a glycerophospholipid, a salt, conjugate, and derivative thereof, and any mixture thereof, and poly-unsaturated fatty acid (PUFA) acyl groups, particularly long-chain poly-unsaturated fatty acid (LC-PUFA) acyl groups, preferably omega-3 and/or omega-6 acyl groups, at a concentration of least 5% (w/w) of total fatty acids content of said preparation, preferably more than 10% (w/w), more preferably 20-50% (w/w), wherein said PUFA is covalently bound to said glycerophospholipid.

Said lipid may be a naturally occurring lipid, or a synthetic lipid.

Preferably, said lipid is a glycerophospholipid in which at least some of the sn-1 or sn-2 groups of the glycerol backbone are substituted with said poly-unsaturated fatty acid (PUFA) acyl groups.

In one particular embodiment, said lipid is a glycerophosphlipid of formula I:

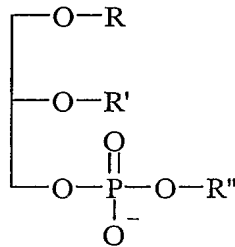

Formula (I)

wherein R'' represents a moiety selected from serine (PS), choline (PC), ethanolamine (PE), inositol (PI), glycerol (PG) and hydrogen (phosphatidic acid - PA), and R and R', which may be identical or different, independently represent hydrogen or an acyl group, wherein said acyl group is selected from saturated, mono-unsaturated or poly-unsaturated acyl groups (PUFA), particularly long-chain poly-unsaturated fatty acids (LC-PUFA), more preferably omega-3 and/or omega-6 acyl groups, and salts thereof, with the proviso that R and R' cannot simultaneously represent hydrogen, and wherein said polyunsaturated acyl groups comprise at least 5% (w/w) of total lipid fatty acids, preferably more than 10% (w/w), and particularly 20-50% (w/w).

In one more particular embodiment of said preparation, R represents hydrogen and R' represents an acyl group. Alternatively, R' represents hydrogen and R represents an acyl group.

Considering these latter embodiments, when said acyl group is preferably an omega-3 acyl group, it may be an eicosapentaenoyl (EPA), a

docosahexaenoyl (DHA) group, or linolenic omega-3 group. And, when said acyl group is preferably an omega-6 acyl group, it may be an arachidonoyl (ARA) group, or a linoleic omega-6 group. A further possibility is that said acyl group may be a linolenoyl (18:3) group.

In a yet further embodiment of the preparation of the invention, R" may be any one of serine, choline, ethanolamine, inositol or glycerol.

In a further particular embodiment, the identity and content of R and R' are predetermined.

The preparation of the invention which comprises the compound of formula I in which R" is serine, mimics the composition of human brain PS.

Nonetheless, the invention also refers to preparations comprising the compound of formula I in which R" is serine, which are different from human brain PS, but still have an improved bioactivity, particularly as compared to soybean-PS.

Traditionally, PS active ingredients used as dietary supplements were produced by the extraction of animal brains, particularly bovine brains. The PS extracted from animal brain tissues, similarly to human brain PS, has a fatty acid composition which is characterized by relatively higher levels of omega-3 moieties, compared to the levels of omega-3 found in plant phospholipids.

PS has the following structure:

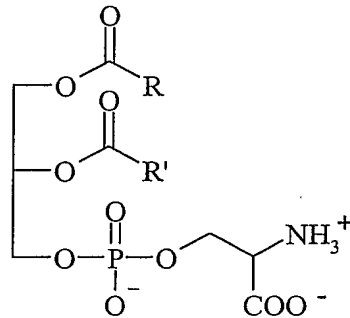

Formula II

Human brain PS is characterized by over 20-30% PS containing omega-3 fatty acyls, preferably at the *sn*-2 position of the glycerol moiety, and mainly DHA or EPA. As mentioned above, phospholipids, and PS in particular, are responsible for membrane structure and physical properties. One of the major physical properties governed by phospholipids is the fluidity of these membranes. Omega-3 fatty acids, DHA and EPA in particular, also have a crucial role in membrane fluidity in light of their unique 3D structure. Therefore, PS with omega-3 fatty acyl moieties, DHA and EPA in particular, has unique bio-functionality which cannot stem from just the basic phospholipid skeleton of this phospholipid.

Considering the risks involved with prion diseases, particularly bovine spongiform encephalopathy (BSE), as well as other disadvantages associated with ingredients obtained from animal sources, PS supplements are usually prepared using PS originating from soybean lecithin. This lecithin is enriched, usually enzymatically, with PS. This method of production results in PS with a fatty acid profile of soybean phospholipids, which is characterized by low level of omega-3 fatty acids, and almost no DHA and EPA. This PS active ingredient is also known as soybean-PS.

Although the bio-functionality of soybean-PS in the improvement of cognitive function has been shown to be similar to that of bovine-PS, it is still different from human brain PS. It is a purpose of the present invention to provide a PS ingredient with a predetermined fatty acid composition that mimics the fatty acid composition of the human brain PS.

It is a further object of the present invention to provide a PS ingredient which, while not identical to naturally occurring brain PS, is characterized by improved functionality, particularly in comparison with soybean-PS. This improved PS ingredient has a predetermined fatty acid composition.

The PS ingredient of the present invention is enriched with omega-3 fatty acyls, preferably DHA, EPA or linolenic omega-3. Furthermore, the PS of this invention is enriched with omega-3 fatty acyls covalently bonded to either or both of the *sn*-1 or *sn*-2 positions of the glycerol moiety in the PS backbone.

The present invention is also related and describes other phospholipids, such as phosphatidylcholine (PC), phosphatidylethanolamine (PE), phosphatidyl-inositol (PI), phosphatidylglycerol (PG) and phosphatidic acid (PA), enriched with omega-3 fatty acids, preferably DHA, EPA, or linolenic acid which are covalently bonded at either or both of the *sn*-1 or *sn*-2 positions of the glycerol moiety of the phospholipid. Alternatively, the phospholipids of the invention are enriched with omega-6 fatty acids.

When referring to PS in the present description, it should be taken to mean also any other lipid, such as, but not limited to, the polar lipids listed above.

In a preferred embodiment, the amount of omega-3 (particularly EPA, DHA or linolenic acid) or omega-6 (particularly ARA and linoleic acid)

fatty acids in the PS ingredient of the invention is greater than 10% at either or both of the *sn*-1 or *sn*-2 positions, preferably at the *sn*-2 position, preferably over 20% and most preferably above 40%.

As mentioned, the desired omega-3/omega-6 fatty acyls can be bonded at both or only one of the *sn*-1 and *sn*-2 positions.

The fatty acid composition of the PS preparation of this invention can have a predetermined fatty acid composition similar to or different from the fatty acid composition found in normal healthy human brain, provided it has enhanced activity, particularly compared to the activity of plant PS, for example soybean-PS.

The preparation of the omega-3/omega-6-enriched PS preparation of this invention can be enzymatic, chemical or by molecular biology methods. Briefly, the PS can be enriched with omega-3 or omega-6 moieties by enzymatic processes, e.g. enrichment of a natural phospholipid/lecithin with omega-3 fatty acids by enzymatic transesterification/esterification followed by transformation of the head group to serine (using PLD enzymes) to obtain a PS-omega-3/omega-6 conjugate. Another enzymatic pathway is to obtain a lecithin or phospholipid source which is naturally rich in omega-3 acids, such as krill phospholipids, and transform their head groups to serine. It is to be noted that the fatty acid composition of the PS obtained by this method has an omega-3 composition which is predetermined by the source of choice (fish, krill, algae, etc.). Such methods have been thoroughly described in Applicant's co-pending PCT Application claiming priority from IL158553.

The PS-omega-3/omega-6 ingredient of the present invention can also be prepared by chemical transesterification/esterification methods that will enrich the *sn*-1 and 2 positions with omega-3 or omega-6 acyl residues.

Such methods of preparation of PS-omega-3 and PS-omega-6 have been described in Applicant's co-pending PCT Application claiming priority from IL158553.

Alternatively, the PS ingredient of the present invention can be prepared by GMO (genetically modified organisms)/biotechnology methods, for example, providing phospholipids-producing organisms with omega-3 or omega-6 fatty acids to obtain phospholipids enriched with omega-3 or omega-6 PS. It may be preferred to use genetically engineered plants or microorganisms, to avoid use of animal sources.

The PS of this invention can have the omega-3 or omega-6 fatty acid composition of a specific lecithin raw material, relatively rich with omega-3 or omega-6 fatty acids, enriched with PS to yield a PS ingredient with elevated omega-3 or omega-6 fatty acids levels, compared to soybean-PS. Such is the case, for example, when phospholipids from krill are used as the starting material, as described above.

In a preferred embodiment the PS enriched with omega-3 or omega-6 can be soybean-PS or any other PS, from plant, animal, for example krill, or microorganism source. In a further preferred embodiment the omega-3 or omega-6 enrichment can be performed on a lecithin, which in turn is enriched with PS by transphosphatidylation.

It is the purpose of this invention to provide a novel PS ingredient, enriched with omega-3 fatty acids, resulting in an ingredient with improved efficacy compared to ingredients containing natural or simply enriched PS.

The improved PS preparation of this invention exhibits enhanced activity in the improvement and treatment of cognitive and mental conditions and



disorders as well as the maintenance of normal functions of brain related systems and processes. These include, but are not limited to ADHD, multiple sclerosis (MS), dyslexia, depression, learning capabilities, intensity of brain waves, stress, mental and psychiatric disorders, neurological disorders, hormonal disorders, concentration and attention, mood, brain glucose utilization, and general cognitive and mental well being.

The novel lipid preparation of this invention exhibits enhanced activity in the improvement of cognitive functions, as detailed hereunder, over omega-3 or omega-6 lipids *per se* or soybean-PS. Furthermore, under certain conditions or for all or specific disorders, the lipid preparation of the invention is effective at a dosage of less than 100 mg/day. This is lower than the current recommended daily dosage of soybean-PS (100-300mg/day) or omega-3 lipids (approx. 1-2g/day or more) currently available in the market. Nonetheless, dosages of 100-600mg/day are preferred for enhanced efficacy of the lipid preparation of the invention.

An important advantage of the PS preparation of the invention is that it exhibits multifunctional activity. This multi-functionality is exhibited by improvement in cognitive and mental functions, together with improvement of other health disorders or conditions.

The enhanced activity of this PS ingredient, as well as its multi-functionality, may arise from the unique structure of this ingredient and its influence on the physical and chemical properties of cell membranes in brain tissues as well as other organs and tissues.

The enhanced activity of this PS ingredient, as well as its multi-functionality, may also be attributed to the enhanced bioavailability of the omega-3 fatty acids, due to their incorporation in the PS skeleton. Thus,

the omega-3 fatty acids can be delivered to the brain across the blood-brain barrier, being a part of the PS molecule, which readily passes this barrier. The PS functions as a delivery platform for the fatty acids bound thereto, to various organs and tissues, thereby enhancing their bioavailability.

The additional health disorders or conditions which are affected by the multifunctional PS preparation of the invention include, but are not limited to high blood cholesterol levels, high triglycerides levels, high blood fibrinogen levels, HDL/LDL ratio, diabetes, metabolic syndrome, menopausal or post-menopausal conditions, hormone related disorders, vision disorders, inflammatory disorders, immune disorders, liver diseases, chronic hepatitis, steatosis, phospholipid deficiency, lipid peroxidation, dysrhythmia of cell regeneration, destabilization of cell membranes, coronary artery disease, high blood pressure, cancer, hypertension, aging, kidney disease, skin diseases, edema, gastrointestinal diseases, peripheral vascular system diseases, allergies, airways diseases, neurodegenerative and psychiatric diseases.

The new ingredients of the invention can be delivered and utilized in a variety of products. Such products include dietary supplements, functional foods, pharmaceutical delivery systems, etc.

The preparation of pharmaceutical compositions is well known in the art and has been described in many articles and textbooks, see e.g., Gennaro A. R. ed. (1990) *Remington's Pharmaceutical Sciences*, Mack Publishing Company, Easton, Pennsylvania, and especially pages 1521-1712 therein.

As dietary supplements, the preparations of the invention may be used in the form of soft gel capsules, tablets, syrups, and other common dietary supplements delivery systems.

As functional foods, the preparations of the invention can be incorporated and used in a variety of foods, such as dairy products, ice-creams, biscuits, soy products, pastry and bread, sauces, condiments, oils and fats, margarines, spreads, cereals, drinks and shakes, infant formulas, infant foods (biscuits, mashed vegetables and fruits, cereals), bars, snacks, candies, chocolate products.

As pharmaceutical products, the preparations of the invention can be delivered orally, intravenously, or by any other conventional or special route of administration.

The new preparations of the invention may be in the form of fluid oil, powder, granules, wax, paste, oil or aqueous emulsion, and any other form that will enable its use in the target applications.

Pharmaceutical or nutraceutical formulations comprising the PS preparation of the invention may include physiologically acceptable free flowing agents, other additives, excipients, dessicants and diluents, colorants, aroma and taste ingredients, and any ingredients that control physical, organoleptic, and other properties, as well as additional active ingredients, for example minerals, vitamins, other nutritional additives.

The utilization of omega-3 lipids in a variety of applications, and especially as ingredient of functional foods, is hindered due to their distinct fish odor. Thus, another advantage of the omega-3 enriched phospholipids ingredients of the invention is that they have reduced odor or taste of omega-3 acyl moieties, due to the covalent binding of these groups to the PS backbone. This increases the vapor pressure of these materials, hence reducing their distinct aroma. Thus, the covalent binding of the omega-3 fatty acids to the phospholipid backbone, especially PS,

alters and improves their taste properties. Moreover, the PS ingredient of the invention also offers enhanced stability to the oxidation sensitive omega-3 fatty acids. Phospholipids in general, and PS in particular, are known to act as anti-oxidants and stabilizers.

These benefits make the lipid preparation of the invention highly beneficial and important in a variety of applications and especially in functional foods, where stability, aroma and taste are fundamental requirements.

Furthermore, these novel ingredients can be formulated with additional lipids for an even enhanced bio-functionality and efficacy.

The polar lipids derivatives of PUFA, such as the PS-PUFA derivatives have exhibited high stability as a preparation and additionally in several food applications, used in the clinical trials of the present invention. The stability of these sensitive compounds is emerging from the covalent combination of phospholipids, known in the past to be used as preservatives and of the un-stable PUFA moieties.

The new ingredients of the invention can be delivered and utilized in a variety of products. Such products include dietary supplements, functional foods, pharmaceutical delivery systems, etc.

Disclosed and described, it is to be understood that this invention is not limited to the particular examples, process steps, and materials disclosed herein as such process steps and materials may vary somewhat. It is also to be understood that the terminology used herein is used for the purpose of describing particular embodiments only and not intended to be limiting since the scope of the present invention will be limited only by the appended claims and equivalents thereof.

It must be noted that, as used in this specification and the appended claims, the singular forms "a", "an" and "the" include plural referents unless the content clearly dictates otherwise.

Throughout this specification and the claims which follow, unless the context requires otherwise, the word "comprise", and variations such as "comprises" and "comprising", will be understood to imply the inclusion of a stated integer or step or group of integers or steps but not the exclusion of any other integer or step or group of integers or steps.

The following Examples are representative of techniques employed by the inventors in carrying out aspects of the present invention. It should be appreciated that while these techniques are exemplary of preferred embodiments for the practice of the invention, those of skill in the art, in light of the present disclosure, will recognize that numerous modifications can be made without departing from the spirit and intended scope of the invention.

## **Examples**

### **Example 1**

#### *Methods:*

#### *Animals and diet*

Male Wistar rats originated from the same colonies were obtained from Harlen. Fifty rats were randomly divided into five dietary supplemented groups, in addition to their normal diet: (i) a group fed 0.1g medium-chain triglycerides (MCT)/1ml supplement matrix (MCT group); (ii) a group fed 0.1g DHA/EPA (20/30% of total fatty acids composition, diluted with MCT to generate 30% (w/w) LC-PUFA compound) triglycerides/1ml supplement matrix (LC-PUFA group); (iii) a group fed 0.1g soybean lecithin-derived

PS (20% SB-PS w/w)/1 ml supplement matrix (SB-PS group); and (iv) a group fed 0.1g PS-  $\omega$ 3 (20% PS w/w, and total LC-PUFA composition of 30%)/1 ml supplement matrix (PS group). The supplement matrices were stored at -20°C, and fresh portions were fed to the rats every day. All supplements were handled so as to minimize oxidation of the fatty acids. Rats consumed the diet and water *ad libitum*. All rats were housed in a standard environment, in which temperature was maintained at 24  $\pm$  0.5°C, and the relative humidity was kept at 65  $\pm$  5% with 12-h periods of light and dark. Body weight was measured at the beginning and the end of the treatment period.

The PS-  $\omega$ 3 compound used in this study mimics the fatty acids composition of the mammalian brain PS, with respect to its DHA content (20%). Generally, in animal cells, the fatty acid composition of PS varies from tissue to tissue, but does not appear to resemble the precursor phospholipids, either because of selective utilization of specific molecular species for biosynthesis or because of re-modeling of the lipid via deacylation-reacylation reactions. In human plasma, 1-stearoyl-2-oleoyl and 1-stearoyl-2-arachidonoyl species predominate, but in brain and many others related tissues 1-stearoyl-2-docosahexaenoyl species are very abundant [O'Brien *et al.* (1964) *J Lipid Res.* 5(3):329-38]. An early work by Yabuuchi *et al.* [Yabuuchi *et al.* (1968) *J Lipid Res.* 9(1):65-7] established that the DHA content in bovine gray matter is up to 30% of the total fatty acids composition; most of the total amount of DHA was located at the sn-2 position (60%). It was the bovine brain PS that Toffano and Bruni reported in the early 1980's to be a pharmacologically active compound, which counteracts age-related changes in the central nervous system [Toffano *et al.* (1980) *Pharmacol.Res. Commun.* 12:829-845].

*Behavioral testing*

Water maze test, which was developed by Morris [Stewart, CA. and Morris, RG. (1993) The water maze. In: Behavioural Neuroscience: A Practical Approach. Vol. 1 (Saghal, A., ed.), pp. 107–122. Oxford University Press, New York, NY.], uses a circular tank (137 cm diameter, 35 cm deep) constructed of opaque white plastic. It is filled with water (21–22°C) to a depth of 28 cm, and the water is rendered opaque by the addition of soluble, nontoxic white latex paint. In the place version of the maze, the rat develops a spatial map of the extra-maze cues, which it then uses to locate the platform. Thus the distance swum to the platform and the time taken in doing so should decrease over testing sessions (days) as the rat learns the location of the platform. Moreover, it is expected that if the rat has learned the location of the platform in relation to the extra-maze cues, its initial response on the probe trial will be to swim directly to the quadrant in which it expects to find the platform. Thus the distance swum (and time spent) in the target quadrant should be greater than that in the other two quadrants (excluding the start quadrant). The distance swum to the platform as well as the latency to reach the platform were monitored using the video-based tracking system. The behavioral testing was conducted during the dark cycle, when rats are normally most active.

The pool was located in a test room in which there were many extra-maze spatial cues. On the first three days, the rats were required to locate the hidden platform (15.5 cm x 15.5 cm) situated 1 cm below the surface of the water. There were two acquisition testing sessions per day, with four trials per session. On each trial, the rat was placed, facing the wall, in one of the four quadrants in the tank, and allowed to swim for a maximum of 60 seconds. Once the rat found the platform, it remained there for 5 seconds before being returned to the holding cage, which was kept warm on a heating pad. If the rat failed to find the platform in that time, it was placed on it for 5 seconds before being returned to the holding cage. Each

of the eight trials conducted each day was started from a different quadrant, with the order determined pseudorandomly (not twice from the same quadrant) and varying from day to day. The intertrial interval (ITI) was 120 seconds, counted from the end of one trial to the beginning of the next. On fourth day, followed by a session as abovementioned, the platform was removed from the tank, and a probe trial was conducted by placing the rat in the quadrant opposite to that of the platform and then allowing it to swim for 60 seconds. The day following the probe trial, the rats were tested with a session in which the maze was set up as previously described, followed by a session in which the platform was repositioned to the center of the opposite quadrant. The latency to find the platform on each trial was recorded. Scopolamine (1mg/Kg) was intraperitoneally (i.p.) administered 30 minutes before the indicated trials.

*Lipid extraction and NMR analyses*

At the end of the behavioral testing, the rats were anesthetized with Halothane and then decapitated. Liver and brain tissues were quickly removed and stored (at -80°C). The lipid fraction of the rat tissues were extracted using a modified version of the technique described by Bligh and Dyer 1959 [Bligh and Dyer, (1959) *Can. J. Biochem. Physiol.* **37**, 911-917]. Briefly, 500-700 mg and 300-1200 mg of liver and brain tissues, respectively, were homogenized in a solution of CDCl<sub>3</sub>, methanol and CS-EDTA (1:2:2 v:v:v). The homogenates were further agitated using ultrasonic bath (10 min, 80°C), followed by additional vigorous shaking (20 min). The relative ratio of the phospholipids in the homogenates was measured using high-resolution <sup>31</sup>P-NMR at 121.MHZ using a 7.06 Tesla General Electric spectrometer.

These homogenates were further analyzed for their fatty acids distribution. First, the lipids extracts were desalted by reverse-phase chromatography using an RP-18 column [Williams *et al.* (1980) *J.*



*Neurochem.*; **35**, 266–269]; diheptadecanoyl phosphatidylcholine was added as internal standard before the loading on the column. Phospholipids were separated from neutral lipids, such as cholesterol, on silica gel plates (Merck 60) developed in isohexane: ether: formic acid 80:20:2 (v:v:v). The phospholipids spot was visualized by spraying primulin solution and compared with authentic phospholipids standards. Henicasonoic methyl ester (C21:0) was added as a 2nd internal standard and the phospholipids were converted to methyl esters by mild acid hydrolysis with 1% methanolic H<sub>2</sub>SO<sub>4</sub> overnight at 50°C. The fatty acids profile of the different samples was determined by gas-liquid chromatography.

### *Results*

Anti-dementia effects of bovine brain cortex-derived PS (BC-PS) has been demonstrated by several double-blind, placebo-controlled studies, see review by [Kidd P. (1996) *Alt Med Rev.* **1**(2):70-84]. In the past decade both BC-PS and soybean lecithin transphosphatidylated PS (SB-PS) were shown to recover the scopolamine-induced amnesia in rodent, although the fatty acids composition is considerably different between these compounds [Zanotti A *et al.* (1986) *Psychopharmacology (Berl)*. **90**(2):274-5.; Claro F. *et al.* (1999) *Physiol Behav.* **67**(4):551-4; Sakai M. (1996) *Nutr Sci Vitaminol. (Tokyo)* **42**(1):47-54; Furushiro M *et al.* (1997) *Jpn J Pharmacol.* **75**(4):447-50]. The means of PS administration in these studies was predominantly intravenous or intraperitoneal; although Furushiro *et al.* described also oral administration of SB-PS that antagonized amnesic effects of scopolamine. However, in the latter study the investigator used a considerable high dose of SB-PS, ranging between 60 to 240 mg/Kg.

In the presented study, rat diet was supplemented with the above-mentioned treatments (diets i, ii, iii, iv and v) for three months before the

maze test was performed. In the acquisition stage (Figure 1A-1D) there is an expected and marked increase in the latency time to find the platform after the administration of scopolamine (1mg/Kg) of all groups. Although the latency curves of MCT and PS-  $\omega$ 3 groups are similar, there is a statistically smaller difference in the latency change, induced by scopolamine, in the PS-  $\omega$ 3 group with respect to the latency presented by the MCT group (P-value < 0.07 Vs. P-value < 0.0007, respectively). Similarly, the groups treated with SB-PS or LC-PUFA, demonstrated a reduced effect of scopolamine on their learning curves, with respect to the MCT group (see Figure 1A-1D). Having all groups learn the task at a similar rate, resembles data presented by Blokland *et al.* [Blokland *et al.* (1999) *Nutrition* 15(10): 778-83], which showed no difference between PS obtained from different sources and the empty vehicle, in a water maze test.

What is particular to the present trial is the accelerated rate in learning the task under the scopolamine sedation. This was not demonstrated previously [Furushiro *et al.* (1997) *id ibid.*; Suzuki *et al.*, (2000) *Jpn. J. Pharmacol.* 84, 86-8]. Note that in these studies the rodent faced a different task (passive avoidance). In Suzuki *et al.* 2001 (*J. Nutr.* 131: 2951-6) the investigators utilized considerably older rats (24-25 months old) than the ones tested in the present trial. The latency time in the acquisition step was considerably longer for the aged rats compared to the young ones that were tested (eight weeks). Interestingly, although the latency time in the present trial of non-sedated rats is somewhat comparable to the younger rats tested by Suzuki *et al.* [Suzuki *et al.* (2001) *id ibid.*], the scopolamine-induced amnesia latency time in the MCT group resembles the one obtained at the described study for elderly rats. In conclusion, scopolamine induced a comparable long latency time in the control group (MCT). This effect was augmented to a different extent by long-term treatment of rats with either PS or LC-PUFA.

In the probe trial, the rats treated with PS-  $\omega$ 3 showed a distinctively higher tendency than MCT-treated ones ( $P < 0.085$ ) to be present at the zone in which the platform was located during the acquisition of the task (Figure 2), indicating that the rats had learned the spatial location of the platform. Moreover, PS-  $\omega$ 3 treated rats presented a reduced tendency ( $P < 0.08$ ) to swim in the periphery zone, but rather spent in the central zone. These latter indications, presented by the PS-  $\omega$ 3 group are related to a higher adventurous characteristic and could be somewhat correlated with the open field behavior trial. Interestingly, in Blokland *et al.* [Blokland *et al.* (1999) *id ibid.*] BC-PS treated mice demonstrated a non-significant but clear tendency to be less adventurous in the open field behavior trial, by spending less time in the center area. With respect to the remarkable learning abilities demonstrated by the rats that were treated with PS-  $\omega$ 3, it is interesting to compare their performance in the Morris water maze task in the spatial probe test to the one obtained by the SB-PS treated animals by Suzuki *et al* [Suzuki *et al* (2001) *id ibid.*]. Though the percent of time spent in the quadrant where the platform was located is similar (~45%), it is remarkable that the dosage in the current study was merely one third of the administration levels in Suzuki *et al* 2001 (20mg/kg vs. 60mg/kg, respectively). Indeed, in the present study there was no significant change in the time that the SB-PS (20mg/kg) treated rats spent in this quadrant when compared with the values obtained by the MCT-treated group [Fig.1C and Fig. 1A, respectively]. In summary, the PS-  $\omega$ 3 treated group learning abilities were markedly higher than the control, in a considerably low level of PS administration. In addition, the rats treated with PS-  $\omega$ 3 were less conservative and more adventurous in studying the maze in the absence of the platform.

Finally, the most prominent and outstanding data obtained in the present study was the response to the repositioning of the platform. All groups

presented a shorter latency in finding the platform at the first session, when compared to the one obtained by the MCT-treated group, under scopolamine sedation (Figure 3A-3D). These data suggest that LC-PUFA, and more potently PS, can attenuate scopolamine-induced amnesia, as previously presented by other studies (see selected references above).

Surprisingly, in the second session, there were no differences between the latency in finding the platform after its repositioning in all groups but the PS- $\omega$ 3 treated group. In fact, it seemed that in all treatments but the PS- $\omega$ 3 there was no learning process of the position of the platform. The PS- $\omega$ 3 group presented a remarkably different behavior; it seemed that there was no lag in the learning of the repositioned platform in the rat treated with this anti-muscarinic drug. The ability of the PS- $\omega$ 3 treated group to locate the platform after it had been repositioned seemed to be contradictory with the result obtained earlier in the spatial probe test (Fig. 2), where these rats showed preference for the third quadrant. Pearce and colleagues [Pearce *et al.* (1998) *Nature* **396**: 75-77] attempted to resolve this discrepancy, by describing two means for memorizing a specific spatial location. One is to use a cognitive map that encodes information about the geometric relationship between the object and several land marks (the cognitive map method) and the other is the use of heading vectors that specify the direction and distance from a single landmark to the object (the heading vector method). In the present test, the rats could locate the platform from the above-mentioned cues and/or from the distance and direction with respect to the walls. In the acquisition and the spatial probe test, both methods contributed to the score of finding the platform. However, in the repositioning test, the cognitive abilities which are related to the heading vector method and the short-term memory (working memory), made the difference. The heading vector method, because the distance from the wall was not effected by the repositioning (just the quadrant), and the working memory due to the

benefits in memorizing the areas already explored that enable an effective search in the pool.

It has been previously reported that the mechanism by which PS attenuates the scopolamine effect could be attributed not only to a beneficial effect on the cholinergic circuitry, but PS could also have an effect on the serotonergic neuronal system [Furushiro *et al.* (1997) *id ibid.*]. It appears that the presented data could be the result of more than one neuronal system alteration, possibly the dopaminergic. In an earlier study [Drago *et al.* (1981) *Neurobiol Aging*, 2(3):209-13], it was suggested that the alteration in the obtained behavioral changes between BC-PS treated aged rats to their control could be attributed not only to the modifications in cholinergic and serotonergic transmission, as described above, but also through affecting the catecholaminergic (like dopamine) system. In this study the facilitated acquisition of active avoidance behavior as studied in shuttle-box and pole jumping test situations, and the retention of active and passive avoidance responses were improved in the PS-treated rats. Tsakiris [Tsakiris, S. (1984) *Z Naturforsch [C]*, 39(11-12):1196-8] reported on an indirect effect of PS on the dopamine related adenylyl cyclase, through membrane fluidity mechanism. Interestingly, it has also been reported [Chalon, *et al.* (1998) *J Nutr.*; 128(12):2512-9] that enriched diet with high level of (n-3) PUFA could result in an effect on the cortical dopaminergic function. It is conceivable that the existence of LC-PUFA on the backbone of the phospholipids was highly beneficial in terms of such a multi-neurotransmitter mechanism.

The biochemical analyses of the present results in liver tissues (Fig. 4A) shows that in rats supplemented with PS for three months (SB-PS and PS- $\omega$ 3) there was a notable increase in the levels of the primer phospholipids, i.e. phosphatidylcholine (PC). These data is consistent with early observations regarding the liver and its major role in the

phospholipids uptake and the primary metabolism of most fatty acids. Wijendran and colleagues [Wijendran *et al.* (2002) *Pediatr. Res.* 51:265-272] described a study in which baboons were fed labeled LC-PUFA on the backbone of PC and triglycerides, and demonstrated that the levels of incorporation of LC-PUFA on a phospholipid backbone to the liver was higher than the extent of incorporation of LC-PUFA on the triglycerides backbone. In addition, PS levels of rats fed with PS- $\omega$  3 were elevated in cortex tissues analyses of phospholipids distribution (Figure 4B), comparing with MCT. Interestingly, the phospholipids fatty acids profile of these cortices (Table 1) demonstrate a marked elevation in the DHA content of the rats fed with PS- $\omega$ 3 (P=0.007). Similar elevation was noted for LC-PUFA fed rats, however to a reduced extent compared with PS- $\omega$ 3 treatment (14.6 versus 17.5, respectively P=0.03) and MCT (14.6 versus 12.3, respectively P=0.02). This difference in the DHA levels between the two omega-3 groups might suggest enhanced bioavailability of DHA when it is esterified to the backbone of phospholipids rather than to triglycerides. Similar conclusions were drawn by Lemaitre-Delaunay and colleagues [Lemaitre-Delaunay *et al.* (1999) *J. Lipid Res.*; 40:1867-1874], when they had study the kinetics and metabolic fate of labeled DHA on triglycerides versus its enrichment in lysophosphatidylcholine, and by Wijendran *et al.* [Wijendran *et al.* (2002) *id ibid.*] in the above-mentioned baboons study.

Interestingly, this increase in DHA content in the cortices of both PS- $\omega$ 3 and LC-PUFA fed rats is accompanied with a statistically significant decrease in the levels of oleic acids and to somewhat lower extent of linoleic acid (Table 1) in the phospholipids fraction. Similar changes in the ratios of the fatty acids profile was demonstrated by others, by feeding rodents with dietary fats enriched with LC-PUFA [for example: Yamamoto *et al.* (1987) *J. Lipid Res.* 28: 144-151]. The SB-PS group showed a very similar profile to the MCT group.

In sum, the improved performance in the Morris water maze test of the PS-  $\omega$ 3 treated rats under scopolamine sedation strongly supports the potency of PS-  $\omega$ 3 as an anti-dementia and age-associated memory impairment effects. This cognitive enhancement is further supported by the biochemical evidence of the elevated phospholipids levels in the liver and brain tissues (Fig. 4A-4B), and with elevated levels of DHA attached to the phospholipids from the cortex of the PS-  $\omega$ 3 fed rats.

Table 1 summarizes the effect of dietary LC-PUFA from different sources on the fatty acids profile in cerebral phospholipids from elderly Wistar rats. Fatty acids from the purified phospholipids fraction were analyzed by gas-liquid chromatography. The major fatty acids are expressed as % of total fatty acids in the phospholipids. Values represent mean $\pm$ S.D. of four different rats per treatment. Statistical significant between different supplements and MCT group is presented as followed: \* P<0.05; \*\* P<0.01.

**Table 1**

Fatty acids	MCT	LC-PUFA	SB-PS	PS- $\omega$ 3
C16:0	12.9 $\pm$ 1.4	14.6 $\pm$ 4.7	13.7 $\pm$ 4.7	13.6 $\pm$ 4.4
C16:1	1.0 $\pm$ 0.7	1.0 $\pm$ 0.3	1.5 $\pm$ 0.4	1.5 $\pm$ 0.8
C18:0	17.9 $\pm$ 1.0	20.1 $\pm$ 1.3*	17.2 $\pm$ 2.8	18.0 $\pm$ 5.5
C18:1 (n-9)	36.5 $\pm$ 1.8	32.0 $\pm$ 2.8*	37.0 $\pm$ 6.8	30.7 $\pm$ 4.1*
C18:1 (n-7)	3.7 $\pm$ 0.5	4.3 $\pm$ 0.2*	4.0 $\pm$ 0.3	4.8 $\pm$ 1.5
C18:2	7.2 $\pm$ 0.7	4.5 $\pm$ 0.6**	7.1 $\pm$ 2.6	5.1 $\pm$ 2.7
C20:1	2.5 $\pm$ 0.5	2.9 $\pm$ 0.8	2.1 $\pm$ 0.4	2.3 $\pm$ 0.3
C22:6	12.3 $\pm$ 1.7	14.6 $\pm$ 0.6*	12.4 $\pm$ 3.2	17.5 $\pm$ 2.4**
C24:1	3.4 $\pm$ 1.0	3.3 $\pm$ 1.3	2.8 $\pm$ 0.9	2.0 $\pm$ 1.2*
rest	2.7 $\pm$ 0.1	2.8 $\pm$ 0.4	2.1 $\pm$ 0.9	4.5 $\pm$ 3.0

### Example 2 – PS-omega-3 in the treatment of ADHD children

Attention-deficit/hyperactivity disorder (ADHD) encompasses a broad constellation of behavioural and learning problems and its definition and

diagnosis remain controversial [Kamper (2001) *J. Pediatr.* **139**:173-4; Richardson *et al.* (2000) *Prostaglandins Leukot. Essent. Fatty Acids*, **63**(1-2):79-87]. The etiology of ADHD is acknowledged to be both complex and multi-factorial. Traditionally, ADHD is the diagnosis used to describe children who are inattentive, impulsive, and/or hyperactive. Roughly 20-25% of children with ADHD show one or more specific learning disabilities in math, reading, or spelling [Barkley, R.A. (1990) *Attention-deficit hyperactivity disorder: a handbook for diagnosis and treatment*. New York: Guilford Press]. Children with ADHD often have trouble performing academically and paying attention, and may be disorganized, have poor self-discipline, and have low self-esteem. A conservative estimate is that 3-5% of the school-age population has ADHD [American Psychiatric Association. Diagnostic and statistical manual of mental disorders. 4th ed. (DSM-IV) Washington, DC: American Psychiatric Association, 1994]. Treatments for ADHD include behavior therapy and medications, mainly methylphenidate (Ritalin™). Psychostimulant drugs and antidepressants are often used to calm children with ADHD, with an effectiveness rate of ~75% (Swanson *et al.* *Except Child* 1993; **60**:154-61). The advantages of using these medications include rapid response, ease of use, effectiveness, and relative safety. Disadvantages include possible side effects, including decreased appetite and growth, insomnia, increased irritability, and rebound hyperactivity when the drug wears off [Ahmann *et al.* (1993) *Pediatrics*; **91**:1101-6]. Moreover, these medications do not address the underlying causes of ADHD. Thus, studies to elucidate the potential contributors to the behavior problems in ADHD may lead to more effective treatment strategies for some children.

Omega-3 fatty acids are specifically implicated in maintaining central nervous system function. Deficiency of n-3 fatty acids in rats and monkeys has been associated with behavioral, sensory, and neurological dysfunction [Yehuda *et al.* (1993) *Proc. Natl. Acad. Sci. USA*; **90**:10345-9;



Reisbick *et al.* (1994) *Physiol. Behav.* **55**:231-9; Enslin *et al.* (1991) *Lipids*; **26**:203-8]. Several studies have focused on essential fatty acid metabolism in children with ADHD [Colquhoun *et al.* (1981) *Med Hypotheses*; **7**:673-679]. Children with hyperactivity have been reported to be more thirsty than normal children and have symptoms of eczema, asthma, and other allergies [Mitchell *et al.* (1987) *Clin. Pediatr.*; **26**:406-11]. For example, in a cross-sectional study in 6–12-y-old boys recruited from central Indiana, it was showed that 53 subjects with ADHD had significantly lower proportions of key fatty acids in the plasma polar lipids [arachidonic acid (AA; 20:4n-6), eicosapentaenoic acid (EPA; 20:5n-3), and docosahexaenoic acid (DHA; 22:6n-3)] and in red blood cell total lipids (20:4n-6 and 22:4n-6) than did 43 control subjects [Stevens *et al.* (1995) *Am. J. Clin. Nutr.*; **62**:761–8]. However, recent publications [Hirayama *et al.* (2004) *Eur. J. Clin. Nutr.*; **58**(3):467-73; Voigt *et al.* (2001) *J Pediatr.*; **139**(2):189-96] that investigated whether DHA supplementation would result with ameliorate the symptoms in ADHD children, suggested that careful attention should be paid as to which fatty acid(s) is used. In these studies DHA supplementation had demonstrated only marginal if any beneficial effects.

Recently, it has been suggested that one of the possible solutions to the nutrient deficiencies which are common in ADHD, could be PS supplementation [Kidd (2000) *Altern Med Rev.*; **5**(5):402-28].

### *Method*

#### *Subjects and diet*

Ninety 8-to-13-year old children diagnosed according to the DSM-IV as ADHD, were assigned randomly, in a double-blind fashion to receive PS- $\omega$ 3 (300 mg/d; containing total 450 mg/d DHA/EPA), 450 mg/d DHA/EPA or canola oil (30 per group) for two months, while not taking stimulant medication or other supplements. Characterizing the subject as ADHD included a score lower than -1.8 in the Test of Variables of Attention.

*Data Analysis*

At the conclusion of the trial, ADHD children were scored according to parental behavioural rating scales (Connors' Rating scale).

*Results and discussion*

Use of complementary therapies is particularly common among patients with chronic, incurable, or frequently relapsing conditions. For example, use of complementary and alternative medical therapies (CAM) is common in children with cancer, asthma, and cystic fibrosis. Parents or subjects who seek CAM typically do so because such therapies are more consistent with their values, are more empowering, and are perceived as more natural and less risky than conventional treatments. The majority of these patients do not abandon mainstream therapies but use herbs and other forms of CAM as adjunctive treatments. Only a minority (<40%) talk with their pediatricians about their use of CAM. Because of the stigma and side effects that accompany use of stimulant medications, many families turn to CAM to treat ADHD. Typically, only 70% of children respond to stimulants such as Ritalin™, and of those who do, approximately half report side effects from their medications. In an Australian survey of 290 families seen at a multidisciplinary referral center for ADHD, 64% had tried at least one "other therapy," most commonly dietary restriction, multivitamin supplementation, and occupational therapy [Stubberfield *et al.* (1999) *J Paediatr Child Health*;35:450-3].

In the presented study the different supplementation was formulated into a popular chocolate paste (see below). Using this matrix enable the parents to administer the treatments in a non-conventional form to their children and provided a reduced organoleptic effect characteristic of the marine-derived compounds (see below).

The parental rating survey, at the end of the treatment period, measured the attention deficit, hyperactivity and impulsivity of the children, as well as the aggression as assessed by parents, teachers, siblings and peers. The results indicate a distinctively large placebo effect. This effect is somewhat reduced if the placebo-treated ADHD children that failed to complete the study due to severe behavioral deterioration are taken into consideration. It seemed that most of these children insisted on reassigning for Ritalin™ administration. However, the present data also clearly demonstrate PS- $\omega$ 3 as a potent agent. All in all, ~70% of the parents of the PS- $\omega$ 3 treated ADHD children indicated some improvement in the behavioural score of their children, whereas 50% of these parents provided clear indications for multiple beneficial effect of the supplement on their children behavior. This prominent effect is 2.2-fold higher than the improvement obtained by placebo (~30%). Comparison of the parental scoring of LC-PUFA on ADHD children behavior with the parallel rating that followed three months of PS- $\omega$ 3 administration, point at the latter to have a higher score. While both compounds demonstrated similar extent of marginal improvement, PS- $\omega$ 3 had a marked higher rate of substantial improvement (47% versus 35%, respectively) with the lowest rats of lack or deteriorating effects (21% & 11% versus 26% and 17%, respectively). These effects of PS- $\omega$ 3 supplementation could be attributed to both enhanced bioavailability of omega-3 fatty acids and through PS well documented effects on mood, stress and anxiety.

### **Example 3 – Effect of PC-DHA consumption in ApoE° mice**

#### *Methods*

#### *Animal diet*

Apolipoprotein E deficient (ApoE°) mice [Hayek T. *et al.* (1994) *Biochem. Biophys. Res. Commun.* **201**:1567-1574] at 8 weeks of age, were assigned randomly (5 mice each) to LC-PUFA enriched lecithin (30% omega-3 of total fatty acids composition; PC-DHA group) or placebo. The mice were

fed, besides the regular chow diet, once every three days with either 25  $\mu$ l PC-DHA or PBS, via oral gavage, during 10 weeks.

Each mouse consumed approximately 5 mL of water/day, and 5 g of chow/day.

#### *Serum lipids peroxidation*

Serum was diluted 1:4 in PBS. Serum susceptibility to oxidation was determined by incubating serum sample with 100mM of the free radical generating compound, 2'-2'-azobis 2'-amidinopropane hydrochloride (AAPH), which is an aqueous soluble azo compound that thermally decomposes to produce peroxy radicals at a constant rate. The formation of thiobarbituric reactive substances (TBARS) and of lipid peroxides was measured and compared to serum that was incubated under similar conditions, but without AAPH.

#### *Results and Discussion:*

ApoE<sup>o</sup> mice are widely used as an animal model for atherosclerosis as they develop severe hypercholesterolemia and atherosclerotic lesions on a chow diet. Moreover, accelerated atherosclerosis is associated with increased lipid peroxidation of plasma lipoproteins and arterial cells in these mice [Hayek T. et al. (1994) *id ibid.*; Keidar S. (1998) *Life Sci.* **63**:1-11].

Figure 6 shows how prolonged PC-DHA consumption by ApoE<sup>o</sup> mice resulted in a clear tendency ( $P < 0.10$ ) to reduce the serum susceptibility to AAPH-induced oxidation by 16% (in comparison to placebo).

#### *Organoleptic issues*

The utilization of omega-3 lipids in a variety of applications, and especially as ingredient of functional foods, is hindered due to their distinct fish odor. Thus, another advantage of the omega-3 enriched phospholipids ingredients of the invention is that they have reduced odor

or taste of omega-3 acyl moieties, due to the covalent binding of these groups to the PS backbone. This increases the vapor pressure of these materials, hence reducing their distinct aroma. Thus, the covalent binding of the omega-3 fatty acids to the phospholipid backbone, especially PS, alters and improves their taste properties. Moreover, the PS ingredient of the invention also offers enhanced stability to the oxidation sensitive omega-3 fatty acids. Phospholipids in general, and PS in particular, are known to act as anti-oxidants and stabilizers.

These benefits make this novel phospholipids' preparation of the invention highly beneficial and important in a variety of applications and especially in functional foods, where stability, aroma and taste are fundamental requirements.

Furthermore, these novel ingredients can be formulated with additional lipids for an even enhanced bio-functionality and efficacy.

The starting compound used for the above-mentioned clinical trial in ADHD patients, was LC-PUFA enriched PS mixed with fish oil. Originally, this product and the control fish oil were formulated in food products like energy bars; however the responses from expert panels were categorically devastating, pointing at severe organoleptic problems. In order to overcome this taste barrier the PS-  $\omega$ 3 product of the invention was de-oiled. The end-product of this process was a paste that when reformulated with either inert or dominant – organoleptic saturated fats could be easily formulated in chocolate bars, chocolate spread, chocolate coated cornflakes, low-fat dairy products or concentrated milk. Each one of these formulations had an evidently reduced organoleptic objection from both the expert panels and the trial volunteers.

47.

The polar lipids derivatives of PUFA, such as the PS-PUFA derivatives have exhibited high stability as a preparation and additionally in several food applications, used in the clinical trials of this invention. This stability, of these sensitive compounds is emerging from the covalent combination of phospholipids, known in the past to be used as preservatives and of the un-stable PUFA moieties.

The stability of a commercially prepared fish oil (omega-3 fatty acid) for laboratory rodent diet [Lytle *et al.* (1992) *Nutr Cancer*; 17(2):187-94] or as an enrichment in spreadable fats [Kolanowski *et al.* (2001) *Int J Food Sci Nutr.*; 52(6):469-76] was addressed by several studies as the public awareness towards the beneficial effects of LC-PUFA increased. A major effort was directed at maintaining the oxidative stability of the fish oil, as these fatty acids are subject to rapid and/or extensive oxidation and other chemical changes by exposure to air, light, or heat during processing or when stored for various lengths of time. The common solution presented in these studies was supplementation the fish oil matrix with antioxidants like butylated hydroxytoluene, butylated hydroxyquinone and alpha-tocopherol, or alternatively, dilution of concentrated fish oil to a limit of 1% in a saturated fats matrix. However, Song and colleagues [Song *et al.* (1997) *Biosci Biotechnol Biochem.*; 61(12):2085-8] had already evaluated the peroxidative stability of DHA-containing oils the form of phospholipids, triglycerides, and ethyl esters in the dark at 25°C in a bulk phase during 10 weeks storage. They had shown that DHA-containing oil in the form of phospholipids was more resistant to the oxidative degradation of DHA than that in the form of triglycerides and ethyl esters in a bulk phase.

The abovementioned PS- $\omega$ 3 containing products utilized for the clinical studies were tested for their shelf-life and stability in room temperature. The enriched PS- $\omega$ 3 formulated in condensed milk (1 g product per 10 ml

milk) was analyzed by  $^{31}\text{P}$ -NMR for stability in cycles of freeze-thawing for a week, and was found to be stable. In the second phase, PS- $\omega$ 3 in a chocolate paste matrix (0.75 g product per 20 g chocolate spread) was tested for stability after two weeks storage in room temperature. This formulation also presented a stable percentage of PS, in  $^{31}\text{P}$ -NMR analysis. In conclusion, we had been able to establish that  $\omega$ -3 containing phospholipids are highly stable in room temperature, as well as in freezing-thawing cycles, as oppose to  $\omega$ -3 containing triglycerides known to rapidly decay after antioxidant consumption.

**Claims:**

1. A lipid preparation, wherein said lipid is selected from the group consisting of a glycerophospholipid and salts, conjugates and derivatives and thereof and any mixture thereof, and poly-unsaturated fatty acid (PUFA) acyl groups, particularly long-chain poly-unsaturated fatty acid (LC-PUFA) acyl groups, preferably omega-3 and/or omega-6 acyl groups, at a concentration of least 5% (w/w) of total fatty acids content of said preparation, preferably more than 10% (w/w), more preferably 20-50% (w/w), wherein said PUFA is covalently bonded to said lipid.
2. A lipid preparation of claim 1 wherein said lipid is a naturally occurring lipid, or a synthetic lipid.
3. A lipid preparation of claim 2, wherein said lipid is a glycerophospholipid in which at least some of the sn-1 or sn-2 groups of the glycerol backbone are substituted with said poly-unsaturated fatty acid (PUFA) acyl groups.
4. A lipid preparation of any one of claims 1 to 3, wherein said lipid is a glycerophospholipid of formula I:

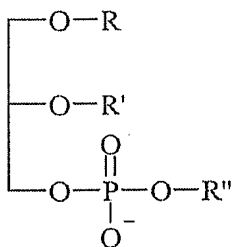

Formula I

wherein R'' represents a moiety selected from serine (PS), choline (PC), ethanolamine (PE), inositol (PI), glycerol (PG) and hydrogen (phosphatidic acid - PA), and R and R', which may be identical or different, independently represent hydrogen or an acyl group, wherein said acyl



group is selected from saturated, mono-unsaturated or poly-unsaturated acyl groups (PUFA), particularly long-chain poly-unsaturated fatty acids (LC-PUFA), more preferably omega-3 and/or omega-6 acyl groups, and salts thereof, with the proviso that R and R' cannot simultaneously represent hydrogen, and wherein said polyunsaturated acyl groups comprise at least 5% (w/w) of total lipid fatty acids, preferably more than 10% (w/w), and particularly 20-50% (w/w).

5. A preparation of claim 4, wherein R represents hydrogen and R' represents an acyl group.

6. A preparation of claim 4, wherein R' represents hydrogen and R represents an acyl group.

7. A preparation of any one of claims 4 to 6, wherein said acyl group is an omega-3 acyl group, preferably an eicosapentaenoyl (EPA), a docosahexaenoyl (DHA) group, or linolenic omega-3 group.

8. A preparation of any one of claims 4 to 6, wherein said acyl group is an omega-6 acyl group, preferably an arachidonoyl (ARA) group, or a linoleic omega-6 group.

9. A preparation of any one of claims 4 to 6, wherein said acyl group is a linolenoyl (18:3) group.

10. A preparation of any one of claims 4 to 9, wherein R'' represents serine, choline, ethanolamine, inositol, glycerol, and H.

11. A preparation according to any one of claims 4 to 10, wherein the identity and content of R and R' are predetermined.

12. A preparation of claim 10, wherein R" is serine, characterized in that it mimics the composition of human brain PS.

13. A preparation of claim 10 or 12, wherein R" is serine, characterized in that it is different from human brain PS and has improved bioactivity compared to soybean-PS.

14. A PS preparation, wherein said PS is derived from any one of plant, animal or microorganism source, said preparation being enriched with PS of formula I, wherein R" represents a serine moiety.

15. A preparation of any one of claims 12 to 14, characterized in that it is effective at a lower dosage compared to soybean-PS, while having similar and/or improved bioactivity compared to soybean-PS.

16. A preparation of any one of claims 1 to 15, wherein said omega-3 or omega-6 is more stable than a omega-3 or omega-6 in the free fatty acid form, bonded to a triglyceride or as an ethyl ester.

17. A preparation of any one of claims 1 to 16, characterized in having a reduced or absent of fish-related organoleptic effects.

18. A preparation of any one of claims 1 to 17, said preparation being enriched with PS of formula I, characterized in having a reduced or absent of fish-related organoleptic effects.

19. A preparation of any one of claims 1 to 18, for use in the reduction and/or prevention of serum oxidative stress leading to atherosclerosis, cardiovascular disorders and/or coronary heart disease.

20. A preparation of any one of claims 1 to 18, for use in the improvement and treatment of cognitive and mental conditions and disorders as well as the maintenance of normal functions of brain-related systems and processes, preferably ADHD, aging, Alzheimer's disease, Parkinson's disease, multiple sclerosis (MS), dyslexia, depression, learning capabilities, intensity of brain waves, stress, anxiety, mental and psychiatric disorders, concentration and attention, mood, brain glucose utilization, general cognitive and mental well being, neurological disorders and hormonal disorders.

21. A preparation of any one of claims 1 to 18, said preparation being enriched with PS of formula I, for use in any one of the improvement and treatment of ADHD, and reducing ADHD symptoms in children.

22. A preparation of any one of claims 1 to 24, for enhancing the bioavailability of polyunsaturated fatty acids, particularly omega-3 and/or omega-6 fatty acids.

23. A preparation of any one of claims 1 to 22, for use in combined improvement of cognitive and mental functions together with improvement of additional health disorders or conditions.

24. The preparation of claim 23, wherein said additional health disorders or conditions are at least one of: high blood cholesterol levels, high triglycerides levels, high blood fibrinogen levels, HDL/LDL ratio, diabetes, metabolic syndrome, menopausal or post-menopausal conditions, hormone related disorders, vision disorders, inflammatory disorders, immune disorders, liver diseases, chronic hepatitis, steatosis, phospholipid deficiency, lipid peroxidation, dysrhythmia of cell regeneration, destabilization of cell membranes, coronary artery disease, high blood pressure, cancer, hypertension, aging, kidney disease, skin diseases,

edema, gastrointestinal diseases, peripheral vascular system diseases, allergies, neurodegenerative and psychiatric diseases.

25. A nutraceutical composition comprising a phospholipid preparation as claimed in any one of claims 1 to 24.

26. A nutraceutical composition of claim 25, in the form of softgel capsules, tablets, syrups, or any other common dietary supplement delivery system.

27. A functional food article comprising the phospholipid preparation of any one of claims 1 to 21.

28. The functional food article of claim 27, selected from dairy products, ice-creams, biscuits, soy products, bakery, pastry and bread, sauces, soups, prepared foods, frozen foods, condiments, confectionary, oils and fats, margarines, spreads, fillings, cereals, instant products, drinks and shakes, infant formulas, infant foods (biscuits, mashed vegetables and fruits, cereals), bars, snacks, candies and chocolate products.

29. A pharmaceutical composition comprising the phospholipids preparation of any one of claims 1 to 21, and optionally at least one pharmaceutically acceptable additive, diluent or excipient.

30. A pharmaceutical composition of claim 29, further optionally comprising at least one pharmaceutically active agent.

31. The preparation of any one of claims 1 to 24, wherein said PUFA has increased bioavailability to the organism when comparing to a composition comprising PUFA alone.

1/8

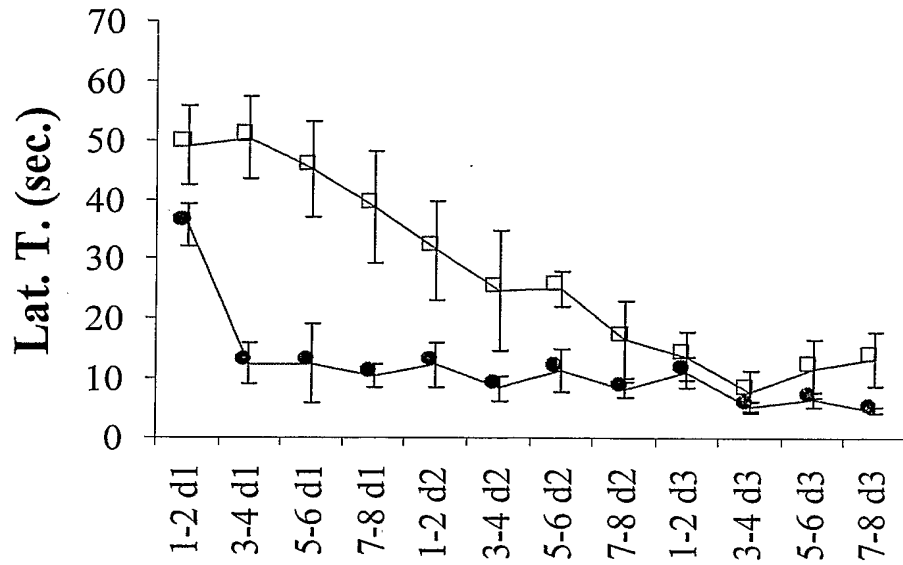

Fig. 1A

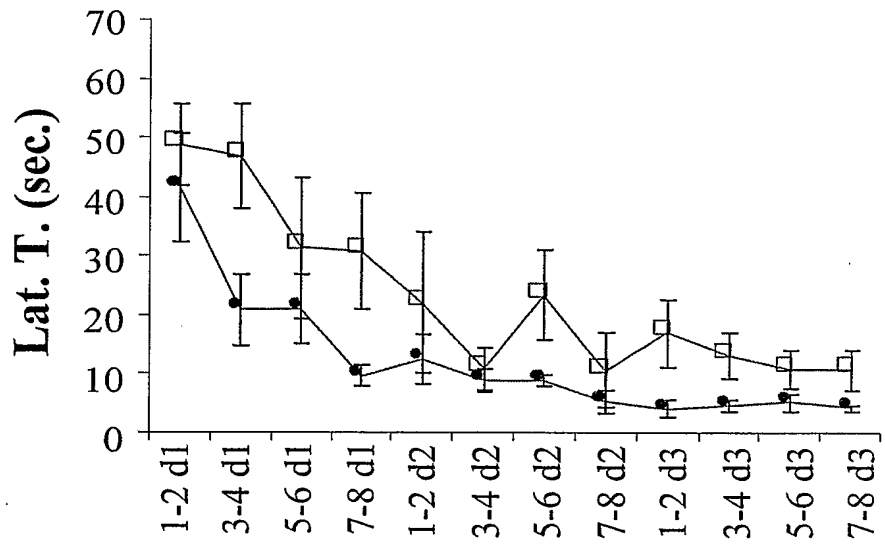

Fig. 1B

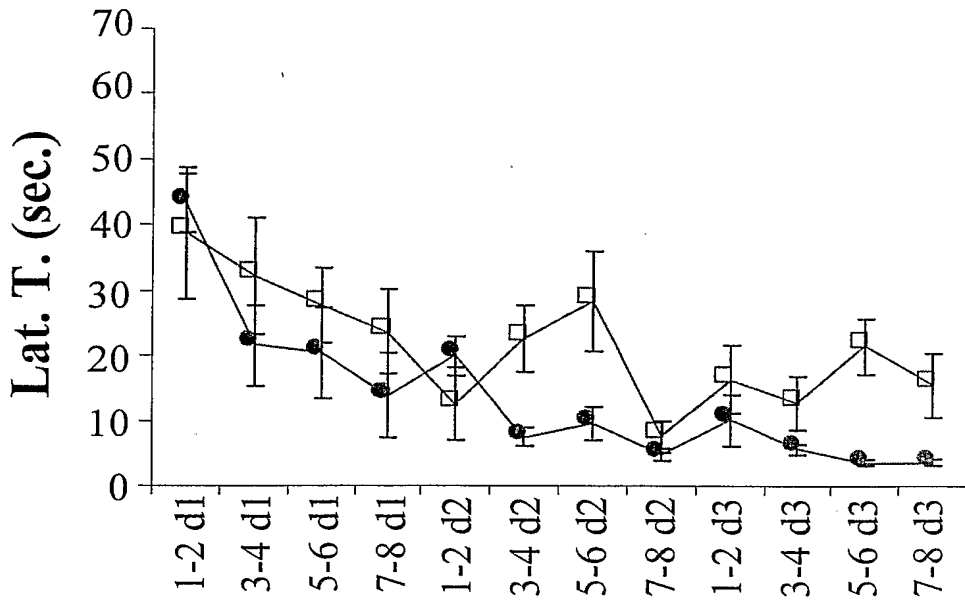

Fig. 1C

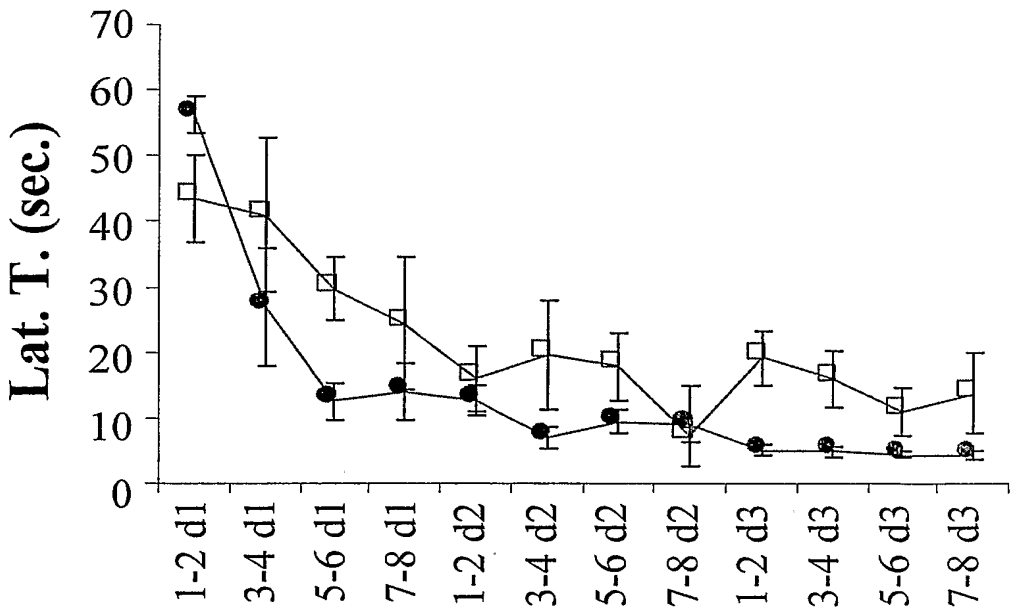

Fig. 1D

3/8

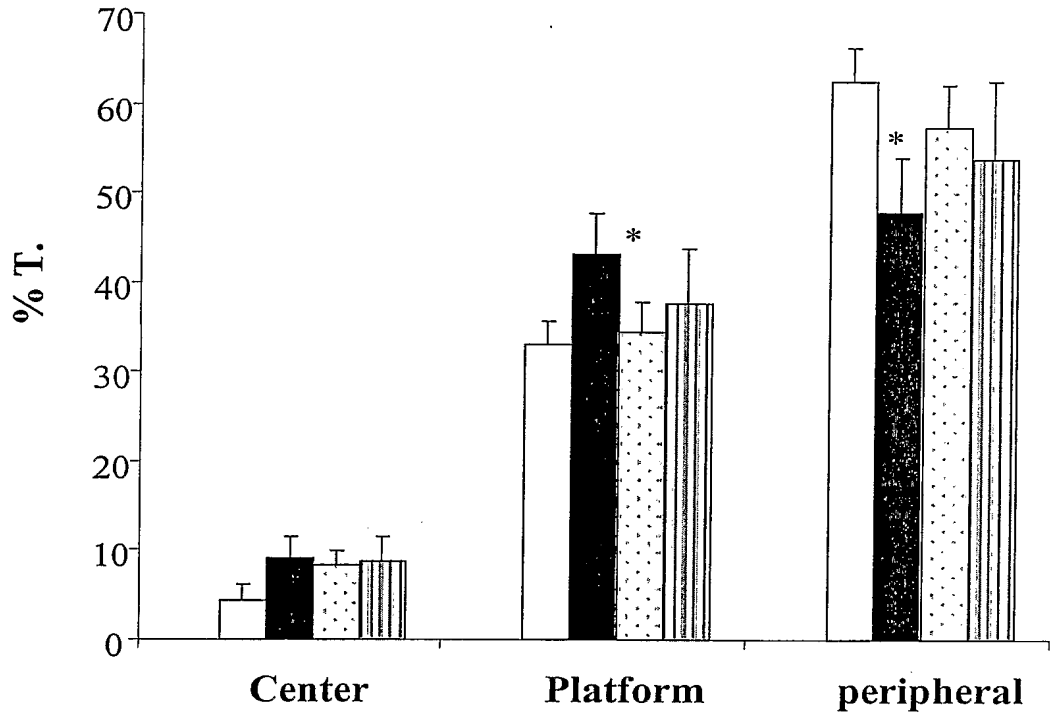

Fig. 2

4/8

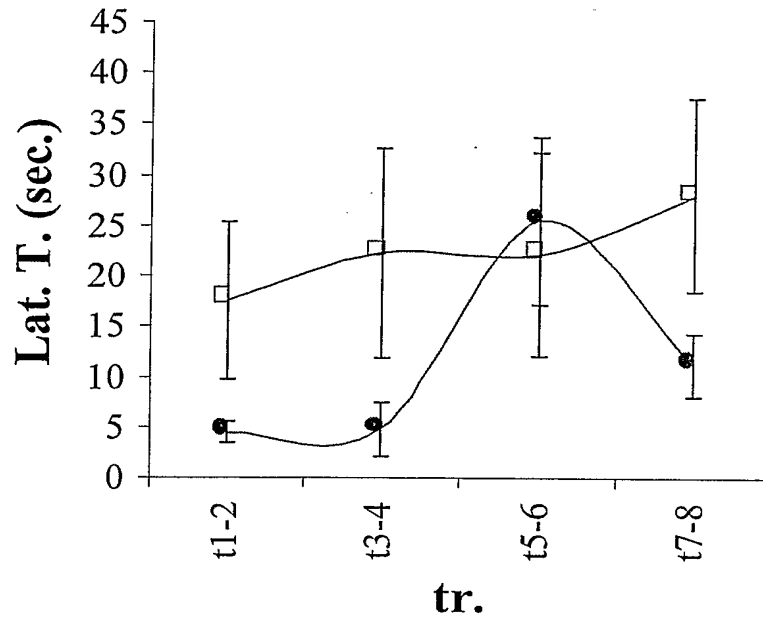

Fig. 3A

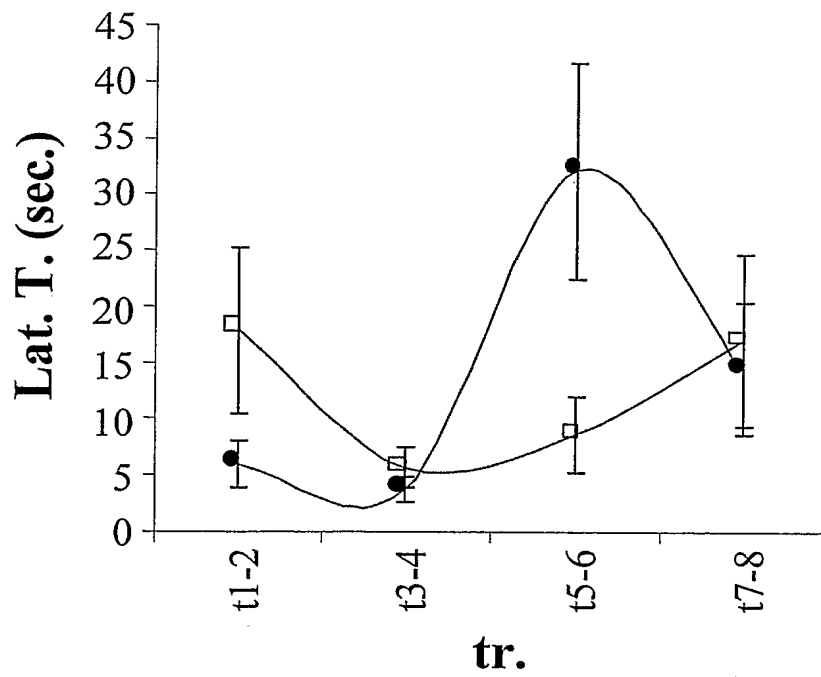

Fig. 3B



5/8

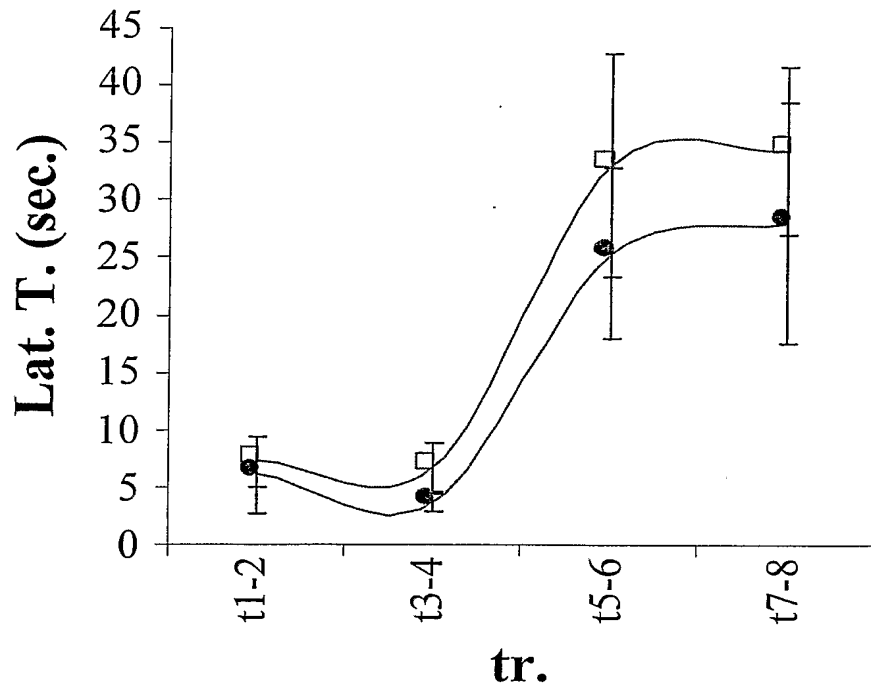

Fig. 3C

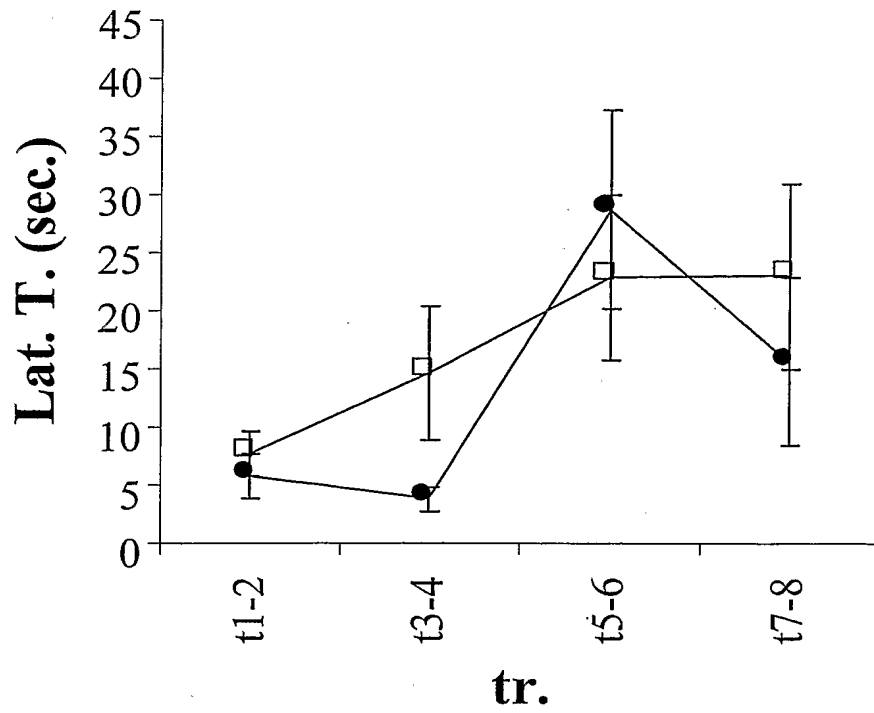

Fig. 3D

6/8

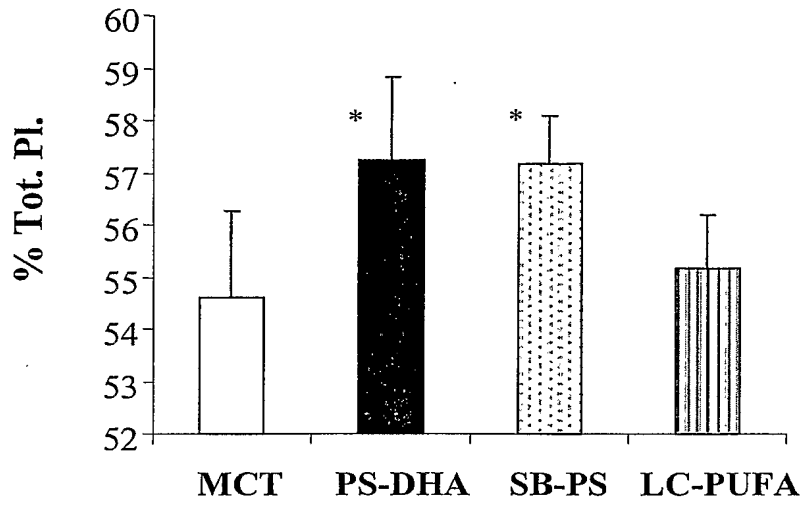

Fig. 4A

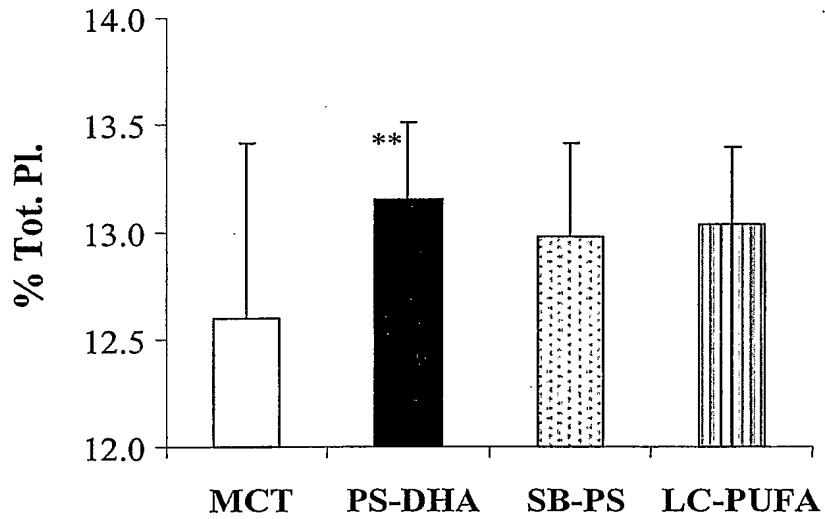

Fig. 4B

7/8

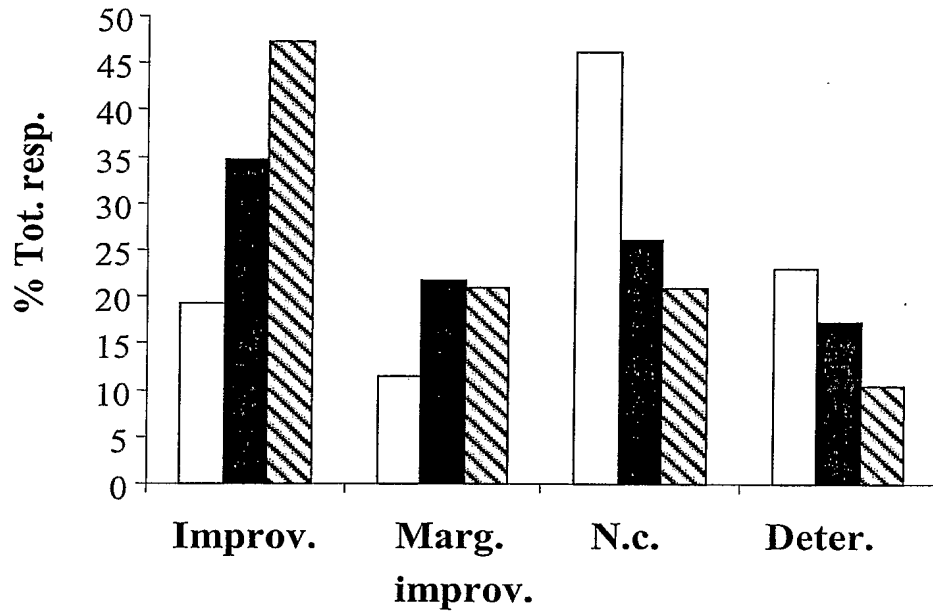

Fig. 5

8/8

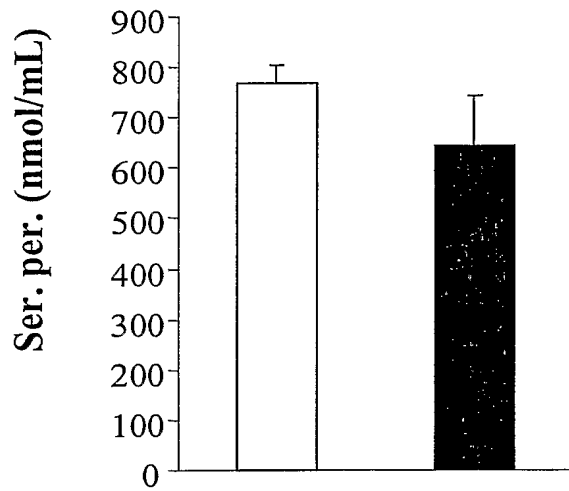

Fig. 6

(19) World Intellectual Property  
Organization  
International Bureau



(43) International Publication Date  
28 April 2005 (28.04.2005)

PCT

(10) International Publication Number  
**WO 2005/038037 A2**

(51) International Patent Classification<sup>7</sup>: C12P 9/00, 7/64, C07F 9/10, A61K 31/685, A23J 7/00

(21) International Application Number:  
PCT/IL2004/000958

(22) International Filing Date: 21 October 2004 (21.10.2004)

(25) Filing Language: English

(26) Publication Language: English

(30) Priority Data:  
158553 22 October 2003 (22.10.2003) IL

(71) Applicant (for all designated States except US): ENZY-MOTEC LTD. [IL/IL]; Ramat-Gavriel Industrial Park, P.O. Box 6, 23106 Migdal HaEmek (IL).

(72) Inventors; and

(75) Inventors/Applicants (for US only): PLATT, Dorit [IL/IL]; P.O. Box 249, 17906 Shimshit (IL). LAOUZ, Hala [IL/IL]; P.O. Box 637, 15235 Kfar Kana (IL). PELLEDD, Dori [IL/IL]; 29 HaShahar Street, 45325 Hod HaSharon (IL). SHULMAN, Avidor [IL/IL]; 29 HaGomeh Street, 36090 Kiryat Tivon (IL).

(74) Agents: LUZZATTO, Kfir et al.; P.O. Box 5352, 84152 Beer Sheva (IL).

(81) Designated States (unless otherwise indicated, for every kind of national protection available): AE, AG, AL, AM, AT, AU, AZ, BA, BB, BG, BR, BW, BY, BZ, CA, CH, CN, CO, CR, CU, CZ, DE, DK, DM, DZ, EC, EE, EG, ES, FI, GB, GD, GE, GH, GM, HR, HU, ID, IL, IN, IS, JP, KE, KG, KP, KR, KZ, LC, LK, LR, LS, LT, LU, LV, MA, MD, MG, MK, MN, MW, MX, MZ, NA, NI, NO, NZ, OM, PG, PH, PL, PT, RO, RU, SC, SD, SE, SG, SK, SL, SY, TJ, TM, TN, TR, TT, TZ, UA, UG, US, UZ, VC, VN, YU, ZA, ZM, ZW.

(84) Designated States (unless otherwise indicated, for every kind of regional protection available): ARIPO (BW, GH, GM, KE, LS, MW, MZ, NA, SD, SL, SZ, TZ, UG, ZM, ZW), Eurasian (AM, AZ, BY, KG, KZ, MD, RU, TJ, TM), European (AT, BE, BG, CH, CY, CZ, DE, DK, EE, ES, FI, FR, GB, GR, HU, IE, IT, LU, MC, NL, PL, PT, RO, SE, SI, SK, TR), OAPI (BF, BJ, CF, CG, CI, CM, GA, GN, GQ, GW, ML, MR, NE, SN, TD, TG).

Published:  
— without international search report and to be republished upon receipt of that report

For two-letter codes and other abbreviations, refer to the "Guidance Notes on Codes and Abbreviations" appearing at the beginning of each regular issue of the PCT Gazette.



WO 2005/038037 A2

(54) Title: METHODS FOR PREPARING PHOSPHOLIPIDS CONTAINING OMEGA-3 AND OMEGA-6 MOIETIES

(57) Abstract: Methods for the production of omega-3 and/or omega-6 enriched glycerophospholipids are provided, which are based on enzymatic transesterification and esterification through phospholipases PLA1 and PLA2, chemical synthesis, and enzymatic synthesis through phospholipase D. Phosphatidylserine, phosphatidylcholine, phosphatidylinositol and phosphatidylethanolamine preparations are also provided, as well as food articles, pharmaceutical compositions and capsules comprising thereof.

## METHODS FOR PREPARING PHOSPHOLIPIDS CONTAINING OMEGA-3 AND OMEGA-6 MOIETIES

### Field of the Invention

The invention relates to the production of phospholipid preparations which are enriched with omega-3 and omega-6 fatty acids. The omega-3 and omega-6-enriched phospholipid preparations produced by the methods of the invention can be used as nutraceuticals or nutraceutical additives to functional foods or pharmaceutical compositions.

### Background of the Invention

Phospholipids containing poly-unsaturated fatty acids (PUFA) supply the organism with important building blocks which improve membrane fluidity, an essential property for the function of biological membranes.

Studies conducted with PUFA containing phospholipids have shown that these biomaterials have many important physiological roles. They are high-energy, basic, structural, and functional elements of all biological membranes such as cells, blood corpuscles, lipoproteins, and the surfactant. Furthermore, they are indispensable for cellular differentiation, proliferation, and regeneration, maintaining and promoting the biological activity of many membrane-bound proteins and receptors. PUFA-containing phospholipids also play a decisive role in the activity and activation of numerous membrane-located enzymes, such as sodium-potassium-ATPase, adenylate cyclase, and lipoprotein lipase, are important for the transport of molecules through membranes and control membrane-dependent metabolic processes between the intracellular and intercellular space. Moreover, some PUFAs,

such as linoleic acid, are precursors of the cytoprotective prostaglandins and other eicosanoids.

Due to all of their properties, many health benefits have been attributed to the consumption of fatty acids and in particular PUFA. For example, it has been reported that PUFA of the type omega-3 and omega-6 may be effective in the treatment and prevention of cardiovascular disease (CVD) [Din et al. 2004 BMJ 2004; 328:30-5; Hirafuji et al. J Pharmacol Sci. 2003; 92(4):308-16], immune disorders and inflammation [Heller et al. Drugs 1998; 55:487-96; Gil Biomed Pharmacother. 2002; 56(8):388-96], , renal disorders [Donadio et al. Semin Nephrol. 2004; 24(3):225-43; Das et al. Prostaglandins Leukot Essent Fatty Acids. 2001; 65(4):197-203], allergies [Mickleborough et al. Am J Respir Crit Care Med. 2003; 168(10):1181-9; Simopoulos J Am Coll Nutr. 2002; 21(6):495-505; Arm et al. Allergy Proc. 1994; 15(3):129-34], diabetes [Stene et al. Am J Clin Nutr. 2003; 78(6):1128-34; Mori et al. Free Radic Biol Med. 2003;35(7):772-81; Simopoulos Am J Clin Nutr. 1999; 70(3 Suppl):560S-569S], and even cancer [Larsson et al. Am J Clin Nutr. 2004; 79(6):935-45; Astorg Cancer Causes Control. 2004;15(4):367-86].

Besides its benefits with regards to CVD, diabetes and cancer, DHA is also important for enhancement of brain function, and in particular for brain development in infants. Nutritional studies, investigating the importance of DHA in the brain, found that low levels of DHA are associated with depression, memory loss, dementia and visual problems [Kalmijn et al. Neurology 2004; 62(2):275-280; Conquer et al. Lipids 2000; 35(12):1305-1312; Logan Altern Med Rev. 2003; 8(4):410-25; Cho et al. Am J Clin Nutr. 2001; 73(2):209-18. Fugh-Berman et al. Psychosom Med. 1999; 61(5):712-28]. All studies showed a dramatic improvement in the elderly brain function as blood levels of DHA increased [Naliwaiko et al. Nutr Neurosci. 2004; 7(2):91-

9; Frasura-Smith et al. Biol Psychiatry. 2004; 55(9):891-6; Moriguchi et al. J Neurochem. 2003; 87(2):297-309; Horrocks et al. Pharmacol Res. 1999; 40(3):211-25].

The human body does not synthesize DHA in sufficient amounts. Therefore it is necessary to obtain it from the diet. DHA is initially obtained through the placenta, then from breast milk, and later from sources like fish, red meats, animal organ meats and eggs. These types of fatty acids are naturally occurring mainly in fish and algae, where they are randomly distributed on the *sn-1*, *sn-2*, and *sn-3* positions of the glycerol backbone of triglycerides. In particular, tuna, salmon and sardines are rich sources.

Furthermore, the ability to enzymatically produce omega-6 and omega-3 products of linoleic and alpha-alpha linolenic acid declines with age. Thus, as human beings age, there is an increased need to acquire DHA directly from diet or supplements.

Because DHA is important for signal transmission in the brain, eye and nervous system, many consumers concerned with maintaining mental acuity seek for a pure, safe way to supplement their DHA levels. Until recently, the primary source of DHA dietary supplements has been fish oils.

In light of the important physiological roles of phospholipids containing PUFA for human health, and the scarce availability of said compounds in the organism, there is a demand for dietary supplementation of PUFA-containing phospholipids.

Many PUFA-containing agents suffer from stability and quality problems due to the high degree of oxidation of the polyunsaturated fatty acids. These



problems require the incorporation of antioxidants as well as the utilization of special measures which attempts to reduce this oxidation. The utilization of phospholipids as carriers of PUFA may result in enhanced stability of such products due to the anti-oxidative properties of phospholipids.

PUFA-containing phospholipids may be prepared by various ways, mainly by (i) enzymatic esterification and transesterification of phospholipids, (ii) chemical synthesis of phospholipids, or (iii) enzymatic transphosphatidylation of phospholipids.

One example was reported by Hosokawa et al. [Hosokawa, M. *et al.* (1995) *J.Am.Oil Chem.Soc.* 72:1287], wherein phospholipids containing PUFA at the *sn*-1 position were prepared by lipozyme-catalyzed acidolysis of phosphatidylcholine (PC) with a mixture of eicosapentenoic acid (EPA) and docosahexaenoic acid (DHA) in hexane media. In addition PC containing PUFA at the *sn*-2 position was prepared by PLA2-mediated condensation of lyso-PC and PUFA in glycerol as a reaction medium. The addition of a small amount of formamide (as a water-mimic) to the reaction mixture gave best results, with 60% yield. In contrast to this process, our enzymatic reactions are preformed without an organic solvent but in the DHA-FFA itself. We don't have to add water mimic since the water bounded to the enzymatic preparation is sufficiently for the reaction and do not cause the hydrolytic reaction to proceed to a great extent (up to 5% Lysophospholipids , i.e.the hydrolytic product , from overall phospholipids).

In the same reference Hosokawa describes the transphosphatidylation of the omega-3 containing phosphatidylcholine to phosphatidylethanol amine and phosphatidyl serine. The transphosphatidylation occurs in biphasic system of ethylacetate and buffer. At the end, the recovered phospholipids was purified

by TLC. This method is valid however could not be used for the production of large quantities.

Another example of enzymatic esterification of long PUFA and lyso-PC was reported [Lilja-Hallberg, M. and Harrod, M. (1994) *Biocatalysis*, **9**, 195-207]. Phosphatidylcholine was synthesized from lyso-PC and long PUFA using immobilized PLA<sub>2</sub> (immobilized on polymeric carrier Deloxan). The esterification was performed using the fatty acids as main solvent and isooctane or ethanol at low concentrations (7-45%) as additional solvents. The best yield of PC (22%) was found in the isooctane system when its concentrations were below 7% and the reaction times were as long as 9 days. The long reaction, combined with the heating at 45°C, make these conditions very problematic with respect to the stability of omega-3 towards oxidation. The diminished stability, together with the use of organic solvents, such as isooctane, makes this process less convenient for the production of PC in large scale.

Mutua and Akoh [Mutua, L. N. and Akoh, C. C. (1993) *JAOCS*, **70** (2): 125] modified phospholipids through lipase-catalyzed transesterification in order to incorporate n-3 PUFA. The phospholipid modification was carried out in organic media with lipase from *Mucor miehei* and PLA<sub>2</sub> as biocatalysts. The phosphatidylcholine was initially hydrolyzed and then synthesized with omega-3 fatty acids. The enzyme that gave the best incorporation was non-immobilized lipase from *Mucor miehei* (17.7 mol%) followed by non-immobilized PLA<sub>2</sub> (17.2 mol%) . With the PLA<sub>2</sub>, the yield of PC was not satisfactory.

Synthesis of phosphatidylethanolamine (PE), which contains highly unsaturated fatty acids specifically in the *sn*-2 position, was performed with

porcine PLA<sub>2</sub> by Hosokawa *et al* [Masashi Hosokawa *et al.* (1995) *International Journal of Food Science and Technology*, **29**, 721-725.]. PE was synthesized from lysophosphatidylethanolamine and highly unsaturated fatty acids (HUFA), utilizing glycerol as a solvent, and resulting in a yield of 27% up to 94.5% of *sn*-2 EPA-containing PE. Reactions were terminated by addition of chloroform:methanol:water mixture and the products recovered from the chloroform layer were separated on silica columns.

WO 91/00918 reports a method for the preparation of a phospholipid with carboxylic acid residue in the 2-position and a phospholipid with an omega-3 acid residue in the 2-position. The preparation is through esterification of the lyso phospholipids with an omega-3 fatty acid in microemulsion of organic solvent (like isooctane or heptane), in the presence of 0.1-2% of water. Apart from the lyso-phospholipid, the surface-active component comprises at least one nonionic or anionic surface active component. After a 24-hour reaction, the phospholipid fraction was obtained with a yield of 7%, of which more than 90% contained omega-3 fatty acid residues.

WO 91/03564 discloses a process whereby phospholipids and fatty acid (or ester) are treated with suitable lipase to obtain at least 5-20% exchange of the fatty acid. The process is obtained by using a lipase immobilized on a particulate macroporous carrier. The immobilized enzyme has water content prior to contact with the phospholipids in the range of 5-15% (by weight). The process is carried out in organic solvent such as petroleum ether or heptane.

Egger *et al.* studied PLA<sub>2</sub> synthesis and the hydrolysis of PC in a water controlled organic medium, using PC and oleic acid as reactants [Egger, D. *et al.* (1997) *Biochimica et Biophysica Acta* **1343**, 76-84]. The best yield in the

synthetic reaction was 60%, at a water activity of 0.11 and an oleic concentration of 1.8M, however the synthesis was in the absence of omega-3 and omega-6.

There are several reports on the chemical synthesis of phospholipids.

Existing chemical methods for 1,2-diacyl PC synthesis rely primarily on acylation of lysoPC with fatty acyl chlorides [Baer, E. and Buchnead, D. (1959) *Can.J.Biochem.Physiol.* **37**, 953-959] and acid anhydrides [Pugh, E. and Kates, M. (1975) *J. Lipid Res.* **16**, 392-394]. The reagents are usually used in large excess. Further, the use of fatty acyl chlorides may be accompanied by the formation of significant amounts of several side products [Aneja, R. and Chadha, J. S. (1971) *Biochim. Biophys. Acta* **239**, 84-91]. Acylation with anhydrides require relatively vigorous conditions, e.g. 48 hours at 80°C [Robles, E. C. and van DenBerg, D. (1969) *Biochim.Biophys.Acta* **187**, 520-526] and the yield most often is unsatisfactory. Furthermore, one equivalent of the acyl substituent in the anhydride is wasted since fatty acyl carboxylate is the leaving group of the acylating agent. Methods which avoid the use of such extreme conditions have also been published and involve the use of catalysts like p-dimethylaminopyridine [Chhitar M. *et al.* (1977) *Proc. Natl. Acad. Sci. USA* **74**(10), 4315-4319] or 4-pyrrolidinopyridine [Mason, J. T. *et al.* (1981) *Analytical Biochemistry* **113**, 96-101]. Yields are excellent and the reaction is convenient to carry out. The drawback of using pyrrolidine is a slow rate of acylation, unless a large excess of anhydride is used.

Nicholas *et al.* report a method for synthesis of mixed acid phosphatidylcholine that relies on a silver-ion catalyzed acylation of lysoPC with 2-pyridinethiol fatty acid esters [Nicholas, A. W. *et al.* (1983) *Lipids*,

18(6), 1983]. Although this method appears to be applicable for a variety of diacyl PC, its feasibility for using in product designed for food grade process appears to be very poor since it utilizes hazardous chemicals such as 2-pyridethiol and phosgene.

Werner and Benson reported a method for preparation of unsaturated phosphatidylcholine, which can be carried out on moderate or small scale under mild conditions and uses twice the theoretical amount of fatty acid [Werner, T. G. and Benson, A. A. (1977) *Journal of Lipid Research*, 18,548]. The main disadvantage of this process is that it is not applicable to large scale industry process for obtaining phospholipids with unsaturated fatty acids.

Lindberg *et al.* reported a new synthesis of phospholipids [Lindberg, J. (2002) *J.Org.Chem.* 67,194-199] starting from enantiomerically pure (S)-glycidol. Direct phosphorylation and subsequent opening of the epoxide produced dibenzyl-protected lysoalkyl phosphatidic acid with 67% yield. DCC and DMAP promoted esterification of the lysophospholipid with palmitic acid and subsequent debenylation of the phosphate produced 1-o-alkyl-2-O-acyl-phosphatidic acid in 40% overall yield from (S)-glycidol. All the reactions were in the absence of omega-3 and omega-6 fatty acids. The insertion of omega -3 and 6 is the main barrier in the esterification of fatty acids with phospholipids.

Haider *et al.* have also described chemical synthesis of PC bearing icosadienoyl group at the 1- position, with very long chain PUFAs [Haider, S. *et al.* (1998) *Chemistry Letters*, 175]. The synthesis was performed in the presence of ethanol-free chloroform at room temperature, using a synthetic phosphatidyl choline, prepared through carbon chain elongation of linoleic

acid via malonic ester synthesis, preparation of lyso-phosphatidylcholine via lipase catalyzed mono-acylation of 2-O-methoxyethoxymethylglycerol and phosphodiester synthesis, and finally DCC-mediated esterification.

It is important to mention that PS is the major acidic phospholipid component in the membranes of the brain. It has been the subject of numerous human clinical trials of memory loss, mood, cognitive performance and learning abilities. Many of the studies show that PS can be helpful for those with age-related memory impairment, and that it can even help optimizing the cognition in those with no cognitive impairment [Sakai et al. *J Nutr Sci Vitaminol* 1996;42:47-54; Heiss et al. *Dementia* 1994; 5:88-98; Kidd (1996) *id ibid.*; Crook et al. *Psychopharmacol Bull* 1992;28:61-66].

Dietary PS is efficiently and rapidly absorbed in the intestine, is taken up into the blood, and readily crosses the blood-brain barrier to reach the nerve cells of the brain.

PS can be extracted from bovine brain or from plants, or it can be produced from soybean lecithin using biocatalysis. The main difference between the two sources is the type of fatty acids attached to positions 1 and 2 on the phospholipid skeleton. Long-chain polyunsaturated n-3 type fatty acids are characteristic of marine fat and occur pervasively in the phospholipids of marine species.

Phosphatidylserine can be made by using the transphosphatidylation reaction with phospholipases D (PLDs), by which the head group of phospholipids can be readily modified. Thus, phosphatidylserine can be produced from phosphatidylcholine or any other phospholipid mixture and serine by catalysis with PLD.

US 5,965,413 describes a process for the production of phosphatidylserine having a long chain unsaturated fatty acid in its side chain. In this process a natural lecithin containing long chain unsaturated fatty acid side chain is used as starting material. The transphosphatidylation was performed in the presence of serine, PLD and ethyl acetate as a solvent. Hosokawa et al. describe a method for PLD-mediated transphosphatidylation of squid lecithin with L-serine, in the preparation of DHA acid-containing phosphatidylserine, in which the synthesis is conducted in a biphasic system of organic solvent and 0.2M acetate buffer [Hosokawa M. *et al.* (2000) *J. Agric. Food Chem.* 48, 4550-4554]. This transphosphatidylation process was performed on very low scale, The biphasic reaction system consists of 2.5 ml of organic solvent, 30 mg squid lecithin in addition to 0.8 unit of PLD dissolved in 1 ml acetate buffer containing 3.4M L-serine.

The present invention provides improved and more cost-effective methods for the production of omega-3/omega-6 enriched glycerophospholipids.

Thus, it is an object of the present invention to provide an improved enzymatic interesterification process for the enrichment of phospholipids with omega-3 and omega-6 fatty acids. The interesterification includes the processes of transesterification of lecithin with omega-3 and 6 fatty acid and esterification process.

It is another object of the present invention to provide chemical methods for the production of omega-3 and omega-6 enriched phosphatidylcholine, phosphatidylinositol, phosphatidylserine and phosphatidylethanolamine.

It is a further object of the present invention to provide a method for the production of stabilized phosphatidylserine preparations enriched with omega-3/omega-6 acid residues. In the method presented herein, the production is by transphosphatidylation of lecithin that contains omega-3 and omega -6 fatty acids by a simple, single step reaction, which can be easily performed on industrial scales.

These and other objects of the invention will become apparent as the description proceeds.

#### Summary of the Invention

The present invention provides various methods for the preparation of glycerophospholipids enriched with omega-3 and/or omega-6. Said methods are essentially methods of enzymatic transesterification and esterification of glycerophospholipids, chemical synthesis, and enzymatic production of phosphatidylserine, in the presence of immobilized PLD.

Thus, in a first aspect, the present invention provides a method for the production of a glycerophospholipid enriched with omega-3 and/or omega-6 fatty acids through enzymatic transesterification, comprising the steps of:

- a) incubating said glycerophospholipid with an omega-3 and/or omega-6 fatty acid source in the presence of an immobilized phospholipase which can catalyze transesterification at the *sn*-1 and/or *sn*-2 positions of the glycerol moiety, for a suitable period of time to give a glycerophospholipid enriched with said omega-3 and/or omega-6 fatty acids at the *sn*-1 and/or *sn*-2 positions;
- b) removing and filtering the upper layer which contains the said enriched



glycerophospholipid, in order to separate the glycerophospholipid from the enzyme; and

c) optionally de-oiling the filtrate to remove excess FFA;

In one embodiment of this method, said glycerophospholipid is any one of phosphatidylcholine, phosphatidylserine (PS), phosphatidylinositol (PI) and phosphatidylethanolamine (PE).

In another aspect the invention provides a method for the production of a glycerophospholipid enriched with omega-3 and/or omega-6 fatty acids through enzymatic esterification, comprising the steps of:

a) incubating said glycerophospholipid in an aqueous medium or in an organic solvent with an immobilized phospholipase, which is *sn*-1 or *sn*-2 regio-specific, to give the corresponding lyso-phospholipid;

b) incubating said lysophospholipid with an omega-3 and/or omega-6 fatty acid source in the presence of an immobilized phospholipase which can catalyze esterification at the *sn*-1 and/or *sn*-2 positions of the glycerol moiety, for a suitable period of time to give a glycerophospholipid enriched with said omega-3 and/or omega-6 fatty acids at the *sn*-1 and/or *sn*-2 positions;

c) removing and filtering the upper layer which contains the said enriched glycerophospholipid, in order to eliminate remaining enzyme; and

d) optionally de-oiling the filtrate with acetone to remove excess neutral phospholipids.

In one particular embodiment of the above method, said glycerophospholipid is any one of phosphatidylcholine, phosphatidylserine, phosphatidylinositol and phosphatidylethanolamine.

In the above-described process, the termination of the reaction is by filtering out the enzyme, and adding acetone for the deoiling process, further to which the phospholipids are precipitated and filtered out. This is much less harmful than the process described for example by Hosokawa *et al.* (1995) *id ibid.*, wherein the final step involves washes with a mixture of chloroform, methanol and water.

The immobilized enzyme used in the above-described methods may be any one of PLA<sub>1</sub> or PLA<sub>2</sub>, and the reaction is carried out in aqueous media. When the enzyme is not immobilized, the reaction is carried out in an organic solvent.

In a further aspect the present invention provides chemical methods for the synthesis of enriched glycerophospholipids. In one method, the chemical synthesis of a glycerophospholipid enriched with omega-3 and/or omega-6 fatty acid starts from its corresponding lyso-glycerophospholipid, and comprises the steps of:

- a) dissolving said lyso-glycerophospholipid with said omega-3 and/or omega-6 fatty acid source in a suitable organic solvent, preferably dichloromethane;
- b) incubating the mixture obtained in step (a) with a coupling reagent for a suitable period of time while stirring;
- c) filtering the product, preferably with Celite<sup>R</sup>.

In a second method, the chemical synthesis of a glycerophospholipid enriched with omega-3 and/or omega-6 fatty acids starts from its corresponding lyso-glycerophospholipid, and differs in the reactive moieties used in the synthetic procedure, which comprises the steps of:

- a) incubating a mixture of said lyso-glycerophospholipid and said omega-3 and/or omega-6 fatty acid source under acidic conditions, for example in the

presence of naphthalene beta sulphonic acid, wherein said mixture is optionally dissolved in an organic solvent, for a suitable period of time while stirring;

- b) extracting the phospholipids with a suitable organic solvent; and
- c) evaporating the solvent.

Said enriched glycerophospholipid obtained further to the above-described chemical methods is any one of phosphatidylcholine and phosphatidylinositol. Thus, the present invention also provides phosphatidylcholine, phosphatidylserine, phosphatidylethanolamine and phosphatidylinositol preparations obtained through said chemical methods.

Most importantly, for all of the above-described methods (transesterification, esterification and chemical methods), the omega-3 source may be docosahexaenoic acid (DHA), eicosapentaenoic acid (EPA), and alpha linolenic acid in the form of a free fatty acid, an ethyl ester of any one of said fatty acids, or a triglyceride comprising thereof. Likewise, the omega-6 source may be any one of gamma linoleic acid (GLA), arachidonic acid (ARA), and linoleic acid in the form of a free fatty acid, an ethyl ester of any one of said fatty acids, or a triglyceride comprising thereof.

In a yet further aspect the present invention provides a method for the production of a phosphatidylserine preparation enriched with omega-3 and/or omega-6 fatty acids, comprising the steps of:

- a) incubating an aqueous mixture of L-serine with lecithin which is rich with omega-3 or omega-6 fatty acid residues in the presence of phospholipase D, for a suitable period of time to give phosphatidylserine;
- b) removing and filtering the upper layer which contains the phosphatidylserine;

- c) washing the filtrate with water to remove excess serine;
- d) washing the resulting phosphatidylserine with ethanol to remove any traces of phospholipase; and
- e) drying the washed phosphatidylserine wherein the resulting phosphatidylserine is enriched with omega-3 or omega-6 fatty acid residues which are covalently bound to the phospholipid backbone.

Said lecithin may be derived from a marine animal, like for example krill, or it may also be obtained through any one of the above-described methods.

In one embodiment of the method of producing enriched phosphatidylserine, said omega-3 or omega-6 fatty acids are selected from the group consisting of EPA, DHA, GLA, arachidonic acid alpha linolenic acid and linoleic acid.

In another embodiment of this method, said phospholipase is immobilized on an insoluble matrix and is optionally surfactant coated.

The present invention thus further provides:

- a phosphatidylserine (PS) preparation enriched with omega-3 or omega-6 acyl moieties prepared by any one of the methods of transesterification, esterification, utilizing PLD, or through the chemical methods as described above.
- a phosphatidylcholine (PC) preparation enriched with omega-3 or omega-6 acyl moieties prepared by any one of the methods of transesterification, esterification, or through chemical methods as described above.
- a phosphatidylinositol (PI) preparation enriched with omega-3 or omega-6 acyl moieties prepared by any one of the method of transesterification, esterification, or through chemical methods as described above.
- a phosphatidylethanolamine (PE) preparation enriched with omega-3 or

omega-6 acyl moieties prepared by the methods of transesterification, esterification, or through the chemical methods as described above.

Any of these enriched glycerophospholipid preparations may further comprise at least one additional functional ingredient and/or at least one non-functional nutritionally acceptable ingredient. For the PS, PI and PE preparations, said additional functional ingredient may be, for example, lecithin.

Any one of the enriched glycerophospholipid preparations of the invention may be used as nutraceutical foods and/or drug additives.

The present invention further provides a food article comprising at least one of: the phosphatidylserine preparation of the invention, the phosphatidylcholine preparation of the invention, the phosphatidylinositol preparation of the invention and the phosphatidylethanolamine of the invention.

In an even further aspect, the present invention provides a pharmaceutical composition comprising as active agent at least one of the omega-3/omega-6 enriched glycerophospholipids presented by the invention, or specifically, PS, PC, PI or PE as prepared by any one of the methods described herein, respectively.

Another particular aspect of the present invention is a capsule, containing any one of the PS preparation of the invention, the PC preparation of the invention, the PE preparation of the invention or the PI preparation of the invention, or any combination thereof. Said capsule is preferably, but not limited to a gelatin capsule.

Due to its known properties in brain function, as previously mentioned, the stabilized phosphatidylserine preparation of the present invention may be used as an enhancer of cognitive performance and learning ability, and in preventing memory loss, particularly age-related memory loss.

### **Detailed Description of the Invention**

The present invention provides various methods for the preparation of glycerophospholipids enriched with omega-3 and/or omega-6. Said methods are essentially methods of enzymatic transesterification and esterification of glycerophospholipids, chemical synthesis, and enzymatic production of phosphatidylserine, in the presence of immobilized PLD.

The present inventors have developed synthetic pathways that enable the industrial production of the aforementioned phospholipids, which possess unique nutritional and clinical benefits.

The synthetic pathways described herein may be divided into three main categories:

1. Enzymatic esterification and transesterification of phospholipids with omega-3 and/or omega-6 fatty acids utilizing PLA<sub>1</sub> or PLA<sub>2</sub> enzymes, accordingly.
2. Chemical esterification of phospholipids with omega-3 and omega-6 acyl donors.
3. Enzymatic transphosphatidylation of phospholipids with PLD.

Thus, the present invention provides an improved enzymatic interesterification processes for the enrichment of phospholipids with omega 3 and 6 fatty acids. The interesterification includes a process of

transesterification of lecithin with omega-3 and 6 fatty acids and an esterification process. In the latter, lecithin is converted to lyso lecithin by PLA<sub>1</sub> or PLA<sub>2</sub> and the resulting lyso-lecithin product then reacts with omega-3 and/or omega-6 fatty acids. Both enzymatic processes utilize enzymes that are modified and immobilized by the AMIET technology (Activation Modification Immobilization Enzyme Technology), described in US 6,605,452.

Thus, in a first aspect, the present invention provides a method for the production of a glycerophospholipid enriched with omega-3 and/or omega-6 fatty acids through enzymatic transesterification, comprising the steps of:

- a) incubating said glycerophospholipid with an omega-3 and/or omega-6 fatty acid source in the presence of an immobilized phospholipase which can catalyze transesterification at the *sn*-1 and/or *sn*-2 positions of the glycerol moiety, for a suitable period of time to give a glycerophospholipid enriched with said omega-3 and/or omega-6 fatty acids at the *sn*-1 and/or *sn*-2 positions;
- b) removing and filtering the upper layer which contains the said enriched glycerophospholipid, in order to separate the glycerophospholipid from the enzyme; and
- c) optionally de-oiling the filtrate to remove excess FFA;

In one embodiment of this method, said glycerophospholipid is any one of phosphatidylcholine, phosphatidylserine (PS), phosphatidylinositol (PI) and phosphatidylethanolamine (PE).

In another aspect the invention provides a method for the production of a glycerophospholipid enriched with omega-3 and/or omega-6 fatty acids through enzymatic esterification, comprising the steps of:

- a) incubating said glycerophospholipid in an aqueous medium or in an

organic solvent with an immobilized phospholipase, which is *sn*-1 or *sn*-2 regio-specific, to give the corresponding lyso-phospholipid;

b) incubating said lysophospholipid with an omega-3 and/or omega-6 fatty acid source in the presence of an immobilized phospholipase which can catalyze esterification at the *sn*-1 and/or *sn*-2 positions of the glycerol moiety, for a suitable period of time to give a glycerophospholipid enriched with said omega-3 and/or omega-6 fatty acids at the *sn*-1 and/or *sn*-2 positions;

c) removing and filtering the upper layer which contains the said enriched glycerophospholipid, in order to eliminate remaining enzyme; and

d) optionally de-oiling the filtrate with acetone to remove excess FFA.

In one particular embodiment of the above method, said glycerophospholipid is any one of phosphatidylcholine, phosphatidylserine, phosphatidylinositol and phosphatidylethanolamine.

In the above-described process, the termination of the reaction is by filtering out the enzyme, and adding acetone for the deoiling process, further to which the phospholipids deposit and are filtered out. This is much less harmful than the process described for example by Hosokawa *et al.* (1995) *id ibid.*, wherein the final step involves washes with a mixture of chloroform, methanol and water.

The immobilized enzyme used in the above-described methods may be any one of PLA<sub>1</sub> or PLA<sub>2</sub>, and the reaction is carried out in aqueous media. When the enzyme is not immobilized, the reaction is carried out in an organic solvent.

Most importantly, the enzyme utilized in this method may be re-cycled, which reflects significant reduction in the cost of the reaction and consequently also



of the final product, thus making these methods much more cost-effective than what is currently available in the market.

The present invention also provides two different chemical processes: one using DCC/DMAP and the other based on esterification with naphthalene-beta sulphonic acid.

In a further aspect the present invention provides chemical methods for the synthesis of enriched glycerophospholipids. In one method, the chemical synthesis of a glycerophospholipid enriched with omega-3 and/or omega-6 fatty acid starts from its corresponding lyso-glycerophospholipid, and comprises the steps of:

- a) dissolving said lyso-glycerophospholipid with said omega-3 and/or omega-6 fatty acid source in a suitable organic solvent, preferably dichloromethane;
- b) incubating the mixture obtained in step (a) with a coupling agent for a suitable period of time while stirring;
- c) filtering the product, preferably with Celite<sup>R</sup>.

In one specific embodiment, said coupling agent may be any one of N,N-dicyclohexylcarbodiimide (DCC), 4-dimethylaminopyridine (DMAP) and diisohexylcarbodiimide.

In a second method, the chemical synthesis of a glycerophospholipid enriched with omega-3 and/or omega-6 fatty acids starts from its corresponding lyso-glycerophospholipid, and differs in the reactive moieties used in the synthetic procedure, which comprises the steps of:

- a) incubating a mixture of said lyso-glycerophospholipid and said omega-3 and/or omega-6 fatty acid source under acidic conditions, for example in the presence of naphthalene beta sulphonic acid, wherein said mixture is

optionally dissolved in an organic solvent, for a suitable period of time while stirring;

- b) extracting the phospholipids with a suitable organic solvent, for example ethylacetate; and
- c) evaporating the solvent.

Said enriched glycerophospholipid obtained further to the above-described chemical methods is any one of phosphatidylcholine and phosphatidylinositol. Thus, the present invention also provides phosphatidylcholine, phosphatidylserine, phosphatidylethanolamine and phosphatidylinositol preparations obtained through said chemical methods.

Most importantly, for all of the above-described methods (transesterification, esterification and chemical methods), the omega-3 source may be docosahexaenoic acid (DHA), eicosapentaenoic acid (EPA), and alpha linolenic acid in the form of a free fatty acid, an ethyl ester of any one of said fatty acids, or a triglyceride comprising thereof. Likewise, the omega-6 source may be any one of gamma linoleic acid (GLA), arachidonic acid (ARA), and linoleic acid in the form of a free fatty acid, an ethyl ester of any one of said fatty acids, or a triglyceride comprising thereof.

Thus, it is a further object of the present invention to provide improved chemical interesterification processes for the enrichment of phospholipids with omega 3 and 6 fatty acids. The methods comprise the enzymatic hydrolysis of soy lecithin and esterification of the lysolecithin with omega 3 and 6 fatty acids by two alternative chemical ways. One involves the esterification with DCC and DMAP, wherein 10% DCC and 50% phospholipids are preferably utilized. The second esterification is performed with naphthalene-beta-sulphonic acid, at 135-145°C for about 5-6 hours in a

vacuum, under pressure of about 1 mm Hg. The lecithin obtained by the two ways can be further transformed to phosphatidylserine enriched with omega-3 or omega-6 by the process described in applicant's co-pending PCT application claiming priority from IL158552.

It is important to mentioned that in contrast to processes described by others [see e.g. Haider *et al.* (1998) *id ibid.*] the procedure presented herein involves the hydrolysis of natural occurring lecithin and esterification with solvents that are less toxic than chloroform. Thus, the process described in the present invention (after the complete removal of all reagents and solvents) is more suitable for use in the generation of products with food grade quality.

Human brain PS is characterized by about 20-30% PS containing omega-3 fatty acyls, preferably at the *sn*-2 position of the glycerol moiety, and mainly DHA or EPA. As mentioned above, phospholipids, and PS in particular, are responsible for membrane structure and physical properties. One of the major physical properties governed by phospholipids is the fluidity of these membranes. Omega-3 fatty acids, DHA and EPA in particular, also have a crucial role in membrane fluidity in light of their unique 3D structure. Therefore, PS with omega-3 fatty acyl moieties, DHA and EPA in particular, has unique bio-functionality which cannot stem from just the basic phospholipid skeleton of this phospholipid.

The present inventors have developed synthetic pathways that enable the industrial production of the aforementioned phospholipids, which possess unique nutritional and clinical benefits. The synthetic pathways described herein may thus be divided into three main categories:

1. Enzymatic esterification and transesterification of phospholipids with omega-3 and/or omega-6 fatty acids utilizing PLA<sub>1</sub> or PLA<sub>2</sub> enzymes, accordingly.
2. Chemical esterification of phospholipids with omega-3 and omega-6 acyl donors.
3. Enzymatic transphosphatidylation of phospholipids with PLD.

Polyunsaturated fatty acids are known to be bioactive compounds. Because those fatty acids are very unstable, enzymatic conversion of PUFA's under mild conditions is worthwhile.

Among the enzymes that can be utilized for esterifications and/or transesterifications are the lipases and the two types of phospholipases – PLA<sub>1</sub> and PLA<sub>2</sub>.

The production of glycerophospholipid preparations that are suitable as food ingredients or nutraceuticals is a major advantage over obtaining said glycerophospholipids from animal sources. Considering the risks involved with prion diseases, particularly bovine spongiform encephalopathy (BSE), as well as other disadvantages associated with ingredients obtained from animal sources, glycerophospholipid supplements (PS, PC, etc.) derived from animal sources are to be avoided. Furthermore, PS originating from plant lecithin is characterized by low levels of omega-3 fatty acids, with almost no DHA and EPA. Thus, the only viable way for the population to be safely supplied with said dietary supplements is through their industrial synthesis from safe raw materials.

It is therefore desirable to provide a PS ingredient with a fatty acid composition that mimics the fatty acid composition of the human brain PS.

Applicant's co-pending PCT Application No. IL2004/000895 describes the synthesis of stabilized phosphatidylserine preparations. This process has now been further developed for the preparation of omega-3 and omega-6 containing phosphatidylserine.

Thus, in a further aspect, the present invention provides a process for the preparation of a stable phosphatidylserine composition of matter, comprising the steps of:

- (a) incubating an aqueous mixture of L-serine and optionally appropriate organic solvents with lecithin which is rich in omega-3 and/or omega-6 fatty acid in the presence of a phospholipase D (PLD), for a suitable period of time to give phosphatidylserine;
- (b) removing the upper layer which contains the phosphatidylserine;
- (c) obtaining the phosphatidylserine from said removed upper layer by standard means;
- (d) washing the phosphatidylserine obtained in step (c) with an appropriate aqueous solution to remove excess L-serine;
- (e) optionally washing the phosphatidylserine obtained in step (d) with a suitable organic solvent, preferably ethanol at an elevated temperature; and
- (f) drying the phosphatidylserine obtained in step (e).

The resulting phosphatidylserine is enriched with omega-3 or omega-6 fatty acid residues, which are covalently attached to the phospholipid backbone.

Omega-3 and omega-6 may be obtained from a variety of phospholipid sources, such as marine animals and egg yolks. One important source of omega-3 PUFA is the krill.

In another embodiment the method of the invention may employ a PLD which is immobilized on a suitable rigid matrix. The immobilized enzymatic preparation can be filtered off the reaction medium at the end of the reaction. An advantage of this immobilized enzyme preparation is that it can be re-used in many further reaction batches. Matrix-immobilized, preferably surfactant-coated phospholipases can be prepared according to the methods described in WO00/56869, fully incorporated herein by reference.

A further advantage of the method of the invention is that the resulting phosphatidylserine preparations are stable to decomposition during prolonged storage, or in different nutritional, nutraceutical or pharmaceutical applications.

The content of omega-3 or omega-6 fatty acid residues in the preparations produced by the method of the invention may vary, and is preferably from about 10 to about 60-70% of the total acid moieties content.

According to the present invention it is possible to control the position of the omega-3 fatty acid either by choosing the raw lecithin that contains the desired fatty acid on the beta position (which is preferable) or by conducting the hydrolysis of the lecithin by specific phospholipase e.g. PLA<sub>1</sub> or PLA<sub>2</sub>.

In a further embodiment, the invention relates to omega-3/omega-6-enriched PS preparations, particularly as produced by the method of the invention.

One clear advantage provided by the present invention is that it makes possible to control the position of the insertion of omega-3 and 6 fatty acid either by choosing the raw lecithin that contains the desired fatty acid on the beta position (which is preferable) for a transphosphatidylation or by

conducting the hydrolysis of the lecithin by specific phospholipase e.g. PLA<sub>1</sub> or PLA<sub>2</sub> and then esterify the lyso product with omega 3 or 6 fatty acid.

The present invention thus further provides:

- a phosphatidylserine (PS) preparation enriched with omega-3 or omega-6 acyl moieties prepared by any one of the methods of transesterification, esterification, and utilizing PLD.
- a phosphatidylcholine (PC) preparation enriched with omega-3 or omega-6 acyl moieties prepared by any one of the methods of transesterification, esterification, or through chemical methods as described above.
- a phosphatidylinositol (PI) preparation enriched with omega-3 or omega-6 acyl moieties prepared by any one of the method of transesterification, esterification, or through chemical methods as described above.
- a phosphatidylethanolamine (PE) preparation enriched with omega-3 or omega-6 acyl moieties prepared by the methods of transesterification or esterification.

Any of these enriched glycerophospholipid preparations may further comprise at least one additional functional ingredient and/or at least one non-functional nutritionally acceptable ingredient. For the PS, PI and PE preparations, said additional functional ingredient may be, for example, lecithin.

Any one of the enriched glycerophospholipid preparations of the invention may be used as nutraceutical foods and/or drug additives.

The present invention further provides a food article comprising at least one of: the phosphatidylserine preparation of the invention, the phosphatidylcholine preparation of the invention, the phosphatidylinositol

preparation of the invention and the phosphatidylethanolamine of the invention.

In an even further aspect, the present invention provides a pharmaceutical composition comprising as active agent at least one of the omega-3/omega-6 enriched glycerophospholipids presented by the invention, or specifically, PS, PC, PI or PE as prepared by any one of the methods described herein, respectively.

Another particular aspect of the present invention is a capsule, containing any one of the PS preparation of the invention, the PC preparation of the invention, the PE preparation of the invention or the PI preparation of the invention, or any combination thereof. Said capsule is preferably, but not limited to a gelatin capsule.

Due to its known properties in brain function, as previously mentioned, the stabilized phosphatidylserine preparation of the present invention may be used as an enhancer of cognitive performance and learning ability, and in preventing memory loss, particularly age-related memory loss.

## **Examples**

### **1. Analytical Procedures:**

1.a. Analytical method for the detection of 1 and 2 lyso phosphatidylcholine as described [*JAOCS*, 78, 10 (2001)].



### 1.b. HPLC method for analyzing phospholipids

The HPLC analysis were carried out with Merck Hitachi D7000-IF instrument consisting of an Autosampler L7200 and a Polymer Laboratories LTD – PL-ELS 1000 detector. PC, PS, PA, PE, Lyso PC, and Lyso PS were separated on Lichrospher Si 60 5 $\mu$ m column.

### 1.c. Fatty acid analysis of the phospholipids

In order to analyze the fatty acid composition of the phospholipids, internal standard (C17 phosphatidylcholine) was added to the sample. The phospholipids were applied to 20X20 TLC plate and developed in 80:20:2 isohexane:ether:formic acid system. The TLC plates were sprayed with primuline solution (0.01% in 60:40 acetone: water), placed under UV lamp and the desire bands marked and scrabbed. Second internal standard had been added to the silica that consists of C21-Methyl ester. The silica and lipids were subjected to acidic hydrolysis by adding 1 ml of toluene and 2 ml of 2% H<sub>2</sub>SO<sub>4</sub> in methanol. The acidic hydrolysis was for 16 h in a 50C. At the end of the hydrolysis, 5 ml of 5% NaCl (in DDW) was added, followed by 2 ml of isohexane. The tube had being vortex, spined down, and the upper phase (organic with isohexane and fatty acids) transferred to another tube, and an additional extraction with 2 ml of isohexane is performed.

To the combined upper phases of the phospholipids hydrolysis, 3 ml of 2% potassium carbonate (KHCO<sub>3</sub> in DDW) was added; the tube vortexed and spun down for phase separations. The upper phase was then transferred through an ammonium sulfate column (pre-washed with iso-hexane) and an additional 2 ml of iso-hexane were used to wash the column. The tube was dried under nitrogen, and then resuspended for Gas Chromatography analysis. A model GC-HP gas chromatograph was employed, equipped with

fused silica capillary 007 Carbowax 20M column, 25 meters, 0.25mm I.D. and 0.1  $\mu$  Film thickness.

### **Example 1 - Enzyme preparations**

#### **- Materials:**

L-Serine: CAS N.56-45-1 (Degussa).

Lecithin: krill (high concentrations of long-chain PUFA).

Calcium chloride: CALCIOL (Marschall™, Rhodiafood).

Acetic Acid: CAS N 64-19-7 (Acetex Chimie).

Sodium Hydroxide: CAS N. 1310-73-2 (Sigma Chemical Co.)

MCT Crodamol GTCC: Manufacture by Croda.

Titriplex<sup>R</sup> III (ethylenedinitrilotetraacetic acid disodium salt dihydrate) (Merck KgaA)

Hexane (Sigma-Aldrich).

Dicyclohexylcarbodiimide (DCC) (Acros)

Dimethylaminopyridine (DMAP) (Acros)

Naphtalene beta sulphonic acid (Sigma)

PC (70%)- (Phospholipids GmbH)

#### **- Immobilization of the enzymes**

Matrix-immobilized, preferably surfactant-coated phospholipases and lipases can be prepared according to the methods described in WO00/56869, fully incorporated herein by reference.

Briefly, the crude enzyme (300mg/l protein) is dissolved in 1L tris buffer, pH 6.5 containing 4 g insoluble inorganic or organic matrix (Celite, silica gel, alumina, polypropylene or ion-exchange resin). The solution is stirred vigorously with a magnetic stirrer for 30 minutes at 25°C. In the case of surfactant-coated immobilized enzyme preparations, sorbitan mono-stearate is added drop-wise to the stirred enzyme solution. All enzyme preparations

(i.e. both the surfactant-coated immobilized lipases and the immobilized-crude lipases) are sonicated for 10 minutes and then stirred for 8 hours at 25°C. The formed precipitate is collected by either filtration or centrifugation (12,000 rpm, 4°C), followed by overnight freezing at -20°C and lyophilization.

### Example 2

Transesterification reactions with immobilized phospholipase (PLA<sub>1</sub> from *Aspergillus niger*) were carried out over fixed time periods, usually for 16 hours, at 45 °C in a rotary shaker in 50 ml Erlenmeyer flask containing 32.5 gr mixture of soy PC (70%) from Phospholipids GmbH and DHA-FFA (70%, Croda) in the ratio of 1:5.5 and 5 gr of immobilized phospholipase. At the end of the reaction, after 48 hours, the enzyme was filtered out and recycled in similar process and the phospholipids were subjected to hydrolysis to methyl esters for GC analysis (results summarized in Table 1). In case that the phospholipids fraction is needed, it is possible to obtain that fraction by adding an acetone and filter the solid that consists mainly of phospholipids.

In contrast to other systems described (e.g. WO91/03564) this process our process is conducted in solvent free system and the water content of the immobilized enzyme is low, resulting in much less hydrolysis during the synthetic reaction.

In this enzymatic process the inventors obtained 3-fold higher incorporation of omega-3 fatty acids in the phospholipids, when compared to the yield obtained by others [see e.g., Mutua, L. N. and Akoh, C. C. (1993) *id ibid.*]. Moreover, the present procedure utilizes immobilized enzyme, which may be re-used. Both factors have a great impact on the final cost and stability of the end product.

**Table 1: Fatty acid content of the phosphatidylcholine before and after the transesterification reaction.**

	C16:0	C18:0	C18:1	C18:2	C18:3	C20:5	C22:6
<b>Before</b>	13	5	12	62	6		
<b>After</b>	5	2	10	10	4	10	59

As can be seen from Table 1, 70% of the fatty acid on the phosphatidylcholine are omega-3 fatty acid

Calculating the percentage of saturated vs. unsaturated fatty acids before and after the reaction (without taking into account the omega-3 fatty acid), shows that the percentage of saturated fatty acids increased to 25% while there was a decrease in the unsaturated fatty acid. Those changes in the identity of the fatty acid can indicate that the insertion of omega-3 was preferable at the second position (since most of the unsaturated fatty acids are located on the second position of the phospholipids, whereas the saturated fatty acids are located at the 1st position).

### **Example 3 - Enzymatic esterification of phosphatidylcholine**

#### *- Preparation of Lysophosphatidylcholine*

Lyso-phosphatidylcholine can be obtained by hydrolysis with PLA<sub>2</sub> in Tris buffer or water followed by extraction of the lyso product. 0.2 g of PLA<sub>2</sub> were added to 2 g of PC, in 100 ml buffer Tris pH=8 and 10mM CaCl<sub>2</sub>. After 16 hours of reaction, ethyl acetate was added in order to extract the neutral lipids as well as the phospholipids. After evaporation of the organic solvent, the residue was dissolved in a mixture of ethyl acetate and 2-propanol (95:5), and all neutral lipids were extracted from the mixture leaving the 2-lysophosphatidylcholine as the main component.

An optional process for concentrating the phospholipids is to add acetone to the reaction mixture and filter the phospholipids.

Esterification of lyso-phosphatidylcholine was conducted under the same conditions as described for the transesterification of phosphatidylcholine.

#### **Example 4 - Chemical esterification of phosphatidylcholine**

##### *a. Esterification catalyzed by DCC and DMAP*

Both reagents, DCC (Dicyclohexylcarbodiimide) and DMAP (dimethylaminopyridine) were dried for 16 hours at room temperature. 1 g of lyso PC (47%) and 0.8 gr of DHA-FFA (70%) were combined with 0.5 gr DMAP and 0.4 g DCC in 10 ml dichloromethane. The reaction was stirred for 16 hours at room temperature, filtered through Celite™ and analyzed for fatty acid distribution of the phosphatidylcholine product (Table 2). The conversions were almost 100% as no lyso-phosphatidylcholine was left after the reaction was ended.

**Table 2: Fatty acid distribution of the phosphatidylcholine obtained by esterification of lyso-phosphatidylcholine and omega-3 fatty acids**

	<b>C16:0</b>	<b>C18:0</b>	<b>C18:1</b>	<b>C18:2</b>	<b>C18:3</b>	<b>C20:5</b>	<b>C22:6</b>
<b>Before*</b>	13	5	12	62	6		
<b>After</b>	3	2	9	28	2	7	49

\* the percentage of the fatty acid before the reaction, related to the fatty acid distribution in the phosphatidylcholine starting material (before the hydrolysis into the lyso product).

As can be seen from Table 2, almost 60% of the fatty acid content on the phosphatidylcholine is omega-3.

In order to be able to predict and determine the reaction product configuration, it is necessary to start the synthesis with the appropriate lyso isomer (1 or 2 lyso).

*b. Chemical esterification of phosphatidylcholine using acidic conditions.*

The main advantage in acidic catalytic esterifications is the fact that the equilibrium is much more suppressed and the reaction proceeds mainly to the products. In a typical procedure, 3.5 g of deoiled lysophosphatidylcholine were combined with 7 g of DHA-FFA and 0.7 g of naphthalene beta-sulphonic acid under vacuum of 0.1 mm Hg at 90 °C degree. The reaction was followed by the HPLC and the formation of the phosphatidylcholine was almost complete. At the end of the reaction, after 5 hours, the reaction was extracted with hexane and water, and the hexane layer dried with magnesium sulphate and evaporated. The product had been analyzed for its omega-3 content by hydrolysis and methylation of the fatty acid. The results are summarized in Table 3.

**Table 3**

	C16:0	C18:0	C18:1	C18:2	C18:3	C20:5	C22:6
<b>Before*</b>	13	5	12	62	6		
<b>After</b>	4	2	9	14	0.5	10	60

\* the percentage of the fatty acid before the reaction, related to the fatty acid distribution in the phosphatidylcholine starting material (before the hydrolysis to the lyso product).

As can be seen in Table 3, 70% of the fatty acid contains omega 3 fatty acids. By calculation of the saturated and unsaturated fatty acid (without taking into account the omega-3 fatty acid) before and after the reaction, it is clear that the percentage of each fatty acid did not change. This result is expected since the chemical catalysts have no preferences to any of the positions in the phospholipids backbone.

**Example 5 - Transphosphatidylation of phosphatidylcholine**

All of the products described before can be transformed to phosphatidylserine by Phospholipase D in the presence of serine. In a typical reaction 380 g of L-Serine were placed in a 2 liter reactor filled with 1140 ml phosphate buffer pH 5.6 containing 200mM CaCl<sub>2</sub>. After complete dissolution of the serine, 80gr of marine lecithin were added.

The mixture was stirred at 40°C for 1 hour, to homogeneously disperse the phospholipid in the aqueous phase.

2.1 g of enzyme (Phospholipase D) were added to the aqueous dispersion. The reaction mixture was stirred for 24 hours. The upper layer consisting of the phospholipid dispersion was removed from the reactor. The dispersion was washed four times with water to remove the excess serine.

The phosphatidylserine was washed with ethanol to remove traces of enzyme. The obtained ethanol cake of phosphatidylserine was dissolved in 1L hexane and stirred for 1 hour. Serine precipitated as a white solid. The mixture was filtered and the hexane was evaporated to obtain phosphatidylserine. For further concentration of the phosphatidylserine obtained, acetone was added and the phospholipids fraction filtered out from the solution containing mainly triglycerides. The composition of the phosphatidylserine and omega-3 before and after deoiling appear in Table 4. Final weight was 30 g.

**Table 4: Omega-3 Fatty Acid Analysis of the Phosphatidylserine-product**

	%PS	%DHA on the PS	% EPA on the PS	Total DHA (%)	Total EPA (%)
<b>Before deoiling</b>	20	15.4	27.4	9	15
<b>After deoiling</b>	40	15.4	27.4	15	26

**Example 6: Large scale reaction**

A large scale reaction of transphosphatidylation of phospholipids with PLD, for producing phosphatidylserine enriched with omega-3 or omega-6 was performed. The same reaction as described in Example 5 was performed in large scale, in a 5 liter reactor containing 600 g of DHA-enriched lecithin stirred with 1.2 Kg of L-serine dissolved in 3.5 liter buffer. 10 g of PLD enzyme (1500 U) were added to facilitate the transphosphatidylation reaction. The final phosphatidylserine concentration, after deoiling, was 38%.

The process described in the present invention is a one phase system which may be performed in large scale, in 5 liter reactors containing 600 g of lecithin, and thus it is much more advantageous than other systems previously described [e.g. Hosokawa M. *et al.* (2000) *id ibid.*]



**Claims:**

1. A method for the production of a glycerophospholipid enriched with omega-3 and/or omega-6 fatty acids through enzymatic transesterification, comprising the steps of:
  - a. incubating said glycerophospholipid with an omega-3 and/or omega-6 fatty acid source in the presence of an immobilized phospholipase which can catalyze transesterification at the *sn*-1 and/or *sn*-2 positions of the glycerol moiety, for a suitable period of time to give a glycerophospholipid enriched with said omega-3 and/or omega-6 fatty acids at the *sn*-1 and/or *sn*-2 positions;
  - b. removing and filtering the upper layer which contains the said enriched glycerophospholipid, in order to separate the glycerophospholipid from the enzyme; and
  - c. optionally de-oiling the filtrate to remove excess FFA;
2. The method according to claim 1 wherein said glycerophospholipid is any one of phosphatidylcholine, phosphatidylserine (PS), phosphatidylinositol (PI) and phosphatidylethanolamine (PE).
3. The method according to claim 1 or claim 2, wherein said omega-3 fatty acid source is at least one of docosahexaenoic acid (DHA), eicosapentaenoic acid (EPA), and alpha linolenic acid, in the form of a free fatty acid, an ethyl ester of any one of said fatty acids or a triglyceride comprising thereof .
4. The method according to any one of claims 1 to 3, wherein said omega-6 fatty acid source is at least one of gamma linoleic acid (GLA) and arachidonic acid (ARA), in the form of a free fatty acid, an ethyl ester of any one of said fatty acids or a triglyceride comprising thereof.

5. The method according to any one of claims 1 to 4, wherein said enzyme may be re-cycled.
6. A method for the production of a glycerophospholipid enriched with omega-3 and/or omega-6 fatty acids through enzymatic esterification, comprising the steps of:
  - a. incubating said glycerophospholipid in an aqueous medium with an immobilized phospholipase or in an organic solvent with a non-immobilized phospholipase, which is *sn*-1 or *sn*-2 regio-specific, to give the corresponding lyso-phospholipid;
  - b. incubating said lysophospholipid with an omega-3 and/or omega-6 fatty acid source in the presence of an immobilized phospholipase which can catalyze esterification at the *sn*-1 and/or *sn*-2 positions of the glycerol moiety, for a suitable period of time to give a glycerophospholipid enriched with said omega-3 and/or omega-6 fatty acids at the *sn*-1 and/or *sn*-2 positions;
  - c. removing and filtering the upper layer which contains the said enriched glycerophospholipid, in order to eliminate remaining enzyme; and
  - d. optionally de-oiling the filtrate with to remove excess FFA.
7. The method according to claim 6 wherein said glycerophospholipid is any one of phosphatidylcholine, phosphatidylserine, phosphatidylinositol and phosphatidylethanolamine.
8. The method according to any one of claims 6 or 7, wherein said omega-3 fatty acid source is at least one of DHA, EPA and alpha linolenic acid, in the form of a free fatty acid, an ethyl ester of any one of said fatty acids or a triglyceride comprising thereof.

9. The method according to any one of claims 6 to 8, wherein said omega-6 fatty acid source is at least one of GLA and ARA, in the form of a free fatty acid, an ethyl ester of any one of said fatty acids or a triglyceride comprising thereof.
10. The method according to any one of claims 1 to 9, wherein said immobilized enzyme is any one of PLA<sub>1</sub> or PLA<sub>2</sub>.
11. The method according to any one of claims 6 to 10, wherein when said glycerophospholipid is in an aqueous medium the phospholipase used is PLA<sub>2</sub>.
12. The method according to any one of claims 6 to 10, wherein when said glycerophospholipid is in an organic solvent the phospholipase used is PLA<sub>1</sub>.
13. A method for the chemical synthesis of a glycerophospholipid enriched with omega-3 and/or omega-6 fatty acids from its corresponding lyso-glycerophospholipid, comprising the steps of:
- dissolving said lyso-glycerophospholipid and said omega-3 and/or omega-6 fatty acid source in a suitable organic solvent, preferably dichloromethane;
  - incubating the mixture obtained in step (a) with coupling reagents, preferably N,N-dicyclohexylcarbodiimide (DCC) and 4-dimethylaminopyridine (DMAP) for a suitable period of time while stirring;
  - optionally, analyzing the product through HPLC; and
  - filtering the product, preferably with Celite<sup>R</sup>.
14. A method for the chemical synthesis of a glycerophospholipid enriched with omega-3 and/or omega-6 fatty acids from its corresponding lyso-

glycerophospholipid, comprising the steps of:

- a. incubating a mixture of said lyso-glycerophospholipid and said omega-3 and/or omega-6 fatty acid source under acidic conditions, for example in the presence of naphthalene beta sulphonic acid, wherein said mixture is optionally dissolved in an organic solvent, for a suitable period of time while stirring;
- b. extracting the phospholipids with a suitable organic solvent; and
- c. evaporating the solvent.

15. The method according to any one of claims 13 and 14, wherein said glycerophospholipid is any one of phosphatidylcholine and phosphatidylinositol.

16. The method according to any one of claims 13 to 15, wherein said omega-3 fatty acid source is at least one of DHA, EPA and alpha-linolenic acid, in the form of a free fatty acid, an ethyl ester of any one of said fatty acids, or a triglyceride comprising thereof.

17. The method according to any one of claims 13 to 15, wherein said omega-6 fatty acid source is at least one of GLA and ARA, in the form of a free fatty acid, an ethyl ester of any one of said fatty acids, or a triglyceride comprising thereof.

18. A method for the production of a phosphatidylserine preparation enriched with omega-3 and/or omega-6 fatty acids, comprising the steps of:

- a. incubating an aqueous mixture of L-serine with lecithin which is rich with omega-3 or omega-6 fatty acid residues in the presence of a phospholipase D, for a suitable period of time to give phosphatidylserine;
- b. removing and filtering the upper layer which contains the

phosphatidylserine;

- c. washing the filtrate with water to remove excess serine;
- d. washing the resulting phosphatidylserine with ethanol to remove any traces of phospholipase; and
- e. drying the washed phosphatidylserine wherein the resulting phosphatidylserine is enriched with omega-3 or omega-6 fatty acid residues which are covalently bound to the phospholipid backbone.

19. The method of claim 18, wherein said lecithin is derived from a marine animal.

20. The method of claim 18, wherein said phosphatidylcholine is produced by any one of the methods of claims 1 to 16.

21. The method according to any one of claims 23 to 25, wherein said omega-3 or omega-6 fatty acids are selected from the group consisting of EPA, DHA, GLA, arachidonic acid, and alpha linolenic acid .

22. The method of any one of claims 18 to 21, wherein said phospholipase is immobilized on an insoluble matrix and is optionally surfactant coated.

23. A phosphatidylserine preparation enriched with omega-3 or omega-6 acyl moieties prepared by the method of any one of claims 1 to 12 and 18 to 22.

24. The phosphatidylserine preparation of claim 23, further comprising at least one additional functional ingredient, such as lecithin and/or at least one non-functional nutritionally acceptable ingredient.

25. The phosphatidylserine preparation of any one of claims 23 or 24, for use as a nutraceutical food and/or drug additive.
26. A food article comprising the phosphatidylserine preparation of any one of claims 23 to 25.
27. A pharmaceutical composition comprising as active agent the phosphatidylserine preparation of any one of claims 23 to 25.
28. A capsule containing the phosphatidylserine preparation of any one of claims 23 to 25, wherein said capsule is preferably a gelatin capsule.
29. The stabilized phosphatidylserine preparation of any one of claims 23 to 25, for use as an enhancer of cognitive performance and learning ability.
30. The stabilized phosphatidylserine preparation of any one of claims 23 to 25, for use in preventing memory loss, particularly age-related memory loss.
31. A phosphatidylcholine preparation enriched with omega-3 or omega-6 acyl moieties, prepared by any one of the methods of claims 1 to 17.
32. The phosphatidylcholine preparation of claim 31, further comprising at least one additional functional ingredient and/or at least one non-functional nutritionally acceptable ingredient.
33. The phosphatidylcholine preparation of any one of claims 31 or 32, for use as a nutraceutical food and/or drug additive.

34. A food article comprising the phosphatidylcholine preparation of any one of claims 31 to 33.
35. A pharmaceutical composition comprising as active agent the phosphatidylcholine preparation of any one of claims 31 to 33.
36. A capsule containing the phosphatidylcholine preparation of any one of claims 31 to 33, wherein said capsule is preferably a gelatin capsule.
37. A phosphatidylinositol preparation enriched with omega-3 or omega-6 acyl moieties, prepared by any one of the methods of claims 1 to 17.
38. The phosphatidylinositol preparation of claim 37, further comprising at least one additional functional ingredient, such as lecithin and/or at least one non-functional nutritionally acceptable ingredient.
39. The phosphatidylinositol preparation of any one of claims 37 or 38, for use as a nutraceutical food and/or drug additive.
40. A food article comprising the phosphatidylinositol preparation of any one of claims 37 to 39.
41. A pharmaceutical composition comprising as active agent the phosphatidylinositol preparation of any one of claims 37 to 39.
42. A capsule containing the phosphatidylinositol preparation of any one of claims 37 to 39, wherein said capsule is preferably a gelatin capsule.

43. A phosphatidylethanolamine preparation enriched with omega-3 or omega-6 acyl moieties, prepared by any one of the methods of claims 1 to 12.

44. The phosphatidylethanolamine preparation of claim 43, further comprising at least one additional functional ingredient, such as lecithin and/or at least one non-functional nutritionally acceptable ingredient.

45. The phosphatidylethanolamine preparation of any one of claims 43 or 44, for use as a nutraceutical food and/or drug additive.

46. A food article comprising the phosphatidylethanolamine preparation of any one of claims 43 to 45.

47. A pharmaceutical composition comprising as active agent the phosphatidylethanolamine preparation of any one of claims 43 to 45.

48. A capsule containing the phosphatidylethanolamine preparation of any one of claims 43 to 45, wherein said capsule is preferably a gelatin capsule.

49. A food article comprising a mixture of at least two of the glycerophospholipids produced by any one of the methods of claims 1 to 22.

50. A food article comprising a mixture of at least two glycerol-phospholipids selected from the group comprised of: a phosphatidylserine preparation according to any one of claims 23 to 25, a phosphatidylcholine preparation according to any one of claims 31 to 33, a phosphatidylinositol preparation according to any one of claims 37 to 39, and a phosphatidylethanolamine preparation according to any one of claims 43 to 45.



51. A pharmaceutical composition comprising as active ingredient a mixture of at least two of the glycerophospholipids produced by any one of the methods of claims 1 to 22.

52. A pharmaceutical composition comprising as active ingredient at least two glycerophospholipids selected from the group comprised of: a phosphatidylserine preparation according to any one of claims 23 to 25, a phosphatidylcholine preparation according to any one of claims 31 to 33, a phosphatidylinositol preparation according to any one of claims 37 to 39, and a phosphatidylethanolamine preparation according to any one of claims 43 to 45.

53. A capsule containing a mixture of at least two of the glycerophospholipids produced by any one of the methods of claims 1 to 22.

54. A capsule containing a mixture of at least two glycerophospholipids selected from the group comprised of: a phosphatidylserine preparation according to any one of claims 23 to 25, a phosphatidylcholine preparation according to any one of claims 31 to 33, a phosphatidylinositol preparation according to any one of claims 37 to 39, and a phosphatidylethanolamine preparation according to any one of claims 43 to 45.

(19) World Intellectual Property Organization  
International Bureau



(43) International Publication Date  
19 July 2007 (19.07.2007)

PCT

(10) International Publication Number  
WO 2007/080514 A2

- (51) International Patent Classification:  
C11B 1/10 (2006.01) C11B 3/00 (2006.01)
- (21) International Application Number:  
PCT/IB2007/000098
- (22) International Filing Date: 15 January 2007 (15.01.2007)
- (25) Filing Language: English
- (26) Publication Language: English
- (30) Priority Data:  
PA 2006 00057 13 January 2006 (13.01.2006) DK  
60/758,956 13 January 2006 (13.01.2006) US
- (71) Applicants (for all designated States except US): KRILL  
A/S [DK/DK]; c/o Novi A/S, Bredgade 56, DK-1260  
København K (DK). ALFA LAVAL COPENHAGEN  
A/S [DK/DK]; Oil and Protein Technology, Maskinvej 5,  
DK-2860 Søborg (DK).
- (72) Inventors; and
- (75) Inventors/Applicants (for US only): LARSEN, Peter,  
Mose [DK/DK]; Valmuearken 16, DK-5260 Odense  
S (DK). FEY, Stephen, John [GB/DK]; Middelfartvej  
469, DK-5491 Blommenslyst (GB). BREUNING, Jesper  
[DK/DK]; Mikkelborg Park 30, 2.tv, DK-2970 Hørsholm  
(DK). LUDVIGSEN, Bent [DK/DK]; Valmuehaven 53,  
DK-2765 Smørum (DK).
- (74) Agent: BUDDE, SCHOU & OSTENFELD A/S; Vester  
Søgade 10, DK-1601 Copenhagen V (DK).

- (81) Designated States (unless otherwise indicated, for every  
kind of national protection available): AE, AG, AL, AM,  
AT, AU, AZ, BA, BB, BG, BR, BW, BY, BZ, CA, CH, CN,  
CO, CR, CU, CZ, DE, DK, DM, DZ, EC, EE, EG, ES, FI,  
GB, GD, GE, GH, GM, GT, HN, HR, HU, ID, IL, IN, IS,  
JP, KE, KG, KM, KN, KP, KR, KZ, LA, LC, LK, LR, LS,  
LT, LU, LV, LY, MA, MD, MG, MK, MN, MW, MX, MY,  
MZ, NA, NG, NI, NO, NZ, OM, PG, PH, PL, PT, RO, RS,  
RU, SC, SD, SE, SG, SK, SL, SM, SV, SY, TJ, TM, TN,  
TR, TT, TZ, UA, UG, US, UZ, VC, VN, ZA, ZM, ZW.
- (84) Designated States (unless otherwise indicated, for every  
kind of regional protection available): ARIPO (BW, GH,  
GM, KE, LS, MW, MZ, NA, SD, SL, SZ, TZ, UG, ZM,  
ZW), Eurasian (AM, AZ, BY, KG, KZ, MD, RU, TJ, TM),  
European (AT, BE, BG, CH, CY, CZ, DE, DK, EE, ES, FI,  
FR, GB, GR, HU, IE, IS, IT, LT, LU, LV, MC, NL, PL, PT,  
RO, SE, SI, SK, TR), OAPI (BF, BJ, CF, CG, CI, CM, GA,  
GN, GQ, GW, ML, MR, NE, SN, TD, TG).

**Declarations under Rule 4.17:**

- as to applicant's entitlement to apply for and be granted a  
patent (Rule 4.17(ii))
- as to the applicant's entitlement to claim the priority of the  
earlier application (Rule 4.17(iii))

**Published:**

- without international search report and to be republished  
upon receipt of that report

[Continued on next page]

(54) Title: A METHOD FOR THE EXTRACTION OF LIPID FRACTIONS FROM KRILL

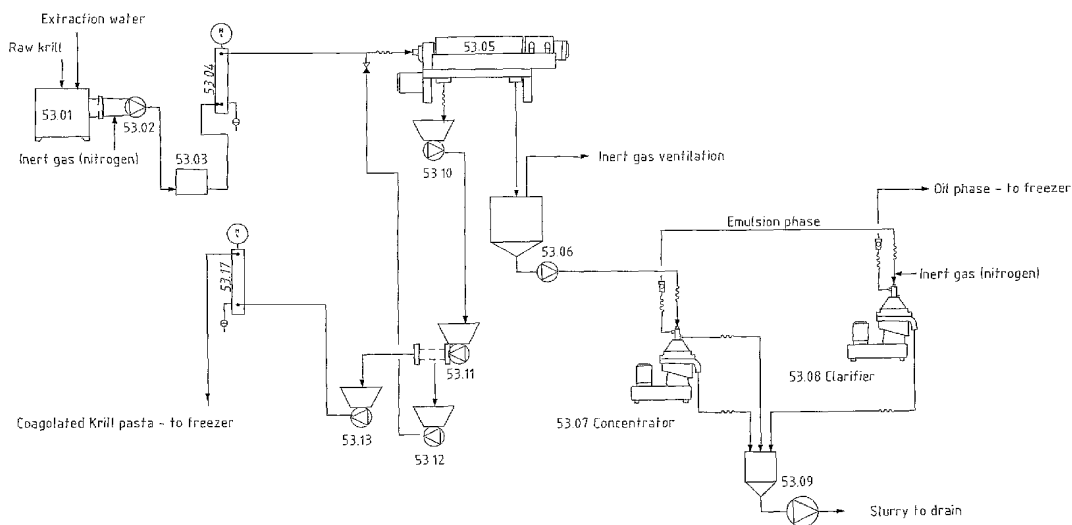

(57) Abstract: According to the present disclosure there is provided a method for extracting lipid fractions from krill, wherein freshly captured krill is ground to produce a slurry, which is gently heated to a temperature below 90°C for less than 45 minutes, whereafter the liquid into an aqueous phase and a krill oil phase from which a krill oil extract is derived without the use of organic solvents. Moreover there is also provided a pharmaceutical composition for the treatment of thrombosis in a patient comprising an effective amount of a krill oil extract.

WO 2007/080514 A2



---

*For two-letter codes and other abbreviations, refer to the "Guidance Notes on Codes and Abbreviations" appearing at the beginning of each regular issue of the PCT Gazette.*

## A METHOD FOR THE EXTRACTION OF LIPID FRACTIONS FROM KRILL

### FIELD OF THE INVENTION

5 This invention relates to a novel method and equipment for extracting lipid fractions from marine and aquatic animals such as krill, Calanus, fish and sea mammals, which method does not utilize high temperatures and/or organic solvent and thus preserves valuable components in the extracted animal material.

### 10 BACKGROUND OF THE INVENTION

Marine and aquatic animal oils and fractions thereof contain various therapeutic agents. For example, it is reported that various marine and aquatic animal oils have anti-inflammatory properties. Marine and aquatic animal oils are also reported as  
15 helpful in reducing the incidence of cardiovascular disease. Also, some marine and aquatic animal oils are reported as suppressing the development of certain forms of lupus and renal diseases. As a further example, krill may be used as a source of enzymes for debridement of ulcers and wounds or to facilitate food digestion. Also marine and aquatic oils contain various antioxidants, which may have potential  
20 therapeutic properties.

Krill is the common name for small, shrimp-like crustaceans that swarm in dense shoals, especially in Antarctic waters. It is one of the most important food sources (especially protein) for fish, some kind of birds and especially for baleen whales. Krill is  
25 also a good source of omega-3 fatty acid, which are well known for their beneficial effects on human health.

It is known in the art to use krill and/or marine enzymes for the treatment of a great variety of diseases in human and animals such as infections, inflammations, cancers,  
30 HIV/AIDS, pain, polyps, warts, haemorrhoids, plaque, wrinkles, thin hair, allergic itch, anti-adhesion, eye disease, acne, cystic fibrosis and immune disorders including autoimmune diseases and cancer.

It is also known in the art that krill and/or marine oils may be used for the treatment of  
35 autoimmune lupus and other autoimmune diseases and can also be used for treating cardiovascular diseases.

Various methods for extracting marine and aquatic animal oils are known. For example, it is known to extract fish oil using organic solvents such as hexane and ethanol. It is also known to measure the fat content in fish muscle tissue using solvents such as acetone.

5

U.S. Pat. No. 4,331,695 describes a method using pressurized solvents which are gaseous at room temperature, such as propane, butane or hexane. The extraction is performed at preferred temperatures of 15 to 80° C on shredded vegetable or finely divided animal products. The extracted oils are then made to precipitate under high  
10 pressure and elevated temperatures of 50 to 200° C. However, hexane is a poor extraction solvent for marine animals such as krill. Furthermore, the high temperatures used in the precipitation step negatively alters the lipids.

Canadian Patent Application 2,115,571 describes a method for extracting oils from  
15 various brown and red algae species. The method provides, for example, extraction using nearly pure ethanol for 40 hours.

U.S. Pat. No. 5,006,281 describes a method for extracting oil from marine and aquatic animals such as fish. The marine and aquatic animal is first treated with an antioxidant  
20 compound, finely divided and centrifuged to separate the oil phase from the aqueous phase and solid phase. The oil phase is then further treated with antioxidant to remove undesirable odour or taste.

Canadian Patent 1,098,900 describes a method for extracting oils from krill. The  
25 method involves emulsifying fresh or defrosted krill in an aqueous medium. The oil fraction is recovered by centrifugation.

Folch published in J. Biol. Chem. 226: 497-509 in 1957 an article entitled "A simple method for the isolation and purification of total lipids from animal tissues" proposes an  
30 extraction method using chloroform and methanol. This method is not commercially feasible because of the toxicity of the solvents involved.

However, most of the krill oil extract used for these treatments has only conserved its  
35 omega-3 fatty acids as active ingredients, which is a very small part of all the active ingredients of the krill itself. This fact dramatically reduces the potential of the krill and/or marine oil as a treatment for human diseases.

There is an increasing demand for treatments using products derived from a natural source, therefore, it would be highly desirable to be provided with a krill and/or marine extract having an enhanced potential for prevention and/or treatment and/or management of disease.

5

US Patent 6,800,299 discloses a method for extracting lipid fractions from marine and aquatic animal material by acetone extraction. The resulting non-soluble and particulate fraction is preferably subjected to an additional solvent extraction with an alcohol, preferably ethanol, isopropanol or t-butanol or an ester of acetic acid, preferably ethyl acetate to achieve extraction of the remaining soluble lipid fraction from the marine and aquatic animal material. The remaining non-soluble particulate content is also recovered since it is enriched in proteins and contains a useful amount of active enzymes. Also provided herein is a krill extract. It is reported that these marine and aquatic animal oils have anti-inflammatory properties. Marine and aquatic animal oils are also reported as helpful in reducing the incidence of cardiovascular disease. As a further example the patent mentions that krill may be used as a source of enzymes for debridement of ulcers and wounds or to facilitate food digestion.

WO02102394A2 discloses a process for the preparation of a krill oil extract, which process includes the steps of placing krill and/or marine material in a ketone solvent to achieve extraction of the soluble lipid fraction from the krill; then separating the liquid and solid contents; then recovering a first lipid rich fraction from the liquid contents by evaporation of the solvent present in the liquid contents; then placing the solid contents in an organic solvent to achieve extraction of the remaining soluble lipid fraction from the krill material; then separating the liquid and solid contents; then recovering a second lipid rich fraction by evaporation of the solvent from the liquid contents; and finally recovering the solid contents. Diseases that can be treated and/or prevented by using the krill oil extract are *inter alia* cardiovascular diseases. In this respect it is mentioned that the Krill oil has been shown to decrease cholesterol *in vivo*, inhibit platelet adhesion and plaque formation and reduce vascular endothelial inflammation in a patient.

Canadian Patent 1,098,900 describes a method for extracting oils and producing proteins from krill comprising emulsification of lipids of krill in an aqueous medium, separation of the emulsion of lipids from the krill mass, alkaline extraction of proteins from the krill mass, separation of the protein extract produced from chitin integuments,

and finally separation of protein from the protein extract. The document mentions that krill is a prospective source of food and other practically useful products such as chitin and lipids which find wide application in different branches, such as food industry, textile, and medicine.

5

WO03011873A2 discloses a phospholipid extract from *inter alia* krill, with therapeutic properties, such as those essential for the maintenance of a healthy cardiovascular system. The phospholipid extract comprises a variety of phospholipids, fatty acid, metals and a novel flavonoid. The method for the preparation of this extract is generally carried out by a method similar to the one described in US Patent 6,800,299 (see above; and utilises organic solvents), which procedure produces two successive lipid fractions and a dry residue enriched in protein, including active enzymes.

WO8401715A1 and WO09533471A1 disclose various aspects of so-called krill enzymes, which are water-soluble. It is mentioned that in krill a mixture of different enzymes exists, such as e.g. proteinases (with acidic and neutral-to-alkaline pH-optima), peptidases (exo- and endopeptidases), lipases, phospholipases, amylases and other carbohydrate degrading enzymes, phosphatases nucleases, nucleotidases and esterases. The proteolytic (trypsin-like) activity existing in a water extract from krill has been studied and described. WO09533471A1 disclose the use of one or more krill enzymes for the manufacture of an intravasal pharmaceutical composition for thrombolysis in a mammal host.

As appears from the above cited prior art current available technology for production of marine oils are usually based on a thermal process such as those used in the fish meal process, and in some particular cases on a solvent extraction method, such as hexane extraction or similar highly effective solvent. However the solvent method which is necessary to get the optimum oil quality, cannot be implemented on a fishing vessel. In addition the most active solvents are not suitable for pharmaceutical processing.

Thus, the prior art disclose extraction methods involving the use of organic solvents or high temperatures or both – none of which are optimal from the point of view of the biological activity of the oil.

35

## SUMMARY OF THE INVENTION

In accordance with the present invention there is provided a novel marine lipid extract obtainable by a process with following characteristics:

5

- Processing temperature below 60 °C, and more precisely with an optimum processing just under 27 °C.
- Mechanical and physical disruption of the lipid cell membrane to facilitate low temperature extraction.
- 10 • Processing takes place under inert gas to prevent oxidation or denaturation of fat and proteins
- Intermediate processing tanks kept at a minimum level to reduce residence time.
- The oil is frozen immediately after recovery to stabilize it.

15

In accordance with the present invention, there is provided a novel lipid extract obtainable by the process of the present invention. The novel lipid extract is derived from marine raw materials found in any marine environment around the world, for  
20 example, for krill, the Antarctic ocean (*euphasia superba*), the Pacific ocean (*euphasia pacifica*), the Atlantic ocean, the Indian ocean, in particular coastal regions of Mauritius Island and/or Reunion Island of Madagascar, Canadian West Coast, Japanese Coast, St-Lawrence Gulf and Fundy Bay, but other sources of marine raw materials obviously exist.

25

The present invention describes a method for extracting lipid fractions from marine raw materials, said method comprising the steps of:

- Feeding freshly captured raw material into a grinder to produce a slurry comprising particles of less than 5 mm prior to further processing
- 30 • Ultra sound disintegration of cell membranes to expose the marine oil without heating the slurry appreciably
- Heating the slurry gently to a temperature below 60°C, preferably between 25°C and 27°C
- Separating the solid material from the liquid
- 35 • Separating the liquid into an aqueous phase and a lipid phase



wherein the extraction does not involve the use of organic solvents or temperatures above 60°C, and each process step takes place in an inert gas environment.

5 Additionally according to the present invention there is provided a apparatus for performing the process of the invention.

#### DETAILED DESCRIPTION OF THE INVENTION

10 Specifically, according to a first aspect of the present invention there is provided a method for extracting lipid fractions from marine raw materials, such as krill, said method comprising the steps of:

- supplying an inert gas (e.g. nitrogen) to reduce or exclude oxygen
- placing the raw material in a grinder to mechanically disrupt fat cell  
15 membranes
- ultra sound sonication of the grinded material to facilitate extraction of the soluble lipid fraction;
- separating the liquid and solid components;
- recovering a lipid rich fraction from the liquid component;

20 wherein the extraction is performed at a temperature below 60 °C, preferably below 30°C, and does not involve the use of organic solvents.

Specifically, according to a second aspect of the present invention there is provided an apparatus for carrying out the method of the present invention comprising

- 25 • means for grinding and ultra sound sonication of the marine raw material,
- means for extracting the majority of the liquid fraction of the material,
- means for recovering the light phase of the liquid fraction,
- means for recovering a concentrated marine lipid,
- means for accumulating remaining solid components and subsequently pressing  
30 residue liquid therefrom,
- means for returning the additional extracted liquid to means for recovering the additional lipid extract

Example 1

Preparation of the lipid extract of the present invention.

5

The invented process may be performed with an apparatus comprising one or more of components referred to in Figure 1, and in particular:

- |    |        |  |
|----|--------|--|
| 10 | 53.01. | Grinding of the product and addition of extraction water – Max. 5 mm holeplate grinder.                      |
|    | 53.02. | Feed pump for ultra sound sonicator, Contherm and decanter.  |
|    | 53.03. | Heavy duty ultrasound sonication to disintegrate cell membrane.  |
| 15 | 53.04. | Contherm scraped heat exchanger - Temperature condition by heating to maximum 30 °C                          |
|    | 53.05. | Decanter centrifuge for extracting liquid.   |
|    | 53.06. | Feed pump for separator  |
|    | 53.07. | Concentrator centrifuge to recover emulsified fat phase  |
| 20 | 53.08. | Clarifying centrifuge to recover the clean marine oil  |
|    | 53.09. | Slurry pump for heavy and sludge phases from centrifuges   |
|    | 53.10. | Solid phase pump   |
|    | 53.11. | High pressure dewatering press – applying a pressure of minimum 15 bar to press residual liquid from product |
| 25 | 53.12. | Pump to return additional extracted liquid to a process step prior to the decanter                           |
|    | 53.13. | Press cake pump  |
|    | 53.14. | Contherm pasturising the press cake before freezing.   |

30 A preferred embodiment comprises at least:

- means for grinding (53.01) and ultra sound sonication of (53.03) the marine raw material,
- means for extracting the majority of the liquid fraction of the material (53.05),
- 35 • means for recovering the light phase of the liquid fraction (53.07),
- means for recovering a concentrated marine lipid (53.08),

- means for accumulating (53.09, 53.10) remaining solid components and subsequently pressing residue liquid therefrom (53.11), and
- means for returning (53.12) the additional extracted liquid to means for recovering the additional lipid extract (53.07).

5

Preferably the entire process is carried out under an inert atmosphere, such as nitrogen or helium.

The inventors have also envisaged that the present invention may be carried out by  
10 applying supercritical CO<sub>2</sub> extraction.

**CLAIMS**

1. A method for extracting lipid fractions from marine raw materials, such as krill, said method comprising the steps of:
- 5       • placing the raw material in a grinder to mechanically disrupt fat cell membranes;
- Ultra sound sonication of the ground material to facilitate extraction of the soluble lipid fraction;
- separating the liquid and solid components;
- 10       • recovering a lipid rich fraction from the liquid component;
- recovering a protein rich cake;
- wherein the extraction is performed at a temperature below 60 °C and does not involve the use of organic solvents.
- 15 2. A method as in claim 1, wherein separating the liquid and solid components is effected by techniques selected from the group consisting of mechanical pressure, filtration, centrifugation and sedimentation.
3. A method as in claim 1, wherein the extraction is performed at a temperature
- 20 between 25°C and 27°C.
4. A method as in claim 1, wherein the extraction is performed under an inert atmosphere.
- 25 5. A marine lipid extract obtainable by a method according to any one of claims 1 to 4.
6. A method according to any one of claims 1 to 4, wherein the marine raw material is krill.
- 30 7. A krill oil extract obtainable by a method according to claim 6.
8. An apparatus for carrying out the method of any one of the claims 1 to 4 comprising
- means for grinding (53.01) and ultra sound sonication of (53.03) the marine raw material,
- 35       • means for extracting the majority of the liquid fraction of the material (53.05),
- means for recovering the light phase of the liquid fraction (53.07),

- means for recovering a concentrated marine lipid (53.08)
  - means for accumulating (53.09, 53.10) remaining solid components and subsequently pressing residue liquid therefrom (53.11), and
  - means for returning (53.12) the additional extracted liquid to means for recovering
- 5 the additional lipid extract (53.07).

9. An apparatus for carrying out the method of any one of the claims 1 to 4 comprising:

- Feed pump for ultra sound sonicator, Contherm and decanter,
- 10 • Heavy duty ultrasound sonication to disintegrate cell membrane,
- Contherm scraped heat exchanger - Temperature condition by heating to maximum 30 °C,
- Decanter centrifuge for extracting liquid,
- Feed pump for separator,
- 15 • Concentrator centrifuge to recover emulsified fat phase,
- Clarifying centrifuge to recover the clean marine oil,
- Slurry pump for heavy and sludge phases from centrifuges,
- Solid phase pump,
- High pressure dewatering press – applying a pressure of minimum 15 bar to press
- 20 residual liquid from product,
- Pump to return additional extracted liquid to a process step prior to the decanter,
- Press cake pump, and
- Contherm pasturising the press cake before freezing.

25 10. An apparatus according to claim 8 or 9, wherein the method is carried out under an inert atmosphere.

Figure 1

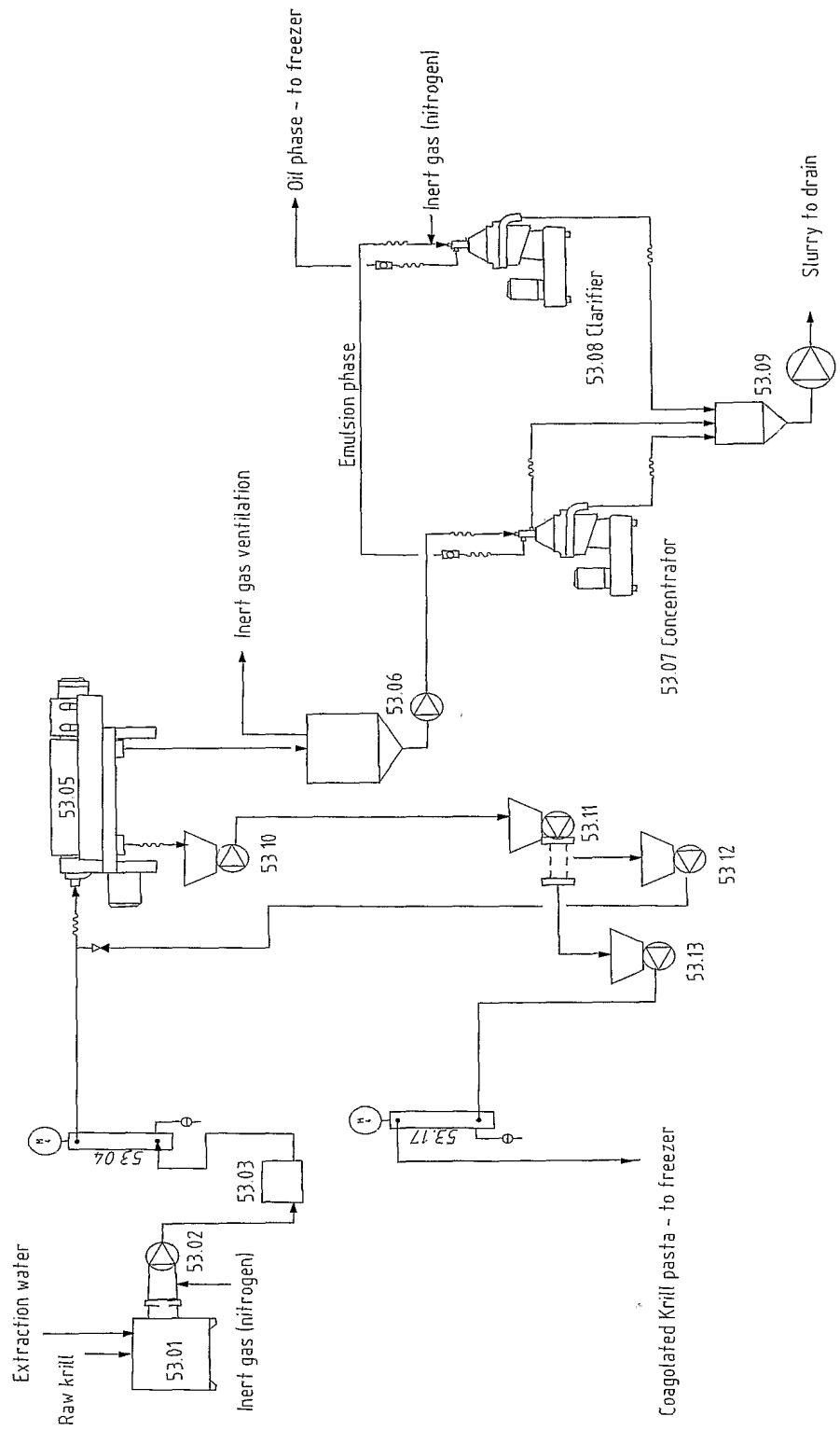

(19) World Intellectual Property Organization  
International Bureau



(43) International Publication Date  
19 July 2007 (19.07.2007)

PCT

(10) International Publication Number  
**WO 2007/080515 A1**

(51) International Patent Classification:

A61P 7/02 (2006.01) C11B 1/14 (2006.01)  
A61P 9/10 (2006.01) A23L 1/30 (2006.01)  
A61P 9/14 (2006.01) A23D 9/00 (2006.01)  
C11B 1/02 (2006.01)

(21) International Application Number:

PCT/IB2007/000099

(22) International Filing Date: 15 January 2007 (15.01.2007)

(25) Filing Language: English

(26) Publication Language: English

(30) Priority Data:

PA 2006 00058 13 January 2006 (13.01.2006) DK  
US 60/758,957 13 January 2006 (13.01.2006) US  
US 60/777,630 28 February 2006 (28.02.2006) US

(71) Applicant (for all designated States except US): **AKER BIOMARINE ASA** [NO/NO]; Fjordalléen 16, P.O. Box 1423 Vika, N-0115 Oslo (NO).

(72) Inventors; and

(75) Inventors/Applicants (for US only): **LARSEN, Peter, Mose** [DK/DK]; Valmueemarken 16, DK-5260 Odense S (DK). **FEY, Stephen, John** [GB/DK]; Middelfartvej 469, DK-5491 Blommenslyst (GB).

(74) Agent: **BUDE, SCHOU & OSTENFELD A/S**; Vester Søgade 10, DK-1601 Copenhagen V (DK).

(81) Designated States (unless otherwise indicated, for every kind of national protection available): AE, AG, AL, AM, AT, AU, AZ, BA, BB, BG, BR, BW, BY, BZ, CA, CH, CN, CO, CR, CU, CZ, DE, DK, DM, DZ, EC, EE, EG, ES, FI, GB, GD, GE, GH, GM, GT, HN, HR, HU, ID, IL, IN, IS, JP, KE, KG, KM, KN, KP, KR, KZ, LA, LC, LK, LR, LS, LT, LU, LV, LY, MA, MD, MG, MK, MN, MW, MX, MY, MZ, NA, NG, NI, NO, NZ, OM, PG, PH, PL, PT, RO, RS, RU, SC, SD, SE, SG, SK, SL, SM, SV, SY, TJ, TM, TN, TR, TT, TZ, UA, UG, US, UZ, VC, VN, ZA, ZM, ZW.

(84) Designated States (unless otherwise indicated, for every kind of regional protection available): ARIPO (BW, GH, GM, KE, LS, MW, MZ, NA, SD, SL, SZ, TZ, UG, ZM, ZW), Eurasian (AM, AZ, BY, KG, KZ, MD, RU, TJ, TM), European (AT, BE, BG, CH, CY, CZ, DE, DK, EE, ES, FI, FR, GB, GR, HU, IE, IS, IT, LT, LU, LV, MC, NL, PL, PT, RO, SE, SI, SK, TR), OAPI (BF, BJ, CF, CG, CI, CM, GA, GN, GQ, GW, ML, MR, NE, SN, TD, TG).

Declarations under Rule 4.17:

— as to applicant's entitlement to apply for and be granted a patent (Rule 4.17(ii))

[Continued on next page]

(54) Title: THROMBOSIS PREVENTING KRILL EXTRACT

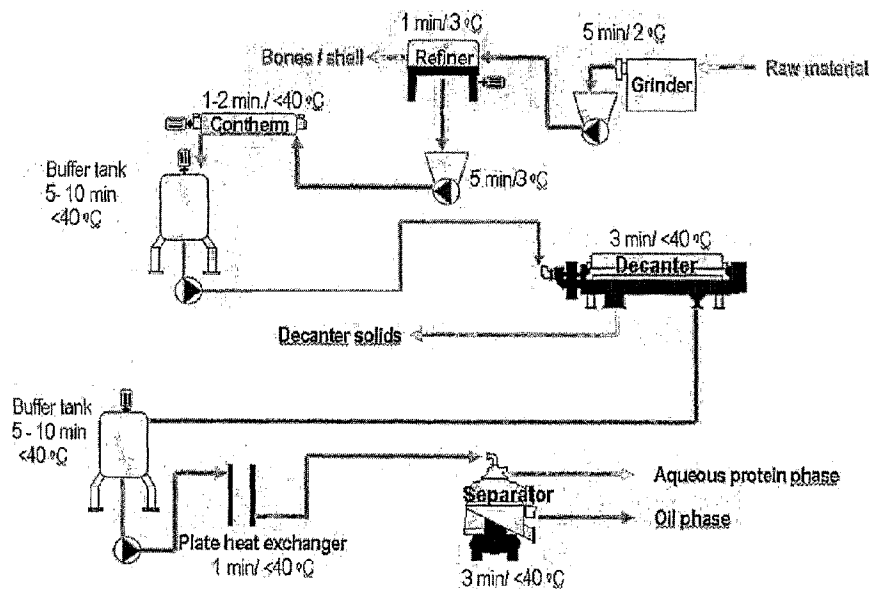

(57) Abstract: In accordance with the present disclosure there is provided a novel marine lipid extract obtainable by a process wherein processing temperature below 60 °C; mechanical and physical disruption of the lipid cell membrane to facilitate low temperature extraction; processing takes place under inert gas to prevent oxidation or denaturation of fat and proteins; intermediate processing tanks kept at a minimum level to reduce residence time; and the oil is frozen immediately after recovery to stabilize it.



WO 2007/080515 A1



- *as to the applicant's entitlement to claim the priority of the earlier application (Rule 4.17(iii))*

*For two-letter codes and other abbreviations, refer to the "Guidance Notes on Codes and Abbreviations" appearing at the beginning of each regular issue of the PCT Gazette.*

**Published:**

- *with international search report*
- *before the expiration of the time limit for amending the claims and to be republished in the event of receipt of amendments*



## THROMBOSIS PREVENTING KRILL EXTRACT

### FIELD OF THE INVENTION

This invention relates to novel extracts derived from krill, which can prevent and/or treat thrombosis. This invention also relates to a method for the extraction of lipid fractions from krill in order to obtain the novel extracts of the present invention. More specifically, the invention relates to an improved method of extracting lipid fractions without using high temperatures and/or organic solvents.

### BACKGROUND OF THE INVENTION

Krill is the common name for small, shrimp-like crustaceans that swarm in dense shoals, especially in Antarctic waters. It is one of the most important food sources (especially protein) for fish, some kind of birds and especially for baleen. Krill is also a good source of omega-3 fatty acids, which are well known for their beneficial effects on human health.

It is known in the art to use krill and/or marine enzymes for the treatment of a great variety of diseases in human and animals such as infections, inflammations, cancers, HIV/AIDS, pain, polyps, warts, hemorrhoids, plaque, wrinkles, thin hair, allergic itch, anti-adhesion, eye disease, acne, cystic fibrosis and immune disorders including autoimmune diseases and cancer.

It is also known in the art that krill and/or marine oils may be used for the treatment of autoimmune murine lupus and other autoimmune diseases and can also be used for treating cardiovascular diseases.

However, most of the krill oil extracts used for these treatments has only conserved its omega-3 fatty acids as active ingredients, which is a very small part of all the active ingredients of the krill itself. This fact dramatically reduces the potential of the krill and/or marine oil as a treatment for these diseases.

There is an increasing demand for treatments using products derived from a natural source, therefore, it would be highly desirable to be provided with a krill and/or marine extract having an enhanced potential for prevention and/or treatment and/or management of disease.

US Patent 6,800,299 discloses a method for extracting lipid fractions from marine and aquatic animal material by acetone extraction. The resulting non-soluble and particulate fraction is preferably subjected to an additional solvent extraction with an alcohol, preferably ethanol,

isopropanol or t-butanol or an ester of acetic acid, preferably ethyl acetate to achieve extraction of the remaining soluble lipid fraction from the marine and aquatic animal material. The remaining non-soluble particulate content is also recovered since it is enriched in proteins and contains a useful amount of active enzymes. Also provided herein is a krill extract. It is reported that these marine and aquatic animal oils have anti-inflammatory properties. Marine and aquatic animal oils are also reported as helpful in reducing the incidence of cardiovascular disease. As a further example the patent mentions that krill may be used as a source of enzymes for debridement of ulcers and wounds or to facilitate food digestion.

WO02102394A2 discloses a process for the preparation of a krill oil extract, which process includes the steps of placing krill and/or marine material in a ketone solvent to achieve extraction of the soluble lipid fraction from the krill; then separating the liquid and solid contents; then recovering a first lipid rich fraction from the liquid contents by evaporation of the solvent present in the liquid contents; then placing the solid contents in an organic solvent to achieve extraction of the remaining soluble lipid fraction from the krill material; then separating the liquid and solid contents; then recovering a second lipid rich fraction by evaporation of the solvent from the liquid contents; and finally recovering the solid contents. Diseases that can be treated and/or prevented by using the krill oil extract are *inter alia* cardiovascular diseases. In this respect it is mentioned that the Krill oil has been shown to decrease cholesterol *in vivo*, inhibit platelet adhesion and plaque formation and reduce vascular endothelial inflammation in a patient.

Canadian Patent 1,098,900 describes a method for extracting oils and producing proteins from krill comprising emulsification of lipids of krill in an aqueous medium, separation of the emulsion of lipids from the krill mass, alkaline extraction of proteins from the krill mass, separation of the protein extract produced from chitin integuments, and finally separation of protein from the protein extract. The document mentions that krill is a prospective source of food and other practically useful products such as chitin and lipids which find wide application in different branches, such as food industry, textile, and medicine.

WO03011873A2 discloses a phospholipid extract from *inter alia* krill, with therapeutic properties, such as those essential for the maintenance of a healthy cardiovascular system. The phospholipid extract comprises a variety of phospholipids, fatty acid, metals and a novel flavonoid. The method for the preparation of this extract is generally carried out by a method similar to the one described in US Patent 6,800,299 (see above; includes organic solvents),

which procedure produces two successive lipid fractions and a dry residue enriched in protein, including active enzymes.

WO8401715A1 and WO09533471A1 disclose various aspects of so-called krill enzymes, which are water-soluble. It is mentioned that in krill a mixture of different enzymes exists, such as e.g. proteinases (with acidic and neutral-to-alkaline pH-optima), peptidases (exo- and endopeptidases), lipases, phospholipases, amylases and other carbohydrate degrading enzymes, phosphatases nucleases, nucleotidases and esterases. The proteolytic (trypsin-like) activity existing in a water extract from krill has been studied and described. WO09533471A1 disclose the use of one or more krill enzymes for the manufacture of an intravasal pharmaceutical composition for thrombolysis in a mammal host.

The potential of krill oil to prevent thrombosis has been disclosed in the prior art; however such a preventive effect has so far only been ascribed to the presence of powerful antioxidants and the special composition of poly-unsaturated fatty acids. The present inventors have surprisingly found that krill oil prepared by a novel process, which is from a physical-chemical point of view very gentle to the krill material due to relatively low temperature and no use of organic solvents, comprises other therapeutically valuable components than known from conventional krill oil extracts as well as other known fish oil; such components include inter alia high molecular (MWt > 200 kDa) hydrophobic proteins.

## **SUMMARY OF THE INVENTION**

In accordance with the present invention there is provided a novel krill oil extract for the prevention and/or treatment of thrombosis.

The general extraction method of the present invention will now be described. The starting material, consisting of freshly harvested and preferably finely divided krill material, is subjected to extraction, for about two hours and preferably overnight. However, extraction time is not critical to the yield of lipid extraction. To facilitate extraction, it is preferable to use particles of less than 0.5 mm in diameter. Extraction is preferably conducted under inert atmosphere and at a temperature in the order of about 5° C or less. The inventors have also envisaged that the present invention may be carried out by applying supercritical CO<sub>2</sub> extraction.

Preferably, the beginning of the extraction will be conducted under agitation for about 10 to 40

minutes, preferably 20 minutes. The solubilized lipid fractions are separated from the solid material by standard techniques including, for example, filtration, centrifugation or sedimentation. Filtration is preferably used.

## **DETAILED DESCRIPTION OF THE INVENTION**

In accordance with the present invention, there is provided a novel krill extract for prevention and/or treatment and/or therapy of thrombosis.

The novel oil extract is derived from krill found in any marine environment around the world, for example, the Antarctic ocean (*euphasia superba*), the Pacific ocean (*euphasia pacifica*), the Atlantic ocean, the Indian ocean, in particular coastal regions of Mauritius Island and/or Reunion Island of Madagascar, Canadian West Coast, Japanese Coast, St-Lawrence Gulf and Fundy Bay, and this oil extract is a lipid fraction.

According to a first aspect of the present invention there is provided a method for extracting lipid fractions from krill, said method comprising the steps of:

- placing the krill material in a blender to mechanically disrupt fat cell membranes;
- separating the liquid and solid components;
- recovering a lipid rich fraction from the liquid component;

wherein the extraction is performed quickly at a temperature below 60 °C and does not involve the use of organic solvents.

According to another aspect of the present invention there is provided a method for extracting lipid fractions from krill, said method comprising the steps of:

- Feeding freshly captured krill into a grinder to produce a slurry
- Heating the slurry gently to a temperature below 90°C for less than 45 minutes
- Separating the solid material from the liquid
- Separating the liquid into an aqueous phase and a krill oil phase

wherein the extraction does not involve the use of organic solvents.

According to the invention there is also provided a pharmaceutical composition for the treatment of thrombosis in a patient comprising an effective amount of a krill oil extract obtainable by a method according to the present invention.

## EXAMPLES

As used herein, the term omega-3 fatty acid refers to polyunsaturated fatty acids that have the final double bond in the hydrocarbon chain between the third and fourth carbon atoms from the methyl end of the molecule. Non-limiting examples of omega-3 fatty acids include, but are not limited to 5,8,11,14,17-eicosapentaenoic acid (EPA), 4,7,10,13,16,19-docosahexanoic acid (DHA) and 7,10,13,16,19-docosapentanoic acid (DPA).

### Example 1

Preparation of the krill oil extract of the present invention (see also Fig 1).

#### *Preparation of the krill oil*

The method of preparation is a continuous flow process and so the times given represent the average time that the material is in each stage of the process and the temperatures are typical (and may vary by  $\pm 3^{\circ}\text{C}$ ).

1. The freshly captured krill are fed into the grinder together with process water and shredded at  $2^{\circ}\text{C}$  for 5 minutes.
2. This is then fed into a refiner which separates the chitin shell from the slurry (1 minute,  $3^{\circ}\text{C}$ ).
3. The slurry is then passed into a heat exchanger and warmed gently up to a temperature about  $35^{\circ}\text{C}$  (max below  $40^{\circ}\text{C}$ ) (1-2 minutes) and then stored in a buffer tank for 5 to 10 minutes. All subsequent processes occur at temperatures below  $40^{\circ}\text{C}$ .
4. A centrifugal decanter is then used to separate the solid material from the liquid (3 minutes).
5. The liquid fraction is then stored in a buffer tank for 5 to 10 minutes.
6. The temperature of the liquid is adjusted to  $35^{\circ}\text{C}$  using a countercurrent plate heat exchanger (1 minute).
7. The liquid is then separated into an aqueous phase and a krill oil phase.

*Preparation of the stock solution of krill oil*

1. Autoclave glycerol (analytical quality) and leave to cool to room temperature
2. Mix 100  $\mu$ L of krill oil with 1000  $\mu$ L autoclaved glycerol
3. Shake mixture for 6 min. on a minibead beater (Biospec. Products, USA) at room temperature
4. Add 900  $\mu$ L diluted CPD solution (Compoflex<sup>®</sup>, Fresenius HemoCare 61348 Bad Hamburg, Germany containing: citric acid monohydrate 3.27g, Sodium citrate dihydrate 26.3g, sodium dihydrogen phosphate dehydrate 2.51g, glucose monohydrate 25.3g made up to 1L).
5. Shake mixture for 6 min. on minibead beater 4 times at room temperature

*Preparation of the dilute solutions of krill oil*

1. The stock is diluted sequentially (1:10), shaking for 6 minutes at each dilution.
2. Immediately before use, shake mixture for 6 min. on a minibead beater at room temperature

*Preparation of the stock solution of CPD Glycerol control solution*

1. Mix 100  $\mu$ L of diluted CPD solution with 1000  $\mu$ L autoclaved glycerol
2. Shake mixture for 6 min. on minibead beater at room temperature
3. Add 900  $\mu$ L diluted CPD solution
4. Shake mixture for 6 min. on minibead beater 2 times at room temperature
5. Repeat 4. immediately before use

Example 2

Effect of the krill oil extract of the present invention on the aggregation time of thrombocytes.

*Preparation of human blood*

Blood samples were taken from normal subjects. 3.8 mm plastic tubes containing 0.38 ml 0.129M sodium citrate buffer (CPD buffer, pH 5.5) were used to store the blood. The buffered blood was then mixed with the krill or fish oil to achieve a final oil concentration varying from  $5 \times 10^{-2}$  to  $5 \times 10^{-18}$  Vol%. The blood cells were treated with krill or fish oil for 60 minutes before aggregation tests were performed.

*Blood aggregation time*

The thrombocyte aggregation tests were performed with a PFA 100 aggregometer (Dade Bering), which is a microprocessor controlled apparatus with single test vials. The unit comprises a small reservoir, a capillary and a membrane, which is covered with 2 mg genuine, type 1 collagen and 50 mg adenosin-5'-diphosphate (ADP). The blood is pipetted directly into the reservoir and aspirated through a capillary with a diameter of 200  $\mu\text{m}$  with a constant negative pressure resulting in high shear stress. The capillary ends with a membrane having an aperture with a diameter of 150  $\mu\text{m}$ . The thrombocytes are then activated by collagen and ADP. Upon aggregation the blood flow is stopped due to clogging, which is referred to as closing time. The test automatically stops after 300 seconds. The normal value is between 62.5 – 120.5 seconds for ADP.

*Determination of anti-aggregation effect*

Dilute krill oil solutions were added to whole human blood samples and allowed to react in accordance with the following steps:

1. Serial dilutions of the krill oil or other oils under investigation were added to the human blood samples and gently shaken for 1 hour at room temperature on a "HETO-blood turner" at a rotational speed of 10 rpm.
2. Exactly 800 $\mu\text{L}$  of the blood-oil sample were placed in the reaction cartridge (DADE PFA collagen/epitest cartridge containing 4 $\mu\text{g}$  epinephrine bitartrate and 2 $\mu\text{g}$  type 1 equine collagen). The blood was then allowed to clot at 37°C for up to 300 seconds (preset instrument maximum).
3. Measurements were read from the display and printed out recorded

Figure 2 shows the effects of various oils on the rate of aggregation of human whole blood.

Samples of human whole blood are aggregated at the start and end of every experiment ("Start blood" and "End blood" on the abscissa) to determine the rate of blood aggregation for the donor. As an additional control carried out just after and just before the start and end whole blood aggregation determinations, an aliquot of the vehicle is added and the aggregation determination is repeated ("Start Glycerol/CPD" and "End Glycerol/CPD"). These controls are performed to ensure that the ability of the blood to aggregate does not change during the experimentation (see the trend line for the glycerol/CPD points). Between these control experiments, the blood is treated (as described in the text) with various concentrations of the different oils for 1hr before its ability to aggregate is determined. Dotted line - fish oil; dashed

line a commercially available krill oil; solid line krill oil prepared in the manner disclosed here. The graph shows typical data from a single patient.

As can be seen in Figure 2, the fish oil can be diluted to a concentration of only about  $1 \times 10^{-4}$  before it loses its effect. A commercially available krill oil can be diluted to about  $5 \times 10^{-6}$  before it loses its effect (i.e. it is about 500 times more effective than fish oil). Krill oil prepared in the manner described here can be diluted to a concentration of about  $5 \times 10^{-12}$  before it loses its effect. This is a million times more effective than the existing krill oil preparations and five hundred million times better than fish oil (note that the abscissa is a logarithmic scale).

Figure 3 (graph 1) shows the inhibiting effect of krill oil on the aggregation of thrombocytes in blood samples from 6 subjects. It also appears that the effect varies from subject to subject; and furthermore blood from one of the subjects was not influenced at all by the presence of krill oil.

In Figure 4 (graph 2) the effect of krill oil C on blood from the same subject was analysed twice with a 21 day interval. The effect of krill oil C on the aggregation of thrombocytes is significant; however it must be concluded that the difference in the concentration required to achieve a significant inhibition varies with more than  $10^{-3}$  Vol%.

### Example 3

Comparison of krill oils and fish oils with respect to the effect on blood aggregation

These experiments serve to demonstrate that the krill oil obtainable by the process of the present invention prevents formation of thrombosis (based on the same experimental procedure as laid down in Examples 1 and 2) to a higher degree than known krill oils and other fish oils.



The experiments include 2 fish oils as well as 3 different krill oils:

- Krill oil A: Krill caught in large nets and subjected to a long process time
- Krill oil B: Krill caught in smaller nets and subjected to a short process time
- Krill oil C: Krill sucked up and processed very rapidly (in accordance with the present invention)
- Fish oil A: Newly cold pressed cod fish oil
- Fish oil B: Pikasol (OTC registered natural pharmaceutical containing concentrated Omega-3 rich fish oil; contains 62% omega-3 fatty acids, mainly EPA and DHA; Pikasol is produced from highly refined fish oil from the cleanest oceans in the world)

The oils are dissolved in a 1:1 mixture with glycerol and CPD (Gly/CPD-mixture). Every single dilution is performed with the Gly/CPD-mixture to ensure that the glycerol concentration remains constant about  $5 \times 10^{-3}$  Vol%.

It is known that the quality of krill oil may vary considerably due to the way the krill material has been "caught". As discussed above the prior envisages that the amount of phospholipids, omega-3 and omega-6 polyunsaturated fatty acids and various antioxidants is responsible for the therapeutic effects attributable to krill oil. As appears from Fig 5 (graph 3) the three krill oils have very different effects on the aggregation. Surprisingly, the different effects could not be ascribed to differences in the amount of e.g. polyunsaturated fatty acids. On the contrary it appeared (based on 2D gel electrophoresis) that 5 proteins were present in Krill oil C (according to the present invention) but only in minute amounts in krill oil B and not traceable in krill oil A. This observation stems with the fact that many proteins in krill are extremely sensible for proteolytic degradation, which starts right after the krill has been caught.

As already mentioned the therapeutic effect of antioxidants and polyunsaturated fatty acids from fish oil on cardiovascular diseases is well known. Accordingly, the present inventors have compared the effect the effect of Krill oil C and fish oils A and B with respect to their ability to prevent thrombocyte formation (verified with the above described aggregation test). Fig 6 (graph 4) demonstrates that Krill oil C (according to the present invention) has a far more pronounced inhibitory effect on the thrombocyte aggregation than is the case with the fish oils.

### Conclusions drawn from Examples 1-3

Based on the experimental evidence provided so far the following conclusions may be drawn:

- Krill oil prepared by the process according to the present invention has a strong inhibitory effect on human thrombocyte aggregation in blood samples,
- The difference between the intensity of the effect may possibly be ascribed to certain proteins of the krill oil, and
- There is a substantial difference between how blood from different subjects responds to the krill oil with respect to aggregation time, however it may validly said that the krill oil obtained with the process of the present invention is far more effective than krill oils and fish oils obtained by traditional high temperature/solvent extraction methods.

### Example 4

Phospholipids are to be extracted from the solid fraction obtained in example 1 (step 4) using ethanol. After removal of the ethanol, the phospholipids are to be mixed with the krill oil phase obtained from the liquid fraction in example 1 (step 7) into a krill oil composition. The anti-thrombotic effects of this krill oil composition are to be compared with other krill oil products extracted with organic solvents by investigating the effect on the aggregation time of thrombocytes in-vitro. The krill oil products (mixtures of krill triglycerides and krill phospholipids) for this comparison are to be extracted from krill or krill meal using organic solvents as described in US 6,800,299. It is to be observed that the anti-thrombotic effects of the krill oil composition obtained by the methods described herein are superior to any krill oil product extracted with organic solvents such as acetone.

### Example 5

The krill oil compositions tested in example 4, the krill oil extracted obtained in example 1 (step 7), krill oil obtained using organic solvents and a control are to be administered in humans (in-vivo) for a period of 5 weeks. Diets are to contain approximately 38% of energy as fat excluding the lipid in the supplement. Around 2 g of each product are to be administered in a way that preserves the biological effect of the krill oil. Non-limiting examples of administration are oral, sublingual or transdermal. After termination of the experiment, ex vivo and in vitro platelet aggregation, and variables of coagulation, fibrinolysis, and hematology are to be evaluated. Ex vivo platelet aggregation time are to be measured by filtragemetry and in vitro platelet aggregation induced by collagen and ADP measured by PFA 100 aggregometer. Variables of coagulation (factor VII amidolytic activity and concentrations of fibrinogen and prothrombin fragment 1 and 2) and fibrinolysis [plasminogen activator inhibitor (PAI) activity

and concentrations of tissue plasminogen activator (tPA)/PAI-1 complexes] are to be determined by standard methods. It is to be observed that the subjects treated with the krill oil composition described in example 4 and the krill lipid extract obtained in example 1 (step 7) show superior anti-thrombotic activity than subjects treated with krill oil compositions obtained using organic solvents and control. Prevention of thrombosis is linked to prevention of myocardial infarction and stroke. Hence, the krill oil composition described in example 4 and example 1 (Step 7) can be used to prevent these pathologies.

**CLAIMS**

1. A method for extracting lipid fractions from krill, said method comprising the steps of:
- placing the krill material in a grinder or blender to mechanically disrupt cell membranes;
  - separating the liquid and solid components;
  - recovering a lipid rich fraction from the liquid component;

wherein the extraction is performed at a temperature below 60 °C and does not involve the use of organic solvents.

2. A method as in claim 1, wherein separating the liquid and solid components is effected by techniques selected from the group consisting of mechanical pressing, filtration, centrifugation and sedimentation.

3. A method as in claim 1, wherein the extraction is performed at a temperature below 27°C, preferably below 15°C, more preferably below 5°C.

4. A krill oil extract obtainable by a method according to any one of claims 1 to 3.

5. A krill oil extract according to claim 4 for use as a medicament.

6. A pharmaceutical composition comprising the krill oil extract of claim 4.

7. A pharmaceutical composition for the treatment of thrombosis in a patient comprising an effective amount of a krill oil extract obtainable by a method according to any one of claims 1 to 3 in association with a pharmaceutically acceptable carrier.

8. The composition of claim 7, further comprising at least one of compounds selected from the group consisting of glycerol, dimethyl-sulphoxide (DMSO), linoleic acid, alpha-linoleic acid, arachidonic acid, oleic acid, palmitic acid, palmitoleic acid, stearic acid, cholesterol, triglycerides, monoglycerides, all-trans retinal, canthexanthin, carotene, zinc, selenium, sodium, potassium and calcium.

9. Use of the krill oil extract obtainable by the method of any one of claims 1-3 for the production of a medicament for decreasing development of thrombosis in a patient.

10. A composition for inhibiting platelet adhesion and plaque formation in arteries of a patient comprising an effective amount of krill oil extract in association with a pharmaceutically acceptable carrier, wherein said krill oil extract is obtainable from a method according to any one of claims 1 to 3.

11. A krill oil extract obtainable by a method comprising the steps of:

- Feeding freshly captured krill into a grinder to produce a slurry
- Heating the slurry gently to a temperature below 90°C in less than 45 minutes
- Separating the solid material from the liquid
- Separating the liquid into an aqueous phase and a krill oil phase wherein the extraction does not involve the use of organic solvents.

12. A food product comprising the krill oil extract of claim 4.

13. An animal feed comprising the krill oil extract of claim 4.

14. A food supplement comprising the krill oil extract of claim 4.

15. A composition comprising the krill oil extract of claim 4 and phospholipids, said phospholipids having the following structure:

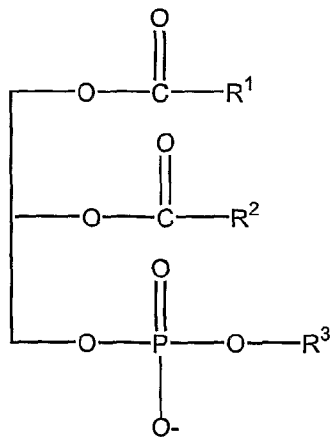

wherein R1 is a fatty acid, R2 is a fatty acid, and R3 is selected from the group consisting of H or choline, ethanolamine, inositol or serine.

16. The composition in claim 15, wherein at least 1% (w/w) of the said fatty acids are unsaturated fatty acids.

17. The composition in claim 15, wherein at least 1% (w/w) of the said fatty acids are omega-3 fatty acids.
18. A food product comprising the composition in any of the claims 15 to 17.
19. An animal feed comprising the composition in any of the claims 15 to 17
20. A food supplement comprising the composition in any of the claims 15 to 17.
21. A pharmaceutical comprising the composition in any of the claims 15 to 17.
22. A method of preventing platelet adhesion in a patient comprising administering to said patient a therapeutically effective amount of the composition in any of the claims 15 to 21.
23. A method for preventing stroke or heart attack in a patient comprising administering to said patient a therapeutically effective amount of the composition in any of the claims 15 to 21.
24. A method of preventing platelet adhesion and plaque formation in a patient comprising administering to said patient a therapeutically effective amount of krill oil, wherein said krill oil is obtained without organic solvent extraction.
25. A method of preventing platelet adhesion and plaque formation in a patient comprising administering to said patient a therapeutically effective amount of krill oil composition, wherein said krill oil composition comprises triglyceride, phospholipid and protein fractions.
26. The method of claim 25, wherein said protein fraction comprises high molecular weight hydrophobic proteins.
27. A composition comprising a krill oil extract isolated from krill comprising triglyceride, phospholipid and protein fractions.
28. A pharmaceutical comprising the composition of claim 27.

Figure 1

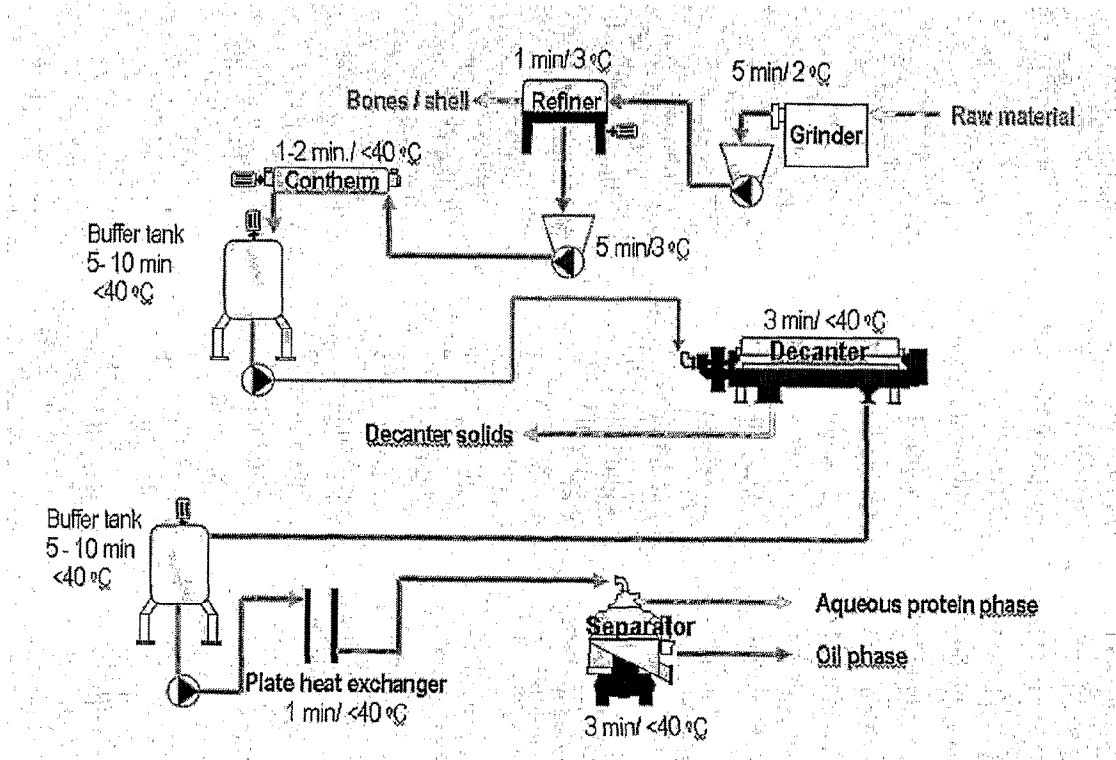

2/6

Figure 2

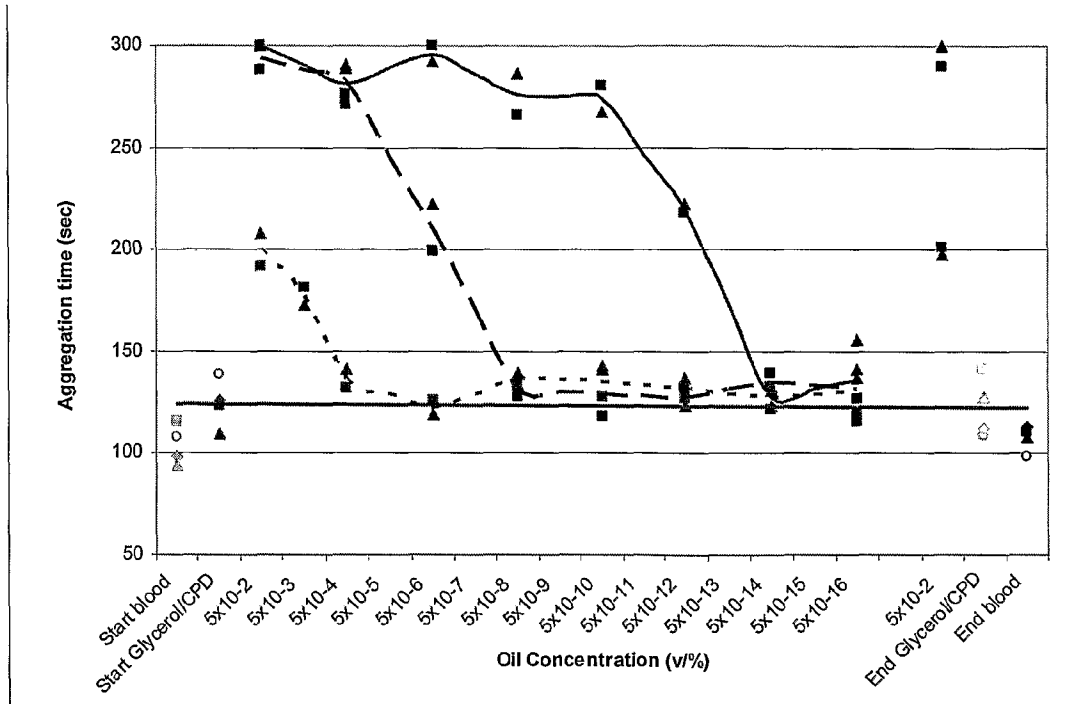
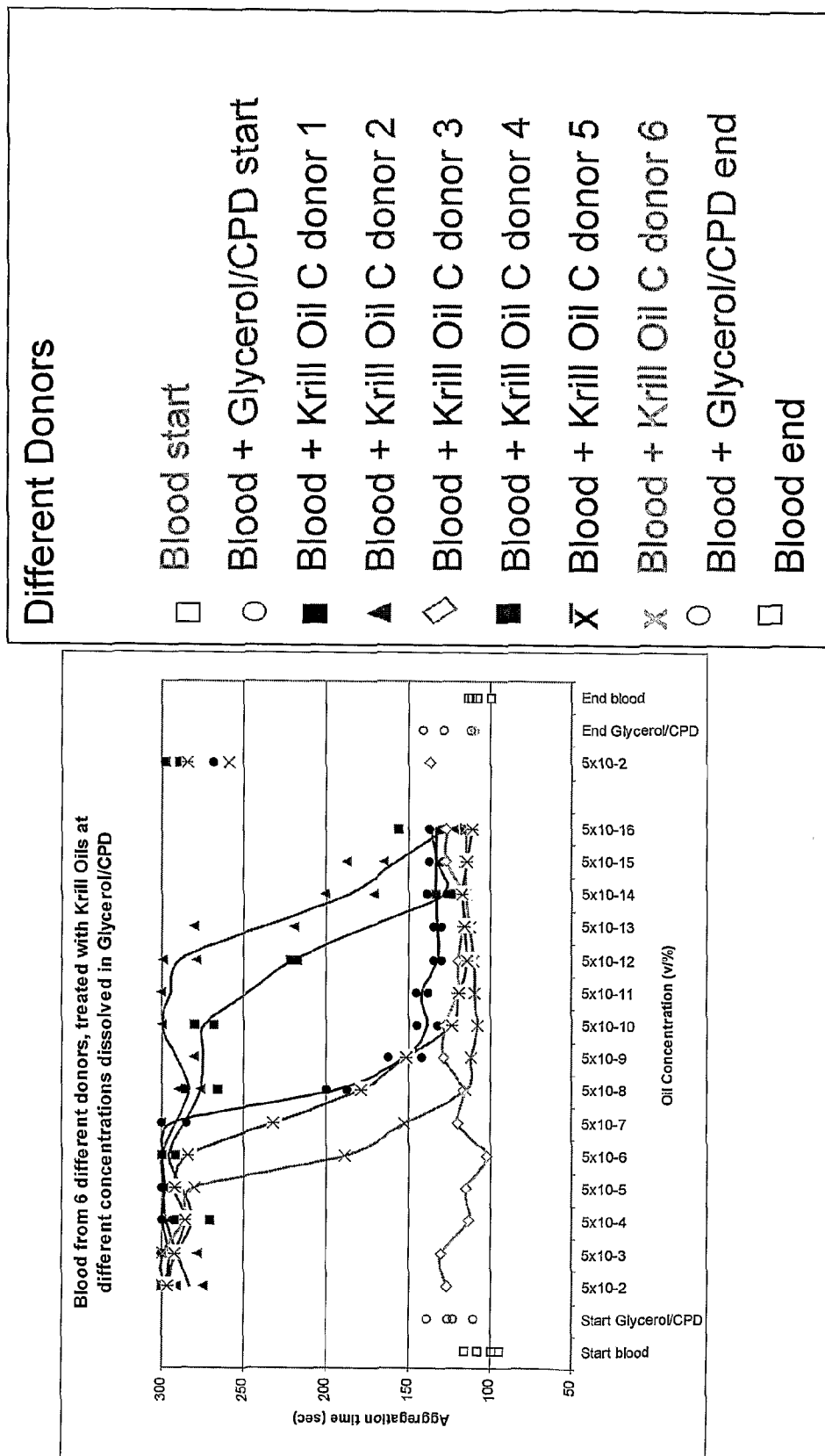



Figure 3



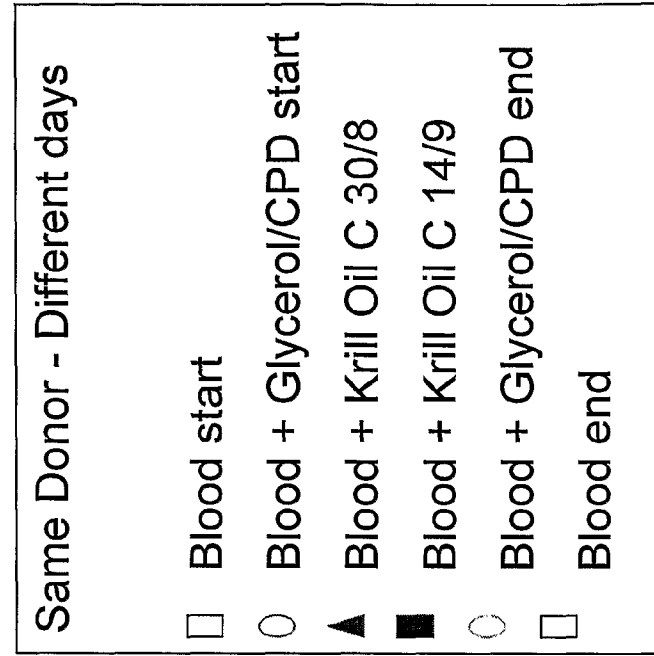

Figure 4

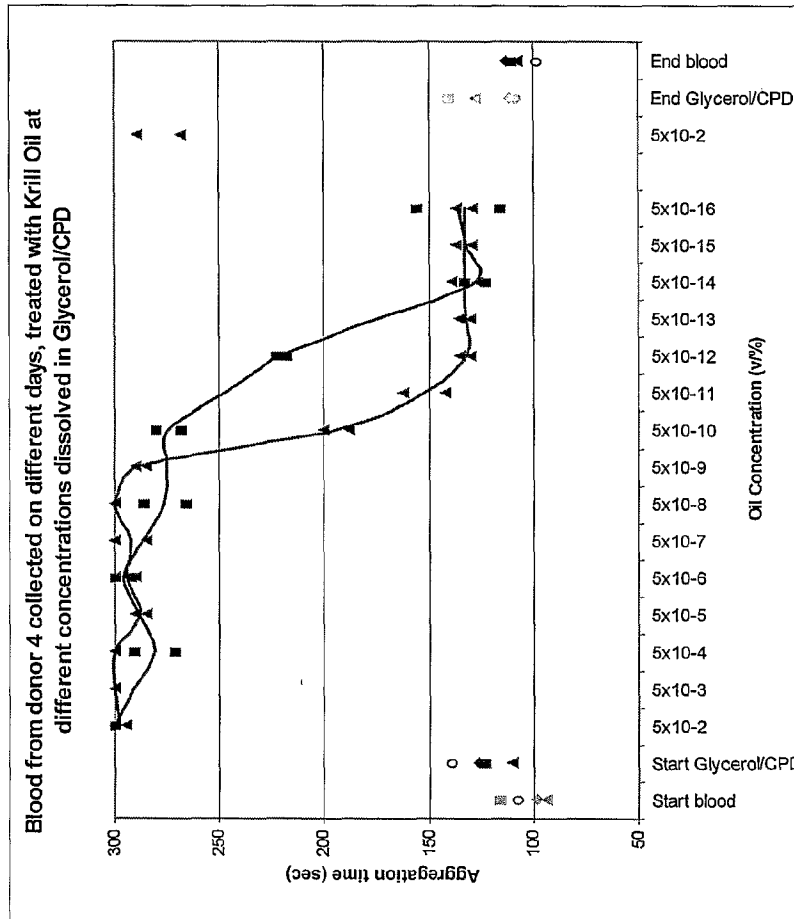

Figure 5

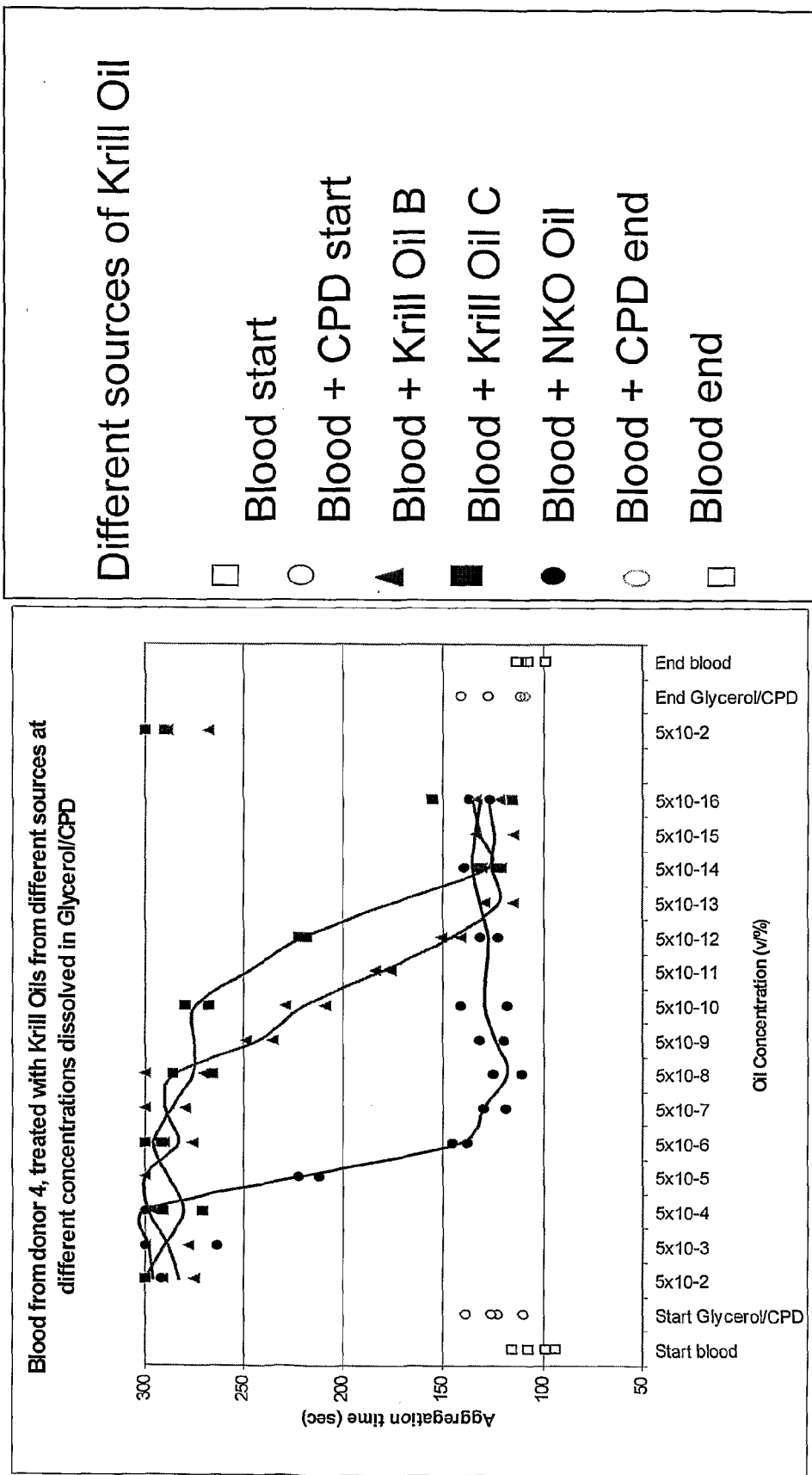
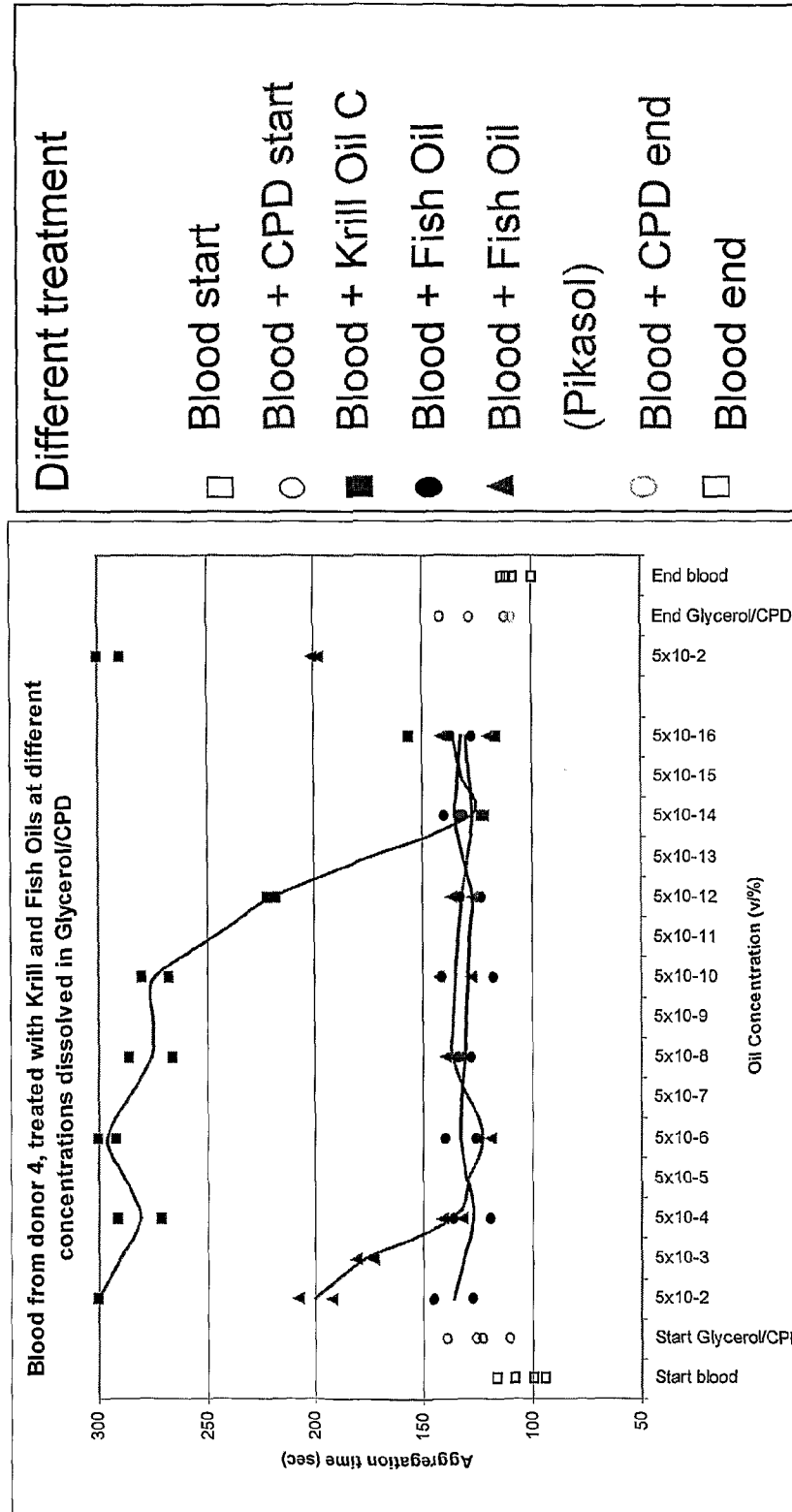

Figure 6



**INTERNATIONAL SEARCH REPORT**

International application No  
PCT/IB2007/000099

**A. CLASSIFICATION OF SUBJECT MATTER**  
 INV. A61P7/02 A61P9/10 A61P9/14 C11B1/02 C11B1/14  
 A23L1/30 A23D9/00

According to International Patent Classification (IPC) or to both national classification and IPC

**B. FIELDS SEARCHED**  
 Minimum documentation searched (classification system followed by classification symbols)  
 C11B A23L A61P A23D

Documentation searched other than minimum documentation to the extent that such documents are included in the fields searched

Electronic data base consulted during the international search (name of data base and, where practical, search terms used)  
 EPO-Internal, CHEM ABS Data, WPI Data, FSTA, BIOSIS

**C. DOCUMENTS CONSIDERED TO BE RELEVANT**

Category*	Citation of document, with indication, where appropriate, of the relevant passages	Relevant to claim No.
X	US 4 036 993 A (IKEDA IZUMI ET AL) 19 July 1977 (1977-07-19)  example 2	1-8, 10-21, 27,28
X	DE 30 38 190 A1 (ALFA LAVAL AB [SE]) 23 April 1981 (1981-04-23)  page 7, paragraph 2 - page 9, paragraph 2	1-8, 10-21, 27,28
X	WO 2005/075613 A (BEAUDOIN ADRIEN [CA]) 18 August 2005 (2005-08-18)  page 6, paragraph 2 table 9	1-8, 10-21, 27,28
	----- -/--	

Further documents are listed in the continuation of Box C.       See patent family annex.

\* Special categories of cited documents :

<p>*A* document defining the general state of the art which is not considered to be of particular relevance</p> <p>*E* earlier document but published on or after the international filing date</p> <p>*L* document which may throw doubts on priority claim(s) or which is cited to establish the publication date of another citation or other special reason (as specified)</p> <p>*O* document referring to an oral disclosure, use, exhibition or other means</p> <p>*P* document published prior to the international filing date but later than the priority date claimed</p>	<p>*T* later document published after the international filing date or priority date and not in conflict with the application but cited to understand the principle or theory underlying the invention</p> <p>*X* document of particular relevance; the claimed invention cannot be considered novel or cannot be considered to involve an inventive step when the document is taken alone</p> <p>*Y* document of particular relevance; the claimed invention cannot be considered to involve an inventive step when the document is combined with one or more other such documents, such combination being obvious to a person skilled in the art.</p> <p>*&amp;* document member of the same patent family</p>
--	--

Date of the actual completion of the international search  25 April 2007	Date of mailing of the international search report  15/05/2007
--	--

Name and mailing address of the ISA/ European Patent Office, P.B. 5818 Patentlaan 2 NL - 2280 HV Rijswijk Tel. (+31-70) 340-2040, Tx. 31 651 epo nl, Fax: (+31-70) 340-3016	Authorized officer  Rooney, Kevin
---	---

## INTERNATIONAL SEARCH REPORT

International application No

PCT/IB2007/000099

C(Continuation). DOCUMENTS CONSIDERED TO BE RELEVANT		
Category*	Citation of document, with indication, where appropriate, of the relevant passages	Relevant to claim No.
X	<p>DATABASE CA [Online]            CHEMICAL ABSTRACTS SERVICE, COLUMBUS,            OHIO, US; 1989,            PIVOVAROV, P. P. ET AL: "Electronic            spectra of oil-based extracts from            krill"            XP002430957            retrieved from STN            Database accession no. 1989:593160            abstract            &amp; IZVESTIYA VYSSHIKH UCHEBNYKH ZAVEDENII,            PISHCHEVAYA TEKHNLOGIYA , (3), 72-4            CODEN: IVUPA8; ISSN: 0579-3009, 1989,            -----</p>	<p>1-8,            10-21,            27,28</p>
X	<p>URAKAZE M ET AL: "INFUSION OF EMULSIFIED            TRIICOSAPENTAENOYL-GLYCEROL INTO RABBITS.            - THE EFFECTS ON PLATELET AGGREGATION,            POLYMORPHONUCLEAR LEUKOCYTE ADHESION, AND            FATTY ACID COMPOSITION IN PLASMA AND            PLATELET PHOSPHOLIPIDS"            THROMBOSIS RESEARCH, TARRYTOWN, NY, US,            vol. 44, no. 5, 1986, pages 673-682,            XP000650534            ISSN: 0049-3848            the whole document            -----</p>	<p>1-25,27,            28</p>
X	<p>WO 02/102394 A (NEPTUNE TECHNOLOGIES &amp;            BIORESS [CA]; SAMPALIS TINA [CA])            27 December 2002 (2002-12-27)            the whole document            -----</p>	<p>22-25</p>
X	<p>YAMAGUCHI, K., ET AL.: "Supercritical            carbon dioxide extraction of oils from            antarctic krill"            JOURNAL OF AGRICULTURAL AND FOOD            CHEMISTRY.,            vol. 34, 1986, pages 904-907, XP002430955            USAMERICAN CHEMICAL SOCIETY. WASHINGTON.            the whole document            -----</p>	<p>1-8,            10-21,            27,28</p>
X	<p>US 2004/241249 A1 (SAMPALIS TINA [CA])            2 December 2004 (2004-12-02)            example 1            -----</p>	<p>1-25,27,            28</p>
A	<p>BUNEA, R., EL FARRAH, K., AND DEUTSCH, L.:            "Evaluation of the effects of neptune            krill oil on the clinical course of            hyperlipidemia"            ALTERNATIVE MEDICINE REVIEW,            vol. 9, no. 4, 2004, pages 420-428,            XP002430956            USTHORNE RESEARCH INC., SANDPOINT,            the whole document            -----</p>	<p>1-28</p>
	----- -/--	