

Table 10: Fatty acid composition *E. pacifica*

Solvent	Saturated	Unsaturated			Unidentified	
		Mono	Di	Poly	H-Poly	
chlo-meth	26,18	22,54	1,91	4,31	26,34	18,72
acetone	21,4	22,18	1,75	4,67	24,52	25,49
acetone	19,09	22,11	2,03	4,79	30,24	21,72
ethanol	45,93	22,96	1,23	2,72	11,11	16,05 (500 µg/mL)
	45,96	22,98	1,24	2,48	11,18	16,15 (200 µg/mL)

Data expressed in percentage of total fatty acids (%).

**TABLE 11. OPTIMAL CONDITIONS FOR LIPID EXTRACTION OF
AQUATIC ANIMAL TISSUES (suggested procedure)**

<u>STEP</u>	<u>CONDITIONS</u>
Grinding (if particles > 5mm)	4°C
Lipid extraction	sample-acetone ratio of 1:6 (w/v) 2h (including swirling 20 min) 4°C
Filtration	organic solvent resistant filter under reduced pressure
Washing	sample-acetone ratio of 1:2 (w/v) pure and cold acetone
Filtration	organic solvent resistant filter under reduced pressure
Evaporation	under reduced pressure
Oil-water separation	4°C
Lipid extraction	sample-ethanol ratio of 1:2 (w/v) pure ethanol 30 min 4°C
Filtration	organic solvent resistant filter under reduced pressure
Evaporation	under reduced pressure

Bibliography

- Bowyer, D.E., Leat, W.M.F., Howard, A.N. and Gresham, G.A. 1962. The determination of the fatty acid composition of serum lipids separated by thin-layer chromatography; and a comparison with column chromatography. BBA. 70: 423-431
- Chandrasekar, B., Troyer, D.A., Venkatraman, J.T. and Fernandes, G. 1996. Tissue specific regulation of transforming growth factor beta by omega-3 lipid-rich krill oil in autoimmune murine lupus. Nutr Res. 16(3): 489-503
- Christensen, M.S., Hoy, C-E. and Redgrave, T.G. 1994. Lymphatic absorption of *n*-3 polyunsaturated fatty acids from marine oils with different intramolecular fatty acid distributions. BBA. 1215: 198-204
- Difco laboratories. 1984. Difco Manual Dehydrated Culture Media and Reagents for Microbiology. 10th ed. Detroit.
- Folch, J., Lees, M. and Sloane-Stanley, G.H. 1957. A simple method for the isolation and purification of total lipids from animal tissues. J. biol. Chem. 226: 497-509
- Goodman Gilman, A., Goodman, L.L. and Gilman, A. 1980. The Pharmacological Basis of Therapeutics. 6th ed. Collier Macmillan Canada Ltd, Toronto.
- Hellgren, L., Karlstam, B., Mohr, V. and Vincent, J. 1991. Krill enzymes. A new concept for efficient debridement of necrotic ulcers. Int J Dermatol. 30(2): 102-103
- Prawn Hatchery Food. 1997. <http://www.kk-tech.com/krill.html>
- Runge, J.A. and Joly, P. 1994. Rapport sur l'état des invertébrés en 1994: 7:0 Zooplancton (Euphausiacés et *Calanus*) de l'Estuaire et du Golfe du Saint-Laurent.
- Sargent, J.R. 1997. Fish oils and human diet. Br J Nutr. 78 Suppl 1: S5-S13

Although the present invention has been described herein above by way of preferred embodiments thereof, it can be modified, without departing from the spirit and nature of the subject invention as defined in the appended claims.

WHAT IS CLAIMED IS:

1. A method for extracting lipids from an aquatic animal tissue comprising the steps of:
 - a) suspending said animal aquatic tissue in an organic solvent;
 - b) extracting lipids by successive organic solvent treatment;and
 - c) collecting said lipids in a first fraction and an organic insoluble fraction.
2. The method of claim 1, wherein said organic solvent of a) is acetone.
3. The method of claim 1 or 2, wherein said organic solvent of b) is selected from at least one of acetone and alcohol.
4. The method of claim 1, 2 or 3, wherein said organic insoluble fraction comprises a dry residue fraction which is enriched in protein.
5. The method of claim 1, 2, 3 or 4, wherein said aquatic animal tissue is at least one tissue selected from the group consisting of krill tissue, *Calanus* tissue and fish tissue.
6. A lipid extract obtained by the method of claim 2, 3, 4 or 5.

7. A protein rich fraction obtained by the method of claim 4 or 5.
8. A lipid extract having the properties in accordance with the present invention.

CONFIDENTIEL

Injection Date : 98-03-24 20:09:39
 Sample Name : 7
 Acq. Operator : Chantal Beaudoin

Seq. Line : -
 Vial : 1
 Inj : 1
 Inj Volume : Manually

Method : C:\HPCHEM\1\METHODS\ALAIN2.M
 Last changed : 98-03-24 19:56:07 by Chantal Beaudoin
 (modified after loading)

Méthode corrigée lors de l'installation de la nouvelle colonne le 12 septembre 1997. Température du four 170 degré C et purge flow = 150 ml/min. Flux dans la colonne : 4,0 ml/min. Augmentation de la température a 175 degré C et le purge flow est descendu a 140 ml/min, le 13 mars 1998.

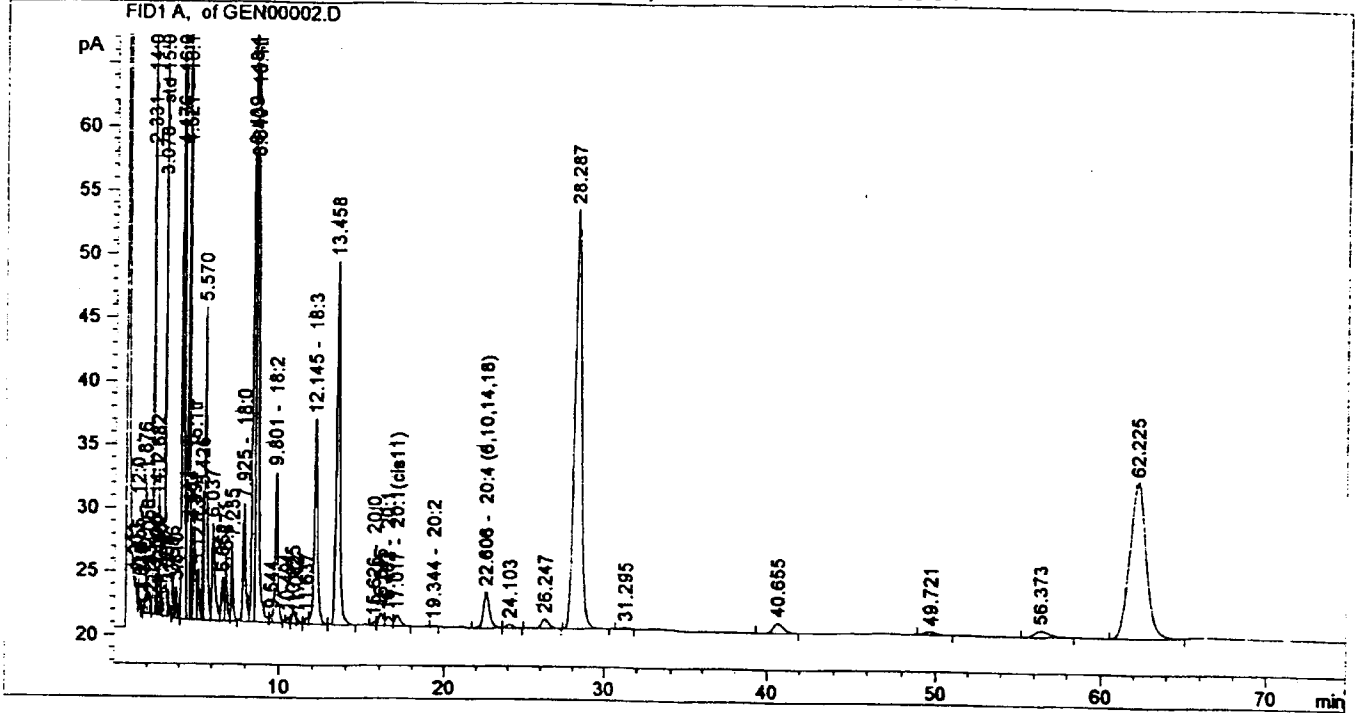

Figure 1: Gas-liquid chromatography of fatty acids from dry krill (chloroform-methanol).

CONFIDENTIEL

CONFIDENTIEL

Injection Date : 98-03-25 20:00:46
 Sample Name : 11
 Acq. Operator : Chantal Beaudoin

Seq. Line : -
 Vial : 1
 Inj : 1
 Inj Volume : Manually

Method : C:\HPCHEM\1\METHODS\ALAIN2.M
 Last changed : 98-03-25 18:55:58 by Chantal Beaudoin
 (modified after loading)

Méthode corrigée lors de l'installation de la nouvelle colonne 12 septembre 1997. Température du four 170 degré C et purge flow = 150 ml/min. Flux dans la colonne : 4,0 ml/min. Augmentation de la température a 175 degré C et le purge flow est descendu a 140 ml/min, le 13 mars 1998.

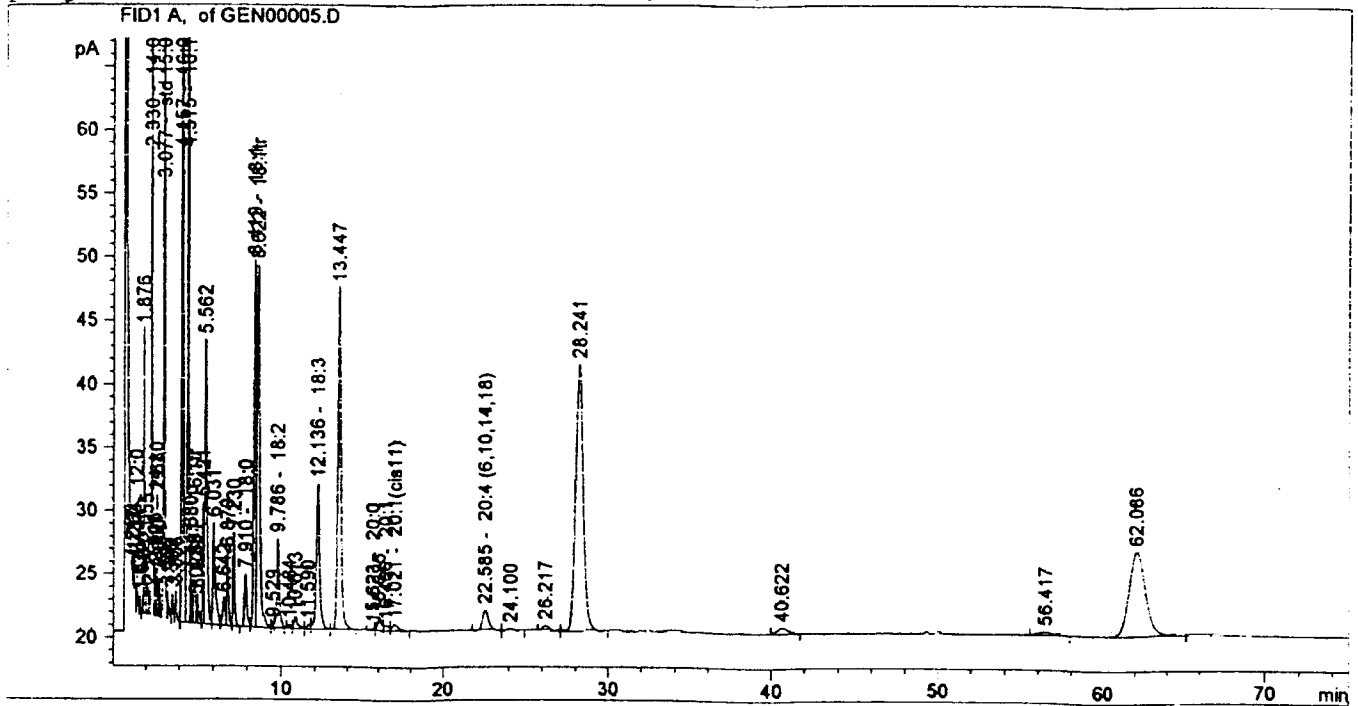

Figure 2: Gas-liquid chromatography of fatty acids from dry krill (acetone).

CONFIDENTIEL

CONFIDENTIEL

Injection Date : 98-04-01 18:48:05
 Sample Name : 26
 Acq. Operator : Chantal Beaudoin

Seq. Line : -
 Vial : 1
 Inj : 1
 Inj Volume : Manually

Method : C:\HPCHEM\1\METHODS\ALAIN2.M
 Last changed : 98-04-01 18:45:50 by Chantal Beaudoin
 (modified after loading)

Méthode corrigée lors de l'installation de la nouvelle colonne le 12 septembre 1997. Température du four 170 degré C et purge flow = 150 ml/min. Flux dans la colonne : 4,0 ml/min. Augmentation de la température a 175 degré C et le purge flow est descendu a 140 ml/min, le 13 mars 1998.

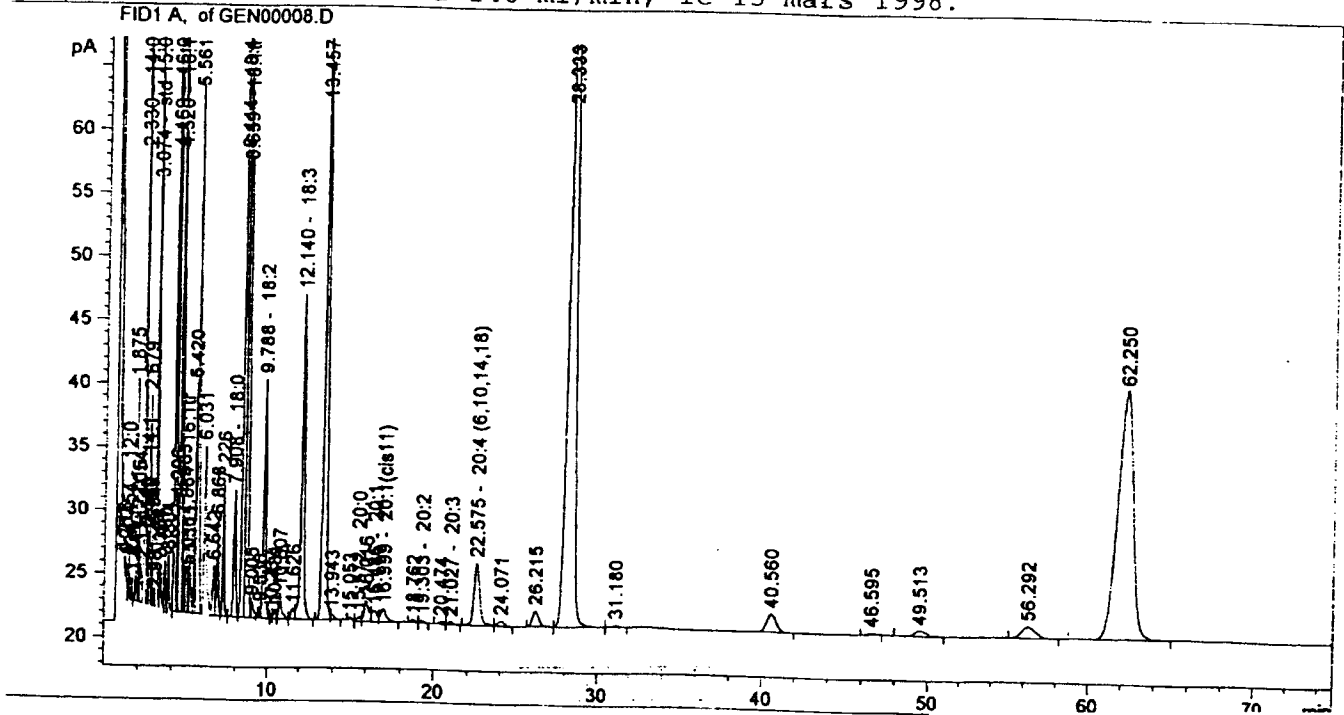

Figure 3: Gas-liquid chromatography of fatty acids from frozen krill (acetone).

CONFIDENTIEL

CONFIDENTIEL

Injection Date : 98-04-02 17:35:45
Sample Name : 28
Acq. Operator : Chantal Beaudoin

Seq. Line : -
Vial : 1
Inj : 1
Inj Volume : Manually

Method : C:\HPCHEM\1\METHODS\ALAIN2.M
Last changed : 98-04-02 17:28:39 by Chantal Beaudoin
(modified after loading)

Méthode corrigée lors de l'installation de la nouvelle colonne 12 septembre 1997. Température du four 170 degré C et purge flow = 150 ml/min. Flux dans la colonne : 4,0 ml/min. Augmentation de la température a 175 degré C et le purge flow est descendu a 140 ml/min, le 13 mars 1998.

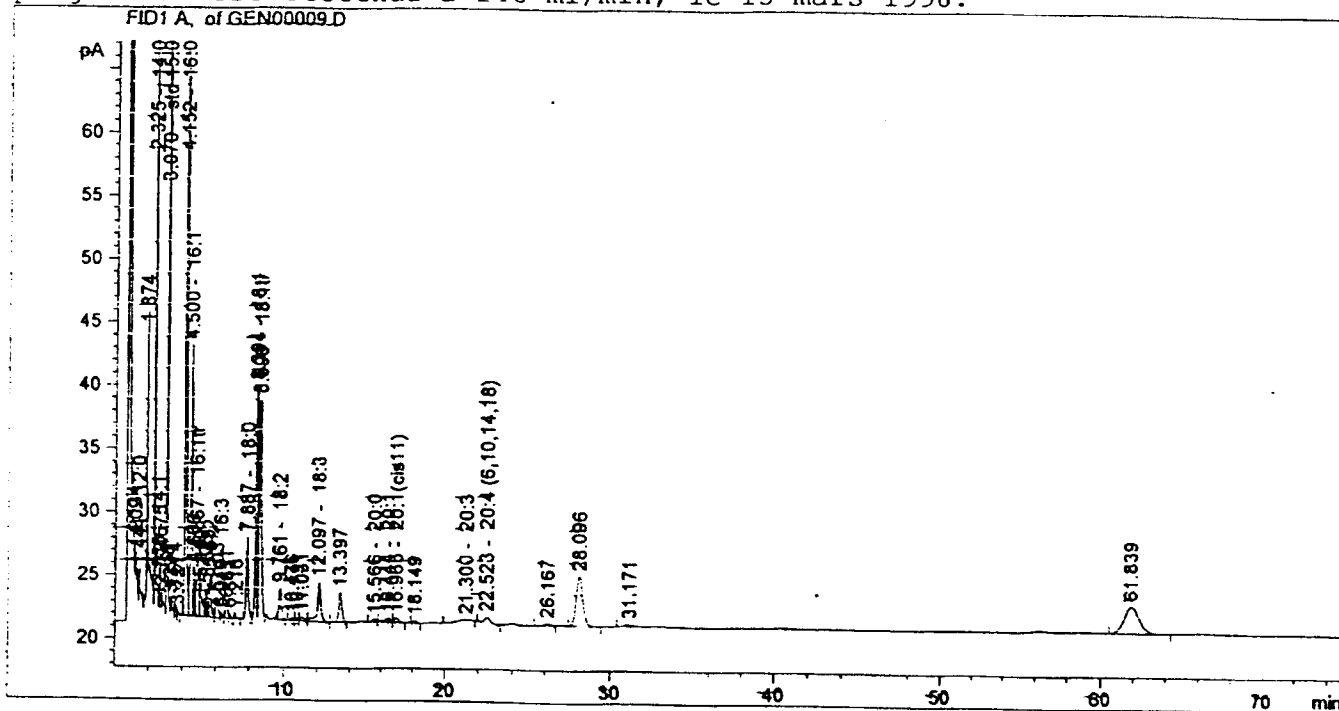

Figure 4: Gas-liquid chromatography of fatty acids from frozen krill (ethanol).

CONFIDENTIEL

CONFIDENTIAL

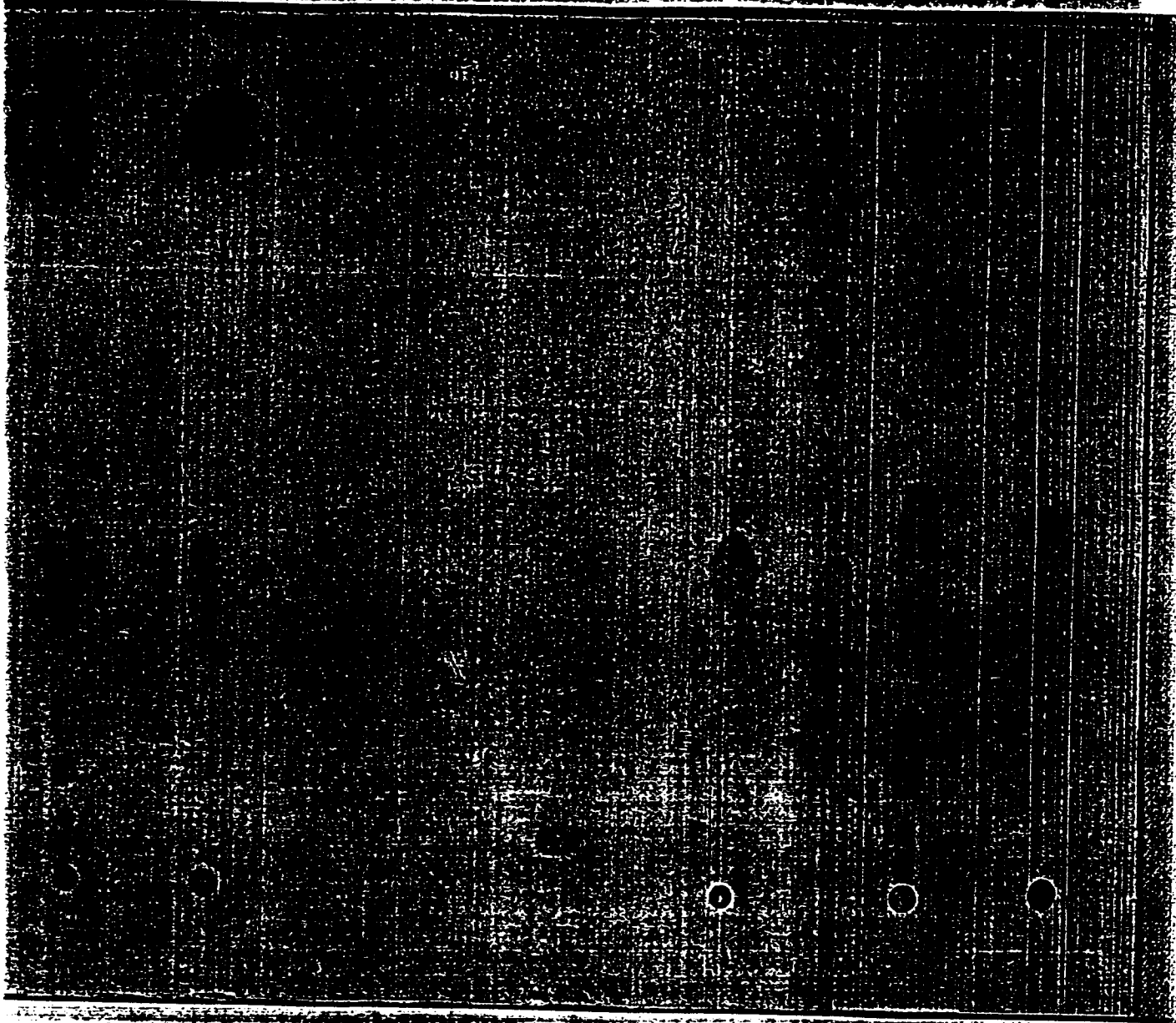

Figure 5: Thin-layer chromatography of neutral lipids of *Calanus* sp. (acetone), *Calanus* sp. (ethanol), sample of other interest, cholesterol 20mg/mL, egg (acetone), *M. norvegica* (acetone) and *M. norvegica* (ethanol). Hexane-ethyl ether-acetic acid (90:10:1, v/v).

CONFIDENTIAL

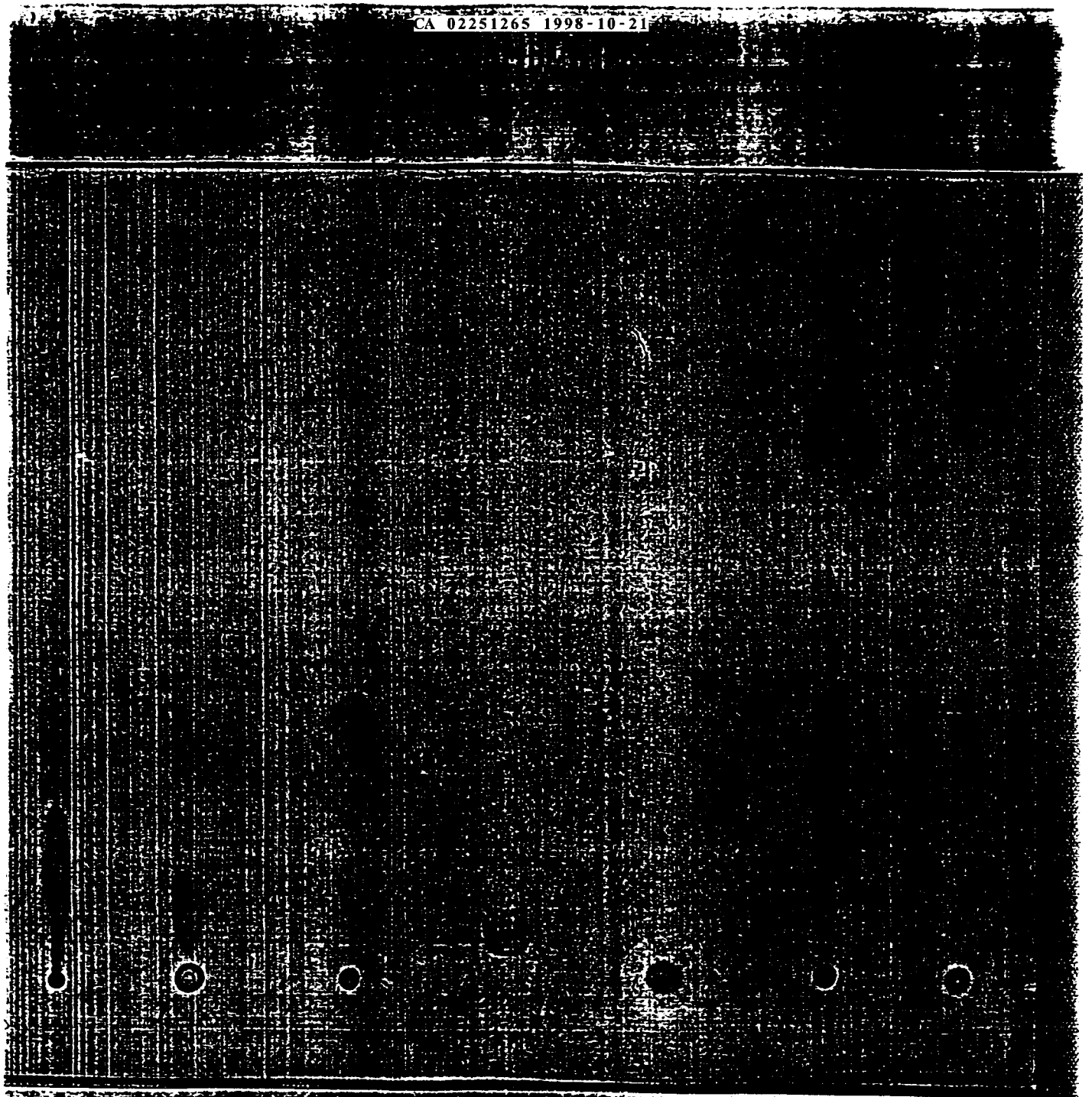

Figure 6: Thin-layer chromatography of neutral lipids of *E. pacifica* (acetone), *E. pacifica* (ethanol), egg (acetone), cholesterol 20 mg/mL, sample of other interest, *Calanus* sp. (acetone) and *Calanus* sp. (ethanol).
Hexane-ethyl ether-acetic acid (90:10:1, v/v).

CONFIDENTIAL

CONFIDENTIAL

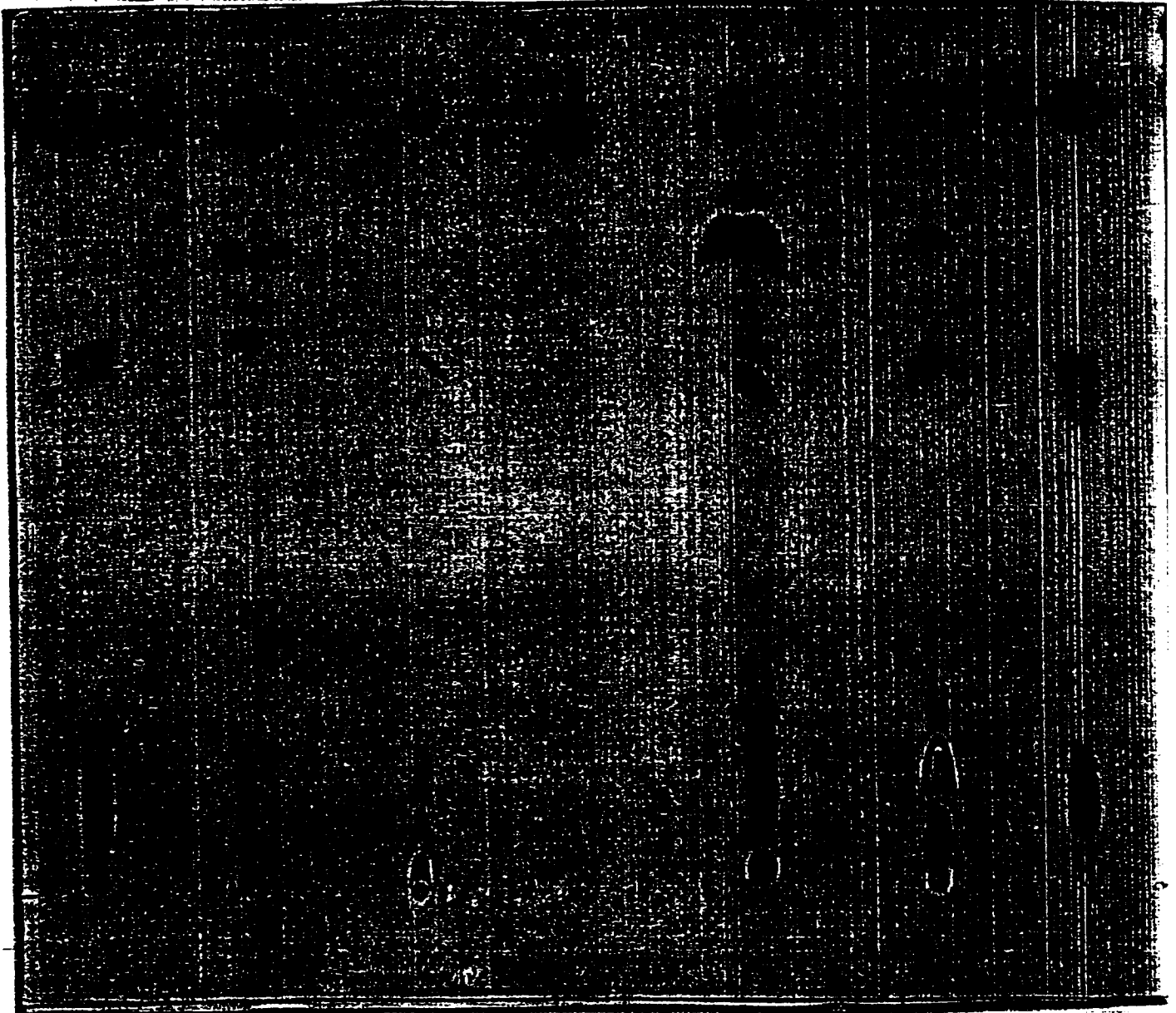

Figure 7: Thin-layer chromatography of phospholipids of *Calanus* sp. (acetone), *Calanus* sp. (ethanol), cholesterol 20 mg/mL, *M. norvegica* (acetone), *M. norvegica* (ethanol) and egg (acetone). Chloroform-methanol-water (80:25:2, v/v).

CONFIDENTIAL

CONFIDENTIAL

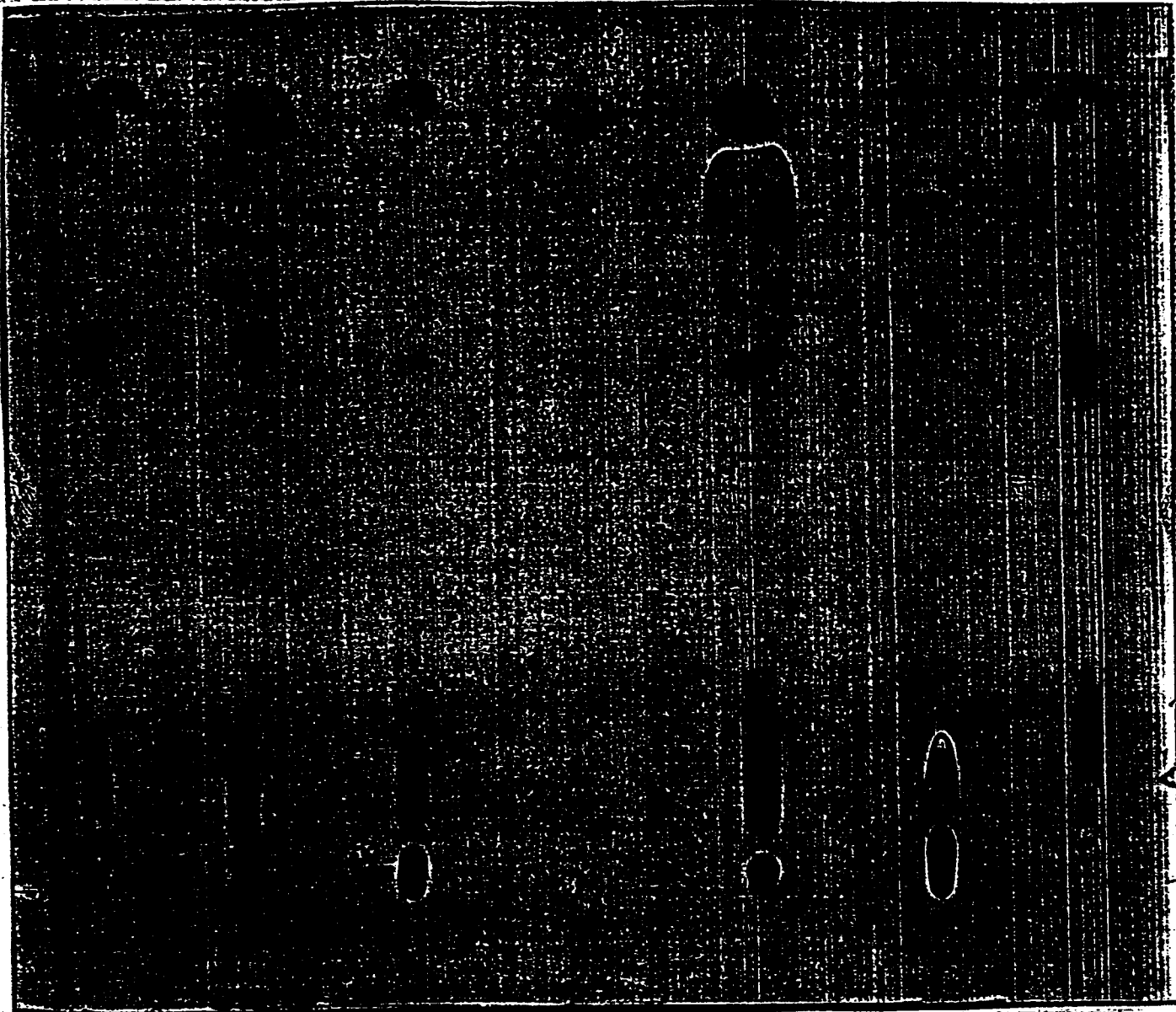

Figure 8: Thin-layer chromatography of phospholipids of *Calanus* sp. (acetone), *Calanus* sp. (ethanol), cholesterol 20 mg/mL, *E. pacifica* (acetone), *E. pacifica* (ethanol) and egg (acetone). Chloroform-methanol-water (80:25:2), v/v.

CONFIDENTIAL

FIGURE 9. INFLUENCE OF INCUBATION TIME IN ACETONE ON LIPID EXTRACTION
(*E. pacifica*).

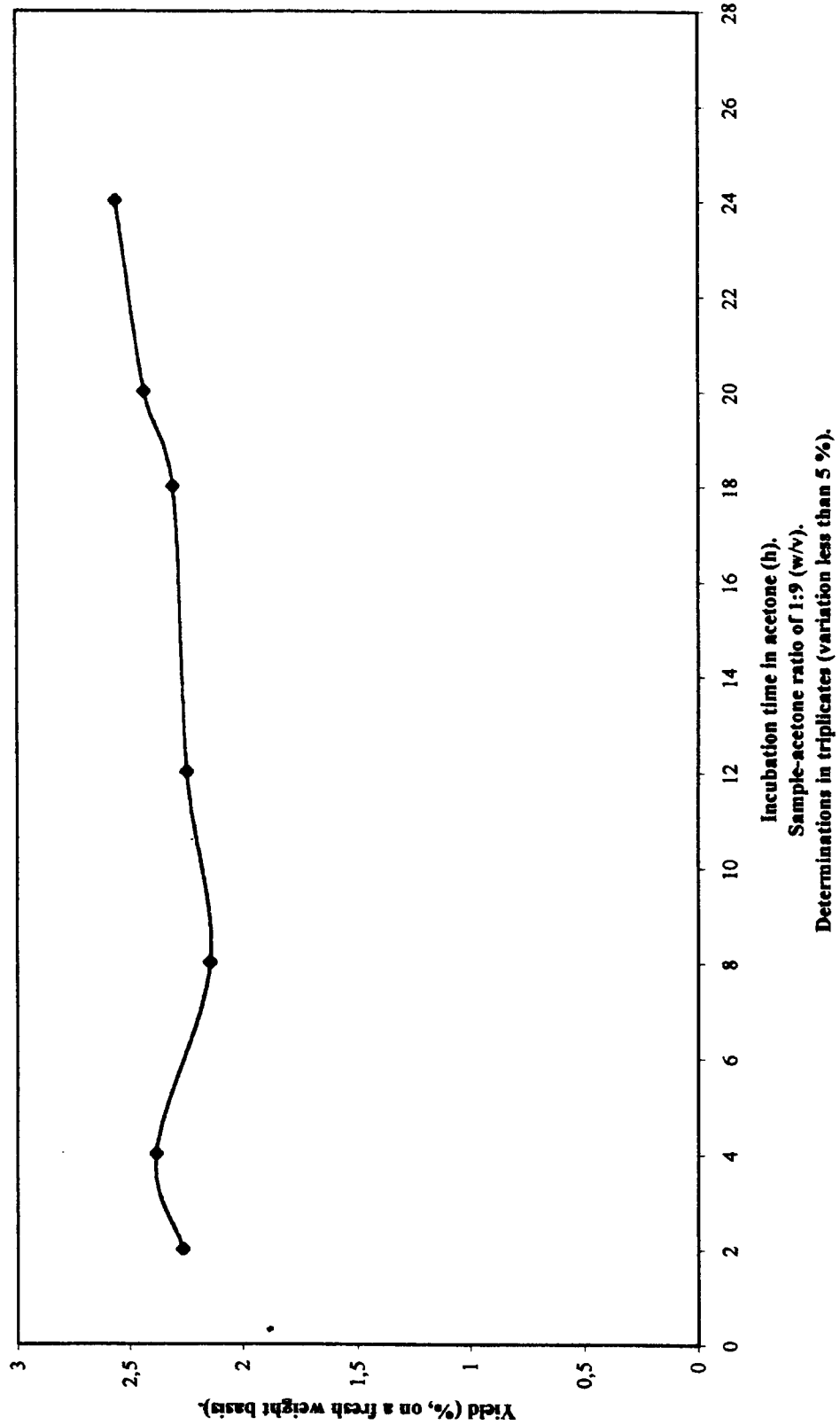

FIGURE 10. INFLUENCE OF THE VOLUME OF ACETONE ON LIPID EXTRACTION
(*E. pacifica*).

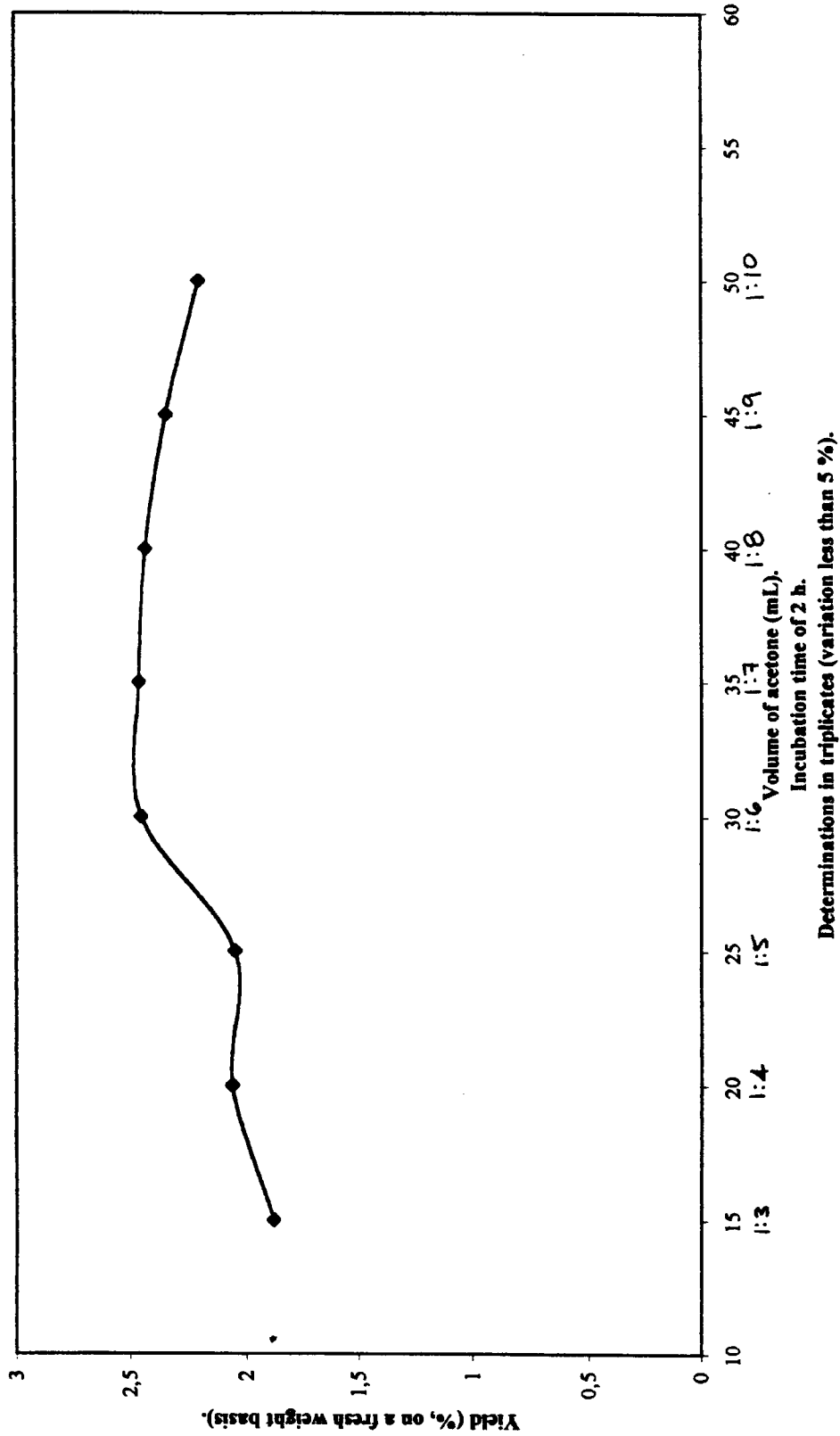

FIGURE 11. INFLUENCE OF INCUBATION TIME IN ETHANOL ON LIPID EXTRACTION (T. raschii).

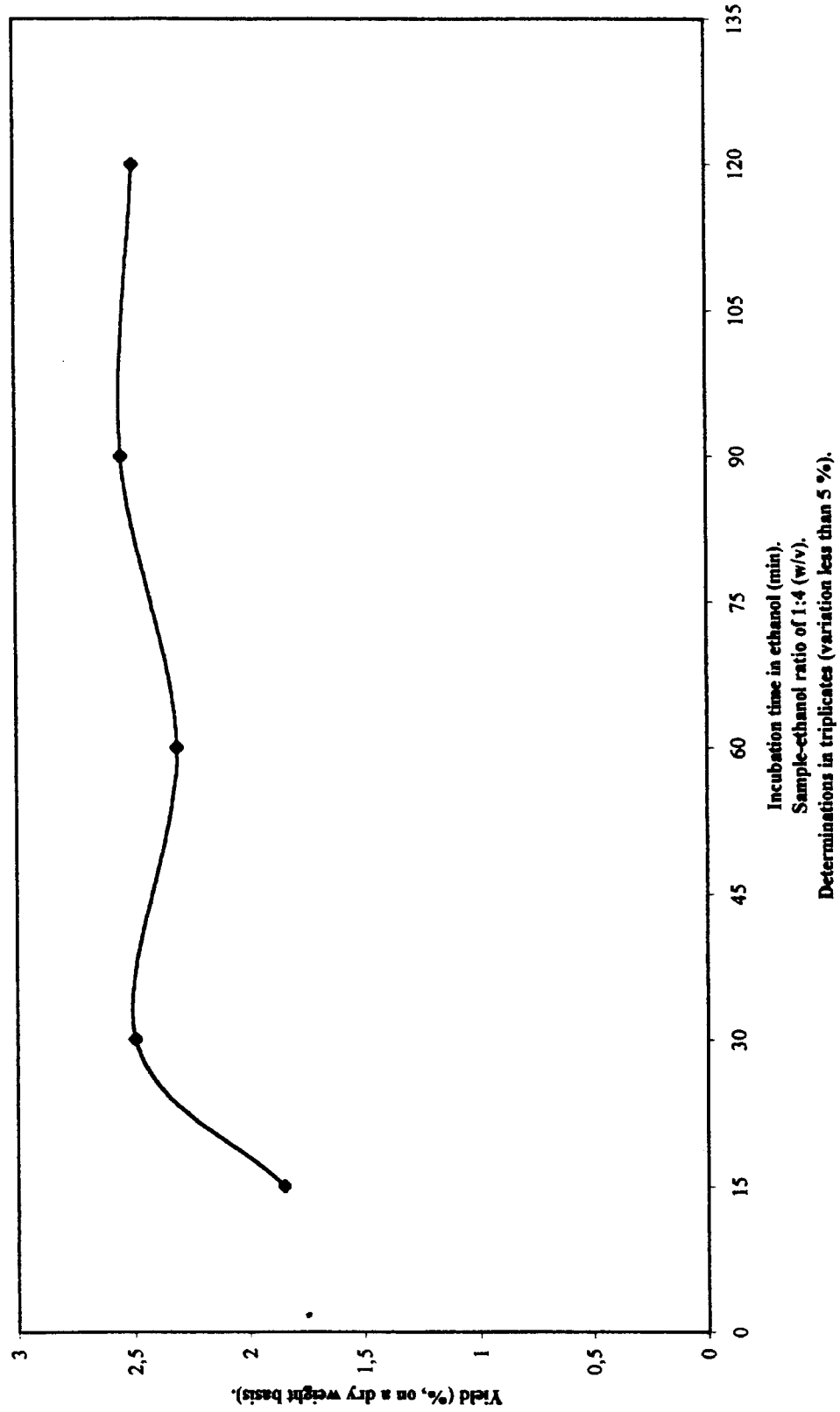
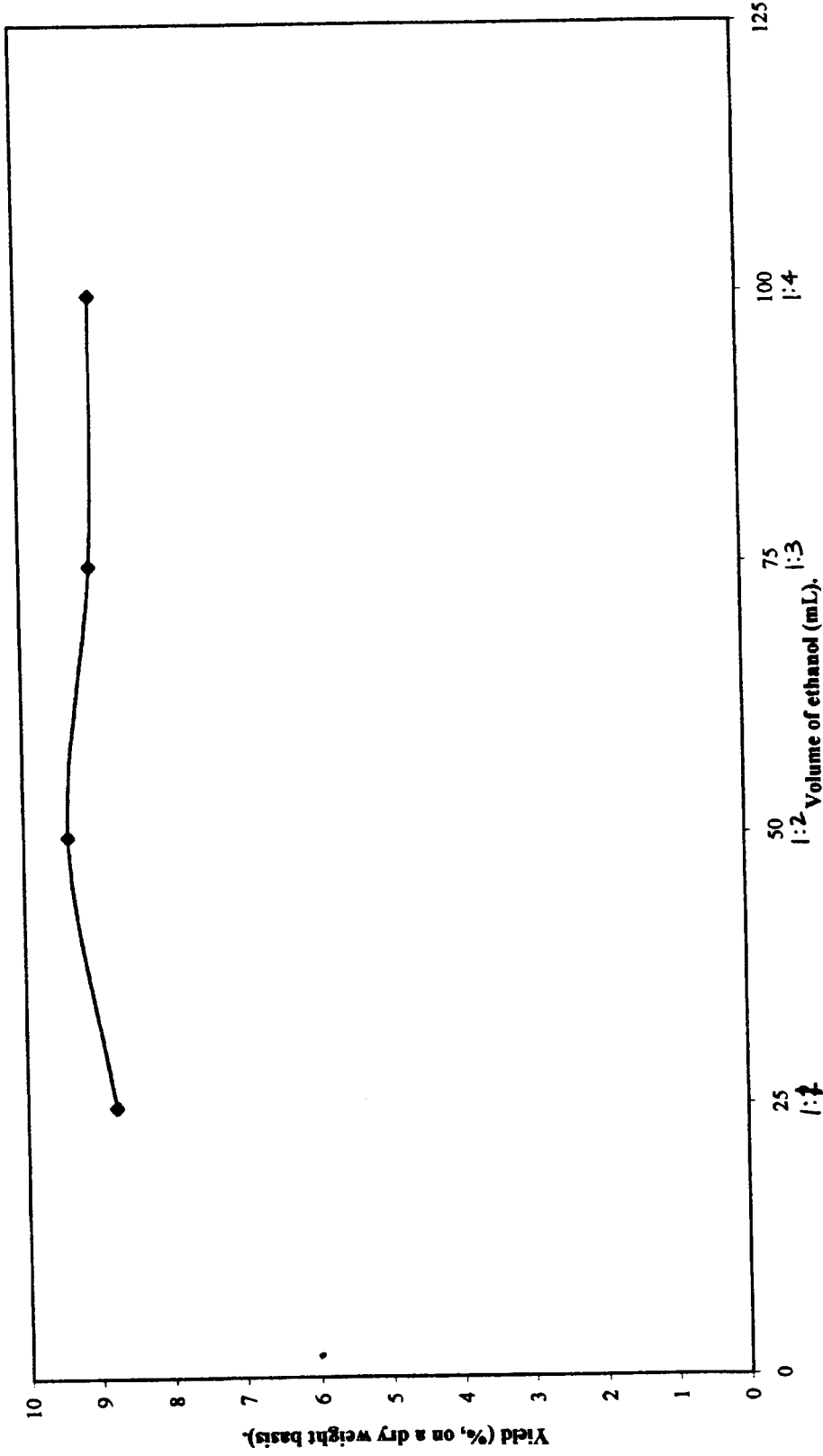

FIGURE 12. INFLUENCE OF THE VOLUME OF ETHANOL ON LIPID EXTRACTION (*E. pacifica*).



Incubation time of 30 min.
Determinations in triplicates (variation less than 5 %).

⑫ 公開特許公報 (A)

昭60-153779

⑬ Int. Cl. 4

A 23 L 1/42
A 61 K 9/48
31/355

識別記号

ADL

庁内整理番号

8412-4B
6742-4C
7330-4C

⑭ 公開 昭和60年(1985)8月13日

審査請求 未請求 発明の数 1 (全2頁)

⑮ 発明の名称 栄養補助食品

⑯ 特 願 昭59-10625

⑰ 出 願 昭59(1984)1月24日

⑱ 発 明 者 望 月 俊 治 東京都中野区上鷲宮4丁目9番6号
⑲ 発 明 者 福 岡 脩 多摩市永山4の4の21の304
⑳ 出 願 人 豊年製油株式会社 東京都千代田区大手町1丁目2番3号

明 細 書

1. 発明の名称

栄養補助食品

2. 特許請求の範囲

- (1) ビタミンEおよび大豆レシチンをエイコサペンタエン酸含量の高い油に溶解してなる混合液状物をセラチンのカプセル内に封入した栄養補助食品。
- (2) エイコサペンタエン酸含量の高い油が、イワシ油、サバ油、イカ油、オキアミ油、ミンク鯨油等のごとき水産動物油である特許請求の範囲第(1)項記載の栄養補助食品。

3. 発明の詳細な説明

本発明はビタミンE、大豆レシチンおよびエイコサペンタエン酸含量の高い油を主成分とする新規な栄養補助食品に関するものである。

近年、①豊かな食生活がもたらす栄養バランスの偏り、②嗜好優先の食生活がもたらす偏食、過剰摂取、③運動、休息、栄養の健康保持バランスのくずれによる栄養損失、④高齢化社会に対応し得る補助栄養の必然性、等の要素を背景として栄養補助食品の需要が急激に増加しており、特に成人病は食生活の改善によって予防せんとする思想が強いため栄養補助食品が好まれて食されている。

本発明はこのような食生活上のニーズから導かれたものであり、①細胞の老化を防ぐ、②コレステロール値を下げて動脈硬化を防止する、③過酸化脂質の発生をおさえて細胞の活性化を促す、④血管を浄化して脳卒中や心筋梗塞を防止する等の機能を有するビタミンEと、①ビタミンEならびにエイコサペンタエン酸の吸収を促進する、②コレステロールを低下させて動脈硬化を防止する等の機能を有する大豆レシチンと、抗血小板凝集作用に基づく抗血栓、抗動脈硬化等の機能を有するエイコサペンタエン酸含量の高い油を組合せた新規な栄養補助食品を提供せんとするものである。

すなわち、本発明は、ビタミンEおよび大豆レシチンをエイコサペンタエン酸含量の高い油に溶解してなる混合液状物をセラチンのカプセル内に封入した栄養補助食品である。

本発明において使用するビタミンEは、公知の製造法、例えば、植物油の不ケン化物を分子蒸留あるいはクロマトグラフィー等によって濃縮する方法で得られたものが適当であるが、その製造法は限定されるものではなく、また、その起源も限定されない。

小麦胚芽油、サフラワー油、米油、コーン油等の液状植物油中にはビタミンEが多く含まれているが、この含有量はせいぜい0.3%以下であるためこれをそのまま使用することは好ましくない。

本発明におけるビタミンEの配合量は、カプセル内に封

入する液状物全体中に占める割合が少なくとも1%必要であり、これ以下では生体内での生理活性作用が劣り、前記のごときビタミンEの効能が十分得られない。

また、ビタミンEと併用する大豆レシチンは、通常、大豆油の脱ガム工程で副生するガム質を脱水、乾燥して得られる大豆油を含んだ大豆リン脂質(所謂大豆レシチン)が適当であるが、アセトン、アルコール等により精製または濃縮されたレシチンを用いてもよく、また、ケファリン含量の少ないもしくはケファリン含量のない分別レシチンを使用することもできる。

この大豆レシチンが、カプセル内に封入する液状物全体中に占める割合は少なくとも1%必要であり、これ以下では前記のごとき大豆レシチンの効能が十分得られない。さらに、ビタミンEと大豆レシチンを溶解するエイコサペンタエン酸($C_{20:5}$)含量の高い油は、イワシ油、イカ油、オキアミ油、ミンク鯨油等のごときエイコサペンタエン酸を8%以上含有する水産動物油の精製油、あるいはこれらの油から分別法の手段によってエイコサペンタエン酸を濃縮して得られる油等が使用できる。

本発明におけるエイコサペンタエン酸含量の高い油の配合量は、カプセル内に封入する液状物全体中に占める割合が少なくとも10%必要であり、これ以下ではエイコサペンタエン酸の生体内での生理活性作用が劣り、前記のごときエイコサペンタエン酸の効能が十分得られない。ビタミンEおよび大豆レシチンをエイコサペンタエン酸

含量の高い油に溶解してなる混合液状物は、必要に応じ、これら各成分の有効濃度を維持できる範囲内において、小麦胚芽油、サフラワー油、米油、コーン油、大豆油、菜種油等の液状植物油で希釈することができる。

このようにして得られた混合液状物は、次いで、常法に従ってセラチンのカプセル内に封入する。

この封入方法の一例としては、混合液状物をセラチン、グリセリン、および水を溶解後射出成型したセラチンカプセルに所定量注入し、その後、注入口を加熱密封して本発明の栄養補助食品を製造する。

セラチンカプセルの形状は球形、ラクビーボール形等任意である。

このようにして得られた本発明の栄養補助食品は、細胞の老化を防ぎ、コレステロール値を下げ、過酸化脂質の発生をおさえ、血管を浄化する等の作用を有するビタミンEと、ビタミンEおよびエイコサペンタエン酸の吸収を促進し、コレステロールを低下させる等の作用を有する大豆レシチンと、抗血小板凝集による抗血栓および抗動脈硬化等の作用を有するエイコサペンタエン酸を含有するものであるから、これら各生理活性成分の相互作用によって、血中コレステロールを下げ、高血圧を防ぎ、細胞を若返らせて活性化するほか、心筋梗塞、脳梗塞のごとき血栓性疾患等、循環器系成人病の治療および予防に効果を有する等、健康食品としての機能を発揮し得るものである。

次に本発明の実施例を示す。

実施例 1.

ビタミンE 25重量部および大豆レシチン 25重量部を精製イワシ油(エイコサペンタエン酸含量約16%) 50重量部に混合し、約60℃に加熱、攪拌して均一に溶解した。

一方、セラチン60重量部、グリセリン30重量部、水10重量部を均一に混合し、フィルム状にした後、容量約300 m^3 のカプセル状に射出成型してセラチン容器を製造した。

この容器に前記の混合液状物を注入し、しかる後、注入口を加熱密封して本発明の栄養補助食品を得た。

実施例 2.

ビタミンE 30重量部および大豆レシチン 30重量部を、市販のエイコサペンタエン酸濃縮油(日本油脂製、サンオメガ、エイコサペンタエン酸含量約25%)とサフラワー油を1:1の重量割合で混合したエイコサペンタエン酸含量の高い油 40重量部に混合し、約60℃に加熱、攪拌して均一に溶解した。

一方、セラチン60重量部、グリセリン30重量部、水10重量部を均一に混合し、フィルム状にした後、容量約300 m^3 のカプセル状に射出成型してセラチン容器を製造した。

この容器に前記の混合液状物を注入し、しかる後、注入口を加熱密封して本発明の栄養補助食品を得た。

(51) Int. Cl 4 Classification Symbol Internal No.	(43) Publication Date August 13, 1985
A 23 L 1 / 42	8412 - 4B
A 61 K 9 / 48	6742 - 4C
31 / 355 ADL	7330 - 4C

	Request for Review	Unrequested	Number of Claims 1 (Total 2 Pages)
(54) Title of Invention	Nutritional Supplement		
	(21) Application Number	Sho 59 - 10625	
	(22) Application Date	January 24, 1984	
(72) Inventor	Motuski Kenji	Tokyo-to, Nakano-ku, UenoMiya 4 Choume 9 Ban 6 Go	
(72) Inventor	Fukuoka Ryuu	Tama-shi Nagayama 4 No 4 No 21 No 304	
(71) Applicant	Honen Seiyu Co. Ltd.	Tokyo-to, Chiyoda-ku, Otemachi 1 Choume 2 Ban 3 Go	

Specification

1. Title of Invention

Nutritional supplement

2. Scope of Claims

(1) A nutritional supplement being contained inside a gelatin capsule and comprising a nutritional liquid being formed by melting vitamin E, soybean lecithin in an oil having high eicosapentaenoic acid content.

(2) A nutritional supplement of claim 1 wherein the oil having high eicosapentaenoic acid content is a sea animal oil such as pilchard oil, mackerel oil, cuttlefish oil, krill oil, or mink oil.

3. Detailed Explanation of the Invention

The present invention relates to a new nutritional supplement having as its primary ingredients vitamin E, soybean lecithin, and an oil having high eicosapentaenoic acid content. In recent years, the demand for nutritional supplements has greatly increased due to factors such as (1) lack of nutritional balance brought about by a rich food culture, (2) pickiness and lack of food diversity caused by a selective food palette, (3) lack of nutrition brought about by a breakdown in balance of nutrition and health, exercise, and energy, and (4) the necessity for supplementary nutrition to correspond to an aging population. In particular, the desire to stem adult disease by the improvement of food life is strong, so people enjoy eating nutritional supplements.

The present invention arises out of the aforementioned nutritional needs and its object is to provide a new nutritional supplement from the combination of vitamin E, which (1) prevents the aging of cells, (2) lowers cholesterol and prevents the hardening of arteries, (3) prevents the occurrence of liquid fatty deposits and encourages cell life, (4) cleans and washes blood vessels and prevents brain or heart blood clots; soybean lecithin, which (1) encourages the absorption of vitamin E and eicosapentaenoic acid, (2) reduces cholesterol and prevents hardening of blood vessels and oil having high eicosapentaenoic acid content, which is effective anti-platelet aggregation, making it an anti-coagulant and acts to prevent the hardening of blood vessels.

In other words, the present invention is a nutritional supplement consisting of vitamin E and soybean lecithin melted in an oil having high eicosapentaenoic acid content in liquid form inserted into a gelatin capsule.

As for the vitamin E used in the present invention, items obtained by publicly known methods such as concentration by chromatography or molecular distillation of plant oils are appropriate, but the method of production thereof is not limited, and the source of energy is also not limited.

Vitamin E is included in great amounts in safflower oil, rice oil, corn oil, and other oil from water dwelling plants. However, the concentration

of the oil is at most 0.3%, so using any of these as-is is not desirable.

The amount of vitamin E included in the present invention must be at least 1% of the liquid included in the capsule. If less than this concentration is achieved the activity of the vitamin in the body is reduced, and the benefits of vitamin E cannot be achieved.

Also, soybean fatty substance containing soybean oil obtained by dehydrating and drying gum produced by the production of soybean gum is generally acceptable for the soybean lecithin used in conjunction with vitamin E, but it is also acceptable to use lecithin that has been sugared and concentrated via acetone or alcohol, and it is also possible to use separated lecithin that contains little of no keratin.

This soybean lecithin must be present in the liquid that is inserted into the capsule in a concentration of at least 1%. As noted before, if the concentration falls below this level the effects of the substance will not be sufficient. In addition, for oil with a high concentration of eicosapentaenoic acid (C20 : 5) that has vitamin E and soybean lecithin dissolved within it, an oil with a eicosapentaenoic acid content of 8% or higher may be used, such as that found in sea animal oils such as pilchard oil, mackerel oil, cuttlefish oil, krill oil, or mink oil, or an oil that was derived from one of the above and had was concentrated with respect to eicosapentaenoic acid content.

The concentration of oil having a high concentration of eicosapentaenoic acid in the present invention must be at least 10% of the volume of liquid in the capsule. If this concentration is not achieved then the effect of the oil in the body will be lacking and as noted before the

Below, the embodiments of the present invention are explained.
Embodiment 1.

25 parts vitamin E and 25 parts soybean lecithin are dissolved into 50 parts fish oil (containing 16% eicosapentaenoic acid), heated to around 60 degrees Celsius, and dried.

Then 60 parts gelatin, 30 parts glycerin, and 10 parts water are uniformly mixed, are made to take a film like form, are poured into a 300 milligram capsule and put into a gelatin container. The aforementioned compound is poured into this container, the entry point is heat sealed, and the nutritional supplement of the present invention is formed.

Embodiment 2

30 parts vitamin E by weight and 30 parts soybean lecithin are dissolved into a 1:1 mixture of safflower oil and market concentrated eicosapentaenoic acid oil (produced by Nippon Yushi Co. Ltd., Sun Omega, and containing 25% eicosapentaenoic acid), the mixture being 40 parts. The liquid is heated to around 60 degrees Celsius and dried.

Then 60 parts gelatin, 30 parts glycerin, and 10 parts water are uniformly mixed, are made to take a film like form, are poured into a 300 milligram capsule and put into a gelatin container. The aforementioned compound is poured into this container, the entry point is heat sealed, and the nutritional supplement of the present invention is formed.

effects will not be sufficient. A nutritional supplement formed by melting vitamin E and soybean lecithin in oil with a high concentration of eicosapentaenoic acid, within the scope wherein it is possible to maintain the relative levels of the various substances, may be diluted with safflower oil, rice oil, corn oil, soybean oil, or seaweed oil or other sea life oil. Mixed oil obtained in this way is inserted into a gelatin capsule under normal circumstances.

As one example of the method of sealing the substance in a capsule, the mixed liquid will be sealed in a gelatin capsule in a certain amount, the gelatin formed by melting gelatin, glycerin, and water. After that, the entry hole will be heated and sealed to create the nutritional substance of the present invention.

The form of the gelatin capsules may be spherical or in the form of a rugby ball.

Because the nutritional supplement of the present invention obtained in this way contains vitamin E which prevents the aging of cells, lowers cholesterol numbers, prevents excess fat deposits, and has other positive side effects, as well as contains soybean lecithin, which acts to lower cholesterol and promote the absorption of eicosapentaenoic acid, and contains eicosapentaenoic acid, which acts to prevent the hardening of blood vessels, the combined effects of the various ingredients act to reduce the cholesterol levels in the blood, prevent high blood pressure, reduce fat, and promote heart and brain function in brain and heart medical patients, and acts to treat and prevent adult circulatory diseases, and as such can be said to function as a nutritional supplement.

(19)日本国特許庁 (J P)

(12) 公開特許公報 (A)

(11)特許出願公開番号

特開平8-231391

(43)公開日 平成8年(1996)9月10日

(51)Int.Cl. ⁹	識別記号	庁内整理番号	F I	技術表示箇所
A 6 1 K 31/20	AAM		A 6 1 K 31/20	AAM

審査請求 未請求 請求項の数5 O L (全 4 頁)

(21)出願番号	特願平7-36362	(71)出願人	392030380 株式会社神奈川化学研究所 神奈川県相模原市西大沼4丁目4番1号
(22)出願日	平成7年(1995)2月24日	(71)出願人	000173762 財団法人相模中央化学研究所 神奈川県相模原市西大沼4丁目4番1号
		(71)出願人	592197599 株式会社富士薬品 埼玉県大宮市桜木町4丁目383番地
		(72)発明者	矢澤 一良 神奈川県相模原市鶴野森1-28-10
		(72)発明者	宮永 和夫 群馬県前橋市関根町3-5-29

最終頁に続く

(54)【発明の名称】 痴呆症状改善薬

(57)【要約】

【目的】 痴呆症状を速やかに改善する、副作用のない痴呆症状改善薬を提供する。

【構成】 ドコサヘキサエン酸を有効成分として含有することを特徴とする痴呆症状改善薬。

【効果】 痴呆症による意欲の低下、せん妄、対人関係の悪化、徘徊、落ちつきのなさ等の精神症状、および／または痴呆症による計算能力の低下、判断力の低下、高次機能の低下等の知的機能の低下を改善する。

AKBM 1076

000001

RIMFROST EXHIBIT 1024 page 0473

AKER6771PC80804514

【特許請求の範囲】

【請求項1】 ドコサヘキサエン酸を有効成分として含有することを特徴とする痴呆症状改善薬。

【請求項2】 痴呆症状が痴呆症による精神症状である、請求項1に記載の痴呆症状改善薬。

【請求項3】 精神症状が、痴呆症による意欲の低下、せん妄、対人関係の悪化、落ちつきのなさ、および／または徘徊である、請求項2に記載の痴呆症状改善薬。

【請求項4】 痴呆症状が痴呆症による知的機能の低下である、請求項1に記載の痴呆症状改善薬。

【請求項5】 知的機能の低下が、痴呆症による計算能力の低下、判断力の低下、および／または高次機能の低下である、請求項1に記載の痴呆症状改善薬。

【発明の詳細な説明】

【0001】

【産業上の利用分野】本発明は痴呆症に伴う痴呆症状を改善する薬剤に関し、更に詳しくは、ドコサヘキサエン酸を有効成分として含有することを特徴とする痴呆症状改善薬に関するものである。

【0002】

【従来技術】近年の人口の高齢化に伴い、痴呆症に対する薬剤の開発は医学的にも社会的にもますます重要な課題となっている。例えば、痴呆症患者の意欲の低下およびせん妄、あるいは対人関係でのトラブル等により、家族との関係が悪化して家庭介護が困難となることは最も大きな問題として指摘されている。従来種々の薬剤が痴呆症状改善薬として開発されてきたが、その効果は必ずしも満足しうるものではないばかりか、頭痛、めまい、自覚性低下、感情障害、胃腸障害等の副作用を伴うことが多く、より優れた痴呆症状改善薬に対する期待は大きい。

【0003】ドコサヘキサエン酸は脳や網膜の興奮性膜に多く含まれている不飽和脂肪酸で、アラキドン酸カスケードを阻害する作用を有していることが知られている。またこのほかに、幾つかの有用な生理作用を有することが知られており、例えば、脳機能改善組成物、学習能力増強剤、記憶力増強剤、痴呆予防剤、痴呆治療剤、または脳機能改善効果を有する機能性食品（特開平2-49723号）、コリン作動性薬剤（特開平1-279830号）、血栓症治療剤（特開昭57-35512号）等の特許出願がなされている。これらの中で、特開平2-49723号はドコサヘキサエン酸による学習能力や記憶力の増強及び血小板凝集の抑制作用を明らかにしているにすぎず、痴呆症状の改善については具体的開示は全くない。また、特開平1-279830号はドコサヘキサエン酸によりコリンエステラーゼ阻害剤であるフィズスチグミンの脳への送達量が増加することに関するものである。

【0004】

【発明が解決しようとする課題】本発明は、痴呆症状を

速やかに改善する、副作用のない痴呆症状改善薬を提供することにある。

【0005】

【課題を解決するための手段】本発明者らは、健康食品として広く知られているドコサヘキサエン酸を痴呆症患者に投与すると、その痴呆症状が速やかに改善されるという新たな知見に基づき、本発明を完成するに至った。

【0006】すなわち、本発明は、ドコサヘキサエン酸を有効成分として含有することを特徴とする痴呆症状改善薬を提供する。

【0007】本発明の痴呆症状改善薬は、多発梗塞性痴呆、脳血管性痴呆、脳機能障害による痴呆、ならびにアルツハイマー型痴呆等の痴呆症に随伴する精神症状（例えば、意欲の低下、せん妄、対人関係の悪化、落ちつきのなさ、徘徊等）あるいは知的機能の低下（例えば、計算能力の低下、判断力の低下、高次機能の低下等）などに適用される。

【0008】本発明に用いるドコサヘキサエン酸とは、遊離酸をはじめ、その塩、エステル、グリセリド、リン脂質、コリン化合物、アスコルビン酸化合物、アミノ酸化合物等を意味するものである。このドコサヘキサエン酸を含む油としては、好ましくは総脂肪酸中のドコサヘキサエン酸（遊離酸として）の占める割合が10%以上のものが良く、このようなものの例を上げるとイワシ、サバ、アジ、サケ、サンマなどの青背魚より抽出した魚油、マグロやカツオなどの大型海産魚の眼窩脂肪由来の魚油、微生物由来の油脂、オキアミ油、タラやイカ肝臓より抽出した海産物由来の油脂などが好ましい例として挙げられる。

【0009】本発明の痴呆症状改善薬は治療のために経口的あるいは非経口的に投与することができる。経口投与剤としては散剤、顆粒剤、カプセル剤、錠剤などの固形製剤あるいはシロップ剤、エリキシル剤などの液状製剤とすることができる。また、非経口投与剤として注射剤とすることができる。これらの製剤は活性成分に薬理学的、製剤学的に認容される製造助剤を加えることにより常法に従って製造される。更に公知の技術により持続性製剤とすることも可能である。当該製造助剤を用いる場合は、本発明の痴呆症状改善薬中のドコサヘキサエン酸（遊離酸として）の配合量は通常は10～100重量%、好ましくは50～100重量%である。

【0010】上記製造助剤としては、内服用製剤（経口剤）、注射用製材（注射剤）、粘膜投与剤（パッカ、トローチ、坐剤等）、外用剤（軟膏、貼付剤等）などの投与経路に応じた適当な製剤用成分から使用される。

【0011】例えば、経口剤および粘膜投与剤にあっては、賦形剤（例：澱粉、乳糖、結晶セルロース、乳糖カルシウム、メタケイ酸アルミン酸マグネシウム、無水ケイ酸）、崩壊剤（例：カルボキシメチルセルロース、カルボキシメチルセルロースカルシウム）、滑沢剤（例：

ステアリン酸マグネシウム、タルク)、コーティング剤(例:ヒドロキシエチルセルロース、白糖、ヒドロキシプロピルセルロース、ポリビニルピロリドン)、矯味剤などの製剤用成分が使用される。

【0012】顆粒剤を製造するには湿式又は乾式造粒し、錠剤を製造するにはこれらの散剤及び顆粒剤をそのままあるいはステアリン酸マグネシウム、タルクなどの滑沢剤を加えて打錠すればよい。これらの顆粒又は錠剤はヒドロキシプロピルメチルセルロースフタレート、メタアクリル酸、メタアクリル酸メチルコポリマーなどの腸溶性基剤で被覆して腸溶性製剤、あるいはエチルセルロース、カルナウバロウ、硬化油などで被覆して持続性製剤とすることもできる。また、カプセル剤を製造するには散剤又は顆粒剤を硬カプセルに充填するか、活性成分をそのままあるいはグリセリン、ポリエチレングリコール、ゴマ油、オリーブ油などに溶解したのちゼラチン膜で被覆し軟カプセル剤とすることができる。

【0013】経口投与用の液状製剤を製造するには活性成分と白糖、ソルビトール、グリセリンなどの甘味剤とを水に溶解して透明なシロップ剤、更に精油、エタノールなどを加えてエリキシル剤とするか、アラビアゴム、トラガント、ポリソルベート80、カルボキシメチルセルロースナトリウムなどを加えて乳剤又は懸濁剤としてもよい。これらの液状製剤には所望により矯味剤、着色剤、保存剤などを加えてもよい。

【0014】また注射剤にあっては、水性注射剤を構成し得る溶解剤ないし溶解補助剤(例:注射用蒸留水、生理食塩水、プロピレングリコール)、懸濁化剤(例:ポリソルベート80などの界面活性剤)、pH調整剤(例:有機酸またはその金属塩)、安定剤などの製剤用成分が使用される。

【0015】注射剤を製造するには活性成分を必要に応じて塩酸、水酸化ナトリウム、乳剤、乳酸ナトリウム、リン酸一水素ナトリウム、リン酸二水素ナトリウムなどのpH調整剤、塩化ナトリウム、ブドウ糖などの等張化剤とともに注射用蒸留水に溶解し、無菌ろ過してアンプルに充填するか、更にマンニトール、デキストリン、シクロデキストリン、ゼラチンなどを加えて真空下凍結乾燥し、用時溶解型の注射剤としてもよいし、活性成分にレシチン、ポリソルベート80、ポリオキシエチレン硬化ヒマシ油などを加えて水中で乳化せしめ注射用乳剤とす

ることもできる。

【0016】さらに外用剤にあっては、水性ないし油性の溶解剤ないし溶解補助剤(例:アルコール、脂肪酸エステル類)、粘着剤(例:カルボキシビニルポリマー、多糖類)、乳化剤(例:界面活性剤)などの製剤用成分が使用される。直腸投与剤を製造するには活性成分及びカカオ脂、脂肪酸のトリ、ジ及びモノグリセリド、ポリエチレングリコールなどの坐剤用基剤とを加温して溶解し型に流しこんで冷却するか、活性成分をポリエチレングリコール、大豆油などに溶解したのちゼラチン膜で被覆すればよい。

【0017】その他、上記構成を有する本発明の痴呆症状改善薬は、公知の製造法、例えば日本薬局方第10版製剤総則記載の方法ないし適当な改良を加えた方法によっても製造することができる。

【0018】とくに本発明の痴呆症状改善薬は、高純度の(例えば90%以上)のドコサヘキサエン酸を軟カプセル剤の形態で投与するのが、投与が簡便な点で好ましい。

【0019】本発明の痴呆症状改善薬の有効成分であるドコサヘキサエン酸の投与量は、患者の体重、症状等により異なるが、一般には一日当たり、100~2000mg/人程度であり、一日1回~数回に分けて投与する。

【0020】以下、本発明を実施例により詳細に説明する。

【0021】

【実施例】

試験例1. 精神症状の改善度評価試験

脳血管性痴呆患者13名、アルツハイマー型痴呆患者(アルツハイマー病と老年痴呆)5名の対象者に対して、従来の薬剤に加えてDHA70mg入りカプセルを10錠~20錠投与(以下、DHA投与群と略)し、DHAの投与前と投与6ヶ月後の検査結果を比較検討した。併せて、従来の薬剤治療を継続した群(以下、投与不変群と略;24名)を対照群として同様の検査を施行し、DHA投与群との変化を比較した。結果を表1に示す。

【0022】

【表1】

表1. 精神症状の改善度

	改善	やや改善	不変	悪化
脳血管性痴呆	9	1	2	1
アルツハイマー型痴呆	0	5	0	0

【0023】なお、脳血管性痴呆における改善の内容

は、主にせん妄が改善された症例が2例、主に意欲が改

善された症例が3例、主に対人関係が改善された症例が3例、主に徘徊が改善された症例が1例であった。また、アルツハイマー型痴呆においては、意欲、対人関係、落ちつきが改善された症例が、おのおの3例、1例、1例であった。投与不変群は、この間、症状の変化はみられず、全例不変と評価された。

【0024】試験例2. 知的機能低下の改善度評価試験

試験例1と同じ対象者に対して、計算力、判断力及び高次機能の3項目を知的機能の簡易評価検査とし、コース立方体組合せテストを動作性知能の簡易評価検査とした。検査は、投与前と投与後6ヶ月後の計2回行い、結果は統計学的に処理をした。結果を表2に示す。

【0025】

【表2】

表2. 知的機能の改善度

知的機能	DHA投与群		投与不変群	
	投与前 (試験開始時)	6ヶ月後	試験開始時	6ヶ月後
計算力総点	6.2±3.3	6.9±3.0	3.4±2.9	3.1±3.3
判断力総点	4.6±3.0	5.5±3.3	4.1±2.9	2.6±2.4
高次機能	5.1±2.9	6.0±2.9	3.6±3.3	2.4±2.8

【0026】なお、コース立方体およびIQ（動作性）試験においても、投与前後で改善が認められた。

フロントページの続き

(72)発明者 宮川 富三雄
神奈川県相模原市南台1-2-12

(72)発明者 村松 宏
東京都日野市西平山5-27-10

(51) Int. Cl 6	Classification Symbol	Internal No.	FI	Technology Display	Location
A61K 31 / 20	AAM		A61K 31 / 20	AAM	

Request for Review Unrequested Number of Claims 5 (Total 4 Pages)

(21) Application Number	7 - 36362	(71) Applicant	392030380
(22) Application Date	February 24, 1995	(71) Applicant	Kanagawa Kagaku Kenkyuujo Co. Ltd. Kanagawa-ken, Sumohara-shi, Nishi Onuma 4 Choume 4 Ban 1 Go 000173762
		(71) Applicant	Sumo Central Chemical Research Location Foundation Kanagawa-ken, Sumohara-shi, Nishi Onuma 4 Choume 4 Ban 1 Go 592197599
		(71) Applicant	Fuji Yakuhin Co. Ltd. Saitama-ken, Omiya-shi, Sakuragi Machi 4 Choume 383 Banchi
		(72) Inventor	Ichira Yasawa Kanagawa_ken, Sumohara-shi, Kami-no- mori 1 - 28 - 10
		(72) Inventor	Miyanaga Kazuo Gunma-ken, Maebashi-shi, Kanne Machi 3 - 5 - 29

Continued on the last page

(54) [Title of the Invention] Medicine for Improvement of Dementia Symptoms

(57) [Abstract]

[Objective] To smoothly improve the symptoms of dementia and provide a medicine for said improvement without side effects.

[Structure] A medicine for improvement of dementia symptoms that has as a characteristic the inclusion of docosahexaenoic acid (DHA).

[Effect] The medicine improves the following ailments caused by dementia: loss of will, delirium, worsening of human relationships, loitering, manic psychological episodes and/or the reduction of powers of calculation, reduction of judgment, and reduction in the intellectual capacities and functioning of the higher functions.

[Scope of Claims]

[Claim 1] A medicine for improvement of dementia symptoms being characterized by including as an active ingredient DHA.

[Claim 2] A medicine for improvement of dementia symptoms of claim 1 that treats an adverse psychological state that is dementia.

[Claim 3] A medicine for improvement of dementia symptoms of claim 2 working to reduce will loss, delirium, worsening of human relationships, manic states, and/or loitering.

[Claim 4] A medicine for improvement of dementia symptoms of claim 1 working to reduce the loss of higher functions and of judgment brought about by dementia.

[Claim 5] A medicine for improvement of dementia symptoms of claim 1 working to reduce the loss of intellectual capacity, loss of facilities of calculation, loss of judgment, and/or loss of higher function due to dementia.

[Detailed Description of the Invention]

[0001]

[Industrial Field of Use] The present invention is in relation to a medicine for the betterment of mental symptoms that accompany dementia, and in particular relates to a medicine for the improvement of dementia symptoms that includes as an active ingredient DHA.

[0002]

[Related Art] With the aging of society in recent years, the development of medicine for the treatment of dementia has become more important both medically and socially. For example, a dementia patient may suffer worsening family relationships as a result of loss of will, delirium, or trouble in interpersonal relationships, and the looking after of the patient within the family becomes difficult. This has been pointed out as the most serious cause for concern. In past years many medicines have been developed for dementia, but the results haven't always been satisfactory. Furthermore, the traditional medicine can cause headache, dizziness, reduction in sex drive, emotional disturbances, and other side effects such as damage to the stomach. It is with this that there has been great expectation for the development of a new medicine for dementia.

[0003] DHA is present in abundance in the brain and the thick mucus membranes. DHA is known to stop the functioning of arachidonic acid. Also, in addition to this, it is known that DHA contains several useful biological functions. For example, the following patent applications have been made: substance for the increase of brain function, medicine for the improvement of academic performance, medicine for improvement of memory, dementia prevention substance, substance for the treatment of dementia, and functional food that improves brain function (Hei 2 – 49723), cholinergic agent (Hei 1 – 279830), agent for the treatment of thrombosis (Sho 57 – 35512), among others. Among these, patent application Hei 2 – 49723 shows that DHA can aid in the improvement of academic ability as well as increasing memory performance, and also acts to prevent the formation of platelet aggregation. However, this application said nothing more and did not hint at the specific application of DHA to dementia. Also, Application Hei 1 – 279830 is in relation to the increase of transmission volume to the brain of physostigmine, a cholinesterase antagonist, via the DHA.

[0004]

[Problem Solved by the Invention] The present invention provides a medicine to improve with the symptoms of dementia without providing side effects.

[0005]

[Method of Solving the Problem] The inventors of the present invention gave DHA, widely known for being a health food, to dementia patients, whereupon the symptoms of the dementia were immediately lessened, and based on that discovery gathered to file this application.

[0006] In other words, the present invention provides a medicine for the improvement of dementia symptoms that includes DHA.

[0007] The medicine for the improvement of dementia symptoms of the present invention is applied to psychological states accompanying dementia from multiple infarction, brain blood vessel function, brain damage, or Alzheimer's disease (such as loss of will, delirium, worsening of human relationships, mania, loitering, etc.) or the reduction in intellectual capabilities (for example a reduction in the powers of calculation, a reduction in judgment, or a reduction in higher order functions).

[0008] The DHA used in the present invention is an isolated acid, and refers to salt, ester, glyceride, phospholipids, choline compounds, ascorbic acid compounds, amino acid compounds. As for the oil that includes the DHA, an inclusion ratio of 10% or more DHA (as an isolated acid) within general fatty acids. As an example of such an oil, the fish oil extracted from blue backed fish such as Japanese pilchard, mackerel, horse mackerel, salmon, and Pacific saury, the fish oil from large ocean fish eye oil, such as that of the tuna or the shipjack tuna, oil coming from microorganisms, krill oil, and oil from industrial products extracted from the livers of Pacific cod and dolphins.

[0009] The medicine for the improvement of the symptoms of dementia of the present invention may be administered either orally or non-orally. For oral administration, powder, granule, capsule, lozenge, and other solid forms of administration are acceptable. Alternatively, the medicine may be administered as syrup, elixir, and other liquid forms. Also, for non-oral administration an injection can be given. By adding these forms of manufacturing to the approved medicine that is the active portion of the drug the medicine may be manufactured in the normal fashion. Furthermore, it is also possible to turn the medicine into extended release tablets via publicly known methods. When using those manufacturing helper substances the DHA levels within the medicine for the improvement of the symptoms of dementia of the present invention is between 10 and 100 % by weight, and preferably between 50 and 100 % by weight.

[0010] An appropriate manufacturing helper substance will be used in the above in accordance with the administration method, for example, internal use substances (oral medicine), injection use substances (injected medicine), adhesive administration substances (buccal, troche, and suppositories).

[0011] For example, in oral and adhesive administration excipients (example: starch, milk sugar, crystal cellulose, milk calcium, metakei acid aluminum acid magnesium, waterless silicic acid), collapse agents (example: carboxymethylcellulose, carboxymethyl cellulose calcium), lubricants (example: sterin acid magnesium, talc), coatings (example: hydroxyl methyl

cellulose, sugar, hydroxyl propyl cellulose), and taste making agents, and other production substances may be used.

[0012] In order to manufacture granules, wet or dry droplets are formed, and in order to produce pills, it is permissible to form the tablets with the powder and granules either left as they are or with additional stearic acid magnesium, talc, or other lubricant. These granules or tablets are coated with a stomach settling agent such as hydroxypropyl – methyl cellulose phthalate or methacrylic acid or methacrylic acid methyl copolymer, among others, and coating is made using stomach setting agent or ethyl cellulose, carnauba wax, hardened oil, or other substance. By doing so a durable pharmaceutical product may be produced. Also, in order to produce the medicine in capsule form, the powder or granules are filled into a hard capsule or the active ingredients are coated with a gelatin film either as is or after being melted into gelatin, polyethelyn glycol, sesame oil, olive oil, or other oil. In this way it is possible to generate a soft capsule.

[0013] In order to produce liquid medicine for oral administration, the active ingredient and a sweetener such as refined sugar, sorbitol, glycerol are dissolved in water, a clear syrup, essential oil, and ethanol are added making an elixir-like medicine, or alternatively gum arabic, tragacanth gum, polysorbate 80, carboxymethyl cellulose (CMC), or another such substance is added and an emulsion or a suspension is produced. This is also acceptable. Flavor agents, color changing agents, and/or preservatives may be added to the liquid solutions discussed herein, according to taste.

[0014] Also, stable production medicine components are used for injectable medicine, such as solution from water soluble injectable medicine and melted helper substances (example injection use distilled water, biological salt water, or propylene glycol), suspension substances (example: polysorbate 80 or other surfactant), pH regulation substances (example: organic acid or its metal salt).

[0015] In order to produce injection-use medication, the active ingredients are mixed with salts, sodium hydroxide, emulsion, emulsion natrium, dibasic sodium phosphate, sodium dihydrogen-phosphate, and other pH adjusting agents, sodium chloride, grape sugars, and other tonicity adjusting agents in injection use distilled water. The solution is sterilized and poured into an ampoule. Alternatively, mannitol, dextrin, cyclo-dextrin, gelatin, and other substances are added, fired into crystals under vacuum conditions, and placed into a form to be melted at the time of injection. To the active ingredients are added lecithin, polysolvent 80, polyoxyethylene hydrogenated castor oil, and other substances, melted into water and made into an injectable solution.

[0016] Additionally, water or oil soluble medicines or soluble helper substances (example: alcohol, fatty acid esters), adhesives (example: carboxy vinyl polymer multi-sugars), emulsifiers (example: surfactants), and other substances are used as ingredients in externally administrable medicine. In producing rectally administered medicine the active ingredients and cocoa butter, fatty acid salts, monoglycerides and other suppository use substances are humidified, melted, poured into a mold, hardened, and frozen. Alternatively, the active ingredient could be melted in polyethylene glycol, soybean oil, or other oil, and thereafter coated in a gelatin film.

[0017] Additionally, the medicine for the improvement of dementia symptoms of the present invention with the above listed characteristics may be produced using publicly known manufacturing methods, for example as stipulated in version 10 of the Pharmacy Act of Japan, noted in the manufacturing addendum, or a method that has appropriately modified the aforementioned method.

[0018] In particular, the medicine for the improvement of dementia of the present invention administration of a high purity concentration of DHA (for example, 90% or above) via a soft capsule is desirable because of the ease of administration.

[0019] The amount of DHA administered in the medicine to prevent the symptoms of dementia of the present invention will vary based on the body weight and health conditions of the patient, but in general, the dose will range from 100 to 2000 mg / person with between one and several administrations per day.

[0020] Below we explain the present invention in detail by following an embodiment of the present invention.

[0021]

[Embodiments]

Embodiment 1. Test to measure level of psychological improvement

The targets of this test were 13 cranial blood vessel related dementia patients and 5 Alzheimer's related dementia patients. In addition to traditional treatments, 10 – 20 capsules including 70 mg of DHA each were administered (hereinafter referred to as the "DHA Administration Group"), and the results of the test were compared before administration and 6 months after administration. Also, a group that continued traditional pharmaceutical treatments (hereinafter referred to as the "Unchanging Administration Group"; 24 individuals) were targeted for the same test and the variance from the DHA Administration Group was observed. The results appear in Table 1.

[0022]

[Table 1]

	Recovered	Somewhat Recovered	No Change	Worsened
Cranial Blood Vessel Dementia	9	1	2	1
Alzheimer's Dementia	0	5	0	0

[0023] To further break down the content of the “improvements” seen in the cranial blood vessel related dementia patients, 2 cases of improvement in delirium were seen, 3 cases of greatly improved ambition were observed, 3 cases of improved loitering were observed. Also, among the Alzheimer’s dementia patients we observed 1 case each of improved ambition, human relationships, and manic states, respectively, for a total of 3 observed improvements. The Unchanging Administration Group did not show any change in symptoms in this same period, and all cases were evaluated to have no change.

[0024] Embodiment 2. Test to measure improvement of loss of intellectual capacity.

The calculation skills, judgment, and higher functions of the same test group as test 1 were evaluated. This test was a simple evaluation of intellectual abilities. Also, a course correction and pathfinding test was administered as a simple measure of motor control. The test was administered twice, once before administration of DHA and once 6 months after the administration of DHA. The results were statistically aggregated. The results are shown in Table 2.

[0025]
[Table 2]

Table 2. Level of Improvement of Intellectual Abilities

Intellectual Ability	DHA Admin Group		Unchanged Group	
	Preadmin (at test start time)	6 months post – admin	Pre-admin	6 months post - admin
Calculation Abilities Total	6.2 +- 3.3	6.9 +- 3.0	3.4 +- 2.4	3.1 +- 3.3
Judgment Total	4.6 +- 3.0	5.5 +- 3.3	4.1 +- 2.9	2.6 +- 2.4
Higher Function Total	5.1 +- 2.9	6.0 +- 2.9	3.6 +- 3.3	2.4 +- 2.8

[0026] Note that in both the motor and IQ tests,

improvements were seen after the administration of DHA.

Continued from the front page

(72) Inventor Miyakawa Fumio
Kanagawa-ken, Sumohara-shi, Nandai 1 – 2 – 12

(72) Inventor Muramatsu Ei
Tokyo-to, Hino-shi, Nishi Hirayama 5 – 27 – 10

IN THE UNITED STATES PATENT AND TRADEMARK OFFICE

In re Application of: Bruheim et al. Group No.: 1651
Serial No.: 12/057,775 Examiner: D. K. Ware
Filed: 28 March 2008
Entitled: BIOEFFECTIVE KRILL OIL COMPOSITIONS

INFORMATION DISCLOSURE STATEMENT LETTER

EFS WEB FILED
Commissioner for Patents
P.O. Box 1450
Alexandria, VA 22313-1450

Sir or Madam:

The citations listed in the attached IDS Form PTO-SB08 may be material to the examination of the above-identified application, and are therefore submitted in compliance with the duty of disclosure defined in 37 C.F.R. §§ 1.56 and 1.97. The Examiner is requested to make these citations of official record in this application.

Applicants wish to bring to the Examiner's attention that we are not providing copies of US Patents or published US patent applications as instructed under 37 CFR 1.98(a)(2).

This Information Disclosure Statement under 37 C.F.R. §§ 1.56 and 1.97 is not to be construed as a representation that a search has been made, that additional information material to the examination of this application does not exist, or that any one or more of these citations constitutes prior art.

The Commissioner is hereby authorized to charge any required fees or credit any overpayments to Attorney Deposit Account No.: 50-4302, referencing Attorney Docket No.: AKBM-14409/US-5/ORD.

Respectfully submitted,

Dated: 14 January 2014

/J. Mitchell Jones/
J. Mitchell Jones
Registration No. 44,174
Casimir Jones S.C.
2275 Deming Way
Suite 310
Middleton, WI 53562
Phone: (608) 662-1277
Fax: (608) 662-1276

Electronic Acknowledgement Receipt

EFS ID:	17912253
Application Number:	12057775
International Application Number:	
Confirmation Number:	1945
Title of Invention:	BIOEFFECTIVE KRILL OIL COMPOSITIONS
First Named Inventor/Applicant Name:	Inge Bruheim
Customer Number:	72960
Filer:	John Mitchell Jones/Thomas Vita
Filer Authorized By:	John Mitchell Jones
Attorney Docket Number:	AKBM-14409/US-5/ORD
Receipt Date:	15-JAN-2014
Filing Date:	28-MAR-2008
Time Stamp:	14:54:44
Application Type:	Utility under 35 USC 111(a)

Payment information:

Submitted with Payment	no
------------------------	----

File Listing:

Document Number	Document Description	File Name	File Size(Bytes)/ Message Digest	Multi Part /.zip	Pages (if appl.)
1	Information Disclosure Statement (IDS) Form (SB08)	14409US5ORD_sIDS-SB08_1_14-JAN-2014.pdf	615141 <small>b13e2518ea96f1a50de739d17bfcadade8cc45a1</small>	no	9

Warnings:

Information:

2	Information Disclosure Statement (IDS) Form (SB08)	14409US5ORD_sIDS-SB08_2_14-JAN-2014.pdf	614395 1bbbc73334ece1a2d8e4f660826a5e64d2d5eb8e	no	6
Warnings:					
Information:					
A U.S. Patent Number Citation or a U.S. Publication Number Citation is required in the Information Disclosure Statement (IDS) form for autoloading of data into USPTO systems. You may remove the form to add the required data in order to correct the Informational Message if you are citing U.S. References. If you chose not to include U.S. References, the image of the form will be processed and be made available within the Image File Wrapper (IFW) system. However, no data will be extracted from this form. Any additional data such as Foreign Patent Documents or Non Patent Literature will be manually reviewed and keyed into USPTO systems.					
3	Foreign Reference	CA_2251265.pdf	2606934 0d0cf91d6c4a013e4a303a1baaa3a76f1f86ce45	no	37
Warnings:					
Information:					
4	Foreign Reference	JP_60-153779.pdf	337913 bef72535133c5da2230d7063e6cd34c9076cdd15	no	4
Warnings:					
Information:					
5	Foreign Reference	JP_H08-231391.pdf	605628 4fe0913fe7625a64acc53f902086421686a0e90a	no	8
Warnings:					
Information:					
6	Non Patent Literature	Action-Closing-Prosecution_348-Patent.pdf	5135351 95ea46cd94ac86cd3ef7f50ee3fa5d98b6862e6a	no	85
Warnings:					
Information:					
7	Non Patent Literature	April-2-2012_Response-351-Patent.pdf	1632679 0489ba3472b813ba43be88ab7df70e557223a03d	no	43
Warnings:					
Information:					
8	Non Patent Literature	Bell-Dick_1991_pp565-573.pdf	7696241 551e38e100d39b666887d1dd4a7d8aa22ca49060	no	10
Warnings:					
Information:					
9	Non Patent Literature	Bell_1989.pdf	566403 b6ce9b8c47f6b597302bfcf157b7bd6c52f55e3	no	4
Warnings:					
Information:					

10	Non Patent Literature	Bell_1990_pp115-118.pdf	900791	no	4
			1ad0350e509037a63c37be5deecaecad00274173		
Warnings:					
Information:					
11	Non Patent Literature	Neptune_2001-Press-Release.pdf	278786	no	2
			68fbdde4684aa0bfd2e76e68feb9d67b4d1554aa		
Warnings:					
Information:					
12	Non Patent Literature	Balassa_1971_pp245-265.pdf	967593	no	22
			88965e0c511024056657e2b4a6d051d7e4b13f60		
Warnings:					
The page size in the PDF is too large. The pages should be 8.5 x 11 or A4. If this PDF is submitted, the pages will be resized upon entry into the Image File Wrapper and may affect subsequent processing					
Information:					
13	Non Patent Literature	Bergelson_1980_pp1-13.pdf	3102611	no	28
			0ee23c80bd15d1289ec7f3b90c0fbc67355e00c6		
Warnings:					
Information:					
14	Non Patent Literature	Bottino_1975_pp479-484.pdf	464866	no	6
			c9c5ee05115f6e1f5422980845f339839c48ba7		
Warnings:					
Information:					
15	Non Patent Literature	Buda_1994_pp8234-8238.pdf	1213898	no	5
			9129b1787cc48872b7f380c95e907d78df029549		
Warnings:					
Information:					
16	Non Patent Literature	Certificate-of-translation-of-Ex-1072.pdf	118041	no	1
			2a1017ebf592450a92d7ac4d36395e31a7de93d9		
Warnings:					
Information:					
17	Non Patent Literature	Certificate-of-translation-of-Ex-1074.pdf	1092783	no	1
			f96cea273a8c22db60b6ed559e24acd60c18af39		
Warnings:					
Information:					
18	Non Patent Literature	Certificate-of-translation-of-Ex-1076.pdf	1084936	no	1

Warnings:					
Information:					
19	Non Patent Literature	Certification-of-translation-of-Ex-1070.pdf	153318 769e6f415df53c86a4596945dfe2a569d158a1de	no	1
Warnings:					
Information:					
20	Non Patent Literature	Certified-translation-of-Ex-1070.pdf	411130 c43be624467bcf29a189700141b8c309463dac13	no	6
Warnings:					
Information:					
21	Non Patent Literature	Certified-translation-of-Ex-1072.pdf	2551610 f48eba40ae008676971c332d42f02d23266b9911	no	41
Warnings:					
Information:					
22	Non Patent Literature	Certified-translation-of-Ex-1074.pdf	238549 d0eff59d804a33cffa2fb8787b9033da469f8d0	no	2
Warnings:					
Information:					
23	Non Patent Literature	Buchi_R-220_Rotovapor_manual.pdf	8113298 4076240a39807852a6007041846533c76ce43cc	no	50
Warnings:					
Information:					
24	Non Patent Literature	Certified-translation-of-Ex-1076.pdf	377246 303e46d60da5b81ae3b423d57359f3b0acdf7be84	no	4
Warnings:					
Information:					
25	Non Patent Literature	Declaration-Bjorn-Ole-Haugsgjerd-8278351.pdf	1909204 c7fdc67aed9b6b5ac5c69d9aba093790bc5b0fb2	no	12
Warnings:					
The page size in the PDF is too large. The pages should be 8.5 x 11 or A4. If this PDF is submitted, the pages will be resized upon entry into the Image File Wrapper and may affect subsequent processing					
Information:					
26	Non Patent Literature	Declaration-Bjorn-Ole-Haugsgjerd-8030348.pdf	883006 be6030ff122f86ceec060f1ebf57f6e9842fe3989	no	5
Warnings:					
The page size in the PDF is too large. The pages should be 8.5 x 11 or A4. If this PDF is submitted, the pages will be resized upon entry into the Image File Wrapper and may affect subsequent processing					

Information:					
27	Non Patent Literature	Declaration-Chong-Lee-8030348.pdf	6748007 165b8bf2c3d975650b1420ea5eb6b6f324748c4b	no	66
Warnings:					
Information:					
28	Non Patent Literature	Declaration-Earl-White-8030348.pdf	2297870 2d1526ad8493915b84cb99563c03aa1e6713ba41	no	32
Warnings:					
Information:					
29	Non Patent Literature	Declaration-Ivar-Storro-8278351.pdf	510106 b0a00ad9ba76bab6abe1372e0fda2441d75df8e5	no	52
Warnings:					
Information:					
30	Non Patent Literature	Declaration-Ivar-Storro-8383675.pdf	510106 b0a00ad9ba76bab6abe1372e0fda2441d75df8e5	no	52
Warnings:					
Information:					
31	Non Patent Literature	Declaration-Jacek-Jaczynski-8030348.pdf	4421426 42fa07d1060e89ccce0918c1a469283fd0c659d6	no	56
Warnings:					
Information:					
32	Non Patent Literature	Declaration-Jaczynski-8278351.pdf	1242963 1a482958151fec24e12a8a2503d1ec72d715b1d0	no	15
Warnings:					
Information:					
33	Non Patent Literature	Declaration-Albert-Lee-8278351.pdf	5298067 8a417b9511bdbf84968a602cadb4f92a544cef072	no	27
Warnings:					
Information:					
34	Non Patent Literature	Declaration-Albert-Lee-8383675.pdf	5298075 7f8317362b8cafe2fc24941712e03f7d5b7cc4ea	no	27
Warnings:					
Information:					
35	Non Patent Literature	Declaration-Jeff-Moore-8278351.pdf	2412612 79454c2d464b5fd1a30c58b382fb6ad8c0ee1a11	no	39
Warnings:					

The page size in the PDF is too large. The pages should be 8.5 x 11 or A4. If this PDF is submitted, the pages will be resized upon entry into the Image File Wrapper and may affect subsequent processing

Information:

36	Non Patent Literature	Declaration-Jeff-Moore-8383675.pdf	2412612	no	39
			79454c2d464b5fd1a30c58b382fb6ad8c0ee1a11		

Warnings:

The page size in the PDF is too large. The pages should be 8.5 x 11 or A4. If this PDF is submitted, the pages will be resized upon entry into the Image File Wrapper and may affect subsequent processing

Information:

37	Non Patent Literature	Declaration-Richard-van-Breemen-8278351_part-1.pdf	2616809	no	100
			d99d452fac53904de4eaf89eb1cb94ea5027f02e		

Warnings:

Information:

38	Non Patent Literature	Declaration-Richard-van-Breemen-8383675_part-1.pdf	2616809	no	100
			d99d452fac53904de4eaf89eb1cb94ea5027f02e		

Warnings:

Information:

39	Non Patent Literature	Declaration-Shahidi-8030348.pdf	14885188	no	160
			64111aa99bd72a17d8e2e4f92ebc2b62abc17be7		

Warnings:

Information:

40	Non Patent Literature	Declaration-Shahidi-8278351.pdf	544046	no	8
			b00f0560c8af664684a888f08a7931963e7d8c66		

Warnings:

Information:

41	Non Patent Literature	Declaration-Thomas-Brenna-8278351.pdf	3695838	no	244
			2581add7e497f969b6f6aa945fa7db91ef831477		

Warnings:

Information:

42	Non Patent Literature	Declaration-Thomas-Brenna-8383675.pdf	3695838	no	244
			2581add7e497f969b6f6aa945fa7db91ef831477		

Warnings:

Information:

43	Non Patent Literature	Declaration-Thomas-Gundersen-8030348.pdf	8097462	no	67
			801cce0cc9e8f1605c45969b59d9160562d45c74		

Warnings:

Information:

44	Non Patent Literature	Declaration-Richard-van-Breemen-8278351_part-2.pdf	7716256 7c3b6c48daeb7a7a62abd400dfb5fbaddad10438	no	115
Warnings:					
Information:					
45	Non Patent Literature	Declaration-Richard-van-Breemen-8383675_part-2.pdf	7716243 4c4eadcfaa070747d7b5129510d51e18b6a69f21	no	115
Warnings:					
Information:					
46	Non Patent Literature	Declaration-Suzanne-Budge-8278351.pdf	3927519 0859756fa0a9d02754485cf66be15b452d57f85c	no	18
Warnings:					
Information:					
47	Non Patent Literature	Declaration-Suzanne-Budge-8383675.pdf	3927521 5c1e6f4a5b93ef8110d44fb8b212b8ca79d8374f	no	18
Warnings:					
Information:					
48	Non Patent Literature	Declaration-Tina-Sampalis-8030348.pdf	5362024 88f2571deff892828a032272ae8893565e30228f	no	32
Warnings:					
Information:					
49	Non Patent Literature	Declaration-Yeboah-8030348.pdf	8949960 8d8d99f6f57e09d61ba7cfff1660b054b6c51d0b2	no	80
Warnings:					
Information:					
50	Non Patent Literature	Declaration-Yeboah-8278351.pdf	1065747 d57fffa765ec1d35e9ec0247ea0b202308e1b0d	no	13
Warnings:					
Information:					
51	Non Patent Literature	Eichberg_1939_pp51-54.pdf	1479216 d5f765669acaa03a4bae6e29e5228fc35ade3d24	no	4
Warnings:					
Information:					
52	Non Patent Literature	Expert-Witness-Report-Theodore-Welch-337-TA-877.pdf	3552129 bc261e2e3e05c7b19d49ec0eef0fd1f83b3ba1f5	no	60
Warnings:					
Information:					

53	Non Patent Literature	Farkas_1998.pdf	475393 21cdd944cb15e1ef2529902da6e0bd59b1778975	no	4
Warnings:					
Information:					
54	Non Patent Literature	Declaration-Van-Breemen-351.pdf	7328482 14fd532b4e75c4a9c8f248a19c1dc128661a411e	no	114
Warnings:					
Information:					
55	Non Patent Literature	Declaration-Van-Breemen-348.pdf	7582523 dc90897063f795998a6cc49dc82b0363e0cc256	no	114
Warnings:					
Information:					
56	Non Patent Literature	Final-Prospectus-May-11-2001.pdf	5062909 68f848dd6669646a0dc2e7a5d4c640945e6ffbb	no	75
Warnings:					
Information:					
57	Non Patent Literature	FisheriesAgency-Fujita_1985_pp273-307.pdf	18832464 5c37c9e743942c8e8b4217a3323baeba7c3164e8	no	22
Warnings:					
Information:					
58	Non Patent Literature	Folch_1957_pp497-509.pdf	1435175 b8f92cd7cc9fce68b370c3b8fa511f26be4d2b10	no	15
Warnings:					
Information:					
59	Non Patent Literature	Grant-Request-Ex-parte-Reexamination-351-patent.pdf	629763 f323ea1e0ef0ca39c053b49e9c327df9e2461b5	no	14
Warnings:					
Information:					
60	Transmittal Letter	14409US5ORD_sIDS-Transmittal-14-JAN-2014.pdf	109365 7920956bd093af197c9d9cf51532761677f422c3	no	1
Warnings:					
Information:					
Total Files Size (in bytes):				196128874	

This Acknowledgement Receipt evidences receipt on the noted date by the USPTO of the indicated documents, characterized by the applicant, and including page counts, where applicable. It serves as evidence of receipt similar to a Post Card, as described in MPEP 503.

New Applications Under 35 U.S.C. 111

If a new application is being filed and the application includes the necessary components for a filing date (see 37 CFR 1.53(b)-(d) and MPEP 506), a Filing Receipt (37 CFR 1.54) will be issued in due course and the date shown on this Acknowledgement Receipt will establish the filing date of the application.

National Stage of an International Application under 35 U.S.C. 371

If a timely submission to enter the national stage of an international application is compliant with the conditions of 35 U.S.C. 371 and other applicable requirements a Form PCT/DO/EO/903 indicating acceptance of the application as a national stage submission under 35 U.S.C. 371 will be issued in addition to the Filing Receipt, in due course.

New International Application Filed with the USPTO as a Receiving Office

If a new international application is being filed and the international application includes the necessary components for an international filing date (see PCT Article 11 and MPEP 1810), a Notification of the International Application Number and of the International Filing Date (Form PCT/RO/105) will be issued in due course, subject to prescriptions concerning national security, and the date shown on this Acknowledgement Receipt will establish the international filing date of the application.

INFORMATION DISCLOSURE STATEMENT BY APPLICANT (Not for submission under 37 CFR 1.99)	Application Number		12057775	
	Filing Date		2008-03-28	
	First Named Inventor	Inge Bruheim		
	Art Unit	1651		
	Examiner Name	Ware		
	Attorney Docket Number	NATNUT-14409/US-5/ORD		

U.S.PATENTS						Remove
Examiner Initial*	Cite No	Patent Number	Kind Code ¹	Issue Date	Name of Patentee or Applicant of cited Document	Pages,Columns,Lines where Relevant Passages or Relevant Figures Appear
	1					

If you wish to add additional U.S. Patent citation information please click the Add button. Add

U.S.PATENT APPLICATION PUBLICATIONS						Remove
Examiner Initial*	Cite No	Publication Number	Kind Code ¹	Publication Date	Name of Patentee or Applicant of cited Document	Pages,Columns,Lines where Relevant Passages or Relevant Figures Appear
	1					

If you wish to add additional U.S. Published Application citation information please click the Add button. Add

FOREIGN PATENT DOCUMENTS								Remove
Examiner Initial*	Cite No	Foreign Document Number ³	Country Code ² j	Kind Code ⁴	Publication Date	Name of Patentee or Applicant of cited Document	Pages,Columns,Lines where Relevant Passages or Relevant Figures Appear	T ⁵
	1	2004/112767	WO		2004-12-29	Advanced Bionutrition Corp.		<input type="checkbox"/>

If you wish to add additional Foreign Patent Document citation information please click the Add button Add

NON-PATENT LITERATURE DOCUMENTS				Remove
Examiner Initials*	Cite No	Include name of the author (in CAPITAL LETTERS), title of the article (when appropriate), title of the item (book, magazine, journal, serial, symposium, catalog, etc), date, pages(s), volume-issue number(s), publisher, city and/or country where published.		T ⁵

INFORMATION DISCLOSURE STATEMENT BY APPLICANT (Not for submission under 37 CFR 1.99)	Application Number		12057775
	Filing Date		2008-03-28
	First Named Inventor	Inge Bruheim	
	Art Unit		1651
	Examiner Name	Ware	
	Attorney Docket Number		NATNUT-14409/US-5/ORD

	1	European Search Report, EP Patent Application No. EP12187516, mailed June 10, 2013	<input type="checkbox"/>
--	---	--	--------------------------

If you wish to add additional non-patent literature document citation information please click the Add button Add

EXAMINER SIGNATURE

Examiner Signature		Date Considered	
--------------------	--	-----------------	--

*EXAMINER: Initial if reference considered, whether or not citation is in conformance with MPEP 609. Draw line through a citation if not in conformance and not considered. Include copy of this form with next communication to applicant.

¹ See Kind Codes of USPTO Patent Documents at www.USPTO.GOV or MPEP 901.04. ² Enter office that issued the document, by the two-letter code (WIPO Standard ST.3). ³ For Japanese patent documents, the indication of the year of the reign of the Emperor must precede the serial number of the patent document. ⁴ Kind of document by the appropriate symbols as indicated on the document under WIPO Standard ST.16 if possible. ⁵ Applicant is to place a check mark here if English language translation is attached.

INFORMATION DISCLOSURE STATEMENT BY APPLICANT (Not for submission under 37 CFR 1.99)	Application Number	12057775
	Filing Date	2008-03-28
	First Named Inventor	Inge Bruheim
	Art Unit	1651
	Examiner Name	Ware
	Attorney Docket Number	NATNUT-14409/US-5/ORD

CERTIFICATION STATEMENT

Please see 37 CFR 1.97 and 1.98 to make the appropriate selection(s):

That each item of information contained in the information disclosure statement was first cited in any communication from a foreign patent office in a counterpart foreign application not more than three months prior to the filing of the information disclosure statement. See 37 CFR 1.97(e)(1).

OR

That no item of information contained in the information disclosure statement was cited in a communication from a foreign patent office in a counterpart foreign application, and, to the knowledge of the person signing the certification after making reasonable inquiry, no item of information contained in the information disclosure statement was known to any individual designated in 37 CFR 1.56(c) more than three months prior to the filing of the information disclosure statement. See 37 CFR 1.97(e)(2).

See attached certification statement.

The fee set forth in 37 CFR 1.17 (p) has been submitted herewith.

A certification statement is not submitted herewith.

SIGNATURE

A signature of the applicant or representative is required in accordance with CFR 1.33, 10.18. Please see CFR 1.4(d) for the form of the signature.

Signature	/J. Mitchell Jones/	Date (YYYY-MM-DD)	2013-08-01
Name/Print	J. Mitchell Jones	Registration Number	44174

This collection of information is required by 37 CFR 1.97 and 1.98. The information is required to obtain or retain a benefit by the public which is to file (and by the USPTO to process) an application. Confidentiality is governed by 35 U.S.C. 122 and 37 CFR 1.14. This collection is estimated to take 1 hour to complete, including gathering, preparing and submitting the completed application form to the USPTO. Time will vary depending upon the individual case. Any comments on the amount of time you require to complete this form and/or suggestions for reducing this burden, should be sent to the Chief Information Officer, U.S. Patent and Trademark Office, U.S. Department of Commerce, P.O. Box 1450, Alexandria, VA 22313-1450. **DO NOT SEND FEES OR COMPLETED FORMS TO THIS ADDRESS. SEND TO: Commissioner for Patents, P.O. Box 1450, Alexandria, VA 22313-1450.**

Privacy Act Statement

The Privacy Act of 1974 (P.L. 93-579) requires that you be given certain information in connection with your submission of the attached form related to a patent application or patent. Accordingly, pursuant to the requirements of the Act, please be advised that: (1) the general authority for the collection of this information is 35 U.S.C. 2(b)(2); (2) furnishing of the information solicited is voluntary; and (3) the principal purpose for which the information is used by the U.S. Patent and Trademark Office is to process and/or examine your submission related to a patent application or patent. If you do not furnish the requested information, the U.S. Patent and Trademark Office may not be able to process and/or examine your submission, which may result in termination of proceedings or abandonment of the application or expiration of the patent.

The information provided by you in this form will be subject to the following routine uses:

1. The information on this form will be treated confidentially to the extent allowed under the Freedom of Information Act (5 U.S.C. 552) and the Privacy Act (5 U.S.C. 552a). Records from this system of records may be disclosed to the Department of Justice to determine whether the Freedom of Information Act requires disclosure of these records.
2. A record from this system of records may be disclosed, as a routine use, in the course of presenting evidence to a court, magistrate, or administrative tribunal, including disclosures to opposing counsel in the course of settlement negotiations.
3. A record in this system of records may be disclosed, as a routine use, to a Member of Congress submitting a request involving an individual, to whom the record pertains, when the individual has requested assistance from the Member with respect to the subject matter of the record.
4. A record in this system of records may be disclosed, as a routine use, to a contractor of the Agency having need for the information in order to perform a contract. Recipients of information shall be required to comply with the requirements of the Privacy Act of 1974, as amended, pursuant to 5 U.S.C. 552a(m).
5. A record related to an International Application filed under the Patent Cooperation Treaty in this system of records may be disclosed, as a routine use, to the International Bureau of the World Intellectual Property Organization, pursuant to the Patent Cooperation Treaty.
6. A record in this system of records may be disclosed, as a routine use, to another federal agency for purposes of National Security review (35 U.S.C. 181) and for review pursuant to the Atomic Energy Act (42 U.S.C. 218(c)).
7. A record from this system of records may be disclosed, as a routine use, to the Administrator, General Services, or his/her designee, during an inspection of records conducted by GSA as part of that agency's responsibility to recommend improvements in records management practices and programs, under authority of 44 U.S.C. 2904 and 2906. Such disclosure shall be made in accordance with the GSA regulations governing inspection of records for this purpose, and any other relevant (i.e., GSA or Commerce) directive. Such disclosure shall not be used to make determinations about individuals.
8. A record from this system of records may be disclosed, as a routine use, to the public after either publication of the application pursuant to 35 U.S.C. 122(b) or issuance of a patent pursuant to 35 U.S.C. 151. Further, a record may be disclosed, subject to the limitations of 37 CFR 1.14, as a routine use, to the public if the record was filed in an application which became abandoned or in which the proceedings were terminated and which application is referenced by either a published application, an application open to public inspections or an issued patent.
9. A record from this system of records may be disclosed, as a routine use, to a Federal, State, or local law enforcement agency, if the USPTO becomes aware of a violation or potential violation of law or regulation.

(19) World Intellectual Property
Organization
International Bureau



(43) International Publication Date
29 December 2004 (29.12.2004)

PCT

(10) International Publication Number
WO 2004/112767 A1

(51) International Patent Classification⁷: **A61K 31/065**

(81) Designated States (*unless otherwise indicated, for every kind of national protection available*): AE, AG, AL, AM, AT, AU, AZ, BA, BB, BG, BR, BW, BY, BZ, CA, CH, CN, CO, CR, CU, CZ, DE, DK, DM, DZ, EC, EE, EG, ES, FI, GB, GD, GE, GH, GM, HR, HU, ID, IL, IN, IS, JP, KE, KG, KP, KR, KZ, LC, LK, LR, LS, LT, LU, LV, MA, MD, MG, MK, MN, MW, MX, MZ, NA, NI, NO, NZ, OM, PG, PH, PL, PT, RO, RU, SC, SD, SE, SG, SK, SL, SY, TJ, TM, TN, TR, TT, TZ, UA, UG, US, UZ, VC, VN, YU, ZA, ZM, ZW.

(21) International Application Number:
PCT/US2004/019972

(22) International Filing Date: 21 June 2004 (21.06.2004)

(25) Filing Language: English

(26) Publication Language: English

(30) Priority Data:
60/479,507 19 June 2003 (19.06.2003) US

(84) Designated States (*unless otherwise indicated, for every kind of regional protection available*): ARIPO (BW, GH, GM, KE, LS, MW, MZ, NA, SD, SL, SZ, TZ, UG, ZM, ZW), Eurasian (AM, AZ, BY, KG, KZ, MD, RU, TJ, TM), European (AT, BE, BG, CH, CY, CZ, DE, DK, EE, ES, FI, FR, GB, GR, HU, IE, IT, LU, MC, NL, PL, PT, RO, SE, SI, SK, TR), OAPI (BF, BJ, CF, CG, CI, CM, GA, GN, GQ, GW, ML, MR, NE, SN, TD, TG).

(71) Applicant (*for all designated States except US*): **ADVANCED BIONUTRITON CORPORATION** [US/US]; 6430 Dobbin Road, Suite C, Columbia, MD 21045 (US).

(72) Inventors; and

(75) Inventors/Applicants (*for US only*): **HAREL, Moti** [US/US]; 2012 Masters Drive, Baltimore, MD 21209 (US). **PIECHOCKI, John** [US/US]; 8710 Meadow Wood Court, Odenton, MD 21113 (US). **KYLE, David, J.** [US/US]; 1801 Narbeth Road, Catonsville, MD 21228 (US).

Published:
— *with international search report*
— *before the expiration of the time limit for amending the claims and to be republished in the event of receipt of amendments*

(74) Agents: **COLBY, Gary, D.** et al.; Duane Morris LLP, One Liberty Place, Philadelphia, PA 19103-7396 (US).

For two-letter codes and other abbreviations, refer to the "Guidance Notes on Codes and Abbreviations" appearing at the beginning of each regular issue of the PCT Gazette.



WO 2004/112767 A1

(54) Title: IMPROVED ABSORPTION OF FAT-SOLUBLE NUTRIENTS

(57) Abstract: Carotenoids are provided as dietary supplements to animal feed. These supplements improve the bioavailability of carotenoids by providing them in combination with phospholipids. The invention provides animal feeds for aquatic and terrestrial animals, and methods for making the feeds.

TITLE OF THE INVENTION

[0001] Improved Absorption of Fat-Soluble Nutrients

BACKGROUND OF THE INVENTION

[0002] This application is related to improving the bioavailability of carotenoids as provided in formulated mixtures to animals. The invention provides both a specific composition and a method of manufacture for improved delivery of carotenoids.

[0003] This invention relates to a carotenoid composition and methods for its manufacture and use. In one aspect, the invention relates to carotenoids, synthetic or naturally produced by a single-celled organism, and phospholipids containing highly unsaturated fatty acids. In another aspect, the invention relates to methods of increasing carotenoid stability during feed processing and improving bioavailability in the gastrointestinal (GI) tract of coldwater species. In yet another aspect, the invention relates to using products made from these carotenoid compositions as a dietary supplement in various animal feeds.

[0004] The carotenoids, as a class of compounds, are classified into two main groups: carotenes and xanthophylls. In contrast to carotenes, which are pure polyene hydrocarbons, such as beta-carotene or lycopene, xanthophylls contain oxygen functional groups, such as hydroxyls, epoxy and/or oxo groups. Typical representatives of the xanthophyll group are astaxanthin, canthaxanthin and zeaxanthin.

[0005] A distinct red color is of prime importance to customer acceptance of a subset of food products, particularly aquatic food animals such as salmon, trout, shrimp, lobster and many other marine animals (Hinostroza, Huberman et al. 1997; Bjerkgeng and Berge 2000). The oxygenated carotenoids (xanthophylls) are responsible for the red color of these aquatic animals. These xanthophylls are also useful for adding pigmentation to the flesh and products of other animals, and to other foodstuffs, for example poultry and eggs, various dairy products, snack foods, and the like.

[0006] Astaxanthin is the most abundant carotenoid present in the aquatic world (Shahidi, Metusalach et al. 1998). Aquatic animals, like terrestrial animals, generally cannot synthesize astaxanthin or any other carotenoid, although many of these animals

accumulate carotenoid compounds that are present in their diets. Some of these animals, such as crustaceans, can interconvert some carotenes to xanthophylls, of which astaxanthin is the predominant compound formed. However, aquatic fish accumulate dietary astaxanthin even though these fish cannot convert any other carotenoid compound to astaxanthin. Therefore, the astaxanthin present in aquatic fish, and in products produced from these fish, must be derived directly from dietary sources.

[0007] Currently, synthetic astaxanthin is added to feeds of aquacultured salmonids to provide a source of this carotenoid (Bell, McEvoy et al. 1998). In some cases, synthetic canthaxanthin (another xanthophyll that is very closely related to astaxanthin) is used in place of astaxanthin in feeds for salmonids, but this compound does not function as well in these fishes as the naturally predominant astaxanthin (Bell, McEvoy et al. 1998).

[0008] Natural sources of dietary astaxanthin, including krill, crawfish, crustacean processing by-products, bacteria, yeast, algae, and higher plants are in great demand by aquacultural industries. However, these natural sources tend to be too expensive and of limited availability and reliability to be commercially viable. Lycopene is an alternative natural carotenoid that might meet the cost criterion for inclusion in feeds (Clark, Yao et al. 2000). It is in a class of carotenoids that characteristically gives color to many vegetables.

[0009] Carotenoids are easily isomerized by heat, acid or light. Once isomerized, they lose their biological antioxidant properties (Fennema 1996). The high demands placed on xanthophyll-containing formulations with respect to coloring action and bioavailability can thus not always be met because of these problems (Yeum and Russell 2002). Indeed, various processes and a number of combined emulsifying/spray-drying processes (see patents DE-A-12 11 911 or in EP-A-0 410 236) have been proposed to improve the color yields and to increase the absorbability or bioavailability carotenoids.

[0010] One specific problem which has not yet been addressed is related to the low body temperature of salmonid fishes, which is equal to the temperature of the water in which they inhabit, generally 0 to 14°C. Natural astaxanthin, especially those in *Phaffia* yeasts, are concentrated in oil droplets that contain about 13% palmitic acid (16:0) with a melting point of 64°C, and about 32% oleic acid (18:1n9) with a melting point of 16°C (Deuel 1951). Because of these high melting point fatty acids, the astaxanthin containing oil droplets solidify near 10°C. This makes it difficult for the fish to incorporate the

astaxanthin from the solidified oil droplet at water temperatures below 10°C. This is especially problematic for coldwater fish.

BRIEF SUMMARY OF THE INVENTION

[0011] The invention alleviates these problems by providing a process for preparing a mixture of carotenoids and phospholipids rich in highly unsaturated fatty acids (PUFA). The process comprises the following steps:

[0012] a) Preparing a molecularly-associated composition of carotenoids and a phospholipid with an edible oil or a mixture of water and a water-miscible organic solvent. If appropriate, a water-dispersible dry powder could also be prepared. To achieve dispersion, e.g., in the form of a suspension or an emulsion, it is advantageous to use an edible oil (such as, but not limited to, sesame oil, corn oil, cottonseed oil, soybean oil, or peanut oil) plus esters of medium chain-lengths vegetable fatty acids or fish oils (such as, but not limited to, mackerel, capelin, menhaden or cod liver oil).

[0013] b) Further increasing the stability of the carotenoids to oxidative decay by adding stabilizers such as, but not limited to, alpha-tocopherol, *t*-butylated hydroxytoluene, *t*-butylated hydroxyanisole, ascorbic acid or ethoxyquin.

[0014] c) Providing the carotenoids used to produce the composition from natural sources and/or synthetic sources.

[0015] d) The phospholipids used to produce the composition are rich in polyunsaturated fatty acids (PUFA) having two or more double bonds in at least 20% of total fatty acids.

[0016] e) The carotenoid composition according to the invention can also contain at least one other active substance in concentrations of 0.01 to 40% by weight.

[0017] Possible examples of these active substances are the following:

[0018] Other carotenoids such as for example bixin, zeaxanthin, cryptoxanthin, citranaxanthin, canthaxanthin, astaxanthin, beta-apo-4-carotenal, beta-apo-8-carotenal, beta-apo-8-carotenoic esters, lycopene, or lutein, singly or as a mixture.

[0019] Vitamins, such as vitamin A, vitamin A acetate, vitamin A palmitate, riboflavin, vitamin B₁₂, ascorbic acid, ascorbyl palmitate, nicotinic acid, nicotinamide, pyridoxine hydrochloride, vitamin D₃, tocopherol, tocopherol acetate, tocopherol palmitate, tocotrienol, vitamin K, thiamine, calcium pantothenate, biotin, lipoic acid, folic acid, and folic acid

derivatives (such as tetraBASF hydrofolic acid, 5-methyltetrahydrofolic acid, 10-formyltetrahydrofolic acid) and 5-formyltetrahydrofolic acid).

[0020] Compounds with vitamin or coenzyme characteristics, such as choline chloride, carnitine, taurine, creatine, ubiquinones, S-methylmethionine, and S-adenosylmethionine.

[0021] Polyunsaturated fatty acids, such as linoleic acid, linolenic acid, arachidonic acid (ARA), eicosapentaenoic acid (EPA), and docosahexaenoic acid (DHA) and esters thereof including but not limited to triglycerides.

[0022] Glutathione and its esters such as, for example GSH monomethyl ester, GSH dimethyl ester, GSH monoethyl ester, and GSH diethyl ester.

[0023] Depending on the nature of the formulation, it may contain, besides the carotenoids, at least one other additive such as, for example, oils, protective colloids, alkaloids (such as piperine (Badmaev, Majeed et al. 1999)), and antioxidants.

[0024] Examples of protective colloids that can be used are gelatin, fish gelatin, starch, dextrin, plant proteins, pectin, gum arabic, casein, caseinate, or mixtures thereof. It is also possible to employ polyvinyl alcohol, polyvinylpyrrolidone, methylcellulose, carboxymethylcellulose, hydroxypropylcellulose, and alginates.

[0025] To increase the mechanical stability of the dry powder, it is also possible to add to the colloid a plasticizer such as sugars or sugar alcohols, such as sucrose, glucose, lactose, invert sugar, sorbitol, mannitol, or glycerol.

[0026] The use of the PUFA-rich phospholipids as part of this formulation also provides additional benefit to the survival and health of the animal consuming the invention's formulation (Bracco and Decekbaum 1992; Furuita, Takeuchi et al. 1998; Place and Harel 2002).

[0027] The present invention provides a mixture comprising a carotenoid and PUFA-rich phospholipid.

[0028] The present invention provides a composition comprising a mixture including a carotenoid either in synthetic or natural form and a phospholipid having at least 20% PUFA, where the phospholipid is in an amount sufficient to improve carotenoid stability and bioavailability and prevent solidification when the composition is fed to coldwater species, and the carotenoid is in an amount sufficient to produce acceptable coloring in edible tissues.

[0029] The present invention also provides a molecularly-associated complex comprising a carotenoids and a phospholipid.

[0030] The present invention provides a composition comprising a molecularly-associated complex including an amount of a carotenoid and an amount of a phospholipid, wherein the amount of the phospholipid is sufficient to improve carotenoids stability and bioavailability and prevent solidification when the composition is fed to coldwater species and the amount of the carotenoid is sufficient to produce acceptable coloring of edible tissues.

[0031] The present invention also provides a mixture comprising a carotenoid, a phospholipid, and a bioactive compound, or a bioactive complex (comprising a carotenoid/phospholipid/bioactive compound), and/or mixtures or combinations thereof.

[0032] The present invention provides a composition comprising a mixture including a carotenoid, a phospholipid and a bioactive compound, a bioactive complex, or mixtures or combinations thereof, wherein the phospholipid is present in an amount sufficient to improve the carotenoids' stability and bioavailability and prevent solidification when the composition is fed to coldwater species, and wherein the amount of the total carotenoid is sufficient to produce acceptable coloring of edible tissues.

[0033] The present invention provides a composition comprising a cellular material and a phospholipids wherein the phospholipid to cellular material is in the ratio of from about 1:1 to about 1:100 and the cellular material comprises long chain polyunsaturated fatty acids and/or carotenoids.

[0034] The present invention also provides a method for making a carotenoid-containing composition with increased carotenoid stability and bioavailability with low melting temperature when fed to cold-water species, including the step of mixing carotenoids and a PUFA-rich phospholipid. The method can further include the step of mixing the carotenoid/phospholipid composition with another bioactive compound forming an alternative and useful composition.

[0035] The present invention also provides a method for making a carotenoid-containing composition with increased stability and bioavailability including the step of contacting a carotenoid and a phospholipid under conditions sufficient to maintain the carotenoid and the phospholipid in a molecularly-associated form. The method can further

include the step of admixing the carotenoid/phospholipid molecular association with a bioactive compound.

[0036] The present invention also provides for making a long chain polyunsaturated fatty acid (LC-PUFA) composition with increased stability and bioavailability including the step of contacting a cellular material containing said LC-PUFA and a phospholipid under conditions sufficient to maintain the LC-PUFA and the phospholipid in a molecular association form. The method can further include the step of admixing the LC-PUFA/phospholipid molecular association with a bioactive compound.

[0037] The present invention also provides a method for enhancing the pigmentation of coldwater animals by providing such animals with a feed enriched with a composition that consists of a cellular source of carotenoid such as, but not limited to *Phaffia* yeast, *Haematococcus* algae, marigold flowers, mixed with a PUFA-enriched phospholipid such as, but not limited to, plant lecithins, egg yolk lecithin, phospholipid-rich extracts from animals or animal byproducts, and phospholipid-rich extracts from microbial sources. The cellular or synthetic carotenoid material and phospholipid material are premixed and homogenized prior to the addition to a feed in order to stabilize and solubilize the carotenoid and such a process surprisingly results in the enhanced bioavailability of the carotenoids by the coldwater animal.

BRIEF SUMMARY OF THE SEVERAL VIEWS OF THE DRAWINGS

[0038] Figure 1. Improved total carotenoid content of rainbow trout using conditions as described in Example 5 (for the Astaxanthin compared to Astaxanthin + DHA-phospholipid) and Example 4 for Astaxanthin compared to Astaxanthin + soy lecithin. The control had no added astaxanthin in the diet (some residual carotenoids were in the original diet). The soy lecithin gave a 34% higher incorporation of astaxanthin (AX) than AX alone. The DHA-rich phospholipid gave 56% higher incorporation of AX than AX alone.

DETAILED DESCRIPTION OF THE INVENTION

[0039] Definitions

[0040] Unless otherwise stated, the following terms shall have the following meanings:

[0041] The term "solution" means a liquid and any mixture of a liquid and a solid that has fluid attributes, e.g., flowable or having appreciable fluidity at standard temperature and

pressure, including, without limitation, a dispersion of a solid(s) in a liquid, an emulsion, a slurry, a micro-emulsion, colloidal suspension, a suspension, or the like.

[0042] An "emulsion" is suspension of one liquid in another with which the first will not mix. The first liquid can be suspended as small globules in the second liquid. An oil or an aqueous form of the compositions of this invention can be emulsified into an aqueous solution.

[0043] An "active substance" is any material that functions or is capable of functioning in a manner characteristic of that substance.

[0044] The term "molecular association" or "molecularly-associated" means a combination of two or more molecular species associated via any known stabilizing atomic or molecular level interaction or any combination thereof, where the interactions include, without limitation, bonding interactions such as covalent bonding, ionic bonding, hydrogen bonding, coordinate bonding, or any other molecular bonding interaction, electrostatic interactions, a polar or hydrophobic interactions, or any other classical or quantum mechanical stabilizing atomic or molecular interaction.

[0045] The term "species" is defined as any species in the animal kingdom, including mammals, fish, crustaceans and mollusks.

[0046] An "aquatic animal" is an animal that lives primarily in an aquatic environment, and includes fish, crustaceans, and mollusks. Aquaculture methods and/or commercial production practices have been developed to cultivate aquatic animals.

[0047] A "fish" and the plural "fish" are defined in this invention as any Osteichthyea or Chondrichthyea fish, such as, but not limited to, sharks, rays, sturgeon, eels, anchovy, herring, carp, smelt, salmon, trout, hakes, cod, rockfish, bass, drum, mackerel, tuna, butterfish, catfish, flounder, and seabream.

[0048] A "crustacean" and the plural "crustaceans" are defined in this invention as any member of the Class *Crustacea*, such as, but not limited to, shrimp, lobsters, red claws, and crabs.

[0049] A "terrestrial animal" is one that lives primarily on land in a non-aquatic environment, such as, but not limited to cows, pigs, and chickens.

[0050] The term "phospholipid" refers to any lipid or fatty acid having a covalently attached a phosphate group in the molecular structure. These phospholipids are preferably sourced from vegetable material such as, but not limited to, soy, corn, palm, canola, rice,

flax, coconut, combinations thereof, and are usually obtained as byproduct of the process of refining the vegetable oil. These phospholipids may be comprised of any of phosphatidyl choline (PC), phosphatidyl serine (PS), phosphatidyl ethanolamine (PE) and/or phosphatidyl inositol (PI), or a combination thereof.

[0051] The term "PUFA-rich phospholipid" means a phospholipid containing at least 20% fatty acids with 2 or more double bonds.

[0052] The term "carotenoid" encompasses any molecule in a class of yellow to red pigments, including carotenes and xanthophylls. "Carotenes" are orange-yellow to red pigments that are found in some animal tissues and plants, and may be converted to Vitamin A in the liver. "Xanthophylls" are yellow pigments, some of which may be found with chlorophyll in green plants.

[0053] Description

[0054] The inventors have found that a unique mix, including carotenoid compounds and PUFA-rich phospholipid (such as soy lecithin, DHA-, EPA- or ARA-rich phospholipid extracts) improves the bioavailability of carotenoids when consumed by coldwater fish. Additionally, the phospholipids increase oxidation stability of the carotenoids compared to other types of standard preparations. It is well documented that carotenoids are sensitive to photo- and thermal-oxidation, which results in major carotenoid losses during feed preparation and storage. Moreover, natural sources of carotenoids include a high level of saturated oils. Saturated oils become solidified at low water temperature and thereby reduce bioavailability of the carotenoid in the animal GI tract. The present invention overcomes the problems associated with standard carotenoid formulations by combining carotenoids with PUFA-rich phospholipid, where the phospholipid increases the efficacy of the carotenoid absorption at low temperatures.

[0055] The present invention relates broadly to formulations including carotenoids and PUFA-rich phospholipid compositions. Additionally, methods for producing such compositions and their use in formulation of novel feeds are disclosed.

[0056] Examples of phospholipid include, without limitation, phosphatidyl cholines (such as phosphatidyl choline (PC), dipalmitoylphosphatidylcholine (DPPC), other disaturated phosphatidyl cholines), phosphatidyl ethanolamines, phosphatidylinositol, phosphatidyl serines (sphingomyelin or other ceramides), various other phospholipids,

phospholipid-containing oils (such as lecithin oils derived from soy beans), or mixtures and combinations thereof. The phospholipids of the present formulation can also be found in PUFA-rich extracts of single cell organisms such as, but not limited to, *Cryptocodinium* sp., *Schizochytrium* sp., *Mortierella* sp. and *Paracoccus* sp. Phospholipids of the present invention can also be derived from animal sources including, but not limited to, animal organ extracts (e.g., brain, liver, other animal process wastes), egg yolk, egg yolk extracts, fish byproducts and fish byproduct extracts (i.e., processed waste products from preparation of fish meal or purified fish oil). Preferred phospholipids are from *Cryptocodinium* sp., *Schizochytrium* sp. and *Mortierella* sp., and plant lecithins. Phospholipids useful for this invention would be those wherein at least 20% of the fatty acid residues have 2 or more double bonds. Preferred phospholipids would be those containing at least 20% of the fatty acid residues with 3 or more double bonds. Particularly preferred phospholipids would be those containing at least 10% of the fatty acid residues with 4 or more double bonds. Most particularly preferred phospholipids would be those containing at least 20% of the fatty acid residues with 4 or more double bonds.

[0057] Generally, the weight ratio of carotenoids to PUFA-rich phospholipid is between about 2:1 and about 1:100, with ratios between about 2:1 and 1:50 being preferred and ratios between about 1:1 and 1:10 being particularly preferred and ratios between about 1:1 and about 1:5 being especially particularly preferred.

[0058] The effective amount of the carotenoids for use in the composition of this invention ranges from about 0.1 mg per kg feed to about 1000 mg per kg feed depending on the carotenoids and the phospholipid used in the composition. Amounts between about 1 mg per kg feed to about 500 mg per feed being preferred, with amounts between about 2 mg per kg feed and 50 mg per feed being particularly preferred. A sufficient amount of phospholipid is generally an amount of phospholipid between about 0.01 mg per mg carotenoids and about 5000 mg per mg carotenoids, with amounts between about 0.5 mg per mg carotenoids and 2500 mg per mg carotenoids being preferred, and amounts between 2 mg per mg carotenoids and about 250 mg per mg carotenoids being particularly preferred, and amounts between about 2 mg per mg carotenoids and about 100 mg per mg carotenoids being especially particularly preferred.

[0059] The compositions of the present invention can be in any desirable form, including, without limitation, a solid (such as a powder, granules, a semi-solid such as a

paste or the like), an emulsion, or a solution. An emulsion means that an oil or aqueous form of the compositions of this invention is emulsified in an aqueous solution. In addition, the emulsion can be a standard emulsion or a micro-emulsion where the mixture is forced through a nozzle or in other methods that generate micro-emulsions. Solutions of this invention employ a suitable solvent in which the composition is soluble or highly soluble.

[0060] Generally, the compositions of this invention are formulated to be directly mixed with other feed ingredients prior to processing. However, the formulations can also be emulsified or blended with a carrier oil to top-coat the feed after processing.

[0061] In formulations of this invention that combine a phospholipid, such as lecithin, and a carotenoid, such as astaxanthin, the phospholipid acts to prevent oxidation of the carotenoids as well as to improve its solubility. Thus, the formulations of this invention, which supplement carotenoids with phospholipids, show significantly more stability, thus removing a major impediment that severely limits the utility of natural carotenoids in feed preparation. The carotenoid/phospholipid formulations of this invention not only have increased stability, but the formulations also increase the bioavailability of the carotenoids when taken by coldwater animals. Current carotenoid formulations contain large quantities of high melting temperature oils. These preparations therefore lose a major part of their effectiveness when taken by coldwater species due to the phase of the oil (i.e., solid). The carotenoids of the invention associate with PUFA-rich phospholipids in such a way as to preserve their liquidity and become more available for uptake in the small intestines, especially at low temperatures. Additionally, it is thought that the PUFA-rich phospholipid-carotenoid formulations of this invention improve carotenoid bioavailability by interfering with the interaction of carotenoids with other feed components during digestion in the fish stomach, permitting carotenoids to exit the stomach in a bioavailable form.

[0062] For example, the carotenoids (naturally produced by a single celled-organism or synthetic) can be combined with different concentrations of either purified phospholipids or crude phospholipids. For example, PC is available in a purified form comprising > 90% PC or in crude extracts from soybeans in de-oiled and oiled states (American Lecithin Company). Crude phospholipid extracts containing over 40% DHA or ARA of total fatty acids are also available (Advanced BioNutrition Corp., Columbia, MD). The presence of PUFA-rich phospholipid, such as lecithin, in the formulations of this invention prevents carotenoid solidification, thereby increasing bioavailability of carotenoids in the GI tract of

coldwater species. Thus, the presence of a PUFA-rich phospholipid in the compositions of this invention allows a reduction in carotenoid dosages in feed and the shortening of the administration period prior to harvesting without losing the desired coloring.

[0063] Further improvement in bioavailability may be achieved by the addition of an alkaloid, such as piperine, to the carotenoid/phospholipid composition.

[0064] The addition of PUFA-rich phospholipids can also significantly increase the bioavailability of the carotenoids. This is an improvement, since in certain instances carotenoids have bioavailabilities of about 50% or less necessitating relatively large doses of the carotenoids for a longer period of time. The PUFA-rich phospholipids result in improved bioavailability of the carotenoids especially by coldwater species. The improved bioavailability can range from about a 20% increase to as much as about a 60% or greater increase by carefully choosing the type of PUFA-rich phospholipid and the ratio of the carotenoids and PUFA-rich phospholipids.

[0065] It should be noted that a number of substances that are used as additives to enhance carotenoid absorption are known irritants or damaging agents of the GI mucosa. Therefore, these would be contraindicated for use with carotenoids. Such substances would include: short chain fatty acids (such as citric acid, decanoic acid, caprylic acid or the like), long-chain unsaturated free fatty acids (such as oleic acid or the like), detergents (such as BRIJ, TWEEN-80, sodium deoxycholate, or the like), and chelators of polyvalent metal cations (such as EDTA, EGTA, or the like).

[0066] Because of their degree of unsaturation, carotenoids are inherently prone to oxidative degradation. Preserving the integrity of the double bonds of the carotenoids through processing and storage is a critical problem in the preparation of feeds, food and supplements therefore containing such materials. At the same time the preservation of the double bonds of the carotenoids is critical for the efficacy of the carotenoid itself. Kyle and Becker (WO 00/54575) have described a process whereby a DHA-containing oil is stabilized by lecithin at levels up to 8% of the oil. AN additional aspect of this invention involves the combination of lecithin with the carotenoid containing material is in the stabilization of the carotenoid against oxidation.

[0067] Another aspect of the present invention is the combination of the lecithin with other cellular materials comprising long chain polyunsaturated fatty acids (LC-PUFAs). Microorganisms such as, but not limited to, *Cryptocodinium*, *Schizochytrium*,

Thraustochytrium, Ulkenia, Mortierella, etc. are prone to oxidation as a result of their high content of LC-PUFA. Schzochytrium, Thraustochytrium and Ulkenia, in particular, are very fragile and can release oil during the process of harvesting and drying. The use of high concentration of phospholipids (especially lecithin) during the drying process can impart a high degree of stability to the resulting dry biomass of these microorganisms and increase the bioavailability of the LC-PUFAs themselves. Lecithin to biomass ratios from about 1:100 to about 1:1 are effective in increasing stability and bioavailability of the oils.

[0068] Methods for Making Carotenoid/Phospholipid Compositions

[0069] One preferred class of compositions of this invention are compositions that include a carotenoid or carotenoids and PUFA-rich phospholipid or PUFA-rich phospholipids generally prepared by contacting carotenoid and phospholipid under conditions to promote molecular association of the carotenoid and phospholipid. Such conditions typically will include the use of mixing procedures that promote molecular interactions and associations, use of a solvent and/or buffer, and controlled physical parameters (such as temperature, pressure and time) to permit an optimal degree of interaction and association.

[0070] The chemical interaction is preferably performed by aggressive or vigorous mixing. Such mixing procedures include vortex mixing, other high shear mixing procedures, sonication, other molecular level mixing procedures, or the like. The time and temperature of mixing should be designed to maximize interactions between the carotenoids and the phospholipids without causing thermal or shear damage to the molecules themselves. Generally, the mixing time will range from about 5 minutes to several hours, with times ranging between 10 minutes and 1 hour being preferred.

[0071] Generally, the mixing temperature will range from ambient to a temperature of at least 10% below the lowest breakdown temperature for the carotenoids or phospholipids being mixed. Preferably, the temperature will be between ambient temperature to about 60°C.

[0072] In preparing the formulations of this invention, the carotenoids can be mixed with synthetic, purified naturally derived, or crude phospholipids or can be mixed with various grades of lecithin or other PUFA-rich oils obtained from single-celled organisms. Carotenoids may be in the form of pure carotenoid (synthetic or otherwise) or as cellular

material from high carotenoid microorganisms such as but not limited to Pfaffia or Heamatococcus and the mixture of phospholipids to microbial cell biomass may be in the range from 1 part phospholipid to from 1 to 100 parts cellular biomass. Especially useful phospholipid concentrations range from about 15 to about 93% PC by weight. Moreover, the formulations can use either de-oiled or oil-based phospholipid preparations.

[0073] Regardless of the form of the phospholipid, generally the ratio of carotenoids to phospholipids ranges from about 1:100 to about 10:1, preferably, from about 1:25 to about 2:1, and particularly from about 1.0:10.0 to about 1.0:1.0.

[0074] In formulations using de-oiled phospholipids, the de-oiled phospholipids are initially dissolved in an organic solvent such as ethanol, and then mixed with carotenoids. This is followed by mixing, such as vortexing and/or sonication mixing. In formulations using oiled phospholipids, the oil-based phospholipids are simply combined with a carotenoid compound and mixed by vortexing and/or sonication, if needed. Sonication or mixing temperatures are preferably between ambient and about 60°C.

[0075] Another preferred process for making the compositions of this invention includes the dissolving of phospholipids and carotenoids in a polar solvent. Suitable solvents include, without limitation, chlorocarbons (such as chloroform, or the like), lower alcohols (such as methanol, ethanol, isopropanol or the like), or any other solvent in which the phospholipids and the carotenoids have some solubility, and the solvent is removable, e.g., by evaporation, or the like.

[0076] Methods for making LC-PUFA phospholipids compositions. In preparing the formulations of this invention, the LC-PUFA-containing biomass such as, but not limited to Schyzochytrium, can be mixed with synthetic, purified naturally derived or crude phospholipids or can be mixed with various grades of lecithin or other PUFA-rich oils obtained from single cell organisms. Especially useful phospholipids concentrations ranging from about 15 to about 93% PC by weight. Moreover, the formulations can use either de-oiled and oiled-based phospholipids preparations. Mixtures of phospholipids and cellular material containing LC-PUFAs can range from 1 part to from 1 to 100 parts cellular material.

[0077] Examples

[0078] The following examples are included for example only to illustrate the preparation of compositions of present invention containing a carotenoids and PUFA-rich phospholipid, and are in no way meant to limit the scope or teaching of this invention.

[0079] Example 1

[0080] Preparation of a composition of synthetic astaxanthin and soy lecithin.

[0081] A sample of 60 g of soy lecithin (American Lecithin Co) was dissolved in ethanol, 30 g synthetic astaxanthin (AHD International, Atlanta, GA) was added, the mixture sonicated at 60°C for 5 minutes, and the solvent evaporated under vacuum. The resulting powder can be incorporated with other feed ingredients or dissolved in oil and top-coated onto the feed particles.

[0082] Example 2

[0083] Preparation of a composition of *Haematococcus* (containing natural astaxanthin) and phospholipid extract from *Cryptocodinium* species.

[0084] A sample of 50 g of algal phospholipids (Advanced BioNutrition, Columbia, MD) and 100 g *Haematococcus* (Naturouse, Cyanotech Corporation Kailua-Kona, HI) were mixed vigorously for 1 h at room temperature. The mixture was dissolved in 850 ml of Menhaden oil (Omega Protein, Houston, TX) and used to top-coat standard fish feed pellets. The feed pellets were top coated at a level of 20 g of the above mixture per kg feed. This produced a feed containing about 50 mg astaxanthin per kg feed. This feed was then used to color the flesh of aquatic animals that consumed the feed.

[0085] Example 3

[0086] Preparation of a composition of *Phaffia rhodozyma* yeast biomass and phospholipid extract from *Cryptocodinium* sp.

[0087] *Phaffia* yeast was grown under standard conditions in a fermentor and biomass was harvested by centrifugation and diluted to 30% solids with water. Then 13.3 g of algal phospholipids (8 g on a dry weight basis) (ABN, Columbia, MD) was mixed vigorously with 333 g of the *Phaffia* slurry (100 g on a dry weight basis) to facilitate molecular association between the carotenoid and the phospholipids. The material was then dried on a rotary drum dryer at low temperatures and the resulting flakes were milled under liquid

nitrogen to produce a coarse powder. The resulting powder was then mixed with a commercial trout feed and cold pressed into feed pellets (1.2 - 2.0 mm, Ziegler Bros Inc. Gardners, PA) using standard techniques.

[0088] Example 4

[0089] Preparation of a composition of *Phaffia rhodozyma* yeast biomass and soy lecithin.

[0090] One hundred grams of *Phaffia* yeast biomass (Archer-Daniels-Midland Company, Decatur, IL) was mixed with water to give a slurry with a 30% water content. Eight g of soy lecithin (American Lecithin Co) was added to the slurry and the resultant mixture was homogenized vigorously to facilitate molecular association between the carotenoid and the phospholipids. The slurry was then dried in a freeze dryer and collected as a powder. This material had the following composition: 1.5% astaxanthin, 8% phospholipid, 50% fatty acids with 2 or more double bonds, and 20% of the fatty acids with 4 or more double bonds. This mixture was then incorporated into 10 kg commercial fishmeal pellets using standard methods with cold pressing or cold extrusion (Ziegler Bros Inc. Gardners, PA).

[0091] Example 5

[0092] Feeding of trout fish with a feed containing natural astaxanthin from *Phaffia* and a PUFA-containing phospholipid.

[0093] Five diets were prepared by Ziegler Bros Inc. (Gardners, PA) according to the following compositions:

[0094] Diet 1 contained 12.5 g *Phaffia* biomass per kg feed (100 mg astaxanthin/kg feed).

[0095] Diet 2 contained 13.8 g of the composition described in Example 3 per kg feed (100 mg astaxanthin/kg feed).

[0096] Diet 3 contained 7.6 g of the composition described in Example 3 per kg feed (50 mg astaxanthin/kg feed).

[0097] Diet 4 contained no *Phaffia* (0 mg astaxanthin/kg feed).

[0098] Diet 5 contained 7.6 g of the composition described in Example 4 per kg feed (50 mg astaxanthin/kg feed).

[0099] Five groups of 20 trout fish per group were fed 4.4% body weight/day for 21 days. White muscle tissues were sampled from 5 fish in each group on day 21 and freeze-dried for 48 h. Total carotenoids were extracted from the tissues by homogenizing in 5 ml of absolute ethanol and 5 ml ethyl acetate. The homogenates were centrifuged (1000 x g for 5 min) and the supernatants dried under a stream of nitrogen and dissolved in 2 ml of hexane. Total carotenoids were measured spectrophotometrically at 470 nm.

[0100] The effect of the diet on muscle pigmentation is presented in Table 1:

Table 1

	<u>Absorbance at 470 nm</u>
Diet 1	0.19
Diet 2	0.30
Diet 3	0.11
Diet 4	0.05
Diet 5	0.14

[0101] As can be seen from Table 1, Diet 4, with no *Phaffia* and no astaxanthin, provided the least amount of muscle pigmentation indicative of carotenoid content ($A_{470} = 0.05$). Diet 3 and Diet 5, with no *Phaffia* and 50 mg astaxanthin provided by the compositions of Example 3 and Example 4, respectively, provided intermediate amounts of muscle pigmentation. Diet 1, with *Phaffia* biomass providing twice as much, i.e., 100 mg astaxanthin, provided only a slightly higher amount of coloration than Diets 3 and 5. Diet 2, with no *Phaffia* and 100 mg astaxanthin provided by the composition of Example 3, provided the highest amount of coloration. It improved the muscle coloring by 56%, compared to Diet 1.

[0102] Example 6

[0103] Preparation of Schizochytrium biomass with a high degree of oxidative stability.

[0104] Schizochytrium biomass is produced using conventional fermentation technology and harvested by centrifugal harvesting processes to a solid content of about 20%. To this 100g of slurry (20g dry weight Schizochytrium containing about 10g of LC-PUFA enriched oil) 2 g of soy lecithin (American Lecithin Co.) is added. The resultant

mixture is thoroughly mixed and then dried using a rotary drum dryer, or any other drying process and collected as powder or flake. The resulting flake product has a high degree of oxidative stability and bioavailability relative to a similar product produced without the lecithin treatment.

[0105] While this invention has been described fully and completely, it should be understood that, within the scope of the appended claims, the invention may be practiced otherwise than as specifically described. Although the invention has been disclosed with reference to its preferred embodiments, from reading this description those of skill in the art may appreciate changes and modification that may be made which do not depart from the scope and spirit of the invention as described above and claimed hereafter.

[0106] All references cited herein are incorporated by reference, including the following.

[0107] Patent References

[0108] US 6,261,598

[0109] US 6,476,010

[0110] US 6,436,437

[0111] US 6,403,056

[0112] US 6,358,524

[0113] US 6,296,877

[0114] US 6,413,736

[0115] US 6,022,701

[0116] US 5,972,642

[0117] US 5,935,808

[0118] PA20020177181

[0119] EP-A-0 410 236

[0120] DE-A-12 11 911

[0121] Literature References

[0122] Badmaev, V., M. Majeed, et al. (1999). "Piperine, an alkaloid derived from black pepper increases serum response of beta-carotene during 14-days of oral beta-carotene supplementation." Nutr Res 19: 381-388.

- [0123] Bell, J. G., J. McEvoy, et al. (1998). "Flesh Lipid and Carotenoid Composition of Scottish Farmed Atlantic Salmon (*Salmo salar*)." J Agric Food Chem **46**(1): 119-127.
- [0124] Bjerkeng, B. and G. M. Berge (2000). "Apparent digestibility coefficients and accumulation of astaxanthin E/Z isomers in Atlantic salmon (*Salmo salar* L.) and Atlantic halibut (*Hippoglossus hippoglossus* L.)." Comp Biochem Physiol B Biochem Mol Biol **127**(3): 423-32.
- [0125] Bracco, U. and R. Decekbaum (1992). Polyunsaturated fatty acids in human nutrition. New York, New York, Raven Press.
- [0126] Canizares-Villanueva, R. O., E. Rios-Leal, et al. (1998). "[Microbial sources of pigments]." Rev Latinoam Microbiol **40**(1-2): 87-107.
- [0127] Clark, R. M., L. Yao, et al. (2000). "A comparison of lycopene and astaxanthin absorption from corn oil and olive oil emulsions." Lipids **35**(7): 803-6.
- [0128] Deuel, H. (1951). The lipids. New York, New York, Interscience Publishers.
- [0129] Fennema, O. (1996). Food Chemistry, Marcel Decker.
- [0130] Furuita, H., T. Takeuchi, et al. (1998). "Effects of eicosapentaenoic and docosahexaenoic acids on growth, survival and brain development of larval Japanese flounder (*Paralichthys olivaceus*)." Aquaculture **161**: 269-279.
- [0131] Goto, S., K. Kogure, et al. (2001). "Efficient radical trapping at the surface and inside the phospholipid membrane is responsible for highly potent antiperoxidative activity of the carotenoid astaxanthin." Biochim Biophys Acta **1512**(2): 251-8.
- [0132] Hinostroza, G. C., A. Huberman, et al. (1997). "Pigmentation of the rainbow trout (*Oncorhynchus mykiss*) with oil-extracted astaxanthin from the langostilla (*Pleuroncodes planipes*)." Arch Latinoam Nutr **47**(3): 237-41.
- [0133] Lockwood, S. F., S. O'Malley, et al. (2003). "Improved aqueous solubility of crystalline astaxanthin (3,3'-dihydroxy-beta, beta-carotene-4,4'-dione) by Captisol (sulfobutyl ether beta-cyclodextrin)." J Pharm Sci **92**(4): 922-6.
- [0134] Pane, L., L. Radin, et al. (1996). "The carotenoid pigments of a marine *Bacillus firmus* strain." Boll Soc Ital Biol Sper **72**(11-12): 303-8.
- [0135] Parajo, J. C., V. V. Santos, et al. (1998). "Production of carotenoids by *phaffia rhodozyma* growing on media made from hemicellulosic hydrolysates of eucalyptus globulus wood." Biotechnol Bioeng **59**(4): 501-6.

- [0136] Place, A. R. and M. Harel (2002). Use of arachidonic acid for enhanced culturing of fish larvae and broodstock. US Pat. Publ. 20020110582 A1.
- [0137] Shahidi, F., Metusalach, et al. (1998). "Carotenoid pigments in seafoods and aquaculture." Crit Rev Food Sci Nutr **38**(1): 1-67.
- [0138] Shibata, A., Y. Kiba, et al. (2001). "Molecular characteristics of astaxanthin and beta-carotene in the phospholipid monolayer and their distributions in the phospholipid bilayer." Chem Phys Lipids **113**(1-2): 11-22.
- [0139] Tsubokura, A., H. Yoneda, et al. (1999). "Paracoccus carotinifaciens sp. nov., a new aerobic gram-negative astaxanthin-producing bacterium." Int J Syst Bacteriol **49 Pt 1**: 277-82.
- [0140] Yeum, K. J. and R. M. Russell (2002). "Carotenoid bioavailability and bioconversion." Annu Rev Nutr **22**: 483-504.

CLAIMS

We Claim:

1. A composition comprising at least one carotenoid and at least one phospholipid, wherein the carotenoid comprises at least 1% of the total mass and the phospholipid comprises at least 5% of the total mass, and the ratio of carotenoid to phospholipid is from about 1:100 to about 1:0.01.
2. The composition of Claim 1, wherein the carotenoid has a microbial source.
3. The composition of Claim 2, wherein the microbial source is chosen from *Phaffia*, *Haematococcus*, *Schizochytrium* and *Paracoccus*.
4. The composition of Claim 1, wherein the carotenoid is chosen from astaxanthin, zeaxanthin, canthaxanthin, lutein, beta-carotene, and lycopene.
5. The composition of Claim 1, wherein the carotenoid is synthetic.
6. The composition of Claim 1, wherein the phospholipid comprises more than about 20% polyunsaturated fatty acids having two or more double bonds.
7. The composition of Claim 1, wherein the phospholipid comprises more than about 10% polyunsaturated fatty acids having three or more double bonds.
8. The composition of Claim 1, wherein the phospholipid comprises more than about 10% polyunsaturated fatty acids having four or more double bonds.
9. The composition of Claim 1, wherein the phospholipid comprises more than about 20% polyunsaturated fatty acids having four or more double bonds.
10. The composition of Claim 1, wherein the phospholipid is of microbial origin.
11. The composition of Claim 1, wherein the phospholipid is an egg lecithin.
12. The composition of Claim 1, wherein the phospholipid has an origin chosen from fish, crustacean, and shellfish.
13. The composition of Claim 1, wherein the phospholipid is of mammalian origin.

14. The composition of Claim 13, wherein the phospholipid is of mammalian brain origin.
15. The composition of Claim 1, wherein the ratio of carotenoids to phospholipids is from about 1:50 to about 2:1.
16. The composition of Claim 1, wherein the ratio of carotenoids to phospholipids is from about 1:10 to about 1:1.
17. The composition of Claim 1, wherein the ratio of carotenoids to phospholipids is from about 1:5 to about 1:1.
18. An animal feed comprising the composition of any of Claims 1 to 17, wherein the carotenoid content is between about 0.1 mg and about 1000 mg per kg of feed.
19. The composition of Claim 18, wherein the animal is an aquatic animal.
20. The composition of Claim 19, wherein the aquatic animal is typically cultured below a temperature of 20°C.
21. The composition of Claim 19, wherein the aquatic animal is a fish.
22. The composition of Claim 19, wherein the aquatic animal is a crustacean.
23. The composition of Claim 18, wherein the animal is a terrestrial animal.
24. The composition of Claim 23, wherein the terrestrial animal is a bird.
25. A method of pigmenting an animal or animal-derived product, comprising providing a feed as described in Claims 18-24.
26. The method of Claim 25, wherein the animal-derived product is chosen from an egg and a processed egg product.
27. The method of Claim 25, wherein the animal or animal-derived product is chosen from a whole animal, the processed flesh of an animal, and a processed animal product.

28. A method of preparing an animal feed, feed supplement, or feed ingredient by
- (a) first mixing at least one carotenoid and at least one phospholipid, wherein the carotenoid comprises at least 1% of the total mass and the phospholipid comprises at least 5% of the total mass, wherein the ratio of the carotenoid to phospholipid is from about 1:100 to about 1:0.01; and
 - (b) then combining the carotenoid/phospholipid mixture with animal feed, feed supplement, or feed ingredient to provide a final carotenoid content between about 0.1 mg and about 1000 mg per kg; and
 - (c) then processing the feed, feed supplement, or feed ingredient into a deliverable form.
29. A method as in Claim 28, wherein the deliverable form comprises a pelleted feed.
30. A method as in Claim 28, wherein more than one carotenoid is mixed with the phospholipid.
32. A method of preparing an animal feed by:
- (a) first mixing at least one carotenoid and at least one phospholipid, wherein the carotenoids comprise at least 1% of the total mass and the total phospholipids comprise at least 5% of the total mass, and the ratio of the carotenoid to phospholipid is from about 1:00 to about 1:0.01;
 - (b) then combining the mixture with a carrier in a ratio of about 1 to about 100 parts carrier:mixture; and
 - (c) then coating standard feed pellets with a composition comprising the mixture and the carrier.
33. The method of Claim 32, wherein the carrier comprises an oil.
34. The method of Claim 32, wherein the coating comprises a top coating.

Figure 1.

Improved Total Carotenes (TC) Assimilation With DHA-PL (Trout)

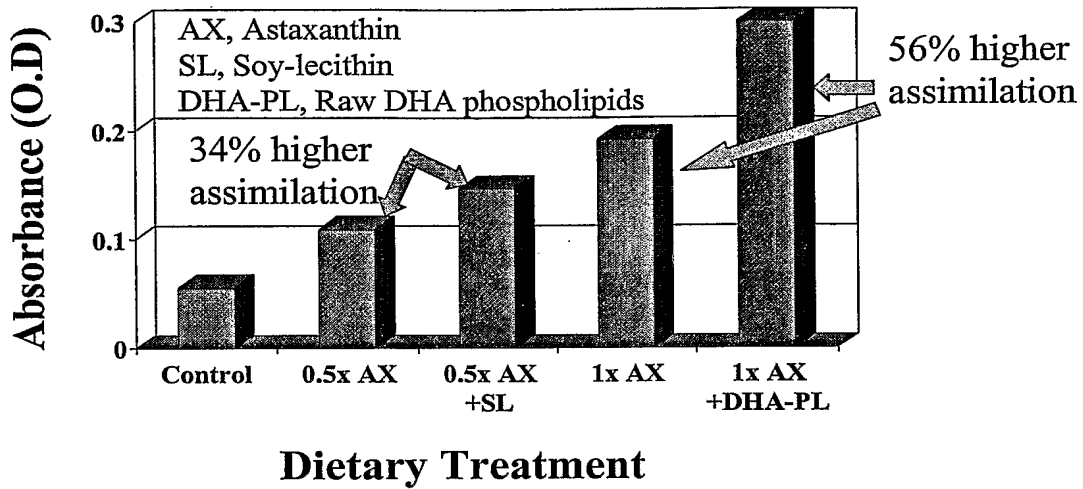

INTERNATIONAL SEARCH REPORT

International application No.

PCT/US04/19972

A. CLASSIFICATION OF SUBJECT MATTER

IPC(7) : A61K 31/065
 US CL : 514/726

According to International Patent Classification (IPC) or to both national classification and IPC

B. FIELDS SEARCHED

Minimum documentation searched (classification system followed by classification symbols)
 U.S. : 514/726

Documentation searched other than minimum documentation to the extent that such documents are included in the fields searched
 NONE

Electronic data base consulted during the international search (name of data base and, where practicable, search terms used)
 WEST

C. DOCUMENTS CONSIDERED TO BE RELEVANT

Category *	Citation of document, with indication, where appropriate, of the relevant passages	Relevant to claim No.
A	US 6,261,598 B1 (RUNGE et al.) 17 July 2001 (17.07.2001), see the retire document.	1-32

Further documents are listed in the continuation of Box C.

See patent family annex.

* Special categories of cited documents:	"T"	later document published after the international filing date or priority date and not in conflict with the application but cited to understand the principle or theory underlying the invention
"A" document defining the general state of the art which is not considered to be of particular relevance	"X"	document of particular relevance; the claimed invention cannot be considered novel or cannot be considered to involve an inventive step when the document is taken alone
"E" earlier application or patent published on or after the international filing date	"Y"	document of particular relevance; the claimed invention cannot be considered to involve an inventive step when the document is combined with one or more other such documents, such combination being obvious to a person skilled in the art
"L" document which may throw doubts on priority claim(s) or which is cited to establish the publication date of another citation or other special reason (as specified)	"&"	document member of the same patent family
"O" document referring to an oral disclosure, use, exhibition or other means		
"P" document published prior to the international filing date but later than the priority date claimed		

Date of the actual completion of the international search

29 September 2004 (29.09.2004)

Date of mailing of the international search report

26 OCT 2004

Name and mailing address of the ISA/US

Mail Stop PCT, Attn: ISA/US
 Commissioner for Patents
 P.O. Box 1450
 Alexandria, Virginia 22313-1450

Facsimile No. (703) 305-3230

Authorized officer

Christopher Low
 Christopher Low

Telephone No. 571-272-1600

Electronic Acknowledgement Receipt

EFS ID:	16476339
Application Number:	12057775
International Application Number:	
Confirmation Number:	1945
Title of Invention:	BIOEFFECTIVE KRILL OIL COMPOSITIONS
First Named Inventor/Applicant Name:	Inge Bruheim
Customer Number:	72960
Filer:	John Mitchell Jones/Vickie Hoeft
Filer Authorized By:	John Mitchell Jones
Attorney Docket Number:	AKBM-14409/US-5/ORD
Receipt Date:	01-AUG-2013
Filing Date:	28-MAR-2008
Time Stamp:	17:47:34
Application Type:	Utility under 35 USC 111(a)

Payment information:

Submitted with Payment	no
------------------------	----

File Listing:

Document Number	Document Description	File Name	File Size(Bytes)/ Message Digest	Multi Part /.zip	Pages (if appl.)
1	Transmittal Letter	14409US5ORD_IDSletterFS080 12013.pdf	82262 <small>1490fde3ba50287619b47baf3d88d941153 e0d09</small>	no	1

Warnings:

Information:

2	Information Disclosure Statement (IDS) Form (SB08)	14409US5InformationDisclosur eStatement08012013.pdf	612267 a1b646a60997a2a2af2f42944e19d155880 defda	no	4
Warnings:					
Information:					
A U.S. Patent Number Citation or a U.S. Publication Number Citation is required in the Information Disclosure Statement (IDS) form for autoloading of data into USPTO systems. You may remove the form to add the required data in order to correct the Informational Message if you are citing U.S. References. If you chose not to include U.S. References, the image of the form will be processed and be made available within the Image File Wrapper (IFW) system. However, no data will be extracted from this form. Any additional data such as Foreign Patent Documents or Non Patent Literature will be manually reviewed and keyed into USPTO systems.					
3	Other Reference-Patent/App/Search documents	EPSearchReportEP12187516. pdf	306889 05e6124c12eb01919bfb5eff812ce7264958 c3d3	no	8
Warnings:					
Information:					
4	Foreign Reference	WO2004112767.pdf	1371659 bf898e0b5df9ce5a7a99b2a1da2f6b9fa4d 145c	no	25
Warnings:					
Information:					
Total Files Size (in bytes):			2373077		
<p>This Acknowledgement Receipt evidences receipt on the noted date by the USPTO of the indicated documents, characterized by the applicant, and including page counts, where applicable. It serves as evidence of receipt similar to a Post Card, as described in MPEP 503.</p> <p><u>New Applications Under 35 U.S.C. 111</u> If a new application is being filed and the application includes the necessary components for a filing date (see 37 CFR 1.53(b)-(d) and MPEP 506), a Filing Receipt (37 CFR 1.54) will be issued in due course and the date shown on this Acknowledgement Receipt will establish the filing date of the application.</p> <p><u>National Stage of an International Application under 35 U.S.C. 371</u> If a timely submission to enter the national stage of an international application is compliant with the conditions of 35 U.S.C. 371 and other applicable requirements a Form PCT/DO/EO/903 indicating acceptance of the application as a national stage submission under 35 U.S.C. 371 will be issued in addition to the Filing Receipt, in due course.</p> <p><u>New International Application Filed with the USPTO as a Receiving Office</u> If a new international application is being filed and the international application includes the necessary components for an international filing date (see PCT Article 11 and MPEP 1810), a Notification of the International Application Number and of the International Filing Date (Form PCT/RO/105) will be issued in due course, subject to prescriptions concerning national security, and the date shown on this Acknowledgement Receipt will establish the international filing date of the application.</p>					

IN THE UNITED STATES PATENT AND TRADEMARK OFFICE

In re Application of:	Inge Bruheim, et al	Confirmation:	1945
Serial No.:	12/057,775	Group No.:	1651
Filed:	03-28-2008	Examiner:	Ware, Deborah K.
Entitled:	BIOEFFECTIVE KRILL OIL COMPOSITIONS		

INFORMATION DISCLOSURE STATEMENT LETTER

EFS Web Filed
Commissioner for Patents
P.O. Box 1450
Alexandria, VA 22313-1450

Sir or Madam:

The citations listed in the attached **IDS Form SB08A** may be material to the examination of the above-identified application, and are therefore submitted in compliance with the duty of disclosure defined in 37 C.F.R. §§ 1.56 and 1.97.

Applicants wish to bring to the Examiner’s attention that we are not providing copies of US Patents as instructed under 37 CFR 1.98(a)(2). The Examiner is requested to make these citations of official record in this application.

CERTIFICATION STATEMENT

Applicants wish to bring to the Examiner’s attention that the references supplied in this IDS are from a June 10, 2013 EP Search Report (copy attached). The present IDS is filed within three months of the mailing of the Search Report; therefore, no fees are due.

This Information Disclosure Statement under 37 C.F.R. §§ 1.56 and 1.97 is not to be construed as a representation that a search has been made, that additional information material to the examination of this application does not exist, or that any one or more of these citations constitutes prior art.

The Commissioner is hereby authorized to charge any required fees or credit any overpayments to Attorney Deposit Account No.: **50-4302**, referencing Attorney Docket No.: **NATNUT-14409/US-5/ORD**.

Dated: August 1, 2013

/J. Mitchell Jones/
J. Mitchell Jones
Registration No. 44,174
CASIMIR JONES, S.C.
2275 Deming Way, Suite 310
Middleton, WI 53562
608.662.1277

POWER OF ATTORNEY OR REVOCAION OF POWER OF ATTORNEY WITH A NEW POWER OF ATTORNEY AND CHANGE OF CORRESPONDENCE ADDRESS	Application Number	12/057,775
	Filing Date	28-Mar-2008
	First Named Inventor	Inge Bruheim
	Title	BIOEFFECTIVE KRILL OIL COMPOSITIONS
	Art Unit	1651
	Examiner Name	Ware, Deborah
	Attorney Docket Number	AKBM-14409/US-5/ORD

I hereby revoke all previous powers of attorney given in the above-identified application.

A Power of Attorney is submitted herewith.

OR

I hereby appoint Practitioner(s) associated with the following Customer Number as my/our attorney(s) or agent(s) to prosecute the application identified above, and to transact all business in the United States Patent and Trademark Office connected therewith:

72960

OR

I hereby appoint Practitioner(s) named below as my/our attorney(s) or agent(s) to prosecute the application identified above, and to transact all business in the United States Patent and Trademark Office connected therewith:

Practitioner(s) Name	Registration Number

Please recognize or change the correspondence address for the above-identified application to:

The address associated with the above-mentioned Customer Number.

OR

The address associated with Customer Number:

OR

<input type="checkbox"/> Firm or Individual Name			
Address			
City	State	Zip	
Country			
Telephone	Email		

I am the:

Applicant/Inventor.

OR

Assignee of record of the entire interest. See 37 CFR 3.71. Statement under 37 CFR 3.73(b) (Form PTO/SB/96) submitted herewith or filed on _____

SIGNATURE of Applicant or Assignee of Record			
Signature	<i>Arthur H. Hallvard Maki</i>	Date	March 1, 2013
Name	HALLVARD MAKI	Telephone	+1 724 1300 00
Title and Company	CEO, Aker BioMarine AS		

NOTE: Signatures of all the inventors or assignees of record of the entire interest or their representative(s) are required. Submit multiple forms if more than one signature is required, see below*.

*Total of _____ forms are submitted.

This collection of information is required by 37 CFR 1.31, 1.32 and 1.33. The information is required to obtain or retain a benefit by the public which is to file (and by the USPTO to process) an application. Confidentiality is governed by 35 U.S.C. 122 and 37 CFR 1.11 and 1.14. This collection is estimated to take 3 minutes to complete, including gathering, preparing, and submitting the completed application form to the USPTO. Time will vary depending upon the individual case. Any comments on the amount of time you require to complete this form and/or suggestions for reducing this burden, should be sent to the Chief Information Officer, U.S. Patent and Trademark Office, U.S. Department of Commerce, P.O. Box 1450, Alexandria, VA 22313-1450. DO NOT SEND FEES OR COMPLETED FORMS TO THIS ADDRESS. SEND TO: Commissioner for Patents, P.O. Box 1450, Alexandria, VA 22313-1450.

If you need assistance in completing the form, call 1-800-PTO-9199 and select option 2.

Under the Paperwork Reduction Act of 1995, no persons are required to respond to a collection of information unless it displays a valid OMB control number.

STATEMENT UNDER 37 CFR 3.73(b)

Applicant/Patent Owner: Inge Bruheim

Application No./Patent No.: 12/057,775 Filed/Issue Date: 28-Mar-2008

Titled: **BIOEFFECTIVE KRILL OIL COMPOSITIONS**

AKER BIOMARINE AS, a corporation
(Name of Assignee) (Type of Assignee, e.g., corporation, partnership, university, government agency, etc.)

states that it is:

- 1. the assignee of the entire right, title, and interest in;
- 2. an assignee of less than the entire right, title, and interest in (The extent (by percentage) of its ownership interest is _____ %); or
- 3. the assignee of an undivided interest in the entirety of (a complete assignment from one of the joint inventors was made)

the patent application/patent identified above, by virtue of either:

A. An assignment from the inventor(s) of the patent application/patent identified above. The assignment was recorded in the United States Patent and Trademark Office at Reel _____, Frame _____, or for which a copy therefore is attached.

OR

B. A chain of title from the inventor(s), of the patent application/patent identified above, to the current assignee as follows:

1. From: INVENTORS To: AKER BIOMARINE ASA

The document was recorded in the United States Patent and Trademark Office at Reel 023089, Frame 0864, or for which a copy thereof is attached.

2. From: AKER BIOMARINE ASA To: AKER BIOMARINE AS

The document was recorded in the United States Patent and Trademark Office at Reel 029802, Frame 0828, or for which a copy thereof is attached.

3. From: _____ To: _____

The document was recorded in the United States Patent and Trademark Office at Reel _____, Frame _____, or for which a copy thereof is attached.

Additional documents in the chain of title are listed on a supplemental sheet(s).

As required by 37 CFR 3.73(b)(1)(i), the documentary evidence of the chain of title from the original owner to the assignee was, or concurrently is being, submitted for recordation pursuant to 37 CFR 3.11.

[NOTE: A separate copy (i.e., a true copy of the original assignment document(s)) must be submitted to Assignment Division in accordance with 37 CFR Part 3, to record the assignment in the records of the USPTO. See MPEP 302.08]

The undersigned (whose title is supplied below) is authorized to act on behalf of the assignee.

Signature

March 1, 2013
Date

HALLVARD Mørk
Printed or Typed Name

CEO
Title

This collection of information is required by 37 CFR 3.73(b). The information is required to obtain or retain a benefit by the public which is to file (and by the USPTO to process) an application. Confidentiality is governed by 35 U.S.C. 122 and 37 CFR 1.11 and 1.14. This collection is estimated to take 12 minutes to complete, including gathering, preparing, and submitting the completed application form to the USPTO. Time will vary depending upon the individual case. Any comments on the amount of time you require to complete this form and/or suggestions for reducing this burden, should be sent to the Chief Information Officer, U.S. Patent and Trademark Office, U.S. Department of Commerce, P.O. Box 1450, Alexandria, VA 22313-1450. DO NOT SEND FEES OR COMPLETED FORMS TO THIS ADDRESS. SEND TO: Commissioner for Patents, P.O. Box 1450, Alexandria, VA 22313-1450.

If you need assistance in completing the form, call 1-800-PTO-9199 and select option 2.

Privacy Act Statement

The **Privacy Act of 1974 (P.L. 93-579)** requires that you be given certain information in connection with your submission of the attached form related to a patent application or patent. Accordingly, pursuant to the requirements of the Act, please be advised that: (1) the general authority for the collection of this information is 35 U.S.C. 2(b)(2); (2) furnishing of the information solicited is voluntary; and (3) the principal purpose for which the information is used by the U.S. Patent and Trademark Office is to process and/or examine your submission related to a patent application or patent. If you do not furnish the requested information, the U.S. Patent and Trademark Office may not be able to process and/or examine your submission, which may result in termination of proceedings or abandonment of the application or expiration of the patent.

The information provided by you in this form will be subject to the following routine uses:

1. The information on this form will be treated confidentially to the extent allowed under the Freedom of Information Act (5 U.S.C. 552) and the Privacy Act (5 U.S.C. 552a). Records from this system of records may be disclosed to the Department of Justice to determine whether disclosure of these records is required by the Freedom of Information Act.
2. A record from this system of records may be disclosed, as a routine use, in the course of presenting evidence to a court, magistrate, or administrative tribunal, including disclosures to opposing counsel in the course of settlement negotiations.
3. A record in this system of records may be disclosed, as a routine use, to a Member of Congress submitting a request involving an individual, to whom the record pertains, when the individual has requested assistance from the Member with respect to the subject matter of the record.
4. A record in this system of records may be disclosed, as a routine use, to a contractor of the Agency having need for the information in order to perform a contract. Recipients of information shall be required to comply with the requirements of the Privacy Act of 1974, as amended, pursuant to 5 U.S.C. 552a(m).
5. A record related to an International Application filed under the Patent Cooperation Treaty in this system of records may be disclosed, as a routine use, to the International Bureau of the World Intellectual Property Organization, pursuant to the Patent Cooperation Treaty.
6. A record in this system of records may be disclosed, as a routine use, to another federal agency for purposes of National Security review (35 U.S.C. 181) and for review pursuant to the Atomic Energy Act (42 U.S.C. 218(c)).
7. A record from this system of records may be disclosed, as a routine use, to the Administrator, General Services, or his/her designee, during an inspection of records conducted by GSA as part of that agency's responsibility to recommend improvements in records management practices and programs, under authority of 44 U.S.C. 2904 and 2906. Such disclosure shall be made in accordance with the GSA regulations governing inspection of records for this purpose, and any other relevant (*i.e.*, GSA or Commerce) directive. Such disclosure shall not be used to make determinations about individuals.
8. A record from this system of records may be disclosed, as a routine use, to the public after either publication of the application pursuant to 35 U.S.C. 122(b) or issuance of a patent pursuant to 35 U.S.C. 151. Further, a record may be disclosed, subject to the limitations of 37 CFR 1.14, as a routine use, to the public if the record was filed in an application which became abandoned or in which the proceedings were terminated and which application is referenced by either a published application, an application open to public inspection or an issued patent.
9. A record from this system of records may be disclosed, as a routine use, to a Federal, State, or local law enforcement agency, if the USPTO becomes aware of a violation or potential violation of law or regulation.

Electronic Acknowledgement Receipt

EFS ID:	15093234
Application Number:	12057775
International Application Number:	
Confirmation Number:	1945
Title of Invention:	BIOEFFECTIVE KRILL OIL COMPOSITIONS
First Named Inventor/Applicant Name:	Inge Bruheim
Customer Number:	72960
Filer:	John Mitchell Jones/Vickie Hoeft
Filer Authorized By:	John Mitchell Jones
Attorney Docket Number:	AKBM-14409/US-5/ORD
Receipt Date:	01-MAR-2013
Filing Date:	28-MAR-2008
Time Stamp:	14:10:55
Application Type:	Utility under 35 USC 111(a)

Payment information:

Submitted with Payment	no
------------------------	----

File Listing:

Document Number	Document Description	File Name	File Size(Bytes)/ Message Digest	Multi Part /.zip	Pages (if appl.)
1	Power of Attorney	14409US5PowerEXEC.pdf	187624 <small>cc609bffb977bacbd2b39290db832e1c3e521ae6</small>	no	3

Warnings:

Information:

This Acknowledgement Receipt evidences receipt on the noted date by the USPTO of the indicated documents, characterized by the applicant, and including page counts, where applicable. It serves as evidence of receipt similar to a Post Card, as described in MPEP 503.

New Applications Under 35 U.S.C. 111

If a new application is being filed and the application includes the necessary components for a filing date (see 37 CFR 1.53(b)-(d) and MPEP 506), a Filing Receipt (37 CFR 1.54) will be issued in due course and the date shown on this Acknowledgement Receipt will establish the filing date of the application.

National Stage of an International Application under 35 U.S.C. 371

If a timely submission to enter the national stage of an international application is compliant with the conditions of 35 U.S.C. 371 and other applicable requirements a Form PCT/DO/EO/903 indicating acceptance of the application as a national stage submission under 35 U.S.C. 371 will be issued in addition to the Filing Receipt, in due course.

New International Application Filed with the USPTO as a Receiving Office

If a new international application is being filed and the international application includes the necessary components for an international filing date (see PCT Article 11 and MPEP 1810), a Notification of the International Application Number and of the International Filing Date (Form PCT/RO/105) will be issued in due course, subject to prescriptions concerning national security, and the date shown on this Acknowledgement Receipt will establish the international filing date of the application.

INFORMATION DISCLOSURE STATEMENT BY APPLICANT (Not for submission under 37 CFR 1.99)	Application Number		12057775	
	Filing Date		2008-03-28	
	First Named Inventor	Inge Bruheim		
	Art Unit	1651		
	Examiner Name	Ware, Deborah K.		
	Attorney Docket Number	AKBM-14409/US-5/ORD		

U.S.PATENTS						Remove
Examiner Initial*	Cite No	Patent Number	Kind Code ¹	Issue Date	Name of Patentee or Applicant of cited Document	Pages,Columns,Lines where Relevant Passages or Relevant Figures Appear
	1					

If you wish to add additional U.S. Patent citation information please click the Add button. Add

U.S.PATENT APPLICATION PUBLICATIONS						Remove
Examiner Initial*	Cite No	Publication Number	Kind Code ¹	Publication Date	Name of Patentee or Applicant of cited Document	Pages,Columns,Lines where Relevant Passages or Relevant Figures Appear
	1					

If you wish to add additional U.S. Published Application citation information please click the Add button. Add

FOREIGN PATENT DOCUMENTS								Remove
Examiner Initial*	Cite No	Foreign Document Number ³	Country Code ² j	Kind Code ⁴	Publication Date	Name of Patentee or Applicant of cited Document	Pages,Columns,Lines where Relevant Passages or Relevant Figures Appear	T ⁵
	1	2002322233	AU		2003-02-17	Neptune Technologies & Bioresources, Inc.		<input type="checkbox"/>
	2	04057853	JP		1992-02-25	CHLORINE ENG CORP LTD		<input checked="" type="checkbox"/>

If you wish to add additional Foreign Patent Document citation information please click the Add button Add

NON-PATENT LITERATURE DOCUMENTS						Remove
---------------------------------	--	--	--	--	--	--------

INFORMATION DISCLOSURE STATEMENT BY APPLICANT (Not for submission under 37 CFR 1.99)	Application Number	12057775
	Filing Date	2008-03-28
	First Named Inventor	Inge Bruheim
	Art Unit	1651
	Examiner Name	Ware, Deborah K.
	Attorney Docket Number	AKBM-14409/US-5/ORD

Examiner Initials*	Cite No	Include name of the author (in CAPITAL LETTERS), title of the article (when appropriate), title of the item (book, magazine, journal, serial, symposium, catalog, etc), date, pages(s), volume-issue number(s), publisher, city and/or country where published.	T ⁵
	1	CN Office Action mailed April 27, 2012, JP Patent Application No. 200880112125.6 (and English translation)	<input checked="" type="checkbox"/>
	2	FRICKE, et al., Lipid, Sterol and Fatty Acid Composition of Antarctic Krill (<i>Euphausia superba</i> Dana), <i>Lipids</i> (1984) 19 (11): 821-827.	<input type="checkbox"/>
	3	FRICKE, et al., 1-O-Alkylglycerolipids in Antarctic Krill (<i>Euphausia Superba</i> Dana), <i>Comp. Biochem. Physiol.</i> (1986) 85B(1): 131-134	<input type="checkbox"/>
	4	GORDEEV, K.Y., et al. "Fatty Acid Composition of the Main Phospholipids of the Antarctic Krill, <i>Euphausia superba</i> ," <i>Chem. Nat. Cmpds.</i> (1990) 26(2), pp. 143-147	<input type="checkbox"/>
	5	GRANTHAM (1977) Southern Ocean Fisheries Survey Programme, FAO Rome, GLO/SO/77/3: 1-61.	<input type="checkbox"/>
	6	RAVENTOS et al., Application and Possibilities of Supercritical CO ₂ Extraction in Food Processing Industry: An Overview, <i>Food Science and Technology International</i> (2002) 8: 269-284	<input type="checkbox"/>
	7	TANAKA, T., et al., Platelet-activating Factor (PAF)-like Phospholipids Formed during Peroxidation of Phosphatidylcholines from Different Foodstuffs, <i>Biosci. Biotech. Biochem.</i> (1995) 59 (8), pp. 1389-93	<input type="checkbox"/>
	8	WINTHER, et al., Elucidation of Phosphatidylcholine Composition in Krill Oil Extracted from <i>Euphausia superba</i> , <i>Lipids</i> (2011) 46: 25-36	<input type="checkbox"/>

If you wish to add additional non-patent literature document citation information please click the Add button [Add](#)

EXAMINER SIGNATURE

Examiner Signature		Date Considered	
--------------------	--	-----------------	--

*EXAMINER: Initial if reference considered, whether or not citation is in conformance with MPEP 609. Draw line through a citation if not in conformance and not considered. Include copy of this form with next communication to applicant.

**INFORMATION DISCLOSURE
STATEMENT BY APPLICANT**
(Not for submission under 37 CFR 1.99)

Application Number	12057775
Filing Date	2008-03-28
First Named Inventor	Inge Bruheim
Art Unit	1651
Examiner Name	Ware, Deborah K.
Attorney Docket Number	AKBM-14409/US-5/ORD

¹ See Kind Codes of USPTO Patent Documents at www.USPTO.GOV or MPEP 901.04. ² Enter office that issued the document, by the two-letter code (WIPO Standard ST.3). ³ For Japanese patent documents, the indication of the year of the reign of the Emperor must precede the serial number of the patent document. ⁴ Kind of document by the appropriate symbols as indicated on the document under WIPO Standard ST.16 if possible. ⁵ Applicant is to place a check mark here if English language translation is attached.

INFORMATION DISCLOSURE STATEMENT BY APPLICANT (Not for submission under 37 CFR 1.99)	Application Number	12057775
	Filing Date	2008-03-28
	First Named Inventor	Inge Bruheim
	Art Unit	1651
	Examiner Name	Ware, Deborah K.
	Attorney Docket Number	AKBM-14409/US-5/ORD

CERTIFICATION STATEMENT

Please see 37 CFR 1.97 and 1.98 to make the appropriate selection(s):

That each item of information contained in the information disclosure statement was first cited in any communication from a foreign patent office in a counterpart foreign application not more than three months prior to the filing of the information disclosure statement. See 37 CFR 1.97(e)(1).

OR

That no item of information contained in the information disclosure statement was cited in a communication from a foreign patent office in a counterpart foreign application, and, to the knowledge of the person signing the certification after making reasonable inquiry, no item of information contained in the information disclosure statement was known to any individual designated in 37 CFR 1.56(c) more than three months prior to the filing of the information disclosure statement. See 37 CFR 1.97(e)(2).

See attached certification statement.

The fee set forth in 37 CFR 1.17 (p) has been submitted herewith.

A certification statement is not submitted herewith.

SIGNATURE

A signature of the applicant or representative is required in accordance with CFR 1.33, 10.18. Please see CFR 1.4(d) for the form of the signature.

Signature	/J. Mitchell Jones/	Date (YYYY-MM-DD)	2012-11-15
Name/Print	J. Mitchell Jones	Registration Number	44174

This collection of information is required by 37 CFR 1.97 and 1.98. The information is required to obtain or retain a benefit by the public which is to file (and by the USPTO to process) an application. Confidentiality is governed by 35 U.S.C. 122 and 37 CFR 1.14. This collection is estimated to take 1 hour to complete, including gathering, preparing and submitting the completed application form to the USPTO. Time will vary depending upon the individual case. Any comments on the amount of time you require to complete this form and/or suggestions for reducing this burden, should be sent to the Chief Information Officer, U.S. Patent and Trademark Office, U.S. Department of Commerce, P.O. Box 1450, Alexandria, VA 22313-1450. **DO NOT SEND FEES OR COMPLETED FORMS TO THIS ADDRESS. SEND TO: Commissioner for Patents, P.O. Box 1450, Alexandria, VA 22313-1450.**

Privacy Act Statement

The Privacy Act of 1974 (P.L. 93-579) requires that you be given certain information in connection with your submission of the attached form related to a patent application or patent. Accordingly, pursuant to the requirements of the Act, please be advised that: (1) the general authority for the collection of this information is 35 U.S.C. 2(b)(2); (2) furnishing of the information solicited is voluntary; and (3) the principal purpose for which the information is used by the U.S. Patent and Trademark Office is to process and/or examine your submission related to a patent application or patent. If you do not furnish the requested information, the U.S. Patent and Trademark Office may not be able to process and/or examine your submission, which may result in termination of proceedings or abandonment of the application or expiration of the patent.

The information provided by you in this form will be subject to the following routine uses:

1. The information on this form will be treated confidentially to the extent allowed under the Freedom of Information Act (5 U.S.C. 552) and the Privacy Act (5 U.S.C. 552a). Records from this system of records may be disclosed to the Department of Justice to determine whether the Freedom of Information Act requires disclosure of these records.
2. A record from this system of records may be disclosed, as a routine use, in the course of presenting evidence to a court, magistrate, or administrative tribunal, including disclosures to opposing counsel in the course of settlement negotiations.
3. A record in this system of records may be disclosed, as a routine use, to a Member of Congress submitting a request involving an individual, to whom the record pertains, when the individual has requested assistance from the Member with respect to the subject matter of the record.
4. A record in this system of records may be disclosed, as a routine use, to a contractor of the Agency having need for the information in order to perform a contract. Recipients of information shall be required to comply with the requirements of the Privacy Act of 1974, as amended, pursuant to 5 U.S.C. 552a(m).
5. A record related to an International Application filed under the Patent Cooperation Treaty in this system of records may be disclosed, as a routine use, to the International Bureau of the World Intellectual Property Organization, pursuant to the Patent Cooperation Treaty.
6. A record in this system of records may be disclosed, as a routine use, to another federal agency for purposes of National Security review (35 U.S.C. 181) and for review pursuant to the Atomic Energy Act (42 U.S.C. 218(c)).
7. A record from this system of records may be disclosed, as a routine use, to the Administrator, General Services, or his/her designee, during an inspection of records conducted by GSA as part of that agency's responsibility to recommend improvements in records management practices and programs, under authority of 44 U.S.C. 2904 and 2906. Such disclosure shall be made in accordance with the GSA regulations governing inspection of records for this purpose, and any other relevant (i.e., GSA or Commerce) directive. Such disclosure shall not be used to make determinations about individuals.
8. A record from this system of records may be disclosed, as a routine use, to the public after either publication of the application pursuant to 35 U.S.C. 122(b) or issuance of a patent pursuant to 35 U.S.C. 151. Further, a record may be disclosed, subject to the limitations of 37 CFR 1.14, as a routine use, to the public if the record was filed in an application which became abandoned or in which the proceedings were terminated and which application is referenced by either a published application, an application open to public inspections or an issued patent.
9. A record from this system of records may be disclosed, as a routine use, to a Federal, State, or local law enforcement agency, if the USPTO becomes aware of a violation or potential violation of law or regulation.

(12) STANDARD PATENT
(19) AUSTRALIAN PATENT OFFICE

(11) Application No. **AU 2002322233 B2**

(54) Title
Natural marine source phospholipids comprising flavonoids, polyunsaturated fatty acids and their applications

(51) International Patent Classification(s)
C07F 9/10 (2006.01) **A61P 25/00** (2006.01)
A23J 7/00 (2006.01) **A61P 35/00** (2006.01)
A23K 1/16 (2006.01) **A61Q 19/00** (2006.01)
A23L 1/30 (2006.01) **C07D 407/14** (2006.01)
A61K 8/55 (2006.01) **C11B 1/10** (2006.01)

(21) Application No: **2002322233** (22) Date of Filing: **2002.07.29**

(87) WIPO No: **WO03/011873**

(30) Priority Data

(31) Number (32) Date (33) Country
60/307,842 **2001.07.27** **US**

(43) Publication Date: **2003.02.17**

(43) Publication Journal Date: **2003.05.29**

(44) Accepted Journal Date: **2008.10.23**

(71) Applicant(s)
Neptune Technologies & Bioresources Inc.

(72) Inventor(s)
Sampalis, Fotini

(74) Agent / Attorney
Blake Dawson Patent Attorneys, Level 35 Grosvenor Place 225 George Street, Sydney, NSW, 2000

(56) Related Art
HOSOKAWA et al, Journal of Agricultural and Food Chemistry 2000, Vol. 48, No. 10, Pages 4550-4554.
HENDERSON et al, Lipids, 1994, Vol. 29, No. 5, Pages 311-317
WO 2000/023546 A1 (UNIVERSITE DE SHERBROOKE) 27 April 2000
EP 0209037 B1 (INVERNI DELLA BEFFA S.P.A) 28 February 1990
EP 0275005 B1 (INDENA S.p.A) 11 August 19
BELL et al "Molecular Species Composition of the Major Diacyl Glycerophospholipids from Muscle, Liver, Retina and Brain of Cod" Lipids, 1991, Vol. 26, No. 8, Pages 565-573
US 4963527 A (BOMBARDELLI et al) 16 October 1990

CORRECTED VERSION

(19) World Intellectual Property Organization
International Bureau



(43) International Publication Date
13 February 2003 (13.02.2003)

PCT

(10) International Publication Number
WO 03/011873 A3

(51) International Patent Classification⁷: C07F 9/10, C07D
407/14, A23J 7/00, A61K 31/683, 31/685, A61P 25/00,
35/00, A61K 7/00, C11B 1/10

CZ, DE, DK, DM, DZ, EC, EE, ES, FI, GB, GD, GE, GH,
GM, HR, HU, ID, IL, IN, IS, JP, KE, KG, KP, KR, KZ, LC,
LK, LR, LS, LT, LU, LV, MA, MD, MG, MK, MN, MW,
MX, MZ, NO, NZ, OM, PH, PI., PT, RO, RU, SD, SE, SG,
SI, SK, SL, TJ, TM, TN, TR, TT, TZ, UA, UG, US, UZ,
VN, YU, ZA, ZM, ZW.

(21) International Application Number: PCT/CA02/01185

(22) International Filing Date: 29 July 2002 (29.07.2002)

(25) Filing Language: English

(26) Publication Language: English

(30) Priority Data:
60/307,842 27 July 2001 (27.07.2001) US

(84) Designated States (*regional*): ARIPO patent (GH, GM,
KE, LS, MW, MZ, SD, SL, SZ, TZ, UG, ZM, ZW),
Eurasian patent (AM, AZ, BY, KG, KZ, MD, RU, TJ, TM),
European patent (AT, BE, BG, CH, CY, CZ, DE, DK, EE,
ES, FI, FR, GB, GR, IE, IT, LU, MC, NL, PT, SE, SK,
TR), OAPI patent (BF, BJ, CF, CG, CI, CM, GA, GN, GQ,
GW, ML, MR, NE, SN, TD, TG).



(71) Applicant (*for all designated States except US*): NEP-
TUNE TECHNOLOGIES & BIORESSOURCES INC.
[CA/CA]; 500, St-Martin Boulevard West, Suite 550,
Laval, Québec H7M 3Y2 (CA).

Published:
— with international search report

(72) Inventor; and

(75) Inventor/Applicant (*for US only*): SAMPALIS, Fotini
[CA/CA]; 1348 Elizabeth Boulevard, Laval, Quebec H7W
3J8 (CA).

(88) Date of publication of the international search report:
1 May 2003

(74) Agents: SABET, Sohrab et al.; Smart & Biggar, 1000 de
la Gauchetière Ouest, Suite 3400, Montréal, Quebec H3B
4W5 (CA).

(48) Date of publication of this corrected version:
7 August 2003

(81) Designated States (*national*): AE, AG, AL, AM, AT, AU,
AZ, BA, BB, BG, BR, BY, BZ, CA, CH, CN, CO, CR, CU,

(15) Information about Correction:
see PCT Gazette No. 32/2003 of 7 August 2003, Section II

For two-letter codes and other abbreviations, refer to the "Guidance Notes on Codes and Abbreviations" appearing at the beginning of each regular issue of the PCT Gazette.

WO 03/011873 A3

(54) Title: NATURAL MARINE SOURCE PHOSPHOLIPIDS COMPRISING FLAVONOIDS, POLYUNSATURATED FATTY ACIDS AND THEIR APPLICATIONS

(57) Abstract: A phospholipid extract from a marine or aquatic biomass possesses therapeutic properties. The phospholipid extract comprises a variety of phospholipids, fatty acid, metals and a novel flavonoid.

NATURAL MARINE SOURCE PHOSPHOLIPIDS COMPRISING FLAVONOIDS,
POLYUNSATURATED FATTY ACIDS AND THEIR APPLICATIONS

Cross-Reference to Related Application

5 This application claims the benefit of United States
Provisional Patent Application Serial No. 60/307,842, filed
July 27, 2001, which is incorporated herein by reference in its
entirety.

Field of the Invention

10 The present invention is directed to nutraceutical,
pharmaceutical or cosmetic compositions, particularly to
phospholipid compositions derived from natural marine or
aquatic sources.

Background of the Invention

15 WO 92/21335 published on December 10, 1992 and
corresponding United States Patent No. 5,434,183 issued on July
18, 1995 describes a phospholipid emulsion derived from marine
and/or synthetic origin comprising polyunsaturated fatty acids
and having anti-inflammatory and immunosuppressive effects and
20 which promotes normal brain or retinal development and
function. U.S. 5,434,183 does not disclose the presence of
flavonoids or nervonic acid (a mono-unsaturated fatty acid) in
the composition.

25 JP 2215351, published on August 28, 1990, discloses a
method for extracting and purifying phospholipids from fresh
krill. Krill is lyophilized and then extracted with ethanol to
produce an extract which is fractionated by absorption column
chromatography to produce high purity phosphatidyl choline and
phosphatidyl ethanolamine. There is no disclosure of a
30 composition comprising a flavonoid or nervonic acid.

WO 00/23546, published on April 27, 2000, discloses methods for extracting lipid fractions from marine and aquatic animal material by acetone extractions. The resulting non-soluble and particulate fraction is further solvent extracted with ethanol or ethylacetate to achieve further lipid extractions.

Hosokawa et al. (35), published in 2000, discloses the conversion of docosahexanoic acid containing phosphatidylcholines (DHA-PC) from squid skin lecithin to docosahexanoic acid containing phosphatidylserines (DHA-PS) via transphosphatidylation with phospholipase D (PLD). According to Table 2 of this reference, the fatty acid composition of the phospholipid includes important portions of eicosapentanoic acid. There is no disclosure concerning any pharmaceutical, nutraceutical, or cosmetic use of a composition comprising a flavonoid.

Henderson et al. (36), published in 1994, discloses lipid compositions of the pineal organ from rainbow trout comprising phospholipids. According to Table 4 of this reference, said phospholipids contain fatty acids corresponding to eicosapentanoic and docosahexanoic acid. Similarly, Bell et al. (37), published in 1991, discloses phospholipid compositions derived from different organs of cod. Moreover, Wiegand et al. (38), published in 1983, discloses polyene derivatives of phosphatidylcholine as phospholipid molecular species of frog receptor membranes. However, there is no disclosure in any of these references concerning any pharmaceutical, nutraceutical, or cosmetic use of a composition comprising a flavonoid.

WO 97/39759, published on October 30, 1997, discloses ω -3 fatty acids and ω -3 phosphatidylcholine in the treatment of bipolar disorder. The preferred ω -3 phosphatidylcholine

derivatives comprise eicosapentanoic and/or docosahexanoic acid. However, there is no disclosure concerning any pharmaceutical, nutraceutical, or cosmetic use of phospholipids beyond the treatment of bipolar disorder or the use of a composition comprising a flavonoid.

EP 0609078 A1, published on March 8, 1994, discloses a phospholipid comprising two different unsaturated fatty acids, wherein a preferred phospholipid contains both eicosapentanoic and docosahexanoic acid. Furthermore, the phospholipid can be used in the preparation of foods, skin care preparations, or pharmaceutical agent. However, there is no disclosure concerning any pharmaceutical, nutraceutical, or cosmetic use of a composition comprising a flavonoid.

15 Summary of the Invention

In one aspect, the invention provides novel phospholipids, wherein the two fatty acids chains of the phospholipid are occupied by eicosapentanoic acid (EPA) and docosahexanoic acid (DHA) simultaneously, within the same molecule, i.e.: a phospholipid of the general formula (I):

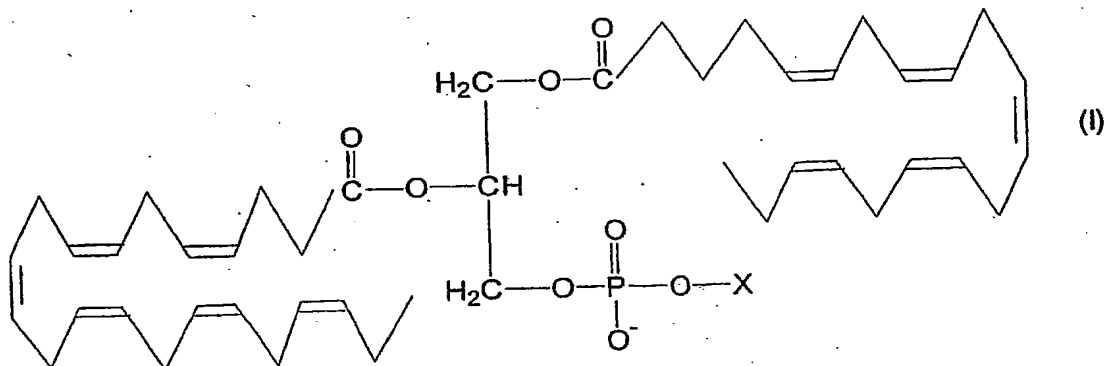

wherein X represents a moiety normally found in a phospholipid.

According to a further aspect of the present invention there is provided a composition, comprising:

(a) a phospholipid of the general formula (I),

5

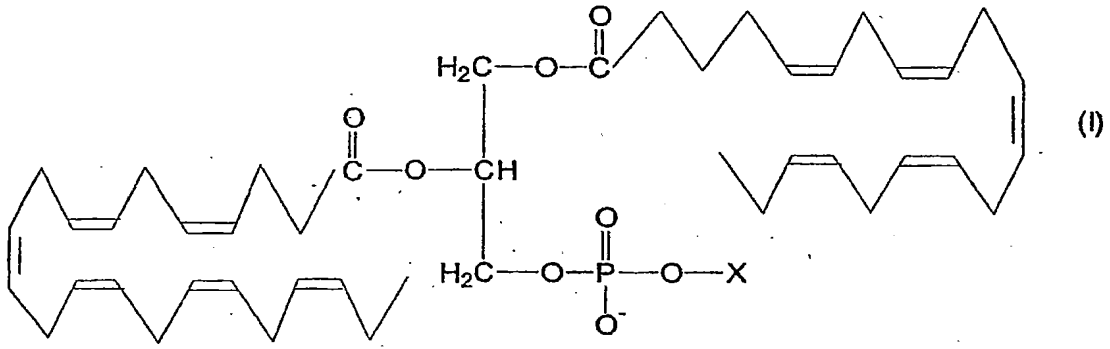

10

wherein X is $-\text{CH}_2\text{CH}_2\text{NH}_3$, $-\text{CH}_2\text{CH}_2\text{N}(\text{CH}_3)_3$ or

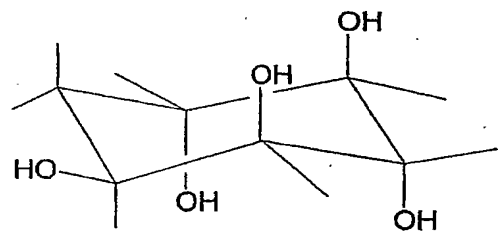

, and

15

(b) a flavonoid of the general formula (II),

20

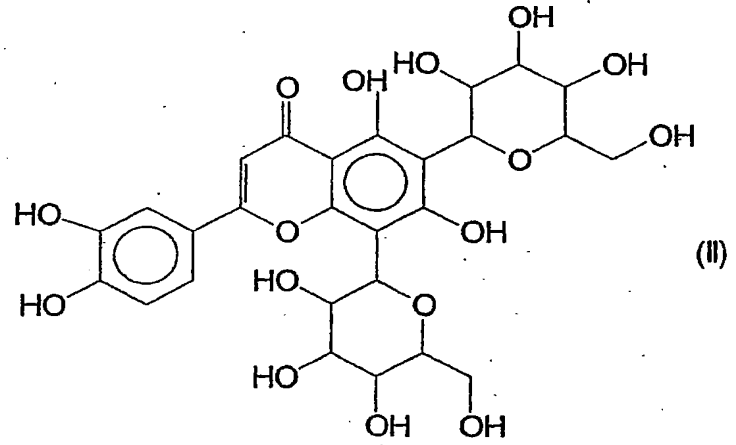

In a further aspect, the invention provides a novel flavonoid compound (II):

5

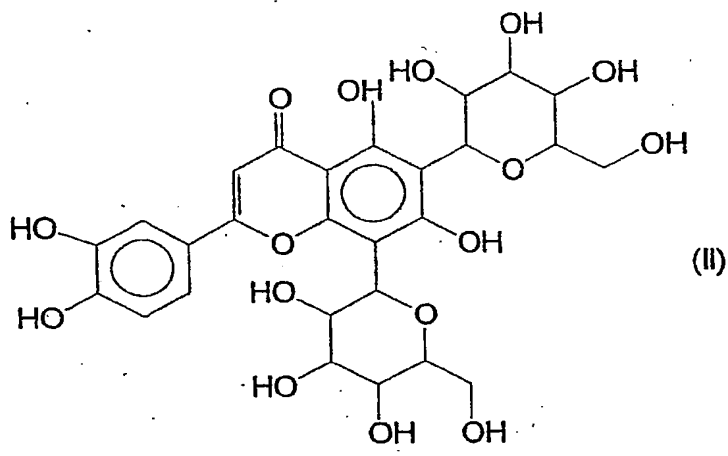

10

There is also provided a composition comprising the above noted phospholipid and flavonoid derived from a marine or aquatic biomass. The composition and the components are useful in the prevention or treatment of a variety of disease states and for the aesthetic enhancement of an animal, including human, body. Commercial packages containing the composition are also within the invention.

15

The novel phospholipids and the novel flavonoid compound are derived from an extract from a marine or aquatic biomass.

20

There is also provided a phospholipid extract comprising the above noted phospholipids and flavonoid compound derived from a marine or aquatic biomass. The extract and the components are useful in the prevention or treatment of a variety of disease states and for the aesthetic enhancement of an animal, including human, body. Pharmaceutical, nutraceutical and cosmetic compositions containing the extract and uses thereof are also within the invention, as are commercial packages contain the compositions of the invention.

25

- 3b -

Detailed Description of the Invention

1. Phospholipids

Phospholipids are complex lipids containing
5 phosphorus. The phosphatides, known as phospholipids, are
usually divided into groups on the basis of compounds from
which they are derived. In addition to two chains of fatty
acids they contain phosphoric acid, glycerol and nitrogenous
bases such as choline. Important phospholipids are
10 phosphatidylcholine (PC), phosphatidylethanolamine (PE) and
phosphatidylinositol (PI). Their nature as amphophilic
molecules provides them with unique physicochemical properties.
Their function as the principle components of cell membranes
makes phospholipids essential for all vital cell processes.
15 They are wide spread as secretory and structural components of
the body and can mimic or enhance natural physiological
process.

- 4 -

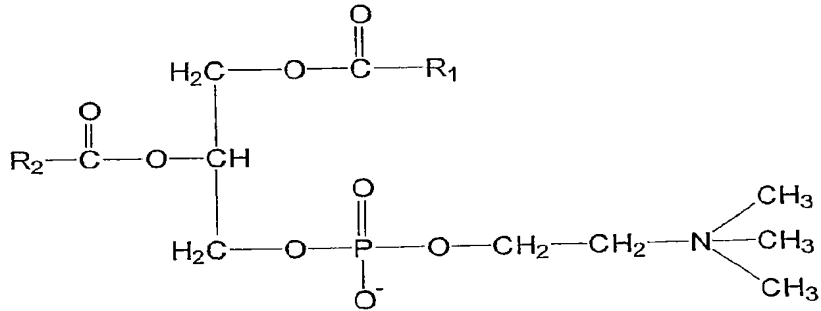

5

Phosphatidylcholine — common structure
 R_1 and R_2 are fatty acid residues,
 different for each molecular species

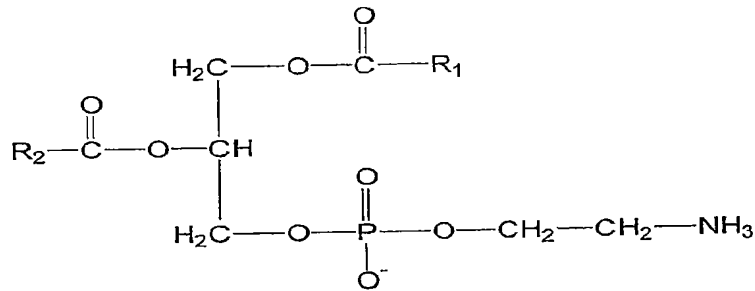

10

Phosphatidylethanolamine — common structure
 R_1 and R_2 are fatty acid residues,
 different for each molecular species

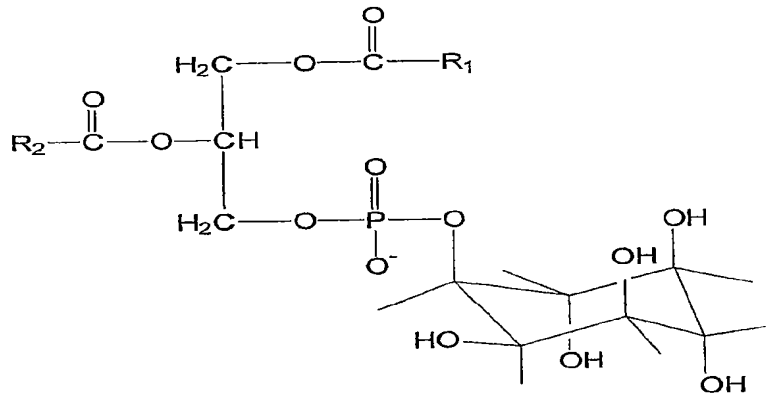

15

Phosphatidylinositol — common structure
 R_1 and R_2 are fatty acid residues,
 different for each molecular species

20

- 5 -

Phospholipid production may be either synthetic or through extraction from natural tissues. The chief source of commercial natural phospholipids are soybean, egg yolk and cows (brain and liver). Since an individual phospholipid may
5 contain a variety of fatty acid residues, it may be described as pure only with this limitation in mind. Naturally occurring essential polyunsaturated fatty acids can contribute to the activation of cellular metabolism. The main fatty acid found in phospholipid products is linoleic acid (C18:2n6), present in
10 soybean at more than 65%. The longest chain polyunsaturated fatty acids found in commercially available phospholipids either as preparations or individually are 20:4 among the eicosanoids, known as arachidonic acid, and 22:6 known as docosahexanoic acid.

15 Arachidonic acid is a fatty acid that is found as part of phospholipid membranes, generally as part of phosphatidylcholine and phosphatidylinositol. Adverse cellular stimuli will activate enzymes (phospholipase) that cleave arachidonic acid from the phospholipid backbone in the cell
20 membrane. Arachidonic acid, which serves as the precursor for prostaglandins and prostacyclin (PGs, PGI₂) and thromboxane (TXs), can then be metabolized by one of two major pathways: the cyclooxygenase (COX) pathway or the lipoxygenase pathway. The COX pathway products, PGG₂ and PGH₂, can then be acted upon
25 by thromboxane synthase (in platelets) or prostacyclin synthase (in endothelium) to form TXs or PGI₂, respectively. Arachidonic acid can also be acted upon by 5-lipoxygenase, primarily in leukocytes, to form leukotrienes (LTs). One or more of these metabolites can mediate all the signs and symptoms associated
30 with arachidonic acid, i.e. inflammatory disease and pain.

Platelets, leukocytes, smooth muscle, and endothelium can produce vasoactive substances, products of arachidonic acid metabolism such as prostaglandins (PGs), prostacyclin (PGI₂),

- 6 -

leukotrienes (LTs), and thromboxanes (TXs). These substances can either act as vasodilators or as vasoconstrictors. PGI₂ is essential in vascular function since it inhibits platelet adhesion to the vascular endothelium and has significant vasodilatation qualities. Damaged endothelial cells cannot produce PGI₂, making the vessel more susceptible to thrombosis and vasospasm. Thromboxanes and leukotrienes serve a vascular function during inflammation, generally producing vasoconstriction. Prostaglandins have a vascular role during inflammation, and also play a more subtle role in normal flow regulation, most notably as modulators of other control mechanisms. Prostaglandins have both vasoconstrictor and vasodilator activities. Leukotrienes and prostaglandins can also increase the endothelial membrane permeability thus promoting edema during inflammation. Arachidonic acid is naturally present in most phospholipid mixtures or emulsions available today.

Nervonic acid (C24:1) is also called selacholeic acid or tetracosenic acid. Nervonic acid is the predominant nutrient of white matter in glucoside, which is quantitatively contained in nerve tissue and white matter. The absence of nervonic acid may result in cerebral lesion, fatigue, hypodynamia, amentia, and senile dementia. Nervonic acid, tetracosenic acid in another name, is monounsaturated, non-oxidable/decomposed and absorptive. It is called a rare tonic as it is rare existent in nature. It may be obtained in small quantities by extracting from cerebral chondriosome. Therefore, the substance is far below the demand of human body. In foreign countries, nervonic acid mainly comes from shark brain and oil.

- 7 -

1.1 Phosphatidylinositol Clinical Applications

Recent advances in nutritional and biochemical research have documented inositol as an important dietary and cellular constituent. Functions of phosphatidylinositol in biological membranes include the regulation of cellular responses to external stimuli and/or nerve transmission as well as the mediation of enzyme activity through interactions with various specific proteins (1).

Inositol has been identified as an important dietary and cellular constituent. Biochemical functions:

- a. Regulation of cellular responses to external stimuli
- b. mediation of enzyme activity.

Phosphoinositide composition of the central nervous system cell membranes are fatty-acid enriched and consist primarily of phosphatidylinositol (PI), phosphatidylinositol-4-phosphate (PIP), and phosphatidylinositol-4,5-biphosphate (PIP2). Once the membrane is stimulated, phospholipase C is activated and consequently inositol triphosphate along with diacylglycerol is produced. PI is used as a precursor for phosphatidylinositol-3-phosphate and 3,4,5-triphosphate (2).

Active transport carriers, calcium pumps in the cell membrane itself, and in the endoplasmic reticulum, keep cytoplasmic calcium concentration very low. Usually the calcium concentration inside the cytoplasm is 5,000-10,000 times less than the concentration in the extracellular fluid. This endoplasmic store of calcium can be accessed upon stimulation by inositol. Inositol triphosphate is released from the cell membrane and travels through the cytoplasm until it reaches the endoplasmic reticulum. This inositol then releases the sequestered calcium, which can go on to mediate

- 8 -

the release of neurotransmitters in response to depolarization (3).

In addition to releasing endoplasmic reticulum calcium, inositol functions as the major central nervous system non-nitrogenous osmoregulator. Modulation of this inositol pool is regulated in response to states of high or low osmolalities. The inositol pool is supplied via a sodium/inositol transporter, a sodium dependent active transport system, and a passive low affinity transporter (4,5).

Numerous non-inositol receptors have been identified in the central nervous system that can potentially interact with the inositol signaling system. Most of these receptors are linked to the G proteins and produce inositol-1,4,5-triphosphate as second messengers. These receptors can be found in nearly every human organ system. The potential interactions between these receptors and their agonists are responsible for regulation of the body on a day-to-day basis. In view of the complexity of these systems and their actions, a perfect balance is required for regulation of the signaling systems.

Theoretically, an imbalance of inositol concentration could potentially affect the development and function of one or all of these receptors. Cholinergic receptors are located in the liver, heart, stomach, and lungs. Serotonin and glutamine receptors are found mostly in the central nervous system (CNS) tissues. Adrenergic receptors are present in various tissues including CNS, vascular tissues, and heart. Histaminergic receptors are predominantly found in the lungs and stomach.

Clinical Applications

A change in CNS availability of inositol may produce altered brain signaling and eventually lead to the development of neurological disorders.

5 a. Depression:

The pathophysiology of depression is believed to be linked to a deficiency of neurotransmitters at post-synaptic receptor sites. According to the catecholamine theory, the deficiency is in the amount of norepinephrine; in the
10 indolamine theory the deficiency is in the amount of serotonin. Receptors linked to the inositol signalling system include serotonin (5HT2a and 5HT2b) and norepinephrine (alpha 1a, 1b, and 1d).

In 1978, Barkai et al demonstrated depressed patients
15 had significantly decreased cerebrospinal fluid (CSF) levels of inositol as compared to healthy patients (6). In 1993 this theory was expanded to conclude that administration of high-dose inositol could increase CSF levels by as much as 70 percent (7). This led to the study of inositol for treatment
20 of depression (8,9). In 1995 Levine et al completed a double-blind study for treatment of depression using inositol at a dose of 12 grams daily compared to placebo. Patients receiving inositol showed significant improvement in depression as ranked by the Hamilton Depression Rating Scale (33.4 +/- 6 versus .6
25 +/- 10). Another important observation was the absence of manic episodes in the bipolar patients treated with inositol. This lack of manic episodes may suggest that when the signalling system is not overactive, addition of inositol will not increase the signalling system's activity (10,11). It can
30 be concluded that inositol is effective in managing the clinical manifestations of depression.

- 10 -

b. Panic Disorder:

Benjamin et al expanded the clinical use of inositol by evaluating its effectiveness in panic disorder (12). This was an eight week double-blind, crossover study whereby
5 patients were treated with inositol daily for four weeks and then crossed over to the other study arm. Improvement was assessed using patient diaries, the Marks-Matthews Phobia Scale, the Hamilton Anxiety Rating Scale, and the Hamilton Depression Scale. The frequency and severity of panic attacks
10 and the severity of agoraphobia declined significantly more after inositol than after placebo (a decrease from 10 attacks per week to 3 per week in the treated group compared to a decrease from 10 to 6 in the placebo group). The authors conclude inositol's efficacy and safety, and the fact that
15 inositol is a natural component of the human diet, make it a potentially attractive therapeutic agent for panic disorder.

c. Obsessive Compulsive Disorder (OCD):

Since the phosphatidylinositol cycle, as a second messenger is known to affect several neurotransmitters,
20 including serotonin receptors, inositol was studied for treatment in OCD in a double-blind, placebo controlled, crossover trial. Thirteen patients were treated for six weeks. There was a significant improvement at week six during the inositol period when compared to placebo period. There were no
25 side-effects reported during the study period (1).

d. Alzheimer's Disease (AD):

Although the role of aluminum in AD is still speculative at best, the presence of aluminosilicates at the core of senile plaques in diseased neurons is a consistent
30 feature found in the CNS of AD patients during autopsy. It is known that aluminum inhibits the incorporation of inositol into

- 11 -

phospholipids and the hydrolysis of the phosphoinositides by binding to one of two specific phosphate groups. This binding of phosphate and aluminum affects the calcium releasing effects of the cell. The resulting profound disturbance of the
5 phosphatidylinositol second messenger system may account for neuronal malfunction and eventual cell death (13).

Since the potential role of aluminum as a causative agent for cell death may be affected by the deregulation of calcium concentration, possibly due to inositol depletion,
10 supplementation with inositol may produce positive CNS effects. Recent data suggests the loss of PI second messenger system target sites and IP3 receptors may add to cognitive impairment and the failure of conventional therapies in AD. Therefore, supplementation of inositol to replenish the diminished PI
15 system may be beneficial in the treatment of AD (13-20).

In 1996 Barak et al completed a double-blind, controlled, crossover study of six grams inositol daily compared to placebo for 30 days in 11 Alzheimer's patients. Patients in the study were diagnosed with dementia of the AD
20 type as classified by DSM - IIIR and aged 65 years or older. The Cambridge Mental Disorder of the Elderly Examination (CAMDEX) was used as the basic assessment parameter and was administered upon admission into the study. Included in CAMDEX is part A: patient's present physical and mental state, part B:
25 Cognitive Subscale of CAMDEX (CAMCOG), part C: interviewers observations, and part D: physical examination. CAMCOG was repeated at two, four, six, and eight weeks. Participants scored 80 or less on the CAMCOG examination and their symptoms of depression were not severe (21).

30 Patients were excluded from the study if they had a history of psychiatric, alcohol, and/or drug addiction disorders, or abnormalities in baseline laboratory values

- 12 -

(blood count, electrolytes, liver or kidney functions, VDRL, or CT scan) not consistent with AD. Patients with additional neurologic, metabolic, endocrinologic disorders, or presence of internal disease that grossly impaired brain functioning were also excluded.

Subjects were given either three grams inositol or placebo in the morning and again in the evening. After four weeks patients were crossed over into the other arm (inositol or placebo) for an additional four weeks. Only benzodiazepines were allowed during the study period (15 mg of oxazepam or equivalent), provided the patient was receiving it on study entry.

Analysis of the improvement scores of all patients who completed the study showed inositol increased the total CAMCOG score from a baseline of 31.36 +/- 20.90 to 40.09 +/- 24.54, while the placebo group increased from baseline of 35.9 +/- 25.96 to 39.27 +/- 25. The authors concluded only two of the eight subscales (language and orientation) showed significant improvement with inositol.

Inositol's proposed mechanism of action in the CNS does not include direct manipulation with either pre- or post-receptors. However, it may indirectly affect the relationship between receptor and agonist. By mediating the physiochemical characteristics of the M1 pre-synaptic receptor (solubility, osmolality, etc.), inositol may alter the binding site and influence the signaling that occurs as a result.

1.2 Aging

Phosphatidylcholine rich in polyunsaturated fatty acids is indispensable for cellular differentiation, proliferation and regeneration. The physiologic functions of these phospholipids are related to the morphology of the

- 13 -

biological membranes, the incorporation of these molecules into membranes and thus the maintenance of intact cell membranes.

The current study was designed to investigate the effects of Polyunsaturated phosphatidylcholine on age-related hearing loss by evaluating its ability to preserve
5 mitochondrial function, protect mitochondrial DNA from oxidative damage and preserve auditory sensitivity (22).

Harlan-Fischer 344 rats, 18-20 months of age, were used as the experimental subjects.

10 The subjects were caged individually and maintained at 21 to 22° C in a 12:12 light-dark cycle b.

A dose of 300mg/kg/day of Polyunsaturated phosphatidylcholine was supplemented to each subject, by adding it to the oral diet.

15 The animals were divided randomly into two groups (n = 7 for each group). Group-1 served as the control, and group-2 as the experimental group.

At the onset of the study, Auditory Brainstem Responses were obtained to measure baseline hearing thresholds
20 in all subjects.

Age-associated changes in hearing sensitivities were then recorded at two-month intervals for six months.

In order to assess age-related changes in mitochondrial function, mitochondrial membrane potentials were
25 studied using flow cytometry. For this purpose, peripheral blood was obtained from each subject at the beginning and at the end of the protocol.

At the conclusion, the subjects were euthanized (according to NIH protocol), and tissue samples were obtained

- 14 -

from brain and cochlea (stria vascularis and auditory nerve) to study mitochondrial DNA deletion associated with aging. This was achieved by amplifying the specific common aging mitochondrial deletion by Polymerase Chain Reaction. DNA
5 quantification was performed. The data obtained for each protocol was compared between the two groups and analyzed using ANOVA.

The effects of Polyunsaturated phosphatidylcholine on age-related hearing loss demonstrate a gradual age-associated
10 decline in hearing sensitivities at all the frequencies tested (3, 6, 9, 12 and 18 kHz).

There was a statistically significant preservation of hearing noted in the treated subjects at all frequencies, which was observed at four and six months of treatment.

15 Overall, there was a continued decline in hearing in the control subjects and a statistically significant protective effect of Polyunsaturated phosphatidylcholine on the experimental subjects ($p < .005$).

Mitochondrial membrane potentials were recorded by
20 flow cytometry as a measure of the uptake of Rhodamine 123 by mitochondria.

The mean fluorescence intensity (MFI) in group-1 subjects measured 3190 and 2100 at the beginning and end of the study, respectively.

25 This, approximately, 30% decline in membrane potential with time was statistically significant ($p = 0.003$).

Conversely, the MFI in the experimental group remained essentially unchanged at 2990 from 3165 at the beginning of the study.

- 15 -

This difference between the control and treated groups was statistically significant ($p < 0.05$), demonstrating the protective effect of polyunsaturated phosphatidylcholine supplementation on mitochondrial membrane potential.

5 Phospholipids are integral structural components of all biological membranes with polyunsaturated phosphatidylcholine and phosphatidylethanolamine being the predominant types, quantitatively. They constitute the phospholipid bilayer structure of cellular membranes, which is
10 responsible for membrane stability and cellular function. Polyunsaturated phosphatidylcholine maintains and promotes the activity of several membrane bound proteins and enzymes, including Na-K ATPase, adenylate cyclase and glutathione reductase. They are also known to be precursors of
15 cytoprotective agents such as eicosanoids, prostaglandins and antioxidants.

The results of these studies suggest that polyunsaturated phosphatidylcholine and phosphatidylethanolamine may protect mitochondrial function by
20 preserving the age-related decline in mitochondrial membrane potentials and hence their activity. The observation that there was less mitochondrial DNA damage in the treated group may explain the effect of preservation of hearing loss associated with aging, by the ability of polyunsaturated
25 phosphatidylcholine and phosphatidylethanolamine to specifically up-regulate cochlear mitochondrial function. There are many studies demonstrating the effects of mitochondrial metabolites on cognition and aging (22-33). Additionally, recent work has shown that acetyl-L-carnitine and -lipoic acid
30 delay the progression of age-related hearing loss by protecting cochlear mitochondrial DNA from oxidative damage (34). These results support the membrane hypothesis of aging and provide further evidence to support this theory as a possible

- 16 -

explanation for age-related hearing loss. Thus, PPC may be one of many rational approaches to consider for the purpose of membrane preservation, enhanced mitochondrial function, reduction of age-associated mitochondrial DNA damage and
5 slowing of some of the aging processes.

1.3 Effect of phosphoglycolipid extract (NT factor) on normal and cancerous cells

Reduced levels of phospholipids in normal cells can limit metabolic activity and limit available energy.
10 Phospholipids, as part of the membrane structure:

- i. maintain membrane integrity
- ii. regulate enzyme activities and membrane transport processes through changes in membrane fluidity (Spector 1981, 1985)
- 15 iii. Signal transduction utilizes phosphatidylcholine and phosphatidylinositol for the production of diacyl-glycerol (DAG) by phospholipase C (Berridge 1989) and for the production of inositol triphosphate (IP3) (Ranan 1990, Michell 1988, Margolis 1990).
- 20 iv. One of the choline phospholipids (1-alkyl-2 acetyl-SN-glycerol-3-phosphocholine) is the substrate for the synthesis of platelet activating factor (Synder 1989).
- v. The arachidonic acid found as part of the structure of choline or inositol phospholipid is utilized for the production
25 of prostaglandin and leukotriene (Nordoy 1990).
- vi. The choline of phosphatidylcholine may be used in neural tissue for the synthesis of acetylcholine (Blusztain 1987)
- vii. Phosphoglycolipid improves cell maintenance and metabolic activity of normal cells.

- 17 -

viii. Phosphatidylcholine derivatives disrupt cancer cells at concentrations that do not affect normal cells.

ix. Phosphatidylcholine is selectively cytotoxic to cancer cells in vitro (Hoffman 1986, Harmann 1986, Berger 1984).

5 a. Such compounds inhibit HL60 leukemic cells at a dosage that has no effect on normal human marrow cells, the tissue from which the leukemic cells are derived.

 b. Normal cells were able to tolerate 4 times higher dosage than the leukemic cells during 24 hours incubation with
10 the phospholipid preparation (Berdel 1986).

 c. There was up to a 5-fold difference in sensitivity between the normal and tumor cells with breast, ovarian, and lung cancer cells, as well as with mesothelioma cells (Namba 1993).

15 1.4 Imaging

 Polyunsaturated phospholipids are known to be important with regard to the biological functions of essential fatty acids, for example, involving neural tissues such as the brain and retina. The NMR spectra of polyunsaturated bilayers
20 are dramatically different from those of less unsaturated phospholipid bilayers. MD simulations can aid in interpreting the complex NMR spectra of polyunsaturated bilayers, in conjunction with electron density profiles determined from small-angle X-ray diffraction studies. This work clearly
25 demonstrates preferred helical and angle-iron conformations of the polyunsaturated chains in liquid-crystalline bilayers, which favor chain extension while maintaining bilayer flexibility. The presence of relatively long, extended fatty acyl chains may be important for solvating the hydrophobic
30 surfaces of integral membrane proteins, such as rhodopsin. In

- 18 -

addition, the polyallylic DHA chains have a tendency to adopt back-bended (hairpin-like) structures, which increase the interfacial area per lipid. Finally, the material properties have been analyzed in terms of the response of the bilayer to mechanical stress. Simulated bilayers of phospholipids containing docosahexaenoic acid were less sensitive to the applied surface tension than were saturated phospholipids, possibly implying a decrease in membrane elasticity (area elastic modulus, bending rigidity). The above features distinguish DHA-containing lipids from saturated or nonunsaturated lipids and may be important for their biological modes of action.

1.5 In Summary

The functions of the phospholipids are multiple and different for each phospholipid:

- a. Sphingosine and carbohydrate containing lipids are mainly concentrated in nervous tissues.
- b. The hydrophilic and hydrophobic parts of the phospholipid molecule allow them to function as emulsifying agents in order to maintain the proper colloidal state of protoplasm.
- c. Phospholipids aid the transport of triglycerides through the liver, especially during mobilization from adipose tissue.
- d. Phospholipids and their metabolites play an important role in intracellular signalling, for example via phosphatidylinositol specific phospholipase C, phospholipase D or phosphatidylinositol-kinases.
- e. Through their concentration in cell membranes they may somehow be involved in the transport of hydrophobic constituents into and out of cells.

- 19 -

f. Phospholipids affect brain function in two substantial ways: (Cohen B.M., Babb S.M., Yurgelun-Todd D., et al. *Brain choline uptake and cognitive function in middle age. Biol. Psych.* 1997;41:90S.)

- 5 a. The membranes of brain cells depend on phospholipids as part of their structure. Phosphatidylserine (PS) is concentrated in the cell membranes of the brain.
- 10 b. Phospholipids are required for the production of neurotransmitters.
- c. Choline is a component of the neurotransmitter acetylcholine. Without adequate levels of acetylcholine, the brain can't store or retrieve information efficiently.
- 15 d. Lower choline levels in the brain are an underlying factor for age-related cognitive disorders.
- e. Patients submitted to increased choline uptake show significant improvement in their ability to recall information and perform on memory retention tests, suggesting a causal relationship between poor choline status and cognition.
- 20

- 25 g. Phosphatidylserine (PS) in Dementia-Related Diseases:
- a. Dementia is the deterioration of mental function, particularly affecting memory, concentration, and judgment.
- 30 b. A frequent cause of dementia is Alzheimer's disease.
- c. The first double-blind trial of PS for Alzheimer's disease was published about a decade ago. (Delwaide P.J., et al. *Double-blind randomized controlled study of phosphatidylserine in demented subjects. Acta Neur. Scand.* 1986;73:136-140.) In this study, 35 Alzheimer's patients were either given a placebo or 300 mg. per day of PS for six weeks. The PS group showed significant improvement after this short-term supplementation period.
- 35 d. More recently, a large double-blind study of 494 elderly patients with symptoms of cognitive decline compared a placebo to 300 mg. per day of PS for six months. (Cenacchi T., Bertoldin T., Farina C., et al. *Cognitive decline in the elderly: A double-blind, placebo-controlled multicenter study on efficacy of phosphatidylserine administration. Aging Clin.*
- 40
- 45

- 20 -

Exp. Res. 1993;5:123-133.) Memory and learning of the PS-treated group was significantly improved over the placebo group, as well as certain emotional and behavior components of Alzheimer's disease.

5

- e. Supplements of PS have also shown impressive results in older populations with memory impairment unrelated to Alzheimer's disease. (Crook T.H., et al. *Effects of phosphatidylserine in age-associated memory impairment. Neurology* 1991;41:644-649.) Three months of taking 300 mg. of PS daily, in one study, reversed the decline of memory function in a group of 149 patients. The memory function of these men and women initially averaged that of a typical 64 years old. After taking PS supplements, the average memory function was 52 years old -- a mental gain of 12 years.

10

15

20 h. Restoring and Preserving Liver Function:

- a. While the phospholipid PS dominates in the mental function arena, the phospholipid phosphatidylcholine (PC) is the major player for liver health.

25

- b. PC protects the liver against damage from alcoholism, pharmaceuticals, pollutant substances, viruses, and other toxic influences, most of which operate by damaging cell membranes.

30

- c. Many of the studies using PC supplements to aid recovery of the liver are based on 800 mg. per day (taken with meals). (Kidd P.M. *Phosphatidylcholine: A superior protectant against liver damage. Alt. Med. Rev.* 1996; 1:258-274.) Although PC is a source of choline, studies reviewed by Dr. Kidd suggest that PC is superior to choline; in fact choline in its pure form may be detrimental to the liver's recovery from toxic overload (such as in alcoholism). As a lipotropic, choline transports fats within the body, while inadequate choline intake might result in an unhealthy accumulation of fat in the liver. (Newberne P.M., Nauss K.M., and de Camargo J.L. *Lipotropes, immunocompetence, and cancer. Cancer Res.* 1983;43:2426S-2434S.)

35

40

45

2. Flavonoids

Flavonoids are polyphenolic compounds ubiquitous in nature. They are categorized into isoflavones, anthocyanidins, flavans, flavonols, flavones, citrus flavonoids, hesperidin, 5 chalcones, catechins, rutin, and flavanones. Essential flavonoids, such as quercetin in onions and genistein in soy are actually considered subcategories rather than independent categories. Over 4,000 flavonoids have been identified in 10 fruits, vegetables and beverages (tea, coffee, beer, wine and fruit drinks). Even though they have a similar molecular structure between them, their functions are different from each other. Flavonoids have been shown to have antibacterial, anti-inflammatory, antiallergic, antimutagenic, antiviral, antineoplastic, anti-thrombotic, and vasodilatory activity. 15 Quercetin has been proven to block the "sorbitol pathway" which is directly associated with diabetes as well as to prevent LDL-cholesterol oxidative damage, which is essential for the maintenance of a healthy cardiovascular system.

Flavonoids are found in a wide range of fruits and 20 vegetables. For example, Quercetin (a flavonol in vegetables, fruit and onions), Xanthohumol (a prenylated chalcone in beer), Isoxanthohumol (a prenylated flavanone in beer), Genistein (an isoflavone in soy), Chalconaringenin (a non-prenylated chalcone in citrus fruits) and Naringenin (a non-prenylated flavanone in 25 citrus fruits).

In plants flavonoids have very well defined functions. First, the accumulation of pigment in flower petals, seeds and leafs. Flowers, as pollinators, must attract pollen carriers. Second, they protect plants from UV damage, 30 by absorbing UV at the epidermal layer. Third, they protect the plants against insects and pathogens.

- 22 -

The flavonoid biosynthetic pathway is one of the best understood plant secondary metabolism pathways (1992, Gerats). The key enzymes are phenylalanine-ammonia lyase and chalcone synthase. Phenylalanine-ammonia lyase converts phenylalanine into cinnamic acid as it controls the total flow of carbons into phenolics which is shown to be the limiting step in this pathway (1974, Creasy). Another key enzyme of the flavonoid pathway is the chalcone synthase. It condenses three molecules of malonyl-CoA with one molecule p-coumaroyl-CoA to form a C₁₅ intermediate, naringenin chalcone, with a R stereochemistry at the 2nd carbon. Chalcone isomerase, transforms the intermediate into the first flavonoid of the pathway, 2S-flavonone (naringenin). This reaction is part of all major flavonoid biosynthesis pathways. Chalcone synthase and chalcone isomerase form a complex ensuring the right stereochemistry (1996, Lyster).

The structural components of flavonoids include two benzene rings on either side of a 3-carbon ring. Different combinations of hydroxyl groups, sugars, oxygens, and methyl groups attached to these structures create the various categories of flavonoids mentioned above. The capacity of flavonoids to act as an antioxidant depends upon their biochemical structure, and more specifically, the position of the hydroxyl groups. Epicatechin gallate, epigallocatechin gallate, luteolin and quercetin exhibit the highest antioxidant activity, followed by epigallocatechin, gallic acid, epicatechin, catechin, rutin, and dihydroquercetin. It is worth noting at this point that the only difference between quercetin or luteolin (the most potent) and dihydroquercetin (the least potent) is the double bond between the second (2nd) and third (3rd) carbons on the center (C) ring. The presence of this double bond significantly increases the antioxidant activity of the flavonoid. Antioxidant activity can be

- 23 -

increased with the addition of another hydroxyl group on the B or C ring.

5

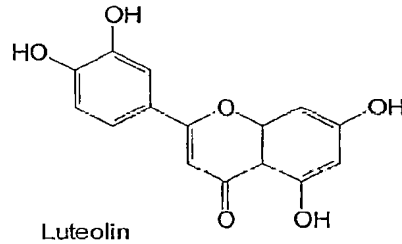

10

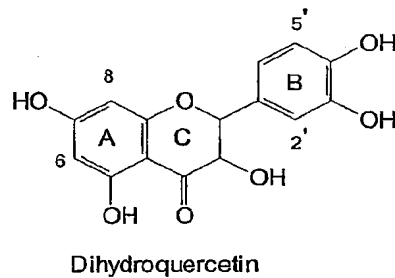
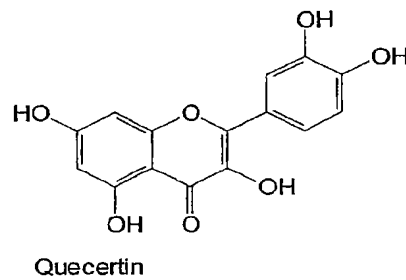

15 The potent antioxidant activity of flavonoids seems to be the most important function of flavonoids, responsible for many of the above mentioned health benefits.

The flavonoids most recognised by scientists until today are:

20 Quercetin and quercetin chalcone

Quercetin chalcone, is quercetin with an opened C ring and the oxygen found in the C-ring of quercetin converted into a hydroxyl group. Quercetin is mainly found in tea and even more in green tea.

- 24 -

Oligomeric Proanthocyanidins

Oligomeric proanthocyanidins are oligomeric flavonoids, usually dimers and trimers, based on the flavan-3-ol, or catechin, molecule, sometimes attached to gallic acid. They are found in the bark of pine trees, in grape seeds and skins, in peanut skins, cranberries, tea, and other sources.

Ginkgo Biloba Extract

Ginkgo biloba extracts contain 24% ginkgo flavone glycosides and 6% terpenes. They are extracted from the eldest living tree species, Ginkgo Biloba. Scientific research suggests that the beneficial constituents of ginkgo biloba extracts are quercetin and myricetin.

Luteolin

Luteolin is a flavonoid found in the same foods as apigenin (vegetables and fruits). Scientific research has shown that luteolin and quercetin can inhibit platelet activating factor and suppress the inflammatory response induced by allergens.

Flavonoids have been studied for the last 60 years. Their antioxidant activity is accepted as a scientific fact. Epidemiological, clinical, and laboratory research on flavonoids demonstrates the use of flavonoids in the prevention and/or treatment of cardiovascular disease, cancer, inflammatory conditions, asthma, periodontal disease, liver disease, cataracts and macular degeneration. Until today there has never been a flavonoid extracted from anything other than a plant, vegetable, fruit or algae.

- 25 -

3. Preparation of Extracts

The phospholipid extract of the present invention may be extracted from a variety of marine or aquatic biomass sources. Preferred sources of the phospholipid composition are crustaceans, in particular, zooplankton. A particularly preferred zooplankton is Krill. Krill can be found in any marine environment around the world. For example, the Antarctic Ocean (where the krill is Euphasia superba), the Pacific Ocean (where the krill is Euphasia pacifica), the Atlantic Ocean and the Indian Ocean all contain krill habitats. In particular, the coastal regions of Mauritius Island and/or Reunion Island off Madagascar, the Canadian West Coast, the Japanese Coast, the Gulf of St. Lawrence and the Bay of Fundy are krill habitats.

The phospholipid extract of the present invention is preferably a product of initial processing of the biomass. As such, the phospholipids are extracted from the biomass grease as opposed to the oil, the oil being a product of subsequent processing steps of a biomass. Since the phospholipid extract is derived from the biomass grease, the viscosity of the phospholipid extract tends to be higher than extracts from biomass oils. The extract has a very high natural stability with a peroxide value of zero or approaching zero and a good Oil Stability Index of less than about 0.2 Meq/kg after 20 or more hours. Table 1 below details the stability of the extract.

- 26 -

TABLE 1

<u>Stability indexes of the extract after 50 hours at 97.8°C</u>	
Peroxide value (mEq/kg)	<0.1
Oil Stability Index (after 50 hours) at 97.8°C (mEq/kg)	<0.1
Saponification Index	70-180
Iodine Index (%)	60-130

Phospholipids are generally present in the extract in an amount of at least 40% w/w, preferably at least 45% w/w. More preferably, the amount of phospholipid is from about 45-60% w/w. A variety of types of phospholipids may be present in the extract. These include phosphatidylethanolamine, phosphatidylinositol, phosphatidylserine, phosphatidylcholine and sphingomyelin.

The phospholipid extract preferably further comprises a number of other components. The extract may also comprise fatty acids, antioxidants and/or metals.

Fatty acids found in the phospholipid extract may be saturated, monounsaturated or polyunsaturated fatty acids. Polyunsaturated fatty acids are particularly preferred, the omega-3 and omega-6 fatty acids being most preferred. In particular, docosahexaenoic acid (DHA), eicosapentaenoic acid (EPA), myristic acid, myristoleic acid, lignoceric acid, linolenic acid, alpha linolenic acid, nervonic acid, linoleic acid, oleic acid, stearic acid, palmitic acid and palmitoleic acid are present in significant quantities. Arachidonic acid content of the extract is generally very low to non-existent despite the presence of phosphatidyl inositol and phosphatidyl serine. Other lipid components that may be present in the extract include monoglycerides, triglycerides and/or cholesterol.

- 27 -

Table 2 below details the fatty acid compositions of the phospholipids of the extract.

TABLE 2

5 The fatty acid composition of the extract of the phospholipids

Fatty Acids	Total PL FA%	PC FA%	PE FA%
C14:0 MYRISTIC	2.04	1.70	0.7
C14:1 MYRISTOLEIC	1.22		
C15:0 PENTADECANOIC	0.2	0.30	0.3
C16:0 PALMITIC	24.08	26.50	23.9
C16:1 PALMITOLEIC	2.24	2.30	0.7
C18:0 STEARIC	1.02	1.30	2.9
C18:1 OLEIC	9.18	11.90	24.1
C18:2n6 LINOLEIC	1.63	2.30	0.8
C18:3n6 GLA	1.02	0.30	
C18:3n3 ALA	1.02	1.30	
C18:4n3 OTA	1.84	2.00	0.3
C20:0 ARACHIDIC			
C20:1 cis-11-EICOSENOIC	0.41	0.60	0.7
C20:2n6 EICOSADIENOIC			
C20:3n6 METHYL ETA		0.20	
C20:4n6 ARACHIDONIC	0.61	0.70	0.6
C20:3n3 Homo- γ -LINOLENIC			
C20:4n3			
C20:5n3 EPA	27.35	31.90	12.9
C22:0 BEHENIC			
C22:1 ERUCIC	1.22	1.50	
C22:2n6			
C22:4n6			
C22:5n6 METHYL DPA			
C22:5n3 DPA		1.00	
C22:6n3 DHA	24.9	14.20	32.1
C24:0 LIGNOCERIC			
C24:1 NERVONIC			
Total	100.0	100	100

Compared to phospholipids existing in the market today, the extract phospholipids:

- 10 a. achieve a superior profile;
- b. have the highest quantities of polyunsaturated fatty acids;
- c. have the highest quantities of DHA;
- d. are the only phospholipids that contain EPA; and
- 15 e. are the only phospholipids that contain a combination of EPA and DHA on the same molecule.

- 28 -

PL = phospholipid
FA = fatty acid
PC = phosphatidylcholine
PE = phosphatidylethanolamine

5

Free fatty acids are present in the extract in an amount of at least 4% w/w and preferably at least 5% w/w.

Polyunsaturated fatty acids, in particular omega-3 fatty acids, preferably make up at least 15% w/w, more preferably at least 40% w/w, and even more preferably at least 45% w/w, of the total lipids in the extract. DHA and EPA are generally the largest component of the fatty acids and preferably account for at least 32% w/w, more preferably at least 35% or 37%, of the total lipid content of the extract.

10
15

Table 3 below details the fatty acid composition of the total lipids of the extract.

TABLE 3

Fatty acid composition of total lipids of the extract

<u>Sample</u>	<u>%</u>
Fatty Acid Composition	
C14:0	≥3.00
C14:1	≥0.01
C15:0	≥0.3
C16:0	≥20.00
C16:1	≥3.25
C18:0	≥1.00
C18:1	≥10.00
C18:2n6	≥2.00
C18:3n6 GLA	≥0.04
C18:3n3 ALA	≥0.01
C18:4n3	≥1.50
C20:0	≥0.05
C20:1	≥1.00
C20:2n6	≥0.05
C20:3n6	≥0.05
C20:4n6	≤0.50
C20:3n3	≥0.01
C20:4n3	≥0.20
C20:5n3 EPA	≥25.00
C22:0	≥0.01
C22:1	≥1.50
C22:2n6	≥0.03
C22:4n6	≥0.01
C22:5n6	≥0.01
C22:5n3 DPA	≥0.50
C22:6n3 DHA	≥10.00
C24:0	≥0.01
C24:1	≥0.05

5

Table 4 below also details the fatty acid composition of the total lipids of the extract.

TABLE 4

Fatty acid composition of total lipids of the extract

10

Saturated (g/100g lipid)	≥22.00
Monounsaturated (g/100g lipid)	≥11.00
Polyunsaturated (g/100g lipid)	≥35.00
Omega-3 (g/100g lipid)	≥30.00
Omega-6 (g/100g lipid)	≥1.00

Antioxidants present in the extract may include vitamin A (for example, all-trans retinol), vitamin E (for example, alpha-tocopherol), beta-carotene, astaxanthin (mainly esterified but non-esterified may be present), canthaxanthin and/or flavonoids. Antioxidants are preferably present in the extract in an amount of at least 20 and preferably at least 200 mg/100 ml.

Table 5 below details the lipids and other compounds (non-metal) of the extract.

10

TABLE 5

Lipid composition, vitamins A and E, pigments and flavonoids of the extract

Monoglycerides (MG) (g/100g sample)	≥0.7
Triglycerides (TG) (g/100g sample)	≥3.00
Free Fatty Acids (FFA) (g/100g sample)	≥5.00
Cholesterol (g/100g sample)	≤2.00
Total Phospholipids (PL) (g/100g sample)	≥40.00
Phosphatidyl Ethanolamine (PE) (g/100g sample)	≥2.50
Phosphatidyl Inositol (PI) (g/100g sample)	≥0.20
Phosphatidyl Serine (PS) (g/100g sample)	≥0.20
Phosphatidyl Choline (PC) (g/100g sample)	≥35.00
Sphingomyelin (g/100g sample)	≥0.50
Vitamin A (µg/100 ml)	≥1,400
Vitamin E (µg/100 ml)	≥15
Beta-Carotene (µg/100 ml)	≥1,600
Astaxanthin (mg/100 ml)	≥10
Canthaxanthin (mg/100ml)	≥10
Flavonoid (mg/100ml)	>7.0

15

The metals present in the extract are preferably zinc and selenium. Zinc is preferably present in an amount of at least 0.05 mg/100g of extract while selenium is generally present in an amount of less than 3 mg/100g of extract.

20

Table 6 below details the metals content of the extract.

TABLE 6

Metal composition and solvent residue of the extract mixture

Zinc (mg/100g)	>0.1
Selenium (mg/100g)	<2
Solvent residue	<25 ppm

5

Table 7 below details the physiochemical characteristics of the extract.

TABLE 7

10 Physiochemical characteristics of the extract

Color	Red
Viscosity (cPs)	<1300
Odor	Fish

Extraction of the phospholipid composition from the biomass is generally carried out by a method similar to the one described in commonly owned PCT publication number WO 00/23546, published on April 27, 2000, the disclosure of which is incorporated herein by reference. The extraction is generally carried out by successive acetone and alcohol treatments. For the extraction of the instant application, the preferred treatment involves the use of >60% acetone in the first extraction followed by extraction with a mixture of organic solvents at 65-95%/45-50% preferably acetone, ethyl acetate/ethanol mixture. The most preferred extraction solvent system is 100% acetone in the first extraction followed with a 95%/5% ethyl acetate/ethanol mixture. However, other ketones can also be used in combination with or in place of acetone. The alcohol can be other than ethanol, e.g., isopropanol or t-butanol. The acetate may also vary. Further, the ratio of alcohol to acetate may vary widely from 100:0 to 0:100. The procedure produces two successive lipid fractions and a dry residue enriched in protein, including active enzymes.

- 32 -

Preferably, freshly harvested and finely divided marine and aquatic animal material is subjected to acetone extraction, for at least about two hours and preferably overnight. However, extraction time is not critical to the yield of lipid extracted. Particle sizes of comminuted crustacean less than 5 mm are preferred. The extraction is preferably conducted under an inert atmosphere and at a temperature of about 5 degrees Celsius or less. The mixture may be agitated during extraction and a volume ratio of about 6:1 of acetone to biomass is generally most preferred.

The solubilized lipid fraction is separated from the solid starting material by known techniques, for example, by filtration, centrifugation or sedimentation. Filtration is preferred. The residue is optionally washed with acetone to recover more lipid and the acetone removed by flash evaporation or spray drying. Water residue is allowed to separate from the lipid extract at low temperature.

The solid residue left on the filter from the initial extraction is suspended and extracted with 95/5 ethyl acetate/ethanol, preferably two volumes (original volume of material). The filtrate is evaporated yielding a second fraction of lipids. Extraction period is not critical although it is preferred to extract for about 30 minutes at a temperature below about 5 degrees Celsius.

Each phospholipid is subdivided into multiple categories depending on the fatty acids that are attached to the molecule. The biological activity, bioavailability as well as the value of phospholipids is determined by the purity and the source:

- 33 -

a. Purity:

i. Optimal purity of the phospholipid or flavonoid of the invention is at least 99% by weight. The purity of the phospholipid or flavonoid after extraction from the krill may vary, but will normally be in the range of at least 90% to 100% of the/or mixture of phospholipid compound(s). Usually, the purity will be at least 95%. Preferably, the purity will be at least 96%, 97% or 98%. More preferably, the purity will be at least 99.5%. Most preferably, the purity will be at least 99.9%. By "purity" is meant that the phospholipid or flavonoid of the invention is isolated from other phospholipids, flavonoids, or components of the extract, to the weight percent specified. Isolation may be performed by e.g. HPLC. For example, a phospholipid that is 99% pure, contains less than 1% by weight of any material other than the specified phospholipid.

ii. Higher bioavailability and efficacy is achieved with higher purity.

iii. Phospholipid market value is directly analogous to the purity achieved for the final product.

b. Source and fatty acid content:

i. The types of fatty acids attached to the phospholipid is widely dependent upon the source.

ii. Plant source phospholipids contain mainly palmitic acid (16:0), stearic acid (18:0), vaccenic acid (18:1), linoleic acid (18:2) or alpha-linoleic acid (18:3).

iii. Animal source phospholipids contain a higher percentage of longer-chain fatty acids with higher degree of unsaturation like homo-gamma-linoleic acid (20:3),

- 34 -

arachidonic acid (20:4), behenic acid (22:0) and docosahexanoic acid -DHA (22:6).

iv. Neptune Krill Oil™ (the present invention) phospholipids contain high quantities of eicosapentanoic acid -EPA (20:5) and docosahexanoic acid -DHA (22:6). Their fatty acid profile closely resembles that of human brain phospholipids.

v. The efficacy in human health and the value of phospholipids increases directly analogous to the length of the fatty acid chain and the degree of unsaturation. Therefore, phospholipids with more polyunsaturated fatty acids attached to them are more efficacious and of higher value.

vi. Arachidonic acid, although polyunsaturated, has been proven to predispose to inflammatory disease. Hence, moderate quantities are preferred.

vii. DHA and EPA are the two most active polyunsaturated fatty acids in the human body, contributing to all health benefits associated with omega-3 fatty acids.

viii. The highest quantities of polyunsaturated fatty acids contained in the phospholipids in the market today are:

a.	Arachidonic acid	:30.1%
b.	Homo-gamma-linolenic acid	:9.0%
c.	DHA	:8.4%

4. Pharmaceutical, nutraceutical and cosmetic compositions

The phospholipid extract of the present invention may be used with or without other additives. Preferably, no other additives are used. However, if other additives are used, pharmaceutical or nutraceutical formulations may be made by

- 35 -

methods known in the art. For example, the compositions of the present invention may be formulated in a conventional manner using one or more pharmaceutically or nutraceutically acceptable carriers. Thus, the extract may be formulated for oral administration. For oral administration, the pharmaceutical or nutraceutical compositions may take the form of, for example, tablets or capsules prepared by conventional means with pharmaceutically or nutraceutically acceptable excipients such as binding agents (e.g., pregelatinised maize starch, polyvinylpyrrolidone or hydroxypropyl methylcellulose); filters (e.g., lactose, microcrystalline cellulose or calcium phosphate); lubricants (e.g., magnesium stearate, talc or silica); disintegrants (e.g., potato starch or sodium starch glycollate); or wetting agents (e.g., sodium lauryl sulphate). The tablets may be coated by methods well known in the art. Liquid preparations for oral administration may take the form of, for example, solutions, syrups or suspensions, or they may be presented as a dry product for constitution with water or other suitable vehicle before use. Such liquid preparations may be prepared by conventional means with pharmaceutically or nutraceutically acceptable additives such as suspending agents (e.g., sorbitol syrup, methyl cellulose or hydrogenated edible fats); emulsifying agents (e.g., lecithin or acacia); non-aqueous vehicles (e.g., almond oil, oily esters or ethyl alcohol); and preservatives (e.g., methyl or propyl p-hydroxybenzoates or sorbic acid).

When the phospholipid extract of the inventions is used as a nutraceutical, it can be in the form of foods, beverages, energy bars, sports drinks, supplements or other forms all as are known in the art.

As noted above, the phospholipid extract of the invention is also useful in cosmetic preparations, e.g.,

- 36 -

moisturizing creams, sun-block products and other topical cosmetic products as known in the art.

The phospholipid extract of the present invention may be used in the treatment or prevention of a variety of disease states including: liver disease; chronic hepatitis; steatosis; 5 liver fibrosis; alcoholism; malnutrition; chronic parenteral nutrition; phospholipid deficiency; lipid peroxidation; disarrhythmia of cell regeneration; destabilization of cell membranes; coronary artery disease caused by 10 hypercholesterolemia; high blood pressure; menopausal or post-menopausal conditions; cancer, e.g., skin cancer; hypertension; aging; benign prostatic hyperplasia; kidney disease; edema; skin diseases; gastrointestinal diseases; peripheral vascular system diseases (e.g. leg ulcers); pregnancy toxemia; and 15 neurodegenerative and psychiatric diseases (e.g. Parkinson's, Alzheimer's, autism, attention deficit disorder, learning disorders, mood disorders, bipolar depression, multiple sclerosis, muscular dystrophy).

The extracts are also useful for targeting tumors and 20 can be used in conjunction with radioisotopes for diagnosing central nervous system tumors. The extract can also be used to reduce local fat deposits and reducing visible cellulite. The extract can also be used in aesthetics such as breast enlargement by acting on the lobular tissue of the breast and 25 by increasing hydration of the breast.

As noted above, the present invention provides novel phospholipids derived from a marine or aquatic biomass. The novel phospholipids have the general formula (I):

- 37 -

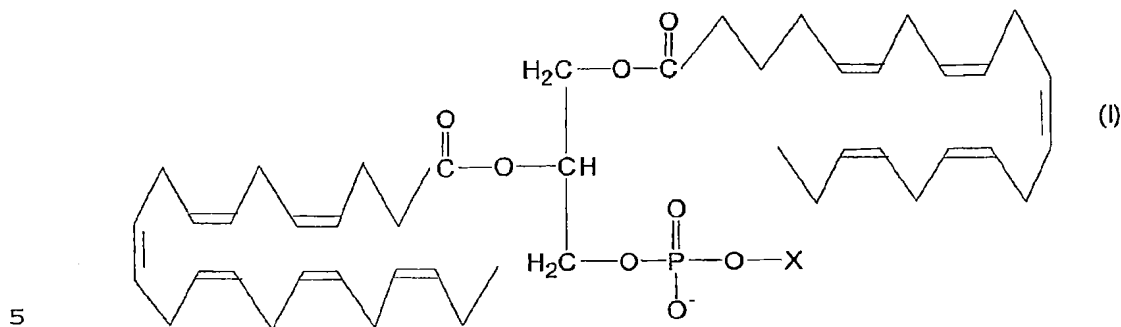

wherein X represents a moiety normally found in phospholipids, e.g., $-\text{CH}_2\text{CH}_2\text{N}(\text{CH}_3)_3$, $\text{CH}_2\text{CH}_2\text{NH}_3$ or

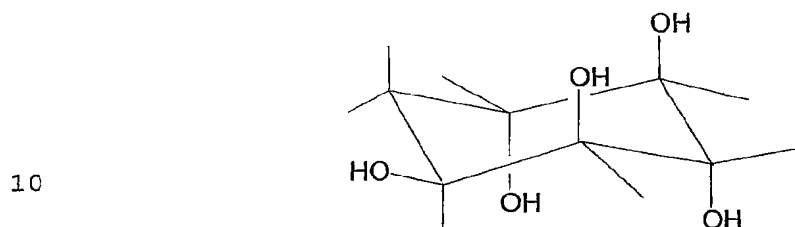

for phosphatidylcholine, phosphatidylethanolamine or phosphatidylinositol, respectively.

15 The left hand acid residue is derived from docosahexanoic acid (DHA) [C22:6n3]. The right hand acid residue is derived from eicosapentaenoic acid (EPA) [C20:5n3].

These novel phospholipids have all of the uses noted above for phospholipids in pharmaceutical, nutraceutical and cosmetic compositions.

20 As noted above, the present invention also provides a novel flavonoid compound derived from a marine or aquatic biomass. The novel flavonoid compound has the formula (II):

- 38 -

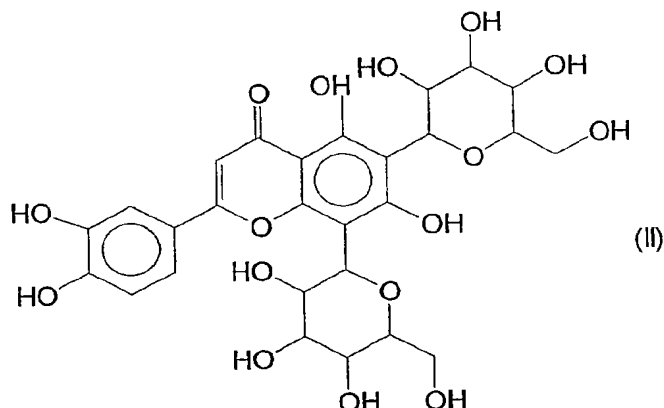

5

The novel flavonoid is an antioxidant and thus is useful in the pharmaceutical, nutraceutical and cosmetic compositions of the invention.

As used herein and in the claims, where the term
10 "about" is used with a numerical value, the numerical value may vary by at least $\pm 50\%$. Preferably, the variation will be $\pm 40\%$ or $\pm 30\%$ and more preferably $\pm 20\%$ or $\pm 10\%$. Even more preferred variations are in the range $\pm 5\%$, $\pm 4\%$, $\pm 3\%$ or $\pm 2\%$. Most preferably, the variation is in the range of $\pm 1\%$.

15 Brief Description of the Drawings

Figs. 1 to 3 are chromatograms of the product of Example 1.

Fig. 4 is a mass spectrograph for characterizing the novel flavonoid compound (II).

20 The invention is further illustrated by the following non-limiting examples.

The extraction of the phospholipids for Example 1 was as described above for krill extractions.

Examples*Materials and Methods*

For analysis of lipids, samples were dissolved in solvent and standards were added. Lipid classes were isolated using silica gel and quantified. Fatty acid composition of total lipids and individual phospholipids was determined by gas chromatography. Pigments were measured by reversed phase high performance liquid chromatography.

Example 1

This example illustrates the isolation and molecular characterization of the phospholipids from the extract.

Sample #804 molecular species determination

The sample contains large amounts of phospholipids, mainly:

PC (438.48 mg/g lipid)
PE (183.15 mg/g lipid)

Preliminary results were obtained only for these two phospholipid fractions.

METHODS**20 Separation of main phospholipid fractions**

To obtain large quantities of PC and PE, separation was done by Thin Layer Chromatography (TLC) and bands identity was confirmed by HPLC.

Diacylglycerol formation

Both fractions (PC and PE) were incubated with phospholipase C, the enzyme which removes choline phosphate

from PC and ethanolamine phosphate from PE. The remaining diacylglycerols were extracted with ethyl ether.

Benzoate derivatization

Each mixture of diacylglycerols needed to be derivatized (using benzoic anhydride and 4-dimethyl-aminopyridine) to make further separation possible. In a parallel experiment, derivatization was done for three standard authentic diacylglycerols, dilinolein, diolein and dipalmitin.

Subclass separation

A preliminary separation of diacylglycerols derivatives into subclasses was done by TLC. Diacylglycerol derivatives obtained from PC and from PE separated into two major bands (#3 and #4). Additional bands #2 were also visible very close to the start. Only bands #3 and #4 were processed further because their localization corresponded to the localization of main band #2 obtained for a mixture of standards (benzoate derivatives of dilinolein, diolein and dipalmitin).

Example TLC plate separation

# 3		
#2	#4 (Rf = 0.37)	#4 (Rf = 0.37)
	#3 (Rf = 0.25)	#3 (Rf = 0.25)
	#2	#2
Start Std mix	Start PC	Start PE

20

HPLC fractionation

- 41 -

Bands #3 and #4 obtained for PC and PE were eluted and further separated into individual diacylglycerol species by HPLC. To confirm a number of peaks for the subsequent GC analysis, each peak was collected and separately re-run on HPLC.

Number of confirmed peaks:

For PC band #3, nine peaks were identified and confirmed.
For PC band #4, nine peaks were identified and confirmed.
For PE band #3, eight peaks were identified and confirmed.
10 For PE band #4, eight peaks were identified and confirmed.

See Figure 1.

Hydrolysis, methyl ester derivatization and GC analysis

For both PC and PE, all confirmed peaks obtained from HPLC separation of band #3 were hydrolyzed and fatty acid profiles were determined by GC after conversion into methyl esters. Peak identity was assessed by mass spectrometry. Fatty acid profiles were compared to those obtained for intact PC and PE fractions subjected to hydrolysis and methylation.

Results

20 The peak surface areas calculated for fatty acid molecular species in selected fractions are summarized in Table 8. The peak fatty acid areas for intact PC and PE fraction are in Table 9. The representative Gas Chromatography profiles for an individual fraction and for intact phospholipid (PC) are
25 presented in Table 10.

The Gas Chromatography profiles obtained for individual peaks were only partly consistent with profiles obtained for intact PC. They contained only 5-6 major peaks while Gas Chromatography profiles of intact phospholipids

consist of much higher number of peaks. Among the 5-6 peaks consistently found in molecular species profiles, only two had identity confirmed by mass spectrometry (C16:0 and C18:0). Among the remaining three peaks, one did not correspond to any fatty acid and two had retention times identical to those of authentic omega-3 fatty acids, EPA and DHA.

The C16:0 peak was prominent in all individual molecular species profiles and was also prominent in the intact phospholipid fractions. For the C18:0 peak, its proportions found in individual peaks were relatively high. Oleic acid (C18:1) was found at high levels in both PC and PE fatty acid profile.

TABLE 8

Molecular species peak areas obtained for selected fractions.

15

Fraction	C16:0	C18:0	EPA	RT 48.33	DHA
PC band #3 F1	205.27	57.79	42.76	103.83	62.07
PC band #3 F2	21.39	8.87	0	71.96	7.11
PC band #3 F3	58.74	17.70	0	45.64	14.75
PC band #3 F4	93.41	9.72	0	44.31	9.19
PC band #3 F5	19.87	9.67	4.56	46.89	3.96
PC band #3 F6	15.26	10.34	12.45	59.86	14.29
PC band #3 F7	28.32	10.93	30.70	56.83	25.12
PC band #3 F8	6.39	4.49	0	84.24	11.89
PC band #3 F9	14.65	8.21	8.60	58.95	28.22
PE band #3 F2	4.50	10.79	0	77.68	9.19
PE band #3 F3	26.85	22.14	14.45	49.62	21.76
PE band #3 F4	13.08	22.45	28.70	62.11	29.43
PE band #3 F5	22.42	20.34	11.06	100.79	30.61
PE band #3 F6	3.05	6.13	4.93	54.88	7.28

- 43 -

TABLE 9

Selected fatty acid peak areas of intact PC and PE

	C16:0	C18:0	C18:1	EPA	Un-identified	DHA
Retention time	15.80	21.66	22.36+22.63	39.68	48.34	53.59
PC	1141.36	35.75	257.99	642.50	68.61	192.22
PE	166.43	20.45	87.75	59.77	110.27	109.63

5

See Fig. 2

TABLE 10

The representative GC profiles for an individual fraction and
for intact phospholipid (PE)

10

CH	PKNO	TIME	AREA	HEIGHT	MK	IDNO	CONC
1	5	0.826	17654310	1368301	E		21.8397
	13	2.637	11027760	1352920	E		13.6422
	14	2.916	2167386	203115	E		2.6812
	15	3.15	597812	87264	V		0.7395
	22	4.408	667991	60799	V		0.8264
	29	7.063	7293939	290768			9.0231
	30	8.397	144489	13997			0.1787
	32	9.933	32467398	1384059	E		40.1646
	33	10.252	8166303	661493	V		10.1023
	43	14.451	348072	20030			0.4306
	44	14.813	102126	9975			0.1263
	45	15.12	198366	21561			0.2454
TOTAL			80835952	5474282			100

See Fig. 3

Example 2

15 UVB-Induced Skin Cancer

Objectives

To evaluate the photoprotective potential of krill extract against UVB-induced skin cancer.

Study Design

Randomized control trial

Statistical significance $p < 0.05$

Study Phase

5 Pre-clinical

Experimental Animals

Type: Nude Mice

Strain: C57BL6 Nude Congenic Mice - B6NU -T (heterozygotes)

(Preference of specific type because of proven susceptibility
10 to skin cancer).

Study Protocol

Number of nude mice = 96

Randomization groups: 48 placebo: 16 per os

16 local application

15 16 per os and local application

48 krill extract: 16 per os

16 local application

16 per os and local application

20 In order to establish efficacy of krill extract for
the prevention of skin cancer, the test was conducted as a
randomized double blind controlled trial (both the pathologist
and the research assistant were blind). Half of the mice were
treated orally or topically or both with extract containing
100% by weight of krill extract and the other half underwent

- 45 -

the same method of treatment with a placebo. The groups were divided as follows:

Nutrition: Week 1: fat-free chow

Week 2-20: according to group

5 Experimental Design:

The mice were divided in six groups as follows:

Group A: fat-free chow with supplementation of soy extract
(20% of total calories)

10 Group B: fat-free chow (100% of calories) + local application
of soy extract 2 times per day

Group C: fat-free chow with supplementation of soy extract
(20% of total calories) + local application of soy extract 2
times per day

15 Group D: fat-free chow with supplementation of krill extract
(20% of total calories)

Group E: fat-free chow (100% of calories) + local application
of krill extract 2 times per day

20 Group F: fat-free chow with supplementation of krill extract
(20% of total calories) + local application of krill extract 2
times per day

Week 2-20: UVB radiation using a fluorescent test lamp,
emission spectrum 270 - 400 nm.

Week 3-20: liquid from blisters formed is examined for PGE2
levels

- 46 -

Week 3-20: mice are anaesthetized with ether and sacrificed when malignant tumours have formed or at the end of the 20 weeks.

5 Skin is examined by pathologist for signs of carcinogenesis.

The results are shown in the following Table 11.

TABLE 11

Application	Frequency of cancer	
	Krill Oil Frequency %	Placebo Frequency %
Oral	13	69.3
Topical	0	63.8
Oral & Topical	0	37.5

10

In conclusion, the results of the present study demonstrate that both oral and topical krill extract maybe effectively used for the protection of skin against the harmful effects of UVB radiation including skin cancer.

15 Example 3

This example illustrates the use of the present krill extract in improving dyslexia and abnormal motor function in a 7 year old girl.

20 2g per day of the krill extract were given to a 7 year old girl suffering from dyslexia and abnormal motor function. After 1.5 months, she showed:

- Increased learning ability (blind observation by psychologist)
- Improved motor function (moderate ice skating)
- Improved social skills
- Improved speech

25

Accordingly, the krill extract has beneficial neurological properties.

- 47 -

All publications cited in this specification are herein incorporated by reference as if each individual publication were specifically and individually indicated to be incorporated by reference. The citation of any publication is
5 for its disclosure prior to the filing date and should not be construed as an admission that the present invention is not entitled to antedate such publication by virtue of prior invention.

Although the foregoing invention has been described
10 in some detail by way of illustration and example for purposes of clarity of understanding, it is readily apparent to those of ordinary skill in the art in light of the teachings of this invention that certain changes and modifications may be made thereto without departing from the spirit or scope of the
15 appended claims.

References

1. Lisa Colodny, Pharm D. and Ronald L. Hoffman, M.D. Altern Med Rev 1998;3(6):432-447.
- 5 2. Vandal R. Role of inositol in the treatment of psychiatric disorders. CNS Drugs 1997;7:6-16.
3. Gill DL, Ghosh TK, Mullaney JM. Calcium signaling mechanisms in endoplasmic reticulum activated by inositol 1,4,5 triphosphate and GTP. Cell Calcium 1989;10:363-374.
- 10 4. Parthasarathy L, Vadnal R, Parthasarathy R, et al. Biochemical and molecular properties of lithium-sensitive myo-inositol monophosphatase. Life Sci 1994;54:1127-1142.
5. Kitamura H, Yamauchi A, Sugiura T, et al. Inhibition of myo-inositol transport causes acute renal failure with selective medullary injury in the rat. Kidney Int 15 1998;53:146-153.
6. Barkai A, Dunner D, Gross H, et al. Reduced myo-inositol levels in cerebrospinal fluid from patients with affective disorder. Biol Psychiatry 1978;13:65-72.
- 20 7. Levine J, Rapaport A, Lev L, et al. Inositol treatment raises CSF inositol levels. Brain Research 1993;627:168-169.
8. Levine J. Controlled trials of inositol in psychiatry. Eur Neuropsychopharmacol 1997;7:147-155.
- 25 9. Cohen H, Kotler M, Kaplan Z, et al. Inositol has behavioral effects with adaptation after chronic administration. J Neural Transm 1997;104:299-305.

10. Levine J, Barak Y, Gonzalves M, et al. Double-blind, controlled trial of inositol treatment of depression. Am J Psychiatry 1995;152:792-794.

5 11. Levine J, Barak Y, Kofman O, et al. Follow-up and relapse of an inositol study of depression. Isr J Psychiatry Relat Sci 1995;32:14-21.

12. Benjamin J, Levine J, Fux M, et al. Double-blind, placebo-controlled, crossover trial of inositol treatment for
10 panic disorder. Am J Psychiatry 1995;15:1084-1086.

13. Birchall J, Chappell J. Aluminum, chemical physiology, and Alzheimer's disease. Lancet 1988;29:1008-1010.

14. Cheng D, Ren H, Tang X. Huperzine A. A novel promising acetylcholinesterase inhibitor. Neuroreport 1996;8:97-101.

15 15. Kawakami Y, Inoue A, Kawai T, et al. The rationale for E2020 as a potent acetylcholinesterase inhibitor. Bioorg Med Chem 1996;4:1429-1446.

16. Knopman D, Schneider L, Davis K, et al. Long term tacrine (Cognex) treatment: effects on nursing home placement and
20 mortality, tacrine study group. Neurology 1996;47:166-167.

17. Mohr E, Nair N, Sampson M, et al. Treatment of Alzheimer's disease with sabeluzole: functional and structural correlates. Clin Neuropharmacol 1997;20:338-345.

18. Rogers S, Friedhoff L. The efficacy and safety of
25 donepezil in patients with Alzheimer's disease: results of a US multicentre, randomized, double-blind, placebo-controlled trial. The donepezil study group. Dementia 1996;7:293-303.

- 19. Schneider L, Farlow M, Pogoda J. Potential role for estrogen replacement in the treatment of Alzheimer's dementia. Am J Med 1997;103:46S-50S.
- 5 20. Van Dyck C, Lin C, Robinson R, et al. The acetylcholine releaser linopiridine increases parietal regional cerebral blood flow in Alzheimer's disease. Psychopharmacology 1997;132:217-226.
- 10 21. Barak Y, Levine J, Glasman A, et al. Inositol treatment of Alzheimer's disease: a double blind, cross-over placebo controlled trial. Prog Neuropsychopharmacol Biol Psychiatry 1996;20:729-735.
- 15 22. Michael D. Seidman, MD., FACS Polyunsaturated Phosphatidylcholine in NT Factor™ Improves Mitochondrial Function, Auditory Sensitivity and May Slow Some Aspects of the Aging Processes. Anti-aging Medical News, winter 2001-01.
- 20 23. Imperato A, Ramacci MT, Angelucci L. Acetyl L-carnitine enhances acetylcholine release in the striatum and hippocampus of awake freely moving rats. Neuroscience letters. 1989: 107(1-3): 251-255.
- 24. Ghirardi O, Milano S, Ramacci MT, Angelucci L. Effects of acetyl L-carnitine chronic treatment on discrimination models in aged rats. Physiol. Behav. 1988;44(6): 769-773.
- 25 25. Caprioli A, Ghirardi O, Ramacci MT, Angelucci L. Age-dependent deficits in radial maze performance in the rat: effect of chronic treatment with acetyl L-carnitine. Prog. in Neuropsychopharmacol. Biol. Psychiatr. 1990;14(3):3 59-369.

- 50a -

Bast A and Haenen GRMM. Interlay between lipoic acid and glutathione in the protection against microsomal lipid peroxidation. *Biochem. Biophys. Acta.* 1988; 963: 558-561.

- 5 26. Suzuki YJ, Aggarwal B, Packer L. Alpha-lipoic acid is a potent inhibitor of NFkB activation in human Tcells. *Biochem. Biophys. Res. Commun.* 1992; 189:1709-1715.
- 10 27. Kagan VE, Shvedova A, Serbinova E, Khan S, Swanson C, Poweel R, Packer L. Dihydrolipoic acid: A universal antioxidant both in the membrane and in the aqueous phase. *Biochem Pharmacol.* 1992; 44: 1637-1649.
- 15 28. Devasagayam TP, Subramanian M, Pradhan DS, Sies H. *Chemical Biological Interactions.* 1993; 86: 79-92.
29. Gadaleta MN, Petruzalla V, Daddabbo L, et al. Mitochondrial DNA transcription and translation in aged rat. Effect of acetyl-L-carnitine. *Ann.N.Y. Acad. Sci.* 1994; 717: 150-160.
- 20 30. Paradies G, Ruggiero FM, Petrosillo G, Gadaleta MN, Quagliariello E. Carnitine-acylcarnitine translocase activity in cardiac mitochondria from aged rats: the effect of acetyl-L-carnitine. *Mech. of aging and develop.* 1995; 84(2):103-112.
- 25 31. Aureli T, Miccheli A, Ricciolini R, Di Cocco M, et al. Aging brain: effect of acetyl L-carnitine treatment on rat brain energy and phospholipid metabolism. A study by ³¹P and ¹H NMR spectroscopy. *Brain Research.* 1990; 526(1):108-112.
32. Sebinova E, Khwaja S, Reznick AZ, Packer L. Thiocctic acid protects against ischemia-reperfusion injury in the

- 50b -

isolated perfused Langendorff heart. Free Rad. Res. Commun. 1994; 17: 49-58.

- 5 33. Seidman MD, Khan MJ, Bai U, Shirwany N, Quirk WS. Biologic Activity of Mitochondrial Metabolites on Aging and Age-Related Hearing Loss. Am. J. Otol. 2000;21:161-167.
- 10 34. Hosokawa M., Shimatani T., Kanada T., Inoue Y., and Takahashi K. Conversion of Docosahexaenoic Acid-Containing Phosphatidylserine from Squid Skin Lecithin by Phospholipase D-Mediated Transphosphatidylation. J. Agric. Food Chem. 2000, 48, 4550-4554.
35. Henderson R.J., Bell M.V., Park M.T., Sargent J.R., and Falcon J. Lipid Composition of the Pineal Organ from Rainbow Trout. Lipids, 29(5), 311-317 (1994).
- 15 36. Bell M.V. and Dick J.R. Molecular Species Composition of the Major Diacyl Glycerophospholipids from Muscle, Liver, Retina, and Brain of Cod. Lipids, 26(8), 565-573 (1991).
- 20 37. Wiegand R.D. and Anderson R.E. Phospholipid Molecular Species of Frog Rod Outer Segment Membranes. Exp. Eye Res., 37(2), 157-173 (1983).

2002322233 18 Feb 2008

51

CLAIMS:

1. A composition, comprising :

(a) a phospholipid of the general formula (I),

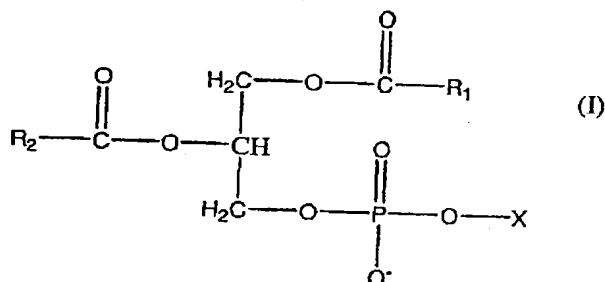

wherein R_1 and R_2 is docosahexaenoic acid (DHA) or eicosapentaenoic acid (EPA), and X is $-\text{CH}_2\text{CH}_2\text{NH}_3$, $-\text{CH}_2\text{CH}_2\text{N}(\text{CH}_3)_3$, or

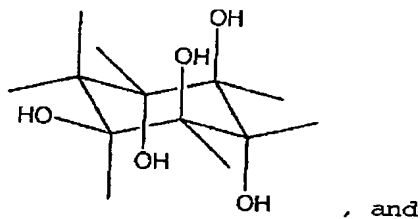

(b) an antioxidant,

wherein DHA and EPA are attached simultaneously on the phospholipid and wherein the carboxy moiety attached to R_1 and R_2 is the carbonyl group of said EPA and DHA.

2. The composition according to claim 1, further comprising a flavonoid of the general formula (II)

203755378_1

2002322233 18 Feb 2008

52

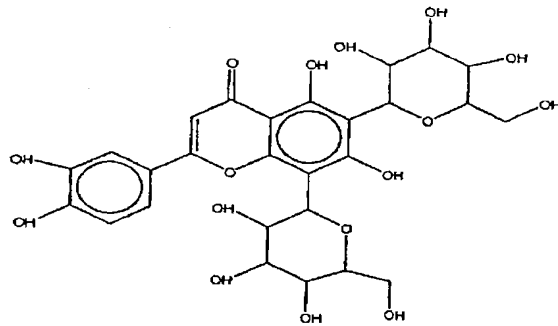

3. The composition according to claim 1 or 2, wherein the composition is derived from at least one marine or aquatic biomass.
4. The composition according to claim 3, wherein the biomass is crustaceans.
5. The composition as according to claim 3 or 4, wherein the biomass is zooplankton.
6. The composition according to claim 5, wherein the zooplankton is krill.
7. The composition according to any one of claims 3 to 6, wherein the composition is derived from initial processing of the biomass.
8. The composition according to claim 7, wherein the processing is conducted at a temperature of about 5°C or less.
9. The composition according to claim 7 or 8, wherein the composition is derived from the biomass grease.
10. The composition according to any one of claims 1 to 9, comprising at least about 40% w/w phospholipid.
11. The composition according to claim 10, comprising at least about 45% w/w phospholipids.
12. The composition according to claim 11, comprising from about 45 to 60% w/w phospholipid.

203755378_1

2002322233 18 Feb 2008

53

13. The composition according to any one of claims 1 to 12, wherein the composition comprises at least one phospholipid selected from the group consisting of phosphatidylcholine, phosphatidylethanolamine, phosphatidylinositol, phosphatidylserine and sphingomyelin.
14. The composition according to any one of claims 1 to 13, further comprising a phospholipid comprising saturated, monounsaturated or polyunsaturated fatty acids.
15. The composition according to claim 14, wherein the polyunsaturated fatty acids are selected from the group consisting of omega-3 and omega-6 fatty acids.
16. The composition according to claim 14, wherein the fatty acids are selected from the group consisting of docosahexaenoic acid (DHA), eicosapentaenoic acid (EPA), myristic acid, myristoleic acid, lignoceric acid, linolenic acid, alpha linolenic acid, nervonic acid, linoleic acid, oleic acid, stearic acid, palmitic acid and palmitoleic acid.
17. The composition according to any one of claims 1 to 16, further comprising lipids.
18. The composition according to claim 17, wherein the additional lipids are selected from at least one lipids from the group consisting of monoglycerides, triglycerides, and cholesterol or a mixture thereof.
19. The composition according to any one of claims 1 to 18, further comprising at least about 4% w/w of free fatty acids.
20. The composition according to claim 19, comprising at least about 5% w/w of free fatty acids.
21. The composition according to any one of claims 17 to 20, wherein polyunsaturated fatty acids comprise at least about 15% w/w of the total lipids in the composition.

203755378_1

22. The composition according to claim 21, wherein polyunsaturated fatty acids comprise at least about 40% w/w of the total lipids in the composition.
23. The composition according to claim 22, wherein polyunsaturated fatty acids comprise at least about 45% w/w of the total lipids in the composition.
24. The composition according to any one of claims 21 to 23, wherein the polyunsaturated fatty acids are omega-3 fatty acids.
25. The composition according to any one of claims 17 to 24, wherein DHA and EPA comprise at least about 32% w/w of the total lipids in the composition.
26. The composition according to claim 25, wherein DHA and EPA comprise at least about 35% w/w of the total lipids in the composition.
27. The composition according to any one of claims 1 to 26, wherein the antioxidant is selected from at least one of the group consisting of vitamin A, vitamin E, beta-carotene, astaxanthin, canthaxanthin, flavonoid and mixture thereof.
28. The composition according to claim 27, wherein the vitamin A is all-trans retinol, the vitamin E is alpha-tocopherol, and the astaxanthin is mainly esterified.
29. The composition according to any one of claims 1 to 28, further comprising a metal.
30. The composition according to claim 29, wherein the metal is zinc, selenium or a mixture thereof.
31. The composition according to any one of claims 17 to 30, wherein the fatty acid composition of the lipids in the composition is about:

203755378_1

18 Feb 2008

2002322233

2002322233 18 Feb 2008

55

Fatty Acids	Total Phospholipid Fatty Acid%	Phosphatidyl-choline Fatty Acid %	Phosphatidyl-ethanolamine Fatty Acid%
C14:0 MYRISTIC	2	2	0.7
C14:1 MYRISTOLEIC	1		
C15:0 PENTADECANOIC	0.2	0.3	0.3
C16:0 PALMITIC	24	27	24
C16:1 PALMITOLEIC	2	2	0.7
C18:0 STEARIC	1	1	3
C18:1 OLEIC	9	12	24
C18:2n6 LINOLEIC	2	2	0.8
C18:3n6 GLA	1	0.3	
C18:3n3 ALA	1	1	
C18:4n3 OTA	2	2	0.3
C20:0 ARACHIDIC			
C20:1 cis-11-EICOSENOIC	0.5	0.6	0.7
C20:2n6 EICOSADIENOIC			
C20:3n6 METHYL ETA		0.2	
C20:4n6 ARACHIDONIC	0.6	0.7	0.6
C20:3n3 Homo-γ-LINOLENIC			

203755378_1

56

C20:4n3			
C20:5n3 EPA	27	32	13
C22:0 BEHENIC			
C22:1 ERUCIC	1	1.5	
C22:2n6			
C22:4n6			
C22:5n6 METHYL DPA			
C22:5n3 DPA		1.0	
C22:6n3 DHA	25	14	32
C24:0 LIGNOCERIC			
C24:1 NERVONIC			
Total	100.0	100	100

32. The composition according to claim 31, wherein the total fatty acid composition of all the lipids in the composition is about:

Sample	%
Fatty Acid Composition	
C14 : 0	≥3.00
C14 : 1	≥0.01
C15 : 0	≥0.3
C16 : 0	≥20.00

203755378_1

2002322233 18 Feb 2008

2002322233 18 Feb 2008

57

C16 : 1	≥3.25
C18 : 0	≥1.00
C18 : 1	≥10.00
C18 : 2n6	≥2.00
C18 : 3n6 GLA	≥0.04
C18 : 3n3 ALA	≥0.01
C18 : 4n3	≥1.50
C20 : 0	≥0.05
C20 : 1	≥1.00
C20 : 2n6	≥0.05
C20 : 3n6	≥0.05
C20 : 4n6	≤0.50
C20 : 3n3	≥0.01
C20 : 4n3	≥0.20
C20 : 5n3 EPA	≥25.00
C22 : 0	≥0.01
C22 : 1	≥1.50
C22 : 2n6	≥0.03
C22 : 4n6	≥0.01
C22 : 5n6	≥0.01
C22 : 5n3 DPA	≥0.50
C22 : 6n3 DHA	≥10.00

203755378_1

58

C24 : 0	≥0.01
C24 : 1	≥0.05

33. The composition according to claim 32, wherein the total fatty acid composition of all the lipids further is about:

Saturated (g/100g lipid)	≥22.00
Monounsaturated (g/100g lipid)	≥11.00
Polyunsaturated (g/100g lipid)	≥35.00
Omega-3 (g/100g lipid)	≥30.00
Omega-6 (g/100g lipid)	≥1.00

34. The composition according to any one of claims 1 to 32, further comprising about:

Monoglycerides (MG) (g/100g sample)	≥0.7
Triglycerides (TG) (g/100g sample)	≥3.00
Free Fatty Acids (FFA) (g/100g sample)	≥5.00
Cholesterol (g/100g sample)	≤2.00
Total Phospholipids (PL) (g/100g sample)	≥40.00
Phosphatidyl Ethanolamine (PE) (g/100g sample)	≥2.50
Phosphatidyl Inositol (PI) (g/100g sample)	≥0.20
Phosphatidyl Serine (PS) (g/100g sample)	≥0.20

203755378_1

18 Feb 2008

2002322233

2002322233 18 Feb 2008

59

Phosphatidyl Choline (PC) (g/100g sample)	≥35.00
Sphingomyelin (g/100g sample)	≥0.50
Vitamin A (μg/100g ml)	≥1,400
Vitamin E (μg/100g sample)	≥15
Beta-Carotene (μg/100g ml)	≥1,600
Astaxanthin (g/100g ml)	≥10
Canthaxanthin (mg/100g ml)	≥10
Flavonoid (mg/100 ml)	≥7.0

35. Use of the composition according to any one of claims 1 to 33, for the manufacture of a medicament for the prevention or treatment of liver disease.
36. Use of the composition according to any one of claims 1 to 33, for the prevention or treatment of liver disease.
37. Use of the composition according to any one of claims 1 to 33, for the manufacture of a medicament for the prevention or treatment of chronic hepatitis.
38. Use of the composition according to any one of claims 1 to 33, for the prevention or treatment of chronic hepatitis.
39. Use of the composition according to any one of claims 1 to 33, for the manufacture of a medicament for the prevention or treatment of steatosis.
40. Use of the composition according to any one of claims 1 to 33, for the prevention or treatment of steatosis.

203755378_1

41. Use of the composition according to any one of claims 1 to 33, for the manufacture of a medicament for the prevention or treatment of liver fibrosis.
42. Use of the composition according to any one of claims 1 to 33, for the prevention or treatment of liver fibrosis.
43. Use of the composition according to any one of claims 1 to 33, for the manufacture of a medicament for the prevention or treatment of alcoholism.
44. Use of the composition according to any one of claims 1 to 33, for the prevention or treatment of alcoholism.
45. Use of the composition according to any one of claims 1 to 33, for the manufacture of a medicament for the prevention or treatment of malnutrition.
46. Use of the composition according to any one of claims 1 to 33, for the prevention or treatment of malnutrition
47. Use of the composition according to any one of claims 1 to 33, for the manufacture of a medicament for the prevention or treatment of chronic parenteral malnutrition.
48. Use of the composition according to any one of claims 1 to 33, for the prevention or treatment of chronic parenteral malnutrition.
49. Use of the composition according to any one of claims 1 to 33, for the manufacture of a medicament for the prevention or treatment of phospholipids deficiency.
50. Use of the composition according to any one of claims 1 to 33, for the prevention or treatment of phospholipids deficiency.
51. Use of the composition according to any one of claims 1 to 33, for the manufacture of a medicament for the prevention or treatment of lipid peroxidation.
52. Use of the composition according to any one of claims 1 to 33,

203755378_1

2002322233 18 Feb 2008

61

- for the prevention or treatment of lipid peroxidation.
53. Use of the composition according to any one of claims 1 to 33, for the manufacture of a medicament for the prevention or treatment of disarrhythmia of cell regeneration.
54. Use of the composition according to any one of claims 1 to 33, for the prevention or treatment of disarrhythmia of cell regeneration.
55. Use of the composition according to any one of claims 1 to 33, for the manufacture of a medicament for the prevention or treatment of destabilization of cell membranes.
56. Use of the composition according to any one of claims 1 to 33, for the prevention or treatment of destabilization of cell membranes.
57. Use of the composition according to any one of claims 1 to 33, for the manufacture of a medicament for the prevention or treatment of coronary artery disease caused by hypercholesterolemia, high blood pressure, menopausal or post-menopausal conditions.
58. Use of the composition according to any one of claims 1 to 33, for the prevention or treatment of coronary artery disease caused by hypercholesterolemia, high blood pressure, menopausal or post-menopausal conditions.
59. Use of the composition according to any one of claims 1 to 33, for the manufacture of a medicament for the prevention of cancer.
60. Use of the composition according to any one of claims 1 to 33, for the prevention of cancer.
61. Use of claim 59 or 60, wherein cancer is skin cancer.
62. Use of claim 59 to 61, wherein the use of the composition is oral or topical.
63. Use of the composition according to any one of claims 1 to 33,

203755378_1

for the manufacture of a medicament for the prevention or treatment of hypertension.

64. Use of the composition according to any one of claims 1 to 33, for the prevention or treatment of hypertension.
65. Use of the composition according to any one of claims 1 to 33, for the manufacture of a medicament for the prevention or treatment of effects of ageing.
66. Use of the composition according to any one of claims 1 to 33, for the prevention or treatment of effects ageing.
67. Use of the composition according to any one of claims 1 to 33, for the manufacture of a medicament for the prevention or treatment of benign prostatic hyperplasia.
68. Use of the composition according to any one of claims 1 to 33, for the prevention or treatment of benign prostatic hyperplasia.
69. Use of the composition according to any one of claims 1 to 33, for the manufacture of a medicament for the prevention or treatment of kidney disease.
70. Use of the composition according to any one of claims 1 to 33, for the prevention or treatment of kidney disease.
71. Use of the composition according to any one of claims 1 to 33, for the manufacture of a medicament for the prevention or treatment of edema.
72. Use of the composition according to any one of claims 1 to 33, for the prevention or treatment of edema.
73. Use of the composition according to any one of claims 1 to 33, for the manufacture of a medicament for the prevention or treatment of skin diseases.
74. Use of the composition according to any one of claims 1 to 33, for the prevention or treatment of skin diseases.

203755378_1

18 Feb 2008

2002322233

2002322233 22 Sep 2008

63

75. Use of the composition according to any one of claims 1 to 33, for the manufacture of a medicament for the prevention or treatment of gastrointestinal diseases.
76. Use of the composition according to any one of claims 1 to 33, for the prevention or treatment of gastrointestinal diseases.
77. Use of the composition according to any one of claims 1 to 33, for the manufacture of a medicament for the prevention or treatment of peripheral vascular system diseases.
78. Use of the composition according to any one of claims 1 to 33, for the prevention or treatment of peripheral vascular system disease.
79. Use of the composition according to claim 78, wherein the peripheral vascular system disease is ulcers.
80. Use of the composition according to any one of claims 1 to 33, for the manufacture of a medicament for the prevention or treatment of pregnancy toxemia.
81. Use of the composition according to any one of claims 1 to 33, for the prevention or treatment of pregnancy toxemia.
82. Use of the composition according to any one of claims 1 to 33, for the manufacture of a medicament for the prevention or treatment of neurodegenerative or psychiatric disease.
83. Use of the composition according to any one of claims 1 to 33, for the prevention or treatment of neurodegenerative or psychiatric disease.
84. The use of claim 81 or 82, wherein the neurodegenerative or psychiatric disease is dementia, Parkinson's, Alzheimer's, autism, attention deficit disorder, learning disorders, mood disorders, behavioural disorders, multiple sclerosis or muscular dystrophy.

203755378_2

22 Sep 2008

2002322233

63a

85. Use of claim 84, wherein the learning disorder is dyslexia.

86. Use of the composition according to any one of claims 1 to 33,
for the

203755378_2

2002322233 18 Feb 2008

64

- manufacture of a medicament for the prevention or treatment of abnormal motor function.
87. Use of the composition according to any one of claims 1 to 33, for the prevention or treatment of abnormal motor function.
88. Use of the composition according to any one of claims 1 to 33, in conjunction with a radioisotope for diagnosing or targeting tumors.
89. Use of the composition according to any one of claims 1 to 33, in conjunction with a radioisotope for the manufacture of a medicament for diagnosing or targeting tumors.
90. Use of claim 88 or 89, wherein the tumors are central nervous system tumors.
91. Use of the composition according to any one of claims 1 to 33, for the manufacture of a medicament for reducing local fat deposits and reducing visible cellulite.
92. Use of the composition according to any one of claims 1 to 33, for reducing local fat deposits and reducing visible cellulite.
93. Use of the composition according to any one of claims 1 to 33, for the manufacture of a medicament for aesthetic enhancement.
94. Use of the composition according to any one of claims 1 to 33, for aesthetic enhancement.
95. Use of the composition according to claim 94, wherein the aesthetic enhancement is breast enlargement.
96. A commercial package comprising the composition according to claim 1 to 33 together with instructions for use in treating cancer.
97. A commercial package comprising the composition according to claim 1 to 33 together with instructions for use in treating skin cancer.

203755378_1

98. A commercial package comprising the composition according to claim 1 to 33 together with instructions for use in treating learning disorders.
99. A commercial package comprising the composition according to claim 1 to 33 together with instructions for use in treating dyslexia.
100. A commercial package comprising the composition according to claim 1 to 33 together with instructions for use in treating abnormal motor function.
101. Use of the composition according to any one of claims 2 to 33, for the manufacture of a medicament for the prevention or treatment of cardiovascular disease.
102. Use of the composition according to any one of claims 2 to 33, for the prevention or treatment of cardiovascular disease.
103. Use of the composition according to any one of claims 2 to 33, for the manufacture of a medicament for the prevention or treatment of inflammatory conditions.
104. Use of the composition according to any one of claims 2 to 33, for the prevention or treatment of inflammatory conditions.
105. Use of the composition according to any one of claims 2 to 33, for the manufacture of a medicament for the prevention or treatment of asthma.
106. Use of the composition according to any one of claims 2 to 33, for the prevention or treatment of asthma.
107. Use of the composition according to any one of claims 2 to 33, for the manufacture of a medicament for the prevention or treatment of periodontal disease.
108. Use of the composition according to any one of claims 2 to 33, for the prevention or treatment of periodontal disease.

203755378_1

18 Feb 2008

2002322233

2002322233 18 Feb 2008

66

109. Use of the composition according to any one of claims 2 to 33, for the manufacture of a medicament for the prevention or treatment of cataracts.
110. Use of the composition according to any one of claims 2 to 33, for the prevention or treatment of cataracts.
111. Use of the composition according to any one of claims 2 to 33, for the manufacture of a medicament for the prevention or treatment of macular degeneration.
112. Use of the composition according to any one of claims 2 to 33, for the prevention or treatment of macular degeneration.
113. A composition substantially as described with reference to and as illustrated in the accompanying figures.
114. Use of a composition, said use being substantially as described with reference to and as illustrated in the accompanying figures.

203755378_1

1/4

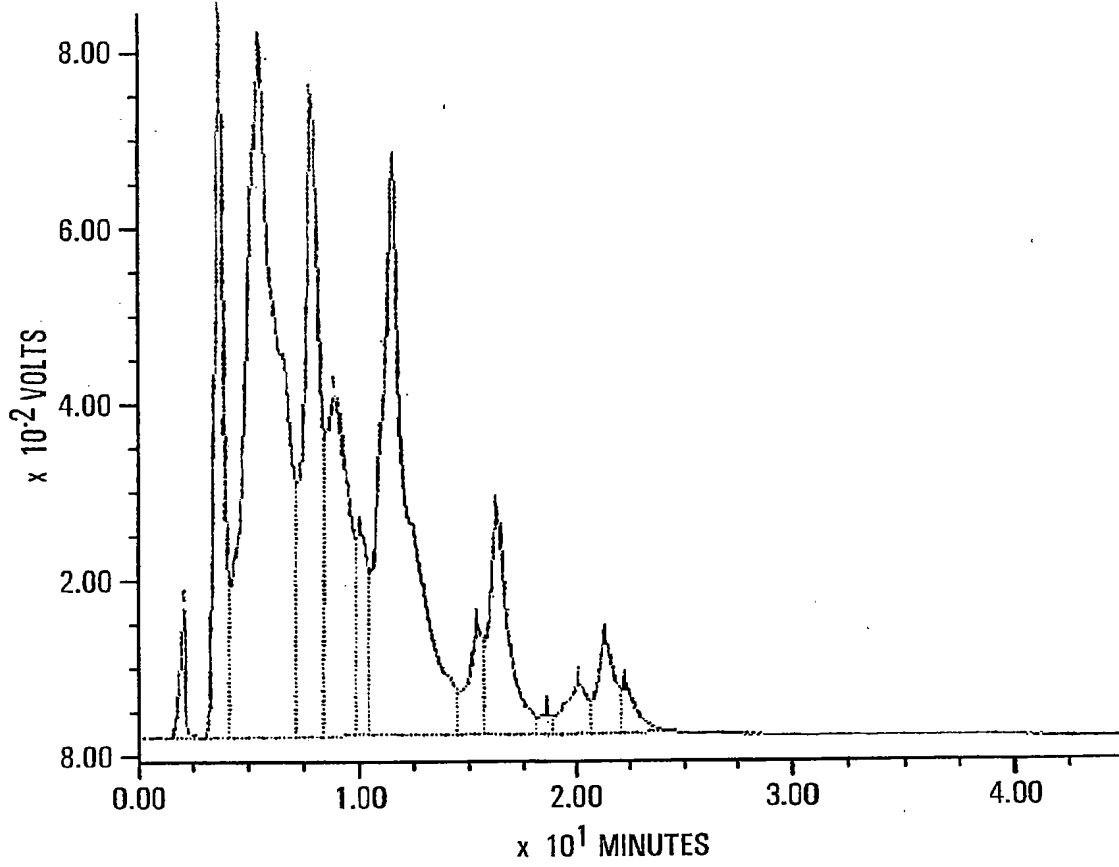

Fig. 1

2/4

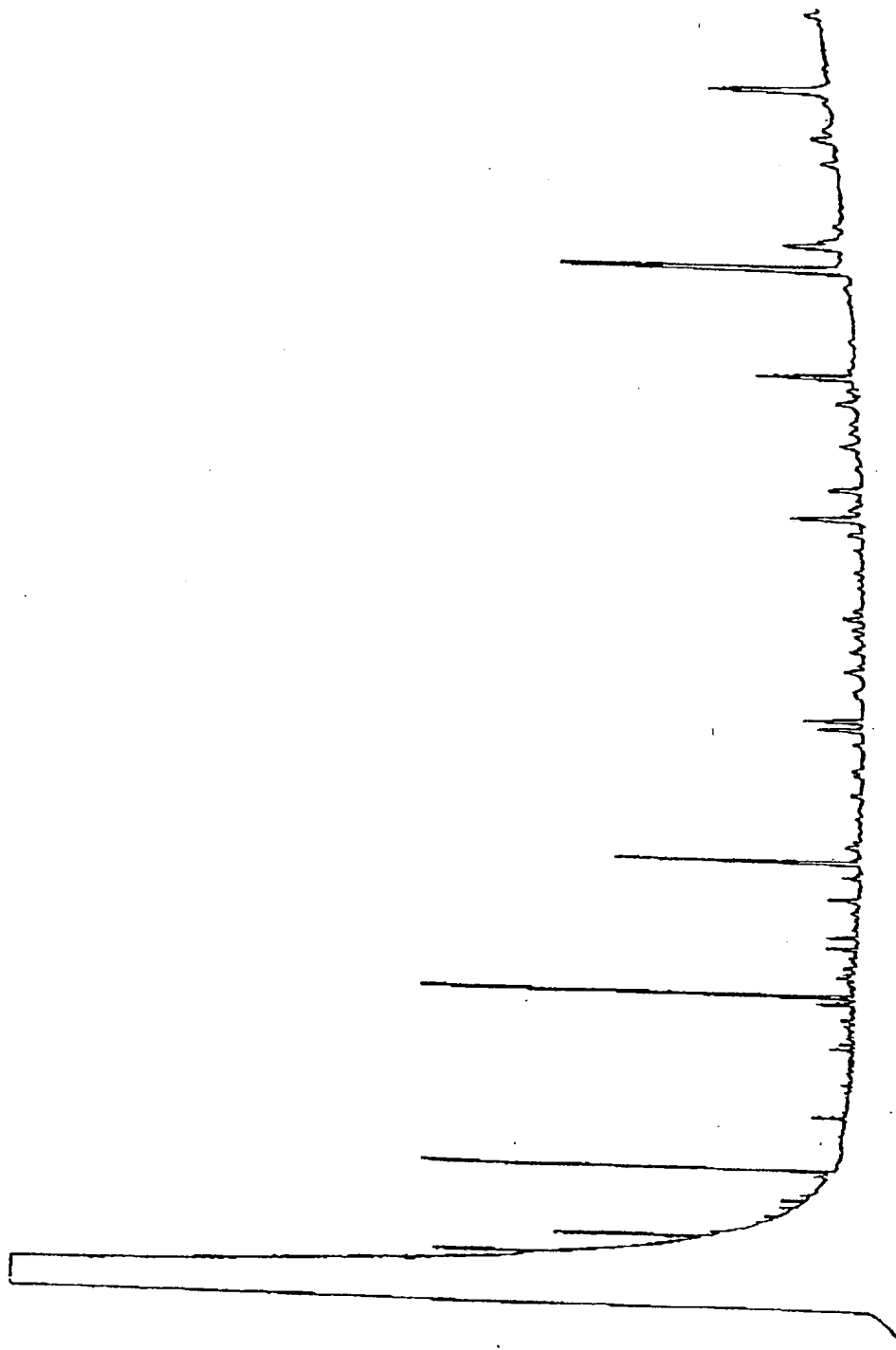

Fig. 2

3/4

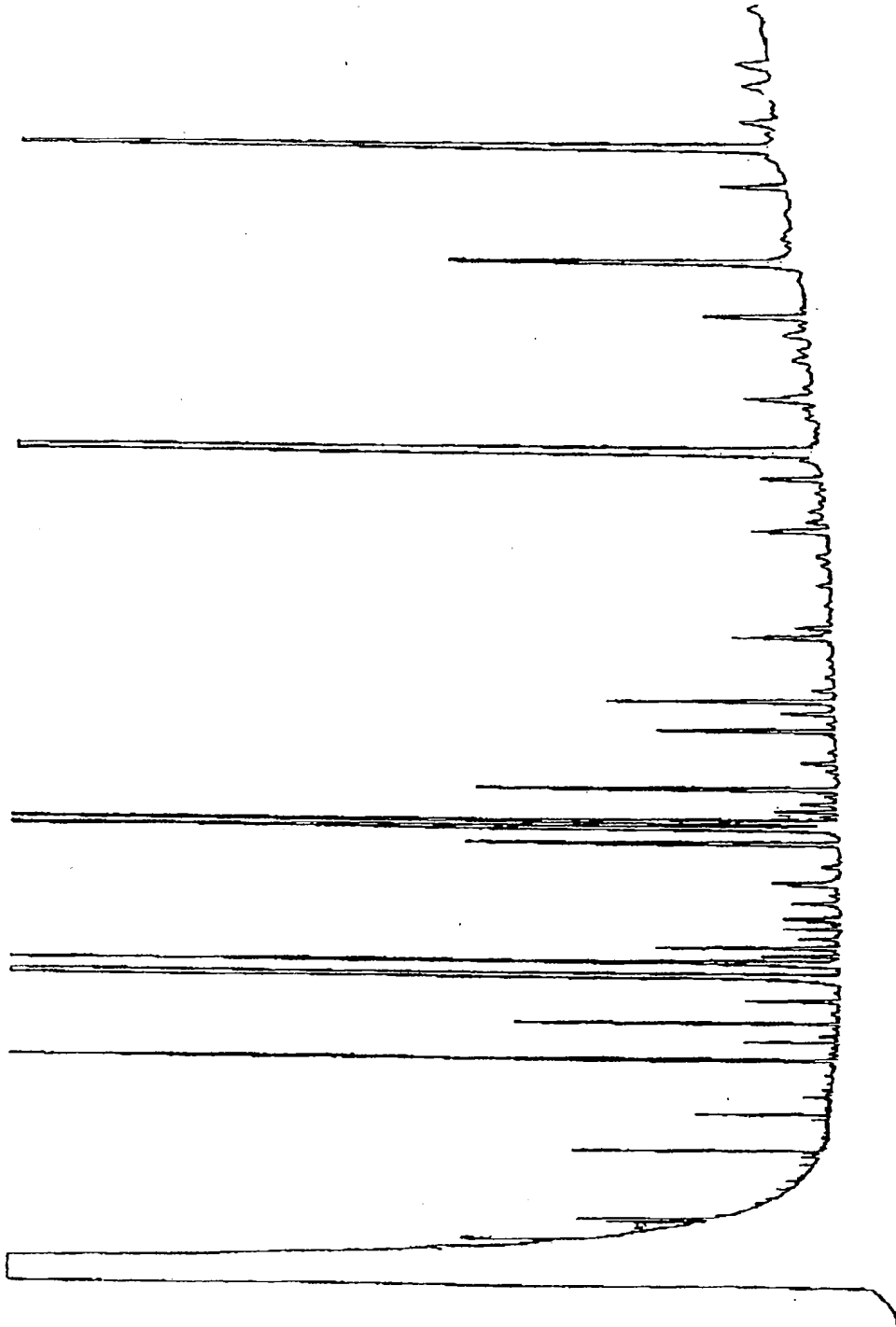
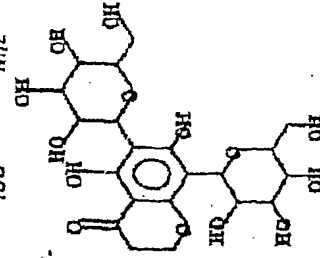
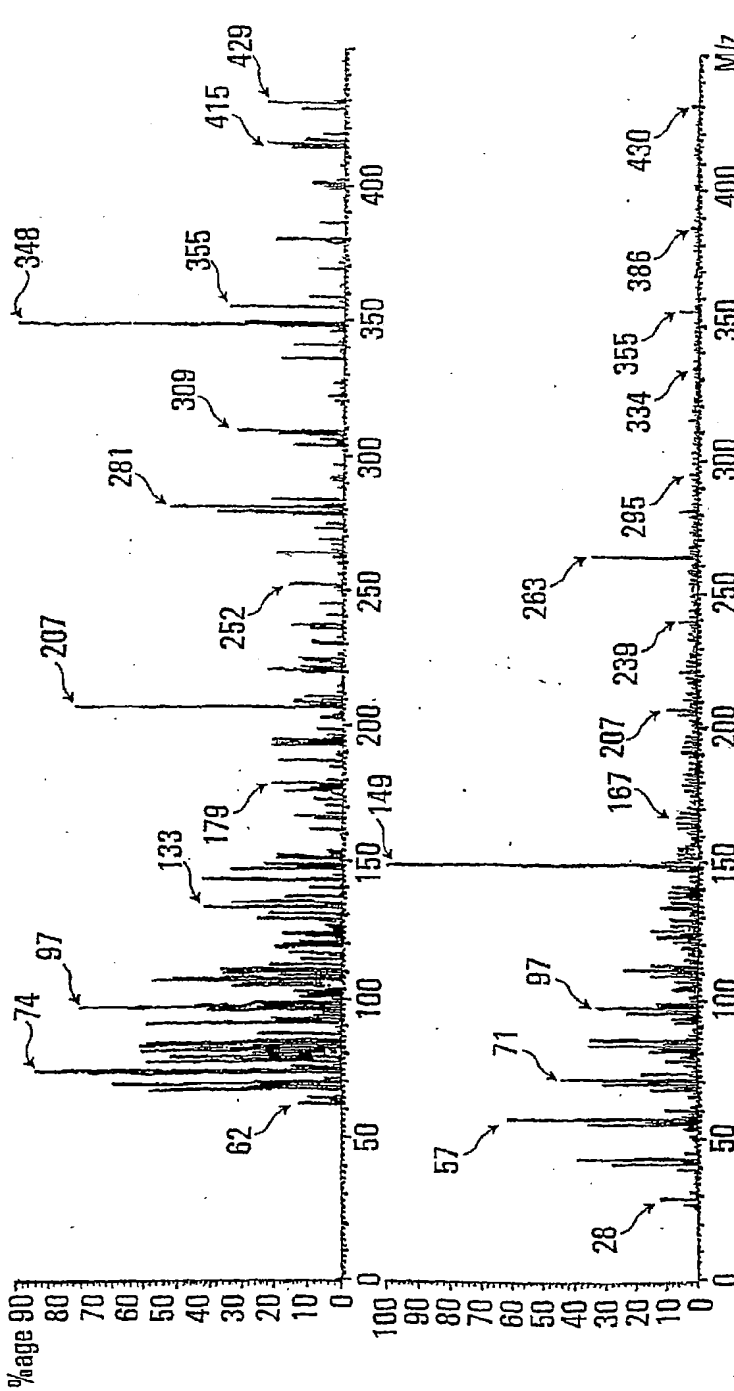

Fig. 3

92 OCTOBER 2002 22:10:02

4/4



SI : 515
 Name (s) : 4H-1-Benzopyran-4-one, 2-(3,4-dihydroxyphenyl)-6,8-di-beta-D-glucopyranosyl-5,7-dihydroxy-

- (2) Luteolin 2
- (3) Luteolin 6, 8-C-diglucoside
- (4) 6,8-Di-C-glucosyluteolin
- (5) Flavone, 6, 8-diglucopyranosyl-3',4',5,7-tetrahydroxy-
- (6) 6,8-Diglucopyranosyl-3',4',5,7-tetrahydroxyflavone
- (7) 6,8-Di-C-beta-glucosyluteolin

Formula : C27H30O16
 MW : 610
 CAS# : 29428-58-8
 NIST# : 44069
 ID# : 38622
 Database : Main

Fig. 4

EPO - DG 1

06. 11. 2002

109



Espacenet

Bibliographic data: JP4057853 (A) — 1992-02-25

METHOD FOR EXTRACTING AND SEPARATING COLORING MATTER FROM KRILL

Inventor(s): TOKUMORI TSUNEO; SUMIDA YOKO; TSUYAMA KOICHI;
KUNISHIRO IYOKO; OKADA HARUO; TANI TOSHIFUMI ±

Applicant(s): CHLORINE ENG CORP LTD; ITANO REITOU KK ±

Classification: - international: C09B61/00; (IPC1-7): C09B61/00
- European:

Application number: JP19900170549 19900628

Priority number (s): JP19900170549 19900628

Also published as: JP2963152 (B2)

Abstract of JP4057853 (A)

PURPOSE:To prepare a reddish orange coloring matter having a high safety in a high concn. by extracting, with CO₂ in a supercritical state, krill shells of which the protein has been decomposed by a protease. **CONSTITUTION:**Krill shells are treated with a protease to decompose the protein in the shells and the treatment product is filtered. The residue of filtration is dried to give treated shells having a water content of 6-8% and a mean particle size of 200 µm or lower. The treated shells are put into an extraction vessel 5. An extractant comprising a liq.; CO₂ in an amt. of 30-40 pts.wt. based on one pt.wt. treated shells having a coloring matter concn. of 30 mg/100 g is supplied through a supercooling apparatus 2 to a pump 3, pressurized at the pump 3 to 100-250 kg/cm², heated with a heat exchanger 4 to 35-40 deg.C to bring it into a supercritical state, and transferred to the extraction vessel 5 to extract an oil in the treated shells. After the pressure of the oil-contg. CO₂ in the supercritical state is reduced to 40-60 kg/cm² with a pressure reducing valve 6, the CO₂ is delivered through a selector valve 11 to the first separating vessel 7 to separate the oil, and recycled through a selector valve 13, a pressure reducing valve 9, a condense 10, a water separator 15, and a storage vessel 1 to the extraction vessel 5.; Then, selector valves 11 and 13 are closed while selector valves 12 and 14 are opened, and the CO₂ contg. the coloring matter is transferred to the second separating

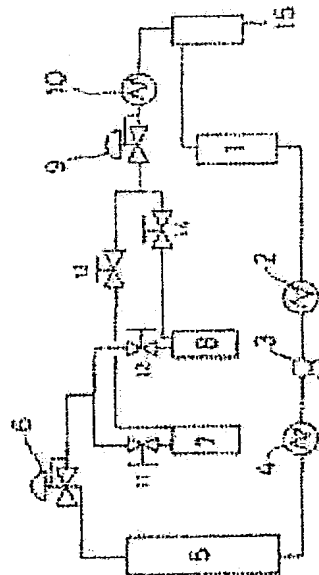

vessel 8, where the CO₂ is evaporated to give a coloring matter with a concn. of 2000-10000 mg/100g.

Last updated: 14.03.2012 Worldwide Database 5.7.38: 93p

(19) Japan Patent Office (JP)
(12) Unexamined Patent Application Publication (A)

(11) Unexamined Patent
Application Publication No.
H4-57853

(51) Intl. Classification⁵: ID Code: Internal File No.:
C 09 B 61/00 A 7537-4H

(43) Publication Date: February 25, 1992

Examination Requested: No Number of Claims: 5 (7 Pages Total)

(54) Title of Invention: METHOD FOR EXTRACTING AND SEPARATING PIGMENT FROM KRILL

(21) Patent Application No.: H2-170549

(22) Filing Date: June 28, 1990

(72) Inventor: Tsuneo TOKUMORI
201 Koporasan, 2097-3 Chayamachi, Kurashiki City, Okayama Prefecture
(72) Inventor: Yoko SUMIDA
1-6-29 Gakunancho, Okayama City, Okayama Prefecture
(72) Inventor: Koichi TSUYAMA
202 Sejuru Shinbo-Kita, 1135-10 Shinbo, Okayama City, Okayama Prefecture
(72) Inventor: Iyoko KUNISHIRO
706-1 Shinbo, Okayama City, Okayama Prefecture
(72) Inventor: Haruo OKADA
1068 Ushijima, Kamajimacho, Oe-gun, Tokushima Prefecture
(72) Inventor: Toshifumi TANI
26-4 Higashiboji, Kitanadacho Awata, Naruto City, Tokushima Prefecture
(71) Applicant: Chlorine Engineers Corp. Ltd.
Shosen Mitsu Bldg., 2-1-1 Toranomom, Minato-ku, Tokyo
(71) Applicant: Itano Reitou K.K.
33-2 Nikkenya, Setocho Myojin, Naruto City, Tokushima Prefecture
(74) Agent: Akira YONEZAWA, Patent Agent, and seven others

Specification

1. Title of Invention

Method for extracting and separating pigment from krill

2. Claims

(1) A method for extracting and separating pigment from krill, wherein, using as a starting material krill shells that are the residue after krill has been decomposed by a protease and the protein removed, pigment is extracted and separated with supercritical carbon dioxide as an extraction agent.

(2) The method for extracting and separating pigment from krill according to claim 1, wherein extraction and separation are characterized in that

the extract from the krill shells is fractionated while varying the pressure of supercritical carbon dioxide in two stages.

(3) The method for extracting and separating pigment from krill according to claim 1, wherein extraction and separation are characterized in that the extract from the krill shells is fractionated by separation over time without varying the pressure of supercritical carbon dioxide.

(4) The method for extracting and separating pigment from krill according to claim 1, wherein extraction and separation are characterized in that components extracted in an extraction tank are fractionated by a plurality of separation tanks of different conditions.

(5) The method for extracting and separating pigment from krill according to any one of claims 1 through 4, characterized in that the moisture content ratio of krill shells is from 10% to 30%.

3. Detailed Description of the Invention (Industrial Field of Use)

The present invention relates to a method for obtaining high-concentration pigment by separating the reddish-orange pigment having a primary component of astaxanthin contained in krill, and in particular, it relates to a method of extraction and separation using supercritical carbon dioxide.

(Prior Art)

The reddish-orange pigment having a primary component of astaxanthin contained in krill has generally been extracted from krill organisms using an organic solvent. This extract contains various components, starting with the lipids that are contained in krill. In particular, concentration and separation of only the pigment contained in the pigment extract is necessary because oxidative decomposition products such as unsaturated fatty acids and glycerol esters thereof bonded to or coexisting with the pigment give off an unpleasant odor, or reaction products in the course of oxidative decomposition such as unsaturated fatty acids cause fading of the pigment.

As methods for concentrating and separating pigment from krill pigment extract liquid, Japanese Unexamined Patent Application Publication No. S60-4558 and Japanese Examined Patent Application Publication No. S61-52183 propose a method in which the pH of krill pigment extract liquid extracted by an organic solvent such as n-hexane or acetone is neutralized and lipids are then decomposed by a lipase, and a method in which pigment liquid is separated from a liquid in which an alkali has been added to decompose lipids or other impurities, and then this pigment liquid is extracted and separated by molecular distillation or by a fluid in the supercritical state.

(Problems the Invention is to Solve)

In the proposed krill pigment concentration and separation methods of prior art, numerous steps are required, including a step of extracting krill pigment liquid from krill organisms by an organic solvent, a neutralization step, a step of decomposing lipids and impurities by lipase or alkali, a step of decomposing the decomposition products of impurities and krill

pigment, and an extraction step by molecular distillation or a fluid in the supercritical state.

Furthermore, it has been reported that the reddish-orange pigment contained in krill has astaxanthin as a primary component and has 100 to 1000 times the antioxidant action of vitamin E, and is anticipated to be used as a drug starting substance in the future. If used as a drug starting substance, however, steps such as solvent removal will be required in order to completely eliminate residue of the organic solvent used in the krill pigment liquid extraction step.

A method has also been considered wherein krill are extracted directly by supercritical carbon dioxide without going through treatment steps, but it is difficult to extract and separate only the pigment because the large amount of moisture and various useful components contained in krill are simultaneously extracted.

(Means for Solving Problems)

The present inventors arrived at the present invention as a result of diligent research to solve the above problems.

Since krill contains a large amount of useful components such as proteins, it has been used in applications such as starting materials for processed foods. Among these applications, the proteins contained in krill have been separated and used in the starting materials of amino acids, rather than krill being used as is. However, the krill shells from which such proteins used in starting materials of amino acids have been removed were discarded or only used as feed for cultivated fish in the past.

The present inventors discovered that krill pigment is produced without going through special pretreatment steps by employing a simple method wherein krill pigment liquid is extracted from krill using a supercritical fluid, by using the shells remaining after components such as proteins from krill have been removed as the starting material of pigment production.

That is to say, pigment is extracted by a supercritical fluid using as a starting material krill shells that are the residue obtained by methods such as filtration after the useful components such as proteins in the krill have been decomposed by enzymes.

The supercritical fluid in the present invention is a fluid in a state beyond the critical temperature and critical pressure. In the case of carbon dioxide, it is the state at 31°C or above, 75.3 Kg/cm² or above;

for propane, 96.7°C or above, 43.4 Kg/cm² or above; for ethane, 9.9°C or above, 52.2 Kg/cm² or above. These fluids are characterized by having density close to that of a liquid and a large expansion coefficient close to that of a gas, and can be used in extraction and separation of various organic matter. In the method of the present invention, carbon dioxide in particular is used as the supercritical fluid. When carbon dioxide gas is used, not only are the steps required in extraction and separation of pigment simplified, but there is absolutely no danger even if the carbon dioxide used as the extraction agent remains in the extracted pigment, for example, and the obtained pigment can be used without a problem in many fields starting with pharmaceuticals.

Additionally, supercritical carbon dioxide used as an extraction agent has no risk of explosion or combustion in air like hydrocarbons do. Furthermore, since the critical temperature and critical pressure of carbon dioxide are relatively low, dissolution characteristics can be easily varied by varying the temperature and pressure, and it is possible to perform extraction with an extraction agent having dissolution characteristics suited to pigment extraction and separation.

The method of the present invention is to extract pigment with supercritical carbon dioxide using krill shells as a starting material. The method of the present invention was achieved by studying the extraction conditions such as extraction pressure, temperature and fractionation method for performing efficient extraction and separation of pigment, and by studying the water content ratio of the starting material krill.

The present invention will be described below in reference to the drawings.

FIG. 1 is a flowchart of equipment having a means for switching among a plurality of separation tanks for implementing the method of the present invention.

The extraction agent carbon dioxide passes from a liquid carbon dioxide storage tank 1 to a supercooler 2, after which it is pressurized to a prescribed pressure by a pump 3, and then heated to a prescribed temperature by a heat exchanger 4, and supplied as supercritical carbon dioxide to an extraction tank 5 filled with krill shells.

The starting material krill shells primarily contain chitin, proteins, triglyceride esters, triglyceride

esters, monoglyceride esters (oil components) and pigment (astaxanthin). The residue obtained when frozen krill is thawed and then the extract portion in which the proteins decomposed by a protease have been filtered out is a powder with an average particle size of 200 μm, and normally has a water content ratio of 6% to 8% after it is dried.

Since supercritical carbon dioxide has the characteristic that it decomposes the oil components and pigment of krill shells, only two components are extracted from the krill shells, but in order to separate these two components, the extraction operation is divided into two stages.

Namely, in the first extraction, the oil components contained in the krill shells are extracted by passing through 30 parts by weight to 40 parts by weight of supercritical carbon dioxide having a temperature of 30°C to 50°C and a relatively low pressure of 100 Kg/cm² to 250 Kg/cm² for every 1 part by weight of krill shells having a pigment concentration of 30 mg/100 g, which is equivalent to the concentration of contained astaxanthin.

The supercritical carbon dioxide that contains oil components is reduced in pressure to 40 Kg/cm² to 60 Kg/cm² by a pressure reducing valve 6, and led into a first separation tank 7 via a switching valve 11.

In the first separation tank 7, carbon dioxide in the gas state which has separated the oil components is further reduced in pressure and adiabatically expanded by a switching valve 13 and a pressure reducing valve 9, and after being liquefied by a condenser 10, it passes through a water separator 15 and returns to the liquid carbon dioxide storage tank 1 where it is recirculated.

Then, supercritical carbon dioxide is supplied to the extraction tank 5 at a pressure higher than the pressure during the first extraction stage. That is, 30 parts by weight to 40 parts by weight of supercritical carbon dioxide having a temperature of 30°C to 50°C and a pressure of 300 Kg/cm² to 500 Kg/cm² is supplied to the extraction tank for every 1 part by weight of krill shells, and by closing the switching valves 11 and 13 and opening switching valves 12 and 14, carbon dioxide containing extract with a pressure of 40 Kg/cm² to 60 Kg/cm² is led to a second separation tank 8 by the pressure reducing valve 6.

In the second separation tank 8, carbon dioxide in the gas state is returned to the liquid carbon dioxide

storage tank 1 in the same way as in the first extraction step. From the second separation tank, pigment with an extremely high concentration of 2000 mg/100 g to 10,000 mg/100 g can be obtained.

High-concentration pigment is obtained by successive two-stage high-pressure extraction as described above, but it is possible to efficiently collect it by providing a plurality of separation tanks and switching among them.

Furthermore, even if the two-stage extraction is not performed while varying the pressure as described above, it is possible to similarly perform extraction and separation at the same pressure.

That is, extraction and separation of high-concentration pigment is also possible by the extraction operation illustrated in FIG. 2. To describe the operation in reference to FIG. 2, carbon dioxide is fed from the liquid carbon dioxide storage tank 1 through the supercooler 2 to the pump 3, and pressured to a prescribed pressure. Then, it is heated to a prescribed temperature by the heat exchanger 4 to make a supercritical fluid, which is supplied to the extraction tank 5 filled with krill shells.

30 parts by weight to 50 parts by weight of supercritical carbon dioxide at a temperature of 35°C to 50°C and a pressure of 300 Kg/cm² to 500 Kg/cm² is passed through for every 1 part by weight of krill shells (pigment concentration 30 mg/100 g). In the extraction tank, oil components are extracted initially, and then high-concentration pigment is extracted, and the supercritical carbon dioxide gas containing the extract is reduced in pressure to 40 Kg/cm² to 60 Kg/cm² by the pressure reducing valve 6 and led to the first separation tank 7.

The carbon dioxide that comes out from the first separation tank is further reduced in pressure by the pressure reducing valve 9, and after being liquefied by the condenser 10, it passes through the water separator 15 and returns to the liquid carbon dioxide storage tank 1.

In this extraction method, because supercritical carbon dioxide of relatively high pressure is used from the start of extraction, pigment is also extracted together with the oil components, resulting in loss of pigment. Therefore, after extraction is performed by supplying 15 parts by weight to 25 parts by weight of supercritical carbon dioxide for every 1 part of krill shells, the extract, which is primarily made up of oil components, is

separated from a feed out valve 16 provided on the bottom of the first separation tank 7. Then, by supplying 15 parts by weight to 25 parts by weight of supercritical carbon dioxide for every 1 part of krill shells, pigment concentrate is obtained in the first separation tank.

The pigment concentration in the oil components obtained by this method was from 10 mg/100 g to 30 mg/100 g, and the pigment concentration in the pigment concentrate was from 2000 mg/100 g to 10,000 mg/100 g.

In this method, because supercritical carbon dioxide of relatively high pressure is used from the start of extraction, a slight amount of pigment is contained in the oil components that constitute the initial extract, but this method has the advantage that extraction time can be shortened compared to the aforementioned method that uses supercritical carbon dioxide in two stages of low pressure and high pressure.

Furthermore, FIG. 3 illustrates a method in which a plurality of tanks are provided in succession, and pigment is efficiently recovered while varying the separation conditions by varying the set pressure and temperature of each separation tank.

The method will be described below in reference to FIG. 3.

Carbon dioxide is fed from the liquid carbon dioxide storage tank 1 through the supercooler 2 to the pump 3, and pressurized to a prescribed pressure. After that, it is heated to a prescribed temperature by the heat exchanger 4 and supplied as supercritical carbon dioxide to the extraction tank 5 filled with krill shells.

Here, the supercritical carbon dioxide supplied to the extraction tank 5 has a temperature of 35°C to 50°C and a pressure of 300 Kg/cm² to 500 Kg/cm².

Oil components and pigment are extracted from the krill shells in the extraction tank, and the supercritical carbon dioxide that contains these oil components and pigment is reduced in pressure by the pressure reducing valve 6, and led to a high-pressure separation tank 17.

The high-pressure separation tank 17 is held in the supercritical state at a pressure lower than inside the extraction tank at a temperature of 35°C to 50°C and a pressure of 100 Kg/cm² to 300 Kg/cm². Pigment concentrate is collected in the tank, and the supercritical carbon dioxide that contains oil components is reduced in pressure by a pressure

reducing valve 18 and led to a low-pressure separation tank 19.

While the low-pressure separation tank 17 is held in a gas state at a temperature of 20°C to 30°C and a pressure of 40 Kg/cm² to 60 Kg/cm², the carbon dioxide is again reduced in pressure by the pressure reducing valve 9, and after being liquefied by the condenser 10, the moisture it contains is removed by the water separator 15, and the carbon dioxide is returned to the liquid carbon dioxide storage tank 1.

When this method is used, by passing through 30 parts by weight to 40 parts by weight of supercritical carbon dioxide of a relatively high pressure of 300 Kg/cm² to 500 Kg/cm² for every 1 part by weight of krill shells (pigment concentration 30 mg/100 g), pigment with an extremely high concentration of 2000 mg/100 g to 10,000 mg/100 g can be obtained in the high-pressure separation tank, and oil components having a low pigment concentration can be obtained as an extract in the low-pressure separation tank.

In the method in which the supercritical carbon dioxide supplied to the extraction tank is initially at a relatively low pressure below 300 Kg/cm² and then supercritical carbon dioxide at a relatively high pressure is supplied, the yielded quantity of pigment is high because almost no pigment is extracted in the initial extract, but extraction takes a long time. On the other hand, in the method in which the initial extraction extracts oil components are extracted in the initial extraction step using supercritical carbon dioxide at a relatively high pressure of 300 Kg/cm² to 500 Kg/cm² and then the extract of pigment concentrate is separated over time, the equipment configuration is simple and extraction time is short, but since some pigment is contained in the oil components obtained as the initial extract, there is the problem that the yielded quantity of pigment is reduced. However, the method illustrated in FIG. 3, in which a plurality of separation tanks having different set pressures and temperatures is provided and extracts of components are obtained in succession under different extraction conditions, is superior to the aforementioned two methods.

Furthermore, in the present invention, by performing extraction after increasing the moisture content of the krill shells (pigment concentration 30 mg/100 g) used as the starting material to 10 wt% to 30 wt%, it is possible to speed up extraction speed, particularly the initial extraction speed, and as a

result, it is possible to reduce the amount of pigment contained in the extract of oil components initially obtained in extraction when supercritical carbon dioxide at a relatively high pressure of 300 Kg/cm² to 500 Kg/cm² is used, and therefore, a reduction of the amount of pigment contained in the oil components and lost can be prevented.

Because water has been added, water is extracted together with pigment, but since water and pigment can be easily separated into two layers, adding water does not hinder extraction and separation of pigment in any way.

However, if the water content ratio exceeds 30%, a reduction in extraction speed in the initial extraction is seen, and therefore it is undesirable if the amount of water exceeds 30%.

It is preferred that the water content ratio of the krill shells be adjusted by controlling the dry state in the krill treatment step, but in cases where krill shells of relatively low moisture content in the dry state are used, it is necessary to disperse water in the krill shells and sufficiently mix before the extraction step.

[Operation]

The present invention is a method for producing pigment made up of astaxanthin contained in krill in which it is extracted using as a production starting material krill shells that are the residue after krill has been decomposed by a protease and the protein and so forth removed, and using supercritical carbon dioxide as an extraction agent. The method of the present invention can produce krill pigment without going through a special pretreatment step using an organic solvent.

(Examples)

The present invention will be described in further detail below by giving examples of the present invention.

Example 1

Using a protease as a protein decomposition enzyme, frozen krill after thawing were made to undergo a proteolysis reaction for 2 hours at 47 °C to 48°C, and then the liquid was filtered and the separated residue was dried to obtain krill shells containing 6% water. An extraction tank having a volume of 25 liters was packed with 6 Kg of these krill shells (pigment concentration 30 mg/100 g). While holding the tank temperature at 40°C, supercritical carbon dioxide having a temperature of 40°C and pressure of 200 Kg/cm² was supplied for

4 hours at a supply rate of 60 Kg per hour. In a separation tank set to a pressure of 50 Kg/cm² and temperature of 30°C, carbon dioxide and liquid were separated, and 1398 g of extract with a pigment concentration of 7.1 mg/100 g was obtained from a feed out valve on the bottom of the separation tank.

Additionally, in the extraction tank, supercritical carbon dioxide at a temperature of 40°C and pressure of 400 Kg/cm² was supplied for 4 hours at a supply rate of 60 Kg per hour, and in the separation tank set to a pressure of 50 Kg/cm² and temperature of 30°C, 13.4 g of high-concentration extract having a pigment concentration of 8331 mg/100 g was obtained from the residue of the previous extract.

Example 2

An extraction tank having a volume of 25 liters was packed with 6 Kg of krill shells (pigment concentration 30 mg/100 g) having the same components as those used as a starting material in example 1. While holding the tank temperature at 40°C, supercritical carbon dioxide having a temperature of 40°C and pressure of 400 Kg/cm² was supplied for 2 hours at a supply rate of 60 Kg per hour. 1703 g of extract with a pigment concentration of 42.8 mg/100 g was obtained from a feed out valve on the bottom of a separation tank set to a pressure of 50 Kg/cm² and temperature of 30°C.

Additionally, in the extraction tank, supercritical carbon dioxide at a temperature of 40°C and pressure of 400 Kg/cm² was supplied for 5 hours at a supply rate of 60 Kg per hour, and in the separation tank set to a pressure of 50 Kg/cm² and temperature of 30°C, 10 g of high-concentration pigment having a pigment concentration of 5874 mg/100 g was obtained.

Example 3

An extraction tank having a volume of 1 liter was packed with 250 g of krill shells (pigment concentration 30 mg/100 g) having the same components as those used as a starting material in example 1. While holding the tank temperature at 40°C, supercritical carbon dioxide having a

temperature of 40°C and pressure of 400 Kg/cm² was supplied for 2.5 hours at a supply rate of 2.5 Kg per hour. The supercritical carbon dioxide containing the extract obtained in the extraction tank was supplied to a high-pressure separation tank held in the supercritical state.

While holding the high-pressure separation tank at a temperature of 40°C and pressure of 250 Kg/cm², the extract in the low-pressure separation tank was supplied via a pressure reducing valve to a low-pressure separation tank held at 20°C and 60 Kg/cm².

As a result, 0.44 g of pigment with a pigment concentration of 7072 mg/100 g was obtained from the high-pressure separation tank, and 70.57 g of pigment with a pigment concentration of 6.2 mg/100 g was obtained from the low-pressure separation tank.

Example 4

Water was dispersed and sufficiently mixed with 6 Kg of krill shells having the same components as those used as a starting material in example 1, and extraction and separation of pigment were performed while varying the water content ratio of the starting material.

An extraction tank having a volume of 25 liters was packed with the krill shells of different water content ratios, and while holding the extraction tank temperature at 40°C, supercritical carbon dioxide having a temperature of 40°C and pressure of 400 Kg/cm² was supplied, and it was separated in a separation tank set to a pressure of 50 Kg/cm² and temperature of 30°C. The amount of oil component fraction obtained from the start of extraction and the amount of pigment obtained after fractionation of the oil components ended are shown in Table 1 together with extraction time.

(intentionally blank)

Table 1

Water content ratio (%)	Oil components		Pigment concentrate	
	Extraction time (hours)	Extracted quantity (g) Pigment concentration (mg/100 g)	Extraction time (hours)	Extracted quantity (g) Pigment concentration (mg/100 g)
3	2	1649	3	18.7
		12.3		1660
7	2	1703	3	6.8
		42.8		7832
14	1	1546	2	11.9
		28.3		6084

(Advantageous Effect of the Invention)

The present invention is a method that extracts reddish-orange pigment containing astaxanthin from krill shells using supercritical carbon dioxide, which makes effective use of krill shells as starting materials, which were treated as waste in the past, by extracting the useful components from krill. Moreover, since it does not use organic solvents and so forth, the process is simple and does not require organic solvent separation steps, and it can extract and separate pigment by a method that is highly safe even in the fields of foods and pharmaceuticals.

4. Brief Description of the Drawings

FIG. 1 is a flowchart of extraction equipment that switches among multiple separation tanks used for implementing the method of the present invention. FIG. 2 is a flowchart of equipment used when fractionating two components at the same pressure for implementing the method of the present invention. FIG. 3 is a flowchart of equipment having separation tanks at different pressures used for implementing the method of the present invention.

- Liquid carbon dioxide storage tank ... 1
- Supercooler ... 2
- Pump ... 3
- Heat exchanger ... 4
- Extraction tank ... 5
- Pressure reducing valve ... 6
- First separation tank ... 7
- Second separation tank ... 8
- Pressure reducing valve ... 9
- Condenser ... 10
- Switching valves... 11, 12, 13, 14
- Water separator... 15
- Feed out valve ... 16
- High-pressure separation tank ... 17
- Pressure reducing valve ... 18
- Low-pressure separation tank ... 19

Patent Applicant: Chlorine Engineers Corp. Ltd.
(and one other)
Agent: Akira YONEZAWA, Patent Agent (and seven others)

FIG. 1

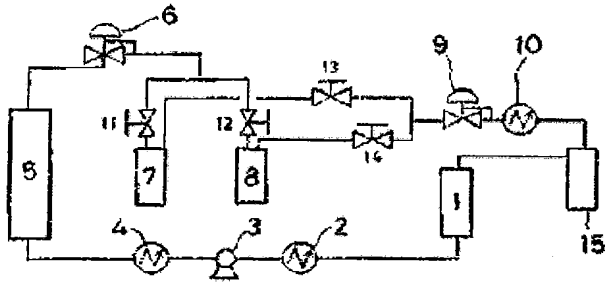

FIG. 2

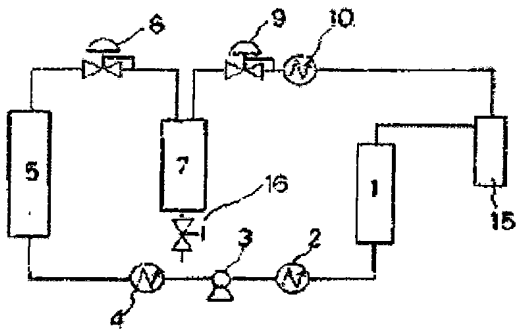
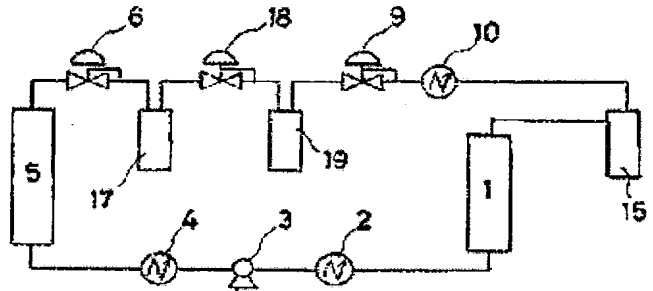

FIG. 3



Electronic Acknowledgement Receipt

EFS ID:	14233305
Application Number:	12057775
International Application Number:	
Confirmation Number:	1945
Title of Invention:	BIOEFFECTIVE KRILL OIL COMPOSITIONS
First Named Inventor/Applicant Name:	Inge Bruheim
Customer Number:	72960
Filer:	John Mitchell Jones/Vickie Hoeft
Filer Authorized By:	John Mitchell Jones
Attorney Docket Number:	NATNUT-14409/US-5/ORD
Receipt Date:	15-NOV-2012
Filing Date:	28-MAR-2008
Time Stamp:	15:53:28
Application Type:	Utility under 35 USC 111(a)

Payment information:

Submitted with Payment	no
------------------------	----

File Listing:

Document Number	Document Description	File Name	File Size(Bytes)/ Message Digest	Multi Part /.zip	Pages (if appl.)
1	Transmittal Letter	14409US5ORD_IDSletter11152 012.pdf	81767 <small>f21a078b2154dd35095e088d8d96effd58d9d672</small>	no	1

Warnings:

Information:

2	Information Disclosure Statement (IDS) Form (SB08)	14409US5IDS11152012.pdf	613246 06b7557bb6422e7707d2e472de65fbcdd78925ca	no	5
Warnings:					
Information:					
A U.S. Patent Number Citation or a U.S. Publication Number Citation is required in the Information Disclosure Statement (IDS) form for autoloading of data into USPTO systems. You may remove the form to add the required data in order to correct the Informational Message if you are citing U.S. References. If you chose not to include U.S. References, the image of the form will be processed and be made available within the Image File Wrapper (IFW) system. However, no data will be extracted from this form. Any additional data such as Foreign Patent Documents or Non Patent Literature will be manually reviewed and keyed into USPTO systems.					
3	Foreign Reference	AU2002322233.pdf	2639818 7204d9544d141b91cac7ed47a2876b81766bebea	no	78
Warnings:					
Information:					
4	Foreign Reference	JP4057853.pdf	630360 3d125e1770e62133750d378d781463876b0a944f	no	10
Warnings:					
Information:					
5	Non Patent Literature	30102CN1PCTOfficeActionChineseEnglish.pdf	1391615 71c9764c775ba37911ed51fd48f549fed936c14	no	21
Warnings:					
Information:					
6	Non Patent Literature	Fricke1984.pdf	195109 53401eed6567b183c0d9da5aa0fa7ed8effbd887	no	9
Warnings:					
The page size in the PDF is too large. The pages should be 8.5 x 11 or A4. If this PDF is submitted, the pages will be resized upon entry into the Image File Wrapper and may affect subsequent processing					
Information:					
7	Non Patent Literature	Fricke1986.pdf	419639 38093d74c4b273a8ea3f49b84122549a9d4f3948	no	8
Warnings:					
Information:					
8	Non Patent Literature	Gordeev1990.pdf	366063 4e7b4812c0af3939a51244e75fa282c670a5f9fa	no	5
Warnings:					
Information:					
9	Non Patent Literature	Grantham1977.pdf	4188436 95939a174fe2ad364b0bbc6783193faddec24d9b	no	72
Warnings:					

Information:					
10	Non Patent Literature	Raventos2002.pdf	1307291	no	19
			38730a2b079c81dc54b6d0786536b1f35943f7cc		
Warnings:					
Information:					
11	Non Patent Literature	TANAKA1995.pdf	799812	no	9
			9c6c0e359c67b005d0bf1a56dd54b40fa6005d1b		
Warnings:					
Information:					
12	Non Patent Literature	Winther2011.pdf	844558	no	12
			5fb177eae304806c3b86d0e96524e52734afc60		
Warnings:					
Information:					
Total Files Size (in bytes):				13477714	

This Acknowledgement Receipt evidences receipt on the noted date by the USPTO of the indicated documents, characterized by the applicant, and including page counts, where applicable. It serves as evidence of receipt similar to a Post Card, as described in MPEP 503.

New Applications Under 35 U.S.C. 111

If a new application is being filed and the application includes the necessary components for a filing date (see 37 CFR 1.53(b)-(d) and MPEP 506), a Filing Receipt (37 CFR 1.54) will be issued in due course and the date shown on this Acknowledgement Receipt will establish the filing date of the application.

National Stage of an International Application under 35 U.S.C. 371

If a timely submission to enter the national stage of an international application is compliant with the conditions of 35 U.S.C. 371 and other applicable requirements a Form PCT/DO/EO/903 indicating acceptance of the application as a national stage submission under 35 U.S.C. 371 will be issued in addition to the Filing Receipt, in due course.

New International Application Filed with the USPTO as a Receiving Office

If a new international application is being filed and the international application includes the necessary components for an international filing date (see PCT Article 11 and MPEP 1810), a Notification of the International Application Number and of the International Filing Date (Form PCT/RO/105) will be issued in due course, subject to prescriptions concerning national security, and the date shown on this Acknowledgement Receipt will establish the international filing date of the application.

IN THE UNITED STATES PATENT AND TRADEMARK OFFICE

In re Application of:	Inge Bruheim, et al	Confirmation:	1945
Serial No.:	12/057,775	Group No.:	1651
Filed:	03-28-2008	Examiner:	Ware, Deborah K.
Entitled:	BIOEFFECTIVE KRILL OIL COMPOSITIONS		

INFORMATION DISCLOSURE STATEMENT LETTER

EFS Web Filed
Commissioner for Patents
P.O. Box 1450
Alexandria, VA 22313-1450

Sir or Madam:

The citations listed in the attached **IDS Form SB08A** may be material to the examination of the above-identified application, and are therefore submitted in compliance with the duty of disclosure defined in 37 C.F.R. §§ 1.56 and 1.97.

Applicants wish to bring to the Examiner's attention that we are not providing copies of US Patents as instructed under 37 CFR 1.98(a)(2). The Examiner is requested to make these citations of official record in this application.

This Information Disclosure Statement under 37 C.F.R. §§ 1.56 and 1.97 is not to be construed as a representation that a search has been made, that additional information material to the examination of this application does not exist, or that any one or more of these citations constitutes prior art.

The Commissioner is hereby authorized to charge any required fees or credit any overpayments to Attorney Deposit Account No.: **50-4302**, referencing Attorney Docket No.: **NATNUT-14409/US-5/ORD**.

Dated: November 15, 2012

/J. Mitchell Jones/
J. Mitchell Jones
Registration No. 44,174
CASIMIR JONES, S.C.
2275 Deming Way, Suite 310
Middleton, WI 53562
608.662.1277

**REQUEST FOR CONTINUED EXAMINATION(RCE)TRANSMITTAL
(Submitted Only via EFS-Web)**

Application Number	12057775	Filing Date	2008-03-28	Docket Number (if applicable)	NATNUT-14409/US-5/ORD	Art Unit	1651
First Named Inventor	Inge Bruheim			Examiner Name	Ware, Deborah K.		

This is a Request for Continued Examination (RCE) under 37 CFR 1.114 of the above-identified application.
Request for Continued Examination (RCE) practice under 37 CFR 1.114 does not apply to any utility or plant application filed prior to June 8, 1995, or to any design application. The Instruction Sheet for this form is located at WWW.USPTO.GOV

SUBMISSION REQUIRED UNDER 37 CFR 1.114

Note: If the RCE is proper, any previously filed unentered amendments and amendments enclosed with the RCE will be entered in the order in which they were filed unless applicant instructs otherwise. If applicant does not wish to have any previously filed unentered amendment(s) entered, applicant must request non-entry of such amendment(s).

Previously submitted. If a final Office action is outstanding, any amendments filed after the final Office action may be considered as a submission even if this box is not checked.

Consider the arguments in the Appeal Brief or Reply Brief previously filed on _____

Other _____

Enclosed

Amendment/Reply

Information Disclosure Statement (IDS)

Affidavit(s)/ Declaration(s)

Other _____

MISCELLANEOUS

Suspension of action on the above-identified application is requested under 37 CFR 1.103(c) for a period of months _____
(Period of suspension shall not exceed 3 months; Fee under 37 CFR 1.17(i) required)

Other _____

FEES

The RCE fee under 37 CFR 1.17(e) is required by 37 CFR 1.114 when the RCE is filed.

The Director is hereby authorized to charge any underpayment of fees, or credit any overpayments, to Deposit Account No 504302

SIGNATURE OF APPLICANT, ATTORNEY, OR AGENT REQUIRED

Patent Practitioner Signature

Applicant Signature

Signature of Registered U.S. Patent Practitioner			
Signature	/J. Mitchell Jones/	Date (YYYY-MM-DD)	2012-09-07
Name	J. Mitchell Jones	Registration Number	44174

This collection of information is required by 37 CFR 1.114. The information is required to obtain or retain a benefit by the public which is to file (and by the USPTO to process) an application. Confidentiality is governed by 35 U.S.C. 122 and 37 CFR 1.11 and 1.14. This collection is estimated to take 12 minutes to complete, including gathering, preparing, and submitting the completed application form to the USPTO. Time will vary depending upon the individual case. Any comments on the amount of time you require to complete this form and/or suggestions for reducing this burden, should be sent to the Chief Information Officer, U.S. Patent and Trademark Office, U.S. Department of Commerce, P.O. Box 1450, Alexandria, VA 22313-1450.

If you need assistance in completing the form, call 1-800-PTO-9199 and select option 2.

Privacy Act Statement

The Privacy Act of 1974 (P.L. 93-579) requires that you be given certain information in connection with your submission of the attached form related to a patent application or patent. Accordingly, pursuant to the requirements of the Act, please be advised that: (1) the general authority for the collection of this information is 35 U.S.C. 2(b)(2); (2) furnishing of the information solicited is voluntary; and (3) the principal purpose for which the information is used by the U.S. Patent and Trademark Office is to process and/or examine your submission related to a patent application or patent. If you do not furnish the requested information, the U.S. Patent and Trademark Office may not be able to process and/or examine your submission, which may result in termination of proceedings or abandonment of the application or expiration of the patent.

The information provided by you in this form will be subject to the following routine uses:

1. The information on this form will be treated confidentially to the extent allowed under the Freedom of Information Act (5 U.S.C. 552) and the Privacy Act (5 U.S.C. 552a). Records from this system of records may be disclosed to the Department of Justice to determine whether the Freedom of Information Act requires disclosure of these records.
2. A record from this system of records may be disclosed, as a routine use, in the course of presenting evidence to a court, magistrate, or administrative tribunal, including disclosures to opposing counsel in the course of settlement negotiations.
3. A record in this system of records may be disclosed, as a routine use, to a Member of Congress submitting a request involving an individual, to whom the record pertains, when the individual has requested assistance from the Member with respect to the subject matter of the record.
4. A record in this system of records may be disclosed, as a routine use, to a contractor of the Agency having need for the information in order to perform a contract. Recipients of information shall be required to comply with the requirements of the Privacy Act of 1974, as amended, pursuant to 5 U.S.C. 552a(m).
5. A record related to an International Application filed under the Patent Cooperation Treaty in this system of records may be disclosed, as a routine use, to the International Bureau of the World Intellectual Property Organization, pursuant to the Patent Cooperation Treaty.
6. A record in this system of records may be disclosed, as a routine use, to another federal agency for purposes of National Security review (35 U.S.C. 181) and for review pursuant to the Atomic Energy Act (42 U.S.C. 218(c)).
7. A record from this system of records may be disclosed, as a routine use, to the Administrator, General Services, or his/her designee, during an inspection of records conducted by GSA as part of that agency's responsibility to recommend improvements in records management practices and programs, under authority of 44 U.S.C. 2904 and 2906. Such disclosure shall be made in accordance with the GSA regulations governing inspection of records for this purpose, and any other relevant (i.e., GSA or Commerce) directive. Such disclosure shall not be used to make determinations about individuals.
8. A record from this system of records may be disclosed, as a routine use, to the public after either publication of the application pursuant to 35 U.S.C. 122(b) or issuance of a patent pursuant to 35 U.S.C. 151. Further, a record may be disclosed, subject to the limitations of 37 CFR 1.14, as a routine use, to the public if the record was filed in an application which became abandoned or in which the proceedings were terminated and which application is referenced by either a published application, an application open to public inspections or an issued patent.
9. A record from this system of records may be disclosed, as a routine use, to a Federal, State, or local law enforcement agency, if the USPTO becomes aware of a violation or potential violation of law or regulation.

Electronic Patent Application Fee Transmittal

Application Number:	12057775
Filing Date:	28-Mar-2008
Title of Invention:	BIOEFFECTIVE KRILL OIL COMPOSITIONS
First Named Inventor/Applicant Name:	Inge Bruheim
Filer:	John Mitchell Jones/Vickie Hoeft
Attorney Docket Number:	NATNUT-14409/US-5/ORD

Filed as Large Entity

Utility under 35 USC 111(a) Filing Fees

Description	Fee Code	Quantity	Amount	Sub-Total in USD(\$)
Basic Filing:				
Pages:				
Claims:				
Miscellaneous-Filing:				
Petition:				
Patent-Appeals-and-Interference:				
Post-Allowance-and-Post-Issuance:				
Extension-of-Time:				

Description	Fee Code	Quantity	Amount	Sub-Total in USD(\$)
Miscellaneous:				
Request for continued examination	1801	1	930	930
Total in USD (\$)				930

Electronic Acknowledgement Receipt

EFS ID:	13684183
Application Number:	12057775
International Application Number:	
Confirmation Number:	1945
Title of Invention:	BIOEFFECTIVE KRILL OIL COMPOSITIONS
First Named Inventor/Applicant Name:	Inge Bruheim
Customer Number:	72960
Filer:	John Mitchell Jones/Vickie Hoeft
Filer Authorized By:	John Mitchell Jones
Attorney Docket Number:	NATNUT-14409/US-5/ORD
Receipt Date:	07-SEP-2012
Filing Date:	28-MAR-2008
Time Stamp:	13:45:19
Application Type:	Utility under 35 USC 111(a)

Payment information:

Submitted with Payment	yes
Payment Type	Deposit Account
Payment was successfully received in RAM	\$930
RAM confirmation Number	11
Deposit Account	504302
Authorized User	

The Director of the USPTO is hereby authorized to charge indicated fees and credit any overpayment as follows:

Charge any Additional Fees required under 37 C.F.R. Section 1.16 (National application filing, search, and examination fees)

Charge any Additional Fees required under 37 C.F.R. Section 1.17 (Patent application filing, search, and examination fees)

Charge any Additional Fees required under 37 C.F.R. Section 1.19 (Document supply fees)

Charge any Additional Fees required under 37 C.F.R. Section 1.20 (Post Issuance fees)

Charge any Additional Fees required under 37 C.F.R. Section 1.21 (Miscellaneous fees and charges)

File Listing:

Document Number	Document Description	File Name	File Size(Bytes)/ Message Digest	Multi Part /.zip	Pages (if appl.)
1		14409US5Response09072012.pdf	88799 f3a583da3d9837582e4692fa45f70835a4a1a747	yes	18
Multipart Description/PDF files in .zip description					
	Document Description		Start		End
	Amendment After Final		1		1
	Claims		2		13
	Applicant Arguments/Remarks Made in an Amendment		14		18
Warnings:					
Information:					
2	Request for Continued Examination (RCE)	14409US5RCE09072012.pdf	697798 251edde30526ba30b1e5b4929b56cf13fb47194f	no	3
Warnings:					
Information:					
3	Fee Worksheet (SB06)	fee-info.pdf	30406 b40451fd06ff0f6c26df7768084b5a1fc664831a	no	2
Warnings:					
Information:					
Total Files Size (in bytes):			817003		

This Acknowledgement Receipt evidences receipt on the noted date by the USPTO of the indicated documents, characterized by the applicant, and including page counts, where applicable. It serves as evidence of receipt similar to a Post Card, as described in MPEP 503.

New Applications Under 35 U.S.C. 111

If a new application is being filed and the application includes the necessary components for a filing date (see 37 CFR 1.53(b)-(d) and MPEP 506), a Filing Receipt (37 CFR 1.54) will be issued in due course and the date shown on this Acknowledgement Receipt will establish the filing date of the application.

National Stage of an International Application under 35 U.S.C. 371

If a timely submission to enter the national stage of an international application is compliant with the conditions of 35 U.S.C. 371 and other applicable requirements a Form PCT/DO/EO/903 indicating acceptance of the application as a national stage submission under 35 U.S.C. 371 will be issued in addition to the Filing Receipt, in due course.

New International Application Filed with the USPTO as a Receiving Office

If a new international application is being filed and the international application includes the necessary components for an international filing date (see PCT Article 11 and MPEP 1810), a Notification of the International Application Number and of the International Filing Date (Form PCT/RO/105) will be issued in due course, subject to prescriptions concerning national security, and the date shown on this Acknowledgement Receipt will establish the international filing date of the application.

IN THE UNITED STATES PATENT AND TRADEMARK OFFICE

In re Application of:	Bruheim et al.	Art Unit:	1651
Serial No.:	12/057,775	Examiner:	Ware
Filed:	March 28, 2008	Confirmation:	1945
Entitled:	BIOEFFECTIVE KRIL OIL COMPOSITIONS		

**REQUEST FOR CONTINUED EXAMINATION AND RESPONSE
TO OFFICE ACTION MAILED JUNE 7, 2012**

EFS WEB FILED

Commissioner for Patents
P.O. Box 1450
Alexandria, Virginia 22313-1450

Examiner Ware:

This communication is responsive to the Office Action mailed June 7, 2012. The Commissioner is hereby authorized to charge any fees during the entire pendency of this application, including fees due under 37 C.F.R. §§ 1.16 and 1.17 that may be required, including any required extension of time fees, or credit any overpayment to Deposit Account 50-4302, referencing Attorney Docket No. **NATNUT-14409/US-5/ORD**. This paragraph is intended to be a CONSTRUCTIVE PETITION FOR EXTENSION OF TIME in accordance with 37 C.F.R. § 1.136(a)(3).

CLAIM AMENDMENTS

1. (Withdrawn) A composition comprising:
from about 3% to 10% ether phospholipids on a w/w basis;
from about 35% to 50% non-ether phospholipids on w/w basis, so that the total amount of ether phospholipids and non-ether phospholipids in the composition is from about 48% to 60% on a w/w basis;
from about 20% to 45% triglycerides on a w/w basis;
and from about 400 to about 2500 mg/kg astaxanthin.
2. (Withdrawn) The composition of Claim 1, wherein said ether phospholipids are selected from the group consisting of alkylacylphosphatidylcholine, lyso-alkylacylphosphatidylcholine, alkylacylphosphatidylethanolamine, and combinations thereof.
3. (Withdrawn) The composition of Claim 1, wherein said ether lipids are greater than 90% alkylacylphosphatidylcholine.
4. (Withdrawn) The composition of Claim 1, wherein said non-ether phospholipids are selected from the group consisting of phosphatidylcholine, phosphatidylserine, phosphatidylethanolamine and combinations thereof.
5. (Withdrawn) The composition of Claim 1, wherein said composition comprises a blend of lipid fractions obtained from *Euphausia superba*.
6. (Withdrawn) The composition of Claim 1, wherein said composition comprises from about 25% to 30% omega-3 fatty acids as a percentage of total fatty acids and wherein from about 80% to 90% of said omega-3 fatty acids are attached to said phospholipids.
7. (Withdrawn) A capsule containing the composition of Claim 1.

8. (Withdrawn) A composition comprising:
from about 3% to 10% ether phospholipids on a w/w basis; and
from about 400 to about 2500 mg/kg astaxanthin.
9. (Withdrawn) The composition of Claim 8, further comprising from about 35% to 50% non-ether phospholipids on w/w basis, so that the total amount of ether phospholipids and non-ether phospholipids in the composition is from about 38% to 60% on a w/w basis.
10. (Withdrawn) The composition of Claim 8, further comprising from about 20% to 45% triglycerides on a w/w basis.
11. (Withdrawn) The composition of Claim 8, wherein said ether phospholipids are selected from the group consisting of alkylacylphosphatidylcholine, lyso-alkylacylphosphatidylcholine, alkylacylphosphatidylethanolamine, and combinations thereof.
12. (Withdrawn) The composition of Claim 11, wherein said ether lipids are greater than 90% alkylacylphosphatidylcholine.
13. (Withdrawn) The composition of Claim 8, wherein said non-ether phospholipids are selected from the group consisting of phosphatidylcholine, phosphatidylserine, phosphatidylethanolamine and combinations thereof.
14. (Withdrawn) The composition of Claim 8, wherein said composition comprises a blend of lipid fractions obtained from *Euphausia superba*.
15. (Withdrawn) The composition of Claim 10, wherein said composition comprises from about 25% to 30% omega-3 fatty acids as a percentage of total fatty acids and wherein from about 80% to 90% of said omega-3 fatty acids are attached to said phospholipids.
16. (Withdrawn) A capsule containing the composition of Claim 8.

17. (Withdrawn) A blended krill oil composition comprising:
 - from about 45% to 55% w/w phospholipids;
 - from about 20% to 45% w/w triglycerides;
 - and from about 400 to about 2500 mg/kg astaxanthin.

18. (Withdrawn) The composition of Claim 17, wherein said blended krill oil product comprises a blend of lipid fractions obtained from *Euphausia superba*.

19. (Withdrawn) The composition of Claim 17, wherein said composition comprises from about 25% to 30% omega-3 fatty acids as a percentage of total fatty acids and wherein from about 80% to 90% of said omega-3 fatty acids are attached to said phospholipids.

20. (Withdrawn) A *Euphausia superba* krill oil composition comprising:
 - from about 3% to about 10% w/w ether phospholipids;
 - from about 27% to 50% w/w non-ether phospholipids so that the amount of total phospholipids in the composition is from about 30% to 60% w/w;
 - from about 20% to 50% w/w triglycerides;
 - from about 400 to about 2500 mg/kg astaxanthin; and
 - from about 20% to 35% omega-3 fatty acids as a percentage of total fatty acids in said composition, wherein from about 70% to 95% of said omega-3 fatty acids are attached to said phospholipids.

21. (Withdrawn) A dietary supplement comprising encapsulated *Euphausia superba* krill oil comprising from about 3% to about 10% w/w ether phospholipids; from about 27% to 50% w/w non-ether phospholipids so that the amount of total phospholipids in the composition is from about 30% to 60% w/w; from about 20% to 50% w/w triglycerides; from about 400 to about 2500 mg/kg astaxanthin; and from about 20% to 35% omega-3 fatty acids as a percentage of total fatty acids in said composition, wherein from about 70% to 95% of said omega-3 fatty acids are attached to said phospholipids.

22. (Withdrawn) A method of making a *Euphausia superba* krill oil composition comprising:
contacting *Euphausia superba* with a polar solvent to provide a polar extract comprising phospholipids;

contacting *Euphausia superba* with a neutral solvent to provide a neutral extract comprising triglycerides and astaxanthin;

combining said polar extract and said neutral extract to provide *Euphausia superba* krill oil from about 3% to about 10% w/w ether phospholipids; from about 27% to 50% w/w non-ether phospholipids so that the amount of total phospholipids in the composition is from about 30% to 60% w/w; from about 20% to 50% w/w triglycerides; from about 400 to about 2500 mg/kg astaxanthin; and from about 20% to 35% omega-3 fatty acids as a percentage of total fatty acids in said composition, wherein from about 70% to 95% of said omega-3 fatty acids are attached to said phospholipids.

23. (Withdrawn) The method of Claim 22, further comprising the step of encapsulating the *Euphausia superba* krill oil.

24. (Withdrawn) A *Euphausia superba* krill oil produced by the method of Claim 22.

25. (Withdrawn) A method of producing a dietary supplement comprising;

contacting *Euphausia superba* with a polar solvent to provide an polar extract comprising phospholipids;

contacting *Euphausia superba* with a neutral solvent to provide a neutral extract comprising triglycerides and astaxanthin;

combining said polar extract and said neutral extract to provide *Euphausia superba* krill oil from about 3% to about 10% w/w ether phospholipids; from about 27% to 50% w/w non-ether phospholipids so that the amount of total phospholipids in the composition is from about 30% to 60% w/w; from about 20% to 50% w/w triglycerides; from about 400 to about 2500 mg/kg astaxanthin; and from about 20% to 35% omega-3 fatty acids as a percentage of total fatty acids in said composition, wherein from about 70% to 95% of said omega-3 fatty acids are attached to said phospholipids;

encapsulating said *Euphausia superba* krill oil.

26. (Withdrawn) A composition comprising at least 65% (w/w) of phospholipids, said phospholipids characterized in containing at least 35% omega-3 fatty acid residues.
27. (Withdrawn) The composition according to claim 26, wherein the composition is derived from a marine or aquatic biomass.
28. (Withdrawn) The composition according to claim 26, wherein the composition is derived from krill.
29. (Withdrawn) The composition of Claim 26, wherein said composition comprises less than 2% free fatty acids.
30. (Withdrawn) The composition of Claim 26, wherein said composition comprises less than 10% triglycerides.
31. (Withdrawn) The composition of Claim 26, wherein said phospholipids comprise greater than 50% phosphatidylcholine.
32. (Withdrawn) The composition of Claim 26, wherein the composition comprises at least 500 mg/kg astaxanthin esters.
33. (Withdrawn) The composition of Claim 26, wherein the composition comprises at least 500 mg/kg astaxanthin esters and at least 36% (w/w) omega-3 fatty acids.
34. (Withdrawn) The composition of Claim 26, wherein the composition comprises less than about 0.5g/100g total cholesterol.
35. (Withdrawn) The composition of Claim 26, wherein the composition comprises less than about 0.45% arachidonic acid (w/w).

36. (Withdrawn) A krill lipid extract comprising at least 500 mg/kg astaxanthin esters and at least 36% (w/w) omega-3 fatty acids.
37. (Withdrawn) A krill lipid extract comprising at least 100 mg/kg astaxanthin esters, at least 20% (w/w) omega-3 fatty acids, and less than about 0.45% arachidonic acid (w/w).
38. (Withdrawn) A method comprising administering the composition of Claim 1 to a subject in an amount effective for reducing insulin resistance, reducing inflammation, improving blood lipid profile and reducing oxidative stress.
39. (Withdrawn) A krill lipid extract comprising greater than about 80% triglycerides and greater than about 90 mg/kg astaxanthin esters.
40. (Withdrawn) The krill lipid extract of Claim 39, characterized in containing from about 5% to about 15% omega-3 fatty acid residues.
41. (Withdrawn) The krill lipid extract of Claim 39, characterized in containing less than about 5% phospholipids.
42. (Withdrawn) The krill lipid extract of Claim 39, characterized in comprising from about 5% to about 10% cholesterol.
43. (Withdrawn) A krill meal composition comprising less than about 50g/kg total fat.
44. (Withdrawn) The krill meal composition of Claim 43 comprising from about 5 to about 20 mg/kg astaxanthin esters.
45. (Withdrawn) The krill meal composition of Claim 43 comprising greater than about 65% protein.

46. (Withdrawn) The krill meal composition of Claim 43 comprising greater than about 70% protein.

47. (Withdrawn) An animal feed comprising the krill meal of Claim 46.

48. (Withdrawn) A method of increasing flesh coloration in an aquatic species comprising feeding said aquatic species a composition comprising the krill meal of Claim 46.

49. (Withdrawn) A method of increasing growth and overall survival rate of aquatic species by feeding the krill meal of Claim 46.

50. (Currently amended) A method of producing krill oil containing phospholipids comprising:

- a) cooking and drying krill to provide cooked and dried krill meal; ~~and~~
- b) ~~extracting~~ contacting said cooked and dried krill meal with a polar solvent to extract a krill oil containing phospholipids from said cooked and dried krill meal, wherein said krill oil containing phospholipids comprises from about 3% to about 10% w/w ether phospholipids; from about 27% to 50% w/w non-ether phospholipids so that the amount of total phospholipids in the composition is from about 30% to 60% w/w; and from about 20% to 50% w/w triglycerides; and
- c) providing a delipidated krill meal following said extraction comprising greater than 65% protein and less than 50 g/kg total fat.

51. (Cancelled)

52. (Currently amended) The method of Claim 50, wherein said cooked and dried krill meal is stored prior to said contacting ~~extraction~~ step.

53. (Currently amended) The method of Claim 50, wherein said contacting ~~extracting~~ step further comprises extraction by supercritical fluid extraction.

54. (Previously presented) The method of Claim 53, wherein said supercritical fluid extraction is a two step process comprising a first extraction step with carbon dioxide and from 1 to 10% of a co-solvent and a second extraction step with carbon dioxide and from 10-30% of a co-solvent, wherein said co-solvent in said first and second extraction steps is a C₁-C₃ monohydric alcohol.

55. (Currently amended) A krill oil containing phospholipids produced by the method of claim 50.

56. (Withdrawn) A method of production of krill oil comprising:

- a) providing fresh krill;
- b) treating said fresh krill to denature lipases and phospholipases in said fresh krill to provide a denatured krill product; and
- c) extracting oil from said denatured krill product.

57. (Withdrawn) The method of claim 56 in which the denaturation step comprises heating of said fresh krill.

58. (Withdrawn) The method of claim 56 in which the denaturation step comprises heating said fresh krill after grinding.

59. (Withdrawn) The method of claim 56, further comprising storing said denatured krill product at room temperature or below between the denaturation step and the extraction step.

60. (Withdrawn) The method of claim 56, wherein the enzyme denaturation step is achieved by application of heat.

61. (Withdrawn) The method of claim 56, wherein the extraction step comprises use of supercritical carbon dioxide, with or without use of a polar modifier.

62. (Withdrawn) The method of claim 56, wherein the extraction step comprises the use of ethanol.
63. (Withdrawn) The method of Claim 56, wherein the extraction step comprises ethanol extraction followed by acetone to precipitation of phospholipids.
64. (Withdrawn) The method of Claim 56, wherein said denatured krill product is a meal.
65. (Withdrawn) Oil produced by the method of Claim 56.
66. (Withdrawn) A composition comprising an oil extracted from krill having a phosphatidylcholine content of greater than about 50% (w/w).
67. (Withdrawn) The composition of Claim 66, wherein said oil has a phosphatidylcholine content of greater than about 70% (w/w).
68. (Withdrawn) The composition of Claim 66, wherein said oil has a phosphatidylcholine content of greater than about 80% (w/w).
69. (Withdrawn) The composition of Claim 66, wherein said composition comprises less than 2% free fatty acids.
70. (Withdrawn) The composition of Claim 66, wherein said composition comprises less than 10% triglycerides.
71. (Withdrawn) The composition of Claim 66, wherein the composition comprises at least 500 mg/kg astaxanthin esters.
72. (Withdrawn) The composition of Claim 66, wherein the composition comprises less than about 0.45% arachidonic acid (w/w).

73. (Withdrawn) A composition comprising odorless krill oil.
74. (Withdrawn) The composition of Claim 73, wherein said odorless krill oil comprises less than about 10 mg/kg (w/w) trimethylamine.
75. (Withdrawn) An odorless krill oil produced by the method comprising:
extracting a neutral krill oil from a krill oil containing material by supercritical fluid extraction to provide a deodorized krill material, wherein said neutral krill oil contains odor causing compounds and
extracting a polar krill oil from said deodorized krill material by supercritical fluid extraction with a polar entrainer to provide an essentially odorless krill oil.
76. (Withdrawn) A composition comprising krill oil containing less than about 70 micrograms/kilogram (w/w) astaxanthin esters.
77. (Withdrawn) The composition of claim 76, comprising less than about 50 micrograms/kilogram (w/w) astaxanthin esters.
78. (Withdrawn) The composition of claim 76, comprising less than about 20 micrograms/kilogram (w/w) astaxanthin esters.
79. (Withdrawn) The composition of claim 76, comprising less than about 5 micrograms/kilogram (w/w) astaxanthin esters.
80. (Withdrawn) A krill oil produced by the process comprising:
pumping fresh krill from a trawl onto a ship, heating the krill to provide a krill material, and extracting oil from the krill material.
81. (Withdrawn) A method of reducing diet-induced hyperinsulinemia, insulin insensitivity, muscle mass hypertrophy, serum adiponectin reduction or hepatic steatosis comprising:

in a subject exposed to a high fat diet, administering to said subject exposed to a high fat diet an effective amount of a krill oil composition under conditions such that a condition selected from the group consisting of diet-induced hyperinsulinemia, insulin insensitivity, muscle mass hypertrophy, serum adiponectin reduction and hepatic steatosis is reduced.

82. (Withdrawn) The method of Claim 81, wherein said effective amount of a krill oil composition is from 0.2 grams to 10 grams of said krill oil composition.

83. (Withdrawn) The method of Claim 81, wherein said krill oil composition comprises: from about 45% to 55% w/w phospholipids; from about 35% to 45% w/w triglycerides; and from about 400 to about 2500 mg/kg astaxanthin.

84. (Withdrawn) The method of Claim 81, wherein said krill oil composition comprises a blend of lipid fractions obtained from *Euphausia superba*.

85. (Withdrawn) A method of reducing diet-induced hyperinsulinemia, insulin insensitivity, muscle mass hypertrophy, serum adiponectin reduction or hepatic steatosis comprising in a subject consuming a high fat diet or a normal fat diet:

administering to said subject consuming a high fat diet or a normal fat diet an effective amount of a krill oil composition under conditions such that a condition selected from the group consisting of diet-induced hyperinsulinemia, insulin insensitivity, muscle mass hypertrophy, serum adiponectin reduction and hepatic steatosis is reduced.

86. (Withdrawn) A method of inducing diuresis in a subject comprising:
administering to said subject an effective amount of a krill oil composition under conditions such that diuresis is induced.

87. (Withdrawn) A method of increasing muscle mass in a subject, comprising:
administering to said subject an effective amount of a krill oil composition under conditions such that muscle mass is increased.

88. (Withdrawn) A method of decreasing protein catabolism in a subject, comprising:
administering to said subject an effective amount of a krill oil composition under
conditions such that protein catabolism is decreased.

89. (Withdrawn) A method of decreasing lipid content in the heart of a subject, comprising:
administering to said subject an effective amount of a krill oil composition under
conditions such that lipid content in the heart of the subject is decreased.

90. (Withdrawn) A method of decreasing lipid content in the liver of a subject, comprising:
administering to said subject an effective amount of a krill oil composition under
conditions such that lipid content in the liver of the subject is decreased.

REMARKS

Claims 50 and 51-55 are pending and under examination following entry of this amendment. Claims 50, 52, 53 and 55 have been amended. Support for the amendments may be found in the specification, for example at page 7, lines 19-30 (polar solvent and phospholipid composition), page 3, line 26 – page 4, line 11 (phospholipid composition), page 5, lines 6 – 12 (meal composition), and the claims as originally filed among other places. No new matter has been added. All amendments and cancellation of claims are made without acquiescing to any of the Examiner's arguments or rejections, and solely for the purpose of expediting the patent application process in a manner consistent with the PTO's Patent Business Goals (PBG), and without waiving the right to prosecute the cancelled claims (or similar claims) in the future.

The following rejections are at issue:

1. Claims 50, 52 and 55 are rejected as anticipated by Japanese Abstract 04-057853 or US 2003/0113432;
2. Claims 50 and 52-55 are rejected as being obvious over Japanese Abstract 04-057853 and US 2003/0113432 in view of Kamiya (US 20060193962).

These rejections are addressed in order below.

1. The claims are not anticipated

Claims 50-53 and 55 are rejected as anticipated by Japanese Abstract 04-057853 or US 2003/0113432. Applicants respectfully disagree. Nevertheless, Applicants have amended the claims to clarify that the extraction process with a polar solvent yields a krill oil with a specified phospholipid content as well as a high-protein, low fat residual meal. The Japanese abstract discloses a protease treated and mechanically ground composition:

Krill shells are treated with a protease to decompose the protein in the shells and the treatment product is filtered. The residue of filtration is dried to give treated shells having a water content of 6-8% and a mean particle size of 200 μm or lower. The treated shells are put into an extraction vessel 5.

The purpose of the process is to extract a coloring pigment from krill shells: "To prepare a reddish orange coloring matter having a high safety in a high concn. by extracting, with CO₂ in a supercritical state, krill shells of which the protein has been decomposed by a protease."

Applicants respectfully submit that the alleged prior art process, which uses only krill shells, is substantially different from the claimed process which uses a polar solvent to extract a specified phospholipid-rich oil and high protein, low fat krill meal.

In response to Applicant's previous arguments, the Examiner states:

The argument that only krill shells are used is noted, however, the krill oil is obtained from krill meal which the reference does disclose. However, newly cited WO teaches that the krill meal contains all of the components of krill and will produce the krill oil as claimed. Also parts of the krill organism can remain in the shell and be treated as well because the organism is enclosed by the carapace of the shell(s). The reference does not disclose that the krill is removed entirely from the shells and that the shells are absent of any krill remainder. Thus, in light of the newly cited reference and these arguments the rejection is sustained over at least some of the claims.

The currently amended claim address the reasoning by the Examiner with respect to the Japanese abstract as extraction from krill shells, even if they have residual material associated with the shells, would not yield a high phospholipid krill oil or low fat, high protein meal as claimed. The shells of krill are primarily composed of chitin which is a carbohydrate, not a protein. Therefore, the residual material would be primarily chitin. Furthermore, the extract from the krill shells would comprise lipids associated with the shells, primarily a pigment (astaxanthin which is normally present as an ester with a fatty acid). This process would not use a polar solvent as claimed because the pigments are poorly soluble in polar solvents. A non-polar solvent would have be utilized for the extraction. Furthermore, the extracted material would not contain etherphospholipids, phospholipids, or triglycerides in the specified amounts.

With respect to US 2003/0113432, Applicant first notes that paragraph 45 does not teach extraction of a lipid from the disclosed powder. The Examiner states that:

WO teaches Krill lipid (e.g. krill oil) at [0045], lines 1-8. An apparatus comprising a cooker and a drier is disclosed at [0051], at page 5, col. 1, lines 1-2. Heating which is akin to cooking is disclosed at page 5, line 17 at col. 2. Cooking and drying step is disclosed at [0051], lines 1-12, to provide dried krill meal. Extraction of Krill oil is disclosed at [0045], line 3. WO clearly teaches that the krill meal contains all of its components and is not extracted and since it is dried it can inherently be stored before extraction.

Applicant respectfully submits that paragraph 45 does not teach extraction of an oil from the krill powder described elsewhere in the application. This paragraph is a generic statement directed to

krill oil in general, not krill oil extracted from a specific source material by a polar solvent. As provided in paragraph 45:

[0045] There are several indexes indicating a degree of lipid degradation. About the lipid in krill, particularly, the krill lipid having been extracted and refined, it is known that, during the preservation, a peroxide value hardly increases and only a carbonyl value increases. In other words, it is pointed out that degradation of the krill lipid differs in creation of oxides and progress rate of the decomposing reaction from those in general fish oil, etc.

As can be seen, this paragraph merely makes a statement degradation of stored krill oil is different than fish oil. There is no statement that krill lipids being discussed were extracted from the powder described in the remainder of the specification. Furthermore, the paragraphs around paragraph 45 address the lipids found in the powder, not lipids extracted from the powder. The comparison is between a powder to which antioxidants have been added as compared to a powder where no antioxidants have been added.

In any event, the current claims have been amended to clearly distinguish US 2003/0113432. US 2003/0113432 does not teach any extraction from the krill powder, much less extraction with a polar solvent to provide a krill oil with the specified phospholipid content. Likewise, US 2003/0113432 does not teach a process where a high protein, low fat meal is obtained.

Applicants further submit that neither Japanese Abstract 04-057853 nor US 2003/0113432 teach a krill oil with the lipid content defined in Claim 50.

Applicants respectfully submit that the cited references do not teach each element of the claims and thus request that the anticipation rejections be withdrawn.

2. The claims are not obvious

Claims 50 and 52-55 are rejected as being obvious over Japanese Abstract 04-057853 and US 2003/0113432 in view of Kamiya (US 20060193962) Applicants respectfully disagree. In any event, the amendments to the claims address the rejection. None of the references, alone or combined teach extraction of a krill oil with the claimed phospholipid content or production of a krill meal with the claimed protein and fat content.

As discussed above, the currently amended claim address the reasoning by the Examiner with respect to the Japanese abstract as extraction from krill shells, even if they have residual

material associated with the shells, would not yield a high phospholipid krill oil or low fat, high protein meal as claimed. The shells of krill are primarily composed of chitin which is a carbohydrate, not a protein. Therefore, the residual material would be primarily chitin. Furthermore, the extract from the krill shells would comprise lipids associated with the shells, primarily a pigment (astaxanthin which is normally present as an ester with a fatty acid). This process would not use a polar solvent as claimed because the pigments are poorly soluble in polar solvents. A non-polar solvent would have to be utilized for the extraction. Furthermore, the extracted material would not contain etherphospholipids, phospholipids, or triglycerides in the specified amounts.

As also discussed above, US 2003/0113432 does not teach extraction of any lipid from the powders disclosed in the application, much less use a polar solvent to provide oils or meals with the specified compositions.

Kamiya does not cure these deficiencies. In particular, Kamiya is directed to extraction from Hydrangea. Neither the nature nor the target of the extraction is identified. Instead, Kamiya lists a number of different, generic extraction technologies. There is no disclosure of krill or even phospholipid extracts in general.

As can be seen, none of the references, alone or combined, teach the processes for production of a krill oil or meal with the specified compositions. Thus, any prima facie case of obviousness established by the Examiner is rebutted because the combined references do not teach element of the claims.

Furthermore, the references are not properly combinable in view of the amended claims. Japanese Abstract 04-057853 is directed to extraction of a coloring pigment from the shells of krill. US 2003/0113432 does not teach extraction of any lipid from the krill powders disclosed in the application with any type of solvent, polar or otherwise. Kamiya is directed to extraction of some unidentified compound from Hydrangea and simply lists a number of extraction methods that could be used. There is no motivation in any of the references to make a polar phospholipid extract and the resulting high protein, low fat meal from a cooked and dried krill meal as claimed. Thus, any prima facie case of obviousness established by the Examiner is rebutted because the references are not properly combinable in view of the amendments to the claims.

For these reasons, Applicant requests that the obviousness rejection be withdrawn.

CONCLUSION

If a telephone interview would aid in the prosecution of this application, the Examiner is encouraged to call the undersigned collect at (608) 662-1277.

Dated: September 7, 2012

/J. Mitchell Jones/

John Mitchell Jones
Registration No. 44,174

Casimir Jones, S.C.
2275 Deming Way, Suite 310
Middleton, WI, 53562
(608) 662-1277

Under the Paperwork Reduction Act of 1995, no persons are required to respond to a collection of information unless it displays a valid OMB control number.

PATENT APPLICATION FEE DETERMINATION RECORD Substitute for Form PTO-875	Application or Docket Number 12/057,775	Filing Date 03/28/2008	<input type="checkbox"/> To be Mailed
---	---	----------------------------------	---------------------------------------

APPLICATION AS FILED – PART I			OTHER THAN SMALL ENTITY				
(Column 1)		(Column 2)	SMALL ENTITY <input type="checkbox"/>		OR	SMALL ENTITY	
FOR	NUMBER FILED	NUMBER EXTRA	RATE (\$)	FEE (\$)		RATE (\$)	FEE (\$)
<input checked="" type="checkbox"/> BASIC FEE <small>(37 CFR 1.16(a), (b), or (c))</small>	N/A	N/A	N/A		OR	N/A	310
<input type="checkbox"/> SEARCH FEE <small>(37 CFR 1.16(k), (j), or (m))</small>	N/A	N/A	N/A			N/A	
<input type="checkbox"/> EXAMINATION FEE <small>(37 CFR 1.16(o), (p), or (q))</small>	N/A	N/A	N/A			N/A	
TOTAL CLAIMS <small>(37 CFR 1.16(j))</small>	minus 20 =	*	X \$ =			X \$ =	
INDEPENDENT CLAIMS <small>(37 CFR 1.16(h))</small>	minus 3 =	*	X \$ =			X \$ =	
<input type="checkbox"/> APPLICATION SIZE FEE <small>(37 CFR 1.16(s))</small>	If the specification and drawings exceed 100 sheets of paper, the application size fee due is \$250 (\$125 for small entity) for each additional 50 sheets or fraction thereof. See 35 U.S.C. 41(a)(1)(G) and 37 CFR 1.16(s).						
<input type="checkbox"/> MULTIPLE DEPENDENT CLAIM PRESENT <small>(37 CFR 1.16(j))</small>							
* If the difference in column 1 is less than zero, enter "0" in column 2.			TOTAL			TOTAL	310

APPLICATION AS AMENDED – PART II					OTHER THAN SMALL ENTITY				
(Column 1)		(Column 2)	(Column 3)		SMALL ENTITY		OR	SMALL ENTITY	
AMENDMENT	09/07/2012	CLAIMS REMAINING AFTER AMENDMENT	HIGHEST NUMBER PREVIOUSLY PAID FOR	PRESENT EXTRA	RATE (\$)	ADDITIONAL FEE (\$)		RATE (\$)	ADDITIONAL FEE (\$)
	Total <small>(37 CFR 1.16(i))</small>	* 89	Minus	** 89	=	0	OR	X \$60=	0
	Independent <small>(37 CFR 1.16(h))</small>	* 24	Minus	***25	=	0	OR	X \$250=	0
<input type="checkbox"/> Application Size Fee <small>(37 CFR 1.16(s))</small>									
<input type="checkbox"/> FIRST PRESENTATION OF MULTIPLE DEPENDENT CLAIM <small>(37 CFR 1.16(j))</small>							OR		
					TOTAL ADD'L FEE		OR	TOTAL ADD'L FEE	0

APPLICATION AS AMENDED – PART II					OTHER THAN SMALL ENTITY				
(Column 1)		(Column 2)	(Column 3)		SMALL ENTITY		OR	SMALL ENTITY	
AMENDMENT	CLAIMS REMAINING AFTER AMENDMENT	HIGHEST NUMBER PREVIOUSLY PAID FOR	PRESENT EXTRA	RATE (\$)	ADDITIONAL FEE (\$)		RATE (\$)	ADDITIONAL FEE (\$)	
	Total <small>(37 CFR 1.16(i))</small>	*	Minus	**	=		OR	X \$ =	
	Independent <small>(37 CFR 1.16(h))</small>	*	Minus	***	=		OR	X \$ =	
<input type="checkbox"/> Application Size Fee <small>(37 CFR 1.16(s))</small>									
<input type="checkbox"/> FIRST PRESENTATION OF MULTIPLE DEPENDENT CLAIM <small>(37 CFR 1.16(j))</small>							OR		
					TOTAL ADD'L FEE		OR	TOTAL ADD'L FEE	

* If the entry in column 1 is less than the entry in column 2, write "0" in column 3.
 ** If the "Highest Number Previously Paid For" IN THIS SPACE is less than 20, enter "20".
 *** If the "Highest Number Previously Paid For" IN THIS SPACE is less than 3, enter "3".
 The "Highest Number Previously Paid For" (Total or Independent) is the highest number found in the appropriate box in column 1.

Legal Instrument Examiner:
 /GLORIA TRAMMELL/

This collection of information is required by 37 CFR 1.16. The information is required to obtain or retain a benefit by the public which is to file (and by the USPTO to process) an application. Confidentiality is governed by 35 U.S.C. 122 and 37 CFR 1.14. This collection is estimated to take 12 minutes to complete, including gathering, preparing, and submitting the completed application form to the USPTO. Time will vary depending upon the individual case. Any comments on the amount of time you require to complete this form and/or suggestions for reducing this burden, should be sent to the Chief Information Officer, U.S. Patent and Trademark Office, U.S. Department of Commerce, P.O. Box 1450, Alexandria, VA 22313-1450. DO NOT SEND FEES OR COMPLETED FORMS TO THIS ADDRESS. **SEND TO: Commissioner for Patents, P.O. Box 1450, Alexandria, VA 22313-1450.**

If you need assistance in completing the form, call 1-800-PTO-9199 and select option 2.



UNITED STATES PATENT AND TRADEMARK OFFICE

UNITED STATES DEPARTMENT OF COMMERCE
United States Patent and Trademark Office
Address: COMMISSIONER FOR PATENTS
P.O. Box 1450
Alexandria, Virginia 22313-1450
www.uspto.gov

APPLICATION NO.	FILING DATE	FIRST NAMED INVENTOR	ATTORNEY DOCKET NO.	CONFIRMATION NO.
12/057,775	03/28/2008	Inge Bruheim	NATNUT-14409/US-5/ORD	1945
72960	7590	06/07/2012	EXAMINER	
Casimir Jones, S.C. 2275 DEMING WAY, SUITE 310 MIDDLETON, WI 53562			WARE, DEBORAH K	
			ART UNIT	PAPER NUMBER
			1651	
			MAIL DATE	DELIVERY MODE
			06/07/2012	PAPER

Please find below and/or attached an Office communication concerning this application or proceeding.

The time period for reply, if any, is set in the attached communication.

DETAILED ACTION

Claims 1-50 and 52-90 are pending.

Response to Amendment

The Amendments filed April 4, 2012, were received and entered.

Information Disclosure Statement

The information disclosure statements (IDSs) submitted on March 21, 2012, February 21, 2012 and January 25, 2012, were received. The submissions are in compliance with the provisions of 37 CFR 1.97. Accordingly, the information disclosure statements are being considered by the examiner.

Election/Restrictions

Applicant's election without traverse of Group VIII, claims 50-55, 51, now canceled so remaining elected, claims 50 and 52-55, original election in the reply filed on October 31, 2011, and was acknowledged.

Claims 1-49 and 56-90 are hereby withdrawn from further consideration pursuant to 37 CFR 1.142(b) as being drawn to a nonelected inventions, there being no allowable generic or linking claim. Election was made without traverse in the reply filed on October 31, 2011.

Claim Rejections - 35 USC § 102

The following is a quotation of the appropriate paragraphs of 35 U.S.C. 102 that form the basis for the rejections under this section made in this Office action:

A person shall be entitled to a patent unless –

Art Unit: 1651

(b) the invention was patented or described in a printed publication in this or a foreign country or in public use or on sale in this country, more than one year prior to the date of application for patent in the United States.

Claims 50, 52 and 55 are rejected under 35 U.S.C. 102(b) as being clearly anticipated by Patent Abstract of Japan 04-057853, dated Feb. 25, 1992, cited on previously enclosed PTO-1449 Form or **newly cited** US 2003/0113432, cited on enclosed PTO-892 form.

Claims drawn to method for producing oil and an oil produced thereby.

Abstract 04-057853 teaches method for extracting krill oil comprising a) providing krill meal; and extracting oil from the krill meal (powdered form of krill parts). The meal (powdered form of krill parts) can be provided from heat-treated krill parts and is storable. The extracting is carried out by supercritical extraction. An oil is produced by the method.

WO teaches Krill lipid (e.g. krill oil) at [0045], lines 1-8. An apparatus comprising a cooker and a drier is disclosed at [0051], at page 5, col. 1, lines 1-2. Heating which is akin to cooking is disclosed at page 5, line 17 at col. 2. Cooking and drying step is disclosed at [0051], lines 1-12, to provide dried krill meal. Extraction of Krill oil is disclosed at [0045], line 3. WO clearly teaches that the krill meal contains all of its components and is not extracted and since it is dried it can inherently be stored before extraction.

The claims are identical to the abstract and WO as discussed above and are considered to be clearly anticipated by the teachings therein. Krill shells are part of krill

Art Unit: 1651

and oil is obtained from the krill parts. The krill parts are dried and hence subjected to heating to provide for the krill meal which is subjected to supercritical extraction in two steps to obtain the oil. WO clearly teaches cooking and drying and extraction is disclosed as well which will be carried out on a prepared product having all the contents including oil or lipid. The krill lipid or oil is not different than any krill oil or lipid as disclosed in the art or Applicants have not shown a single difference. The krill oil as claimed must be different than the oil or lipid as disclosed, no matter how it is prepared. Krill meal can be stored before it is desired to extract an oil therefrom. The claims are anticipated by the cited references.

Response to Arguments

Applicant's arguments filed April 4, 2012, have been fully considered but they are not persuasive. The argument that only krill shells are used is noted, however, the krill oil is obtained from krill meal which the reference does disclose. However, newly cited WO teaches that the krill meal contains all of the components of krill and will produce the krill oil as claimed. Also parts of the krill organism can remain in the shell and be treated as well because the organism is enclosed by the carapace of the shell(s). The reference does not disclose that the krill is removed entirely from the shells and that the shells are absent of any krill remainder. Thus, in light of the newly cited reference and these arguments the rejection is sustained over at least some of the claims.

Claim Rejections - 35 USC § 103

Art Unit: 1651

The following is a quotation of 35 U.S.C. 103(a) which forms the basis for all obviousness rejections set forth in this Office action:

(a) A patent may not be obtained though the invention is not identically disclosed or described as set forth in section 102 of this title, if the differences between the subject matter sought to be patented and the prior art are such that the subject matter as a whole would have been obvious at the time the invention was made to a person having ordinary skill in the art to which said subject matter pertains. Patentability shall not be negated by the manner in which the invention was made.

The factual inquiries set forth in *Graham v. John Deere Co.*, 383 U.S. 1, 148 USPQ 459 (1966), that are applied for establishing a background for determining obviousness under 35 U.S.C. 103(a) are summarized as follows:

1. Determining the scope and contents of the prior art.
2. Ascertaining the differences between the prior art and the claims at issue.
3. Resolving the level of ordinary skill in the pertinent art.
4. Considering objective evidence present in the application indicating obviousness or nonobviousness.

This application currently names joint inventors. In considering patentability of the claims under 35 U.S.C. 103(a), the examiner presumes that the subject matter of the various claims was commonly owned at the time any inventions covered therein were made absent any evidence to the contrary. Applicant is advised of the obligation under 37 CFR 1.56 to point out the inventor and invention dates of each claim that was not commonly owned at the time a later invention was made in order for the examiner to

Art Unit: 1651

consider the applicability of 35 U.S.C. 103(c) and potential 35 U.S.C. 102(e), (f) or (g) prior art under 35 U.S.C. 103(a).

Claims 50 and 52-55 are rejected under 35 U.S.C. 103(a) as being unpatentable over JP as cited and discussed above and the **newly cited** WO cited above, in view of Kamiya et al (US 20060193962A1), cited on enclosed PTO-892 Form.

Claims are discussed above as if the JP abstract.

WO teaches Krill lipid (e.g. krill oil) at [0045], lines 1-8. An apparatus comprising a cooker and a drier is disclosed at [0051], at page 5, col. 1, lines 1-2. Heating which is akin to cooking is disclosed at page 5, line 17 at col. 2. Cooking and drying step is disclosed at [0051], lines 1-12, to provide dried krill meal. Extraction of Krill oil is disclosed at [0045], line 3. WO clearly teaches that the krill meal contains all of its components and is not extracted and since it is dried it can inherently be stored before extraction.

Kamiya et al, US 20060193962A1, teach extraction with supercritical fluid and solvent [0043], and the solvent can be a monohydric alcohol [0049], ranging from 1 to 20% [0059].

Claim differs from JP in that monohydric alcohol is not disclosed.

It would have been obvious to one of ordinary skill in the art at the time the claimed invention was made to carry out supercritical extraction of JP and WO using a co-solvent monohydric alcohol as disclosed by Kamiya et al to produce oil from krill. To carry out more than one extract step is an obvious modification of the cited prior art. Alcohol extraction is a well known extractant as disclosed by Kamiya et al.

Art Unit: 1651

Each of the claim feature are disclosed and one of skill would have been motivated to carry out the process steps to provide oil with the expectation of successful results. Clearly the claim is prima facie obvious over the cited prior art.

Response to Arguments

Applicant's arguments filed April 4, 2012, have been fully considered but they are not persuasive. The newly added WO reference clearly teaches that krill oil or lipid can be extracted from cooked and/or dried krill meal as desired, or at least the same is suggested by the teachings of the steps. One of skill may not desire to extract the oil until ready to do so since it will be contained and preserved in the whole contents of the krill until ready and needed for use by those of skill in the art. Supercritical extraction is a well known process and disclosed by the cited prior art combination of references. Each element is disclosed or at least suggested by the cited prior art. The rejection is sustained.

Applicant's amendment necessitated the new ground(s) of rejection presented in this Office action. Accordingly, **THIS ACTION IS MADE FINAL**. See MPEP § 706.07(a). Applicant is reminded of the extension of time policy as set forth in 37 CFR 1.136(a).

A shortened statutory period for reply to this final action is set to expire THREE MONTHS from the mailing date of this action. In the event a first reply is filed within TWO MONTHS of the mailing date of this final action and the advisory action is not mailed until after the end of the THREE-MONTH shortened statutory period, then the shortened statutory period will expire on the date the advisory action is mailed, and any

Art Unit: 1651

extension fee pursuant to 37 CFR 1.136(a) will be calculated from the mailing date of the advisory action. In no event, however, will the statutory period for reply expire later than SIX MONTHS from the date of this final action.

All claims fail to be patentably distinguishable over the state of the art discussed above and cited on the enclosed PTO-892 and/or PTO-1449. Therefore, the claims are properly rejected.

The remaining references listed on the enclosed PTO-892 and/or PTO-1449 are cited to further show the state of the art.

No claims are allowed.

Any inquiry concerning this communication or earlier communications from the examiner should be directed to DEBBIE K. WARE whose telephone number is (571)272-0924. The examiner can normally be reached on 9:30-6:00.

If attempts to reach the examiner by telephone are unsuccessful, the examiner's supervisor, Mike Wityshyn can be reached on 571-272-0926. The fax phone number for the organization where this application or proceeding is assigned is 571-273-8300. Information regarding the status of an application may be obtained from the Patent Application Information Retrieval (PAIR) system. Status information for published applications may be obtained from either Private PAIR or Public PAIR. Status information for unpublished applications is available through Private PAIR only. For more information about the PAIR system, see <http://pair-direct.uspto.gov>.

Should you have questions on access to the Private PAIR system, contact the Electronic Business Center (EBC) at 866-217-9197 (toll-free). If you would like

Application/Control Number: 12/057,775

Page 9

Art Unit: 1651

assistance from a USPTO Customer Service Representative or access to the automated information system, call 800-786-9199 (IN USA OR CANADA) or 571-272-1000.

/Deborah K. Ware/

Deborah K. Ware

Primary Examiner

Art Unit 1651

Notice of References Cited	Application/Control No. 12/057,775	Applicant(s)/Patent Under Reexamination BRUHEIM ET AL.	
	Examiner DEBBIE K. WARE	Art Unit 1651	Page 1 of 1

U.S. PATENT DOCUMENTS

*	Document Number Country Code-Number-Kind Code	Date MM-YYYY	Name	Classification
*	A US-2003/0113432	06-2003	Yoshitomi et al.	426/643
	B US-			
	C US-			
	D US-			
	E US-			
	F US-			
	G US-			
	H US-			
	I US-			
	J US-			
	K US-			
	L US-			
	M US-			

FOREIGN PATENT DOCUMENTS

*	Document Number Country Code-Number-Kind Code	Date MM-YYYY	Country	Name	Classification
	N				
	O				
	P				
	Q				
	R				
	S				
	T				

NON-PATENT DOCUMENTS

*	Document Number Country Code-Number-Kind Code	Date MM-YYYY	Country	Name	Classification
		Include as applicable: Author, Title Date, Publisher, Edition or Volume, Pertinent Pages)			
	U				
	V				
	W				
	X				

*A copy of this reference is not being furnished with this Office action. (See MPEP § 707.05(a).)
Dates in MM-YYYY format are publication dates. Classifications may be US or foreign.

Receipt date: 01/25/2012

12057775 - GAI: 1651

Doc code: IDS

Doc description: Information Disclosure Statement (IDS) Filed

Approved for use through 07/31/2012. OMB 0651-0031
U.S. Patent and Trademark Office; U.S. DEPARTMENT OF COMMERCE

Under the Paperwork Reduction Act of 1995, no persons are required to respond to a collection of information unless it contains a valid OMB control number.

INFORMATION DISCLOSURE STATEMENT BY APPLICANT (Not for submission under 37 CFR 1.99)	Application Number		12057775	
	Filing Date		2008-03-28	
	First Named Inventor	Inge Bruheim		
	Art Unit	1651		
	Examiner Name	Ware, Deborah K.		
	Attorney Docket Number	NATNUT-14409/US-5/ORD		

U.S.PATENTS						Remove
Examiner Initial*	Cite No	Patent Number	Kind Code ¹	Issue Date	Name of Patentee or Applicant of cited Document	Pages,Columns,Lines where Relevant Passages or Relevant Figures Appear
	1	5266564		1993-11-30	Modolell	
	2	8030348		2011-10-04	Sampalis, Fotni	
	3	7666447		2010-02-23	Rockway	

If you wish to add additional U.S. Patent citation information please click the Add button.

Add

U.S.PATENT APPLICATION PUBLICATIONS						Remove
Examiner Initial*	Cite No	Publication Number	Kind Code ¹	Publication Date	Name of Patentee or Applicant of cited Document	Pages,Columns,Lines where Relevant Passages or Relevant Figures Appear
	1	20080166419		2008-07-10	Sones	

If you wish to add additional U.S. Published Application citation information please click the Add button.

Add

FOREIGN PATENT DOCUMENTS								Remove
Examiner Initial*	Cite No	Foreign Document Number ³	Country Code ² i	Kind Code ⁴	Publication Date	Name of Patentee or Applicant of cited Document	Pages,Columns,Lines where Relevant Passages or Relevant Figures Appear	T ⁵
	1	2004-534800	JP		2004-11-18	Kohyo		<input type="checkbox"/>

INFORMATION DISCLOSURE STATEMENT BY APPLICANT (Not for submission under 37 CFR 1.99)	Application Number	12057775	12057775 - GAU: 1651
	Filing Date	2008-03-28	
	First Named Inventor	Inge Bruheim	
	Art Unit	1651	
	Examiner Name	Ware, Deborah K.	
	Attorney Docket Number	NATNUT-14409/US-5/ORD	

2	07/080515	WO		2007-07-19	Aker Biomarine ASA	<input type="checkbox"/>
---	-----------	----	--	------------	--------------------	--------------------------

If you wish to add additional Foreign Patent Document citation information please click the Add button **Add**

NON-PATENT LITERATURE DOCUMENTS

Remove

Examiner Initials*	Cite No	Include name of the author (in CAPITAL LETTERS), title of the article (when appropriate), title of the item (book, magazine, journal, serial, symposium, catalog, etc), date, pages(s), volume-issue number(s), publisher, city and/or country where published.	T ⁵
	1	SIKORSKI, E., "The Utilization of Krill For Food," Food Process Eng., 1:845-855 (1980)	<input type="checkbox"/>
	2	BUDZINSKI, E., et al., "Possibilities of processing and marketing of products made from Antarctic Krill", FAO Fish. Tech. Pap. (268) 46 pages (1985)	<input type="checkbox"/>
	3	BUNEA R., et al., "Evaluation of the Effects of Neptune Krill Oil on the Clinical Course of Hyperlipidemia," Alternative Medicine Review, Thorne Research Inc., Sandpoint, US, Vol. 9, No. 4, January 1, 2004	<input type="checkbox"/>
	4	GORDEEV, K.Y., et al. "Fatty Acid Composition of the Main Phospholipids of the Antarctic Krill, Euphausia superba," Khim. Prirod. Soed. 2 (1990), pp. 181-187	<input type="checkbox"/>

If you wish to add additional non-patent literature document citation information please click the Add button **Add**

EXAMINER SIGNATURE

Examiner Signature	/Deborah Ware/	Date Considered	06/04/2012
--------------------	----------------	-----------------	------------

*EXAMINER: Initial if reference considered, whether or not citation is in conformance with MPEP 609. Draw line through a citation if not in conformance and not considered. Include copy of this form with next communication to applicant.

¹ See Kind Codes of USPTO Patent Documents at www.USPTO.GOV or MPEP 901.04. ² Enter office that issued the document, by the two-letter code (WIPO Standard ST.3). ³ For Japanese patent documents, the indication of the year of the reign of the Emperor must precede the serial number of the patent document. ⁴ Kind of document by the appropriate symbols as indicated on the document under WIPO Standard ST.16 if possible. ⁵ Applicant is to place a check mark here if English language translation is attached.

Receipt date: 02/21/2012

12057775 - GAI: 1651

Doc code: IDS
 Doc description: Information Disclosure Statement (IDS) Filed

Approved for use through 07/31/2012. OMB 0651-0031
 U.S. Patent and Trademark Office; U.S. DEPARTMENT OF COMMERCE
 Under the Paperwork Reduction Act of 1995, no persons are required to respond to a collection of information unless it contains a valid OMB control number.

INFORMATION DISCLOSURE STATEMENT BY APPLICANT (Not for submission under 37 CFR 1.99)	Application Number		12057775	
	Filing Date		2008-03-28	
	First Named Inventor	Inge Bruheim		
	Art Unit	1651		
	Examiner Name	Ware, Deborah K.		
	Attorney Docket Number	NATNUT-14409/US-5/ORD		

U.S.PATENTS						Remove
Examiner Initial*	Cite No	Patent Number	Kind Code ¹	Issue Date	Name of Patentee or Applicant of cited Document	Pages,Columns,Lines where Relevant Passages or Relevant Figures Appear
	1					

If you wish to add additional U.S. Patent citation information please click the Add button. Add

U.S.PATENT APPLICATION PUBLICATIONS						Remove
Examiner Initial*	Cite No	Publication Number	Kind Code ¹	Publication Date	Name of Patentee or Applicant of cited Document	Pages,Columns,Lines where Relevant Passages or Relevant Figures Appear
	1					

If you wish to add additional U.S. Published Application citation information please click the Add button. Add

FOREIGN PATENT DOCUMENTS								Remove
Examiner Initial*	Cite No	Foreign Document Number ³	Country Code ² j	Kind Code ⁴	Publication Date	Name of Patentee or Applicant of cited Document	Pages,Columns,Lines where Relevant Passages or Relevant Figures Appear	T ⁵
	1	2003-530448	JP		2003-10-14	Westfalia Separator Industry GmbH		<input type="checkbox"/>

If you wish to add additional Foreign Patent Document citation information please click the Add button Add

NON-PATENT LITERATURE DOCUMENTS				Remove
Examiner Initials*	Cite No	Include name of the author (in CAPITAL LETTERS), title of the article (when appropriate), title of the item (book, magazine, journal, serial, symposium, catalog, etc), date, pages(s), volume-issue number(s), publisher, city and/or country where published.		T ⁵

INFORMATION DISCLOSURE STATEMENT BY APPLICANT (Not for submission under 37 CFR 1.99)	Application Number		12057775	12057775 - GAU: 1651
	Filing Date		2008-03-28	
	First Named Inventor	Inge Bruheim		
	Art Unit	1651		
	Examiner Name	Ware, Deborah K.		
	Attorney Docket Number	NATNUT-14409/US-5/ORD		

1	December 8, 2011 Office Action, KR Patent Application No. 10-2010-7006897 and its English translation	<input type="checkbox"/>
---	---	--------------------------

If you wish to add additional non-patent literature document citation information please click the Add button **Add**

EXAMINER SIGNATURE

Examiner Signature	/Deborah Ware/	Date Considered	06/04/2012
--------------------	----------------	-----------------	------------

***EXAMINER:** Initial if reference considered, whether or not citation is in conformance with MPEP 609. Draw line through a citation if not in conformance and not considered. Include copy of this form with next communication to applicant.

¹ See Kind Codes of USPTO Patent Documents at www.USPTO.GOV or MPEP 901.04. ² Enter office that issued the document, by the two-letter code (WIPO Standard ST.3). ³ For Japanese patent documents, the indication of the year of the reign of the Emperor must precede the serial number of the patent document. ⁴ Kind of document by the appropriate symbols as indicated on the document under WIPO Standard ST.16 if possible. ⁵ Applicant is to place a check mark here if English language translation is attached.

WEST Search History for Application 12057775

Creation Date: 2012052914:28

Prior Art Searches

Query	DB	Op.	Plur.	Thes.	Date
"krill oil"	PGPB, USPT, USOC, EPAB, JPAB, DWPI, TDBD	OR	YES		01-03-2012
("krill oil") and "krill meal"	PGPB, USPT, USOC, EPAB, JPAB, DWPI, TDBD	OR	YES		01-03-2012
("krill oil" and "krill meal") and "supercritical fluid"	PGPB, USPT, USOC, EPAB, JPAB, DWPI, TDBD	OR	YES		01-03-2012
extract? and krill and oil and meal and supercritical	PGPB, USPT, USOC, EPAB, JPAB, DWPI, TDBD	OR	YES		01-03-2012
2004241249	PGPB	OR	YES		01-03-2012
200400241249	PGPB	OR	YES		01-03-2012
20040241249	PGPB	OR	YES		01-03-2012
(20040241249) and "supercritical"	PGPB	OR	YES		01-03-2012
(20040241249) and "solvent extraction"	PGPB	OR	YES		01-03-2012
(20040241249) and "extract"	PGPB	OR	YES		01-03-2012
(20040241249 and "extract") and "oil"	PGPB	OR	YES		01-03-2012
(20040241249 and "extract" and "oil") and "meal"	PGPB	OR	YES		01-03-2012
supercritical and extraction and krill	PGPB, USPT, USOC, EPAB, JPAB, DWPI, TDBD	OR	YES		01-03-2012
(supercritical and extraction and krill) and co-solvent	PGPB, USPT, USOC, EPAB, JPAB, DWPI, TDBD	OR	YES		01-03-2012
(supercritical and extraction and krill and co-solvent) and oil	PGPB, USPT, USOC, EPAB, JPAB, DWPI, TDBD	OR	YES		01-03-2012
supercritical and extraction and alcohol		OR	YES		01-03-2012

	PGPB, USPT, USOC, EPAB, JPAB, DWPI, TDBD				
(supercritical and extraction and alcohol) and monohydric	PGPB, USPT, USOC, EPAB, JPAB, DWPI, TDBD	OR	YES		01-03-2012
(supercritical and extraction and alcohol and monohydric) and krill and meal	PGPB, USPT, USOC, EPAB, JPAB, DWPI, TDBD	OR	YES		01-03-2012
krill and oil and cooking and drying	PGPB, USPT, USOC, EPAB, JPAB, DWPI, TDBD	OR	YES		05-29-2012
(krill and oil and cooking and drying) and extracting	PGPB, USPT, USOC, EPAB, JPAB, DWPI, TDBD	OR	YES		05-29-2012

Receipt date: 03/21/2012

12057775 - GAI: 1651

Doc code: IDS

Doc description: Information Disclosure Statement (IDS) Filed

Approved for use through 07/31/2012. OMB 0651-0031
U.S. Patent and Trademark Office; U.S. DEPARTMENT OF COMMERCE

Under the Paperwork Reduction Act of 1995, no persons are required to respond to a collection of information unless it contains a valid OMB control number.

INFORMATION DISCLOSURE STATEMENT BY APPLICANT (Not for submission under 37 CFR 1.99)	Application Number		12057775	
	Filing Date		2008-03-28	
	First Named Inventor	Inge Bruheim		
	Art Unit	1651		
	Examiner Name	Ware		
	Attorney Docket Number	NATNUT-14409/US-5/ORD		

U.S. PATENTS						Remove
Examiner Initial*	Cite No	Patent Number	Kind Code ¹	Issue Date	Name of Patentee or Applicant of cited Document	Pages, Columns, Lines where Relevant Passages or Relevant Figures Appear
	1					

If you wish to add additional U.S. Patent citation information please click the Add button. Add

U.S. PATENT APPLICATION PUBLICATIONS						Remove
Examiner Initial*	Cite No	Publication Number	Kind Code ¹	Publication Date	Name of Patentee or Applicant of cited Document	Pages, Columns, Lines where Relevant Passages or Relevant Figures Appear
	1					

If you wish to add additional U.S. Published Application citation information please click the Add button. Add

FOREIGN PATENT DOCUMENTS							Remove	
Examiner Initial*	Cite No	Foreign Document Number ³	Country Code ² j	Kind Code ⁴	Publication Date	Name of Patentee or Applicant of cited Document	Pages, Columns, Lines where Relevant Passages or Relevant Figures Appear	T ⁵
	1	JP-A-S52-114046	JP		1977-09-24	Kokai		<input type="checkbox"/>
	2	JP-A-S51-125774	JP		1976-11-02	Nichiro Gyogyo et al.		<input type="checkbox"/>

If you wish to add additional Foreign Patent Document citation information please click the Add button Add

NON-PATENT LITERATURE DOCUMENTS						Remove
---------------------------------	--	--	--	--	--	--------

INFORMATION DISCLOSURE STATEMENT BY APPLICANT (Not for submission under 37 CFR 1.99)	Application Number	12057775	12057775 - GAU: 1651
	Filing Date	2008-03-28	
	First Named Inventor	Inge Bruheim	
	Art Unit	1651	
	Examiner Name	Ware	
	Attorney Docket Number	NATNUT-14409/US-5/ORD	

Examiner Initials*	Cite No	Include name of the author (in CAPITAL LETTERS), title of the article (when appropriate), title of the item (book, magazine, journal, serial, symposium, catalog, etc), date, pages(s), volume-issue number(s), publisher, city and/or country where published.	T ⁵
	1	JP Office Action mailed February 23, 2012, JP Patent Application No. 2010-522444 (and English translation)	<input type="checkbox"/>

If you wish to add additional non-patent literature document citation information please click the Add button **Add**

EXAMINER SIGNATURE

Examiner Signature	<i>/Deborah Ware/</i>	Date Considered	06/04/2012
--------------------	-----------------------	-----------------	------------

*EXAMINER: Initial if reference considered, whether or not citation is in conformance with MPEP 609. Draw line through a citation if not in conformance and not considered. Include copy of this form with next communication to applicant.

¹ See Kind Codes of USPTO Patent Documents at www.USPTO.GOV or MPEP 901.04. ² Enter office that issued the document, by the two-letter code (WIPO Standard ST.3). ³ For Japanese patent documents, the indication of the year of the reign of the Emperor must precede the serial number of the patent document. ⁴ Kind of document by the appropriate symbols as indicated on the document under WIPO Standard ST.16 if possible. ⁵ Applicant is to place a check mark here if English language translation is attached.

Search Notes 	Application/Control No. 12057775	Applicant(s)/Patent Under Reexamination BRUHEIM ET AL.
	Examiner DEBBIE K WARE	Art Unit 1651

SEARCHED			
Class	Subclass	Date	Examiner

SEARCH NOTES		
Search Notes	Date	Examiner
WEST, NPL and INV: see search history print out	12/2011-1/2012	DKW
WEST, NPL and INV: see search history print out	6/2012	DKW

INTERFERENCE SEARCH			
Class	Subclass	Date	Examiner

--	--

Connecting via Winsock to STN at pto-stn on port 23

Welcome to STN International! Enter x:X

LOGINID:ssspt189dxw

PASSWORD:

TERMINAL (ENTER 1, 2, 3, OR ?):2

* * * * * Welcome to STN International * * * * *

NEWS 1 OCT 11 Instructor-led and self paced STN learning resources
available at <https://cas.csod.com/Default.aspx?c=001>

NEWS 2 APR 26 Expanded Swedish Patent Application Coverage in CA/CAplus
Provides More Current and Complete Information

NEWS 3 APR 28 The DWPI (files WPINDEX, WPIDS and WPIX) on STN have been
enhanced with thesauri for the European Patent Classifications

NEWS 4 MAY 02 MEDLINE Improvements Provide Fast and Simple Access to DOI and
Chemical Name Information

NEWS 5 MAY 12 European Patent Classification thesauri added to the INPADOC
files, PCTFULL, GBFULL and FRFULL

NEWS 6 MAY 23 Enhanced performance of STN biosequence searches

NEWS 7 JUN 20 STN on the Web Enhanced with New Patent Family Assistant and
Updated Structure Plug-In

NEWS 8 JUN 20 INPADOC databases enhanced with first page images

NEWS 9 JUN 20 PATDPA database updates to end in June 2011

NEWS 10 JUN 26 MARPAT Enhancements Save Time and Increase Usability

NEWS 11 JUL 25 STN adds Australian patent full-text database,
AUPATFULL, including the new numeric search feature.

NEWS 12 AUG 01 CA Sections Added to ACS Publications Web Editions
Platform

NEWS 13 AUG 16 INPADOC: Coverage of German Patent Data resumed,
enhanced legal status

NEWS 14 AUG 18 Upgrade now to STN Express, Version 8.5

NEWS 15 SEP 01 CAS Journal Coverage Now Includes Ahead-of-Print
Articles for More Than 100 Journal Titles

NEWS 16 SEP 01 Older Versions of STN Express to be Discontinued
Beginning in March 2012

NEWS 17 SEP 09 USAN Database Updates Offer Superior Currency on STN(R)

NEWS 18 SEP 26 STN Adds Canadian Patent Full-text Database - CANPATFULL

NEWS 19 SEP 26 GEOREF and ENCOMPLIT databases were reloaded on
September 24, 2011.

NEWS 20 SEP 26 Updates to the IFIPAT/IFIUDB/IFICDB databases have resumed.

NEWS 21 SEP 26 ECLA Thesaurus in CA/CAplus Improves Patent Searching on STN

NEWS 22 SEP 26 Access AUPATFULL and CANPATFULL databases with STN Viewer

NEWS 23 OCT 26 New STN Revolutionizes Patent Searching for Professionals

NEWS 24 DEC 1 CA/CAplus Now Includes Examiner Citations for Japanese Patents

NEWS 25 DEC 1 CAS Expands Global Patent Coverage - Intellectual Property
Corporation of Malaysia Becomes 62nd Authority on CA/CAplus

NEWS 26 DEC 5 STN on the Web Enhancements Include Compatibility with
Microsoft Windows 7

NEWS 27 DEC 14 Removal of ITRD and PATIPC databases from STN

NEWS 28 DEC 15 Rolled-up IPC Core Codes Removed from IPC Reclassifications in
Patent Databases on STN

NEWS EXPRESS 18 AUGUST 2011 CURRENT WINDOWS VERSION IS V8.5,
AND CURRENT DISCOVER FILE IS DATED 11 AUGUST 2011.

NEWS HOURS STN Operating Hours Plus Help Desk Availability
NEWS LOGIN Welcome Banner and News Items
NEWS TRAINING Find instructor-led and self-directed training opportunities

Enter NEWS followed by the item number or name to see news on that specific topic.

All use of STN is subject to the provisions of the STN customer agreement. This agreement limits use to scientific research. Use for software development or design, implementation of commercial gateways, or use of CAS and STN data in the building of commercial products is prohibited and may result in loss of user privileges and other penalties.

* * * * * STN Columbus * * * * *

FILE 'HOME' ENTERED AT 15:15:33 ON 03 JAN 2012

=> index bioscience		
COST IN U.S. DOLLARS	SINCE FILE	TOTAL
	ENTRY	SESSION
FULL ESTIMATED COST	0.24	0.24

INDEX 'ADISCTI, ADISINSIGHT, ADISNEWS, AGRICOLA, ANABSTR, ANTE, AQUALINE, AQUASCI, BIOENG, BIOSIS, BIOTECHABS, BIOTECHDS, BIOTECHNO, CABA, CAPLUS, CEABA-VTB, CIN, CONFSCI, CROPB, CROPU, DDFB, DDFU, DGENE, DISSABS, DRUGB, DRUGU, EMBAL, EMBASE, ESBIODBASE, ...' ENTERED AT 15:15:47 ON 03 JAN 2012

56 FILES IN THE FILE LIST IN STNINDEX

Enter SET DETAIL ON to see search term postings or to view search error messages that display as 0* with SET DETAIL OFF.

=> s krill and oil and meal and supercritical(p)extract? and solvent and heat? and treat?

0* FILE ADISNEWS
0* FILE ANTE
0* FILE AQUALINE
0* FILE BIOENG
0* FILE BIOTECHABS
0* FILE BIOTECHDS
0* FILE BIOTECHNO
0* FILE CEABA-VTB
0* FILE CIN

22 FILES SEARCHED...

0* FILE FOMAD
0* FILE FROSTI
0* FILE FSTA

33 FILES SEARCHED...

1 FILE IFIPAT
0* FILE KOSMET
0* FILE NTIS
0* FILE PASCAL

48 FILES SEARCHED...

28 FILE USPATFULL
4 FILE USPAT2

51 FILES SEARCHED...

0* FILE WATER
1 FILE WPIDS
1 FILE WPINDEX

5 FILES HAVE ONE OR MORE ANSWERS, 56 FILES SEARCHED IN STNINDEX

L1 QUE KRILL AND OIL AND MEAL AND SUPERCRITICAL(P)EXTRACT? AND SOLVENT AND HEAT? AND TREAT?

=> file ifipat uspatfull uspat2

COST IN U.S. DOLLARS

SINCE FILE	TOTAL
ENTRY	SESSION
3.70	3.94

FULL ESTIMATED COST

FILE 'IFIPAT' ENTERED AT 15:19:01 ON 03 JAN 2012
COPYRIGHT (C) 2012 IFI CLAIMS(R) Patent Services (IFI)

FILE 'USPATFULL' ENTERED AT 15:19:01 ON 03 JAN 2012
CA INDEXING COPYRIGHT (C) 2012 AMERICAN CHEMICAL SOCIETY (ACS)

FILE 'USPAT2' ENTERED AT 15:19:01 ON 03 JAN 2012
CA INDEXING COPYRIGHT (C) 2012 AMERICAN CHEMICAL SOCIETY (ACS)

=> s l1

L2 33 L1

=> dup rem l2

PROCESSING COMPLETED FOR L2

L3 32 DUP REM L2 (1 DUPLICATE REMOVED)

=> s l3 andcarbon(p)dioxide

MISSING OPERATOR L3 ANDCARBON

The search profile that was entered contains terms or nested terms that are not separated by a logical operator.

=> s l3 and dioxide

L4 27 L3 AND DIOXIDE

=> d l4 1-27

L4 ANSWER 1 OF 27 IFIPAT COPYRIGHT 2012 IFI on STN

AN 11934106 IFIPAT;IFIUDB;IFICDB

TI BIOEFFECTIVE KRILL OIL COMPOSITIONS; Having high amounts of phospholipids, astaxanthin esters and/or omega-3 contents; antiinflammation, antioxidant effects, improving insulin resistance and blood lipid profile

IN Banni Sebastiano (IT); Bruheim Inge (NO); Cohn Jeffrey Stuart (AU); Griinari Mikko (FI); Mancinelli Daniele (NO); Tilseth Snorre (NO)

PA Aker BioMarine ASA NO (79725)

PI US 20080274203 A1 20081106

AI US 2008-57775 20080328 (12)

PRAI US 2007-920483P 20070328 (Provisional)

US 2007-975058P 20070925 (Provisional)

US 2007-983446P 20071029 (Provisional)

FI US 20080274203 20081106

DT Utility; Patent Application - First Publication

FS CHEMICAL

APPLICATION

ED Entered STN: 7 Nov 2008

Last Updated on STN: Jan 2011

CLMN 90

L4 ANSWER 2 OF 27 USPATFULL on STN

AN 2011:287830 USPATFULL

TI Reducing the Risk of Pathological Effects of Traumatic Brain Injury

IN Hadley, Kevin, Elkridge, MD, UNITED STATES

Fealey, Terence, Marietta, GA, UNITED STATES
Bailes, Julian E., Morgantown, WV, UNITED STATES
PI US 20110257267 A1 20111020
AI US 2010-904049 A1 20101013 (12)
PRAI US 2009-251230P 20091013 (61)
DT Utility
FS APPLICATION
LN.CNT 2397
INCL INCLM: 514/547.000
INCLS: 514/560.000; 514/549.000
NCL NCLM: 514/547.000
NCLS: 514/549.000; 514/560.000
IPC IPCI A61K0031-232 [I,A]; A61P0025-00 [I,A]; A61K0031-202 [I,A]
CAS INDEXING IS AVAILABLE FOR THIS PATENT.

L4 ANSWER 3 OF 27 USPATFULL on STN
AN 2011:251469 USPATFULL
TI SOLVENT-FREE PROCESS FOR OBTAINING PHOSPHOLIPIDS AND NEUTRAL ENRICHED
KRILL OILS
IN Sclabos Katevas, Dimitri, Santiago, CHILE
Toro Guerra, Raul R., Santiago, CHILE
Chiong Lay, Mario M., Santiago, CHILE
PA THAROS LTD., Santiago, CHILE (non-U.S. corporation)
LONZA LTD., Basel, SWITZERLAND (non-U.S. corporation)
PI US 20110224450 A1 20110915
AI US 2011-96644 A1 20110428 (13)
RLI Continuation-in-part of Ser. No. WO 2009-IB7269, filed on 30 Oct 2009,
PENDING
DT Utility
FS APPLICATION
LN.CNT 2021
INCL INCLM: 554/023.000
INCLS: 554/008.000; 554/078.000
NCL NCLM: 554/023.000
NCLS: 554/008.000; 554/078.000
IPC IPCI C11B0001-00 [I,A]; C07F0009-10 [I,A]
IPCR C11B0001-00 [I,A]; C07F0009-10 [I,A]
CAS INDEXING IS AVAILABLE FOR THIS PATENT.

L4 ANSWER 4 OF 27 USPATFULL on STN
AN 2011:212256 USPATFULL
TI METHOD FOR PRODUCING LIPIDS
IN Yoshikawa, Kazuhiro, Tokyo, JAPAN
Mikajiri, Akihiro, Tokyo, JAPAN
PA NIPPON SUISAN KAISHA, LTD., Tokyo, JAPAN (non-U.S. corporation)
PI US 20110189760 A1 20110804
AI US 2009-120842 A1 20090924 (13)
WO 2009-JP66530 20090924
20110425 PCT 371 date
PRAI JP 2008-248986 20080926
DT Utility
FS APPLICATION
LN.CNT 1345
INCL INCLM: 435/271.000
INCLS: 554/020.000
NCL NCLM: 435/271.000
NCLS: 554/020.000
IPC IPCI C11C0001-00 [I,A]; C11B0001-00 [I,A]
IPCR C11C0001-00 [I,A]; C11B0001-00 [I,A]
CAS INDEXING IS AVAILABLE FOR THIS PATENT.

L4 ANSWER 5 OF 27 USPATFULL on STN

AN 2011:211870 USPATFULL
TI METHOD FOR CONCENTRATING LIPIDS
IN Yoshikawa, Kazuhiro, Tokyo, JAPAN
PA NIPPON SUISAN KAISHA, LTD., Tokyo, JAPAN (non-U.S. corporation)
PI US 20110189374 A1 20110804
AI US 2009-120875 A1 20090924 (13)
WO 2009-JP66529 20090924
20110425 PCT 371 date
PRAI JP 2008-248986 20080926
DT Utility
FS APPLICATION
LN.CNT 961
INCL INCLM: 426/601.000
INCLS: 554/008.000
NCL NCLM: 426/601.000
NCLS: 554/008.000
IPC IPCI A23D0009-00 [I,A]; C11B0001-06 [I,A]
IPCR A23D0009-00 [I,A]; C11B0001-06 [I,A]
CAS INDEXING IS AVAILABLE FOR THIS PATENT.

L4 ANSWER 6 OF 27 USPATFULL on STN
AN 2011:198158 USPATFULL
TI METHODS OF TREATING AND PREVENTING NEUROLOGICAL DISORDERS USING
DOCOSAHEXAENOIC ACID
IN AISEN, Paul S., Solana Beach, CA, UNITED STATES
Quinn, Joseph F., Portland, OR, UNITED STATES
Yurko-Mauro, Karin, Silver Spring, MD, UNITED STATES
PA MARTEK BIOSCIENCES CORPORATION, Columbia, MD, UNITED STATES (U.S.
corporation)
PI US 20110177061 A1 20110721
AI US 2010-833913 A1 20100709 (12)
PRAI US 2009-224836P 20090710 (61)
US 2010-359792P 20100629 (61)
DT Utility
FS APPLICATION
LN.CNT 2653
INCL INCLM: 424/133.100
INCLS: 514/560.000; 514/120.000; 514/547.000; 514/549.000; 514/297.000;
514/319.000; 514/479.000; 514/215.000; 424/184.100; 424/172.100;
424/152.100; 514/458.000
NCL NCLM: 424/133.100
NCLS: 424/152.100; 424/172.100; 424/184.100; 514/120.000; 514/215.000;
514/297.000; 514/319.000; 514/458.000; 514/479.000; 514/547.000;
514/549.000; 514/560.000
IPC IPCI A61K0031-202 [I,A]; A61K0031-661 [I,A]; A61K0031-232 [I,A];
A61K0031-473 [I,A]; A61K0031-445 [I,A]; A61K0031-27 [I,A];
A61K0031-55 [I,A]; A61K0039-00 [I,A]; A61K0039-395 [I,A];
A61K0031-355 [I,A]; A61P0025-28 [I,A]; A61P0025-00 [I,A]
IPCR A61K0031-202 [I,A]; A61K0031-232 [I,A]; A61K0031-27 [I,A];
A61K0031-355 [I,A]; A61K0031-445 [I,A]; A61K0031-473 [I,A];
A61K0031-55 [I,A]; A61K0031-661 [I,A]; A61K0039-00 [I,A];
A61K0039-395 [I,A]; A61P0025-00 [I,A]; A61P0025-28 [I,A]
CAS INDEXING IS AVAILABLE FOR THIS PATENT.

L4 ANSWER 7 OF 27 USPATFULL on STN
AN 2011:146375 USPATFULL
TI KRILL OIL PROCESS
IN Breivik, Harald, Porsgrunn, NORWAY
Thorstad, Olav, Porsgrunn, NORWAY
PA PRONOVA BIOPHARMA NORGE AS, Lysaker, NORWAY (non-U.S. corporation)
PI US 20110130458 A1 20110602
AI US 2009-992365 A1 20090515 (12)

WO 2009-NO184 20090515
 20110211 PCT 371 date
 PRAI US 2008-53455P 20080515 (61)
 DT Utility
 FS APPLICATION
 LN.CNT 688
 INCL INCLM: 514/560.000
 INCLS: 426/608.000; 426/417.000
 NCL NCLM: 514/560.000
 NCLS: 426/417.000; 426/608.000
 IPC IPCI A61K0031-202 [I,A]; A61P0003-06 [I,A]; A61P0003-00 [I,A];
 A61P0009-00 [I,A]; A61P0009-04 [I,A]; A61P0009-10 [I,A];
 A23D0007-00 [I,A]; A23D0009-00 [I,A]
 IPCR A61K0031-202 [I,A]; A23D0007-00 [I,A]; A23D0009-00 [I,A];
 A61P0003-00 [I,A]; A61P0003-06 [I,A]; A61P0009-00 [I,A];
 A61P0009-04 [I,A]; A61P0009-10 [I,A]
 CAS INDEXING IS AVAILABLE FOR THIS PATENT.

 L4 ANSWER 8 OF 27 USPATFULL on STN
 AN 2011:117434 USPATFULL
 TI POWDERED COMPOSITION CONTAINING OIL-SOLUBLE COMPONENT, FUNCTIONAL FOOD
 USING THE SAME, AND PACKAGED PRODUCT THEREOF
 IN Suzuki, Keiichi, Kanagawa, JAPAN
 Sasaki, Hidemi, Kanagawa, JAPAN
 Serizawa, Shinichiro, Kanagawa, JAPAN
 Arakawa, Jun, Kanagawa, JAPAN
 PA FUJIFILM CORPORATION, Minato-ku, Tokyo, JAPAN (non-U.S. corporation)
 PI US 20110104340 A1 20110505
 AI US 2008-673977 A1 20080819 (12)
 WO 2008-JP65061 20080819
 20100218 PCT 371 date
 PRAI JP 2007-213712 20070820
 JP 2007-230582 20070905
 DT Utility
 FS APPLICATION
 LN.CNT 2345
 INCL INCLM: 426/096.000
 INCLS: 426/654.000; 426/590.000
 NCL NCLM: 426/096.000
 NCLS: 426/590.000; 426/654.000
 IPC IPCI A21D0002-16 [I,A]; A23L0002-52 [I,A]
 IPCR A21D0002-16 [I,A]; A23L0002-52 [I,A]
 CAS INDEXING IS AVAILABLE FOR THIS PATENT.

 L4 ANSWER 9 OF 27 USPATFULL on STN
 AN 2011:117391 USPATFULL
 TI METHODS OF USING KRILL OIL TO TREAT RISK FACTORS FOR
 CARDIOVASCULAR, METABOLIC, AND INFLAMMATORY DISORDERS
 IN BRUHEIM, Inge, Volda, NORWAY
 Tilseth, Snorre, Bergen, NORWAY
 Cohn, Jeffery, Sydney, AUSTRALIA
 Griinari, Mikko, Espoo, FINLAND
 Mancinelli, Daniele, Orsta, NORWAY
 Hoem, Nils, Oslo, NORWAY
 Vik, Hogne, Eiksmarka, NORWAY
 Banni, Sebastiano, Calgliari, ITALY
 PA Aker BioMarine A.S.A., Oslo, NORWAY (non-U.S. corporation)
 PI US 20110104297 A1 20110505
 AI US 2010-790575 A1 20100528 (12)
 RLI Continuation-in-part of Ser. No. US 2008-57775, filed on 28 Mar 2008,
 PENDING
 PRAI US 2007-975058P 20070925 (60)

US 2007-983446P 20071029 (60)
 US 2008-24072P 20080128 (61)
 US 2009-181743P 20090528 (61)
 US 2007-920483P 20070328 (60)
 DT Utility
 FS APPLICATION
 LN.CNT 2547
 INCL INCLM: 424/522.000
 INCLS: 426/002.000
 NCL NCLM: 424/522.000
 NCLS: 426/002.000
 IPC IPCI A61K0035-56 [I,A]; A61P0009-10 [I,A]; A61P0003-04 [I,A];
 A61P0003-00 [I,A]
 IPCR A61K0035-56 [I,A]; A61P0003-00 [I,A]; A61P0003-04 [I,A];
 A61P0009-10 [I,A]
 CAS INDEXING IS AVAILABLE FOR THIS PATENT.

L4 ANSWER 10 OF 27 USPATFULL on STN
 AN 2011:97925 USPATFULL
 TI Methods for Treating Traumatic Brain Injury
 IN Bailes, Julian E., Morgantown, WV, UNITED STATES
 PI US 20110086914 A1 20110414
 AI US 2010-904045 A1 20101013 (12)
 PRAI US 2009-251234P 20091013 (61)
 DT Utility
 FS APPLICATION
 LN.CNT 2356
 INCL INCLM: 514/549.000
 INCLS: 514/560.000
 NCL NCLM: 514/549.000
 NCLS: 514/560.000
 IPC IPCI A61K0031-232 [I,A]; A61K0031-20 [I,A]; A61P0025-00 [I,A]
 IPCR A61K0031-232 [I,A]; A61K0031-20 [I,A]; A61P0025-00 [I,A]
 CAS INDEXING IS AVAILABLE FOR THIS PATENT.

L4 ANSWER 11 OF 27 USPATFULL on STN
 AN 2011:92475 USPATFULL
 TI Docosahexaenoic Acid Gel Caps
 IN PANKER, Cynthia A., Jessup, MD, UNITED STATES
 Billard, Michael Ames, Laurel, MD, UNITED STATES
 Ryan, Alan, Ellicott City, MD, UNITED STATES
 Dangi, Bindi, Elkridge, MD, UNITED STATES
 PI US 20110082205 A1 20110407
 AI US 2010-896763 A1 20101001 (12)
 PRAI US 2009-247944P 20091001 (61)
 DT Utility
 FS APPLICATION
 LN.CNT 2444
 INCL INCLM: 514/549.000
 NCL NCLM: 514/549.000
 IPC IPCI A61K0031-232 [I,A]; A61P0003-06 [I,A]
 IPCR A61K0031-232 [I,A]; A61P0003-06 [I,A]
 CAS INDEXING IS AVAILABLE FOR THIS PATENT.

L4 ANSWER 12 OF 27 USPATFULL on STN
 AN 2010:256169 USPATFULL
 TI PHOSPHOLIPID AND PROTEIN TABLETS
 IN Tilseth, Snorre, Bergen, NORWAY
 Hoem, Nils, Oslo, NORWAY
 PA AKER BIOMARINE ASA, Oslo, NORWAY (non-U.S. corporation)
 PI US 20100227792 A1 20100909
 AI US 2010-711822 A1 20100224 (12)

PRAI US 2009-155758P 20090226 (61)
DT Utility
FS APPLICATION
LN.CNT 3112
INCL INCLM: 514 2
NCL NCLM: 514/005.500
NCLS: 514/691.000
IPC IPCI A61K0038-02 [I,A]
IPCR A61K0038-02 [I,A]
CAS INDEXING IS AVAILABLE FOR THIS PATENT.

L4 ANSWER 13 OF 27 USPATFULL on STN
AN 2010:255355 USPATFULL
TI LOW VISCOSITY PHOSPHOLIPID COMPOSITIONS
IN Tilseth, Snorre, Bergen, NORWAY
PA AKER BIOMARINE ASA, Oslo, NORWAY (non-U.S. corporation)
PI US 20100226977 A1 20100909
AI US 2010-711553 A1 20100224 (12)
RLI Continuation-in-part of Ser. No. US 2008-201325, filed on 29 Aug 2008,
PENDING
PRAI US 2009-155767P 20090226 (61)
US 2007-968765P 20070829 (60)

DT Utility
FS APPLICATION
LN.CNT 2394
INCL INCLM: 424/456.000
INCLS: 426/601.000; 426/417.000; 514/078.000
NCL NCLM: 424/456.000
NCLS: 426/417.000; 426/601.000; 514/078.000
IPC IPCI A61K0031-685 [I,A]; A23D0009-00 [I,A]; A23D0009-02 [I,A];
A61K0009-48 [I,A]; A61P0009-00 [I,A]; A61P0019-00 [I,A];
A61P0029-00 [I,A]
IPCR A61K0031-685 [I,A]; A23D0009-00 [I,A]; A23D0009-02 [I,A];
A61K0009-48 [I,A]; A61P0009-00 [I,A]; A61P0019-00 [I,A];
A61P0029-00 [I,A]
CAS INDEXING IS AVAILABLE FOR THIS PATENT.

L4 ANSWER 14 OF 27 USPATFULL on STN
AN 2010:228249 USPATFULL
TI METHODS FOR IMPROVING COGNITIVE FUNCTION AND DECREASING HEART RATE
IN YURKO-MAURO, Karin, Silver Spring, MD, UNITED STATES
PA MARTEK BIOSCIENCES CORPORATION, Columbia, MD, UNITED STATES (U.S.
corporation)
PI US 20100203123 A1 20100812
AI US 2010-699009 A1 20100202 (12)
PRAI US 2009-149310P 20090202 (61)
US 2009-183548P 20090602 (61)

DT Utility
FS APPLICATION
LN.CNT 2358
INCL INCLM: 424/456.000
INCLS: 514/560.000; 514/549.000; 514/458.000
NCL NCLM: 424/456.000
NCLS: 514/458.000; 514/549.000; 514/560.000
IPC IPCI A61K0009-64 [I,A]; A61K0031-20 [I,A]; A61K0031-22 [I,A];
A61K0031-355 [I,A]; A61P0025-00 [I,A]; A61P0009-00 [I,A]
IPCR A61K0009-64 [I,A]; A61K0031-20 [I,A]; A61K0031-22 [I,A];
A61K0031-355 [I,A]; A61P0009-00 [I,A]; A61P0025-00 [I,A]
CAS INDEXING IS AVAILABLE FOR THIS PATENT.

L4 ANSWER 15 OF 27 USPATFULL on STN
AN 2010:161551 USPATFULL

TI PROCESS FOR PRODUCTION OF OMEGA-3 RICH MARINE PHOSPHOLIPIDS FROM KRILL
 IN Breivik, Harald, Porsgrunn, NORWAY
 PI US 20100143571 A1 20100610
 AI US 2007-515098 A1 20071115 (12)
 WO 2007-NO402 20071115
 20100217 PCT 371 date
 PRAI US 2006-859289P 20061116 (60)
 DT Utility
 FS APPLICATION
 LN.CNT 537
 INCL INCLM: 426/643.000
 INCLS: 426/417.000; 554/021.000; 568/366.000; 536/020.000
 NCL NCLM: 426/643.000
 NCLS: 426/417.000; 536/020.000; 554/021.000; 568/366.000
 IPC IPCI A23L0001-325 [I,A]; A23K0001-10 [I,A]; A23K0001-18 [I,A];
 C11B0001-10 [I,A]; C07C0045-78 [I,A]; C08B0037-08 [I,A]
 IPCR A23L0001-325 [I,A]; A23K0001-10 [I,A]; A23K0001-18 [I,A];
 C07C0045-78 [I,A]; C08B0037-08 [I,A]; C11B0001-10 [I,A]
 CAS INDEXING IS AVAILABLE FOR THIS PATENT.

L4 ANSWER 16 OF 27 USPATFULL on STN
 AN 2009:109974 USPATFULL
 TI Polyunsaturated Fatty Acid-Containing Solid Fat Compositions and Uses
 and Production Thereof
 IN Namal Senanayake, S.P. Janaka, Lexington, KY, UNITED STATES
 Ahmed, Naseer, Lexington, KY, UNITED STATES
 Fichtali, Jaouad, Lexington, KY, UNITED STATES
 PA Martek Biosciences Corporation, Columbia, MD, UNITED STATES (U.S.
 corporation)
 PI US 20090099260 A1 20090416
 AI US 2008-201728 A1 20080829 (12)
 PRAI US 2007-969536P 20070831 (60)
 DT Utility
 FS APPLICATION
 LN.CNT 2660
 INCL INCLM: 514/560.000
 INCLS: 426/601.000; 426/072.000
 NCL NCLM: 514/560.000
 NCLS: 426/072.000; 426/601.000
 IPC IPCI A61K0031-20 [I,A]; A23D0007-005 [I,A]; A23L0001-30 [I,A]
 IPCR A61K0031-20 [I,A]; A23D0007-005 [I,A]; A23L0001-30 [I,A]
 CAS INDEXING IS AVAILABLE FOR THIS PATENT.

L4 ANSWER 17 OF 27 USPATFULL on STN
 AN 2009:67318 USPATFULL
 TI METHOD FOR MAKING KRILL MEAL
 IN Tilseth, Snorre, Bergen, NORWAY
 Hostmark, Oistein, Loddefjord, NORWAY
 PA Aker BioMarine ASA, Oslo, NORWAY (non-U.S. corporation)
 PI US 20090061067 A1 20090305
 AI US 2008-201325 A1 20080829 (12)
 PRAI US 2007-968765P 20070829 (60)
 DT Utility
 FS APPLICATION
 LN.CNT 2307
 INCL INCLM: 426/602.000
 INCLS: 426/417.000; 210/149.000; 426/480.000; 426/609.000; 426/648.000;
 426/608.000; 366/145.000; 366/147.000
 NCL NCLM: 426/602.000
 NCLS: 210/149.000; 366/145.000; 366/147.000; 426/417.000; 426/480.000;
 426/608.000; 426/609.000; 426/648.000
 IPC IPCI A23D0007-005 [I,A]; A23D0007-02 [I,A]; A23D0007-04 [I,A];

A23L0001-29 [I,A]; B01F0015-06 [I,A]; A23L0001-33 [I,A];
A23L0001-326 [I,A]; B01D0021-30 [I,A]
IPCR A23D0007-005 [I,A]; A23D0007-02 [I,A]; A23D0007-04 [I,A];
A23L0001-29 [I,A]; A23L0001-326 [I,A]; A23L0001-33 [I,A];
B01D0021-30 [I,A]; B01F0015-06 [I,A]

CAS INDEXING IS AVAILABLE FOR THIS PATENT.

L4 ANSWER 18 OF 27 USPATFULL on STN
AN 2006:254989 USPATFULL
TI Natural astaxanthin extract reduces dna oxidation
IN Chew, Boon P., Pullman, WA, UNITED STATES
Park, Jean Soon, Pullman, WA, UNITED STATES
PI US 20060217445 A1 20060928
AI US 2004-565717 A1 20040726 (10)
WO 2004-US24314 20040726
20060123 PCT 371 date
PRAI US 2003-490121P 20030725 (60)
DT Utility
FS APPLICATION
LN.CNT 1366
INCL INCLM: 514/690.000
INCLS: 514/763.000; 514/560.000
NCL NCLM: 514/690.000
NCLS: 514/560.000; 514/763.000
IPC IPCI A61K0031-12 [I,A]; A61K0031-015 [I,A]
IPCR A61K0031-12 [I,A]; A61K0031-015 [I,A]
CAS INDEXING IS AVAILABLE FOR THIS PATENT.

L4 ANSWER 19 OF 27 USPATFULL on STN
AN 2006:227598 USPATFULL
TI Preventive or remedy for arthritis
IN Kamiya, Toshikazu, Ibaraki, JAPAN
Nakagiri, Ryusuke, Chapel Hill, NC, UNITED STATES
PA Kyowa Hakko Kogyo Co., Ltd., Tokyo, JAPAN, 100-8185 (non-U.S.
corporation)
PI US 20060193962 A1 20060831
AI US 2004-552526 A1 20040409 (10)
WO 2004-JP5115 20040409
20051011 PCT 371 date
PRAI JP 2003-107405 20030411
DT Utility
FS APPLICATION
LN.CNT 1047
INCL INCLM: 426/615.000
NCL NCLM: 426/615.000
IPC IPCI A23L0001-212 [I,A]
IPCR A23L0001-212 [I,A]; A23K0001-14 [I,A]; A23K0001-16 [I,A];
A23L0001-30 [I,A]; A61K0031-7008 [I,A]; A61K0031-726 [I,A];
A61K0036-00 [I,A]; A61K0036-185 [I,A]; A61P0019-02 [I,A]
CAS INDEXING IS AVAILABLE FOR THIS PATENT.

L4 ANSWER 20 OF 27 USPATFULL on STN
AN 2004:209092 USPATFULL
TI Process for producing a plant extract containing plant powder
IN Sakai, Yasushi, Tsukuba-shi, JAPAN
Yokoo, Yoshiharu, Sagamihara-shi, JAPAN
PI US 20040161524 A1 20040819
US 7521079 B2 20090421
AI US 2003-481519 A1 20031219 (10)
WO 2002-JP6226 20020621
PRAI JP 2001-188480 20010621
DT Utility

FS APPLICATION
LN.CNT 1479
INCL INCLM: 426/655.000
NCL NCLM: 426/655.000
NCLS: 426/433.000; 426/594.000; 426/597.000
IPC [7]
IPCI A23L0001-28 [ICM,7]
IPCI-2 A23L0001-28 [I,A]
IPCR A23L0001-28 [I,A]; A23K0001-14 [I,A]; A23K0001-16 [I,A];
A23L0001-30 [I,A]; A61K0036-185 [I,A]

L4 ANSWER 21 OF 27 USPATFULL on STN
AN 2004:209046 USPATFULL
TI Preventives or remedies for arthritis
IN Nakagiri, Rysuke, Tokyo, JAPAN
Kamiya, Toshikazu, Tsuchiura-shi, JAPAN
Suda, Toshio, Sunto-gun, JAPAN
Miki, Ichiro, Mishima-shi, JAPAN
PI US 20040161478 A1 20040819
AI US 2003-480044 A1 20031209 (10)
WO 2002-JP5790 20020611
PRAI JP 2001-181947 20010615
JP 2002-70702 20020314

DT Utility
FS APPLICATION
LN.CNT 1301
INCL INCLM: 424/725.000
NCL NCLM: 424/725.000
IPC [7]
IPCI A61K0035-78 [ICM,7]
IPCR A21D0002-36 [I,A]; A21D0013-08 [I,A]; A23K0001-14 [I,A];
A23K0001-16 [I,A]; A23L0001-30 [I,A]; A61K0036-185 [I,A];
A61P0019-02 [I,A]; A61P0029-00 [I,A]

L4 ANSWER 22 OF 27 USPATFULL on STN
AN 2004:159281 USPATFULL
TI Liver funcion protecting or ameliorating agent
IN Sakai, Yasushi, Tsukuba-shi, JAPAN
Kayahashi, Shun, Tsukuba-shi, JAPAN
Hashizume, Erika, Tsukuba-shi, JAPAN
Nakagiri, Ryusuke, Tokyo, JAPAN
PI US 20040122085 A1 20040624
US 7332522 B2 20080219
AI US 2003-473867 A1 20031003 (10)
WO 2002-JP3098 20020328

DT Utility
FS APPLICATION
LN.CNT 1146
INCL INCLM: 514/470.000
NCL NCLM: 514/457.000; 514/470.000
NCLS: 514/470.000; 549/283.000
IPC [7]
IPCI A61K0031-365 [ICM,7]
IPCI-2 A61K0031-34 [I,A]; A61K0031-343 [I,A]
IPCR A61K0031-34 [I,A]; A23L0001-30 [I,A]; A61K0031-343 [I,A];
A61K0031-365 [I,A]; A61K0031-366 [I,A]; A61P0001-16 [I,A];
C07D0307-88 [I,A]; C07D0311-76 [I,A]

CAS INDEXING IS AVAILABLE FOR THIS PATENT.

L4 ANSWER 23 OF 27 USPATFULL on STN
AN 2003:64375 USPATFULL
TI Processes for extracting carotenoids and for preparing feed materials

IN Kagan, Michael, Jerusalem, ISRAEL
Braun, Sergei, Zur Hadassa, ISRAEL
PI US 20030044495 A1 20030306
US 6818239 B2 20041116
AI US 2002-172747 A1 20020617 (10)
RLI Continuation of Ser. No. WO 2000-IL846, filed on 18 Dec 2000, UNKNOWN
PRAI GB 1999-30194 19991221
DT Utility
FS APPLICATION
LN.CNT 526
INCL INCLM: 426/250.000
NCL NCLM: 426/429.000; 426/250.000
NCLS: 426/250.000; 426/253.000; 426/431.000; 426/478.000; 426/540.000
IPC [7]
IPCI A23L0001-27 [ICM,7]
IPCI-2 A23L0001-28 [ICM,7]; A23L0001-27 [ICS,7]
IPCR A23L0001-27 [I,A]; A23L0001-275 [I,A]; C07C0403-00 [I,A];
C07C0403-24 [I,A]; C09B0061-00 [I,A]
CAS INDEXING IS AVAILABLE FOR THIS PATENT.

L4 ANSWER 24 OF 27 USPATFULL on STN
AN 2002:205917 USPATFULL
TI Liver function protecting or improving agent
IN Nakagiri, Ryusuke, Tsukuba-shi, JAPAN
Kamiya, Toshikazu, Tsukuba-shi, JAPAN
Hashizume, Erika, Tsukuba-shi, JAPAN
Sakai, Yasushi, Inashiki-gun, JAPAN
Kayahashi, Shun, Tsukuba-shi, JAPAN
PI US 20020110605 A1 20020815
AI US 2001-10154 A1 20011210 (10)
PRAI JP 2000-375510 20001211
DT Utility
FS APPLICATION
LN.CNT 1786
INCL INCLM: 424/725.000
NCL NCLM: 424/725.000
IPC [7]
IPCI A61K0035-78 [ICM,7]
IPCR A21D0002-36 [I,A]; A21D0013-08 [I,A]; A23K0001-14 [I,A];
A23K0001-16 [I,A]; A23L0001-212 [I,A]; A23L0001-30 [I,A];
A61K0036-185 [I,A]; A61P0001-16 [I,A]
CAS INDEXING IS AVAILABLE FOR THIS PATENT.

L4 ANSWER 25 OF 27 USPAT2 on STN
AN 2004:209092 USPAT2
TI Process for producing an extract of Hydrangea containing plant powder
IN Sakai, Yasushi, Tsukuba, JAPAN
Yokoo, Yoshiharu, Sagamihara, JAPAN
PA Kyowa Hakko Kogyo Co., Ltd., Tokyo, JAPAN (non-U.S. corporation)
PI US 7521079 B2 20090421
WO 2003000074 20030301
AI US 2002-481519 20020621 (10)
WO 2002-JP6226 20020621
20031219 PCT 371 date
PRAI JP 2001-188480 20010621
DT Utility
FS GRANTED
LN.CNT 1371
INCL INCLM: 426/655.000
INCLS: 426/594.000; 426/597.000; 426/433.000
NCL NCLM: 426/655.000
NCLS: 426/433.000; 426/594.000; 426/597.000

IPC IPCI A23L0001-28 [ICM,7]
IPCI-2 A23L0001-28 [I,A]
IPCR A23L0001-28 [I,A]; A23K0001-14 [I,A]; A23K0001-16 [I,A];
A23L0001-30 [I,A]; A61K0036-185 [I,A]
EXF 426/597; 426/433; 426/594

L4 ANSWER 26 OF 27 USPAT2 on STN
AN 2004:159281 USPAT2
TI Liver function protecting or ameliorating agent
IN Sakai, Yasushi, Tsukuba, JAPAN
Kayahashi, Shun, Tsukuba, JAPAN
Hashizume, Erika, Tsukuba, JAPAN
Nakagiri, Ryusuke, Tokyo, JAPAN
PA Kyowa Hakko Kogyo Co., Ltd., Tokyo, JAPAN (non-U.S. corporation)
PI US 7332522 B2 20080219
WO 2002080904 20021017
AI US 2002-473867 20020328 (10)
WO 2002-JP3098 20020328
20031003 PCT 371 date
PRAI JP 2001-106600 20010405
DT Utility
FS GRANTED
LN.CNT 1099
INCL INCLM: 514/457.000
INCLS: 514/470.000; 549/283.000
NCL NCLM: 514/457.000; 514/470.000
NCLS: 514/470.000; 549/283.000
IPC IPCI A61K0031-365 [ICM,7]
IPCI-2 A61K0031-34 [I,A]; A61K0031-343 [I,A]
IPCR A61K0031-34 [I,A]; A23L0001-30 [I,A]; A61K0031-343 [I,A];
A61K0031-365 [I,A]; A61K0031-366 [I,A]; A61P0001-16 [I,A];
C07D0307-88 [I,A]; C07D0311-76 [I,A]
EXF 549/283; 549/290; 549/307; 549/289; 514/457; 514/470
CAS INDEXING IS AVAILABLE FOR THIS PATENT.

L4 ANSWER 27 OF 27 USPAT2 on STN
AN 2003:64375 USPAT2
TI Processes for extracting carotenoids and for preparing feed materials
IN Kagan, Michael, Jerusalem, ISRAEL
Braun, Sergei, Zur Hadassa, ISRAEL
PA Fermentron Ltd., Jerusalem, ISRAEL (non-U.S. corporation)
PI US 6818239 B2 20041116
AI US 2002-172747 20020617 (10)
RLI Continuation of Ser. No. WO 2000-IL846, filed on 18 Dec 2000
PRAI GB 1999-30194 19991221
DT Utility
FS GRANTED
LN.CNT 501
INCL INCLM: 426/429.000
INCLS: 426/431.000; 426/478.000; 426/250.000; 426/253.000; 426/540.000
NCL NCLM: 426/429.000; 426/250.000
NCLS: 426/250.000; 426/253.000; 426/431.000; 426/478.000; 426/540.000
IPC [7]
IPCI A23L0001-27 [ICM,7]
IPCI-2 A23L0001-28 [ICM,7]; A23L0001-27 [ICS,7]
IPCR A23L0001-27 [I,A]; A23L0001-275 [I,A]; C07C0403-00 [I,A];
C07C0403-24 [I,A]; C09B0061-00 [I,A]
EXF 426/807; 426/250; 426/253; 426/635; 426/425; 426/429; 426/430; 426/431;
426/478; 426/540; 424/439; 424/451
CAS INDEXING IS AVAILABLE FOR THIS PATENT.

=> d hist

(FILE 'HOME' ENTERED AT 15:15:33 ON 03 JAN 2012)

INDEX 'ADISCTI, ADISINSIGHT, ADISNEWS, AGRICOLA, ANABSTR, ANTE, AQUALINE, AQUASCI, BIOENG, BIOSIS, BIOTECHABS, BIOTECHDS, BIOTECHNO, CABA, CAPLUS, CEABA-VTB, CIN, CONFSCI, CROPB, CROPU, DDFB, DDFU, DGENE, DISSABS, DRUGB, DRUGU, EMBAL, EMBASE, ESBIOBASE, ...' ENTERED AT 15:15:47 ON 03 JAN 2012
SEA KRILL AND OIL AND MEAL AND SUPERCRITICAL(P)EXTRACT? AND SOL

0* FILE ADISNEWS
0* FILE ANTE
0* FILE AQUALINE
0* FILE BIOENG
0* FILE BIOTECHABS
0* FILE BIOTECHDS
0* FILE BIOTECHNO
0* FILE CEABA-VTB
0* FILE CIN
0* FILE FOMAD
0* FILE FROSTI
0* FILE FSTA
1 FILE IFIPAT
0* FILE KOSMET
0* FILE NTIS
0* FILE PASCAL
28 FILE USPATFULL
4 FILE USPAT2
0* FILE WATER
1 FILE WPIDS
1 FILE WPINDEX

L1 QUE KRILL AND OIL AND MEAL AND SUPERCRITICAL(P)EXTRACT? AND SOL

FILE 'IFIPAT, USPATFULL, USPAT2' ENTERED AT 15:19:01 ON 03 JAN 2012

L2 33 S L1
L3 32 DUP REM L2 (1 DUPLICATE REMOVED)
L4 27 S L3 AND DIOXIDE

=> logoff

ALL L# QUERIES AND ANSWER SETS ARE DELETED AT LOGOFF

LOGOFF? (Y)/N/HOLD:y

COST IN U.S. DOLLARS

SINCE FILE TOTAL

ENTRY SESSION

FULL ESTIMATED COST

43.57 47.51

STN INTERNATIONAL LOGOFF AT 15:21:58 ON 03 JAN 2012

Connecting via Winsock to STN at pto-stn on port 23

Welcome to STN International! Enter x:X

LOGINID:ssspt189dxw

PASSWORD:

TERMINAL (ENTER 1, 2, 3, OR ?):2

* * * * * Welcome to STN International * * * * *

NEWS 1 FEB 1 Instructor-led and on-demand STN training options available from CAS

NEWS 2 AUG 01 CA Sections Added to ACS Publications Web Editions Platform

NEWS 3 AUG 16 INPADOC: Coverage of German Patent Data resumed, enhanced legal status

NEWS 4 AUG 18 Upgrade now to STN Express, Version 8.5

NEWS 5 SEP 01 CAS Journal Coverage Now Includes Ahead-of-Print Articles for More Than 100 Journal Titles

NEWS 6 SEP 01 Older Versions of STN Express to be Discontinued Beginning in March 2012

NEWS 7 SEP 09 USAN Database Updates Offer Superior Currency on STN(R)

NEWS 8 SEP 26 STN Adds Canadian Patent Full-text Database - CANPATFULL

NEWS 9 SEP 26 GEOREF and ENCOMPLIT databases were reloaded on September 24, 2011.

NEWS 10 SEP 26 Updates to the IFIPAT/IFIUDB/IFICDB databases have resumed.

NEWS 11 SEP 26 ECLA Thesaurus in CA/CAPLUS Improves Patent Searching on STN

NEWS 12 SEP 26 Access AUPATFULL and CANPATFULL databases with STN Viewer

NEWS 13 OCT 26 New STN Revolutionizes Patent Searching for Professionals

NEWS 14 DEC 1 CA/CAPLUS Now Includes Examiner Citations for Japanese Patents

NEWS 15 DEC 1 CAS Expands Global Patent Coverage - Intellectual Property Corporation of Malaysia Becomes 62nd Authority on CA/CAPLUS

NEWS 16 DEC 5 STN on the Web Enhancements Include Compatibility with Microsoft Windows 7

NEWS 17 DEC 14 Removal of ITRD and PATIPC databases from STN

NEWS 18 DEC 15 Rolled-up IPC Core Codes Removed from IPC Reclassifications in Patent Databases on STN

NEWS 19 JAN 12 Structure Graphics Have Been Added to Abstracts for MARPAT and CA/CAPLUS on STN

NEWS 20 JAN 15 Online Access to Very Large Chemical Structure Images Enhanced on STN

NEWS 21 JAN 26 IFICLS Updates Resume on STN

NEWS 22 JAN 31 MEDLINE Reload - Updated MeSH Vocabulary and Two New Fields on STN

NEWS 23 FEB 1 INPADOC Databases Enhanced with Japanese Patent Classifications, Current U.S. Classification and Japanese Legal Status.

NEWS 24 FEB 3 Access More Than 32,000 Harmonized Tariff Codes Now in CHEMLIST on STN

NEWS 25 FEB 13 PCTFULL Documents with Non-Latin Filing Language Enhanced with English Machine Translations

NEWS 26 FEB 28 REACH List of Registered Substances Now in CHEMLIST on STN

NEWS 27 MAR 12 RTECS Database on STN Enhanced with Aquatic and In Vitro Exposure Toxicity Data

NEWS 28 MAR 12 MARPAT Database Enhanced with Additional Markush Backfile Content for STN

NEWS 29 MAR 19 The 1MOBILITY and 2MOBILITY databases were reloaded on March 18, 2012

NEWS 30 MAR 19 STN Adds Chinese Patent Full Text Database - CNFULL

NEWS 31 MAR 19 Get the Content You Need Sooner with ePub Ahead of Print Records Available in MEDLINE on STN!

NEWS 32 MAR 30 NAPRALERT Updated with More Natural Products Information

NEWS 33 APR 9 CAS Expands Global Patent Coverage - The Eurasian Patent Organization Becomes 63rd Authority on CA/CAPLUS

NEWS 34 APR 16 DWPI Database (WPINDEX, WPIDS, WPIX) Enhanced with Numerical Property Search Feature

NEWS 35 APR 23 RSS Delivery for STN Alerts (SDIs) is Now Available on STN

NEWS 36 MAY 9 INIS, BABS and GMELIN97 Databases Removed from STN

NEWS 37 MAY 21 Reload of FSTA Database

NEWS 38 MAY 21 Search DOIs in CA/CAplus on STN
NEWS 39 MAY 23 Get the Latest Version of STN Express, Version 8.5.1!

NEWS EXPRESS 23 MAY 2012 CURRENT WINDOWS VERSION IS V8.5.1,
AND CURRENT DISCOVER FILE IS DATED 19 APRIL 2012.

NEWS HOURS STN Operating Hours Plus Help Desk Availability
NEWS LOGIN Welcome Banner and News Items
NEWS TRAINING Find instructor-led and self-directed training opportunities

Enter NEWS followed by the item number or name to see news on that specific topic.

All use of STN is subject to the provisions of the STN customer agreement. This agreement limits use to scientific research. Use for software development or design, implementation of commercial gateways, or use of CAS and STN data in the building of commercial products is prohibited and may result in loss of user privileges and other penalties.

* * * * * STN Columbus * * * * *

FILE 'HOME' ENTERED AT 14:50:46 ON 29 MAY 2012

=> index bioscience
COST IN U.S. DOLLARS

SINCE FILE	TOTAL
ENTRY	SESSION
0.24	0.24

FULL ESTIMATED COST

INDEX 'ADISCTI, ADISINSIGHT, ADISNEWS, AGRICOLA, ANABSTR, ANTE, AQUALINE, AQUASCI, BIOENG, BIOSIS, BIOTECHABS, BIOTECHDS, BIOTECHNO, CABA, CAPLUS, CEABA-VTB, CIN, CONFSCI, CROPB, CROPU, DDFB, DDFU, DGENE, DISSABS, DRUGB, DRUGU, EMBAL, EMBASE, ESBIODBASE, ...' ENTERED AT 14:51:15 ON 29 MAY 2012

56 FILES IN THE FILE LIST IN STNINDEX

Enter SET DETAIL ON to see search term postings or to view search error messages that display as 0* with SET DETAIL OFF.

=> s krill and oil and cook? and dry?(p)krill and krill(p)meal and extract?(p)krill(p)oil

- 0* FILE ADISNEWS
- 0* FILE ANTE
- 0* FILE AQUALINE
- 0* FILE BIOENG
- 0* FILE BIOTECHABS
- 0* FILE BIOTECHDS
- 0* FILE BIOTECHNO
- 0* FILE CEABA-VTB
- 0* FILE CIN

29 FILES SEARCHED...

- 0* FILE FOMAD
- 0* FILE FROSTI
- 3 FILE IFIPAT
- 0* FILE KOSMET
- 0* FILE NTIS
- 0* FILE PASCAL
- 9 FILE USPATFULL

50 FILES SEARCHED...

- 3 FILE USPAT2
- 0* FILE WATER

4 FILE WPIDS
4 FILE WPINDEX

5 FILES HAVE ONE OR MORE ANSWERS, 56 FILES SEARCHED IN STNINDEX

L1 QUE KRILL AND OIL AND COOK? AND DRY?(P)KRILL AND KRILL(P)MEAL AND EXTRACT?
(P)KRILL(P)OIL

=> file ifipat uspatfull uspat2
COST IN U.S. DOLLARS

	SINCE FILE	TOTAL
	ENTRY	SESSION
FULL ESTIMATED COST	1.48	1.72

FILE 'IFIPAT' ENTERED AT 14:52:35 ON 29 MAY 2012
COPYRIGHT (C) 2012 IFI CLAIMS(R) Patent Services (IFI)

FILE 'USPATFULL' ENTERED AT 14:52:35 ON 29 MAY 2012
CA INDEXING COPYRIGHT (C) 2012 AMERICAN CHEMICAL SOCIETY (ACS)

FILE 'USPAT2' ENTERED AT 14:52:35 ON 29 MAY 2012
CA INDEXING COPYRIGHT (C) 2012 AMERICAN CHEMICAL SOCIETY (ACS)

=> s l1
L2 15 L1

=> dup rem l2
PROCESSING COMPLETED FOR L2
L3 13 DUP REM L2 (2 DUPLICATES REMOVED)

=> d l3 1-13

L3 ANSWER 1 OF 13 IFIPAT COPYRIGHT 2012 IFI on STN DUPLICATE 1
AN 12887434 IFIPAT;IFIUDB;IFICDB
TI SOLVENT-FREE PROCESS FOR OBTAINING PHOSPHOLIPIDS AND NEUTRAL ENRICHED
KRILL OILS
IN Sclabos Katevas Dimitri (CL); Toro Guerra Raul R (CL); Chiong Lay Mario M
(CL)
PA THAROS LTD CL
LONZA LTD CH
(50035)
PI US 20110224450 A1 20110915
AI US 2011-96644 20110428 (13)
RLI WO 2009-IB7269 20091030 CONTINUATION-IN-PART PENDING
FI US 20110224450 20110915
DT Utility; Patent Application - First Publication
FS CHEMICAL
APPLICATION
ED Entered STN: 21 Oct 2011
Last Updated on STN: 13 Jan 2012
CLMN 25

L3 ANSWER 2 OF 13 USPAT2 on STN
AN 2007:272601 USPAT2
TI Gels, gel composites, and gel articles
IN Chen, John Y., Hillsborough, CA, UNITED STATES
PA Applied Elastomerics, Inc., South San Francisco, CA, UNITED STATES (U.S.
corporation)
PI US 7930782 B2 20110426
AI US 2007-810584 20070605 (11)
RLI Continuation-in-part of Ser. No. US 2007-787257, filed on 12 Apr 2007,
Pat. No. US 7661164 Continuation-in-part of Ser. No. US 2004-912464,
filed on 4 Aug 2004, Pat. No. US 7226484 Continuation-in-part of Ser.

No. US 2002-420489, filed on 21 Apr 2002, Pat. No. US 7222380
Continuation-in-part of Ser. No. US 2003-420492, filed on 21 Apr 2003,
Pat. No. US 7344568 Continuation-in-part of Ser. No. US 2000-721213,
filed on 21 Nov 2000, Pat. No. US 6867253

DT Utility
FS GRANTED
LN.CNT 5886
INCL INCLM: 005/655.500
INCLS: 005/636.000; 005/652.000; 005/654.000; 005/909.000; 602/041.000;
602/061.000; 602/062.000; 602/063.000; 623/016.110; 623/020.140;
623/021.110; 623/023.400; 623/027.000; 623/033.000; 623/036.000;
524/270.000; 524/284.000; 524/490.000; 524/491.000; 524/549.000;
524/571.000; 524/575.000; 521/050.000; 521/054.000; 521/139.000;
521/140.000; 521/148.000
NCL NCLM: 005/655.500; 525/240.000
NCLS: 005/636.000; 005/652.000; 005/654.000; 005/909.000; 521/050.000;
521/054.000; 521/139.000; 521/140.000; 521/148.000; 524/270.000;
524/284.000; 524/490.000; 524/491.000; 524/549.000; 524/571.000;
524/575.000; 602/041.000; 602/061.000; 602/062.000; 602/063.000;
623/016.110; 623/020.140; 623/021.110; 623/023.400; 623/027.000;
623/033.000; 623/036.000
IPC IPCI C08L0023-16 [I,A]
IPCI-2 B29C0067-20 [I,A]; B60R0021-26 [I,A]; A61F0002-80 [I,A];
B60K0028-00 [I,A]; A47C0007-00 [I,A]
IPCR B29C0067-20 [I,A]; A47C0007-00 [I,A]; A61F0002-80 [I,A];
B60K0028-00 [I,A]; B60R0021-26 [I,A]
CAS INDEXING IS AVAILABLE FOR THIS PATENT.

L3 ANSWER 3 OF 13 USPATFULL on STN
AN 2010:256169 USPATFULL
TI PHOSPHOLIPID AND PROTEIN TABLETS
IN Tilseth, Snorre, Bergen, NORWAY
Hoem, Nils, Oslo, NORWAY
PA AKER BIOMARINE ASA, Oslo, NORWAY (non-U.S. corporation)
PI US 20100227792 A1 20100909
AI US 2010-711822 A1 20100224 (12)
PRAI US 2009-155758P 20090226 (61)
DT Utility
FS APPLICATION
LN.CNT 3112
INCL INCLM: 514 2
NCL NCLM: 514/005.500
NCLS: 514/691.000
IPC IPCI A61K0038-02 [I,A]
IPCR A61K0038-02 [I,A]
CAS INDEXING IS AVAILABLE FOR THIS PATENT.

L3 ANSWER 4 OF 13 USPATFULL on STN
AN 2010:255355 USPATFULL
TI LOW VISCOSITY PHOSPHOLIPID COMPOSITIONS
IN Tilseth, Snorre, Bergen, NORWAY
PA AKER BIOMARINE ASA, Oslo, NORWAY (non-U.S. corporation)
PI US 20100226977 A1 20100909
AI US 2010-711553 A1 20100224 (12)
RLI Continuation-in-part of Ser. No. US 2008-201325, filed on 29 Aug 2008,
PENDING
PRAI US 2009-155767P 20090226 (61)
US 2007-968765P 20070829 (60)
DT Utility
FS APPLICATION
LN.CNT 2394
INCL INCLM: 424/456.000

INCLS: 426/601.000; 426/417.000; 514/078.000
NCL NCLM: 424/456.000
NCLS: 426/417.000; 426/601.000; 514/078.000
IPC IPCI A61K0031-685 [I,A]; A23D0009-00 [I,A]; A23D0009-02 [I,A];
A61K0009-48 [I,A]; A61P0009-00 [I,A]; A61P0019-00 [I,A];
A61P0029-00 [I,A]
IPCR A61K0031-685 [I,A]; A23D0009-00 [I,A]; A23D0009-02 [I,A];
A61K0009-48 [I,A]; A61P0009-00 [I,A]; A61P0019-00 [I,A];
A61P0029-00 [I,A]
CAS INDEXING IS AVAILABLE FOR THIS PATENT.

L3 ANSWER 5 OF 13 IFIPAT COPYRIGHT 2012 IFI on STN DUPLICATE 2
AN 12061067 IFIPAT;IFIUDB;IFICDB
TI METHOD FOR MAKING KRILL MEAL
IN Hostmark Oistein (NO); Tilseth Snorre (NO)
PA Aker BioMarine ASA NO (79725)
PI US 20090061067 A1 20090305
AI US 2008-201325 20080829 (12)
PRAI US 2007-968765P 20070829 (Provisional)
FI US 20090061067 20090305
DT Utility; Patent Application - First Publication
FS CHEMICAL
APPLICATION
ED Entered STN: 10 Mar 2009
Last Updated on STN: 9 Apr 2009
CLMN 51

L3 ANSWER 6 OF 13 USPATFULL on STN
AN 2008:312554 USPATFULL
TI BIOEFFECTIVE KRILL OIL COMPOSITIONS
IN Bruheim, Inge, Volda, NORWAY
Griinari, Mikko, Espoo, FINLAND
Tilseth, Snorre, Bergen, NORWAY
Banni, Sebastiano, Cagliari, ITALY
Cohn, Jeffrey Stuart, Camperdown, AUSTRALIA
Mancinelli, Daniele, Orsta, NORWAY
PA AKER BIOMARINE ASA, Oslo, NORWAY (non-U.S. corporation)
PI US 20080274203 A1 20081106
AI US 2008-57775 A1 20080328 (12)
PRAI US 2007-920483P 20070328 (60)
US 2007-975058P 20070925 (60)
US 2007-983446P 20071029 (60)
US 2008-24072P 20080128 (61)

DT Utility
FS APPLICATION
LN.CNT 2199
INCL INCLM: 424/522.000
INCLS: 514/121.000; 514/078.000; 514/114.000; 426/601.000
NCL NCLM: 424/522.000
NCLS: 426/601.000; 514/078.000; 514/114.000; 514/121.000
IPC IPCI A61K0035-56 [I,A]; A61K0031-661 [I,A]; A61K0031-685 [I,A];
A61P0003-02 [I,A]; A23D0009-00 [I,A]; A61K0031-66 [I,A]
IPCR A61K0035-56 [I,A]; A23D0009-00 [I,A]; A61K0031-66 [I,A];
A61K0031-661 [I,A]; A61K0031-685 [I,A]; A61P0003-02 [I,A]
CAS INDEXING IS AVAILABLE FOR THIS PATENT.

L3 ANSWER 7 OF 13 USPATFULL on STN
AN 2007:272601 USPATFULL
TI Gels, gel composites, and gel articles
IN Chen, John Y., Hillsborough, CA, UNITED STATES
PI US 20070238835 A1 20071011
US 7930782 B2 20110426

AI US 2007-810584 A1 20070605 (11)
 RLI Continuation-in-part of Ser. No. US 2007-787257, filed on 12 Apr 2007,
 PENDING Continuation-in-part of Ser. No. US 2004-912464, filed on 4 Aug
 2004, GRANTED, Pat. No. US 7226484 Continuation-in-part of Ser. No. US
 2003-613567, filed on 2 Jul 2003, GRANTED, Pat. No. US 7093316
 Continuation-in-part of Ser. No. US 2003-420489, filed on 21 Apr 2003,
 GRANTED, Pat. No. US 7222380 Continuation-in-part of Ser. No. US
 2003-420487, filed on 21 Apr 2003, GRANTED, Pat. No. US 7193002
 Continuation-in-part of Ser. No. US 2003-420488, filed on 21 Apr 2003,
 GRANTED, Pat. No. US 7134929 Continuation-in-part of Ser. No. US
 2003-420490, filed on 21 Apr 2003, GRANTED, Pat. No. US 7105607
 Continuation-in-part of Ser. No. US 2003-420491, filed on 21 Apr 2003,
 GRANTED, Pat. No. US 7093599 Continuation-in-part of Ser. No. US
 2003-420492, filed on 21 Apr 2003, PENDING Continuation-in-part of Ser.
 No. US 2003-420493, filed on 21 Apr 2003, GRANTED, Pat. No. US 7067583
 Continuation-in-part of Ser. No. US 2004-896047, filed on 22 Jul 2004,
 PENDING Continuation-in-part of Ser. No. US 2002-273828, filed on 17 Oct
 2002, GRANTED, Pat. No. US 6909220 Continuation-in-part of Ser. No. US
 2002-334542, filed on 31 Dec 2002, GRANTED, Pat. No. US 7159259
 Continuation-in-part of Ser. No. US 2002-299073, filed on 18 Nov 2002,
 ABANDONED Continuation-in-part of Ser. No. US 2002-199364, filed on 20
 Jul 2002, GRANTED, Pat. No. US 6794440 Continuation-in-part of Ser. No.
 US 2002-199361, filed on 20 Jul 2002, GRANTED, Pat. No. US 7134236
 Continuation-in-part of Ser. No. US 2002-199362, filed on 20 Jul 2002,
 GRANTED, Pat. No. US 7208184 Continuation-in-part of Ser. No. US
 2002-199363, filed on 20 Jul 2002, GRANTED, Pat. No. US 7108873
 Continuation-in-part of Ser. No. US 2000-721213, filed on 21 Nov 2000,
 GRANTED, Pat. No. US 6867253 Continuation-in-part of Ser. No. US
 1998-130545, filed on 8 Aug 1998, GRANTED, Pat. No. US 6627275
 Continuation-in-part of Ser. No. US 1999-230940, filed on 3 Feb 1999,
 GRANTED, Pat. No. US 6161555 Continuation-in-part of Ser. No. US
 1997-863794, filed on 27 May 1997, GRANTED, Pat. No. US 6117176
 PRAI JP 2003-204428 20030731
 WO 1994-US4278 19940419
 WO 1994-US7314 19940627
 DT Utility
 FS APPLICATION
 LN.CNT 5757
 INCL INCLM: 525/240.000
 NCL NCLM: 005/655.500; 525/240.000
 NCLS: 005/636.000; 005/652.000; 005/654.000; 005/909.000; 521/050.000;
 521/054.000; 521/139.000; 521/140.000; 521/148.000; 524/270.000;
 524/284.000; 524/490.000; 524/491.000; 524/549.000; 524/571.000;
 524/575.000; 602/041.000; 602/061.000; 602/062.000; 602/063.000;
 623/016.110; 623/020.140; 623/021.110; 623/023.400; 623/027.000;
 623/033.000; 623/036.000
 IPC IPCI C08L0023-16 [I,A]
 IPCI-2 B29C0067-20 [I,A]; B60R0021-26 [I,A]; A61F0002-80 [I,A];
 B60K0028-00 [I,A]; A47C0007-00 [I,A]
 IPCR B29C0067-20 [I,A]; A47C0007-00 [I,A]; A61F0002-80 [I,A];
 B60K0028-00 [I,A]; B60R0021-26 [I,A]
 CAS INDEXING IS AVAILABLE FOR THIS PATENT.
 L3 ANSWER 8 OF 13 USPAT2 on STN
 AN 2004:24434 USPAT2
 TI Gelatinous food elastomer compositions and articles for use as fishing
 bait
 IN Chen, John Y., Pacifica, CA, UNITED STATES
 PA Applied Elastomerics, Inc., South San Francisco, CA, UNITED STATES (U.S.
 corporation)
 PI US 7208184 B2 20070424
 AI US 2002-199362 20020720 (10)

DT Utility
FS GRANTED
LN.CNT 4932
INCL INCLM: 426/001.000
INCLS: 043/042.000; 043/042.240; 424/084.000
NCL NCLM: 426/001.000
NCLS: 043/042.000; 043/042.240; 424/084.000
IPC IPCI A23L0001-00 [ICM,7]
IPCI-2 A23L0001-00 [I,A]
IPCR A23L0001-00 [I,A]; A01K0085-01 [I,A]; A01K0097-04 [I,A]
EXF 426/1; 043/42; 043/42.24; 424/84
CAS INDEXING IS AVAILABLE FOR THIS PATENT.

L3 ANSWER 9 OF 13 USPAT2 on STN
AN 2004:24385 USPAT2
TI Gelatinous food elastomer compositions and articles
IN Chen, John Y., Pacifica, CA, UNITED STATES
PA Applied Elastomerics, Inc., South San Francisco, CA, UNITED STATES (U.S. corporation)
PI US 7108873 B2 20060919
AI US 2002-199363 20020720 (10)
RLI Continuation-in-part of Ser. No. US 2001-721213, filed on 21 Nov 2001, Pat. No. US 6867253 Continuation-in-part of Ser. No. US 2001-896047, filed on 30 Jun 2001, PENDING Continuation-in-part of Ser. No. US 1999-421886, filed on 5 Oct 1999, ABANDONED Continuation-in-part of Ser. No. US 1999-285809, filed on 1 Apr 1999, ABANDONED Continuation-in-part of Ser. No. US 1999-274498, filed on 23 Mar 1999, Pat. No. US 6420475 Continuation-in-part of Ser. No. US 1998-130545, filed on 8 Aug 1998, Pat. No. US 6627275 Continuation-in-part of Ser. No. US 1997-984459, filed on 3 Dec 1997, Pat. No. US 6324703 Continuation-in-part of Ser. No. WO 1997-US17534, filed on 30 Sep 1997, Pat. No. WO 6161555 Continuation-in-part of Ser. No. US 1997-909487, filed on 12 Jul 1997, Pat. No. US 6050871 Continuation-in-part of Ser. No. US 1997-863794, filed on 27 May 1997, Pat. No. US 6117176 Continuation-in-part of Ser. No. US 1996-719817, filed on 30 Sep 1996, Pat. No. US 6148830 Continuation-in-part of Ser. No. US 1996-665343, filed on 17 Jun 1996, PENDING Continuation-in-part of Ser. No. US 1996-612586, filed on 8 Mar 1996, Pat. No. US 6552109 Continuation-in-part of Ser. No. US 1995-581191, filed on 29 Dec 1995, Pat. No. US 5760117 Continuation-in-part of Ser. No. US 1995-581188, filed on 29 Dec 1995, ABANDONED Continuation-in-part of Ser. No. US 1995-581125, filed on 29 Dec 1995, Pat. No. US 5962572 Continuation-in-part of Ser. No. US 1994-288690, filed on 11 Aug 1994, Pat. No. US 5633286 Continuation-in-part of Ser. No. WO 1994-US7314, filed on 27 Jun 1994, Pat. No. WO 5868597 Continuation-in-part of Ser. No. WO 1994-US4278, filed on 19 Apr 1994, Pat. No. WO 6033383

DT Utility
FS GRANTED
LN.CNT 3521
INCL INCLM: 426/001.000
INCLS: 426/573.000; 524/505.000
NCL NCLM: 426/001.000; 424/439.000
NCLS: 426/573.000; 524/505.000
IPC IPCI A61K0047-00 [ICM,7]
IPCI-2 A01K0097-04 [I,A]; A23L0001-05 [I,A]
IPCR A01K0097-04 [I,A]; A23L0001-05 [I,A]; A23L0001-317 [I,A]; A23L0001-325 [I,A]; A61K0047-00 [I,A]
EXF 524/505; 424/486; 426/1; 426/648; 426/656; 426/534; 426/555; 426/573
CAS INDEXING IS AVAILABLE FOR THIS PATENT.

L3 ANSWER 10 OF 13 IFIPAT COPYRIGHT 2012 IFI on STN
AN 04308583 IFIPAT;IFIUDB;IFICDB

TI Protein and lipid sources for use in aquafeeds and animal feeds and a process for their preparation; Subjecting oilseed to heat treatment to reduce concentration of antinutritional components to obtain heat-treated seed; dehulling seed to produce a meat fraction, a hull fraction or a mixture; cold pressing to obtain plant oils and meals
 IN Shand Ian (CA); Cairns Robert E (CA); Higgs David (CA)
 PA Canada Fisheries and Oceans Minister of CA (51835)
 PI US 6955831 B2 20051018 (CITED IN 002 LATER PATENTS)
 US 20030072866 A1 20030417
 AI US 2002-76499 20020219 (10)
 RLI US 2000-566728 20000509 CONTINUATION-IN-PART ABANDONED
 PRAI CA 2001-2334745 20010213
 WO 2001-CA663 20010508
 CA 2001-2351903 20010626
 FI US 6955831 20051018
 US 20030072866 20030417
 DT Utility; Granted Patent - Utility, with Pre-Grant Publication
 FS CHEMICAL
 GRANTED
 ED Entered STN: 19 Oct 2005
 Last Updated on STN: Jan 2011
 MRN 012837 MFN: 0842
 CLMN 32

L3 ANSWER 11 OF 13 USPATFULL on STN
 AN 2004:24434 USPATFULL
 TI Gelatinous food elastomer compositions and articles for use as fishing bait
 IN Chen, John Y., Pacifica, CA, UNITED STATES
 PI US 20040018272 A1 20040129
 US 7208184 B2 20070424
 AI US 2002-199362 A1 20020720 (10)
 DT Utility
 FS APPLICATION
 LN.CNT 4354
 INCL INCLM: 426/001.000
 NCL NCLM: 426/001.000
 NCLS: 043/042.000; 043/042.240; 424/084.000
 IPC [7]
 IPCI A23L0001-00 [ICM,7]
 IPCI-2 A23L0001-00 [I,A]
 IPCR A23L0001-00 [I,A]; A01K0085-01 [I,A]; A01K0097-04 [I,A]
 CAS INDEXING IS AVAILABLE FOR THIS PATENT.

L3 ANSWER 12 OF 13 USPATFULL on STN
 AN 2004:24385 USPATFULL
 TI Gelatinous food elastomer compositions and articles
 IN Chen, John Y., Pacifica, CA, UNITED STATES
 PI US 20040018223 A1 20040129
 US 7108873 B2 20060919
 AI US 2002-199363 A1 20020720 (10)
 DT Utility
 FS APPLICATION
 LN.CNT 3229
 INCL INCLM: 424/439.000
 NCL NCLM: 426/001.000; 424/439.000
 NCLS: 426/573.000; 524/505.000
 IPC [7]
 IPCI A61K0047-00 [ICM,7]
 IPCI-2 A01K0097-04 [I,A]; A23L0001-05 [I,A]
 IPCR A01K0097-04 [I,A]; A23L0001-05 [I,A]; A23L0001-317 [I,A];
 A23L0001-325 [I,A]; A61K0047-00 [I,A]

CAS INDEXING IS AVAILABLE FOR THIS PATENT.

L3 ANSWER 13 OF 13 USPATFULL on STN
AN 2003:165578 USPATFULL
TI Process for making dried powdery and granular krill
IN Yoshitomi, Bunji, Tokyo, JAPAN
Shigematsu, Yoshiaki, Tokyo, JAPAN
PA NIPPON SUISAN KAISHA, LTD., Tokyo, JAPAN (non-U.S. corporation)
PI US 20030113432 A1 20030619
AI US 2002-283063 A1 20021030 (10)
RLI Continuation of Ser. No. US 2001-807953, filed on 25 Apr 2001, PENDING
PRAI JP 1998-311730 19981102
DT Utility
FS APPLICATION
LN.CNT 481
INCL INCLM: 426/643.000
NCL NCLM: 426/643.000
IPC [7]
IPCI A23L0001-325 [ICM,7]
IPCR A23B0004-03 [I,A]; A23L0001-325 [I,A]; A23L0001-326 [I,A];
A23L0001-33 [I,A]

=> d 13 13 kwic

L3 ANSWER 13 OF 13 USPATFULL on STN
TI Process for making dried powdery and granular krill
AB A dried powdery and granular krill product containing all components of krill. The proteolytic enzymes originally contained in krill materials are perfectly disabled. The product is produced by a process including only heating as means for denaturing protein and disabling the proteolytic enzymes originally contained in krill materials. The product is produced by a process including no chemicals treatment to remove water and disable or inactivate the proteolytic enzymes in any production steps, and generating no wastewater. The production process comprises the steps of lightly dehydrating krill, coarsely crushing the krill, and drying the coarsely crushed krill under heating. Thus, water is removed from the krill by only heating, and degradation of the lipid in the krill product is prevented without using an anti-oxidant. Application fields are enlarged and the preservation characteristic is improved. The so-called zero-emission. . . .
SUMM [0002] The present invention relates to a dried powdery and granular krill product which contains all components of krill and in which lipid degradation is sufficiently prevented with no need of an anti-oxidant.
SUMM [0004] Krill are animal plankton living primarily in the Arctic and Antarctic Oceans, and about 80 kinds of krill have been known up to date. Of those many kinds of krill, Antarctic Krill (*Euphasia superba*) living in the Antarctic Ocean are found in abundance as one of natural resources. Therefore, survey of the resource and development of the method of catching the krill have been extensively conducted in the period of 1970 to 1985, including studies for developing methods of processing the krill to be useful in practical applications.
SUMM [0005] Krill are comparable to fish, flesh and fowl in point of nutritive value, but there are several problems in processing the krill for practical applications. One of the problems is that krill lose freshness in short time. If krill are left to stand after being caught, the heads and chests of the krill start changing into black color in 1-2 hours even at a low atmospheric temperature of about 0° C. Further, shells of the heads and chests of krill are so vulnerable to external pressure that the krill are easily broken down upon impacts applied at the time of catching, whereupon the enzymes

present in the internal organs flow out and decompose muscles. Those phenomena occur under actions of the enzymes present in krill. It is thought that tyrosinase is responsible for the former color-changing phenomenon, and protease is responsible for the latter muscle-decomposing. . . .

SUMM [0006] Accordingly, those enzymes require to be disabled or inactivated when processing krill. In other words, it has been required immediately after catching krill to quickly freeze the krill down to below -40° C., thereby inactivating the enzymes, or to heat the krill up to above 80° C., thereby disabling the enzymes, followed by preserving the krill.

SUMM [0007] Known krill products include raw frozen and peeled krill products which are subjected to quick freezing and then preserved in a frozen condition, boiled krill products which are heated and then preserved in a frozen condition, and krill meal which is heated and dried and then preserved at the normal temperature. The following Tables 1 and 2 list classifications of those products depending on how krill are processed, and features and points to be improved of the products.

SUMM . . . Japan, the product price greatly depends on the transportation cost. There is hence a desire for extracting excellent characteristics of krill more efficiently and realizing krill products having a higher value added.

TABLE 1

Processing	Processing Object	Product Examples
Quick freezing, Preserve in frozen condition	Inactivate enzymes	Raw frozen and stripped krill
Heating, Preserve in frozen condition	Disable enzymes	Boiled krill
Heating & Preserve at normal temperature	drying, Disable enzymes	Krill meal

SUMM . . . Points to be improved

Raw frozen and stripped krill	Products have flavor, taste and feeling of raw krill.	Remaining high water content and activity of enzymes necessitate storage and distribution in frozen state. Enzymes are activated upon thawing and product quality degrades. Drips flow out.
-------------------------------------	---	---

Boiled krill	Heating disables enzymes and makes protein stable to give meat-like feeling.	Flavor and taste components flow out during boiling. Cold chain is required because of high water content.
--------------	---	---

Krill meal	Heating disables enzymes and makes protein stable. Meal can be stored at normal temp. because of low water content.	Digestibility lowers due to protein denaturation during heating. Water-soluble components flow out into stickwater.
------------	--	---

SUMM [0010] Japanese Unexamined Patent Publication No. 57-11876 discloses a method of impeding activity of the proteolytic enzymes in krill and utilizing the krill as protein materials. With the disclosed method, a krill paste is degenerated with alcohol to effect fixation (denaturation) of protein and degeneration of the enzymes at the same time. The processed krill paste is then washed with water to remove alcohol. The disclosed method however has the following problems.

SUMM [0013] 3. Polar lipid is removed together with alcohol during washing with water. Most of the lipid in krill is phospholipid and is rich in polyunsaturated fatty acids (PUFAs). Thus these PUFAs are removed.

SUMM . . . square. The shrimp materials thus processed are dried under heating to thereby provide dried shrimp granules. Considering specific properties of krill, however, it is inferred that even if krill are dried under heating after being processed in a similar manner as in the prior art, ground krill are very difficult to dry into a satisfactory condition.

SUMM [0018] From intensive studies, the inventors found that when krill are processed in a similar manner as in the prior art, lipid, protein and water contained in the krill are brought into an emulsified state, and the processed krill are very difficult to dry even with a heating and drying machine. Such a difficulty is related to the fact that most of the lipid in krill is phospholipid, as described above, and therefore emulsification is further increased. In other words, water in the krill is stabilized in structure with emulsification and becomes still harder to evaporate under heating.

SUMM [0019] In addition, when krill are crushed into the form of ground meat, the proteolytic enzymes present in the internal organs of the krill develop activity, and a temperature rise during the grinding process increases the activity of those enzymes. As a consequence, proteolysis in the krill is promoted and specific taste is deteriorated.

SUMM [0021] An object of the present invention is therefore to effectively utilize krill as one of valuable aquatic resources, and to provide a dried powdery and granular krill product and a method of producing the dried powdery and granular krill product, which contains all components of krill and has a good preservation ability while activity of the enzymes in the krill is totally disabled.

SUMM [0022] The present invention resides in a dried powdery and granular krill product that contains all components of krill. Because of containing all components of krill, the present product has a function capable of sufficiently preventing degradation of the lipid in the krill product without using an anti-oxidant. In the dried powdery and granular krill product, the proteolytic enzymes originally contained in krill materials are perfectly disabled. Accordingly, the present invention also resides in a dried powdery and granular krill product which contains all components of krill and in which the proteolytic enzymes originally contained in krill materials are perfectly disabled. The present product is produced by a process including only heating as means for denaturing protein and disabling the proteolytic enzymes originally contained in krill materials. Accordingly, the present invention further resides in a dried powdery and granular krill product which contains all components of krill, in which the proteolytic enzymes originally contained in krill materials are perfectly disabled, and which is produced by a process including only heating as means for denaturing protein and disabling the proteolytic enzymes originally contained in krill materials.

SUMM [0023] The dried powdery and granular krill product of the present invention is produced by a process including no chemicals treatment to remove water and disable or. . . the proteolytic enzymes in any production steps, and generating no wastewater. The production process comprises the steps of lightly dehydrating krill, coarsely crushing the krill, and drying the coarsely crushed krill under heating.

SUMM [0024] The dried powdery and granular krill product of the present invention is subjected to no chemical treatment using chemicals, etc. in any production steps, and is. . . Also, there is no step in the production process in which wastewater is generated. Thus, water is removed from the krill by only heating. Moreover, application fields are enlarged and the preservation characteristic is improved. The so-called zero-emission method and product,. . .

SUMM [0025] The production method of the present invention comprises steps of

removing seawater from krill, coarsely crushing the krill, and drying the coarsely crushed krill under heating. In the conventional process of producing krill meal, krill are first boiled in water in the same amount as the krill, and are then subjected to separation into solid and liquid components. The solid component is heated and dried using a . . . drier. The liquid component obtained from the solid/liquid separation is called stickwater and preserved separately. For this reason, the conventional krill meal contains less water-soluble components than the krill product of the present invention, and therefore has disadvantages in not providing satisfactory flavor and taste in the extracted form,. . . the conventional production process is disadvantageous in that protein is excessively denatured by heating applied in both the boiling and heating/drying steps, and digestibility of the product is reduced.

- DRWD [0026] FIG. 1 is a graph showing activity of the proteolytic enzymes remaining in raw krill and the product of the present invention; and
- DETD [0028] There are 80 or more kinds of krill as described above, but the kind of krill used in the present invention is not restricted. In addition to krill, mysids are also usable.
- DETD [0029] Krill primarily used in an embodiment are Antarctic Krill (*Euphasia superba*) which have been employed in industrial fields.
- DETD [0031] Krill used as materials are put into a fish tank at once after being caught. The krill are then put in a dehydrator to remove seawater, etc. attaching to the krill surfaces. The type of the dehydrator is not particularly restricted, but outer shells of krill are so fragile that the shells are easily broken down under pressure of 40-140 g/cm^{sup.2} and the internal components flow. . . Therefore, the type of the dehydrator is preferably selected so that an excessive physical load will not be applied to krill.
- DETD [0032] The dehydrated krill are chopped to improve thermal efficiency in the heating and drying process. The type of a machine used for chopping the krill is not particularly restricted. The grain size of the chopped krill is selected to a coarsely crushed state, i.e., about 1.5-2.5 cm square, at which outer shells and muscular tissues of the krill materials remain. This process can be performed with, e.g., a known mincing apparatus, which is usually employed for grinding meat. .
- DETD [0033] The chopped krill are dried under heating. The type of a machine for use in this process is also not particularly restricted. While a known heating and drying machine such as a steam type disk dryer, for example, can be used, the machine is preferably adjustable in heating time, heating temperature, degree of agitation, and so forth. Because the internal components of krill as one of natural resources change depending on the season, it is desired to adjust the parameters of the machine in match with the change of the internal components of krill for obtaining products with constant quality.
- DETD [0034] The heating time and the heating temperature are set to such an extent that the muscular protein of krill and the proteolytic enzymes in krill are denatured and degenerated under heating, and that the water content is reduced down to below 10% from a point of ensuring good preservation. It is important that the heating and drying process is not performed at overly high temperatures and for an overly long time, and is performed at the necessary. . . values to satisfy the above-described conditions. Excessive heating lowers digestibility due to extreme denaturation, reduces astaxanthin, natural dye, present in krill, reduces vitamins, and oxidizes lipid. On the other hand, if heating is insufficient, activity of the proteolytic enzymes in krill remains, which leads to a deterioration of product quality. If the water content is over ten and several percents, the krill product gathers mold during preservation.
- DETD [0035] The dried krill are very fragile, including the shells, and therefore can be easily crushed any desired grain size.

DETD [0036] The krill product of the present invention can be used as a main material of feed for cultured fish in place of. . .

DETD . . . above in connection with the prior art is attributable to crushing of raw materials into the form of ground meat, krill materials are first chopped into pieces having a size of 20-30% of the body length (about 1.5-2.5 cm square) and are then put into a heating and drying machine in the present invention. As a result, the krill materials are avoided from being emulsified and the drying efficiency is enhanced. Further, strong activity of the proteolytic enzymes present in the internal organs of krill is suppressed and an adverse influence upon flavor and taste of the krill product is reduced. In addition, the chopped krill do not adhere to the heating surface and can be heated appropriately, thus greatly contributing to improvement of product quality.

DETD [0038] Moreover, since the dried krill product obtained in accordance with the method of the present invention has a large grain size and maintains a fair part of shapes of the krill materials, it is also possible to produce products utilizing the shapes of the krill materials advantageously. Additionally, the dried krill can be simply crushed into a desired grain size as required.

DETD [0040] FIG. 1 shows comparatively activity of the proteolytic enzymes remaining in raw krill and the krill product of the present invention.

DETD . . . as a substrate. As will be seen from FIG. 1, the activity of the remaining proteolytic enzymes in the raw krill is increased with lapse of the reaction time, while the activity of the remaining proteolytic enzymes in the krill product of the present invention is hardly changed. This suggests that the proteolytic enzymes remain not alive in the krill product of the present invention and they are perfectly disabled in the production process, and that a possibility of quality deterioration of the krill product during the preservation is low.

DETD [0042] Preservation characteristics of the krill product of the present invention will be described with reference to Tables 3 and 4 below.

DETD [0043] For comparison, the results listed in Table 3 were obtained by preparing two groups of the krill product of the present invention, in one of which ethoxyquin that is most generally used as an anti-oxidant in meal, etc. was added to the krill product and in the other of which no ethoxyquin was added, and then measuring a change of product quality by. . .

DETD [0045] There are several indexes indicating a degree of lipid degradation. About the lipid in krill, particularly, the krill lipid having been extracted and refined, it is known that, during the preservation, a peroxide value hardly increases and only a carbonyl value increases. In other words, it is pointed out that degradation of the krill lipid differs in creation of oxides and progress rate of the decomposing reaction from those in general fish oil, etc.

TABLE 3

	Acid value		Peroxide value	Carbonyl value	
	with no anti-oxidant	with anti-oxidant		with	with
DETD			no. . .		

. . . from Table 4, a phenomenon of the lipid degrading at apparently different rates during the preservation was found between the krill product of the present invention and a control prepared by perfectly removing all the water-soluble components originally present in krill from the krill product of the present invention. Although the material responsible for the above phenomenon is not yet known, it is believed that the water-soluble components originally present in krill have some anti-oxidizing action. For this reason, in the krill product of

the present invention which contains all the components of krill in an enriched condition, lipid degradation can be prevented satisfactorily without using any anti-oxidant.

TABLE 4

	Peroxide value	Carbonyl. . .
DETD	[0048]	1. Process Flow Including Plant for Drying Krill
DETD	[0049]	An outline of the process flow is as shown in FIG. 2. Krill materials are first conveyed by a krill supply apparatus from a fish tank to a material tank, and are then supplied to a dehydrator in a proper lot. The use of a dehydrator basically intends to remove seawater contained in the krill materials. Since it is expected that the amount of water contained in krill varies depending on the materials, a diaphragm is adjusted to provide a proper dehydration rate, taking into account the performance. . . are then supplied to a drier. The materials are boiled in the drier under heating with vapor, followed by further drying. At the time when reaching a predetermined water content, the drying is stopped and a resulting dried semifinished product is ejected. The dried semifinished product is conveyed to a product tank, . . .
DETD	[0050]	The conventional production process for krill meal is represented by raw krill→boiling→centrifugal separation or solid/liquid separation→extraction of solid→drying→crushing→packaging. The liquid component was removed in the centrifugal separation step, and the useful components of krill contained in the liquid component were discarded. It can be said from one aspect that the krill meal was a product resulted from drying the sludge.
DETD	[0051]	By contrast, the process flow for producing the krill product of the present invention is represented by raw krill→removal of water attached to krill→boiling→drying→crushing→packaging. The centrifugal separation step is not included. In the boiling and drying steps, the enzymes in krill are disabled and the krill components are stabilized through thermal degeneration. Thus, the components originally contained in the krill are all kept in the product without being discarded externally. An apparatus for implementing the above process is featured in omitting a step of squeezing boiled krill using a decanter or a press. The krill drying apparatus used in the present invention differs from the conventional meal producing apparatus in that a cooker and a drier are combined in an integral structure.
DETD	[0053]	Table 5 lists component analytical values of the krill product of the present invention. For comparison, Table 5 also lists component analytical values of the krill meal produced by the conventional process. In particular, the krill product of the present invention contains free amino acids as much as more than twice the amount contained in the conventional krill meal. The free amino acids deeply take part in developing flavor and taste of the product when eaten, attractant of feed. . .
DETD	[0054]	Since the squeezing step subsequent to boiling of the krill materials is omitted, the components developing flavor and taste are not lost and the krill product of the present invention has good flavor. Further, the production process of the present invention generates no appreciable wastewater and provides a high yield.

TABLE 5

	Krill meal	Product of invention
Water	6.5	8.3

Coarse protein	64.0	65.1
(Free amino acid)	(2.9)	(7.54)
Coarse fat	7.0	7.0
Coarse. . .		

DETD [0055] According to the present invention, a method is provided which can effectively utilize krill, as one of important aquatic resources, in a perfect manner without any loss due to efflux of krill components. The dried powdery and granular krill product obtained by the present invention contains all the components originally contained in the krill, and strong activity of the enzymes specific to the krill is disabled. Therefore, the krill product of the present invention can be widely applied to not only the feed industry, but also the food industry.

CLM What is claimed is:
1. A dried powdery and granular krill product containing all components of krill.

CLM What is claimed is:
2. A dried powdery and granular krill product according to claim 1, wherein the proteolytic enzymes originally contained in krill materials are perfectly disabled.

CLM What is claimed is:
3. A dried powdery and granular krill product according to claim 1 or 2, wherein said product is produced by a process including only heating as means for denaturing protein and disabling the proteolytic enzymes originally contained in krill materials.

CLM What is claimed is:
4. A dried powdery and granular krill product according to claim 1, 2 or 3, wherein said product is produced by a process including no chemicals treatment. . .

CLM What is claimed is:
5. A dried powdery and granular krill product according to any one of claims 1 to 4, wherein said product is produced by a process comprising the steps of lightly dehydrating krill, coarsely crushing the krill, and drying the coarsely crushed krill under heating.

=> d hist

(FILE 'HOME' ENTERED AT 14:50:46 ON 29 MAY 2012)

INDEX 'ADISCTI, ADISINSIGHT, ADISNEWS, AGRICOLA, ANABSTR, ANTE, AQUALINE, AQUASCI, BIOENG, BIOSIS, BIOTECHABS, BIOTECHDS, BIOTECHNO, CABA, CAPLUS, CEABA-VTB, CIN, CONFSCI, CROPB, CROPU, DDFB, DDFU, DGENE, DISSABS, DRUGB, DRUGU, EMBAL, EMBASE, ESBIOWASE, ...' ENTERED AT 14:51:15 ON 29 MAY 2012
SEA KRILL AND OIL AND COOK? AND DRY?(P)KRILL AND KRILL(P)MEAL A

```

-----
0* FILE ADISNEWS
0* FILE ANTE
0* FILE AQUALINE
0* FILE BIOENG
0* FILE BIOTECHABS
0* FILE BIOTECHDS
0* FILE BIOTECHNO
0* FILE CEABA-VTB
0* FILE CIN
0* FILE FOMAD
0* FILE FROSTI
3 FILE IFIPAT

```

0* FILE KOSMET
0* FILE NTIS
0* FILE PASCAL
9 FILE USPATFULL
3 FILE USPAT2
0* FILE WATER
4 FILE WPIDS
4 FILE WPINDEX

L1 QUE KRILL AND OIL AND COOK? AND DRY?(P)KRILL AND KRILL(P)MEAL A

FILE 'IFIPAT, USPATFULL, USPAT2' ENTERED AT 14:52:35 ON 29 MAY 2012

L2 15 S L1

L3 13 DUP REM L2 (2 DUPLICATES REMOVED)

=> logoff

ALL L# QUERIES AND ANSWER SETS ARE DELETED AT LOGOFF

LOGOFF? (Y)/N/HOLD:y

COST IN U.S. DOLLARS

SINCE FILE	TOTAL
ENTRY	SESSION
29.49	31.21

FULL ESTIMATED COST

STN INTERNATIONAL LOGOFF AT 14:55:32 ON 29 MAY 2012

IN THE UNITED STATES PATENT AND TRADEMARK OFFICE

In re Application of:	Bruheim et al.	Art Unit: 1651
Serial No.:	12/057,775	Examiner: Ware
Filed:	March 28, 2008	Confirmation: 1945
Entitled:	BIOEFFECTIVE KRIL OIL COMPOSITIONS	

**RESPONSE TO OFFICE ACTION
MAILED JANUARY 6, 2012**

EFS WEB FILED

Commissioner for Patents
P.O. Box 1450
Alexandria, Virginia 22313-1450

Examiner Ware:

This communication is responsive to the Office Action mailed January 6, 2012. The Commissioner is hereby authorized to charge any fees during the entire pendency of this application, including fees due under 37 C.F.R. §§ 1.16 and 1.17 that may be required, including any required extension of time fees, or credit any overpayment to Deposit Account 50-4302, referencing Attorney Docket No. **NATNUT-14409/US-5/ORD**. This paragraph is intended to be a CONSTRUCTIVE PETITION FOR EXTENSION OF TIME in accordance with 37 C.F.R. § 1.136(a)(3).

IN THE CLAIMS

1. (Withdrawn) A composition comprising:
from about 3% to 10% ether phospholipids on a w/w basis;
from about 35% to 50% non-ether phospholipids on w/w basis, so that the total amount of ether phospholipids and non-ether phospholipids in the composition is from about 48% to 60% on a w/w basis;
from about 20% to 45% triglycerides on a w/w basis;
and from about 400 to about 2500 mg/kg astaxanthin.
2. (Withdrawn) The composition of Claim 1, wherein said ether phospholipids are selected from the group consisting of alkylacylphosphatidylcholine, lyso-alkylacylphosphatidylcholine, alkylacylphosphatidylethanolamine, and combinations thereof.
3. (Withdrawn) The composition of Claim 1, wherein said ether lipids are greater than 90% alkylacylphosphatidylcholine.
4. (Withdrawn) The composition of Claim 1, wherein said non-ether phospholipids are selected from the group consisting of phosphatidylcholine, phosphatidylserine, phosphatidylethanolamine and combinations thereof.
5. (Withdrawn) The composition of Claim 1, wherein said composition comprises a blend of lipid fractions obtained from *Euphausia superba*.
6. (Withdrawn) The composition of Claim 1, wherein said composition comprises from about 25% to 30% omega-3 fatty acids as a percentage of total fatty acids and wherein from about 80% to 90% of said omega-3 fatty acids are attached to said phospholipids.
7. (Withdrawn) A capsule containing the composition of Claim 1.

8. (Withdrawn) A composition comprising:
from about 3% to 10% ether phospholipids on a w/w basis; and
from about 400 to about 2500 mg/kg astaxanthin.
9. (Withdrawn) The composition of Claim 8, further comprising from about 35% to 50% non-ether phospholipids on w/w basis, so that the total amount of ether phospholipids and non-ether phospholipids in the composition is from about 38% to 60% on a w/w basis.
10. (Withdrawn) The composition of Claim 8, further comprising from about 20% to 45% triglycerides on a w/w basis.
11. (Withdrawn) The composition of Claim 8, wherein said ether phospholipids are selected from the group consisting of alkylacylphosphatidylcholine, lyso-alkylacylphosphatidylcholine, alkylacylphosphatidylethanolamine, and combinations thereof.
12. (Withdrawn) The composition of Claim 11, wherein said ether lipids are greater than 90% alkylacylphosphatidylcholine.
13. (Withdrawn) The composition of Claim 8, wherein said non-ether phospholipids are selected from the group consisting of phosphatidylcholine, phosphatidylserine, phosphatidylethanolamine and combinations thereof.
14. (Withdrawn) The composition of Claim 8, wherein said composition comprises a blend of lipid fractions obtained from *Euphausia superba*.
15. (Withdrawn) The composition of Claim 10, wherein said composition comprises from about 25% to 30% omega-3 fatty acids as a percentage of total fatty acids and wherein from about 80% to 90% of said omega-3 fatty acids are attached to said phospholipids.
16. (Withdrawn) A capsule containing the composition of Claim 8.

17. (Withdrawn) A blended krill oil composition comprising:
 - from about 45% to 55% w/w phospholipids;
 - from about 20% to 45% w/w triglycerides;
 - and from about 400 to about 2500 mg/kg astaxanthin.

18. (Withdrawn) The composition of Claim 17, wherein said blended krill oil product comprises a blend of lipid fractions obtained from *Euphausia superba*.

19. (Withdrawn) The composition of Claim 17, wherein said composition comprises from about 25% to 30% omega-3 fatty acids as a percentage of total fatty acids and wherein from about 80% to 90% of said omega-3 fatty acids are attached to said phospholipids.

20. (Withdrawn) A *Euphausia superba* krill oil composition comprising:
 - from about 3% to about 10% w/w ether phospholipids;
 - from about 27% to 50% w/w non-ether phospholipids so that the amount of total phospholipids in the composition is from about 30% to 60% w/w;
 - from about 20% to 50% w/w triglycerides;
 - from about 400 to about 2500 mg/kg astaxanthin; and
 - from about 20% to 35% omega-3 fatty acids as a percentage of total fatty acids in said composition, wherein from about 70% to 95% of said omega-3 fatty acids are attached to said phospholipids.

21. (Withdrawn) A dietary supplement comprising encapsulated *Euphausia superba* krill oil comprising from about 3% to about 10% w/w ether phospholipids; from about 27% to 50% w/w non-ether phospholipids so that the amount of total phospholipids in the composition is from about 30% to 60% w/w; from about 20% to 50% w/w triglycerides; from about 400 to about 2500 mg/kg astaxanthin; and from about 20% to 35% omega-3 fatty acids as a percentage of total fatty acids in said composition, wherein from about 70% to 95% of said omega-3 fatty acids are attached to said phospholipids.

22. (Withdrawn) A method of making a *Euphausia superba* krill oil composition comprising:
contacting *Euphausia superba* with a polar solvent to provide a polar extract comprising phospholipids;
contacting *Euphausia superba* with a neutral solvent to provide a neutral extract comprising triglycerides and astaxanthin;
combining said polar extract and said neutral extract to provide *Euphausia superba* krill oil from about 3% to about 10% w/w ether phospholipids; from about 27% to 50% w/w non-ether phospholipids so that the amount of total phospholipids in the composition is from about 30% to 60% w/w; from about 20% to 50% w/w triglycerides; from about 400 to about 2500 mg/kg astaxanthin; and from about 20% to 35% omega-3 fatty acids as a percentage of total fatty acids in said composition, wherein from about 70% to 95% of said omega-3 fatty acids are attached to said phospholipids.
23. (Withdrawn) The method of Claim 22, further comprising the step of encapsulating the *Euphausia superba* krill oil.
24. (Withdrawn) A *Euphausia superba* krill oil produced by the method of Claim 22.
25. (Withdrawn) A method of producing a dietary supplement comprising;
contacting *Euphausia superba* with a polar solvent to provide an polar extract comprising phospholipids;
contacting *Euphausia superba* with a neutral solvent to provide a neutral extract comprising triglycerides and astaxanthin;
combining said polar extract and said neutral extract to provide *Euphausia superba* krill oil from about 3% to about 10% w/w ether phospholipids; from about 27% to 50% w/w non-ether phospholipids so that the amount of total phospholipids in the composition is from about 30% to 60% w/w; from about 20% to 50% w/w triglycerides; from about 400 to about 2500 mg/kg astaxanthin; and from about 20% to 35% omega-3 fatty acids as a percentage of total fatty acids in said composition, wherein from about 70% to 95% of said omega-3 fatty acids are attached to said phospholipids;
encapsulating said *Euphausia superba* krill oil.

26. (Withdrawn) A composition comprising at least 65% (w/w) of phospholipids, said phospholipids characterized in containing at least 35% omega-3 fatty acid residues.
27. (Withdrawn) The composition according to claim 26, wherein the composition is derived from a marine or aquatic biomass.
28. (Withdrawn) The composition according to claim 26, wherein the composition is derived from krill.
29. (Withdrawn) The composition of Claim 26, wherein said composition comprises less than 2% free fatty acids.
30. (Withdrawn) The composition of Claim 26, wherein said composition comprises less than 10% triglycerides.
31. (Withdrawn) The composition of Claim 26, wherein said phospholipids comprise greater than 50% phosphatidylcholine.
32. (Withdrawn) The composition of Claim 26, wherein the composition comprises at least 500 mg/kg astaxanthin esters.
33. (Withdrawn) The composition of Claim 26, wherein the composition comprises at least 500 mg/kg astaxanthin esters and at least 36% (w/w) omega-3 fatty acids.
34. (Withdrawn) The composition of Claim 26, wherein the composition comprises less than about 0.5g/100g total cholesterol.
35. (Withdrawn) The composition of Claim 26, wherein the composition comprises less than about 0.45% arachidonic acid (w/w).

36. (Withdrawn) A krill lipid extract comprising at least 500 mg/kg astaxanthin esters and at least 36% (w/w) omega-3 fatty acids.
37. (Withdrawn) A krill lipid extract comprising at least 100 mg/kg astaxanthin esters, at least 20% (w/w) omega-3 fatty acids, and less than about 0.45% arachidonic acid (w/w).
38. (Withdrawn) A method comprising administering the composition of Claim 1 to a subject in an amount effective for reducing insulin resistance, reducing inflammation, improving blood lipid profile and reducing oxidative stress.
39. (Withdrawn) A krill lipid extract comprising greater than about 80% triglycerides and greater than about 90 mg/kg astaxanthin esters.
40. (Withdrawn) The krill lipid extract of Claim 39, characterized in containing from about 5% to about 15% omega-3 fatty acid residues.
41. (Withdrawn) The krill lipid extract of Claim 39, characterized in containing less than about 5% phospholipids.
42. (Withdrawn) The krill lipid extract of Claim 39, characterized in comprising from about 5% to about 10% cholesterol.
43. (Withdrawn) A krill meal composition comprising less than about 50g/kg total fat.
44. (Withdrawn) The krill meal composition of Claim 43 comprising from about 5 to about 20 mg/kg astaxanthin esters.
45. (Withdrawn) The krill meal composition of Claim 43 comprising greater than about 65% protein.

46. (Withdrawn) The krill meal composition of Claim 43 comprising greater than about 70% protein.
47. (Withdrawn) An animal feed comprising the krill meal of Claim 46.
48. (Withdrawn) A method of increasing flesh coloration in an aquatic species comprising feeding said aquatic species a composition comprising the krill meal of Claim 46.
49. (Withdrawn) A method of increasing growth and overall survival rate of aquatic species by feeding the krill meal of Claim 46.
50. (Currently amended) A method of producing krill oil comprising:
- a) ~~cooking and drying krill to providing~~ provide cooked and dried krill meal; and
 - b) extracting a krill oil from said cooked and dried krill meal.
51. (Cancelled)
52. (Original) The method of Claim 50, wherein said krill meal is stored prior to said extraction step.
53. (Original) The method of Claim 50, wherein said extracting step comprises extraction by supercritical fluid extraction.
54. (Currently amended) The method of Claim 53, wherein said supercritical fluid extraction is a two step process comprising a first extraction step with carbon dioxide and from 1 to 10% of a co-solvent and a second extraction step with carbon dioxide and from 10-30% of a co-solvent, wherein said co-solvent in said first and second extraction steps is a C₁-C₃ monohydric alcohol.
55. (Currently amended) A ~~krill~~ krill oil produced by the method of claim 50.
56. (Withdrawn) A method of production of krill oil comprising:

- a) providing fresh krill;
- b) treating said fresh krill to denature lipases and phospholipases in said fresh krill to provide a denatured krill product; and
- c) extracting oil from said denatured krill product.

57. (Withdrawn) The method of claim 56 in which the denaturation step comprises heating of said fresh krill.

58. (Withdrawn) The method of claim 56 in which the denaturation step comprises heating said fresh krill after grinding.

59. (Withdrawn) The method of claim 56, further comprising storing said denatured krill product at room temperature or below between the denaturation step and the extraction step.

60. (Withdrawn) The method of claim 56, wherein the enzyme denaturation step is achieved by application of heat.

61. (Withdrawn) The method of claim 56, wherein the extraction step comprises use of supercritical carbon dioxide, with or without use of a polar modifier.

62. (Withdrawn) The method of claim 56, wherein the extraction step comprises the use of ethanol.

63. (Withdrawn) The method of Claim 56, wherein the extraction step comprises ethanol extraction followed by acetone to precipitation of phospholipids.

64. (Withdrawn) The method of Claim 56, wherein said denatured krill product is a meal.

65. (Withdrawn) Oil produced by the method of Claim 56.

66. (Withdrawn) A composition comprising an oil extracted from krill having a phosphatidylcholine content of greater than about 50% (w/w).

67. (Withdrawn) The composition of Claim 66, wherein said oil has a phosphatidylcholine content of greater than about 70% (w/w).

68. (Withdrawn) The composition of Claim 66, wherein said oil has a phosphatidylcholine content of greater than about 80% (w/w).

69. (Withdrawn) The composition of Claim 66, wherein said composition comprises less than 2% free fatty acids.

70. (Withdrawn) The composition of Claim 66, wherein said composition comprises less than 10% triglycerides.

71. (Withdrawn) The composition of Claim 66, wherein the composition comprises at least 500 mg/kg astaxanthin esters.

72. (Withdrawn) The composition of Claim 66, wherein the composition comprises less than about 0.45% arachidonic acid (w/w).

73. (Withdrawn) A composition comprising odorless krill oil.

74. (Withdrawn) The composition of Claim 73, wherein said odorless krill oil comprises less than about 10 mg/kg (w/w) trimethylamine.

75. (Withdrawn) An odorless krill oil produced by the method comprising:
extracting a neutral krill oil from a krill oil containing material by supercritical fluid extraction to provide a deodorized krill material, wherein said neutral krill oil contains odor causing compounds and
extracting a polar krill oil from said deodorized krill material by supercritical fluid extraction with a polar entrainer to provide an essentially odorless krill oil.
76. (Withdrawn) A composition comprising krill oil containing less than about 70 micrograms/kilogram (w/w) astaxanthin esters.
77. (Withdrawn) The composition of claim 76, comprising less than about 50 micrograms/kilogram (w/w) astaxanthin esters.
78. (Withdrawn) The composition of claim 76, comprising less than about 20 micrograms/kilogram (w/w) astaxanthin esters.
79. (Withdrawn) The composition of claim 76, comprising less than about 5 micrograms/kilogram (w/w) astaxanthin esters.
80. (Withdrawn) A krill oil produced by the process comprising:
pumping fresh krill from a trawl onto a ship, heating the krill to provide a krill material, and extracting oil from the krill material.
81. (Withdrawn) A method of reducing diet-induced hyperinsulinemia, insulin insensitivity, muscle mass hypertrophy, serum adiponectin reduction or hepatic steatosis comprising:
in a subject exposed to a high fat diet, administering to said subject exposed to a high fat diet an effective amount of a krill oil composition under conditions such that a condition selected from the group consisting of diet-induced hyperinsulinemia, insulin insensitivity, muscle mass hypertrophy, serum adiponectin reduction and hepatic steatosis is reduced.

82. (Withdrawn) The method of Claim 81, wherein said effective amount of a krill oil composition is from 0.2 grams to 10 grams of said krill oil composition.

83. (Withdrawn) The method of Claim 81, wherein said krill oil composition comprises: from about 45% to 55% w/w phospholipids; from about 35% to 45% w/w triglycerides; and from about 400 to about 2500 mg/kg astaxanthin.

84. (Withdrawn) The method of Claim 81, wherein said krill oil composition comprises a blend of lipid fractions obtained from *Euphausia superba*.

85. (Withdrawn) A method of reducing diet-induced hyperinsulinemia, insulin insensitivity, muscle mass hypertrophy, serum adiponectin reduction or hepatic steatosis comprising in a subject consuming a high fat diet or a normal fat diet:

administering to said subject consuming a high fat diet or a normal fat diet an effective amount of a krill oil composition under conditions such that a condition selected from the group consisting of diet-induced hyperinsulinemia, insulin insensitivity, muscle mass hypertrophy, serum adiponectin reduction and hepatic steatosis is reduced.

86. (Withdrawn) A method of inducing diuresis in a subject comprising:
administering to said subject an effective amount of a krill oil composition under conditions such that diuresis is induced.

87. (Withdrawn) A method of increasing muscle mass in a subject, comprising:
administering to said subject an effective amount of a krill oil composition under conditions such that muscle mass is increased.

88. (Withdrawn) A method of decreasing protein catabolism in a subject, comprising:
administering to said subject an effective amount of a krill oil composition under conditions such that protein catabolism is decreased.

89. (Withdrawn) A method of decreasing lipid content in the heart of a subject, comprising:
administering to said subject an effective amount of a krill oil composition under
conditions such that lipid content in the heart of the subject is decreased.

90. (Withdrawn) A method of decreasing lipid content in the liver of a subject, comprising:
administering to said subject an effective amount of a krill oil composition under
conditions such that lipid content in the liver of the subject is decreased.

REMARKS

Claims 50 and 51-55 are pending following entry of this amendment. Claim 52 has been cancelled without prejudice. Claims 50, 54 and 55 have been amended. Support for the amendments may be found in the specification, for example at page 42, lines 1-4, and the in the claims as originally filed among other places. No new matter has been added. All amendments and cancellation of claims are made without acquiescing to any of the Examiner's arguments or rejections, and solely for the purpose of expediting the patent application process in a manner consistent with the PTO's Patent Business Goals (PBG), and without waiving the right to prosecute the cancelled claims (or similar claims) in the future.

The following rejections are at issue:

1. Claims 50-55 are rejected as being indefinite;
2. Claims 50-53 and 55 are rejected as anticipated by Japanese Abstract 04-057853;
3. Claim 54 is rejected as being obvious over Japanese Abstract 04-057853 in view of Kamiya (US 20060193962).

These rejections are addressed in order below.

1. The claims are definite

Claims 50-55 are rejected as being indefinite. The claims have been amended to correct the antecedent basis issues notes by the Examiner for oil and co-solvent as well as the second step. Applicants respectfully request that this rejection be withdrawn.

2. The claims are not anticipated

Claims 50-53 and 55 are rejected as anticipated by Japanese Abstract 04-057853. Applicants respectfully disagree. Nevertheless, Applicants have amended the claims to clarify that the meal is a cooked and dried meal. The Japanese abstract discloses a protease treated and mechanically ground composition:

Krill shells are treated with a protease to decompose the protein in the shells and the treatment product is filtered. The residue of filtration is dried to give treated shells having a water content of 6-8% and a mean particle size of 200 μm or lower. The treated shells are put into an extraction vessel 5.

There is no cooking step as currently claimed. Furthermore, the purpose of the process is to extract a coloring pigment from krill shells: "To prepare a reddish orange coloring matter having a high safety in a high concn. by extracting, with CO2 in a supercritical state, krill shells of which the protein has been decomposed by a protease." Applicants respectfully submit that the alleged prior art process, which uses only krill shells, is substantially different from the claimed process which uses the krill organism. The prior art process, which utilizes shells, will not produce a krill oil as claimed. Applicants respectfully request that the rejection be withdrawn and the claims passed to allowance.

3. The claims are not obvious

Claim 54 is rejected as being obvious over Japanese Abstract 04-057853 in view of Kamiya (US 20060193962). Applicants respectfully disagree. In any event, the amendments to the claims address the rejection. Kamiya does not cure the deficiencies noted for Japanese Abstract 04-057853 above. Namely, Kamiya does not teach extraction of krill oil from a cooked and dried krill meal. Accordingly, the combined references do not teach each element of the claims. Any prima facie case of obviousness allegedly established by the Examiner is therefore rebutted. Applicants respectfully request that the rejection be withdrawn and the claims passed to allowance.

CONCLUSION

If a telephone interview would aid in the prosecution of this application, the Examiner is encouraged to call the undersigned collect at (608) 662-1277.

Dated: April 4, 2012

/J. Mitchell Jones/

John Mitchell Jones
Registration No. 44,174

Casimir Jones, S.C.
2275 Deming Way, Suite 310
Middleton, WI, 53562
(608) 662-1277

Electronic Acknowledgement Receipt

EFS ID:	12463979
Application Number:	12057775
International Application Number:	
Confirmation Number:	1945
Title of Invention:	BIOEFFECTIVE KRILL OIL COMPOSITIONS
First Named Inventor/Applicant Name:	Inge Bruheim
Customer Number:	72960
Filer:	John Mitchell Jones/Vickie Hoeft
Filer Authorized By:	John Mitchell Jones
Attorney Docket Number:	NATNUT-14409/US-5/ORD
Receipt Date:	04-APR-2012
Filing Date:	28-MAR-2008
Time Stamp:	14:32:46
Application Type:	Utility under 35 USC 111(a)

Payment information:

Submitted with Payment	no
------------------------	----

File Listing:

Document Number	Document Description	File Name	File Size(Bytes)/ Message Digest	Multi Part /.zip	Pages (if appl.)
1		14409US5Response04042012.pdf	126856 2c358de6d8cb6c30be77f2905b36ed0a1a1523d2	yes	15

Multipart Description/PDF files in .zip description			
Document Description		Start	End
Amendment/Req. Reconsideration-After Non-Final Reject		1	1
Claims		2	13
Applicant Arguments/Remarks Made in an Amendment		14	15

Warnings:

Information:

Total Files Size (in bytes):	126856
-------------------------------------	--------

This Acknowledgement Receipt evidences receipt on the noted date by the USPTO of the indicated documents, characterized by the applicant, and including page counts, where applicable. It serves as evidence of receipt similar to a Post Card, as described in MPEP 503.

New Applications Under 35 U.S.C. 111

If a new application is being filed and the application includes the necessary components for a filing date (see 37 CFR 1.53(b)-(d) and MPEP 506), a Filing Receipt (37 CFR 1.54) will be issued in due course and the date shown on this Acknowledgement Receipt will establish the filing date of the application.

National Stage of an International Application under 35 U.S.C. 371

If a timely submission to enter the national stage of an international application is compliant with the conditions of 35 U.S.C. 371 and other applicable requirements a Form PCT/DO/EO/903 indicating acceptance of the application as a national stage submission under 35 U.S.C. 371 will be issued in addition to the Filing Receipt, in due course.

New International Application Filed with the USPTO as a Receiving Office

If a new international application is being filed and the international application includes the necessary components for an international filing date (see PCT Article 11 and MPEP 1810), a Notification of the International Application Number and of the International Filing Date (Form PCT/RO/105) will be issued in due course, subject to prescriptions concerning national security, and the date shown on this Acknowledgement Receipt will establish the international filing date of the application.

Under the Paperwork Reduction Act of 1995, no persons are required to respond to a collection of information unless it displays a valid OMB control number.

PATENT APPLICATION FEE DETERMINATION RECORD Substitute for Form PTO-875	Application or Docket Number 12/057,775	Filing Date 03/28/2008	<input type="checkbox"/> To be Mailed
---	---	----------------------------------	---------------------------------------

APPLICATION AS FILED – PART I			OTHER THAN SMALL ENTITY				
	(Column 1)	(Column 2)	SMALL ENTITY <input type="checkbox"/>	OR			
FOR	NUMBER FILED	NUMBER EXTRA	RATE (\$)	FEE (\$)	OR	RATE (\$)	FEE (\$)
<input type="checkbox"/> BASIC FEE <small>(37 CFR 1.16(a), (b), or (c))</small>	N/A	N/A	N/A			N/A	
<input type="checkbox"/> SEARCH FEE <small>(37 CFR 1.16(k), (j), or (m))</small>	N/A	N/A	N/A			N/A	
<input type="checkbox"/> EXAMINATION FEE <small>(37 CFR 1.16(o), (p), or (q))</small>	N/A	N/A	N/A			N/A	
TOTAL CLAIMS <small>(37 CFR 1.16(j))</small>	minus 20 =	*	X \$ =		OR	X \$ =	
INDEPENDENT CLAIMS <small>(37 CFR 1.16(h))</small>	minus 3 =	*	X \$ =			X \$ =	
<input type="checkbox"/> APPLICATION SIZE FEE <small>(37 CFR 1.16(s))</small>	If the specification and drawings exceed 100 sheets of paper, the application size fee due is \$250 (\$125 for small entity) for each additional 50 sheets or fraction thereof. See 35 U.S.C. 41(a)(1)(G) and 37 CFR 1.16(s).						
<input type="checkbox"/> MULTIPLE DEPENDENT CLAIM PRESENT <small>(37 CFR 1.16(j))</small>							
* If the difference in column 1 is less than zero, enter "0" in column 2.			TOTAL			TOTAL	

APPLICATION AS AMENDED – PART II					OTHER THAN SMALL ENTITY				
	(Column 1)	(Column 2)	(Column 3)						
AMENDMENT	04/04/2012	CLAIMS REMAINING AFTER AMENDMENT	HIGHEST NUMBER PREVIOUSLY PAID FOR	PRESENT EXTRA	RATE (\$)	ADDITIONAL FEE (\$)	OR	RATE (\$)	ADDITIONAL FEE (\$)
	Total <small>(37 CFR 1.16(i))</small>	* 89	Minus	** 90	=	0	OR	X \$60=	0
	Independent <small>(37 CFR 1.16(h))</small>	* 24	Minus	***25	=	0	OR	X \$250=	0
	<input type="checkbox"/> Application Size Fee <small>(37 CFR 1.16(s))</small>								
	<input type="checkbox"/> FIRST PRESENTATION OF MULTIPLE DEPENDENT CLAIM <small>(37 CFR 1.16(j))</small>						OR		
					TOTAL ADD'L FEE		OR	TOTAL ADD'L FEE	0

	(Column 1)	(Column 2)	(Column 3)						
AMENDMENT		CLAIMS REMAINING AFTER AMENDMENT	HIGHEST NUMBER PREVIOUSLY PAID FOR	PRESENT EXTRA	RATE (\$)	ADDITIONAL FEE (\$)	OR	RATE (\$)	ADDITIONAL FEE (\$)
	Total <small>(37 CFR 1.16(i))</small>	*	Minus	**	=		OR	X \$ =	
	Independent <small>(37 CFR 1.16(h))</small>	*	Minus	***	=		OR	X \$ =	
	<input type="checkbox"/> Application Size Fee <small>(37 CFR 1.16(s))</small>								
	<input type="checkbox"/> FIRST PRESENTATION OF MULTIPLE DEPENDENT CLAIM <small>(37 CFR 1.16(j))</small>						OR		
					TOTAL ADD'L FEE		OR	TOTAL ADD'L FEE	

* If the entry in column 1 is less than the entry in column 2, write "0" in column 3.
 ** If the "Highest Number Previously Paid For" IN THIS SPACE is less than 20, enter "20".
 *** If the "Highest Number Previously Paid For" IN THIS SPACE is less than 3, enter "3".
 The "Highest Number Previously Paid For" (Total or Independent) is the highest number found in the appropriate box in column 1.

Legal Instrument Examiner:
 /ROSS W. BROWN/

This collection of information is required by 37 CFR 1.16. The information is required to obtain or retain a benefit by the public which is to file (and by the USPTO to process) an application. Confidentiality is governed by 35 U.S.C. 122 and 37 CFR 1.14. This collection is estimated to take 12 minutes to complete, including gathering, preparing, and submitting the completed application form to the USPTO. Time will vary depending upon the individual case. Any comments on the amount of time you require to complete this form and/or suggestions for reducing this burden, should be sent to the Chief Information Officer, U.S. Patent and Trademark Office, U.S. Department of Commerce, P.O. Box 1450, Alexandria, VA 22313-1450. DO NOT SEND FEES OR COMPLETED FORMS TO THIS ADDRESS. **SEND TO: Commissioner for Patents, P.O. Box 1450, Alexandria, VA 22313-1450.**

If you need assistance in completing the form, call 1-800-PTO-9199 and select option 2.

INFORMATION DISCLOSURE STATEMENT BY APPLICANT (Not for submission under 37 CFR 1.99)	Application Number	12057775
	Filing Date	2008-03-28
	First Named Inventor	Inge Bruheim
	Art Unit	1651
	Examiner Name	Ware
	Attorney Docket Number	NATNUT-14409/US-5/ORD

U.S. PATENTS						Remove
Examiner Initial*	Cite No	Patent Number	Kind Code ¹	Issue Date	Name of Patentee or Applicant of cited Document	Pages, Columns, Lines where Relevant Passages or Relevant Figures Appear
	1					

If you wish to add additional U.S. Patent citation information please click the Add button.

Add

U.S. PATENT APPLICATION PUBLICATIONS						Remove
Examiner Initial*	Cite No	Publication Number	Kind Code ¹	Publication Date	Name of Patentee or Applicant of cited Document	Pages, Columns, Lines where Relevant Passages or Relevant Figures Appear
	1					

If you wish to add additional U.S. Published Application citation information please click the Add button.

Add

FOREIGN PATENT DOCUMENTS							Remove	
Examiner Initial*	Cite No	Foreign Document Number ³	Country Code ² j	Kind Code ⁴	Publication Date	Name of Patentee or Applicant of cited Document	Pages, Columns, Lines where Relevant Passages or Relevant Figures Appear	T ⁵
	1	JP-A-S52-114046	JP		1977-09-24	Kokai		<input type="checkbox"/>
	2	JP-A-S51-125774	JP		1976-11-02	Nichiro Gyogyo et al.		<input type="checkbox"/>

If you wish to add additional Foreign Patent Document citation information please click the Add button

Add

NON-PATENT LITERATURE DOCUMENTS						Remove
---------------------------------	--	--	--	--	--	--------

INFORMATION DISCLOSURE STATEMENT BY APPLICANT (Not for submission under 37 CFR 1.99)	Application Number		12057775
	Filing Date		2008-03-28
	First Named Inventor	Inge Bruheim	
	Art Unit		1651
	Examiner Name	Ware	
	Attorney Docket Number		NATNUT-14409/US-5/ORD

Examiner Initials*	Cite No	Include name of the author (in CAPITAL LETTERS), title of the article (when appropriate), title of the item (book, magazine, journal, serial, symposium, catalog, etc), date, pages(s), volume-issue number(s), publisher, city and/or country where published.	T ⁵
	1	JP Office Action mailed February 23, 2012, JP Patent Application No. 2010-522444 (and English translation)	<input type="checkbox"/>

If you wish to add additional non-patent literature document citation information please click the Add button **Add**

EXAMINER SIGNATURE

Examiner Signature		Date Considered	
--------------------	--	-----------------	--

*EXAMINER: Initial if reference considered, whether or not citation is in conformance with MPEP 609. Draw line through a citation if not in conformance and not considered. Include copy of this form with next communication to applicant.

¹ See Kind Codes of USPTO Patent Documents at www.USPTO.GOV or MPEP 901.04. ² Enter office that issued the document, by the two-letter code (WIPO Standard ST.3). ³ For Japanese patent documents, the indication of the year of the reign of the Emperor must precede the serial number of the patent document. ⁴ Kind of document by the appropriate symbols as indicated on the document under WIPO Standard ST.16 if possible. ⁵ Applicant is to place a check mark here if English language translation is attached.

INFORMATION DISCLOSURE STATEMENT BY APPLICANT (Not for submission under 37 CFR 1.99)	Application Number	12057775
	Filing Date	2008-03-28
	First Named Inventor	Inge Bruheim
	Art Unit	1651
	Examiner Name	Ware
	Attorney Docket Number	NATNUT-14409/US-5/ORD

CERTIFICATION STATEMENT

Please see 37 CFR 1.97 and 1.98 to make the appropriate selection(s):

That each item of information contained in the information disclosure statement was first cited in any communication from a foreign patent office in a counterpart foreign application not more than three months prior to the filing of the information disclosure statement. See 37 CFR 1.97(e)(1).

OR

That no item of information contained in the information disclosure statement was cited in a communication from a foreign patent office in a counterpart foreign application, and, to the knowledge of the person signing the certification after making reasonable inquiry, no item of information contained in the information disclosure statement was known to any individual designated in 37 CFR 1.56(c) more than three months prior to the filing of the information disclosure statement. See 37 CFR 1.97(e)(2).

- See attached certification statement.
- The fee set forth in 37 CFR 1.17 (p) has been submitted herewith.
- A certification statement is not submitted herewith.

SIGNATURE

A signature of the applicant or representative is required in accordance with CFR 1.33, 10.18. Please see CFR 1.4(d) for the form of the signature.

Signature	/J. Mitchell Jones/	Date (YYYY-MM-DD)	2012-03-21
Name/Print	J. Mitchell Jones	Registration Number	44174

This collection of information is required by 37 CFR 1.97 and 1.98. The information is required to obtain or retain a benefit by the public which is to file (and by the USPTO to process) an application. Confidentiality is governed by 35 U.S.C. 122 and 37 CFR 1.14. This collection is estimated to take 1 hour to complete, including gathering, preparing and submitting the completed application form to the USPTO. Time will vary depending upon the individual case. Any comments on the amount of time you require to complete this form and/or suggestions for reducing this burden, should be sent to the Chief Information Officer, U.S. Patent and Trademark Office, U.S. Department of Commerce, P.O. Box 1450, Alexandria, VA 22313-1450. **DO NOT SEND FEES OR COMPLETED FORMS TO THIS ADDRESS. SEND TO: Commissioner for Patents, P.O. Box 1450, Alexandria, VA 22313-1450.**

Privacy Act Statement

The Privacy Act of 1974 (P.L. 93-579) requires that you be given certain information in connection with your submission of the attached form related to a patent application or patent. Accordingly, pursuant to the requirements of the Act, please be advised that: (1) the general authority for the collection of this information is 35 U.S.C. 2(b)(2); (2) furnishing of the information solicited is voluntary; and (3) the principal purpose for which the information is used by the U.S. Patent and Trademark Office is to process and/or examine your submission related to a patent application or patent. If you do not furnish the requested information, the U.S. Patent and Trademark Office may not be able to process and/or examine your submission, which may result in termination of proceedings or abandonment of the application or expiration of the patent.

The information provided by you in this form will be subject to the following routine uses:

1. The information on this form will be treated confidentially to the extent allowed under the Freedom of Information Act (5 U.S.C. 552) and the Privacy Act (5 U.S.C. 552a). Records from this system of records may be disclosed to the Department of Justice to determine whether the Freedom of Information Act requires disclosure of these records.
2. A record from this system of records may be disclosed, as a routine use, in the course of presenting evidence to a court, magistrate, or administrative tribunal, including disclosures to opposing counsel in the course of settlement negotiations.
3. A record in this system of records may be disclosed, as a routine use, to a Member of Congress submitting a request involving an individual, to whom the record pertains, when the individual has requested assistance from the Member with respect to the subject matter of the record.
4. A record in this system of records may be disclosed, as a routine use, to a contractor of the Agency having need for the information in order to perform a contract. Recipients of information shall be required to comply with the requirements of the Privacy Act of 1974, as amended, pursuant to 5 U.S.C. 552a(m).
5. A record related to an International Application filed under the Patent Cooperation Treaty in this system of records may be disclosed, as a routine use, to the International Bureau of the World Intellectual Property Organization, pursuant to the Patent Cooperation Treaty.
6. A record in this system of records may be disclosed, as a routine use, to another federal agency for purposes of National Security review (35 U.S.C. 181) and for review pursuant to the Atomic Energy Act (42 U.S.C. 218(c)).
7. A record from this system of records may be disclosed, as a routine use, to the Administrator, General Services, or his/her designee, during an inspection of records conducted by GSA as part of that agency's responsibility to recommend improvements in records management practices and programs, under authority of 44 U.S.C. 2904 and 2906. Such disclosure shall be made in accordance with the GSA regulations governing inspection of records for this purpose, and any other relevant (i.e., GSA or Commerce) directive. Such disclosure shall not be used to make determinations about individuals.
8. A record from this system of records may be disclosed, as a routine use, to the public after either publication of the application pursuant to 35 U.S.C. 122(b) or issuance of a patent pursuant to 35 U.S.C. 151. Further, a record may be disclosed, subject to the limitations of 37 CFR 1.14, as a routine use, to the public if the record was filed in an application which became abandoned or in which the proceedings were terminated and which application is referenced by either a published application, an application open to public inspections or an issued patent.
9. A record from this system of records may be disclosed, as a routine use, to a Federal, State, or local law enforcement agency, if the USPTO becomes aware of a violation or potential violation of law or regulation.



特許庁
2000円

特許願

昭和50年4月25日

特許庁長官殿

1. 発明の名称

南水洋産オキアミの加工方法

2. 発明者

住所 東京都世田谷区祖師谷3丁目21番8号

日魯漁業株式会社祖師谷アパート

氏名 大西隆三 外2名

3. 特許出願人

住所 東京都千代田区有楽町一丁目12番1号

名称 日魯漁業株式会社 外1名

代表者 加藤琢治

国籍

4. 代理人

住所 〒105 東京都港区西新橋1丁目2番9号

三井物産館内 電話(591)0261番

(2400) 氏名 金丸義男 外4名

金丸特許事務所内(6145) 氏名 朝内忠夫 外3名

50 049765

明 細 書

1. 発明の名称

南水洋産オキアミの加工方法

2. 特許請求の範囲

南水洋産オキアミに外力を加えることにより肉部は殻中に残り肝臓を体外に押し出して除去し、肝臓を除去したオキアミを採肉装置により処理することにより肉部を得、ついでこの肉部を加熱して熱凝固蛋白質を取得することを特徴とする南水洋産オキアミの加工方法。

3. 発明の詳細な説明

本発明は南水洋産オキアミの加工方法に関する。南水洋産オキアミ (Euphausia superba, 以下単にオキアミという) は、南水洋に生棲するアミの一種であり小エビに似た体長約15~50mmの大型の動物性プランクトンである。

オキアミの資源量は10~15億トンと推定されており、成長が速く2年で成熟するので、全世界の漁獲量に近い5,000~7,000万トン程度を

①9 日本国特許庁

公開特許公報

①特開昭 51-125774

④公開日 昭51.(1976)11.2

②特願昭 50-49765

②出願日 昭50.(1975)4.25

審査請求 未請求 (全3頁)

庁内整理番号

697149

②日本分類

J4 F0

⑤ Int. Cl?

A23J 1/04

A22C 29/02

毎年漁獲しても再生産に悪影響を及ぼさない程の莫大な量があると言われており、従つてこれを動物性タンパク質源として利用するための加工方法の開発が急がれている。

オキアミを食品として利用するために現在実用化され、あるいは開発されている加工方法としては(1)殻付きのまま煮熟し、ついで冷凍あるいは乾燥する方法、(2)殻付きのまま細断した後搾り出し、これを加熱して熱凝固蛋白質等を得る方法、(3)オキアミの肝臓の強力な消化酵素を利用してオキアミ・ソリユールを製造する方法、および(4)魚類のFPC (Fish Protein Concentrate) と同様の方法でイソプロパノール等を経剤として使用してオキアミFPCを製造する方法、等がある。これらの方法中(2)の熱凝固蛋白質を得る方法はオキアミの蛋白質を能率よく採取しかつ大量に処理するのに適した方法である。

しかしながら、これらのいずれの加工方法においても処理工程中に内臓を除去することが困難で

あるため、最終製品中に内臓液が混入することを避けられず、特に肝臓にはエグ味や苦味があり油相分も含有されており、また強力な消化酵素が含有されているので、甲殻類特有の炭白で爽快味のあるうま味の減退した製品しか得られず、また消化酵素の作用により歩留りが低下し、かつ冷蔵保存を行った場合においても製品の品質が低下していくという欠点がある。

本発明は前記(2)の方法によりオキアミの蛋白質を能率よく採取しかつ大量に処理して熱凝固蛋白質を製造するにあたり、肝臓液を予め除去することにより、美味でかつ長期保存性のあるオキアミ熱凝固蛋白質を製造する方法を提供することを目的とする。

従つて本発明によれば、南氷洋産オキアミに外力を加えることにより肉部は殻中に残し肝臓を体外に押し出して除去し、肝臓を除去したオキアミを採肉装置により処理することにより肉部を得、ついでこの肉部を加熱して熱凝固蛋白質を取得することを特徴とする南氷洋産オキアミの加工方法が

つぎに肝臓液を除去した殻付オキアミを、そのままあるいは予め直径5mm程度の肉挽機で破砕した後、例えば圧搾機で圧搾して殻部を除去し粥状又は濃厚なジュース状の肉部を得る。この場合、使用した圧搾機の種類によつては肉部に若干の微細な殻が混入することがあるので、必要に応じてそのままの状態あるいは清水を加えた後濾過を行なつて混入している殻を除去する。

つぎにかく得られた粥状又は濃厚なジュース状の肉部を、90℃程度に加熱することによりオキアミの蛋白質の大部分を占める熱凝固性蛋白質を熱凝固させ、淡黄色の塊肉状凝固蛋白質と淡黄色透明な液部(ブロス)とを生成させる。ついでこれをそのまま濾過するかあるいは遠心分離して凝固蛋白質とブロスとに分離する。かく得られた凝固蛋白質は肝臓液を含有していないためエグ味や苦味がなく甲殻類の身肉に特有のうま味を有しており、肝臓液除去処理を行わない方法で得られた凝固蛋白質に較べて極めて美味である。ブロスは必要に応じて更に遠心分離または濾過を行ないついで滅菌

提供される。

オキアミを大型トロール漁船で捕獲し、船上に引揚げて積み重ねた場合、オキアミの鮮度が極めて良好な場合でも、約40cm程度積み重ねるだけで下積みのオキアミの頭胸部にある臓器、特に肝臓部がおしつぶされて黄色の肝臓液が排出される。本発明者らは実験結果から、生鮮オキアミに対し約40~140g/cm²程度の僅かな外力を加えるかあるいは1000g程度の遠心力を数分間加えることにより、肝臓液が体外に容易に排出されることを認めた。

本発明においては前記(2)のごとき方法に従つてオキアミの肉部を採取するにあたり、先ず上記したごとき方法によりオキアミの体内から肝臓液を排出させ除去する。肝臓液を排出させたオキアミの体の表面には肝臓液がまだ僅かに付着しているので、清水または海水で簡単に洗浄するかあるいはシャワー等で洗浄してこれを除去することにより殆んど完全に肝臓液の付着していないオキアミを得る。

輪枷で蒸籠して甲殻類特有の美味なエキスを得る。なおこのエキスを凝固蛋白質中に適量混入させることにより凝固蛋白質の味を著るしく向上させることができる。

本発明の方法により得られる凝固蛋白質は、肝臓成分を含まないために冷蔵保存中の品質保持性が優れており、肝臓液除去処理を行わないで製造した熱凝固蛋白質が約8か月で呈味を損ねるのに対し、本発明による製品は1年間の保存にも耐えることができる。

南氷洋におけるオキアミの漁期は12月~2月の融氷期に限られており、従つて1年以上の保存寿命を要求されるオキアミ製品の製造においては本発明の上記の効果は極めて重要な効果である。なお、圧搾機で肉部から分離した殻部は煮熟後乾燥して優良な飼料として利用し得る。

実施例

生鮮な南氷洋産オキアミ25kgをバスケット型遠心分離機に投入し、遠心力1000gで2分間回転させることにより肝臓およびその他の内臓を

特開昭51-125774(3)

殆んど完全に除去して、頭胸部が扁平になりしかも尾腹部に肉を有するオキアミ12.5kgを得た。このオキアミを0.5mmの空隙を有する回転圧搾式骨肉分離機により圧搾分離することにより肉状の肉部7.5kg(原料のオキアミの60%の収率)を得、これを直ちに不銹鋼製の加熱容器に移し、十分攪拌しながら、直火で75℃まで加熱した(この間に60℃附近で蛋白が一部凝固した)。つぎに加熱容器を沸騰湯煎中に移し、攪拌しながら加熱を続けた。83℃で急速に蛋白の凝固が始まり、90℃で凝固が完了したことが認められたが90℃になお2分間保持した。

つぎに容器を流水槽に浸漬して内容物を70℃程度まで冷却し、ついでガーゼ布で濾過した。かく得られた凝固蛋白を再びバスケット型遠心分離機に入し、遠心力2000g程度で3分間脱水することにより、水分60%の淡黄色塊肉状のオキアミ熱凝固蛋白4.2kgを得た(収率34%)。この熱凝固蛋白には苦味やエグ味が全くなく、肝臓液除去処理をしない製品に比べてすぐれた甲殻類

特有のうま味があつた。熱凝固蛋白を分離した後、肉部は更に遠心力3000gで3分間遠心分離し、ついで減圧濃縮機により45ブリックス(水分60%前後)まで濃縮して比較的粘度の低いエキス250gを得た(収率2%)このエキスにも前記熱凝固蛋白と同様、苦味やエグ味が全くなく、甲殻類に特有のうま味があつた。

上記の熱凝固蛋白を小型冷凍パンに装入して成型し、-35℃で急速冷凍を行ない-25℃で保存試験を実施した結果、本発明による肝臓液除去処理を行わないものは3ヶ月で褐変し始め、6ヶ月で味に変化が認められたのに対し、本発明の方法により製造されたものは1年経過しても味の変化は殆んど認められずまた油煙臭も少なかつた。

代理人	朝	内	忠	夫
同	八	木	田	茂
同	浜	野	孝	雄
同	森	田	哲	二

5.添附書類の目録

- (1) 明細書 1通
- (2) 図面 1通
- (3) 委任状 1通 追て補充

3
(2) 代理人

住所 東京都港区西新橋1丁目2番9号
三井物産館内 金丸特許事務所内

氏名 朝 内 忠 夫

同所 八 木 田 茂

同所 浜 野 孝 雄

同所 森 田 哲 二

特許出願人及び

6.前記以外の発明者、代理人

(1) 発明者

住所 東京都大田区北千束2丁目45番17号

氏名 寺 瀬 経 夫

住所 東京都府中市浅間町3-2

日魯漁業株式会社府中アパート

氏名 赤 沢 治 夫

(2) 特許出願人

住所 神奈川県横須賀市長瀬2丁目1番1号

名称 太平鋼材株式会社

代表者 寺 瀬 経 夫

公開特許公報

昭52—114046

⑤Int. Cl.²
A 23 J 1/04
A 22 C 29/02
A 23 L 1/325

識別記号

⑥日本分類
34 F 0

庁内整理番号
7110—49

④公開 昭和52年(1977)9月24日

発明の数 2
審査請求 未請求

(全 4 頁)

⑤4蛋白質液及び蛋白質粉末の製造方法

⑦発明者 江口通

東京都杉並区下井草5—18—5

⑧特 願 昭51—29290

同 本田和利

⑨出 願 昭51(1976)3月19日

桶川市加納384—6

⑩発明者 橋本誠二

同 阿部靖国

大宮市大字土屋299—19

柏市吉野沢8—46

同 小川明彦

⑪出願人 日研化学株式会社

浦和市下木崎1160天沼下8—30

東京都中央区築地5丁目4番14号

1

明 細 書

1. 発明の名称

蛋白質液及び蛋白質粉末の製造方法

2. 特許請求の範囲

① 乾燥オキアミを水又は塩水に浸漬して肉質部分を溶出させたのちオキアミの甲殻を除去し、かくして得られる溶出液を加熱し、ついで生成した凝固物を除去することを特徴とする蛋白質液の製造方法。

② 乾燥オキアミを水又は塩水に浸漬して肉質部分を溶出させたのちオキアミの甲殻を除去し、かくして得られる溶出液を加熱し、生成した凝固物を除去して得られる蛋白質液に糖質を加え混合懸液したのち噴霧乾燥することを特徴とする蛋白質粉末の製造方法。

3. 発明の詳細を説明

本発明は、乾燥オキアミから脂肪分を含まない蛋白質液又は蛋白質粉末を製造する方法に関するものである。

オキアミは広く海洋に分布する動物性プランクトンの一種でエビに似た体長1〜7cm程度の甲殻類で、主にナガス鯨及び白ナガス鯨の餌として知られている。特に南極海に棲息するユーファシア・スベルバ (Euphasia superba) 種は、推定資源量数億トンといわれ、鯨の減少とともに増加の傾向にある。この豊富な資源を食用に供し、将来予想される蛋白質源の不足に備えることは重要な意義を有することである。このため、各方面においてオキアミの食品化への研究が行なわれるようになってきたが、未だ満足な成果は得られていない。このように研究が遅れている原因として、嗜好的なもののほかに可食化、保存性に次のような問題点が指摘されている。

① オキアミはエビにくらべて小形であるうえ甲殻が体全体の30%もあり、しかも柔軟なため、脱殻がきわめて困難である。このため、ムキエビのような製品とすることが難しく、従って蛋白質部分のみを有効に利用するには、

肉質部分を蒸出せざるを得ないが、そのための有効な手段は未だ見出されていない。

- (2) オキアミはそのままの状態でも食用とすることが不可能ではないが、オキアミ特有の臭(アミン臭)と味を有する。これは所謂、悪味悪臭ではないが少量の摂取でもすぐ飽きるものである。かつて、大量摂取にはむかないものである。これらの臭や味はオキアミの脂質中に含まれる高度不飽和脂肪酸等に起因するところが大きく、さらにこの高度不飽和脂肪酸の酸化は、保存性、嗜好性を悪くする原因ともなっている。このような魚体中の高度不飽和脂肪酸を取り除く方法としては、例えば、*n*-ヘキサン、シクロヘキサン、アセトン等の有機溶媒により脱脂する方法が一般に用いられているが、かかる方法では原料からくる特長が失われ、旨味がなくなつてしまう他、有機溶媒を用いるため、製造コストが高くなり、また食品衛生法上、天然食品として取扱うことができなくなるという致命的な欠陥をもつ

という知見を得るに至つた。

本発明はかかる新知見にもとづいて完成されたもので、乾燥オキアミを所定時間水又は塩水に浸漬して肉質部分を蒸出させたのち、オキアミの甲殻を除去し、かくして得られる蒸出液を加熱して蛋白質凝固物を生成させ、ついでこの凝固物を除去して、脂肪分を含まない蛋白質液を得ることから成る方法であり、且つ、かくして得られる蛋白質液に糊質を加えて攪拌下に加温して均一に混合溶解したのち、常法により噴霧乾燥を行つて蛋白質粉末を製造する方法である。

本発明で用いられる乾燥オキアミは、捕獲直後のオキアミをそのまま乾燥したもの、又は捕獲後そのまま凍結した生凍結オキアミを解凍後乾燥したもの等が用いられ、オキアミを予め煮熟した後乾燥したものは本発明には適さない。また、本発明によれば、原料として用いられる乾燥オキアミの水分含量が低い程対固形分収率が低くなり、また水分含量が

ている。したがつて、オキアミ中の高度不飽和脂肪酸等の脂質を有機溶媒を使用することなく除去することができればオキアミの食品化にとつて極めて好ましいことであるが、未だこのような方法は知られていない。

- (3) オキアミは、通常捕獲後直ちに生のまま、あるいは煮熟して冷凍保蔵される。しかし、オキアミは普通約80%の水分を含んでおり、これがために凍結製品の解凍時には大量のドリップ(drip)が生じ、オキアミのもつている多量の可溶性蛋白質がかなりドリップへ移行されて失われるので、その有効な利用方法を開発することも急務である。

本発明者らはかかる点を解決するべく研究を重ね、先に生及び凍結オキアミから脂肪分のない良質な高蛋白質液及び高蛋白質粉末を得る方法を発明し、特願昭50-152874として特許出願したが更に研究を進めた結果、水分含量の少ない乾燥オキアミからも水又は塩水を用いて水溶性蛋白質を有効に抽出しうる

高い程原料全体に対する収率が低下する。したがつて、本発明に用いられる原料の乾燥オキアミとしては、水分含量10~50%のものが最も好ましいが、場合によつては水分含量がこの範囲を越えるものも使用することができる。

これらの乾燥オキアミを浸漬する場合、凍結されているものを原料とするときは、水を加えて解凍後そのまま浸漬すれば良い。浸漬は通常室温以下の温度で、5~24時間行い。浸漬中に攪拌等を行えば更に短時間で目的を達成することができる。浸漬液の量はオキアミが充分ひたる程度の量以上あれば充分であり、浸漬中に攪拌等を行つてもさしつかえない。また、浸漬液として塩水を用いる場合は、3%程度の比較的低温度の塩水を用いることが製品中の塩分を少なくする上で好ましい。つぎに、浸漬液からオキアミの甲殻を濾過あるいは金網ですくう等の方法で除去し、必要により、更に甲殻に付着している肉質部分を

洗い落すことにより、オキアミの溶出液を得ることができる。

つぎに、溶出液を加熱するには、15～30分間蒸煮すれば充分である。この加熱により、高価不飽和脂肪酸等の脂肪分が一部の蛋白質と共に凝固物として析出するが、このものは、遠心分離器、加圧濾過器(フィルタープレス)、減圧濾過器(オリバーフィルター)等で容易に除去することができる。以上の方法により脂肪分を含まない蛋白質液を得ることができる。この蛋白質液は、必要により活性炭で脱色することにより更に良質な蛋白質液にすることができる。

本発明によれば、上記の如くして得られる蛋白質液に所定量の糖質を加え、必要により加熱し、均一に混合溶解したのち、常法により噴霧乾燥することにより蛋白質粉末にすることができる。この場合に加える糖質としては、乳糖、麦芽糖の如き糖類、可溶性デンプンの如き澱粉類、デキストリン、粉あめの如

好性の面でもすぐれている。また、本発明によれば、生凍結品を原料とする方法に比べて水分含量の低い原料を用いるので輸送上のみならず貯蔵上からも極めて経済的であり、また、処理操作の上でも対原料収率が著しく向上するので極めて有利である。オキアミは固形分の約70%が粗蛋白質であるが、本発明方法によれば、この内の約6割程度を蛋白質液として得ることができる。更に本発明方法には、アルカリ、酸、有機溶媒等の化学薬品の添加あるいはこれらを使用する処理が全くない。したがって、本発明方法により得られた蛋白質液又は蛋白質粉末は食品衛生法上問題がないという優れた利点を有する。

つぎに実施例を示し、本発明を更に詳細に説明する。

実施例 1

水分含量15%のオキアミ100kgを真水1460kgに12時間10℃以下で浸漬することによりオキアミの肉質部分を浸漬液中に溶出

き澱粉中間分解物、あるいは、これらの澱粉中間分解物を還元して得られる糖類アルコール等が用いられる。加える糖質の量は、糖質の種類により多少差はあるが、通常蛋白質液中の蛋白質含量に対し0.7～3倍量用いるのが好ましい。糖質の量が少なすぎると蛋白質粉末の吸湿性が著しくなり、保存性等の面から好ましくない。

本発明によつて得られた蛋白質液は外観が概ね淡黄色でエビの芳香及び味覚を有するため調味料の主原料として有用である。また、本発明によつて得られる蛋白質粉末は、外観が概ね淡灰白色でソフトなエビ臭と味覚を有し、口あたりも滑らかで溶け易いので種々の食品における主原料並びに副原料として有用であり、且つ栄養価の向上、味覚の改善等を目的として、従来の水産ねり製品あるいは風味を珍重するスナック食品、香辛料等にも添加、使用することができる。また、脂肪分を含まないため酸化が起りにくく、保存性、嗜

せしめる。つぎに、オキアミの魚体をすくひ上げて取り除き、更にこの魚体を真水235kgで2回洗浄しオキアミの溶出液1660kgを得る。この溶出液を30分間蒸煮することによつて紫灰色の凝固物が析出する。つぎに、凝固物は、帆布を施した濾過器で濾し取ることによつて、脂肪分を含まない蛋白質液1620kg(蛋白質含量2.2%)を得ることができる。つづいて、この蛋白質液をカーボン800gで脱色することにより、殆ど無色の蛋白質液を得ることができる。

つぎに、ここに得られた蛋白質液(蛋白質量35.6kg)に対し、デキストリン69kg(蛋白質量に対し1.94倍量)を加え、撈拌下に加熱して均一に溶解した後、噴霧乾燥することによつて良質な蛋白質粉末108kgを得ることができる。

上記の方法により得られた蛋白質液、蛋白質粉末及び通常の乾燥により得られた乾燥オキアミ粉末の成分組成を第1表に示す。

第 1 表

	蛋白質液	蛋白質粉末	乾燥オキアミ粉末
水分	95.6%	3.8%	4.0%
粗蛋白質	2.2	53.9	70.4
脂肪	0	0.1	5.9
灰分	0.2	3.1	11.4
食塩	0.2	3.1	2.4
糖質	—	56.0	—

実施例 2

水分含量 40% のオキアミ 100 ㍑ を真水 940 ㍑ に 12 時間 10°C 以下で浸漬することによりオキアミの肉質部分を浸漬液中に溶出せしめる。つぎに、オキアミの魚体をすくい上げて取り除き、更にこの魚体を真水 155 ㍑ で 2 回洗浄しオキアミの溶出液 1060 ㍑ を得る。この溶出液を 30 分間蒸煮することによつて紫灰色の凝固物が析出する。つぎに、凝固物は、ろ布を施したろ過器でろし取ることによつて、脂肪分を含まない蛋白質液 995 ㍑

特開 昭52-114046 (4)

(蛋白質含量 2.8%) を得ることができる。

つづいて、この蛋白質液をカーボン 800 ㍑ で脱色することにより、殆ど無色の蛋白質液を得ることができる。

つぎに、ここに得られた蛋白質液 (蛋白質量 27.9 ㍑) に対し、デキストリン 54 ㍑ (蛋白質量に対し 1.94 倍量) を加え、攪拌下に加温して均一に溶解した後、噴霧乾燥することによつて良質な蛋白質粉末 84.5 ㍑ を得ることができる。

特許出願人 日研化学株式会社

Electronic Acknowledgement Receipt

EFS ID:	12358705
Application Number:	12057775
International Application Number:	
Confirmation Number:	1945
Title of Invention:	BIOEFFECTIVE KRILL OIL COMPOSITIONS
First Named Inventor/Applicant Name:	Inge Bruheim
Customer Number:	72960
Filer:	John Mitchell Jones/Vickie Hoeft
Filer Authorized By:	John Mitchell Jones
Attorney Docket Number:	NATNUT-14409/US-5/ORD
Receipt Date:	21-MAR-2012
Filing Date:	28-MAR-2008
Time Stamp:	15:49:12
Application Type:	Utility under 35 USC 111(a)

Payment information:

Submitted with Payment	no
------------------------	----

File Listing:

Document Number	Document Description	File Name	File Size(Bytes)/ Message Digest	Multi Part /.zip	Pages (if appl.)
1	Transmittal Letter	14409US5ORD_IDSletterFS022 02012.pdf	73624 <small>df4bb288bec02f3c9bbc888b4ca504b3f300b60</small>	no	1

Warnings:

Information:

2	Information Disclosure Statement (IDS) Form (SB08)	14409IDS03212012.pdf	529226 700dc273948b5bb998623413e8bcf04029c989f8	no	4
Warnings:					
Information:					
A U.S. Patent Number Citation or a U.S. Publication Number Citation is required in the Information Disclosure Statement (IDS) form for autoloading of data into USPTO systems. You may remove the form to add the required data in order to correct the Informational Message if you are citing U.S. References. If you chose not to include U.S. References, the image of the form will be processed and be made available within the Image File Wrapper (IFW) system. However, no data will be extracted from this form. Any additional data such as Foreign Patent Documents or Non Patent Literature will be manually reviewed and keyed into USPTO systems.					
3	Non Patent Literature	JPOfficeAction.pdf	267109 8aa58581f1fba973bfb7836d5137fdec11686fa7	no	6
Warnings:					
Information:					
4	Foreign Reference	JP51125774.pdf	202953 f9941eaa79a3f678c825b632c841282a78ae003f	no	3
Warnings:					
Information:					
5	Foreign Reference	JP52114046.pdf	235284 6c5aba15820bc9acefea0035e8f0292417c6ec36	no	4
Warnings:					
Information:					
Total Files Size (in bytes):				1308196	
<p>This Acknowledgement Receipt evidences receipt on the noted date by the USPTO of the indicated documents, characterized by the applicant, and including page counts, where applicable. It serves as evidence of receipt similar to a Post Card, as described in MPEP 503.</p> <p><u>New Applications Under 35 U.S.C. 111</u> If a new application is being filed and the application includes the necessary components for a filing date (see 37 CFR 1.53(b)-(d) and MPEP 506), a Filing Receipt (37 CFR 1.54) will be issued in due course and the date shown on this Acknowledgement Receipt will establish the filing date of the application.</p> <p><u>National Stage of an International Application under 35 U.S.C. 371</u> If a timely submission to enter the national stage of an international application is compliant with the conditions of 35 U.S.C. 371 and other applicable requirements a Form PCT/DO/EO/903 indicating acceptance of the application as a national stage submission under 35 U.S.C. 371 will be issued in addition to the Filing Receipt, in due course.</p> <p><u>New International Application Filed with the USPTO as a Receiving Office</u> If a new international application is being filed and the international application includes the necessary components for an international filing date (see PCT Article 11 and MPEP 1810), a Notification of the International Application Number and of the International Filing Date (Form PCT/RO/105) will be issued in due course, subject to prescriptions concerning national security, and the date shown on this Acknowledgement Receipt will establish the international filing date of the application.</p>					

IN THE UNITED STATES PATENT AND TRADEMARK OFFICE

In re Application of:	Inge Bruheim, et al	Confirmation:	1945
Serial No.:	12/057,775	Group No.:	1651
Filed:	03-28-2008	Examiner:	Ware, Deborah K.
Entitled:	BIOEFFECTIVE KRILL OIL COMPOSITIONS		

INFORMATION DISCLOSURE STATEMENT LETTER

EFS Web Filed
Commissioner for Patents
P.O. Box 1450
Alexandria, VA 22313-1450

Sir or Madam:

The citations listed in the attached **IDS Form SB08A** may be material to the examination of the above-identified application, and are therefore submitted in compliance with the duty of disclosure defined in 37 C.F.R. §§ 1.56 and 1.97.

Applicants wish to bring to the Examiner’s attention that we are not providing copies of US Patents as instructed under 37 CFR 1.98(a)(2). The Examiner is requested to make these citations of official record in this application.

Applicants wish to bring to the Examiner’s attention that the references supplied in this IDS are from the JP Office Action mailed February 23, 2012 from related JP Patent Application No. 2010-52244.

This Information Disclosure Statement under 37 C.F.R. §§ 1.56 and 1.97 is not to be construed as a representation that a search has been made, that additional information material to the examination of this application does not exist, or that any one or more of these citations constitutes prior art.

The Commissioner is hereby authorized to charge any required fees or credit any overpayments to Attorney Deposit Account No.: **50-4302**, referencing Attorney Docket No.: **NATNUT-14409/US-5/ORD**.

Dated: March 21, 2012

/J. Mitchell Jones/
J. Mitchell Jones
Registration No. 44,174
CASIMIR JONES, S.C.
2275 Deming Way, Suite 310
Middleton, WI 53562
608.662.1277

INFORMATION DISCLOSURE STATEMENT BY APPLICANT (Not for submission under 37 CFR 1.99)	Application Number		12057775	
	Filing Date		2008-03-28	
	First Named Inventor	Inge Bruheim		
	Art Unit	1651		
	Examiner Name	Ware, Deborah K.		
	Attorney Docket Number	NATNUT-14409/US-5/ORD		

U.S.PATENTS						Remove
Examiner Initial*	Cite No	Patent Number	Kind Code ¹	Issue Date	Name of Patentee or Applicant of cited Document	Pages,Columns,Lines where Relevant Passages or Relevant Figures Appear
	1					

If you wish to add additional U.S. Patent citation information please click the Add button. Add

U.S.PATENT APPLICATION PUBLICATIONS						Remove
Examiner Initial*	Cite No	Publication Number	Kind Code ¹	Publication Date	Name of Patentee or Applicant of cited Document	Pages,Columns,Lines where Relevant Passages or Relevant Figures Appear
	1					

If you wish to add additional U.S. Published Application citation information please click the Add button. Add

FOREIGN PATENT DOCUMENTS								Remove
Examiner Initial*	Cite No	Foreign Document Number ³	Country Code ² j	Kind Code ⁴	Publication Date	Name of Patentee or Applicant of cited Document	Pages,Columns,Lines where Relevant Passages or Relevant Figures Appear	T ⁵
	1	2003-530448	JP		2003-10-14	Westfalia Separator Industry GmbH		<input type="checkbox"/>

If you wish to add additional Foreign Patent Document citation information please click the Add button Add

NON-PATENT LITERATURE DOCUMENTS				Remove
Examiner Initials*	Cite No	Include name of the author (in CAPITAL LETTERS), title of the article (when appropriate), title of the item (book, magazine, journal, serial, symposium, catalog, etc), date, pages(s), volume-issue number(s), publisher, city and/or country where published.		T ⁵

INFORMATION DISCLOSURE STATEMENT BY APPLICANT (Not for submission under 37 CFR 1.99)	Application Number	12057775
	Filing Date	2008-03-28
	First Named Inventor	Inge Bruheim
	Art Unit	1651
	Examiner Name	Ware, Deborah K.
	Attorney Docket Number	NATNUT-14409/US-5/ORD

1	December 8, 2011 Office Action, KR Patent Application No. 10-2010-7006897 and its English translation	<input type="checkbox"/>
---	---	--------------------------

If you wish to add additional non-patent literature document citation information please click the Add button **Add**

EXAMINER SIGNATURE

Examiner Signature		Date Considered	
--------------------	--	-----------------	--

*EXAMINER: Initial if reference considered, whether or not citation is in conformance with MPEP 609. Draw line through a citation if not in conformance and not considered. Include copy of this form with next communication to applicant.

¹ See Kind Codes of USPTO Patent Documents at www.USPTO.GOV or MPEP 901.04. ² Enter office that issued the document, by the two-letter code (WIPO Standard ST.3). ³ For Japanese patent documents, the indication of the year of the reign of the Emperor must precede the serial number of the patent document. ⁴ Kind of document by the appropriate symbols as indicated on the document under WIPO Standard ST.16 if possible. ⁵ Applicant is to place a check mark here if English language translation is attached.

**INFORMATION DISCLOSURE
STATEMENT BY APPLICANT**
(Not for submission under 37 CFR 1.99)

Application Number	12057775
Filing Date	2008-03-28
First Named Inventor	Inge Bruheim
Art Unit	1651
Examiner Name	Ware, Deborah K.
Attorney Docket Number	NATNUT-14409/US-5/ORD

CERTIFICATION STATEMENT

Please see 37 CFR 1.97 and 1.98 to make the appropriate selection(s):

That each item of information contained in the information disclosure statement was first cited in any communication from a foreign patent office in a counterpart foreign application not more than three months prior to the filing of the information disclosure statement. See 37 CFR 1.97(e)(1).

OR

That no item of information contained in the information disclosure statement was cited in a communication from a foreign patent office in a counterpart foreign application, and, to the knowledge of the person signing the certification after making reasonable inquiry, no item of information contained in the information disclosure statement was known to any individual designated in 37 CFR 1.56(c) more than three months prior to the filing of the information disclosure statement. See 37 CFR 1.97(e)(2).

- See attached certification statement.
- The fee set forth in 37 CFR 1.17 (p) has been submitted herewith.
- A certification statement is not submitted herewith.

SIGNATURE

A signature of the applicant or representative is required in accordance with CFR 1.33, 10.18. Please see CFR 1.4(d) for the form of the signature.

Signature	/J. Mitchell Jones/	Date (YYYY-MM-DD)	2012-02-20
Name/Print	J. Mitchell Jones	Registration Number	44174

This collection of information is required by 37 CFR 1.97 and 1.98. The information is required to obtain or retain a benefit by the public which is to file (and by the USPTO to process) an application. Confidentiality is governed by 35 U.S.C. 122 and 37 CFR 1.14. This collection is estimated to take 1 hour to complete, including gathering, preparing and submitting the completed application form to the USPTO. Time will vary depending upon the individual case. Any comments on the amount of time you require to complete this form and/or suggestions for reducing this burden, should be sent to the Chief Information Officer, U.S. Patent and Trademark Office, U.S. Department of Commerce, P.O. Box 1450, Alexandria, VA 22313-1450. **DO NOT SEND FEES OR COMPLETED FORMS TO THIS ADDRESS. SEND TO: Commissioner for Patents, P.O. Box 1450, Alexandria, VA 22313-1450.**

Privacy Act Statement

The Privacy Act of 1974 (P.L. 93-579) requires that you be given certain information in connection with your submission of the attached form related to a patent application or patent. Accordingly, pursuant to the requirements of the Act, please be advised that: (1) the general authority for the collection of this information is 35 U.S.C. 2(b)(2); (2) furnishing of the information solicited is voluntary; and (3) the principal purpose for which the information is used by the U.S. Patent and Trademark Office is to process and/or examine your submission related to a patent application or patent. If you do not furnish the requested information, the U.S. Patent and Trademark Office may not be able to process and/or examine your submission, which may result in termination of proceedings or abandonment of the application or expiration of the patent.

The information provided by you in this form will be subject to the following routine uses:

1. The information on this form will be treated confidentially to the extent allowed under the Freedom of Information Act (5 U.S.C. 552) and the Privacy Act (5 U.S.C. 552a). Records from this system of records may be disclosed to the Department of Justice to determine whether the Freedom of Information Act requires disclosure of these records.
2. A record from this system of records may be disclosed, as a routine use, in the course of presenting evidence to a court, magistrate, or administrative tribunal, including disclosures to opposing counsel in the course of settlement negotiations.
3. A record in this system of records may be disclosed, as a routine use, to a Member of Congress submitting a request involving an individual, to whom the record pertains, when the individual has requested assistance from the Member with respect to the subject matter of the record.
4. A record in this system of records may be disclosed, as a routine use, to a contractor of the Agency having need for the information in order to perform a contract. Recipients of information shall be required to comply with the requirements of the Privacy Act of 1974, as amended, pursuant to 5 U.S.C. 552a(m).
5. A record related to an International Application filed under the Patent Cooperation Treaty in this system of records may be disclosed, as a routine use, to the International Bureau of the World Intellectual Property Organization, pursuant to the Patent Cooperation Treaty.
6. A record in this system of records may be disclosed, as a routine use, to another federal agency for purposes of National Security review (35 U.S.C. 181) and for review pursuant to the Atomic Energy Act (42 U.S.C. 218(c)).
7. A record from this system of records may be disclosed, as a routine use, to the Administrator, General Services, or his/her designee, during an inspection of records conducted by GSA as part of that agency's responsibility to recommend improvements in records management practices and programs, under authority of 44 U.S.C. 2904 and 2906. Such disclosure shall be made in accordance with the GSA regulations governing inspection of records for this purpose, and any other relevant (i.e., GSA or Commerce) directive. Such disclosure shall not be used to make determinations about individuals.
8. A record from this system of records may be disclosed, as a routine use, to the public after either publication of the application pursuant to 35 U.S.C. 122(b) or issuance of a patent pursuant to 35 U.S.C. 151. Further, a record may be disclosed, subject to the limitations of 37 CFR 1.14, as a routine use, to the public if the record was filed in an application which became abandoned or in which the proceedings were terminated and which application is referenced by either a published application, an application open to public inspections or an issued patent.
9. A record from this system of records may be disclosed, as a routine use, to a Federal, State, or local law enforcement agency, if the USPTO becomes aware of a violation or potential violation of law or regulation.

(51)Int.Cl. ⁷	識別記号	F I	テームト* (参考)	
C 1 1 B	11/00	C 1 1 B	11/00	4 C 0 8 6
A 2 3 J	7/00	A 2 3 J	7/00	4 D 0 5 6
A 6 1 K	31/661	A 6 1 K	31/661	4 H 0 5 9
A 6 1 P	3/02	A 6 1 P	3/02	
B 0 1 D	11/04	B 0 1 D	11/04	C

審査請求 未請求 予備審査請求 有 (全 35 頁) 最終頁に続く

(21)出願番号 特願2001-574225(P2001-574225)
 (86) (22)出願日 平成13年4月12日(2001.4.12)
 (85)翻訳文提出日 平成14年10月10日(2002.10.10)
 (86)国際出願番号 PCT/IB01/00841
 (87)国際公開番号 WO01/076715
 (87)国際公開日 平成13年10月18日(2001.10.18)
 (31)優先権主張番号 100 18 213.5
 (32)優先日 平成12年4月12日(2000.4.12)
 (33)優先権主張国 ドイツ (DE)
 (31)優先権主張番号 60/271,209
 (32)優先日 平成13年2月23日(2001.2.23)
 (33)優先権主張国 米国 (US)

(71)出願人 ウエストファリア セバレイター インダ
 ストリー ゲーエムベーハー
 ドイツ, デー-59302 エルデ, ヴェ
 ルナー-ハビヒーストラーセ 1
 (72)発明者 フルシュカ, ステファン, エム.
 ドイツ, 59302 エルデ, エーネーブ
 ラウクジーペーストラーセ 7
 (72)発明者 キルシュナー, ステファン
 ドイツ, 33334 キュータースロフ,
 エルゼンキルムストラーセ 61
 (74)代理人 弁理士 山田 行一 (外1名)

最終頁に続く

(54)【発明の名称】 油と極性脂質を含有する天然物質の分画方法

(57)【要約】

本発明は、極性脂質リッチ物質、好ましくはリン脂質の製造プロセスに関する。好ましくは、該極性脂質リッチ物質を、脱油した天然物質から、水とアルコールを用いた抽出によって分離と回収し、得られた混合物を密度分離を用いて分離する。また本発明は、リン脂質の抽出と回収の前に天然物質を脱油するための改良されたプロセスも含む。

アルコール濃度の関数としてのリン脂質の可溶度

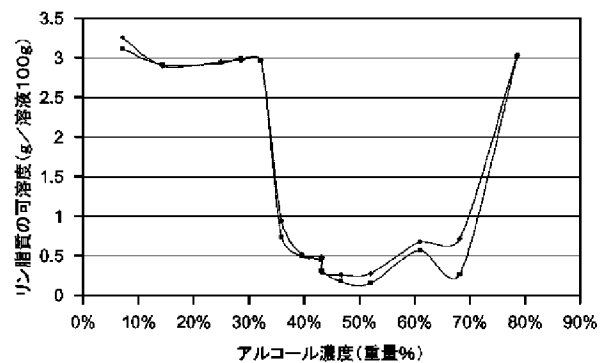

【特許請求の範囲】

【請求項1】 低油含有量極性脂質含有物質の分画プロセスであって、

(a) 前記低油含有量極性脂質含有物質を、水と水溶性有機溶媒に混合するステップと、

(b) 該混合物を密度分離にかけて軽相と重相に分けるステップとを有するプロセス。

【請求項2】 前記水溶性有機溶媒が、極性溶媒を有する請求項1に記載のプロセス。

【請求項3】 前記水溶性有機溶媒が、アルコールを有する請求項1に記載のプロセス。

【請求項4】 前記水溶性有機溶媒が、 $C_1 \sim C_8$ のアルコールを有する請求項1に記載のプロセス。

【請求項5】 前記水溶性有機溶媒が、イソプロパノール、エタノール、又はこれらの混合物を有する請求項1に記載のプロセス。

【請求項6】 密度分離にかけられる前記物質が、水溶性有機溶媒と水の混合物中に可溶化／分散され、前記水溶性有機溶媒が、存在する水溶性有機溶媒と水の合計量の約5～約35重量%を占める請求項1～5のいずれかに記載のプロセス。

【請求項7】 密度分離にかけられる前記物質が、水溶性有機溶媒と水の混合物中に可溶化／分散され、前記水溶性有機溶媒が、存在する水溶性有機溶媒と水の合計量の約68～約98重量%を占める請求項1～6のいずれかに記載のプロセス。

【請求項8】 該プロセスの実行中に温度が65℃を超えない請求項1～7のいずれかに記載のプロセス。

【請求項9】 プロセス中のpHが、pH4～約pH10である請求項1～8のいずれかに記載のプロセス。

【請求項10】 前記混合ステップと密度分離ステップが少なくとも1回繰り返される請求項1～9のいずれかに記載のプロセス。

【請求項11】 前記低油含有量極性脂質含有物質が、卵と、魚と、甲殻類

と、微生物と、脳組織と、牛乳と、肉と、脂肪種子をはじめとする植物物質との少なくとも1種から得られる請求項1～10のいずれかに記載のプロセス。

【請求項12】 前記低油含有量極性脂質含有物質中にもともと存在する前記極性脂質の少なくとも60%が、極性脂質リッチ軽相中で回収される請求項1～11のいずれかに記載のプロセス。

【請求項13】 油／極性脂質／タンパク質含有混合物の分画プロセスであって、

(a) 前記混合物から油を分離し、油リッチ画分と極性脂質／タンパク質リッチ画分を形成するステップと、

(b) 前記極性脂質／タンパク質リッチ画分に、水溶性有機溶媒を加えるステップと、

(c) 前記水溶性有機溶媒と極性脂質／タンパク質リッチ画分を密度分離にかけて、極性脂質リッチ画分とタンパク質リッチ画分を形成するステップとを有するプロセス。

【請求項14】 前記ステップ(a)の油の分離が、

(a) 前記油／極性／タンパク質含有混合物をホモジナイズするステップと、

(b) 前記混合物に水溶性有機溶媒と水を加えるステップと、

(c) 該混合物を、油リッチ画分と極性脂質／タンパク質リッチ画分に分離するステップと

を有する請求項13に記載のプロセス。

【請求項15】 前記ステップ(a)の油の分離が、

(a) 前記混合物に水溶性有機溶媒と水を加えるステップと、

(b) 前記油／極性脂質／タンパク質含有混合物を、ホモジナイズするステップと、

(c) 該混合物を、油リッチ画分と極性脂質／タンパク質リッチ画分に分離するステップと

を有する請求項13又は14に記載のプロセス。

【請求項16】 前記ステップ(a)の油の分離が、

(a) 前記油／極性脂質／タンパク質含有混合物をホモジナイズするステップ

と、

- (b) 前記混合物に水溶性有機溶媒と水を加えるステップと、
- (c) 該混合物をホモジナイズするステップと、
- (d) 該混合物を、油リッチ画分と極性脂質／タンパク質リッチ画分に分離するステップと

を有する請求項13に記載のプロセス。

【請求項17】 前記油／極性脂質／タンパク質含有混合物が、卵から得られる請求項13～16のいずれかに記載のプロセス。

【請求項18】 水溶性有機溶媒が、密度分離後に極性脂質リッチ画分とタンパク質リッチ画分から回収される請求項13～17のいずれかに記載のプロセス。

【請求項19】 前記ステップ(a)で形成される前記極性脂質／タンパク質リッチ画分が、約30～50重量%の極性脂質と、約50～70重量%のタンパク質を有する請求項13～18のいずれかに記載のプロセス。

【請求項20】 前記ステップ(a)で形成される前記油リッチ画分が、約75～約95重量%のトリアシルグリセロールを有する請求項13～19のいずれかに記載のプロセス。

【請求項21】 前記油／極性脂質／タンパク質含有混合物が更にコレステロールを有し、前記コレステロールの大部分が、ステップ(a)の分離に従って前記油リッチ画分に相当する請求項13～20のいずれかに記載のプロセス。

【請求項22】 ステップ(b)で加えられる前記水溶性有機溶媒が、水溶性有機溶媒／水混合物を形成し、前記水溶性有機溶媒が、存在する水溶性有機溶媒と水の合計量の約20～約35重量%を占める請求項13～21のいずれかに記載のプロセス。

【請求項23】 ステップ(b)で加えられる前記水溶性有機溶媒が、水溶性有機溶媒／水混合物を形成し、前記水溶性有機溶媒が、存在する水溶性有機溶媒と水の合計量の約68～約98重量%を占める、請求項13～21のいずれかに記載のプロセス。

【請求項24】 前記水溶性有機溶媒が、向流洗浄と、蒸発と、乾燥とのい

いずれかにより回収される請求項13～23のいずれかに記載のプロセス。

【請求項25】 前記極性脂質リッチ画分を乾燥して水溶性有機溶媒を回収し、残留タンパク質を沈殿させるために約80重量%を超える水溶性有機溶媒を含む水溶性有機溶媒/水混合物で洗浄し、さらに乾燥して水溶性有機溶媒を回収する請求項13～24のいずれかに記載のプロセス。

【請求項26】 前記水溶性有機溶媒の添加により、前記タンパク質の少なくとも一部が沈殿し、この沈殿物が密度分離によって回収される請求項25記載のプロセス。

【請求項27】 水の添加により、前記極性脂質リッチ画分から残留タンパク質が除去される請求項13～26のいずれかに記載のプロセス。

【請求項28】 前記水溶性有機溶媒が極性溶媒を含む、請求項13～27のいずれかに記載のプロセス。

【請求項29】 前記水溶性有機溶媒が、アルコールを有する請求項13～27のいずれかに記載のプロセス。

【請求項30】 前記水溶性有機溶媒が、 C_1 ～ C_8 のアルコールを有する請求項13～27のいずれかに記載のプロセス。

【請求項31】 前記水溶性有機溶媒が、イソプロパノール、エタノール、又はこれらの混合物のいずれかを有する請求項13～27のいずれかに記載のプロセス。

【請求項32】 プロセス中のpHが、pH4～約pH10である請求項13～31のいずれかに記載のプロセス。

【請求項33】 前記混合物が、卵と、魚と、甲殻類と、微生物と、脳組織と、牛乳と、肉と、脂肪種子をはじめとする植物物質との少なくとも1種から得られる請求項13～32のいずれかに記載のプロセス。

【請求項34】 前記混合物中に当初より存在する前記極性脂質の少なくとも60%が、極性脂質画分中で回収される請求項13～33のいずれかに記載のプロセス。

【請求項35】 プロセス中に温度が65℃を超えない請求項13～34のいずれかに記載のプロセス。

【請求項36】 水溶性有機溶媒の使用により、極性脂質含有混合物から極性脂質を回収するためのプロセスであって、前記回収を助けるために水溶性有機溶媒の水溶液中への極性脂質の比較的高い可溶性を利用し、該水溶性有機溶媒は該水溶液中のうちの35重量%未満又は68重量%を超える量を占める、上記プロセス。

【請求項37】 前記混合物が、卵と、魚と、甲殻類と、微生物と、脳組織と、牛乳と、肉と、脂肪種子をはじめとする植物物質との少なくとも1種から得られる請求項36に記載のプロセス。

【請求項38】 前記極性脂質が、リン脂質を有する請求項1～37のいずれかに記載のプロセス。

【請求項39】 前記プロセスの少なくとも一部が、低酸素雰囲気中で行われる請求項1～38のいずれかに記載のプロセス。

【請求項40】 油／極性脂質／タンパク質含有混合物を分画するプロセスであって、

(a) 前記油／極性脂質／タンパク質含有混合物に水溶性有機溶媒を加えるステップと、

(b) 該油／極性脂質／タンパク質含有混合物をホモジナイズするステップと、

(c) 前記混合物から油を分離し、油リッチ画分と極性脂質／タンパク質リッチ画分を形成するステップとを有するプロセス。

【請求項41】 前記ステップ(a)と、前記ステップ(b)と、前記ステップ(c)が、

(a) 前記油／極性脂質／タンパク質含有混合物をホモジナイズするステップと、

(b) 水溶性有機溶媒と水を、前記混合物に加えるステップと、

(c) 該混合物を、油リッチ画分と極性脂質／タンパク質リッチ画分に分離するステップとを有する請求項40に記載のプロセス。

【請求項42】 前記ステップ（a）と、前記ステップ（b）と、前記ステップ（c）が、

（a）水溶性有機溶媒と水を、前記混合物に加えるステップと、

（b）前記水溶性有機溶媒と油／極性脂質／タンパク質含有混合物を、ホモジナイズするステップと、

（c）該混合物を、油リッチ画分と極性脂質／タンパク質リッチ画分に分離するステップと

を有する請求項40又は請求項41に記載のプロセス。

【請求項43】 前記ステップ（a）と、前記ステップ（b）と、前記ステップ（c）が、

（a）前記油／極性脂質／タンパク質含有混合物を、ホモジナイズするステップと、

（b）水溶性有機溶媒と水を前記混合物に加えるステップと、

（c）得られた混合物をホモジナイズするステップと、

（d）得られた混合物を油リッチ画分と極性脂質／タンパク質リッチ画分に分離するステップと、

を有する請求項40に記載のプロセス。

【請求項44】 前記混合物が、卵と、魚と、甲殻類と、微生物と、脳組織と、牛乳と、肉と、脂肪種子をはじめとする植物物質との少なくとも1種から得られる請求項40～43のいずれかに記載のプロセス。

【請求項45】 前記ホモジナイズが、約100バール～約1000バールの圧力で行われる請求項14～44のいずれかに記載のプロセス。

【請求項46】 前記ホモジナイズが、約150バール～約350バールの圧力で行われる請求項14～45のいずれかに記載のプロセス。

【請求項47】 前記油／極性脂質／タンパク質含有混合物が、水溶性有機溶媒と水の混合物の中に可溶化／分散され、該混合物中において前記水溶性有機溶媒は、存在する水溶性有機溶媒と水の合計量の約5%～約35重量%を占める請求項40～46のいずれかに記載のプロセス。

【請求項48】 極性脂質リッチ画分を得るために行われる前記密度分離が

2つのステップで行われ、第1ステップでは、存在する水溶性有機溶媒と水の合計量における該水溶性有機溶媒の割合が約5～約35重量%を占め、密度分離により第1極性脂質リッチ画分が得られ、第2ステップでは、存在する水溶性有機溶媒と水の合計量における該水溶性有機溶媒の割合が約68～約98重量%を占め、密度分離により第2極性脂質リッチ画分が得られ、該第2極性脂質リッチ画分が第1極性脂質リッチ画分よりも高い割合で極性脂質を有する請求項1～39のいずれかに記載のプロセス。

【請求項49】 極性脂質リッチ画分中のコレステロールを減らすための方法であって、

(a) コレステロールをゼロないし少量しか含まない油を、前記極性脂質リッチ画分に添加するステップと、

(b) 該コレステロールを該油相中に隔離させるために該混合物を脱油することにより、該極性脂質リッチ画分中のコレステロール量を減らすステップとを有する方法。

【請求項50】 前記請求項1～49のプロセスのいずれかによって生成される、油含有の、極性脂質含有の、又はタンパク質含有の、生成物。

【発明の詳細な説明】

【0001】

【発明の属する技術分野】

本発明は、抽出、分離と回収の分野、特に天然物質等の混合物から極性脂質リッチ画分を抽出、分離と回収する分野に関する。物質中の他の画分を同時に回収することができ、これらの画分（例えばタンパク質リッチ画分など）は、抽出プロセスで穏やかな条件が使用されるので、これらの元々の機能の大部分または全てを保持する。

【0002】

【従来の技術】

極性脂質は例えば、リン脂質（例えばホスファチジルコリン、ホスファチジルエタノールアミン、ホスファチジルイノシトール、ホスファチジルセリン、ホスファチジルグリセロールまたはジホスファチジルグリセロール等）、セファリン、スフィンゴリピド（スフィンゴミエリンとグリコスフィンゴリピド）、グリセロ糖脂質等を挙げることができる。リン脂質は、以下の主な構造ユニットで構成される：脂肪酸、グリセロール、リン酸、アミノアルコールと炭水化物。これらは一般に、植物、微生物と動物の膜構造において重要な役割を担う構造脂質であると考えられている。これらの化学構造によって、極性脂質は双極性を示し、極性溶媒と非極性溶媒の両方において可溶性または部分的な可溶性を示す。本明細書において極性脂質という用語は、天然の極性脂質に限らず、化学修飾された極性脂質も含む。油という用語は様々な意味を有するが、本明細書で用いられる際には、トリアシルグリセロール画分を指すものとする。

【0003】

極性脂質（特にリン脂質）の重要な特徴の1つは、これらが一般的には多不飽和脂肪酸（PUFA：2以上の不飽和結合を有する脂肪酸）を含むことである。多くの植物、微生物と動物系において、これらは特に、 $\omega-3$ と $\omega-6$ シリーズの高度不飽和脂肪酸（HUF A：4以上の不飽和結合を有する脂肪酸）に富んでいる。これらの高度不飽和脂肪酸は、トリアシルグリセロールの状態では不安定であると考えられるが、リン脂質に組み込まれると強化された安定性を示す。

【0004】

市販されているPUFAリッチリン脂質の主な起源は、大豆とキャノーラ種子である。これらの生物物質（バイオマテリアル）は、遺伝子修飾されない限りは、はっきり認められる量のHUF Aを含まない。リン脂質（一般的にはレシチンと呼ばれる）は、これらの脂肪種子から植物油抽出プロセスの副産物として常套的に回収される。例えば、大豆またはキャノーラ油の製造において、豆（種子）をまず熱処理した後に砕き、すりつぶし、と／またはフレーク状にし、その後ヘキサン等の非極性溶媒で抽出する。ヘキサンは、これらの種子から、様々な量の極性脂質（レシチン）と一緒にトリアシルグリセロールリッチ画分を取り除く。次に、通常の油精製プロセスの一部として物理的もしくは化学的に抽出油の脱ガム（レシチン除去）を行い、沈殿したレシチンを回収する。しかし、このプロセスは以下の2つの欠点を有する：（1）ヘキサンで抽出する前に種子を熱処理しなければならず、これは処理コストを増大させ且つタンパク質画分を変質させることにより、副産物としてのその価値を低下させる；と（2）ヘキサン等の非極性溶媒の使用は、対処しなければならない毒性と引火性の問題も呈する。

【0005】

「脱ガム」プロセスで抽出された粗レシチンは、最大で約33%の油（トリアシルグリセロール）を含み得る。粗レシチンからこの油を分離するための1つの好適な方法は、アセトンによる抽出である。油（トリアシルグリセロール）はアセトン中に可溶性であり、レシチンは不溶性である。遠心分離によりアセトン溶液を沈殿物（レシチン）から分離し、該沈殿物をまずは流動層乾燥機で乾燥してから真空乾燥オープンで乾燥して、該産物を乾燥しているときに残留アセトンを回収する。一般には乾燥温度50から70℃が用いられる。得られた乾燥レシチンは、約2から4重量%の油（トリアシルグリセロール）を含む。70℃を超えるプロセス温度はリン脂質の熱分解につながり得る。しかし、70℃未満の温度であっても、アセトンの存在により、該リン脂質の感覚刺激的品質を損なわせ得る生成物の形成につながる。これら副産物は、生成物にカビ臭と、辛い後味を付与し得る。

【0006】

ヘキサン等の非極性溶媒の使用を回避するため、とアセトンベース・プロセスのマイナスの副作用を回避するために、超臨界流体（特に超臨界CO₂）の使用を含む多くのプロセスが提唱された。例えば、米国特許第4,367,178号は、粗大豆レシチン調製物から油を除去することにより該調製物を一部精製するための超臨界CO₂の使用を開示している。ドイツ国特許第DE-A30 11 185号とDE-A 32 29 041号は、超臨界CO₂とエタンをそれぞれ用いた粗レシチンの脱油方法を開示している。プロパンなどの少量の炭化水素を超臨界CO₂に加えて共留剤として作用させることを含む他の超臨界プロセスが提案されている。しかし、超臨界流体抽出システムは非常に資本支出が大きく、また連続的な操作ができない。さらに、抽出時間が長く、抽出前にバイオマテリアルを乾燥しなければならず、またこれにより、酸化防止剤を用いて得られた乾燥産物を安定化することがさらに難しくなる。これらの要因の全てにより、超臨界プロセスは、極性脂質物質またはこれらの物質の混合物を抽出と回収するための最も費用のかかる選択肢のうちの1つとなっている。そのため、低圧力での液化炭化水素での抽出を用いた他のプロセスが記載されている。例えば、米国特許第2,548,434号は、脂肪種子物質を脱油しと低圧力（35～45バール）且つ高温（79～93℃）で液体炭化水素を用いて粗レシチンを回収するための方法を開示している。米国特許第5,597,602号は、さらに低い圧力と温度で動作する同様のプロセスについて記載している。しかし、これらの改良を行っても、超臨界流体抽出は依然として非常にコスト高であり、大規模な商業規模で食品用途でのリン脂質の製造には現在使用されていない。

【0007】

【発明が解決しようとする課題】

HUFAリッチ極性脂質の主な流通物質は卵黄である。産業規模では卵リン脂質の回収のために、主に2つの方法が用いられている。いずれの方法も、抽出前に卵黄の乾燥を必要とする。第1のプロセスでは、乾燥した卵黄粉末をアセトンでまず抽出してトリアシルグリセロールを除去する。次にこれを純粋アルコールで抽出してリン脂質を除去する。第2のプロセスでは、純粋アルコールを用いて乾燥卵黄から油／レシチン画分を抽出する。次に油／レシチン相をアセトンで抽

出して、トリアシルグリセロールを除去し、レシチン画分を残す。これらの方法にはどちらにも幾つかの欠点がある：（１）処理前にまず卵黄を乾燥しなければならない（コストの高いステップ）、とさらにこの乾燥プロセスはタンパク質にダメージを与えたりまたはこれを変性させて、その食品成分としての価値を大きく低下させる；（２）効果的にするために、これらのプロセスで用いられるアルコールとアセトン濃度は８０％を超える、好ましくは９０％を超えるものでなければならない。これより高い純度の溶媒はさらに高価であり、高濃度の溶媒の使用はタンパク質の変性につながり、これらの価値を低下させる；と（３）２つのタイプの溶媒を回収するためには別々の溶媒回収条件が利用可能でなければならない、これは設備コストを増大させる。これら３つの欠点の全ては卵黄からの極性脂質リッチ画分の分離と回収コストの大きな増大につながる。

【０００８】

カナダ国特許第１，３３５，０５４号は、エタノール、高温、濾過と低温結晶化を用いた、新鮮な液体卵黄からの抽出によりタンパク質、油とレシチン画分を得るためのプロセスについて記載している。しかしこの方法は、幾つかの欠点を有する：（１）高濃度のエタノールの使用によるタンパク質の変性；（２）このプロセスがエタノールに限定される；（３）このプロセスでは、まずタンパク質を除去してから、油画分からレシチンを回収する。レシチン生成物の純度は開示されていない。

【０００９】

現在の技術的状況を鑑みると、動作コストが低く、関連する副産物の価値を保護し、且つ極性脂質生成物中のHUF Aの総合品質を保護する、食品級極性脂質生成物のための改良された抽出技法が依然として必要である。

【００１０】

【課題を解決するための手段】

本発明に従って、従来技術の欠点の全ては含まない、天然のバイオマテリアルから極性脂質を回収するための改良されたプロセスが提供される。本発明は、これまで可能と考えられていたものよりもかなり低い濃度のアルコールを用いて部分的にまたは完全に脱油されたバイオマテリアルから極性脂質と／または極性脂

質含有混合物を回収するためのプロセスである。また本発明は、本発明中にその概要が記されている方法による抽出／回収前にバイオマテリアルを脱油するための改良されたプロセスも提供する。

【0011】

本発明の1つの実施形態に従って、低油含有量極性脂質含有物質（を分画するためのプロセスが提供される。このプロセスは、低油含有量極性脂質含有物質に水と水溶性有機溶媒を混合するステップ、と該混合物を（例えば重量や遠心力を用いた）密度分離にかけてこれを軽相と重相に分けるステップを含む。好ましくは、該軽相は極性脂質リッチ画分を含み、と該重相はタンパク質リッチ画分を含む。「低油含有」とは、その極性脂質含有物質が、トリアシルグリセロールを乾燥重量で約20%未満、好ましくは約15%未満、より好ましくは約10%未満、と最も好ましくは約5%未満有することを意味する。低油含有極性脂質リッチ物質は、極性脂質リッチ物質から油を除去することによって、または油含有量の低い極性脂質リッチ物質を選択することによって、得ることができる。例えば、（脂肪種子を除く）ある植物物質とある微生物は、油含有量の低い極性脂質リッチ物質として使用することができる。好ましくは、低油含有量極性脂質含有物質中にもともと存在する極性脂質の少なくとも60%とより好ましくは少なくとも80%が極性脂質リッチ軽相中で回収される。

【0012】

本発明の他の実施形態に従って、油／極性脂質／タンパク質含有混合物の分画プロセスが提供される。このプロセスは、該混合物から油を分離して油リッチ画分と極性脂質／タンパク質リッチ画分を形成するステップ、該極性脂質／タンパク質リッチ画分に水溶性有機溶媒を加えるステップ、と該水溶性有機溶媒と極性脂質／タンパク質リッチ画分を（例えば重力や遠心力を用いた）密度分離にかけて、極性脂質リッチ画分とタンパク質リッチ画分を形成するステップ、を含む。好ましくは、該混合物中にもともと存在する極性脂質の少なくとも60%とより好ましくは少なくとも80%が極性脂質リッチ画分中で回収される。

【0013】

本発明の他の実施形態に従って、水溶性有機溶媒を用いて極性脂質含有混合物

から極性脂質を回収するためのプロセスであって、該回収を助けるために該水溶性有機溶媒の水溶液中への極性脂質の比較的高い可溶度を利用し、ここで、該水溶性有機溶媒は該水溶液中のうちの35重量%未満または68重量%を超える量を占める、上記プロセスが提供される。

【0014】

本発明の他の実施形態に従って、油／極性脂質／タンパク質含有混合物の分画プロセスが提供される。このプロセスは、該油／極性脂質／タンパク質含有混合物に水溶性有機溶媒を加えるステップ、該水溶性有機溶媒と油／極性脂質／タンパク質含有混合物をホモジナイズにかけけるステップ、と該混合物から油を分離して油リッチ画分と極性脂質／タンパク質リッチ画分を形成するステップを含む。

【0015】

本発明の実施形態の利点は、他の既知の方法よりもコストが非常に低いことである。本発明の実施形態の利点は、抽出タンパク質等の他の副産物を劣化から保護することにより副産物としてのこれらの販売価値を増大させることである。本発明の実施形態の利点は、極性脂質の中のHUF Aを劣化から保護することである。これらの利点は、本発明の主なアスペクトの幾つかによるものである：（1）脱油の前にバイオマテリアルを乾燥する必要がない；（2）このプロセスは低濃度のアルコールを使用する；（3）関連する副産物の品質と機能が劣化（例えば高温または高濃度溶媒によるタンパク質の変性；脂質の酸化；望ましくない副産物の形成など）から保護される；と（4）（設備と処理ステップの両方の点において）プロセス全体が非常に単純である。好ましくは、プロセスのステップは、不活性もしくは非反応性ガス（例えば窒素、二酸化炭素、アルゴンなど）の使用、溶媒蒸気の使用、部分的もしくは完全な真空の使用、またはこれらの任意の組合せを含み得る低酸素雰囲気下で行われる。

【0016】

本発明は、図面を参照することによってより簡単に理解することができる。

【0017】

【発明の実施の形態】

極性脂質（リン脂質を含む）は、その二極性の性質により、湿潤剤と乳化剤と

しての商業的に非常に高い関心を集めている。またこれらの特性は、リン脂質中のHUF Aの安定性を高めるのみならず、これらのバイオアベイラビリティを向上させるのにも役立ち得る。これらの特性により、リン脂質は、栄養補助製品、食品、子供用食品、と医薬用途で使用するための理想的形体の成分となっている。

【0018】

本発明者等は、極性脂質が高濃度のアルコール（例えば68%を超えるアルコール濃度）だけでなく、低濃度のアルコール（アルコール約35%未満）にも非常に良く溶けることを、思いがけず発見した（図1）。本発明の目的のために、リン脂質は、本願明細書中で記載されるタイプの設備によって遠心分離にかけた時に固まったり連続相（しばしば上清または軽相とも呼ばれる）から分離したりしない場合、「可溶性」と記載される。アルコール約35～約68重量%のアルコール濃度範囲では、極性脂質は非常に低い可溶度を示す。本発明は、極性脂質のこの特徴（低アルコール濃度での高い可溶度/分散度）を利用し、これを幾つかの方法で利用して、天然バイオマテリアルから極性脂質（特にリン脂質）を低コストで抽出と回収するためのプロセスを開発することができる。

【0019】

HUF A含有極性脂質に富む天然のバイオマテリアルとしては、魚、甲殻類、微生物、卵、脳組織、牛乳、肉、と脂肪種子を含む植物物質が挙げられる。本明細書において「魚、甲殻類、微生物、卵、脳組織、牛乳、肉、と脂肪種子を含む植物物質」という用語は、これらを遺伝子改変したものも含むものとする。これらの物質中のリン脂質の含有量は一般には低く、通常は0.1～約4湿量%程度である。その結果、これらのリン脂質を回収するには大量の物質を処理することが必要である。従来の抽出技術はコストが高くつくため、リン脂質と特にHUF A富化リン脂質は非常に高価であり、そのため子供用食品、医薬品と化粧品産業での使用に限られていた。本発明の利点の1つは、極性脂質（特にリン脂質）を費用効率のよい方法で抽出することである。

【0020】

本発明のプロセスの1つの実施形態の第1ステップにおいて、低油含有物質が

選択されるか、または該物質を好適な脱油プロセスによって（ただし好ましくはタンパク質の変性を生じさせない脱油プロセスによって）脱油する。これには、高温（約65℃を超える）または高濃度溶媒（例えば約50%を超える）を用いないプロセスが含まれる。好ましくは、国際特許出願公開番号第WO96/05278号（米国特許第5,928,696号）に概説されている脱油プロセスが用いられる。好ましくは、この脱油プロセスに解決の鍵となる変更が加えられる。本発明者等は、アルコールと水を加える前にバイオマテリアルをホモジナイズすること、またはアルコールと水を加える前にホモジナイズをすることによって、ただし最も好ましくはアルコールと水を加える前後両方でホモジナイズをすることによって、ホモジナイズを行わないものに比べて油回収率が最大で85%改善されることを、思いがけず発見した（図2）。本明細書中において、「ホモジナイズ」とは、圧力下において該混合物を小さなオリフィスに通過させたりコロイダルミルを用いる等の高速剪断プロセス、または他の高速剪断プロセス等を含む。好ましくは、混合物を小さなオリフィスから押し出す場合、ホモジナイズは、約100パール～約1000パール、より好ましくは約150～約350パールの圧力で行われる。これは思いがけない結果である。というのは、当業者はこのタイプの混合物をホモジナイズすれば、非常に破壊しにくい非常に強いエマルションが形成されてプロセス効率を下げると思うからである。

【0021】

プロセス全体を通して低濃度のアルコールを用いるレシチン回収プロセスの概要が図3に記載されている。この実施例では極性脂質リッチバイオマテリアルとして液体卵黄を用いる。しかし、他の極性脂質含有バイオマテリアル（例えば魚、甲殻類、微生物、脳組織、牛乳、肉、と脂肪種子を含む植物物質等）は、このプロセスを若干改良して同様の方法で処理することもできることを理解されたい。このプロセスの第1ステップでは、この物質を、任意の周知の脱油プロセスによって（ただし好ましくはタンパク質の変性を生じさせない脱油プロセスによって）脱油する。より効率良く油を回収するためには、そのバイオマテリアルの中の遊離油と同様に脂肪含有細胞状粒子中の油を分離することができるように、ホモジナイズによって物質を剪断して該脂肪含有細胞状粒子を破壊する。次にアル

コールと水を卵黄に加えて、この混合物を再びホモジナイズする。この水溶液中のアルコール濃度は約5～約35重量%、好ましくは約20～約35重量%、と最も好ましくは約25～約30重量%であってもよい。次にこの遊離油を遠心力によって密度の差により分離する。これによって以下の2つの画分が回収される：(1) 約50～70%のタンパク質(乾燥重量%)と約30～50乾燥重量%の極性脂質を含む画分、この混合物は卵黄に比べてコレステロール含有量が非常に低い；と(2) その卵黄のトリアシルグリセロールの約85%を含む卵油。該タンパク質/レシチン画分に低濃度アルコールを更に混ぜると、レシチンが分散し、これをその後遠心力によってタンパク質から分離する。タンパク質とレシチン生成物の向流洗浄/遠心分離または逆流洗浄/分離を用いて、生成物の純度とプロセス全体の経済的な面を向上させることができる。このプロセスではタンパク質は変性せず、(その機能性のおかげで) このプロセスの副産物としての高い再販価値を保持する。これにより、生成される全ての生成物の全体的なコストを下げる。

【0022】

このプロセスにおいて必要とされる設備は単純であるため、このプロセス全体は、低酸素雰囲気(例えばこのプロセスの好適な実施形態においては窒素)下で非常に簡単に行うことができ、さらに該極性脂質中のHUF Aを酸化から保護する。例えば、気密デカンタを用いてこの混合物から油を分離することができる。好適なデカンタは、ドイツ、エルデのWestfalia Separator Industry GmbH から入手可能なCA226-28Gas Tightモデルであり、このモデルは、遠心分離場(において固体含有量の多い懸濁液から油を連続的に分離することができる。タンパク質から極性脂質を分離するために有用な気密分離装置は、ドイツ、エルデのWestfalia Separator Industry GmbH から入手可能なSC6-06-576 Gas Tightモデルであり、このモデルは、遠心分離場において固体含有量の多い懸濁液から固体を連続的に分離することができる。

【0023】

また、このプロセスの改良されたバージョンも開発された。このプロセスにおいて、低アルコール濃度を用いた脱油とレシチン洗浄ステップは、先に概説した

プロセスに似ている。ただし、レシチン相を乾燥した後は、該レシチン相は濃縮アルコールで洗浄される。タンパク質は高濃度のアルコールに溶けないので、これらは沈殿し（レシチンは溶けるが）、沈殿したタンパク質を（例えば重力または遠心力を用いた）密度分離によって分離する。次にタンパク質低減レシチンを水とアルコールの蒸発によって濃縮する。このプロセスのバリエーションの利点は、高品質と低品質のレシチン画分の両方を産生するための選択肢を提供すること、と高品質のレシチンを提供する際に、該タンパク質のごく一部しか変性しないことである。

【0024】

またこのプロセスを、脱油ステップの後に高濃度のアルコールを用いるためにも改良した。バイオマテリアルを脱油した後の処理ステップは、低アルコール濃度プロセスとほぼ同様であるが、希釈アルコールの代わりに濃縮アルコールを加える。脱油の後、極性脂質／タンパク質即席産物の濃縮と乾燥が行われる。濃縮／乾燥ステップは、極性脂質を再び溶解するために加える必要がある濃縮アルコールの量を減少させるために必要である。乾燥極性脂質／タンパク質相を濃縮アルコールで洗浄し、タンパク質を沈殿させる。沈殿したタンパク質を、（重力または遠心力を用いた）密度分離により、向流洗浄システムにおいて分離する。アルコールと水の蒸発によって、タンパク質低減極性脂質を濃縮する。このプロセスの利点は、必要とされる熱エネルギーが低いことである。主な欠点は、該タンパク質の全てが変性し、価値が低くなることである。

【0025】

理論で限定しようとする訳ではないが、上記プロセスの根底にあるメカニズムの幾つかについては以下にさらに詳しく記載されるものと考えられる。ホモジナイズに関して、細胞物質の破壊はここで起こるものと思われる。目的は、全ての成分を均質に分配すること、すなわち均質な多分散系（タンパク質、油、リポタンパク質、連続相水）を作製することであって、該多分散系は、水性もしくは純粋アルコールを加えたときに、局所的な不可逆的タンパク質変性を生じさせることなく、ただちに均一に（即ち均質に）分配されることができるようなものである。温度は、油相に溶けるレシチンの量をできるだけ少なくするために、可能な

限り低く保たれる。タンパク質の1次と2次構造を破壊せずに4次と3次構造を破壊するためには、ホモジナイズプロセスで用いられる圧力は、好ましくは1000バール未満、とより好ましくは600バール未満でなければならない。アルコール濃度は好ましくは30重量%、より好ましくは約28%である。アルコールが過度に低いと、タンパク質の膨張がひどくなり、小さな遊離脂肪球がタンパク質中に取り込まれることもある。リポタンパク質の形態で結合した脂肪は極性脂質（リン脂質）の放出を妨げないので、その割合はここでは詳しく考慮しない。

【0026】

原則として、アルコール濃度が高ければ、タンパク質の収縮は増すが、水性相がより非極性に近い程、より極性の高い脂質が該油相中に溶解すると考えられる。したがって、適度な濃度と温度は、例えば少数の予備実験（遠心分離テスト）を各物質毎に行うことによって、見つけなければならない。

【0027】

物質の天然の水分含有量を考慮に入れると、水性アルコールを加えて、約25～30%の好適な最終濃度のアルコールを作製し、分散液を再びホモジナイズする。収縮したタンパク質分子と脂肪液滴は互いに分離する。こうしてこれらの中間にある中間相（脂肪球の表面に存在する極性脂質層）を破壊する。従って、油は該分散液中に遊離相としてより存在し易くなる。一方ではこの油中水エマルションにおいて平衡を確立するために、極性脂質は再び脂肪球の周りを取り囲み、また他方では油滴が凝集してより大きな油滴となる。このため、遠心分離場の追加的力が用いられる。その後、今や大きくなった油滴は合体する（すなわち分離可能な連続相を形成する）ことができる。

【0028】

ホモジェナイザーを用いた手法は、これによって非常に小さな油滴が生成されるので、当業者には驚くべきことである。過去の方法では、エマルションの等級が大きな内部表面積によって大きくなるので、分離する前に油滴のサイズを小さくすることはしなかった。反対に、油が凝集して大きな油滴になるように攪拌または混練を慎重に行っていた。中でも、粘度も減少させるために、この捏揉プロ

セスにおいて熱が有用であった。約300バール以上にホモジナイズ圧力を増加させることにより、より多くの油を分離することもできるという驚くべき効果は、タンパク質、極性脂質と油（実際には非極性脂質相）と溶媒相との相互作用により説明することができる。

【0029】

従って、油分離が必ず生じ、これにより一般には（剪断により破壊された）液滴の表面張力と表面状態がその元の平衡を取り戻す。これは、ホモジナイズしたスラリーを好ましくはすぐに密度分離装置（好ましくは適当な設計と幾何学的考慮のなされた遠心分離機）に入れ、そこで非極性脂質（油）と、タンパク質、水とアルコールを含む極性脂質とに分離することを意味する。粘度の低下は等級には必要ないが、ホモジナイズを行わない油回収では必要である（国際特許出願公開WO96/05278号に記載）。ホモジナイズしたスラリーを遠心分離場に直接移しかえることは、この融合を助けるために重要であろう。

【0030】

好ましくはデカンタ（遠心分離機を含む他のタイプの密度分離装置もこの目的のために首尾良く使用される）で1段階もしくは2段階で油を分離した後、理想的には、後でタンパク質相の中で水でアルコール濃度を低下させたときに、該混合物の極性が増大し、これによりレシチンが遊離水／アルコール相の中で再び結合して油が「放出」するが、該遊離水／アルコール相の中には油滴が見られないように、全ての遊離油画分（脂質と非極性脂質）を分離する。通常は、アルコール濃度が低下すると（すなわち油可溶度が該極性脂質相においてなくなると）、この極性脂質／タンパク質／アルコール混合物の中の油が遊離する。驚くべきことに、2倍のホモジナイズと遠心分離の後に、アルコール濃度がたった15%であっても、ほんの僅かな遊離油しか遠心分離することができないことが分かった。

【0031】

コレステロールを含むステロールは、油相よりも極性脂質相に対して大きな親和性を有し得る。これにより、油相よりも極性脂質相の中のステロール含有量が高くなる。油もしくは極性脂質相中へのステロールの移動は、混合物のpHを変

える、温度を変更する、または該水性相の極性を増減するために塩等の加工助剤を加えることにより、操作することができる。極性脂質リッチ画分中のコレステロールを減らすための他の方法は、コレステロールを全くもしくは殆ど含まない油を極性脂質リッチ画分に加えて脱油プロセスを繰り返すことである。このようにして、コレステロールを油相中に分離することができる。

【0032】

【実施例】

実施例 1

低アルコール抽出プロセス：100 kg の液体卵黄（42 kg 乾燥物質を含む）をホモジナイズした後、エタノール（純度96%、35.4 kg）と水（30.7 kg）をこの卵黄に加えた。得られたアルコール濃度は全体で約20重量%（アルコールと水のみに関しては27重量%）であった。次にこの混合物を再びホモジナイズし、デカンタ遠心分離機を用いて該混合物を遠心分離にかけ、油相とアルコール/水相を生成した。この脱油ステップにより、17 kg の卵黄油と149 kg のアルコール/水相ができた。次に、このアルコール/水相を、セパレータ遠心分離機を用いた向流洗浄プロセスを用いて、同じ低濃度のアルコールで3回洗浄した。このプロセスにより、2つの画分が得られた：（1）リン脂質リッチ画分（脂質相）、これを乾燥すると全部で17 kg の乾燥物質（リン脂質8 kg を含む）を含む生成物が得られた；と（2）タンパク質リッチ画分、これを乾燥すると、12 kg の乾燥物質（タンパク質11 kg とリン脂質0.3 kg を含む）が得られた。卵黄1つあたり平均重量約16.0 g（それぞれ卵黄1つあたりリン脂質約1.7 g を含む）として、卵黄100 kg で約10.6 kg のリン脂質が得られる。このプロセスによってリン脂質リッチ画分中で回収されるリン脂質8.0 kg は、約76%のリン脂質画分の回収効率である。

【0033】

実施例 2

高アルコールのポリッシングステップを伴う低アルコール抽出プロセス：100 kg の液体卵黄（42 kg 乾燥物質を含む）をホモジナイズした後、エタノールと水を加えて該混合物をアルコール/水相中の最終アルコール濃度30重量%

とした。次にこの混合物を再びホモジナイズし、デカンタ遠心分離機を用いて該混合物を遠心分離にかけ、油相とアルコール／水相を生成した。この脱油ステップにより、16kgの卵黄油と134kgのアルコール／水相（26kgの乾燥物質を含む）ができた。次に、72kgのエタノールと170kgの水をこのアルコール／水相に加えて、これを混合し、セパレータ遠心分離機で遠心分離にかけた。これにより、2つの画分が得られた：（1）11kgの乾燥物質を含む脂質相（299kg）；と（2）15kgの乾燥物質を含む固相（78kg）。画分1は少量のタンパク質とリン脂質とを含んでおり、画分2は主にタンパク質を含んでいた。次に画分1を乾燥して重量11.2kgとし、20kgのエタノール（96%）をこの画分に加えた。次にこの混合物をセパレータ遠心分離機で処理し、10kgの乾燥物質を含む液相を得た。次にこの液相を乾燥して最終的な重量を10.5kgとした（10.0kg乾燥物質－リン脂質画分）。画分2の中の固体78kgも乾燥して、全量16kg（または乾燥物質15kg－タンパク質画分）とした。卵黄1つあたり平均重量約16.0g（それぞれ卵黄1つあたりリン脂質約1.7gを含む）として、卵黄100kgで約10.6kgのリン脂質が得られる。このプロセスで回収されるリン脂質10.0kgは、約90%を超えるリン脂質画分の最小回収効率である。

【0034】

実施例3

高アルコール極性脂質抽出プロセスを伴う低アルコール脱油プロセス：100kgの液体卵黄（45kg乾燥物質を含む）をホモジナイズした後、エタノールと水を加えて、該混合物をアルコール／水相中の最終アルコール濃度30重量%とした。次にこの混合物を再びホモジナイズし、デカンタ遠心分離機を用いて該混合物を遠心分離にかけ、油相とアルコール／水相を生成した。この脱油ステップにより、17kgの卵黄油と139kgのアルコール／水相（28kgの乾燥物質を含む）ができた。次にこのアルコール／水相を乾燥し（109kgのアルコールと水を回収）、物質30kgを得た（28kg乾燥物質）。エタノール（純度96%）90kgをこの物質に加え、この混合物をセパレータ遠心分離機で処理して、液相（リン脂質を含む）とタンパク質を含む固相を得た。液相（全量

80kg、乾燥物質10.4kgを含む)を乾燥して、乾燥物質(リン脂質)10.4kgを含む生成物10.6kgを得た。

固相(全量40kg)を乾燥して、18.5kgの生成物、つまりタンパク質(乾燥物質17.6kgを含む)を得た。卵黄1つあたり平均重量約16.0g(それぞれ卵黄1つあたりリン脂質約1.7gを含む)として、卵黄100kgで約10.6kgのリン脂質が得られる。このプロセスで回収されるリン脂質10.0kgは、約90%を超えるリン脂質画分の最小回収効率である。

【0035】

本発明は、様々な実施形態において、本明細書中に実質的に説明と記載された成分、方法、プロセス、システムと/または装置、例えば様々な実施形態、サブコンビネーション、とこれらのサブセット等を含む。当業者であれば、本明細書の開示内容を理解すれば、本発明をどのように実施と使用すべきかが分かるであろう。本発明は、様々な実施形態において、本明細書中またはこれらの様々な実施形態に説明と/または記載されていない事項を含まない装置とプロセスの提供も含む。例えば、性能を高めたり、簡単にしたり、と/または実施コストを削減したりするために従来装置またはプロセスにおいて用いられるようなこのような事項を含まない場合が挙げられる。

【0036】

本発明についてのこれまでの説明は、例示と説明のために提供された。これまでの記載は、本発明を本明細書中に記載された形態に限定するものではない。本発明の説明は、1以上の実施形態ならびにそれをある種改良/改変したものの説明を含んでいるが、他の改良と変更が本発明の範囲内に含まれる(例えば本明細書の開示内容を理解した後の当業者の能力と知識の範囲内にあるものなど)。許容される程度に他の実施形態(例えば、特許請求の範囲に記載されたものに代わる、これと交換可能など/またはこれと同等な構造、機能、範囲またはステップ等。このような代替的な、交換可能など/または同等な構造、機能、範囲またはステップが本明細書中に開示されているか否かにかかわらず)を含む権利を得るものとする。また、任意の特許を受けることができる主題に公然と限定とするものではない。

【図面の簡単な説明】

【図 1】

アルコール濃度の関数としての、リン脂質（極性脂質の形態）の可溶度を表すグラフである。

【図 2】

卵黄の脱油に対するホモジナイズ化の影響を表すグラフである。

【図 3】

低濃度アルコールに基づく（極性脂質抽出プロセスの例としての）リン脂質抽出プロセスを表すグラフである。

【図 4】

低濃度アルコールに基づく（極性脂質抽出プロセスの例としての）リン脂質抽出プロセスであって、高濃度アルコールを用いたステップを伴うリン脂質のポリッシングステップを追加した場合の結果を表すグラフである。

【図 5】

抽出プロセスのリン脂質回収部分を通して高濃度アルコールの使用に基づく（極性脂質抽出プロセスの例としての）リン脂質抽出プロセスを表すグラフである。

。

【図1】

アルコール濃度の関数としてのリン脂質の可溶度

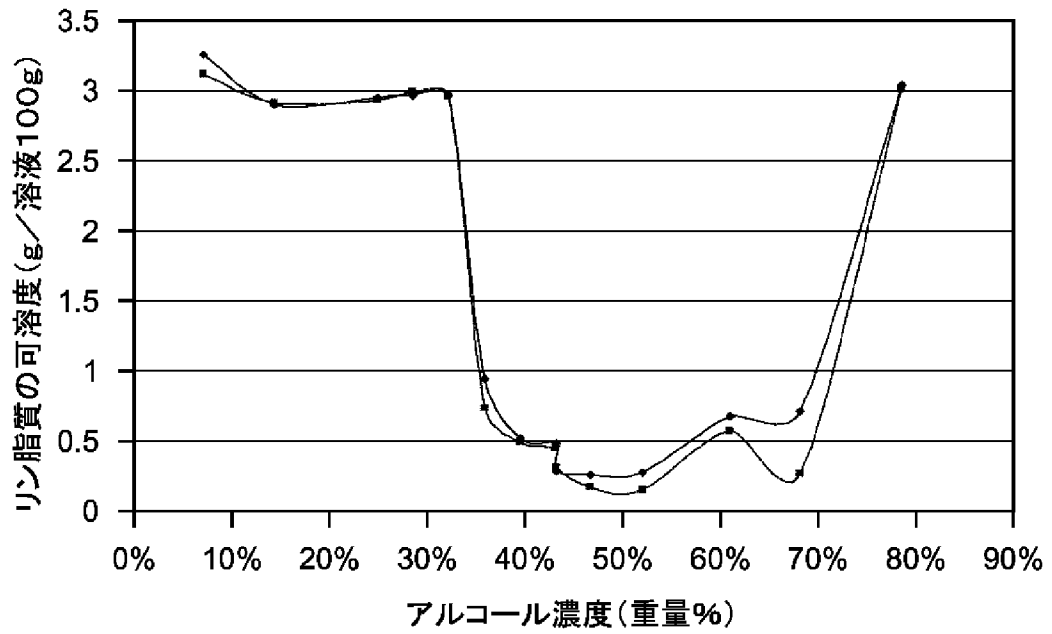

【図2】

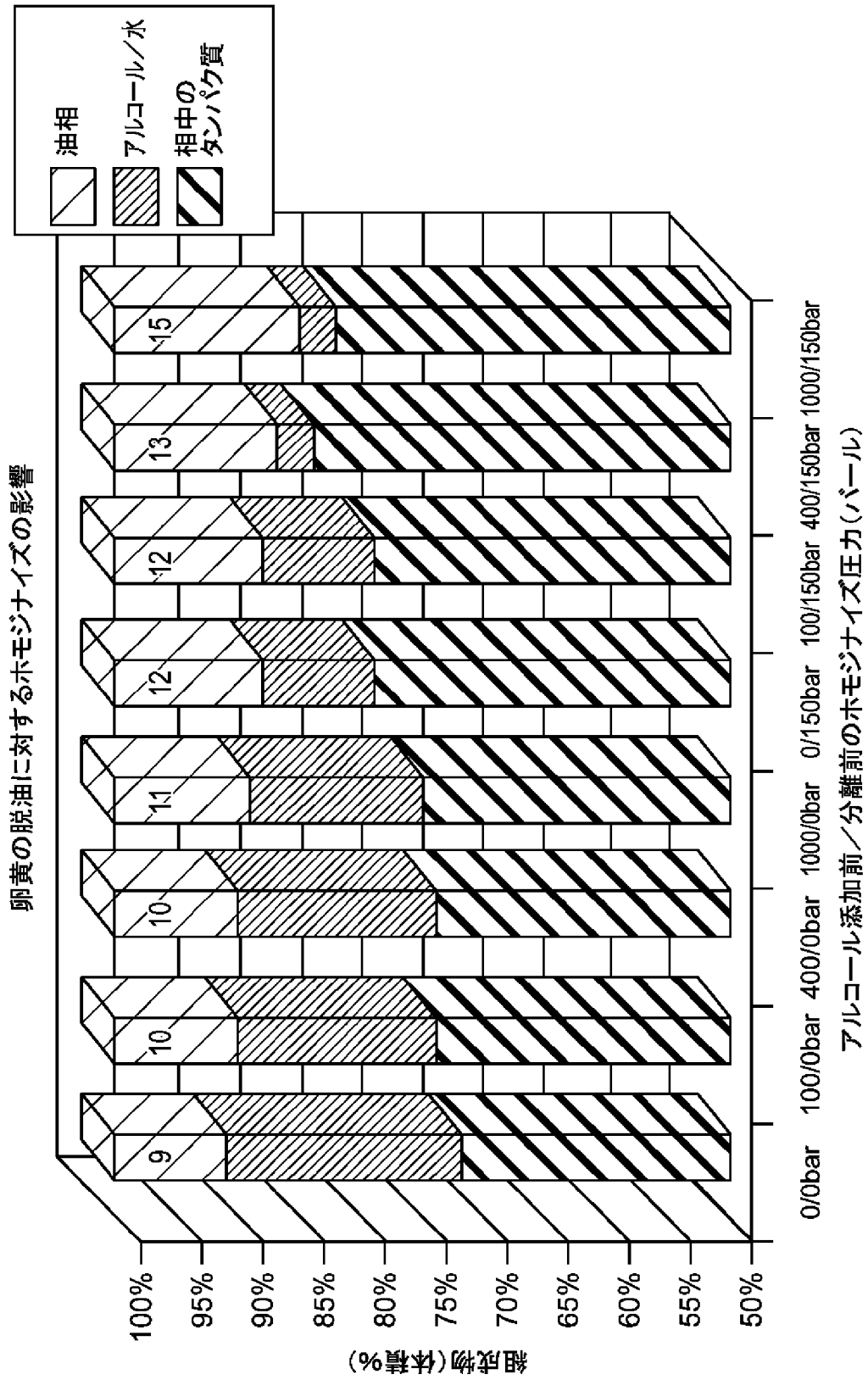

脱油と極性脂質回収段階の双方に対して
低濃度アルコールを用いた極性脂質抽出プロセス

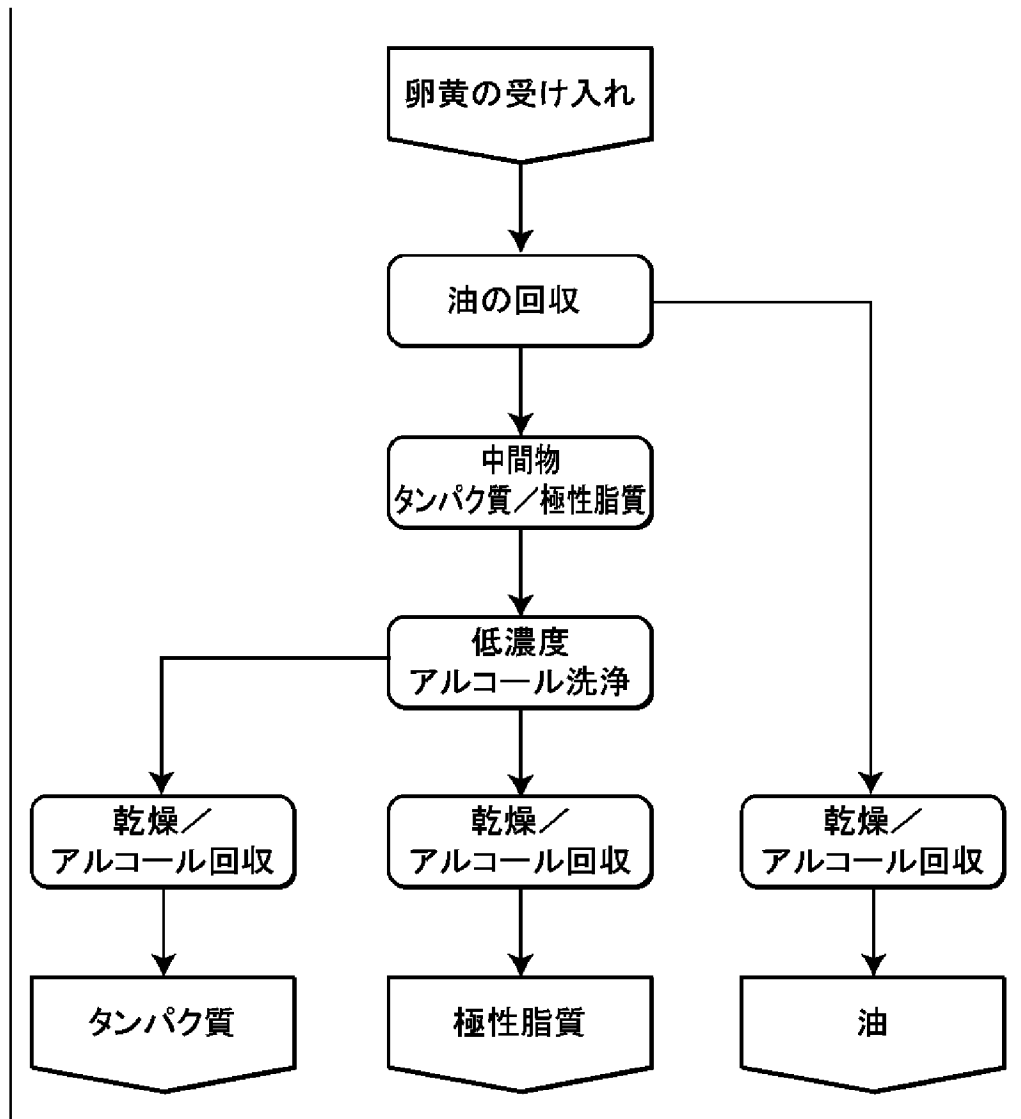

脱油と極性脂質回収段階の双方に対して
低濃度アルコールを用いた極性脂質抽出プロセス

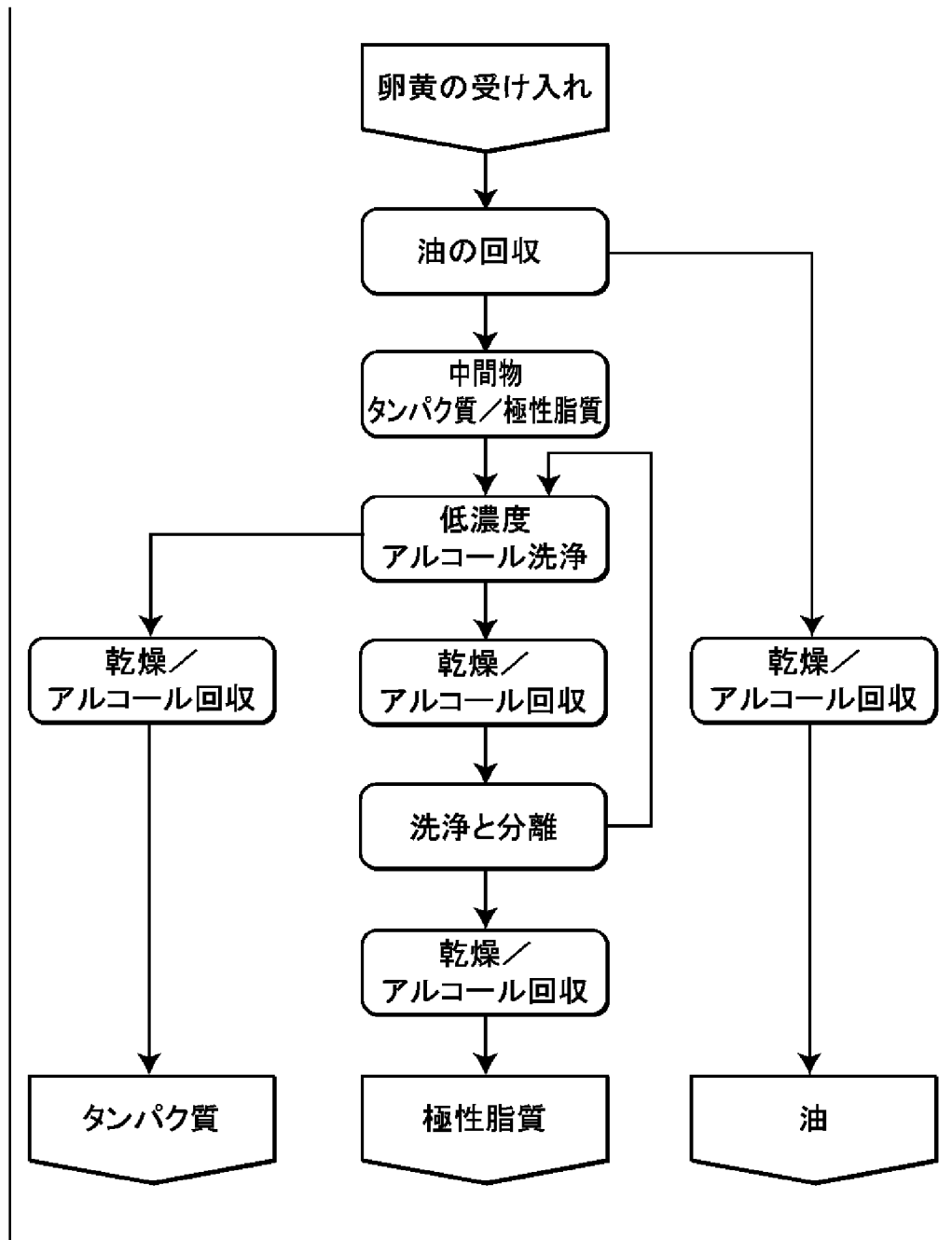

脱油段階では低濃度アルコールを用い、極性脂質回収段階では高濃度アルコールを用いる極性脂質抽出プロセス

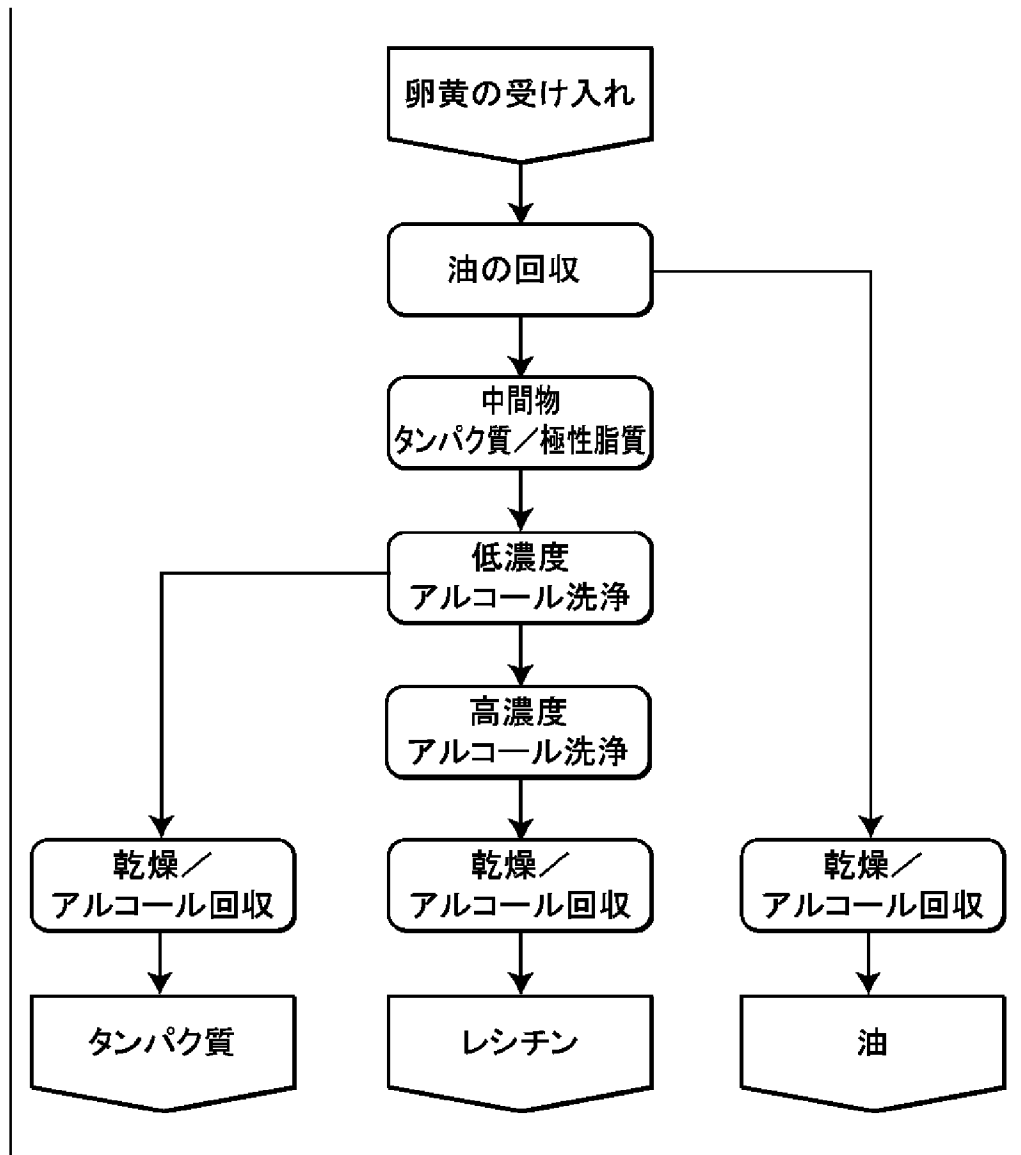

INTERNATIONAL SEARCH REPORT

International Application No
PC/IB 01/00841

A. CLASSIFICATION OF SUBJECT MATTER IPC 7 A23J/08 C11B1/00 C11B7/00 A23D9/013 A23J7/00 A23L1/32		
According to International Patent Classification (IPC) or to both national classification and IPC		
B. FIELDS SEARCHED Minimum documentation searched (classification system followed by classification symbols) IPC 7 A23J C11B A23D A23L		
Documentation searched other than minimum documentation to the extent that such documents are included in the fields searched		
Electronic data base consulted during the international search (name of data base and, where practical, search terms used) EPO-internal, WPI Data, PAJ, FSTA		
C. DOCUMENTS CONSIDERED TO BE RELEVANT		
Category *	Citation of document, with indications, where appropriate, of the relevant passages	Relevant to claim No.
X	US 5 883 273 A (MCCOMBS CHARLES ALLAN ET AL) 16 March 1999 (1999-03-16) column 6, line 53 -column 7, line 43 column 8, line 45-55 claims 1-24; examples 1,8 --- -/--	1-9, 11, 36-39, 50
<input checked="" type="checkbox"/> Further documents are listed in the continuation of box C.		
<input checked="" type="checkbox"/> Patent family members are listed in annex.		
* Special categories of cited documents:		
'A' document defining the general state of the art which is not considered to be of particular relevance 'E' earlier document but published on or after the international filing date 'L' document which may throw doubts on priority claim(s) or which is cited to establish the publication date of another citation or other special reason (as specified) 'O' document referring to an oral disclosure, use, exhibition or other means 'P' document published prior to the international filing date but later than the priority date claimed 'T' later document published after the international filing date or priority date and not in conflict with the application but cited to understand the principle or theory underlying the invention 'X' document of particular relevance; the claimed invention cannot be considered novel or cannot be considered to involve an inventive step when the document is taken alone 'Y' document of particular relevance; the claimed invention cannot be considered to involve an inventive step when the document is combined with one or more other such documents, such combination being obvious to a person skilled in the art. 'G' document member of the same patent family		
Date of the actual completion of the international search 31 January 2002		Date of mailing of the international search report 21.02.2002
Name and mailing address of the ISA European Patent Office, P.O. 5818 Patentean 2 NL - 2280 HV Rijswijk Tel: (+31-70) 340-2040, Tx: 31 651 epo nl, Fax: (+31-70) 340-3016		Authorized officer Rooney, K

Form PC/7/SA21D (second sheet) (July 1992)

INTERNATIONAL SEARCH REPORT

International Application No
PC1/IB 01/00841

C.(Continuation) DOCUMENTS CONSIDERED TO BE RELEVANT		
Category	Citation of document, with indication, where appropriate, of the relevant passages	Relevant to claim No.
X	<p>DATABASE FSTA 'Online! INTERNATIONAL FOOD INFORMATION SERVICE (IFIS), FRANKFURT/MAIN, DE; AN:80-3-03-q0050, XP002177927</p> <p>abstract & MILEWSKI J; RUTKOWSKI A: "Solubility of egg yolk lipids in an aqueous ethanol medium" ZESZYTY NAUKOWE SZKOLY GLOWNEJ GOSPODARSTWA WIEJSKIEGO AKADEMII, no. 12, 1978, pages 95-0102, Warsaw, Poland</p>	<p>1-8, 10-13, 17, 18, 22-24, 28-31, 33-38, 48, 50</p>
X	<p>US 4 357 353 A (STRAUSS KUNO ET AL) 2 November 1982 (1982-11-02)</p> <p>column 2, line 26-38 claims 1-12; example 1</p>	<p>1-8, 11-13, 17, 22-24, 28-31, 33-38</p>
Y		<p>14-16, 40-44, 47</p>
Y	<p>CA 1 335 054 A (CANADIAN EGG MARKETING AGENCY) 4 April 1995 (1995-04-04) cited in the application figure 1; example 2</p>	<p>14-16, 40-44, 47</p>
A	<p>claims 1-33</p>	<p>19-21, 25, 26, 45, 46</p>
X	<p>US 5 780 095 A (JACKESCHKY MARTIN) 14 July 1998 (1998-07-14) column 1, line 24-32 claim 1; examples 1-10</p>	<p>49</p>
X	<p>WO 93 22931 A (SOURCE FOOD TECHNOLOGY INC) 25 November 1993 (1993-11-25) claims 1, 2</p>	<p>49</p>

6

Form PCT/ISA/210 (continuation of second sheet) (July 1992)

page 2 of 2

INTERNATIONAL SEARCH REPORT

national application No.
PCT/IB 01/00841

Box I Observations where certain claims were found unsearchable (Continuation of item 1 of first sheet)

This International Search Report has not been established in respect of certain claims under Article 17(2)(a) for the following reasons:

- 1. Claims Nos.:
because they relate to subject matter not required to be searched by this Authority, namely:

- 2. Claims Nos.:
because they relate to parts of the International Application that do not comply with the prescribed requirements to such an extent that no meaningful International Search can be carried out, specifically:

- 3. Claims Nos.:
because they are dependant claims and are not drafted in accordance with the second and third sentences of Rule 6.4(a).

Box II Observations where unity of invention is lacking (Continuation of item 2 of first sheet)

This International Searching Authority found multiple inventions in this international application, as follows:

see additional sheet

- 1. As all required additional search fees were timely paid by the applicant, this International Search Report covers all searchable claims.

- 2. As all searchable claims could be searched without effort justifying an additional fee, this Authority did not invite payment of any additional fee.

- 3. As only some of the required additional search fees were timely paid by the applicant, this International Search Report covers only those claims for which fees were paid, specifically claims Nos.:

- 4. No required additional search fees were timely paid by the applicant. Consequently, this International Search Report is restricted to the invention first mentioned in the claims; it is covered by claims Nos.:

Remark on Protest

- The additional search fees were accompanied by the applicant's protest.
- No protest accompanied the payment of additional search fees.

FURTHER INFORMATION CONTINUED FROM PCT/ISA/ 210

This International Searching Authority found multiple (groups of) inventions in this international application, as follows:

1. Claims: 1-48,50

Process for fractionating a material which contains polar lipids comprising the steps of blending said material with a water soluble organic solvent followed by the use of differential density to separate light and heavy phases.

2. Claim : 49

Method for cholesterol reduction in polar lipid fractions comprising the steps of adding an oil which has little or no cholesterol to a polar lipid fraction and removing the oil from the polar lipid fraction with a concomitant reduction in cholesterol.

INTERNATIONAL SEARCH REPORT

information on patent family members

Intr. National Application No
PCT/IB 01/00841

Patent document cited in search report	Publication date	Patent family member(s)	Publication date
US 5883273	A 16-03-1999	WO 9727275 A1	31-07-1997
US 4357353	A 02-11-1982	DE 2948607 A1 JP 56092748 A US 4465693 A	11-06-1981 27-07-1981 14-08-1984
CA 1335054	A 04-04-1995	CA 1335054 A1 WO 9103946 A1	04-04-1995 04-04-1991
US 5780095	A 14-07-1998	WO 9314649 A1 US 6177120 B1 AU 1168492 A CA 2128240 A1 DE 59207349 D1 EP 0621754 A1 GR 3022177 T3 JP 3024798 B2 JP 7503840 T MX 9300299 A1	05-08-1993 23-01-2001 01-09-1993 05-08-1993 14-11-1996 02-11-1994 31-03-1997 21-03-2000 27-04-1995 01-07-1993
WO 9322931	A 25-11-1993	US 5436018 A AU 684249 B2 AU 4382893 A CA 2135785 A1 EP 0644718 A1 JP 7509505 T NZ 253475 A WO 9322931 A1	25-07-1995 11-12-1997 13-12-1993 25-11-1993 29-03-1995 19-10-1995 28-07-1998 25-11-1993

Form PCT/ISA210 (patent family annex) (July 1997)

(51)Int. Cl. ⁷	識別記号	F I	テームコード (参考)
C 1 1 B 7/00		C 1 1 B 7/00	
(81)指定国	EP(AT, BE, CH, CY, DE, DK, ES, FI, FR, GB, GR, IE, IT, LU, MC, NL, PT, SE, TR), OA(BF, BJ, CF, CG, CI, CM, GA, GN, GW, ML, MR, NE, SN, TD, TG), AP(GH, GM, KE, LS, MW, MZ, SD, SL, SZ, TZ, UG, ZW), EA(AM, AZ, BY, KG, KZ, MD, RU, TJ, TM), AE, AG, AL, AM, AT, AU, AZ, BA, BB, BG, BR, BY, BZ, CA, CH, CN, CR, CU, CZ, DE, DK, DM, DZ, EE, ES, FI, GB, GD, GE, GH, GM, HR, HU, ID, IL, IN, IS, JP, KE, KG, KP, KR, KZ, LC, LK, LR, LS, LT, LU, LV, MA, MD, MG, MK, MN, MW, MX, MZ, NO, NZ, PL, PT, RO, RU, SD, SE, SG, SI, SK, SL, TJ, TM, TR, TT, TZ, UA, UG, US, UZ, VN, YU, ZA, ZW		
(72)発明者	ラッセンフォーフェル, ユルゲン ドイツ, 59302 エルデ, パッペルヴ ク 9		
(72)発明者	ヴィト, ヴィリ ドイツ, 49545 テックレンブルク, クリーヴク 34		
Fターム(参考)	4C086 AA04 DA40 ZC22 4D056 AB12 AB14 AC06 BA09 CA26 CA28 DA01 DA02 DA05 DA10 4H059 AA04 BA12 BA33 BA83 BB02 BB03 BC03 BC05 BC06 BC43 CA13 CA72 CA73 CA74		

Electronic Acknowledgement Receipt

EFS ID:	12113042
Application Number:	12057775
International Application Number:	
Confirmation Number:	1945
Title of Invention:	BIOEFFECTIVE KRILL OIL COMPOSITIONS
First Named Inventor/Applicant Name:	Inge Bruheim
Customer Number:	72960
Filer:	John Mitchell Jones/Vickie Hoeft
Filer Authorized By:	John Mitchell Jones
Attorney Docket Number:	NATNUT-14409/US-5/ORD
Receipt Date:	21-FEB-2012
Filing Date:	28-MAR-2008
Time Stamp:	16:18:36
Application Type:	Utility under 35 USC 111(a)

Payment information:

Submitted with Payment	no
------------------------	----

File Listing:

Document Number	Document Description	File Name	File Size(Bytes)/ Message Digest	Multi Part /.zip	Pages (if appl.)
1	Transmittal Letter	14409US5IDSLetter02202012.pdf	73561 <small>cfa3b4946fd8432e5b8ecd20830c8191c4de ad4b</small>	no	1

Warnings:

Information:

2	Information Disclosure Statement (IDS) Form (SB08)	14409IDS02202012.pdf	611886 c8a61f2ce661a5a160d5b394e578aca5477e3e21	no	4
Warnings:					
Information:					
A U.S. Patent Number Citation or a U.S. Publication Number Citation is required in the Information Disclosure Statement (IDS) form for autoloading of data into USPTO systems. You may remove the form to add the required data in order to correct the Informational Message if you are citing U.S. References. If you chose not to include U.S. References, the image of the form will be processed and be made available within the Image File Wrapper (IFW) system. However, no data will be extracted from this form. Any additional data such as Foreign Patent Documents or Non Patent Literature will be manually reviewed and keyed into USPTO systems.					
3	Non Patent Literature	KROfficeAction12082012.pdf	832090 58d7295b3cb0fe0d118368e0d3dfeb17f3ba6b29	no	19
Warnings:					
Information:					
4	Foreign Reference	JP2003530448.pdf	1507863 e92cead67c13c8b2246d6fd73e3d314d86d8cdac	no	35
Warnings:					
Information:					
Total Files Size (in bytes):				3025400	
<p>This Acknowledgement Receipt evidences receipt on the noted date by the USPTO of the indicated documents, characterized by the applicant, and including page counts, where applicable. It serves as evidence of receipt similar to a Post Card, as described in MPEP 503.</p> <p><u>New Applications Under 35 U.S.C. 111</u> If a new application is being filed and the application includes the necessary components for a filing date (see 37 CFR 1.53(b)-(d) and MPEP 506), a Filing Receipt (37 CFR 1.54) will be issued in due course and the date shown on this Acknowledgement Receipt will establish the filing date of the application.</p> <p><u>National Stage of an International Application under 35 U.S.C. 371</u> If a timely submission to enter the national stage of an international application is compliant with the conditions of 35 U.S.C. 371 and other applicable requirements a Form PCT/DO/EO/903 indicating acceptance of the application as a national stage submission under 35 U.S.C. 371 will be issued in addition to the Filing Receipt, in due course.</p> <p><u>New International Application Filed with the USPTO as a Receiving Office</u> If a new international application is being filed and the international application includes the necessary components for an international filing date (see PCT Article 11 and MPEP 1810), a Notification of the International Application Number and of the International Filing Date (Form PCT/RO/105) will be issued in due course, subject to prescriptions concerning national security, and the date shown on this Acknowledgement Receipt will establish the international filing date of the application.</p>					

IN THE UNITED STATES PATENT AND TRADEMARK OFFICE

In re Application of:	Inge Bruheim, et al	Confirmation:	1945
Serial No.:	12/057,775	Group No.:	1651
Filed:	03-28-2008	Examiner:	Ware, Deborah K.
Entitled:	BIOEFFECTIVE KRILL OIL COMPOSITIONS		

INFORMATION DISCLOSURE STATEMENT LETTER

EFS Web Filed
Commissioner for Patents
P.O. Box 1450
Alexandria, VA 22313-1450

Sir or Madam:

The citations listed in the attached **IDS Form SB08A** may be material to the examination of the above-identified application, and are therefore submitted in compliance with the duty of disclosure defined in 37 C.F.R. §§ 1.56 and 1.97.

Applicants wish to bring to the Examiner’s attention that we are not providing copies of US Patents as instructed under 37 CFR 1.98(a)(2). The Examiner is requested to make these citations of official record in this application.

Applicants wish to bring to the Examiner’s attention that the references supplied in this IDS are from the December 8, 2011 Office Action from related KR Patent Application No. 10-2010-7006897.

This Information Disclosure Statement under 37 C.F.R. §§ 1.56 and 1.97 is not to be construed as a representation that a search has been made, that additional information material to the examination of this application does not exist, or that any one or more of these citations constitutes prior art.

The Commissioner is hereby authorized to charge any required fees or credit any overpayments to Attorney Deposit Account No.: **50-4302**, referencing Attorney Docket No.: **NATNUT-14409/US-5/ORD**.

Dated: February 20, 2012

/J. Mitchell Jones/
J. Mitchell Jones
Registration No. 44,174
CASIMIR JONES, S.C.
2275 Deming Way, Suite 310
Middleton, WI 53562
608.662.1277

INFORMATION DISCLOSURE STATEMENT BY APPLICANT (Not for submission under 37 CFR 1.99)	Application Number		12057775	
	Filing Date		2008-03-28	
	First Named Inventor	Inge Bruheim		
	Art Unit	1651		
	Examiner Name	Ware, Deborah K.		
	Attorney Docket Number	NATNUT-14409/US-5/ORD		

U.S.PATENTS						Remove
Examiner Initial*	Cite No	Patent Number	Kind Code ¹	Issue Date	Name of Patentee or Applicant of cited Document	Pages,Columns,Lines where Relevant Passages or Relevant Figures Appear
	1	5266564		1993-11-30	Modolell	
	2	8030348		2011-10-04	Sampalis, Fotni	
	3	7666447		2010-02-23	Rockway	

If you wish to add additional U.S. Patent citation information please click the Add button.

Add

U.S.PATENT APPLICATION PUBLICATIONS						Remove
Examiner Initial*	Cite No	Publication Number	Kind Code ¹	Publication Date	Name of Patentee or Applicant of cited Document	Pages,Columns,Lines where Relevant Passages or Relevant Figures Appear
	1	20080166419		2008-07-10	Sones	

If you wish to add additional U.S. Published Application citation information please click the Add button.

Add

FOREIGN PATENT DOCUMENTS								Remove
Examiner Initial*	Cite No	Foreign Document Number ³	Country Code ² j	Kind Code ⁴	Publication Date	Name of Patentee or Applicant of cited Document	Pages,Columns,Lines where Relevant Passages or Relevant Figures Appear	T ⁵
	1	2004-534800	JP		2004-11-18	Kohyo		<input type="checkbox"/>

INFORMATION DISCLOSURE STATEMENT BY APPLICANT (Not for submission under 37 CFR 1.99)	Application Number		12057775	
	Filing Date		2008-03-28	
	First Named Inventor	Inge Bruheim		
	Art Unit	1651		
	Examiner Name	Ware, Deborah K.		
	Attorney Docket Number	NATNUT-14409/US-5/ORD		

	2	07/080515	WO		2007-07-19	Aker Biomarine ASA		<input type="checkbox"/>
--	---	-----------	----	--	------------	--------------------	--	--------------------------

If you wish to add additional Foreign Patent Document citation information please click the Add button **Add**

NON-PATENT LITERATURE DOCUMENTS

Remove

Examiner Initials*	Cite No	Include name of the author (in CAPITAL LETTERS), title of the article (when appropriate), title of the item (book, magazine, journal, serial, symposium, catalog, etc), date, pages(s), volume-issue number(s), publisher, city and/or country where published.	T ⁵
	1	SIKORSKI, E., "The Utilization of Krill For Food," Food Process Eng., 1:845-855 (1980)	<input type="checkbox"/>
	2	BUDZINSKI, E., et al., "Possibilities of processing and marketing of products made from Antarctic Krill", FAO Fish. Tech. Pap. (268) 46 pages (1985)	<input type="checkbox"/>
	3	BUNEA R., et al., "Evaluation of the Effects of Neptune Krill Oil on the Clinical Course of Hyperlipidemia," Alternative Medicine Review, Thorne Research Inc., Sandpoint, US, Vol. 9, No. 4, January 1, 2004	<input type="checkbox"/>
	4	GORDEEV, K.Y., et al. "Fatty Acid Composition of the Main Phospholipids of the Antarctic Krill, Euphausia superba," Khim. Prirod. Soed. 2 (1990), pp. 181-187	<input type="checkbox"/>

If you wish to add additional non-patent literature document citation information please click the Add button **Add**

EXAMINER SIGNATURE

Examiner Signature		Date Considered	
--------------------	--	-----------------	--

*EXAMINER: Initial if reference considered, whether or not citation is in conformance with MPEP 609. Draw line through a citation if not in conformance and not considered. Include copy of this form with next communication to applicant.

¹ See Kind Codes of USPTO Patent Documents at www.USPTO.GOV or MPEP 901.04. ² Enter office that issued the document, by the two-letter code (WIPO Standard ST.3). ³ For Japanese patent documents, the indication of the year of the reign of the Emperor must precede the serial number of the patent document. ⁴ Kind of document by the appropriate symbols as indicated on the document under WIPO Standard ST.16 if possible. ⁵ Applicant is to place a check mark here if English language translation is attached.

**INFORMATION DISCLOSURE
STATEMENT BY APPLICANT**
(Not for submission under 37 CFR 1.99)

Application Number	12057775
Filing Date	2008-03-28
First Named Inventor	Inge Bruheim
Art Unit	1651
Examiner Name	Ware, Deborah K.
Attorney Docket Number	NATNUT-14409/US-5/ORD

CERTIFICATION STATEMENT

Please see 37 CFR 1.97 and 1.98 to make the appropriate selection(s):

That each item of information contained in the information disclosure statement was first cited in any communication from a foreign patent office in a counterpart foreign application not more than three months prior to the filing of the information disclosure statement. See 37 CFR 1.97(e)(1).

OR

That no item of information contained in the information disclosure statement was cited in a communication from a foreign patent office in a counterpart foreign application, and, to the knowledge of the person signing the certification after making reasonable inquiry, no item of information contained in the information disclosure statement was known to any individual designated in 37 CFR 1.56(c) more than three months prior to the filing of the information disclosure statement. See 37 CFR 1.97(e)(2).

See attached certification statement.

The fee set forth in 37 CFR 1.17 (p) has been submitted herewith.

A certification statement is not submitted herewith.

SIGNATURE

A signature of the applicant or representative is required in accordance with CFR 1.33, 10.18. Please see CFR 1.4(d) for the form of the signature.

Signature	/J. Mitchell Jones/	Date (YYYY-MM-DD)	2012-01-24
Name/Print	J. Mitchell Jones	Registration Number	44174

This collection of information is required by 37 CFR 1.97 and 1.98. The information is required to obtain or retain a benefit by the public which is to file (and by the USPTO to process) an application. Confidentiality is governed by 35 U.S.C. 122 and 37 CFR 1.14. This collection is estimated to take 1 hour to complete, including gathering, preparing and submitting the completed application form to the USPTO. Time will vary depending upon the individual case. Any comments on the amount of time you require to complete this form and/or suggestions for reducing this burden, should be sent to the Chief Information Officer, U.S. Patent and Trademark Office, U.S. Department of Commerce, P.O. Box 1450, Alexandria, VA 22313-1450. **DO NOT SEND FEES OR COMPLETED FORMS TO THIS ADDRESS. SEND TO: Commissioner for Patents, P.O. Box 1450, Alexandria, VA 22313-1450.**

Privacy Act Statement

The Privacy Act of 1974 (P.L. 93-579) requires that you be given certain information in connection with your submission of the attached form related to a patent application or patent. Accordingly, pursuant to the requirements of the Act, please be advised that: (1) the general authority for the collection of this information is 35 U.S.C. 2(b)(2); (2) furnishing of the information solicited is voluntary; and (3) the principal purpose for which the information is used by the U.S. Patent and Trademark Office is to process and/or examine your submission related to a patent application or patent. If you do not furnish the requested information, the U.S. Patent and Trademark Office may not be able to process and/or examine your submission, which may result in termination of proceedings or abandonment of the application or expiration of the patent.

The information provided by you in this form will be subject to the following routine uses:

1. The information on this form will be treated confidentially to the extent allowed under the Freedom of Information Act (5 U.S.C. 552) and the Privacy Act (5 U.S.C. 552a). Records from this system of records may be disclosed to the Department of Justice to determine whether the Freedom of Information Act requires disclosure of these records.
2. A record from this system of records may be disclosed, as a routine use, in the course of presenting evidence to a court, magistrate, or administrative tribunal, including disclosures to opposing counsel in the course of settlement negotiations.
3. A record in this system of records may be disclosed, as a routine use, to a Member of Congress submitting a request involving an individual, to whom the record pertains, when the individual has requested assistance from the Member with respect to the subject matter of the record.
4. A record in this system of records may be disclosed, as a routine use, to a contractor of the Agency having need for the information in order to perform a contract. Recipients of information shall be required to comply with the requirements of the Privacy Act of 1974, as amended, pursuant to 5 U.S.C. 552a(m).
5. A record related to an International Application filed under the Patent Cooperation Treaty in this system of records may be disclosed, as a routine use, to the International Bureau of the World Intellectual Property Organization, pursuant to the Patent Cooperation Treaty.
6. A record in this system of records may be disclosed, as a routine use, to another federal agency for purposes of National Security review (35 U.S.C. 181) and for review pursuant to the Atomic Energy Act (42 U.S.C. 218(c)).
7. A record from this system of records may be disclosed, as a routine use, to the Administrator, General Services, or his/her designee, during an inspection of records conducted by GSA as part of that agency's responsibility to recommend improvements in records management practices and programs, under authority of 44 U.S.C. 2904 and 2906. Such disclosure shall be made in accordance with the GSA regulations governing inspection of records for this purpose, and any other relevant (i.e., GSA or Commerce) directive. Such disclosure shall not be used to make determinations about individuals.
8. A record from this system of records may be disclosed, as a routine use, to the public after either publication of the application pursuant to 35 U.S.C. 122(b) or issuance of a patent pursuant to 35 U.S.C. 151. Further, a record may be disclosed, subject to the limitations of 37 CFR 1.14, as a routine use, to the public if the record was filed in an application which became abandoned or in which the proceedings were terminated and which application is referenced by either a published application, an application open to public inspections or an issued patent.
9. A record from this system of records may be disclosed, as a routine use, to a Federal, State, or local law enforcement agency, if the USPTO becomes aware of a violation or potential violation of law or regulation.

Electronic Patent Application Fee Transmittal

Application Number:	12057775
Filing Date:	28-Mar-2008
Title of Invention:	BIOEFFECTIVE KRILL OIL COMPOSITIONS
First Named Inventor/Applicant Name:	Inge Bruheim
Filer:	John Mitchell Jones
Attorney Docket Number:	NATNUT-14409/US-5/ORD

Filed as Large Entity

Utility under 35 USC 111(a) Filing Fees

Description	Fee Code	Quantity	Amount	Sub-Total in USD(\$)
Basic Filing:				
Pages:				
Claims:				
Miscellaneous-Filing:				
Petition:				
Patent-Appeals-and-Interference:				
Post-Allowance-and-Post-Issuance:				
Extension-of-Time:				

Description	Fee Code	Quantity	Amount	Sub-Total in USD(\$)
Miscellaneous:				
Submission- Information Disclosure Stmt	1806	1	180	180
Total in USD (\$)				180

Electronic Acknowledgement Receipt

EFS ID:	11906104
Application Number:	12057775
International Application Number:	
Confirmation Number:	1945
Title of Invention:	BIOEFFECTIVE KRILL OIL COMPOSITIONS
First Named Inventor/Applicant Name:	Inge Bruheim
Customer Number:	72960
Filer:	John Mitchell Jones/Vickie Hoeft
Filer Authorized By:	John Mitchell Jones
Attorney Docket Number:	NATNUT-14409/US-5/ORD
Receipt Date:	25-JAN-2012
Filing Date:	28-MAR-2008
Time Stamp:	11:42:48
Application Type:	Utility under 35 USC 111(a)

Payment information:

Submitted with Payment	yes
Payment Type	Deposit Account
Payment was successfully received in RAM	\$180
RAM confirmation Number	21970
Deposit Account	504302
Authorized User	

The Director of the USPTO is hereby authorized to charge indicated fees and credit any overpayment as follows:

Charge any Additional Fees required under 37 C.F.R. Section 1.16 (National application filing, search, and examination fees)

Charge any Additional Fees required under 37 C.F.R. Section 1.17 (Patent application filing, search, and examination fees)

Charge any Additional Fees required under 37 C.F.R. Section 1.19 (Document supply fees)

Charge any Additional Fees required under 37 C.F.R. Section 1.20 (Post Issuance fees)

Charge any Additional Fees required under 37 C.F.R. Section 1.21 (Miscellaneous fees and charges)

File Listing:

Document Number	Document Description	File Name	File Size(Bytes)/ Message Digest	Multi Part /.zip	Pages (if appl.)
1	Transmittal Letter	14409US5IDSLetter01242012.pdf	73326 fa62420ce082e95fcd8bf3867ed55ff79d97298b	no	1
Warnings:					
Information:					
2	Foreign Reference	JPA2004534800.pdf	1831904 01b0eb7d7150ad8436d4ab1c0ff7e6796d98a34e	no	60
Warnings:					
Information:					
3	Foreign Reference	WO2007080515.pdf	1126330 14a09da6f685f2301096da43381d3f9e2bbde013	no	27
Warnings:					
Information:					
4	Non Patent Literature	BUDZINSKI1985.pdf	2606929 cdea47d9074c0ec8bab93e6ad83f9ef4ae5dc099	no	51
Warnings:					
Information:					
5	Non Patent Literature	Bunea2004print.pdf	97505 44f351c4bf6f11a65d72a0891f26ef366741be95	no	9
Warnings:					
Information:					
6	Non Patent Literature	SIKORSKI.pdf	473015 3415d6af73aed943aa6d2bfe78ea24134168714c	no	11
Warnings:					
Information:					
7	Information Disclosure Statement (IDS) Form (SB08)	14409US5ORDIDS01242012.pdf	612564 25fdb919eb9d44342fc47c97df4005df3d3ff413	no	4
Warnings:					
Information:					
8	Non Patent Literature	Gordeev1990.pdf	366063 4e7b4812c0af3939a51244e75fa282c670a576f7	no	5

Warnings:					
Information:					
9	Fee Worksheet (SB06)	fee-info.pdf	30265	no	2
			ae777c7e2e36389c9d4a58d05b2534694163967e		
Warnings:					
Information:					
Total Files Size (in bytes):				7217901	
<p>This Acknowledgement Receipt evidences receipt on the noted date by the USPTO of the indicated documents, characterized by the applicant, and including page counts, where applicable. It serves as evidence of receipt similar to a Post Card, as described in MPEP 503.</p> <p><u>New Applications Under 35 U.S.C. 111</u> If a new application is being filed and the application includes the necessary components for a filing date (see 37 CFR 1.53(b)-(d) and MPEP 506), a Filing Receipt (37 CFR 1.54) will be issued in due course and the date shown on this Acknowledgement Receipt will establish the filing date of the application.</p> <p><u>National Stage of an International Application under 35 U.S.C. 371</u> If a timely submission to enter the national stage of an international application is compliant with the conditions of 35 U.S.C. 371 and other applicable requirements a Form PCT/DO/EO/903 indicating acceptance of the application as a national stage submission under 35 U.S.C. 371 will be issued in addition to the Filing Receipt, in due course.</p> <p><u>New International Application Filed with the USPTO as a Receiving Office</u> If a new international application is being filed and the international application includes the necessary components for an international filing date (see PCT Article 11 and MPEP 1810), a Notification of the International Application Number and of the International Filing Date (Form PCT/RO/105) will be issued in due course, subject to prescriptions concerning national security, and the date shown on this Acknowledgement Receipt will establish the international filing date of the application.</p>					

IN THE UNITED STATES PATENT AND TRADEMARK OFFICE

In re Application of:	Inge Bruheim, et al	Confirmation:	1945
Serial No.:	12/057,775	Group No.:	1651
Filed:	03-28-2008	Examiner:	Ware, Deborah K.
Entitled:	BIOEFFECTIVE KRILL OIL COMPOSITIONS		

INFORMATION DISCLOSURE STATEMENT LETTER

EFS Web Filed
Commissioner for Patents
P.O. Box 1450
Alexandria, VA 22313-1450

Sir or Madam:

The citations listed in the attached **IDS Form SB08A** may be material to the examination of the above-identified application, and are therefore submitted in compliance with the duty of disclosure defined in 37 C.F.R. §§ 1.56 and 1.97.

Applicants wish to bring to the Examiner's attention that we are not providing copies of US Patents as instructed under 37 CFR 1.98(a)(2). The Examiner is requested to make these citations of official record in this application.

This Information Disclosure Statement under 37 C.F.R. §§ 1.56 and 1.97 is not to be construed as a representation that a search has been made, that additional information material to the examination of this application does not exist, or that any one or more of these citations constitutes prior art.

The Commissioner is hereby authorized to charge any required fees or credit any overpayments to Attorney Deposit Account No.: **50-4302**, referencing Attorney Docket No.: **NATNUT-14409/US-5/ORD**.

Dated: January 24, 2012

/J. Mitchell Jones/
J. Mitchell Jones
Registration No. 44,174
CASIMIR JONES, S.C.
2275 Deming Way, Suite 310
Middleton, WI 53562
608.662.1277

JP 2004-534800 A 2004.11.18

(19) 日本国特許庁(JP)

(12) 公表特許公報(A)

(11) 特許出願公表番号

特表2004-534800

(P2004-534800A)

(43) 公表日 平成16年11月18日(2004.11.18)

(51) Int. Cl. ⁷	F I	テーマコード (参考)
A 6 1 K 35/56	A 6 1 K 35/56	4 C 0 8 3
A 6 1 K 7/00	A 6 1 K 7/00	C 4 C 0 8 6
A 6 1 K 7/48	A 6 1 K 7/00	D 4 C 0 8 7
A 6 1 K 31/015	A 6 1 K 7/00	E 4 C 2 0 6
A 6 1 K 31/07	A 6 1 K 7/00	F
審査請求 未請求 予備審査請求 有 (全 60 頁) 最終頁に続く		

(21) 出願番号	特願2003-504980 (P2003-504980)	(71) 出願人	503459752
(86) (22) 出願日	平成14年6月7日 (2002.6.7)		ネプチューン テクノロジーズ アンド
(85) 翻訳文提出日	平成15年12月15日 (2003.12.15)		バイオリソーシイズ インク
(86) 国際出願番号	PCT/CA2002/000843		カナダ H7M 3Y2 ケベック ラバ
(87) 国際公開番号	W02002/102394		ル プレアウ 500 プールヴァール
(87) 国際公開日	平成14年12月27日 (2002.12.27)		サンマルティン オウエ 500
(31) 優先権主張番号	60/298,383	(74) 代理人	100093230
(32) 優先日	平成13年6月18日 (2001.6.18)		弁理士 西澤 利夫
(33) 優先権主張国	米国 (US)	(72) 発明者	サンパリ ティナ
			カナダ H7W 3J8 ケベック ラバ
			ル エリザベス ビルド 1348
		Fターム(参考)	4C083 AA081 AA082 BB11 CC01 CC02
			CC04 CC05 CC07 DD12 DD22
			DD23 DD27 DD31 DD38 DD41
			EE12 FF01
			最終頁に続く

(54) 【発明の名称】 心臓血管疾患、関節炎、皮膚ガン、糖尿病、月経前症候群および経皮送達のためのオキアミおよび/または海洋生物の抽出物

(57) 【要約】

本発明は心臓血管疾患、慢性関節リウマチ、皮膚ガン、糖尿病、月経前症候群および経皮送達増強の予防および/または治療に関する。本発明の方法は療治効果的な量のオキアミ油および/または海洋生物油を患者に投与することを含む。本発明はまた、これら疾患の予防および/または治療のための組成物に関する。

【特許請求の範囲】

【請求項1】

患者におけるコレステロールを低下させるための組成物であって、効果的な量のオキアミ油および／または海洋生物油を薬学的に受容可能なキャリアとともに含み、前記オキアミ油および／または海洋生物油が、以下の工程：

a)オキアミおよび／または海洋生物の材料をケトン溶媒（好ましくは、アセトン）に入れて、前記海洋動物材料および／または水生動物材料からの可溶性脂質画分を抽出し；

b)これを液体内容物と固体内容物に分離し；

c)分離した液体内容物に存在する溶媒を蒸発させることによって液体内容物から第1の脂質富含有画分を回収し；

d)前記固体内容物を、アルコール（好ましくは、エタノール、イソプロパノールまたはt-ブタノール）および酢酸エステル（好ましくは、酢酸エチル）からなる溶媒群から選択される有機溶媒に入れて、前記海洋動物材料および／または水生動物材料からの残留可溶性脂質画分を抽出し；

e)これを液体内容物と固体内容物に分離し；

f)分離した液体内容物から溶媒を蒸発させることによって第2の脂質富含有画分を回収し；および

g)固体内容物を回収する工程

からなるプロセスから得られる組成物。

【請求項2】

患者におけるコレステロールを低下させるための組成物であって、効果的な量のオキアミ油および／または海洋生物油を薬学的に受容可能なキャリアとともに含み、前記オキアミ油および／または海洋生物油が、エイコサペンタエン酸、ドコサヘキサンエン酸、ホスファチジルコリン、ホスファチジルイノシトール、ホスファチジルセリン、ホスファチジルエタノールアミン、スフィンゴミエリン、 α -トコフェロール、アスタキサンチンおよびフラボノイドを含む組成物。

【請求項3】

リノール酸、 α -リノール酸、アラキドン酸、オレイン酸、パルミチン酸、パルミトレイン酸、ステアリン酸、コレステロール、トリグリセリド、モノグリセリド、全トランスレチノール、カンタキサンチン、 β -カロテン、亜鉛、セレン、ネルボン酸、ナトリウム、カリウムおよびカルシウムからなる群の少なくとも1つをさらに含む、請求項2に記載の組成物。

【請求項4】

患者におけるコレステロールを低下させる方法であって、請求項1～3のいずれか一項に記載される組成物の効果的な量を前記患者に投与することを含む方法。

【請求項5】

前記投与が経口的に行われる、請求項4に記載の方法。

【請求項6】

前記オキアミ抽出物および／または海洋生物抽出物が1日あたり1グラム～4.8グラムの範囲の量で投与される、請求項4に記載の方法。

【請求項7】

前記量が4.8グラムである、請求項6に記載の方法。

【請求項8】

患者におけるコレステロールを低下させるための、請求項1～3のいずれか一項に記載される組成物の使用。

【請求項9】

患者におけるコレステロールを低下させる医薬品を製造するための、請求項1～3のいずれか一項に記載される組成物の使用。

【請求項10】

患者の動脈における血小板接着およびプラーク形成を阻害するための組成物であって、効

10

20

30

40

50

果的な量のオキアミ油および／または海洋生物油を薬学的に受容可能なキャリアとともに含み、前記オキアミ油および／または海洋生物油が、以下の工程：

a) オキアミおよび／または海洋生物の材料をケトン溶媒（好ましくは、アセトン）に入れて、前記海洋動物材料および／または水生動物材料からの可溶性脂質画分を抽出し；

b) これを液体内容物と固体内容物に分離し；

c) 分離した液体内容物に存在する溶媒を蒸発させることによって液体内容物から第1の脂質富含画分を回収し；

d) 前記固体内容物を、アルコール（好ましくは、エタノール、イソプロパノールまたはn-ブタノール）および酢酸エステル（好ましくは、酢酸エチル）からなる溶媒群から選択される有機溶媒に入れて、前記海洋動物材料および／または水生動物材料からの残留可溶性脂質画分を抽出し；

10

e) これを液体内容物と固体内容物に分離し；

f) 分離した液体内容物から溶媒を蒸発させることによって第2の脂質富含画分を回収し；および

g) 固体内容物を回収する工程

からなるプロセスから得られる組成物。

【請求項11】

患者の動脈における血小板接着およびプラーク形成を阻害するための組成物であって、効果的な量のオキアミ油および／または海洋生物油を薬学的に受容可能なキャリアとともに含み、前記オキアミ油および／または海洋生物油が、エイコサペンタエン酸、ドコサヘキサエン酸、ホスファチジルコリン、ホスファチジルイノシトール、ホスファチジルセリン、ホスファチジリエタノールアミン、スフィンゴミエリン、 α -トコフェロール、アスタキサンチンおよびフラボノイドを含む組成物。

20

【請求項12】

リノール酸、 α -リノール酸、アラキドン酸、オレイン酸、パルミチン酸、パルミトレイン酸、ステアリン酸、コレステロール、トリグリセリド、モノグリセリド、全トランスレチノール、カンタキサンチン、 β -カロテン、亜鉛、セレン、ネルボン酸、ナトリウム、カリウムおよびカルシウムからなる群の少なくとも1つをさらに含む、請求項11に記載の組成物。

【請求項13】

患者の動脈における血小板接着およびプラーク形成を阻害する方法であって、請求項11～12のいずれか一項に記載される組成物の効果的な量を前記患者に投与することを含む方法。

30

【請求項14】

前記投与が経口的に行われる、請求項13に記載の方法。

【請求項15】

前記オキアミ抽出物および／または海洋生物抽出物が1日あたり1グラム～4.8グラムの範囲の量で投与される、請求項13に記載の方法。

【請求項16】

前記量が4.8グラムである、請求項15に記載の方法。

40

【請求項17】

患者の動脈における血小板接着およびプラーク形成を阻害するための、請求項11～13のいずれか一項に記載される組成物の使用。

【請求項18】

患者の動脈における血小板接着およびプラーク形成を阻害する医薬品を製造するための、請求項11～13のいずれか一項に記載される組成物の使用。

【請求項19】

患者における高血圧を防止するための予防薬組成物であって、予防効果的な量のオキアミ油および／または海洋生物油を薬学的に受容可能なキャリアとともに含み、前記オキアミ油および／または海洋生物油が、以下の工程：

50

- a) オキアミおよび／または海洋生物の材料をケトン溶媒（好ましくは、アセトン）に入れて、前記海洋動物材料および／または水生動物材料からの可溶性脂質画分を抽出し；
- b) これを液体内容物と固体内容物に分離し；
- c) 分離した液体内容物に存在する溶媒を蒸発させることによって液体内容物から第1の脂質富含画分を回収し；
- d) 前記固体内容物を、アルコール（好ましくは、エタノール、イソプロパノールまたはt-ブタノール）および酢酸エステル（好ましくは、酢酸エチル）からなる溶媒群から選択される有機溶媒に入れて、前記海洋動物材料および／または水生動物材料からの残留可溶性脂質画分を抽出し；
- e) これを液体内容物と固体内容物に分離し；
- f) 分離した液体内容物から溶媒を蒸発させることによって第2の脂質富含画分を回収し；および
- g) 固体内容物を回収する工程からなるプロセスから得られる予防薬組成物。

10

【請求項20】

患者における高血圧を防止するための予防薬組成物であって、予防効果的な量のオキアミ油および／または海洋生物油を薬学的に受容可能なキャリアとともに含み、前記オキアミ油および／または海洋生物油が、エイコサペンタエン酸、ドコサヘキサエン酸、ホスファチジルコリン、ホスファチジルイノシトール、ホスファチジルセリン、ホスファチジルエタノールアミン、スフィンゴミエリン、 α -トコフェロール、アスタキサンチンおよびフラボノイドを含む予防薬組成物。

20

【請求項21】

リノール酸、 α -リノール酸、アラキドン酸、オレイン酸、パルミチン酸、パルミトレイン酸、ステアリン酸、コレステロール、トリグリセリド、モノグリセリド、全トランスレチノール、カンタキサンチン、 β -カロテン、亜鉛、セレン、ネルボン酸、ナトリウム、カリウムおよびカルシウムからなる群の少なくとも1つをさらに含む、請求項20に記載の組成物。

【請求項22】

患者における高血圧を防止するための方法であって、請求項19～21のいずれか一項に記載される組成物の予防効果的な量を前記患者に投与することを含む方法。

30

【請求項23】

前記投与が経口的に行われる、請求項22に記載の方法。

【請求項24】

前記オキアミ抽出物および／または海洋生物抽出物が1日あたり1グラム～4.8グラムの範囲の量で投与される、請求項22に記載の方法。

【請求項25】

前記量が4.8グラムである、請求項24に記載の方法。

【請求項26】

患者における高血圧を防止するための、請求項19～21のいずれか一項に記載される組成物の使用。

40

【請求項27】

患者における高血圧を防止する医薬品を製造するための、請求項19～21のいずれか一項に記載される組成物の使用。

【請求項28】

関節炎を症状的に抑制または治療するための療治用組成物であって、療治効果的な量のオキアミ油および／または海洋生物油を薬学的に受容可能なキャリアとともに含み、前記オキアミ油および／または海洋生物油が、以下の工程：

- a) オキアミおよび／または海洋生物の材料をケトン溶媒（好ましくは、アセトン）に入れて、前記海洋動物材料および／または水生動物材料からの可溶性脂質画分を抽出し；
- b) これを液体内容物と固体内容物に分離し；

50

c)分離した液体内容物に存在する溶媒を蒸発させることによって液体内容物から第1の脂質富含画分を回収し；

d)前記固体内容物を、アルコール（好ましくは、エタノール、イソプロパノールまたはt-ブタノール）および酢酸エステル（好ましくは、酢酸エチル）からなる溶媒群から選択される有機溶媒に入れて、前記海洋動物材料および／または水生動物材料からの残留可溶性脂質画分を抽出し；

e)これを液体内容物と固体内容物に分離し；

f)分離した液体内容物から溶媒を蒸発させることによって第2の脂質富含画分を回収し；および

g)固体内容物を回収する工程

10

からなるプロセスから得られる療治用組成物。

【請求項29】

前記関節炎が、慢性関節リウマチおよび変形性関節症からなる群から選択される、請求項28に記載の方法。

【請求項30】

関節炎を症状的に抑制または治療するための療治用組成物であって、療治効果的な量のオキアミ油および／または海洋生物油を薬学的に受容可能なキャリアとともに含み、前記オキアミ油および／または海洋生物油が、エイコサペンタエン酸、ドコサヘキサエン酸、ホスファチジルコリン、ホスファチジルイノシトール、ホスファチジルセリン、ホスファチジルエタノールアミン、スフィンゴミエリン、 α -トコフェロール、アスタキサンチンおよびフラボノイドを含む療治用組成物。

20

【請求項31】

リノール酸、 α -リノール酸、アラキドン酸、オレイン酸、パルミチン酸、パルミトレイン酸、ステアリン酸、コレステロール、トリグリセリド、モノグリセリド、全トランスレチノール、カンタキサンチン、 β -カロテン、亜鉛、セレン、ネルボン酸、ナトリウム、カリウムおよびカルシウムからなる群の少なくとも1つをさらに含む、請求項30に記載の組成物。

【請求項32】

前記関節炎が、慢性関節リウマチおよび変形性関節症からなる群から選択される、請求項30に記載の組成物。

30

【請求項33】

患者における関節炎を症状的に抑制または治療するための方法であって、請求項29～32のいずれか一項に記載される組成物の療治効果的な量を前記患者に投与することを含む方法。

【請求項34】

前記投与が経口的に行われる、請求項33に記載の方法。

【請求項35】

前記オキアミ抽出物および／または海洋生物抽出物が1日あたり1グラム～4.8グラムの範囲の量で投与される、請求項33に記載の方法。

【請求項36】

40

前記量が4.8グラムである、請求項35に記載の方法。

【請求項37】

患者における慢性関節リウマチの症状を抑制するための、またはそれを治療するための、請求項29～32のいずれか一項に記載される組成物の使用。

【請求項38】

患者における慢性関節リウマチの症状抑制薬、または治療薬を製造するための、請求項29～32のいずれか一項に記載される組成物の使用。

【請求項39】

患者における皮膚ガンを防止するための予防薬組成物であって、予防効果的な量のオキアミ油および／または海洋生物油を薬学的に受容可能なキャリアとともに含み、前記オキア

50

ミ油および／または海洋生物油が、以下の工程：

- a) オキアミおよび／または海洋生物の材料をケトン溶媒（好ましくは、アセトン）に入れて、前記海洋動物材料および／または水生動物材料からの可溶性脂質画分を抽出し；
- b) これを液体内容物と固体内容物に分離し；
- c) 分離した液体内容物に存在する溶媒を蒸発させることによって液体内容物から第1の脂質富含画分を回収し；
- d) 前記固体内容物を、アルコール（好ましくは、エタノール、イソプロパノールまたはt-ブタノール）および酢酸エステル（好ましくは、酢酸エチル）からなる溶媒群から選択される有機溶媒に入れて、前記海洋動物材料および／または水生動物材料からの残留可溶性脂質画分を抽出し；
- e) これを液体内容物と固体内容物に分離し；
- f) 分離した液体内容物から溶媒を蒸発させることによって第2の脂質富含画分を回収し；および
- g) 固体内容物を回収する工程からなるプロセスから得られる予防薬組成物。

【請求項40】

患者における皮膚ガンを防止するための予防薬組成物であって、予防効果的な量のオキアミ油および／または海洋生物油を薬学的に受容可能なキャリアとともに含み、前記オキアミ油および／または海洋生物油が、エイコサペンタエン酸、ドコサヘキサエン酸、ホスファチジルコリン、ホスファチジルイノシトール、ホスファチジルセリン、ホスファチジルエタノールアミン、スフィンゴミエリン、 α -トコフェロール、アスタキサンチンおよびフラボノイドを含む予防薬組成物。

【請求項41】

リノール酸、 α -リノール酸、アラキドン酸、オレイン酸、パルミチン酸、パルミトレイン酸、ステアリン酸、コレステロール、トリグリセリド、モノグリセリド、全トランスレチノール、カンタキサンチン、 β -カロテン、亜鉛、セレン、ネルボン酸、ナトリウム、カリウムおよびカルシウムからなる群の少なくとも1つをさらに含む、請求項40に記載の組成物。

【請求項42】

皮膚ガンを防止する方法であって、請求項39～41のいずれか一項に記載される組成物の療治効果的または予防効果的な量を患者に投与することを含む方法。

【請求項43】

前記投与が経口的に行われる、請求項42に記載の方法。

【請求項44】

前記オキアミ抽出物および／または海洋生物抽出物が1日あたり1グラム～4.8グラムの範囲の量で投与される、請求項42に記載の方法。

【請求項45】

前記量が4.8グラムである、請求項44に記載の方法。

【請求項46】

患者における皮膚ガンを防止するための、請求項39～41のいずれか一項に記載される組成物の使用。

【請求項47】

患者における皮膚ガンを防止する医薬品を製造するための、請求項39～41のいずれか一項に記載される組成物の使用。

【請求項48】

患者に皮膚に局所的に塗布する療治薬の経皮輸送を増強するための組成物であって、増強効果的な量のオキアミ油および／または海洋生物油を薬学的に受容可能なキャリアとともに含み、前記オキアミ油および／または海洋生物油が、以下の工程：

- a) オキアミおよび／または海洋生物の材料をケトン溶媒（好ましくは、アセトン）に入れて、前記海洋動物材料および／または水生動物材料からの可溶性脂質画分を抽出し；

- b)これを液体内容物と固体内容物に分離し；
 c)分離した液体内容物に存在する溶媒を蒸発させることによって液体内容物から第1の脂質富含画分を回収し；
 d)前記固体内容物を、アルコール（好ましくは、エタノール、イソプロパノールまたはt-ブタノール）および酢酸エステル（好ましくは、酢酸エチル）からなる溶媒群から選択される有機溶媒に入れて、前記海洋動物材料および／または水生動物材料からの残留可溶性脂質画分を抽出し；
 e)これを液体内容物と固体内容物に分離し；
 f)分離した液体内容物から溶媒を蒸発させることによって第2の脂質富含画分を回収し；および
 g)固体内容物を回収する工程からなるプロセスから得られる組成物。

10

【請求項49】

患者における皮膚に局部的に塗布する療治薬の経皮輸送を増強するための組成物であって、増強効果的な量のオキアミ油および／または海洋生物油を薬学的に受容可能なキャリアとともに含み、前記オキアミ油および／または海洋生物油が、エイコサペンタエン酸、ドコサヘキサエン酸、ホスファチジルコリン、ホスファチジルイノシトール、ホスファチジルセリン、ホスファチジルエタノールアミン、スフィンゴミエリン、 α -トコフェロール、アスタキサンチンおよびフラボノイドを含む組成物。

【請求項50】

リノール酸、 α -リノール酸、アラキドン酸、オレイン酸、パルミチン酸、パルミトレイン酸、ステアリン酸、コレステロール、トリグリセリド、モノグリセリド、全トランスレチノール、カンタキサンチン、 β -カロテン、亜鉛、セレン、ネルボン酸、ナトリウム、カリウムおよびカルシウムからなる群の少なくとも1つをさらに含む、請求項49に記載の組成物。

20

【請求項51】

患者における皮膚に局部的に塗布する療治薬の経皮輸送を増強するための方法であって、請求項48～50のいずれか一項に記載される組成物の増強効果的な量を前記患者に投与することを含む方法。

【請求項52】

前記投与が経口のおよび／または局所的に行われる、請求項51に記載の方法。

30

【請求項53】

前記オキアミ抽出物および／または海洋生物抽出物が1日あたり1グラム～4.8グラムの範囲の量で投与される、請求項51に記載の方法。

【請求項54】

前記量が4.8グラムである、請求項53に記載の方法。

【請求項55】

患者における皮膚に局部的に塗布する療治薬の経皮輸送を増強するための、請求項48～50のいずれか一項に記載される組成物の使用。

【請求項56】

患者における皮膚に局部的に塗布する療治薬の経皮輸送を増強する医薬品を製造するための、請求項48～50のいずれか一項に記載される組成物の使用。

40

【請求項57】

患者における皮膚に局部的に塗布する化粧品の経皮輸送を増強するための組成物であって、増強効果的な量のオキアミ油および／または海洋生物油を薬学的に受容可能なキャリアとともに含み、前記オキアミ油および／または海洋生物油が、以下の工程：

- a)オキアミおよび／または海洋生物の材料をケトン溶媒（好ましくは、アセトン）に入れて、前記海洋動物材料および／または水生動物材料からの可溶性脂質画分を抽出し；
 b)これを液体内容物と固体内容物に分離し；
 c)分離した液体内容物に存在する溶媒を蒸発させることによって液体内容物から第1の脂

50

質富含有画分を回収し；

d)前記固体内容物を、アルコール（好ましくは、エタノール、イソプロパノールまたはt-ブタノール）および酢酸エステル（好ましくは、酢酸エチル）からなる溶媒群から選択される有機溶媒に入れて、前記海洋動物材料および／または水生動物材料からの残留可溶性脂質画分を抽出し；

e)これを液体内容物と固体内容物に分離し；

f)分離した液体内容物から溶媒を蒸発させることによって第2の脂質富含有画分を回収し；および

g)固体内容物を回収する工程

からなるプロセスから得られる組成物。

10

【請求項58】

患者における皮膚に局所的に塗布する化粧品の経皮輸送を増強するための組成物であって、増強効果的な量のオキアミ油および／または海洋生物油を薬学的に受容可能なキャリアとともに含み、前記オキアミ油および／または海洋生物油が、エイコサペンタエン酸、ドコサヘキサンエン酸、ホスファチジルコリン、ホスファチジルイノシトール、ホスファチジルセリン、ホスファチジルエタノールアミン、スフィンゴミエリン、 α -トコフェロール、アスタキサンチンおよびフラボノイドを含む組成物。

【請求項59】

リノール酸、 α -リノール酸、アラキドン酸、オレイン酸、パルミチン酸、パルミトレイン酸、ステアリン酸、コレステロール、トリグリセリド、モノグリセリド、全トランスレチノール、カンタキサンチン、 β -カロテン、亜鉛、セレン、ネルボン酸、ナトリウム、カリウムおよびカルシウムからなる群の少なくとも1つをさらに含む、請求項58に記載の組成物。

20

【請求項60】

皮膚に局所的に塗布する化粧品の経皮輸送を増強するための方法であって、請求項57～59のいずれか一項に記載される組成物の増強効果的な量を患者に投与することを含む方法。

【請求項61】

前記投与が経口のおよび／または局所的に行われる、請求項60に記載の方法。

【請求項62】

前記オキアミ抽出物および／または海洋生物抽出物が1日あたり1グラム～4.8グラムの範囲の量で投与される、請求項60に記載の方法。

30

【請求項63】

前記量が4.8グラムである、請求項62に記載の方法。

【請求項64】

患者における皮膚に局所的に塗布する化粧品経皮輸送を増強するための、請求項57～59のいずれか一項に記載される組成物の使用。

【請求項65】

患者における皮膚に局所的に塗布する化粧品の経皮輸送を増強する医薬品を製造するための、請求項57～59のいずれか一項に記載される組成物の使用。

40

【請求項66】

患者における月経前症候群の症状を軽減させるための組成物であって、増強効果的な量のオキアミ油および／または海洋生物油を薬学的に受容可能なキャリアとともに含み、前記オキアミ油および／または海洋生物油が、以下の工程：

a)オキアミおよび／または海洋生物の材料をケトン溶媒（好ましくは、アセトン）に入れて、前記海洋動物材料および／または水生動物材料からの可溶性脂質画分を抽出し；

b)これを液体内容物と固体内容物に分離し；

c)分離した液体内容物に存在する溶媒を蒸発させることによって液体内容物から第1の脂質富含有画分を回収し；

d)前記固体内容物を、アルコール（好ましくは、エタノール、イソプロパノールまたはt-

50

ブタノール) および酢酸エステル (好ましくは、酢酸エチル) からなる溶媒群から選択される有機溶媒に入れて、前記海洋動物材料および/または水生動物材料からの残留可溶性脂質画分を抽出し;

e) これを液体内容物と固体内容物に分離し;

f) 分離した液体内容物から溶媒を蒸発させることによって第2の脂質富含有画分を回収し; および

g) 固体内容物を回収する工程

からなるプロセスから得られる組成物。

【請求項67】

患者における月経前症候群の症状を軽減させるための組成物であって、増強効果的な量のオキアミ油および/または海洋生物油を薬学的に受容可能なキャリアとともに含み、前記オキアミ油および/または海洋生物油が、エイコサペンタエン酸、ドコサヘキサエン酸、ホスファチジルコリン、ホスファチジルイノシトール、ホスファチジルセリン、ホスファチジルエタノールアミン、スフィンゴミエリン、 α -トコフェロール、アスタキサンチンおよびフラボノイドを含む組成物。

10

【請求項68】

リノール酸、 α -リノール酸、アラキドン酸、オレイン酸、パルミチン酸、パルミトレイン酸、ステアリン酸、コレステロール、トリグリセリド、モノグリセリド、全トランスレチノール、カンタキサンチン、 β -カロテン、亜鉛、セレン、ネルボン酸、ナトリウム、カリウムおよびカルシウムからなる群の少なくとも1つをさらに含む、請求項67に記載の組成物。

20

【請求項69】

患者における月経前症候群の症状を軽減させるための方法であって、請求項66~68のいずれか一項に記載される組成物の増強効果的な量を前記患者に投与することを含む方法。

【請求項70】

前記投与が経口的に行われる、請求項69に記載の方法。

【請求項71】

前記オキアミ抽出物および/または海洋生物抽出物が1日あたり1グラム~4.8グラムの範囲の量で投与される、請求項69に記載の方法。

30

【請求項72】

前記量が4.8グラムである、請求項71に記載の方法。

【請求項73】

患者における月経前症候群の症状を軽減させるための、請求項66~68のいずれか一項に記載される組成物の使用。

【請求項74】

患者における月経前症候群の症状を軽減させる医薬品を製造するための、請求項66~68のいずれか一項に記載される組成物の使用。

【請求項75】

患者における血中グルコースレベルを制御するための組成物であって、増強効果的な量のオキアミ油および/または海洋生物油を薬学的に受容可能なキャリアとともに含み、前記オキアミ油および/または海洋生物油が、以下の工程:

40

a) オキアミおよび/または海洋生物の材料をケトン溶媒 (好ましくは、アセトン) に入れて、前記海洋動物材料および/または水生動物材料からの可溶性脂質画分を抽出し;

b) これを液体内容物と固体内容物に分離し;

c) 分離した液体内容物に存在する溶媒を蒸発させることによって液体内容物から第1の脂質富含有画分を回収し;

d) 前記固体内容物を、アルコール (好ましくは、エタノール、イソプロパノールまたはt-ブタノール) および酢酸エステル (好ましくは、酢酸エチル) からなる溶媒群から選択される有機溶媒に入れて、前記海洋動物材料および/または水生動物材料からの残留可溶性

50

脂質画分を抽出し；

e)これを液体内容物と固体内容物に分離し；

f) 分離した液体内容物から溶媒を蒸発させることによって第2の脂質富含有画分を回収し；および

g)固体内容物を回収する工程

からなるプロセスから得られる組成物。

【請求項76】

患者における血中グルコースレベルを制御するための組成物であって、増強効果的な量のオキアミ油および／または海洋生物油を薬学的に受容可能なキャリアとともに含み、前記オキアミ油および／または海洋生物油が、エイコサペンタエン酸、ドコサヘキサエン酸、ホスファチジルコリン、ホスファチジルイノシトール、ホスファチジルセリン、ホスファチジルエタノールアミン、スフィンゴミエリン、 α -トコフェロール、アスタキサンチンおよびフラボノイドを含む組成物。

10

【請求項77】

リノール酸、 α -リノール酸、アラキドン酸、オレイン酸、パルミチン酸、パルミトレイン酸、ステアリン酸、コレステロール、トリグリセリド、モノグリセリド、全トランスレチノール、カンタキサンチン、 β -カロテン、亜鉛、セレン、ネルボン酸、ナトリウム、カリウムおよびカルシウムからなる群の少なくとも1つをさらに含む、請求項76に記載の組成物。

【請求項78】

患者における血中グルコースレベルを制御するための方法であって、請求項75～77のいずれか一項に記載される組成物の増強効果的な量を前記患者に投与することを含む方法。

20

【請求項79】

前記投与が経口的に行われる、請求項78に記載の方法。

【請求項80】

前記オキアミ抽出物および／または海洋生物抽出物が1日あたり1グラム～4.8グラムの範囲の量で投与される、請求項78に記載の方法。

【請求項81】

前記量が4.8グラムである、請求項80に記載の方法。

30

【請求項82】

患者における血中グルコースレベルを制御するための、請求項75～77のいずれか一項に記載される組成物の使用。

【請求項83】

患者における血中グルコースレベルを制御する医薬品を製造するための、請求項75～77のいずれか一項に記載される組成物の使用。

【発明の詳細な説明】

【技術分野】

【0001】

本発明は、いくつかの疾患を予防および／または治療することができる、オキアミおよび／または海洋生物に由来する多用途な療治用の抽出物に関する。

40

【背景技術】

【0002】

オキアミは、特に南極水域において密集した群で群がる小さいエビ様甲殻類（しかしながらエビとは異なる）に対する一般名である。オキアミは、重要なタンパク質源として、魚類、ある種の鳥類、そして特にヒゲクジラには最も重要な食物源の1つである。オキアミはまた、その健康上の利点がよく知られている ω -3脂肪酸の良好な供給源でもある。

【0003】

オキアミおよび／または海洋生物の酵素を、感染症、炎症、ガン、HIV/AIDS、痛み、ポリプ、いぼ、痔、プラーク、しわ、薄毛、アレルギー性のかゆみ、接着不全、眼病、座瘡、

50

變胞性線維症、および免疫障害（自己免疫疾患およびガンを含む）などのヒトおよび動物における非常に様々な疾患の治療のための使用が、この分野では知られている。

【0004】

オキアミ油および／または海洋生物油は、自己免疫性マウス狼瘡および他の自己免疫疾患の治療に使用できること、また心臓血管疾患の治療に使用できることが、この分野では知られている。

【0005】

しかし、これらの治療に使用されるオキアミ油および／または海洋生物油は、オキアミおよび／または海洋生物自身が持つ数ある有効成分の中のほんのひとつにしか過ぎない ω -3脂肪酸を有効成分として含有しているだけである。そのため、これらの疾患に対する治療薬としてのオキアミ油および／または海洋生物油の潜在能力は弱められている。

10

【0006】

天然資源を由来とする産生物を使用した治療に対する要望が大きくなっている。それゆえ、疾患の予防および／または治療および／または疾病管理に対してより効果の高いオキアミ抽出物および／または海洋生物抽出物を提供することが非常に望ましい。

【発明の開示】

【発明が解決しようとする課題】

【0007】

本発明により、いくつかの疾患を予防および／または療治および／または治療する方法で、療治効果的な量のオキアミ油および／または海洋生物油を患者に投与することを含む方法が提供される。

20

【課題を解決するための手段】

【0008】

本発明の好ましい実施形態において、オキアミ油および／または海洋生物油は、以下の工程：

a) オキアミおよび／または海洋生物の材料をケトン溶媒（好ましくは、アセトン）に入れて、前記海洋動物材料および／または水生動物材料からの可溶性脂質画分を抽出し；

b) これを液体内容物と固体内容物に分離し；

c) 分離した液体内容物に存在する溶媒を蒸発させることによって液体内容物から第1の脂質富含画分を回収し；

30

d) 前記固体内容物を、アルコール（好ましくは、エタノール、イソプロパノールまたはt-ブタノール）および酢酸エステル（好ましくは、酢酸エチル）からなる溶媒群から選択される有機溶媒に入れて、前記海洋動物材料および／または水生動物材料からの残留可溶性脂質画分を抽出し；

e) これを液体内容物と固体内容物に分離し；

f) 分離した液体内容物から溶媒を蒸発させることによって第2の脂質富含画分を回収し；および

g) 固体内容物を回収する工程

からなるプロセスから得られる。

【0009】

本発明の好ましい実施形態において、オキアミ油および／または海洋生物油は、エイコサペンタエン酸、ドコサヘキサンエン酸、ホスファチジルコリン、ホスファチジルイノシトール、ホスファチジルセリン、ホスファチジルエタノールアミン、スフィンゴミエリン、 α -トコフェロール、全トランスレチノール、アスタキサンチンおよびフラボノイドを含む。

40

【0010】

本発明の別の実施形態において、オキアミ油および／または海洋生物油は、エイコサペンタエン酸、ドコサヘキサンエン酸、リノレイン酸、 α -リノレイン酸、リノール酸、アラキドン酸、オレイン酸、パルミチン酸、パルミトレイン酸、ステアリン酸、ネルボン酸、ホスファチジルコリン、ホスファチジルイノシトール、ホスファチジルセリン、ホスファ

50

チジルエタノールアミン、スフィンゴミエリン、コレステロール、トリグリセリド、モノグリセリド、 α -トコフェロール、全トランスレチノール、アスタキサンチン、カンタキサンチン、 β -カロテン、フラボノイド、亜鉛、セレン、ナトリウム、カリウムおよびカルシウムを含む。

【0011】

本発明のさらに別の実施形態において、オキアミ油および／または海洋生物油は、エイコサペンタエン酸、ドコサヘキサエン酸、リノレイン酸、 α -リノレイン酸、リノール酸、アラキドン酸、オレイン酸、パルミチン酸、パルミトレイン酸、ステアリン酸、ホスファチジルコリン、ホスファチジルイノシトール、ホスファチジルセリン、ホスファチジルエタノールアミン、スフィンゴミエリン、コレステロール、トリグリセリド、モノグリセリド、 α -トコフェロール、全トランスレチノール、アスタキサンチン、カンタキサンチン、 β -カロテン、亜鉛およびセレンを含む。

10

【0012】

本発明の方法によって治療および／または予防され得る疾患には、心臓血管疾患、関節炎、皮膚ガン、糖尿病、月経前症候群および経皮輸送増強がある。

【0013】

本発明により、前記に記載された疾患を治療および／または予防および／または療治するための組成物で、療治効果的な量のオキアミ油および／または海洋生物油を薬学的に受容可能なキャリアとともに含む組成物もまた提供される。

【0014】

本発明により、前記に記載された疾患を治療および／または予防および／または療治するための、オキアミ油および／または海洋生物油の使用がさらに提供される。

20

【0015】

本発明により、前記に記載された疾患を治療および／または予防および／または療治するための医薬品を製造するための、オキアミ油および／または海洋生物油の使用もまた提供される。

【発明を実施するための最良の形態】

【0016】

本発明により、いくつかの疾患を防止および／または治療および／または療治するための、オキアミおよび／または海洋生物の抽出物が提供される。

30

【0017】

酵素を含まない多用途な療治用の抽出油は、例えば、南極海（ナンキョクオキアミ (*euphasia superba*))、太平洋（ツノナシオキアミ (*euphasia pacifica*))、大西洋、インド洋（特に、モーリシャス島および／またはマダガスカルのレユニオン島の沿岸領域）、カナダ西海岸、日本沿岸、セントローレンス湾およびファンディ湾など、世界中のどこにでも海洋環境にも生息するオキアミおよび／または海洋生物に由来する。この抽出油は遊離脂肪酸脂質画分である。

【0018】

抽出プロセスは下記のように記載することができる：

- (a) 海洋性および／または水生のオキアミおよび／または海洋生物をケトン溶媒（好ましくは、アセトン）に入れて、オキアミおよび／または海洋生物からの油脂を抽出する；
- (b) 液相および固相を分離すること；
- (c) 液相に存在する溶媒を蒸発させることによって、工程(b)で得られた液相から脂質富含画分を回収する；
- (d) 固相を有機溶媒に入れる。その際、有機溶媒としてはアルコール（好ましくは、エタノール、イソプロパノールまたはt-ブタノール）または酢酸エステル（好ましくは、酢酸エチル）が使用できる。なお、これは、残留する可溶性脂質画分を固相から抽出するために行われる。；
- (e) 液相および固相を分離すること；および
- (f) 液相に存在する溶媒を蒸発させることによって、工程(e)で得られた液相から脂質富含

40

50

有画分を回収すること。

【0019】

酵素を含まないオキアミおよび／または海洋生物の抽出油の有効成分は下記の通りである：

〔脂質〕

i) ω -3：

i. エイコサペンタエン酸：>8g/100g

ii. ドコサヘキサンエン酸：>2g/100g

iii. リノレイン酸：>0.10g/100g

iv. α -リノレイン酸：>0.3g/100g

10

本発明において ω -3は30g/100gよりも多いことが好ましい実施形態である。

ii) ω -6：

i. リノール酸：>0.9g/100g

ii. アラキドン酸：<0.45g/100g、好ましくは<0.6g/100g

iii) ω -9：

i. オレイン酸：>5g/100g

iv) パルミチン酸：>10g/100g

v) パルミトレイン酸：0.08g/100g

vi) ステアリン酸：>0.5g/100g

20

〔リン脂質〕

ホスファチジルコリン：>4.5g/100g

ホスファチジルイノシトール：>107mg/100g

ホスファチジルセリン：>75mg/100g

ホスファチジルエタノールアミン：>0.5g/100g

スフィンゴミエリン：>107mg/100g

〔中性脂質〕

コレステロール：<3g/100g

トリグリセリド：<55g/100g

モノグリセリド：>0.5g/100g

本発明の別の実施形態において、オキアミ抽出物および／または海洋生物抽出物の中性脂

30

質は以下を含む：

ジグリセリド：>0.5g/100g

〔抗酸化物質〕

α -トコフェロール（ビタミンE）：>1.0IU/100g

全トランスレチノール（ビタミンA）：>1500IU/100g

β -カロテン：>3000 μ g/100ml

〔色素〕

アスタキサンチン：>20mg/100g

カンタキサンチン：>2mg/100g

〔金属〕

40

亜鉛：>0.1mg/100g

セレン：>0.1mg/100g

本発明の別の実施形態において、オキアミ抽出物および／または海洋生物の抽出物にはまた、下記が含まれる：

フラボノイド：>0.5mg/100g

ナトリウム：<500mg/100g

カルシウム：>0.1mg/100g

カリウム：>50mg/100g

アルミニウム：<8.5mg/100g

タンパク質：>4g/100g

50

水分および揮発性成分：＜0.8%。

【0020】

オキアミ油抽出物および／または海洋生物抽出油の特性、抽出物が、抽出プロセスに由来する溶媒残渣を25ppm未満で含有するものした。

該抽出油は下記の安定度指数を有している：

過酸化物価：＜0.1(mEq/kg)

油安定度指数：＜0.1(97.8℃で50時間後の数値)

けん化指数：70～180

ヨウ素価：60～130%

本発明をよりわかりやすく説明するために、以下に本発明の実施例を示して本発明に詳細な説明するが、これは本発明の範囲を限定するものではない。 10

【実施例1】

【0021】

心臓血管疾患の防止および／または治療

オキアミ抽出油および／または海洋生物抽出油は、コレステロールを生体内で低下させることが示されている。この抽出油はまた、血小板の接着およびプラークの形成を阻害し、患者における血管内皮炎症を軽減させる。この抽出油は高血圧を予防できる。この抽出油は低密度リポタンパク質の酸化を妨げる。この抽出油は、アポB-100の増大した細胞内分解によってVLDLの分泌に対する阻害作用を有し得る。この抽出油はまた、CIIIアポリポタンパク質BおよびCIII非アポリポタンパク質Bリポタンパク質を減少させ、かつアンチトロピンIIIレベルを増大させる作用を示すことから、心筋梗塞後症候群を予防できる。オキアミ抽出油および／または海洋生物抽出油は、冠状動脈疾患、高脂血症、高血圧、虚血性疾患（すなわち狭心症、心筋梗塞、脳虚血、虚血の医学的や分析学的な証拠を伴わない発作、不整脈）に関連するヒトでの心臓血管疾患に対する予防的使用に好適である。 20

【0022】

動脈硬化性冠状動脈疾患および高脂血症の経過に対するオキアミ油および／または海洋生物油の効果を評価するために、高脂血症が知られている患者で試験を行った（前向き臨床試験、統計学的有意性 $p < 0.05$ ）。

【0023】

13名の患者グループにオキアミ油および／または海洋生物油の高濃度カプセル剤を投与した。魚油と、オキアミ油および／または海洋生物油とはともに、等しい量の ω -3脂肪酸を含有していた。推奨される投薬量は、800mgの油をそれぞれが含有するカプセルで1日あたり1錠～6錠である。この試験では、それぞれの患者に1日あたり6錠のカプセルを投与した。 30

【0024】

該患者より、投薬前および2ヶ月の投薬後に、LDL、HDL、トリグリセリド、バイタルサイン（血圧や心拍数）、CBC、SGOT/SGPT、 γ -GT、ALP、尿素、クレアチン、グルコース、 K^+ 、 Na^+ 、 Ca^{2+} および総間接的ビリルビンコレステロールのデータを採取した。

【0025】

表1には、前記の試験結果が示されている： 40

【0026】

【表1】

ペアードサンプル検定

測定項目	平均値	S.D.	標準誤差 平均	差の95%信頼性区間		t 値	d f	自由度
				下 限	上 限			
				コレステロール	.4854			
トリグリセリド	.3538	.54543	.15127	.0242	.6834	2.339	12	.037
HDL	-.2108	-.28859	.08281	-.3912	-.0303	-2.545	12	.026
LDL	.2846	.47333	.13128	-.0014	.5708	2.168	12	.051
Chol/HDL	.3000	.53446	.14523	.0370	.5000	2.420	12	.032

以上より、1g~4.8gのオキアミ抽出物を毎日の摂取することにより、被験患者に対して15%の範囲でコレステロールが低下し、15%の範囲でトリグリセリドが低下し、8%の範囲でHDLが増大し、13%の範囲でLDLが低下し、またコレステロール/HDL比が14%低下するという効果が認められた。

【0027】

このことは、オキアミ抽出物の摂取が、アテローム性動脈硬化の主要な原因因子であるこ

10

20

30

40

50

とが知られている高脂血症に苦しんでいる患者に対して優れた効果を有することを示している。

【実施例2】

【0028】

関節炎の治療

オキアミ油および／または海洋生物油は、ヒト患者におけるインターロイキン-8およびインターロイキン-1の産生を低下させることで、痛みを発する関節の数および日々使用する鎮痛剤量を少なくするという臨床的な改善効果をもたらすことより、成人の関節炎、ステイル病、多関節性または少数関節性の若年性関節リウマチ、慢性関節リウマチ、変形性関節症に伴う関節炎の症状を緩和する。なお、出血傾向のある患者または重度の精神病患者はこの調査では除外した。

10

【0029】

クラスI、IIまたはIIIの進行である変形性関節症と診断され治療を受けており、試験前少なくとも3ヶ月間は非ステロイド性抗炎症剤（NSAIDs）および／または鎮痛剤の投与を受けている患者に関して、変形性関節症の臨床的経過に対するオキアミ油および／または海洋生物油の投与効果を評価するために、試験を行った（前向き臨床試験、統計学的有意性 $p < 0.05$ ）。

【0030】

13名の患者グループに、オキアミ油および／または海洋生物油の高濃度カプセルを、オキアミ油がカプセルあたり800mgであるカプセルの1日あたり6錠の割合で投与した。推奨される投薬量は、純度の高いオキアミ抽出物で1日あたり1グラム～4.8グラムの範囲内である。被験者には20%の脂肪（動物脂肪は10%未満）、40%のタンパク質、および40%の炭水化物からなる通常健康食療法に従うことを依頼した。

20

【0031】

本試験において被験者の要件は、年齢が50歳～65歳の間であること（性別は男女どちらでもよい）、試験6ヶ月前～12ヶ月前に痛みとこりがある変形性関節症の臨床的診断（軽度～中程度）を受けた患者で、試験に先立ちX線撮影で病変が確認されていることである。あわせて、少なくとも試験前の3ヶ月間にわたって、アセトアミノフェン、抗炎症剤、もしくはオピオイド鎮痛剤の使用を必要とする変形性関節症(OA)のある程度の症状が認められていることも上記要件に含まれる。患者には、ウォッシュアウト目的のために試験開始前の1週間はあらゆる鎮痛薬の使用を止めるように依頼した。

30

【0032】

被験者より除外する基準は、重度の変形性関節症である場合、NSAIDs、アスピリン、もしくは他の抗炎症剤を継続的に使用し止めることが出来ない場合、無作為訪問で4週間以内に局所的鎮痛剤の使用したと認められる場合、過去3ヶ月以内に膝へのステロイド注射を行っている場合、3ヶ月以内に理学療法または筋肉調整を開始した場合、海産食物アレルギー、抗凝血剤またはサリチラートを使用している場合、1日あたりカクテル3杯を超えるアルコールを摂取している場合、痛みの評価に影響をきたすような医学的疾患や関節炎疾患を併発している場合、どちらかの膝が手術前（関節鏡検査を含む）である場合、公知の「二次性」変形性関節症の要因が認められる場合である。

40

【0033】

評価は、NSAIDsおよび／または鎮痛剤および／またはSAARDsの1日量、痛みを有する関節の数、腫れた関節の数、朝のこわばりの持続時間、目視によるアナログスケール（0～100）でのWOMACスケール、ならびにSF36に基づいた。予備的な結果が2ヶ月後に得られた。日常活動のために要求されるNSAIDおよび／または鎮痛剤および／またはSAARDの数が開始時および開始後2ヶ月で記録されている。

【0034】

表2に示した結果より、関節炎の緩和に対するオキアミ抽出物の摂取の効果が明らかになった。

【0035】

50

【表 2】

	頻 度	%	有効%	累積%
変化なし	3	23.1	23.1	23.1
痛みの緩和	10	76.9	76.9	100.0
合 計	13	100.0	100.0	

10

これは、13名の内の10名（76.9%）が痛みの著しい緩和および大きい関節（下部背骨、膝、肩）の柔軟性の著しい改善を報告したことを示している。

【実施例 3】

【0036】

皮膚ガンの予防

オキアミ油および／または海洋生物油は、そのレチノールの抗ガン性作用、アスタキサンチンの抗ガン性作用、およびそのリン脂質の抗ガン性作用のために皮膚ガンの予防剤であることが示されている。

【0037】

UVBにより誘導される皮膚ガンに対するオキアミ油および／または海洋生物油の潜在的な光保護能力を評価するために、研究を、皮膚ガンに対するその感受性が証明されているので、ヌードマウス、好ましくは、C57BL6ヌード類遺伝子系マウスであるB6NU-T（ヘテロ接合体）に対して行った。

20

【0038】

被験マウスを下記のグループとした：魚油を投与するグループ（全48匹）、うち経口補給（po）による投与（16匹）、局所適用による投与（16匹）、poおよび局所適用による投与（16匹）；オキアミ油および／または海洋生物油を投与するグループ（全48匹）、；poによる投与（16匹）、局所適用による投与（16匹）、poおよび局所適用による投与（16匹）。皮膚ガンの防止に対するオキアミ油および／または海洋生物油の効力を明らかにするために、無作為化盲検対照方式で試験を行った（統計学的有意性 $p < 0.05$ ）。半数のマウスは100重量%のオキアミ油および／または海洋生物油を含有する油を経口的にまたは局所的にまたはそれらの両方の方法で投与し、残る半数についても魚油で同様に投与を行った。

30

【0039】

栄養摂取は、最初の1週間については無脂肪餌であり、その後の2週間～20週間については、1日あたり1mlの油の量で下記に記載するグループに従って変更された。

【0040】

マウスは下記のように6群に分けられた：

グループA：魚油の補給（総カロリーの20%）を伴う無脂肪餌

グループB：無脂肪餌（100%のカロリー）+1日に2回の魚油の局所適用

グループC：魚油の補給（総カロリーの20%）を伴う無脂肪餌+1日に2回のダイズ油の局所適用

グループD：オキアミ油および／または海洋生物油の補給（総カロリーの20%）を伴う無脂肪餌

グループE：無脂肪餌（100%のカロリー）+1日に2回のオキアミ油および／または海洋生物油の局所適用

グループF：オキアミ油および／または海洋生物油の補給（総カロリーの20%）を伴う無脂肪餌+1日に2回のオキアミ油および／または海洋生物油の局所適用。

40

【0041】

50

マウスは、第2週～第20週の期間中、蛍光試験ランプ（放射スペクトル：270～400nm）を使用してUVB線に暴露した。該試験ランプをマウスから30cmの距離に配置し、1日あたり30分間UVBに暴露して試験を行った。試験開始20週間終了後、または悪性の腫瘍が生じた時点で、被験マウスをエーテルで麻酔し屠殺した。皮膚のガン発生の徴候を病理学者によって盲検的に調べられた。

【0042】

下記の表（表3～表8）には、マウスの皮膚に紫外線照射試験を5週間の行った時のガンの発生について得られた結果が示されている。

【0043】

【表3】

10

オキアミ抽出物の経口摂取

		頻度	割合 (%)	有効%	累積%
有効	良性	14	87.5	87.5	87.5
	ガン	2	12.5	12.5	100.0
	合計	16	100.0	100.0	

20

【0044】

【表4】

コントロールの経口摂取

		頻度	割合 (%)	有効%	累積%
有効	良性	14	87.5	87.5	87.5
	ガン	2	12.5	12.5	100.0
	合計	16	100.0	100.0	

30

【0045】

【表5】

オキアミ抽出物の局所的摂取

		頻度	割合 (%)	有効%	累積%
有効	良性	16	100.0	100.0	100.0

40

【0046】

【表6】

コントロールの局所的摂取

		頻 度	割合 (%)	有効%	累積%
有 効	良 性	5	31.3	31.3	31.3
	ガ ン	11	85.8	85.8	100.0
	合 計	16	100.0	100.0	

10

【0047】

【表7】

オキアミ抽出物の経口摂取および局所的摂取

		頻 度	割合 (%)	有効%	累積%
有 効	良 性	16	100.0	100.0	100.0

20

【0048】

【表8】

コントロールの経口摂取および局所的摂取

		頻 度	割合 (%)	有効%	累積%
有 効	良 性	10	62.5	62.5	62.5
	ガ ン	5	37.5	37.5	100.0
	合 計	16	100.0	100.0	

30

これらの結果より、オキアミ油の経口使用および局所的使用はともに、皮膚ガンを誘導するUVBの有害な作用から皮膚を保護する効果的があることが示された。

【実施例4】

【0049】

40

塗布療治薬における経皮輸送

オキアミ油および／または海洋生物油は、皮膚科学的な局所的に用いる塗布療治薬に対する基質として経皮輸送を増強する。オキアミ油および／または海洋生物油は、クリーム、軟膏、ゲル、ローションおよびオイルによって皮膚科学的処置において使用することができる。オキアミ油および／または海洋生物油はまた、麻酔剤、コルチコステロイド、抗炎症剤、抗生物質およびケトン分解機能に関連することなどの様々な治療適用において使用することができる。

【0050】

オキアミ油および／または海洋生物油を局所的治療のための基質として用いた場合の効力、またオキアミ油および／または海洋生物油を単独であるいは基質として用いた場合の経

50

皮吸収速度を評価するために、C57BL6スード類遺伝子系マウスであるB6NU-T（ヘテロ接合体）に対する無作為化盲検対照方式で試験を行った。

【0051】

表5および表6に表される結果は、オキアミ油による局所的治療により、真皮を介したレチノールおよび他の抗酸化物質の吸収が促進され、これにより強力な光保護能力がもたらされ、その結果、UVBによって誘導される皮膚ガンからの100%保護されたのである。対照的に、魚油を全トランスレチノールとともに塗布した場合は、ガン発生率が68.8%であった。

【実施例5】

【0052】

皮膚に局所的に塗布する化粧品の経皮輸送をオキアミ油および／または海洋生物油は、クリーム、軟膏、ゲル、ローションまたはオイルによる皮膚の水和、しわ防止、角質溶解剤、剥皮および美顔用パックに関連する皮膚科学的な局所的化粧適用のための基質としての経皮送達を増強するために使用することができる。

【0053】

老化によるしわ、および顔面のしわにおけるオキアミ油および／または海洋生物油の効果を評価するために、顔の乾燥肌およびしわに悩む被験者に対する前向き臨床試験により研究を行った。これら被験者は、他の皮膚科学的もしくは非皮膚科学的な病気によって重度に限定された予後診断を受けた者ではなく、また出血傾向のある患者および重度の精神病患者はこの調査では除外した。顔の乾燥肌またはしわを有する13名の健康な白人女性がこの研究には含まれている。被験女性は、800mgのオキアミ油を含有するカプセルを、1日あたり6カプセル摂取することが依頼されている。推奨される1日投薬量は約1g～4.8gのオキアミ抽出物である。

【0054】

表9には、前記に記載された方法に従って皮膚の水和について得られた結果が示されている。

【0055】

【表9】

皮膚の保湿効果の変化

	頻度	%	有効%	累積%
変化なし	4	30.8	30.8	30.8
保湿効果あり	9	69.2	69.2	100.0
合計	13	100.0	100.0	

2ヶ月にわたる試験的研究の結果では、13名の内の9名（69.2%）がヒト被験者における皮膚（顔、手および腕）の保湿効果の上昇、肌のきめと弾力性の著しい改善が見られた。

【0056】

さらに、これらの結果はまた、オキアミ抽出物がしわを取る方法として有用であることを示している。オキアミ油に含まれる全トランスレチノールのしわ取り剤としての仕組みは次のとおりである：

- ・再生作用および特有な抗炎症作用
- ・血液循環の改善
- ・細胞分裂および代謝回転の速度を増大させて表皮再生を活性化させること

- ・ケラチンの分化を促進させること
- ・コラーゲンを再生すること
- ・新陳代謝される皮膚の最表層の細胞について、処置を行わなかった日光による損傷細胞より正常に成熟できること
- ・皮膚を構造的に支持するタンパク質コラーゲンおよびエラスチンを分解する酵素の活性化を低減させること。

【0057】

患者の皮膚に施されたオキアミ抽出物を用いて得られた結果は、オキアミ抽出物が、水和を増大させること、および上記に記載される仕組みによるしわ取り効果を有していることを示している。

10

【実施例6】

【0058】

月経前症候群

表10には、女性における月経前症候群に関連する痛みおよび気分変化を軽減させるためのオキアミ油の使用から得られた結果が示される。オキアミ油の抽出物が、2ヶ月間にわたり7名の女性に投与した。被験女性には、800mgのオキアミ油を含有するカプセルを、1日あたり6カプセルを投与した。推奨される1日投薬量は約1g～4.8gのオキアミ抽出物である。被験者はすべて、自身の普段の食習慣を続けること、また食事について何らかの制限を開始しないように指示された。重大な副作用は何ら報告されなかった。

【0059】

被験者の女性はすべて、顕著な情緒的および／または身体的な不快を月経の7日前～10日前に訴えている人である。月経前症候群の評価は、既に確立している0（症状なし）～10（耐えられない）で表される自己評価の視覚的アナログ尺度を用いて行い、これによって月経前の不快症状に対するオキアミ抽出物の効果を評価する予備的なデータとして使用した。

20

【0060】

2ヶ月間の投薬治療をおこなった本研究の被験女性の60%にあたるデータ分析を行った。大多数の女性（73.3%）は、月経前の情緒的苦悩および身体的苦悩の両方について、臨床的に著しい軽減が認められた（表10参照）。

【0061】

【表10】

30

月経前症候群の症候学に対するオキアミ抽出物の効果の頻度分布

PMS症状	頻度	有効%	累積%
変化なし	26.7	26.7	26.7
前向き	73.3	73.3	100.0
合計	100.0	100.0	

40

【実施例7】

【0062】

糖尿病

ヒト患者8名に対し、800mgのオキアミ油を含有するカプセルを、1日あたり6カプセル、2ヶ月間に渡り投与した。推奨される1日投薬量は約1g～4.8gのオキアミ抽出物である。表11には、2ヶ月後の患者について試験されたグルコースの変化が示されている。

【0063】

50

【表 1 1】

患者におけるグルコースの変化

ベアード差							
試験パラメーター	平均値	S.D.	標準誤差 平均	差の95%信頼性区間	t 値	d f	自由度
グルコース	.5778	.60369	.20123	.1137-1.0418	2.871	8	.021

10

血中グルコースの20%の低下が、オキアミ抽出物を摂取した患者について認められた。このことは、オキアミ抽出物の摂取が血中グルコース含有量を抑制し、従って、ヒト患者において糖尿病を抑制することを示している。

【0064】

本発明をその具体的な実施形態に結び付けて記載したが、さらなる改変が可能であり、付記される請求項の範囲に従うような、そして本明細書に記載した本質的特徴に当てはめることが可能であるような、そして本発明に関連する技術分野における公知のあるいは慣例的な方法の範囲内にあるような、本発明が開示する内容からの逸脱を含み、また本発明の原理に一般的に従うような本発明のあらゆる適応、利用もしくは改変を含むものとして、

20

【国際公開パンフレット】

(12) INTERNATIONAL APPLICATION PUBLISHED UNDER THE PATENT COOPERATION TREATY (PCT)

(19) World Intellectual Property Organization
International Bureau



(43) International Publication Date
27 December 2002 (27.12.2002)

PCT

(10) International Publication Number
WO 02/102394 A2

- (51) International Patent Classification: A61K 35/60 (31/23)
- (21) International Application Number: PCT/CA02/028643
- (22) International Filing Date: 7 June 2002 (07.06.2002)
- (25) Filing Language: English
- (26) Publication Language: English
- (30) Priority Data: 60298363 18 June 2001 (18.06.2001) US
- (71) Applicant (for all designated States except US): NEPTUNE TECHNOLOGIES & BIORESOURCES INC. [CA/CA]; 500, boulevard St-Martin Ouest, Bureau 500, Laval, Québec H7M 3Y2 (CA).
- (72) Inventor; and
- (75) Inventor/Applicant (for US only): SAMPALIS, Tina [CA/CA]; 1348 Elisabeth Blvd, Laval, Québec H7W 3J8 (CA).
- (74) Agents: OGLIVY RENAULT et al.; Suite 1600, 1981 McGill College Avenue, Montreal, Québec H3A 2Y3 (CA).

(81) Designated States (optional): AU, AG, AL, AM, AT, AU, AZ, BA, BB, BG, BR, BY, BZ, CA, CH, CN, CO, CR, CU, CZ, DE, DK, DM, DZ, EC, EE, ES, FI, GB, GD, GE, GR, GM, HN, HU, ID, IL, IN, IS, JP, KE, KG, KP, KR, KZ, LC, LK, LR, LS, LU, LV, MA, MD, MG, MK, MN, MW, MX, MY, NZ, NI, NO, OM, PH, PL, PT, RO, RU, SD, SE, SG, SI, SK, SL, TH, TM, TN, TR, TT, TZ, UA, UG, US, UZ, VN, YU, ZA, ZM, ZW.

(84) Designated States (regional): ARIPO patent (GH, GM, KE, LS, MW, MZ, SD, SI, SZ, TZ, UG, ZM, ZW), Eurasian patent (AM, AZ, BY, KG, KZ, MD, RU, TJ, TM), European patent (AT, BE, CH, CY, DE, DK, ES, FR, GB, GR, HU, IT, LI, MC, NL, PT, SE, TR), OAPI patent (BF, BJ, CI, CG, CI, CM, GA, GN, GQ, GW, ML, MR, NE, SN, TD, TG).

Published: without international search report and to be republished upon receipt of final report

For two-letter codes and other abbreviations, refer to the "Guidance Notes on Codes and Abbreviations" appearing at the beginning of each regular issue of the PCT Gazette.



WO 02/102394 A2

(54) Title: KRILL AND/OR MARINE EXTRACTS FOR PREVENTION AND/OR TREATMENT OF CARDIOVASCULAR DISEASES, ARTHRITIS, SKIN CANCER, DIABETIS, PREMENSTRUAL SYNDROME AND TRANSDERMAL TRANSPORT

(57) Abstract: The present invention relates to a method of treatment and/or prevention of cardiovascular disease, rheumatoid arthritis, skin cancer, premenstrual syndrome, diabetes and transdermal transport enhancement. The method comprises the administration of a therapeutically effective amount of krill and/or marine oil to a patient. The present invention also relates to a composition for the treatment and/or prevention of these diseases.

Krill and/or marine extracts for prevention and/or treatment of cardiovascular diseases, arthritis, skin cancer, diabetes, premenstrual syndrome and transdermal transport.

BACKGROUND OF THE INVENTION

Field of the Invention

This invention relates to multi-therapeutic extracts derived from krill and/or marine, which can prevent and/or treat several diseases.

Description of Prior Art

Krill is the common name for small, shrimp-like crustaceans, however not shrimp, that swarm in dense shoals, especially in Antarctic waters. It is one of the most important food source for fish, some kind of birds and especially for baleen whales as being an important source of protein. Krill is also a good source of omega-3 fatty acid, which are well known for their health benefits.

It is known in the art to use krill and/or marine enzymes for the treatment of a great variety of diseases in human and animals such as infections, inflammations, cancers, HIV/AIDS, pain, polyps, warts, hemorrhoids, plaque, wrinkles, thin hairs, allergic itch, anti-adhesion, eye disease, acne, cystic fibrosis and immune disorders including autoimmune disease and cancer.

It is also known in the art that krill and/or marine oil may be used for the treatment of autoimmune murine lupus and other autoimmune diseases and can also be used for treating cardiovascular diseases.

However, the krill and/or marine oil used for these treatments has only conserved its omega-3 fatty acids as active ingredients, which is a very small part of all the active ingredients of the krill and/or marine itself. This fact reduces the potential of the krill and/or marine oil as a treatment for these diseases.

There is an increasing demand for treatments using products derived from a natural source, therefore, it would be highly desirable to be provided with a krill and/or marine extract having an enhanced potential for prevention and/or treatment and/or management of disease.

SUBSTITUTE SHEET (RULE 26)

SUMMARY OF THE INVENTION

In accordance with the present invention there is provided a method of prevention, therapy and/or treatment of several disease, the method comprising the administration of a therapeutically effective amount of krill and/or marine oil to a patient.

In a preferred embodiment of the present invention the krill and/or marine oil is obtained from a process comprising the steps of:

(a) placing krill and/or marine material in a ketone solvent, preferably acetone to achieve extraction of the soluble lipid fraction from the marine and/or aquatic animal material;

(b) separating the liquid and solid contents;

(c) recovering a first lipid rich fraction from the liquid contents by evaporation of the solvent present in the liquid contents;

(d) placing the solid contents in an organic solvent selected from the group of solvents consisting of alcohol, preferably ethanol, isopropanol or t-butanol and esters of acetic acid, preferably ethyl acetate to achieve extraction of the remaining soluble lipid fraction from the marine and/or aquatic material;

(e) separating the liquid and solid contents;

(f) recovering a second lipid rich fraction by evaporation of the solvent from the liquid contents; and

(g) recovering the solid contents.

In a preferred embodiment of the present invention, the krill and/or marine oil comprises Eicosapentanoic acid, Docosahexanoic acid, Phosphatidylcholine, Phosphatidylinositol, Phosphatidylserine, Phosphatidylethanolamine, Sphingomyelin, α -tocopherol, all-trans retinol, Astaxanthin and flavonoid.

In another embodiment of the present invention, the krill and/or marine oil comprises Eicosapentanoic acid, Docosahexanoic acid, Linolenic acid, Alpha-linolenic acid, Linoleic acid, Arachidonic acid, Oleic

SUBSTITUTE SHEET (RULE 26)

acid, palmitic acid, palmitoleic acid, stearic acid, nervonic acid, Phosphatidylcholine, Phosphatidylinositol, Phosphatidylserine, Phosphatidylethanolamine, Sphingomyelin, Cholesterol, Triglycerides, Monoglycerides, α -tocopherol, all-trans retinol, Astaxanthin, Canthaxanthin, β -carotene, flavonoid, Zinc, Selenium, sodium, potassium and calcium.

In another embodiment of the present invention, the krill and/or marine oil comprises Eicosapentanoic acid, Docosahexanoic acid, Linolenic acid, Alpha-linolenic acid, Linoleic acid, Arachidonic acid, Oleic acid, palmitic acid, palmitoleic acid, stearic acid, Phosphatidylcholine, Phosphatidylinositol, Phosphatidylserine, Phosphatidylethanolamine, Sphingomyelin, Cholesterol, Triglycerides, Monoglycerides, α -tocopherol, all-trans retinol, Astaxanthin, Canthaxanthin, β -carotene, Zinc and Selenium.

The diseases that can be treated and/or prevented by the method of the present invention are cardiovascular diseases, arthritis, skin cancer, diabetes, premenstrual syndrome and transdermal transport enhancement.

In accordance with the present invention there is also provided a composition for the treatment and/or prevention and/or therapy of the previously mentioned diseases, the composition comprising a therapeutically effective amount of krill and/or marine oil in association with a pharmaceutically acceptable carrier.

In accordance with the present invention, it is further provided the use of krill and/or marine oil for the treatment and/or prevention and/or therapy of the previously mentioned diseases.

In accordance with the present invention, it is also provided the use of krill and/or marine oil for the manufacture of a medicament for the treatment and/or prevention and/or therapy of the previously mentioned diseases.

DETAILED DESCRIPTION OF THE INVENTION

In accordance with the present invention, there is provided krill and/or marine extract for prevention and/or treatment and/or therapy of several diseases.

A multi-therapeutic oil extract free of enzyme is derived from krill and/or marine, found in any marine environment around the world, for example, the Antarctic ocean (*euphasia superba*), the Pacific ocean (*euphasia pacifica*), the Atlantic ocean, the Indian ocean, in particular coastal regions of Mauritius Island and/or Reunion Island of Madagascar, Canadian West Coast, Japanese Coast, St-Lawrence Gulf and Fundy Bay, and this oil extract is a free fatty acid lipid fraction.

The extraction process can be described as the following:

- (a) Placing marine and/or aquatic krill and/or marine in a ketone solvent, preferably acetone, to achieve the extraction of grease from the krill and/or marine;
- (b) Separating the liquid and the solid phases;
- (c) Recovering a lipid rich fraction from the liquid phase obtained at step (b) by evaporation of the solvent present in the liquid phase;
- (d) Placing the solid phase in an organic solvent, which can be alcohol, preferably ethanol, isopropanol or t-butanol, or esters of acetic acid, preferably ethyl acetate. This in order to extract the remaining soluble lipid fraction from the solid phase;
- (e) Separating the liquid and the solid phases; and
- (f) Recovering a lipid rich fraction from the liquid phase obtained at step (e) by evaporation of the solvent present in the liquid phase.

The active components of the enzyme-free krill and/or marine oil extract are:

lipids

i) Omega-3:

i. Eicosapentaenoic acid: >8g/100g

ii. Docosahexaenoic acid: >2g/100g

iii. Linolenic acid: >0.10g/100g

iv. Alpha-linolenic acid: >0.3g/100g

In the preferred embodiment of the present invention, the Omega-3 are found in more than 30g/100g.

ii) Omega-6: i. Linoleic acid: >0.9g/100g

ii. Arachidonic acid: <0.45g/100g, preferably < 0.6g/100g

iii) Omega-9: i. Oleic acid: >5g/100g

iv) palmitic acid: >10g/100g

v) palmitoleic acid: 0.08g/100g

vi) stearic acid: > 0.5g/100g

Phospholipids

Phosphatidylcholine: >4.5g/100g

Phosphatidylinositol: >107mg/100g

Phosphatidylserine: >75 mg/100g

Phosphatidylethanolamine: >0.5g/100g

Sphingomyelin: >107mg/100g

Neutral lipids

Cholesterol: <3g/100g

Triglycerides: <55g/100g

Monoglycerides: >0.5g/100g

In another embodiment of the present invention, the neutral lipids of the krill and/or marine extract also comprises:

Diglycerides: >0.5g/100g

Antioxidants

α -tocopherol (vitamin E): >1.0 IU/100g

all-trans retinol (vitamin A): >1500 IU/100g

β -carotene: > 3000 μ g/100 ml

SUBSTITUTE SHEET (RULE 26)

WO 02/102394

6

PCT/CA02/00443

Pigments

Astaxanthin: >20 mg/100g

Canthaxanthin: > 2 mg/100g

Metals

Zinc: >0.1 mg/100g

Selenium: >0.1 mg/100g

In another embodiment of the present invention, the krill and/or marine extract also comprises:

Flavonoids: >0.5mg/100g

Sodium: < 500mg/100g

Calcium: >0.1mg/100g

Potassium: > 50mg/100g

Aluminum: < 8.5mg/100g

Protein: > 4g/100g

Moisture and volatile matter: <0.8%

After characterization of the krill and/or marine oil extract, it was determined that the extract contains less than 25 ppm of solvent residue from the extraction process.

The oil has the following stability indexes:

Peroxide value: < 0.1(mEq/kg)

Oil Stability index: < 0.1 after 50 hours at 97.8°C

Saponification index: 70-180

Iodine value:60-130%

The present invention will be more readily understood by referring to the following examples which are given to illustrate the invention rather than to limit its scope.

SUBSTITUTE SHEET (RULE 26)

Example 1**Cardiovascular disease prevention and/or treatment**

Krill and/or marine oil has been shown to decrease cholesterol *in vivo*. It also inhibits platelet adhesion and plaque formation and reduces vascular endothelial inflammation in a patient. It can offer hypertension prophylaxis. It prevents oxidation of low-density lipoprotein. It may have an inhibitory effect on the secretion of VLDL due to increased intracellular degradation of apo B-100. It also offers a post-myocardial infarction prophylaxis because of its ability to decrease CIII apolipoprotein B, to decrease CIII non-apolipoprotein B lipoproteins and to increase antithrombin III levels. Krill and/or marine oil is suitable for prophylactic usage against cardiovascular disease in human where cardiovascular disease relates to coronary artery disease, hyperlipidemia, hypertension, ischemic disease (relating to angina, myocardial infarction, cerebral ischemia, shock without clinical or laboratory evidence of ischemia, arrhythmia)

To evaluate the effects of krill and/or marine oil on the course of arteriosclerotic coronary artery disease and hyperlipidemia, a study was performed (prospective clinical trial, statistical significance $p < 0.05$) with patients with known hyperlipidemia.

A group of 13 patients took krill and/or marine oil concentrate gelules. Both fish oil and krill and/or marine oil contained equal amounts of omega-3 fatty acids. Recommended dosage is of 1 to 6 capsules per day, each capsule containing 800 mg of oil. In this study, each patient took 6 capsules per day.

The patients were tested for LDL, HDL, Triglycerides, vital signs, CBC, SGOT/SGPT, γ -GT, ALP, Urea, Creatine, Glucose, K^+ , Na^+ , Ca^{2+} and total indirect bilirubin cholesterol before treatment and also at 2 months.

Table 1 is showing the results obtained from the previously described tests:

SUBSTITUTE SHEET (RULE 26)

Table 1
Paired Samples Test

Parameter tested	Mean	SD.	Std. Error Mean	95% Confidence Interval of the Difference		t-value	df	Sig. (2-tailed)
				Lower	Upper			
				Cholesterol	4954			
Triglycerides	3538	.54543	.15127	.0242	.6834	2.339	12	.037
HDL	2108	.29859	.08281	-.3912	-.0303	-2.545	12	.029
LDL	2846	.47333	.13128	-.0014	.5706	2.168	12	.051
Chol / HDL	3600	.53446	.14823	.0370	.6830	2.428	12	.032

From the above, it was shown that a daily uptake of 1 to 4.8 g of krill extract was providing to the patients a cholesterol decrease in the range of 15%, a triglycerides decrease in the range of 15%, a HDL increase in the range of 8%, a LDL decrease in the range of 13% and a Cholesterol/HDL ratio decrease of 14%.

This shows that an uptake of krill extract has a beneficial effect on patient suffering from hyperlipidemia, which is known to be the primary causative factor of atherosclerosis.

Example 2
Arthritis treatment

Krill and/or marine oil offers symptomatic relief for Arthritis where arthritis relates to adult arthritis, Still's disease, polyarticular or pauciarthritic juvenile rheumatoid arthritis, rheumatoid arthritis, osteoarthritis because it has been shown that it provides a clinical improvement in decreasing the number of tender joints and of analgesics consumed daily by decreasing the production of Interleukin-8 and Interleukin-1 in human patients. Patients with a bleeding tendency or severe psychiatric disease were excluded from the study.

To evaluate the effects of krill and/or marine oil supplementation on the clinical course of osteoarthritis, a study was performed (prospective clinical trial, statistical significance $p < 0.05$) with patients diagnosed with and treated for osteoarthritis which is Active class I, II or III and having

treatment with NSAIDs and/or analgesics for at least 3 months before enrollment.

A group of 13 patients took krill and/or marine oil concentrate capsules at a daily rate of 6 capsules of 800mg krill oil per capsule. The recommended dosage varies between 1 and 4.8 grams of pure krill extract per day. Patients were asked to follow a normal healthy diet consisting of 20% fat (less than 10% animal fat), 40% protein and 40% carbohydrates.

The inclusion criteria for the study are being aged between 50 and 65 years, both genders being admissible, having a clinical diagnosis of primary osteoarthritis (mild to moderate) 6 to 12 months prior to study enrollment including pain and stiffness, radiographic confirmation of illness prior to enrollment. It also include evidence of measurable symptoms of OA for at least 3 months prior to study enrollment requiring the use of acetaminophen, anti-inflammatory agents or opioid analgesics. Patients were asked to stop the use of all "pain-killers" the week prior to initiation of the trial for wash-out purposes.

The Exclusion criteria were a severe osteoarthritis, unavoidable sustained use of NSAID's, aspirin or other medicines for anti-inflammatory use, use of topical anaesthetics within 4 weeks of randomization visit, steroid injection into either knee within past 3 months, initiation of physical therapy or muscle conditioning within 3 months, seafood allergies, use of anticoagulants or salicylates, alcohol consumption exceeding 3 mixed drinks per day, concurrent medical/arthritis disease that could confound or interfere with the evaluation of pain, prior surgery (including arthroscopy) of either knee, a known "secondary" cause of osteoarthritis.

Evaluation was based on daily dose of NSAIDs and/or analgesics and/or SAARDs, number of painful joints, number or swollen joints, duration of morning stiffness, visual analog scale (0-100) WOMACscale and SF36. Preliminary results have been obtained after 2 months. The number of NSAIDs and/or analgesics and/or SAARDs required for daily functioning has been recorded at initiation and at 2 months after initiation.

Results shown at Table 2 demonstrate the effect of an uptake of krill extract on the relief of arthritis.

SUBSTITUTE SHEET (RULE 26)

Table 2

	Frequency	%	Valid %	Cumulative %
No change	3	23.1	23.1	23.1
Pain relief	10	76.9	76.9	100.0
Total	13	100.0	100.0	

This shows that ten out of 13 (76.9%) people reported a significant pain relief and improvement of flexibility of large joints (lower back, knees, shoulders)

Example 3**Skin Cancer Prophylaxis**

Krill and/or marine oil has been shown to be a skin cancer prophylactic because of its retinol anti-carcinogenic effect, Astaxanthin anti-carcinogenic effect and its phospholipid anti-carcinogenic effect.

To evaluate the photoprotective potential of krill and/or marine oil against UVB-induced skin cancer, a study was performed on nude mice, preferably on C57BL6 Nude Congenic Mice - B6NU-T (heterozygotes) because of their proven susceptibility to skin cancer.

Groups were formed as follows: 48 fish oil: 16 with oral supplementation (po) 16 with local application, 16 with po and local application; 48 krill and/or marine oil: 16 with po, 16 with local application, 16 with po and local application. In order to establish efficacy of krill and/or marine oil for the prevention of skin cancer, the test was conducted as a randomized blind controlled trial (statistical significance $p < 0.05$). Half of the mice have been treated orally or topically or both with oil containing 100% by weight krill and/or marine oil and the other half have been treated the same way with fish oil.

Nutrition was fat-free chow for the first week and was modified accordingly with the assigned group as described below for the following 2-20 weeks in the quantity of 1 ml of oil per day.

The mice were divided in six groups as follows:

Group A: fat-free chow with supplementation of fish oil (20% of total calories)

SUBSTITUTE SHEET (RULE 26)

Group B: fat-free chow (100% of calories) + local application of fish oil 2 times per day

Group C: fat free chow with supplementation of fish oil (20% of total calories) + local application of soy oil 2 times per day

Group D: fat-free chow with supplementation of krill and/or marine oil (20% of total calories)

Group E: fat free chow (100% of calories) + local application of krill and/or marine oil 2 times per day

Group F: fat-free chow with supplementation of krill and/or marine oil (20% of total calories) + local application of krill and/or marine oil 2 times per day

The mice had been submitted to UVB radiation using a fluorescent test lamp, emission spectrum 270-400 nm during weeks 2-20. The essay were performed during 30 minutes of UVB exposure per day and the test lamp was at a distance of 30 cm from the mice. At the end of the 20 weeks, or when malignant tumors had formed, mice were anesthetized with ether and sacrificed. Skin was examined blind by pathologists for signs of carcinogenesis.

The following tables (Tables 3-8) are showing the results obtained about the incidence of cancer when ultra-violet radiations are administered to mice's skin during 5 weeks.

Table 3
Krill extract Oral uptake

		Frequency	Percent	Valid Percent	Cumulative Percent
Valid	Benign	14	87.5	87.5	87.5
	Cancer	2	12.5	12.5	100.0
	Total	16	100.0	100.0	

SUBSTITUTE SHEET (RULE 26)

WO 02/102394

12

PCT/CA02/00843

Table 4**Control Oral uptake**

		Frequency	Percent	Valid Percent	Cumulative Percent
Valid	Benign	14	87.5	87.5	87.5
	Cancer	2	12.5	12.5	100.0
	Total	16	100.0	100.0	

Table 5**Krill extract topical uptake**

		Frequency	Percent	Valid Percent	Cumulative Percent
Valid	BENIGN	16	100.0	100.0	100.0

Table 6**Control topical uptake**

		Frequency	Percent	Valid Percent	Cumulative Percent
Valid	BENIGN	5	31.3	31.3	31.3
	Cancer	11	68.8	68.8	100.0
	Total	16	100.0	100.0	

Table 7**Krill extract topical and oral uptake**

		Frequency	Percent	Valid Percent	Cumulative Percent
Valid	BENIGN	16	100.0	100.0	100.0

SUBSTITUTE SHEET (RULE 26)

Table 8
Control topical and oral uptake

		Frequency	Percent	Valid Percent	Cumulative Percent
Valid	BENIGN	10	62.5	62.5	62.5
	Cancer	6	37.5	37.5	100.0
	Total	16	100.0	100.0	

The results obtained shows that both oral and topical use of krill oil is effective for the protection of the skin against the harmful effects fo UVB radiation induced skin cancer.

Example 4

Transdermal transport in therapeutic applications

Krill and/or marine oil enhances transdermal transportation as a substrate for dermatological topical therapeutic applications. It may be used in dermatological treatments via creams, ointments, gels, lotions and oils. It may also be used in various therapeutic applications such as relating to anesthetic, corticosteroids, anti-inflammatory, antibiotic and ketolytic functions.

To evaluate the efficacy of krill and/or marine oil as a substrate for topical treatments and the speed of transdermal absorption of krill and/or marine alone or as a substrate, a study was performed as a randomized blind controlled trial on C57BL6 nude Congenic Mice - B6NU-T (heterozygotes).

The results appearing in tables 5 and 6 are showing that topical treatment with krill oil facilitate the absorption of retinol and other antioxydants through the dermis which in turn result in significant photoprotective potential which in turn results in 100% protection from UVB induced skin cancer. In contrast, fish oil application with all-trans retinol resulted in 68.8% incidence of cancer.

SUBSTITUTE SHEET (RULE 26)

Example 5

Transdermal Transport for dermatological topical cosmetic applications

Krill and/or marine oil can be used to enhance transdermal transportation as a substrate for dermatological topical cosmetic applications where cosmetic applications relate to skin hydration, anti-wrinkle, keratolytics, peeling and mask via creams, ointments, gels, lotions or oils.

To evaluate the effects of Krill and/or marine oil in aging and facial wrinkles, a study was conducted as a prospective clinical trial on patients concerned about facial dryness and wrinkles. Those patients had no prognosis severely limited by other dermatological or non-dermatological condition, bleeding tendency or severe psychiatric disease.

13 Healthy caucasian women with facial dryness or wrinkles have been included in this study. Women have been asked to take 6 capsules a day, each capsule containing 800 mg of krill extract. The recommended daily dosage is of about 1 to 4.8 g of krill extract.

Table 9 shows results obtained on skin hydration following the method previously described.

Table 9
Changes in skin hydration

	Frequency	%	Valid %	Cumulative %
No change	4	30.8	30.8	30.8
Hydration	9	69.2	69.2	100.0
Total	13	100.0	100.0	

The results of the pilot study after 2 months indicate that nine out of 13 (69.2%) people reported a significant improvement of the hydration, texture and elasticity of the skin (face, hands and arms) in human patients.

Moreover, these results are also indicative that krill extract is useful for anti-wrinkle treatment. The mechanism of all-trans retinol, which is included in the krill oil, as an anti-wrinkle works as follows:

SUBSTITUTE SHEET (RULE 26)

- Regeneration and distinctive anti-inflammatory effects
- Improve blood irrigation
- Increases the epidermis regeneration by increasing the rate of cell division and turnover
- Accelerates the differentiation of keratin
- Regenerates the collagen
- Allows cells in the top layer of the skin, which are always being replaced, to mature more normally than untreated sun-damaged cells
- Reduces the activation of enzymes that break down the proteins collagen and elastin that provide structural support for the skin.

The results obtained with krill extract administered on a patient's skin show that the krill extract is having an anti-wrinkle effect by increasing the hydration and the mechanism above described.

Example 6

Premenstrual syndrome

Table 10 shows results obtained from the use of krill oil to reduce the pain and mood changes associated with premenstrual syndrome in women. Krill oil extract was administered to 7 women during 2 months. The women were taking 6 capsules of krill extract per day, each capsule containing 800 mg of krill oil. A recommended daily intake of krill oil is of about 1 to 4.8 grams. All participants were advised to continue with their usual nutrition habits and to refrain from initiating any restrictions in their diet. No serious side effects were reported.

All women enrolled reported noticeable emotional and/or physical discomfort 7 to 10 days prior to menstruation. A self-assessment visual analogue scale validated for the assessment of the premenstrual syndrome, ranging from 0 (no symptoms) to 10 (unbearable) was used as a primary outcome in order to evaluate the effect of krill extract on premenstrual discomfort.

Data analysis has been reported on 60% of the women participating in the study who have completed a two months regimen. The

majority of the women (73.3%) showed a clinically significant reduction in both emotional and physical distress prior to menstruation (see Table 10).

Table 10
Frequency distribution of the effect of krill extract on premenstrual syndrome symptomatology

PMS symptoms	Frequency %	Valid %	Cumulative %
No change	26.7	26.7	26.7
Positive	73.3	73.3	100.0
Total	100.0	100.0	

Example 7
Diabetes

8 human patients were taking krill extract at the dosage of 6 capsules a day, each capsule containing 800 mg of krill extract, during 2 months. A recommended daily intake of krill oil is of about 1 to 4.8 grams. The Table 11 is showing the variation in the glucose tested for the patients after 2 months.

Table 11
Variation in glucose in patients

Paired Differences							
Parameter tested	Mean	SD.	Std. Error Mean	95% Confidence Interval of the Difference	t-value	df	Sig. (2-tailed)
Glucose	.5778	.60369	.20123	.1137 - 1.0418	2.871	8	.021

A blood glucose decrease of 20% was obtained for the patients taking krill extract, which shows that an uptake of krill extract is controlling blood glucose content and therefore controlling diabetes in human patients.

While the invention has been described in connection with specific embodiments thereof, it will be understood that it is capable of further modifications and this application is intended to cover any variations, uses, or adaptations of the invention following, in general, the principles of the invention and including such departures from the present disclosure as come within known or customary practice within the art to which the invention pertains and as may be applied to the essential features hereinbefore set forth, and as follows in the scope of the appended claims.

SUBSTITUTE SHEET (RULE 26)

WHAT IS CLAIMED IS:

1. A composition for decreasing cholesterol in a patient comprising an effective amount of krill and/or marine oil in association with a pharmaceutically acceptable carrier, wherein said krill and/or marine oil is obtained from a process comprising the steps of:
 - a) placing krill and/or marine material in a ketone solvent, preferably acetone to achieve extraction of the soluble lipid fraction from said marine and/or aquatic animal material;
 - b) separating the liquid and solid contents;
 - c) recovering a first lipid rich fraction from the liquid contents by evaporation of the solvent present in the liquid contents;
 - d) placing said solid contents in an organic solvent selected from the group of solvents consisting of alcohol, preferably ethanol, isopropanol or t-butanol and esters of acetic acid, preferably ethyl acetate to achieve extraction of the remaining soluble lipid fraction from said marine and/or aquatic animal material;
 - e) separating the liquid and solid contents;
 - f) recovering a second lipid rich fraction by evaporation of the solvent from the liquid contents; and
 - g) recovering the solid contents.
2. A composition for decreasing cholesterol in a patient comprising an effective amount of krill and/or marine oil in association with a pharmaceutically acceptable carrier, wherein said krill and/or marine oil comprises Eicosapentanoic acid, Docosahexanoic acid, Phosphatidylcholine, Phosphatidylinositol, Phosphatidylserine, Phosphatidylethanolamine, Sphingomyelin, α -tocopherol, Astaxanthin, and flavonoid.
3. The composition of claim 2, further comprising at least one of the group consisting of Linoleic acid, Alpha-linoleic acid, arachidonic acid, oleic acid, palmitic acid, palmitoleic acid, stearic acid, cholesterol,

SUBSTITUTE SHEET (RULE 26)

triglycerides, monoglycerides, all-trans retinol, canthaxanthin, β -carotene, zinc, selenium, nervonic acid, sodium, potassium and calcium.

4. A method of decreasing cholesterol in a patient, said method comprising administering an effective amount of the composition of any one of claims 1-3 to said patient.

5. The method of claim 4, wherein said administering is effected orally.

6. The method of claim 4, wherein said krill and/or marine extract is administered in a quantity in a range of 1 to 4.8 grams per day.

7. The method of claim 6, wherein said quantity is 4.8 grams.

8. Use of the composition of any one of claims 1-3 for decreasing cholesterol in a patient.

9. Use of the composition of any one of claims 1-3 for the production of a medicament for decreasing cholesterol in a patient.

10. A composition for inhibiting platelet adhesion and plaque formation in arteries of a patient comprising an effective amount of krill and/or marine oil in association with a pharmaceutically acceptable carrier, wherein said krill and/or marine oil is obtained from a process comprising the steps of:

a) placing krill and/or marine material in a ketone solvent, preferably acetone to achieve extraction of the soluble lipid fraction from said marine and/or aquatic animal material;

b) separating the liquid and solid contents;

c) recovering a first lipid rich fraction from the liquid contents by evaporation of the solvent present in the liquid contents;

d) placing said solid contents in an organic solvent selected from the group of solvents consisting of alcohol, preferably ethanol, isopropanol or t-butanol and esters of acetic acid, preferably ethyl acetate to achieve extraction of the remaining soluble lipid fraction from said marine and/or aquatic animal material;

e) separating the liquid and solid contents;

SUBSTITUTE SHEET (RULE 26)

f) recovering a second lipid rich fraction by evaporation of the solvent from the liquid contents; and

g) recovering the solid contents.

11. A composition for inhibiting platelet adhesion and plaque formation in arteries of a patient comprising an effective amount of krill and/or marine oil in association with a pharmaceutically acceptable carrier, wherein said krill and/or marine oil comprises Eicosapentaenoic acid, Docosahexanoic acid, Phosphatidylcholine, Phosphatidylinositol, Phosphatidylserine, Phosphatidylethanolamine, Sphingomyelin, α -tocopherol, Astaxanthin, and flavonoid.

12. The composition of claim 11, further comprising at least one of the group consisting of Linoleic acid, Alpha-linoleic acid, arachidonic acid, oleic acid, palmitic acid, palmitoleic acid, stearic acid, cholesterol, triglycerides, monoglycerides, all-trans retinol, canthaxanthin, β -carotene, zinc, selenium, nervonic acid, sodium, potassium and calcium.

13. A method of inhibiting platelet adhesion and plaque formation in arteries of a patient, said method comprising administering an effective amount of the composition of any one of claims 11-12 to said patient.

14. The method of claim 13, wherein said administering is effected orally.

15. The method of claim 13, wherein said krill and/or marine extract is administered in a quantity in a range of 1 to 4.8 grams per day.

16. The method of claim 15, wherein said quantity is 4.8 grams.

17. Use of the composition of any one of claims 11-13 for inhibiting platelet adhesion and plaque formation in arteries of a patient.

18. Use of the composition of any one of claims 11-13 for the production of a medicament for inhibiting platelet adhesion and plaque formation in arteries of a patient.

19. A prophylactic composition for preventing hypertension in a patient comprising a prophylactic effective amount of krill and/or marine oil in association with a pharmaceutically acceptable carrier, wherein said krill and/or marine oil is obtained from a process comprising the steps of:

SUBSTITUTE SHEET (RULE 26)

a) placing krill and/or marine material in a ketone solvent, preferably acetone to achieve extraction of the soluble lipid fraction from said marine and/or aquatic animal material;

b) separating the liquid and solid contents;

c) recovering a first lipid rich fraction from the liquid contents by evaporation of the solvent present in the liquid contents;

d) placing said solid contents in an organic solvent selected from the group of solvents consisting of alcohol, preferably ethanol, isopropanol or t-butanol and esters of acetic acid, preferably ethyl acetate to achieve extraction of the remaining soluble lipid fraction from said marine and/or aquatic animal material;

e) separating the liquid and solid contents;

f) recovering a second lipid rich fraction by evaporation of the solvent from the liquid contents; and

g) recovering the solid contents.

20. A prophylactic composition for prevention of hypertension in a patient comprising a prophylactic effective amount of krill and/or marine oil in association with a pharmaceutically acceptable carrier, wherein said krill and/or marine oil comprises Eicosapentanoic acid, Docosahexanoic acid, Phosphatidylcholine, Phosphatidylinositol, Phosphatidylserine, Phosphatidylethanolamine, Sphingomyelin, α -tocopherol, Astaxanthin, and flavonoid.

21. The composition of claim 20, further comprising at least one of the group consisting of Linoleic acid, Alpha-linoleic acid, arachidonic acid, oleic acid, palmitic acid, palmitoleic acid, stearic acid, cholesterol, triglycerides, monoglycerides, all-trans retinol, canthaxanthin, β -carotene, zinc, selenium, nervonic acid, sodium, potassium and calcium.

22. A method of preventing hypertension in a patient, said method comprising administering a prophylactic effective amount of the composition of any one of claims 19-21 to said patient.

23. The method of claim 22, wherein said administering is effected orally.

24. The method of claim 22, wherein said krill and/or marine extract is administered in a quantity in a range of 1 to 4.8 grams per day.
25. The method of claim 24, wherein said quantity is 4.8 grams.
26. Use of the composition of any one of claims 19-21 for preventing hypertension in a patient.
27. Use of the composition of any one of claims 19-21 for the production of a medicament for preventing hypertension in a patient.
28. A therapeutical composition for symptomatic controlling or treating arthritis comprising a therapeutically effective amount of krill and/or marine oil in association with a pharmaceutically acceptable carrier, wherein said krill and/or marine oil is obtained from a process comprising the steps of:
- a) placing krill and/or marine material in a ketone solvent, preferably acetone to achieve extraction of the soluble lipid fraction from said marine and/or aquatic animal material;
 - b) separating the liquid and solid contents;
 - c) recovering a first lipid rich fraction from the liquid contents by evaporation of the solvent present in the liquid contents;
 - d) placing said solid contents in an organic solvent selected from the group of solvents consisting of alcohol, preferably ethanol, isopropanol or t-butanol and esters of acetic acid, preferably ethyl acetate to achieve extraction of the remaining soluble lipid fraction from said marine and/or aquatic animal material;
 - e) separating the liquid and solid contents;
 - f) recovering a second lipid rich fraction by evaporation of the solvent from the liquid contents; and
 - g) recovering the solid contents.
29. The composition of claim 28, wherein said arthritis is selected from the group consisting of rheumatoid arthritis and osteoarthritis.
30. A therapeutical composition for symptomatic controlling or treating arthritis comprising a therapeutically effective amount of krill and/or

marine oil in association with a pharmaceutically acceptable carrier, wherein said krill and/or marine oil comprises Eicosapentanoic acid, Docosahexanoic acid, Phosphatidylcholine, Phosphatidylinositol, Phosphatidylserine, Phosphatidylethanolamine, Sphingomyelin, α -tocopherol, Astaxanthin, and flavonoid.

31. The composition of claim 30, further comprising at least one of the group consisting of Linoleic acid, Alpha-linoleic acid, arachidonic acid, oleic acid, palmitic acid, palmitoleic acid, stearic acid, cholesterol, triglycerides, monoglycerides, all-trans retinol, canthaxanthin, β -carotene, zinc, selenium, nervonic acid, sodium, potassium and calcium.

32. The composition of claim 30, wherein said arthritis is selected from the group consisting of rheumatoid arthritis and osteoarthritis.

33. A method for symptomatic controlling or treating arthritis in a patient, said method comprising administering a therapeutically effective amount of the composition of any one of claims 29-32 to said patient.

34. The method of claim 33, wherein said administering is effected orally.

35. The method of claim 33, wherein said krill and/or marine extract is administered in a quantity in a range of 1 to 4.8 grams per day.

36. The method of claim 35, wherein said quantity is 4.8 grams.

37. Use of the composition of any one of claims 29-32 for symptomatic controlling or treating rheumatoid arthritis in a patient.

38. Use of the composition of any one of claims 29-32 for the production of a medicament for symptomatic controlling or treating rheumatoid arthritis in a patient.

39. A prophylactic composition for prevention of skin cancer in a patient comprising a prophylactic effective amount of krill and/or marine oil in association with a pharmaceutically acceptable carrier, wherein said krill and/or marine oil is obtained from a process comprising the steps of:

a) placing krill and/or marine material in a ketone solvent, preferably acetone to achieve extraction of the soluble lipid fraction from said marine and/or aquatic animal material;

- b) separating the liquid and solid contents;
 - c) recovering a first lipid rich fraction from the liquid contents by evaporation of the solvent present in the liquid contents;
 - d) placing said solid contents in an organic solvent selected from the group of solvents consisting of alcohol, preferably ethanol, isopropanol or t-butanol and esters of acetic acid, preferably ethyl acetate to achieve extraction of the remaining soluble lipid fraction from said marine and/or aquatic animal material;
 - e) separating the liquid and solid contents;
 - f) recovering a second lipid rich fraction by evaporation of the solvent from the liquid contents; and
 - g) recovering the solid contents.
40. A prophylactic composition for prevention of skin cancer in a patient comprising a prophylactic effective amount of krill and/or marine oil in association with a pharmaceutically acceptable carrier, wherein said krill and/or marine oil comprises Eicosapentanoic acid, Docosahexanoic acid, Phosphatidylcholine, Phosphatidylinositol, Phosphatidylserine, Phosphatidylethanolamine, Sphingomyelin, α -tocopherol, Astaxanthin, and flavonoid.
41. The composition of claim 40, further comprising at least one of the group consisting of Linoleic acid, Alpha-linoleic acid, arachidonic acid, oleic acid, palmitic acid, palmitoleic acid, stearic acid, cholesterol, triglycerides, monoglycerides, all-trans retinol, canthaxanthin, β -carotene, zinc, selenium, nervonic acid, sodium, potassium and calcium.
42. A method of prevention of skin cancer, said method comprising administering a therapeutically or a prophylactic effective amount of the composition of any one of claims 39-41 to a patient.
43. The method of claim 42, wherein said administering is effected orally.
44. The method of claim 42, wherein said krill and/or marine extract is administered in a quantity in a range of 1 to 4.8 grams per day.
45. The method of claim 44, wherein said quantity is 4.8 grams.

SUBSTITUTE SHEET (RULE 26)

46. Use of the composition of any one of claims 39-41 for preventing skin cancer in a patient.

47. Use of the composition of any one of claims 39-41 for the production of a medicament for preventing skin cancer in a patient.

48. A composition for enhancing transdermal transportation for dermatological topical therapeutic applications in a patient comprising an enhancing effective amount of krill and/or marine oil in association with a pharmaceutically acceptable carrier, wherein said krill and/or marine oil is obtained from a process comprising the steps of:

a) placing krill and/or marine material in a ketone solvent, preferably acetone to achieve extraction of the soluble lipid fraction from said marine and/or aquatic animal material;

b) separating the liquid and solid contents;

c) recovering a first lipid rich fraction from the liquid contents by evaporation of the solvent present in the liquid contents;

d) placing said solid contents in an organic solvent selected from the group of solvents consisting of alcohol, preferably ethanol, isopropanol or t-butanol and esters of acetic acid, preferably ethyl acetate to achieve extraction of the remaining soluble lipid fraction from said marine and/or aquatic animal material;

e) separating the liquid and solid contents;

f) recovering a second lipid rich fraction by evaporation of the solvent from the liquid contents; and

g) recovering the solid contents.

49. A composition for enhancing transdermal transportation for dermatological topical therapeutic applications in a patient comprising an enhancing effective amount of krill and/or marine oil in association with a pharmaceutically acceptable carrier, wherein said krill and/or marine oil comprises Eicosapentanoic acid, Docosahexanoic acid, Phosphatidylcholine, Phosphatidylinositol, Phosphatidylserine,

Phosphatidylethanolamine, Sphingomyelin, α -tocopherol, Astaxanthin, and flavonoid.

50. The composition of claim 49, further comprising at least one of the group consisting of Linoleic acid, Alpha-linoleic acid, arachidonic acid, oleic acid, palmitic acid, palmitoleic acid, stearic acid, cholesterol, triglycerides, monoglycerides, all-trans retinol, canthaxanthin, β -carotene, zinc, selenium, nervonic acid, sodium, potassium and calcium.

51. A method for enhancing transdermal transportation for dermatological topical therapeutic applications in a patient, said method comprising administering an enhancing effective amount of the composition of any one of claims 48-50 to said patient.

52. The method of claim 51, wherein said administering is effected orally and/or topically.

53. The method of claim 51, wherein said krill and/or marine extract is administered in a quantity in a range of 1 to 4.8 grams per day.

54. The method of claim 53, wherein said quantity is 4.8 grams.

55. Use of the composition of any one of claims 48-50 for enhancing transdermal transportation for dermatological topical therapeutic applications in a patient.

56. Use of the composition of any one of claims 48-50 for the production of a medicament for enhancing transdermal transportation for dermatological topical therapeutic applications in a patient.

57. A composition for enhancing transdermal transportation for dermatological cosmetic applications in a patient comprising an enhancing effective amount of krill and/or marine oil in association with a pharmaceutically acceptable carrier, wherein said krill and/or marine oil is obtained from a process comprising the steps of:

a) placing krill and/or marine material in a ketone solvent, preferably acetone to achieve extraction of the soluble lipid fraction from said marine and/or aquatic animal material;

b) separating the liquid and solid contents;

c) recovering a first lipid rich fraction from the liquid contents by evaporation of the solvent present in the liquid contents;

d) placing said solid contents in an organic solvent selected from the group of solvents consisting of alcohol, preferably ethanol, isopropanol or t-butanol and esters of acetic acid, preferably ethyl acetate to achieve extraction of the remaining soluble lipid fraction from said marine and/or aquatic animal material;

e) separating the liquid and solid contents;

f) recovering a second lipid rich fraction by evaporation of the solvent from the liquid contents; and

g) recovering the solid contents.

58. A composition for enhancing transdermal transportation for dermatological cosmetic applications in a patient comprising an enhancing effective amount of krill and/or marine oil in association with a pharmaceutically acceptable carrier, wherein said krill and/or marine oil comprises Eicosapentanoic acid, Docosahexanoic acid, Phosphatidylcholine, Phosphatidylinositol, Phosphatidylserine, Phosphatidylethanolamine, Sphingomyelin, α -tocopherol, Astaxanthin, and flavonoid.

59. The composition of claim 58, further comprising at least one of the group consisting of Linoleic acid, Alpha-linoleic acid, arachidonic acid, oleic acid, palmitic acid, palmitoleic acid, stearic acid, cholesterol, triglycerides, monoglycerides, all-trans retinol, canthaxanthin, β -carotene, zinc, selenium, nervonic acid, sodium, potassium and calcium.

60. A method for enhancing transdermal transportation for dermatological cosmetic applications, said method comprising administering an enhancing effective amount of the composition of any one of claims 57-59 to a patient.

61. The method of claim 60, wherein said administering is effected orally and/or topically.

62. The method of claim 60, wherein said krill and/or marine extract is administered in a quantity in a range of 1 to 4.8 grams per day.

63. The method of claim 62, wherein said quantity is 4.8 grams.
64. Use of the composition of any one of claims 57-59 for enhancing transdermal transportation for dermatological cosmetic applications in a patient.
65. Use of the composition of any one of claims 57-59 for the production of a medicament for enhancing transdermal transportation for dermatological cosmetic applications in a patient.
66. A composition for reducing premenstrual syndrome's symptoms in a patient comprising an enhancing effective amount of krill and/or marine oil in association with a pharmaceutically acceptable carrier, wherein said krill and/or marine oil is obtained from a process comprising the steps of:
- a) placing krill and/or marine material in a ketone solvent, preferably acetone to achieve extraction of the soluble lipid fraction from said marine and/or aquatic animal material;
 - b) separating the liquid and solid contents;
 - c) recovering a first lipid rich fraction from the liquid contents by evaporation of the solvent present in the liquid contents;
 - d) placing said solid contents in an organic solvent selected from the group of solvents consisting of alcohol, preferably ethanol, isopropanol or t-butanol and esters of acetic acid, preferably ethyl acetate to achieve extraction of the remaining soluble lipid fraction from said marine and/or aquatic animal material;
 - e) separating the liquid and solid contents;
 - f) recovering a second lipid rich fraction by evaporation of the solvent from the liquid contents; and
 - g) recovering the solid contents.
67. A composition for reducing premenstrual syndrome's symptoms in a patient comprising an enhancing effective amount of krill and/or marine oil in association with a pharmaceutically acceptable carrier, wherein said krill and/or marine oil comprises Eicosapentanoic acid, Docosahexanoic acid, Phosphatidylcholine, Phosphatidylinositol,

SUBSTITUTE SHEET (RULE 26)

Phosphatidylserine, Phosphatidylethanolamine, Sphingomyelin, α -tocopherol, Astaxanthin, and flavonoid.

68. The composition of claim 67, further comprising at least one of the group consisting of Linoleic acid, Alpha-linoleic acid, arachidonic acid, oleic acid, palmitic acid, palmitoleic acid, stearic acid, cholesterol, triglycerides, monoglycerides, all-trans retinol, canthaxanthin, β -carotene, zinc, selenium, nervonic acid, sodium, potassium and calcium.

69. A method for reducing premenstrual syndrome's symptoms in a patient, said method comprising administering an enhancing effective amount of the composition of any one of claims 66-68 to said patient.

70. The method of claim 69, wherein said administering is effected orally.

71. The method of claim 69, wherein said krill and/or marine extract is administered in a quantity in a range of 1 to 4.8 grams per day.

72. The method of claim 71, wherein said quantity is 4.8 grams.

73. Use of the composition of any one of claims 66-68 for reducing premenstrual syndrome's symptoms in a patient.

74. Use of the composition of any one of claims 66-68 for the production of a medicament for reducing premenstrual syndrome's symptoms in a patient.

75. A composition for controlling blood glucose level in a patient comprising an enhancing effective amount of krill and/or marine oil in association with a pharmaceutically acceptable carrier, wherein said krill and/or marine oil is obtained from a process comprising the steps of:

a) placing krill and/or marine material in a ketone solvent, preferably acetone to achieve extraction of the soluble lipid fraction from said marine and/or aquatic animal material;

b) separating the liquid and solid contents;

c) recovering a first lipid rich fraction from the liquid contents by evaporation of the solvent present in the liquid contents;

SUBSTITUTE SHEET (RULE 26)

d) placing said solid contents in an organic solvent selected from the group of solvents consisting of alcohol, preferably ethanol, isopropanol or t-butanol and esters of acetic acid, preferably ethyl acetate to achieve extraction of the remaining soluble lipid fraction from said marine and/or aquatic animal material;

e) separating the liquid and solid contents;

f) recovering a second lipid rich fraction by evaporation of the solvent from the liquid contents; and

g) recovering the solid contents.

76. A composition for controlling blood glucose level in a patient comprising an enhancing effective amount of krill and/or marine oil in association with a pharmaceutically acceptable carrier, wherein said krill and/or marine oil comprises Eicosapentanoic acid, Docosahexanoic acid, Phosphatidylcholine, Phosphatidylinositol, Phosphatidylserine, Phosphatidylethanolamine, Sphingomyelin, α -tocopherol, Astaxanthin, and flavonoid.

77. The composition of claim 76, further comprising at least one of the group consisting of Linoleic acid, Alpha-linoleic acid, arachidonic acid, oleic acid, palmitic acid, palmitoleic acid, stearic acid, cholesterol, triglycerides, monoglycerides, all-trans retinol, canthaxanthin, β -carotene, zinc, selenium, nervonic acid, sodium, potassium and calcium.

78. A method for controlling blood glucose level in a patient, said method comprising administering an enhancing effective amount of the composition of any one of claims 75-77 to said patient.

79. The method of claim 78, wherein said administering is effected orally.

80. The method of claim 78, wherein said krill and/or marine extract is administered in a quantity in a range of 1 to 4.8 grams per day.

81. The method of claim 80, wherein said quantity is 4.8 grams.

82. Use of the composition of any one of claims 75-77 for controlling blood glucose level in a patient.

83. Use of the composition of any one of claims 75-77 for the production of a medicament for controlling blood glucose level in a patient.

SUBSTITUTE SHEET (RULE 26)

【国際公開パンフレット（コレクトバージョン）】

(12) INTERNATIONAL APPLICATION PUBLISHED UNDER THE PATENT COOPERATION TREATY (PCT)

(19) World Intellectual Property Organization
International Bureau



(43) International Publication Date
27 December 2002 (27.12.2002)

PCT

(10) International Publication Number
WO 02/102394 A3

- (51) International Patent Classification: A61K 35/60, 31/23
 - (52) International Application Number: PCT/CA02/00643
 - (53) International Filing Date: 7 June 2002 (07.06.2002)
 - (54) Filing Language: English
 - (55) Publication Language: English
 - (56) Priority Data: 18 June 2001 (18.06.2001) US 60/298,383
 - (71) Applicant (for all designated States except US): NEPTUNE TECHNOLOGIES & BIORESSOURCES INC. [CA/CA]: 501, boulevard St. Martin Ouest, Bureau 501, Laval, Québec H7M 3Y2 (CA).
 - (72) Inventor; and
 - (73) Inventor/Applicant (for US only): SAMPALIS, Tina [CA/CA]: 1348 Elisabeth Blvd., Laval, Québec H7W 3J8 (CA).
 - (74) Agents: OGHILVY RENAULT et al.; Suite 1600, 1981 McGill College Avenue, Montreal, Québec H3A 2Y3 (CA).
 - (81) Designated States (national): AF, AG, AI, AM, AU, AZ, BA, BB, BG, BR, BY, BZ, CA, CH, CN, CO, CR, CU, CZ, DE, DK, DM, DZ, EC, EE, ES, FI, GB, GD, GE, GH, GM, HR, HU, ID, IL, IN, IS, JP, KE, KG, KP, KR, KZ, LC, LK, LR, LS, LT, LU, LV, MA, MD, MG, MK, MN, MW, MX, MY, NZ, OM, PH, PL, PT, RO, RU, SD, SE, SG, SI, SK, SL, TJ, TM, TN, TR, TT, TZ, UA, UG, US, UZ, VN, YU, ZA, ZM, ZW.
 - (84) Designated States (regional): ARIPO patent (GH, GM, KE, LS, MW, MZ, SD, SI, SZ, TZ, UG, ZM, ZW), Eurasian patent (AM, AZ, BY, KG, KZ, MD, RU, TJ, TM), European patent (AT, BE, CH, CY, DE, ES, FI, FR, GB, GR, IE, IT, LI, LU, MC, NL, PT, SE, TR), OAPI patent (BF, BI, CI, CG, CL, CM, GA, GN, GQ, GW, ML, MR, NI, SN, TD, TG).
- Published:**
— with international search report
before the expiration of the time limit for amending the claims and to be republished in the event of receipt of amendments
- (88) Date of publication of the international search report: 10 April 2003
- For two-letter codes and other abbreviations, refer to the "Guidance Notes on Codes and Abbreviations" appearing at the beginning of each regular issue of the PCT Gazette.*



WO 02/102394 A3

(54) Title: KRILL AND/OR MARINE EXTRACTS FOR PREVENTION AND/OR TREATMENT OF CARDIOVASCULAR DISEASES, ARTHRITIS, SKIN CANCER, DIABETES, PREMENSTRUAL SYNDROME AND TRANSDERMAL TRANSPORT

(57) Abstract: The present invention relates to a method of treatment and/or prevention of cardiovascular disease, rheumatoid arthritis, skin cancer, premenstrual syndrome, diabetes and transdermal transport enhancement. The method comprises the administration of a therapeutically effective amount of krill and/or marine oil to a patient. The present invention also relates to a composition for the treatment and/or prevention of these diseases.

【 國際調查報告 】

INTERNATIONAL SEARCH REPORT		International Application No. PCT/CA 02/00843
A. CLASSIFICATION OF SUBJECT MATTER IPC 7 A61K35/69 A61K31/23		
According to International Patent Classification (IPC) or to both national classification and IPC		
B. FIELDS SEARCHED Minimum documentation searched (classification system followed by classification symbols) IPC 7 A61K		
Documentation searched other than minimum documentation to the extent that such documents are included in the fields searched		
Electronic data base consulted during the international search (name of data base and, where practical, search terms used)		
C. DOCUMENTS CONSIDERED TO BE RELEVANT		
Category *	Description of document, with indication, where appropriate, of the relevant passages	Relevant to claim No.
X	WO 00 23546 A (BEAUDOIN ADRIEN ; UNIV SHERBROOKE (CA) ; MARTIN GENEVIEVE (CA)) 27 April 2000 (2000-04-27) page 1, line 12 -page 2, line 10; claim 1 -----	1,4-10, 19,28, 29,32, 39,48, 57,66,75
<input type="checkbox"/> Further documents are listed in the continuation of box C. <input checked="" type="checkbox"/> Patent family members are listed in annex.		
* Special categories of cited documents: "A" document defining the general state of the art which is not considered to be of particular relevance "E" earlier document but published on or after the international filing date "L" document which may throw doubts on priority claim(s) or which is cited to establish the publication date of another claim or other special reason (as specified) "O" document referring to an oral disclosure, use, exhibition or other means "P" document published prior to the international filing date but later than the priority date claimed "T" later document published after the international filing date or priority date and not in conflict with the application but cited to understand the principle or theory underlying the invention "X" document of particular relevance: the claimed invention cannot be considered novel or cannot be considered to involve an inventive step when the document is taken alone "Y" document of particular relevance: the claimed invention cannot be considered to involve an inventive step when the document is compared with one or more other such documents, such combination being obvious to a person skilled in the art "Z" document member of the same patent family		
Date of the actual completion of the international search		Date of mailing of the international search report
17 September 2002		03.02.03
Name and mailing address of the ISA European Patent Office, P.O. Box 5518 Patentstrasse 2 NL 2200 HV Rijswijk Tel: (+31-70) 345-2000, Tlx: 51 601 epo nl, Fax: (+31-70) 346-3016		Authorized officer Escolier Blasco, P

Form PCT/ISA/210 (second sheet) July 1999

INTERNATIONAL SEARCH REPORT

International application No.
PCT/CA 02/06843

Box I Observations where certain claims were found unsearchable (Continuation of item 1 of first sheet)

This International Search Report has not been established in respect of certain claims under Article 17(2)(a) for the following reasons:

- Claims Nos.:
because they relate to subject matter not required to be searched by this Authority, namely:
Although claims 4-7 are directed to a method of treatment of the human body, the search has been carried out and based on the alleged effects of the composition.
- Claims Nos.:
because they relate to parts of the International Application that do not comply with the prescribed requirements to such an extent that no meaningful International Search can be carried out, specifically:
- Claims Nos.:
because they are dependent claims and are not drafted in accordance with the second and third sentences of Rule 6.4(a).

Box II Observations where unity of invention is lacking (Continuation of item 2 of first sheet)

The International Searching Authority found multiple inventions in this international application, as follows:

- As all required additional search fees were timely paid by the applicant, this International Search Report covers all searchable claims.
- As all searchable claims could be searched without effort justifying an additional fee, this Authority did not invite payment of any additional fee.
- As only some of the required additional search fees were timely paid by the applicant, this International Search Report covers only those claims for which fees were paid, specifically claims Nos.:
- No required additional search fees were timely paid by the applicant. Consequently, this International Search Report is restricted to the invention first mentioned in the claims; it is covered by claims Nos.:
1, 10, 19, 28, 29, 32, 39, 48, 57, 66, 75 (partly) and 4-9 (partly)

Remark on Protest: The additional search fees were accompanied by the applicant's protest.
 No protest accompanied the payment of additional search fees.

Form PCT/ISA/210 (continuation of first sheet) (1) (July 1998)

INTERNATIONAL SEARCH REPORT Information on patent family members			International Application No. PCT/CA 02/00843	
Parent document cited in search report	Publication date	Patent family member(s)	Publication date	
WO 0023546 A	27-04-2000	AU 6455299 A	08-05-2000	
		BR 9914699 A	19-07-2001	
		CN 1324394 T	28-11-2001	
		EP 1123368 A	16-08-2001	
		JP 2002527684 T	27-08-2002	
		NO 20611915 A	21-06-2001	
		PL 347396 A	08-04-2002	

Form PCT/ISAR/10 (patent family annex) (July 1992)

フロントページの続き

(51)Int.Cl. ⁷	F I	テーマコード (参考)
A 6 1 K 31/122	A 6 1 K 7/00	G
A 6 1 K 31/20	A 6 1 K 7/00	H
A 6 1 K 31/201	A 6 1 K 7/00	K
A 6 1 K 31/202	A 6 1 K 7/48	
A 6 1 K 31/22	A 6 1 K 31/015	
A 6 1 K 31/353	A 6 1 K 31/07	
A 6 1 K 31/355	A 6 1 K 31/122	
A 6 1 K 31/575	A 6 1 K 31/20	
A 6 1 K 31/683	A 6 1 K 31/201	
A 6 1 K 31/685	A 6 1 K 31/202	
A 6 1 K 31/688	A 6 1 K 31/22	
A 6 1 K 33/00	A 6 1 K 31/353	
A 6 1 K 33/04	A 6 1 K 31/355	
A 6 1 K 33/30	A 6 1 K 31/575	
A 6 1 P 3/06	A 6 1 K 31/683	
A 6 1 P 3/10	A 6 1 K 31/685	
A 6 1 P 5/24	A 6 1 K 31/688	
A 6 1 P 9/00	A 6 1 K 33/00	
A 6 1 P 9/06	A 6 1 K 33/04	
A 6 1 P 9/10	A 6 1 K 33/30	
A 6 1 P 9/12	A 6 1 P 3/06	
A 6 1 P 15/00	A 6 1 P 3/10	
A 6 1 P 17/00	A 6 1 P 5/24	
A 6 1 P 17/02	A 6 1 P 9/00	
A 6 1 P 19/02	A 6 1 P 9/06	
A 6 1 P 35/00	A 6 1 P 9/10	
A 6 1 P 37/06	A 6 1 P 9/10	1 0 3
	A 6 1 P 9/12	
	A 6 1 P 15/00	
	A 6 1 P 17/00	
	A 6 1 P 17/02	
	A 6 1 P 19/02	
	A 6 1 P 35/00	
	A 6 1 P 37/06	

(81)指定国 AP(GH, GM, KE, LS, MW, MZ, SD, SL, SZ, TZ, UG, ZM, ZW), EA(AM, AZ, BY, KG, KZ, MD, RU, T J, TM), EP(AT, BE, CH, CY, DE, DK, ES, FI, FR, GB, GR, IE, IT, LU, MC, NL, PT, SE, TR), OA(BF, BJ, CF, CG, CI, CM, GA, GN, GQ, GW, ML, MR, NE, SN, TD, TG), AE, AG, AL, AM, AT, AU, AZ, BA, BB, BG, BR, BY, BZ, CA, CH, CN, CO, CR, CU, CZ, DE, DK, DM, DZ, EC, EE, ES, FI, GB, GD, GE, GH, GM, HR, HU, ID, IL, IN, IS, JP, KE, KG, KP, KR, KZ, LC, LK, LR, LS, LT, LU, LV, MA, MD, MG, MK, MN, MW, MX, MZ, NO, NZ, OM, PH, PL, PT, RO, RU, SD, SE, SG, SI, SK, SL, TJ, TM, TN, TR, TT, TZ, UA, UG, US, UZ, VN, YU, ZA, ZM, ZW

F ターム(参考) 4C086 AA01 AA02 BA08 BA09 DA11 DA41 DA42 HA02 HA03 HA04
 HA06 MA02 MA05 MA52 MA63 NA14 ZA36 ZA38 ZA40 ZA42
 ZA45 ZA81 ZA89 ZA96 ZB08 ZB15 ZB26 ZC11 ZC33 ZC35
 4C087 AA01 AA02 BB20 CA06 CA19 MA52 MA63 NA14 ZA36 ZA38
 ZA40 ZA42 ZA45 ZA81 ZA89 ZA96 ZB08 ZB15 ZB26 ZC11
 ZC33 ZC35

4C206 AA01 AA02 BA04 CA10 CB25 DA03 DA04 DA05 DB06 KA01
MA02 MA05 MA13 MA21 MA24 MA30 MA72 MA83 NA14 ZA36
ZA38 ZA40 ZA42 ZA45 ZA81 ZA89 ZA96 ZB08 ZB15 ZB26
ZC11 ZC33 ZC35

(19) World Intellectual Property Organization
International Bureau



(43) International Publication Date
19 July 2007 (19.07.2007)

PCT

(10) International Publication Number
WO 2007/080515 A1

(51) International Patent Classification:

A61P 7/02 (2006.01) C11B 1/14 (2006.01)
A61P 9/10 (2006.01) A23L 1/30 (2006.01)
A61P 9/14 (2006.01) A23D 9/00 (2006.01)
C11B 1/02 (2006.01)

(21) International Application Number:

PCT/IB2007/000099

(22) International Filing Date: 15 January 2007 (15.01.2007)

(25) Filing Language: English

(26) Publication Language: English

(30) Priority Data:

PA 2006 00058 13 January 2006 (13.01.2006) DK
US 60/758,957 13 January 2006 (13.01.2006) US
US 60/777,630 28 February 2006 (28.02.2006) US

(71) Applicant (for all designated States except US): **AKER BIOMARINE ASA** [NO/NO]; Fjordalléen 16, P.O. Box 1423 Vika, N-0115 Oslo (NO).

(72) Inventors; and

(75) Inventors/Applicants (for US only): **LARSEN, Peter, Mose** [DK/DK]; Valmuemarken 16, DK-5260 Odense S (DK). **FEY, Stephen, John** [GB/DK]; Middelfartvej 469, DK-5491 Blommenslyst (GB).

(74) Agent: **BUDE, SCHOU & OSTENFELD A/S**; Vester Søgade 10, DK-1601 Copenhagen V (DK).

(81) Designated States (unless otherwise indicated, for every kind of national protection available): AE, AG, AL, AM, AT, AU, AZ, BA, BB, BG, BR, BW, BY, BZ, CA, CH, CN, CO, CR, CU, CZ, DE, DK, DM, DZ, EC, EE, EG, ES, FI, GB, GD, GE, GH, GM, GT, HN, HR, HU, ID, IL, IN, IS, JP, KE, KG, KM, KN, KP, KR, KZ, LA, LC, LK, LR, LS, LT, LU, LV, LY, MA, MD, MG, MK, MN, MW, MX, MY, MZ, NA, NG, NI, NO, NZ, OM, PG, PH, PL, PT, RO, RS, RU, SC, SD, SE, SG, SK, SL, SM, SV, SY, TJ, TM, TN, TR, TT, TZ, UA, UG, US, UZ, VC, VN, ZA, ZM, ZW.

(84) Designated States (unless otherwise indicated, for every kind of regional protection available): ARIPO (BW, GH, GM, KE, LS, MW, MZ, NA, SD, SL, SZ, TZ, UG, ZM, ZW), Eurasian (AM, AZ, BY, KG, KZ, MD, RU, TJ, TM), European (AT, BE, BG, CH, CY, CZ, DE, DK, EE, ES, FI, FR, GB, GR, HU, IE, IS, IT, LT, LU, LV, MC, NL, PL, PT, RO, SE, SI, SK, TR), OAPI (BF, BJ, CF, CG, CI, CM, GA, GN, GQ, GW, ML, MR, NE, SN, TD, TG).

Declarations under Rule 4.17:

— as to applicant's entitlement to apply for and be granted a patent (Rule 4.17(ii))

[Continued on next page]

(54) Title: THROMBOSIS PREVENTING KRILL EXTRACT

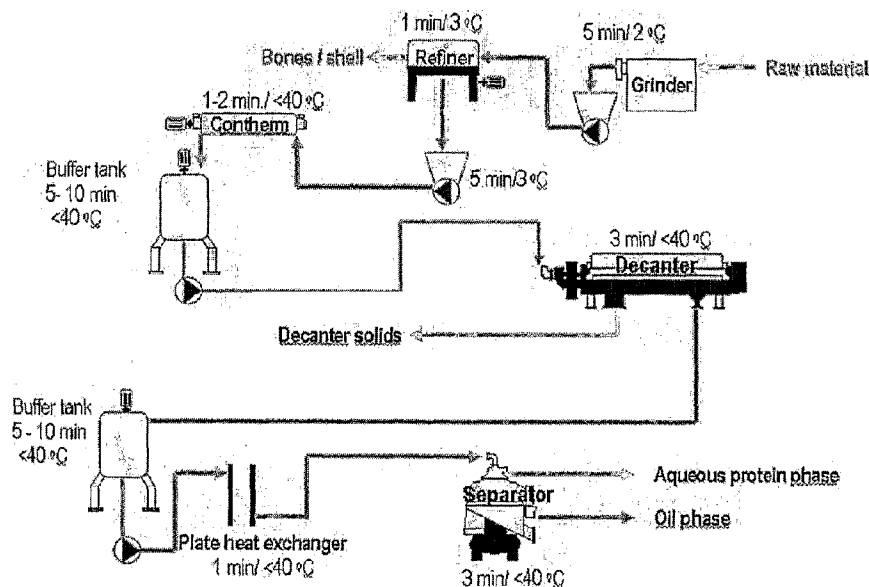

(57) Abstract: In accordance with the present disclosure there is provided a novel marine lipid extract obtainable by a process wherein processing temperature below 60 °C; mechanical and physical disruption of the lipid cell membrane to facilitate low temperature extraction; processing takes place under inert gas to prevent oxidation or denaturation of fat and proteins; intermediate processing tanks kept at a minimum level to reduce residence time; and the oil is frozen immediately after recovery to stabilize it.

WO 2007/080515 A1



- *as to the applicant's entitlement to claim the priority of the earlier application (Rule 4.17(iii))*

Published:

- *with international search report*
- *before the expiration of the time limit for amending the claims and to be republished in the event of receipt of amendments*

For two-letter codes and other abbreviations, refer to the "Guidance Notes on Codes and Abbreviations" appearing at the beginning of each regular issue of the PCT Gazette.

THROMBOSIS PREVENTING KRILL EXTRACT

FIELD OF THE INVENTION

This invention relates to novel extracts derived from krill, which can prevent and/or treat thrombosis. This invention also relates to a method for the extraction of lipid fractions from krill in order to obtain the novel extracts of the present invention. More specifically, the invention relates to an improved method of extracting lipid fractions without using high temperatures and/or organic solvents.

BACKGROUND OF THE INVENTION

Krill is the common name for small, shrimp-like crustaceans that swarm in dense shoals, especially in Antarctic waters. It is one of the most important food sources (especially protein) for fish, some kind of birds and especially for baleen. Krill is also a good source of omega-3 fatty acids, which are well known for their beneficial effects on human health.

It is known in the art to use krill and/or marine enzymes for the treatment of a great variety of diseases in human and animals such as infections, inflammations, cancers, HIV/AIDS, pain, polyps, warts, hemorrhoids, plaque, wrinkles, thin hair, allergic itch, anti-adhesion, eye disease, acne, cystic fibrosis and immune disorders including autoimmune diseases and cancer.

It is also known in the art that krill and/or marine oils may be used for the treatment of autoimmune murine lupus and other autoimmune diseases and can also be used for treating cardiovascular diseases.

However, most of the krill oil extracts used for these treatments has only conserved its omega-3 fatty acids as active ingredients, which is a very small part of all the active ingredients of the krill itself. This fact dramatically reduces the potential of the krill and/or marine oil as a treatment for these diseases.

There is an increasing demand for treatments using products derived from a natural source, therefore, it would be highly desirable to be provided with a krill and/or marine extract having an enhanced potential for prevention and/or treatment and/or management of disease.

US Patent 6,800,299 discloses a method for extracting lipid fractions from marine and aquatic animal material by acetone extraction. The resulting non-soluble and particulate fraction is preferably subjected to an additional solvent extraction with an alcohol, preferably ethanol,

isopropanol or t-butanol or an ester of acetic acid, preferably ethyl acetate to achieve extraction of the remaining soluble lipid fraction from the marine and aquatic animal material. The remaining non-soluble particulate content is also recovered since it is enriched in proteins and contains a useful amount of active enzymes. Also provided herein is a krill extract. It is reported that these marine and aquatic animal oils have anti-inflammatory properties. Marine and aquatic animal oils are also reported as helpful in reducing the incidence of cardiovascular disease. As a further example the patent mentions that krill may be used as a source of enzymes for debridement of ulcers and wounds or to facilitate food digestion.

WO02102394A2 discloses a process for the preparation of a krill oil extract, which process includes the steps of placing krill and/or marine material in a ketone solvent to achieve extraction of the soluble lipid fraction from the krill; then separating the liquid and solid contents; then recovering a first lipid rich fraction from the liquid contents by evaporation of the solvent present in the liquid contents; then placing the solid contents in an organic solvent to achieve extraction of the remaining soluble lipid fraction from the krill material; then separating the liquid and solid contents; then recovering a second lipid rich fraction by evaporation of the solvent from the liquid contents; and finally recovering the solid contents. Diseases that can be treated and/or prevented by using the krill oil extract are *inter alia* cardiovascular diseases. In this respect it is mentioned that the Krill oil has been shown to decrease cholesterol *in vivo*, inhibit platelet adhesion and plaque formation and reduce vascular endothelial inflammation in a patient.

Canadian Patent 1,098,900 describes a method for extracting oils and producing proteins from krill comprising emulsification of lipids of krill in an aqueous medium, separation of the emulsion of lipids from the krill mass, alkaline extraction of proteins from the krill mass, separation of the protein extract produced from chitin integuments, and finally separation of protein from the protein extract. The document mentions that krill is a prospective source of food and other practically useful products such as chitin and lipids which find wide application in different branches, such as food industry, textile, and medicine.

WO03011873A2 discloses a phospholipid extract from *inter alia* krill, with therapeutic properties, such as those essential for the maintenance of a healthy cardiovascular system. The phospholipid extract comprises a variety of phospholipids, fatty acid, metals and a novel flavonoid. The method for the preparation of this extract is generally carried out by a method similar to the one described in US Patent 6,800,299 (see above; includes organic solvents),

which procedure produces two successive lipid fractions and a dry residue enriched in protein, including active enzymes.

WO8401715A1 and WO09533471A1 disclose various aspects of so-called krill enzymes, which are water-soluble. It is mentioned that in krill a mixture of different enzymes exists, such as e.g. proteinases (with acidic and neutral-to-alkaline pH-optima), peptidases (exo- and endopeptidases), lipases, phospholipases, amylases and other carbohydrate degrading enzymes, phosphatases nucleases, nucleotidases and esterases. The proteolytic (trypsin-like) activity existing in a water extract from krill has been studied and described. WO09533471A1 disclose the use of one or more krill enzymes for the manufacture of an intravasal pharmaceutical composition for thrombolysis in a mammal host.

The potential of krill oil to prevent thrombosis has been disclosed in the prior art; however such a preventive effect has so far only been ascribed to the presence of powerful antioxidants and the special composition of poly-unsaturated fatty acids. The present inventors have surprisingly found that krill oil prepared by a novel process, which is from a physical-chemical point of view very gentle to the krill material due to relatively low temperature and no use of organic solvents, comprises other therapeutically valuable components than known from conventional krill oil extracts as well as other known fish oil; such components include inter alia high molecular (MWt > 200 kDa) hydrophobic proteins.

SUMMARY OF THE INVENTION

In accordance with the present invention there is provided a novel krill oil extract for the prevention and/or treatment of thrombosis.

The general extraction method of the present invention will now be described. The starting material, consisting of freshly harvested and preferably finely divided krill material, is subjected to extraction, for about two hours and preferably overnight. However, extraction time is not critical to the yield of lipid extraction. To facilitate extraction, it is preferable to use particles of less than 0.5 mm in diameter. Extraction is preferably conducted under inert atmosphere and at a temperature in the order of about 5° C or less. The inventors have also envisaged that the present invention may be carried out by applying supercritical CO₂ extraction.

Preferably, the beginning of the extraction will be conducted under agitation for about 10 to 40

minutes, preferably 20 minutes. The solubilized lipid fractions are separated from the solid material by standard techniques including, for example, filtration, centrifugation or sedimentation. Filtration is preferably used.

DETAILED DESCRIPTION OF THE INVENTION

In accordance with the present invention, there is provided a novel krill extract for prevention and/or treatment and/or therapy of thrombosis.

The novel oil extract is derived from krill found in any marine environment around the world, for example, the Antarctic ocean (*euphasia superba*), the Pacific ocean (*euphasia pacifica*), the Atlantic ocean, the Indian ocean, in particular coastal regions of Mauritius Island and/or Reunion Island of Madagascar, Canadian West Coast, Japanese Coast, St-Lawrence Gulf and Fundy Bay, and this oil extract is a lipid fraction.

According to a first aspect of the present invention there is provided a method for extracting lipid fractions from krill, said method comprising the steps of:

- placing the krill material in a blender to mechanically disrupt fat cell membranes;
- separating the liquid and solid components;
- recovering a lipid rich fraction from the liquid component;

wherein the extraction is performed quickly at a temperature below 60 °C and does not involve the use of organic solvents.

According to another aspect of the present invention there is provided a method for extracting lipid fractions from krill, said method comprising the steps of:

- Feeding freshly captured krill into a grinder to produce a slurry
- Heating the slurry gently to a temperature below 90°C for less than 45 minutes
- Separating the solid material from the liquid
- Separating the liquid into an aqueous phase and a krill oil phase

wherein the extraction does not involve the use of organic solvents.

According to the invention there is also provided a pharmaceutical composition for the treatment of thrombosis in a patient comprising an effective amount of a krill oil extract obtainable by a method according to the present invention.

EXAMPLES

As used herein, the term omega-3 fatty acid refers to polyunsaturated fatty acids that have the final double bond in the hydrocarbon chain between the third and fourth carbon atoms from the methyl end of the molecule. Non-limiting examples of omega-3 fatty acids include, but are not limited to 5,8,11,14,17-eicosapentaenoic acid (EPA), 4,7,10,13,16,19-docosahexanoic acid (DHA) and 7,10,13,16,19-docosapentanoic acid (DPA).

Example 1

Preparation of the krill oil extract of the present invention (see also Fig 1).

Preparation of the krill oil

The method of preparation is a continuous flow process and so the times given represent the average time that the material is in each stage of the process and the temperatures are typical (and may vary by $\pm 3^{\circ}\text{C}$).

1. The freshly captured krill are fed into the grinder together with process water and shredded at 2°C for 5 minutes.
2. This is then fed into a refiner which separates the chitin shell from the slurry (1 minute, 3°C).
3. The slurry is then passed into a heat exchanger and warmed gently up to a temperature about 35°C (max below 40°C) (1-2 minutes) and then stored in a buffer tank for 5 to 10 minutes. All subsequent processes occur at temperatures below 40°C .
4. A centrifugal decanter is then used to separate the solid material from the liquid (3 minutes).
5. The liquid fraction is then stored in a buffer tank for 5 to 10 minutes.
6. The temperature of the liquid is adjusted to 35°C using a countercurrent plate heat exchanger (1 minute).
7. The liquid is then separated into an aqueous phase and a krill oil phase.

Preparation of the stock solution of krill oil

1. Autoclave glycerol (analytical quality) and leave to cool to room temperature
2. Mix 100 μ L of krill oil with 1000 μ L autoclaved glycerol
3. Shake mixture for 6 min. on a minibead beater (Biospec. Products, USA) at room temperature
4. Add 900 μ L diluted CPD solution (Compoflex[®], Fresenius HemoCare 61348 Bad Hamburg, Germany containing: citric acid monohydrate 3.27g, Sodium citrate dihydrate 26.3g, sodium dihydrogen phosphate dehydrate 2.51g, glucose monohydrate 25.3g made up to 1L).
5. Shake mixture for 6 min. on minibead beater 4 times at room temperature

Preparation of the dilute solutions of krill oil

1. The stock is diluted sequentially (1:10), shaking for 6 minutes at each dilution.
2. Immediately before use, shake mixture for 6 min. on a minibead beater at room temperature

Preparation of the stock solution of CPD Glycerol control solution

1. Mix 100 μ L of diluted CPD solution with 1000 μ L autoclaved glycerol
2. Shake mixture for 6 min. on minibead beater at room temperature
3. Add 900 μ L diluted CPD solution
4. Shake mixture for 6 min. on minibead beater 2 times at room temperature
5. Repeat 4. immediately before use

Example 2

Effect of the krill oil extract of the present invention on the aggregation time of thrombocytes.

Preparation of human blood

Blood samples were taken from normal subjects. 3.8 mm plastic tubes containing 0.38 ml 0.129M sodium citrate buffer (CPD buffer, pH 5.5) were used to store the blood. The buffered blood was then mixed with the krill or fish oil to achieve a final oil concentration varying from 5×10^{-2} to 5×10^{-18} Vol%. The blood cells were treated with krill or fish oil for 60 minutes before aggregation tests were performed.

Blood aggregation time

The thrombocyte aggregation tests were performed with a PFA 100 aggregometer (Dade Bering), which is a microprocessor controlled apparatus with single test vials. The unit comprises a small reservoir, a capillary and a membrane, which is covered with 2 mg genuine, type 1 collagen and 50 mg adenosin-5'-diphosphate (ADP). The blood is pipetted directly into the reservoir and aspirated through a capillary with a diameter of 200 μm with a constant negative pressure resulting in high shear stress. The capillary ends with a membrane having an aperture with a diameter of 150 μm . The thrombocytes are then activated by collagen and ADP. Upon aggregation the blood flow is stopped due to clogging, which is referred to as closing time. The test automatically stops after 300 seconds. The normal value is between 62.5 – 120.5 seconds for ADP.

Determination of anti-aggregation effect

Dilute krill oil solutions were added to whole human blood samples and allowed to react in accordance with the following steps:

1. Serial dilutions of the krill oil or other oils under investigation were added to the human blood samples and gently shaken for 1 hour at room temperature on a "HETO-blood turner" at a rotational speed of 10 rpm.
2. Exactly 800 μL of the blood-oil sample were placed in the reaction cartridge (DADE PFA collagen/epitest cartridge containing 4 μg epinephrine bitartrate and 2 μg type 1 equine collagen). The blood was then allowed to clot at 37°C for up to 300 seconds (preset instrument maximum).
3. Measurements were read from the display and printed out recorded

Figure 2 shows the effects of various oils on the rate of aggregation of human whole blood.

Samples of human whole blood are aggregated at the start and end of every experiment ("Start blood" and "End blood" on the abscissa) to determine the rate of blood aggregation for the donor. As an additional control carried out just after and just before the start and end whole blood aggregation determinations, an aliquot of the vehicle is added and the aggregation determination is repeated ("Start Glycerol/CPD" and "End Glycerol/CPD"). These controls are performed to ensure that the ability of the blood to aggregate does not change during the experimentation (see the trend line for the glycerol/CPD points). Between these control experiments, the blood is treated (as described in the text) with various concentrations of the different oils for 1hr before its ability to aggregate is determined. Dotted line - fish oil; dashed

line a commercially available krill oil; solid line krill oil prepared in the manner disclosed here. The graph shows typical data from a single patient.

As can be seen in Figure 2, the fish oil can be diluted to a concentration of only about 1×10^{-4} before it loses its effect. A commercially available krill oil can be diluted to about 5×10^{-6} before it loses its effect (i.e. it is about 500 times more effective than fish oil). Krill oil prepared in the manner described here can be diluted to a concentration of about 5×10^{-12} before it loses its effect. This is a million times more effective than the existing krill oil preparations and five hundred million times better than fish oil (note that the abscissa is a logarithmic scale).

Figure 3 (graph 1) shows the inhibiting effect of krill oil on the aggregation of thrombocytes in blood samples from 6 subjects. It also appears that the effect varies from subject to subject; and furthermore blood from one of the subjects was not influenced at all by the presence of krill oil.

In Figure 4 (graph 2) the effect of krill oil C on blood from the same subject was analysed twice with a 21 day interval. The effect of krill oil C on the aggregation of thrombocytes is significant; however it must be concluded that the difference in the concentration required to achieve a significant inhibition varies with more than 10^{-3} Vol%.

Example 3

Comparison of krill oils and fish oils with respect to the effect on blood aggregation

These experiments serve to demonstrate that the krill oil obtainable by the process of the present invention prevents formation of thrombosis (based on the same experimental procedure as laid down in Examples 1 and 2) to a higher degree than known krill oils and other fish oils.

The experiments include 2 fish oils as well as 3 different krill oils:

- Krill oil A: Krill caught in large nets and subjected to a long process time
- Krill oil B: Krill caught in smaller nets and subjected to a short process time
- Krill oil C: Krill sucked up and processed very rapidly (in accordance with the present invention)
- Fish oil A: Newly cold pressed cod fish oil
- Fish oil B: Pikasol (OTC registered natural pharmaceutical containing concentrated Omega-3 rich fish oil; contains 62% omega-3 fatty acids, mainly EPA and DHA; Pikasol is produced from highly refined fish oil from the cleanest oceans in the world)

The oils are dissolved in a 1:1 mixture with glycerol and CPD (Gly/CPD-mixture). Every single dilution is performed with the Gly/CPD-mixture to ensure that the glycerol concentration remains constant about 5×10^{-3} Vol%.

It is known that the quality of krill oil may vary considerably due to the way the krill material has been "caught". As discussed above the prior envisages that the amount of phospholipids, omega-3 and omega-6 polyunsaturated fatty acids and various antioxidants is responsible for the therapeutic effects attributable to krill oil. As appears from Fig 5 (graph 3) the three krill oils have very different effects on the aggregation. Surprisingly, the different effects could not be ascribed to differences in the amount of e.g. polyunsaturated fatty acids. On the contrary it appeared (based on 2D gel electrophoresis) that 5 proteins were present in Krill oil C (according to the present invention) but only in minute amounts in krill oil B and not traceable in krill oil A. This observation stems with the fact that many proteins in krill are extremely sensible for proteolytic degradation, which starts right after the krill has been caught.

As already mentioned the therapeutic effect of antioxidants and polyunsaturated fatty acids from fish oil on cardiovascular diseases is well known. Accordingly, the present inventors have compared the effect the effect of Krill oil C and fish oils A and B with respect to their ability to prevent thrombocyte formation (verified with the above described aggregation test). Fig 6 (graph 4) demonstrates that Krill oil C (according to the present invention) has a far more pronounced inhibitory effect on the thrombocyte aggregation than is the case with the fish oils.

Conclusions drawn from Examples 1-3

Based on the experimental evidence provided so far the following conclusions may be drawn:

- Krill oil prepared by the process according to the present invention has a strong inhibitory effect on human thrombocyte aggregation in blood samples,
- The difference between the intensity of the effect may possibly be ascribed to certain proteins of the krill oil, and
- There is a substantial difference between how blood from different subjects responds to the krill oil with respect to aggregation time, however it may validly said that the krill oil obtained with the process of the present invention is far more effective than krill oils and fish oils obtained by traditional high temperature/solvent extraction methods.

Example 4

Phospholipids are to be extracted from the solid fraction obtained in example 1 (step 4) using ethanol. After removal of the ethanol, the phospholipids are to be mixed with the krill oil phase obtained from the liquid fraction in example 1 (step 7) into a krill oil composition. The anti-thrombotic effects of this krill oil composition are to be compared with other krill oil products extracted with organic solvents by investigating the effect on the aggregation time of thrombocytes in-vitro. The krill oil products (mixtures of krill triglycerides and krill phospholipids) for this comparison are to be extracted from krill or krill meal using organic solvents as described in US 6,800,299. It is to be observed that the anti-thrombotic effects of the krill oil composition obtained by the methods described herein are superior to any krill oil product extracted with organic solvents such as acetone.

Example 5

The krill oil compositions tested in example 4, the krill oil extracted obtained in example 1 (step 7), krill oil obtained using organic solvents and a control are to be administered in humans (in-vivo) for a period of 5 weeks. Diets are to contain approximately 38% of energy as fat excluding the lipid in the supplement. Around 2 g of each product are to be administered in a way that preserves the biological effect of the krill oil. Non-limiting examples of administration are oral, sublingual or transdermal. After termination of the experiment, ex vivo and in vitro platelet aggregation, and variables of coagulation, fibrinolysis, and hematology are to be evaluated. Ex vivo platelet aggregation time are to be measured by filragnetometry and in vitro platelet aggregation induced by collagen and ADP measured by PFA 100 aggregometer. Variables of coagulation (factor VII amidolytic activity and concentrations of fibrinogen and prothrombin fragment 1 and 2) and fibrinolysis [plasminogen activator inhibitor (PAI) activity

and concentrations of tissue plasminogen activator (tPA)/PAI-1 complexes] are to be determined by standard methods. It is to be observed that the subjects treated with the krill oil composition described in example 4 and the krill lipid extract obtained in example 1 (step 7) show superior anti-thrombotic activity than subjects treated with krill oil compositions obtained using organic solvents and control. Prevention of thrombosis is linked to prevention of myocardial infarction and stroke. Hence, the krill oil composition described in example 4 and example 1 (Step 7) can be used to prevent these pathologies.

CLAIMS

1. A method for extracting lipid fractions from krill, said method comprising the steps of:
- placing the krill material in a grinder or blender to mechanically disrupt cell membranes;
 - separating the liquid and solid components;
 - recovering a lipid rich fraction from the liquid component;

wherein the extraction is performed at a temperature below 60 °C and does not involve the use of organic solvents.

2. A method as in claim 1, wherein separating the liquid and solid components is effected by techniques selected from the group consisting of mechanical pressing, filtration, centrifugation and sedimentation.

3. A method as in claim 1, wherein the extraction is performed at a temperature below 27°C, preferably below 15°C, more preferably below 5°C.

4. A krill oil extract obtainable by a method according to any one of claims 1 to 3.

5. A krill oil extract according to claim 4 for use as a medicament.

6. A pharmaceutical composition comprising the krill oil extract of claim 4.

7. A pharmaceutical composition for the treatment of thrombosis in a patient comprising an effective amount of a krill oil extract obtainable by a method according to any one of claims 1 to 3 in association with a pharmaceutically acceptable carrier.

8. The composition of claim 7, further comprising at least one of compounds selected from the group consisting of glycerol, dimethyl-sulphoxide (DMSO), linoleic acid, alpha-linoleic acid, arachidonic acid, oleic acid, palmitic acid, palmitoleic acid, stearic acid, cholesterol, triglycerides, monoglycerides, all-trans. retinal, canthexanthin, carotene, zinc, selenium, sodium, potassium and calcium.

9. Use of the krill oil extract obtainable by the method of any one of claims 1-3 for the production of a medicament for decreasing development of thrombosis in a patient.

10. A composition for inhibiting platelet adhesion and plaque formation in arteries of a patient comprising an effective amount of krill oil extract in association with a pharmaceutically acceptable carrier, wherein said krill oil extract is obtainable from a method according to any one of claims 1 to 3.

11. A krill oil extract obtainable by a method comprising the steps of:

- Feeding freshly captured krill into a grinder to produce a slurry
- Heating the slurry gently to a temperature below 90°C in less than 45 minutes
- Separating the solid material from the liquid
- Separating the liquid into an aqueous phase and a krill oil phase wherein the extraction does not involve the use of organic solvents.

12. A food product comprising the krill oil extract of claim 4.

13. An animal feed comprising the krill oil extract of claim 4.

14. A food supplement comprising the krill oil extract of claim 4.

15. A composition comprising the krill oil extract of claim 4 and phospholipids, said phospholipids having the following structure:

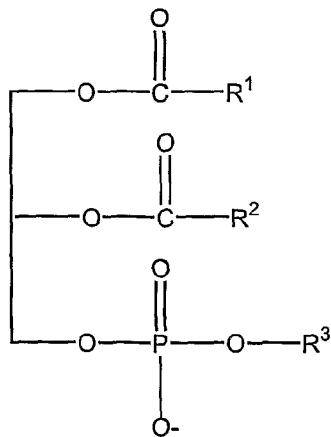

wherein R1 is a fatty acid, R2 is a fatty acid, and R3 is selected from the group consisting of H or choline, ethanolamine, inositol or serine.

16. The composition in claim 15, wherein at least 1% (w/w) of the said fatty acids are unsaturated fatty acids.

17. The composition in claim 15, wherein at least 1% (w/w) of the said fatty acids are omega-3 fatty acids.
18. A food product comprising the composition in any of the claims 15 to 17.
19. An animal feed comprising the composition in any of the claims 15 to 17.
20. A food supplement comprising the composition in any of the claims 15 to 17.
21. A pharmaceutical comprising the composition in any of the claims 15 to 17.
22. A method of preventing platelet adhesion in a patient comprising administering to said patient a therapeutically effective amount of the composition in any of the claims 15 to 21.
23. A method for preventing stroke or heart attack in a patient comprising administering to said patient a therapeutically effective amount of the composition in any of the claims 15 to 21.
24. A method of preventing platelet adhesion and plaque formation in a patient comprising administering to said patient a therapeutically effective amount of krill oil, wherein said krill oil is obtained without organic solvent extraction.
25. A method of preventing platelet adhesion and plaque formation in a patient comprising administering to said patient a therapeutically effective amount of krill oil composition, wherein said krill oil composition comprises triglyceride, phospholipid and protein fractions.
26. The method of claim 25, wherein said protein fraction comprises high molecular weight hydrophobic proteins.
27. A composition comprising a krill oil extract isolated from krill comprising triglyceride, phospholipid and protein fractions.
28. A pharmaceutical comprising the composition of claim 27.

Figure 1

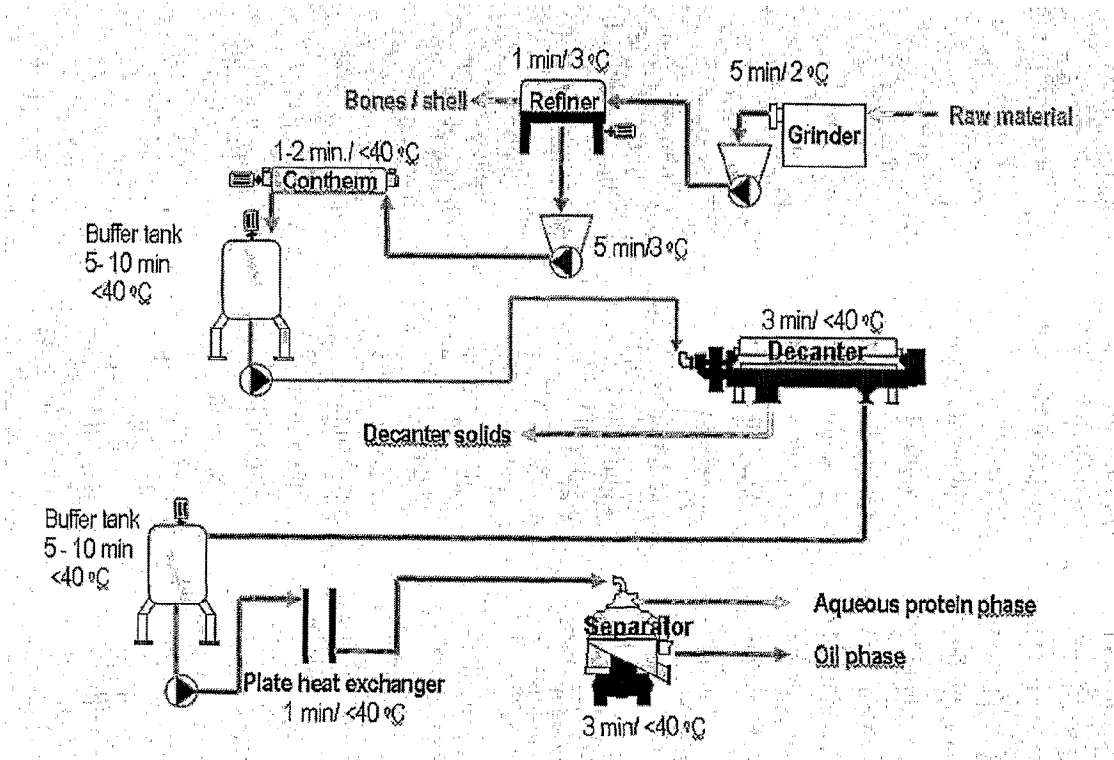

2/6

Figure 2

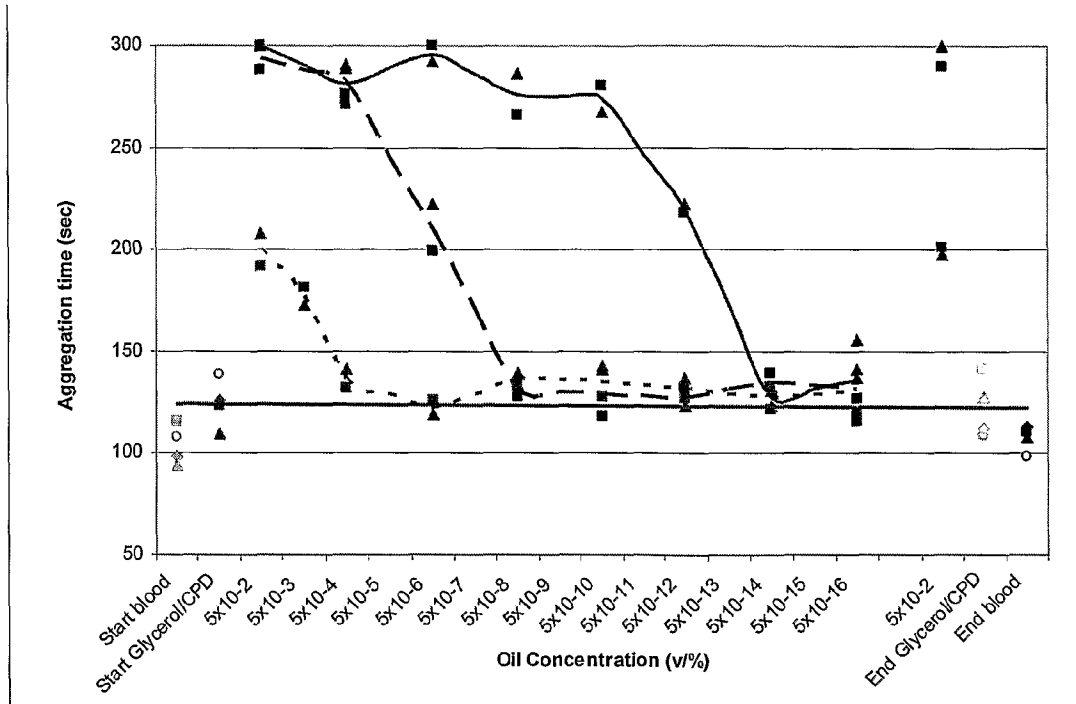
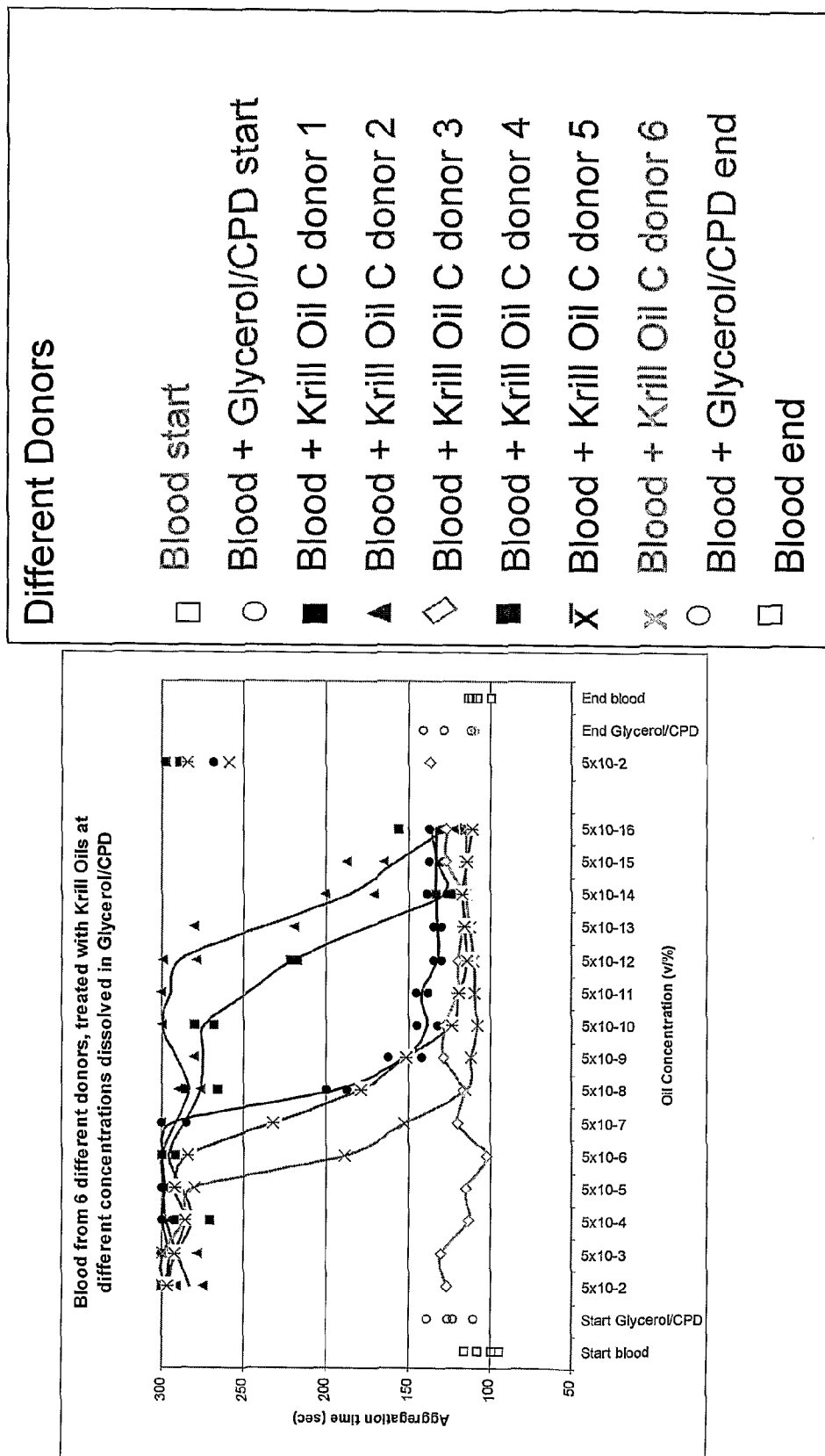

Figure 3



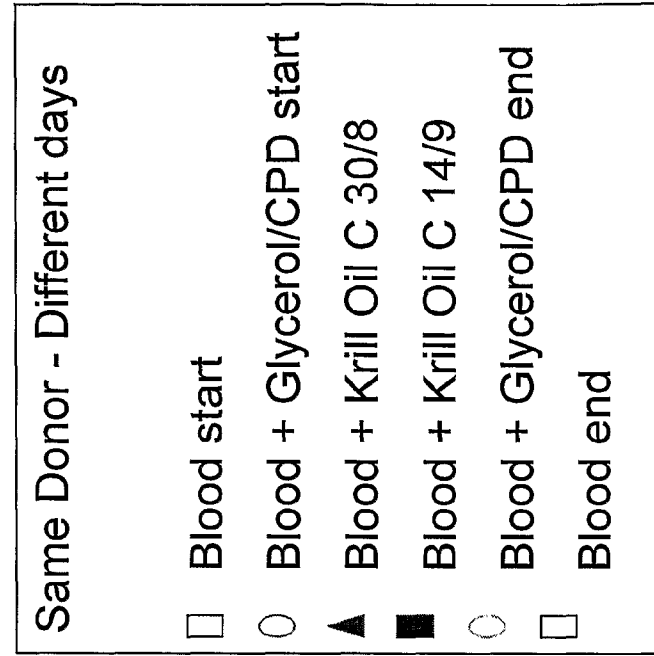

Figure 4

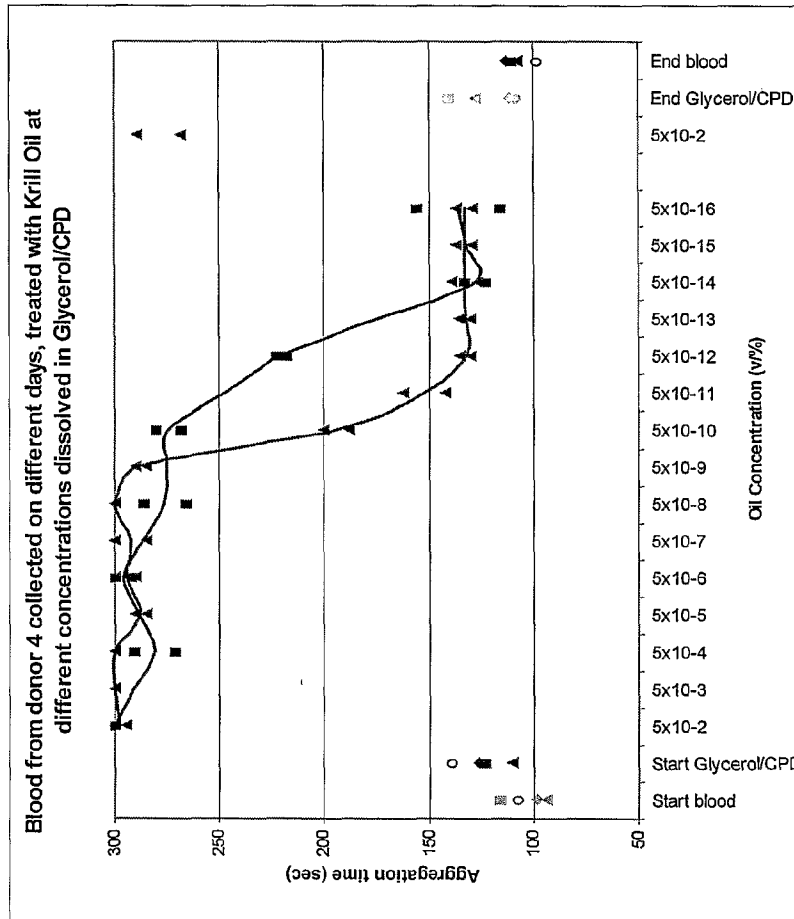

Figure 5

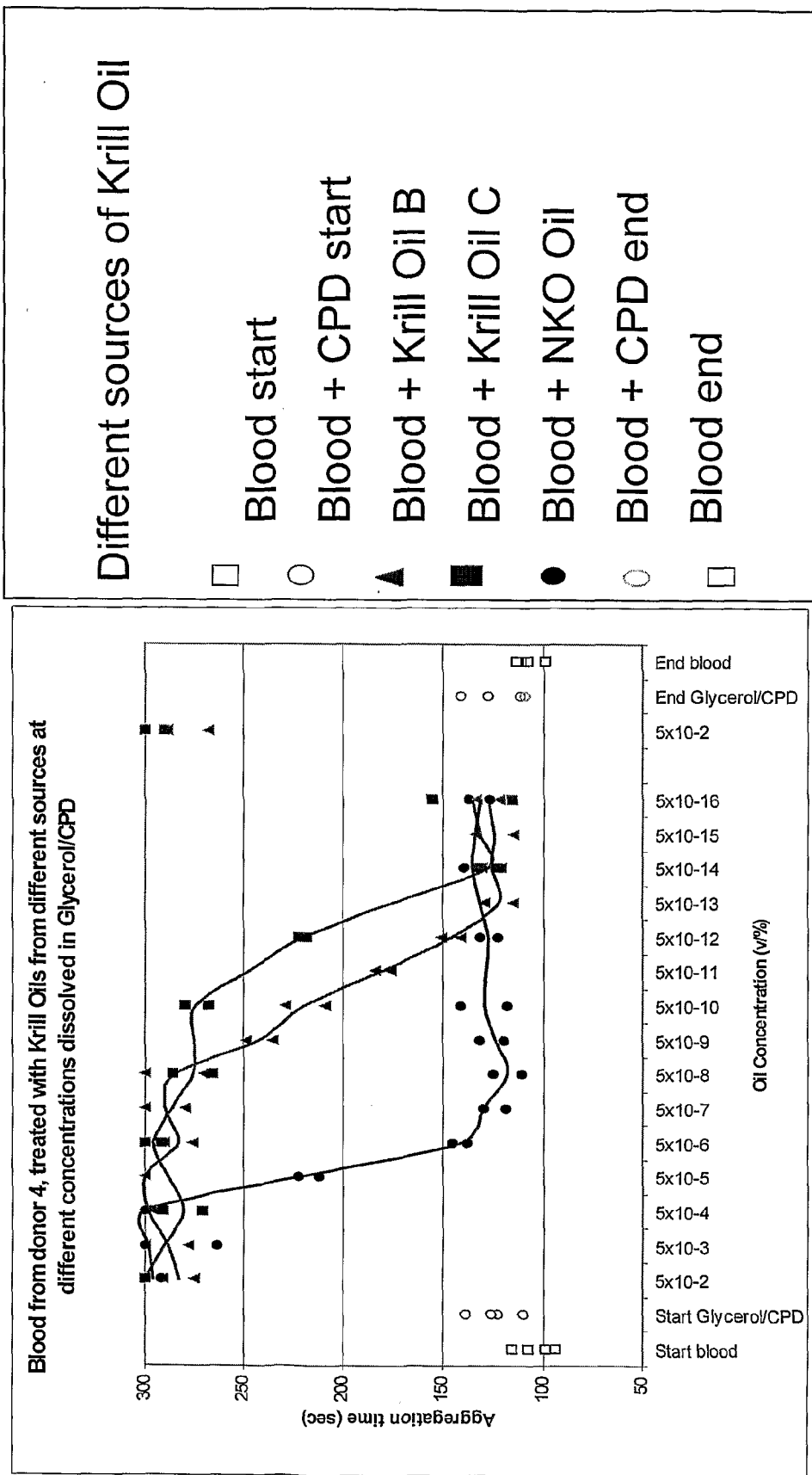
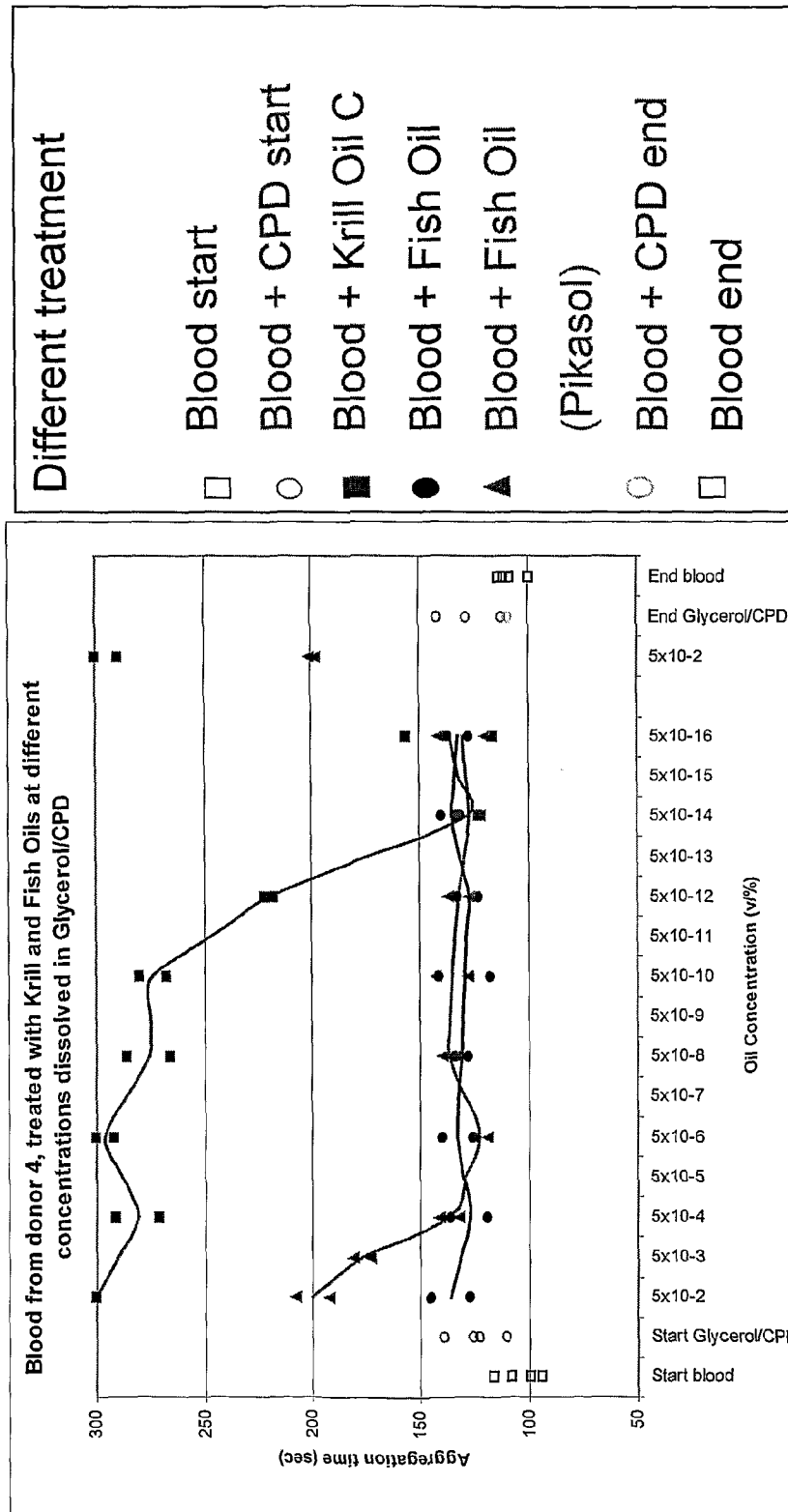

Figure 6



INTERNATIONAL SEARCH REPORT

International application No
PCT/IB2007/000099

A. CLASSIFICATION OF SUBJECT MATTER
 INV. A61P7/02 A61P9/10 A61P9/14 C11B1/02 C11B1/14
 A23L1/30 A23D9/00

According to International Patent Classification (IPC) or to both national classification and IPC

B. FIELDS SEARCHED
 Minimum documentation searched (classification system followed by classification symbols)
 C11B A23L A61P A23D

Documentation searched other than minimum documentation to the extent that such documents are included in the fields searched

Electronic data base consulted during the international search (name of data base and, where practical, search terms used)
 EPO-Internal, CHEM ABS Data, WPI Data, FSTA, BIOSIS

C. DOCUMENTS CONSIDERED TO BE RELEVANT

Category*	Citation of document, with indication, where appropriate, of the relevant passages	Relevant to claim No.
X	US 4 036 993 A (IKEDA IZUMI ET AL) 19 July 1977 (1977-07-19) example 2	1-8, 10-21, 27,28
X	DE 30 38 190 A1 (ALFA LAVAL AB [SE]) 23 April 1981 (1981-04-23) page 7, paragraph 2 - page 9, paragraph 2	1-8, 10-21, 27,28
X	WO 2005/075613 A (BEAUDOIN ADRIEN [CA]) 18 August 2005 (2005-08-18) page 6, paragraph 2 table 9	1-8, 10-21, 27,28
	----- -/--	

Further documents are listed in the continuation of Box C. See patent family annex.

* Special categories of cited documents :

A document defining the general state of the art which is not considered to be of particular relevance	*T* later document published after the international filing date or priority date and not in conflict with the application but cited to understand the principle or theory underlying the invention
E earlier document but published on or after the international filing date	*X* document of particular relevance; the claimed invention cannot be considered novel or cannot be considered to involve an inventive step when the document is taken alone
L document which may throw doubts on priority claim(s) or which is cited to establish the publication date of another citation or other special reason (as specified)	*Y* document of particular relevance; the claimed invention cannot be considered to involve an inventive step when the document is combined with one or more other such documents, such combination being obvious to a person skilled in the art.
O document referring to an oral disclosure, use, exhibition or other means	*Z* document member of the same patent family
P document published prior to the international filing date but later than the priority date claimed	

Date of the actual completion of the international search 25 April 2007	Date of mailing of the international search report 15/05/2007
--	--

Name and mailing address of the ISA/ European Patent Office, P.B. 5818 Patentlaan 2 NL - 2280 HV Rijswijk Tel. (+31-70) 340-2040, Tx. 31 651 epo nl, Fax: (+31-70) 340-3016	Authorized officer Rooney, Kevin
---	---

INTERNATIONAL SEARCH REPORT

International application No

PCT/IB2007/000099

C(Continuation). DOCUMENTS CONSIDERED TO BE RELEVANT		
Category*	Citation of document, with indication, where appropriate, of the relevant passages	Relevant to claim No.
X	<p>DATABASE CA [Online] CHEMICAL ABSTRACTS SERVICE, COLUMBUS, OHIO, US; 1989, PIVOVAROV, P. P. ET AL: "Electronic spectra of oil-based extracts from krill" XP002430957 retrieved from STN Database accession no. 1989:593160 abstract & IZVESTIYA VYSSHIKH UCHEBNYKH ZAVEDENII, PISHCHEVAYA TEKHNLOGIYA , (3), 72-4 CODEN: IVUPA8; ISSN: 0579-3009, 1989, -----</p>	<p>1-8, 10-21, 27,28</p>
X	<p>URAKAZE M ET AL: "INFUSION OF EMULSIFIED TRIICOSAPENTAENOYL-GLYCEROL INTO RABBITS. - THE EFFECTS ON PLATELET AGGREGATION, POLYMORPHONUCLEAR LEUKOCYTE ADHESION, AND FATTY ACID COMPOSITION IN PLASMA AND PLATELET PHOSPHOLIPIDS" THROMBOSIS RESEARCH, TARRYTOWN, NY, US, vol. 44, no. 5, 1986, pages 673-682, XP000650534 ISSN: 0049-3848 the whole document -----</p>	<p>1-25,27, 28</p>
X	<p>WO 02/102394 A (NEPTUNE TECHNOLOGIES & BIORESS [CA]; SAMPALIS TINA [CA]) 27 December 2002 (2002-12-27) the whole document -----</p>	<p>22-25</p>
X	<p>YAMAGUCHI, K., ET AL.: "Supercritical carbon dioxide extraction of oils from antarctic krill" JOURNAL OF AGRICULTURAL AND FOOD CHEMISTRY., vol. 34, 1986, pages 904-907, XP002430955 USAMERICAN CHEMICAL SOCIETY. WASHINGTON. the whole document -----</p>	<p>1-8, 10-21, 27,28</p>
X	<p>US 2004/241249 A1 (SAMPALIS TINA [CA]) 2 December 2004 (2004-12-02) example 1 -----</p>	<p>1-25,27, 28</p>
A	<p>BUNEA, R., EL FARRAH, K., AND DEUTSCH, L.: "Evaluation of the effects of neptune krill oil on the clinical course of hyperlipidemia" ALTERNATIVE MEDICINE REVIEW, vol. 9, no. 4, 2004, pages 420-428, XP002430956 USTHORNE RESEARCH INC., SANDPOINT, the whole document -----</p>	<p>1-28</p>
	----- -/--	

INTERNATIONAL SEARCH REPORT

International application No

PCT/IB2007/000099

C(Continuation). DOCUMENTS CONSIDERED TO BE RELEVANT

Category*	Citation of document, with indication, where appropriate, of the relevant passages	Relevant to claim No.
A	WO 95/33471 A (M D SERV EUROP S A [FR]; HELLGREN LARS [SE]; MOHR VIGGO [NO]; VINCENT) 14 December 1995 (1995-12-14) the whole document	26
A	WO 03/000061 A (TRANSUCRANIA S A [ES]; PIVOVAROV PAVEL PETROVICH [ES]; PIVOVAROV EUGEN) 3 January 2003 (2003-01-03) the whole document	1-28
A	DATABASE WPI Week 198810 Derwent Publications Ltd., London, GB; AN 1988-068398 XP002430959 & JP 63 023819 A (KAO CORP) 1 February 1988 (1988-02-01) abstract	1-28

INTERNATIONAL SEARCH REPORT

International application No.
PCT/IB2007/000099

Box II Observations where certain claims were found unsearchable (Continuation of item 2 of first sheet)

This International Search Report has not been established in respect of certain claims under Article 17(2)(a) for the following reasons:

1. Claims Nos.: —
because they relate to subject matter not required to be searched by this Authority, namely:

Although claims 22-26 are directed to a method of treatment of the human/animal body, the search has been carried out and based on the alleged effects of the compound/composition.
2. Claims Nos.:
because they relate to parts of the International Application that do not comply with the prescribed requirements to such an extent that no meaningful International Search can be carried out, specifically:
3. Claims Nos.:
because they are dependent claims and are not drafted in accordance with the second and third sentences of Rule 6.4(a).

Box III Observations where unity of invention is lacking (Continuation of item 3 of first sheet)

This International Searching Authority found multiple inventions in this international application, as follows:

1. As all required additional search fees were timely paid by the applicant, this International Search Report covers all searchable claims.
2. As all searchable claims could be searched without effort justifying an additional fee, this Authority did not invite payment of any additional fee.
3. As only some of the required additional search fees were timely paid by the applicant, this International Search Report covers only those claims for which fees were paid, specifically claims Nos.:
4. No required additional search fees were timely paid by the applicant. Consequently, this International Search Report is restricted to the invention first mentioned in the claims; it is covered by claims Nos.:

Remark on Protest

- The additional search fees were accompanied by the applicant's protest.
- No protest accompanied the payment of additional search fees.

INTERNATIONAL SEARCH REPORT

Information on patent family members

International application No PCT/IB2007/000099

Patent document cited in search report	Publication date	Patent family member(s)	Publication date	
US 4036993	A	19-07-1977	CA 1068542 A1	24-12-1979
			FR 2308320 A1	19-11-1976
			JP 932246 C	14-11-1978
			JP 51125773 A	02-11-1976
			JP 53007508 B	18-03-1978
			NO 753131 A	26-10-1976
			SU 727109 A3	05-04-1980
DE 3038190	A1	23-04-1981	JP 56064767 A	02-06-1981
			NO 803050 A	13-04-1981
			SE 431502 B	13-02-1984
			SE 7908433 A	12-04-1981
WO 2005075613	A	18-08-2005	EP 1727882 A1	06-12-2006
			US 2005192634 A1	01-09-2005
WO 02102394	A	27-12-2002	CA 2449898 A1	27-12-2002
			CN 1516592 A	28-07-2004
			EP 1406641 A2	14-04-2004
			JP 2004534800 T	18-11-2004
US 2004241249	A1	02-12-2004	NONE	
WO 9533471	A	14-12-1995	AU 7278094 A	04-01-1996
WO 03000061	A	03-01-2003	NONE	
JP 63023819	A	01-02-1988	NONE	



UNITED STATES PATENT AND TRADEMARK OFFICE

UNITED STATES DEPARTMENT OF COMMERCE
United States Patent and Trademark Office
Address: COMMISSIONER FOR PATENTS
P.O. Box 1450
Alexandria, Virginia 22313-1450
www.uspto.gov

Table with 5 columns: APPLICATION NO., FILING DATE, FIRST NAMED INVENTOR, ATTORNEY DOCKET NO., CONFIRMATION NO.
12/057,775 03/28/2008 Inge Bruheim NATNUT-14409/US-5/ORD 1945

72960 7590 01/06/2012
Casimir Jones, S.C.
2275 DEMING WAY, SUITE 310
MIDDLETON, WI 53562

EXAMINER

WARE, DEBORAH K

ART UNIT PAPER NUMBER

1651

MAIL DATE DELIVERY MODE

01/06/2012

PAPER

Please find below and/or attached an Office communication concerning this application or proceeding.

The time period for reply, if any, is set in the attached communication.

Office Action Summary

Application No. 12/057,775	Applicant(s) BRUHEIM ET AL.	
Examiner DEBBIE K. WARE	Art Unit 1651	

-- The MAILING DATE of this communication appears on the cover sheet with the correspondence address --

Period for Reply

A SHORTENED STATUTORY PERIOD FOR REPLY IS SET TO EXPIRE 3 MONTH(S) OR THIRTY (30) DAYS, WHICHEVER IS LONGER, FROM THE MAILING DATE OF THIS COMMUNICATION.

- Extensions of time may be available under the provisions of 37 CFR 1.136(a). In no event, however, may a reply be timely filed after SIX (6) MONTHS from the mailing date of this communication.
- If NO period for reply is specified above, the maximum statutory period will apply and will expire SIX (6) MONTHS from the mailing date of this communication.
- Failure to reply within the set or extended period for reply will, by statute, cause the application to become ABANDONED (35 U.S.C. § 133). Any reply received by the Office later than three months after the mailing date of this communication, even if timely filed, may reduce any earned patent term adjustment. See 37 CFR 1.704(b).

Status

- 1) Responsive to communication(s) filed on 31 October 2011.
- 2a) This action is **FINAL**.
- 2b) This action is non-final.
- 3) An election was made by the applicant in response to a restriction requirement set forth during the interview on _____; the restriction requirement and election have been incorporated into this action.
- 4) Since this application is in condition for allowance except for formal matters, prosecution as to the merits is closed in accordance with the practice under *Ex parte Quayle*, 1935 C.D. 11, 453 O.G. 213.

Disposition of Claims

- 5) Claim(s) 1-90 is/are pending in the application.
5a) Of the above claim(s) 1-54 and 56-90 is/are withdrawn from consideration.
- 6) Claim(s) _____ is/are allowed.
- 7) Claim(s) 50-55 is/are rejected.
- 8) Claim(s) _____ is/are objected to.
- 9) Claim(s) _____ are subject to restriction and/or election requirement.

Application Papers

- 10) The specification is objected to by the Examiner.
- 11) The drawing(s) filed on 7/16/08 and 3/28/08 is/are: a) accepted or b) objected to by the Examiner.
Applicant may not request that any objection to the drawing(s) be held in abeyance. See 37 CFR 1.85(a).
Replacement drawing sheet(s) including the correction is required if the drawing(s) is objected to. See 37 CFR 1.121(d).
- 12) The oath or declaration is objected to by the Examiner. Note the attached Office Action or form PTO-152.

Priority under 35 U.S.C. § 119

- 13) Acknowledgment is made of a claim for foreign priority under 35 U.S.C. § 119(a)-(d) or (f).
a) All b) Some * c) None of:
1. Certified copies of the priority documents have been received.
2. Certified copies of the priority documents have been received in Application No. _____.
3. Copies of the certified copies of the priority documents have been received in this National Stage application from the International Bureau (PCT Rule 17.2(a)).

* See the attached detailed Office action for a list of the certified copies not received.

Attachment(s)

- 1) Notice of References Cited (PTO-892)
- 2) Notice of Draftsperson's Patent Drawing Review (PTO-948)
- 3) Information Disclosure Statement(s) (PTO/SB/08)
Paper No(s)/Mail Date 3/8/11, (2 of 2).
- 4) Interview Summary (PTO-413)
Paper No(s)/Mail Date. _____.
- 5) Notice of Informal Patent Application
- 6) Other: _____.

DETAILED ACTION

Claims 1-90 are pending.

Information Disclosure Statement

The information disclosure statements (IDSs) submitted on March 8, 2011, were received. The submission are in compliance with the provisions of 37 CFR 1.97. Accordingly, the information disclosure statements are being considered by the examiner.

Election/Restrictions

Applicant's election without traverse of Group VIII, claims 50-55, in the reply filed on October 31, 2011, is acknowledged.

Claims 1-49 and 56-90 are hereby withdrawn from further consideration pursuant to 37 CFR 1.142(b) as being drawn to a nonelected inventions, there being no allowable generic or linking claim. Election was made **without** traverse in the reply filed on October 31, 2011.

Claim Rejections - 35 USC § 112

The following is a quotation of the second paragraph of 35 U.S.C. 112:

The specification shall conclude with one or more claims particularly pointing out and distinctly claiming the subject matter which the applicant regards as his invention.

Claims 50-55 are rejected under 35 U.S.C. 112, second paragraph, as being indefinite for failing to particularly point out and distinctly claim the subject matter which applicant regards as the invention.

Claim 50 recites the limitation "oil" in line 3. There is insufficient antecedent basis for this limitation in the claim.

Art Unit: 1651

Claim 54 recites the limitation "said co-solvent" in line 4. There is insufficient antecedent basis for this limitation in the claim. It is unclear that the recitation refers to "a cosolvent" in first extraction step and second extraction. Also "a second extraction" lacks antecedent basis for step b) because it does not refer to step b) in terms of second extraction step. Also "An oil" as recited in claim 55, lacks antecedent basis.

Claim Rejections - 35 USC § 102

The following is a quotation of the appropriate paragraphs of 35 U.S.C. 102 that form the basis for the rejections under this section made in this Office action:

A person shall be entitled to a patent unless –

(b) the invention was patented or described in a printed publication in this or a foreign country or in public use or on sale in this country, more than one year prior to the date of application for patent in the United States.

Claims 50-53 and 55 are rejected under 35 U.S.C. 102(b) as being clearly anticipated by Patent Abstract of Japan 04-057853, dated Feb. 25, 1992, cited on enclosed PTO-1449 Form.

Claims drawn to method for producing oil and an oil produced thereby.

Abstract 04-057853 teaches method for extracting krill oil comprising a)providing krill meal; and extracting oil from the krill meal (powdered form of krill parts). The meal (powdered form of krill parts) can be provided from heat-treated krill parts and is storable. The extracting is carried out by supercritical extraction. An oil is produced by the method.

The claims are identical to the abstract as discussed above and are considered to be clearly anticipated by the teachings therein. Krill shells are part of krill and oil is obtained from the krill parts. The krill parts are dried and hence subjected to heating to

Art Unit: 1651

provide for the krill meal which is subjected to supercritical extraction in two steps to obtain the oil.

Claim Rejections - 35 USC § 103

The following is a quotation of 35 U.S.C. 103(a) which forms the basis for all obviousness rejections set forth in this Office action:

(a) A patent may not be obtained though the invention is not identically disclosed or described as set forth in section 102 of this title, if the differences between the subject matter sought to be patented and the prior art are such that the subject matter as a whole would have been obvious at the time the invention was made to a person having ordinary skill in the art to which said subject matter pertains. Patentability shall not be negated by the manner in which the invention was made.

The factual inquiries set forth in *Graham v. John Deere Co.*, 383 U.S. 1, 148 USPQ 459 (1966), that are applied for establishing a background for determining obviousness under 35 U.S.C. 103(a) are summarized as follows:

1. Determining the scope and contents of the prior art.
2. Ascertaining the differences between the prior art and the claims at issue.
3. Resolving the level of ordinary skill in the pertinent art.
4. Considering objective evidence present in the application indicating obviousness or nonobviousness.

This application currently names joint inventors. In considering patentability of the claims under 35 U.S.C. 103(a), the examiner presumes that the subject matter of the various claims was commonly owned at the time any inventions covered therein were made absent any evidence to the contrary. Applicant is advised of the obligation under 37 CFR 1.56 to point out the inventor and invention dates of each claim that was not commonly owned at the time a later invention was made in order for the examiner to consider the applicability of 35 U.S.C. 103(c) and potential 35 U.S.C. 102(e), (f) or (g) prior art under 35 U.S.C. 103(a).

Art Unit: 1651

Claim 54 is rejected under 35 U.S.C. 103(a) as being unpatentable over JP as cited and discussed above, in view of Kamiya et al (US 20060193962A1), cited on enclosed PTO-892 Form.

Claims are discussed above as if the JP abstract.

Kamiya et al, US 20060193962A1, teach extraction with supercritical fluid and solvent [0043], and the solvent can be a monohydric alcohol [0049], ranging from 1 to 20% [0059].

Claim differs from JP in that monohydric alcohol is not disclosed.

It would have been obvious to one of ordinary skill in the art at the time the claimed invention was made to carry out supercritical extraction of JP using a co-solvent monohydric alcohol as disclosed by Kamiya et al to produce oil from krill.

Each of the claim feature are disclosed and one of skill would have been motivated to carry out the process steps to provide oil with the expectation of successful results. Clearly the claim is prima facie obvious over the cited prior art.

All claims fail to be patentably distinguishable over the state of the art discussed above and cited on the enclosed PTO-892 and/or PTO-1449. Therefore, the claims are properly rejected.

The remaining references listed on the enclosed PTO-892 and/or PTO-1449 are cited to further show the state of the art.

No claims are allowed.

Art Unit: 1651

Any inquiry concerning this communication or earlier communications from the examiner should be directed to DEBBIE K. WARE whose telephone number is (571)272-0924. The examiner can normally be reached on 9:30-6:00.

If attempts to reach the examiner by telephone are unsuccessful, the examiner's supervisor, Mike Wityshyn can be reached on 571-272-0926. The fax phone number for the organization where this application or proceeding is assigned is 571-273-8300.

Information regarding the status of an application may be obtained from the Patent Application Information Retrieval (PAIR) system. Status information for published applications may be obtained from either Private PAIR or Public PAIR. Status information for unpublished applications is available through Private PAIR only. For more information about the PAIR system, see <http://pair-direct.uspto.gov>. Should you have questions on access to the Private PAIR system, contact the Electronic Business Center (EBC) at 866-217-9197 (toll-free). If you would like assistance from a USPTO Customer Service Representative or access to the automated information system, call 800-786-9199 (IN USA OR CANADA) or 571-272-1000.

/Deborah K. Ware/
Deborah K. Ware
Primary Examiner
Art Unit 1651

Notice of References Cited	Application/Control No. 12/057,775	Applicant(s)/Patent Under Reexamination BRUHEIM ET AL.	
	Examiner DEBBIE K. WARE	Art Unit 1651	Page 1 of 1

U.S. PATENT DOCUMENTS

*	Document Number Country Code-Number-Kind Code	Date MM-YYYY	Name	Classification
*	A US-2006/0193962	08-2006	Kamiya et al.	426/615
	B US-			
	C US-			
	D US-			
	E US-			
	F US-			
	G US-			
	H US-			
	I US-			
	J US-			
	K US-			
	L US-			
	M US-			

FOREIGN PATENT DOCUMENTS

*	Document Number Country Code-Number-Kind Code	Date MM-YYYY	Country	Name	Classification
	N				
	O				
	P				
	Q				
	R				
	S				
	T				

NON-PATENT DOCUMENTS

*	Document Number Country Code-Number-Kind Code	Date MM-YYYY	Country	Name	Classification
	Include as applicable: Author, Title Date, Publisher, Edition or Volume, Pertinent Pages)				
	U				
	V				
	W				
	X				

*A copy of this reference is not being furnished with this Office action. (See MPEP § 707.05(a).)
Dates in MM-YYYY format are publication dates. Classifications may be US or foreign.

Receipt date: 03/08/2011

12057775 - GAI: 1651

Doc code: IDS

Doc description: Information Disclosure Statement (IDS) Filed

Approved for use through 07/31/2012. OMB 0651-0031
U.S. Patent and Trademark Office; U.S. DEPARTMENT OF COMMERCE

Under the Paperwork Reduction Act of 1995, no persons are required to respond to a collection of information unless it contains a valid OMB control number.

INFORMATION DISCLOSURE STATEMENT BY APPLICANT (Not for submission under 37 CFR 1.99)	Application Number	12057775
	Filing Date	2008-03-28
	First Named Inventor	Inge Bruheim
	Art Unit	1636
	Examiner Name	
	Attorney Docket Number	NATNUT-14409/US-5/ORD

U.S.PATENTS							Remove
Examiner Initial*	Cite No	Patent Number	Kind Code ¹	Issue Date	Name of Patentee or Applicant of cited Document	Pages,Columns,Lines where Relevant Passages or Relevant Figures Appear	
	1	4119619		1978-10-10	ROGOZHIN SERGEI VASILIEVICH et al.		
	2	5434183		1995-07-18	LARSSON-BACKSTROM		
	3	6537787		2003-03-25	GILDAS		
	4	6800299		2004-10-05	BEAUDOIN & MARTIN		
	5	5266564		1993-11-30	MODELELL et al		

If you wish to add additional U.S. Patent citation information please click the Add button.

Add

U.S.PATENT APPLICATION PUBLICATIONS							Remove
Examiner Initial*	Cite No	Publication Number	Kind Code ¹	Publication Date	Name of Patentee or Applicant of cited Document	Pages,Columns,Lines where Relevant Passages or Relevant Figures Appear	
	1	20030044495		2003-03-06	KAGAN and BRAUN		

INFORMATION DISCLOSURE STATEMENT BY APPLICANT (Not for submission under 37 CFR 1.99)	Application Number		12057775	12057775 - GAU: 1651
	Filing Date		2008-03-28	
	First Named Inventor	Inge Bruheim		
	Art Unit		1636	
	Examiner Name			
	Attorney Docket Number		NATNUT-14409/US-5/ORD	

2	20040241249	2004-12-02	SAMPALIS	
---	-------------	------------	----------	--

If you wish to add additional U.S. Published Application citation information please click the Add button.

FOREIGN PATENT DOCUMENTS

Examiner Initial*	Cite No	Foreign Document Number ³	Country Code ² i	Kind Code ⁴	Publication Date	Name of Patentee or Applicant of cited Document	Pages, Columns, Lines where Relevant Passages or Relevant Figures Appear	T ⁵
	1	8701265	BR		1987-03-12	SATO		<input type="checkbox"/>
	2	1098900	CA		1981-04-07	ROGOZHIN, et al		<input type="checkbox"/>
	3	0609078	EP		1994-08-03	SCOTIA HOLDINGS PLC		<input type="checkbox"/>
	4	1127497	EP		2001-08-29	NIPPON SUISAN KAISHA LTD		<input type="checkbox"/>
	5	1406641	EP		2004-04-14	NEPTUNE TECHNOLOGIES & BIORESSOURCES INC.		<input type="checkbox"/>
	6	670306	EP		1995-06-09	NIPPON OIL CO. LTD		<input type="checkbox"/>
	7	2097014	GB		1982-10-27	BAIKOFF		<input type="checkbox"/>
	8	921537	GB		1999-06-09	PICKER NORDSTAR INC.		<input type="checkbox"/>

Receipt date: 03/08/2011

Application Number	12057775	12057775 - GAU: 1651
Filing Date	2008-03-28	
First Named Inventor	Inge Bruheim	
Art Unit	1636	
Examiner Name		
Attorney Docket Number	NATNUT-14409/US-5/ORD	

**INFORMATION DISCLOSURE
STATEMENT BY APPLICANT**
(Not for submission under 37 CFR 1.99)

9	02049091	JP		1990-02-19	SUNTORY LTD	<input type="checkbox"/>
10	2215351	JP		1990-08-28	TAIYO FISHERY CO LTD.	<input type="checkbox"/>
11	2524217	JP		1996-08-14	TAIYO FISHERY CO LTD.	<input type="checkbox"/>
12	2963152	JP		1992-02-25	CHLORINE ENG CORP LTD	<input type="checkbox"/>
13	2000/23546	WO		2000-04-27	UNIV SHERBROOKE	<input type="checkbox"/>
14	3081692	JP		1994-07-19	CHLORINE ENG CORP LTD	<input type="checkbox"/>
15	3344887	JP		1997-07-08	IKEDA SHOKKEN KK	<input type="checkbox"/>
16	3467794	JP		2003-09-05	NIPPON OIL & FATS CO LTD	<input type="checkbox"/>
17	3486778	JP		2003-10-31	GREEN CROSS CORP	<input type="checkbox"/>
18	3611222	JP		1997-08-05	CHLORINE ENG CORP LTD	<input type="checkbox"/>
19	3678317	JP		2005-05-20	CHLORINE ENG CORP LTD	<input type="checkbox"/>

INFORMATION DISCLOSURE STATEMENT BY APPLICANT (Not for submission under 37 CFR 1.99)	Receipt date: 03/08/2011	Application Number	12057775	12057775 - GAU: 1651
	Filing Date	2008-03-28		
	First Named Inventor	Inge Bruheim		
	Art Unit	1636		
	Examiner Name			
	Attorney Docket Number	NATNUT-14409/US-5/ORD		

20	4012665	JP		1992-01-17	MATSUSHITA ELECTRIC IND CO LTD	<input type="checkbox"/>
21	61281159	JP		1986-12-11	SHISEIDO CO LTD; NIPPON SUISAN KAISHA LTD.	<input type="checkbox"/>
22	2001-158736	JP	A	2001-06-12	SNOW BRAND MILK PROD CO LTD	<input type="checkbox"/>
23	2003-003192	JP	A	2003-01-08	UNITIKA LTD	<input type="checkbox"/>
24	2003-048831	JP	A	2003-02-21	SUNTORY LTD	<input type="checkbox"/>
25	2003-146883	JP	A	2003-05-21	SNOW BRAND MILK PROD CO LTD	<input type="checkbox"/>
26	2003-531857	JP	A	2003-10-28	HENDERSON	<input type="checkbox"/>
27	2004-525180	JP	A	2004-08-19	YEDA RESEARCH AND DEVELOPMENT CO. LTD.	<input type="checkbox"/>
28	2004-536059	JP	A	2004-12-02	MARTEK BIOSCIENCES BOULDER CORPORATION	<input type="checkbox"/>
29	2005-245379	JP	A	2005-09-15	NIPPON SUISAN KAISHA LTD	<input type="checkbox"/>
30	2006-069948	JP	A	2006-03-16	HIROSE YUKIHIRO	<input type="checkbox"/>

INFORMATION DISCLOSURE STATEMENT BY APPLICANT (Not for submission under 37 CFR 1.99)	Receipt date: 03/08/2011	Application Number	12057775	12057775 - GAU: 1651
	Filing Date	2008-03-28		
	First Named Inventor	Inge Bruheim		
	Art Unit	1636		
	Examiner Name			
	Attorney Docket Number	NATNUT-14409/US-5/ORD		

	31	2006-083136	JP	A	2006-03-30	SUNTORY LTD		<input type="checkbox"/>
	32	2006-290784	JP	A	2006-10-26	HIROSE YUKIHIRO		<input type="checkbox"/>
	33	2006-316073	JP	A	2006-11-24	IBR ISRAELI BIOTECHNOLOGY RESEARCH LTD		<input type="checkbox"/>
	34	2006-328014	JP	A	2006-12-07	HIROSE YUKIHIRO		<input type="checkbox"/>
	35	2006-502196	JP	A	2006-01-19	SUNTORY LIMITED		<input type="checkbox"/>
	36	2006-528233	JP	A	2006-12-14	BTG INTERNATIONAL LIMITED		<input type="checkbox"/>
	37	2007-126455	JP	A	2007-05-24	FUJI CHEM IND CO LTD		<input type="checkbox"/>
	38	2007-246404	JP	A	2007-09-27	SNOW BRAND MILK PROD CO LTD		<input type="checkbox"/>
	39	2007-502805	JP	A	2007-02-15	BTG INTERNATIONAL LIMITED		<input type="checkbox"/>
	40	2007-509131	JP	A	2007-04-12	ENZYMOTEC LTD.		<input type="checkbox"/>
	41	2007-518764	JP	A	2007-07-12	BRUZZESE		<input type="checkbox"/>

INFORMATION DISCLOSURE STATEMENT BY APPLICANT (Not for submission under 37 CFR 1.99)	Application Number	12057775	12057775 - GAU: 1651
	Filing Date	2008-03-28	
	First Named Inventor	Inge Bruheim	
	Art Unit	1636	
	Examiner Name		
	Attorney Docket Number	NATNUT-14409/US-5/ORD	

42	220741	SU		1971-01-06	KRGUCHKOV		<input type="checkbox"/>
43	1986/06082	WO		1986-10-23	MAT-CON RADGIVENDE INGENIØRFIRMA A/S		<input type="checkbox"/>
44	1990/05765	WO		1990-05-31	MIKALSEN		<input type="checkbox"/>
45	1993/24142	WO		1993-12-09	PHAIRSON MEDICAL AB		<input type="checkbox"/>
46	1997/38585	WO		1997-10-23	THE UNIVERSITY OF BRITISH COLUMBIA		<input type="checkbox"/>
47	1997/39759	WO		1997-10-30	BRIGHAM AND WOMEN'S HOSPITAL		<input type="checkbox"/>
48	1998/34498	WO		1998-08-13	BIOZYME SYSTEMS INC.		<input type="checkbox"/>
49	1999/39589	WO		1999-08-12	BIOZYME SYSTEMS INC.		<input type="checkbox"/>

If you wish to add additional Foreign Patent Document citation information please click the Add button

NON-PATENT LITERATURE DOCUMENTS

Examiner Initials*	Cite No	Include name of the author (in CAPITAL LETTERS), title of the article (when appropriate), title of the item (book, magazine, journal, serial, symposium, catalog, etc), date, pages(s), volume-issue number(s), publisher, city and/or country where published.	T ⁵
	1	ANDO and HATANO, 1988, "Isolation of apolipoproteins from carotenoid-carrying lipoprotein in the serum of chum salmon, <i>Oncorhynchus keta</i> ", J. Lipid Research, 29: 1264-1271	<input type="checkbox"/>

INFORMATION DISCLOSURE STATEMENT BY APPLICANT (Not for submission under 37 CFR 1.99)	Receipt date: 03/08/2011	Application Number	12057775	12057775 - GAU: 1651
	Filing Date	2008-03-28		
	First Named Inventor	Inge Bruheim		
	Art Unit	1636		
	Examiner Name			
	Attorney Docket Number	NATNUT-14409/US-5/ORD		

2	AOI et al., 2003, "Astaxanthin limits exercise-induced skeletal and cardiac muscle damage in mice", <i>Antioxidants & Redox Signaling</i> , 5(1): 139-44	<input type="checkbox"/>
3	BRITTON, 1985, "General Carotenoid Methods", <i>Methods in Enzymology</i> , Vol 111, pp. 113-149	<input type="checkbox"/>
4	CALDER, 2006, "n-3 polyunsaturated fatty acids, inflammation, and inflammatory diseases", <i>Am. J. Clin. Nutr.</i> , 83: 1505S	<input type="checkbox"/>
5	CHAREST et al., 2001, "Astaxanthin Extraction from Crawfish Shells by Supercritical CO2 with Ethanol as Cosolvent", <i>J. Aquatic Food Product Technology</i> , 10(3): 79-93	<input type="checkbox"/>
6	CHEN and MEYERS, 1982, "Extraction of Astaxanthin Pigment from Crawfish Waste Using a Soy Oil Process", <i>J. Food Sci.</i> , 47: 892-896	<input type="checkbox"/>
7	CLARKE, 1980, "The Biochemical Composition of Krill, <i>Euphausia superba</i> dana, from South Georgia", <i>J. Exp. Mar. Biol. Ecol.</i> , 43: 221-236	<input type="checkbox"/>
8	CZECZUGA, 1974, "Comparative Studies of Carotenoids in the Fauna of the Gullmar Fjord (Bohuslan, Sweden). II. Crustacea: <i>Eupagurus bernhardus</i> , <i>Hyas coarctatus</i> and <i>Upogebia deltaura</i> ", <i>Marine Biology</i> , 28: 95-98	<input type="checkbox"/>
9	DE RITTER and PURCELL, 1981, "Carotenoid Analytical Methods", <i>Carotenoids as Colorants and Vitamin A Precursors: Technological and Nutritional Applications</i> , pp 815-882	<input type="checkbox"/>
10	DEUTCH, 1995, "Menstrual pain in Danish women correlated with low n-3 polyunsaturated fatty acid intake", <i>Eur. J. Clin. Nutr.</i> , 49(7): 508-16	<input type="checkbox"/>
11	DIEZ et al., 2003, "The role of the novel adipocyte-derived hormone adiponectin in human disease", <i>Eur. J. Endocrinol.</i> , 148(3): 293-300	<input type="checkbox"/>
12	ELLINGSEN et al., 1987, "Biochemistry of the autolytic processes in Antarctic krill post mortem. Autoproteolysis." <i>Biochem. J.</i> 246, 295-305	<input type="checkbox"/>

INFORMATION DISCLOSURE STATEMENT BY APPLICANT (Not for submission under 37 CFR 1.99)	Application Number	12057775	12057775 - GAU: 1651
	Filing Date	2008-03-28	
	First Named Inventor	Inge Bruheim	
	Art Unit	1636	
	Examiner Name		
	Attorney Docket Number	NATNUT-14409/US-5/ORD	

13	EMODI, 1978, "Carotenoids: Properties and Applications", Food Technology, 32(5): 38	<input type="checkbox"/>
14	FELIX-VALENZUELA et al., 2001, "Supercritical CO2/Ethanol Extraction of Astaxanthin from Blue Crab (Callinectes Sapidus) Shell Waste", Journal of Food Process Engineering, 24: 101-112	<input type="checkbox"/>
15	FOX and SCHEER, 1941, "Comparative Studies of the Pigments of Some Pacific Coast Echinoderms", The Biological Bulletin, 441-455	<input type="checkbox"/>
16	FRICKE, et al., 1984, "Lipid, Sterol and Fatty Acid Composition of Antarctic Krill (Euphausia superba Dana)", Lipids, 19 (11): 821-827	<input type="checkbox"/>
17	GEUSENS et al., 1994, "Long-term effect of omega-3 fatty acid supplementation in active rheumatoid arthritis. A 12-month, double-blind, controlled study", Arthritis Rheum., 37(6): 824-9	<input type="checkbox"/>
18	GILCHRIST and GREEN, 1960, "The Pigments of Artemia", Proceedings of the Royal Society, Series B Biological Sciences, Vol 152 No. 946, pp 118-136	<input type="checkbox"/>
19	GOODWIN and SRISUKH, 1949, "Some Observations on Astaxanthin Distribution in Marine Crustacea", Department of Biochemistry, University of Liverpool, pp. 268-270	<input type="checkbox"/>
20	GULYAEV and BUGROVA, 1976 "Removing fats from the protein paste "Okean". Konservnaya I Ovoshchesushil'naya Promyshlennost, (4), 37-8	<input type="checkbox"/>
21	HARDARDOTTIR and KINSELLA, 1988, "Extraction of Lipid and Cholesterol from Fish Muscle with Supercritical Fluids" Journal of Food Science, 53(6): 1656-1658	<input type="checkbox"/>
22	INTERNATIONAL AQUA FEED, 2006, Vol. 9	<input type="checkbox"/>
23	International Search Report and Written Opinion for PCT/GB2008/002934, Dated 2009-03-11	<input type="checkbox"/>

INFORMATION DISCLOSURE STATEMENT BY APPLICANT (Not for submission under 37 CFR 1.99)	Application Number	12057775	12057775 - GAU: 1651
	Filing Date	2008-03-28	
	First Named Inventor	Inge Bruheim	
	Art Unit	1636	
	Examiner Name		
	Attorney Docket Number	NATNUT-14409/US-5/ORD	

24	International Search Report and Written Opinion for PCT/IB2010/000512; dated 2010-06-24	<input type="checkbox"/>
25	International Search Report for PCT/IB2007/000098, dated: 2007-06-26	<input type="checkbox"/>
26	ITOH et al., 2007; "Increased adiponectin secretion by highly purified eicosapentaenoic acid in rodent models of obesity and human obese subjects", <i>Arteriosclerosis, Thrombosis, and Vascular Biology</i> ; 27(9): 1918-1925	<input type="checkbox"/>
27	JOHNSON et al., 1978, "Simple Method for the Isolation of Astaxanthin from the Basidiomycetous Yeast <i>Phaffia rhodozyma</i> ", <i>Applied and Environmental Microbiology</i> , 35(6): 1155-1159	<input type="checkbox"/>
28	KOLAKOWSKA, 1989, "Krill lipids after frozen storage of about one year in relation to storage time before freezing", <i>Die Nahrung Food</i> , 33(3): 241-244	<input type="checkbox"/>
29	KRIS-ETHERTON et al., 2002, "Fish Consumption, Fish Oil, Omega-3 Fatty Acids, and Cardiovascular Disease", <i>Circulation</i> , 106:2747-2757	<input type="checkbox"/>
30	KRISTENSEN et al., 1989, "Dietary supplementation with n-3 polyunsaturated fatty acids and human platelet function: a review with particular emphasis on implications for cardiovascular disease", <i>J. Intern. Med. Suppl.</i> 731:141-50	<input type="checkbox"/>
31	KUNESOVA et al., 2006, "The influence of n-3 polyunsaturated fatty acids and very low calorie diet during a short-term weight reducing regimen on weight loss and serum fatty acid composition in severely obese women", <i>Physiol Res.</i> ; 55 (1):63-72	<input type="checkbox"/>
32	LAIGHT et al., 1999, "F2-isoprostane evidence of oxidant stress in the insulin resistant, obese Zucker rat: effects of vitamin E", <i>Eur. J. Pharmacol.</i> 377(1): 89-92	<input type="checkbox"/>
33	LAMBERTSON and BRAEKKAN, 1971, "Method of Analysis of Astaxanthin and its Occurrence in some Marine Products," <i>J. Sci. Food. Agr.</i> , Vol 22(2): 99-101	<input type="checkbox"/>
34	LIBBY et al., 2006, "Inflammation and Atherothrombosis: From Population Biology and Bench Research to Clinical Practice", <i>J. Amer. Coll. Card.</i> , 48 (9, Suppl. A): A33-A46	<input type="checkbox"/>

INFORMATION DISCLOSURE STATEMENT BY APPLICANT (Not for submission under 37 CFR 1.99)	Application Number	12057775	12057775 - GAU: 1651
	Filing Date	2008-03-28	
	First Named Inventor	Inge Bruheim	
	Art Unit	1636	
	Examiner Name		
	Attorney Docket Number	NATNUT-14409/US-5/ORD	

35	LOPEZ et al., 2004, "Selective extraction of astaxanthin from crustaceans by use of supercritical carbon dioxide", Talanta, 64: 726-731	<input type="checkbox"/>
36	MANDEVILLE, 1991, "Isolation and Identification of Carotenoid Pigments, Lipids and Flavor Active Components from Raw Commercial Shrimp Waste", Food Biotechnology, 5(2): 185-195	<input type="checkbox"/>
37	MEYERS and BLIGH, 1981, "Characterization of Astaxanthin Pigments from Heat-Processed Crawfish Waste", J. Agric. Food Chem., 29: 505-508	<input type="checkbox"/>
38	MEYERS, 1977, "Using Crustacean Meals and Carotenoid-Fortified Diets", Feedstuffs, Vol. 49(19)	<input type="checkbox"/>
39	MEYERS, 1994, "Developments in world aquaculture, feed formulations, and role of carotenoids", Pure & Appl. Chem, Vol. 66(5): 1069-1076	<input type="checkbox"/>
40	MILLS et al., 1989, "Dietary N-6 and N-3 fatty acids and salt-induced hypertension in the borderline hypertensive rat", Lipids, 24(1): 17-24	<input type="checkbox"/>
41	MOATES and VAN BENTEM, 1990, "Separating out the value", Food Science and Technology Today, 4(4): 213-214	<input type="checkbox"/>
42	NIKOLAEVA, 1967 "Amino acid composition of protein-coagulate in krill", VNIRO, 63:161-4	<input type="checkbox"/>
43	PHLEGER, et al. (2002) "Interannual and between species comparison in the lipids, fatty acids, and sterols of Antarctic krill from the US AMLR Elephant Island survey area: 1997 and 1998". Comp Biochem Physiol 131B:733-747	<input type="checkbox"/>
44	POPP-SNIJDERS et al., 1987, "Dietary supplementation of omega-3 polyunsaturated fatty acids improves insulin sensitivity in non-insulin-dependent diabetes", Diabetes Res. 4(3): 141-7	<input type="checkbox"/>
45	SACHINDRA, 2006, "Recovery of carotenoids from shrimp waste in organic solvents", Waste Management, 26: 1092-1098	<input type="checkbox"/>

Receipt date: 03/08/2011 INFORMATION DISCLOSURE STATEMENT BY APPLICANT (Not for submission under 37 CFR 1.99)	Application Number		12057775	12057775 - GAU: 1651
	Filing Date		2008-03-28	
	First Named Inventor	Inge Bruheim		
	Art Unit	1636		
	Examiner Name			
	Attorney Docket Number	NATNUT-14409/US-5/ORD		

46	SAETHER et al., 1986, "Lipids of North Atlantic krill", J Lipid Res., 27(3):274-85.	<input type="checkbox"/>
47	SHAHIDI et al., 1998, "Carotenoid Pigments in Seafoods and Aquaculture" Critical Reviews in Food Science, 38(1): 1-67	<input type="checkbox"/>
48	SIDEHU et al., 1970, "Biochemical Composition and Nutritive Value of Krill (Euphausia superb dana)", J. Sci Food Agr., Vol 21, 293-296	<input type="checkbox"/>
49	SIMOPOULOS, 1991, "Omega-3 fatty acids in health and disease and in growth and development", Am. Clin. Nutr. 54:438-63	<input type="checkbox"/>
50	SOMIYA, 1982, "'Yellow lens' eyes of a stomiatoid deep-sea fish, Malacosteus niger", Proc. R. Soc. Lond., 215: 481-489	<input type="checkbox"/>

If you wish to add additional non-patent literature document citation information please click the Add button

EXAMINER SIGNATURE

Examiner Signature	/Deborah Ware/	Date Considered	12/30/11
--------------------	----------------	-----------------	----------

*EXAMINER: Initial if reference considered, whether or not citation is in conformance with MPEP 609. Draw line through a citation if not in conformance and not considered. Include copy of this form with next communication to applicant.

¹ See Kind Codes of USPTO Patent Documents at www.USPTO.GOV or MPEP 901.04. ² Enter office that issued the document, by the two-letter code (WIPO Standard ST.3). ³ For Japanese patent documents, the indication of the year of the reign of the Emperor must precede the serial number of the patent document. ⁴ Kind of document by the appropriate symbols as indicated on the document under WIPO Standard ST.16 if possible. ⁵ Applicant is to place a check mark here if English language translation is attached.

Connecting via Winsock to STN at pto-stn on port 23

Welcome to STN International! Enter x:X

LOGINID:ssspt189dxw

PASSWORD:

TERMINAL (ENTER 1, 2, 3, OR ?):2

* * * * * Welcome to STN International * * * * *

NEWS 1 OCT 11 Instructor-led and self paced STN learning resources
available at <https://cas.csod.com/Default.aspx?c=001>

NEWS 2 APR 26 Expanded Swedish Patent Application Coverage in CA/CAplus
Provides More Current and Complete Information

NEWS 3 APR 28 The DWPI (files WPINDEX, WPIDS and WPIX) on STN have been
enhanced with thesauri for the European Patent Classifications

NEWS 4 MAY 02 MEDLINE Improvements Provide Fast and Simple Access to DOI and
Chemical Name Information

NEWS 5 MAY 12 European Patent Classification thesauri added to the INPADOC
files, PCTFULL, GBFULL and FRFULL

NEWS 6 MAY 23 Enhanced performance of STN biosequence searches

NEWS 7 JUN 20 STN on the Web Enhanced with New Patent Family Assistant and
Updated Structure Plug-In

NEWS 8 JUN 20 INPADOC databases enhanced with first page images

NEWS 9 JUN 20 PATDPA database updates to end in June 2011

NEWS 10 JUN 26 MARPAT Enhancements Save Time and Increase Usability

NEWS 11 JUL 25 STN adds Australian patent full-text database,
AUPATFULL, including the new numeric search feature.

NEWS 12 AUG 01 CA Sections Added to ACS Publications Web Editions
Platform

NEWS 13 AUG 16 INPADOC: Coverage of German Patent Data resumed,
enhanced legal status

NEWS 14 AUG 18 Upgrade now to STN Express, Version 8.5

NEWS 15 SEP 01 CAS Journal Coverage Now Includes Ahead-of-Print
Articles for More Than 100 Journal Titles

NEWS 16 SEP 01 Older Versions of STN Express to be Discontinued
Beginning in March 2012

NEWS 17 SEP 09 USAN Database Updates Offer Superior Currency on STN(R)

NEWS 18 SEP 26 STN Adds Canadian Patent Full-text Database - CANPATFULL

NEWS 19 SEP 26 GEOREF and ENCOMPLIT databases were reloaded on
September 24, 2011.

NEWS 20 SEP 26 Updates to the IFIPAT/IFIUDB/IFICDB databases have resumed.

NEWS 21 SEP 26 ECLA Thesaurus in CA/CAplus Improves Patent Searching on STN

NEWS 22 SEP 26 Access AUPATFULL and CANPATFULL databases with STN Viewer

NEWS 23 OCT 26 New STN Revolutionizes Patent Searching for Professionals

NEWS 24 DEC 1 CA/CAplus Now Includes Examiner Citations for Japanese Patents

NEWS 25 DEC 1 CAS Expands Global Patent Coverage - Intellectual Property
Corporation of Malaysia Becomes 62nd Authority on CA/CAplus

NEWS 26 DEC 5 STN on the Web Enhancements Include Compatibility with
Microsoft Windows 7

NEWS 27 DEC 14 Removal of ITRD and PATIPC databases from STN

NEWS 28 DEC 15 Rolled-up IPC Core Codes Removed from IPC Reclassifications in
Patent Databases on STN

NEWS EXPRESS 18 AUGUST 2011 CURRENT WINDOWS VERSION IS V8.5,
AND CURRENT DISCOVER FILE IS DATED 11 AUGUST 2011.

NEWS HOURS STN Operating Hours Plus Help Desk Availability
NEWS LOGIN Welcome Banner and News Items
NEWS TRAINING Find instructor-led and self-directed training opportunities

Enter NEWS followed by the item number or name to see news on that specific topic.

All use of STN is subject to the provisions of the STN customer agreement. This agreement limits use to scientific research. Use for software development or design, implementation of commercial gateways, or use of CAS and STN data in the building of commercial products is prohibited and may result in loss of user privileges and other penalties.

* * * * * STN Columbus * * * * *

FILE 'HOME' ENTERED AT 15:15:33 ON 03 JAN 2012

=> index bioscience		
COST IN U.S. DOLLARS	SINCE FILE	TOTAL
	ENTRY	SESSION
FULL ESTIMATED COST	0.24	0.24

INDEX 'ADISCTI, ADISINSIGHT, ADISNEWS, AGRICOLA, ANABSTR, ANTE, AQUALINE, AQUASCI, BIOENG, BIOSIS, BIOTECHABS, BIOTECHDS, BIOTECHNO, CABA, CAPLUS, CEABA-VTB, CIN, CONFSCI, CROPB, CROPU, DDFB, DDFU, DGENE, DISSABS, DRUGB, DRUGU, EMBAL, EMBASE, ESBIODBASE, ...' ENTERED AT 15:15:47 ON 03 JAN 2012

56 FILES IN THE FILE LIST IN STNINDEX

Enter SET DETAIL ON to see search term postings or to view search error messages that display as 0* with SET DETAIL OFF.

=> s krill and oil and meal and supercritical(p)extract? and solvent and heat? and treat?

- 0* FILE ADISNEWS
- 0* FILE ANTE
- 0* FILE AQUALINE
- 0* FILE BIOENG
- 0* FILE BIOTECHABS
- 0* FILE BIOTECHDS
- 0* FILE BIOTECHNO
- 0* FILE CEABA-VTB
- 0* FILE CIN

22 FILES SEARCHED...

- 0* FILE FOMAD
- 0* FILE FROSTI
- 0* FILE FSTA

33 FILES SEARCHED...

- 1 FILE IFIPAT
- 0* FILE KOSMET
- 0* FILE NTIS
- 0* FILE PASCAL

48 FILES SEARCHED...

- 28 FILE USPATFULL
- 4 FILE USPAT2

51 FILES SEARCHED...

- 0* FILE WATER
- 1 FILE WPIDS
- 1 FILE WPINDEX

5 FILES HAVE ONE OR MORE ANSWERS, 56 FILES SEARCHED IN STNINDEX

L1 QUE KRILL AND OIL AND MEAL AND SUPERCRITICAL(P)EXTRACT? AND SOLVENT AND HEAT? AND TREAT?

=> file ifipat uspatfull uspat2

COST IN U.S. DOLLARS

SINCE FILE

TOTAL

ENTRY

SESSION

FULL ESTIMATED COST

3.70

3.94

FILE 'IFIPAT' ENTERED AT 15:19:01 ON 03 JAN 2012
COPYRIGHT (C) 2012 IFI CLAIMS(R) Patent Services (IFI)

FILE 'USPATFULL' ENTERED AT 15:19:01 ON 03 JAN 2012
CA INDEXING COPYRIGHT (C) 2012 AMERICAN CHEMICAL SOCIETY (ACS)

FILE 'USPAT2' ENTERED AT 15:19:01 ON 03 JAN 2012
CA INDEXING COPYRIGHT (C) 2012 AMERICAN CHEMICAL SOCIETY (ACS)

=> s l1

L2 33 L1

=> dup rem l2

PROCESSING COMPLETED FOR L2

L3 32 DUP REM L2 (1 DUPLICATE REMOVED)

=> s l3 andcarbon(p)dioxide

MISSING OPERATOR L3 ANDCARBON

The search profile that was entered contains terms or nested terms that are not separated by a logical operator.

=> s l3 and dioxide

L4 27 L3 AND DIOXIDE

=> d l4 1-27

L4 ANSWER 1 OF 27 IFIPAT COPYRIGHT 2012 IFI on STN
AN 11934106 IFIPAT;IFIUDB;IFICDB
TI BIOEFFECTIVE KRILL OIL COMPOSITIONS; Having high amounts of phospholipids, astaxanthin esters and/or omega-3 contents; antiinflammation, antioxidant effects, improving insulin resistance and blood lipid profile
IN Banni Sebastiano (IT); Bruheim Inge (NO); Cohn Jeffrey Stuart (AU); Griinari Mikko (FI); Mancinelli Daniele (NO); Tilseth Snorre (NO)
PA Aker BioMarine ASA NO (79725)
PI US 20080274203 A1 20081106
AI US 2008-57775 20080328 (12)
PRAI US 2007-920483P 20070328 (Provisional)
US 2007-975058P 20070925 (Provisional)
US 2007-983446P 20071029 (Provisional)
FI US 20080274203 20081106
DT Utility; Patent Application - First Publication
FS CHEMICAL APPLICATION
ED Entered STN: 7 Nov 2008
Last Updated on STN: Jan 2011
CLMN 90

L4 ANSWER 2 OF 27 USPATFULL on STN

AN 2011:287830 USPATFULL

TI Reducing the Risk of Pathological Effects of Traumatic Brain Injury

IN Hadley, Kevin, Elkridge, MD, UNITED STATES

Fealey, Terence, Marietta, GA, UNITED STATES
Bailes, Julian E., Morgantown, WV, UNITED STATES
PI US 20110257267 A1 20111020
AI US 2010-904049 A1 20101013 (12)
PRAI US 2009-251230P 20091013 (61)
DT Utility
FS APPLICATION
LN.CNT 2397
INCL INCLM: 514/547.000
INCLS: 514/560.000; 514/549.000
NCL NCLM: 514/547.000
NCLS: 514/549.000; 514/560.000
IPC IPCI A61K0031-232 [I,A]; A61P0025-00 [I,A]; A61K0031-202 [I,A]
CAS INDEXING IS AVAILABLE FOR THIS PATENT.

L4 ANSWER 3 OF 27 USPATFULL on STN
AN 2011:251469 USPATFULL
TI SOLVENT-FREE PROCESS FOR OBTAINING PHOSPHOLIPIDS AND NEUTRAL ENRICHED
KRILL OILS
IN Sclabos Katevas, Dimitri, Santiago, CHILE
Toro Guerra, Raul R., Santiago, CHILE
Chiong Lay, Mario M., Santiago, CHILE
PA THAROS LTD., Santiago, CHILE (non-U.S. corporation)
LONZA LTD., Basel, SWITZERLAND (non-U.S. corporation)
PI US 20110224450 A1 20110915
AI US 2011-96644 A1 20110428 (13)
RLI Continuation-in-part of Ser. No. WO 2009-IB7269, filed on 30 Oct 2009,
PENDING
DT Utility
FS APPLICATION
LN.CNT 2021
INCL INCLM: 554/023.000
INCLS: 554/008.000; 554/078.000
NCL NCLM: 554/023.000
NCLS: 554/008.000; 554/078.000
IPC IPCI C11B0001-00 [I,A]; C07F0009-10 [I,A]
IPCR C11B0001-00 [I,A]; C07F0009-10 [I,A]
CAS INDEXING IS AVAILABLE FOR THIS PATENT.

L4 ANSWER 4 OF 27 USPATFULL on STN
AN 2011:212256 USPATFULL
TI METHOD FOR PRODUCING LIPIDS
IN Yoshikawa, Kazuhiro, Tokyo, JAPAN
Mikajiri, Akihiro, Tokyo, JAPAN
PA NIPPON SUISAN KAISHA, LTD., Tokyo, JAPAN (non-U.S. corporation)
PI US 20110189760 A1 20110804
AI US 2009-120842 A1 20090924 (13)
WO 2009-JP66530 20090924
20110425 PCT 371 date
PRAI JP 2008-248986 20080926
DT Utility
FS APPLICATION
LN.CNT 1345
INCL INCLM: 435/271.000
INCLS: 554/020.000
NCL NCLM: 435/271.000
NCLS: 554/020.000
IPC IPCI C11C0001-00 [I,A]; C11B0001-00 [I,A]
IPCR C11C0001-00 [I,A]; C11B0001-00 [I,A]
CAS INDEXING IS AVAILABLE FOR THIS PATENT.

L4 ANSWER 5 OF 27 USPATFULL on STN

AN 2011:211870 USPATFULL
TI METHOD FOR CONCENTRATING LIPIDS
IN Yoshikawa, Kazuhiro, Tokyo, JAPAN
PA NIPPON SUISAN KAISHA, LTD., Tokyo, JAPAN (non-U.S. corporation)
PI US 20110189374 A1 20110804
AI US 2009-120875 A1 20090924 (13)
WO 2009-JP66529 20090924
20110425 PCT 371 date
PRAI JP 2008-248986 20080926
DT Utility
FS APPLICATION
LN.CNT 961
INCL INCLM: 426/601.000
INCLS: 554/008.000
NCL NCLM: 426/601.000
NCLS: 554/008.000
IPC IPCI A23D0009-00 [I,A]; C11B0001-06 [I,A]
IPCR A23D0009-00 [I,A]; C11B0001-06 [I,A]
CAS INDEXING IS AVAILABLE FOR THIS PATENT.

L4 ANSWER 6 OF 27 USPATFULL on STN
AN 2011:198158 USPATFULL
TI METHODS OF TREATING AND PREVENTING NEUROLOGICAL DISORDERS USING
DOCOSAHEXAENOIC ACID
IN AISEN, Paul S., Solana Beach, CA, UNITED STATES
Quinn, Joseph F., Portland, OR, UNITED STATES
Yurko-Mauro, Karin, Silver Spring, MD, UNITED STATES
PA MARTEK BIOSCIENCES CORPORATION, Columbia, MD, UNITED STATES (U.S.
corporation)
PI US 20110177061 A1 20110721
AI US 2010-833913 A1 20100709 (12)
PRAI US 2009-224836P 20090710 (61)
US 2010-359792P 20100629 (61)
DT Utility
FS APPLICATION
LN.CNT 2653
INCL INCLM: 424/133.100
INCLS: 514/560.000; 514/120.000; 514/547.000; 514/549.000; 514/297.000;
514/319.000; 514/479.000; 514/215.000; 424/184.100; 424/172.100;
424/152.100; 514/458.000
NCL NCLM: 424/133.100
NCLS: 424/152.100; 424/172.100; 424/184.100; 514/120.000; 514/215.000;
514/297.000; 514/319.000; 514/458.000; 514/479.000; 514/547.000;
514/549.000; 514/560.000
IPC IPCI A61K0031-202 [I,A]; A61K0031-661 [I,A]; A61K0031-232 [I,A];
A61K0031-473 [I,A]; A61K0031-445 [I,A]; A61K0031-27 [I,A];
A61K0031-55 [I,A]; A61K0039-00 [I,A]; A61K0039-395 [I,A];
A61K0031-355 [I,A]; A61P0025-28 [I,A]; A61P0025-00 [I,A]
IPCR A61K0031-202 [I,A]; A61K0031-232 [I,A]; A61K0031-27 [I,A];
A61K0031-355 [I,A]; A61K0031-445 [I,A]; A61K0031-473 [I,A];
A61K0031-55 [I,A]; A61K0031-661 [I,A]; A61K0039-00 [I,A];
A61K0039-395 [I,A]; A61P0025-00 [I,A]; A61P0025-28 [I,A]
CAS INDEXING IS AVAILABLE FOR THIS PATENT.

L4 ANSWER 7 OF 27 USPATFULL on STN
AN 2011:146375 USPATFULL
TI KRILL OIL PROCESS
IN Breivik, Harald, Porsgrunn, NORWAY
Thorstad, Olav, Porsgrunn, NORWAY
PA PRONOVA BIOPHARMA NORGE AS, Lysaker, NORWAY (non-U.S. corporation)
PI US 20110130458 A1 20110602
AI US 2009-992365 A1 20090515 (12)

WO 2009-NO184 20090515
 20110211 PCT 371 date
 PRAI US 2008-53455P 20080515 (61)
 DT Utility
 FS APPLICATION
 LN.CNT 688
 INCL INCLM: 514/560.000
 INCLS: 426/608.000; 426/417.000
 NCL NCLM: 514/560.000
 NCLS: 426/417.000; 426/608.000
 IPC IPCI A61K0031-202 [I,A]; A61P0003-06 [I,A]; A61P0003-00 [I,A];
 A61P0009-00 [I,A]; A61P0009-04 [I,A]; A61P0009-10 [I,A];
 A23D0007-00 [I,A]; A23D0009-00 [I,A]
 IPCR A61K0031-202 [I,A]; A23D0007-00 [I,A]; A23D0009-00 [I,A];
 A61P0003-00 [I,A]; A61P0003-06 [I,A]; A61P0009-00 [I,A];
 A61P0009-04 [I,A]; A61P0009-10 [I,A]
 CAS INDEXING IS AVAILABLE FOR THIS PATENT.

L4 ANSWER 8 OF 27 USPATFULL on STN
 AN 2011:117434 USPATFULL
 TI POWDERED COMPOSITION CONTAINING OIL-SOLUBLE COMPONENT, FUNCTIONAL FOOD
 USING THE SAME, AND PACKAGED PRODUCT THEREOF
 IN Suzuki, Keiichi, Kanagawa, JAPAN
 Sasaki, Hidemi, Kanagawa, JAPAN
 Serizawa, Shinichiro, Kanagawa, JAPAN
 Arakawa, Jun, Kanagawa, JAPAN
 PA FUJIFILM CORPORATION, Minato-ku, Tokyo, JAPAN (non-U.S. corporation)
 PI US 20110104340 A1 20110505
 AI US 2008-673977 A1 20080819 (12)
 WO 2008-JP65061 20080819
 20100218 PCT 371 date
 PRAI JP 2007-213712 20070820
 JP 2007-230582 20070905
 DT Utility
 FS APPLICATION
 LN.CNT 2345
 INCL INCLM: 426/096.000
 INCLS: 426/654.000; 426/590.000
 NCL NCLM: 426/096.000
 NCLS: 426/590.000; 426/654.000
 IPC IPCI A21D0002-16 [I,A]; A23L0002-52 [I,A]
 IPCR A21D0002-16 [I,A]; A23L0002-52 [I,A]
 CAS INDEXING IS AVAILABLE FOR THIS PATENT.

L4 ANSWER 9 OF 27 USPATFULL on STN
 AN 2011:117391 USPATFULL
 TI METHODS OF USING KRILL OIL TO TREAT RISK FACTORS FOR
 CARDIOVASCULAR, METABOLIC, AND INFLAMMATORY DISORDERS
 IN BRUHEIM, Inge, Volda, NORWAY
 Tilseth, Snorre, Bergen, NORWAY
 Cohn, Jeffery, Sydney, AUSTRALIA
 Griinari, Mikko, Espoo, FINLAND
 Mancinelli, Daniele, Orsta, NORWAY
 Hoem, Nils, Oslo, NORWAY
 Vik, Hogne, Eiksmarka, NORWAY
 Banni, Sebastiano, Calgliari, ITALY
 PA Aker BioMarine A.S.A., Oslo, NORWAY (non-U.S. corporation)
 PI US 20110104297 A1 20110505
 AI US 2010-790575 A1 20100528 (12)
 RLI Continuation-in-part of Ser. No. US 2008-57775, filed on 28 Mar 2008,
 PENDING
 PRAI US 2007-975058P 20070925 (60)

US 2007-983446P 20071029 (60)
US 2008-24072P 20080128 (61)
US 2009-181743P 20090528 (61)
US 2007-920483P 20070328 (60)
DT Utility
FS APPLICATION
LN.CNT 2547
INCL INCLM: 424/522.000
INCLS: 426/002.000
NCL NCLM: 424/522.000
NCLS: 426/002.000
IPC IPCI A61K0035-56 [I,A]; A61P0009-10 [I,A]; A61P0003-04 [I,A];
A61P0003-00 [I,A]
IPCR A61K0035-56 [I,A]; A61P0003-00 [I,A]; A61P0003-04 [I,A];
A61P0009-10 [I,A]
CAS INDEXING IS AVAILABLE FOR THIS PATENT.

L4 ANSWER 10 OF 27 USPATFULL on STN
AN 2011:97925 USPATFULL
TI Methods for Treating Traumatic Brain Injury
IN Bailes, Julian E., Morgantown, WV, UNITED STATES
PI US 20110086914 A1 20110414
AI US 2010-904045 A1 20101013 (12)
PRAI US 2009-251234P 20091013 (61)
DT Utility
FS APPLICATION
LN.CNT 2356
INCL INCLM: 514/549.000
INCLS: 514/560.000
NCL NCLM: 514/549.000
NCLS: 514/560.000
IPC IPCI A61K0031-232 [I,A]; A61K0031-20 [I,A]; A61P0025-00 [I,A]
IPCR A61K0031-232 [I,A]; A61K0031-20 [I,A]; A61P0025-00 [I,A]
CAS INDEXING IS AVAILABLE FOR THIS PATENT.

L4 ANSWER 11 OF 27 USPATFULL on STN
AN 2011:92475 USPATFULL
TI Docosahexaenoic Acid Gel Caps
IN PANKER, Cynthia A., Jessup, MD, UNITED STATES
Billard, Michael Ames, Laurel, MD, UNITED STATES
Ryan, Alan, Ellicott City, MD, UNITED STATES
Dangi, Bindi, Elkridge, MD, UNITED STATES
PI US 20110082205 A1 20110407
AI US 2010-896763 A1 20101001 (12)
PRAI US 2009-247944P 20091001 (61)
DT Utility
FS APPLICATION
LN.CNT 2444
INCL INCLM: 514/549.000
NCL NCLM: 514/549.000
IPC IPCI A61K0031-232 [I,A]; A61P0003-06 [I,A]
IPCR A61K0031-232 [I,A]; A61P0003-06 [I,A]
CAS INDEXING IS AVAILABLE FOR THIS PATENT.

L4 ANSWER 12 OF 27 USPATFULL on STN
AN 2010:256169 USPATFULL
TI PHOSPHOLIPID AND PROTEIN TABLETS
IN Tilseth, Snorre, Bergen, NORWAY
Hoem, Nils, Oslo, NORWAY
PA AKER BIOMARINE ASA, Oslo, NORWAY (non-U.S. corporation)
PI US 20100227792 A1 20100909
AI US 2010-711822 A1 20100224 (12)

PRAI US 2009-155758P 20090226 (61)
DT Utility
FS APPLICATION
LN.CNT 3112
INCL INCLM: 514 2
NCL NCLM: 514/005.500
NCLS: 514/691.000
IPC IPCI A61K0038-02 [I,A]
IPCR A61K0038-02 [I,A]
CAS INDEXING IS AVAILABLE FOR THIS PATENT.

L4 ANSWER 13 OF 27 USPATFULL on STN
AN 2010:255355 USPATFULL
TI LOW VISCOSITY PHOSPHOLIPID COMPOSITIONS
IN Tilseth, Snorre, Bergen, NORWAY
PA AKER BIOMARINE ASA, Oslo, NORWAY (non-U.S. corporation)
PI US 20100226977 A1 20100909
AI US 2010-711553 A1 20100224 (12)
RLI Continuation-in-part of Ser. No. US 2008-201325, filed on 29 Aug 2008,
PENDING

PRAI US 2009-155767P 20090226 (61)
US 2007-968765P 20070829 (60)
DT Utility
FS APPLICATION

LN.CNT 2394
INCL INCLM: 424/456.000
INCLS: 426/601.000; 426/417.000; 514/078.000
NCL NCLM: 424/456.000
NCLS: 426/417.000; 426/601.000; 514/078.000
IPC IPCI A61K0031-685 [I,A]; A23D0009-00 [I,A]; A23D0009-02 [I,A];
A61K0009-48 [I,A]; A61P0009-00 [I,A]; A61P0019-00 [I,A];
A61P0029-00 [I,A]
IPCR A61K0031-685 [I,A]; A23D0009-00 [I,A]; A23D0009-02 [I,A];
A61K0009-48 [I,A]; A61P0009-00 [I,A]; A61P0019-00 [I,A];
A61P0029-00 [I,A]

CAS INDEXING IS AVAILABLE FOR THIS PATENT.

L4 ANSWER 14 OF 27 USPATFULL on STN
AN 2010:228249 USPATFULL
TI METHODS FOR IMPROVING COGNITIVE FUNCTION AND DECREASING HEART RATE
IN YURKO-MAURO, Karin, Silver Spring, MD, UNITED STATES
PA MARTEK BIOSCIENCES CORPORATION, Columbia, MD, UNITED STATES (U.S.
corporation)

PI US 20100203123 A1 20100812
AI US 2010-699009 A1 20100202 (12)
PRAI US 2009-149310P 20090202 (61)
US 2009-183548P 20090602 (61)

DT Utility
FS APPLICATION

LN.CNT 2358
INCL INCLM: 424/456.000
INCLS: 514/560.000; 514/549.000; 514/458.000
NCL NCLM: 424/456.000
NCLS: 514/458.000; 514/549.000; 514/560.000
IPC IPCI A61K0009-64 [I,A]; A61K0031-20 [I,A]; A61K0031-22 [I,A];
A61K0031-355 [I,A]; A61P0025-00 [I,A]; A61P0009-00 [I,A]
IPCR A61K0009-64 [I,A]; A61K0031-20 [I,A]; A61K0031-22 [I,A];
A61K0031-355 [I,A]; A61P0009-00 [I,A]; A61P0025-00 [I,A]

CAS INDEXING IS AVAILABLE FOR THIS PATENT.

L4 ANSWER 15 OF 27 USPATFULL on STN
AN 2010:161551 USPATFULL

TI PROCESS FOR PRODUCTION OF OMEGA-3 RICH MARINE PHOSPHOLIPIDS FROM KRILL
 IN Breivik, Harald, Porsgrunn, NORWAY
 PI US 20100143571 A1 20100610
 AI US 2007-515098 A1 20071115 (12)
 WO 2007-NO402 20071115
 20100217 PCT 371 date
 PRAI US 2006-859289P 20061116 (60)
 DT Utility
 FS APPLICATION
 LN.CNT 537
 INCL INCLM: 426/643.000
 INCLS: 426/417.000; 554/021.000; 568/366.000; 536/020.000
 NCL NCLM: 426/643.000
 NCLS: 426/417.000; 536/020.000; 554/021.000; 568/366.000
 IPC IPCI A23L0001-325 [I,A]; A23K0001-10 [I,A]; A23K0001-18 [I,A];
 C11B0001-10 [I,A]; C07C0045-78 [I,A]; C08B0037-08 [I,A]
 IPCR A23L0001-325 [I,A]; A23K0001-10 [I,A]; A23K0001-18 [I,A];
 C07C0045-78 [I,A]; C08B0037-08 [I,A]; C11B0001-10 [I,A]
 CAS INDEXING IS AVAILABLE FOR THIS PATENT.

L4 ANSWER 16 OF 27 USPATFULL on STN
 AN 2009:109974 USPATFULL
 TI Polyunsaturated Fatty Acid-Containing Solid Fat Compositions and Uses
 and Production Thereof
 IN Namal Senanayake, S.P. Janaka, Lexington, KY, UNITED STATES
 Ahmed, Naseer, Lexington, KY, UNITED STATES
 Fichtali, Jaouad, Lexington, KY, UNITED STATES
 PA Martek Biosciences Corporation, Columbia, MD, UNITED STATES (U.S.
 corporation)
 PI US 20090099260 A1 20090416
 AI US 2008-201728 A1 20080829 (12)
 PRAI US 2007-969536P 20070831 (60)
 DT Utility
 FS APPLICATION
 LN.CNT 2660
 INCL INCLM: 514/560.000
 INCLS: 426/601.000; 426/072.000
 NCL NCLM: 514/560.000
 NCLS: 426/072.000; 426/601.000
 IPC IPCI A61K0031-20 [I,A]; A23D0007-005 [I,A]; A23L0001-30 [I,A]
 IPCR A61K0031-20 [I,A]; A23D0007-005 [I,A]; A23L0001-30 [I,A]
 CAS INDEXING IS AVAILABLE FOR THIS PATENT.

L4 ANSWER 17 OF 27 USPATFULL on STN
 AN 2009:67318 USPATFULL
 TI METHOD FOR MAKING KRILL MEAL
 IN Tilseth, Snorre, Bergen, NORWAY
 Hostmark, Oistein, Loddefjord, NORWAY
 PA Aker BioMarine ASA, Oslo, NORWAY (non-U.S. corporation)
 PI US 20090061067 A1 20090305
 AI US 2008-201325 A1 20080829 (12)
 PRAI US 2007-968765P 20070829 (60)
 DT Utility
 FS APPLICATION
 LN.CNT 2307
 INCL INCLM: 426/602.000
 INCLS: 426/417.000; 210/149.000; 426/480.000; 426/609.000; 426/648.000;
 426/608.000; 366/145.000; 366/147.000
 NCL NCLM: 426/602.000
 NCLS: 210/149.000; 366/145.000; 366/147.000; 426/417.000; 426/480.000;
 426/608.000; 426/609.000; 426/648.000
 IPC IPCI A23D0007-005 [I,A]; A23D0007-02 [I,A]; A23D0007-04 [I,A];