



US008177720B2

(12) **United States Patent**  
**Nanba et al.**

(10) **Patent No.:** **US 8,177,720 B2**  
(45) **Date of Patent:** **May 15, 2012**

(54) **APPARATUS FOR DETECTING VITAL FUNCTIONS, CONTROL UNIT AND PULSE WAVE SENSOR**

6,856,829 B2 2/2005 Ohsaki et al.  
2002/0183627 A1\* 12/2002 Nishii et al. .... 600/485  
2004/0162499 A1 8/2004 Nagai et al.  
2006/0074334 A1 4/2006 Coyle

(75) Inventors: **Shinji Nanba**, Kariya (JP); **Toshiaki Shiomi**, Nagoya (JP)

**FOREIGN PATENT DOCUMENTS**

JP A-7-000376 1/1995  
JP A-8-173403 7/1996  
JP A-9-098964 4/1997  
JP A-2003-000552 1/2003  
JP A-2003-038460 2/2003  
JP A-2005-199078 7/2005

(73) Assignees: **DENSO CORPORATION**, Kariya (JP); **Toshiaki Shiomi**, Nagoya (JP)

(\* ) Notice: Subject to any disclaimer, the term of this patent is extended or adjusted under 35 U.S.C. 154(b) by 1342 days.

**OTHER PUBLICATIONS**

Office Action dated Aug. 15, 2008 from Chinese Patent Office in corresponding CN Patent Application No. 200710108768.0 (and English Translation).

(21) Appl. No.: **11/802,607**

Office Action mailed on Jul. 5, 2011 in the corresponding Japanese Patent application No. 2006-152354 (English translation enclosed).

(22) Filed: **May 24, 2007**

\* cited by examiner

**Prior Publication Data**

US 2007/0282227 A1 Dec. 6, 2007

**Foreign Application Priority Data**

May 31, 2006 (JP) ..... 2006-152354

*Primary Examiner* — Miranda Le

*Assistant Examiner* — Tho Tran

(74) *Attorney, Agent, or Firm* — Posz Law Group, PLC

**Int. Cl.**

**A61B 5/02** (2006.01)

(52) **U.S. Cl.** ..... **600/483; 600/484**

(58) **Field of Classification Search** ..... **600/483, 600/486, 500-504**

See application file for complete search history.

**ABSTRACT**

An apparatus for detecting vital functions has a pulse wave sensor attachable to a body and a control unit. The control unit checks if amplitude of pulse wave signals produced from the pulse wave sensor varies. The control unit further checks if a large change in the amplitude during a systolic phase of a pulse wave corresponding to the systolic phase of the heart. If a first large change in the amplitude during a diastolic phase of a pulse wave corresponding to the diastolic phase of the heart, it is highly probable that a motion artifact has occurred. Therefore, a motion artifact flag is set. Next, it is checked if the amplitude in the next diastole is changing by more than 30%. if it is presumed that the occurrence of cough is highly probable, a cough flag is set. if it is neither the motion artifact nor the cough, then a yawn flag is set.

**References Cited**

**U.S. PATENT DOCUMENTS**

5,005,581 A 4/1991 Honeyager  
5,704,367 A 1/1998 Ishikawa et al.  
5,899,927 A 5/1999 Ecker et al.  
6,083,157 A 7/2000 Noller  
6,605,045 B2 8/2003 Ohsaki et al.  
6,669,632 B2 12/2003 Nanba et al.

**26 Claims, 10 Drawing Sheets**

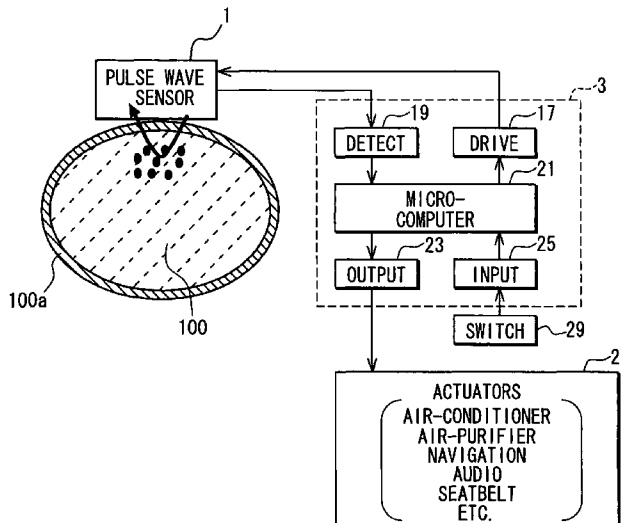

FIG. 1A

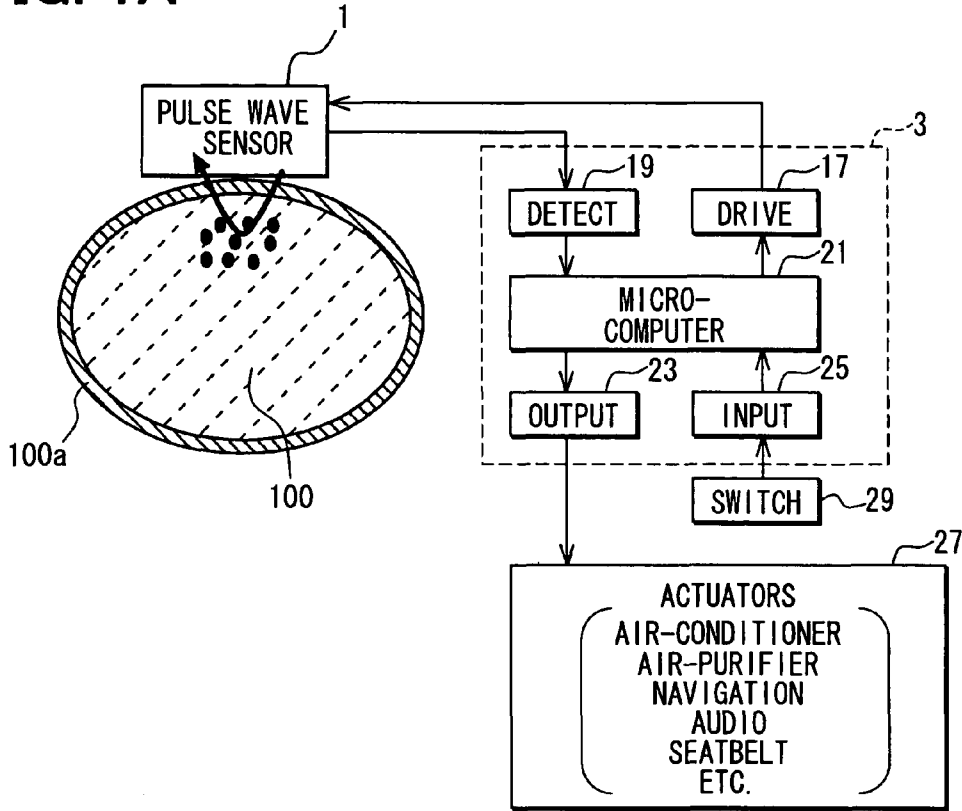
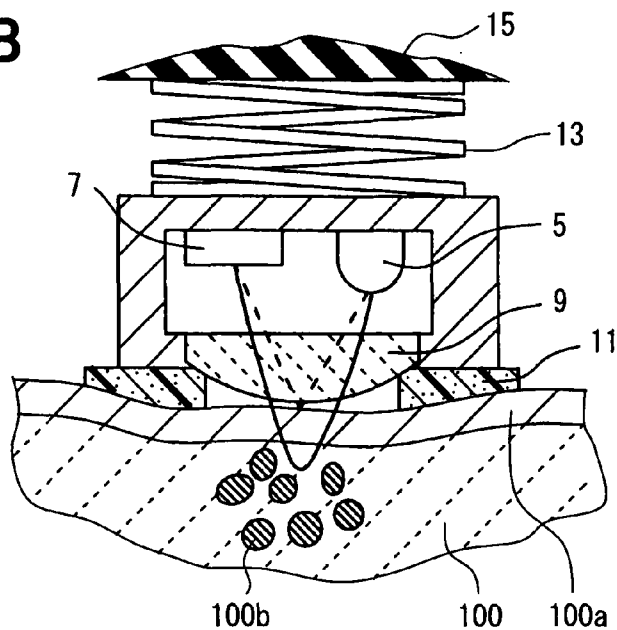
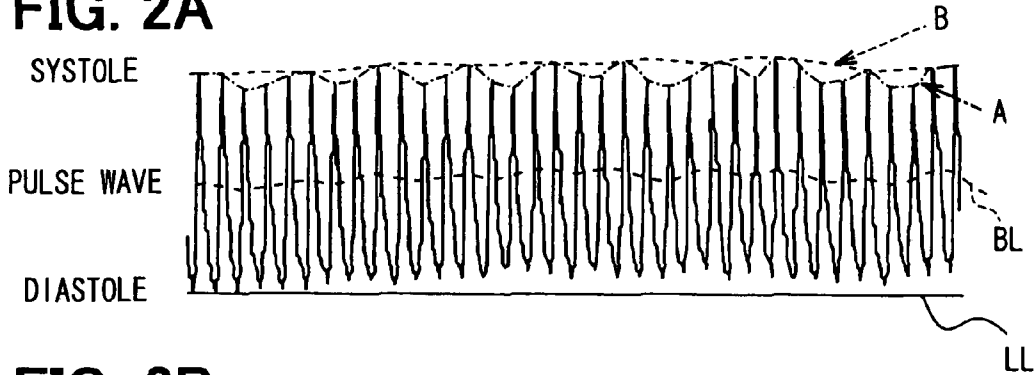

FIG. 1B



**FIG. 2A**

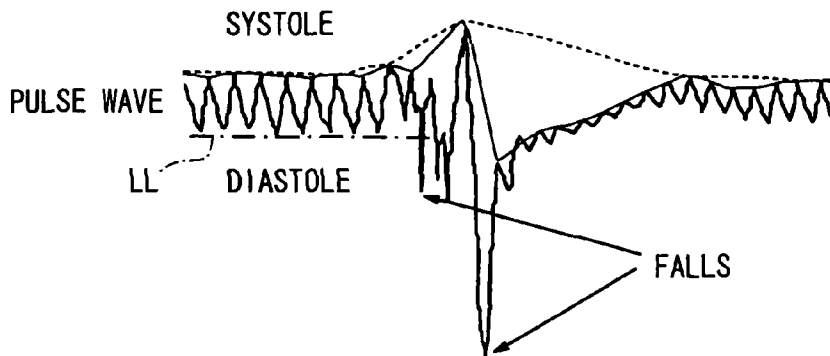

**FIG. 2B**



**FIG. 3A**

MOTION ARTIFACT



**FIG. 3B**

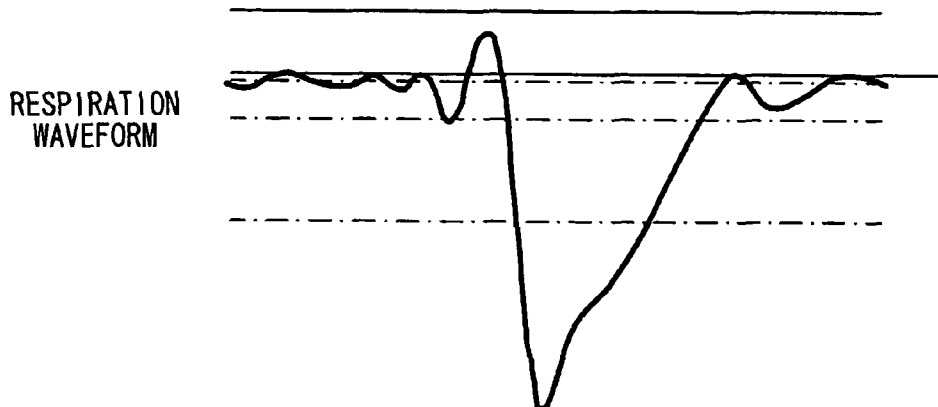

FIG. 4E

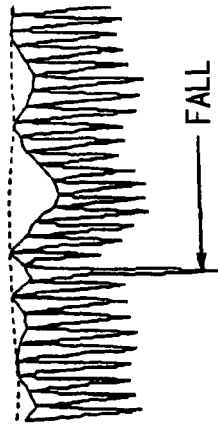

FIG. 4F

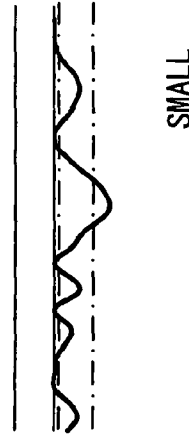

FIG. 4C

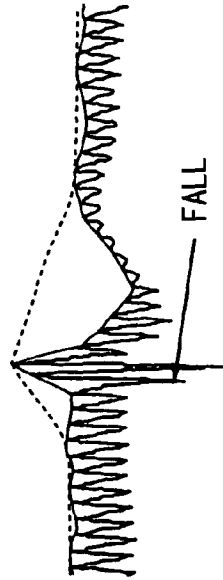

FIG. 4D

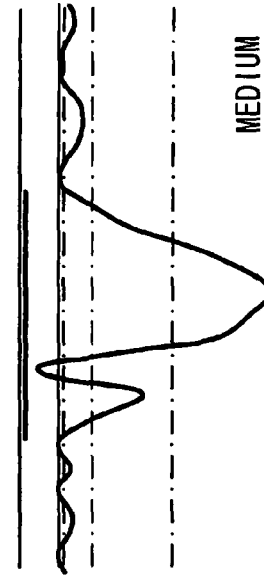

FIG. 4A

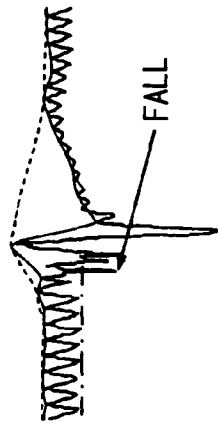
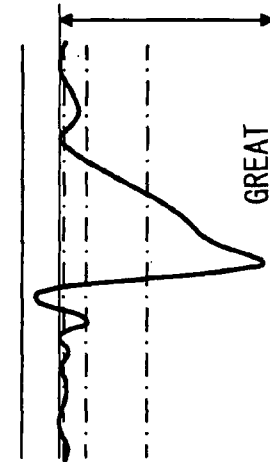
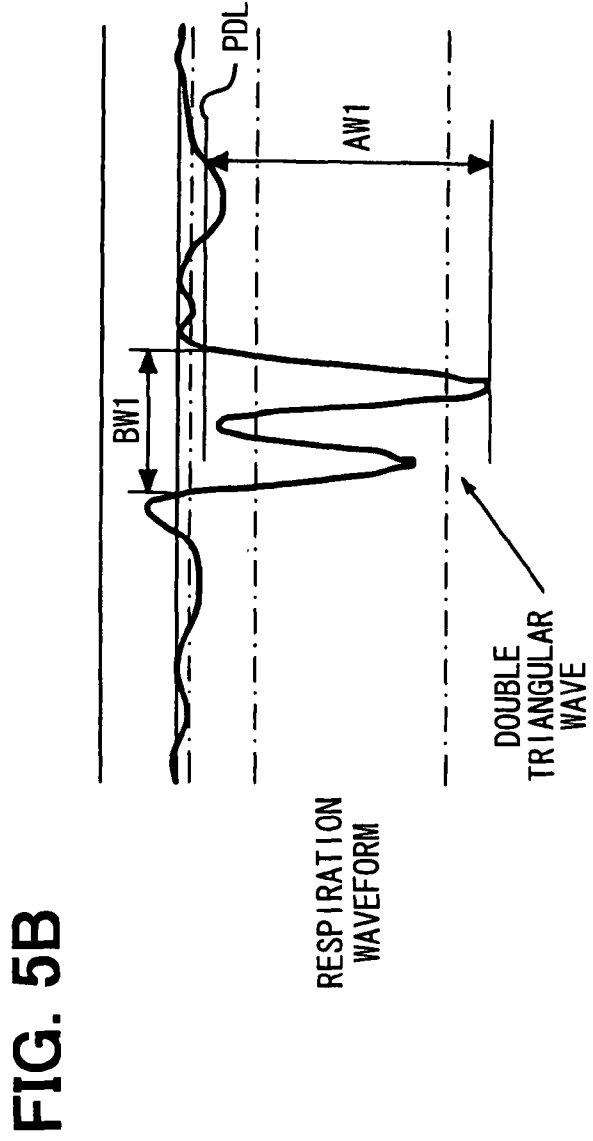
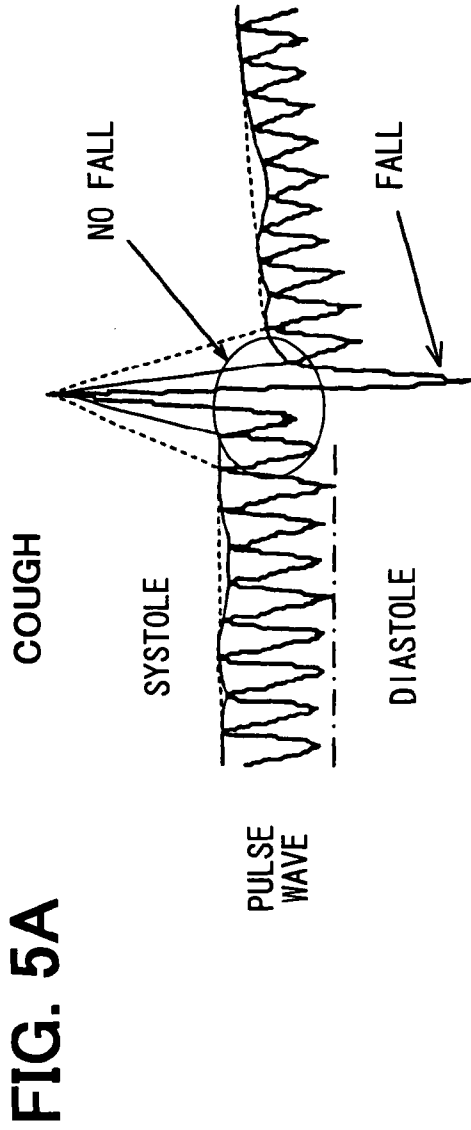

FIG. 4B





# Explore Litigation Insights

Docket Alarm provides insights to develop a more informed litigation strategy and the peace of mind of knowing you're on top of things.

## Real-Time Litigation Alerts



Keep your litigation team up-to-date with **real-time alerts** and advanced team management tools built for the enterprise, all while greatly reducing PACER spend.

Our comprehensive service means we can handle Federal, State, and Administrative courts across the country.

## Advanced Docket Research



With over 230 million records, Docket Alarm's cloud-native docket research platform finds what other services can't. Coverage includes Federal, State, plus PTAB, TTAB, ITC and NLRB decisions, all in one place.

Identify arguments that have been successful in the past with full text, pinpoint searching. Link to case law cited within any court document via Fastcase.

## Analytics At Your Fingertips



Learn what happened the last time a particular judge, opposing counsel or company faced cases similar to yours.

Advanced out-of-the-box PTAB and TTAB analytics are always at your fingertips.

## API

Docket Alarm offers a powerful API (application programming interface) to developers that want to integrate case filings into their apps.

## LAW FIRMS

Build custom dashboards for your attorneys and clients with live data direct from the court.

Automate many repetitive legal tasks like conflict checks, document management, and marketing.

## FINANCIAL INSTITUTIONS

Litigation and bankruptcy checks for companies and debtors.

## E-DISCOVERY AND LEGAL VENDORS

Sync your system to PACER to automate legal marketing.