

Noninvasive Pulse Oximetry Utilizing Skin Reflectance Photoplethysmography

YITZHAK MENDELSON, MEMBER IEEE, AND BURT D. OCHS, MEMBER IEEE

Abstract—The major concern in developing a sensor for reflectance pulse oximetry is the ability to measure large and stable photoplethysmograms from light which is backscattered from the skin. Utilizing a prototype optical reflectance sensor, we showed that by locally heating the skin it is possible to increase the pulsatile component of the reflected photoplethysmograms. Furthermore, we showed that additional improvements in signal-to-noise ratio can be achieved by increasing the active area of the photodetector and optimizing the separation distance between the light source and photodetector. The results from a series of *in vivo* studies to evaluate a prototype skin reflectance pulse oximeter in humans are presented.

I. INTRODUCTION

NONINVASIVE monitoring of arterial hemoglobin oxygen saturation (SaO_2) based upon skin reflectance spectrophotometry was first described by Brinkman and Zijlstra in 1949 [1]. They showed that changes in SaO_2 can be recorded noninvasively from an optical sensor attached to the forehead. Their innovative idea to use light reflection instead of tissue transillumination, which is limited mainly to the finger tips and ear lobes, was suggested as an improvement to enable noninvasive monitoring of SaO_2 from virtually any skin surface. More recent attempts to develop a skin reflectance oximeter utilizing a similar spectrophotometric approach were made by Cohen *et al.* [2] and Takatani [3]. All of those three noninvasive reflectance oximeters attempted to monitor SaO_2 by measuring the absolute light intensity diffusely reflected (backscattered) from the skin.

While those developments represent significant advancements in noninvasive reflectance oximetry, limited accuracy as well as difficulties in absolute calibration were major problems with early reflectance oximeters. Although various methods have been proposed, to date, a versatile noninvasive reflectance oximeter, which can monitor SaO_2 reliably from any location on the skin surface, is not yet available.

Backscattered light from living skin depends not only on the optical absorption spectrum of the blood but also on the structure and pigmentation of the skin. In an attempt to overcome this problem, Mendelson *et al.* [4]

proposed to measure SaO_2 based on the principle of skin reflection photoplethysmography. We showed that SaO_2 can be measured noninvasively by analyzing the pulsatile rather than the absolute, reflected light intensity I_r of the respective red and infrared photoplethysmograms according to the following empirical relationship [4]–[5]:

$$\text{SaO}_2 = A - B [I_r(\text{red})/I_r(\text{infrared})] \quad (1)$$

where A and B are empirically derived constants which are determined statistically during *in vivo* calibration in which the $I_r(\text{red})/I_r(\text{infrared})$ ratio calculated by the pulse oximeter is compared against direct blood SaO_2 measurements. I_r is obtained by a normalization process in which the pulsatile (ac) component of the red and infrared photoplethysmograms is divided by the corresponding nonpulsatile (dc) component.

In clinical applications where presently available transmission pulse oximeters cannot be used, there is a need for an optical sensor which is suitable for monitoring SaO_2 utilizing light reflection from the skin. Although the principles of reflection and transmission pulse oximetry are very similar, the major limitation of reflection pulse oximetry is the comparatively low level photoplethysmograms typically recorded from the skin. The feasibility of reflection pulse oximetry, therefore, is highly dependent on the ability to detect sufficiently strong reflection photoplethysmograms.

This paper describes the considerations in designing a skin reflectance sensor for noninvasive monitoring of SaO_2 . The ability to detect improved photoplethysmographic waveforms through the use of skin heating and multiple photodetectors are discussed. Results from a series of *in vivo* studies to evaluate a prototype skin reflectance pulse oximeter in humans are presented.

II. BACKGROUND

A. Principle of Pulse Oximetry

Pulse oximetry has been invented by Aoyagi *et al.* [6] and further refined by Nakajima *et al.* [7] and Yoshiya *et al.* [8]. This unique approach is based on the assumption that the change in light absorbed by tissue during systole is caused primarily by the arterial blood. Consequently, they showed that changes in light transmission through a pulsating vascular bed can be used to obtain an accurate noninvasive measurement of SaO_2 .

The main advantage of employing a photoplethysmo-

Manuscript received June 17, 1987; revised May 9, 1988. This work was supported by the Whitaker Foundation and the National Science Foundation under Grant ECS-8404397.

The authors are with the Biomedical Engineering Program, Worcester Polytechnic Institute, Worcester, MA 01609.
IEEE Log Number 8822615.

0018-9294/88/1000-0798\$01.00 © 1988 IEEE

graphic technique is that only two wavelengths are required, thereby greatly simplifying the optical sensor. Furthermore, the requirement for blood "arterialization" which was essential in previous nonpulsatile oximeters, such as the eight wavelength Hewlett-Packard (HP) ear oximeter [9], has been eliminated. Hence, there is no need for continuous skin heating. Moreover, skin pigmentation, which can cause variable light attenuation, does not seem to affect the accuracy of pulse oximeters. This is because the ratio of the transmitted red/infrared light intensity, from which SaO_2 is calculated, is obtained by a normalization process in which the ac component of the red and infrared photoplethysmograms is divided by the corresponding dc components.

The basic optical sensor of a noninvasive pulse oximeter consists of a red and infrared light emitting diodes (LED's) and a silicone photodiode. The wavelength of the red LED is typically chosen from regions of the spectra where the absorption coefficient of Hb and HbO_2 are markedly different (e.g., 660 nm). The infrared wavelength, on the other hand, is typically chosen from the spectral region between 940 and 960 nm where the difference in the absorption coefficients of Hb and HbO_2 is relatively small. The photodiode used has a broad spectral response that overlaps the emission spectra of the red and infrared LED's.

The light intensity detected by the photodetector depends, apart from the intensity of the incident light, mainly on the opacity of the skin, reflection by bones, tissue scattering, and the amount of blood present in the vascular bed. The amount of light attenuated by the blood varies according to the pumping action of the heart. Consequently, as tissue blood volume increases during systole, a greater portion of the incident light is absorbed by the arterial blood causing a rapidly alternating signal. Depending on the physiological state of the microvascular bed, typically, these alternating light intensity amounts to approximately 0.05–1 percent of the total light intensity either transmitted through or backscattered from the skin.

Since pulse oximeters rely on the detection of arterial pulsation, significant reduction in peripheral blood flow, such as in hypotension or hypothermia, can limit the reliability of the measurement. Nevertheless, the fact that no user calibration or site preparation is required, and the availability of small, light weight, and easy to apply sensors has made transmission pulse oximeters very popular in various clinical applications.

B. Reflection Versus Transmission Pulse Oximetry

In transmission pulse oximetry, sensor application is obviously limited to areas of the body, such as the finger tips, ear lobes, toes, and in infants the foot or palms where transmitted light can be readily detected. Other locations, which are not accessible to conventional transillumination techniques, i.e., the limbs, forehead, and chest may be monitored in principle using a reflection SaO_2 sensor as shown schematically in Fig. 1.

Although the specific clinical utility of reflectance pulse

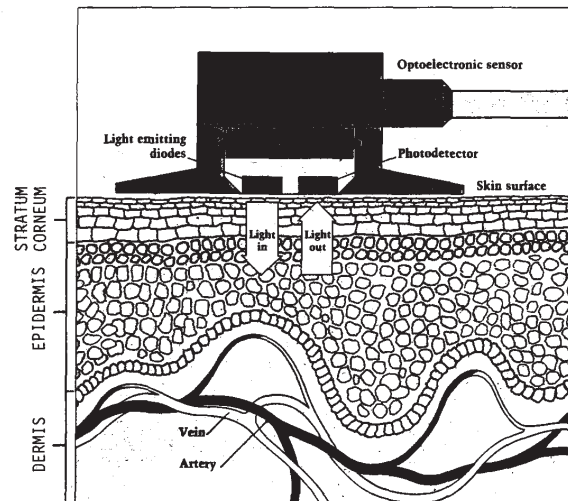

Fig. 1. Principle of reflectance pulse oximetry illustrating the optical sensor and the different layers of the skin.

oximetry has yet to be determined, it appears that the technique may have potential application for neonatal monitoring. For example, a reflectance SaO_2 sensor may be of considerable value in the assessment of fetal distress during delivery if used in addition to presently available screw-type scalp ECG electrodes. Furthermore, since the skin of the chest is supplied by branches of the internal thoracic artery, which in turn stem from blood vessels leaving the aorta above the ductus arteriosus, SaO_2 measurements using a reflectance sensor attached to the chest may prove to be of clinical importance when monitoring newborn infants with a patent ductus arteriosus.

III. METHODS

A. Instrumentation

1) *Reflectance SaO_2 Sensor:* We have constructed and tested a prototype reflectance sensor which consists of three parts: an optical sensor for monitoring SaO_2 , a feedback-controlled heater for varying the local temperature of the skin under the sensor, and a laser Doppler probe for recording relative changes in skin blood flow under the sensor.

A schematic diagram illustrating the front view of the combined sensor is shown in Fig. 2. The sensor assembly can be attached to the skin by means of a double-sided, ring-shaped, tape. This attachment technique is sufficient to maintain the sensor in place without exerting excessive pressure that could significantly reduce local blood flow in the skin.

The optical sensor for monitoring SaO_2 consists of red and infrared LED's with peak emission wavelength of 660 and 950 nm, respectively, and a silicone p-i-n photodiode. The half-power spectral bandwidth of each LED is approximately 20–30 nm. The LED's (dimensions: 0.3 × 0.3 mm) and photodiode (dimension: 2.0 × 3.0 mm)

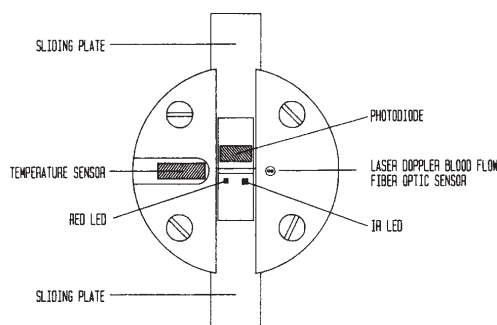

Fig. 2. Frontal view of the combined SaO_2 /laser Doppler skin blood flow sensor.

chips were mounted on separate ceramic substrates. A small drop of clear epoxy resin was applied over the LED's and photodiode for protection. For investigational purposes, the ceramic substrates containing the LED's and photodiode were mounted on separate sliding plates. This arrangement provides convenient adjustment of the separation distance between the LED's and the photodiode from 4 to 11 mm. Undesired specular light reflections from the surface of the skin, as well as direct light path between the LED's and the photodiode, were minimized by recessing and optically shielding the LED's and photodiode inside the sensor assembly.

The feedback-controlled heater consists of a round thermofoil heating element (1.25 cm diameter) and a solid-state temperature transducer (Analog Devices AD590) mounted in close proximity to the surface of the sensor contacting the skin. The heater is capable of delivering a maximum power of 2 W. The temperature of the sensor can be adjusted between 34 and 45°C in 1 +/−0.1°C steps.

The distal ends of two parallel glass optical fibers (diam. 0.15 mm; separation 0.5 mm) were used for recording relative skin blood flow under the reflectance sensor. The fiber tips were mounted in close proximity to the LED's and photodiode. The proximal ends of these optical fibers were coupled to a MEDPACIFIC Model LD 5000 Laser Doppler perfusion monitor (MEDPACIFIC Corp., Seattle, WA). A 5 mW, continuous wave, HeNe laser located inside the perfusion monitor generates a monochromatic beam of red (632.8 nm) light. This light passes to the skin through one optical fiber which illuminates a region of tissue that approximates a hemisphere with a radius of about 1 mm. The light entering the tissue is scattered by the moving red blood cells causing a frequency shift proportional to the blood flow according to the Doppler principle [10]. A portion of the backscattered light from both the nonmoving tissue structures and the moving red blood cells is then collected by an adjacent optical fiber and projected onto a photodiode inside the LD 5000 monitor. The electrical output from this photodiode is processed by the perfusion monitor resulting in a continuous reading

that is proportional to the skin blood flow under the sensor. The instrument was nulled electronically before each study by adjusting the output reading to zero after the sensor was positioned over a stationary surface of white scattering material. To avoid optical interference between the LED's in the SaO_2 sensor and the HeNe laser source, the reflectance pulse oximeter was turned off when skin blood flow measurements were performed.

2) *Reflectance Pulse Oximeter*: The reflectance oximeter generates digital switching pulses to drive the red and infrared LED's in the sensor alternately at a repetition rate of 1 KHz. The time multiplexed output current from the photodiode, which correspond to the red and infrared light intensities reflected from the skin, is first converted to a proportional analog voltage using a low noise operational amplifier configured as a current-to-voltage converter. The resulting output voltage is subsequently decomposed into two separate channels using two sample-and-hold circuits synchronously triggered by the same pulses driving the respective LED's. The red and infrared photoplethysmograms produced are amplified and high-pass filtered (cut-off frequency 15 Hz) to separate the ac pulses from the dc signal of each photoplethysmogram. To enable further signal processing, the respective ac and dc signals of each photoplethysmogram were digitized at a rate of 100 samples/s by an IBM-AT personal computer equipped with a Tecmar 12 bit resolution A/D-D/A data acquisition board. From the recorded signals, a computer algorithm calculates the $I_r(\text{red})/I_r(\text{infrared})$ ratio for each heart-beat. These values are further averaged using a five-point running average algorithm. Another algorithm uses the averaged ratios to compute and display SaO_2 according to (1). The *A* and *B* coefficients necessary for calculating SaO_2 in the oximeter were determined previously in our laboratory based on a calibration study using the HP Model 47201A ear oximeter as a reference.

B. In Vivo Studies

Seven Caucasian volunteers participated in the studies which were approved by our institutional review board. The subjects, five males and two females, were healthy nonsmokers ranging in age from 21 to 29 years.

To establish a reference for measuring SaO_2 , we used the HP 47201A ear oximeter. The oximeter was standardized before each test by placing the ear probe in a special standardization chamber inside the ear oximeter. The ear probe was then attached to the anti-helix portion of the ear pinna with a head mount and elastic head band according to the manufacturer recommendations.

The sensor of the reflectance pulse oximeter was attached either to the volar side of the forearm or the anterior thigh region. In each case, the monitored arm or leg was immobilized in the horizontal position to minimize spurious movement artifacts.

The experimental setup used in our studies is illustrated in Fig. 3.

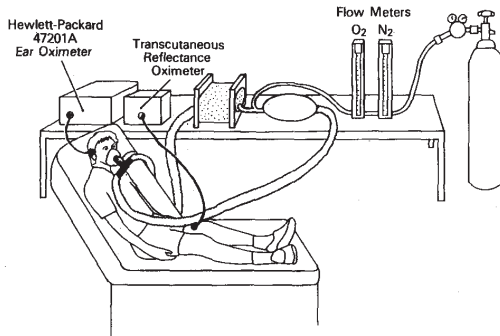

Fig. 3. Experimental setup illustrating the closed loop rebreathing circuit for obtaining different inspired O₂/N₂ concentrations and the attachment of the oximeter sensors to the subject's ear and thigh.

IV. RESULTS

Several *in vivo* studies were performed using the prototype optical reflectance sensor and oximeter as described above. The primary objectives of the first study were to investigate the effect of 1) source/detector separation and 2) local skin heating on the pulsatile component of the red and infrared photoplethysmograms detected by the sensor. In a separate *in vivo* study, we compared SaO₂ values measured by the pulse oximeter from the forearm and thigh of different subjects during progressive hypoxemia with simultaneous recordings obtained from the HP ear oximeter in the range between 70-100 percent.

A. Source/Detector Separation Studies

The purpose of these studies was to determine the relationship between different LED/photodiode separations and the magnitude of the pulsatile component of each reflection photoplethysmogram. We noticed that for a constant LED intensity, the light intensity detected by the photodiode decreases roughly exponentially as the radial distance from the LED's is increased. The same basic relationship applies to both the dc and ac components of the reflected photoplethysmograms as shown in Fig. 4. This is expected since the probability that the incident photons will be absorbed as they traverse a relatively longer path length before reaching the detector is increased.

Fig. 5 shows the relative pulse amplitude of the red and infrared reflected photoplethysmograms recorded from the forearm of one subject. In this study, the incident light intensities of the red and infrared LED's were adjusted by varying the LED driving currents such that for each separation distance the dc component of each photoplethysmogram remained relatively constant. Each point represents the average values obtained for five repeated experiments performed on the same subject. In each experiment, and for each separation distance, the data acquired were averaged over a 30 s time interval.

As shown in Fig. 5, by increasing the separation distance between the LED's and photodiode from 4 to 11

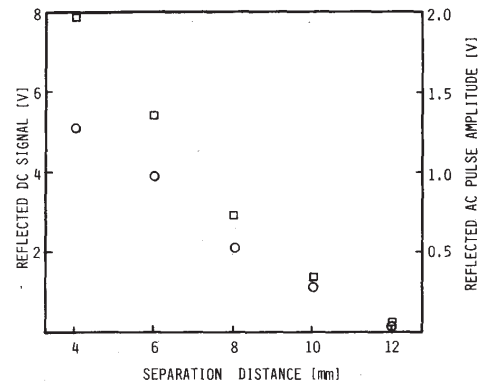

Fig. 4. The effect of LED/photodiode separation on the dc (□) and ac (○) components of the reflected infrared photoplethysmograms. Measurements were performed at a skin temperature of 43°C.

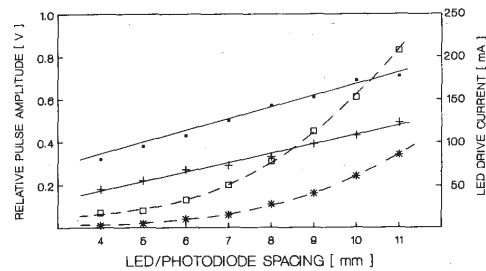

Fig. 5. Effect of LED/photodiode separation on the relative pulse amplitude of the red (+) and infrared (■) photoplethysmograms. The driving currents of the red (□) and infrared (★) LED's required to maintain a constant dc reflectance from the skin are shown for comparison.

mm, we were able to achieve almost a two-fold increase in the pulse amplitude of the infrared photoplethysmogram. Furthermore, as illustrated in Fig. 6, the mean beat-to-beat variations of the infrared photoplethysmograms, which were determined by calculating the respective coefficients of variation (i.e., the standard deviation divided by the mean for a 30 s time interval), decreased from about 7 to 3 percent. This trend indicates that the photoplethysmograms became progressively more stable as the LED/photodetector separation was increased. Similar trends were also observed for the reflected red photoplethysmograms.

B. Skin Heating Studies

Practically, it is difficult to detect large reflection photoplethysmograms from skin areas which are not very vascular, such as the chest and the limbs. In this study, we attempted to determine if local skin heating, which is known to produce vasodilatation of the microvascular bed, could be used as a practical mean to increase the pulsatile component of the reflected photoplethysmograms. Likewise, we sought to determine if skin heating could help to reduce the beat-to-beat variability in the pulsatile components of the recorded photoplethysmograms.

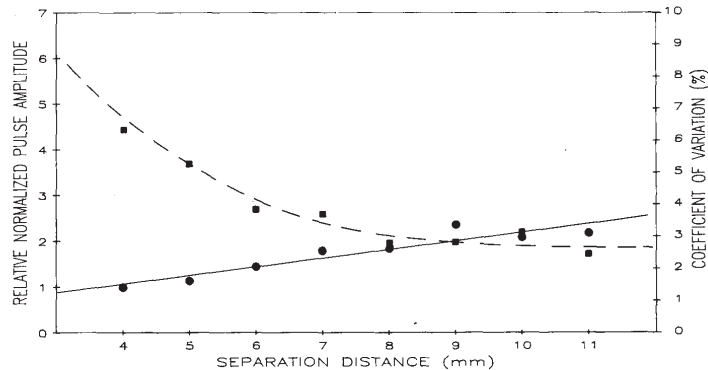

Fig. 6. Effect of LED/photodiode separation on the mean pulse amplitude (•) and the corresponding decrease in the beat-to-beat amplitude fluctuation (■) of the infrared photoplethysmograms expressed in terms of the coefficient of variation. Each pulse amplitude was normalized with respect to a separation distance of 4 mm.

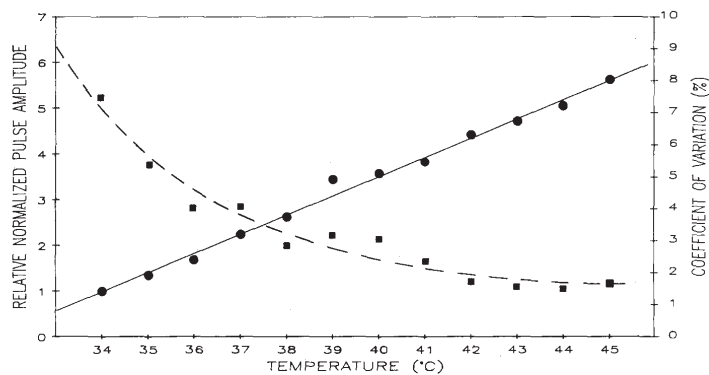

Fig. 7. Effect of skin temperature on the mean pulse amplitude (•) and the corresponding decrease in the coefficient of variation (■) of the infrared photoplethysmograms. Each pulse amplitude was normalized with respect to a separation distance of 4 mm.

Measurements were performed at a constant LED/photodiode separation of 6 mm while the subject was breathing ambient air. After attaching the reflectance sensor to the forearm, the surface of the skin was gradually heated to 45°C in 1°C step increments. The time needed to achieve a desired skin temperature depends on factors such as skin type, local blood flow, heat conductivity of the skin, and the temperature of the surrounding environment. Typically, we found that at each temperature setting, 5 min were sufficient for the skin temperature to reach steady state.

As shown in Fig. 7, by increasing the local skin temperature from 34° to 45°C, we were able to obtain a five-fold increase in the pulse amplitude of the infrared photoplethysmograms. Moreover, by heating the skin, the vascular bed under study becomes vasodilated and, there-

fore, the reflected photoplethysmograms become more stable resulting in smaller beat-to-beat amplitude fluctuations. Consequently, as our data show, the mean coefficient of variation decreased from approximately 7 to 2 percent. Similar trends were also observed for the reflected red photoplethysmograms.

The effect of local skin heating on the pulsatile component of the reflected photoplethysmograms is shown in Fig. 8. The relative skin blood flow for each temperature setting is also shown for comparison. It is clearly seen that as the temperature of the skin was increased from its initial value of 29° to 43°C, the pulse amplitude of the red and infrared photoplethysmograms increased accordingly. Furthermore, the mean pulse amplitude of the recorded waveforms remained relatively constant over a period of approximately 20 min after the heater was turned

Explore Litigation Insights

Docket Alarm provides insights to develop a more informed litigation strategy and the peace of mind of knowing you're on top of things.

Real-Time Litigation Alerts



Keep your litigation team up-to-date with **real-time alerts** and advanced team management tools built for the enterprise, all while greatly reducing PACER spend.

Our comprehensive service means we can handle Federal, State, and Administrative courts across the country.

Advanced Docket Research



With over 230 million records, Docket Alarm's cloud-native docket research platform finds what other services can't. Coverage includes Federal, State, plus PTAB, TTAB, ITC and NLRB decisions, all in one place.

Identify arguments that have been successful in the past with full text, pinpoint searching. Link to case law cited within any court document via Fastcase.

Analytics At Your Fingertips



Learn what happened the last time a particular judge, opposing counsel or company faced cases similar to yours.

Advanced out-of-the-box PTAB and TTAB analytics are always at your fingertips.

API

Docket Alarm offers a powerful API (application programming interface) to developers that want to integrate case filings into their apps.

LAW FIRMS

Build custom dashboards for your attorneys and clients with live data direct from the court.

Automate many repetitive legal tasks like conflict checks, document management, and marketing.

FINANCIAL INSTITUTIONS

Litigation and bankruptcy checks for companies and debtors.

E-DISCOVERY AND LEGAL VENDORS

Sync your system to PACER to automate legal marketing.