



US005656921A

United States Patent [19]

[11] Patent Number: **5,656,921**

Farrall

[45] Date of Patent: **Aug. 12, 1997**

[54] CONTROL OF A VEHICLE POWERTRAIN

5,081,365	1/1992	Field et al.	290/45
5,343,970	9/1994	Severinsky	180/65.2
5,389,050	2/1995	Sakai et al.	477/78
5,390,117	2/1995	Graf et al.	364/424.1
5,487,007	1/1996	Suzuki et al.	364/424.05

[75] Inventor: **Simon David Farrall**, Coventry, England

[73] Assignee: **Rover Group Limited**, Birmingham, England

FOREIGN PATENT DOCUMENTS

0570242	11/1993	European Pat. Off.
2267364	12/1993	United Kingdom

[21] Appl. No.: **443,583**

[22] Filed: **May 17, 1995**

[30] Foreign Application Priority Data

May 24, 1994 [GB] United Kingdom 9410389

[51] Int. Cl.⁶ **H02P 9/04**

[52] U.S. Cl. **322/40; 322/9; 322/38; 180/65.2**

[58] Field of Search 322/9; 180/65.2, 180/165; 290/16; 60/716, 718

[56] References Cited

U.S. PATENT DOCUMENTS

4,282,947	8/1981	Kemper	180/165
4,335,429	6/1982	Kwakatsu	364/424
4,407,132	10/1983	Kwakatsu et al.	60/716
4,533,011	8/1985	Heidemeyer et al.	180/65.2

Primary Examiner—Steven L. Stephan
Assistant Examiner—Nicholas Ponomarenko
Attorney, Agent, or Firm—Davis and Bujold

[57] ABSTRACT

A controller **20** for a vehicle powertrain, the powertrain comprising an electric motor **16** powered by a battery and an engine **14** powered by fossil fuel. The engine **14** is typically an internal combustion petrol engine. The controller **20** is operative to use maps stored in memory to control the torque contributions from the engine and the motor so as to maintain a desired relationship between the contributions of the electric motor **16** and the engine **14** towards the powering of the vehicle, and the controller is adaptive in that it is arranged to adapt said maps by altering one or more values stored therein to obtain a desired relationship.

24 Claims, 4 Drawing Sheets

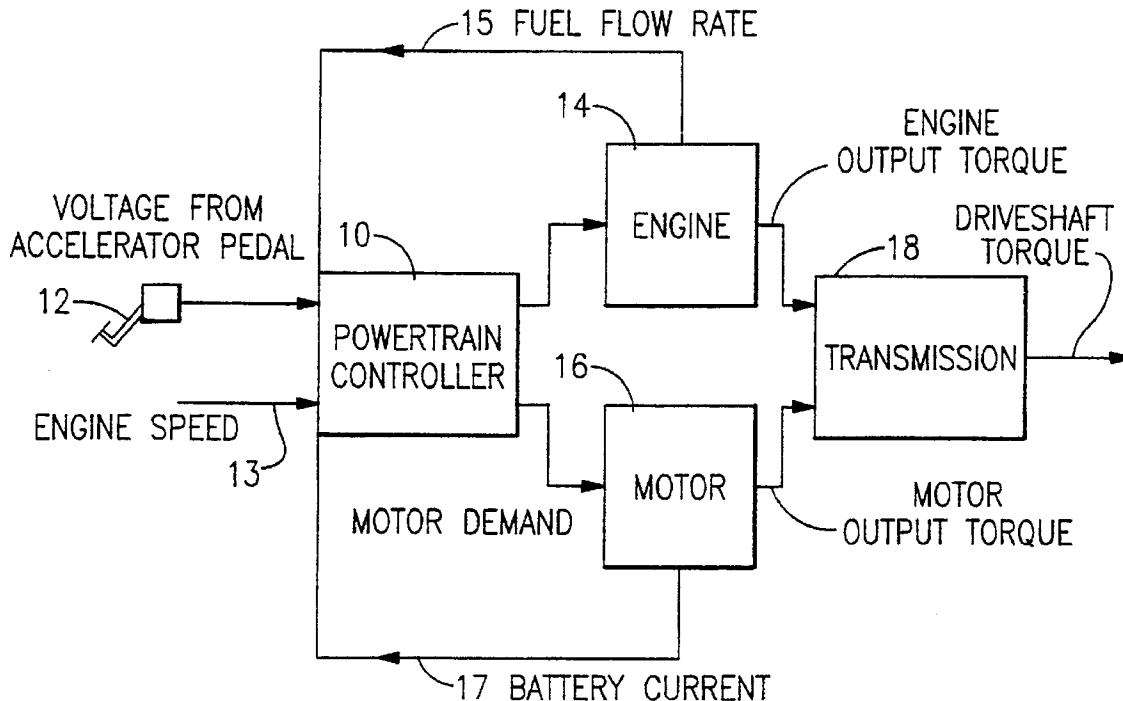

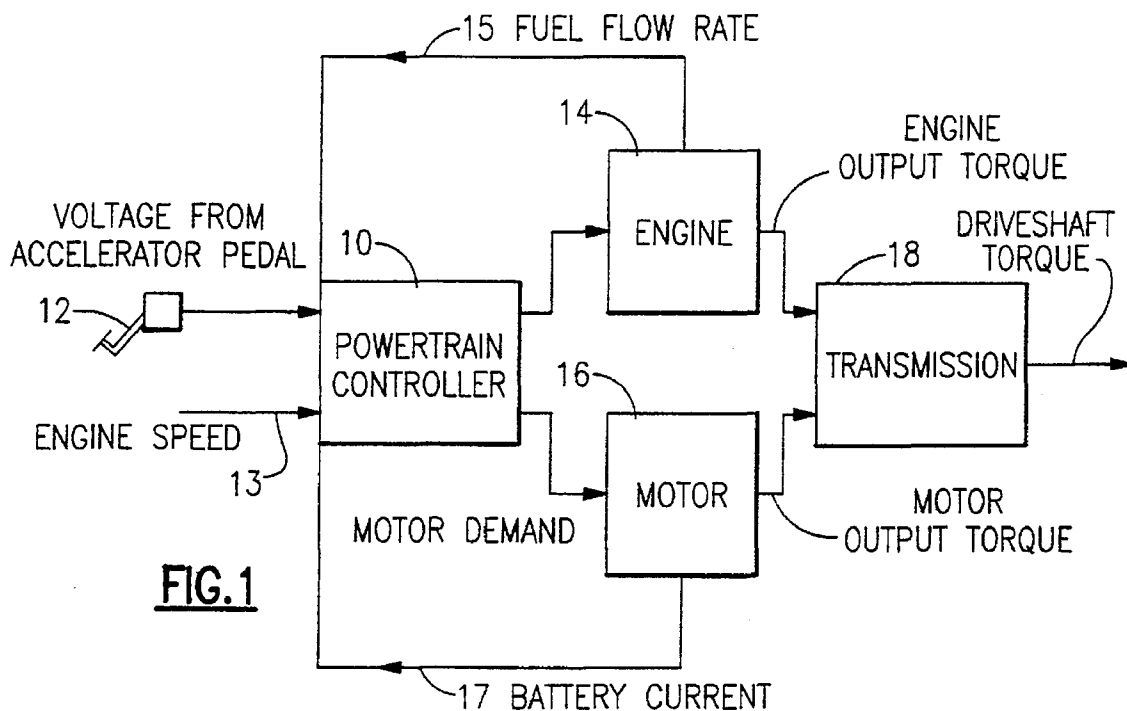

FIG.1

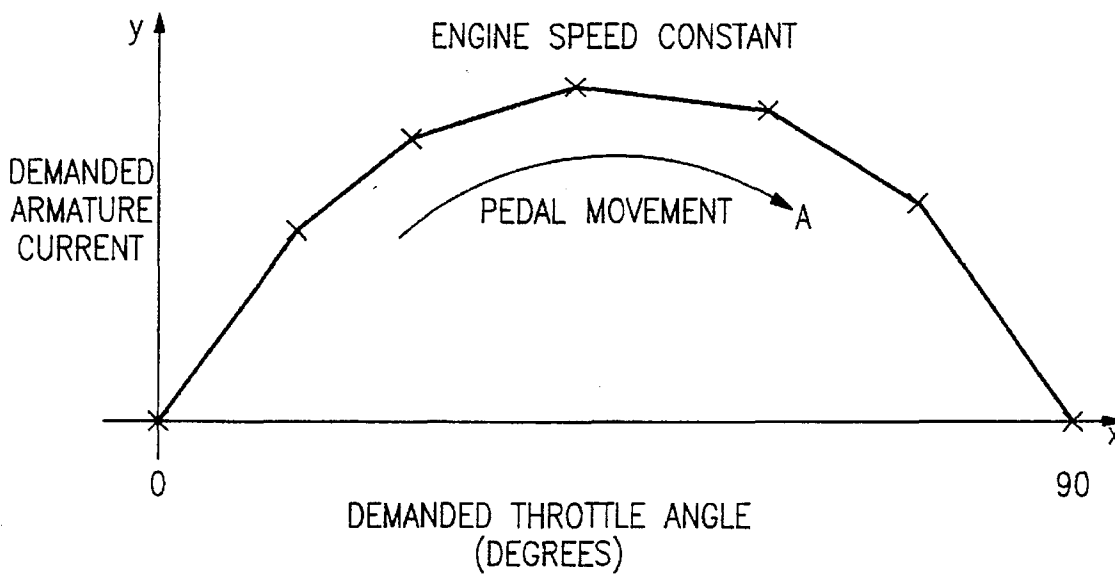
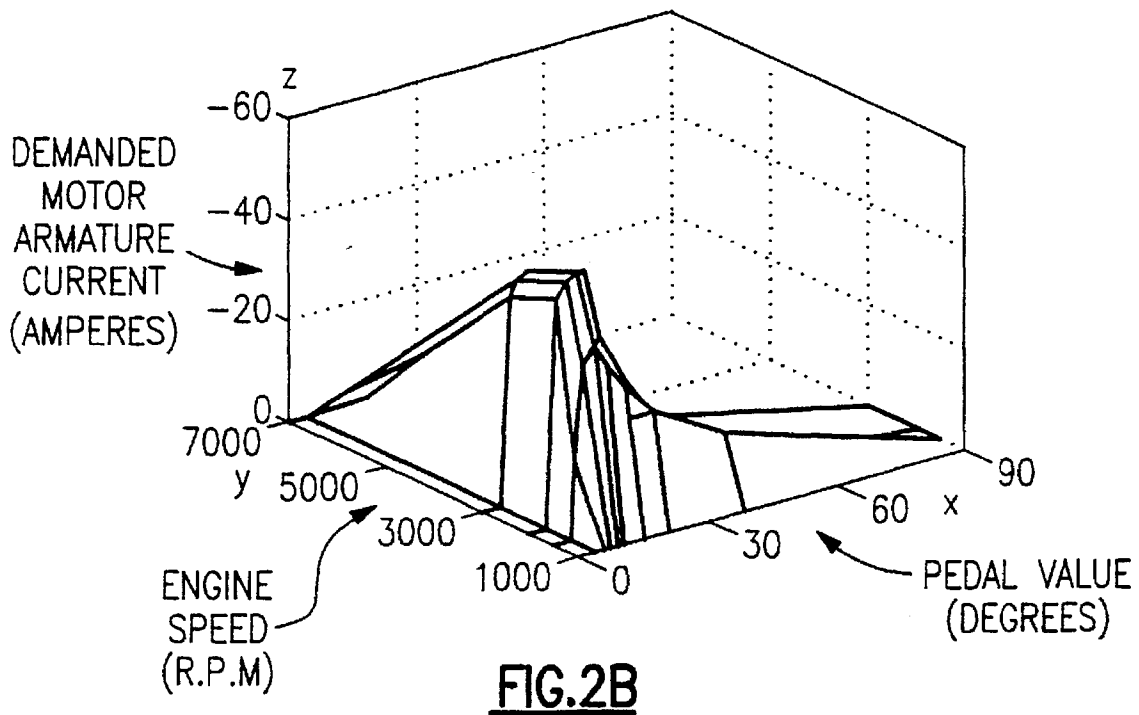
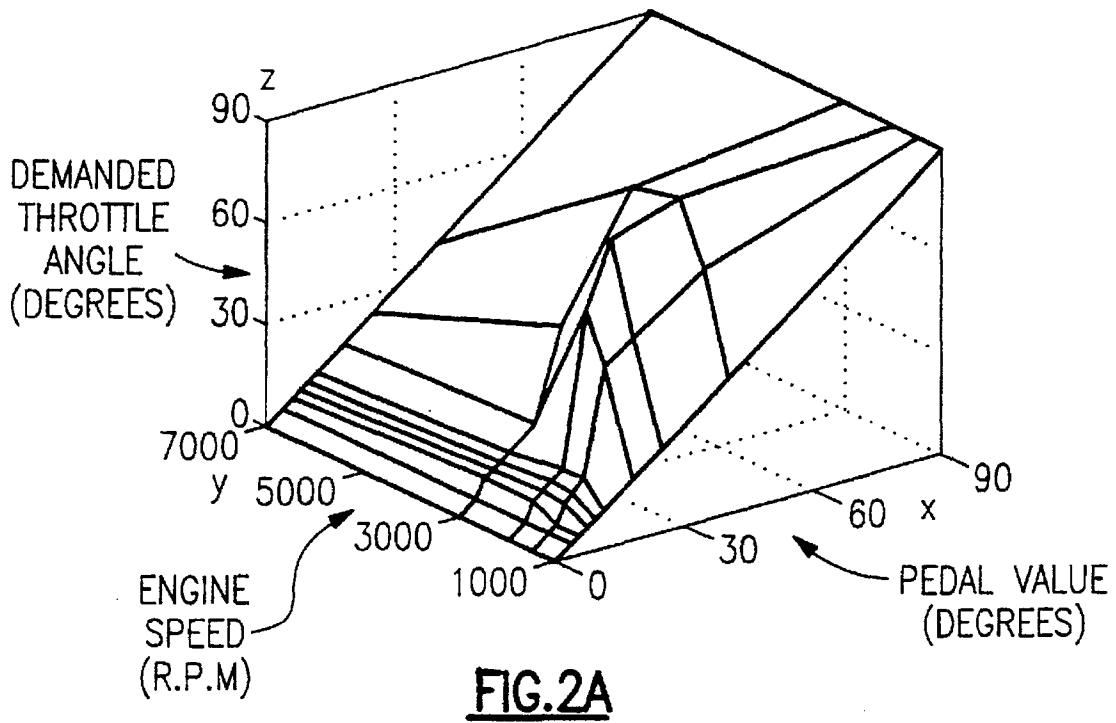

FIG.3



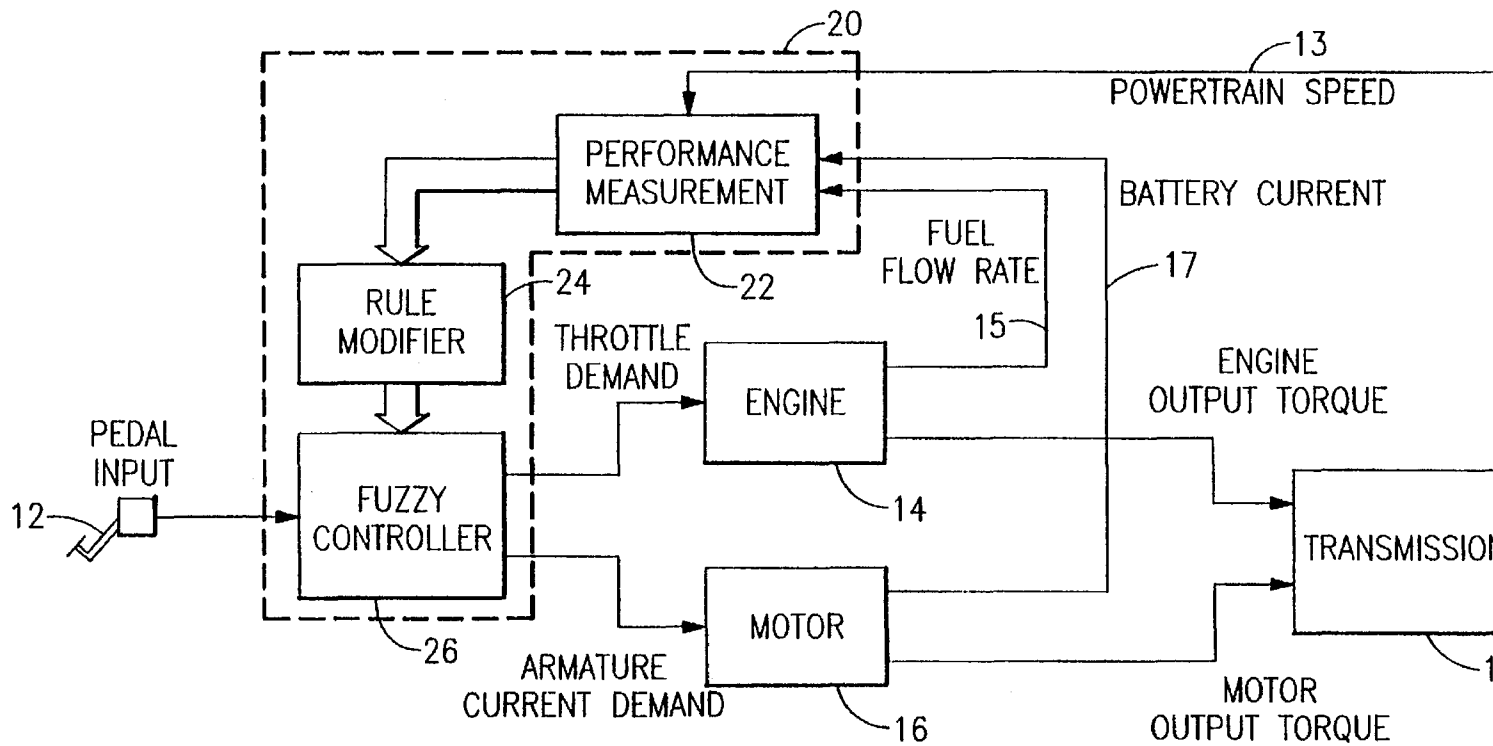
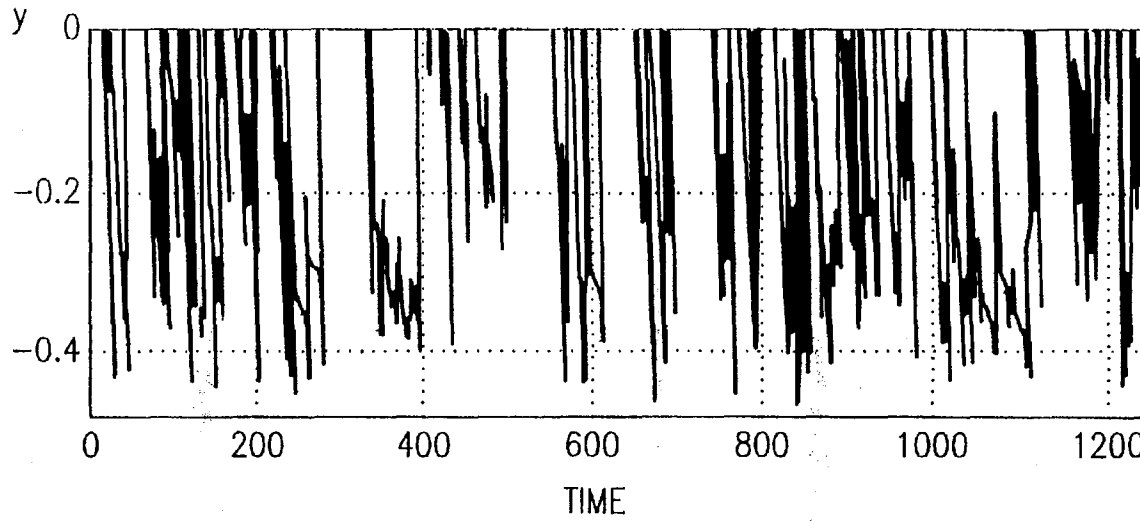

FIG.4

INSTANTANEOUS
PERFORMANCE
MEASURE

FIG.5A



MOVING
AVERAGE OF
INSTANTANEOUS
PERFORMANCE
MEASURE

FIG.5B

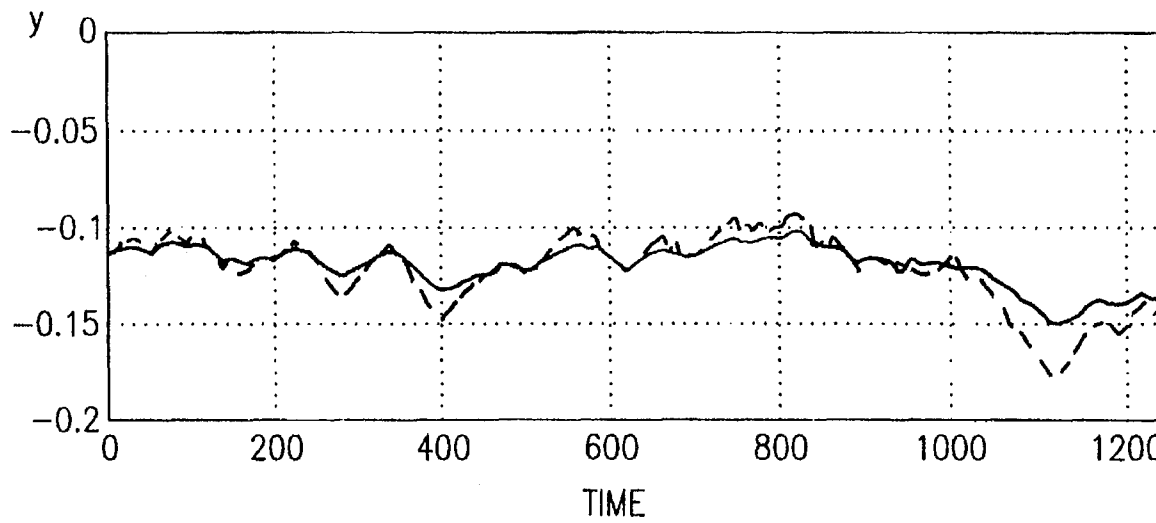

Explore Litigation Insights

Docket Alarm provides insights to develop a more informed litigation strategy and the peace of mind of knowing you're on top of things.

Real-Time Litigation Alerts



Keep your litigation team up-to-date with **real-time alerts** and advanced team management tools built for the enterprise, all while greatly reducing PACER spend.

Our comprehensive service means we can handle Federal, State, and Administrative courts across the country.

Advanced Docket Research



With over 230 million records, Docket Alarm's cloud-native docket research platform finds what other services can't. Coverage includes Federal, State, plus PTAB, TTAB, ITC and NLRB decisions, all in one place.

Identify arguments that have been successful in the past with full text, pinpoint searching. Link to case law cited within any court document via Fastcase.

Analytics At Your Fingertips



Learn what happened the last time a particular judge, opposing counsel or company faced cases similar to yours.

Advanced out-of-the-box PTAB and TTAB analytics are always at your fingertips.

API

Docket Alarm offers a powerful API (application programming interface) to developers that want to integrate case filings into their apps.

LAW FIRMS

Build custom dashboards for your attorneys and clients with live data direct from the court.

Automate many repetitive legal tasks like conflict checks, document management, and marketing.

FINANCIAL INSTITUTIONS

Litigation and bankruptcy checks for companies and debtors.

E-DISCOVERY AND LEGAL VENDORS

Sync your system to PACER to automate legal marketing.