

UNITED STATES PATENT AND TRADEMARK OFFICE

BEFORE THE PATENT TRIAL AND APPEAL BOARD

MEDTRONIC, INC., AND MEDTRONIC VASCULAR, INC.
Petitioners,

v.

TELEFLEX INNOVATIONS S.A.R.L.
Patent Owner.

Case IPR2020-01342
Patent 8,142,413

PATENT OWNER'S OBJECTIONS TO PETITIONERS' DEMONSTRATIVES

Pursuant to the Board’s November 3, 2021 Order Setting Oral Argument, Patent Owner hereby submits the following objections to Petitioners’ demonstratives. Patent Owner met and conferred in good faith with Petitioners on November 15, 2021 and the following objections could not be resolved.

I. Slide 156

Patent Owner objects to Petitioners’ demonstrative slide 156 as improper new argument and evidence since the table and excerpt did not appear in any paper.

Sakurada

	TVAC	Thrombuster	PercuSurge	Rescue
Guide catheter	7 Fr	7 Fr	7 Fr	7 Fr
Larger outer diameter	4.5 Fr	5.7 Fr	5.6 Fr	4.5 Fr
Smaller outer diameter	4.5 Fr	4.5 Fr	3.7 Fr	4.5 Fr
Distal inner lumen (mm ²)	0.9	1.13	0.95	0.65
Proximal inner lumen (mm ²)	0.98	1.37	0.92	0.65
inner support	yes	no	no	yes
shape of distal tip	duckbill	oblique straight	oblique straight	oblique straight
original device for negative pressure	motor drive	30 ml syringe	20 ml syringe	motor drive
aspiration time in a test tube (sec)	20.35 ± 4.07	11.81 ± 1.13	39.50 ± 6.40	61.63 ± 2.73

Passing Ability
 Quantitative measurements of passing ability is shown in Figure 2. Only TVAC was able to pass the third bend. PercuSurge and Thrombuster catheters were able to reach the second bend. The Rescue catheter was only able to pass the first bend.

Ex-1055, 6, 8

DEMONSTRATIVE EXHIBIT—NOT EVIDENCE 156

II. Slide 160

Patent Owner objects to Petitioners’ demonstrative slide 160 as improper new argument and evidence as it is not cited in support of any argument in Petitioners’ papers.

Kataishi – Expectation of Success

tially equal to actual pump pressure when the cut surface 16 completely adsorbs the atheroma (AT), and enables suction of the lipid core (LC) in a vascular endothelium (ET). Thus, the concave cut surface or portion 161 may have any shape, as long as it is angled in an angled direction, i.e., a proximal direction. Generally, the concave cut portion 161 is formed so as to be gently concave so that atheroma can be covered and the gap minimized. The concave cut portion 161 is provided at least partially on the proximal end side of the cut surface 16. More specifically, the concave portion 161 may

Ex-1025 (Kataishi), ¶ [0027]

DEMONSTRATIVE EXHIBIT—NOT EVIDENCE

160

III. Slide 172

Patent Owner objects to Petitioners' demonstrative slide 172 as improper new argument because Petitioners did not cite or reference Adams in connection with its secondary considerations briefing.

Known Elements in the Art: Angled Openings

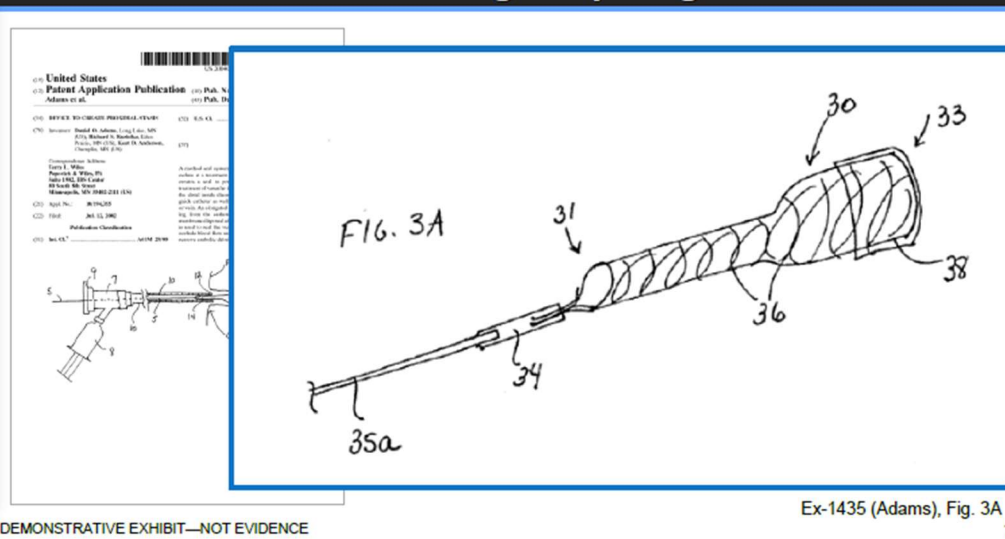

DEMONSTRATIVE EXHIBIT—NOT EVIDENCE

172

Dated: November 17, 2021.

Respectfully submitted,

/J. Derek Vandenburg /

J. Derek Vandenburg (Lead Counsel)

Registration No. 32,179

Carlson, Caspers, Vandenburg
& Lindquist, P.A.

225 South Sixth Street, Suite 4200

Minneapolis, MN 55402

Telephone: (612) 436-9600

Facsimile: (612) 436-9650

Email:

DVandenburg@carlsoncaspers.com

Lead Counsel for Patent Owner

CERTIFICATION OF SERVICE

Pursuant to 37 C.F.R. § 42.6(e) and the agreement of the parties, the undersigned certifies that on November 17, 2021, a true and correct copy of the foregoing *Patent Owner's Objections to Evidence* was served via electronic mail upon the following:

Cyrus A. Morton (Reg. No. 44,954)
Sharon Roberg-Perez (Reg. No. 69,600)
Christopher A. Pinahs (Reg. No. 76,375)
Robins Kaplan LLP
800 LaSalle Avenue, Suite 2800
Minneapolis, MN 55401
Phone: 349-8500
Fax: 612-339-4181
Email: Cmorton@robinskaplan.com
Email: Sroberg-perez@robinskaplan.com
Email: Cpinahs@robinskaplan.com

/J. Derek Vandenburg/
J. Derek Vandenburg (Lead Counsel for Patent Owner)