

UNITED STATES PATENT AND TRADEMARK OFFICE

BEFORE THE PATENT TRIAL AND APPEAL BOARD

REGENERON PHARMACEUTICALS, INC.
Petitioner,

v.

NOVARTIS PHARMA AG,
NOVARTIS TECHNOLOGY LLC,
NOVARTIS PHARMACEUTICALS CORPORATION,
Patent Owners.

Patent Number: 9,220,631

DECLARATION OF HORST KOLLER

TABLE OF CONTENTS

	Page
I. Introduction.....	1
II. Summary of Opinions	1
III. Qualifications and Compensation.....	3
IV. Relevant Legal Standards	7
A. Claim Construction	8
B. Invalidity	9
C. Person of Ordinary Skill in the Art	12
V. Background of the Technology	14
A. Intravitreal Administration of VEGF Antagonists.....	14
B. Pre-filled syringes.....	15
C. Syringe Stopper Forces	20
D. Siliconization of Pre-filled Syringe Components	24
1. “Oily” or “Spray-on” Siliconization	26
2. “Baked-On” Siliconization	30
3. Coated, Uncoated, and Siliconized Stoppers.....	36
E. Sterilization of Pre-filled Syringes.....	39
F. Particulate Content	46
VI. The ’631 Patent.....	48
A. The Claims	48
B. Overview of Specification.....	52
1. The ’631 patent fails to disclose a process for applying low levels of silicone oil	52
2. The ’631 patent fails to disclose the process for terminal sterilization.....	53
C. Meaning of the Claim Terms	53

VII.	The Prior Art to the '631 Patent	55
A.	“Sigg” – WO 2011/006877	55
B.	“Lam” – International Pat. Appl. Pub. No. WO 2008/077155	60
C.	“Boulangé” – International Pat. Appl. Pub. No. WO 2009/030976	65
D.	“Reuter” – Bruno Reuter & Claudia Petersen, <i>Syringe Siliconization</i> , 4 <i>TechnoPharm</i> 2, 238 (2012).....	71
E.	“Fries” – A. Fries, <i>Drug Delivery of Sensitive Biopharmaceuticals with Prefilled Syringes</i> , <i>Drug Delivery Technology</i> , Vol. 9, No. 5	77
F.	“Furfine” – WO 2007/149334.....	78
G.	“Macugen Label” – Macugen [®] Prescribing Information	78
VIII.	Petition 1, Ground 1: Sigg in View of Boulangé Renders Obvious Claims 1-3, 5-9, and 14-22	79
A.	Motivation to Combine Sigg and Boulangé.....	79
1.	Silicone Oil and Break Loose / Slide Forces	79
2.	Particulate Content.....	87
B.	Claim 1	89
1.	[1.a] A pre-filled, terminally sterilized syringe for intravitreal injection	89
2.	[1.b] the syringe comprising a glass body forming a barrel, a stopper and a plunger	90
3.	[1.c] and containing an ophthalmic solution which comprises a VEGF-antagonist, wherein:	92
4.	[1.d] the syringe has a nominal maximum fill volume of between about 0.5 mL and about 1 mL	93
5.	[1.e] the syringe barrel comprises from about 1 µg to 100 µg silicone oil	95
6.	[1.f] the VEGF-antagonist solution comprises no more than 2 particles > 50 µm in diameter per mL.....	96
7.	[1.g] and wherein the syringe has a stopper break loose force of less than about 11N.	99

C.	Claims 2, 3, 5-9, 14, 16-22 and 24	100
1.	Claim 2	100
2.	Claims 3 and 22.....	102
3.	Claims 5 and 6.....	103
4.	Claims 7, 8, and 9.....	103
5.	Claims 14 and 16.....	104
6.	Claim 15	106
7.	Claim 17	109
8.	Claims 18 and 19.....	110
9.	Claim 20	112
10.	Claim 21	114
IX.	Petition 1, Ground 2: Sigg in View of Boulange and Fries Renders Obvious Claims 4, 10 and 23.....	116
X.	Petition 1, Ground 3: Sigg in view of Boulange and Furfine Renders Obvious Claims 11-13	118
A.	Claims 11 and 12.....	119
B.	Claim 13	120
XI.	Petition 2, Ground 1: Lam in View of Reuter Renders Obvious Claims 1-10 and 14-23	121
A.	Motivation to Combine Lam and Reuter	121
1.	Silicone Oil and Break Loose / Slide Forces	121
2.	Particulate Content	128
B.	Claim 1	130
1.	[1.a] A pre-filled, terminally sterilized syringe for intravitreal injection	130
2.	[1.b] the syringe comprising a glass body forming a barrel, a stopper and a plunger	132
3.	[1.c] and containing an ophthalmic solution which comprises a VEGF-antagonist, wherein:	133
4.	[1.d] the syringe has a nominal maximum fill volume of between about 0.5 mL and about 1 mL	134
5.	[1.e] the syringe barrel comprises from about 1 µg to 100 µg silicone oil	134

6.	[1.f] the VEGF-antagonist solution comprises no more than 2 particles >50 µm in diameter per mL.....	137
7.	[1.g] and wherein the syringe has a stopper break loose force of less than about 11N.	140
C.	Claims 2-10 and 14-24	142
1.	Claim 2.....	142
2.	Claims 3 and 22.....	142
3.	Claims 4, 10, and 23	143
4.	Claims 5 and 6.....	144
5.	Claims 7, 8, and 9.....	145
6.	Claims 14 and 16.....	146
7.	Claim 15.....	147
8.	Claim 17.....	150
9.	Claims 18 and 19.....	151
10.	Claim 20.....	152
11.	Claim 21.....	153
XII.	Petition 2, Ground 2: Lam in view of Reuter and Furfine Renders	
	Obvious Claims 11-13	155
A.	Claims 11 and 12.....	156
B.	Claim 13	157
XIII.	Declaration.....	159

I. Introduction

1. I have been retained by Petitioner Regeneron Pharmaceuticals, Inc. (“Petitioner” or “Regeneron”), as an independent expert witness in the above-captioned *inter partes* review (“IPR”), in which Regeneron has requested that the U.S. Patent and Trademark Office cancel as unpatentable all claims of U.S. Patent No. 9,220,631 (“the ’631 patent”).

2. This declaration sets forth my analyses and opinions based on my knowledge, experience, and the materials I have considered. As I explain below, it is my opinion that all claims of the ’631 patent are directed to subject matter that was routine, conventional, and well known in the art before the ’631 patent priority date. As would be readily appreciated by one of skill in the art, the ’631 patent is rendered obvious by the combination of prior art references discussed herein.

3. I have reviewed the documents referenced in this declaration. I understand they have been submitted as exhibits in conjunction with Regeneron’s Petitions for IPR.

II. Summary of Opinions

4. Based on my knowledge, experience, and the materials that I have reviewed, it is my opinion that claims 1-23 of the ’631 patent are obvious.

Specifically:

(i) Claims 1-3, 5-9, and 14-22 are obvious based on International Patent Application Publication No. WO 2011/006877 to Sigg et al. (“Sigg”) (Ex. 1007) in view of International Patent Application Publication No. WO 2009/030976 to Boulange et al. (“Boulange”) (Ex. 1008), and if necessary, USP Chapter <789>, titled “Particulate Matter in Ophthalmic Solutions.” (“USP789”) (Ex. 1019);

(ii) Claims 4, 10 and 23 are obvious based on Sigg in view of Boulange, further in view of A. Fries, *Drug Delivery of Sensitive Biopharmaceuticals with Prefilled Syringes*, Drug Delivery Technology, Vol. 9, No. 5 (May 2009) (“Fries”) (Ex. 1012), and if necessary, USP789;

(iii) Claims 11-13 are obvious based on Sigg in view of Boulange, further in view of International Patent Application Publication No. WO 2007/149334 (“Furfine”) (Ex. 1021), and if necessary, USP789;

(iv) Claims 1-10, and 14-23 are obvious based on Lam in view of Bruno Reuter & Claudia Petersen, *Syringe Siliconization*, 4 TECHNOPHARM 2, 238 (2012) (“Reuter”) (Ex. 1010) , and if necessary, USP789;

(v) Claims 11-13 are obvious based on the combination of Lam in view of Reuter, further in view of Furfine, and if necessary, USP789.

III. Qualifications and Compensation

5. I have a Diplom-Ingenieur (“Dipl.Ing.”) degree in biotechnology from Hochschule Mannheim, which I earned in 1993. A Dipl.Ing is considered equivalent to a master’s engineering degree that would be awarded by a U.S. university. Prior to that I had several years of apprenticeship and work experience as a medical technician in Germany.

6. I am currently the CEO of HK Packaging Consulting, and have held this position since 2015. In this role, I consult worldwide on parenteral packaging, which includes consulting on syringe selection and related primary packaging issues, and consulting on the role of primary and secondary packaging in dosage form and drug product development.

7. At HK Packaging Consulting, I provide technical and regulatory support to both primary packaging manufacturers and pharmaceutical companies. For primary packaging manufacturers, I work on choosing pharmaceutical container materials and components (vials and syringes), setting container specifications, ensuring compliance and testing in accordance with compendia such as the U.S., European Pharmacopeias, and the International Organization for Standardization (“ISO”), and providing support for regulatory filings with the U.S. Food and Drug Administration (“FDA”) and the European Medicines Agency (“EMA” or “EMA”). For pharmaceutical companies, I work as a consultant to provide

troubleshooting services, including technical support and testing methods relating to primary packaging, design and test manufacturing processes relating to filling and finishing of pharmaceutical containers including syringes, selection and optimization of syringe materials and evaluation of components, and assistance with compendial compliance and testing and regulatory filings.

8. Prior to my current role, I worked at Schott Pharmaceutical Packaging in Germany and Switzerland from 2000 to 2015. Schott is a well-known manufacturer of both glass and polymer pre-filled syringes. At Schott I held the following roles in the Syringe Department: Head of Product Technology for New Products from 2000-01; Manager for Research & Development and Quality Management from 2001-03; Head of Scientific and Regulatory Advisory from 2004-07; Manager of Scientific Advisory from 2007-09; Global Quality Manager for Regulatory Affairs from 2009-11; and finally, Head of Technical and Quality Support for the Syringe Business from 2011-15.

9. At Schott, my responsibilities included support of the global syringe business unit regarding questions of technical product requirements and specifications, and support of the global packaging development group for primary and secondary packaging systems with regard to technical, quality and regulatory requirements. My role also included designing and conducting testing programs for packaging systems, especially for glass and polymer syringe systems, including

machine packaging and validation. I coordinated test programs with external partners for extractables and leachables analyses and material testing.

10. After earning my degree and prior to working at Schott, I was the Engineering Supervisor at Abbott GmbH in Germany from 1994 to 1999. At Abbott, I was a Research Technician from 1994-95, and then a Supervisor in Engineering Processes from 1995-99. At Abbott, my responsibilities included maintenance and calibration of equipment for manufacturing and research & development, and optimizing packaging lines for pharmaceutical primary and secondary packaging, including container filling and blister packaging. I also lead the cleaning and sterilization center for glass equipment at Abbott.

11. In addition to my work experience, I have many years of experience participating in professional organizations, standards setting organizations, and pharmacopeias relating to pharmaceutical packaging including syringes. For example, I am an active member of the ISO technical committee, TC 84 on “Devices for administration of medicinal products and catheters,” wherein I am a member of several working groups including WG 3 (needle-based injection systems – injector, container and pen needle) and WG 11 (syringes). I am also an active member of the ISO technical committee, TC 76 on “Transfusion, infusion and injection, and blood processing equipment for medical and pharmaceutical use,” wherein I am a member of several working groups including: WG 2 (rigid container system and related

accessories for parenterals and injectables) of which I am the Convenor, WG 4 (elastomeric parts and components and related secondary packaging), and WG 6 (primary packaging systems for medicinal products). I was *ad hoc* group leader for the WG 2 ISO committee that developed standard 11040-4 for glass syringes and 11040-6 for polymer syringes. I am also the Swiss Medic Delegate for the European Directorate for the Quality of Medicines (EDQM) working group WG 16 on the European Pharmacopoeia Chapter 3 relating to plastics.

12. In addition to the above, I have given numerous presentations at symposiums, conferences, and other professional organizational meetings, including many presentations over the years that relate to parenteral manufacturing, pre-filled syringes, extractables, leachables, the packaging of syringe systems, and regulatory (FDA/EMA) requirements for the packaging of parenterals.

13. My curriculum vitae is attached as Exhibit 1004, and provides further information about my experience, expertise, and presentations.

14. Through my professional experience, I have gained extensive expertise in syringe manufacturing, testing, siliconization, characterization, regulatory compliance, sales, and have a deep understanding of the worldwide syringe market. Through this experience, I have gained knowledge and experience relating to pre-filled syringes, the characterization of syringe stopper movement forces within a syringe, issues relating to syringe component leachables and extractables, issues

relating to siliconization, regulatory requirements on particulate matter for parenterals, and sterilization of container closure systems.

15. I am being compensated at my standard rate of \$450/hour. My compensation is in no way contingent upon my opinions or the outcome of the proceeding.

IV. Relevant Legal Standards

16. I am not an attorney, and therefore my understanding of patent law and the legal standards set forth in this report is based on explanations provided to me by counsel.

17. I understand that for any claim of a patent to claim priority to an earlier application (*i.e.*, to benefit from the earlier application's filing date), the claims of the later patent must be fully supported by the disclosure of the earlier patent application to which priority is claimed. I understand that in order for the claims to be supported, the earlier application's disclosure must be sufficient to allow a person of ordinary skill in the art to reasonably conclude that the inventors were in possession of the claimed invention.

18. I understand that the '631 patent claims priority to a number of patent applications, the earliest of which are European Patent Application No. EP12174860, filed on July 3, 2012, and European Patent Application No. EP12189649, filed on October 23, 2012. However, as I explain in Section VI.A

below, the July 3, 2012 Application No. EP12174860 filing does not support the issued claims of the '631 patent, and therefore the patent claims are not entitled to that priority date, and instead should have a priority date of no earlier than October 23, 2012. Nevertheless, for the purposes of my opinions, I have considered the state of the art as of and shortly before July 3, 2012, and the level of knowledge that a POSITA would have possessed at that time. Unless I state otherwise, whenever I refer to any principle or technical subject matter as having been known or understood, this is meant to denote the knowledge and understanding of a POSITA at or prior to July 3, 2012.¹

A. Claim Construction

19. It is my further understanding that the numbered paragraphs at the end of the disclosure of a U.S. Patent are the patent “claims” that define the metes and bounds of the alleged invention. I understand that these claims of the '631 patent are what is being challenged in the present IPR proceeding.

20. I have been informed that, in this proceeding, the Board must determine the scope of the claims by giving the claims their ordinary and customary meaning

¹ It is my opinion that there is no appreciable difference between the state of the art as of July 3, 2012 and as of October 23, 2012, as it relates to the subject matter claimed in the '631 patent. To the extent I have cited any references herein whose publication date is after July 3, 2012 (*e.g.*, the Reuter reference), it is my opinion that the subject matter disclosed in such references was well-known in the art prior to July 3, 2012 as well.

in light of the specification, as the claims would be interpreted by one of ordinary skill in the art.

21. I understand that patent claims generally include a “transitional” term or phrase, such as “consisting” or “comprising,” which may connect the preamble of the claim to the body of the claim. I have been informed that if a claim uses the term “consisting” as a transition term, that means that the claim is a “closed” claim, which means that the claim is limited to the claim features that follow the transition term and nothing else. On the other hand, I understand that the transition term “comprising” denotes an “open” claim, which means that the claim is not limited to only the features recited in the claim, and could encompass the listed elements as well as other unrecited elements.

B. Invalidity

22. I understand that Regeneron bears the burden of proving that the challenged claims of the '631 patent are invalid, and must prove this by a preponderance of the evidence, which means that invalidity must be shown to be more likely than not.

23. I have been asked to consider the question of whether the claims of the '631 patent would have been obvious. I understand that this analysis must be conducted from the perspective of the person of ordinary skill in the art, and whether the skilled artisan would consider any differences between the prior art and what is

claimed to have been obvious. To make this assessment, I have been informed that the concept of patent obviousness involves four factual inquiries: (1) the scope and content of the prior art; (2) the differences between the claimed invention and the prior art; (3) the level of ordinary skill in the art; and (4) secondary considerations of non-obviousness. I have been instructed that one must not engage in hindsight. Rather, I understand that one should instead consider what the person of ordinary skill in the art would have reason to pursue further, and steps that were routinely done, such as in response to known problems, steps or obstacles.

24. It is my understanding that the following is a non-exhaustive list of rationales that may support the obviousness of an invention: combining prior art elements according to known methods to yield predictable results; simple substitution of one known element for another to obtain predictable results; use of a known technique to improve a similar device (method, or product) in the same way; applying a known technique to a known device (method, or product) ready for improvement to yield predictable results; choosing from a finite number of identified, predictable solutions, with a reasonable expectation of success; and some teaching, suggestion, or motivation in the prior art that would have led a POSITA to modify the prior art reference or to combine prior art reference teachings to arrive at the claimed invention.

25. It is my understanding that the motivation to combine prior art references may be implicit and may be found in the knowledge of one of ordinary skill in the art, or in the nature of the problem to be solved. Specifically, it is my understanding that an implicit motivation to combine exists not only when a suggestion may be gleaned from the prior art as a whole, but when the “improvement” is technology-independent and the combination of references results in a product or process that is more desirable, for example because it is stronger, cheaper, cleaner, faster, lighter, smaller, more durable or more efficient. It is my further understanding that the motivation to combine references may be found in the nature of the problem to be solved where prior art references are directed to precisely the same problem.

26. I also understand that prior art may be relied on for its express disclosure and teachings. I also understand that the prior art may be relied upon for a teaching of features that are necessarily present in the prior art reference even if that specific feature is not expressly or explicitly disclosed.

27. I understand that before reaching any final conclusion on obviousness, the obviousness analysis requires consideration of objective indicia of non-obviousness, if any such indicia are offered. These must be considered to ensure that, for example, there were not some unanticipated problems, obstacles or hurdles that may seem easy to overcome in hindsight, but which were not readily overcome prior

to the relevant invention date of the patents/claims at issue here. I understand that these objective indicia are also known as “secondary considerations of non-obviousness,” and may include long-felt but unmet need and unexpected results, among others. I also understand, however, that any offered evidence of secondary considerations of non-obviousness must be comparable with the scope of the challenged claims. This means that for any offered evidence of secondary considerations of non-obviousness to be given substantial weight, I understand the proponent of that evidence must establish a “nexus” or a sufficient connection or tie between that evidence and the merits of the claimed invention, which I understand specifically incorporates any novel element(s) of the claimed invention. If the secondary consideration evidence offered actually results from something other than the merits of the claim, then I understand that there is no nexus or tie to the claimed invention. I also understand it is the Patent Owner who has the burden of proving that a nexus exists, and I understand that secondary considerations will not overcome a strong showing of obviousness.

C. Person of Ordinary Skill in the Art

28. I have been asked to review U.S. Patent No. 9,220,631 (“the ’631 patent”) from the perspective of a person of ordinary skill in the art (“POSITA”) as of the earliest claimed priority date for the patent—July 3, 2012. I have been asked to evaluate the disclosure and claims of the ’631 patent. I have been further asked

to consider whether the prior art renders obvious the pre-filled syringe covered by claims 1-23 of the '631 patent.

29. It is my opinion that a POSITA relevant to the '631 patent would have had at least an advanced degree (Dipl.Ing, M.S., or Ph.D.), with research experience in mechanical engineering, biomedical engineering, materials science, chemistry, or a related field, or at least 2-3 years of professional experience in one or more of those fields. Furthermore, it is my opinion that a POSITA would have had experience with (i) the design of pre-filled syringes; and (ii) sterilization of drug delivery devices, including those containing sterilization sensitive therapeutics. Such sterilization experience would include experience with microbiology. Based on my education, training and experience, it is my opinion that I can accurately represent the views of a POSITA as of the earliest claimed priority date of July 3, 2012, as to at least claims 1-23 of the '631 patent. The opinions I provide in this declaration are provided using the viewpoint of the POSITA as of July 3, 2012.

30. Claims 24-26 relate to methods of treating a patient suffering from eye disease, by administering an ophthalmic solution using the pre-filled syringe described in claim 1. Because such intravitreal administration must be performed by an ophthalmologist, it is my opinion that a POSITA with respect to claims 24-26 would be an ophthalmologist with experience administering VEGF-antagonist drugs to patients via the intravitreal route. *See* Ex. 1015.036 (“Since an excellent

knowledge of the anatomy and function of the eye is required, only an ophthalmologist should attempt these procedures.”).

V. Background of the Technology

31. I understand that the claims of the '631 patent are generally directed to pre-filled, terminally-sterilized, low volume glass syringes containing a VEGF-antagonist solution, and having low amounts of silicone oil and possessing low break loose and glide forces for the syringe stopper. In this section, I explain the technical concepts underlying the claims of the '631 patent, and also how each of these concepts were well known in the art prior to the effective filing date of the '631 patent.

A. Intravitreal Administration of VEGF Antagonists

32. “Intravitreal administration” refers to “injection directly into the vitreous cavity of the eye.” Ex. 1015.035. For such injections, “[e]xtreme care and precise technique are required to minimize or prevent damage to the eye, especially to the corneal endothelium.” *Id.* at .036. Numerous medical complications could occur from incorrect intravitreal administration, and only small volumes of around 0.1 mL or less should be injected. *Id.* As such, intravitreal injections are typically administered only by ophthalmologists. *Id.*

33. Several VEGF-antagonists were known and commercially available, and utilized to various degrees for different reasons beyond the scope of my opinion,

before the earliest priority date of the '631 patent, including ranibizumab (Lucentis®), aflibercept (Eylea®), and pegaptanib (Macugen®). *See* Ex. 1027, Ex. 1040, Ex. 1009. All three of these VEGF-antagonist drug formulations are intended for intravitreal administration. Because VEGF-antagonist formulations are administered by injection into the eye, they are typically dispensed either in vials to be used with empty disposable syringes (*see* Ex. 1040.014), or in what is known as a pre-filled syringe (*see* Ex. 1009.001).

B. Pre-filled syringes

34. As the name suggests, a pre-filled syringe is a syringe that is packaged and sold with a drug formulation already loaded into the syringe. *See* Ex. 1007 at 1:10-12, 15-17 (“Prefilled containers are a type of medical device that are filled by the manufacturer at the time of assembly and provided to the end user, generally a health-care provider or a patient requiring treatment, in a sterile condition. ... Of the various types of prefilled containers, prefilled syringes are the most common and best suited for parenteral administration of therapeutic products.”). The drug in a pre-filled syringe is typically in a form that is ready to be administered to a patient. Thus, “[p]refilled syringes are containers and drug delivery systems at the same time.” Ex. 1012.006.

35. Pre-filled syringes are considered to be a type of “primary packaging,” which generally refers to the components of a drug delivery system that are in direct

contact with the drug formulation. Primary packaging also includes components such as vials, bottles, closures, etc. Primary packaging can be distinguished from “secondary packaging,” where the latter refers to packaging components such as aluminum caps, cardboard boxes and blister packs that are not intended to come into direct contact with the drug formulation. The following description, taken from FDA’s drug packaging documentation, reflects generally accepted definitions of packaging components:

A primary packaging component means a packaging component that is or may be in direct contact with the dosage form. *A secondary packaging component* means a packaging component that is not and will not be in direct contact with the dosage form.

A container closure system refers to the sum of packaging components that together contain and protect the dosage form. This includes primary packaging components and secondary packaging components, if the latter are intended to provide additional protection to the drug product.

Ex. 1041.005.

36. A pre-filled syringe comprises certain typical components, such as a syringe barrel, which can be made of glass or plastic, with a front end closure system (such as the Vetter OVS® system), a plunger rod, or a stopper². Ex. 1011.002 (describing components of a pre-filled syringe). Pre-filled syringes are also supplied with a needle, referred to as a hypodermic needle, which may be “staked in” (*i.e.*,

² The stopper can also be referred to as a piston. *See e.g.* Ex. 1008 at 9:21-25.

affixed to the administration end of the barrel), or may be connectable to and detachable from a tapered end of the syringe barrel. See Ex. 1012.003 (describing components of a pre-filled syringe); Ex. 1015.344-347 (section on “Components for Prefillable Syringes and for Cartridges”); Ex. 1042 (describing hypodermic needle).

37. Connecting a needle to the tapered end of a syringe barrel is most often done by using what is known as a “Luer” connection, which is a type of tapered connection for fitting the tip of the syringe barrel into the bottom of the needle. Luer connections can be either “Luer lock” connections, where the syringe barrel and needle are securely joined together through a screw or tab connection, or a “Luer slip” connection, wherein the barrel and needle are held together by friction at the tapered Luer connection.

38. The picture below illustrates how typical components of a syringe may be joined together to create a pre-filled syringe, using the example of a needle with a Luer lock connector.

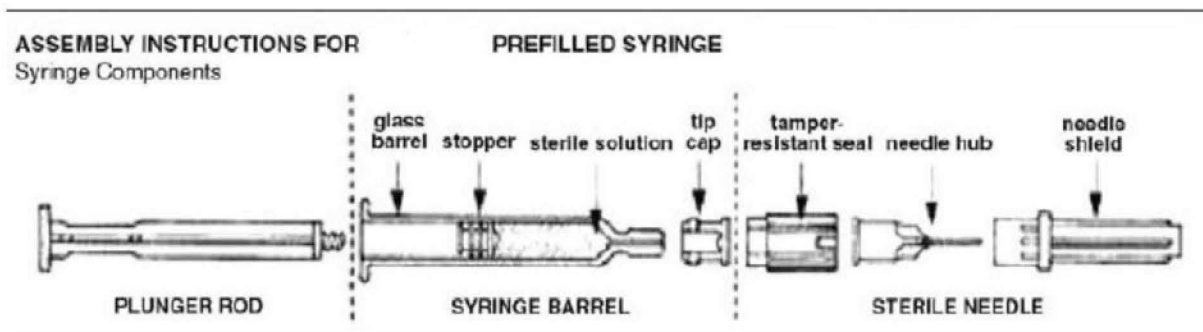

Figure 2: Components of pre-filled syringe

Ex. 1011.002 (Figure 2)

39. Prior to July 2012, pre-filled syringes were well-known in the art for parenteral administration of therapeutic products, and offered advantages over traditional therapeutic packaging such as their ease of use, a reduced risk of contamination, elimination of dosing errors, an increase in drug supply, and a reduction in waste. Ex. 1011.002; *see* Ex. 1007 at 1:13-17. Pre-filled syringes began to gain popularity in the early 1980s, and by 2010 their use had become widespread in the injectable therapeutics industry. Ex. 1015.329. While it is possible to use plastic syringe barrels for pre-filled applications, by 2010 glass barreled syringes held a significant market share in pre-filled syringes over plastic. *See id.*

40. Pre-filled glass syringes had been approved by the FDA prior to 2012 for a variety of applications, including for the intravitreal injection of Macugen® (pegaptanib sodium injection), a VEGF antagonist formulation indicated for the treatment of neovascular (wet) age-related macular degeneration (AMD). *See* Ex. 1009.

41. Pre-filled syringes can be made from standard commercially available syringes that are filled by a syringe filler. Such syringes are generally sold in standardized sizes. The most common example of standardized syringe sizes are those prescribed and promulgated by the International Organization for Standardization (“ISO”). For example, ISO-11040-4 sets forth the ISO’s standardized sizes for syringe barrels. *See* Ex. 1028. In the 0.5 mL to 1.0 mL volume

range, there are three ISO standard sets for barrel dimensions, as shown in the table below:

Nominal Volume	Barrel Inner Diameter (d_2)	Barrel Length (l_1)
0.5 mL	4.65 mm	47.6 mm
1 mL (long)	6.35 mm	54 mm
1 mL (short)	8.65 mm	35.7 mm

Adapted from Ex. 1028.008

42. The ISO has also developed a set of needle standards or “gauges,” which may be found in the ISO-9626 standard for medical grade tubing (ISO-7864 provides further standards for sterile hypodermic needles made from such tubing). The higher the gauge number, the more fine (*i.e.*, thin or narrow) the needle. For example, a standard 30 G x 0.5 inch needle would have an outer diameter of 0.298 to 0.320 mm, an inner diameter of 0.133 to 0.165 mm, and a length of 0.5 inches. Ex. 1043.006. A 25 G x 0.5 inch needle would have an outer diameter of 0.5-0.53 mm, an inner diameter of 0.232 to 0.292 mm, and a length of 0.5 inches. *Id.*

43. For intravitreal applications, it was understood that “[g]enerally, not more than 0.1 mL may be injected.” Ex. 1015.036. Thus, a smaller volume syringe, such as 0.5 mL or 1 mL,³ is used for intravitreal applications. *See* Ex. 1021 at [0059],

³ The deliverable volume of drug product in the syringe will always be less than the nominal volume of the syringe. ISO-11040-4, which sets forth the ISO’s

[0061] (disclosing 1 mL prefilled glass syringe for VEGF-antagonist); Ex. 1007 at 21:10-25 (disclosing 0.5 mL prefilled syringe for Lucentis); Ex. 1062.009 (disclosing that Macugen is provided in a 1 mL glass syringe). Similarly, because injecting a drug into the eye is a delicate task, a fine gauge needle would be used for intravitreal applications, generally at least a 27 G needle or a higher numbered gauge (*i.e.*, thinner). *See, e.g.*, Ex. 1009.007 (using a 30 G needle for intravitreal injection of Macugen).

C. Syringe Stopper Forces

44. As may be readily understood, dispensing medicament from a syringe involves the application of force on the plunger rod, which causes the stopper to move through the syringe barrel and thereby expel the liquid drug formulation out of the needle-end of the syringe barrel.

45. Two types of forces are generally used to describe the movement of a syringe stopper through the barrel upon application of force to the plunger rod. The first is the “break loose” force or the stopper “activation” force, which is the force required to start the movement of the stopper from its resting position. The break loose force is only that amount of force needed to get the stopper to initially start moving. *See* Ex. 1008 at 15:6-8 (“the friction force B is the force required, under

standardized sizes for syringe barrels, does not provide sizing information for syringes of less than 0.5 mL. Ex. 1028.008.

static conditions, to break the contact at the contact region 10 between the piston 3 and the container 2”). The second type of force is the “gliding” force or “glide” force or “slide” force or “extrusion” force, which is “the force that is needed to sustain movement of the plunger.” Ex. 1015.358 (“When looking at the gliding behavior of syringe plungers one makes distinction between the force that is needed to make the plunger start moving and the force that is needed to sustain movement of the plunger. The former is typically called ‘activation force’ or ‘break-loose force,’ while for the latter the names ‘gliding force’ or extrusion force’ or ‘propagation force’ are used.”); Ex. 1008 at 15:9-12 (describing glide force as “the friction force S is the force required, under dynamic conditions, for moving the piston 3 in the container 2”).

46. The Nema textbook presents an exemplary force curve for a pre-filled syringe, below.

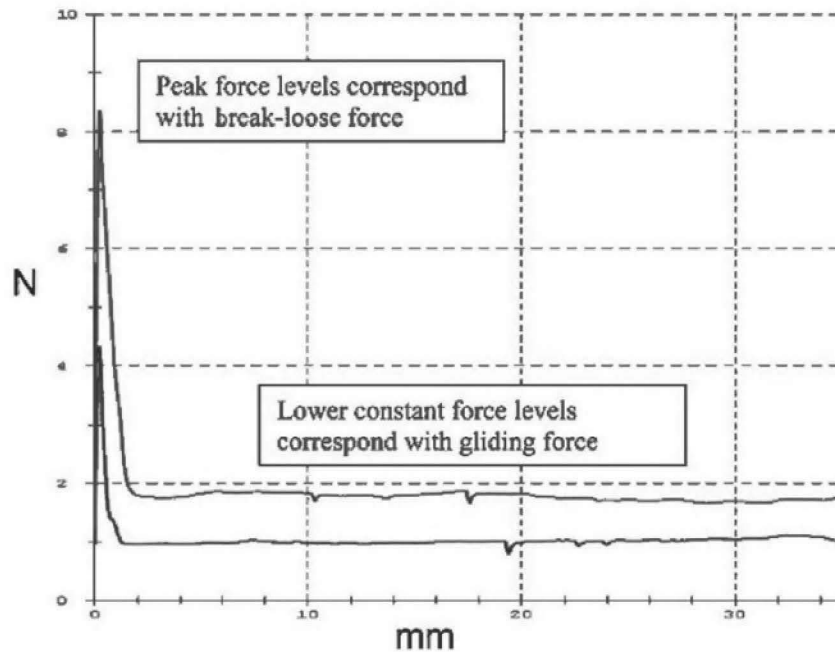

Figure 10 Gliding curves of two different plungers in the same type of barrel. The curves display gliding force as a function of the pathway of the plunger. At the left hand side, peaks correspond with break loose (or activation force). The lower part of the curves corresponds with the gliding force for the two different plungers.

Ex. 1015.359

47. Based on the shape of the above force curve from Nema, especially the sharpness of the initial peak(s), a POSITA would understand that this is either a force curve generated from actual measurements, or a diagrammatic representation approximating a real force curve, because such curves typically reflect a break loose force that spikes and then drops off quickly into a somewhat consistent glide force. Nema describes the above force curve, and the break loose and glide forces depicted therein, as follows:

A typical force curve for the gliding of a plunger in a prefilled syringe is given below. The curve displays the force that is needed to move the plunger as a function of the distance that the plunger travels into the syringe barrel. From this curve it follows that it needs a certain build-up of force to start the movement of the plunger. Thereafter the force

to keep the plunger moving decreases. Gliding forces thus are typically lower than break-loose forces. Break-loose forces must be low enough to guarantee smooth activation of the syringe. Gliding forces equally must be at an acceptably low level. Moreover gliding forces must be continuous, or without increases and decreases. Should the movement be ‘interrupted,’ then one speaks of shattering of the syringe. Shattering obviously for the comfort of the patient must be avoided (Fig. 10).

Ex. 1015.358.

48. The break loose force is largely attributable to the ageing of the stopper within the syringe, which is made out of an elastomeric (rubber) material, and will upon ageing over time expand outwards within the syringe and become sticky, forming a tighter seal against the inside of the syringe barrel. The tighter seal results in a higher force required to initially displace the stopper, which is the break loose force. Because the break loose force is between the stopper and the inside of the barrel, and is the force required to get the stopper to just about begin moving, the break loose force is largely unaffected by the viscosity of the fluid in the pre-filled syringe.

49. There is no set minimum or maximum force required for break loose or glide forces in a pre-filled syringe. However, a POSITA would have been well aware that commercially available syringes were commonly sold as “10 and 5” syringes, meaning they would have a maximum break loose force of 10 N and a slide force of 5 N. *See, e.g.,* Ex. 1012.007 (explaining that “plunger gliding forces in the range of 5 to 10 N” were sufficient to satisfy “syringe functionality” requirements).

While “10 and 5” N are understood to be acceptable forces for such syringes, a POSITA would have understood that the actual tested forces would likely be lower. For example, as shown above, the exemplary force curves presented in Nema demonstrate glide forces below 2 N. Ex. 1015.359.

50. For a syringe to function properly, the stopper should be able to glide through the barrel in a relatively smooth manner to dispense the drug formulation contained within. Smooth movement of the stopper is desired to ensure patient comfort and safety during administration of the drug. The smoothness of delivery becomes even more important when the medication is being injected directly into the eye, as with an intravitreally delivered drug formulation. In addition, lower forces are required for intravitreal injection because of the delicate nature of the eye, requiring “[e]xtreme care and precise technique” for a safe injection. Ex. 1015.036. Thus, it is important to reduce the amount of friction between the stopper and the inside of the syringe barrel, in order to have break loose and glide forces that are appropriate for drug delivery and have the stopper move through the barrel with relative ease.

D. Siliconization of Pre-filled Syringe Components

51. It was well known before the '631 patent that the friction between the stopper and the barrel of a syringe can be reduced by providing an interface between their surfaces. Such an interface can be created by coating the components of the

syringe such as the barrel and the stopper with silicone oil, in a process known as “siliconization.” *See, e.g.*, Ex. 1015.065 (“Silicone oil coating is commonly used on stoppers and on the inside of syringes or cartridges as a lubricant to enable movement of the plunger. . . . Current [baked-on] processes for siliconization of prefilled syringes or cartridges apply well controlled amounts and involves baking of the silicone emulsion.”), .330 (“To meet the need for lubricity and sealability, syringe manufacturers use silicone to coat the glass barrels and elastomer components.”).

52. Silicone oils are one of the most common and preferred lubricants for use in syringes because they are “viscous, inert materials with excellent characteristics as hydrophobic lubricants.” Ex. 1012.006. Silicone oils generally consist of a mixture of polydimethylsiloxane (PDMS) molecules with Si-O chains, varying in length and number of OH groups. *See* Ex. 1012.006; Ex. 1015.314. The molecular structure of silicone oils “determines how silicone oil layers are adsorbed onto glass surfaces and the distribution, thickness, composition, and uniformity of the layers.” Ex. 1012.006.

53. Siliconization is recommended for syringe components that experience dynamic friction, including the inside of syringe barrel and potentially also on the surface of elastomeric components such as the plunger stopper. *Id.*; Ex. 1015.330 (“Silicone facilitates ease of movement of pistons in filling and stoppering equipment, and allows pistons to glide smoothly on activation of syringes.”). In pre-

filled syringes, not only the siliconization of the plunger, but also the siliconization of the inside of the barrel is important. Ex. 1015.358 (“The degree and way of siliconization of the plunger, the degree and way of siliconization of the inside of the barrel and the homogeneity of siliconization of the inside of the barrel over the total path length of the plunger strongly influence break-loose and gliding forces.”).

54. Further, because stoppers are generally made from elastomeric materials, which may be sticky, siliconization can be used to prevent the sticking of rubber stoppers to the syringe barrel. *Id.* at .341 (“Siliconization of rubber closures is necessary to overcome the stickiness that is inherent to typical rubber formulations that are used for parenteral stoppers.”); *id.* at .330 (“To meet the need for lubricity and sealability, syringe manufacturers use silicone to coat the glass barrels and elastomer components.”).

1. “Oily” or “Spray-on” Siliconization

55. One known method of siliconization involves spraying silicone oil directly onto the inside of the syringe barrel to form a lubricant coating on the inside of the barrel. This process is known as “oily” siliconization or “spray-on” siliconization. *See, e.g.*, Ex. 1012.006 (“oily”); Ex. 1013.004 (“oily”); Ex. 1044.003 (“sprayed-on”). For a typical 1 mL syringe, oily siliconization requires about 0.4 mg to 1.0 mg of silicone oil to be deposited on the inner surface of the syringe barrel. *See* Ex. 1014 at [0026]. For example, as explained in Badkar, 0.5 mg to 0.8 mg (500

µg to 800 µg), according to syringe manufacturers, was typical for staked-in needle syringes. Ex. 1044.003.

56. While the oily method is a relatively cheap and effective way to deposit silicone oil on syringe components, oily siliconization has long been known to have several shortcomings, especially when used in pre-filled syringes. One such shortcoming occurs when the rubber stopper within a pre-filled syringe over time starts to displace the silicone coating on the inside of the barrel and comes into direct contact with the inner glass surface, causing what is known as the “break loose effect.” Ex. 1013.004 (“[B]reak loose effect ... can occur during storage when the rubber closure, inside the syringe barrel, expands outwards so that eventually it displaces the low friction silicone coating and comes into direct contact with the inner glass surface.”); Ex. 1011 at 6. The break loose effect causes the stopper to essentially stick to the barrel, requiring higher forces to displace the stopper (i.e., higher break loose or activation forces). This break loose effect is undesirable, and potentially dangerous to the patient, as described by the Schoenknecht article:

The user cannot detect the problem until the point of administration when they try to depress the plunger. Because the rubber closure is essentially stuck to the inside surface of the syringe, a high initial force is needed to shift it. The needle has already penetrated the patient’s skin and the tip is positioned in their tissue at this point, so the lack of control as the extra force is applied and the potential for a sudden movement as the rubber closure is freed up, is clearly undesirable.

Ex. 1013.004. As can be readily understood, the break loose effect is even more undesirable and potentially dangerous when a pre-filled syringe is being used for intravitreal administration of a drug, on account of the danger posed to the patient's sensitive eye structures once the needle has penetrated the eyeball and entered the vitreous humor. *See* Ex. 1015.036 (detailing the potential negative consequences of imprecise intravitreal administration).

57. Utilizing a larger amount of silicone oil is not an acceptable solution to the break loose effect. Oily siliconization already uses a relatively high amount of silicone oil (greater than 200 µg), and this high level of silicone oil (and potentially further increasing the amount of silicone oil) creates other undesirable problems. Possibly the most significant problem with higher levels of silicone oil is that silicone oil “can interact with drug formulation components.” Ex. 1015.330. This is especially problematic for protein therapeutics, because “[s]ub-visual silicone oil particles are thought to promote protein aggregation which can increase the severity of immune responses and reduce the drug's tolerability.” Ex. 1010.004; Ex. 1013.004 (“One particularly common problem has been that [protein therapeutics] can react with the oily form of silicone, which is used as a lubricant to coat the sliding components of the syringe.”). Thus, a POSITA would want to avoid higher levels of silicone oil in pre-filled syringes containing sensitive protein formulations such as VEGF antagonists, because of potential “incompatibilities includ[ing]

aggregation, deformation, and inactivation of native protein structures.” Ex. 1012.006.

58. Moreover, with oily siliconization, it had also been postulated that silicone oil can flow within the syringe barrel from areas of thicker coverage. Ex. 1014 at [0024]. “Detachment of silicone oil in water-filled syringes is possible and can result in particulate matter and clouding phenomenon.” Ex. 1015.330. Silicone oil droplets in injectable formulations are especially problematic in the case of drugs for intravitreal administration, because in addition to potentially causing protein instability from aggregation, injecting silicone oil droplets into the eye could cause visual impairment including the perception of “floaters” in the eye and an increase in intra-ocular pressure. *See, e.g.*, Ex. 1001 at 50-55 (“However, for ophthalmic use, it is desirable to decrease the likelihood of silicone oil droplets being injected into the eye. With multiple injections, the amount of silicone droplets can build up in the eye, causing potential adverse effects, including ‘floaters’ and an increase in intra-ocular pressure.”); Ex. 1015.036 (explaining the precautions necessary for intravitreal administration).

59. Thus, prior to 2012, a POSITA would have been well aware of the drawbacks of oily siliconization, and would have had strong motivation to utilize alternative methods of applying silicone oil.

2. “Baked-On” Siliconization

60. It was well known in the art prior to 2012 that siliconization could be performed to achieve a more homogeneous and thinner coating of silicone oil, while reducing the amount of silicone oil required, through a process known as “baked-on” siliconization, which “involves heating the silicone-coated syringe to a specific temperature for an appropriate time.” Ex. 1013.004; *see, e.g.*, Ex. 1015.330 (describing siliconization achieved by “baking silicone at high heat onto the glass barrels”); Ex. 1011.004 (same); Ex. 1012.006 (same).

61. It was also well known prior to 2012 that the baked-on siliconization process requires only about one-tenth the amount of silicone oil as oily siliconization to achieve the same break loose and glide force. For example, U.S. Patent Publication No. 2012/0091026 (Ex. 1014) explains, with respect to baked-on siliconization, that “the siliconizing operation comprising a polymerization step (i) is more precise and more homogenous than [*sic*] a simple standard siliconizing operation; and (ii) *makes it possible to reduce the amount of silicone that is used...by about a factor of 10 without any loss of lubricating effect.*” Ex. 1014 at [0026] (emphasis added). Boulange (Ex. 1008) at Table 7 shows the low break loose and slide forces for a pre-filled syringe including 4 $\mu\text{g}/\text{cm}^2$ silicone on the syringe barrel (prepared using the baked-on method), whereas 50 $\mu\text{g}/\text{cm}^2$ is used in Example 5 for the spray on method. Fries (Ex. 1012) also reports that such baked-on

siliconized syringes having “low levels” of silicone oil (*i.e.*, those that reduce “[t]he amount of extractable silicone oil . . . below the detection limit (0.03 mg [*i.e.*, 30 µg])”) maintained syringe functionality, with “plunger gliding forces in the range of 5 to 10 N.” Ex. 1012.006-007. Similarly, Badkar (Ex. 1044) discloses that “baked-on syringes . . . approximately contain ten-fold less free silicone oil” and “showed no deleterious impact on product quality.” Ex.1044.008.

62. Another benefit of baked-on siliconization is that the heat treatment affixes a thin layer of silicone oil lubricant—possibly of single layer thickness—to the inner surface of glass syringe barrels, which helps to prevent the silicone oil from breaking off from the inside of the syringe barrel and entering the drug formulation. Ex. 1012.006 (“Mono-layers of the lubricant are affixed to the glass surface.”). This feature of baked-on siliconization reduces the amount of “residual” or “free” silicone oil, which refers to the quantity of silicone oil that is not affixed to the inner surfaces of the syringe barrel and thus could dislodge from the surface and enter the drug formulation. *See* Ex. 1011.004 (“Baked Silicone: Binding the silicone to the glass barrel through a proprietary technology reduces the level of free silicone. This is a clear benefit for silicone-sensitive drugs.”); Ex. 1015.330 (“Recent developments to minimize free silicone include baking silicone at high heat onto the glass barrels, thereby minimizing the amount of free silicone that can interact with drug product.”).

63. As explained above, there are numerous reasons to avoid silicone oil in protein drug formulations, including to avoid protein aggregation, and, in the case of intravitreal injections, to avoid increasing intraocular pressure and causing vision problems. This problem is especially acute in pre-filled syringes, because such devices come prepackaged with drug formulation contained in the device, and as such the drug formulation is in contact with the silicone oil for an extended period of time while the device is in storage. However, in syringes prepared using the baked-on siliconization method, the silicone oil molecules are believed to be held to the inner surface of glass syringe barrels by forces that “range from van de Waals forces to covalent Si-O bonds.” Ex. 1012.006. Such bonds, especially the covalent bonds, which are known to be relatively strong, hold the silicone oil to the glass surface relatively tightly as compared to oily siliconization. *See id.* (depicting the conversion of silicone oil into an Si(R)O coating which increases fixation to the glass). Thus, reducing the amount of residual silicone oil is an added benefit of baked-on siliconization.

64. Reducing the amount of sub-visual silicone oil particles in protein formulations is beneficial because such particles can increase the aggregation potential of proteins. Ex. 1044.007. Reducing the amount of sub-visual particles is especially important for ophthalmologic applications, since sub-visual particle requirements are stringent, as discussed in **Section V.F** below. Thus, baked-on

siliconization is especially recommended for sensitive protein formulations such as VEGF antagonists for intravitreal administration. *See* Ex. 1044.006 (“Overall data suggested that the baked-on silicone process was better suited for protein formulation development in PFS as it represented a lesser degree of risk for the formation of subvisible particulate matter as well as minimized any potential for protein precipitation on the Si-oil droplets.”).

65. It was also known that baked on siliconization can reduce the incidence of the “break loose effect.” Ex. 1013.004 (“The second benefit of baked-on silicone is that it reduces the frequency of the ‘break loose’ effect.”). Specifically, as shown in the Figures 1a and 1b below, taken from the Schoenknecht article (Ex. 1013), comparing oily and baked-on siliconization, “baked-on silicone provides a more consistent coating of the syringe walls, which prevents the expanding rubber closure from touching the glass wall. Lubrication is maintained so that the initial force required to inject using prefilled syringes with baked-on silicone remains consistently low before and after storage.” Ex. 1013.004.

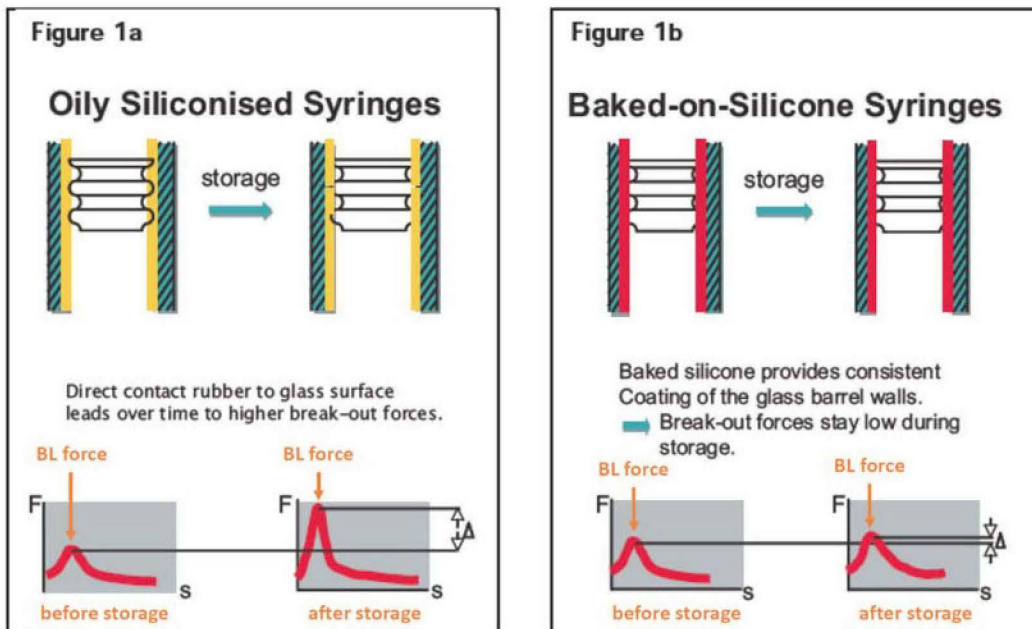

Figures 1a and 1b: the break loose effect

Ex. 1013.004 (Figure 1) (annotated in orange)

66. Thus, a POSITA would understand that baked-on siliconization achieves a thinner layer of silicone oil on the inside of a syringe barrel as compared to oily siliconization. Fries discloses that a baked layer of silicone thickness on glass cartridges measured a mean of 76.83 nm and oily layer thickness a mean of 232.67 nm. Ex. 1012.006. Schoenknecht also notes that the concentration of silicone oil in the baked-on syringe is reduced. Ex. 1013.004.

67. Baked-on siliconization uses silicone oil emulsions such as Dow Corning 365, 35% Dimethicone⁴ NF Emulsion (“DC 365”), a well-known grade of

⁴ Dimethicone is also referred to as polydimethylsiloxane, or PDMS, as stated in ¶ 52, above.

silicone oil emulsion comprising Dow Corning 360 silicone oil diluted in highly purified water (*see* Ex. 1034), which is then sprayed into syringe barrels that undergo heat treatment. *See* Ex. 1012.006 (“The baked siliconization method uses emulsions of silicone oil (eg, Dow Corning 365, 35% Dimethicone NF Emulsion, diluted in HPW)”); Ex. 1001 at 5:9-14 (“Various types of silicone oil are available, but typically either DC360 (Dow Corning®; with a viscosity of 1000 cP) or DC365 emulsion (Dow Corning®; DC360 oil with a viscosity of 350 cP) are used for syringe siliconisation.”). The viscosity of the DC 360 silicone oil in the DC 365 emulsion is 350 cP. *Id.*

68. In summary, baked-on siliconization provides a number of benefits over spray on siliconization. Baked-on siliconization reduces the amount of silicone oil that is applied to the syringe ten-fold. For example, the prior art discloses that a 0.5-1 mL baked-on syringe may utilize 40-100 µg of silicone as compared to 400-1000 µg for the same size oily syringe. The baked-on syringe also retains the break loose and slide forces achieved by an oily syringe, but provides the benefit that the break loose force remains relatively constant over time (even after storage), which is not true of an oily syringe. Finally, the thin silicone layer created by baked-on siliconization adheres to the glass barrel of the syringe, thereby reducing the amount of free silicone oil, which reduces the number of sub-visual particles. This makes baked-on siliconization particularly suited for protein-based therapeutics, which are

known to aggregate in the presence of sub-visual particles, and even more so, those intended for intravitreal administration.

3. Coated, Uncoated, and Siliconized Stoppers

69. One of skill in the art would also understand that the characteristics of the syringe stopper itself plays a role in achieving low break loose and glide forces, while also avoiding break loose effect. Since the stopper (also called the plunger) is in contact with and must slide along the syringe barrel, a POSITA would have understood that:

During the drug shelf life the plunger must maintain an adequate seal on the inner side of the barrel. However, at the time of administration of the drug to the patient, the plunger also must exhibit efficient gliding behavior in the barrel to adequately transfer the syringe contents into the patient.

Ex. 1015.345.

70. Stoppers are generally made from elastomeric materials (*i.e.*, rubbers) because “[f]or a plunger for a prefilled syringe the seal is formed between the ribs of the elastomeric plunger and the inside surface of the glass or plastic barrel,” *id.* at .355, and “the elasticity of such materials allows for preservation of the sterility of the packaged drug.” *Id.* at .339. “Plungers for prefillable syringes are standardized by ISO 11040-5.” *Id.* at .346.

71. In order to maintain the seal between the stopper and the inside of the syringe barrel and to improve lubricity, stoppers are often themselves siliconized.

Id. at .341 (“Siliconization of rubber closures is necessary to overcome the stickiness that is inherent to typical rubber formulations that are used for parenteral stoppers.”).

72. However, as is a consistent theme in the art, pre-filled syringes were known to have additional concerns as compared to disposable syringes in relation to the stoppers used therein, because the stopper in a pre-filled syringe is in constant contact with the drug formulation throughout the storage shelf life of the drug product. Thus, a POSITA would have been aware that minimizing extractables and avoiding high levels of silicone oil are additional features that may be desirable for pre-filled syringe stoppers, as described in the following passage from the Nema textbook:

A very important difference between the plungers in prefillable and in disposable syringes however is the contact time with the drug. For a prefillable syringe this time is expressed in years, whereas for a disposable syringe plunger it will be minutes or hours. This difference has a large impact on the type of material that the plunger is made of. **A prefillable syringe plunger will be designed to ensure adequate gliding behavior as well as to aim for low levels of material that could be extracted from the rubber into the drug product as a leachable**, while disposable syringe plungers will be designed primarily to ensure acceptable administration behavior.

Id. at .347 (emphasis added).

73. It was well known prior to 2012 that providing a coating on the syringe stopper was a potential solution for preventing the leaching of extractables into drug formulations, as well as for reducing break loose and glide forces. *See id.* at .330 (“Use of these coated stoppers provides lubricity for machinability and reduces

piston clumping in feeder bowls. Additional benefits, depending on the coating used, include a decrease in particle generation and a reduction of extractables from the elastomer.”). Coated stoppers are especially useful in pre-filled syringes for protein formulations (such as VEGF-antagonists), because the leaching of extractables would be especially problematic due to possible interactions with the sensitive drug proteins. *Id.* at .350 (“Worth mentioning in this respect are biotech drugs that are used in very small quantities per dose and where no absorption by the vial stopper is allowed. ... For such applications, solutions are offered to the market in the form of coated vial stoppers and coated syringe plungers.”); *see also* Ex. 1021 at [0059], [0061] (disclosing examples of pre-filled glass syringes with coated stoppers containing a VEGF-antagonist).

74. Moreover, certain types of stopper coatings help reduce or eliminate the need for siliconization of the stopper, which is also desirable for pre-filled syringes containing protein formulations such as VEGF-antagonists due to the potential interactions with silicone oil. Ex. 1015.350 (“Since the coating is nontacky in itself, these closures do not require any surface siliconization, which in applications where the drug is sensitive to silicone of course is of highest value.”). Such coated stoppers could nevertheless achieve low break loose and glide forces without the need for additional silicone oil.

75. For example, the Boulange reference teaches that using baked-on siliconization in the syringe barrel can achieve low break loose and glide forces, and that these forces may be lowered even further through the use of coated stoppers, as described further in **Section VII.C** below. Ex. 1008 at 21:1-19. Baked-on siliconization was also known as a means to reduce or avoid the need for siliconization of the stopper. Ex. 1014 at [0026]. By avoiding siliconizing the stopper, less silicone oil would come into contact with the drug formulation in a pre-filled syringe, which is desirable, as I have described above.

E. Sterilization of Pre-filled Syringes

76. Although sterility is a general requirement for many drug products, the FDA and EMA specifically require all ophthalmic products to be sterile, including pre-filled syringes for intravitreal injection. *See, e.g.*, 21 C.F.R. § 200.50 (a)(1) (“Informed medical opinion is in agreement that all preparations offered or intended for ophthalmic use, including preparations for cleansing the eyes, should be sterile. It is further evident that such preparations purport to be of such purity and quality as to be suitable for safe use in the eye.”).

77. Medical products can be sterilized using, for example, “steam sterilization, radiation sterilization, gas sterilization (*e.g.*, with ethylene oxide), and chemical sterilization.” Ex. 1029 at 1:14-16. In the case of a drug product, the means used for sterilization must be compatible with the drug. *See* Ex. 1045.001

(“When deciding on a sterilization method, one of the first considerations should be product compatibility.”). Relevant to the instant case, it was known in the art prior to 2012 that protein drug formulations are sensitive to both high temperatures and interactions with certain types of radiation and substances used, for example, in gas sterilization, such that these sterilization techniques could affect the function of the protein. *See* Ex. 1007 at 7:29-8:2; Ex. 1029 at 1:18-25. For the VEGF-antagonist solutions recited in the ’631 patent claims, high temperature sterilization processes would be disfavored, as would any contained closure system (in this case, a pre-filled syringe) which allowed substantial quantities of a sterilizing gas to interact with the drug inside the container closure system.

78. Several sterilization processes were known that did not require high temperatures, including sterilization using ethylene oxide (“EtO”) gas or vaporized hydrogen peroxide (H₂O₂) (“VHP”), which were both known at least by 2008. *See* Ex. 1046.001 (“Until 2008, there were three options for these purposes; ethylene oxide (EO), gas plasma, and ozone systems.”); *id.* at .002 (“Vaporized hydrogen peroxide (VHP) technology was originally developed by STERIS Corporation and introduced in the early 1990s. It soon became a ‘gold standard’ for pharmaceutical sterilization, in critical environments where drugs are produced and packaged.”). EtO sterilization has been used since the 1950s and VHP systems since at least the 2000s to sterilize heat and moisture-sensitive medical devices. *Id.* at .001-.002. EtO

and VHP can be applied to medical devices to achieve a type of sterilization referred to in the '631 patent as “terminal sterilization,” which, as used therein, refers to the sterilization of the outside surface of the final container (*i.e.* pre-filled syringe) and secondary packaging containing the drug product.

79. “Terminal sterilization” traditionally means that the sterilization of the container closure system *and* the drug product within it may be achieved in a single process. For drugs that are not heat sensitive, the drug and packaging may be sterilized at once, for example by steam sterilization, negating the need for aseptic fill. However, a POSITA would understand that EtO or VHP sterilization of pre-filled syringe containing a drug formulation inside would avoid contact between a drug and EtO gas or VHP, and instead, the objective is sterilizing the outer surface of the syringe. In the case of a pre-filled syringe, in order to ensure a sterile drug formulation, the syringe would be filled under aseptic conditions, in a process known as “aseptic fill.” But, although filled under aseptic conditions, pre-filled syringes are not packed into their secondary packaging in an aseptic environment. Thus, the exterior surfaces are likely to be microbiologically contaminated and in one method to ensure sterility, the exterior surfaces (and any secondary packaging) are sterilized via EtO or VHP sterilization following the aseptic fill. Ex. 1007 at 2:13-19. As explained in greater detail below, the term “terminal sterilization” in the '631 patent includes this latter type of sterilization wherein the outer surface of the pre-filled

syringe is sterilized. *See* Ex. 1001 at 9:49, 55-56; 10:2-4 (emphasis added) (“[t]he package is exposed to the sterili[z]ing gas until the *outside* of the syringe is sterile,” and “it is a requirement that significant amounts of the sterili[z]ing gas should not enter the variable volume chamber of the syringe.”). Throughout this declaration, I will use the term “terminal sterilization” to refer to the context in which it is used in the ’631 patent, unless otherwise specified.

80. Because a POSITA would understand that one of the goals when applying EtO or VHP sterilization to a pre-filled syringe would be to keep the sensitive drug formulation from interacting with these chemicals, keeping the container closure system impermeable to EtO and VHP is important. A pre-filled syringe disclosed in U.S. Patent No. 2005/0182370 to Hato, entitled “Prefilled Syringe with Plunger Backward Movement Limiting Mechanism,” has a mechanism that limits plunger movement, as well as a 3-ribbed stopper, both of which aid in achieving the integrity of the syringe. *See* Ex. 1047.002 (Fig. 3).

81. As of July 2012, the prior art discloses the use of cold sterilization⁵ processes using EtO or VHP to terminally sterilize the outside of pre-filled syringes containing a drug formulation. The Sigg application describes “a terminal sterilization and surface decontamination treatment of prefilled containers,

⁵ Cold sterilization refers to processes that sterilize a product without requiring high temperatures, which would damage sensitive drug formulations.

specifically for sterilization of prefilled containers containing sensitive solutions, such as drug product or biological therapeutic, within secondary packaging.” Ex. 1007 at 3:8-16. Sigg further notes that “[t]erminal sterilization of prefilled containers in secondary packaging is one way to provide the device to an end user with a low bio-burden and low risk of contaminants.” *Id.* at 2:15-17. Sigg also explains that the VHP sterilization methods would be applied to pre-filled syringes containing sensitive protein formulations such as VEGF-antagonists in order to sterilize the outside surface of the syringe (and not the drug formulation itself). *Id.* at 2:13-15 (“Prefilled syringes, although filled under aseptic conditions, are not packed into their secondary packaging in an aseptic environment and are therefore likely to be microbiologically contaminated at their outside.”). Thus, “terminal surface sterilization” is desirable for the disclosed prefilled syringe. *Id.* at 2:31.

82. Sigg describes the VHP sterilization method as:

treating prefilled containers within secondary packaging with controllable vaporized-hydrogen peroxide (VHP). The principle is the formation of a vapor of hydrogen peroxide in containment and a subsequent removal or inactivation of vapors in a controlled manner. Prior to removal or inactivation, VHP condenses on all surfaces, creating a microbiocidal film that decontaminates the container surface.

Id. at 3:11-16.

83. The Nema textbook, for example, describes EtO cold sterilization. Nema characterizes EtO as “[t]he most prevalent gas utilized for sterilization” such that “sterilization using other agents is based on methods used for ETO.” Ex.

1016.260-261. Nema also describes the process sequence used for EtO sterilization. *Id.* at 261.

84. Similarly, Lam describes an EtO gas “terminal sterilization” of a VEGF antagonist in a pre-filled syringe (that is, a sterilization performed post-filling that avoids interaction of the EtO with the VEGF antagonist protein) that allows the protein solution to maintain its stability throughout the sterilization process. *See* Ex. 1029 at 13:9-16:8.

85. U.S. Pat. Appl. Pub. No. 2003/0003014 describes a “terminal sterilization” procedure using hydrogen peroxide plasma, another form of H₂O₂ sterilization, that “permits sensitive biological and therapeutic products to be sterilized externally in the solid or liquid state in their final container (primary packaging).” Ex. 1018 at [0010]-[0011], [0038]-[0039]. The procedure shown to achieve sterility of the outer surfaces of glass carpules containing a protein fibrinogen solution, without affecting the stability of the fibrinogen. *Id.*

86. EtO acts as a sterilization agent by oxidizing the biological molecules of microorganisms. *See* Ex. 1016.260-.261. This effect, while beneficial for killing microorganisms, also will oxidize biologic drug products if they are exposed to EtO gas during the sterilization process. While VHP works by a different mechanism than EtO, it still has the potential to damage biologic drug products. Thus, for pre-filled syringes, the syringe itself would have to be sufficiently closed off to prevent

substantial amounts of the sterilizing gas from coming into contact with the drug formulation within.

87. For similar reasons, anyone handling the drug products would want to avoid direct contact with the sterilization agents. To prevent interaction of EtO and VHP with handlers of the sterilized pre-filled syringes, the gas or vapor must be allowed to sufficiently exit the secondary packaging of pre-filled syringe after the sterilization process is over. For example, the VHP sterilization disclosed in Sigg includes a step to remove VHP by “applying post-treatment measures, within a decontamination chamber.” Ex. 1007 at 10:5-6.

88. The measure of the probability that an individual article may not be sterile is referred to as the sterility assurance level, or SAL, and would have been routine for a POSITA to determine prior to July 2012. For example, Sigg defines both the SAL and the term “sterility,” and recommends a SAL of 10^{-6} for health care products:

“Sterility” as used herein is meant to refer to complete absence of microbial life as defined by a probability of non-sterility or a sterility assurance level (SAL). The required SAL for a given product is based on regulatory requirements. For example, required ***SALs for health care products are defined to be at least 10^{-6}*** , i.e. a chance of less than 1:1 million of a non-sterile product for aseptically manufactured and terminally sterilized products, respectively.

Ex. 1007 at 7:8-13 (emphasis added).

F. Particulate Content

89. As explained above, ophthalmic solutions for injection into the human eye have strict requirements for the number of sub-visual particles they may contain. Regulatory authorities require ophthalmic formulations in pre-filled syringes to have sufficiently low particulate content to avoid complications upon administration. *See* Ex. 1016.144 (explaining that “[a] new U.S. guideline for ophthalmic products was [made] official in 2004”); Ex. 1017 at 10:14-11:13 (“There are also strict controls on sub-visible particulate matter for ophthalmic injections.”); Ex. 1001 at 2:1-4 (“For ophthalmic injections, it is particularly important for the ophthalmic solution to have particularly low particle content.”). The applicable limits on particulate content are set forth in USP789.⁶ *See* Ex. 1019.005-.006; Ex. 1017 at 10:19-22 (“United States Pharmacopoeia (USP) Chapters <788> *Particulate Matter in Injections* and <789> *Particulate Matter in Ophthalmic Solution* describe physical tests for the purpose of enumerating extraneous particles within specific size ranges.”).

90. Particulate matter in USP789 is defined as “mobile, randomly sourced, extraneous substances, other than gas bubbles, that cannot be quantitated by

⁶ USP is a nonprofit scientific organization founded in 1820 that develops and disseminates public compendial standards for drug products. Ex. 1016.108-.109. Here, the USP sets forth the standard for particle size and number, which is an element which the ’631 patent attempts to claim.

chemical analysis because of the small amount of material they represent and because of their heterogeneous composition.” Ex. 1019.005. Specifically, USP789 provides two methods of detecting particulate matter in ophthalmic solutions, the light obscuration and microscopic procedures. *Id.* at .005-.006. The test approach using these procedures is two-stage—first, the light obscuration method is used, which has its own set of test limits. If the light obscuration method is not able to be used for some reason, or if the test fails, the microscopic method must be used. *Id.* The following are the requirements for the number of particles detected by each method: for the light obscuration test, the limit of particles of diameter $\geq 10 \mu\text{m}$ is 50 per mL and the limit of particles of diameter $\geq 25 \mu\text{m}$ is 5 per mL; and for the microscopic particle count test, the limit of particles of diameter $\geq 10 \mu\text{m}$ is 50 per mL, the limit of particles of diameter $\geq 25 \mu\text{m}$ is 5 per mL, and the limit of particles of diameter $\geq 50 \mu\text{m}$ is 2 per mL. *Id.*

91. While the USP is not legally binding, it is well known in the art that USP specifications are de facto requirements for regulatory approval of a drug product. Ex. 1057 (“The U.S. Federal Food, Drug, and Cosmetics Act designates the USP–NF as the official compendia for drugs marketed in the United States. A drug product in the U.S. market must conform to the standards in USP–NF to avoid possible charges of adulteration and misbranding. The USP–NF is also widely used by manufacturers wishing to market therapeutic products worldwide. Meeting USP–

NF standards is accepted globally as assurance of high quality.”); *see also* 21 U.S.C. §§ 321(j), 351(b). Thus, a POSITA would have understood that it is effectively a requirement for all ophthalmic products to meet the USP789 guidelines, including VEGF-antagonists for intravitreal administration.

VI. The '631 Patent

A. The Claims

92. I understand that the petition challenges all of the claims of the '631 patent. Independent claim 1 of the '631 patent is directed to a terminally sterilized pre-filled glass syringe for intravitreal injection, of 0.5 mL to 1 mL volume, having between 1 μ g to 100 μ g of silicone oil in the barrel and a stopper break loose force of less than about 11N, and containing a VEGF-antagonist with no more than 2 particles >50 μ m in diameter per mL. As I explain in this Declaration, a POSITA, in and prior to 2012, would have understood that there was nothing inventive about this combination of features, which were well known in the art at the time. Such pre-filled syringes having baked-on siliconization with low amount of silicone oil and low forces were known and available at the time, and it would have been a routine application of such syringes to add any of the known VEGF-antagonist formulations to the syringe and then terminally sterilize the product. Claim 1 is reproduced below:

1. A pre-filled, terminally sterilized syringe for intravitreal injection, the syringe comprising a glass body forming a barrel,

a stopper and a plunger and containing an ophthalmic solution which comprises a VEGF-antagonist, wherein:

- (a) the syringe has a nominal maximum fill volume of between about 0.5 ml and about 1 ml,
- (b) the syringe barrel comprises from about 1 μ g to 100 μ g silicone oil,
- (c) the VEGF-antagonist solution comprises no more than 2 particles >50 μ m in diameter per ml and wherein the syringe has a stopper break loose force of less than about 11N.

93. The '631 patent claims priority to a European patent publication, EP12174860 (Ex. 1035), which was filed on July 3, 2012. However, EP12174860 does not contain any examples, and does not contain any disclosure of specific *break loose* forces for any syringe disclosed therein. Instead, EP12174860 merely discloses that the *glide* force for certain embodiments of the syringe is “less than about 11N or less than 9N, less than 7N, less than 5N or between about 3N to 5N”:

10 During testing it was found that, for syringes having small dimensions, such as those discussed above, and particularly those described in conjunction with the Figures below, the break loose and sliding forces for the stopper within the syringe are substantially unaffected by reducing the siliconisation levels far below the current standard to the levels discussed here. In one embodiment the glide force for the stopper within the pre-filled syringe is less than about 11N or less than 9N, less than 7N, less than 5N or between about 3N to 5N. Having too great a force required to move the stopper can cause problems during use for some users, for example
15 accurate dose setting or smooth dose delivery may be made more difficult if significant strength is required to move, and/or keep in motion, the stopper.

Ex. 1035 at 6:8-16

94. However, because the independent claim of the '631 patent requires that the *break loose* force is less than about 11 N, and this is required for all of the claims of the '631 patent, a POSITA would not be able to reasonably conclude that the inventors had possession of an invention consisting of a pre-filled syringe with the claimed break loose force based on the disclosure in EP12174860. Thus, the claims of the '631 patent are not entitled to the July 3, 2012 filing date due to this lack of disclosure, and are entitled to a priority date of October 23, 2012 at the earliest.

95. The dependent claims can be grouped as follows, based on the additional features that they add. As I further explain in this Declaration, the features added by these dependent claims were also well-known at or prior to 2012, and a POSITA would have understood that there was nothing inventive about the combination of features recited in these claims.

96. Claims 2-4, 22 and 23 require a range of silicone oil thickness (450 nm or less), narrower ranges for the amount of silicone oil (3-100 μg or 1-50 μg), the type of silicone oil (DC365 emulsion), and the silicone oil viscosity (350 cP viscosity).

97. Claim 5 requires certain particle content limitations for the VEGF-antagonist solution that are set forth in USP789, while claim 6 requires that the solution meets USP789.

98. Claims 7-9 require that the VEGF-antagonist is an anti-VEGF antibody, or more specifically ranibizumab.

99. Claim 10 combines the particle content limitations of claim 5 and the silicone oil viscosity limitation of claim 23.

100. Claims 11-13 require that the VEGF-antagonist is a non-antibody VEGF-antagonist, or more specifically aflibercept.⁷

101. Claims 14-16 require a stopper break loose force of less than 5 N, a stopper slide force of less than 5 N or 11 N, and require a stopper traveling speed (190 mm/min) and needle type at which the force should be measured.

102. Claims 17-21 include limitations relating to sterilization: the syringe is sterilized using H₂O₂ or EtO; the outer surface of the syringe has ≤ 1 ppm H₂O₂ or EtO residue; the total H₂O₂ or EtO residue is ≤ 0.1 mg; less than or equal to 5% of the VEGF-antagonist is alkylated; and the syringe is sterilized with a Sterility Assurance Level of at least 10⁻⁶.

103. Claim 24 is a method of treating a patient suffering from one of several ocular diseases comprising the step of administering an ophthalmic solution using a pre-filled syringe according to claim 1. Dependent claim 25 requires the step of depressing the plunger to align the stopper with a priming mark. Dependent claim

⁷ Aflibercept was developed by Regeneron and is marketed under the trade name EYLEA®.

26 requires that the VEGF-antagonist administered is a non-antibody VEGF-antagonist and the patient previously received treatment with an antibody VEGF-antagonist.

B. Overview of Specification

1. The '631 patent fails to disclose a process for applying low levels of silicone oil

104. The '631 patent claims a syringe with between 1 and 100 μ g of silicone oil on the syringe barrel and break loose and slide forces for the syringe stopper that are less than 11 N. However, the '631 patent does not contain any disclosure of how a POSITA would achieve these low amounts of silicone oil in the barrel. As I have explained herein, it was well-known at the time that using baked-on siliconization results in relatively low break loose and glide forces while still using low levels of silicone oil. To the extent that the Patent Owner were to argue that the '631 patent is directed to a particular method of applying silicone oil that allowed them to achieve the claimed features in a way that was different from the well-known baked-on processes disclosed in the prior art, that alleged teaching of siliconization is not disclosed anywhere in the '631 patent and would not be discernable to a POSITA reading the '631 patent.

105. Similarly, while the '631 patent says that using lower levels of silicone oil and achieving similar low break loose and glide forces as compared to those achieved via an oily siliconization was “surprising,” a POSITA would understand

that there was nothing surprising about this result. Instead, as explained above in **Section V.D.2**, this result would have been expected in 2012 given that baked-on siliconization was known to use about 10 times less silicone oil as compared to oily siliconization while still achieving the same break loose and slide forces.

2. The '631 patent fails to disclose the process for terminal sterilization

106. Likewise, the '631 patent explains that “a careful balancing act is required to ensure that while a suitable level of sterilisation is carried out, the syringe remains suitably sealed, such that the therapeutic is not compromised.” Ex. 1001 1:31-36. The '631 patent says that the sterilization it discloses may be done via “known” methods, such as VHP or EtO, but no details are provided regarding the sterilization process itself. *Id.* at 9:49-54. Instead, the remaining description sets forth only the desired results—how long the syringe remains sterile, the Sterility Assurance Level, the alkylation of the product, and the amount of chemical residue remaining—and no steps to achieving them. *Id.* at 9:55-10:22. In my opinion, the disclosure in the '631 patent does not add anything new to the art of sterilizing a pre-filled syringe.

C. Meaning of the Claim Terms

107. The '631 patent claims a “**terminally sterilized**” pre-filled syringe and discloses in the specification that according to its “terminal sterilisation” methods, “[t]he package is exposed to the sterilising gas until the outside of the syringe is

sterile,” but also that “it is a requirement that significant amounts of the sterilising gas should not enter the variable volume chamber of the syringe.” Ex. 1001 at 9:49, 55-56; 10:2-4. Thus, a POSITA would understand that the term “terminally sterilized” as used in the ’631 patent includes the sterilization of the outside of a pre-filled syringe (*i.e.*, primary packaging component) while minimizing contact between the drug product within the pre-filled syringe and the sterilizing agent being applied.

108. The ’631 patent uses the term “**stopper⁸ break loose force**” consistently with its well-understood meaning in the art, which is the minimum force required to make the stopper start moving from the resting position in the syringe barrel, as I have explained in **Section V.C**. While break loose force changes over time, for baked-on syringes the amount the break loose force change over time is known to be less than for oily syringes. The change in break loose force over time is known as the “break loose” effect, which more specifically refers to the sticking of the stopper to the syringe barrel because of displacement of the silicone oil layer upon ageing of the syringe stopper.

⁸ The ’631 Patent uses the term “stopper,” while other prior art uses the term “piston.” Both of these terms refer to the same component of the syringe, which is pushed by the plunger and forces the drug solution through the needle. A POSITA would understand these terms are used interchangeably in the art.

109. The '631 patent uses the term “**stopper slide force**” (or “glide” force) consistent with its well-understood meaning in the art, which is the minimum force required to sustain the movement of the stopper in the syringe barrel (after movement has already begun), as I have explained in in **Section V.C**. Unlike the break loose force, the glide force does not typically change substantially over time.

110. I note that the '631 patent does not specify *when* the stopper break loose force or the stopper glide force is measured, *i.e.*, whether the forces are measured when the syringe is newly siliconized or after storage for a period of time. As explained above in **Section V.C**, a POSITA would understand that break loose force can increase over time as the syringe ages, and the break loose force may especially increase on account of the break loose effect in oily siliconized syringes. Thus, while it is common to define the storage time of the piston in the syringe when discussing the measured stopper forces, a POSITA would understand that the stopper force-related claim terms would include such forces measured at any time given the lack of specificity in the '631 patent.

VII. The Prior Art to the '631 Patent

A. “Sigg” – WO 2011/006877

111. Sigg (Ex. 1007) is a patent application publication that lists the same lead inventor as the '631 patent, and is assigned on its face to the same entity – Novartis AG. Sigg discloses terminally sterilized, low volume (0.5 – 1.0 mL) pre-

filled glass syringes containing an ophthalmic solution that is a VEGF-antagonist intended for intravitreal injection. I understand that Sigg was not of record during the prosecution of the application that became the '631 patent.

112. Sigg discloses embodiments of terminally sterilized 0.5 mL syringes for intravitreal injection containing the VEGF-antagonist ranibizumab (Lucentis). Ex. 1007 at 9:11-14; 20:17-21. Example 1 of Sigg discloses “prefilled syringes [that] were treated with a vaporized-hydrogen peroxide sterilization treatment,” wherein the syringes contained “protein solutions,” and more specifically, “[a] formulation as described in U.S. Patent No. 7,060,269,” which is a patent disclosing ranibizumab. *Id.* at 20:11-18. The syringes tested in Example 1 of Sigg were “0.5 mL syringes” which a POSITA would understand refers to the size, and therefore the nominal fill volume of the syringe. *Id.* at 20:20.

113. Sigg discloses glass syringes. *See* Ex. 1007 at 2:1-6 (disclosing that sterilizing using gamma rays can cause discoloration to glass as a reason for adopting different sterilization methods, *e.g.*, VHP sterilization), 22:8-11 (disclosing glass syringe in Example 2). While Sigg does not explicitly state the syringes in Example 1 were glass, it would be obvious to a POSITA to use glass syringes in Example 1 for a number of reasons. First, the VEGF-antagonist (Lucentis) within the syringe is sensitive to degradation by VHP. *See id.* at 2:27-29 (“oxidizing gases, while efficient for killing bacterial contamination, also harm biological molecules in

sensitive therapeutic solutions”); 3:27-30 (“It further has been found that among the commercially available primary packaging components, there are only very few packaging material combinations that provide the required tightness of the system such as to avoid ingress of sterilizing gasses into the pharmaceutical liquid enclosed by the prefilled container.”). It was well known in 2012 that glass is impermeable to gas and vapors. I also understand that during prosecution of the application that led to the ’631 patent, Novartis argued that pre-filled syringes for protein formulations such as VEGF-antagonists must be made out of the glass. *See* Ex. 1002.1274-1275 (during prosecution, Novartis argued that “syringes which are prefilled with biologics are comprised of glass barrels,” and made this argument in order to distinguish the ’631 patent application claims from the prior art). Furthermore, the use of glass syringes for VEGF antagonist solutions was well known in the art. Ex. 1009.001 (disclosing that Macugen is supplied in a pre-filled glass syringe); Ex. 1021 at [0059], [0061] (disclosing examples of pre-filled glass syringes containing a VEGF-antagonist). Thus, it would have been obvious to a POSITA to use a glass syringe in the pre-filled syringe embodiment of Example 1.

114. A POSITA would understand that the sterilization disclosed in Sigg is “terminal sterilization” as that term is used in the ’631 patent, because according to the Sigg sterilization method, the drug formulation was first sterilized separately, Ex. 1007 at 20:19-20 (“solution was filtered through a 0.22 μm syringe filter”), then

filled into syringes under sterile conditions, *i.e.*, filled via aseptic fill, *id.* at 20:20-21 (“[f]illing of 0.5 mL syringes was performed in a sterile lab for hydrogen peroxide treatment”), and only then was VHP sterilization applied. *Id.* In addition, Sigg explicitly states that the “invention relates to a method and system for ***terminal sterilization of the outer surface and/or surface decontamination of prefilled containers in secondary packaging***, wherein the prefilled container contains a pharmaceutical or biological drug product.” *Id.* at 1:5-8 (emphasis added).

115. Sigg also explains that the disclosed VHP sterilization methods would be applied to pre-filled syringes containing sensitive protein formulations such as VEGF-antagonists: “Prefilled syringes, although filled under aseptic conditions, are not packed into their secondary packaging in an aseptic environment and are therefore likely to be microbiologically contaminated at their outside.” *Id.* at 2:13-15. Thus, “terminal surface sterilization” is desirable. *Id.* at 2:31. However, prior techniques of sterilizing the surfaces of container closure systems, such as temperature steam and gamma irradiation, cannot be applied to sensitive biologic drug solutions because the sterilization methods risked denaturing or chemically modifying the active ingredient of the drug. *Id.* at 2:20-29; *id.* at 7:29-8:1 (“terminal-sterilization methods suitable for prefilled containers containing sensitive products, such as biotech (biological) drug solutions, which can otherwise be compromised when using classical terminal sterilization processes”). Thus, Sigg teaches a VHP

sterilization method that is specifically intended “for sterilization of prefilled containers containing sensitive solutions, such as a drug product or biological therapeutic, within secondary packaging.” *Id.* at 3:9-11. Sigg further notes that “[t]erminal sterilization of prefilled containers in secondary packaging is one way to provide the device to an end user with a low bio-burden and low risk of contaminants.” *Id.* at 2:15-17.

116. Sigg taught two methods for sterilizing pre-filled syringes: “treatment of prefilled containers in secondary packaging by an application of vaporized-hydrogen peroxide, in which vapors are controllable by certain post-treatment measures, and exposure to tunable-beta radiation, in which the depth of penetration of beta rays into secondary packaging are controllable.” *Id.* at 8:8-12. The VHP sterilization disclosed in Sigg, which is the method relevant here, includes “applying post-treatment measures, within a decontamination chamber” that ensure full removal and thus protection of the sensitive biologic product. *Id.* at 10:5-6. In this way, Sigg proposes that the hydrogen peroxide is able to fully sterilize the exterior and secondary packaging of the product, without risking exposure to the sensitive biologic drug product.

117. The disclosure of Sigg is silent as to the amount of silicone oil used in the tested pre-filled syringes, or the resultant break loose or glide forces that the pre-filled syringes would exhibit when tested. Nevertheless, a POSITA would

understand that because the pre-filled syringes in Sigg contain ranibizumab, which is a VEGF-antagonist for intravitreal administration, it would be advantageous and desirable to minimize the amount of silicone oil used in the pre-filled syringe to avoid negative interactions between the silicone oil and the VEGF-antagonist protein. As explained above in **Section V.D.2**, a POSITA would understand that the amount of silicone oil in a pre-filled syringe can be minimized by using baked-on siliconization, which also reduces the risk of the break loose effect, while still providing low break loose and glide forces as would be required for intravitreal administration. As explained above in **Section V.D.3**, a POSITA would also understand that using coated stoppers would be further advantageous because the stopper coatings help prevent leaching of extractables into the drug formulation upon storage, and further reduce the amount of silicone oil needed.

B. “Lam” – International Pat. Appl. Pub. No. WO 2008/077155

118. Lam (Ex. 1029) is a patent application publication that is assigned on its face to Genentech, Inc. Lam discloses terminally sterilized pre-filled glass syringes containing a VEGF-antagonist intended for intravitreal injection. I understand that Lam was not of record during the prosecution of the application that became the '631 patent.

119. Lam discloses examples in which EtO sterilization is performed on syringes containing Lucentis (ranibizumab), which is a VEGF-antagonist drug

formulation that was on the market prior to 2012. Ex. 1029 at 13:14-15 (“We performed EtO sterilization on syringes containing a ranibizumab solution...”). Lam also teaches that the syringes could be filled with Macugen, another VEGF-antagonist. *Id.* at 11:9-11. A POSITA would understand that both Lucentis and Macugen are injected intravitreally. Lam also teaches EtO sterilization of the object in its secondary packaging such as an EtO-permeable material. *Id.* at 2:1-33.

120. A POSITA would understand that the syringes being sterilized in Lam were “pre-filled syringes” as that term would be understood by a POSITA at the time, because the syringes already contained a drug formulation within the syringe, optionally along with a tip cap to close off the tapered end of the syringe barrel. *See id.* at 13:14-15 (describing the syringes as containing Lucentis); *id.* at 15:12-17 (describing the tip cap added to the syringes being tested).

121. Lam discloses glass syringes. Ex. 1029 at 2:29-31, 3:17-19, claim 21. While Lam does not explicitly state the syringes in the testing on pages 15 and 16 were glass, it would be obvious to a POSITA to use glass syringes in the testing for a number of reasons. First, the VEGF-antagonist within the syringe is sensitive to degradation by EtO. *See id.* at 13:14-15 (“We performed EtO sterilization on syringes containing a ranibizumab solution... .”); *id.* at 2:7-11 (disclosing that the objects to be sterilized must have “an ethylene-oxide (EtO)-impermeable interior space”). It was well known in 2012 that glass is impermeable to gas and vapors.

Ex. 1029 at 3:19 (“As [sic] EtO-impermeable object my [sic] comprise, e.g., glass”)
Lam also teaches that its disclosed methods of EtO sterilization can be applied to syringes wherein “[i]n some embodiments *the syringe comprises glass* and comprises a stopper comprising D777-7 laminated with FluroTec®....” *Id.* at 2:3-33 (emphasis added). In the testing on pages 15 and 16 of Lam, the coated stopper tested corresponds to the aforementioned described embodiment of a glass syringe with a D777-7 laminated stopper. *See generally id.* at 15-16. I also understand that during prosecution of the application that led to the ’631 patent, Novartis argued that pre-filled syringes for protein formulations such as VEGF-antagonists must be made out of the glass. *See* Ex. 1002.1274-1275(during prosecution, Novartis argued that “syringes which are prefilled with biologics are comprised of glass barrels,” and made this argument in order to distinguish the ’631 patent application claims from the prior art). Furthermore, the use of glass syringes for VEGF antagonist solutions was well known in the art. Ex. 1009.001 (disclosing that Macugen is supplied in a pre-filled glass syringe); Ex. 1021 at [0059], [0061] (disclosing examples of pre-filled glass syringes containing a VEGF-antagonist). Thus, it would have been obvious to a POSITA to use a glass syringe in the pre-filled syringe embodiment in the Example disclosed in Lam.

122. The pre-filled syringes disclosed in Lam are for intravitreal administration, and therefore, it would be obvious to a POSITA that the syringes are

small volume syringes, for example 0.5-1 mL in volume. *See* Ex. 1015.036 (administration volume for intravitreal injection is “generally < 0.1 mL”); Ex. 1021 at [0059], [0061] (disclosing a VEGF-antagonist in a 1 mL prefilled glass syringe); Ex. 1062.009 (disclosing that Macugen is provided in a 1 mL glass syringe).

123. A POSITA would understand that the sterilization disclosed in Lam is “terminal sterilization” as that term is used in the ’631 patent, because according to the Lam sterilization method, the drug formulation is first sterilized separately and packaged into sterilized primary packaging whose surface may then be sterilized by the disclosed EtO sterilization methods. *See* Ex. 1029 at 1:22-33 (“Consequently, pharmaceutical compositions are generally sterilized by an alternative method, *e.g.* by filtration, and then packaged into separately sterilized objects. ... In many circumstances it would be advantageous to sterilize the surfaces of these objects in order to reduce the risk of contamination during subsequent handling. ... Thus, there remains a need for efficient and cost-effective methods of surface-sterilizing objects containing ethylene-oxide-sensitive, temperature-sensitive compounds, such as biological molecules, without a significant adverse effect on their activity or integrity.”).

124. Lam explains that the EtO sterilization methods disclosed therein are especially suitable for drug formulations that contain active ingredients that may be damaged by the high temperatures, radiation, or chemical gases used in some

sterilization processes. *See id.* at 1:18-23. Thus, Lam applied the EtO sterilization method to sterilize the outer surface of a pre-filled syringe containing the VEGF-antagonist Lucentis.

125. Lam also explains why a POSITA would wish to terminally sterilize a pre-filled syringe for intravitreal administration. Specifically, Lam teaches that “it would be advantageous to sterilize the surfaces of these objects [*i.e.*, objects containing pharmaceutical compositions] in order to reduce the risk of contamination during subsequent handling,” and specifically that “there is an increased risk of endophthalmitis after intraocular injection if the surface of the syringe used for injection is not sterilized.” *Id.* at 1:26-29.

126. A POSITA reading Lam would understand the disclosed terminal sterilization is compatible with a pre-filled syringe having a coated stopper. Specifically, Lam “also tested several different syringe components: where the stopper on the plunger comprised ... coating of FluroTec® barrier film ...” and taught that despite the added coating on the stopper “the percentage of protein in the basic peak was not statistically different from control.” *Id.* at 15:12-14, 24-25. Lam’s testing showed that the residual EtO on pre-filled syringe embodiments having a coated stopper was even lower than if coated stoppers were not used, which shows that, if anything, the terminal sterilization results were even better when coated stoppers were used. *See id.* at 16:1-2 (Table 3).

127. The disclosure of Lam is silent as to the amount of silicone oil used in the tested pre-filled syringes, or the resultant break loose or glide forces that the pre-filled syringes would exhibit when tested. Nevertheless, a POSITA would understand that because the pre-filled syringes in Lam contain Lucentis, which is a VEGF-antagonist for intravitreal administration, it would be advantageous and desirable to minimize the amount of silicone oil used in the pre-filled syringe to avoid negative interactions between the silicone oil and the VEGF-antagonist protein. As explained above in **Section V.D.2**, a POSITA would understand that the amount of silicone oil in a pre-filled syringe can be minimized by using baked-on siliconization, which reduces the risk of the break loose effect, while still providing low break loose and glide forces as would be required for intravitreal administration.

C. “Boulangé” – International Pat. Appl. Pub. No. WO 2009/030976

128. Boulangé (Ex. 1008) is a published patent application that was filed by Becton-Dickinson, a well-known syringe manufacturer. I understand that Boulangé was not of record during prosecution of the '631 patent.

129. Boulangé discloses force testing conducted on pre-filled syringes with glass barrels and coated or uncoated stoppers (called “pistons” in Boulangé). Ex. 1008 at 13:11-12 (“The container 2 is a glass syringe body accommodating a piston 3 able to move translationally...”); 14:19-21 (“tests were applied on containers filled with 1 mL of demineralised water and each plugged with one piston to be tested

(coated or uncoated”). Boulange specifically discloses a 1 mL syringe with 40 µg of baked-on silicone that has break loose and slide forces of less than 11 N and less than 5 N, as explained below.

130. Table 1 of Boulange describes the different configurations of stoppers (pistons) used in the testing in Boulange, which are labeled A, B1, B2 and C. Piston and stopper are used interchangeably by those skilled in the art. Pistons B1 and B2 include a polymer coating, while pistons A and C do not.

Table 1 : configurations of pistons A, B1 and C

Piston reference	Viscoelastic substrate	Coating	Coating thickness	Surface finish
A (comparative)	Bromobutyl rubber	No	---	Smooth Ra = 0.7 µm Rt = 11.4 µm
B1 (invention)	Bromobutyl rubber	Yes	3 µm	Smooth Ra = 0.9 µm Rt = 12.0 µm
B2 (comparative)	Bromobutyl rubber	Yes	3 µm	Rough Ra = 3.1 µm Rt = 24.0 µm
C (comparative)	Chlorobutyl rubber	No	---	Smooth Ra = 0.7 µm Rt = 11.0 µm

Ex. 1008 at 14:1-3 (Table 1)

131. The testing in Boulange disclosed measurements of break loose force, labeled in Boulange as “friction force B.” *Id.* at 15:6-8 (“the force required, under static conditions, to break the contact at the contact region 10 between the piston 3 and the container 2”). Boulange also discloses measurements of glide forces, labeled

in Boulange as “friction force S” and “friction force F,” both of which are types of slide forces, measured at different points along the syringe barrel. *Id.* at 15:9-11 (“the friction force S is the force required, under dynamic conditions, for moving the piston 3 in the container 2. The friction force S is measured half way of the piston travel.”), 15:13-15 (“the friction force F is the force required, again in dynamic mode, to move the piston 3 when it reaches the end of its travel in the container 2”).

132. In Example 5, Boulange compares the break loose force and slide force of syringes with the silicone oil either baked on (“Scenario 1”) or sprayed on (“Scenario 2”) to the barrel. *Id.* at 20:15-21. The baked on silicone was applied to the syringe body at “a rate of 40 μg for a surface area of 10 cm^2 ,” while the sprayed on silicone was applied “at a rate of 500 μg for a surface area of 10 cm^2 .” *Id.* No silicone oil was applied to the piston in either Scenario 1 or Scenario 2. *Id.* As shown in Table 7 reproduced below, regardless of the configuration of the piston (A, B1 or C), the unaged syringes (T=0)⁹ for the “baked on” silicone method resulted in break loose and slide forces of less than 7 N. The syringe configured with the coated piston (B1) exhibited break loose and slide forces below 5 N for both the unaged (T=0) and aged (T=1) syringe.

⁹ In Table 7 of Boulange, the subscript T refers to the age of the syringe (*i.e.*, T=0 is unaged, T=1 is aged one month, etc.). The “aged” syringes were stored in a chamber for a period of time before testing.

Table 7

← Baked-On →

		Scenario 1			Scenario 2		
Silicone/internal surface of syringe		4 µg/cm ²	4 µg/cm ²	4 µg/cm ²	50 µg/cm ²	50 µg/cm ²	50 µg/cm ²
Silicone/piston		---	---	---	---	---	---
Force (N)		B	S	F	B	S	F
Piston	A T=0	6.8 (0.3)	6.9 (1.4)	4.0 (1.4)	5.5 (0.5)	1.2 (0.3)	4.0 (2.0)
	A T=1	15.7 (2.9)	5.3 (2.6)	6.1 (4.2)	8.8 (1.1)	1.6 (0.7)	5.6 (4.1)
	B1 T=0	2.1 (0.1)	2.5 (0.3)	2.6 (0.3)	1.9 (0.2)	1.3 (0.3)	2.1 (0.7)
	B1 T=1	3.0 (0.4)	3.4 (0.5)	2.8 (0.6)	2.2 (0.2)	1.4 (0.3)	2.4 (0.6)
	C T=0	3.9 (0.6)	6.6 (2.5)	3.9 (2.5)	4.2 (0.6)	1.0 (0.4)	4.7 (2.9)
	C T=1	14.4 (2.2)	4.8 (2.1)	3.6 (1.1)	5.4 (1.2)	1.3 (0.5)	4.3 (2.8)
	A T=3	17.2 (6.1)	4.3 (2.4)	2.9 (1.2)	10.0 (1.0)	1.5 (0.3)	4.0 (3.0)
	A T=5	20.5 (4.0)	6.1 (3.0)	3.0 (1.0)	15.1 (1.4)	2.5 (1.5)	3.0 (2.0)

Ex. 1008 at 21:1-3 (Table 7) (annotated)

133. Thus, as can be seen from Boulange Table 7, above, testing conducted on a pre-filled syringe with uncoated stopper C showed a stopper break loose force of 3.9 N and a stopper glide force as low as 3.9 N. Similarly, the coated stopper B1 showed a stopper break loose force of 2.1 N and a stopper glide force as low as 2.5 N. As explained above in **Section VI.C**, because the '631 patent is silent as to when the stopper break loose force and glide forces are measured, or where along the syringe barrel the glide force is measured, a POSITA would understand that these forces could be measured at any time and glide force can be measured at any place along the syringe barrel.

134. Boulange provides motivation to a POSITA to use the baked-on siliconized syringes disclosed, because Boulange discloses that “with the medical device of the invention, it is possible to decrease the total amount of lubricant, for example silicone oil, that is necessary in such a medical device” and “[i]n consequence, the medical device of the invention allows to limit the risk of interaction between...silicone oil, and the therapeutic molecules potentially stored in the container of the medical device.” Ex. 1008 at 6:23-29.

135. Thus, Boulange is directed to optimizing the functionality of low volume syringes for ease of use by practitioners. *Id.* at 1:3-7, 14:19-20. Specifically, Boulange claims polymer coated pistons to further improve upon already existing pre-filled syringes utilizing low levels of silicone oil. Boulange discloses that the invention provides decreased break loose and slide forces while preserving the tight seal of the container, as well as decreased levels of silicone oil thereby limiting the risk of interaction between the silicone oil and any therapeutic drug stored in the syringe. *Id.* at 6:10-32.

136. Additionally, I note that the break loose and glide force testing results in Boulange’s Example 5 showed improved lubricity from using the coated stopper B1, with B1 showing the best results in Table 7. *Id.* at 21:1-3 (Table 7). This is consistent with what would have been expected by a POSITA at the time, as I explain above in **Section V.D.3**, because it was known that using a coated stopper could

increase lubricity and, when combined with baked-on siliconization, potentially eliminate the need for siliconization of the stopper. *See, e.g.*, Ex. 1014 at [0026]. Moreover, it was known that using a coated stopper could have specific advantages in pre-filled syringes containing sensitive protein formulations, including reducing extractables and leachables that could enter the drug formulation during storage, and reducing the amount of silicone oil, which was known to cause protein aggregation. Ex. 1015.330 (“Additional benefits, depending on the coating used, include a decrease in particle generation and a reduction of extractables from the elastomer.”); *id.* at .350 (“Worth mentioning in this respect are biotech drugs that are used in small quantities per dose and where no absorption by the vial stopper is allowed. ... For such applications, solutions are offered to the market in the form of coated vial stoppers and coated syringe plungers.”); *id.* (“Since the coating is nontacky in itself, these closures do not require any surface siliconization, which in applications where the drug is sensitive to silicone of course is of highest value.”).

137. This is especially advantageous for intravitreally administered protein drug, such as the VEGF-antagonist solutions recited in the claims of the '631 patent, because of the dangers that silicone oil, extractables, and aggregated protein could pose to the eye. For example, in the Furfine patent publication, which disclosed testing of glass pre-filled syringes containing a VEGF-antagonist, the syringes had coated stoppers. Ex. 1021 at [0059], [0061]. Thus, in addition to being motivated to

use the uncoated stopper C from Boulange, a POSITA would have been motivated by the foregoing to use the coated stopper B1 because of the additional benefits described.

D. “Reuter” – Bruno Reuter & Claudia Petersen, *Syringe Siliconization*, 4 TECHNOPHARM 2, 238 (2012)

138. Reuter (Ex. 1010) is an article on pre-filled syringe siliconization that lists Gerresheimer Bunde GmbH as the authors’ employer. Gerresheimer is a well-known syringe manufacturer. Reuter was published in August of 2012. Reuter was not of record during the prosecution of the ’631 patent application.

139. Reuter discloses methods for the siliconization of syringes and also provides background on siliconization, including chemical and physical descriptions of the siliconization process. Reuter discloses 1 mL long syringes siliconized via oily siliconization that have low break loose and glide forces. Specifically, Reuter teaches that “[s]tudies on 1 ml long syringes have revealed considerable potential for reducing the amount of silicone oil required,” and discloses two force curves for a “standard 1 ml long syringe” using 800 μg and 500 μg of silicone oil, respectively, where the respective break loose forces were reported to be 2.5 N and 1.7 N, and the respective glide forces were 1.7 N and 0.5 N. Ex. 1010.004-005. The forces curves from that Reuter study are reproduced below.

Fig. 4: Comparison of extrusion force profiles diving nozzle vs. fixed nozzle.

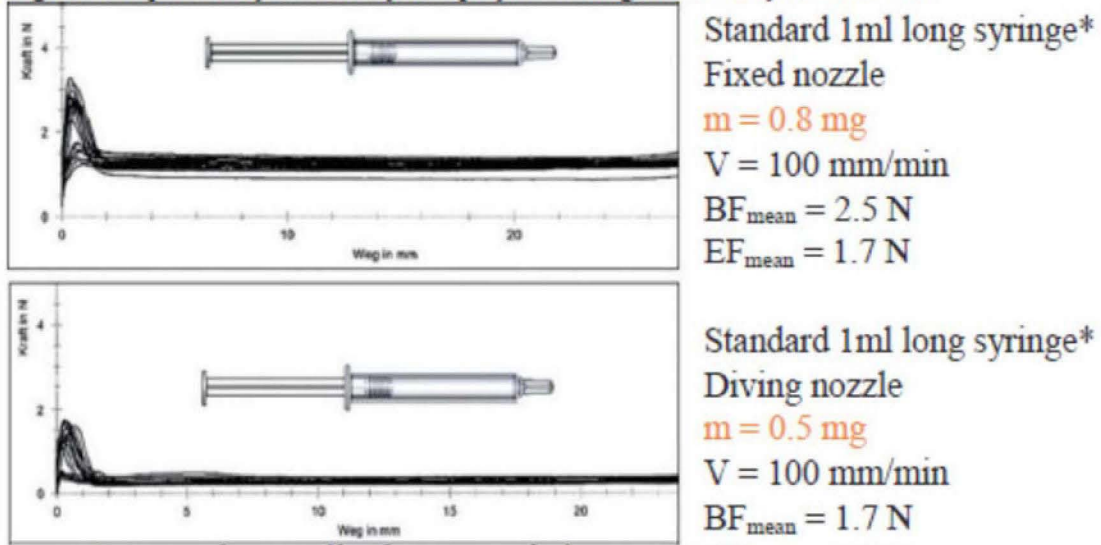

Fig. 5: Extrusion force profile after optimized siliconization.

* Empty syringes

Ex. 1010.005 (Fig. 5)

140. With respect to the above force curves, Reuter teaches that even with oily siliconization, the “quantity of silicone oil per syringe could be reduced by 40% without any impairment in the system’s functional properties.” *Id.* at .004. Thus, Reuter shows that even with oily siliconization, using a diving nozzle to spray on the silicone (*i.e.*, the nozzle moves within the barrel during siliconization) as compared to a fixed nozzle, can result in lower break loose and glide forces and lower amounts of silicone oil being used. *Id.* For a 1 mL syringe, Reuter teaches that 500 µg of silicone oil can produce break loose forces of around 1.7 N and glide forces of 0.5 N.

141. Reuter teaches that “the main objective in siliconization is to achieve the most homogenous possible coating with the minimum possible quantity of

silicone oil.” Ex. 1010.004. Reuter further teaches that baked-on siliconization can be used to achieve an “extremely thin layer of silicone,” which “in conjunction with the low quantity of silicone oil used in the emulsion minimizes free silicone in the syringe and ensures that the required quality of finish is achieved.” *Id.* at .005. Specifically, Reuter teaches that the amount of silicone oil in the syringe barrel resulting from baked-on siliconization is far less than for oily siliconization, because baked-on siliconization results in a layer of silicone oil on the inside of the barrel that “measures 15 [to] 50 nm,” whereas “the average layer thickness with oily siliconization is 500 [to] 1,000 nm.” *Id.* This is consistent with the understanding of a POSITA at the time, that in addition to reducing the quantity of free silicone oil, baked-on siliconization also uses 10% of the amount of silicone oil as compared to oily siliconization, but still results in similar forces. *See, e.g.*, Ex. 1014 at [0026] (baked-on siliconization “makes it possible to reduce the amount of silicone that is used ... by about a factor of 10 without any loss of lubricating effect.”). Reuter similarly teaches that “[b]aked on siliconization reduces the measurable quantity of free silicone oil to approx. 10% of the normal value.” Ex. 1010.005.

142. Reuter explains that “[t]here is a trend towards reduced silicone systems or baked-on siliconization in glass syringe finishing” and provides several reasons for this shift in preferences. *Id.* at .007. Specifically, Reuter explains that by reducing the “measurable quantity of free silicone oil to approx. 10% of the normal

value,” baked-on processes result in “fewer sub-visual and visual silicone oil particles in the solution.” *Id.* at .005. Reuter teaches that “[s]ub-visual silicone oil particles are thought to promote protein aggregation which can increase the severity of immune responses and reduce the drug’s tolerability.” *Id.* at .004. Thus, Reuter explains that baked-on siliconization, which reduces silicone oil content and residual silicone oil, “is therefore recommended for use with sensitive protein formulations,” and specifically “also advantageous for ophthalmological preparations which are associated with very stringent requirements as regards particle contamination.” *Id.* at .005. A POSITA would understand this reference to particle contamination requirements in Reuter to include the requirements disclosed in USP789. Thus, Reuter provides motivation to a POSITA to use baked-on siliconization in syringes containing “sensitive protein formulations,” such as VEGF-antagonists.

143. Reuter also explains other advantages of baked-on siliconization, including increasing “the stability of the mechanical properties of the filled syringe throughout its shelf life.” *Id.* Reuter teaches that baked-on siliconization can ensure that the “breakloose force remains practically constant over the entire storage period.” *Id.* This improvement in the break loose effect is illustrated via Figure 7 of Reuter, reproduced below. These graphs compare the break loose and slide forces before and after storage for an oily siliconized syringe (left side of Figure 7) and a baked-on siliconized syringe (right side of Figure 7). I have annotated the figure

below to point out the break loose force on the graphs. Figure 7 clearly depicts that the break loose and slide forces of the baked-on siliconized syringe will be comparable to the break loose and slide force of the oily siliconized syringe before storage (the graph on the left for each type of syringe), but that unlike the oily siliconized syringe, “the breakloose force remains practically constant over the entire storage period” for the baked-on siliconized syringe, while the break loose force increases after storage for the oily siliconized syringe. Ex. 1010.005-006. Given that Reuter discloses a break loose force of 1.7 N and a slide force of 0.5 N for an oily syringe in Figure 5, a POSITA would understand that the break loose force and slide force for the baked-on syringe (containing 10% the amount of silicone oil) would also be less than 5 N. Reuter’s teaching of a reduction or avoidance of the break loose effect is an additional motivation to a POSITA to use baked-on siliconization (particularly in intravitreal applications where a loss of control due to a higher force required to initiate an injection could result in damage to the anatomical structures in the eye).

Oily siliconized syringe

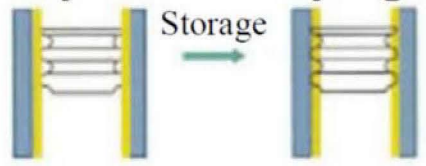

Direct rubber/glass contact leads to higher breakloose forces over the storage period

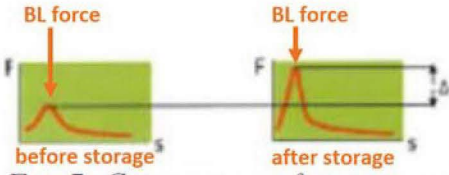
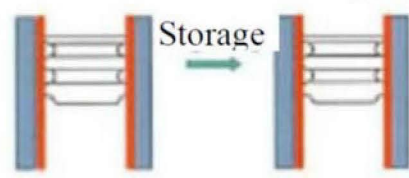
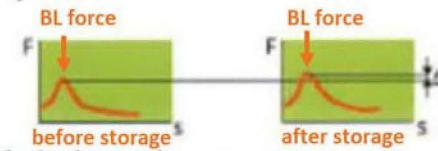

Fig. 7: Comparison of syringes with oily and

Baked-on siliconized syringe



The baked-on siliconization provides a permanent coating
Breakloose forces remain stable over the storage period



baked-on siliconization.

Ex. 1010.006 (annotations in orange)

144. Additionally, with respect to the stoppers of pre-filled syringes, Reuter suggests that using a coating on the stopper can further reduce the amount of silicone oil required to achieve functional break loose and glide forces. *See id.* at .007 (“The gliding properties of the fluoropolymer coating on specially developed plunger stoppers eliminate the need to siliconize plastic syringes.”). A POSITA would understand that if a coated stopper can reduce the amount of silicone oil needed in a plastic syringe, it would have the same effect in a glass syringe.

145. Reuter also teaches that DC 365, a silicone oil emulsion, is typically used for baked-on siliconization, rather than DC 360 (pure silicone oil) which is used for regular oily siliconization. *Id.* at .003 (“For the so called oily siliconization of the syringe barrel DOW CORNING® 360 with a viscosity of 1,000 cSt is used. The

DOW COR-NING® 365 siliconization emulsion is often used in the baked-on siliconization process.”).

E. “Fries” – A. Fries, *Drug Delivery of Sensitive Biopharmaceuticals with Prefilled Syringes*, *Drug Delivery Technology*, Vol. 9, No. 5

146. Fries (Ex. 1012) is an article on the use of pre-filled syringes with biopharmaceuticals. Ex. 1012.003. Fries recognizes that the silicone oil used to lubricate pre-filled syringes has been shown to have “interactions with sensitive biopharmaceuticals,” such as “aggregation, deformation, and inactivation of native protein structures.” *Id.* at .006. To that end, Fries describes that the baked-on siliconization process was developed “to lower the level of free (non-bound) silicone oil in prefilled syringes.” *Id.*

147. Fries explains that the baked-on siliconization process involves spraying an emulsion of silicone oil such as Dow Corning 365 into the syringe barrel followed by heat treatment, which “enables the lubricant to spread out evenly over the glass surface and creates a thin, uniform film.” *Id.* Fries also reports that such syringes having “low levels” of silicone oil (*i.e.*, those that reduce “[t]he amount of extractable silicone oil . . . below the detection limit (0.03 mg [*i.e.*, 30 µg])”) maintained syringe functionality, with “plunger gliding forces in the range of 5 to 10 N.” *Id.* at .006-.007.

F. “Furfine” – WO 2007/149334

148. Furfine (Ex. 1021) is patent publication assigned to Petitioner Regeneron. Furfine describes “[o]phthalmic formulations of a vascular endothelial grow factor (VEGF)-specific fusion protein antagonist . . . suitable for intravitreal administration to the eye.” Ex. 1021 at Abstract. The VEGF-specific proteins (*i.e.*, VEGF-antagonists), called “VEGF trap” in Furfine, include the active ingredient that later became known as aflibercept (EYLEA). *Id.* at [0002] [0005], [0006], [0036], [0045]; *see* Ex. 1001 at 6:38-42.

149. Furfine discloses two examples, Examples 4 and 6, which tested embodiments of a “1 ml prefilled luer glass syringe with 4023/50 FluroTec coated plunger” containing 40 mg/mL of a VEGF-antagonist. Ex. 1021 at [0059], [0061]; *see also id.* at [0036].

G. “Macugen Label” – Macugen[®] Prescribing Information

150. The Macugen Label (Ex. 1009) contains information published online at *Drugs.com* in 2011 from the FDA-approved label for Macugen (pegaptanib sodium), a VEGF antagonist in a glass pre-filled syringe that was initially approved in 2004 for treating wet AMD via intravitreal injection. Ex. 1009.001, .011.

151. The Macugen prefilled syringe included a “dosing line,” or priming mark, to assist in expelling excess drug and air bubbles. *Id.* at .001, .007. A POSITA would understand that this act of priming the syringe would effectively reset the

break loose force to be at or closer to the glide force, because priming would break the initial contact between the stopper and the inside of the barrel that had developed over time during storage.

VIII. Petition 1, Ground 1: Sigg in View of Boulange Renders Obvious Claims 1-3, 5-9, and 14-22

152. As set forth in detail below, claims 1-3, 5-9, and 14-22 of the '631 patent are rendered obvious by Sigg in view of Boulange. The discussion below specifies where each element of the aforementioned claims is found in the applied references, and includes a detailed explanation of the significance of the quotations and citations from the applied references.

A. Motivation to Combine Sigg and Boulange

1. Silicone Oil and Break Loose / Slide Forces

153. As detailed in **Section VII.A** above, Sigg teaches a pre-filled terminally sterilized glass syringe containing a VEGF-antagonist for intravitreal injection with a nominal maximum fill volume of between 0.5 mL and 1 mL. Because Sigg discloses that the pre-filled syringe can contain a sensitive protein or biologic drug product, such as a VEGF-antagonist solution, a POSITA would have been motivated to minimize the amount of silicone oil used in the syringe barrel in order to reduce or avoid the negative interactions that were known to occur between silicone oil and protein or biologic formulation. *See* Ex. 1013.004 (“One particularly common

problem has been that [biotechnology formulations] can react with the oily form of silicone, which is used as a lubricant to coat the sliding components of the syringe.”).

154. A POSITA would be further motivated to lower the amount of silicone oil, because pre-filled syringes are both “containers and drug delivery systems at the same time,” Ex. 1012.006, and therefore the silicone oil in the syringe would be in contact with the protein formulation for an extended period of time, which would heighten the stability concerns. As such, a POSITA would look at avoiding higher levels of silicone oil in pre-filled syringes containing sensitive protein formulations such as VEGF antagonists, because of potential “incompatibilities includ[ing] aggregation, deformation, and inactivation of native protein structures.” *Id.* at .006.

155. Moreover, it was known that silicone oil “can flow away from the inner surface [of a syringe barrel] and pass into the container’s content,” Ex. 1014 at [0024], and such “detachment of silicone oil in water-filled syringes is possible [] and can result in particulate matter and clouding phenomenon.” Ex. 1015.330. Thus, a POSITA would be especially motivated to lower the amount of silicone oil used in pre-filled syringes for intravitreal injection to avoid injecting silicone oil into the eye, which could cause floaters and/or an increase in intra-ocular pressure. *See, e.g.*, Ex. 1025.011 (“silicone contaminants, when injected into the vitreous cavity at the time of anti-VEGF injections, could cause persistent elevations in [intraocular pressure]”); Ex. 1001 at 4:50-55 (“However, for ophthalmic use, it is desirable to

decrease the likelihood of silicone oil droplets being injected into the eye. With multiple injections, the amount of silicone droplets can build up in the eye, causing potential adverse effects, including ‘floaters’ and an increase in intra-ocular pressure.”); Ex. 1015.036 (explaining the precautions necessary for intravitreal administration).

156. As explained in **Section V.D.1** above, there is abundant evidence in the prior art of the risks of silicone oil for biologic products in general, as well as specifically for ophthalmic injections. For example, Nema warns that “[s]ilicone, however, can interact with drug formulation components” and recommends “baking silicone at high heat onto the glass barrels, thereby minimizing the amount of free silicone that can interact with drug product.” Ex. 1015.330.

157. Thus, a POSITA would have looked to reduce or minimize the amount of silicone oil used in the pre-filled syringe of Sigg by using the teachings of Boulange, which discloses baked-on siliconization of a pre-filled syringe, resulting in low break loose and slide forces. A POSITA would have looked to Boulange because it discloses that “with the medical device of the invention, it is possible to decrease the total amount of lubricant, for example silicone oil, that is necessary in such a medical device” and “[i]n consequence, the medical device of the invention allows to limit the risk of interaction between...silicone oil, and the therapeutic molecules potentially stored in the container of the medical device.” Ex. 1008 at

6:23-29. Moreover, a POSITA would have been motivated to employ the baked-on syringes disclosed in Scenario 1 of Example 5 of Boulange because those syringes retain low break loose and slide forces while using approximately one-tenth the amount of silicone oil in comparison to the sprayed-on syringes in Scenario 2 of Example 5 of Boulange. Ex. 1008 at 20:11-21:19 (Example 5). A POSITA would have been particularly motivated to select a syringe with a coated stopper (B1) because it showed the best results in Example 5. Ex. 1008 at 21:1-3 (Table 7).

158. Baked-on siliconization as disclosed in Boulange was also known to be specifically advantageous to protein formulations (such as VEGF-antagonist solutions) because the baking attaches the silicone oil to the inner surface of the syringe barrel, which reduces the amount of “residual” or “free” silicone oil that can enter the protein formulation and cause negative interactions. *See* Ex. 1011.004 (“Baked Silicone: Binding the silicone to the glass barrel through a proprietary technology reduces the level of free silicone. This is a clear benefit for silicone-sensitive drugs.”); Ex. 1015.330 (“Recent developments to minimize free silicone include baking silicone at high heat onto the glass barrels, thereby minimizing the amount of free silicone that can interact with drug product.”). Thus, it was known that “the baked-on silicone process was better suited for protein formulation development in PFS as it represented a lesser degree of risk for the formation of

subvisible particulate matter as well as minimized any potential for protein precipitation on the Si-oil droplets.” Ex. 1044.006.

159. Additionally, it was known that the baked-on process could reduce the incidence of the break-loose effect, as described in **Section V.D.2** above, because the baked-on process results in a more homogeneous coating of silicone oil on the inside of the barrel. Ex. 1012.006 (in baked on siliconization the “[r]emoval of water enables the lubricant to spread out evenly over the glass surface and creates a thin, uniform film”); Ex. 1013.004 (“The second benefit of baked-on silicone is that it reduces the frequency of the ‘break loose’ effect.”). Thus, with baked-on siliconization, “[l]ubrication is maintained so that the initial force required to inject using prefilled syringes with baked-on silicone remains consistently low before and after storage.” Ex. 1013.004. As would have been readily understood by a POSITA, reducing the break loose effect is generally desirable in a pre-filled syringe, but is particularly relevant for intravitreal administration on account of the potential damage that can occur in the eye. *See, e.g.*, Ex. 1015.358 (“Moreover gliding forces must be continuous, or without increases and decreases. Should the movement be ‘interrupted,’ then one speaks of shattering of the syringe.”).

160. As explained in **Section V.D.3** above, it was well known prior to the earliest priority date of the ’631 patent that using coated stoppers was advantageous for protein formulations in pre-filled syringes, because a coating on the stopper could

potentially prevent leaching of extractables from the rubber into the sensitive protein formulation. *See, e.g.*, Ex. 1015.330 (“Use of these coated stoppers provides lubricity for machinability and reduces piston clumping in feeder bowls. Additional benefits, depending on the coating used, include a decrease in particle generation and a reduction of extractables from the elastomer.”); *id.* at 350 (“Worth mentioning in this respect are biotech drugs that are used in very small quantities per dose and where no absorption by the vial stopper is allowed. ... For such applications, solutions are offered to the market in the form of coated vial stoppers and coated syringe plungers.”); *see also* Ex. 1021 at [0059], [0061] (disclosing examples of pre-filled glass syringes with coated stoppers containing a VEGF-antagonist). Additionally, certain types of stopper coatings could help reduce or eliminate the need for siliconization of the stopper, which is also desirable for pre-filled syringes containing protein formulations such as VEGF-antagonists due to the potential interactions with silicone oil. Ex. 1015.350 (“Since the coating is nontacky in itself, these closures do not require any surface siliconization, which in applications where the drug is sensitive to silicone of course is of highest value.”). Such coated stoppers could nevertheless achieve low break loose and glide forces without the need for additional silicone oil, as shown by the testing of Boulange discussed above which shows that the lowest forces were experienced with coated stoppers.

161. A POSITA would have a reasonable expectation that the combination of Sigg and Boulange would result in a terminally sterilized, low volume, pre-filled glass syringe having an amount of silicone oil and break loose and slide forces falling within the ranges claimed in the '631 patent. First, Boulange explicitly discloses a syringe having 40 μg silicone oil for a 1 mL syringe (*i.e.*, 4 $\mu\text{g}/\text{cm}^2$) and resulting break loose and slide forces of less than 3N. Ex. 1008 at 20:15-21:14. A POSITA would understand that the break loose forces disclosed in Table 7 of Boulange would remain substantially the same even when a VEGF-antagonist such as ranibizumab is contained in the syringe rather than water because the viscosity of the fluid does not affect the break loose force. Specifically, as explained in **Section V.C** above, because the break loose force is the force required to get the stopper to just about begin moving, and because the force is between the stopper and barrel and therefore a function of siliconization, and stopper material and coating, the measured break loose force is effectively independent of the viscosity of the fluid within the pre-filled syringe.

162. In addition, while the viscosity of the solution does affect the slide force, the viscosity of a VEGF-antagonist solution such as ranibizumab (1.3 cp) will be sufficiently close to the viscosity of water (1 cp) that the use of ranibizumab instead of water would not substantially affect the slide forces disclosed in Table 7 of Boulange. In the Hagen-Poiseuille formula, the dynamic viscosity of the fluid, ρ ,

varies proportionally with pressure, P , and pressure varies proportionally with force ($P = F / A$, where A is area), so the slide forces would be only 1.3 times greater, for example, if a ranibizumab solution is used in place of water in Example 5 of Boulange.

163. Additionally, a POSITA would not expect any incompatibility between baked-on siliconization as taught by Boulange and VHP sterilization disclosed in Sigg. Specifically, Sigg teaches a POSITA that the VHP technique is broadly applicable to pre-filled syringes. Ex. 1007 at 8:21-25. A POSITA would understand that pre-filled syringes typically contain silicone oil lubricant and would therefore expect that the pre-filled syringes of Sigg contained some silicone oil lubricant, and thus the terminal sterilization being applied was done to a siliconized syringe. Furthermore, a POSITA would understand that the VHP terminal sterilization processes in Sigg would not affect the siliconized interior of the syringe barrel or the break loose or slide forces because Sigg discloses that “the contents of the container are sterile and unaffected by surface decontamination methods as described herein.” Ex. 1007 at 9:16-17. Furthermore, a POSITA would understand that the VHP would not affect the interior of the pre-filled syringe because Sigg discloses that during the decontamination process, VHP is prevented from diffusing into the pre-filled syringe. *Id.* at 14:27-15:20. Thus, a POSITA would have understood that baked-on siliconization is compatible with the VHP sterilization disclosed in Sigg.

164. Boulange also discloses that “invention allows to have decreased activation, sustainable and final forces...without having to add lubricant and while preserving the tightness of the contact region between two parts.” Ex. 1008 at 6:10-14. A POSITA would have understood that maintaining a tight seal provides protection during the sterilization process, which would allow terminal sterilization to be applied without allowing negative interactions with the VEGF-antagonist formulation. Ex. 1007 at 3:27-30 (“It further has been found that among the commercially available primary packaging components, there are only very few packaging material combinations that provide the required tightness of the system such as to avoid ingress of sterilizing gasses into the pharmaceutical liquid enclosed by the prefilled container”). Sigg and Boulange both relate to aspects of pre-filled syringe manufacture, and are therefore complementary to one another, which would further motivate their combination and create a more than reasonable expectation of making a pre-filled syringe as described in the claims of the ’631 patent.

2. Particulate Content

165. Sigg discloses a pre-filled syringe that includes a VEGF-antagonist, such as ranibizumab, for intravitreal injection. A POSITA would understand that the ranibizumab solution disclosed in Sigg is an ophthalmic solution. When making a pre-filled syringe including a VEGF-antagonist for intravitreal injection, such as the ophthalmic ranibizumab solution disclosed in Sigg, a POSITA would have been

aware of and motivated to comply with USP789, which is prior art and sets forth particulate content requirements for ophthalmic solutions. Those particulate content requirements from USP789 were directly copied into the claims of the '631 patent. In order to achieve regulatory compliance and approval, which is ultimately the goal for most if not all pharmaceutical formulations, a POSITA would have understood that compliance with USP789 was highly desirable if not mandatory.

166. A POSITA would have had a reasonable expectation of success that the combination of Sigg and Boulange would result in a pre-filled syringe containing a VEGF-antagonist for intravitreal injection that meets the particulate matter requirements of USP789. A POSITA would understand that the ophthalmic ranibizumab solution disclosed in Sigg should meet the USP789 requirements. The '631 patent provides no information regarding how a VEGF-antagonist solution is prepared such that it complies with the USP789 requirements, thus conceding such a preparation would have been known to a POSITA. Furthermore, a POSITA would understand that ophthalmic solutions of VEGF-antagonists were already known in the art—*i.e.*, Macugen, Lucentis, and Eylea—and that the methods of preparing these solutions such that they meet the requirements of USP789 would be known to one of ordinary skill in the art.

167. With respect to meeting the requirements of USP789, the '631 patent states only that “the syringe has low levels of silicone oil sufficient for the syringe

to meet USP789.” Ex. 1001 at 6:28-30. As explained above, Boulange discloses a syringe siliconized using baked-on siliconization that has low levels of silicone oil falling within the ranges claimed in the ’631 patent. Accordingly, a POSITA would have expected that the combination of Boulange and Sigg would result in a pre-filled syringe meeting the particulate content requirements of USP789.

B. Claim 1

1. [1.a] A pre-filled, terminally sterilized syringe for intravitreal injection

168. Sigg discloses terminal sterilization of pre-filled syringes containing sensitive biologic drug products for intravitreal injection:

Terminal sterilization of prefilled containers in secondary packaging is one way to provide the device to an end user...Moreover there is a strong market need for terminally anti-microbially-treated medical devices, such as prefilled syringes used for intravitreal injections.

Described herein is a terminal sterilization and surface decontamination treatment of prefilled containers, specifically for sterilization of prefilled containers containing sensitive solutions, such as a drug product or biological therapeutic, within secondary packaging.

The method and system described herein decontaminate or, more preferably render sterile an outside surface of primary packaged drug products within a secondary pack, thereby improving safety of products for critical administration (e.g. use in a surgical suite or for intravitreal injections).

In one embodiment, the prefilled container is a syringe... filled with a drug product... In another embodiment, a solution is any drug product having requirements or desirability for sterility of the drug product container surface. In one particular embodiment, the drug product is a protein solution, such as ranibizumab (e.g. 6mg/ml or 10 mg/ml) solution for intravitreal injection.

Ex. 1007 at 2:15-19, 3:8-13, 4:12-15, 9:1-14, 20:10-21:11.

169. Boulange also discloses glass syringes that are filled with water prior to testing. Ex. 1008 at 13:11-12 (“The container 2 is a glass syringe body accommodating a piston 3 able to move translationally...”); 14:19-21 (“tests were applied on containers filled with 1 mL of demineralised water and each plugged with one piston to be tested (coated or uncoated)”).

2. [1.b] the syringe comprising a glass body forming a barrel, a stopper and a plunger

170. Sigg discloses that the pre-filled syringe has a barrel, stopper, and plunger. An annotated version of Figure 1 of Sigg is reproduced below, showing the location of each of these pre-filled syringe components.

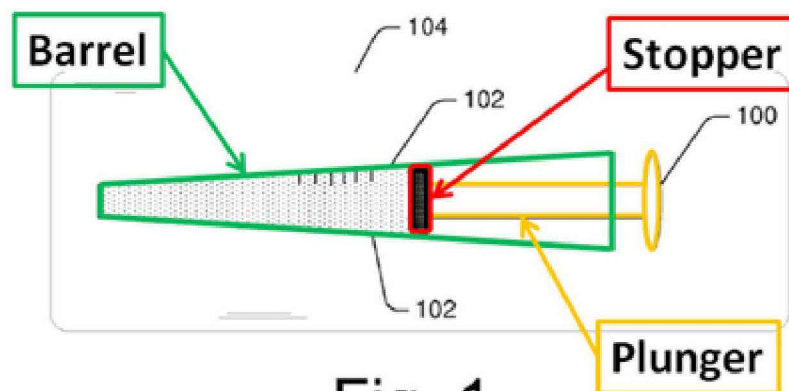

Fig. 1

Ex. 1007.030 (Fig. 1) (annotated)

171. Sigg discloses glass syringes. Ex. 1007 at 2:1-6, 22:8-11. While Sigg does not explicitly state the syringes in Example 1 were glass, as explained in ¶ 113 above, it would have been obvious to a POSITA to utilize a glass syringe for the particular embodiment disclosed in Sigg Example 1 (*i.e.*, a pre-filled syringe containing ranibizumab that is terminally sterilized using VHP).

172. Boulange discloses a syringe comprising a glass body forming a barrel, and a stopper (which is referred to in Boulange as a “piston”):

With reference to figures 1 and 2, the medical device 1 comprises a first and a second parts 2 and 3, one being complementary to the other, for example a piston 3 housed in a container 2, the piston 3 and the internal surface of the container 2 being in contact with one another via a contact region 10. The piston 3 and the container 2 are able to move one with respect to the other in a predetermined gliding movement 4, for example translationally and/or rotationally.

The container 2 is a glass syringe body accommodating a piston 3 able to move translationally along arrow 4 of figure 2 inside the container 2.

Ex. 1008 at 9:21-35, 13:11-12.

173. The “plunger” recited in the ’631 patent’s claims refers to a plunger rod. It would be obvious to a POSITA that, although not depicted in Figures 1 and 2 of Boulange, the syringe stopper would be coupled to a plunger rod in order for the syringe to be used. An annotated version of Figure 2 of Boulange is reproduced below showing where a POSITA would understand the plunger rod would be coupled to the stopper.

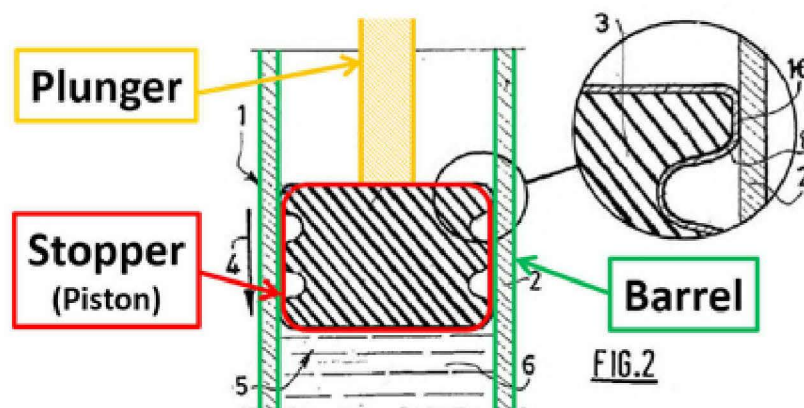

Ex. 1008.29 (Fig. 2) (modified and annotated)

As described in Section V.B above, a plunger rod is a standard component of a pre-filled syringe. A POSITA would understand that the Boulange syringe would include one in order to expel the product contained in the syringe. Often, the two components are used together and therefore stoppers are often referred to as plunger stoppers. See Ex. 1015.315; Ex. 1007 at 2:1-3; Ex. 1014 at [0008].

3. [1.c] and containing an ophthalmic solution which comprises a VEGF-antagonist, wherein:

174. Sigg discloses an embodiment in which the pre-filled syringe contains an ophthalmic solution comprising the VEGF-antagonist ranibizumab (Lucentis):

In another embodiment, a solution is any drug product having requirements or desirability for sterility of the drug product container surface. In one particular embodiment, the drug product is a protein solution, such as ranibizumab (e.g. 6mg/ml or 10 mg/ml) solution for intravitreal injection.

A formulation as described in U.S. Patent No. 7,060,269 was tested for protein degradation following treatment by VHP...Filling of 0.5 mL syringes was performed in a sterile lab for hydrogen peroxide treatment.

Ex. 1007 at 9:11-14, 20:17-21.

175. While Boulange does not explicitly disclose a VEGF-antagonist, a POSITA would understand that the pre-filled syringes disclosed in Boulange with baked-on silicone oil and optionally coated stoppers would be especially preferred for use with protein formulations such as VEGF-antagonist solutions on account of the reduced incompatibility between baked-on siliconization and protein formulations, and also between coated stoppers and protein formulations intended for ophthalmic use. *See* Ex. 1044.006 (“Overall data suggested that the baked-on silicone process was better suited for protein formulation development in PFS as it represented a lesser degree of risk for the formation of subvisible particulate matter as well as minimized any potential for protein precipitation on the Si-oil droplets.”); Ex. 1013.004 (explaining that baked-on siliconization reduces the silicone’s “chemical reactivity” whereby “the product’s stability is increased”); Ex. 1011.004 (baked-on silicone “is a clear benefit for silicone-sensitive drugs”).

4. [1.d] the syringe has a nominal maximum fill volume of between about 0.5 mL and about 1 mL

176. Sigg discloses a syringe with a nominal maximum fill volume of 0.5 mL and 1 mL. Ex. 1007 at 20:20-21 (“Filling of 0.5 mL syringes was performed in a sterile lab for hydrogen peroxide treatment.”); 22:8-10 (“Additionally, the oxidative stress exerted on a 0.5% Polysorbate 20 solution in pre-filled glass syringes (1 mL long, ISO) was investigated by measurement of peroxides according

to standard protocols.”). A POSITA would have understood that the 0.5 mL and 1 mL volumes disclosed in Sigg refers to the nominal maximum fill volume. A POSITA would also have understood that a small volume syringe in the 0.5-1 mL range would be used for intravitreal injection, including for example, injection of ranibizumab, since the amount of fluid capable of being injected into the eye is limited. *See* Ex. 1015.017 (administration volume for intravitreal injection is “generally < 0.1 mL”); *See* Ex. 1021 at [0059], [0061] (disclosing 1 mL prefilled glass syringe for VEGF-antagonist); Ex. 1062.009 (disclosing that Macugen is provided in a 1 mL glass syringe). The fill volume of the syringe has to be more than the volume that is desired for injection, in order to account for priming and loss of product. As explained in **Section V.B**, 0.5 mL and 1 mL are standard syringe sizes.

177. Boulange also discloses a syringe with a nominal maximum fill volume of 1 mL. Ex. 1008 at 14:19-21 (“Activation Gliding Force (AGF) tests were applied on containers filled with 1 mL of demineralised water and each plugged with one piston to be tested (coated or uncoated).”). A POSITA would also understand that “a surface area of 10 cm²,” as disclosed in Example 5 of Boulange, corresponds to a standard 1 mL syringe. According to ISO-11040-4, a standard 1 mL syringe has an inner diameter of 8.65 mm (equivalent to a radius, r , of 4.325 mm and a height (or length), h , of 35.7 mm. Ex. 1028.008 (Table 1). The surface area, S , of the syringe

barrel, can be calculated using those dimensions, using the conversion of 10 mm = 1 cm, and the equation $S = 2\pi rh$, is 9.70, or $\sim 10 \text{ cm}^2$. For a long 1 mL syringe, the inner diameter is 6.35 mm (equivalent to a radius, r , of 3.175 mm and a height (or length), h , of 54 mm. The surface area, S , of the syringe barrel, is 10.77 cm^2 (also $\sim 10 \text{ cm}^2$).

178. Furthermore, a POSITA would understand that the disclosure in Boulange of the amount of silicone oil applied per cm^2 (*i.e.*, $4 \mu\text{g}/\text{cm}^2$ for baked-on siliconization) is applicable regardless of the syringe fill volume (and therefore applicable to both 0.5 mL and 1.0 mL syringes), because in baked-on siliconization, thin “[m]ono-layers of the lubricant are affixed to the glass surface,” which allows “the lubricant to spread out evenly over the glass surface and creates a thin, uniform film,” and therefore the amount of silicone oil applied is proportional to the surface area of the inside of the syringe barrel. Ex. 1012.006.

5. [1.e] the syringe barrel comprises from about 1 μg to 100 μg silicone oil

179. Boulange, in Example 5, discloses pre-filled syringe embodiments wherein “a silicone lubricant was deposited and baked onto the internal surface of the syringe body 2, at a rate of $40 \mu\text{g}$ for a surface area of 10 cm^2 , but no silicone was used or sprayed on the pistons 3.” Ex. 1008 at 20:15-17, 21:1-3 (Table 7 disclosing “ $4 \mu\text{g}/\text{cm}^2$ ” for Scenario 1). A POSITA would understand that the

reference to “a surface area of 10 cm²” refers to the approximate surface area of a 1 mL syringe, as explained above in ¶ 177.

180. As also explained above in ¶ 178, the silicone oil spray rate of 4 µg/cm² rate in Boulange would be expected to remain the same regardless of the syringe size, because in baked-on siliconization the amount of silicone oil used varies directly with the surface area of the surface being sprayed. Thus, at a rate of 4 µg/cm², a total of 27.8, or ~28, µg of silicone oil, would be applied for a 0.5 mL standard syringe using the method of Boulange. This calculation is based on the syringe specifications of ISO-11040-4, wherein a standard 0.5 mL syringe has an inner diameter of 4.65 mm (equivalent to a radius, r , of 2.325 mm and a height (or length), h , of 47.6 mm. The surface area, S , of the syringe barrel, calculated using those dimensions, the conversion of 10 mm = 1 cm, and the equation $S = 2\pi rh$, is 6.95 cm². Multiplying that number by 4 µg/cm², gives you a total of 27.8, or ~28, µg of silicone oil to be applied on the inside of the syringe barrel for a 0.5 mL standard syringe.

6. [1.f] the VEGF-antagonist solution comprises no more than 2 particles > 50 µm in diameter per mL

181. It would be obvious to a POSITA that the combination of Sigg and Boulange would result in a pre-filled syringe comprising a VEGF-antagonist solution with no more than 2 particles > 50 µm in diameter per mL.

182. Sigg discloses a pre-filled syringe containing a solution of the VEGF-antagonist ranibizumab for intravitreal injection. Ex. 1007 at 9:11-14 (“In another embodiment, a solution is any drug product having requirements or desirability for sterility of the drug product container surface. In one particular embodiment, the drug product is a protein solution, such as ranibizumab (e.g. 6mg/ml or 10 mg/ml) solution for intravitreal injection.”), 20:17-21 (“A formulation as described in U.S. Patent No. 7,060,269 was tested for protein degradation following treatment by VHP...Filling of 0.5 mL syringes was performed in a sterile lab for hydrogen peroxide treatment.”).

183. As explained in **Section V.F**, a POSITA would understand that “no more than 2 particles $>50 \mu\text{m}$ in diameter per mL” is one of the USP789 standards required for ophthalmic drugs such a VEGF-antagonist solution intended for intravitreal use. *See* Ex. 1017 at 10:19-22 (“United States Pharmacopoeia (USP) Chapters <788> *Particulate Matter in Injections* and <789> *Particulate Matter in Ophthalmic Solution* describe physical tests for the purpose of enumerating extraneous particles within specific size ranges.”). Specifically, a POSITA would know that a VEGF-antagonist solution for intravitreal administration would need to comply with USP789 for regulatory approval and thus it would need to meet the microscopic particle count test as set forth in USP789 which requires no more than 2 particles of diameter $\geq 50 \mu\text{m}$ per mL. A POSITA would understand that

ophthalmic solutions of VEGF-antagonists were already known in the art—*i.e.*, Macugen, Lucentis, and Eylea—and that preparing these solutions such that they meet the requirements of USP789 would be within the level of ordinary skill in the art.

184. A POSITA would have a reasonable expectation that the combination of Sigg (*i.e.*, a VEGF-antagonist solution in a pre-filled syringe) and Boulange (pre-filled baked-on syringe with low silicone oil) would satisfy the USP789 particulate matter limitations. Ex. 1044.006 (“Overall data suggested that the baked-on silicone process was better suited for protein formulation development in PFS as it represented a lesser degree of risk for the formation of subvisible particulate matter as well as minimized any potential for protein precipitation on the Si-oil droplets.”). A POSITA would understand that the ophthalmic solution disclosed in Sigg is required to meet USP789, as I described above. The ’631 patent does not explain how to achieve a solution that meets USP789 (*see* Ex. 1001 at 6:28-30), and thus concedes that preparation of such a solution was known to a POSITA. Moreover, Boulange discloses a syringe siliconized using baked-on siliconization that has low levels of silicone oil falling within the ranges claimed in the ’631 patent. Accordingly, a POSITA would have expected that the combination of Boulange and Sigg would result in a pre-filled syringe meeting the particulate content requirements of USP789 because Boulange explicitly states that its invention limits the risk of

interaction between the silicone oil and the ophthalmic solution. *See also* Ex. 1008 at 6:26-29 (“the medical device of the invention allows to limit the risk of interaction between a lubricant, for example silicone oil, and the therapeutic molecules potentially stored in the container”).

7. [1.g] and wherein the syringe has a stopper break loose force of less than about 11N.

185. Boulange discloses a pre-filled syringe with a stopper break loose force of less than 11 N. Table 7 from Boulange is reproduced below and discloses break loose forces of 6.6, 2.1 and 3.9 for an unaged syringe (*i.e.*, T=0) for the syringes in which silicone was applied to the syringe barrel using baked-on siliconization. The baked-on syringe including a coated stopper also has a break loose force of 3.0 N at T=1.

Table 7



		Scenario 1			Scenario 2		
Silicone/internal surface of syringe		4 µg/cm ²	4 µg/cm ²	4 µg/cm ²	50 µg/cm ²	50 µg/cm ²	50 µg/cm ²
Silicone/piston		---	---	---	---	---	---
Force (N)		B	S	F	B	S	F
Piston	A _{T=0}	6.6 (0.3)	6.9 (1.4)	4.0 (1.4)	5.6 (0.5)	1.2 (0.3)	4.0 (2.0)
	A _{T=1}	15.7 (2.9)	5.3 (2.6)	6.1 (4.2)	8.8 (1.1)	1.6 (0.7)	5.6 (4.1)
	B1 _{T=0}	2.1 (0.1)	2.5 (0.3)	2.6 (0.3)	1.9 (0.2)	1.3 (0.3)	2.1 (0.7)
	B1 _{T=1}	3.0 (0.4)	3.4 (0.5)	2.8 (0.6)	2.2 (0.2)	1.4 (0.3)	2.4 (0.6)
	C _{T=0}	3.9 (0.6)	6.6 (2.5)	3.9 (2.5)	4.2 (0.6)	1.0 (0.4)	4.7 (2.9)
	C _{T=1}	14.4 (2.2)	4.8 (2.1)	3.6 (1.1)	5.4 (1.2)	1.3 (0.5)	4.3 (2.8)
	A _{T=3}	17.2 (6.1)	4.3 (2.4)	2.9 (1.2)	10.0 (1.0)	1.5 (0.3)	4.0 (3.0)
	A _{T=5}	20.5 (4.0)	6.1 (3.0)	3.0 (1.0)	15.1 (1.4)	2.5 (1.5)	3.0 (2.0)

Ex. 1008 at 21:1-3 (Table 7) (annotations in color)

186. Boulange further discloses that “[t]he medical device of the invention allows to have decreased activation, sustainable and final forces for moving a first part relative to a second part, for example for moving a piston within the container in which it is lodged” and that “it is possible to decrease the total amount of lubricant, for example silicone oil, that is necessary in such a medical device.” Ex. 1008 at 6:10-25. As explained above, a POSITA would understand that the break loose forces disclosed in Table 7 of Boulange would remain substantially the same even when a VEGF-antagonist such as ranibizumab is contained in the syringe rather than water, because the viscosity of the fluid does not affect the break loose force. The break loose force recited in claim 1 of the ’631 patent is nothing more than the measurement of force in a syringe produced by a process (baked-on siliconization) that was already known in the art.

C. Claims 2, 3, 5-9, 14, 16-22 and 24

187. The limitations of claims 2, 3, 5-9, 14, 16-21 and 24 are likewise disclosed and rendered obvious by Sigg in view of Boulange.

1. Claim 2

188. Claim 2 recites “[a] pre-filled syringe according to claim 1, wherein the syringe barrel has an internal coating of silicone oil that has an average thickness of about 450 nm or less.”

189. Further to the explanation provided in Section VIII.B above with respect to claim 1, Boulange discloses a pre-filled syringe with $4 \mu\text{g}/\text{cm}^2$ of silicone oil. Ex. 1008 at 20:15-17 (“a silicone lubricant was deposited and baked onto the internal surface of the syringe body 2, at a rate of $40 \mu\text{g}$ for a surface area of 10 cm^2 , but no silicone was used or sprayed on the pistons 3.”), 21:1-3 (Table 7). Boulange discloses the mass of sprayed on silicone per unit surface area (surface density) and a POSITA would readily be able to convert between surface density and the thickness of the silicone oil, using the known density of silicone oil ($0.97 \text{ g}/\text{cm}^3$). Specifically, the layer thickness of silicone oil is equal to the surface density of the silicone oil being applied (*e.g.*, $4 \mu\text{g}/\text{cm}^2$), divided by the density of the silicone oil itself, which is $0.97 \text{ g}/\text{cm}^3$.

$$\begin{aligned}
 \text{Layer thickness} &= (4 \mu\text{g}/\text{cm}^2) / (0.97 \text{ g}/\text{cm}^3) \\
 &= (4 \mu\text{g}/\text{cm}^2) * (\text{cm}^3/0.97\text{g}) * (10^7 \text{ nm}/\text{cm}) * (\text{g}/10^6 \mu\text{g}) \\
 &= (4 \mu\text{g}/\text{cm}^2) * (\text{cm}^3/0.97\text{g}) * (10^7 \text{ nm}/\text{cm}) * (\text{g}/10^6 \mu\text{g}) \\
 &= (4 * 10 / 0.97) \text{ nm} \\
 &= 41.2 \text{ nm}
 \end{aligned}$$

190. This is significantly less than the 450 nm limit recited in claim 2 of the '631 patent, and it is consistent with the prior art, which shows that it was well known that the thickness of the baked-on silicone oil layer is much thinner than the thickness of oily siliconized layers. For example, the Fries reference states that the typical thickness for baked-on layer is 76.83 nm. Ex. 1012.006. Thus, Boulange not

only discloses a pre-filled syringe with silicone oil that has an average thickness of less than 450 nm, but also teaches a silicone oil layer thickness known to be typical for baked-on silicone oil syringes.

2. Claims 3 and 22

191. Claim 3 recites “[a] pre-filled syringe according to claim 1, wherein the syringe barrel has an internal coating of from about 3 μg to about 100 μg silicone oil.” Claim 22 recites “[a] pre-filled syringe according to claim 1, wherein the syringe barrel has an internal coating of from about 1-50 μg silicone oil.”

192. As explained with regard to limitation [1.e], and further to the explanation provided in **Section VIII.B** above with respect to claim 1, Boulange discloses that “a silicone lubricant was deposited and baked onto the internal surface of the syringe body 2, at a rate of 40 μg for a surface area of 10 cm^2 , but no silicone was used or sprayed on the pistons 3.” Ex. 1008 at 20:15-17, 21:1-3 (Table 7 disclosing “4 $\mu\text{g}/\text{cm}^2$ ” for Scenario 1). A POSITA would understand that the reference to “a surface area of 10 cm^2 ” is referring to the approximate surface area of a 1 mL syringe, as explained with respect to limitation [1.e]. Accordingly, Boulange discloses that the baked-on 1 mL syringe has 40 μg of silicone oil on the syringe barrel.

193. Furthermore, as explained above in **Section VIII.B.4** and **Section VIII.B.5** for limitations [1.d] and [1.e], a POSITA would also understand that the 4

$\mu\text{g}/\text{cm}^2$ rate of silicone application of Boulange would be applicable to other syringe sizes, and would result in approximately 28 μg of silicone oil for a standard 0.5 mL syringe.

3. Claims 5 and 6

194. Claim 5 recites “[a] pre-filled syringe according to claim 1, wherein the VEGF antagonist solution further comprises one or more of (i) no more than 5 particles $\geq 25 \mu\text{m}$ in diameter per mL, and (ii) no more than 50 particles $\geq 10 \mu\text{m}$ in diameter per mL.” Claim 6 recites “[a] pre-filled syringe according to claim 1, wherein the VEGF-antagonist solution meets USP789.”

195. As explained above in **Section V.F**, a POSITA would understand that “(i) no more than 5 particles $\geq 25 \mu\text{m}$ in diameter per mL, and (ii) no more than 50 particles $\geq 10 \mu\text{m}$ in diameter per mL” are USP789 requirements. My analysis above in **Section VIII.A.2** and **Section VIII.B.6** demonstrates that it would be obvious to a POSITA that the combination of Sigg and Boulange would meet the requirements of USP789.

4. Claims 7, 8, and 9

196. Claim 7 recites “[a] pre-filled syringe according to claim 1, wherein the VEGF antagonist is an anti-VEGF antibody.” Claim 8 recites “[a] pre-filled syringe according to claim 7, wherein the anti-VEGF antibody is ranibizumab.” Claim 9

recites “[a] pre-filled syringe according to claim 8, wherein the ranibizumab is at a concentration of 10 mg/mL.”

197. Further to the explanation provided in **Section VIII.B** above with respect to claim 1, Sigg discloses a pre-filled syringe containing ranibizumab, which the '631 Patent describes as an anti-VEGF antibody, and discloses ranibizumab at a concentration of 10 mg/mL. Ex. 1007 at 9:11-14 (“In another embodiment, a solution is any drug product having requirements or desirability for sterility of the drug product container surface. In one particular embodiment, the drug product is a protein solution, such as ranibizumab (e.g. 6mg/mL or 10 mg/mL) solution for intravitreal injection.”), 20:17-21 (“A formulation as described in U.S. Patent No. 7,060,269 was tested for protein degradation following treatment by VHP...Filling of 0.5 mL syringes was performed in a sterile lab for hydrogen peroxide treatment.”); Ex. 1001 at 6:30-35 (“Two antibody VEGF antagonists have been approved for human use, namely ranibizumab (Lucentis®) and bevacizumab (Avastin®)”).

5. Claims 14 and 16

198. Claim 14 recites “[a] pre-filled syringe according to claim 1, wherein the syringe has a stopper break loose force of less than about 5N, and wherein the syringe has a stopper slide force of less than about 5N.” Claim 16 recites “[a] pre-filled syringe according to claim 1, wherein the syringe has a stopper slide force of less than about 11N.”

199. Further to the explanation provided in **Section VIII.B** above with respect to claim 1, Boulange discloses a pre-filled syringe with a stopper break loose force of less than 5N and a stopper slide force of less than 5N. As shown below, the syringe with the coated stopper (B1) has stopper break loose and slide force below 5N at T=0 and T=1.

Table 7

		Scenario 1			Scenario 2		
Silicone/internal surface of syringe		4 µg/cm ²	4 µg/cm ²	4 µg/cm ²	50 µg/cm ²	50 µg/cm ²	50 µg/cm ²
Silicone/piston		---	---	---	---	---	---
Force (N)		B	S	F	B	S	F
Piston	A T=0	6.6 (0.3)	6.9 (1.4)	4.0 (1.4)	5.5 (0.5)	1.2 (0.3)	4.0 (2.0)
	A T=1	15.7 (2.9)	5.3 (2.6)	6.1 (4.2)	6.6 (1.1)	1.6 (0.7)	5.6 (4.1)
	B1 T=0	2.1 (0.1)	2.5 (0.3)	2.6 (0.3)	1.9 (0.2)	1.3 (0.3)	2.1 (0.7)
	B1 T=1	3.0 (0.4)	3.4 (0.5)	2.8 (0.6)	2.2 (0.2)	1.4 (0.3)	2.4 (0.6)
	C T=0	3.9 (0.6)	6.6 (2.5)	3.9 (2.5)	4.2 (0.6)	1.0 (0.4)	4.7 (2.9)
	C T=1	14.4 (2.2)	4.8 (2.1)	3.6 (1.1)	5.4 (1.2)	1.3 (0.5)	4.3 (2.8)
	A T=3	17.2 (6.1)	4.3 (2.4)	2.9 (1.2)	10.0 (1.0)	1.5 (0.3)	4.0 (3.0)
	A T=5	20.5 (4.0)	6.1 (3.0)	3.0 (1.0)	15.1 (1.4)	2.5 (1.5)	3.0 (2.0)

Ex. 1008 at 21:1-3 (Table 7)

See also Ex. 1008 at 6:10-25 (“The medical device of the invention allows to have decreased activation, sustainable and final forces for moving a first part relative to a second part, for example for moving a piston within the container in which it is lodged...Moreover, with the medical device of the invention, it is possible to decrease the total amount of lubricant, for example silicone oil, that is necessary in such a medical device.”).

200. As explained in ¶ 162 above, a POSITA would understand that the forces disclosed in Table 7 of Boulange would remain substantially the same even when a VEGF-antagonist such as ranibizumab is contained in the syringe rather than water. Thus, the claimed break loose and slide force is nothing more than the measurement of force resulting from the baked-on process that was already well known in the art.

6. Claim 15

201. Claim 15 recites “[a] pre-filled syringe according to claim 14, wherein the stopper break loose force or stopper slide force is measured using a filled syringe, at a stopper travelling speed of 190 mm/min, with a 30 G×0.5 inch needle attached to the syringe.” Claim 15 is obvious based on Sigg in view of Boulange because it would be obvious to use a 30 G x 0.5 inch needle for a pre-filled syringe containing a VEGF-antagonist for intravitreal injection, and the break loose forces disclosed in Boulange in Table 7 would be less than 5 N when measured using a filled syringe with a stopper traveling speed of 190 mm/min and a 30 G x 0.5 inch needle.

202. The tests summarized in Table 7 of Boulange were conducted using a 1 mL syringe filled with water and a 380 mm/min stopper speed Ex. 1008 at 14:19-21; 16:13-15; 17:17-18; 20:13-14 Further to the explanation provided in **Section VIII.B** above with respect to claim 1, a POSITA would understand from the disclosure in Boulange that the tests were likely conducted using a standard long 1

mL syringe or a standard short 1 mL syringe with a 27 G or 30 G needle. The calculations allowing a POSITA to reach this conclusion are shown in **Appendix A at Section I.A.**

203. The viscosity of the solution, needle type, and stopper traveling speed are irrelevant to break loose force, and only impact the slide force. As explained above in **Section V.C**, the break loose force is largely attributable to the ageing of the stopper within the syringe, which becomes sticky with age and forms a tight seal against the barrel. The tighter seal results in a higher force required to initially displace the stopper, which is the break loose force. Because the break loose force is between the stopper and the inside of the barrel, and is the force required to get the stopper to just about begin moving, the break loose force is largely unaffected by the viscosity of the fluid in the pre-filled syringe or other factors that impact the slide force, such as needle size and stopper traveling speed.

204. Because VEGF antagonists such as ranibizumab are intended for intravitreal injection into the eye, it would have been obvious to a POSITA to use a thin needle of higher gauge, such as a 30 G needle, for such an application. A needle length of 0.5 inches would also have been obvious to use because of the shallow depth of intravitreal injection, to avoid damaging the optic nerve. *See* Ex. 1015.036 (“Care must be taken not to inject the optic nerve directly. A 1 to 0.5 inch long, 25-gauge stainless steel needle is generally employed.”). Thus, for example, the

Macugen pre-filled syringe used a 30 G x 0.5” needle. *See* Ex. 1009.007. A POSITA would also understand that the selection of an appropriate needle size for administration would have been routine optimization well within ordinary skill. Thus, it would be obvious to a POSITA to utilize a 30 G x 0.5 inch needle with a pre-filled syringe containing a VEGF-antagonist for intravitreal injection as a matter of routine optimization based on the use of a 30 gauge needle for the Macugen pre-filled syringe and the knowledge that a 25-gauge or smaller needle would have been preferred for intravitreal administration.

205. As noted above, because the break loose force is a measure of force required for initial movement only, it is unaffected by the stopper traveling speed, needle type, or viscosity. Thus, the “friction force B” (*i.e.*, break loose force) in Table 7 of Boulange will remain the same if measured at a stopper speed of 190 mm/min, with a 30 G x 0.5 inch needle, and the syringe filled with a VEGF antagonist (such as ranibizumab), as required by claim 15. Thus, it would be obvious to a POSITA that the break loose forces disclosed in Boulange would be maintained at less than 5 N when measured using a stopper traveling speed of 190 mm/min, a 30 G x 0.5 inch needle and the syringe filled with a VEGF antagonist (such as ranibizumab).

206. Likewise, given the results reported in Table 7 from the conditions used in Boulange, the slide force resulting from the conditions in claim 15 can be obtained

from the Hagen-Pousseille formula, as shown in **Appendix A at Section I.B.** As the calculations in the Appendix show, the slide forces listed in Table 7 of Boulange would *also* still be less than 5 N if the syringe is filled with ranibizumab instead of water, used 190 mm/min instead of 380 mm/min, and has a 30 G x 0.5 inch needle. Although the calculations show that the disclosure of Boulange renders claim 15 obvious with regard to value of the slide force, such proof is unneeded, since claim 15 would still be obvious to a POSITA based only on the break loose force. Claim 15 recites “the stopper break loose force *or* stopper slide force,” is measured under the specified conditions, and, as explained above, a POSITA would understand that the break loose force would not be affected by those conditions.

7. **Claim 17**

207. Claim 17 recites “[a] blister pack comprising a pre-filled syringe according to claim 1, wherein the syringe has been sterilised using H₂O₂ or EtO.”

208. Further to the explanation provided in **Section VIII.B** above with respect to claim 1, Sigg discloses a pre-filled syringe packaged in a blister pack that is terminally sterilized by VHP. Ex. 1007 at 6:26-28 (“‘Secondary packaging’ refers to packaging enclosing the pre-filled container, such as plastic wrapping, foil wrapping, paper wrapping or other suitable wrapping, *such as blister packs.*” (emphasis added)), 8:21-24 (“Referring to Fig. 1, a prefilled container 100 previously filled under aseptic conditions is decontaminated on surfaces 102

following encasement or packaging in a secondary package 104 by vaporized-hydrogen peroxide or tunable-beta radiation as described herein.”), 9:1-4 (“In one embodiment, the prefilled container is a syringe...filled with a drug product”).

8. Claims 18 and 19

209. Claim 18 recites “[a] blister pack comprising a pre-filled syringe according to claim 17, wherein the outer surface of the syringe has ≤ 1 ppm EtO or H₂O₂ residue.” Claim 19 recites “[a] blister pack comprising a pre-filled syringe according to claim 17, wherein the syringe has been sterilised using EtO or H₂O₂ and the total EtO or H₂O₂ residue found on the outside of the syringe and inside of the blister pack is ≤ 0.1 mg.”

210. Further to the explanation provided in **Section VIII.B** above with respect to claim 1, and above with respect to claim 17, Sigg teaches a method by which the concentration of the sterilizing gas can be reduced or eliminated after VHP sterilization. Post-treatment measures are used to reverse the direction of vapor diffusion by application of a vacuum and to destroy any residual peroxide traces, for example by eliminating radicals formed by action of VHP and inactivating VHP action such as oxidative action by ultraviolet rays, chemical agents, or gas plasma. Ex. 1007 at 10:17-28; 14:2-26; 15:21-28. Specifically, Sigg discloses a method of VHP terminal sterilization that degrades all potentially remaining hydrogen peroxide residue. Ex. 1007 at 3:22-27 (“Further, inclusion of a gas plasma treatment after

completion of the vaporized hydrogen peroxide cycle will further degrade all potentially remaining hydrogen peroxide residues.”)(emphasis added). Sigg also provides a specific teaching to motivate a POSITA to reduce or eliminate the H₂O₂ residues, stating that the “[p]revention or reduction of leaching of detrimental concentrations of hydrogen peroxide into the protein solution in the syringe, either by removal of vapors or inactivation of vapors, ensures that the long-term stability of the protein is not compromised.” *Id.* A POSITA would understand that removal of all potentially remaining hydrogen peroxide residue, which would leave no residue, would result in having less than 1 ppm H₂O₂ residue on the outer surface, and that to achieve that level would be a matter of routine optimization. For example, Sigg discloses that the method can be optimized by testing various conditions. Ex. 1007 at 3:17-19 (“It has been discovered that by varying the parameters of the antimicrobial treatment, for example - temperature, humidity, treatment duration, pressure, etc., conditions are generated that prevent the leaching of VHP into the syringes.”). Inclusion of the gas plasma treatment to degrade VHP residues is provided as an example of one of the parameters that can be varied. Ex. 1007 at 3:19-24 (“*As an example*, the application of a vacuum at the end of the treatment will inverse the diffusion direction and reduce, if not stop, leaching of hydrogen peroxide through the rubbers. *Further*, inclusion of a gas plasma treatment after completion of the vaporized hydrogen peroxide cycle will further degrade all

potentially remaining hydrogen peroxide residues.”). A POSITA would have understood that such optimization of the methods disclosed in Sigg for removal or inactivation of vapors could be used to achieve the removal of H₂O₂ to the desired level.

211. A POSITA would also understand that removal of all potentially remaining hydrogen peroxide residue, which would leave no residue, would result in having less than 0.1 mg of total H₂O₂ residue on outside of the syringe and inside of the blister pack. As explained above, Sigg discloses that the method can be optimized by testing various conditions. A POSITA would know that such optimization of the methods disclosed in Sigg for removal or inactivation of vapors could be used to achieve the removal of H₂O₂ to the desired level.

9. Claim 20

212. Claim 20 recites “[a] blister pack comprising a pre-filled syringe according to claim 18, wherein $\leq 5\%$ of the VEGF-antagonist is alkylated.”

213. Further to the explanation provided in **Section VIII.B** above with respect to claim 1, and above with respect to claims 17-19, Sigg discloses in Example 1 that the pre-filled syringes containing a VEGF-antagonist were treated with VHP sterilization treatment. Ex. 1007 at 20:11-21 (“In the following experiment, prefilled syringes were treated with a vaporized-hydrogen peroxide sterilization treatment A formulation as described in U.S. Patent No. 7,060,269 was tested for protein

degradation following treatment by VHP.”). The process of terminal sterilization disclosed in Sigg was further shown to not substantially affect the stability of the VEGF-antagonist protein. *Id.* at 20:22-21:3 (“Analysis after the treatment with VHP revealed the following protein contents...there were no differences between the results of the untreated syringes and with hydrogen-peroxide treated syringes.”).

Table 1: Protein Stability Following Treatment with VHP

Batch	IEC (% main peak)	IEC (% basic peak)	SEC (% monomer)
Control			
9823.01 CSi	98	2	100
9823.02 CSi	98	2	100
1 x treatment			
9823.04 CSi	98	2	100
9823.05 CSi	98	2	100
2 x treatment			
9823.07	98	2	100
9823.08	98	2	100

Ex. 1007 at 20:25-21:1 (Table 1)

214. A POSITA would understand that alkylation is a proxy for assessing how much the protein has been affected by the sterilization gas. Accordingly, a POSITA would understand that because Sigg discloses “no differences” between the treated and untreated syringes, the protein contained in the treated syringes would be less than 5% alkylated. The HPLC (high performance liquid chromatography) method used in Sigg, which separates chemical entities based on particular properties, would have been able to detect alkylation of the protein, as well as other

modifications. IEC, or ion exchange chromatography, separates molecules by charge, whereas SEC, or size exclusion chromatography, separates molecules by size. The “basic peak” of the IEC readout would contain the alkylated product, since alkylation increases the basicity of the protein. Thus, since no change in the IEC basic peak between the control and experimental conditions is seen in the experiment disclosed using the terminal sterilization techniques of Sigg, a POSITA would understand that this indicates that no substantial increase in the level of alkylation with the disclosed VHP treatment.

10. Claim 21

215. Claim 21 recites “[a] blister pack comprising a pre-filled syringe according to claim 17, wherein the syringe has been sterilised using EtO or H₂O₂ with a Sterility Assurance Level of at least 10⁻⁶.”

216. Further to the explanation provided in **Section VIII.B** above with respect to claim 1, and above with respect to claim 17, Sigg discloses a method of terminal sterilization using VHP that provides for a sterile packaging of a pre-filled syringe. Ex. 1007 at 10:3-6 (“In one embodiment, terminal sterilization and surface decontamination of prefilled containers within secondary packaging is carried out by treating surfaces of the prefilled container within secondary packaging with vaporized-hydrogen peroxide and applying post-treatment measures, within a decontamination chamber.”).

217. Sigg further defines sterile to mean the complete absence of microbial life, and notes that a standard sterility assurance level (SAL) is at least 10^{-6} . *Id.* at 7:8-13 (“‘Sterility’ as used herein is meant to refer to complete absence of microbial life as defined by a probability of nonsterility or a sterility assurance level (SAL). The required SAL for a given product is based on regulatory requirements. For example, required SALs for health care products are defined to be at least 10^{-6} , i.e. a chance of less than 1:1 million of a non-sterile product for aseptically manufactured and terminally sterilized products, respectively.”).

218. Based on the teachings of Sigg and the knowledge of a POSITA, it would have been a matter of routine optimization for a POSITA to ensure that the sterility assurance level of 10^{-6} is achieved. *Id.* at 15:29-16:10 (“Reference is made to treatment times that are sufficient to terminally sterilize the prefilled container. In one embodiment, a sufficient treatment time or the duration of the presence of vaporized-hydrogen peroxide within the chamber to sufficiently decontaminate the container surface is determined by routine validation...By plotting treatment time against presence of bacterial growth, the treatment time to achieve decontamination, thus the absence of bacterial growth, can easily be determined. Validation techniques apply whether terminal sterilization is carried out by vaporized-hydrogen peroxide as described above or carried out by exposure to beta radiation as described below.”).

IX. Petition 1, Ground 2: Sigg in View of Boulange and Fries Renders Obvious Claims 4, 10 and 23

219. Dependent claims 4 and 23 depend from claim 1, and require that the silicone oil is DC365 emulsion or that the silicone oil has a viscosity of about 350 cP. Dependent claim 10, depends from claim 8 and requires silicone oil with a viscosity of about 350 cP and further recites particulate content requirements from USP789.

4. A pre-filled syringe according to claim 1, wherein the silicone oil is DC365 emulsion.

10. A pre-filled syringe according to claim 8, wherein the silicone oil has a viscosity of about 350 cP, and the VEGF antagonist solution further comprises one or more of (i) no more than 5 particles $\geq 25 \mu\text{m}$ in diameter per mL, and (ii) no more than 50 particles $\geq 10 \mu\text{m}$ in diameter per mL.

23. A pre-filled syringe according to claim 1, wherein the silicone oil has a viscosity of about 350 cP.

220. Further to the explanation provided in Section VIII.B above with respect to claim 1, it was well known in the art prior to 2012 that DC365 could be used as a silicone oil emulsion in the baked-on process, and was a preferred commercially-available emulsion for baking silicone, as shown for example by Fries, teaches that DC365 is used for baked-on siliconization in pre-filled syringes. Ex. 1012.006 (“The baked siliconization method uses emulsions of silicone oil (e.g., Dow Corning 365, 35% Dimethicone NF Emulsion, diluted in HPW) sprayed into

syringe barrels followed by heat treatment in a tunnel.”). The ’631 Patent discloses that DC365, which contains DC360 oil with a viscosity of 350 cP, was typically used for syringe siliconization. Ex. 1001 at 5:9-14 (“Various types of silicone oil are available, but typically either DC360 (Dow Corning®; with a viscosity of 1000 cP) or DC365 emulsion (Dow Coming®; DC360 oil with a viscosity of 350 cP) are used for syringe siliconisation.”); *see also* Ex. 1034.002.

221. A POSITA would have been motivated to combine Fries with Sigg and Boulange. Boulange, in Example 5, discloses a syringe with silicone oil applied to the barrel using baked-on siliconization, but it does not specify the type of the silicone that is used or the viscosity of that silicone oil. Fries is a publication regarding the manufacture of pre-filled syringes, and like Boulange discusses the benefits of lowering the amount of silicone oil used and baked-on siliconization. Ex. 1012.005 (“Even though silicone oil is inert toward most drug products, interactions with sensitive biopharmaceuticals have been observed....Advanced siliconization technology has been developed to lower the level of free (non-bound) silicone oil in prefilled syringes.”). As explained above, Fries discloses that DC365, which has a viscosity of 350 cP, is used for baked-on siliconization in pre-filled syringes. *Id.* at .006; Ex. 1001 at 5:9-14. A POSITA would therefore have been motivated to combine the design option disclosed in Fries regarding the type of silicone oil with the siliconized syringe disclosed in Boulange given that both publications pertain to

lowering the amount of silicone oil and using baked-on siliconization. The results of siliconization using this widely available silicone oil emulsion from Dow Corning with a viscosity of 350 cP would have been predictable, and would have led to a pre-filled syringe as recited in claims 4, 10 and 23 of the '631 patent.

222. As explained in **Section V.F**, a POSITA would understand that “(i) no more than 5 particles $\geq 25 \mu\text{m}$ in diameter per mL, and (ii) no more than 50 particles $\geq 10 \mu\text{m}$ in diameter per mL” are requirements set forth in USP789. My analysis above in **Section VIII.A.2** and **Section VIII.B.6** demonstrates that it would be obvious to a POSITA that the combination of Sigg and Boulange would meet the requirements of USP789.

X. Petition 1, Ground 3: Sigg in view of Boulange and Furfine Renders Obvious Claims 11-13

223. Dependent claims 11, 12 and 13 further require that the VEGF-antagonist is a non-antibody VEGF-antagonist, the non-antibody VEGF-antagonist is aflibercept or conbercept, and the non-antibody VEGF-antagonist is aflibercept at a concentration of 40 mg/mL, respectively. Sigg discloses in one embodiment that the pre-filled syringe includes a VEGF-antagonist (ranibizumab), and it would have been obvious to a POSITA to use a different VEGF-antagonist, such as aflibercept or conbercept, which were both well-known prior to 2012, in the pre-filled syringe for intravitreal administration. Furfine discloses aflibercept, which is a biologic therapeutic approved for treatment of wet AMD that is administered by intravitreal

injection. Furfine also discloses a VEGF-antagonist in a pre-filled glass syringe. Ex. 1021 at [0059], [0061].

224. A POSITA would have been motivated to use aflibercept in a terminally sterilized pre-filled syringe as disclosed in Sigg, for all the reasons discussed above in Section VIII with respect to the VEGF-antagonist solution ranibizumab. Indeed, Sigg makes clear that the disclosed terminal sterilization is applicable to a broad range of solutions, including those that are temperature, oxidation, or radiation sensitive. Ex. 1007 at 6:21-25, 7:20-8:7. Sigg specifically notes that “the prefilled container itself is not drug specific.” *Id.* at 8:6-7. Likewise, Boulange is directed towards improvements for pre-filled syringes used to dispense therapeutic molecules, but is not limited in its use to any particular molecule. Ex. 1008 at 6:26-29. A POSITA would have recognized that aflibercept, marketed as Eylea®, is a sensitive biologic that would be suited for use in the terminally sterilized pre-filled syringe for intravitreal injection disclosed in Sigg.

A. Claims 11 and 12

225. Claim 11 recites “[a] pre-filled syringe according to claim 1 wherein the VEGF antagonist is a non-antibody VEGF antagonist.” Claim 12 recites “[a] pre-filled syringe according to claim 11, wherein the non-antibody VEGF antagonist is aflibercept or conbercept.”

226. Furfine discloses a non-antibody VEGF-antagonist known as aflibercept. Ex. 1021 at [0005] (“Stable formulations of a VEGF-specific fusion protein antagonist are provided. Pharmaceutically acceptable formulations are provided that comprise a VEGF ‘trap’ antagonist with a pharmaceutically acceptable carrier. In specific embodiments, liquid and lyophilized formulations are provided.”), [0006] (“In a first aspect, a stable liquid ophthalmic formulation of a VEGF-specific fusion protein antagonist is provided, comprising a fusion protein that comprises a receptor component consisting essentially of an immunoglobulin-like (Ig) domain 2 of a first VEGF receptor and Ig domain 3 of a second VEGF receptor, and a multimerizing component (also termed a ‘VEGF trap’).”). The ’631 patent states that aflibercept is a non-antibody VEGF-antagonist. Ex. 1001 at 6:36-40.

B. Claim 13

227. Claim 13 recites “[a] pre-filled syringe according to claim 12, wherein the non-antibody VEGF antagonist is aflibercept at a concentration of 40 mg/mL.”

228. Furfine discloses a VEGF-antagonist at a concentration of 40 mg/mL. Ex. 1021 at [0013] (“In a specific preferred embodiment, the stable liquid ophthalmic formulation comprises about 40 mg/mL of the VEGF-antagonist (SEQ ID NO:4), 10 mM sodium phosphate buffer, 40mM sodium chloride, 0.03% polysorbate, and 5% sucrose, pH about 6.2-6.3.”); [0059] (“Stability of 40 mg/mL

VEGF Trap Liquid Formulation Stored at 5°C in Pre-Filled Glass Syringe”). It would have been obvious to a POSITA to use aflibercept at a concentration of 40 mg/mL. *See* Ex. 1040.006 (disclosing approved 40 mg/mL Eylea formulation in vial form).

XI. Petition 2, Ground 1: Lam in View of Reuter Renders Obvious Claims 1-10 and 14-23

229. As set forth in detail below, claims 1-10 and 14-23 of the '631 patent are separately rendered obvious by Lam in view of Reuter. The discussion below specifies where each element of the aforementioned claims is found in the applied references, and includes a detailed explanation of the significance of the quotations and citations from the applied references.

A. Motivation to Combine Lam and Reuter

1. Silicone Oil and Break Loose / Slide Forces

230. As detailed in **Section VII.B**, Lam teaches a pre-filled terminally sterilized glass syringe for intravitreal injection. Because the pre-filled syringe of Lam contained a VEGF-antagonist solution, which is a protein formulation (also loosely referred to in the art as biologics, biotechnology products, etc.), a POSITA would have been motivated to minimize the amount of silicone oil used in the syringe barrel in order to reduce or avoid the negative interactions that were known to occur between silicone oil and protein formulations. *See* Ex. 1013.004 (“One particularly common problem has been that [biotechnology formulations] can react

with the oily form of silicone, which is used as a lubricant to coat the sliding components of the syringe.”).

231. A POSITA would be further motivated to lower the amount of silicone oil, because pre-filled syringes are both “containers and drug delivery systems at the same time,” Ex. 1012.006, and therefore the silicone oil in the syringe would be in contact with the protein formulation for an extended period of time, which would heighten the stability concerns. As such, a POSITA would look to avoid higher levels of silicone oil in pre-filled syringes containing sensitive protein formulations such as VEGF antagonists, because of potential “incompatibilities includ[ing] aggregation, deformation, and inactivation of native protein structures.” Ex. 1012.006.

232. Moreover, it was known that silicone oil “can flow away from the inner surface [of a syringe barrel] and pass into the container’s content,” Ex. 1014 at [0024], and such “[d]etachment of silicone oil in water-filled syringes is possible and can result in particulate matter and clouding phenomenon.” Ex. 1015.330. Thus, a POSITA would be especially motivated to lower the amount of silicone oil used in pre-filled syringes for intravitreal injection to avoid injecting silicone oil into the eye, which could cause floaters and/or an increase in intra-ocular pressure. *See, e.g.*, Ex. 1025.011 (“silicone contaminants, when injected into the vitreous cavity at the time of anti-VEGF injections, could cause persistent elevations in [intraocular

pressure]”); Ex. 1001 at 4:50-55 (“However, for ophthalmic use, it is desirable to decrease the likelihood of silicone oil droplets being injected into the eye. With multiple injections, the amount of silicone droplets can build up in the eye, causing potential adverse effects, including ‘floaters’ and an increase in intra-ocular pressure.”); Ex. 1015.036 (explaining the precautions necessary for intravitreal administration). Thus, a POSITA would have looked to reduce or minimize the amount of silicone oil used in the pre-filled syringe of Lam by using the teachings of Reuter, which disclose baked-on siliconization of a pre-filled syringe, resulting in syringes comprising lower silicone levels.

233. Reuter teaches that it was generally known in the art that “the main objective in siliconization is to achieve the most homogenous possible coating with the minimum possible quantity of silicone oil.” Ex. 1010.004. “Sub-visual silicone oil particles are thought to promote protein aggregation which can increase the severity of immune responses and reduce the drug’s tolerability.” *Id.* Thus, a POSITA would have looked to Reuter because it discloses that “[b]aked-on siliconization reduces the measurable quantity of free silicone oil to approx. 10 % of the normal value. As a result, there are fewer sub-visual and visual silicone oil particles in the solution. This siliconization process is therefore recommended for use with sensitive protein formulations. It is also advantageous for ophthalmological

preparations which are associated with very stringent requirements as regards particle contamination.” *Id.* at .005.

234. Moreover, a POSITA would have been motivated to employ the baked-on syringes disclosed in Reuter because those syringes retain their lubricating effect while using approximately one-tenth the amount of silicone oil in comparison to the sprayed-on syringes. Ex. 1014 at [0026] (baked-on siliconization, “(i) is more precise and more homogenous than [sic] a simple standard siliconizing operation; and (ii) makes it possible to reduce the amount of silicone that is used...by about a factor of 10 without any loss of lubricating effect”); Ex. 1012.006-007 (reporting that baked-on siliconized syringes having “low levels” of silicone oil that reduce “[t]he amount of extractable silicone oil . . . below the detection limit (0.03 mg [*i.e.*, 30 µg])”) while maintaining syringe functionality, with “plunger gliding forces in the range of 5 to 10 N”).

235. Baked-on siliconization as disclosed in Reuter was also known to be specifically advantageous to protein formulations (such as VEGF-antagonist solutions) because the baking attaches the silicone oil to the inner surface of the syringe barrel, which reduces the amount of “residual” or “free” silicone oil that can enter the protein formulation and cause negative interactions. *See* Ex. 1011.004 (“Baked Silicone: Binding the silicone to the glass barrel through a proprietary technology reduces the level of free silicone. This is a clear benefit for silicone-

sensitive drugs.”); Ex. 1010.005 (“Baked-on siliconization reduces the measurable quantity of free silicone oil to approx. 10% of the normal value.”); Ex. 1015.330 (“Recent developments to minimize free silicone include baking silicone at high heat onto the glass barrels, thereby minimizing the amount of free silicone that can interact with drug product.”). Thus, it was known that “the baked-on silicone process was better suited for protein formulation development in PFS as it represented a lesser degree of risk for the formation of subvisible particulate matter as well as minimized any potential for protein precipitation on the Si-oil droplets.” Ex. 1044.006.

236. Additionally, it was known that the baked-on process could reduce the incidence of the break-loose effect, as described in **Section V.D.2** above, because the baked-on process results in a more homogeneous coating of silicone oil on the inside of the barrel. Ex. 1012.006 (in baked on siliconization the “[r]emoval of water enables the lubricant to spread out evenly over the glass surface and creates a thin, uniform film”); Ex. 1013.004 (“The second benefit of baked-on silicone is that it reduces the frequency of the ‘break loose’ effect.”). Thus, with baked-on siliconization, “[l]ubrication is maintained so that the initial force required to inject using prefilled syringes with baked-on silicone remains consistently low before and after storage.” *Id.* As would have been readily understood by a POSITA, reducing the break loose effect is generally desirable in a pre-filled syringe, but is particularly

relevant for intravitreal administration on account of the potential damage that can occur in the eye. *See, e.g.*, Ex. 1015.358 (“Moreover gliding forces must be continuous, or without increases and decreases. Should the movement be ‘interrupted,’ then one speaks of shattering of the syringe.”).

237. A POSITA would have a reasonable expectation that the combination of Lam with Reuter would result in a terminally sterilized, low volume, pre-filled glass syringe having an amount of silicone oil and break loose and slide forces falling within the ranges claimed in the '631 patent. As explained below with respect to limitations [1.e] and [1.g], a POSITA would understand that the baked-on syringe disclosed in Reuter would have low amounts of silicone oil falling with the claimed ranges and break loose and slide forces that also fall within the claimed ranges. This is consistent with other prior art that discloses that baked-on siliconization results in 40 to 100 μg of silicone oil for a 0.5 – 1 mL syringe without any loss in lubricating effect. Ex. 1014 at [0026] (discloses that baked-on siliconization “makes it possible to reduce the amount of silicone that is used (that is, loaded on the inner surface of the container) by about a factor of 10 without any loss in lubricating effect” and that a “0.5-1 mL syringe reservoir” includes “from 40 to 100 μg of silicone.”).

238. A POSITA would understand that the syringe stopper forces in Reuter would remain substantially the same even when a VEGF-antagonist such as

ranibizumab is contained in the syringe rather than, for example, the empty syringe of Reuter, because the viscosity of the fluid does not affect the break loose force.

239. While the viscosity of the solution does affect the slide force, the viscosity of a VEGF-antagonist solution such as ranibizumab (1.3 cp) will not add a significant amount to the slide force. As explained further below, a POSITA would be able to calculate the additional slide force required to expel a VEGF-antagonist solution based on its viscosity, the size of the needle, and the injection speed. Such a calculation would show that the additional force required to expel, for example, a ranibizumab solution (1.3 cp), would be at most approximately 2 N, resulting in a total slide force of 3.7 N or 2.5 N, which is still below 5 N.

240. Additionally, a POSITA would not expect any incompatibility between baked-on siliconization as taught by Reuter and EtO terminal sterilization disclosed in Lam. In fact, Lam teaches a POSITA that the EtO technique is broadly applicable to pre-filled syringes. Ex. 1029 at 2:7-9, 2:29 (“In one aspect, the invention provides a method for surface-sterilizing an object having an ethylene-oxide (EtO)-impermeable interior space containing a compound with a temperature-sensitive and EtO-sensitive activity In some embodiments, the object is a syringe.”). It would be expected that the pre-filled syringes of Lam contained some silicone oil lubricant, and thus the terminal sterilization being applied was done to a siliconized syringe. Reuter discloses using baked-on siliconization, which creates “a permanent

hydrophobic layer” such that “part of the silicone oil cannot be removed [from the syringe barrel surface] with solvent.” Ex. 1010.005. Maintaining such a layer of silicone oil within the barrel ensures the maintenance of a tight seal between the barrel and the stopper during sterilization. *See* Ex. 1015.330 (silicone oil in syringes provides “sealability”). U.S. Patent No. 7,404,278 to Wittland et al. (Ex. 1026) describes the process of applying a silicone emulsion to a pre-fillable syringe body, followed by fixing the silicone oil via heat (baking on the silicone oil), wherein the syringe body is then sterilized “in particular with gas, for example ethylene oxide (ETO).” Ex. 1026 at 3:52-65, 4:16-19. Thus, a POSITA would have understood that baked-on siliconization disclosed in Reuter is compatible with the EtO sterilization disclosed in Lam. In particular, a POSITA would have understood that the sterilization method taught in Lam would not impact the silicone levels or operation forces of Reuter’s syringe because the interior of the syringe would be sealed from the sterilizing agent, as described in Lam and as is understood in the art. *See* Ex. 1029.003 (“In one aspect, the invention provides a method for surface-sterilizing an object having an ethylene-oxide (EtO)-impermeable interior space....”)

2. Particulate Content

241. Lam discloses a pre-filled syringe that includes a VEGF-antagonist, such as ranibizumab, for intravitreal injection. When making a pre-filled syringe

including a VEGF-antagonist for intravitreal injection, a POSITA would have been aware of and motivated to comply with USP789, which is prior art and sets forth particulate content requirements for ophthalmic solutions. Those particulate content requirements from USP789 were directly copied into the claims of the '631 patent. In order to achieve regulatory compliance and approval, which is ultimately the goal for most if not all pharmaceutical formulations, a POSITA would have understood that compliance with USP789 was highly desirable if not mandatory.

242. A POSITA would have had a reasonable expectation of success that the combination of Lam with Reuter would result in a pre-filled syringe containing a VEGF-antagonist for intravitreal injection that meets the particulate matter requirements of USP789. A POSITA would understand that the ophthalmic ranibizumab solution disclosed in Lam should meet the USP789 requirements. The '631 Patent provides no information regarding how a VEGF-antagonist solution is prepared, such that it complies with the USP789 requirements, thus conceding such a preparation would have been known to a POSITA. Furthermore, a POSITA would understand that ophthalmic solutions of VEGF-antagonists were already known in the art—*i.e.*, Macugen, Lucentis, and Eylea—and that the methods of preparing these solutions such that they meet the requirements of USP789 would be known to one of ordinary skill in the art.

243. With respect to meeting the requirements of USP789, the '631 patent states only that "the syringe has low levels of silicone oil sufficient for the syringe to meet USP789." Ex. 1001 at 6:28-30. As explained above, Reuter discloses a syringe siliconized using baked-on siliconization that has low levels of silicone oil falling within the ranges claimed in the '631 patent. In addition, Reuter discloses that baked-on siliconization is "advantageous for ophthalmological preparations which are associated with very stringent requirements as regards particle contamination." Ex. 1010.005. A POSITA would have understood this reference to particle contamination requirements in Reuter to include USP789. Accordingly, a POSITA would have expected that the combination of Lam with Reuter would result in a pre-filled syringe meeting the particulate content requirements of USP789.

B. Claim 1

1. [1.a] A pre-filled, terminally sterilized syringe for intravitreal injection

244. Lam discloses terminal sterilization of pre-filled syringes containing sensitive biologic drug products for intravitreal injection:

The invention is based, in part, on the surprising discovery of ethylene-oxide-based sterilization conditions that will effectively sterilize the surface of an object but which do not significantly damage ethylene-oxide-sensitive, temperature-sensitive compounds contained inside.

In some embodiments, the object is a syringe.

In some embodiments, the compound is present in an aqueous pharmaceutical composition.

In some embodiments, the pharmaceutical composition is designed for intraocular injection.

In some embodiments, the compound is a polypeptide, *e.g.* an antibody, In some embodiments, the antibody is an antigen-binding fragment, *e.g.* a Fab fragment. In some embodiments, the Fab fragment binds VEGF, *e.g.* ranibizumab (LUCENTIS®).

Ex. 1029 at 2:4-6, 2:29, 11:30-31, 2:18-24. A syringe filled with ranibizumab is tested in the Example of Lam. Ex. 1029 at 13:14-15 (“We performed EtO sterilization runs on syringes containing a ranibizumab solution.”).

245. Reuter discloses the siliconization of pre-filled syringes. Ex. 1010.002 (“The siliconization of the syringe barrel is an extremely important aspect of the production of sterile, prefillable glass syringes because the functional interaction of the glass barrel siliconization and the plunger stopper siliconization is crucial to the efficiency of the entire system.”) Reuter also describes the baked-on siliconization methods as relevant to ophthalmological preparations, which a POSITA would understand to include intravitreal injections. *Id.* at 005 (“It is also advantageous for ophthalmological preparations which are associated with very stringent requirements as regards particle contamination.”).

2. [1.b] the syringe comprising a glass body forming a barrel, a stopper and a plunger

246. Lam discloses that the pre-filled syringe has a glass barrel, stopper, and plunger. Ex. 1029 at 2:29-33 (“In some embodiments, the object is a syringe. In some embodiments the syringe comprises glass and comprises a stopper comprising D777-7 laminated with FluroTec®; and a tip cap comprising D777-7 laminated with FluroTec® or D21-7H laminated with FluroTec®.”); *id.* at 15:12-14 (“We also tested several different syringe components: where the stopper on the plunger comprised D777-7 laminated with a 125 μm coating of FluroTec® barrier film. . .”).

247. In addition, as explained above in ¶ 121, it would have been obvious to a POSITA to use glass barrels where the syringe contains ranibizumab, as disclosed in the Example in Lam.

248. Reuter likewise describes a syringe comprising a glass body forming a barrel, and a plunger-stopper. Ex. 1010.002 (“The siliconization of the syringe barrel is an extremely important aspect of the production of sterile, prefillable glass syringes because the functional interaction of the glass barrel siliconization and the plunger stopper siliconization is crucial to the efficiency of the entire system”). Reuter illustrates such a syringe, for example, in Figure 3:

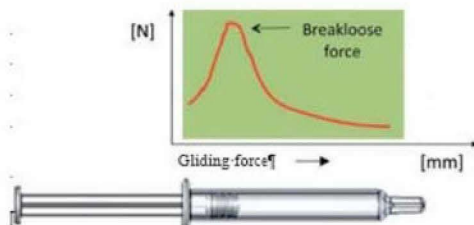

Fig. 3: Extrusion force profile of a prefillable syringe.

Ex. 1010.004 (Fig. 3)

3. [1.c] and containing an ophthalmic solution which comprises a VEGF-antagonist, wherein:

249. Lam discloses an embodiment in which the pre-filled syringe contains an ophthalmic solution comprising the VEGF-antagonist ranibizumab:

We performed EtO sterilization runs on syringes containing a ranibizumab solution . . .

In some embodiments, the compound is a polypeptide, *e.g.* an antibody, In some embodiments, the antibody is an antigen-binding fragment, *e.g.* a Fab fragment. In some embodiments, the Fab fragment binds VEGF, *e.g.* ranibizumab (LUCENTIS®).

Ex. 1029 at 13:14-15, 2:18-24.

250. As explained in **Section VII.D**, above, Reuter also discloses that the baked-on siliconization methods disclosed therein are advantageous for ophthalmological preparations. Ex. 1010.005 (“It is also advantageous for ophthalmological preparations which are associated with very stringent requirements as regards particle contamination.”).

4. [1.d] the syringe has a nominal maximum fill volume of between about 0.5 mL and about 1 mL

251. Although Lam does not specify the maximum fill volume of the syringe containing ranibizumab, it would have been obvious to a POSITA that a small volume syringe in the 0.5-1 mL range would be used for intravitreal injection, including for example, injection of ranibizumab, since the amount of fluid capable of being injected into the eye is limited. *See* Ex. 1015.017 (administration volume for intravitreal injection is “generally < 0.1 mL”); *see* Ex. 1021 at [0059], [0061] (disclosing 1 mL prefilled glass syringe for VEGF-antagonist); Ex.1062.009 (disclosing that Macugen is provided in a 1 mL glass syringe).

252. Reuter also discloses a 1 mL long syringe. Ex. 1010.004 (“Studies on 1 mL long syringes have revealed considerable potential for reducing the amount of silicone oil required.”).

5. [1.e] the syringe barrel comprises from about 1 µg to 100 µg silicone oil

253. Reuter discloses two force curves for a “standard 1 mL long syringe” using 800 µg and 500 µg of silicone oil, respectively, where the respective mean (*i.e.*, average) break loose forces were reported to be 2.5 N and 1.7 N, and the respective mean glide forces were 1.7 N and 0.5 N. Ex. 1010.004-005. The forces curves from that Reuter study are reproduced below.

Fig. 4: Comparison of extrusion force profiles diving nozzle vs. fixed nozzle.

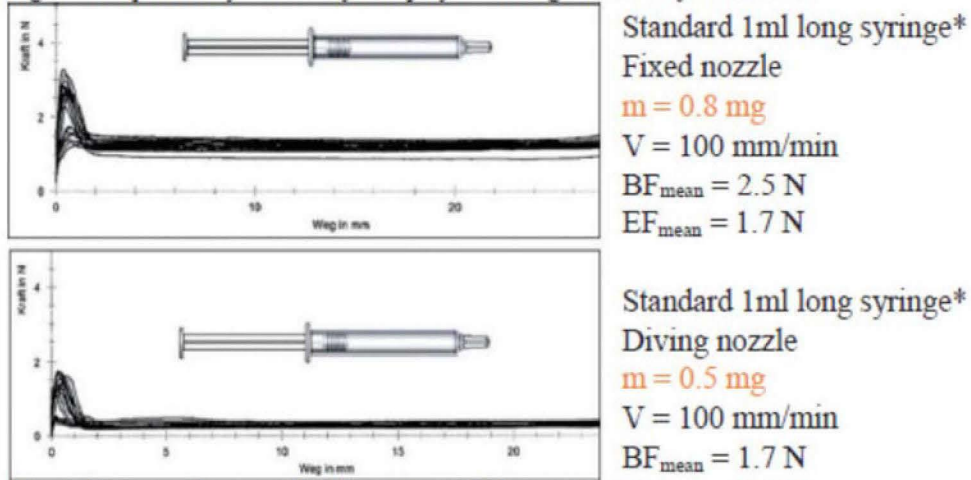

Fig. 5: Extrusion force profile after optimized siliconization.

* Empty syringes

Ex. 1010.005 (Fig. 5)

254. Reuter teaches that baked-on siliconization can be used to greatly reduce the amount of silicone oil in the syringe barrel. Specifically, Reuter teaches that baked-on siliconization could be used to achieve an “extremely thin layer of silicone,” which “in conjunction with the low quantity of silicone oil used in the emulsion minimizes free silicone in the syringe and ensures that the required quality of finish is achieved.” *Id.* at 005. Reuter discloses that the amount of silicone oil used in baked-on siliconization in terms of the silicone layer thickness: “The layer thickness measures 15–50 nm. By comparison, the average layer thickness with oily siliconization is 500–1,000 nm.” *Id.* Based on the thickness, a POSITA would readily be able to obtain the amount of silicone oil per unit area of syringe barrel inner surface (i.e., the surface density), using the known density of the silicone oil

within the DC 365 emulsion.¹⁰ The surface density of the silicone oil being applied is equal to the layer thickness of silicone oil times the density of the silicone oil itself, which is 0.97 g/cm³.

$$\begin{aligned}
 \text{Surface density} &= (50 \text{ nm}) * (0.97 \text{ g/cm}^3) \\
 &= (50 \text{ nm}) * (0.97 \text{ g/cm}^3) * (1 \text{ cm}/10^7 \text{ nm}) * (10^6 \text{ } \mu\text{g/g}) \\
 &= (50 \text{ nm}) * (0.97 \text{ g/cm}^3 \text{ cm}^2) * (1 \text{ cm}/10^7 \text{ nm}) * (10^6 \text{ } \mu\text{g/g}) \\
 &= (50 * 0.97 / 10) \text{ } \mu\text{g/cm}^2 \\
 &= 4.85 \text{ } \mu\text{g/cm}^2
 \end{aligned}$$

255. As explained above in **Section VIII.B.4**, the surface area of a 1 mL standard syringe barrel is 9.70 cm² and the surface area of a 1 mL long syringe barrel is 10.77 cm², such that the total amounts of silicone oil are 47.0 μg and 52.2 μg, respectively. Thus, at the high end of the 15-50 nm thickness range recited in Reuter, the syringe barrel comprises between 47.0 μg and 52.2 μg (i.e., around 50 μg) which is well less than the 100 μg of silicone oil recited in claim 1 of the '631 patent for a 1 mL syringe.

¹⁰ This calculation assumes that substantially all the water from the emulsion is vaporized during the baking process, and what remains coating the syringe barrel is only the silicone oil from the emulsion, which is *Dow Corning 360 Medical Fluid*, 350 cSt, having a density of 0.971 g/cm³. The density of the DC 365 emulsion itself is 0.99 g/cm³, which would therefore lead to a substantially similar calculation and result even if the water from the emulsion is not vaporized.

256. Thus, it would have been obvious to a POSITA to apply the baked-on siliconization process disclosed in Reuter to the 1 mL glass syringe tested in Reuter to achieve lower levels of silicone oil in the barrel while maintaining similar low operable syringe stopper forces. Because Reuter teaches that for the 1 mL syringe tested, 500 μg of silicone oil provided break loose forces of 1.7 N, and a glide force of about 0.5 N, a POSITA would understand that applying the baked-on siliconization process of Reuter would result in similarly operable low forces, which are far below the level claimed in the '631 patent, while using about 10% of the 500 μg of silicone oil, which is about 50 μg silicone oil, consistent with the calculation in the previous paragraphs. Ex. 1010.004-005; *see also* Ex. 1014 at [0026]. The analysis would be the same if a POSITA were to use the 1 mL syringe tested in Reuter which had 800 μg of silicone oil, which would result in similar low operable forces with low silicone oil levels (~ 80 μg) within the claimed range.

6. [1.f] the VEGF-antagonist solution comprises no more than 2 particles >50 μm in diameter per mL

257. It would be obvious to a POSITA that the combination of Lam and Reuter would result in a pre-filled syringe comprising a VEGF-antagonist solution with no more than 2 particles > 50 μm in diameter per mL.

258. Lam discloses a pre-filled syringe containing a solution of ranibizumab intended for intravitreal injection. Ex. 1029 at 13:14-15 (“We performed EtO sterilization runs on syringes containing a ranibizumab solution.”), 2:4-6 (“The

invention is based, in part, on the surprising discovery of ethylene-oxide -based sterilization conditions that will effectively sterilize the surface of an object but which do not significantly damage ethylene-oxide-sensitive, temperature-sensitive compounds contained inside.”). Reuter discloses that the baked-on siliconization method disclosed is “advantageous for ophthalmological preparations which are associated with very stringent requirements as regards particle contamination.” Ex. 1010.005. A POSITA would understand this reference to particle contamination requirements in Reuter to include USP789.

259. As explained in **Section V.F** above, a POSITA would understand that “no more than 2 particles $>50 \mu\text{m}$ in diameter per mL” is one of the USP789 standards required for ophthalmic drugs such a VEGF-antagonist solution intended for intravitreal use. *See* Ex. 1017 at 10:19-22 (“United States Pharmacopoeia (USP) Chapters <788> *Particulate Matter in Injections* and <789> *Particulate Matter in Ophthalmic Solution* describe physical tests for the purpose of enumerating extraneous particles within specific size ranges.”). Specifically, a POSITA would know that a VEGF-antagonist solution for intravitreal administration would need to comply with USP789 for regulatory approval and thus it would need to meet the microscopic particle count test as set forth in USP789 which requires no more than 2 particles of diameter $\geq 50 \mu\text{m}$ per mL. Meeting that requirement would be a matter of routine optimization. A POSITA would understand that ophthalmic

solutions of VEGF-antagonists were already known in the art—i.e., Macugen, Lucentis, and Eylea—and that preparing these solutions such that they meet the requirements of USP789 would be within the level of ordinary skill in the art.

260. A POSITA would have a reasonable expectation that the combination of Lam (VEGF-antagonist in pre-filled syringe) with Reuter (pre-filled baked-on syringe with low silicone) would satisfy the USP789 particulate matter limitations. A POSITA would understand that the ophthalmic solution disclosed in Lam is required to meet USP789, as I described above. The '631 patent does not explain how to achieve a solution that meets USP789 (*see* Ex. 1001 at 6:28-30), and thus concedes that preparation of such a solution was known to a POSITA. Moreover, Reuter discloses a syringe siliconized using baked-on siliconization that has low levels of silicone oil falling within the ranges claimed in the '631 patent. Accordingly, a POSITA would have expected that the combination of Reuter and Lam would result in a pre-filled syringe meeting the particulate content requirements of USP789, given that baked-on siliconization reduces the risk for the formulation of particulate matter. Ex. 1010.005 (“As a result, there are fewer sub-visual and visual silicone oil particles in the solution. The [baked-on] siliconization process is therefore recommended for use with sensitive protein formulations. It is also advantageous for ophthalmological preparations which are associated with very stringent requirements as regards particle contamination.”); Ex. 1044.006

(“Overall data suggested that the baked-on silicone process was better suited for protein formulation development in PFS as it represented a lesser degree of risk for the formation of subvisible particulate matter as well as minimized any potential for protein precipitation on the Si-oil droplets.”).

7. [1.g] and wherein the syringe has a stopper break loose force of less than about 11N.

261. As explained above, Reuter discloses low break loose and slide forces using oily siliconization in a 1 mL long syringe with 800 μg and 500 μg of silicone oil, respectively, where the respective break loose forces were reported to be 2.5 N and 1.7 N, and the respective glide forces were 1.7 N and 0.5 N. Ex. 1010.004-005 (Fig. 5).

262. A POSITA at the time would have been well aware that the application of baked-on siliconization uses about 10% or less of the amount of silicone oil as used in oily siliconization, while still maintaining similarly low operable forces. *See, e.g.*, Ex. 1014 at [0026] (baked-on siliconization “makes it possible to reduce the amount of silicone that is used ... by about a factor of 10 without any loss of lubricating effect.”). Thus, because Reuter discloses the specific break loose and slide forces achieved with the oily siliconized 1 mL glass syringe tested, a POSITA would know that the baked-on process would produce the same or similarly low syringe stopper forces in the same syringe, that fall within the claimed ranges. Figure 7 of Reuter confirms that the break loose and slide forces for the baked-on

syringe are essentially the same as the oily syringe (except that the break loose force of the baked-on syringe is better after storage). Accordingly, a POSITA would understand that the break loose force for the baked-on syringe is less than 11 N.

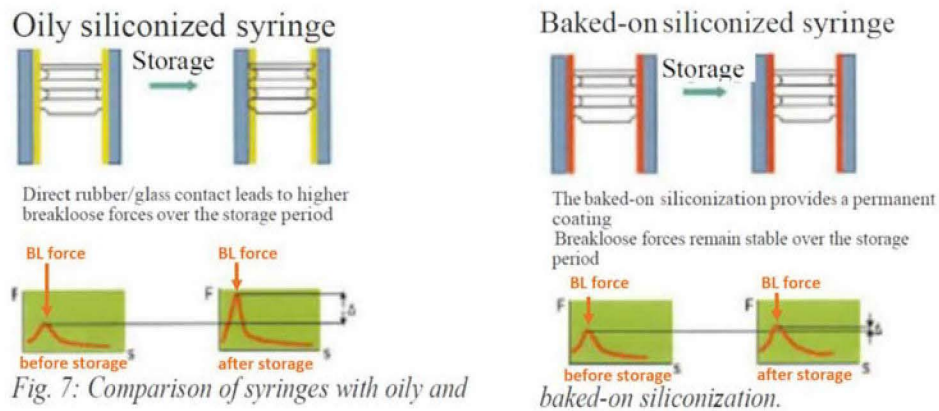

Ex. 1010.006 (Fig. 7) (annotations in orange)

263. Additionally, as explained in ¶ 238 above, a POSITA would understand that the break loose forces disclosed in Figure 5 of Reuter would remain substantially the same even when a VEGF-antagonist such as ranibizumab is contained in the syringe because the viscosity of the fluid in the syringe does not affect the break loose force. Specifically, as explained in Section V.C above, because the break loose force is the force required to get the stopper to just about begin moving, and because the force is between the stopper and barrel and therefore a function of siliconization, and stopper material and coating, the measured break loose force is largely independent of the viscosity of the fluid within the pre-filled syringe.

C. Claims 2-10 and 14-24

264. The limitations of claims 2-10, and 14-24 are likewise disclosed and rendered obvious by Lam in view of Reuter.

1. Claim 2

265. Claim 2 recites “[a] pre-filled syringe according to claim 1, wherein the syringe barrel has an internal coating of silicone oil that has an average thickness of about 450 nm or less.”

266. Reuter discloses that the layer thickness for a syringe with baked-on siliconization is 15-50 nm. Ex. 1010.005 (“The layer thickness measures 15-50 nm. By comparison, the average layer thickness with oily siliconization is 500-1,000 nm. Baked-on siliconization reduces the measurable quantity of free silicone oil to approx. 10% of the normal value.”). According to Reuter, the typical thickness of a baked-on silicone oil layer is 15-50 nm (as opposed to the average layer thickness with oily siliconization is 500-1,000 nm) and another prior art source gives an estimate of 76.83 nm (as opposed to 232.67 nm). *See Id.* at .005; Ex. 1012.006. Reuter not only discloses a pre-filled syringe with silicone oil that has an average thickness of less than 450nm, but also teaches a silicone oil layer thickness known to be typical for baked-on silicone oil syringes.

2. Claims 3 and 22

267. Claim 3 recites “[a] pre-filled syringe according to claim 1, wherein the syringe barrel has an internal coating of from about 3 µg to about 100 µg silicone

oil.” Claim 22 recites “[a] pre-filled syringe according to claim 1, wherein the syringe barrel has an internal coating of from about 1-50 μg silicone oil.”

268. As explained above with regard to limitation [1.e], it would have been obvious for a POSITA to apply the baked-on siliconization process of Reuter to achieve a pre-filled glass syringe containing about 10% of silicone oil as compared to oily siliconization, which is about 50 μg or less for a 1 mL long syringe. Ex. 1010.005. A value of 50 μg or less silicone oil is consistent with other prior art, which discloses values from 40 to 100 μg silicone oil for a 0.5-1 mL baked-on syringe with an inner surface area of approximately 8 cm^2 . Ex. 1014 at [0026] (“40 to 100 μg of silicone are sufficient for the same [0.5-1 mL] syringe (about 5 to 12 $\mu\text{g}/\text{cm}^2$) if silicone is deposited on the inner surfaces of the container and then polymerized, for example by heating”).

3. Claims 4, 10, and 23

269. Dependent claims 4 and 23 depend from claim 1, and require that the silicone oil is DC365 emulsion or that the silicone oil has a viscosity of about 350 cP. Dependent claim 10, depends from claim 8 and requires silicone oil with a viscosity of about 350 cP and further recites particulate content requirements from USP789.

4. A pre-filled syringe according to claim 1, wherein the silicone oil is DC365 emulsion.

10. A pre-filled syringe according to claim 8, wherein the silicone oil has a viscosity of about 350 cP, and the VEGF antagonist solution further comprises one or more of (i) no more than 5 particles $\geq 25 \mu\text{m}$ in diameter per ml, and (ii) no more than 50 particles $\geq 10 \mu\text{m}$ in diameter per ml.

23. A pre-filled syringe according to claim 1, wherein the silicone oil has a viscosity of about 350 cP.

270. Reuter specifically discloses that DC365 silicone oil emulsion was known to be used in the baked-on siliconization process. Ex. 1010.003 (“The DOW CORNING® 365 siliconization emulsion is often used in the baked-on siliconization process”). The viscosity of DC365 is 350 cP. Ex. 1034.002.

271. As explained in **Section V.F**, a POSITA would understand that “(i) no more than 5 particles $\geq 25 \mu\text{m}$ in diameter per ml, and (ii) no more than 50 particles $\geq 10 \mu\text{m}$ in diameter per ml” are requirements set forth in USP789. My analysis above in **Section XI.A.2** and **Section XI.B.6** demonstrates that it would be obvious to a POSITA that the combination of Lam and Reuter would meet the requirements of USP789.

4. Claims 5 and 6

272. Claim 5 recites “[a] pre-filled syringe according to claim 1, wherein the VEGF antagonist solution further comprises one or more of (i) no more than 5 particles $\geq 25 \mu\text{m}$ in diameter per ml, and (ii) no more than 50 particles $\geq 10 \mu\text{m}$ in

diameter per ml.” Claim 6 recites “[a] pre-filled syringe according to claim 1, wherein the VEGF-antagonist solution meets USP789.”

273. As explained above in **Section V.F**, a POSITA would understand that “(i) no more than 5 particles ≥ 25 μm in diameter per ml, and (ii) no more than 50 particles ≥ 10 μm in diameter per ml” are USP789 requirements. My analysis above in **Section XI.A.2** and **Section XI.B.6** demonstrates that it would be obvious to a POSITA that the combination of Lam and Reuter would meet the requirements of USP789.

5. Claims 7, 8, and 9

274. Claim 7 recites “[a] pre-filled syringe according to claim 1, wherein the VEGF antagonist is an anti-VEGF antibody.” Claim 8 recites “[a] pre-filled syringe according to claim 7, wherein the anti-VEGF antibody is ranibizumab.” Claim 9 recites “[a] pre-filled syringe according to claim 8, wherein the ranibizumab is at a concentration of 10 mg/ml.”

275. Lam discloses a pre-filled syringe containing ranibizumab, which the '631 patent characterizes as an antibody VEGF antagonist. Ex. 1029 at 13:14-15 (“We performed EtO sterilization runs on syringes containing a ranibizumab solution.”); Ex. 1001 at 6:30-35 (“Two antibody VEGF antagonists have been approved for human use, namely ranibizumab (Lucentis®) and bevacizumab (Avastin®).”). Lam also discloses that the ranibizumab protein concentration is 10.0

mg/mL for the additional conditions tested and summarized in Table 3. Ex. 1029 at 15:2-3 (“We performed EtO sterilization runs on syringes containing a ranibizumab solution (at 10.0 mg/mL . . .”).

6. Claims 14 and 16

276. Claim 14 recites “[a] pre-filled syringe according to claim 1, wherein the syringe has a stopper break loose force of less than about 5N, and wherein the syringe has a stopper slide force of less than about 5N.” Claim 16 recites “[a] pre-filled syringe according to claim 1, wherein the syringe has a stopper slide force of less than about 11N.”

277. My analysis above in **Section XI.B.7** with respect to limitation [1.g] explains how the break loose and slide forces for a baked-on syringe would be less than 5 N.

278. As explained above, Reuter measures the slide force in empty, needleless syringes at 100 mm/min, a relatively slow speed, and finds a mean slide force of 0.5 N for 1 mL long syringes with 500 µg of silicone oil applied via oily siliconization methods. Ex. 1010.005 at Figure 5. This slide force would be almost entirely comprised of the frictional force between the stopper and the barrel, with little contribution from the forces required to expel fluid (air) from the syringe through the luer tip, which is considerably wider than a needle. The additional force needed to push a ranibizumab formula, with a viscosity of 1.3 cP, even if done

through a half inch 30G needle at 190 mm/s, for example, can be calculated using the Hagen-Poiseuille formula, introduced above in **Section VIII.C.6**, as approximately 2 N. This, added to the friction force of 0.5 N in Figure 5 of Reuter, is 2.5 N. Given that Reuter explains that baked on siliconization allows for the same forces at a tenth of the amount of silicone oil, it would be obvious to a POSITA that a pre-filled syringe meeting the limitations of claim 14 and 16 would have a slide force of less than 5 N.

7. Claim 15

279. Claim 15 recites “[a] pre-filled syringe according to claim 14, wherein the stopper break loose force or stopper slide force is measured using a filled syringe, at a stopper travelling speed of 190 mm/min, with a 30 G×0.5 inch needle attached to the syringe.”

280. Figure 5 of Reuter shows force curves for a “standard 1 ml long syringe” where the respective break loose forces using oily siliconization were reported to be 2.5 N and 1.7 N, and the respective glide forces were 1.7 N and 0.5 N. Ex. 1010.005. As explained above in **Section XI.B.7**, Figure 7 of Reuter confirms that the break loose and slide forces for the lower silicone baked-on syringe are essentially the same as the oily syringe (except that the break loose force of the baked-on syringe is better after storage).

281. The viscosity of the solution, needle type, and stopper traveling speed are irrelevant to break loose force, and only impact the slide force. As explained above in **Section V.C**, the magnitude of the break loose force is largely attributable to the ageing of the stopper within the syringe, which becomes sticky with age and forms a tight seal against the barrel. The tighter seal results in a higher force required to initially displace the stopper, which is the break loose force. Because the break loose force is between the stopper and the inside of the barrel, and is the force required to get the stopper to just about begin moving, the break loose force is largely unaffected by the viscosity of the fluid in the pre-filled syringe or other factors that impact the slide force, such as needle size and stopper traveling speed.

282. Because VEGF antagonists such as ranibizumab are intended for intravitreal injection into the eye, it would have been obvious to a POSITA to use a thin needle of higher gauge, such as a 30 G needle, for such an application. A needle length of 0.5 inches would also have been obvious to use because of the shallow depth of intravitreal injection. For example, the Macugen pre-filled syringe used a 30 G, 0.5 inch needle. *See* Ex. 1009.007. A POSITA would understand that the selection of needle size would have been routine optimization well within ordinary skill.

283. Because the break loose force is a measure of force required for initial movement only, it is unaffected by the stopper traveling speed or needle type, as

explained above. As such, break loose force in Reuter will remain the same if measured at a stopper speed of 190 mm/min, and with a 30 G x 0.5 inch needle, as required by claim 15. Thus, claim 15 is rendered obvious by Lam in view of Reuter because: (i) it would be obvious to a POSITA to utilize a 30 G x 0.5 inch needle with a pre-filled syringe containing a VEGF-antagonist for intravitreal injection; and (ii) it would be obvious to a POSITA that the break loose forces disclosed in Reuter would be maintained at less than 5 N when using the baked on siliconization technique, when measured using a stopper traveling speed of 190 mm/min and a 30 G x 0.5 inch needle.

284. As explained above, Reuter measures the slide force in empty, needleless syringes at 100 mm/min, at relatively slow speed, and finds a mean slide force of 0.5 N for 1 mL long syringes with 500 μ g of silicone oil applied via oily siliconization methods. Ex. 1010.005 at Figure 5. This slide force would be almost entirely comprised of the frictional force between the stopper and the barrel, with little contribution from the forces required to expel fluid (air) from the syringe through the luer tip, which is considerably wider than a needle. The additional force needed to push a ranibizumab formula, with a viscosity of 1.3 cP, through a half inch 30G needle at 190 mm/s, can be calculated using the Hagen-Poiseuille formula, introduced above in **Section VIII.C.6** and **Appendix A at Section I.B**, as approximately 2 N. This, added to the friction force of 0.5 N in Figure 5 of Reuter,

is 2.5 N. Given that Reuter explains that baked on siliconization allows for the same function at a tenth of the amount of silicone oil, it would be obvious to a POSITA that a syringe meeting the limitations of claim 15 and tested using the claimed parameters would have a slide force of less than 5 N. Although the slide force of less than 5N would be obvious, this showing of obviousness based on the slide force is unnecessary, since claim 15 would still be obvious to a POSITA based only on the break loose force. Claim 15 recites “the stopper break loose force or stopper slide force,” is measured under the specified conditions, and, as explained above, a POSITA would understand that the break loose force would not be affected by those conditions.

8. Claim 17

285. Claim 17 recites “[a] blister pack comprising a pre-filled syringe according to claim 1, wherein the syringe has been sterilised using H₂O₂ or EtO.”

286. Lam discloses a pre-filled syringe packaged in a blister pack that is terminally sterilized by EtO. Ex. 1029 at 2:29-33 (“In some embodiments, the object is a syringe. In some embodiments, the syringe comprises glass and comprises a stopper comprising D777-7 laminated with FluroTec®; and a tip cap comprising D777-7 laminated with FluroTec® or D21-7H laminated FluroTec®. In some embodiments, the object is contained within a package comprising an EtO-

permeable material, e.g. TYVEK®.”). A POSITA would have understood that the reference to TYVEK® is a reference to the material of a blister pack.

9. Claims 18 and 19

287. Claim 18 recites “[a] blister pack comprising a pre-filled syringe according to claim 17, wherein the outer surface of the syringe has ≤ 1 ppm EtO or H₂O₂ residue.” Claim 19 recites “[a] blister pack comprising a pre-filled syringe according to claim 17, wherein the syringe has been sterilised using EtO or H₂O₂ and the total EtO or H₂O₂ residue found on the outside of the syringe and inside of the blister pack is ≤ 0.1 mg.”

288. Lam discloses a method of terminal sterilization that results in ≤ 1 ppm EtO residue.

Table 3.

	Tip cap	Stopper	EtO cycle	Time (months)	Resid. EtO (ppm)	% acidic peaks	% main peak	% basic peaks	% basic minus control
A	As above	As above	None (control)	0	NT	0.65	97.70	1.66	(control)
				1	NT	0.59	98.12	1.29	
				2	NT	1.22	97.00	1.78	
B	As above	As above	Cycle 10 Table 2	1	2.4	0.54	98.03	1.43	-0.01
				4	9.4	0.64	97.15	2.21	0.79
				6	4.3	0.87	96.87	2.26	0.66
				9	NT	1.09	96.13	2.78	1.00
C	D777-7 + FluroTec®	D777-7 + FluroTec®	2 h dwell + 4 washes	0	<0.5	0.67	97.57	1.76	0.10
				1	0.46	0.78	97.83	1.39	0.10
				2	1.64	1.24	96.96	1.80	0.02
D	D777-7 + FluroTec®	D777-7 + FluroTec®	1.5 h dwell + 8 washes	0	<0.5	0.66	97.66	1.69	0.03
				1	0.27	0.57	98.17	1.26	-0.03
				2	0.65	1.23	96.98	1.78	0.00
E	D21-7H + FluroTec®	D777-7 + FluroTec®	2 h dwell + 4 washes	0	<0.9	0.67	97.57	1.75	0.09
				1	0.36	0.70	97.92	1.38	0.09
				2	0.68	1.24	96.95	1.80	0.02
F	D21-7H + FluroTec®	D777-7 + FluroTec®	1.5 h dwell + 8 washes	0	0.9	0.65	97.74	1.61	-0.05
				1	0.32	0.75	98.01	1.24	-0.05
				2	0.57	1.25	96.99	1.76	-0.02

Ex. 1029 at 16:1-2 (Table 3) (annotated).

289. A POSITA would understand that such a level of EtO residuals would also be obtainable within a blister pack, which is disclosed in Lam as being EtO permeable. Ex. 1029 at 2:29-33.

290. A POSITA would understand that ≤ 1 ppm EtO residue would be ≤ 0.1 mg EtO residue within the area of a blister pack. The value of 0.5 ppm EtO found in Table 3 of Lam is equivalent of 0.9 mg EtO per cubic meter. Ex. 1048.002. Assuming that the volume inside the blister pack for a single syringe is less than 1/9 of a cubic meter, Lam discloses this limitation. For example, if the blister pack were even as large as a cube with sides of 20 cm (0.2 m) each, the total volume of the blister pack would be .008 cubic meters, which, at a rate of 0.9 mg per cubic meter, would result in .072 mg of EtO residue, which is less than 0.1 mg.

10. Claim 20

291. Claim 20 recites “[a] blister pack comprising a pre-filled syringe according to claim 18, wherein $\leq 5\%$ of the VEGF-antagonist is alkylated.”

292. Lam discloses in the Examples that the pre-filled syringes containing ranibizumab were treated with EtO sterilization treatment. Lam further discloses that stability of the protein is demonstrated by IEC data. Ex. 1029 at 15:17-19. (“We measured the residual EtO in the syringe and the stability of ranibizumab by IEC the same day as the treatment and at various monthly time points thereafter.”). Lam also explains how to determine the percent alkylation by IEC. *Id.* at 3:25-27 (“As used

herein, "percent alkylation" in the context of a polypeptide is the percentage of polypeptide that is in the basic peak relative to polypeptide that is in the acidic or main peaks as measured by IEC.") Table 3 shows the percent acidic peaks, main peak and basic peaks. Thus, an exemplary alkylation can be calculated using the peak data from Row E after two months time. This calculates out to $1.80 / (96.95 + 1.24) \times 100\% = 1.83\%$. IEC is explained further in **Section VIII.C.9**, above.

Table 3.

	Tip cap	Stopper	EtO cycle	Time (months)	Resid. EtO (ppm)	% acidic peaks	% main peak	% basic peaks	% basic minus control
A	As above	As above	None	0	NT	0.65	97.70	1.66	(control)
			(control)	1	NT	0.59	98.12	1.29	
				2	NT	1.22	97.00	1.78	
B	As above	As above	Cycle 10	1	2.4	0.54	98.03	1.43	-0.01
			Table 2	4	9.4	0.64	97.15	2.21	0.79
				6	4.3	0.87	96.87	2.26	0.66
				9	NT	1.09	96.13	2.78	1.00
C	D777-7 + FluroTec®	D777-7 + FluroTec®	2 h dwell +	0	<0.5	0.67	97.57	1.76	0.10
				1	0.46	0.78	97.83	1.39	0.10
			4 washes	2	1.64	1.24	96.96	1.80	0.02
D	D777-7 + FluroTec®	D777-7 + FluroTec®	1.5 h dwell +	0	<0.5	0.66	97.66	1.69	0.03
				1	0.27	0.57	98.17	1.26	-0.03
			8 washes	2	0.65	1.23	96.98	1.78	0.00
E	D21-7H + FluroTec®	D777-7 + FluroTec®	2 h dwell +	0	<0.9	0.67	97.57	1.75	0.09
				1	0.36	0.70	97.92	1.38	0.09
			4 washes	2	0.68	1.24	96.95	1.80	0.02
F	D21-7H + FluroTec®	D777-7 + FluroTec®	1.5 h dwell +	0	0.9	0.65	97.74	1.61	-0.05
				1	0.32	0.75	98.01	1.24	-0.05
			8 washes	2	0.57	1.25	96.99	1.76	-0.02

Ex. 1029 at 16:1-2 (Table 3) (annotated).

11. Claim 21

293. Claim 21 recites [a] blister pack comprising a pre-filled syringe according to claim 17, wherein the syringe has been sterilised using EtO or H₂O₂ with a Sterility Assurance Level of at least 10⁻⁶.

294. Lam discloses a method of terminal sterilization using EtO that provides for a sterile packaging of a pre-filled syringe. *Id.* at 13:12-26 (“We performed experiments to identify whether there were parameters for EtO sterilization that would effectively sterilize the surface of an object but which do not damage an ethylene-oxide-sensitive, temperature-sensitive compound contained inside. . . . In addition to the syringe, each run also included a paper strip with approximately 1.9×10^6 *Bacillus subtilis* spores, which was used to monitor the sterilization as follows: the strip was soaked in media, vortexed vigorously and then serial dilutions were plated and grown for one week. We then varied the following sterilization-critical factors as indicated in Table 1: temperature, relative humidity, time of exposure (gas dwell), and EtO concentration.”).

295. Lam further defines that an object is “sterilized” when “the amount of at least one biological contaminant present on the surface of the object being treated according to the present invention is reduced following the treatment.” *Id.* at 4:3-5. Lam adds that “[t]ypically, the amount is reduced by at least one log (i.e. by at least 10-fold). In some embodiments of the invention, the amount is reduced by 2 logs, 3 logs, 4 logs, 5 logs, or 6 logs.” *Id.* at 4:5-7.

296. A POSITA would understand that measuring the log reduction in *Bacillus subtilis* spores (that is, the killing of *Bacillus subtilis* spores in a typical logarithmic fashion over time or by dose) during sterilization would be used to

optimize the level of sterility assurance by measuring the sterilization conditions needed to reduce the *Bacillus subtilis* spores, such that the desired sterility is achieved. *See, e.g.*, Ex. 1049.003 (Fig. 2). It would be a matter of routine optimization for a POSITA to ensure that the sterility assurance level of 10^{-6} is achieved.

XII. Petition 2, Ground 2: Lam in view of Reuter and Furfine Renders Obvious Claims 11-13

297. Dependent claims 11, 12 and 13 further require that the VEGF-antagonist is a non-antibody VEGF-antagonist, the non-antibody VEGF-antagonist is aflibercept or conbercept, or the non-antibody VEGF-antagonist is aflibercept at a concentration of 40 mg/mL. Lam discloses in one embodiment that the pre-filled syringe includes a VEGF-antagonist (ranibizumab), and it would have been obvious to a POSITA to use a different VEGF-antagonist, such as aflibercept or conbercept, which were both well-known prior to 2012, in the pre-filled syringe for intravitreal administration. Furfine discloses aflibercept, which is a biologic therapeutic approved for treatment of wet AMD that is administered by intravitreal injection. Furfine also discloses a VEGF antagonist in a pre-filled glass syringe. Ex. 1021 at [0059], [0061].

298. A POSITA would have been motivated to use aflibercept in a terminally sterilized pre-filled syringe as disclosed in Lam, for all the reasons discussed above in **Section XI** with respect to the VEGF-antagonist solution ranibizumab. Indeed,

Lam makes it clear that the disclosed terminal sterilization is applicable to a broad range of solutions, including those that are temperature, oxidation, or radiation sensitive. Ex. 1029 at 2:4-6 (“The invention is based, in part, on the surprising discovery of ethylene-oxide-based sterilization conditions that will effectively sterilize the surface of an object but which do not significantly damage ethylene-oxide-sensitive, temperature-sensitive compounds contained inside.”); *see also id.* at 2:7-12 (providing exemplary compositions within the sterile container). Reuter is directed towards improvements for pre-filled syringes used to dispense therapeutic molecules, but is not limited in its use to any particular molecule. Ex. 1010.005. Reuter recommends baked-on siliconization for sensitive protein formulations and states that it is advantageous for ophthalmological preparations.. Ex. 1010.005. A POSITA would have recognized that aflibercept, marketed as EYLEA®, is a sensitive biologic that would be suited for use in the terminally sterilized pre-filled syringe for intravitreal injection disclosed in Lam.

A. Claims 11 and 12

299. Claim 11 recites “[a] pre-filled syringe according to claim 1 wherein the VEGF antagonist is a non-antibody VEGF antagonist.” Claim 12 recites “[a] pre-filled syringe according to claim 11, wherein the non-antibody VEGF antagonist is aflibercept or conbercept.”

300. Furfine discloses a non-antibody VEGF-antagonist known as aflibercept. Ex. 1021 at [0005] (“Stable formulations of a VEGF-specific fusion protein antagonist are provided. Pharmaceutically acceptable formulations are provided that comprise a VEGF ‘trap’ antagonist with a pharmaceutically acceptable carrier. In specific embodiments, liquid and lyophilized formulations are provided.”), [0006] (“In a first aspect, a stable liquid ophthalmic formulation of a VEGF-specific fusion protein antagonist is provided, comprising a fusion protein that comprises a receptor component consisting essentially of an immunoglobulin-like (Ig) domain 2 of a first VEGF receptor and Ig domain 3 of a second VEGF receptor, and a multimerizing component (also termed a ‘VEGF trap’).”). The ’631 patent states that aflibercept is a non-antibody VEGF-antagonist. Ex. 1001 at 6:36-40.

B. Claim 13

301. Claim 13 recites “[a] pre-filled syringe according to claim 12, wherein the non-antibody VEGF antagonist is aflibercept at a concentration of 40 mg/mL.”

302. Furfine discloses a VEGF antagonist at a concentration of 40 mg/mL. Ex. 1021 at [0013] (“In a specific preferred embodiment, the stable liquid ophthalmic formulation comprises about 40 mg/mL of the VEGF-antagonist (SEQ ID NO:4), 10 mM sodium phosphate buffer, 40mM sodium chloride, 0.03% polysorbate, and 5% sucrose, pH about 6.2-6.3.”); [0059] (“Stability of 40 mg/mL

VEGF Trap Liquid Formulation Stored at 5°C in Pre-Filled Glass Syringe”). It would have been obvious to a POSITA to use aflibercept at a concentration of 40 mg/mL. *See* Ex. 1040.006 (disclosing approved 40 mg/mL Eylea formulation in vial form).

XIII. Declaration

303. I declare that all statements made herein of my own knowledge are true and that all statements made on information and belief are believed to be true; and further that these statements were made with the knowledge that willful false statements and the like so made are punishable by fine or imprisonment, or both, under Section 1001 of Title 18 of the United States Code.

Dated: 16 July 2020

By: 
Horst Koller

APPENDIX A

I. Calculations from Section VIII.C.6

A. Calculations of the syringe barrel and needle size used to obtain the results in Boulange Table 7

1. The dimensions of the syringe barrel used in the testing in Boulange's Example 5 are known, and a POSITA would be able to use those barrel dimensions to readily calculate the flow rate of fluid out of the syringe barrel. The flow rate can be used in the Hagen-Poiseuille equation to determine whether a needle was used in Example 5. *Id.* As needle sizes are standardized, a POSITA would then determine and confirm that needle and syringe size.

2. Below is the Hagen-Poiseuille formula to calculate the possible inner diameter of attached needle gauge size, solved for the inner radius, r (v is the mean flow velocity, P is the pressure (*i.e.*, the measured force), ρ is the dynamic viscosity, and l is the length of the needle):

$$\dot{v} = \frac{\pi * r^4 * P}{8 * \rho * l}$$

$$r^4 = \frac{\dot{v} * 8 * \rho * l}{\pi * P}$$

$$r = \sqrt[4]{\frac{\dot{v} * 8 * \rho * l}{\pi * P}}$$

Given from Boulange are the following first set of syringe characteristics and testing conditions for a 1 mL long syringe:

- Fill Volume = 1mL

- Fill Media = WFI = 0.001Pa*s
- Syringe Size = 1mL long = 6.35 mm inner diameter = r = 3.175 mm
- Speed of Glide force testing = 380 mm/min
- Measured Glide force: Table 7; piston Type B1 = 2.5 N
- Assumption for injection into eye: Needle length = 1/2" (12.7mm)

I used the following conversion factors in my calculation:

- 1 N = 10⁵ Pa
- 1 mL = 1000 mm³
- 1 min = 60 s

3. Step 1 is the calculation of mean flow velocity, \dot{v} [mL/min], based on existing information:

$$\text{Volume } V = r^2 * \pi * h$$

$$h = \frac{V}{r^2 * \pi}$$

$$h = \frac{1ml * 1000mm^3}{(3.175mm)^2 * \pi}$$

$$h = 31.6\text{mm (height for 1mL long fill volume / water column)}$$

If the syringe glide force is tested at a speed of 380 mm per 60 s, the stopper must travel 31.6 mm (height, above) along the barrel in 5 seconds. Thus, it takes 5 seconds for one mL of fluid to travel through the barrel. Given 60 seconds in a minute, 12 mL of fluid will travel through the barrel in one minute, giving a mean flow velocity, \dot{v} , of 12 mL/min.

4. Step 2 is the calculation of the inner needle diameter using the Hagen-Poiseuille formula and the known parameters above:

$$r = \sqrt[4]{\frac{\dot{v} * 8 * \rho * l}{\pi * P}}$$

$$r = \sqrt[4]{\frac{12 \dot{m}l * 8 * 0.001 Pa * s * 12.7 mm * min * 1000 mm^3}{\pi min * 2.5 N * 10^5 Pa * ml * 60 s}}$$

$$r = \sqrt[4]{\frac{12 \dot{m}l * 8 * 0.001 Pa * s * 12.7 mm * min * 1000 mm^3}{\pi min * 2.5 N * 10^5 Pa * ml * 60 s}}$$

$$r = \sqrt[4]{0.000025872 mm^4}$$

$$r = 0.07131 \text{ mm}$$

Thus, the inner diameter, D_i , is 0.142 mm, which is twice the inner radius, r .

5. According to ISO 9626 specifications for Stainless Steel Needle Tubing, an inner diameter of 0.142 mm corresponds to a needle gauge size that falls between 27 G (0.184 mm) and 28 G (0.133 mm) for a regular walled needle. Ex. 1043 at 6. If this were a thin-walled needle, the inner diameter of 0.142 mm falls between 30 G (0.165 mm) and 31 G (0.125 mm). *Id.* Given the calculations above, a POSITA would understand that a needle gauge of between 27 G and 30 G was used, and most likely a 27 G normal-walled needle. This is consistent with what a POSITA would have expected to have been used for intravitreal applications. *See* Ex. 1015 at 36 (intravitreal application generally involve “a 25-gauge stainless steel

needle” or smaller). The same calculation may be performed for a standard (also known as “short”) 1 mL syringe. Given from Boulange are the following syringe characteristics and testing conditions, assuming this size of syringe:

- Fill Volume = 1mL
- Fill Media = WFI = 0.001Pa*s
- Syringe Size = 1mL standard = 8.65 mm inner diameter = r = 4.325 mm
- Speed of Glide force testing = 380 mm/min
- Measured Glide force: Table 7; piston Type B1 = 2.5 N
- Assumption for injection into eye: Needle length = ½" (12.7mm)

I used the following conversion factors in my calculation:

- 1 N = 10⁵ Pa
- 1 mL = 1000 mm³
- 1 min = 60 s

6. Step 1 is the calculation of mean flow velocity, \dot{v} [mL/min], based on existing information:

$$\text{Volume } V = r^2 * \pi * h$$

$$h = \frac{V}{r^2 * \pi}$$

$$h = \frac{1ml * 1000mm^3}{(4.325 mm)^2 * \pi}$$

$$h = 17.0 \text{ mm (height for 1mL long fill volume / water column)}$$

If the syringe glide force is tested at a speed of 380 mm per 60 s, the stopper must travel 17.0 mm (height, above) along the barrel in 2.7 seconds. Thus, it takes 2.7 seconds for one mL of fluid to travel through the barrel. Given 60 seconds in a minute, 22 mL of fluid will travel through the barrel in one minute, giving a mean flow velocity, \dot{v} , of 22 mL/min.

7. Step 2 is the calculation of the inner needle diameter using the Hagen-Poiseuille formula and the known parameters above:

$$r = \sqrt[4]{\frac{\dot{v} * 8 * \rho * l}{\pi * P}}$$

$$r = \sqrt[4]{\frac{22 \dot{m}l * 8 * 0.001 Pa * s * 12.7 mm * min * 1000 mm^3}{\pi min * 2.5 N * 10^5 Pa * ml * 60 s}}$$

$$r = \sqrt[4]{\frac{22 \dot{m}l * 8 * 0.001 Pa * s * 12.7 mm * min * 1000 mm^3}{\pi min * 2.5 N * 10^5 Pa * ml * 60 s}}$$

$$r = \sqrt[4]{0.000047432 mm^4}$$

$$r = 0.08299 \text{ mm}$$

Thus, the inner diameter, D_i , is 0.166 mm, which is twice the inner radius, r .

8. According to ISO 9626 specifications for Stainless Steel Needle Tubing, an inner diameter of 0.166 mm corresponds to a needle gauge size that falls between 27 G (0.184 mm) and 28 G (0.133 mm) for a regular walled needle. Ex. 1043 at 6. If this were a thin-walled needle, the inner diameter of 0.166 mm falls

almost exactly at 30 G (0.165 mm). *Id.* Even if a standard 1 mL syringe was used, a POSITA would understand that a needle gauge of between 27 G and 30 G was used. This is consistent with what a POSITA would have expected to have been used for intravitreal applications. *See* Ex. 1015 at 36 (intravitreal application generally involve “a 25-gauge stainless steel needle” or smaller).

B. Calculations of the slide force for claim 15 based on the results in Boulange Table 7

9. Claim 15 necessitates that the speed used to measure force is 190 mm/min and that the needles is a 30 G 1/2 inch needle. The calculations above estimate that a 30 G needle may be used in Boulange, and a 1/2 inch needle is assumed. Thus, the change in the glide force, which measures 2.5 N in Boulange, would change according to the change in measurement speed. 190 mm/min is one half of the 380 mm/min testing speed used in Boulange, and speed is proportion to force. Thus, if the speed is halved, the force should also be halved, resulting in an estimated glide force of 1.25 N, all else being equal.

10. If Boulange is assumed to be performed using a 27 G needle, the change in force using a 30 G needles changes inversely proportionally with the radius of the needle raised to the fourth power, such that:

$$\frac{P_1}{P_2} = \frac{r_2^4}{r_1^4}$$

11. The radius of the needle is either 0.0713 mm (1 mL long) or 0.0830 mm (1 mL standard), as calculated above, and the radius of the 30 G needle is 0.0665 mm. Thus, if the above calculated needle has a force of 1.25 N when measured at 190 mm/min, the 30 G needle measured at 190 mm/min will have a glide force of 3.03 N (1 mL standard) or 1.65 N (1 mL long), if all other conditions in Boulange stay the same.

12. Although claim 15 does not specify what the syringe is filled with when tested, assuming that the syringe is filled with a VEGF antagonist and not the water of Boulange, the viscosity of a VEGF-antagonist solution such as ranibizumab (1.3 cp) is close to the viscosity of water (1 cp). In the Hagen-Poiseuille formula, the dynamic viscosity of the fluid, ρ , varies proportionally with force, so the forces would be only 1.3 times greater, for example, if a ranibizumab solution is used in place of water in Example 5 of Boulange. Using the forces calculated for the 30 G syringe at 190 mm/min, the glide forces for a syringe filled with ranibizumab solution would be 3.94 N (1 mL standard) or 2.15 N (1 mL long). Thus, the glide forces remain under 5 N.