



# Pharmaceutical Dosage Forms: Parenteral Medications

Third Edition

Volume 2: Facility Design,  
Sterilization and Processing



**informa**  
healthcare

Edited by  
Sandeep Nema  
John D. Ludwig

# **Pharmaceutical Dosage Forms**

*This page intentionally left blank*

# **Pharmaceutical Dosage Forms**

**Parenteral Medications  
Third Edition**

**Volume 2  
Facility Design, Sterilization and  
Processing**

**Edited by**

**Sandeep Nema**

*Pfizer, Inc.*

*Chesterfield, Missouri, U.S.A.*

**John D. Ludwig**

*Pfizer, Inc.*

*Chesterfield, Missouri, U.S.A.*

**informa**  
healthcare

New York London



First published in 1984 by Marcel Dekker, Inc., New York, New York.  
This edition published in 2010 by Informa Healthcare, Telephone House, 69 77 Paul Street, London EC2A 4LQ, UK.

Simultaneously published in the USA by Informa Healthcare, 52 Vanderbilt Avenue, 7th Floor, New York, NY 10017, USA.

Informa Healthcare is a trading division of Informa UK Ltd. Registered Office: 37 41 Mortimer Street, London W1T 3JH, UK. Registered in England and Wales number 1072954.

©2010 Informa Healthcare, except as otherwise indicated

No claim to original U.S. Government works

Reprinted material is quoted with permission. Although every effort has been made to ensure that all owners of copyright material have been acknowledged in this publication, we would be glad to acknowledge in subsequent reprints or editions any omissions brought to our attention.

All rights reserved. No part of this publication may be reproduced, stored in a retrieval system, or transmitted, in any form or by any means, electronic, mechanical, photocopying, recording, or otherwise, unless with the prior written permission of the publisher or in accordance with the provisions of the Copyright, Designs and Patents Act 1988 or under the terms of any licence permitting limited copying issued by the Copyright Licensing Agency, 90 Tottenham Court Road, London W1P 0LP, UK, or the Copyright Clearance Center, Inc., 222 Rosewood Drive, Danvers, MA 01923, USA (<http://www.copyright.com/> or telephone 978 750 8400).

Product or corporate names may be trademarks or registered trademarks, and are used only for identification and explanation without intent to infringe.

This book contains information from reputable sources and although reasonable efforts have been made to publish accurate information, the publisher makes no warranties (either express or implied) as to the accuracy or fitness for a particular purpose of the information or advice contained herein. The publisher wishes to make it clear that any views or opinions expressed in this book by individual authors or contributors are their personal views and opinions and do not necessarily reflect the views/opinions of the publisher. Any information or guidance contained in this book is intended for use solely by medical professionals strictly as a supplement to the medical professional's own judgement, knowledge of the patient's medical history, relevant manufacturer's instructions and the appropriate best practice guidelines. Because of the rapid advances in medical science, any information or advice on dosages, procedures, or diagnoses should be independently verified. This book does not indicate whether a particular treatment is appropriate or suitable for a particular individual. Ultimately it is the sole responsibility of the medical professional to make his or her own professional judgements, so as appropriately to advise and treat patients. Save for death or personal injury caused by the publisher's negligence and to the fullest extent otherwise permitted by law, neither the publisher nor any person engaged or employed by the publisher shall be responsible or liable for any loss, injury or damage caused to any person or property arising in any way from the use of this book.

A CIP record for this book is available from the British Library.

Library of Congress Cataloging in Publication Data available on application

ISBN 13: 9781420086454  
ISBN 13: 9781420086539 (three volume set)

Orders may be sent to: Informa Healthcare, Sheepen Place, Colchester, Essex CO3 3LP, UK  
Telephone: +44 (0)20 7017 5540  
Email: [CSDhealthcarebooks@informa.com](mailto:CSDhealthcarebooks@informa.com)  
Website: <http://informahealthcarebooks.com/>

For corporate sales please contact: [CorporateBooksIHC@informa.com](mailto:CorporateBooksIHC@informa.com)  
For foreign rights please contact: [RightsIHC@informa.com](mailto:RightsIHC@informa.com)  
For reprint permissions please contact: [PermissionsIHC@informa.com](mailto:PermissionsIHC@informa.com)

Typeset by MPS Limited, A Macmillan Company  
Printed and bound in India

*We dedicate this work to those who have inspired us.  
To my parents Walter and Ruth Ludwig and my wife Sue Ludwig  
To my parents Hari and Pratibha Nema and my wife Tina Busch Nema*

*This page intentionally left blank*

## Foreword

I was a faculty member at the University of Tennessee and a colleague of Dr. Kenneth Avis when he conceived, organized, and edited (along with H.A. Lieberman and L. Lachman) the first edition of this book series that was published in 1984. It was so well received by the pharmaceutical science community that an expanded three-volume second edition was published in 1992. Dr. Avis did not survive long enough to oversee a third edition, and it was questionable whether a third edition would ever be published until two of his graduate students, Drs. Nema and Ludwig, took it upon themselves to carry on Dr. Avis' tradition.

Their oversight of this third edition is work that their mentor would be highly pleased and proud of. From 29 chapters in the second edition to 43 chapters in this new edition, this three-volume series comprehensively covers both the traditional subjects in parenteral science and technology as well as new and expanded subjects. For example, separate chapter topics in this edition not found in previous editions include solubility and solubilization, depot delivery systems, biophysical and biochemical characterization of peptides and proteins, container-closure integrity testing, water systems, endotoxin testing, focused chapters on different sterilization methods, risk assessment in aseptic processing, visual inspection, advances in injection devices, RNAi delivery, regulatory considerations for excipients, techniques to evaluate pain on injection, product specifications, extractables and leachables, process analytical technology, and quality by design.

The editors have done an outstanding job of convincing so many top experts in their fields to author these 43 chapters. The excellent reputations of the authors and editors of this book will guarantee superb content of each chapter. There is no other book in the world that covers the breadth and depth of parenteral science and technology better than this one. In my opinion, the editors have achieved their primary objectives publishing a book that contains current and emerging sterile product development and manufacturing information, and maintaining the high standard of quality that readers would expect.

*Michael J. Akers  
Baxter BioPharma Solutions  
Bloomington, Indiana, U.S.A.*

*This page intentionally left blank*



## Preface

*Pharmaceutical Dosage Forms: Parenteral Medications* was originally published in 1984 and immediately accepted as a definitive reference in academic institutions and the pharmaceutical industry. The second edition was published in 1993. The ensuing years have produced incredible technological advancement. Classic small-molecule drugs are now complemented by complex molecules such as monoclonal antibodies, antibody fragments, aptamers, antisense, RNAi therapeutics, and DNA vaccines. There have been significant innovations in delivery devices, analytical techniques, in-silico modeling, and manufacturing and control technologies. In addition, the global regulatory environment has shifted toward greater emphasis on science-based risk assessment as evidenced by the evolving cGMPs, quality by design (QbD), process analytical technology (PAT), continuous processing, real time release, and other initiatives. The rapidly changing landscape in the parenteral field was the primary reason we undertook the challenging task of updating the three volumes. Our objectives were to (i) revise the text with current and emerging sterile product development and manufacturing science and (ii) maintain the high standard of quality the readers expect.

The third edition not only reflects enhanced content in all the chapters, but also more than half of the chapters are new underscoring the rapidly advancing technology. We have divided the volumes into logical subunits—volume 1 addresses formulation and packaging aspects; volume 2, facility design, sterilization and processing; and volume 3, regulations, validation and future directions. The authors invited to contribute chapters are established leaders with proven track records in their specialty areas. Hence, the textbook is authoritative and contains much of the collective experience gained in the (bio)pharmaceutical industry over the last two decades. *We are deeply grateful to all the authors who made this work possible.*

Volume 1 begins with a historical perspective of injectable drug therapy and common routes of administration. Formulation of small molecules and large molecules is presented in depth, including ophthalmic dosage forms. Parenteral packaging options are discussed relative to glass and plastic containers, as well as elastomeric closures. A definitive chapter is provided on container closure integrity.

Volume 2 presents chapters on facility design, cleanroom operations, and control of the environment. A chapter discussing pharmaceutical water systems is included. Key quality attributes of sterile dosage forms are discussed, including particulate matter, endotoxin, and sterility testing. The most widely used sterilization techniques as well as processing technologies are presented. Volume 2 concludes with an in-depth chapter on lyophilization.

Volume 3 focuses on regulatory requirements, risk-based process design, specifications, QbD, and extractables/leachables. In addition, we have included chapters on parenteral administration devices, siRNA delivery systems, injection site pain assessment, and control, PAT, and rapid microbiology test methods. Volume 3 concludes with a forward-looking chapter discussing the future of parenteral product manufacturing.

These three volumes differ from other textbooks in that they provide a learned review on developing parenteral dosage forms for *both* small molecules and biologics. Practical guidance is provided, in addition to theoretical aspects, for how to bring a drug candidate forward from discovery, through preclinical and clinical development, manufacturing, validation, and eventual registration.

The editors wish to thank Judy Clarkston and Lynn O'Toole-Bird (Pfizer, Inc.) for their invaluable assistance and organizational support during this project, and Sherri Niziolek and Bianca Turnbull (Informa Healthcare) for patiently leading us through the publishing process.

We also acknowledge the assistance of Pfizer, Inc. colleagues Lin Chen and Min Huang for reviewing several of the chapters.

We would like to express special gratitude to the late Kenneth E. Avis (University of Tennessee College of Pharmacy) for his dedication to teaching and sharing practical knowledge in the area of parenteral medications to so many students over the years, including us. Finally, we acknowledge the contributions of Dr Avis, Leon Lachman, and Herbert A. Lieberman who edited the earlier editions of this book series.

*Sandeep Nema  
John D. Ludwig*



# Contents

Foreword Michael J. Akers vii  
Preface ix  
Contributors xiii

1. **Aseptic manufacturing facility design** 1  
*Mark Caldwell, Bob Helt, Beth Holden, Francesca McBride, and Kevin Schreier*
2. **Personnel and their impact on clean room operations** 56  
*Jeanne Moldenhauer*
3. **The fundamentals of an environmental control program** 80  
*William H. Miele*
4. **Water systems for parenteral facilities** 91  
*Joseph J. Manfredi*
5. **Particulate matter: subvisible** 114  
*D. Scott Aldrich*
6. **Endotoxin testing** 146  
*Michael E. Dawson*
7. **The compendial sterility tests** 187  
*Scott V.W. Sutton*
8. **Industrial sterilization technologies: principles and overview** 195  
*Anne F. Booth*
9. **Steam sterilization** 221  
*James Agalloco*
10. **Gas, vapor, and liquid chemical sterilization** 241  
*James Agalloco*
11. **Dry heat depyrogenation and sterilization** 255  
*Deborah Havlik and Kevin Trupp*
12. **Radiation sterilization** 268  
*Barry P. Fairand and Dusan Razem*

<b>13. Filters and filtration</b>	<b>297</b>
<i>Maik W. Jornitz and Theodore H. Meltzer</i>	
<b>14. Processing of small volume parenterals and large volume parenterals</b>	<b>334</b>
<i>Donald A. Eisenhauer, Roland Schmidt, Christine Martin, and Steven G. Schultz</i>	
<b>15. Freeze-drying: principles and practice</b>	<b>353</b>
<i>Steven L. Nail and Larry A. Gatlin</i>	
<i>Index</i>	<b>383</b>

## Contributors

- James Agalloco** Agalloco & Associates, Belle Mead, New Jersey, U.S.A.
- D. Scott Aldrich** Ultramikro, LLC, Richland, Michigan, U.S.A.
- Anne F. Booth** Booth Scientific, Inc., Hendersonville, North Carolina, U.S.A.
- Mark Caldwell** Jacobs Engineering Group, Inc., Conshohocken, Pennsylvania, U.S.A.
- Michael E. Dawson** Associates of Cape Cod, Inc., Falmouth, Massachusetts, U.S.A.
- Donald A. Eisenhauer** Abbott Laboratories, North Chicago, Illinois, U.S.A.
- Barry P. Fairand** Sterigenics International, Dublin, Ohio, U.S.A.
- Larry A. Gatlin** PK, LLC, Groton, Connecticut, U.S.A.
- Deborah Havlik** R&D Microbiology, Hospira, Inc., Lake Forest, Illinois, U.S.A.
- Bob Helt** Jacobs Engineering Group, Inc., Conshohocken, Pennsylvania, U.S.A.
- Beth Holden** Jacobs Engineering Group, Inc., Conshohocken, Pennsylvania, U.S.A.
- Maik W. Jornitz** Sartorius Stedim North America, Inc., Bohemia, New York, U.S.A.
- Joseph J. Manfredi** GMP Systems, Inc., Fairfield, New Jersey, U.S.A.
- Christine Martin** Abbott GmbH & Co. KG, Ludwigshafen, Germany
- Francesca McBride** Jacobs Engineering Group, Inc., Conshohocken, Pennsylvania, U.S.A.
- Theodore H. Meltzer** Capitola Consultancy, Bethesda, Maryland, U.S.A.
- William H. Miele** Pfizer Global Manufacturing, Kalamazoo, Michigan, U.S.A.
- Jeanne Moldenhauer** Excellent Pharma Consulting, Mundelein, Illinois, U.S.A.
- Steven L. Nail** Baxter Pharmaceutical Solutions, Bloomington, Indiana, U.S.A.
- Dusan Razem** Ruder Boskovic Institute, Zagreb, Croatia
- Roland Schmidt** Abbott GmbH & Co. KG, Ludwigshafen, Germany
- Kevin Schreier** Jacobs Engineering Group, Inc., Conshohocken, Pennsylvania, U.S.A.

**Steven G. Schultz** Abbott Laboratories, North Chicago, Illinois, U.S.A.

**Scott V. W. Sutton** Microbiology Network, Inc., Rochester, New York, U.S.A.

**Kevin Trupp** Global Sterilization Engineering, Hospira, Inc., Lake Forest, Illinois, U.S.A.

# 1 | Aseptic manufacturing facility design

Mark Caldwell, Bob Helt, Beth Holden, Francesca McBride, and Kevin Schreier

## INTRODUCTION

Sterile products may be in liquid or powder form (among others) as drug products and may be presented in formats including ampoules, vials, prefilled syringes, presterilized bottles, and blow-fill-seal containers. Product form and presentation influence processing conditions, equipment selection, and therefore, facility design. The sterile envelope refers to all the steps carried out during and following the final sterile filtration step through process completion, which occurs after filled product containers are sealed and a risk of environmental contamination to the product is eliminated. These steps include:

- Adjuvant, buffer and media formulation
- Addition of excipients
- Adjustment of concentration to achieve target potency
- Sterile filtration
- Component preparation
- Filling, stoppering/plugging, and sealing of product in final dosage containers

The design of the facility must meet all applicable regulatory guidelines, and meet GMP and safety guidelines. Current Good Manufacturing Practice (GMP) requires that areas of operation used for aseptic processing must prevent contamination from particles and microbes that may be present in the air, on product contact surfaces, or shed from personnel (1 5).

When processing biological products, such as live virus vaccines, attenuated vaccines and viral vectors, the biohazard nature of these products place extra demands on the facility. Potent compounds, like some biological products, also pose a risk to the operator and environment. Therefore, the facility and process design must also ensure both product and personnel safety.

This chapter establishes a basis for compliance with the global regulatory expectations for facility design, equipment interfaces, and utility requirements applicable to sterile processing and the manufacture of sterile products (6 10).

## FACILITY DESIGN DRIVERS

As each facility is being designed, process requirements specific to each product must be considered. Each different type of product has different facility needs. Also, the number of products to be manufactured and the production campaign strategy will impact the facility design.

### Product Types

#### *Chemical Bulk Drug Substances (API)*

Sterile chemical bulk drug substances are derived from chemical reactions. Facilities producing sterile API will be required to provide protection of the product during synthesis, isolation, and bulk filling. An adjuvant produced by precipitation is an example of a sterile API.

#### *Potent Compounds*

Potent compounds are classified as those chemical drug substances that are considered to be toxic to humans when exposure limits are exceeded, and may cause allergic reactions, birth defects, cancer, or other conditions. For this reason, it is required to ensure protection of operators working with potent compounds, ensure containment of all operations, and prevent release of products into the environment. It is acceptable to permit production of potent compounds in multiproduct facilities, provided the suite is segregated from other operations.



Following filling, it is recommended to wash the exterior of vials produced in potent compound facilities to limit uncontrolled exposure to the product during downstream operations.

#### *Antibiotics*

Antibiotics are drugs produced to treat bacterial or fungal infections. Antibiotics are considered to be sensitizers and can generate mild to severe allergic reactions in patients and operators. It is required to segregate production operations from personnel outside the production area. Campaigns of antibiotic must be segregated from other products, as the potential for cross-contamination between products can occur. In addition,  $\beta$ -lactam (penicillin) and nonpenicillin based (cephalosporin) antibiotic products are not permitted to be produced in the same facility, as there is evidence that intolerance can occur for one antibiotic type, and not another.

To accomplish this segregation, it is a requirement that a separate dedicated suite be constructed for each antibiotic family. This suite can be housed inside a common structure with other functions. At no time should antibiotic production personnel come into contact with personnel operating in media or fermentation areas while gowned.

Following filling, it is recommended to wash the exterior of vials produced in antibiotic facilities to limit uncontrolled exposure to the product during downstream operations.

#### *Biological Product*

This category includes therapeutic proteins generated by fermentation or cell culture and inactivated vaccines. The facility is to be designed in same way as API production, except that terminal sterilization is often not feasible, due to the fragility of the product.

#### *Live Virus Vaccines*

Vaccines containing a live virus, or viral vector, must be designed to provide containment of the organism to protect both operators and the environment. Viral vectors are virus-like particles that inject genetic material into the cells of the organism being treated and are treated in a similar manner to live viruses. The biosafety level designated for the organism will drive decisions regarding the level of environmental controls that is required for the facility. Typically, these products require the use of adjuvants and will be suspension products, incapable of being filter sterilized. Products cannot be terminally sterilized. Live virus vaccine products can be campaigned in a multiproduct facility, as long as the vaccine production area is segregated from the remainder of the facility. Following the completion of the live virus campaign, the suite will need to be completely decontaminated prior to use for another product.

### **Facility Types**

#### *Single Product, Dedicated*

This facility is designed to produce a single product at any one time, throughout the year, without concern for cross-contamination with a second product. The facility can be operated to produce multiple products in a series of campaigns, converting between products.

#### *Multiproduct Multisuite*

This facility is designed to produce multiple products simultaneously in multiple sterile suites. Sterile operations in each suite are to be segregated from one another to ensure that cross-contamination is prevented. It is a recommendation to clean and decontaminate any used components or equipment prior to exiting the suite and entering the return corridor.

### **Production Area Description**

#### *Conventional Aseptic Technology: Open*

In conventional aseptic processing, the product is exposed to the room environment during operation. For this reason, aseptic operations are required to be performed under ISO 5

conditions, by sufficiently gowned operators, trained in aseptic technique. Sterility assurance levels for aseptic operations, including filling of vials or syringes, can be maximized through the use of barriers such as restricted access barrier systems or isolators to limit the size of the aseptic environment and remove operators from the ISO 5 fill area.

#### *Terminally Sterilized Product*

Whenever possible, it is required to terminally sterilize filled units of product. Application of an “overkill” sterilization methodology can provide a sterility assurance level of  $10^{-6}$ , or better. Sterilization can be by steam, dry heat, gas, or radiation.

#### *Restricted Access Barrier: Open and Closed*

As defined by ISPE: A restricted access barrier system (RABS) is an advanced aseptic processing system that can be utilized in many applications in a fill-finish area. RABS provides an enclosed environment to reduce the risk of contamination to product, containers, closures, and product contact surfaces compared to the risks associated with conventional clean room operations. RABS can operate as “doors closed” for processing with very low risk of contamination similar to isolators, or permit rare “open door interventions” provided appropriate measures are taken (11).

In representative installations recently constructed, there is a wide variety of equipment configurations referred to as RABSs. In construction detail, some approximate isolators in their level of segregation of the clean environment from the background environment, while other examples employ less rigorous segregation between the clean environment and the background room.

When barrier doors are required to be opened, the opening must be protected within an ISO 5 zone, to the extent necessary to ensure continuous ISO 5 coverage. The door must be permitted to be opened without leaving the ISO 5 zone.

#### *Isolation Technology*

As defined by ISPE: An isolator is a leak-tight enclosure designed to protect operators from hazardous/potent processes or protect processes from people or detrimental external environments or both. A basic enclosure consists of a shell, viewing window, glove/sleeve assemblies, supply and exhaust filters, light (s), gauge (s), input and output openings (equipment door airlocks, RTPs, etc.), and various other penetrations. There are two types of isolators:

**Closed isolators.** Isolators operated as closed systems do not exchange unfiltered air or contaminants with adjacent environments. Their ability to operate without personnel access to the critical zone makes isolators capable of levels of separation between the internal and external environment unattainable with other technologies. Because the effectiveness of this separation, closed isolators are ideally suited for application in the preparation of sterile and/or toxic material. Aseptic and containment isolators are two types of closed isolators.

**Open isolators.** Open isolators differ from closed isolators in that they are designed to allow for the continuous or semicontinuous egress of materials during operation while maintaining a level of protection over the internal environment. Open isolators are decontaminated while closed, and then opened during manufacturing. Open isolators typically are used for the aseptic filling of finished pharmaceuticals (11).

#### *Closed Processing*

**Closed system sterile processing.** A closed system is one that does not contain any open aseptic manipulations or interventions by design or operation and does not allow microbial ingress. Validated sterilization cycles must be provided. The product is separated from the surrounding room environment by a sterilizing grade vent filters. Leak testing must occur pre- and post use to demonstrate the system integrity.



## EQUIPMENT AND PROCESS SYSTEM IMPACT ON FACILITY

It is important to start the facility design with an understanding of each process step involved with the manufacture of a sterile product. In this section, an overview is provided for some of the more common process steps, including a description of the major equipment, material flows, and facility impacts.

### Nonactive Materials

Nonactive materials are transported from the warehouse to the weigh/dispense area, where they are dispensed into containers under a hood with high efficiency particulate air (HEPA) filtration. The hoods used in the dispensing operation shall be designed for protection of the product and may also need to protect the operator from exposure to potentially hazardous materials used in the formulation process.

The number of hoods, and type, will be determined by evaluating the number of weighing operations that must be performed, the size of the weighing operations, the compatibility of materials that must be weighed, and any special ergonomic or personnel safety concerns. Materials that are not compatible may need to be dispensed in separate hoods to prevent any cross-contamination concerns. Also, dispensing operations involving large bulk containers will require either a lift assist or pallet jack access to prevent operator injury, requiring the hood to be designed as a walk-in type.

Hoods being designed for product protection typically recirculate air back to the dispensing room to reduce the HVAC consumption for the area. However, when weighing hazardous materials, the air from the hood may need to be captured and exhausted to the roof through some type of environmental control device. Hoods of this type are typically designed to be negatively pressurized with respect to the dispensing room.

Containers may be either single-use or reusable. Single-use containers are disposable. Reusable containers are required to be tracked and controlled to prevent cross-contamination of clean and used containers. Prior to reuse, used containers should be brought to a parts preparation washroom for cleaning and then placed in controlled storage.

Nonactive materials are dispensed into bags or plastic bottles and can be placed into plastic bins as part of preassembled kits. Preweighed nonactive materials are stored as kits and staged until they are ready to be transferred to the formulation area. Identifying labels should be placed on the containers.

It is typical to provide a local WFI drop feeding a sink in the weigh/dispense area, with WFI temperature controlled by a local WFI drop cooler. The WFI drop is periodically flushed and sampled per SOP. WFI is used to prepare solutions of nonactive materials in bottles. This operation may be performed with equipment such as a laboratory agitator.

Bench scales are used for dispensing of smaller-scale materials. Floor scales are used for larger quantities. Balances and measuring equipment should be of an appropriate range and precision.

### Active Materials

#### *Receipt/Storage*

Active materials, API or drug substance (DS), may be received in a wide variety of container types, in either frozen or liquid form, or as a solid. Careful consideration should be given to the form and container type, since this affects the storage, transport, preparation, and handling of API. The following list is provided to indicate the diversity of some common examples.

1. Frozen in cryovessels, ranging in size from 50 to 300 L
2. Frozen in small containers, ranging in size from 1 to 20 L
3. As liquid in small containers, ranging in size from <1 to 20 L
4. As powder in canisters, ranging in size from <1 to 50 kg

Weighing and dispensing can occur for either sterile or nonsterile material.

It is recommended that sterile material be dispensed in an isolator to prevent contamination. The isolator should be fitted with a rapid decon antechamber to facilitate the addition of product and containers to be dispensed.

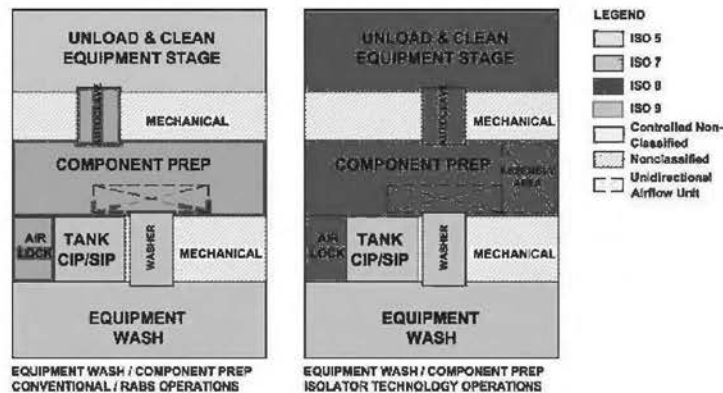

Figure 1 (See color insert) Weigh and dispense.

Nonsterile material should be protected by HEPA filtration during dispensing operations to prevent addition of particulate.

Containers of API should not be opened for sampling prior to use in the formulation area. Therefore, it is recommended that all lot of API containers be received at the warehouse facility with a tag-along container of sample volume, or with a material certificate of analysis from the supplier.

If there are any concerns regarding the cumulative time out of refrigeration for an API container, it should not be removed from cold storage in the warehouse area until it is required for use (Fig. 1).

*Cryovessels*

For transporting large volumes of bulk API, cryovessels are preferred over small containers. However, in addition to the added cost of the cryovessels, special consideration should be given to their storage and transport. Cryovessels can weigh approximately 1000 kg, before being filled with product. For this reason, it is recommended to avoid lifting them onto rack storage. This may impact the size of the storage space, depending on the quantity of material to be stored. This space can be either located within a walk-in freezer or in a special area equipped with a heat transfer system and ample docking stations for the required number of cryovessels.

It is recommended that cryovessels have wheels for portability and ease of movement, although moving them by hand would prove difficult. For long distances, such as transport from warehouse storage, fork trucks should be used. Once inside the formulation area, a tank manipulator can be used, which allows the cryovessel to be pulled or pushed into position.

Used cryovessels need to be cleaned prior to being returned to the supplier. This requires a designated area for the removal of the top head of the cryovessel for inspection and insertion of a CIP ring to properly clean the fin-shaped baffle inside the vessel.

*Frozen or Refrigerated API Containers*

While smaller containers of frozen or liquid API (up to 20 L) can be easier to transport and handle in the refrigerated warehouse, such containers may pose ergonomic concerns for the operator in the formulation area who must handle, manipulate, and lift them. A 20-L container weighs in excess of 40 pounds and may exceed the upper limit deemed acceptable for manual lifting. Therefore, a lift assist device may be required.

Small quantities of API may be received in either reusable or single use containers. While reusable containers must be cleaned and returned, single use containers pose a different set of concerns. Typically, disposable bags and bottles are not designed for either pumped transfer or manipulation by a lift assist. Therefore, disposable containers should be limited to a volume deemed manageable for handling, lifting, and pouring.



### *Thawing*

If API is received in frozen form, an area adjacent to the formulation area should be designated as an API thaw room. Sufficient space shall be provided, depending on the API production requirements and duration of the thaw cycle.

If frozen in cryovessels, ample thaw/shaker stations shall be provided for the required number of cryovessels. At each station, a shaker mechanism is provided to gently mix the API during the thawing process. The thaw module will allow for precise control of the temperature profile during the process.

If frozen in small containers, consideration will be given to the selection of the thawing equipment. A shaker thaw bath will thaw several containers quickly, but needs a water supply. An environmental chamber will also thaw several bottles, but the operation will be performed at a much slower rate, due to the lower heat transfer rate of the air. The number of units will be determined by the quantity of bottles to be thawed for each batch, and the time allotted to perform the operation. If there are concerns regarding the accumulated time out of refrigeration, more units may be required.

Local freezers and refrigerators should be provided in the thaw area to provide staging space for material that is awaiting the thaw process as well as thawed material that is awaiting transport to the formulation room. The refrigerators and freezers should employ some system for segregation to maintain lot-to-lot integrity of the same material as well as containers of different products, avoiding any potential cross-contamination and product loss.

If live virus product is thawed, secondary containment is required during the thawing operation in the event of a container rupture. This can be accomplished by use of an overwrap or use of the thaw bath as secondary containment. Any use of water as a thawing medium for live virus should be routed to biowaste collection.

### **Formulation**

The typical formulation module includes one formulation tank, positioned inside the formulation room, adjacent to a utility panel on the wall. Piping, electrical and instrumentation for the tank are connected to the utility panel. This tank has been cleaned via CIP and has been sanitized by clean steam. Following the sanitization operation, it has been maintained under positive pressure with filtered process air.

Room height should account for elevation of equipment, including open charging operations, agitator clearance, and vent filters. Portable equipment must be able to fit under the door frame without disassembly. Room layout must account for any work platform required for equipment access.

WFI is supplied to this vessel through the utility panel from a local WFI drop, with WFI temperature controlled by a WFI distribution loop cooler. The addition of WFI can be made either manually or automatically. The WFI drop is periodically flushed and sampled per SOP. If the WFI is to be added after the API, it should be added through a dip tube to prevent the development of foam.

Large volume liquid drug substance in cryovessels or portable vessels is pressure transferred into the formulation vessel via a dip tube and can be considered a closed addition.

Solid additions are made through the open manhole of the formulation tank under the protection of a HEPA filtered air supply register. In cases where dust control is important, solid materials can be manually added through a tank nozzle using a lipseal for dust control to protect both the operator and surrounding environment. In cases where hazardous materials are being added to the formulation vessel, the use of an isolator or glove box may be considered.

Small quantity API and nonactive solutions are likewise manually poured into the vessel through a funnel that diverts toward the vessel wall. If necessary, a lift assist may be used due to the weight or awkwardness of the operation. As an alternate design, small quantities of liquid solution can be pumped or pressure transferred.

If quantitative transfers are required for all additions, each container may need to be rinsed with WFI following the transfer operation. This rinse bottle must be made up as part of the formulation recipe and included in the total mass balance.

The agitation in the formulation vessel must be sufficient to dissolve materials that could either sink to the bottom or float on the top of the vessel. For suspension products, vigorous

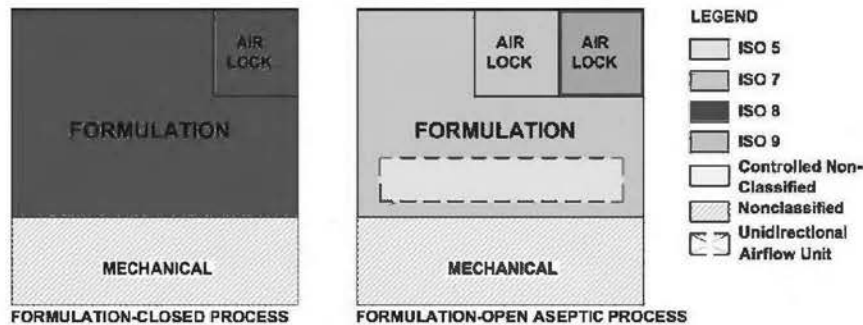

Figure 2 (See color insert) Formulation.

agitation may be essential to keep the disperse system homogenous. However, should crystals be present, the agitation must be gentle enough to avoid breakage.

In certain instances, if the product is oxygen sensitive, the contents of the tank may be sparged with nitrogen. It is also possible that only the gas in the headspace may need to be replaced. The requirement for this feature needs to be evaluated during design of the formulation tank. If nitrogen is used in the facility, it is important to provide oxygen monitoring to ensure that a safe working area exists for operators.

After the additions have been completed and the contents mixed, the pH is typically adjusted. Depending on the process requirements, this operation could be performed by adding predetermined quantities of acid or base to shift the pH. This can be accomplished easily as part of the formulation in a buffered system. In other formulation recipes, the pH may drift and require a titration process at each step in the process.

Once the material has been added, mixed, and at the proper pH, the batch is typically sampled for in-process testing. The in-process material is then pressure transferred through sterile filters to a holding tank or direct to the filling line (Fig. 2).

**Sterile Filtration**

As the in-process material is transferred from the formulation tank to the hold tank or the filling machine, it passes through a set of sterilizing grade filters which, when appropriately validated, will remove bioburden from the fluid stream, producing a sterile effluent. The sterile filtration must be redundant and must be located as close to the point of fill as possible.

Generally, sterile filtration occurs through two 0.2 µm filters configured in series. Both filters are identical in size, area, and porosity. Filter elements are used one time only.

Prior to use, the clean filter housings are fitted with new filter elements. The housings and elements are then steamed in place (SIP). After SIP, the new filter elements are integrity tested to verify the elements are intact prior to product filtration. Integrity testing requires wetting of the filter elements with either product or WFI. The system must be designed to test the second filter without compromising the sterility of the first filter. When WFI is used, if a filter requires replacement, only the SIP must be repeated. A commercially purchased filter integrity tester unit, supplied with process compressed air, shall be used to perform the bubble point test method. Post use, the sterile filters are once again integrity tested in place, or remotely at a bench, to verify the filter elements were intact during filtration.

**Product Filling**

Facilities and equipment for the manufacture of sterile products must be located, designed, constructed, qualified, operated, and maintained to suit the manufacturing process to

- minimize the risk of errors,
- avoid cross-contamination, and
- permit effective cleaning and sanitization.



Assuming the manufacturing process is similar for various products, a new aseptic filling facility should incorporate a degree of flexibility into the design to accommodate changing requirements for product mix and capacity.

Product filling can occur in facilities designed as conventional aseptic operations or in facilities designed to accommodate RABS or isolator technology. Figures 4 and 13 provide illustrations of the impact that technology selection makes on the facility design for vial and syringe filling suites, respectively.

It is recommended to transport presterilized wetted path components from the autoclave to the fill line, using bags for conventional lines, or rapid transfer port (RTP) containers for isolators. Proper space should be provided for the docking and lifting of these devices.

Proper space should also be provided for any lift assist required for operations such as docking of stopper or plunger bags to the RABS or isolator wall.

If portable vessels are used, the position of the vessel needs to be addressed. In a conventional or RABS filling line, the vessel should be maintained outside the ISO 7 fill room to avoid the need for sanitization of the vessel wheels and shell. In an isolator facility, the vessel would be moved adjacent to the filling machine and docked to a pedestal mounted utility panel.

Only one product should be manufactured on a filling line at one time.

#### *Vial and Ampoule Filling*

Sterile products including liquids, lyophilized liquids, and powder can be filled into vials or ampoules. It is recommended to load the glass onto the filling line in an ISO 9 space to avoid additional manipulation of pallets containing glass into ISO 8 areas (Fig. 3).

Figure 4 represents examples of vial filling operations utilizing conventional filling, RABS, and isolators:

**Vial washing.** Cardboard and other packing materials are to be removed prior to entry of vials/ampoules into the ISO 9 infeed area, which remain on pallets. Sufficient room is required to stage pallets of glass and provide space for maneuvering pallets to the filling line. Provisions need to be made for ergonomic assists during loading to prevent operator injury.

The vials are transported to the washer via elevating-type carts. The vials are received in trays on elevating carts or in a brick configuration wrapped where they are manually unwrapped and loaded onto the infeed tray-on station. It is recommended to evaluate component configuration and all load assist systems available for loading vials into the washer. After the vials are fed on the line they are conveyed into the washer for processing. Provisions for plastic waste removal need to be incorporated into the design of the syringe loading area.

Two common types of tray-on stations are linear (declining or fixed-elevation) or rotary, additionally the tray-on station can include a turntable to act as a buffer and/or accumulating device prior to the washing step.

The vials are singularized via a turntable with a star wheel, a turntable with nose guide, or a star wheel alone if the containers are not accumulated prior to rinsing. The vials are inverted at the first processing station before they are rinsed externally and internally.

The washer may incorporate as many as six (6) processing stations consisting of both WFI rinse and air blow nozzle manifolds of sanitary design and construction. The manifolds should be designed to allow WFI and clean dry air sampling. The design of the washer should permit flushing of the WFI use points of the washer.

First the vials are rinsed externally with recycled WFI collected from the final rinsing station. The vials can be cleaned with or without cleaning agents. The surfaces of the vials can be rinsed one to two times. After external rinse and before internal rinse(s) vial externals receive an air blow using sterile filtered dry (process-grade) air.

Following the external rinses, the interior surfaces of the vials are rinsed using hot virgin WFI, feed from the header directly; not heated recycled WFI. After internally rinsing the vials, the final station performs an internal air blow then the vials are inverted and finally transported to the tunnel infeed interface in single file.

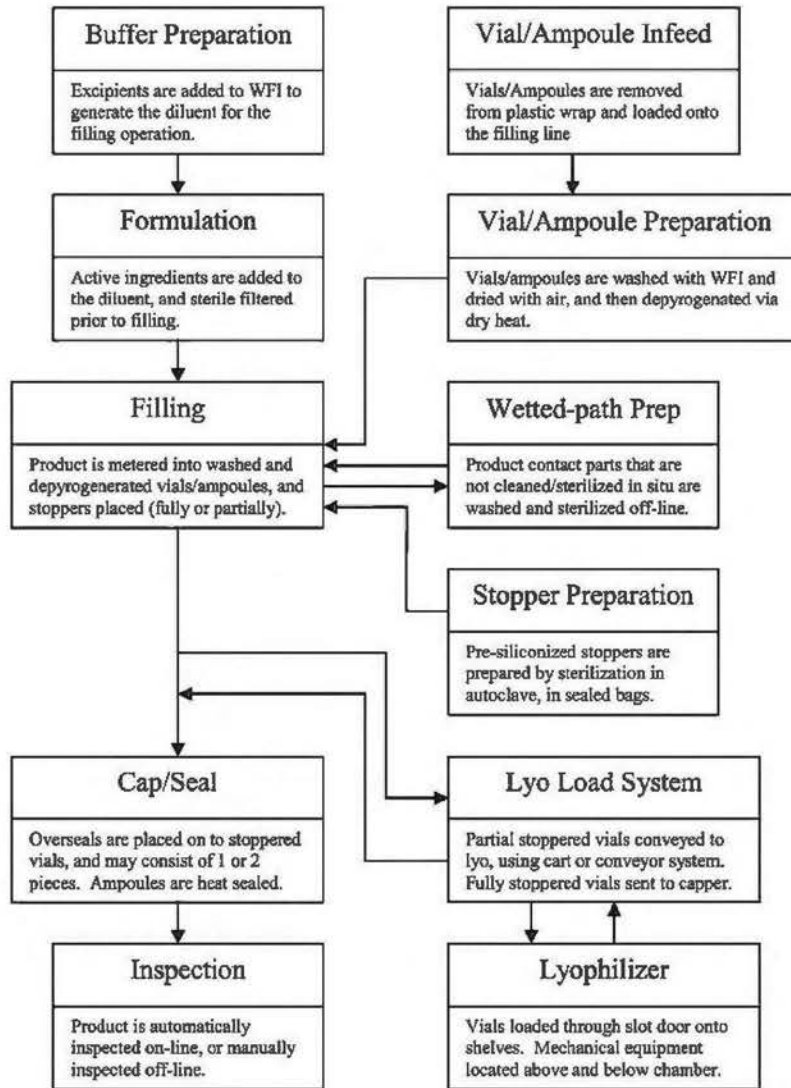

Figure 3 Sample process flow for manufacture of drug products into vials or ampoules.

It is recommended that an exhaust hose be attached to the cover to draw moisture and air away from the processing space to an exhaust fan located above the washroom.

Figure 5 shows a picture of a typical vial washer:

**Depyrogenation.** The vials are conveyed from the washer outfeed under ISO 5 unidirectional airflow to the tunnel infeed zone. The tunnel (Fig. 6) shall be provided with HEPA-filtered air, whether coming directly from the air supply duct or recirculated. The filter over the infeed zone of the tunnel should be sterilizing-grade but as an option can be specified as HEPA-grade.

The vials are accumulated and are desingularized (massed) at the infeed of the tunnel and enter the tunnel in a “bulk” configuration. It is recommended that the control of the bulking process is controlled by the tunnel as this process is critical to control vial back

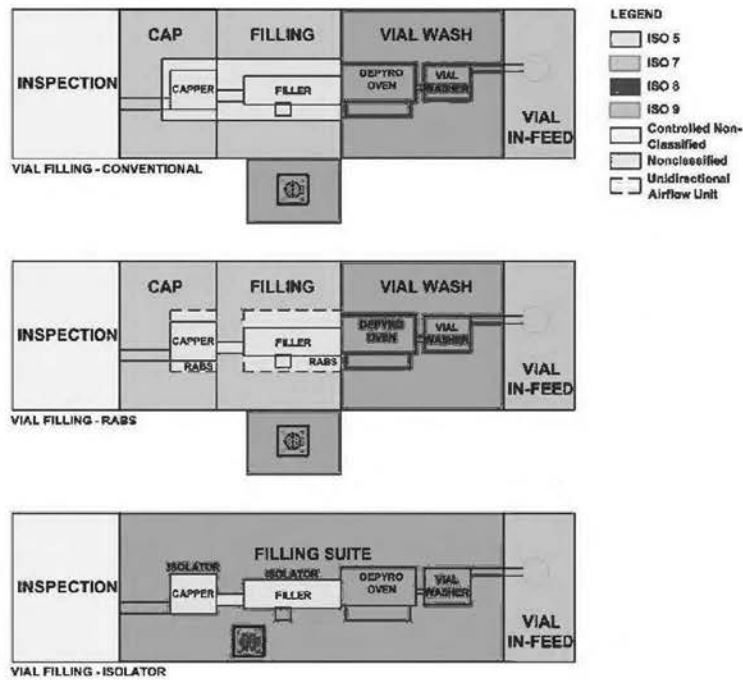

Figure 4 (See color insert) Vial filling.



Figure 5 Vial washer (12).

pressure and load configuration to minimize vial damage (scratching), breakage, and falling. As the vials enter the infeed zone, they are gradually heated up before entering the sterilizing zone.

The sterilizing zone shall be designed to provide uniform load temperature distribution within  $\pm 1.8^{\circ}\text{F}$  ( $1^{\circ}\text{C}$ ) across the tunnel belt. The filters in the sterilizing zone shall be HEPA-grade filters and nonparticle generating to maintain air quality to ISO 5 requirements during all operating modes.

The vials are cooled to ambient prior to exiting the tunnel. The cooling zone should be sterilizable and will incorporate HEPA filtration to maintain ISO 5 air quality in all operating modes.

The sterilizable cooling zone is cooled via cooling coils located under the tunnel belt. At the end of the tunnel, a door should be incorporated to seal the tunnel at the cooling zone from





Figure 6 Depyrogenation tunnel (12).

the filler to allow the tunnel to be cooled or taken out of service while maintaining the controlled environmental conditions of the filling room.

The tunnel should incorporate filter integrity test ports for HEPA filter testing with POA (polyalphaolefin) or other equivalent challenge testing material in place of DOP (dioctyl phthalate aerosols). Isokinetic sample ports (per ISO 14644-3.) should also be located such that connection of probes allow for simple setup for particulate monitoring during tunnel operation.

Adjustable height gates to allow control of differential pressures between zones and the wash and fill rooms should separate each zone. The gates are adjusted statically, during the tunnel qualification process to the appropriate heights for achieving the proper pressure and airflow velocity balance for each vial profile. The gates between the sterilizing zone and the cooling zone and the cooling zone and the filler serve to isolate the cooling zone from these other areas during the cooling zone sterilization cycle.

The frame of the tunnel must allow expansion during the heating in the direction of the washer. It is recommended that the tunnel feature a presterilization mode to permit the heating up of the tunnel prior to production.

It is important to consider the installation details for the tunnel, including any need for shrouds to cover openings from the equipment to the floor or ceiling of the clean room.

An alternate to a depyrogenation tunnel is a batch oven. Batch ovens should be considered if the batch is small (max approximately 20,000 vials for the 2 mL) and infrequent. If a batch oven is considered evaluation of vial washing and handling, tray handling, staging, carts, and pass through oven configuration is required.

Sufficient space is required around the unit for maintenance of the depyrogenation oven such as replacement of terminal filters. In addition, sufficient exhaust is required to remove humidity and heat that is generated in the room while maintaining the pressurization profile of the filling line.

**Vial filling, stopper placement and capping.** The vial filler should be designed as a monoblock filler (Fig. 7) and specified to aseptically fill, stopper, and cap vials with product at the predetermined fill line speed, fill accuracy, and allowable fill velocity limits. The filler should be capable of operating in both a run mode and a maintenance mode.

Particular attention should be paid to the design of the filler and its stations for unidirectional airflow (UAF) via HEPA-filtration provided by the room HVAC system or a dedicated HVAC system.

**Filler infeed** As the vials exit the tunnel, they are singularized and transitioned into the filler by transport conveyor. The vials are positively conveyed and held by a belt designed to transport vials of the predetermined dimensions and mass of the specific glass vial.

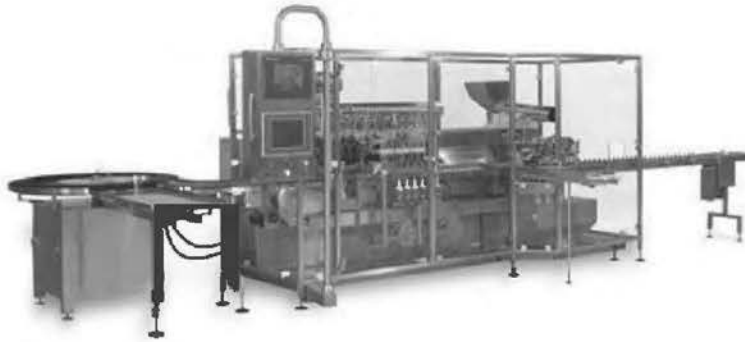

**Figure 7** Monoblock vial filler (12).

The number of filling pumps and dispensing nozzles will be determined by the required line speed and the diameter (bore) of the filling nozzles as the diameter relates to the fluid properties of the particular product being filled. The characteristics of the product will affect the maximum fluid velocity allowable, thus determining the required fill nozzle bore and the number of pumps and nozzles to achieve the line speed.

**Stopper placement** After the vials are filled, the transport system conveys them to the stopper placement station. The preprocessed (cleaned) and sterilized stoppers are supplied to the filling line in disposable bags that docked at the plunger placement station RTP and are feed into a supply hopper through that RTP and are feed into a supply hopper sized according to the filling throughput. The size of the hopper should be dictated by

- the maximum dimensions permissible for sterilization of the hopper in an autoclave
- required unattended run time
- line speed
- maximum allowable load height the stoppers can withstand without being damaged and/or generate particulate.

The hopper will feed stoppers to the sorting bowl where the stoppers are orientated for accurate repeatable placement into the vials. The sorting bowl should be sized to supply stoppers to support the filling line speed and be limited such to permit sterilization in an autoclave.

**Capping** After the vials have a stopper placed the filled and stoppered vials are fitted with clean aluminum caps and then crimped such that the vials are designated as “closed containers.” Care and consideration should be given to the design and operation of the capper to ensure that stoppers do not rise during transport, caps are not damaged during crimping, and particulate generation is minimized. The predetermined stopper placement criteria and capping requirements will be verified by the inspection system located in the packaging area.

Capping operations are to occur under ISO 5 protection. As the operation generates aluminum particulate, continuous monitoring at the capper head is not recommended, although viable monitoring can occur.

It is recommended to provide a transport path for presterilized cap-contact components from the autoclave to the capper. In a conventional or RABS filling line, this path should remain in ISO 7 conditions or provide additional wrapping. In an isolator facility, the components can be conveyed through ISO 8 and reesterilized by vapor phase hydrogen peroxide after installation.



In a conventional or RABS facility, it is required to provide a method for feeding presterilized caps, in bags, into the ISO 7 room. It is important to note that not all aseptic operations require the use of sterile caps.

Sufficient space needs to be provided to stage caps. Proper space should also be provided for any lift assist required for operations such as docking of cap bags to the RABS or isolator wall.

In the ampoule sealing operation, it is required to supply natural gas to the sealing mechanism. It is recommended that a gas bottle manifold be provided outside classified space. In addition, gas detectors, tied to an alarm system, are required at the sealing area for safety.

**Vial check weighing** To minimize product loss (low fills rejected and required % over fill), it is recommended that the filler incorporates a check weighing system to verify and fine tune the fill volume during setup and as verification during the course of a run. A reject bin should be located for fallen or misaligned vials prior to tare weighing. At low speeds, 100% check weighed in line is possible; however, at higher line speeds only 4% of the vials can be check weighed due to the mechanical limitations of removing vials from the line to be check weighed out of place and then replacing them in the line. Typically, for most vendors, the line speed cut off for 100% check weighing is 200 VPM (vials per minute).

On the basis of net weight, the control system will correct the volume of product that is dispensed by the nozzles. The tare and gross weigh verification system should be calibrated prior to each fill operation.

The filler check weigh control system should be programmable to reject vials whose gross product volume does not meet the acceptable minimum and maximum volumes and to alarm after repeated low volume parameters programmed in the controller are exceeded.

**Inspection** Inspection operations can be manual, semiautomatic, or automatic. Tables utilized for manual inspection and sorting of rejects should be designed to permit segregation of pass and nonpass product. Lighting must be adjustable to permit optimal conditions for manual inspection.

Adequate space is to be provided for product to be accumulated onto trays/tubs/containers, covered, labeled, and manually palletized. A staging area for empty pallets needs to be included in the room design.

**Trayloader.** After the vials are capped/closed they are conveyed to the tray-off station where the vials are automatically trayed off and then the full trays are manually stacked on carts or pallets for transport to the packaging area or cold storage. The number of tray stations is determined based on line speed and size of tray.

Figure 8 is a picture of a commonly used tray loader:

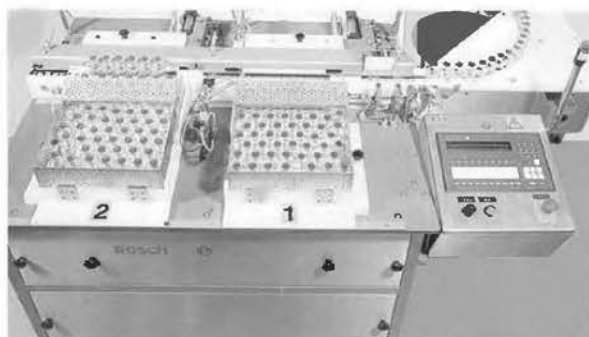

Figure 8 Tray loader (12).

### *Lyophilization*

A lyophilization system generally consists of the following components:

- Drying chamber
- Movable shelves, inside the chamber
- Stoppering mechanism
- Vapor condenser
- Refrigeration system(s)
- Vacuum pumping system(s)

Depending on schedule and batch size requirements, there may also be equipment for automatic loading and unloading of the vials into and out of the chamber.

Typically, the lyophilization process consists of the following events:

- Transporting of liquid product filled, partially stoppered glass vials from the filling room to the lyophilization area.
- Loading of the vials onto the lyophilizer chamber shelves, under aseptic conditions. This may be done automatically, via a conveyor or a loading cart, or manually with the use of HEPA-filtered carts with trays.
- Freezing of the product in the vials by cooling the lyophilizer shelves
- Sublimation of the water by pulling vacuum in the lyophilizer chamber, and then heating the shelves. This vapor leaves the chamber, travels through a duct, and enters into a condenser, where it collects onto cooling coils in the form of ice.
- Once the product has completely dried, full stoppering of the vials by stoppering mechanisms inside the lyophilizer. This is typically performed after a partial release of vacuum.
- Relieving the vacuum in the lyophilizer chamber.
- Unloading of the vials from the chamber.
- Defrosting of the ice accumulated on the condenser coils.
- CIP of the chamber, shelves, and condenser.
- Leak testing of the chamber. This test can be performed either before or after the SIP operation.
- SIP of the chamber.

Lyophilization equipment should not be product specific, but production (i.e., throughput) specific. An overall production schedule must be created, illustrating the maximum production level possible for the facility. This schedule should include all the aspects of production, including preparation of buffers, product formulation, filling and freeze-drying times, equipment cleaning, and sterilization, etc.

Typically, the overall production schedule will be dictated by the most time consuming steps, such as filling and freeze-drying. It is desirable to maximize use of this equipment over the hours of operation. The overall schedule then shall evolve from a balance of targeted batch sizes and formulation activities required to support maximum use of the filling line and the lyophilizers.

When developing a production schedule that includes lyophilization, the following key elements shall be considered, in addition to the other factors related to the formulation and filling operations:

- Number of lyophilizers
- Size of the lyophilizer chamber
- Duration of the lyophilization cycles
- Equipment cleaning and sterilization
- Speed of the lyophilizer loading/unloading system

Consideration should be given for the length of the freeze-drying cycle. As the cycle time is reduced, a larger percentage of time is required for loading, unloading, and equipment turnaround between batches.



Sufficient space is required in the lyophilizer mechanical chase to provide maintenance access to the chamber, condenser, stoppering ram, and refrigeration systems. Platforms and ladders must be provided for safe access. Safety rails need to be provided at the edge of the chamber and condenser to prevent falls. Ladders should be provided with safety cages, if required.

The rear door of the chamber must be opened for inspection and must have a controlled environment.

It is recommended to locate the condenser below the chamber to limit the size of the lyophilizer aisle while maintaining access to the rear door.

**Chamber.** The drying chamber contains the shelves where the product vials are placed for the freeze-drying cycle.

The vials are only partially stoppered when they are introduced in the chamber. To reduce potential of product contamination during loading, there shall be a laminar airflow (LAF) curtain in front of the chamber door.

The chamber will have pressure proof door(s), fabricated of the same material as the chamber. A minimum of one door is required for vial loading, unloading, and maintenance. Typically, the chamber will also have a slot-type door if the vials will be loaded automatically (Fig. 9). The automated loading system will be designed to lock onto to this door prior to the vial transfer. The number of doors will also depend on the facility layout selected for the manufacturing processes: the chamber then can be designed as single sided, with vial loading and unloading from the same side, the clean area, or pass through, with vial loading from one room, and unloading from another room. Mechanical configuration options will be discussed further ahead, in section "Gowning Philosophy."

**Shelves.** Shelves are located inside the lyophilizer chamber and stacked in a vertical arrangement. They are hollow, containing channels through which diathermic heat transfer fluid (HTF) circulates to either cool or heat the shelves. They shall be constructed of 316L stainless steel.

Vial loading can be automatic, with the use of loading equipment, which is discussed in more detail in section "Product Filling." Loading can also be manual, using bottomless type

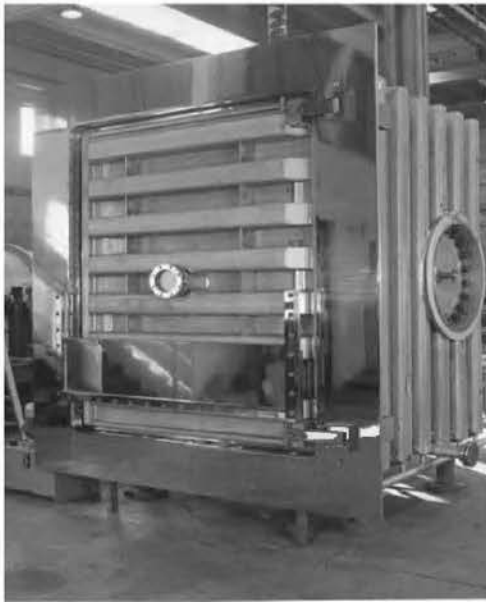

Figure 9 Lyophilizer chamber (13).

trays. With these, the vial pack is placed on the tray and tightly banded together with a ring. The operator places the tray onto the shelf, and then slides the tray off, leaving the vials on the shelf by holding onto the ring. This method places the vials directly onto the shelf surface, which is the preferred setup. The direct contact between shelf and vial promotes optimum heat transfer.

Alternatively, the tray could be left in with the vials for the entire length of the lyophilization cycle. The added material between the shelf and the vial will cause a decrease of heat transfer rate. Although it is possible that this could be a requirement for some products, typically, it is not recommended. With time, the tray could become deformed due to the constant temperature changes it is exposed to. A slight deformation will cause the tray not to be in complete contact with the shelf, compounding the heat transfer issue.

Prior to vial loading, it shall be possible to lower the shelf temperature prior to placement of the vials on the shelves. This is typically done for products that require constant refrigeration. It is recommended that this temperature be above the product freezing point. When this process is employed, it is recommended to provide a low humidity zone at the door to the lyophilization to minimize condensation on the shelves.

The shelf stack is sandwiched between two upper and bottom pressure plates. The plates are connected to a mechanism that moves the shelves up and down. It is this mechanism that allows the complete stoppering of the vials mid-cycle, after the product has dried. As the shelves move closer together, the stoppers are fully inserted in the vials, pushed by the underside of the shelf above.

Shelves must be fully loaded with vials during stoppering. If a shelf remains partially empty after loading all the product vials, empty vials will be loaded to evenly fill the shelf.

The moving mechanism can also be used to facilitate the loading and unloading of vials. For example, initially, the shelves can be collapsed at the bottom of the chamber on top of each other. At the beginning of loading, the top shelf aligns with the door and is loaded first. When it is full, the shelf moves upward one space, allowing the second shelf to be loaded. The process repeats until all shelves are full.

**Condenser.** The liquid removed from the vials during the drying process will accumulate and form ice onto coils containing HTF fluid. In smaller units, these coils can be internal to the chamber. However, more commonly, they are housed in a separate condenser vessel. Both the condenser and the coils shall be made of 316L stainless steel.

The condenser can either be located adjacent to the chamber or at a different elevation (different floors). Selection of the configuration is dictated by the facility layout. It is recommended that the condenser be installed below the chamber to facilitate cleaning and to reduce the facility footprint.

**Refrigeration system.** The refrigeration system(s) cool the HTF that is circulated through the shelves and through the condenser coils. A lyophilizer can have separate, dedicated refrigeration systems, servicing the shelves and condenser circuits independently from each other. Alternatively, there can be one all-encompassing refrigeration system, servicing both circuits. Typically, all condensers would be used for shelf cooling during freezing, and then some of them would be switched to the condenser coils circuit during product drying. This last option of dual purpose compressors is generally more space efficient.

It may be desired to have redundant backup compressors to ensure cycle continuation during the critical drying sequence, even in the event of principal compressor failure. The backup compressor would be sized for cycle continuation only, and not for the larger initial freezing load. Another feature that would support cycle continuation would be automatically switching the compressor cooling media from chilled water to city water in the event of power failure. This would be done because, typically, a plant's chilled water system is not on emergency power. Product value and schedule are principal drivers of these options.

Liquid nitrogen is used for applications requiring a condenser temperature lower than typical compressors can produce. It can also be used as a backup in the event of power loss.



**Vacuum system.** The chamber can be evacuated at different points of the operation (product drying cycle, chamber SIP) to a determined vacuum set point with the use of vacuum pumps.

To achieve a quality high vacuum, it is common practice to use more than one type of pump. An example would be a combination of a rotary vacuum pump plus a mechanical booster pump, in series. As with the condenser, depending on product value and schedule, requirements for equipment redundancy and emergency power must be evaluated.

Additionally, a liquid ring pump may often be used in the chamber and condenser drain lines to promote effective draining of cleaning solutions or steam condensate following CIP and SIP.

**Shelf movement and stoppering mechanism.** The lyophilizer is equipped with a mechanism enabling the movement of the shelves.

As previously mentioned, the vials are stoppered at the end of the drying cycle. As the shelves are moved together, the rubber stoppers are fully inserted into the vials, pushed by the underside of the shelf above.

In hydraulic stoppering, a hydraulic cylinder is mounted on top of the chamber. A hydraulic piston is introduced into the chamber through a seal and is attached to the pressure plate that is positioned above the shelves. The top shelf is connected to the pressure plate, and the shelves are connected to one another. Movement of the plate, thus, will move the shelves.

In hydraulic stoppering, the ram that moves the pressure plate positioned above the shelves can be introduced in the chamber as the shelves move together. To avoid contamination from this ram, which normally resides in the mechanical area of the lyophilizer, it is customary to fit it with protective bellows constructed from stainless steel or other suitable material. The bellows shall be designed to cover the full extension of the ram. The surface exposed to the chamber shall also be able fully cleanable and sterilizable. It is advisable to perform bellows integrity tests prior to SIP to ensure that contamination shall not leak into the chamber.

**Gas system.** After pulling and holding vacuum, the chamber is restored from vacuum back to atmospheric pressure by introducing air or other inert gases, such as nitrogen. The process is also referred to as backfilling.

The gases should pass through sterilizing filters prior to entering the chamber.

It is possible to vary the pressure set point up to which the chamber is backfilled to. For instance, some products require that stoppering occur at a pressure below atmospheric. Upon completion of the vial stoppering step, the chamber is then completely backfilled to atmospheric pressure.

Requirement to backfill the chamber with inert gases is largely dependent on the product being processed. The inert gas would be introduced during the stoppering operation to fill the vial head space. The inert gas is then purged from the chamber, and process air is introduced for complete backfilling prior to vial unloading. It is important to provide oxygen level sensors in inhabited areas adjacent to the lyophilizer both on the clean room side and on the technical chase to notify personnel in the event of a gas leak.

#### *Load System Design*

After the vials have been filled at the filling line, the product needs to be transferred into lyophilizers; the options range from completely manual to completely automatic. This can be done manually with carts or with a fully automated loading system, either cart based or conveyor based. In the cart-based approach, safety concerns with the use of robotic transfer can be accommodated by properly designing the lyophilizers aisle. In the conveyor-based design, personnel access to both sides of the filling line needs to be taken into consideration (Fig. 10).

In cart-based facility designs, it is required to provide barriers in place to prevent operators from entering the travel path of the robotic cart. These barriers can consist of safety rails or walls around the lyophilizer aisle area. Any doors that permit entry must be interlocked to prevent movement of the cart. In addition, operators must be protected from



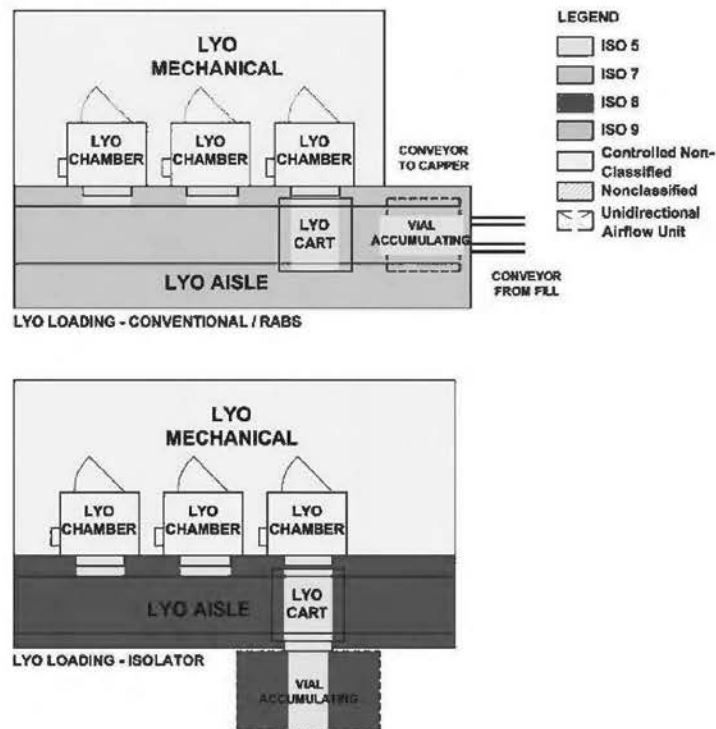

**Figure 10** (See color insert) LYO load/unload.

contacting the powered rail during cleaning of the area. Alternatively, if the power rail is not sufficiently protected, power should be disabled during cleaning of the rail.

In conventional or RABS fill lines, sufficient ISO 5 coverage is to be supplied to permit operator access to the cart for sampling or cleaning, with barrier doors opened. In addition, a row of HEPA filters is required above the slot door to cover any gap during docking of the cart to the lyophilizer. The air is required to be dehumidified to prevent condensation on shelves, if cold loading is required.

Ceiling heights for isolator facilities should account for locations of terminal HEPA filters. Adequate space should be provided to permit routine testing and replacement.

In isolator facilities, space for a docking station is required to permit automated cleaning and sterilization of the cart.

Facility design for cart-based systems need to provide an area for maintenance, permitting full access around the cart.

The loading system must be capable of providing the ability to control vial movement from the filler to the lyophilizer, and from the lyophilizer to downstream operations of capping and inspection. Positive control must be maintained over the vials to prevent tipping. Depending on the layout and production demands, the design may need to provide flexibility to convey different vial sizes for products with different schedules. The loading system must provide ISO 5 laminar flow air above the open vials at all times. It also must be capable of being cleaned and sanitized. The following is a selection of load system options.

**Manual loading with HEPA carts.** This is the most basic, flexible, and cheapest option to load the lyophilizers. It would require the use of manual HEPA filtered transfer carts. Ten to twenty trays are manually loaded into the cart and transferred manually into each lyophilizers through the slot door. This operation requires an ISO 7 lyo aisle with localized ISO 5 at the

lyophilizer doors. Carts are charged at 120 V power outlets and can hold their charge for duration of batch. It can process both vials and syringes. Trays must be used to perform this transfer. The trays must be cleaned and sterilized separately and stored in an ISO 7 environment.

**Manual loading with pusher mechanism.** This option consists of a pushcart type device that rides on rails down the lyo aisle. Vials are manually loaded on to the cart then wheeled down to the lyophilizer. Vials are pushed with a mechanical assist on the cart into the lyophilizer through the slot door. There is much better vial handling with this option, but it may require a slower line speed than targeted. It will require ISO 5 space in the lyo aisle. Although this approach has been successfully implemented, it has not been done recently. This option cannot process syringes. No containment can be offered with this option.

**Conveyor.** This option consists of a conveyor that runs down the lyo aisle from the filler to an auto loader stationed in front of each lyophilizer. A pusher mechanism pushes vials onto each shelf, row by row. After the lyophilization process is completed, the vials are removed by using a pusher in the back of the chamber or a sweep arm to pull vials out through the slot door. Vials are then descrambled and sent by conveyor to the capper. This process eliminates the manual handling of vials. It will require ISO 5 space above the entire length of the conveyor. The use of a buffer table permits continuous operation of the filler during the actuation of the pusher mechanism.

**Transfer cart.** This option consists of an auto loader cart, which shuttles between an accumulating table and each of the lyophilizers (Fig. 11). The system is designed to accumulate enough vials to fill either a full lyo shelf or half of a shelf only. It would not be able to handle syringes. This option would require ISO 7 space in the lyo aisle with at least a localized ISO 5 hood above the cart. If an isolator is used, the lyo aisle environmental grade can be lowered to ISO 8.

**Integration of loading system into the facility.** In a cart-based design, the isolated cart will be required to dock with a cleaning and sterilization station. The station is capable of performing CIP and sterilization by VHP. For a RABS design, the cart would be parked in a maintenance area, where a manual cleaning and sanitization would occur.



**Figure 11** Lyophilizer transfer cart with loader and unloader (13).

Depending on the facility design and the production requirements, the lyophilizer load system may interface with different unit operations, including but not limited to the following:

- Filler outlet conveyor
- Capper inlet conveyor
- Lyophilizer chamber slot door
- Buffer accumulator, if cart, to facilitate the unload of the lyo chamber
- Cleaning/sterilization docking area, if cart and designed as an isolator
- Maintenance area, if cart

#### *Aseptic Syringe Filling Line Process Overview*

There are various options and configurations available for a syringe filling line, including use of presterilized syringes, material of construction, number of chambers, and filling technology. The configuration choice should be based on requirements for the following:

- Product: A specific requirement of the product for one filling technology, due to material incompatibility, product stability, or marketing requirement.
- Component selection: Selection of filling technology must be based on product needs.
- Level of sterility assurance
- Delivery technology: Delivery method affect the selection of the filling technology
- Number of units: Selection of the filling technology must be based on the annual production requirement and batch sizes
- Unit cost: The cost to produce each syringe
- Capital cost: The actual cost to purchase equipment, not including engineering, construction, validation, and commissioning.
- Operational cost: The cost to operated equipment and supporting facility.
- Preference: Is there a clear preference for a specific filling technology due to corporate experience, level of comfort with a given technology, or market demands.

The following figure (Fig. 12) maps the decision process for the appropriate line configuration.

Although alternate technology selections will be mentioned, for this chapter, focus will be on filling of single-chamber, presterilized glass syringes in a nested format.

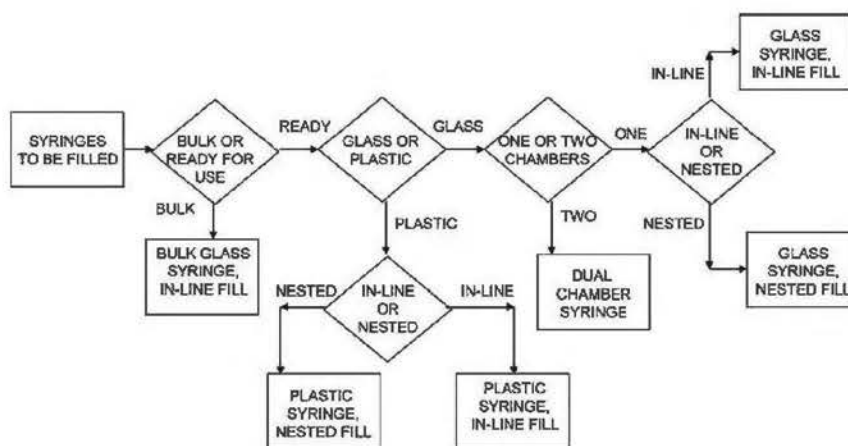

**Figure 12** Syringe filling options.



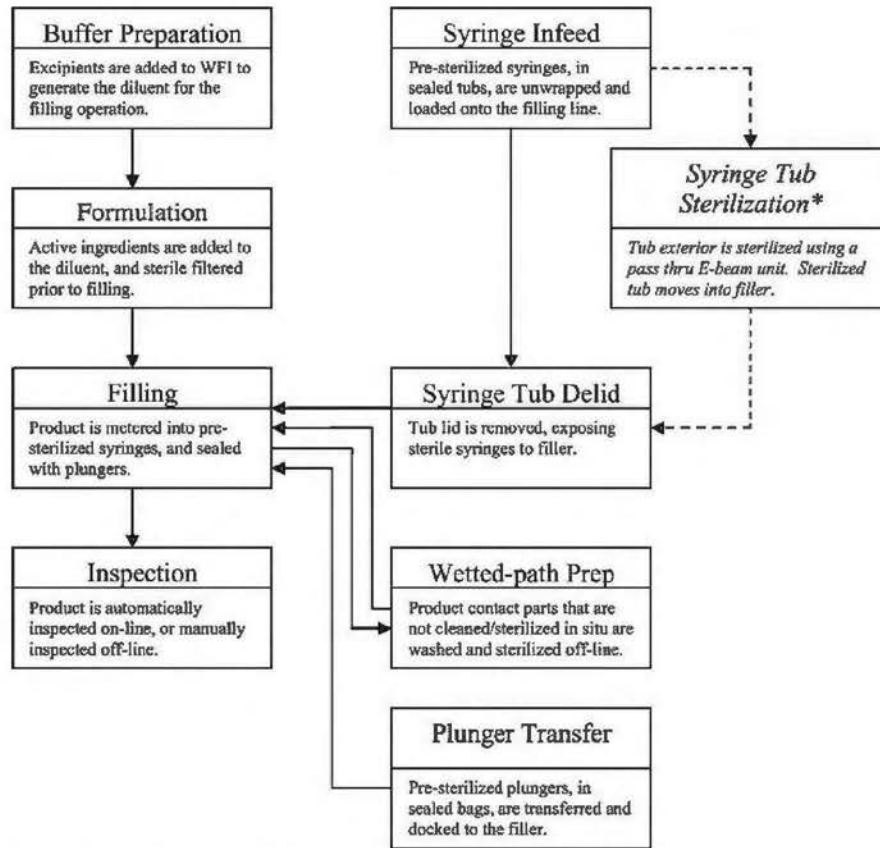

Figure 13 Process flow, nested syringe.



Figure 14 Wrapped tub (14).

**Nested syringe filling.** Typically, the nested syringe filling line process consists of the following events (Fig. 13):

- Transporting empty glass syringes (precleaned and presterilized) in bagged tubs to the nested syringe filler (Fig. 14)
- Sanitizing the bag under unidirectional HEPA-filtered airflow.
- Unwrapping tubs of syringes from their protective bag(s) under unidirectional HEPA-filtered airflow
- Removing the lids of the tubs (delidding) under unidirectional HEPA-filtered airflow
- Automatically conveying the syringes into the syringe filler infeed
- Removing nests from tubs



- Aseptically filling the syringes with sterile filtered product feed from the product hold tank(s)
- Inserting the plunger to the product-filled syringes
- Replacing nests in tubs and conveying to inspection
- Removing syringes from tubs and nests
- Inspecting syringes. Addition of ID code
- Placing syringes into tubs or Rondo trays
- Transferring the closed syringes for downstream processing to the packaging area or cold storage

Figure 15 represents examples of syringe-filling operations utilizing conventional filling, RABS, and isolators.

**Tub sterilization station.** Cardboard and other packing materials are to be removed prior to entry of syringe tubs into the ISO 8 infeed area. In the material airlock, tubs should be transferred onto captured pallets or carts to limit particulate or bioburden. The nested syringe tubs are transported to the filling line and placed onto the infeed at the tub wipe down station, which is under unidirectional HEPA-filtered airflow. The outer bag of the double-bagged tubs is sprayed and wiped down with disinfectant and then removed and disposed. The inner sterilized bag is then removed and the tub is feed forward to the lid removal station.

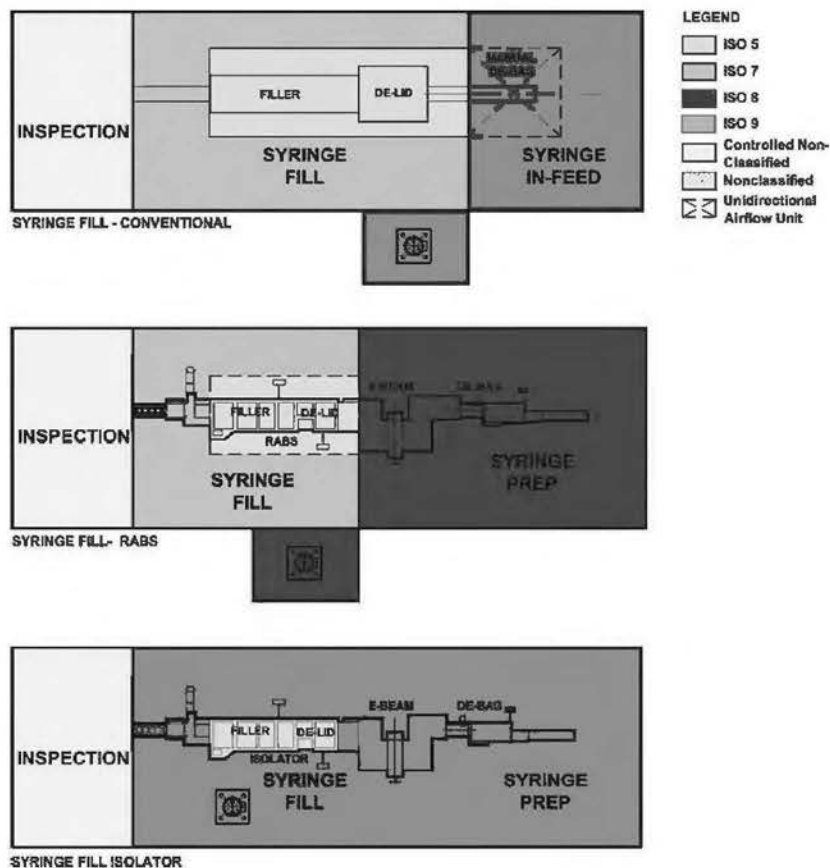

Figure 15 (See color insert) Syringe fill.

Provisions for plastic waste removal need to be incorporated into the design of the syringe loading area.

As there are large quantities of presterilized tubs that must be loaded onto the filling line, the aseptic handling and manipulation of tubs is critical to the process, in a conventional clean room facility. In a conventional facility, plastic overwrap is removed under an HEPA-filtered hood to protect the tubs during the operation. Plastic is peeled back using aseptic technique. Unwrapped tubs are passed through from the loading area into the ISO 7 filling room, utilizing a gravity conveyor. In a RABS or an isolator facility, it is recommended to remove the plastic overwrap and sterilize the exterior surface of the tub prior to entering the fill zone, using technology such as e-beam. The plastic bag can be removed either manually or automatically. Alternatively, for small-scale facilities, vapor-phase hydrogen peroxide (VPHP) chambers can be used to sterilize the bag, with tub inside, prior to entering the ISO 5 fill area.

An "e-beam" can be implemented in lieu of manual disinfection of tubs prior to lid removal station. An e-beam sterilization unit provides repeatable, monitored, validatable sterilization of the tubs and minimizes manual manipulations of the bags and tubs and operator contact prior to entering the ISO 5 filling space. The addition of e-beam sterilization technology, however, adds significant equipment cost and additional facility space requirements to accommodate the footprint required for this type of system.

Sufficient space is required around the unit for maintenance operations such as removal of lead shields, using ergonomic assist. In addition, a maximum distance is allowable from the e-beam generator units to the sterilizer, requiring location of generators in close proximity above room.

When an e-beam sterilizer is used, monitors for ozone and X-ray levels must be provided to ensure a safe working area for operators.

**Lid removal station.** At the lid removal station, the lid, Tyvek cover, and liners are removed from the tub and disposed. The tub is moved from the work space receiving unidirectional HEPA-filtered airflow through a wall partition (pass through) into the ISO 5 filling and plunger insertion machine as the lid is removed.

An automatic lid removal machine can be implemented in lieu of manual lid removal the tubs. An automated lid removal operation provides repeatable, monitored, validatable removal of lids and minimizes manual manipulations and operator contact. The automated system is required when utilizing an e-beam machine.

Adequate space is to be provided for operators to manually remove the lids and liners from tubs in a conventional line, without introduction of particulate or bioburden. It is recommended to provide a barrier for operator segregation. In a RABS or isolator line, this operation is to occur automatically inside a barrier.

Provisions for waste removal needs to be incorporated into the design of the fill room, where the delid operation occurs.

**Nested syringe filling and plunger insertion station.** The syringe filler should be designed as a monoblock filler and specified to aseptically fill and insert a plunger at the predetermined fill line speed, fill accuracy, and allowable fill velocity limits. The filler controller should be capable of operating in both a run mode and a maintenance mode.

Particular attention should be paid to designing the filler and its stations for UAF via HEPA-filtration provided by the room HVAC system or a dedicated HVAC system.

The nested syringes are automatically conveyed from the lid removal station, automatically removed from their nests (Fig. 16), and filled (Fig. 17). The syringe filler should be specified to aseptically fill and insert a plunger into the syringes on a nested-syringe filling system. As they are transitioned into the filler the nested syringes are conveyed and held by a belt designed to transport syringes in nests.

**Singularized syringe filling and plunger insertion station.** The singularized syringes are automatically conveyed from the depyrogenation tunnel to the filler and filled. The syringe filler should be designed and specified to aseptically fill and insert a plunger into the singularized syringes (Fig. 18).

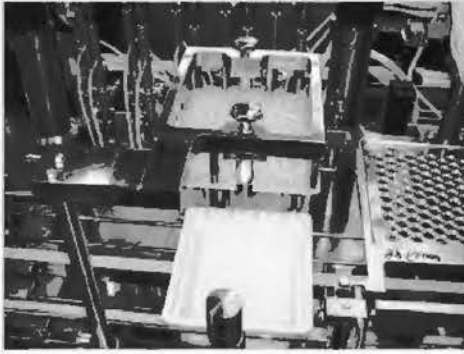

Figure 16 De nesting (15).

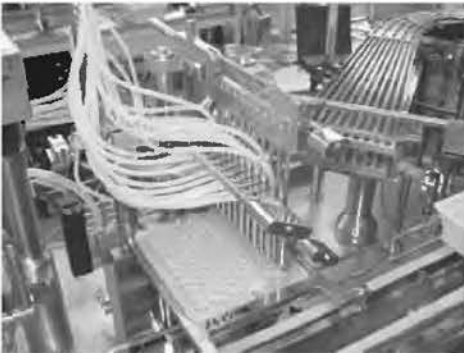

Figure 17 Nested filling (15).

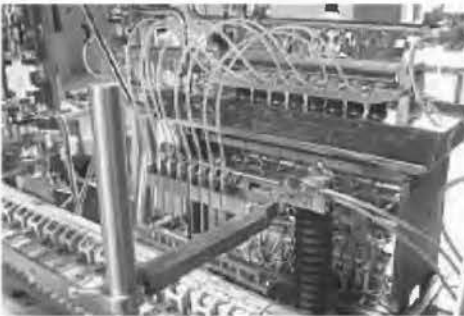

Figure 18 Singularized filling (15).

The syringes will be filled via the product dispensing fill nozzles with the volume of product programmed into the control system. To provide sterile-filtered product, the product is fed via an RTP from the hold tank positioned at the filler to rotary piston filling pumps and sent to the product dispensing nozzles. The product tank/filler docking station with RTP will be subject to unidirectional airflow.

**Plunger insertion.** After the syringes are filled, the syringes will have a plunger inserted. The plunger insertion rams are located immediately after the filling nozzles (Fig. 19). Flushing with gas during the insertion of the plunger and/or the addition of vacuum assist for plunger placement is to be evaluated on a project/product specific level where product protection is





Figure 19 Plunger insertion (15).

required. The preprocessed (cleaned) and sterilized syringe plungers are supplied to the filling line, in disposable bags that docked at the plunger placement station RTP and are feed into a supply hopper through that RTP. (Note: Plungers supplied in matrix form could be considered as an alternate; however, this is an open issue in regards to the RABS design.) The supply hopper is sized according to the filling throughput. The size of the hopper should be dictated by

- the maximum dimensions permissible for sterilization of the hopper in an autoclave
- required unattended run time
- line speed
- maximum allowable load height the plungers can withstand without being damaged and/or generate particulate.

The hopper will feed plungers to the plunger guide track where plungers are oriented for accurate repeatable placement into the syringes by the plunger insertion rams. When the plungers are placed, the containers are considered sealed. The plunger insertion depth is programmable by the control system and will be verified by a downstream inspection.

**Syringe check weighing.** To minimize product loss (low fills rejected and required % over fill) it is recommended that the filler incorporates a check weighing system. The singularized syringe presentation allows individual verification and fine tuning of the fill volume during setup and statistical verification during the course of a run. At low speeds, 100% check weighed in line is possible; however, at higher line speeds approximately 3% of the syringes can be check weighed, due to mechanical limitations of removing syringes from the line to be check weighed out of place and then replace in the line. Typically, for most Vendors, the line speed cut off for 100% check weighing is 200 syringes per minute (SPM).

On the basis of net weight, the control system will correct the volume of product that is dispensed by the nozzles. The tare and gross weigh verification system should be calibrated prior to each fill operation.

The filler check weigh control system should be programmable to reject syringes whose gross product volume does not meet the acceptable minimum and maximum volumes and to alarm after repeated low volumes parameters programmed in the controller are exceeded.

**De-nesting (nested).** After the syringes are closed they are conveyed to the denest station where the syringes are removed from the nests with a 10-syringe manipulator.

At the exit of the machine, it may be desirable to install a paternoster, or elevator, to lift the syringe tubs prior to exiting the room. This permits operators to have access to both sides

of the filling line, improving the personnel flow in the room. The paternoster can also be used to transport tubs to another downstream operations taking place on another level of the building.

The syringes are then singularized for inspection, labeling, or repackaging into Rondo trays. The syringes are removed from the line, placed into tubs with lids, and manually stacked on syringe carts or pallets for transport to the packaging area or cold storage. In the event Rondo trays are used, the tubs and nests are removed from the station for disposal.

#### *Alternate filling technologies*

**Blow-fill-seal.** This fill technology can be considered a closed process as the bottle is formed immediately prior to filling and then sealed under ISO 5 conditions (Fig. 20). Following filling, the plastic ribbon generated in the filler, containing the bottles, needs to be cut away. Strips of bottles are then inspected, using destructive methods. If the product requires containment, additional segregation is required for the workstation.

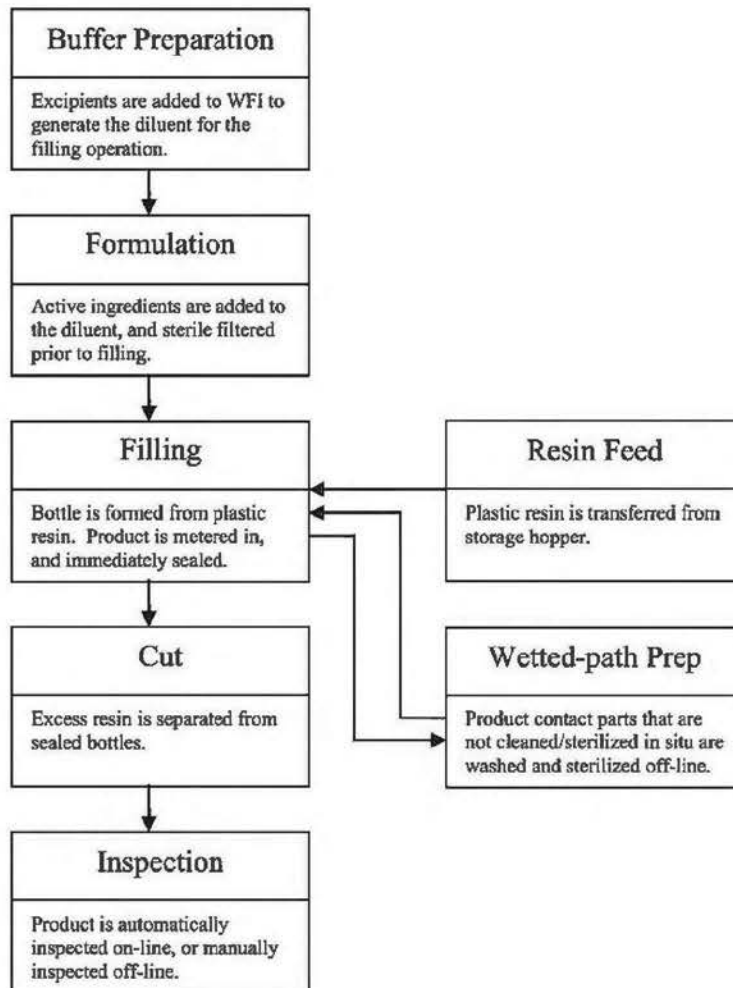

**Figure 20** Process flow, blow fill seal.

Sufficient space needs to be provided for bulk containers of bulk plastic resin. Sufficient ceiling height is required to house the resin feed system. Exhaust ventilation is required to ensure that plastic dust particles are not permitted to migrate from the space and be carried into clean rooms.

As the filler is a closed system, the filling machine can be located in an ISO 8 room. Sufficient room height is required for the resin hopper. Sufficient clearance is required for maintenance of the filler. A flow path, including material air lock, for removal and replacement of filler parts is required.

Provisions for plastic waste removal need to be incorporated into the design of the ribbon cutting area.

As fill check is typically destructive and requires product to be expelled from the filled units, provisions need to be made for a workstation, with vacuum. If product requires containment, additional segregation is required for the workstation.

**Plastic bottle.** The infeed process in presterilized bottle filling is similar to that of the presterilized syringe. As there are large quantities of presterilized bottles, tips, and caps that must be loaded onto the filling line, the aseptic handling and manipulation of components is critical to the process. Cardboard and other packing materials are to be removed prior to conveying bags containing presterilized bottles into the ISO 8 infeed area. In the material airlock, bags of bottles should be transferred onto captured pallets or carts to limit particulate or bioburden.

In a conventional or RABS filling line, outer bags are removed, exposing inner bag. Bags should be unwrapped under HEPA filtration. Bags are handled via aseptic technique and passed into the ISO 7 filling room. In isolator facilities, it is recommended to permit the bags to dock to the isolator for transfer (Fig. 21).

Provisions for plastic waste removal need to be incorporated into the design of the bottle infeed area.

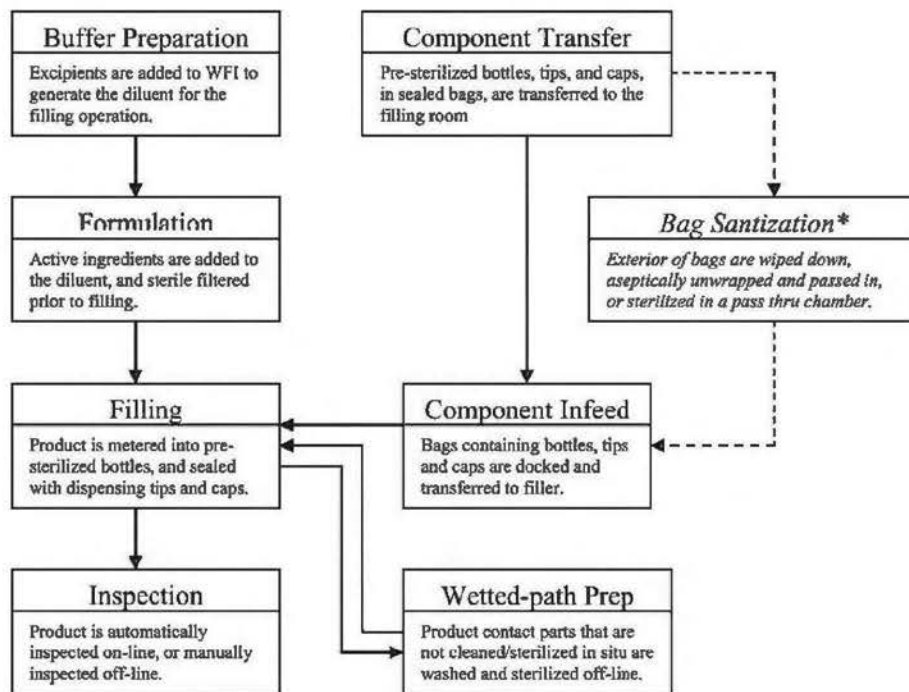

\*Not required if isolation fill technology is used.

Figure 21 Process flow, plastic bottle. \*Not required if isolation fill technology is used.



**Component Prep**

In all sterile facilities, it is important to properly prepare new components for use in the filling operation. It is also required to adequately decontaminate, clean, and sterilize all reusable parts. This section describes the various steps in the component preparation process (Fig. 22).

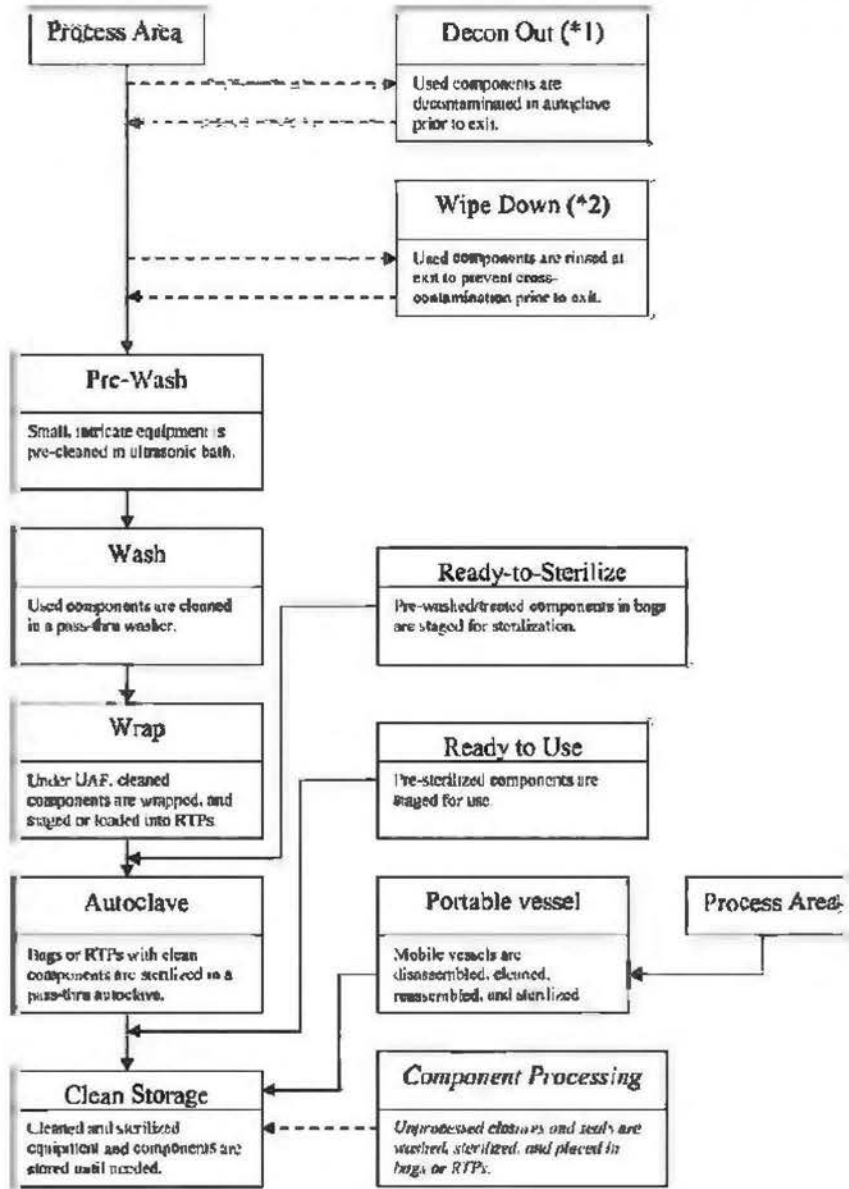

\*1. Required in Live virus facility  
 \*2. Required in potent compound or multi product facility

Figure 22 Process flow, component prep. \*1. Required in live virus facility. \*2. Required in potent compound or multi product facility.

If live virus or viral vectors are in use, it is required to decontaminate any used components or waste prior to exiting the suite. A decontamination autoclave is to be provided for safe disposal of solid materials. For liquid waste, chemical or heat decontamination is required prior to discharge to sewer.

In a multiproduct multisuite facility, it is recommended to place all used components into a secondary containment device, such as a bag or a cart, seal all openings, and wipe down the exterior of all used components prior to exiting the suite and entering the common return corridor.

Once components are returned to the washroom, it is required to disassemble components, discard trash, and wash reusable components. Small intricate components are to be prewashed in an ultrasonic sink prior to placing them through a parts washer.

Adequate space is to be provided for operators to manually wash components and place on drying racks. Exhaust ventilation is required to remove humidity buildup during washing.

It is recommended to provide space for post-use integrity testing of vent filters prior to disassembly at this location.

Provisions for waste removal need to be incorporated into the design of the room.

Pass-through washer shall be provided with specialized racks to contact all internal and external surfaces of components being washed and depyrogenated. Following the washing operation, the washer shall be designed to completely dry all components prior to unload. External ventilation over the unload door is not required for this reason.

Adequate space is to be provided for operators to load, unload, and change racks for different load patterns. A staging area is required for racks that are not in use.

Sufficient space is required for staging of parts to be washed as well as space for washed parts following unload. Unload should be conducted under HEPA filter protection.

When components such as RTPs or small vessels are cleaned in the parts washer, loading and unloading operations are to occur with the assistance of an ergonomic lift to avoid operator injury.

Components that have been washed shall be wrapped under HEPA filter protection to avoid redepositing particulate, including endotoxins. Once bags are sealed, they can be stored on racks. Adequate space is to be provided for the wrapping operation followed by heat sealing of the autoclave bags.

In an isolator facility, it is also required to load the RTP under HEPA filter protection to avoid depositing particulate inside the RTP.

Once bags and RTPs are sealed they can be stored on racks to wait for loading into an autoclave.

Autoclaves are designed to sterilize dry porous (stopper bags) and nonporous loads (steel components). Following sterilization, if components have been placed into sealed containers and cooled to ambient conditions, an ISO 5 area is not required at the exit of the autoclave. If components are not completely sealed, an ISO 5 area is required to complete any reassembly or sealing.

Pass-through autoclave is designed to sterilize all components, porous and nonporous, with clean steam. The autoclave is to be designed with ventilation to provide cooling to components prior to unload. As components are cooled to ambient conditions prior to unload, exhaust ventilation is not required at the exit.

A sufficient space is to be provided for staging of autoclave racks not in use.

Adequate space is to be provided for operators to stage racks of cleaned and sterilized materials required for production operations.

Space is also required for staging mobile vessels. Docking stations are required for this purpose, permitting pressurization with process air or nitrogen and connection to process control for monitoring the vessel pressure. Sufficient space is required for moving vessels in and out of the staging area.

If raw components, including stoppers, caps, and plungers, are to be used in the process, it is recommended to design the facility to accommodate processing on-site. Processing consists of washing, drying, siliconization, and sterilization.



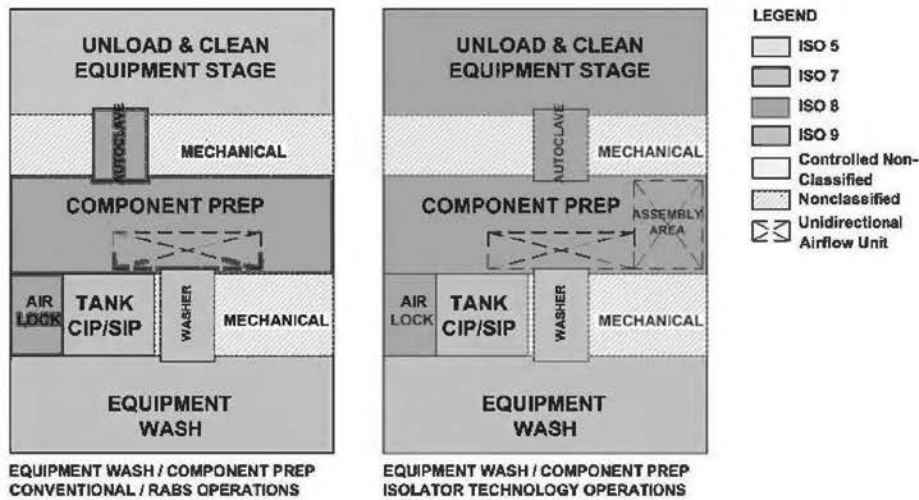

**Figure 23** (See color insert) Equipment wash/component prep.

Components can be loaded into a pass-through processor or into a single-sided processing vessel. The facility will be designed around one technology.

Processed components can be discharged into stainless steel RTP vessels or bags. Adequate space is required to stage empty and full vessels.

Figure 23 represents examples of component preparation operations utilizing conventional filling, RABS, and isolators:

#### Use of Barrier or Isolation Technology

It is recommended that a filling line incorporate a RABS as a minimum. Barrier systems like RABS or isolators protect the product (active ingredients, etc.) from contamination, the environment, or personnel. They also protect the personnel from the product in the case of potent ingredients and compounds. The degree that the operator must be separated from the process or the operator protected from the product in part determines the type of barrier system, RABS, or isolator.

The operation of RABS fillers and isolated fillers require strict adherence to standard operating procedures (SOPs) in regard to material introduction and the use of the gloveports for manipulations and other operator interventions.

Automation and interlocks integrated into the overall design of the RABS or isolator can support the aseptic integrity of the barrier system in place.

Isolator facilities should be designed to include space for adjustable height work platforms at routinely accessed glove ports for ergonomics. Ceiling heights for isolator facilities should account for locations of terminal HEPA filters. Adequate space should be provided to permit routine testing and replacement.

#### RABS

RABS can be designated as passive, active, and closed. The air classification for any type of RABS should be ISO 5 within the critical zone and the background environment should be ISO 7. All RABS provide the enclosed environment with unidirectional airflow positive to the surrounding space or room. All RABS incorporate gloveports for making interventions into the filler while the doors are closed for production. All RABS provide material transfer through RTPs for the introduction and exit of components, tools, trash, environmental monitoring (EM) materials, etc (Fig. 24).





**Figure 24** RABS filling (15).

A passive RABS provides HEPA-filtered air over the critical areas and exhausts the airflow at the bottom of the barrier into the surrounding room returns. For a passive RABS, the RTPs should include HEPA coverage. The vials leave the filler through a small cut out in the barrier commonly referred to a “mouse-hole.” Passive RABS designs are decontaminated via manual disinfection.

An active RABS is designed like a passive RABS but incorporates an integral dedicated HVAC system to supply HEPA-filtered air to the enclosed work environment and exhaust air to the room returns and the HEPA unit. The vials leave the filler through a “mouse-hole,” which can be designed with an exit tunnel. An active RABS is decontaminated via manual disinfection.

A closed RABS is very similar to an isolator and features a dedicated HVAC system to recirculate the airflow within the barrier work environment. The closed RABS features integrated returns ducted directly back to the dedicated HVAC system. The tunnel interface where glassware is introduced into the filler will require an air curtain with integral air return ducts. The vials leave the filler through a “mouse-hole,” which can be designed with an exit tunnel or include HEPA coverage.

Closed RABS and isolators are similarly complex in their design, construction, and operation; however, the decontamination processes between the two different systems should be noted and carefully considered. A closed RABS is decontaminated via manual disinfection; however, an isolator is decontaminated in a highly controlled process utilizing sterilants such as VHP.

### **Isolator**

An isolator is a closed barrier system incorporating hard walls and utilizing HEPA-filtered air to maintain positive or negative pressure within the critical work environment. Manipulations or interventions into the isolator are performed through gloveports, half-suits, and RTPs to isolate the operations personnel from the critical process. The interior of the isolator must maintain ISO 5 conditions with a background of ISO 8. Critical airflow velocities and pressures within the isolator are maintained by the control system (Fig. 25).

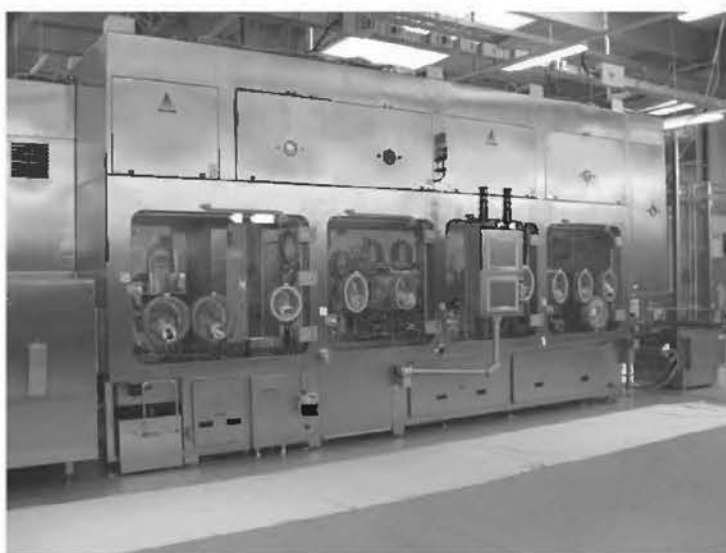

**Figure 25** Isolator filling (16).

#### **General Design Considerations for Transfer Between Machines**

It is essential to maintain a break from one room environment to another when designing the conveyors and transfer mechanisms of a filling line. From one grade to another, the transfers cannot “cross” over; segregation must be maintained whether the conveyor or transfer mechanism is side-to-side or a dead plate (the type of dead plate would depend on the vendor and location of transfer required). The conveyors and transfer mechanisms should be designed to avoid damage to the vials. No catch points should exist on the conveyors or side rails that can tip or scratch the product or damage the identification markings. Mechanical pressure transfers and accumulation that require hard mechanical contact shall be avoided.

Accumulation allows for slight decoupling of the machines and helps smooth out line flow. It is recommended to obtain sufficient accumulation capacity to keep the upstream equipment operating for five minutes minimum (starting with an empty accumulation) with the downstream equipment stopped for all vial sizes. The design, requirements, type, and locations of accumulation should be reviewed prior to final design. Additionally, when considering accumulation, time spent in accumulation and applications of “first in, first out” (FIFO) or periodic accumulation clearance must be addressed.

#### **Stainless Steel Vessels**

Vessels are used for formulation, homogenization, temperature control, and storage of drug products. Vessels shall be of a sanitary design and construction and shall be designed in accordance with current edition of the ASME Boiler and Pressure Vessel Code (17) and the ASME Bioprocessing Equipment (BPE) standards (18).

It is recommended that vessels shall be considered portable when the volume is less than or equal to 300 L and movable when the volume is greater than 300 L but less than 500 L. At or above 500 L, vessels should be considered fixed or stationary. Rooms should be configured to enable the maneuvering of equipment while utilizing ergonomic assists.

Vessels that are exposed to temperatures above 176°F (80°C) through the use of hot WFI, hot CIP solutions or SIP, should be designed for full vacuum service.

All vessels should be jacketed for temperature control, using dimple jackets, which allow for the greatest amount of heat transfer with the least amount of holdup in the jacket. If



required, the jacket fluid should be designed for maintaining the contents at 2°C to 8°C with a propylene glycol/water mixture supplied by a temperature control module.

A single vent filter serves to filter bidirectional flow for both tank venting and process compressed air into the vessel. When designing facilities with portable vessels, all door heights should be set on the basis of the total vessel height, including the vent filter and associated piping, in addition to the dimensions of the vessel.

Weight, a nonintrusive measurement, should be used to determine level rather than other types of intrusive level measurement. If stationary, the formulation tank is mounted on weigh cells for level control. If portable, the vessel can be placed on a floor scale. Prior to use, the empty vessel can be measured and tared. This allows for an accurate measurement of the fluid inside the vessel. Care must be taken during piping design to avoid introducing error in the measurements through pipe stress, which can occur with temperature fluctuations. With proper design (sufficient length and/or bends) sanitary tubing provides enough flexibility to avoid installation of flexible hoses. Schedule 10 or 40 piping will require flexible hoses to be placed in line. Scales can be designed to be either installed in pits or placed on the floor. While pit-mounted scales provide greater access for vessels, they are more difficult to clean and must be located in the exact position they will be needed in. Floor-mounted scales provide more flexibility during design, are easier to clean, but require a ramp from the floor to the scale platform. This ramp will typically require that a tank manipulator be provided to assist the operator.

Following production operations, equipment requiring washing in parts washer are removed. The vessel is fitted with a sprayball. The vessel is connected to a CIP skid at a washing station, designed as a pass-through. This station is provided with a safety curtain to prevent accidental contact of chemical solutions, hot WFI, or clean steam. A sealed floor drain is required in the area. Exhaust ventilation is required to prevent buildup of humidity in the event of an accidental release.

Adequate space is required for operators to make and break connections easily without risking injury including burns.

If local recirculation is required at the vessel station, space is required for a floor-mounted pump.

Proper space should be provided to operate and maintain equipment. All nonessential devices associated with the media or buffer preparation process should be removed from the clean room and located in a technical chase, where they can be routinely inspected. Piping penetrations from the chase into the clean room should be grouped into a single stainless steel wall panel for rigidity and cleanliness.

Following cleaning, but prior to steaming, the sprayball is removed. The vessel is reassembled with all components required for operation and sterilized at the station. Following sterilization, positive pressure is blocked in, the vessel is disconnected, and then moved to staging.

#### **Use of Disposables**

It is possible to replace stainless steel equipment with disposable components, including tanks and piping. Disposable bags have been specially designed to hold liquid, although they will still require stainless steel frames. Liquid transfers can be performed by using presterilized disposable tubing, coupled together by sterile tubing connectors. Solids charges can be conducted via specially designed bags.

When disposable components are used, the requirements for cleaning and sterilization are eliminated, including all piping and automation, which greatly simplifies the construction of the facility. However, product compatibility studies are required to confirm that no issues with product degradation can be anticipated.

### **FACILITY CLEANING AND SANITIZATION**

#### **Filling Line Cleaning and Product Pathway Decontamination**

The filling line should be constructed and designed for surface sanitization with an approved cleaning agent on a periodic basis. The product contact parts, such as the stopper hopper, stopper sorting bowl, change parts, should be cleaned and sterilized. The nonproduct contact



parts, such as starwheels, feed screws, guide discs, should be manually cleaned or disassembled and cleaned out of place in a parts washer.

Isolators are decontaminated with sterilants, such as vapor-phase hydrogen peroxide (VPHP), chlorine dioxide, or peracetic acid. Decontamination cycles for isolators require multiple steps to prepare, introduce, circulate, and exhaust the sterilizing material prior to use in filling, compounding, etc.; the cycle is designed such that it is considered reproducible. VPHP, which is very widely utilized in the industry as a sterilant, is toxic if released into the outside air when concentrated. This issue is among a number of additional details that must be addressed in implementing an isolator for filling line. An isolator decontamination cycle requires adequate time in the operational time cycle for both setup and execution.

#### **Location and Usages of Drains**

Drains are typically required for equipment and facilities housed inside clean rooms. Special considerations are required to ensure that drains do not become sources of contamination. Floor drains are not permitted within classified spaces for aseptic facilities. If spillage occurs from a nonroutine event, it must be mopped up instead. For equipment drains, it is required to separate the equipment from the drain line with the use of an air break. As it is not permitted to have an open drain inside a clean space, the air break should be located in a technical chase.

If it is not possible to locate the air break in a technical chase, the use of a double air break is permitted, allowing an air break locally at the equipment and providing a second break inside a technical chase. Room air from the pressurized clean room flows through the drainpipe into the technical chase. This creates a barrier against migration of contamination into the clean room. In addition, all drain hubs should be sanitized regularly.

At local drains for sample connections, it is typical to provide a funnel at the air break to catch rinses during sampling routines.

It is permitted to use a common drain header for several drain points, provided that cross-contamination cannot occur. For this reason, it is acceptable for drains from a common system to be piped to drain using a common header, but not for drains from multiple systems.

At drain hubs located at floor level in technical chases, it is recommended to install a curb to prevent floor sweepings from becoming inadvertently entering the drain. At each drain hub where steam condensate is routinely encountered, it is typical to provide an HVAC exhaust trunk to extract steam vapors. This practice provides ventilation in technical chases, eliminates buildup of humidity, and inhibits growth of mold. As the steam vapor condenses to form WFI, an appropriate material of construction for the exhaust trunk should be selected.

It is good practice to reduce the temperature of liquid waste entering the process drain system. In low-flow streams that experience high temperatures infrequently, drain coolers using dilution with potable water can be installed. For high volume drain lines that frequently see high temperatures, permanently mounted drain heat exchangers are recommended.

Prior to discharge to municipal sewer, it is typically required to reduce the temperature to below 60°C and adjust the pH to neutralize extremely acidic or basic streams. Collection and treatment equipment can be provided for this purpose, either inside the facility or outside on site.

#### **Waste Decontamination**

If live virus or vectors are in use, it is required to decontaminate any used components or waste prior to exiting the suite. The facility should be configured to permit the use of a pass-through autoclave at the exit of the sterile suite. Used materials should be bagged to prevent contact with operators during transfer.

Liquid waste generated during facility cleaning is also required to be decontaminated chemically prior to discharge to the biowaste collection system. Adequate facilities are to be provided for this operation, including installation of a biowaste discharge point.

Adequate staging space is required to temporarily store material ready for decontamination operations. Provisions for waste removal following decontamination need to be incorporated into the design.

The requirements for collection of waste and the recommended treatment methods are dependent on the biowaste level for the specific product. It is typical to segregate waste streams containing biowaste from waste streams containing process waste.

If possible, it is recommended to inactivate the waste in-process prior to discharge into the biowaste collection system. Inactivation can be either by thermal or by chemical methods. Floor washings from rooms in contact with live virus products can be chemically inactivated prior to discharge to the biowaste system. Waste from equipment such as autoclaves or washers can either be chemically or thermally inactivated prior to discharge.

If containment is required for the collection system, special attention is required for the air break between the equipment drain and the collection system. In this case, any vents on the biowaste collection system would be required to have 0.22 µm vent filters. Air breaks would be provided in vented enclosures, providing containment while providing a break in the system.

The biowaste collection system should be designed to permit periodic decontamination, either by chemical flooding or by steam. Special attention must be paid to all drain connections to ensure that air is not entrapped in lines during decontamination procedures.

#### **Waste Containment and Disposal**

In facilities handling potent compounds, it is required to segregate waste streams that have product contact and treat onsite to isolate or inactivate the compound, or ship off-site for disposal. A segregated waste collection piping system, with collection tank, is required for this purpose.

If the product is insoluble in water, it is possible to filter the waste stream and concentrate the waste to be disposed. If the compound is well characterized, it can be converted by chemical reaction to render it inactive. Equipment and facilities need to be provided for these purposes.

If the process is localized, and at sufficiently small volume, the waste can be drummed up locally rather than providing a segregated drain piping system.

### **ARCHITECTURAL REQUIREMENTS**

#### **Gowning Philosophy**

CGMP requires that areas of operation used for aseptic processing should prevent contamination from particles and microorganisms that may be present in the air, on product contact surfaces, or shed from personnel. Classified pharmaceutical manufacturing areas are defined by their low levels of viable and nonviable particulates that need to be monitored regularly to demonstrate that they are being kept under control. Personnel are one of the greatest sources of particulate contamination in the clean room. Therefore, it is imperative that the shedding of particulates from personnel required to enter a clean room environment is kept to a minimum.

In multiproduct facilities and in facilities where multiple stages of production occur (i.e., pre- and post-viral inactivation) in the same building, segregation and separation of the products, processes, and personnel are critical to avoid cross-contamination. Successful prevention of cross-contamination of products and stages of the process is supported through the control of personnel flow and the gowning program that is implemented.

This is accomplished by establishing a robust personnel gowning program that is based on defining:

- The functional areas and activities performed in the sterile processing areas.
- The quality of the environments of the functional areas.
- Personnel access to the manufacturing areas.
- Personnel hygiene practices.



- The gowning requirements for each functional area.
- The procedures for personnel gowning and degowning.
- The procedures for control and maintenance of gowning supplies.

Written and approved procedures must be implemented for the personnel gowning program that address all aspects of the program, including personnel flows and movements through the facility, gowning procedure training, good aseptic gowning technique, instructions for maintaining the garments' cleanliness and integrity after donning, and the requirements for gowning-qualification.

The gowning protocol will impact the design of the facility by defining the requirements for

- locker room design and layout
- gowning airlock design and layout
- clean gowning supply and storage
- soiled gowning staging and retrieval

### **Architectural and Layout Requirements**

This section focuses on the architectural aspects attributing to the successful design of a compliant and operational sterile process and product manufacturing facility. The primary driver in the design of facilities for this purpose is contamination prevention and the protection of the product.

A compliant facility takes full account of GMP requirements as well as safety, health, and environmental requirements. An operationally successful facility satisfies process requirements; accommodates equipment layout, ergonomics, and maintenance access requirements; and allows for the proper flow of personnel, materials, and waste. Essential aspects of contamination prevention are the adequate segregation of operations, the proper gowning of personnel, and selection of appropriate finish materials.

The following is an overview of the architectural design characteristics, addressing these expectations.

#### *Classification of Spaces*

Critical processes and clean support operations occupy areas of a facility identified as classified GMP space. Classified spaces are designed, operated, and controlled to effectively control risk of contamination from particulates, including microorganisms and endotoxins, having potential direct impact on product quality. Classification designations for classified GMP space include ISO 5 (A), ISO 7 (B), ISO 8 (C), and ISO 9 (D), which are assigned to spaces on the basis of specific operational characteristics, product type, and/or technology used. Refer to section "HVAC Systems and Requirements" for further discussion on the specific criteria for the various classification levels.

ISO 5 is attributed to the critical zone where sterilized product, components, or product-contact equipment are exposed. The ISO 5 environment is achieved within RABS or isolator, or, in conventional facilities, within an LAF zone surrounding critical processes.

ISO 7, ISO 8, and ISO 9 room classifications are assigned depending on operational characteristics and the type of aseptic technology implemented. ISO 7 is required as the background room condition for open aseptic process operations and final product filling using conventional or RABS technology. ISO 8 is required as the background condition when isolators are used. Clean support operations typically occur under ISO 8 and/or ISO 9 conditions.

In certain instances at particular process steps, local protection is required to provide an enhanced operating environment. These enhancements include UAF units, LAF cabinets, and biosafety cabinets (BSC). An additional designation of controlled nonclassified (CNC) is attributed to areas directly related to and supporting classified GMP operations but physically separate.

Tables 1 to 4 list the appropriate minimal classification level for the various process operations and support functions attributed to sterile operations:













**Table 1** Sterile and Nonsterile Material Prep/Sampling

Operation	Sterile Materile		Non-Sterile Material		Remarks
	Contained	Non-Contained	Contained	Non-Contained	
<b>Sampling</b>	BSC or Isolator ISO 8	Isolator ISO 8	LAF Cabinet ISO 9	Downflow Booth *ISO 9	*Non-sterile components (e.g., vials) in ISO 9 room
<b>Weigh &amp; Dispense</b>	BSC or Isolator ISO 8	Isolator ISO 8	LAF Cabinet ISO 9	Downflow Booth ISO 9	
<b>Buffer Prep</b>	NA	NA	NA	LAF *ISO 8	*Open low risk operations or closed operations in ISO 9 room
<b>Buffer Hold</b>	NA	ISO 8	NA	*CNC	*Prior to final sterile filtration
<b>Media</b>	NA	NA	NA	LAF *ISO 8	*Closed operations in ISO 9 room









**Table 2** Opened or Closed Processes

Operations	Process System			Remarks
	Open Aseptic	Open Non-Aseptic	Closed	
<b>Bulk Biological Synthesis:</b>				
Cell Culture - Seed Preparation	ISO 5 ----- ISO 7	LAF ISO 8	ISO 8	
Cell Culture - Bioreactors	ISO 8	ISO 8	CNC	
Recovery	ISO 5 ----- ISO 7	LAF ISO 8	ISO 9	
Purification	ISO 5 ----- ISO 7	LAF ISO 8	*ISO 9	*Final purification occurs in ISO 8
Bulk Filling	ISO 5 ----- ISO 7	LAF ISO 8	ISO 8	
<b>Bulk Chemical Synthesis:</b>				
Final Purification	ISO 5 ----- ISO 7	LAF ISO 8	ISO 8	
<b>Formulation</b>	ISO 5 ----- *ISO 7	LAF ISO 8	ISO 8	*ISO 8 if isolator is used
<b>Sanitization Prep</b>	ISO 5 ----- ISO 7	LAF ISO 8	ISO 8	Preparation of sterile sanitizing agents for wipe down

Table 3 Aseptic Technologies Application Filling

Operation	Aseptic Technologies			Normally Sterilized Product	Remarks
	Conventional Technology	RABS Technology	Isolator Technology		
<b>Vial / Ampoule Filling:</b>					
Vial / Ampoule In-Feed	ISO 9	ISO 9	ISO 9	ISO 9	
Vial Wash / Depyrogenation	ISO 8	ISO 8	ISO 8	ISO 8	
Vial Fill & Stopper / Ampoule Fill & Seal	ISO 5	RABS ISO 5	Isolator ISO 5	ISO 8	Non-lyophilized product in vial will move directly to capping, eliminates re-sterilization
	ISO 7	ISO 7	ISO 8		
Lyo Loading & Unloading	ISO 5	RABS ISO 5	Isolator ISO 5	NA	
	ISO 7	ISO 7	ISO 8		
Capping (pre-sterilized and specialized caps)	ISO 5	RABS ISO 5	Isolator ISO 5	ISO 8	e.g. ADD Vantage, BIO Seab
	ISO 7	ISO 7	ISO 8		
Capping (non-sterile caps)	 ISO 8	 ISO 8	 ISO 8	ISO 9	
External Vial Wash	CNC	CNC	CNC	CNC	
<b>Syringe Filling:</b>					
Syringe In-Feed	 ISO 8	 ISO 8	 ISO 8	NA	
Tub Exterior Sterilization	 ISO 8	ISO 8	ISO 8	NA	
Syringe Fill & Plunger Insert	ISO 5	RABS ISO 5	Isolator ISO 5	NA	
	ISO 7	ISO 7	ISO 8		
<b>Blow Fill Seal:</b>					
Resin Feed	NA	NA	CNC	NA	
Blow / Fill / Seal	NA	NA	BFS* ISO 5 ISO 8	NA	*BFS machine integral ISO 5 zone
Cut	NA	NA	CNC	NA	
Resin Waste	NA	NA	NC	NA	
<b>Pre-Sterilized Bottles:</b>					
Bottle In-Feed	 ISO 8	 ISO 8	 ISO 8	NA	
Bottle Exterior Sterilization	 ISO 8	ISO 8	ISO 8	NA	
Bottle Fill & Cap	ISO 5	RABS ISO 5	Isolator ISO 5	NA	
	ISO 7	ISO 7	ISO 8		

**Table 4** Aseptic Technologies Application Filling Direct Support

Operation	Aseptic Technologies			Terminally Sterilized Product	Remarks
	Conventional Technology	RABS Technology	Isolator Technology		
Pre-Wash / Equipment Wash	ISO 9	ISO 9	ISO 9	ISO 9	
Component Prep	 ISO 8	 ISO 8	 ISO 8	 ISO 8	Washer unload & parts wrapping occur under UAF; refer to Stopper Processing for stopper prep
Autoclave Unload / Staging	ISO 7	ISO 7	ISO 8	ISO 8	Provide UAF zone if cooldown occurs outside of autoclave
Stopper Processing	 ISO 9	 ISO 9	 ISO 9	 ISO 9	Processor vessel charging occurs under UAF; Prewashed stoppers brought directly to Component Prep
Tank CIP / SIP	ISO 9	ISO 9	ISO 9	ISO 9	May occur in dedicated room or in Equipment Wash
Lyo Mechanical Space	*CNC	*CNC	*CNC	NA	*Classification depends upon lyo type & access to lyo chamber-unclassified space may be acceptable
Inspection	CNC	CNC	CNC	CNC	

*Transition Zones and Airlocks*

Transition zones and airlocks are necessary to maintain the integrity of the environmental classifications of spaces by controlling the dispersion of particulates between areas of different classification and to control the movement of personnel and materials into and out of GMP areas.

Transition zones and airlocks support the control of particulates by maintaining air pressure differentials between areas of differing classifications, or, in some instances, by separating adjacent operations occurring at the same level of classification. Airlocks are also utilized to establish a barrier zone (“bubble” or “sink”) when containment is a criteria.

Movement of people and the staging and movement of materials must be designed to minimize errors, maintain gowning room hygiene, and minimize the risk of cross-contamination. Transition zones and airlocks provide a clean space for personnel gowning and a controlled environment for the transfer of materials into GMP areas and between classified areas.

**General airlock expectations.**

- Airlocks are required between areas of different classifications.
- Airlocks must be appropriately sized and environmentally controlled depending on the activity occurring within the airlock (e.g., number of people gowning at one time, or material wipe-down or staging).
- The number of airlocks in sequence is dependent on the number of grade levels between the start and final destination, the operations occurring during the transition (e.g., gowning stages requiring segregation) and containment requirements (hazardous/biohazardous).
- Separate entry airlocks for personnel and materials are typically utilized for entry from nonclassified areas into GMP areas and when entering into areas of higher classification from areas of lesser classification (exception: combined personnel/material airlock may be considered for small scale operations with infrequent material transitions). ISO 5 zones are typically a segregated part of an ISO 7 area with limited direct access.



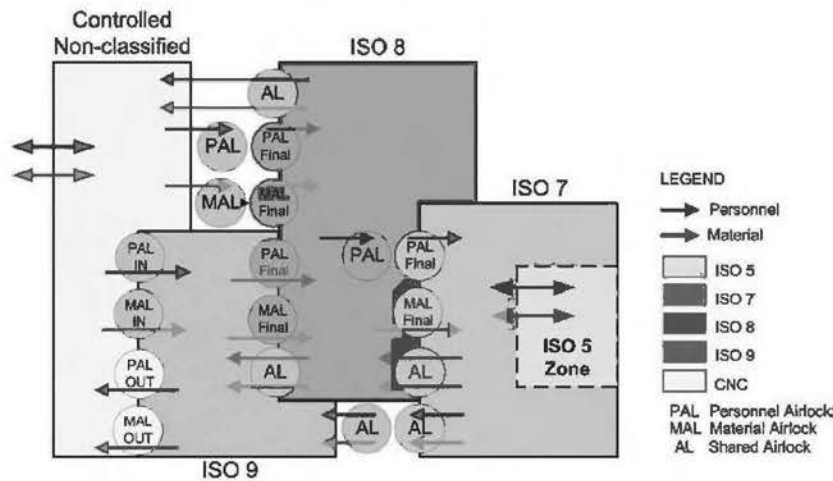

Figure 26 (See color insert) General airlock concept by classification.

- Combined personnel and material entry airlocks are permitted, within a process suite between areas of the same classification.
- Combined personnel and material airlocks are permitted for exiting all classification levels.
- Gowning and degowning typically occur in dedicated airlocks (exception: combined entry/exit personnel airlock may be considered for small scale operations).
- Entry and exit via the same airlock is permissible for areas supporting preparation of nontherapeutic products (e.g., buffer prep).
- Airlock doors are required to be fitted with either physical interlocks to prevent the possibility of more than a single door being open at a time or visible and/or audible warnings such that multiple doors are not simultaneously open; *note: physical interlocks must be connected to a centralized alarm system so that the interlocks automatically disengage in an alarm situation.*

General airlocking and flows are captured in Figure 26.

#### General facility layout expectations.

- Develop a program of spaces based on process, operational and project requirements
- Identify critical adjacencies, recognizing the interdependence of support operations and core activities
- Establish a hierarchy of operational and transition zones
- Identify appropriate classification of spaces based on project drivers (product type, process systems, and technologies utilized, dosage form)
- Properly address the movement of people, materials, and equipment:
  - Provide adequate space to allow orderly movement and staging
  - Provide adequate protection against contamination risks by incorporating unidirectional flow into and out of ISO 7 areas
  - Provide an adequate number of airlocks, gowning rooms and transition zones to accommodate flows, and ensure they are properly sized for the expected level of activity

- Provide adequate space to accommodate process operations, equipment, maintenance operations and storage
- Locate personnel locker rooms and toilets outside the classified manufacturing areas
- Properly address cleaning, sanitizing and housekeeping procedures:
  - Provide adequate facilities for preparation and storage of cleaning supplies in dedicated rooms.
  - Locate cleaning supply rooms in areas outside of ISO 7 classified areas.
  - Segregate areas requiring disinfection with fumigants from areas not intended to be fumigated.
- Minimize activity within classified areas:
  - Provide glazed viewing panels (windows), where appropriate, to allow observation of processes for visual communication for operators within the area and from outside of the process area for visitors and supervisors.
  - Install phones or telecoms where appropriate for audible communication between process areas.
- In addition to CGMP requirements, facilities must be designed to meet the requirements and expectations of other agencies and regulators, including:
  - Local regulatory agency codes and standards.
  - Loss prevention provider standards.
  - Americans with Disabilities Act (for facilities built within the United States) (19).

**Facility types.** Figures 27 and 28 demonstrate the basic layout principles for single product and multiproduct facilities, respectively:

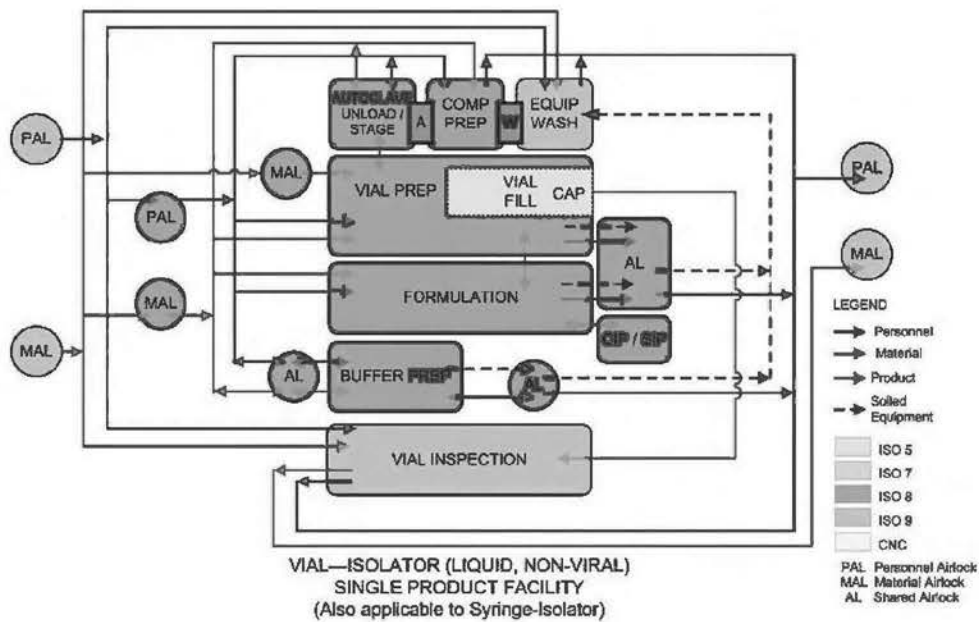

**Figure 27** (See color insert) Single product single suite module.

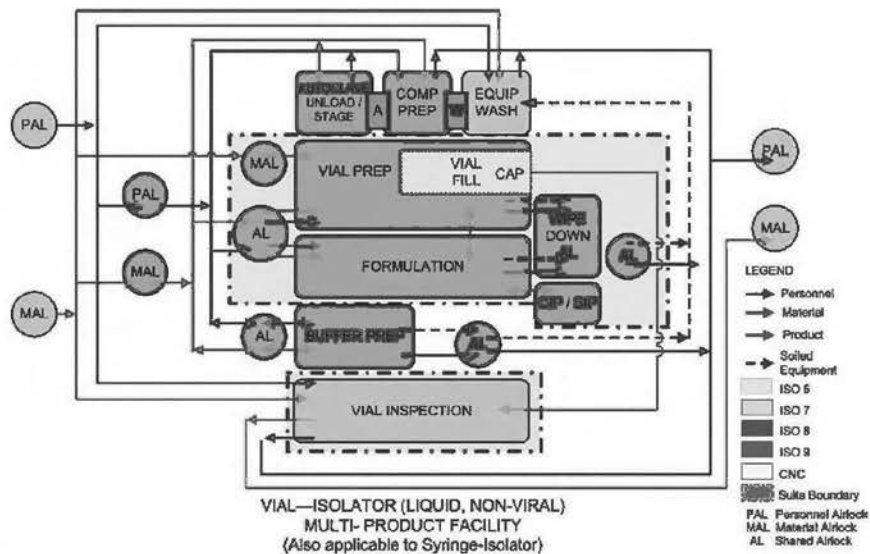

Figure 28 (See color insert) Multiproduct multi suite module.

**Special conditions.** Certain product types including pathogens or genetically modified microorganisms (e.g., some vaccines), and potent compounds (e.g., cytotoxics and steroids) and sensitizing compounds (e.g.,  $\beta$ -lactam antibiotics) present particular issues and special conditions that further impact facility design. Each of these product types requires special accommodation for the containment of the product and protection of the operators working directly with the product.

Special design conditions include:

- Isolators should be considered for all open processes and filling.
- Process areas where open operations occur should be segregated from adjoining areas with a “barrier zone” (bubble or sink airlocks)
- Segregation must be provided for facilities processing potent and sensitizing compounds and for pathogens and genetically modified microorganisms. However, the facility is not required to be constructed as a separate building.
- For potent and sensitizing compounds and for pathogens and genetically modified microorganisms, decontamination is required for all product contact equipment.
- For processes involving the potential generation of aerosols of live cells, special provisions must be made for the decontamination of operator gowns.
- If personnel protective equipment (PPE) is required, the gown and degown airlocks should be configured to accommodate shared equipment (e.g., pass-through cabinets).
- For potent compound products, a misting shower should be included in the degown airlock for use in the event of a mishap.
- Depending on the type of product and the requirements/recommendations of applicable building and fire codes, and regulators (e.g., NIH or CDC), containment of firewater may be necessary (20).

#### Facility Finish Materials

Interior finishes and materials of construction should be appropriate for the type of activity occurring in the area and the recommended level of CGMP compliance. Ease of cleaning is always of utmost importance.



**Finish materials basic criteria.** All exposed surfaces and finish materials in classified areas should be smooth, nonporous, and

- free from cracks and open joints
- resistant to shedding of particles
- resistant to sustaining microbial growth
- resistant to damage from normal mechanical abrasions and impacts
- resistant to damage from repeated application of cleaning agents, disinfectants, sterilants, and sanitizers; note: it is important to identify the cleaning agents and sanitizers used as well as the cleaning protocol. Prior to specifying materials and finishes, confirmation should be obtained from the manufacturer that the materials can withstand exposure to the agents used.

Configuration of the surfaces and their method of interface are also important. Horizontal ledges should be avoided as these are areas where particles and microorganisms could accumulate. Materials should align in the vertical plane, and joints between dissimilar materials should be caulked with sanitary silicone sealant. Coved transitions should be provided between walls and floors and between walls and ceilings.

The selection criteria for appropriate materials should include:

- Constructability and maintainability (local labor capability, difficulty of repair, ease of cleaning)
- Desired appearance (patterns, solid colors)
- Cost (both first cost and lifecycle costs)

**Floor systems.** Floor systems for critical and primary support areas of aseptic manufacturing facilities can be divided into two categories: sheet systems (PVC, rubber) and resin-based multi-layer systems. The appropriate selection of either system is dependent on the following criteria among others:

- Substrate conditions (new or existing concrete slabs)
- Expected frequency of traffic (material loads)
- Expected loading of traffic (heavy rolling loads such as tanks, carts, forklifts, etc.)

In controlled, nonclassified CGMP areas, floor systems such as pigmented concrete sealer, sheet vinyl and thinner resin-based systems may be considered for both cost and functional reasons.

**Wall systems.** Wall systems for critical and primary support areas of fill finish facilities can be composed of site fabricated assemblies (concrete block or metal stud/gypsum board walls with applied coatings), premanufactured assemblies (modular clean room partition systems), or a hybrid of the two.

Wall systems should also be evaluated on the basis of the following additional criteria:

- Expected frequency of reconfiguration/relocation
- Ease of modification (future installation/removal of panels, doors, windows, etc.)
- Design and construction schedule
- Regulations set by building code authorities and recommendations by insurance underwriters (e.g., FM Global)

Coatings, on site-fabricated walls in classified areas, can range from high performance epoxy paint systems to multilayer resin-based systems depending on budget, schedule, and availability of skilled labor.

In controlled, nonclassified CGMP areas, concrete masonry units or metal stud/gypsum board walls are typically specified and finished with high-quality epoxy paint unless there are other factors present that would require more robust systems.

**Ceiling systems.** Ceiling systems are similar to wall systems in that they may be site-fabricated assemblies (suspended or wall-supported gypsum board with applied finish coating or material), premanufactured assemblies (clean room ceiling system), or a hybrid of the two. In addition to the criteria used for wall systems, the selection of the ceiling system is influenced by

- requirement for walkable ceiling surface
- accessibility needs (to controls and devices located above the ceiling); note: care should be taken to locating access points outside of critical areas

The appropriate ceiling finish material is dependent on the system chosen and includes epoxy paint, PVC rigid seamless sheet, high-build surfacing, or PVC-coated composite panel.

Ceilings in controlled nonclassified areas may be suspended clean room type with gypsum or composite panels, hold-down clips, and gaskets or sealant at panel perimeter.

**Doors.** Doors should be seamless, sealed, flush, and box-type without recesses.

- Doors in ISO 5, ISO 7, and ISO 8 areas: frames should be installed flush with adjacent wall surfaces; vision panels should be double glazed and flush with door face.
- Fully glazed doors may be used as an alternative in all areas.
- Door hardware shall be heavy duty commercial grade, and hinges shall be sealed, nonparticle generating.
- Swinging doors should typically swing closed in the direction of airflow to maintain sealing at the jamb and minimize air leakage.
- Sliding doors are not recommended in ISO 5 and ISO 7 areas.
- Doors at material airlocks and otherwise accessed for moving equipment and materials are recommended to have automatic operators.
- Powered (electrical or pneumatic) doors shall be appropriate for the level of classification, taking into account cleanability, exposure to sterilizing agents (including fumigants, if applicable), and electrical classification of the room.

#### **Windows**

- Windows in classified areas shall be of double pane glazing and flush with the wall finish on both sides.
- Windows between classified and controlled nonclassified areas shall have single pane glazing, be flush with the wall finish on the classified side and may have a sloped sill on the unclassified side.
- Windows in controlled nonclassified areas shall have a single glazing pane; the frame shall be epoxy-painted galvanized steel.
- Exterior window are not recommended in classified areas.

#### **Room fixtures**

- All fixtures installed in classified areas must be constructed of materials meeting the same basic criteria for all finish materials.
- All fixtures in classified areas should be designed and fabricated in a manner to minimize joints, ledges, and seams.
- All panels (utility, access) in classified areas shall be installed flush with the wall or ceiling surface.
- Recessed sprinkler heads are to be provided where permitted by building code and underwriters (factory mutual) requirements.
- All penetrations in the wall or ceiling surface in classified spaces must be sealed and gasketed, as required, to prevent air leakage; sealants and gasket materials must meet the same basic criteria for all finish materials.

**Table 5** Comparison of FDA, EU, ISO Requirements

Grade	At rest		In operation	
	EU Max permitted number of particles per m <sup>3</sup> (particles per ft <sup>3</sup> , former Federal STD 209) [ISO Class]			
	0.5 µm	5.0 µm	0.5 µm	5.0 µm
A	3520 (100) [ISO 5]	20 (Note 1) [<ISO 5]	3520 (100) [ISO 5]	20 (Note 1) [<ISO 5]
B	3520 (100) [ISO 5]	29 (Note 1) [ISO 5]	352,000 (10,000) [ISO 7]	2900 (Note 1) [ISO 7]
C	352,000 (10,000) [ISO 7]	2900 (Note 1) [ISO 7]	3,520,000 (100,000) [ISO 8]	29,000 (Note 1) [ISO 8]
D	3,520,000 (100,000) [ISO 8]	29,000 (Note 1) [ISO 8]	Not defined	Not defined

Note 1: FDA traditionally monitors at 0.5 µm and above. EU also monitors 5.0 µm and above.

**Table 6** Comparison of FDA, EU, ISO Classifications

Former US class (particles per ft <sup>3</sup> ≥0.5 µm)	EU "at rest"	EU "in operation"	ISO designation
100	A and B	A	5
10,000	C	B	7
100,000	D	C	8

**HVAC SYSTEMS AND REQUIREMENTS**

**Definition of a Clean Room**

A clean room is a room that is designed and operated to control internal particulate levels. To do this usually requires control of appropriate environmental parameters such as temperature, relative humidity, and pressure level. In the pharmaceutical industry, allowable particulate levels are separated into viable (living, i.e., bacteria) and nonviable categories. The remainder of the section focuses on the nonviable category.

Tables 5 and 6 provide an approximate comparison between the EU, ISO, and the now retired Federal Standard 209 (21).

**Air Change Rates**

Minimum supply air change rates are based on industry general practice and benchmarks. Higher airflow rates may be needed for a given classification when unique operations occur within a room such as open powder handling operations. In addition, actual airflow rates may need to be higher on the basis of equipment heat load, exhaust rates, and pressurization requirements.

Minimum air changes per hour commonly used in industry are:

Grade A (ISO 5):	0.45 m/sec (90 FPM)
Grade B (ISO 5):	30 40 air changes per hour
Grade C (ISO 8):	20 25 air changes per hour
Grade D (ISO 9):	20 22 air changes per hour
Unclassified:	As required to maintain cooling load, ventilation or pressurization.



Additional considerations: Provide an additional 10 to 15 air changes per hour in airlocks and gowning rooms for the listed grade. The instantaneous particulate gain due to people is generally higher in these small spaces.

Certain applications for ISO 5 (grade A) areas and unidirectional flow hoods may require computational fluid dynamic (CFD) modeling to ensure complete coverage of critical area and acceptable airflow patterns.

#### **Low Wall Returns, Balancing Dampers, and Other Duct Considerations**

ISO 5 and ISO 8 areas should have low wall returns located within the room to provide even air distribution throughout the space. To assure adequate airflow patterns, the location of the low wall returns involves a coordinated effort between the process equipment engineer, the architect, and the HVAC engineer.

Low returns should be cleanable and constructed of stainless steel to a point 48 in. above finished floor to allow for cleaning and wash down activities. Design the return grille to be removable and locate 6 to 12 in. above finished floor. Stainless steel type used for return grilles and for low return ducts to be determined on the basis of specific room cleaning requirements and the cleaning agents that will be used. In most cases stainless steel type 304 is adequate.

Always install room return duct and grille even if air balance does not indicate any return air quantity requirement. Pressurization values are estimated via door and various crack calculations. In practice, the calculated pressurization air may be much lower than expected and return air may be required.

Manual volume balancing dampers with double setscrew locking quadrants should be provided for each low air return grille and supply air branch duct. Low air returns within a room combine to a single duct per room where a main room return air balancing damper is to be provided. The main room return air balancing damper must be easily accessible for routine balancing. The accessibility of the other dampers is less critical since they will not be adjusted after start-up but must be available for access during initial balancing.

The room main supply air-balancing damper must be easily accessible. Each terminal HEPA filter should have an integral trim balancing damper in the terminal HEPA filter. This trim damper should be accessible from the process room. Whenever possible, it is recommended to install a damper in the branch duct to each individual terminal HEPA filter.

For areas with tank platforms, low-return grilles should be added at the platform level as well as under the platform to achieve adequate air circulation in support of cleanliness levels.

Ductwork from washer machines or any other equipment that generate moisture should be sloped away from the equipment to a separate moisture collection point and then drained. Consideration should be given to proper duct construction materials and installation methods to ensure liquid tight construction.

#### **Room Pressurization**

The space pressure cascade scheme should be from cleanest room to least clean room. The design differential pressure as measured between different classified rooms to be a minimum 10 to 15 Pa (0.04 0.06 in. water gauge, w.g.), with all doors in their normal closed positions. It is also good practice to design for 5 to 15 Pa (0.02 0.06 in. w.g.) pressure differential between areas of same classification with the more critical space at a higher pressure.

When containment is also required, design a combination of a pressure "sink" and pressure "bubble" to achieve containment and cleanliness cascade.

Coordinate with clean room manufacturer supplying walls and doors to evaluate anticipated door cracks and associated leakage values to maintain intended pressure differentials.

#### **Room Temperature and Relative Humidity**

Set points for classified spaces (ISO 5 through ISO 9) are typically 68°F with 35% to 50% relative humidity. The normal control tolerance for temperature is  $\pm 2^\circ\text{F}$  and  $\pm 5\%$  for relative humidity. Relative humidity controls should be arranged to prevent the humidity from falling below the low limit in the winter and from rising above the high limit in the summer. Some

operating companies prefer to maintain ISO 5 spaces at 66°F with 35% to 45% relative humidity to increase comfort to heavily gowned personnel.

Additional considerations: Individual process rooms should have separate thermostatic control due to variation in cooling loads from room to room. Areas of similar use and internal heat gain (i.e., airlocks) can be combined on a single HVAC zone.

Humidification must be controlled to maintain a stable environment. Where room loads are similar and stable, this may be accomplished centrally through a unit-mounted or duct-mounted humidifier. Plant steam may be used for humidification provided that only acceptable boiler water additives are utilized. However, it is recommended to use a humidification source that does not have additional chemical additives.

Steam for humidification must be discussed early in the project to ensure that plant steam is suitable for use and that the system does not require a costly clean steam supply system. Humidifiers must be installed to be easily accessible to perform routine maintenance.

Proper humidifier selection along with proper ductwork design procedures should be followed to ensure humidifiers are located to allow proper steam absorption. Ductwork materials should be selected for a wet application.

It is preferable to locate temperature and humidity sensors in the return and exhaust air ducts where they can be accessed and maintained without requiring entry into the classified space.

It is recommended to maintain a room criteria chart to assure that all stake holders are aligned regarding room design parameters.

#### **Air Filtration Requirements**

Air-handling systems serving classified areas should be provided with ASHRAE MERV 8 (formerly 30% ASHRAE) and ASHRAE MERV 14 (formerly ASHRAE 95%) upstream of the heating and cooling coils.

ISO 5 through ISO 8 spaces require terminal HEPA filtration of supply air. This means the HEPA filters are located in the ceiling of the room served.

ISO 9 spaces require HEPA filtration, but the HEPA filters can be centrally located in the air-handling unit (AHU).

Assure the duct material does not shed particulate and is kept clean during construction.

In rooms where potent compounds are handled or if the room has a biosafety rating extract air HEPA filtration may be required.

Terminal HEPA filtration can be substituted for central filters for ISO 9 areas when the system serves ISO 9 spaces and spaces of higher classification.

The HEPA filter installation to provide for:

- Injection of a filter challenge aerosol upstream of the filter.
- Sampling to confirm concentration of upstream filter challenge aerosol.
- Scanning the face of the filter when necessary or taking a downstream air sample at a single point. Generally, HEPA filters serving ISO 5 through ISO 8 spaces must be scanned to prove leaks are not present. Centrally located HEPA filters serving ISO 9 spaces can be tested at a single point downstream of the filter. HEPA filters serving ISO 5 spaces are generally scanned twice a year and HEPA filters serving ISO 8 and 9 spaces are tested at least annually.
- Measuring static pressure drop across the filter.
- Assure the HEPA filter media is accessible to test and replace.

#### **Zoning**

AHUs should be dedicated to serve areas of similar use and same classification. Usually, systems should be zoned to reduce the number of AHUs in the facility.

General AHU zoning considerations: Nonclassified spaces should be on a different AHU system than ISO 5 through ISO 9 areas. It is acceptable to place ISO 9 areas on the same system as ISO 5 and ISO 8 areas provided that the ISO 9 area is fitted with terminal HEPA filters. In applications with large ISO 9 supply air requirements, it may be economically advantageous to use a dedicated AHU system for the ISO 9 areas.



Airlocks leading to a process suite should be zoned with the suite.

Nonpathogen and pathogen areas must be served by separate AHU systems. Try to group different pathogen areas according to their biological risk level. It is preferable to zone airlocks leading to an area with a suite with a biological level with the suite even if the air lock does not have a biological rating.

Air from potent, antibiotic, and virus areas should not be circulated to other areas unless a risk analysis proves that HEPA filtration of the return air would be an acceptable strategy.

Try to directly exhaust air from wet areas such as washrooms. It is acceptable to share supply air to these spaces with other spaces.

Special considerations for biological rated areas include:

- Rated area to be negative pressure to surrounding areas with airlocks/vestibules configured for containment.
- Supply/return/exhaust systems to be interlocked to prevent sustained positive pressure in the room.
- must be designed to eliminate any possibility of reversal of airflow upon loss of building power.

### **HVAC System Testing, Adjusting, and Balancing**

#### *The Testing and Balancing Company Requirements*

- A member of either the Associated Air Balance Council (AABC) or National Environmental Balancing Bureau (NEBB), or equivalent, certifying organization.
- In good standing with the certifying organization.
- Listed in the latest certifying organization's directory of certified firms.

#### *Instrumentation*

- Instrumentation shall be calibrated, including field calibration in same environment being tested to properly perform specified TAB work. Instruments shall be recalibrated and certified by approved test agency every 12 months or less depending on usage. TAB reports shall include type of instruments used and last date of calibration and certification.

#### *Prior to Start of Building Construction*

- Report on conditions found that will impede or prevent proper testing, adjusting, and balancing of systems include suggested corrective measures. Report shall also identify additional balancing and measuring devices required in air distribution and piping systems where absolutely essential to system adjusting and balancing. Include locations and sizes of each balancing device.

#### *General Testing, Adjusting, and Balancing*

- Test, adjust, and balance supply and specific exhaust systems within plus 10%/minus 5% of air outlet and inlet quantities and water quantities shown on the drawings except where shown or specified otherwise. Air outlets and inlets include diffusers, registers, grilles, laminar flow modules, and terminal air filter modules. Balance return and general exhaust systems to achieve space pressure relationships, not values indicated on the design drawings.
- Permanently mark air distribution and piping system balancing devices after balancing is complete. Set memory stops where installed.

### **ELECTRICAL**

Electrical installations shall be designed for code compliance by the authority having jurisdiction. This includes domestic and international installations. U.S. applicable standards shall be enforced as a minimum for international locations where relevant standards do not exist.



**Impact of Site Location on Design**

Consideration shall be given to the differences that exist between locations with regard to locally enforced electrical codes. This is particularly true when transferring an existing design from one geographic location to another. Areas that are impacted include

- equipment-labeling requirements, especially in hazardous area locations
- acceptable raceway methods
- hazardous area classification
- wire identification
- materials of construction

**Cord Connected Equipment**

Outlets for cord-connected mobile equipment shall have a dedicated purpose. Consideration should be given to the operation of the facility with respect to mobile equipment (e.g., portable pumps or agitators). The quantity of outlets shall be minimized in classified GMP areas. The location of these devices shall be reviewed to assure that they minimize the impact on production personnel and material movement.

**Outlets and Enclosures Within Classified GMP Areas**

- Surface-mounted receptacles should be weather proof (Nema 4X) and installed in recessed stainless steel box (22).
- Receptacles with corrosion-resistant, spring-loaded gasketed covers suitable for washdown.
- Electrical enclosures, panels, and boxes shall be flush mounted and be constructed of stainless steel. The internal bottom surface of the panel shall be sloped down. All efforts shall be made to minimize the number of enclosures in ISO 5 areas.
- Electrical utility stations housing outlets for process use shall not have doors.
- Locate any code required safety switches outside of the manufacturing space. The safety switch shall be lockable with shunt trip provisions. Locate an approved pushbutton device within the manufacturing space local to the equipment connected to the safety switch. The pushbutton shall de-energize the equipment by activating the shunt trip device in the safety switch.
- If a surface-mounted electrical panel is required, the panel shall be constructed of stainless steel and have a sloped top and internal bottom surface so as not to accumulate dust. The enclosure must be sealed in such a manner to ensure that dust cannot accumulate between the wall and the box.

**Lighting Fixture Requirements**

- In all cases light fixtures shall be sealed to maintain room pressurization.
- Lighting fixtures may be accessible from above or below.
- Grade A areas shall use clean room fixtures that do not interfere with the laminar flow ventilation yet provide uniform distribution of lighting to minimize shadows.
- Other classified GMP areas shall utilize sealed lay-in fluorescent fixtures with clean room type stainless steel covers and smooth lenses for ceilings no more than 12 feet above finished floor. Fixture covers shall be attached with wire to protect from falling to the floor when opened.
- For higher ceilings, consider pendent-mounted metal halide fixtures suspended above clean room ceiling. Clean room type stainless steel frames and smooth lenses shall be provided to permit light into room. Maintenance access must be considered with this installation. If lamps are to be serviced from within the room, these lens covers shall be attached to the fixed frame with wire to protect from falling to the floor when opened.
- If perimeter wall mounted lighting is required, utilize wall-mounted fluorescent fixtures. Avoid horizontal surfaces created on the top of these fixtures such that dust and dirt will not accumulate.

**Illumination**

The quality of illumination is a critical component of a safe and efficient manufacturing area work environment. Furthermore, adequate illumination contributes significantly to the minimization of errors attributable to misreading labels, controls, gauges, etc.

- Illumination levels shall be sufficient for each task. Generally speaking, 60 to 75 foot candles (fc, or 600 750 lux) is adequate for classified areas; however, locally higher levels may be required in areas of inspection and label reading. Note that certain jurisdictions require enhanced illumination requirements such as natural light for quality of worker environment and/or improved efficiency. It is the responsibility of the design engineer to familiarize themselves with these local requirements.
- Provide even light distribution and shadow reduction while minimizing the number of fixtures to facilitate the cleaning of the room.
- Light switches shall not be installed in ISO 5 areas unless required by a specific process criteria.

**Hazardous (Classified) Areas**

It should be recognized that electrical equipment labeled for use in hazardous areas is, generally speaking, less compatible with the cleanability requirements of classified GMP areas. It is recommended to minimize or reduce hazardous areas within cGMP manufacturing spaces. Where hazardous environments cannot be avoided, use materials and installation methods approved for the environment.

**Access Control**

Card readers shall be required on the gowning airlocks providing ingress from controlled unclassified to grade C and from grade C to grade B. No card readers shall be provided for the reverse direction.

- Self-actuated doors shall be held open for a preset minimum time and initiated by a motion sensor. Optical sensors shall not be used to detect motion as a static object, such as a cart left in the doorway, will prohibit the door from closing.
- Airlock engineering controls (interlocks) shall be provided for all gowning, degowning, and material airlocks. At a minimum, this interlock should monitor the correct logic, which is only one door of an airlock open at any time. If proper logic is not followed, a significantly audible alert tone shall initiate for a predetermined amount of time. This tone is intended to alert supervision of a violation of SOP.

**Emergency and UPS Power**

Electrical power is a critical utility for sterile process and product manufacturing sites. Therefore, the power system reliability must be studied to determine appropriate system designs for these facilities.

Product loss prevention is directly proportional to electrical power reliability. Many levels of system redundancy and reliability may be built into the electrical distribution system. Power distribution system costs must be weighed against product value to determine the appropriate design. Table 7 identifies a three-level guideline for identifying power system designs according to product loss prevention.

Means to prevent loss of electricity to critical and specialized systems associated with the process should be evaluated. For example, equipment shall be considered for stand-by power if power loss to the equipment will cause the following to occur:

- Product loss
- Reduced product production
- Equipment damage
- Increased personnel exposure risk



**Table 7** Three Level Power Distribution System

Reliability level	Product value	Normal power system design	UPS/stand by power system design
Level 1	Low shutdown acceptable	No redundancy required. Simple radial system design is acceptable	Life safety systems shall meet applicable code requirements
Level 2	Moderate shutdown acceptable	Looped primary, primary and secondary selective system design recommended	Life safety systems, stand by generation system required for selected equipment
Level 3	High shutdown not acceptable	Primary and secondary selective system design recommended	Life safety systems, stand by generation system, and uninterruptible power system required for selected equipment

**SYSTEM INSTALLATION**

**Automation, Instrumentation, and Controls**

The process control systems will be designed for safe and efficient monitoring and operation of the manufacturing, quality, and facility processes. Automated, semi-automated, and manual controls shall be implemented where necessary to achieve this goal.

The level of automation will be defined for each manufacturing, quality, and facility process. On the basis of the required level of automation and the type of process, several control system architectures can be used, including:

- Programmable logic controller (PLC)/human-machine interface (HMI)
- PLC/supervisory control and data acquisition (SCADA)
- Distributed control system (DCS)

The process control system shall provide for recipe control of the unit operations associated with the formulation area. The process control system shall provide the necessary regulatory, sequential, and batch controls to perform equipment functions such as liquid charging, solids charging, mixing, heating/cooling, purging, inerting, CIP, SIP, and transferring of materials. The process control system shall provide means to alarm the operator for abnormal conditions and provide the necessary safety interlocks.

Although not mandatory, the use of an electronic batch record (EBR) system is preferred. All equipment and systems must be capable of transferring data and communicating with an EBR system, regardless of whether the use of an EBR system is an immediate requirement or a future consideration. If an EBR system is used, the system shall provide a printed report of the formulation operations on a per batch basis.

All process control systems that operate a cGMP equipment or process will be connected to a Data Historian. Quality data to support the EBR will be collected at the Data Historian.

*Control Systems Hardware and Network Design*

All process control systems shall provide adequate alarming and alarm log capabilities to meet all GMP requirements.

All process control systems shall provide interlocking capabilities to protect the people, equipment, and process.

All process control systems shall provide event logging capabilities to meet all GMP requirements.

Where required, process control systems shall provide continuous and historical trending of operating parameters.

Process control systems operating on cGMP equipment and processes shall provide a stand-alone report to support compliance or operational requirements. Wherever possible, report shall use a common reporting format.



All process control systems shall provide the necessary operator interface to monitor and operate the equipment in an efficient and safe manner. Where appropriate, operating parameter with the appropriate security access shall be made available to the operator for manipulation.

All process control systems shall provide the necessary hardware to communicate to an Ethernet manufacturing system network.

#### *Filling Line Control*

The filling line will operate as “island(s) of automation” by which the control of each major equipment component shall operate as stand-alone system not requiring information or communication to operate.

The line components control systems should be capable of operating in both a run mode and a maintenance mode.

All filling line components shall be designed such that a SCADA data collection and monitoring could be implemented at a later date from a control level above the individual controllers.

As a minimum all filling equipment controls shall contain the ability to keep count of consumed components and work-in-progress inventory to facilitate integration with an enterprise resource planning production management system.

#### *Process Analytical Technology*

Gains in quality, safety, and/or efficiency from the application of process analytical technology (PAT) will vary depending on the product but are likely to come from

- Reducing production cycle times by using on-, in-, and/or at-line evaluations and controls.
- Minimizing the risk of rejects, scrap, and reprocessing.
- Considering the possibility of near-real-time release.
- Increasing automation to improve operator safety and reduce human error.
- Facilitating continuous processing to improve efficiency and manage variability
  - Using small-scale equipment to eliminate or minimize certain scale-up issues and dedicated manufacturing facilities to minimize setup, changeover, and cleaning disruptions.
  - Improving energy and material use and increasing throughput.

The application of PAT is project specific and shall be considered on a project basis. As an example, Pat should be evaluated for the following parameters for filling lines:

- Temperature
- Speed
- Pressure
- Flow rate
- Weight
- Number of rejects

#### **Piping Design**

All product-contact piping shall be constructed of hygienic, orbitally welded stainless steel piping and tubing. Electropolishing is not required. The piping system shall be passivated after installation. The materials and installation shall meet ASME BPE standards for high purity piping, including absence of dead legs, the use of sanitary connections, material traceability, welding techniques, and documentation.

Joints in the piping system, including valves, shall be welded whenever possible. When welding is not possible or practical (e.g., connections to equipment or instrumentation), sanitary clamp fittings shall be used with bolted clamps for increased integrity and safety. The use of threaded joints is not permitted.

Proper space should be provided to operate, clean, and maintain equipment. All nonessential devices associated with the formulation process should be removed from the formulation room, and located in a technical chase, where they can be routinely inspected. Piping penetrations from the chase into the clean room should be grouped into a single stainless steel wall panel for rigidity and cleanliness.

Because the entire system is steam sanitized and clean steam condensate is highly corrosive, drain piping shall be constructed of orbitally welded stainless steel tubing. The condensate collection system shall be passivated after installation. Flanged connections are permitted for condensate collection.

All product-contact piping, clean steam distribution lines, and clean steam condensate collection piping shall be insulated and sheathed for personnel safety.

#### *Isolation Valves*

Diaphragm-type valves are specifically preferred for bioprocessing fluid applications. Valves will be designed so that complete drainage of fluid from inlet to outlet is optimized when mounted in the position specified by the manufacturer. All valves shall be capable of being fully opened or exposed during CIP/SIP.

#### *Pressure Safety Valves and Rupture Discs*

Rupture discs on pressure vessels should be installed as close as possible to the system's highest point; however installation shall comply with a length/diameter ( $L/D$ ) ratio of 2:1 or less. The cleaning system design should ensure that the rupture disc will not be damaged by cleaning media impact.

#### *Steam Traps*

Steam traps installed on process systems shall be capable of effectively venting air. Traps shall be sized and installed such that there is no backup of condensate into the process equipment. For these reasons, balanced pressure thermostatic steam traps are preferred. The advantages of using a thermostatic steam trap include complete drainability and the ability to remove noncondensable gases (such as air during start-up) at a high flow rate.

Steam traps in process systems shall be maintainable to allow easy inspection and cleaning. Bolted sanitary clamps should be used for steam trap installation to allow removal for maintenance or replacement.

#### *Materials of Construction*

All components in contact with the in-process materials shall be 316L stainless steel, with an internal surface finish of 25  $\mu\text{mRa}$  max. Electropolishing is recommended, but not required. 304L stainless steel is recommended for other components including the equipment supports, skid framing, and paneling.

### **Equipment Details**

#### *Heat Exchangers*

The use of heat exchangers in direct product contact applications should be avoided because of the product losses that could ensue. Heat exchangers are typically used in temperature control modules, which provide heating and cooling of noncontact heat transfer fluid used in formulation tank jackets. They are also used to provide cooling of WFI, either in the formulation area WFI sub-loop or at the WFI use point.

All heat exchangers shall be shell and tube type exchangers. Heat exchangers shall be of a sanitary design and construction, including use of double tube sheets, and shall be designed in accordance with the current edition of the ASME Boiler and Pressure Vessel Code and the ASME BPE standards.

#### *Transfer Panels*

Transfer panels provide a method of connecting multiple fluid paths, without costly divert valves, automation, and cleaning requirements. The use of transfer panels also accomplishes



complete physical separation of a system with product from cleaning fluids or steam, preventing any concerns of cross-contamination.

Transfer panels shall be self-draining and pitched to a draining point. If the design of the panel is such that it is not physically possible to completely self-drain, then a tray shall be positioned under the panel to collect any material leakage as jumpers are disconnected. The tray, if required, shall be sloped to a drain line equipped with a shut-off valve.

The number of jumper sizes should be minimized to provide the most possible combinations of connections. Conversely, jumpers of different sizes may purposely be used to avoid accidental, undesired connections. The simultaneous crossing of multiple jumpers should be avoided.

Proximity switches shall be provided for each possible jumper position. The automation system can then be used to verify the proper set-up of connections and provide interlocks to prevent loss of containment from open-ended fluid pathways.

The transfer panel or piping system design should provide a means to verify the release of line pressure prior to manually disconnecting a jumper. This can be achieved either through the automation system with in-line pressure indicating transmitters or by physically mounting pressure indicators within the operator's view on the panel or jumper.

#### *Filters*

Filter housings shall be designed to allow for complete venting and draining. Liquid tee-type filter housings should be installed vertically and vent type in-line filter housings should be installed vertically with the condensate/drain port directed downward. All nozzle connections should be of a hygienic design.

Vent filters for hot process services should be heat traced or steam jacketed to prevent the accumulation of moisture in the vent filter.

#### **SUMMARY**

Recently, the trend has been to simplify the complexity of the facility, by requiring additional sterility assurance from the equipment. Use of isolation technology or blow-fill-seal permit more simple facilities to be constructed, as fewer aseptic operations are conducted.

As demonstrated by the preceding chapter, many factors influence the design of a sterile facility. The challenge for any design is to blend the needs for the known processes, select a technology platform, meet known regulatory requirements, and then add the proper level of preinvestment for facility flexibility that may be required to meet future changes in technology and regulations.

#### **REFERENCES**

1. Title 21, Code of Federal Regulations, current Good Manufacturing Practices, Parts 11, 210 and 211, US FDA, April 2008.
2. Title 21, Code of Federal Regulations, current Good Manufacturing Practices, Parts 600, 601, 610, US FDA, April 2008.
3. Title 21, Parts 210 and 211 [Docket No. FDA 2007 N 0379] Amendments to the cGMP Regulations for Finished Pharmaceuticals, Final Rule effective December 8, 2008. Federal Register. Vol 73, No. 174, Monday, September 8, 2008.
4. Guide for Industry Sterile Drug Products Produced by Aseptic Processing current Good Manufacturing Practice, US FDA, September 2004.
5. The United States Pharmacopoeia and National Formulary, USP31 NF 26.
6. The Rules Governing Medicinal Products in the European Union, EU Guidelines to Good Manufacturing Practice.
7. European Pharmacopoeia.
8. International Standard ISO 13408 1, "Aseptic processing of health care products".
9. Sterile Pharmaceutical Products Annex 6, WHO Technical Report Series 902, 2002 (with corrected Table 1).
10. Biological Products Annex 3, WHO Technical Report Series 834, 1993.
11. ISPE, "Definition of Isolator and RABS", taken from Website, 2004.
12. Photo courtesy of Bosch Packaging.



13. Photo courtesy of IMA Edwards.
14. Photo courtesy of Becton, Dickinson and Company.
15. Photo courtesy of Inova Pharma Systems (Optima Group).
16. Photo courtesy of Skan AG.
17. ASME Boiler and Pressure Vessel Code, 2007.
18. ASME Bioprocessing Equipment (BPE) Standard, 2002.
19. Americans with Disabilities Act, 1990.
20. CDC/NIH Biosafety in Microbiological and Biomedical Laboratories (BMBL), 4th ed., 1999.
21. International Standard ISO 14644 1, "Cleanrooms and Associated Controlled Environments Part 1: Classification of Air Cleanliness", 1999 05 01.
22. NEMA Standards Publication 250 2003, "Enclosures for Electrical Equipment (1000 Volts Maximum)".

## 2 | Personnel and their impact on clean room operations

Jeanne Moldenhauer

### INTRODUCTION

In pharmaceutical environments, the presence of contamination is of key concern to the quality of the product. In addition to the presence of contamination, some contaminants are more serious than others depending on the type of product being manufactured. There are a variety of potential sources for contamination in the clean room; for example, the supplies used, transport of the supplies into or out of the area, the utilities used in the manufacturing process, the ingredients used, and the personnel operating in the area. It is critical to use appropriate contamination control procedures to ensure that the final product is safe and effective for its final use.

Pharmaceutical clean rooms may be used to manufacture products for both human and veterinary use. It is very important in these environments to prevent or minimize the risk of contamination. In an aseptic environment, using current technology, it is widely believed and accepted that the involvement of humans in the process is the greatest risk to the sterility of the product (1). The Food and Drug Administration (FDA) indicated that the presence and activity of personnel in manufacturing areas where sterile dosage forms are manufactured, should be considered risk areas in an aseptic process and are necessary components of a process simulation evaluation to ensure that they are not adversely impacting the product manufacture (2).

The risks associated with the presence of contamination vary depending on the type of pharmaceutical product being manufactured; for example, some types of contamination may be allowed for nonsterile products providing they are within specified acceptance criteria. Other products labeled sterile may have more stringent requirements for the allowable levels of contamination, as well as the steps in the manufacturing process where the contamination may be present. A product that is terminally sterilized, meaning that after filling and sealing the product it is subjected to a sterilization cycle in its final container, may allow more contamination throughout the process than one that is aseptically filled. Aseptically filled products are manufactured from presterilized components that are handled aseptically to fill and seal. Since these types of products are not subjected to a final sterilization cycle, the risk of contaminating the product in the event that contamination is present is higher.

It is also widely accepted that the people working in clean room environments are the greatest source of contamination (3). The personnel present contribute contamination to the area by releasing or shedding of viable and nonviable particulates in the area. This happens in varying amounts depending on the personnel activity in the area.

In controlling contamination, one of the key axioms is that you can not contaminate the area if you don't bring contaminants into the room. As such, controlling those operations that can contribute contamination to the area are critical. Since people are a significant source of contamination, it is important to control their activities. Controls should be designed and established that include requirements for hiring new employees, training, monitoring during the working periods, and continuing until the person is no longer working in the area. These controls should include appropriate supervisory observation, testing, and programs to motivate the personnel to correctly perform their assigned activities.

In those cases where contamination events have occurred in manufacturing environments that exceed established allowable limits, one of the common tests that occur is the identification of the microorganism. It is common to use sources like *Bergey's Manual*, which is like an encyclopedia and dictionary of microorganisms, to determine the origin of the type of contamination. The great majority of all organisms found are stated to be human borne. As such, the focus of many investigations does not include the impact the personnel may have on other equipment and items within the clean room.

This chapter describes some of the personnel-related sources of contamination in the manufacturing environment, the impact of these types of contamination, and the types of measures that can be established to control these processes. While other sources of contamination are important, they are not discussed in this chapter as many are discussed elsewhere in this text.

### WHAT IS CLEAN?

There is no one set definition of clean when it comes to clean rooms. In fact, the attributes that may make a room clean could also be the same factors that make it dirty for another attribute. As such, the term clean is relative and can be associated with the specifications of the associated products. For example, you can classify on the basis of various criteria such as chemical contamination, bacterial contamination, nonviable particulates. Looking with the naked eye, a room may appear to be free of particles since we can only see contaminants down to a size of about 25  $\mu\text{m}$  (assuming a strong beam of light is present). This size is about a quarter of the diameter of a piece of hair, which on average is about 100  $\mu\text{m}$  in diameter (4). In reality, there may be a wealth of particles that are present; they just were not detectable with the naked eye.

There are various regulatory and industry guidelines that provide standards for the classification of clean rooms; that is, they describe the requirements that must be met to be "clean" to a specified level. Clean rooms are used for a variety of purposes including both electronics and pharmaceuticals for example. There are specific requirements specified in several documents, with one of the most commonly used designations in the International Standards Organization (ISO) Guidance 14644-1 (5). This guidance describes air cleanliness classifications in terms of the concentration of airborne particles present. The range of particle sizes considered in this evaluation is from 0.1 to 5  $\mu\text{m}$ . It does not look at classification in terms of physical, chemical, or viability of the airborne particles. The classifications in this system are whole numbers starting with 1 and going through 9, with 1 being the cleanest (Fig. 1).

Another commonly used classification system is described in the European GMPs Annex 1 (6). This system uses a letter designation (A through D), with grade A being the cleanest. In the FDA's aseptic guidance, the ISO classification system is supplemented with requirements for microbiological control (2).

### TYPES OF CONTAMINATION

Many different items can cause contamination in a clean room, for example, microorganisms, viruses, dirt (soil), organic matter, animal excrement, pollen, and so forth. In addition, there are man-made contaminants such as tobacco smoke, unburned hydrocarbons, fly ash, dust from things such as construction, engine exhausts, and the like. During manufacturing operations, one can generate contaminants through the garments being worn, the packaging, and other similar operations. People themselves are also a source of contamination. They can shed particles such as skin flakes, dandruff, cosmetics, hair, and fibers. Regardless of the type of contaminant generated, it can contribute to undesirable conditions in a clean room (4). The discussion for this chapter is limited to those contaminants that are or can be emitted from personnel.

Airborne Particulate Cleanliness Classes From ISO 14644-1						
ISO Class	0.1 $\mu\text{m}$	0.2 $\mu\text{m}$	0.3 $\mu\text{m}$	0.5 $\mu\text{m}$	1 $\mu\text{m}$	5 $\mu\text{m}$
1	10	2				
2	100	24	10	4		
3	1 000	237	102	35	8	
4	10 000	2 370	1 020	352	83	
5	100 000	23 700	1 020	3 520	832	29
6	1 000 000	237 000	102 000	35 200	8 320	293
7				352 000	83 200	2 930
8				3 520 000	832 000	29 300
9				35 200 000	8 320 000	293 000

Figure 1 ISO classification scheme.



Two types of particulates may be shed into the environment by the personnel working in an area, viable microorganisms, and nonviable particulates. Some of the types of particulates shed by humans include skin cells and flakes; human hair; moisture droplets from sweat, breathing, and speaking; cosmetics (make-up, hair spray, and deodorants); lint; starch and other particles from fabrics; and dirt flakes. These particles can be dispersed into the air. Once in the air they can either stay in the air, or land on other items and surfaces in the area. Test data indicates that just conducting normal activities, a person could release several hundred colony forming units (CFUs) per hour, even wearing clean clothing (4).

Typically, people give off one outermost layer of epithelial cells every 24 hours, or about  $10^9$  skin cells per day. Skin cells average  $20\ \mu\text{m}$  in size. Approximately 5% to 10% of the cells are less than  $10\ \mu\text{m}$  in size. A portion of these cells is released into the environment and acts as a carrier or a raft for viable microorganisms. These cells may be whole or fragmented. The amount of airborne dispersion varies for each person, for the activities being performed, and over time. However, it is commonly stated that people disperse approximately 1000 cells per minute that are carriers of viable contamination. Comfort levels (e.g., temperature and humidity) for personnel in the clean room also contribute to the amount of airborne dispersion. For example, when the temperature is elevated, some people become more uncomfortable and may perspire. The more they perspire, the more likely they are to more airborne dispersion (7).

In addition to skin fragments, people tend to carry contamination on their clothing and shoes. Shoes and clothing that are worn both inside and outside of the building carry larger populations of microorganisms. This is true for shoes and clothing used in different room classifications as well (7).

Activities conducted outside of the clean room can also contribute to contaminants being brought into the room. Smoking tobacco products can result in tobacco smoke being detected in exhaled air for hours after the smoking occurred. Medicines that have been taken can be found in the skin and hair fragments for days after use. Washing and gowning activities are not always sufficient in totally removing cosmetics that have been used. As such, these external activities can also contribute to the contaminants present (4).

The following sections describe the types and levels of contamination in more detail.

#### **Nonviable Particulate Contamination**

Analysis of the particles present on a person is useful in describing the living conditions and habits of the individual. For example, various contaminants can be deposited on a person during the course of a day. Our everyday operations are not conducted in sterile environments. If you have a pet, there is probably pet dander or other contaminants that are present. Walking around generates millions of particles into the environment. These particles are deposited on other surfaces in the surrounding areas, including other people. Walking itself causes particles that are on the floor to be aerosolized (4). Many of the determinations of forensic scientists are made on the basis of the particulates left on people.

The shedding of particulates gets more complicated because all employees do not shed particulates at the same rate. The rate can be affected by a variety of factors, the activities being conducted, the behavior of the operator, and even just the personnel themselves. For example, some individuals sweat profusely and shed many more particulates than someone who does not sweat at all. Rates at which particulates are shed are typically reported as particles per minute.

Cosmetics are a concern for generation of nonviable particulates. The base of most cosmetics is ground talc. It is used in after shave as well as in the foundation makeup used. When the cheek muscles move, while speaking or coughing, the talc falls off the surface of the skin. Since skin also harbors bacteria, they are frequently attached to the cosmetic material (4). In addition to cosmetics, newer trends like the use of nail wraps and nail extensions have the potential to generate additional levels of contamination.

Regulators have been concerned with particulate levels for many years, as the values could be collected in real time. Since it has historically been impossible to collect viable microbial counts in real time, the particulate level was indicative of the number of total viable microorganisms present in the environment and this provided information on the quality of product currently being manufactured (8).



Data was generated by several different scientists that also gave weight to the measuring of particulate counts for assessing potential contaminants. Scientific studies conducted by Whyte indicated that particles less than 11  $\mu\text{m}$  in size could not contain viable contaminants because of the desiccating nature of the dry clean room environment. Ljungqvist and Reinmuller generated compelling data to show a correlation between particulates in the 10 to 20  $\mu\text{m}$  size and the risk of viable microorganisms as a risk to the manufacturing process (8). The data generated in these studies strengthened the belief that controlling particulate levels can aid in the control of viable microorganisms in an area.

#### **Contamination with Viable Microorganisms**

Skin surfaces give off squamous cells that can serve as sources of contamination for the pharmaceutical environment. This contamination can be composed of both viable and nonviable particulates. The particulates are unique to each individual and they may or may not include viable microorganisms. When the particulates include viable microorganisms they can be a source of contamination in the area.

The contaminants present on humans can also be transferred to the surfaces they touch or with which they come into contact. It is important that the procedures used in the manufacturing operation are able to eliminate or greatly reduce the contamination that has the likelihood to affect the product quality. Touching the surface however is not the only potential source of contamination. Actions such as sneezing, coughing, exhaling, perspiring are also potential sources. Even the dust particles present can carry viable microorganisms (4).

When viable microorganisms are deposited onto surfaces they can replicate if nutrients are available and they are not disturbed. Given sufficient time, the organisms can be emitted from this site for long periods of time. While much concern is given to the single cell present in an aseptic environment, microbes seldom exist in a clean room environment as a single cell. Frequently, they are found riding on dust particles or water droplets. While a bacterial cell may be about 1 to 3  $\mu\text{m}$  in size, the larger dust particle may range 15 to 20  $\mu\text{m}$  (4).

The viable contaminants present in a clean room can be a significant concern. It is possible for them to grow on and in the product being manufactured. Particles can even spread through liquids and powders being used or manufactured in the process. As such, surfaces where particles may have landed should be routinely cleaned and sanitized or sterilized to reduce the risk of subsequent contamination. Since a single microbial cell can replicate itself in about 20 minutes, doubling the initial population, it only takes 10 hours to generate a million cells (4).

Speaking and coughing in the clean room can result in large numbers of microorganisms being released into the room. Use of consonants when speaking generates a pulse sound that results in emission and ejection of material from the back of the mouth. It could be considered a spitting function. If the individual is not wearing a mask or wearing a mask incorrectly, this person is literally spitting into the area (4). Even wearing a mask correctly does not ensure that contamination is prevented. Once the mask gets wet, it only takes about 20 minutes for bacteria to be able to traverse the wet mask and get released into the area. Coughing is described as a mini hurricane by Dr Munzer, president of the American Lung Association (in *USA Today* October 4, 1993). He indicated that a cough generates a 125 mph blast, intended to eliminate an intruder from the lungs (4).

Personnel generate moisture droplets that may contain microorganisms from other activities such as yawning, coughing, sneezing, speaking, and shouting. Coughing may generate 600,000 droplets, while sneezing doubles that amount. The droplets generated from speaking vary by person and activity (4).

The risk of contamination increases if the person is not healthy, or has open or exposed skin wounds.

While traditionally nonviable particulate monitoring has been used as a real-time indirect measure of the level of viable microorganisms in the area, newer technologies have been developed to allow for real-time or near-real-time detection of viable microorganisms. The ScanRDI system (aka ChemScan in Europe) manufactured by AES-Chemunex is able to be used for air (Sampl'air method), surface (ChemSwab), and product monitoring. Surface monitoring methods can also be used for personnel monitoring. With this test methodology one can determine if viable microorganisms are present within a few hours (90 minutes to 4 hours,



depending on the type of test method selected). This system allows for detection of cells without any requirement for the cells to grow prior to detection (9).

The new SMA air sampler, manufactured by Veltek Associates, Inc., allows for the collection of a particulate count and an option to collect viable microorganisms in either a liquid solution or on an agar plate. The liquid collection option allows for the sample to be evaluated with a variety of liquid-based rapid microbiological methods for analysis (10).

Another useful tool for microbial detection has been the IMD-200-1 and the IMD-220-4 manufactured by BioVigilant, Inc. This technology allows for instantaneous microbial detection (real time). It looks like a particle counting probe and uses optical detection and sizing coupled with riboflavin metabolism to determine whether microorganisms are present and how many are present. Using this technology, counts can be made that directly compare the number of viable and nonviable microorganisms that are present. Additionally, because of the sizing, it is also possible to use this instrument to distinguish the number of molds present (separate from the other microorganisms). This system can be used to determine the level of contamination present. It also can aid in studying sources of contamination in an investigation. For example, in a facility with mold contaminants it is typical to spend weeks trying to find the source of the contamination. Using this unit, one can frequently determine the source(s) of contamination quickly. In the area of personnel, this type of system can be useful in training of clean room personnel. As an example, one might monitor the area near a specific individual while they are performing different operations to determine which method of performing an activity has the lowest risk of subsequent contamination. Another use is to evaluate the effectiveness of the gowning procedure. These are just a few ways in which newer technologies can be used to reduce the overall risks of product contamination (11).

The Rapid Enumerated Bioidentification System (REBS) was developed by Battelle. The technology is based on Raman optical spectroscopy. It provides for the detection, identification, and enumeration of particulates and microbial materials without the need for expensive reagents or consumables. The system provides results in approximately 15 minutes. (The timing is targeted to process at a rate of 5 minutes  $\pm$  20 seconds per particle detected.) This system has several features that make it attractive for monitoring for contamination, whether it is in a dry or liquid sample. Some of these features include (12):

- The ability to detect, identify, and enumerate particles that are larger than 300 nm in diameter.
- The consumables are less than \$10/sample.
- Ability to identify molds, yeasts, fungi, gram-positive and gram-negative cells.
- The ability for single-cell, single-particle detection.
- There is minimal sample preparation required.
- Staining is required, only if there is a need to determine if the cell is viable. There are no steps for amplification or lysing required.
- The system is nondestructive, allowing for additional identification systems (like nucleic acid methods) to be used, if necessary.

With the availability and implementation of some of these newer systems, our knowledge base on the types and amounts of contamination present in our clean room environments may increase dramatically. They also aid in identifying and re-remediating contamination events in a timely fashion.

#### **PERSONNEL CHARACTERISTICS**

The personnel present in the clean room can have a significant impact on the contamination present in the environment. The amount of contamination that can be contributed is affected by many things including (13): the amount of microbes present on the skin, those present in the person, the types of microbes present, where they are located, and how they are dispersed (13).

#### **Microbial Load**

The amount of microbial load present on a person's skin varies across time. It is significantly influenced by the personal hygiene habits of the individual. The level initially present on the



person increases as the person is confined in an area, where other personnel are not able to practice their hygiene habits. Additionally, the organisms are not evenly distributed on the body surface. Rather than existing as single cells, microbes are more likely to grow and be in clumps of cells (micro or macro colonies) on the skin surface. To be visible to the naked eye, there must be greater than  $10^6$  cells/mL. The skin microcolonies are typically in the range of  $10^2$  to  $10^5$  cells (13).

### Types of Microorganisms

The predominant types of microorganisms present as contaminants in pharmaceutical products are bacteria and fungi. While viruses may be present, they are typically part of biological products and since they are obligate parasites they do not replicate outside of a cell. The bacteria present are either gram negative or gram positive. Gram reactions are a type of differential stain that provides information regarding the type of cell wall structure. Most of the gram-negative cultures in pharmaceutical applications are bacilli (rod shaped), while most of the gram-positives are bacilli (rod shaped) or cocci (sphere shaped) (13).

In contamination events, *Propionibacterium acnes* is a frequent gram-negative contaminant. Other typical gram-negative contaminants are water contaminants rather than human borne. For gram-positive contaminants, various forms of *Bacillus* are common as are staphylococci, micrococci, and streptococci, the bulk of which are human borne. In the production of biological products, many of the microbes recovered show resistance to antibiotics (usually the ones used in the production process), for example, Gentamicin-resistant *Bacillus cereus*.

The fungi are divided into yeasts and molds. *Candida albicans* and other species are frequent yeast contaminants and can be human borne. Most of the molds in the clean room come from a variety of species and may occasionally be human borne, but most often are a result of poor cleaning in the area.

### Body Areas Shedding Organisms

Figure 2 describes the relative amounts of surface area found in the body.

The body surface is the source of most of the microorganisms shed by humans. While each person maintains a flora unique to himself/herself, there are specific organisms associated with different areas of the body. The amount of microorganism shed from the human into the environment is dependent on specific factors including the amount of microorganisms present on the person and how active the person is, including which body parts are encompassed in the activity (13).

The contaminants given off from the skin, nose, ear, mouth, respiratory track, and intestinal tract tend to be viable microbes. Diseased skin, as seen with eczema and psoriasis, show an increased level of *Staphylococcus aureus* and *Streptococcus pyogenes* as shed organisms. When individuals showing these diseases are working in the clean room, shedding these pathogenic organisms can be a significant risk (13). Another common skin contaminant is *Propionobacter acnes*.

Pathogenic cocci are frequently found in the nose and ear, as are diplococci and *Haemophilus*. Other microorganisms are commonly found in the oral cavity, such as *Streptococcus salivarius*, *Lactobacillus* spp., and *Candida albicans*. The contamination levels present in saliva are about  $10^8$  microbes/mL. Organisms originating in the intestinal tract include anaerobic, nonsporulating rods (putrefactive bacteria) and gram-positive lactobacilli. While aerobic microorganisms can be present, they tend to be much fewer. When present, typical organisms are coliforms, *Proteus*, enterococci, and staphylococci (13).

Portion of Body	Relative Percentage of Body Surface Area
Arm, Left	9
Arm, Right	9
Axilla	<2
Head	9
Leg, Left	18
Leg, Right	18
Perineum	<2
Trunk	37

Figure 2 Relative amounts of body surface area. Source: Adapted from Ref. 13.

Individuals having diseases that result in excessive bacterial oral and nasal discharges can emit these organisms when they cough, sneeze, or blow their noses. Having this type of individual in a clean room with horizontal laminar flow is a greater threat of contamination than having a vertical laminar air flow system, due to the high velocity of material released during sneezing. If horizontal laminar air flow is used, a barrier can be an effective method of eliminating the potential for contamination (13).

#### **Differences in Shedding Rates (Male Versus Female)**

Data generated in studies of shedding rates indicated that males shed microorganisms at a much higher rate (approximately 2500 microbes/contact plate) than corresponding females (approximately 700 microbes/contact plate). Other studies conducted did not show this level of difference in shed rates (13). As new individuals are added to clean room staff, environmental data should be trended and evaluated for potential shedder employees.

#### **The Carrier Concept**

Individuals carry specific microorganisms on their skin surface. Depending on the changes to which the microbes are subjected; it is possible for them to undergo growth and colonization, different from or exceeding the normal flora present. When this happens, the person is described as a carrier. This term was defined by McDade as "an individual in or on whom pathogens reside and multiply, without producing demonstrable disease or ill effect on him." Carriers are classified as temporary and permanent. Temporary carriers only carry the microbes for a short period of time, while permanent carriers carry the microbes for long periods of time. Another term used to describe these types of individuals is shedders or disseminators. Many people may be described as carriers, but few are considered to be disseminators. The importance, however, is that they can have a significant impact on the environment (13).

#### **SELECTION OF CLEAN ROOM PERSONNEL**

The operations conducted by clean room personnel are so important and critical to the overall operation. As such, great care should be taken to ensure that the personnel selected do not inherently adversely affect the environment as well as providing appropriate training on the acceptable behavior to use in the manufacturing environment.

There are four key factors in selecting personnel for clean room operations: physical requirements, skills, job performance, and psychological characteristics (13).

#### **Characteristics of Clean Room Employees**

Individuals that have been selected to work in a clean room environment should be neat and clean. It is important that their hygiene habits will minimize rather than maximize the risk of contamination of the environment. Even their hair is an issue, as it can contribute contamination to the environment. As such, it should be kept clean and dry during the operation. Excessive dandruff or skin flaking also has the potential for significant adverse impact on the environment. Hair issues also apply to males with facial hair (13).

In some companies, evaluation of clean room personnel can include evaluation of the individual's personal health, degree of dry skin/shedding, determinations of whether skin diseases are present which may increase the risk of shedding (like eczema) whether the person has asthma, emphysema, chronic obstructive pulmonary disorders, or other diseases/allergies that cause the individual to breathe through their mouth, cough, or sneeze (13).

The ideal workers in a clean room operation have several common characteristics. Some of these characteristics are as follows:

- Specified level of education (typically at least completion of high school)
- Good manual dexterity
- Good personnel hygiene
- High level of attention to detail (so that they will carefully think through how to perform each activity, and once instructed they will always work in the same way)
- Have a basic understanding of the need to work in a specific way at all times
- Have a basic understanding of the work to be performed.



- Recognize that following the “rules” of behavior is critical for safe manufacture of the product
- Do not shed or give off high levels of particulates (This may be uncontrollable on their part, but it may also make it inappropriate for them to work in this type of area. For example, excessive perspiration or excessive dandruff or flaking of skin could routinely lead to higher than expected counts.)

The clean room is an inappropriate place to select workers only on the basis of their seniority in the company. While satisfactory performance of one’s job is important, so is the concern of cleanliness in performing these tasks. They need to be aware of the risk of contamination and how they can avoid or minimize these risks (13).

The details and work required to operate in a clean room environment can be stressful to the point of making some workers unsuitable for this type of practice. Continued violations of procedures by clean room personnel can contaminate the area and significantly impact the quality of the products produced (13).

Studies conducted by psychologists indicate that good workers have emotionally stable characteristics; average active and social characteristics; and low scores in impulsive, dominant, and reflective characteristics. It is good for them to have even dispositions. Very nervous or emotional personal do not do well in clean room environments (13).

There are some other traits that also are important for clean room personnel including (13):

- They are highly motivated.
- They take pride in performing a good job.
- They have an above average attitude about their job.
- They are willing to endure the inconveniences of working in a clean room, like the aseptic behaviors and gowning that must be performed.
- They maintain cleanliness.
- They are conscientious.
- They want to manufacture a quality product.
- They are orderly and reliable.
- The concept of repetitive operations does not cause them mental stress.
- They pay attention to details.
- They are punctual.
- They are good listeners.
- They are truthful!
- They have a sense of duty, that is, they know what they should do and the importance of performing these tasks as directed.

Working together and having a sense of pride of accomplishment makes for a good operation in the clean room (13).

#### **PERSONNEL FACTORS REQUIRED TO CONTROL CONTAMINATION**

There are many reasons that contamination risks should be controlled in the clean room environment including maintaining product sterility (for sterile products), maintaining the allowable microbial level (for nonsterile products), and preventing pyrogenicity (for products purported to be nonpyrogenic).

Since personnel have a high risk of contaminating the product and process, clean room clothing is used to protect the environment from human-borne contamination. Airborne microorganisms are normally dispersed into the clean room from people on skin cells. Properly designed and used clean room clothing will cover or envelope the person and minimize or eliminate the dispersion of contaminants into the clean room environment. Some clean room clothing may eliminate the dispersion of contaminants, for example, a sealed, water-proof surface, but may be so retentive that the person wearing the clothing becomes overheated and extremely uncomfortable. Being uncomfortable in the clean room can result in poor clean room behavior and subsequent contamination.



The fabrics used for clean room clothing should be tested for various properties, for example, air permeability, the retention of particles, the generation of particles, and the pore size. Other considerations for clothing include the durability of the fabric (e.g., how prone the material is to tearing), effects of aging, washing, drying, sterilization, and flexibility (14-16).

Some companies have shoes that are dedicated to use only when within the manufacturing facility. Another approach is to have shoes dedicated to areas with specific room classifications. A more common approach is to have dedicated shoes for the class 100/grade A/ISO 8 areas and to use shoe covers for the shoes used in other areas. For companies that allow the employees to go outside, for example, smoking, or walking between buildings; special precautions should be taken to ensure that shoes and clothing are appropriately protected during these excursions.

### **Gowning Purposes**

The clean room gown is frequently talked about as the first line of defense in human contamination control. While it is designed to provide a barrier between the individual and the manufacturing or laboratory operation, it does not completely eliminate particles from being shed by the individual. In reality, particulates are shed through several areas of the gown including (13) the seams, zipper or closure areas, openings at the wrist, foot, neck, and around the eyes, and even from the surface of the gown. The amount of dispersion is affected by the type of gown selected, the material, and the environment in which it is used (13).

The clean room gown functions as a filter around the individual. Consider it to be packaging around your body. Packaging engineers will state that "all packages leak." The importance is the rate at which they leak and how much they leak. The same can be said for many of the clean room garments currently worn. Most of the particle sizes important to regulators for their risk of either being contamination or carrying contamination are too small to be seen by the naked eye. On the other hand, many of the openings, for example, the space between threads that are woven together on the gown are very large in the range of 60 to 80  $\mu\text{m}$ . The very small particulates shed can get through the gown. The more tightly the fabric is woven, the smaller the hole, corresponding to reduced dispersion of particulates. The particulates shed through the gown typically come from the street clothes or uniforms worn under the clean room gown and any exposed skin or hair underneath the gown (4).

Testing of some garments that are very poor versus those that are very good have shown differences in shed rate of a million or more particles. Since the various components of the clean room garb may consist of different the amount that can be dispersed may vary. In recent years, one-piece garments have been developed for use (4). One of the newer uniforms actually incorporates the mask and eye shield into the one-piece design, requiring only gloves to be added to complete the uniform.

In class 10,000/grade C/ISO 7 areas overall uniforms are routinely used. It is also possible to wear knee-length lab coats or smocks depending on the operation being conducted.

Clean room garments should have several important properties: nonflammable, limited linting properties, a fiber or weave that does not fuzz, low or no electrostatic generating properties, cleanable without causing linting (if it is reusable), and so forth (4).

Many companies have separate gowning systems for workers and visitors to an area. For example, company employees may wear reusable plant uniforms and reusable clean room garb while visitors (who may not come into direct contact with the product) are allowed to wear a disposable uniform over their street clothing.

In those situations where an individual's personal clothing is worn under the clean room garb, it is important to ensure that they are restricted from wearing fabrics with high linting or shedding properties, for example, mohair sweaters (4).

Some companies use color coded uniforms that make it easy to quickly determine if an employee belongs in an area, and/or their job function.

### **Gown Fabrics**

An important feature of clean room clothing is the material or fabric chosen for each item. One wants to ensure that minimal dispersion of particulates occurs both from under the garment (the plant uniform, skin, or personal clothing) and from the garment itself. The choice

of fabric can dramatically change the amount of particulates that are allowed passage and dispersion (4).

There are several characteristics common to clean room garment design including (4):

- They should be manufactured from synthetic fabrics.
- There should be a minimal number of seams. If seams are present, the raw edges should be enveloped to prevent shedding of lint or opening of the edge.
- There should not be any pockets, belts, pleats, or tucked areas.
- The fabric material used should have filaments that are strong material. They should not be easy to break down.
- The weave of the fabric should be such that the openings are very small, reducing the person's particulates to be dispersed into the environment.
- The sewing threads should be monofilament materials.
- The construction should be such that the body is covered, with closures at the wrist and neck preventing easy release of particulates from these areas.

A variety of fabrics can be used for the construction of clean room garments. The following describes some of the materials that are available for use, although new materials are constantly being developed.

#### **Antistatic Garments**

Most of the materials used with these claims and are rendered antistatic by dipping the material in a topical antistat. When this dipping procedure is properly performed, the materials are about equal in controlling electrostatic properties (4).

#### **Cotton**

This material has low static properties. Unfortunately, it does generate large amounts of particulates. It can harbor microorganisms and requires rigorous cleaning. It is not considered desirable for outer clean room garments (4).

#### **Dacron<sup>®</sup>**

Dacron is made up of polyester fiber. It is considered to be an improvement over Nylon as it is softer and drapes in a smoother fashion. The color is whiter than Nylon and stays white after proper washing. It is also very wrinkle-free unless it is subjected to excessive heat. In the presence of excessive heat, it is likely to cause permanent wrinkles. A fire will melt the polyester rather than cause it to go up in flames. Moisture is absorbed at a very low rate of 0.2% to 0.85%. The long wearability of these garments makes them favorable for clean room wear (4).

#### **Gore-Tex<sup>®</sup>**

This type of garment is manufactured from a laminate of Gore-Tex membranes, which are expanded polytetrafluoroethylene or PRFE, bonded to a monofilament polyester knit. The outer membrane is designed to reduce the cling of particles and contains the particles from inside the garment, for example, on the individual using the garment. It is reported that this type of garment releases about 50% fewer particles than polyester garments. It is also very effective at capture particles approximately 0.1 µm in size (4).

This type of garment allows penetration of moisture into the garment (also called more breathable). Typically, this is associated with a garment that is more comfortable to the wearer (4).

Gore-Tex garments are manufactured as a two-layer fabric and a three-layer fabric (like a sandwich with the PTFE between two polyester layers, one of which may be antistatic). There are special rules for how seams are stitched and also precautions are taken to prevent fraying. It is available with different types of face masks (4).

#### **Membrane Garments**

Membrane garments are manufactured using a membrane film laminated to a base material; sometimes in a sandwich format with two base materials. They are considered the best barrier



for particulate pass-through. If the membrane is damaged or comprised, the barrier properties are compromised (4).

#### **Nylon<sup>®</sup>**

This type of material, a synthetic hydrophobic fiber, can be used for clean room garments, providing static is not an issue. Nylon garments are crisp and firm. They can look silk-like. Typically, they are very durable and stain resistant. Nylon can be easily washed and dries quickly; however, it has a tendency to yellow with age and uncontrolled conditions. It has a low moisture absorbance rate of 4% to 5% (4).

#### **Polyester Garments**

Garments manufactured with polyester fabrics, with continuous filament synthetic yarns, have fewer emissions of particulates through the garments. Polyester fiber is considered strong, nonabsorbent, and may be treated to reduce static charges. In the event that the garment is damaged, worn or tears, it can become a generator of particulates. Polyester garments are selected most often as reusable clean room garments (4).

A tightly woven polyester garment was developed for use in sterile manufacturing operations. This material has the benefits of polyester garments and also increased filtration efficiency. The efficiency of this polyester is similar to that of spun bonded olefin. It is comfortable, easy to wear, and reusable. The moisture vapor transmission rate is similar to standard clean room garments (i.e., better than spun olefin). This material can be sterilized via gamma irradiation (4).

#### **Silvertex<sup>®</sup> Garments**

This type of garment is manufactured using a coated polyester/carbon-suffused nylon monofilament fabric to achieve its barrier properties. The unique coating used makes the garment flexible. It also provides a hygroscopic moisture vapor transmission, keeping the user cool and dry (4).

#### **Tyvek<sup>®</sup>**

This material has been used for clean room garments for decades. They have very small pore openings (about 1/10 the size of reusable garments). Tyvek is usually a single-use, one-time wear garment. It is manufactured out of spun-bonded olefin, which is not a woven fabric. The material is manufactured by laying down fibers of the material to form a sheet and passing them through hot rollers under pressure, fusing them together. The resultant pore sizes are about 10  $\mu\text{m}$  (4).

Tyvek garments are manufactured and sold under various trade names.

#### **Gown Types**

Ljungqvist and Reinmuller (17) executed several studies on the impact of human contamination sources and different clean room clothing systems. These studies were conducted using a dispersal chamber and individuals dressed in modern clean room garments. In these studies, they found that the values of released airborne microbial particulates were not significantly different with the minor variations in gowning styles; for example those with and without goggles, different types of face masks, and different types of hoods. They also found lower values for long-sleeved undershirts that were worn with long-legged clean room pants, when they considered different.

Additional studies were performed to compare the results of garments that had been repeated washed (25 or 50 times) versus new clean room garments. When combined with appropriate clean room undergarments, garments washed and sterilized 50 times were effective in protecting the environment from the human inside the garment (17).

They also indicated that it would be beneficial if the designs of zippers and snap fasteners could be improved, as they were a source of defects throughout their studies (17).

An interesting finding in the same clothing studies was that the coverall systems manufactured for use in the United States were more effective.



**REGULATORY REQUIREMENTS FOR GOWNING**

The FDA current Good Manufacturing Practices (cGMPs) includes requirements for products manufactured for marketing in the United States. The EU GMPs are included in Annex 1 of Eudralex Volume 4. Both of these documents include requirements for personnel gowning practices.

**EU Requirements**

The "Personnel" section of Annex 1 (6) indicates the following:

19. The clothing and its quality should be appropriate for the process and the grade of the working area. It should be worn in such a way as to protect the product from contamination.

Descriptions are also provided for the required clothing in each grade:  
Grade A/B: Headgear should totally enclose hair, and where relevant, beard and moustache; it should be tucked into the neck of the suit; a face mask should be worn to prevent the shedding of droplets. Appropriate sterilized, nonpowdered rubber or plastic gloves and sterilized or disinfected footwear should be worn. Trouser-legs should be tucked inside the footwear and garment sleeves into the gloves. The protective clothing should shed virtually no fibers or particulate matters and retain particles shed by the body.  
Grade C: Hair and, where relevant, beard and moustache should be covered. A single- or two-piece trouser suit, gathered at the wrists and with high neck and appropriate shoes or overshoes should be worn. They should shed virtually no fibers or particulate matters.  
Grade D: Hair and, where relevant, beard should be covered. A general protective suit and appropriate shoes or overshoes should be worn. Appropriate measures should be taken to avoid any contamination coming from outside the clean area.
20. Outdoor clothing should not be brought into changing rooms leading to grade B and C rooms. For every worker in grade A/B area, clean sterile (sterilized or adequately sanitized) protective garments should be provided at each work sessions. Gloves should be regularly disinfected during operations. Masks and gloves changed at least for every working session.
21. Clean area clothing should be cleaned and handled in such a way that it does not gather additional contaminants that can later be shed. These operations should follow written procedures. Separate laundry facilities for such clothing are desirable. Inappropriate treatment of clothing will damage fibers and may increase the risk of shedding particles.

Additional requirements are included in the "Premises" section of the GMPs (18).

27. Changing room should be designed as airlocks and used to provide physical separation of the different stages of changing and so minimize microbial and particulate contamination of protective clothing. They should be flushed effectively with filtered air. The final stage of the changing room should, in the at rest state, be the same grade as the area into which it leads. The use of separate changing rooms for entering and leaving clean areas is sometimes desirable. In general, hand washing facilities should be provided only in the first stage of the changing rooms.

**FDA cGMP Requirements**

Several mandatory requirements are included in §211.28, "Personnel Responsibilities" (19):

- (a). Personnel engaged in the manufacture, processing, packing, or holding of a drug product shall wear clean clothing appropriate for the duties they perform. Protective apparel, such as head, face, hand, and arm coverings, shall be worn as necessary to protect drug products from contamination.
- (b). Personnel shall practice good sanitation and health habits.

- (c). Only personnel authorized by supervisory personnel shall enter those areas of the building and facilities designated as limited-access areas.
- (d). Any person shown at any time (either by medical examination or supervisory observation) to have an apparent illness or open lesions that may adversely affect the safety or quality of drug products shall be excluded from direct contact with components, drug product containers, closures, in-process materials, and drug products until the condition is corrected or determined by competent medical personnel not to jeopardize the safety or quality of drug products. All personnel shall be instructed to report to supervisory personnel any health condition that may have an adverse effect on drug products.

The FDA's guidance on aseptic processing (2), which is labeled pharmaceutical cGMPs, includes expectations for personnel gowning in the "Manufacturing Personnel" section of the document.

Personnel who have been qualified and permitted access to the aseptic processing area should be appropriately gowned. An aseptic processing area gown should provide a barrier between the body and the exposed sterilized materials, and prevent contamination from particles generated by, and microorganisms shed from, the body. Gowns need to be sterile and nonshedding and should cover the skin and the hair. Face masks, hoods, beard/moustache covers, protective goggles, elastic gloves, clean room boots, and shoe overcovers are examples of common elements of gowns. An adequate barrier should be created by the overlapping of gown components (e.g., gloves overlapping sleeves). If an element of the gown is found to be torn or defective, it should be changed immediately.

#### ISO Guidance

Documents from the ISO are not mandatory requirements for all countries; however there is useful information in many of these documents. It should be noted that these documents are not restricted to only pharmaceutical applications. In ISO 14644-5 (20), the Clean room Operations notes in part 4.2 indicates that "the environment and the product shall be protected from contamination generated by the personnel and their clothing. To maximize the containment, the choice of barrier fabric, the clothing style, and the extent of coverage of personnel by the ferment shall be established." It also points out that "clean room clothing shall be made of minimal linting fabrics and materials resisting breakdown and not shedding additional contamination. The necessary cleaning, processing, and packaging shall be defined."

There are several annexes to this document. Annex B discusses the requirements for clean rooms and how the clothing protects the environment from contamination by personnel. It provides information on the types of clothing suggested, for example, hoods, caps, helmets, coveralls, overboots, gloves, facemasks, and goggles or safety glasses. Information regarding the design and construction of clean room garments is also included.

Another addition is Annex C, which discusses the training, access, clothing, and personal items. It includes an example procedure for how to don clean room clothing (17).

#### Other Industry Guidance

*Clean room clothing systems* (17) provide comprehensive information and testing data regarding how people can be a source of contamination in clean rooms. A summary of data is provided on a variety of clean room garments and their effectiveness in preventing contamination. Some of the types of considerations discussed are

- The system used for clothing (clean room and surgical) and how different components contribute to the overall effectiveness.
- The effectiveness of clothing after repetitive washes such as the differences between 25 and 50 washes.
- Case studies evaluating clothing and particulate generation.

Many regulators have critically reviewed and accepted this data.



### **PERSONNEL GOWNING PRACTICES AND PROCEDURES**

Since humans have such a great potential to contaminate the environment, appropriate protective clothing is used to provide a barrier between the human (and its associated contamination) and the environment.

#### **Practices Related to Gowning in Noncritical Processing Zones**

The typical gowning requirements for noncritical processing zones include wearing a plant uniform, with a disposable Tyvek<sup>®</sup> laboratory coat over the uniform. The laboratory coat should be snapped closed all the way from the bottom to the top of the neck. Each time the individual enters the controlled area, clean hair and shoe covers should be used. It is also appropriate to use safety glasses or goggles to minimize the contamination that can originate from the eyebrows and eye area. If these individuals also work in laminar air flow benches or cabinets, latex gloves should also be used. It may be prudent to use a disposable sterile sleeve also (21).

#### **Practices Related to Gowning in Areas**

The gowning selected for personnel that are working in aseptic areas should be sterile and enclose the whole body. It should provide a barrier between the operator and the environment. It is important for the operator to understand how personnel can contribute contamination to the environment. The personnel must be educated to understand that the gown is the key mechanism used to prevent product contamination. The selected gowning should cover the person from head to foot. Ideally, there should be no exposed areas, for example, skin, hair or eyes. These gowns come in both disposable and reusable formats.

The Institute for Environmental Sciences has established test procedures for reusable gowns to ensure that the gown is able to keep particulate matter and maintains a microbial barrier. This testing is performed at the initiation of use and periodically through the life cycle of the gown. When sufficient data has been established, expiration dates should be defined for the gown materials. Many times they are based on the number of times the uniform has been washed and/or sterilized. It is appropriate to qualify or certify vendors of aseptic gowning materials. These procedures should ensure the vendors ability to sterilize the gowning, maintain sterility post sterilization, and so forth (21).

#### **Loss of Protection Using Gowning**

The gowning barrier can be breached. It is important that personnel be aware of the ways that the system can be breached and the associated consequences. The gowning system used is capable of losing its barrier properties in a number of ways, including rips or tears in the gown, gaps in how the sterile mask covers the face, use of glasses or goggles that do not completely cover the eye area, and hoods that have been designed with an opening that extends from the forehead to the chin. All of these examples can result in areas where microorganisms and particulates can be shed and potentially contaminate the environment (21).

Once the uniform or mask gets wet, it also can lose its barrier properties. It has been reported that when personnel talk excessively in the clean room the mask can get wet. Once it gets wet, it only takes about 20 minutes for microorganisms to travel through the moisture barrier. This same type of loss of barrier protection can occur due to excessive perspiration.

#### **Typical Gowning Procedure for Aseptic Areas**

The following description of gowning procedures is utilized by some pharmaceutical manufacturers (21,22).

- Upon entry into the facility, the employee changes into a plant uniform and dedicated plant shoes.
- Clean head and foot covers are donned prior to entry into a controlled area.
- When an employee moves from a noncritical area to a critical area, for example, from a grade C to a grade B area, the operator dons aseptic gowning and enters via a gowning room and airlock.
- As an operator is to enter the gowning area or earlier in the process (e.g., when changing into a plant uniform), all make-up and jewelry are removed.



- The operator washes their hands with soap and water, followed by a sanitizing agent. The agent used should be qualified for effectiveness, with a specified contact time. A common sanitizer is ethanol foam.
- A pair of sterile gloves is donned. The glove is positioned on one hand by grasping the glove using the inside fold of the glove. The second glove is picked up with the first glove using the folded cuff. The bare skin of each hand is never in contact with the exterior of either glove.
- Next the operator places the sterile mask onto their face. It is important to make sure that the exterior of the mask does not come in contact with the face. It should fit tightly on the nose and face, so that there are no gaps with exposed skin or hair. If necessary, the nose bridge should be molded to fit the nose firmly.
- The operator then dons their sterile boots. As the boot is put on, the operator moves from the dirty side of the gowning room to the clean side, typically by stepping over the bench. The sterile boot is not allowed to touch any surface on the dirty side of the gowning room, if ties or clasps are used on the boot, they should be fastened prior to crossing over to the clean side.
- A sterile hood is removed from the package and is placed on the head, over the hair cover. The hood should only be touched on the inside surfaces.
- The sterile gown is removed from the packaging and is donned, only touching the inside of the uniform. Care must be taken to ensure that none of the uniform comes in contact with the floor while gowning. Several different ways to hold and don the gown are available, without contaminating the uniform.
- The leg portion of the sterile boots should be arranged to be over the bottom of the legs, with no exposed areas.
- The sterile goggles or glasses are obtained from the sterile storage area and may be disinfected prior to use.
- A second pair of sterile gloves is donned, using the same technique described previously.
- It is useful to check the gowning in a mirror prior to entering the aseptic area.

Training for operators should include awareness that if any tears, cracks, or excessive dirt is present on the uniform, the gown should be changed in the gowning room (Fig. 3). If the operator's hands go outside of the grade A/class 100/ISO 5 area, the sterile gloves should be changed; this may be performed in the room if double gloving was used (22).

#### **TRAINING PROGRAMS FOR CLEAN ROOM EMPLOYEES**

Since personnel are reported to be the biggest source of contamination in a clean room environment, it is very important that personnel working in these areas be appropriately trained in aseptic technique. They must also have training in the importance of personnel hygiene. For example, while it may be acceptable for a worker in an office setting to come to work when not feeling well, this may not be appropriate in the clean room. Working in aseptic environments requires a high level of attention to detail even in matters of personal cleanliness (3). A comprehensive training program is an essential ingredient of successful clean room operations.

#### **Development of the Training Program**

The training program should be developed by a team of experts, including members of the operations unit, microbiology, quality, and training personnel. This program should at minimum include the following (3):

- Discussion of the basic concepts of microbiology, and how they apply to clean room environments.
- Description of the acceptable types of behavior when working in clean rooms and aseptic areas.
- The regulations (and/or industry guidances) applicable to clean room classification systems, clean room operations, and aseptic processing requirements (including process simulations).
- Discussion of the applicable cGMPs.



Figure 3 Example of a gowned clean room person.

- Gowning requirements and procedures.
- The aseptic techniques that should be used in the clean room, including how to handle materials and transfer items from one area to another.
- The methods used for cleaning and sanitization.

It is important that the finished product be comprehensive, but also something that keeps the interest of the attendee. Use of multidiscipline approach to the development of the program can significantly aid in this process.

#### **Conducting the Training Program**

Training of personnel cannot be completed by only having the individuals read standard procedures and policies. This type of training must also include methods to evaluate whether the personnel have absorbed and understood the material presented. Typical training programs may include classroom instruction, reading of applicable procedures and/or regulations, examinations for the classroom portion, time to practice the various procedures used (with supervision to aid in understanding), and an evaluation of the person's proficiency to accomplish these tasks.

Proficiency is frequently evaluated using supervised operations, and in most cases microbiological qualification as well. The type of microbiological qualification may differ by company, but most require the ability to gown without contaminating the gowning above acceptable limits. Another trend is to have either a complete or "mini" media fill/process simulation as part of the training. The intent is to show that the person can successfully integrate all of the aspects of the training and use it to successfully manufacture product, or simulated tasks.

The regulations in most countries also require that personnel in aseptic areas be qualified in as part of a media fill (process simulation study) on a periodic basis. The time period varies depending on the country's regulations.



### **Management Philosophy and Commitment to Regulatory Compliance**

Training programs within a company are only as successful as the level of management support and commitment provided. The most comprehensive training program will not be successful if management fails to provide support to the system. Employees need to know intuitively that their management believes in this material, its importance, and wants to be compliant to all regulatory requirements.

### **Development of a Positive Attitude**

While it is very important to communicate to personnel, the requirements to act appropriately in gowning and behavior in the clean room environment, it is also important that they do not operate in a constant state of fear. It is important for them to believe that the rules established can be followed and be effective in maintaining the appropriate level of product quality.

### **PROTECTION OF THE ENVIRONMENT FROM PERSONNEL**

There are many types of precautions that can be taken to reduce the risk of personnel contaminating the clean room environment. The three main types are facility designs, gowning, and cleaning and disinfection programs.

#### **Facilities**

Current engineering designs provide several opportunities to protect the environment from the contamination that could occur because of the person working in the clean room. Among the most effective methods are the incorporation of isolators and barrier systems.

Protective barrier systems are used as a generic term to describe the various types of systems available to aid in the prevention of contamination risks to the product and work area. There are two major types of systems: isolators and barriers. They are distinguished by the level of isolation and protection they provide for the area. After this initial classification, there are subgroups or levels within each main category (23).

The definition of a barrier describes it as any physical obstacle to contamination that, for example, separates, demarcates, or serves as a barricade. In other words, one might say that it is anything that separates or holds contamination away from the area (24). It does not offer the same level of isolation and protection as an isolator. Examples of protection apparatus include biosafety cabinets, goggles, gloves, and face shields. Barriers do not typically have complete isolation of humans product/test item interaction (24). In some cases the barrier may include a rapid transfer port, but it is not typical. Barriers (24):

- May serve as personnel protection, for example, cabinets and glove boxes
- May allow human interaction with the product or test area
- Typically do not include sterile transfer capabilities
- Once sterilized, the system cannot maintain sterility
- May be designed to include HEPA filtered air
- Capable to have laminar or unidirectional air flow
- Possible to allow contaminants to penetrate the area
- Allow air exchange with the external environment

An isolator is different from a barrier in that it provides complete separation between the areas, that is, the defined area is completely protected from the external environment. They provide the highest level of separation from environment. Typical construction includes the ability to maintain a germ-free or contained environment, no personnel direct contact with the contained area. Some designs include pressure differentials to ensure that the area containment and sterility are maintained. Isolators come in both a closed and open configuration. Features of isolators include (24):

- They are designed to provide a closed environment
- Environment is fully contained and can be sterilized
- They separate and protect the product/test area from the personnel
- They limit likelihood of human-borne contamination
- They are capable of maintaining their sterile state



- They can be designed or customized to meet user's requirements or may be purchased in an off-the-shelf configuration
- They may also be considered as a controlled size clean room

Assigning levels to the various isolators and barriers might result in the following list (24):

- **Level 1 Partial barrier**  
This type of system provides a minimum level of protection. There is no capability for sterile transfers. The work area cannot be ensured to be sterile during operation. Examples of this type of system include curtains, conventional clean rooms, and personnel protective equipment.
- **Level 2 Closed barrier**  
This type of system has limited the opening and handling area. It provides more protection than a partial barrier. Typically, they do not include sterile transfer capability. Some current systems have added transfer ports to reduce the risks of contamination. The work area for this design cannot be ensured to be sterile during use. It does not provide complete isolation of the personnel from the product/test area. Examples of this type of system include restricted access barriers and glove boxes.
- **Level 3 Open isolator**  
An open isolator provides a high level of isolation for the process and transfer of materials. In these systems, one can maintain the sterility of the area during activity. Overpressure in this area can aid in the integrity of the system, in spite of areas where product or materials exit the isolator, for example, through a mouse hole. Most have special methods or devices for the transfer of materials in and out of the isolator. An example of this type of system is a production isolator that incorporates openings, for example, mouse holes to allow product to exit the area.
- **Level 4 Closed isolator**  
This system provides a totally contained process and associated transfer capabilities. It provides the highest level of protection. The advantage of these systems is that it is a closed system. It can maintain the sterility of the work area during activity. These systems provide specialized methodologies for transfer of materials into and out of the closed environment. Examples of this type of system include closed, leak-tight isolators used for batch production or quality control testing.

The trend to utilize isolators is increasing. This is especially prevalent in aseptic processing of pharmaceutical products. Typically, they use an open isolator where the containers exit through a mouse hole. Isolators are routinely used for sterility testing in the quality control laboratory. Many units are available for sterility testing that can be purchased in an off-the-shelf configuration (23).

For those companies that do not have isolator or barrier systems, the laminar air flow system should have air flow patterns that minimize the risk of personnel contaminating the product and product contact areas. It becomes very important to evaluate the various types of manipulations and interventions that personnel might conduct during the process to demonstrate that these actions do not adversely affect the surrounding environment.

### **Gowning**

Clean room garments, when worn properly, are designed to provide a barrier between the individual working in the clean room and the clean room environment. The effectiveness of this barrier is dependent on the garments selected, the materials used for construction of the garments, and how well the established rules for gowning are followed.

Another concern with gowning effectiveness is the level of particulates present on the individual and their personal hygiene practices.

### **Cleaning and Disinfection Programs**

Cleaning and disinfection programs are key components to maintenance of a controlled clean room environment. Typical components of this type of program are:

- Determining the type of flora routinely present in the environment.
- Finding a cleaning/disinfecting agent(s) that is effective for the types of flora routinely present. Note: While some individuals imply that microorganisms develop a resistance to cleaning agents, similar to bacterial resistance to antibiotics, there is no sufficient data to support this premise. Rather, it is a company choice to use a single disinfectant or a rotation of several disinfectants. It is also common to have different sanitizing agents depending on what is being sanitized, for example, foam agents or spray bottles of isopropyl alcohol for hands and other agents for floors and surfaces. For aseptic processes, it is a regulatory expectation that a sporicidal agent, like bleach, is incorporated into the cleaning and disinfection program.
- In vitro laboratory studies to show the effectiveness of the cleaning/disinfecting agent.
- Validation of the cleaning and disinfection program using at least three replicate studies of performing the cleaning using the specified cleaning procedures and collecting environmental samples both before and after the cleaning regime (in situ studies). For very clean areas, such as aseptic processing areas, it may not be possible to show a reduction in bioburden. If you have a room where zero is the expected count and one is an excursion, it will be difficult if not impossible to show reductions. For these types of areas it may be appropriate to just indicate that the cleaning program does not cause a significant increase in counts.
- After the initial validation, on-going monitoring of the environmental quality is performed to ensure that the cleaning program continues to be effective.

#### **QUALIFICATION OR CERTIFICATION OF PERSONNEL**

Qualification or certification of personnel should be conducted to show that they have correctly gowning for aseptic operations prior to allowing individuals to work in aseptic areas. Demonstration and training to show the proper gowning procedures and aseptic behavior should be conducted prior to the certification. The intent is to ensure that all of the necessary skills and techniques have been learned prior to the individual working with product. When the training has been completed, a series of evaluations should be conducted to ensure that the gowning procedure used does not contribute to the risk of contamination to the environment or product in an aseptic operation. Certification programs vary across companies (7).

A typical certification, or qualification program for personnel gowning typically includes (7):

- Provision of an overview of basic microbiology, and how it is applicable to clean room operations
- Description of the GMP requirements for personnel hygiene and clean room operations
- Description and example of the appropriate behavior for working in aseptic areas
- Discussion and explanation of laminar air flow properties, for example, impact of disruptions, good ways to perform interventions, how to protect the environment
- A description of the requirements for environmental monitoring and sampling methods/techniques and requirements to be used
- Discussion of important regulatory information on aseptic processing (although some companies choose to do this separately from the gowning certification), for example, applicable requirements from the aseptic processing guidance
- Discussion and review of the applicable SOPs for the process
- A physical demonstration of how to perform gowning by an individual who is certified and has demonstrated good techniques. (It is useful to routinely examine gowning techniques used within a facility and across facilities and evaluate what are the best demonstrated practices.)
- Opportunities for the personnel to attempt to gown correctly before going to the aseptic area, for example, in the classroom, with a trainer present to identify any potential concerns
- Employee must perform the gowning correctly in the gowning room with the trainer present



- Employee must gown and be microbiologically sampled at least three separate times. The results of this sampling must meet all established levels or limits. Note: Since this sampling is conducted prior to working in the aseptic area, some companies establish lower levels as acceptable for certification. Typically, an increased number of sites are sampled for qualification. Common programs include 12 to 18 sampling sites on the individual.
- An established procedure for how a person is decertified for gowning, for example, expiration of allotted time period since last certification, maximum amount of time a person can be absent from the aseptic clean room operations (e.g., an employee that has a major medical problem or maternity leave and does not work for several weeks), or what actions, trends, or monitoring results necessitate decertification. For example, if a person routinely fails to meet microbiological monitoring results, does this disqualify them from working in the area?

The requirements for certification are frequently documented on a checklist.

It is also important to ensure that this certification or qualification is updated on a routine basis. There are several types of recertification programs. Limited recertification may include reading the SOP, gowning with a trainer and replicate microbiological monitoring of the gowned individual. This is typically considered for employees that have been previously certified and may not have been working in the aseptic area recently. Periodic recertifications may include review of the entire certification program (7).

These types of programs are frequently used in part or in full, when retraining operators following results that exceed established levels or when adverse trends are observed (7).

Some certification programs only look at absolute numbers, for example, levels to determine if the results are acceptable and they do not look at how the baseline data for the operator changes as a result of gowning and operating in an aseptic condition. For example, trended data may show that an employee has an extremely high percentage of samples that are over the baseline results, 41%, indicating that a significant change has occurred and remedial action should be warranted. There is no regulatory requirement to perform this type of analysis (i.e., comparison to baseline data), but it provides useful information on the skills and training of specific operators (7).

#### **MONITORING OF PERSONNEL—DEMONSTRATION THAT YOUR SYSTEM IS OPERATING IN A STATE OF CONTROL**

It is important to establish programs that demonstrate whether the contamination control systems established are sufficient. Personnel monitoring is typically performed as part of the facility's environmental control program.

##### **Types of Monitoring Methods Used**

There are two predominant types of monitoring used routinely in personnel monitoring, surface sampling with a solid agar medium [e.g., replicate organism and counting (RODAC) plates] and surface sampling using swab sampling. Swab sampling is used less frequently, with traditional methods. With the advance of some of the viability based technologies, there is an increase in the number of people using swab methods coordinated with rapid microbiological methods for sampling. Surface sampling with RODACs and touch plates are the most widely used traditional sampling methods (22).

RODACs are used to sample various sites on the clean room clothing. Touch plates are used for fingerprint impressions [frequently referred to as fingerprint impression sample (FIPS)] of the gloved hand. Some companies use swab samples, especially in their isolator applications to sample the isolator gloves in a more comprehensive manner. The samples are recovered, incubated, and enumerated to determine the number of microorganisms recovered (22).

##### **Sampling Sites**

The number and location of personnel sampling sites used vary. The common thread for all of the sampling methods is the FIPs. All of the regulatory agencies expect to see this type of sampling for aseptic processing. A variety of other sampling locations may be used including

hoods, masks, shoulder, forearms (either frontal, rear, or both sides), wrists, chests, legs or boots (22).

Selection of sampling locations should include consideration of the potential for microbiological risk to the product and/or the environment. For example, in an isolator environment, the gloves and forearms are a likely source of contamination and are usually tested. In many operations, personnel tend to rest the back/bottom of their forearms against surfaces and as such, this might be an appropriate sampling location. If other body parts come into contact with clean room surfaces, these sites should be sampled; for example, people who use their shoulders to push open clean room doors (22).

Some company sampling plans include masks. High counts on mask samples may indicate that the personnel are talking excessively. When the operator is talking frequently, using a mask, the talking results in a wet/moist mask. The wet path allows for microbial passage through the mask. It is postulated that the microorganisms can ingress through a wet mask in about 20 minutes (22).

Goggles and glasses are not typically monitored.

It is not necessary for the same number and type of samples be taken for all employees in the clean room. For example, if a person is responsible for setting up the filling line needle equipment, the criticality of the operation may justify that an increased number of samples are taken and/or that samples be taken at additional locations. Material handlers may also be prone to contamination at different sites (e.g., legs or chest areas) because of how they move or lift the affected materials (22).

The required number of sites, sampling locations, sampling frequencies, and the rationale for how these were determined should be documented, typically in a standard operating procedures or policy. Typically, each person is sampled for two to six different sites (22).

#### **When Should Monitoring Be Performed?**

Use of surface sampling plates, either RODACs or touch plates, results in the potential to leave behind residues of the media on the sample location. This media can then become a harbor for microbial contamination. For this reason, it is appropriate to perform personnel monitoring at the end of production activities, for example, end of shift, before changing out of uniforms, etc. Sanitizing agents may reduce the likelihood of recovery organisms present on gloves. Accordingly, sampling should not be performed immediately following sanitization of gloves (22).

For some operations, for example, critical aseptic connections, it may be appropriate to take the samples at the end of the activity. This may necessitate that the operator changes gloves or uniforms prior to returning to work in the aseptic area (22).

#### **Who Performs the Sampling?**

A common question at manufacturing facilities is who should be responsible for taking the samples? In most cases, the debate is whether microbiologists or manufacturing personnel should be used to perform the sampling. Some companies believe that the quality control (Assurance) microbiologists should perform the sampling, as QC has responsibility for oversight of manufacturing operations. Other companies believe that manufacturing personnel can perform the sampling, if properly trained and qualified. Many times the microbiologists do not want to participate in off-shift sampling (22).

All personnel who are responsible for sampling should be trained in how to perform the sampling, when to perform the sampling, what to do with the samples once they have been taken, concerns/limitations of testing and the basic microbiology associated with the testing methods (22).

For those companies where manufacturing personnel are responsible for sampling, safeguards are established to protect the validity of the sampling methods and results. Typical types of safeguards include (22):

- A qualification program for samplers
- Periodic auditing of sampling methods by qualified microbiologists
- Sampling “booths” or rooms, where auditors routinely monitor or audit the sampling procedures as they are conducted for each batch of product



It is important to also train and qualify the microbiologists who perform sampling in the proper methods and techniques to be used.

#### **What Should be Done with the Data Collected?**

Data obtained from sampling of personnel should be compared to established levels to determine whether these levels are exceeded. It should also be maintained and trended using an appropriate environmental monitoring trending application. If levels are exceeded or adverse trends occur, appropriate corrective and preventative actions (CAPAs) should be taken (22).

#### **Establishing Levels or Limits for Personnel Monitoring Results**

Personnel monitoring levels or limits are specified in some regulatory documents, for example, EU Annex 1 to the GMPs, FDA's Aseptic Processing Guidance. If products are manufactured for countries that have defined regulatory limits, then the established requirements should fall within those limits (22).

For systems where regulatory limits do not exist, the data should be trended and evaluated to determine an appropriate baseline of counts, which are used to establish the acceptable alert and action levels. Keep in mind, however, that environmental data may not be normally distributed, so appropriate evaluations should be conducted to determine if the statistical methods used are appropriate for the data. Another consideration in setting levels is that cells or CFUs should typically be integers. One does not have  $\frac{1}{2}$  or  $\frac{1}{4}$  of a microbial cell present in the environment. Long-term use of statistics where very low levels of contamination are present can result in statistical values for results that make little or no sense.

It may be necessary to have different monitoring levels established for production personnel and cleaning personnel. The nature of the cleaning operations may make them prone to higher levels of contamination while correctly performing their work assignments (22).

#### **ON-GOING EVALUATION AND RISK ASSESSMENTS**

In addition to the initial certification of personnel working in clean rooms, it is important to have on-going programs to evaluate the state of control during operation. The most prevalent way to do this is to incorporate personnel monitoring into the environmental control program.

The levels or limits established during qualification or via regulatory documents are used to standardize acceptable levels of control. These levels or limits should also take into account the risk associated with the procedure, in terms of both the product and the personnel.

#### **CAPAs for Numbers Exceeding Established Levels**

Data should be routinely generated to evaluate the effectiveness of personnel monitoring programs. In the event the established levels are exceeded or an adverse trend in monitoring results is observed an investigation should be conducted. It is important that the investigation occur in a timely manner. Typical types of follow-up actions may include (7):

- A increase in sampling frequency
- Increased observation of personnel behavior and gowning by supervisory personnel
- Retraining of the operator
- Gowning requalification performed earlier than routinely required
- Decertification of the person for the aseptic area until appropriate qualification or certification requirements and training are met
- Reassignment of the individual to another activity outside the clean room.

There are several areas of concern that should be taken into account when dealing with corrective actions for personnel monitoring results. The methods used for personnel monitoring often lack sensitivity, and like all manual operations are prone to human contamination, that is, false positives. The low levels of contamination are allowed in some regulatory guidance documents, for example, a count of one may be an issue. One must remember that microbiology is a logarithmic science, and scientifically there is no real

difference between counts of one and nine. Conversely, the intention or goal of aseptic practices is to operate throughout the manufacturing process contamination free (7).

Some of the typical preventative actions taken by companies include increased training and emphasis on the gowning certification and recertification program (7).

#### NOTE

Throughout this chapter, the identification of a genus or species of microorganism has been given. In recent years, the American Type Culture Collection has been actively sequencing their collection. This has resulted in many genus and/or species names changing. It is important when making decisions about a risk of contamination from an organism to know its current name, any previous names, and any previous similarities/links to other organisms. While every effort has been made to keep these names current, it can be impossible to do so. For the most current information, contact the American Type Culture Collection, or the agency in your country.

#### CONCLUSION

The importance of personnel in clean room operations should not be underestimated. Effective operations require that control of contamination is demonstrated. Personnel monitoring and control, for example, certification are critical components of a control program for aseptic areas. Effective training programs communicate all of the necessary requirements for aseptic gowning and behavior and have definable milestones to show that the operator understands and has effectively implemented these procedures.

#### ACKNOWLEDGMENTS

Over the years, I have benefited from many mentors in the area of environmental monitoring. They include James Agalloco; James Akers, PhD; Peter Cooney, PhD; Karen Ginsbury; Mary Beth Grace; Captain David Hussong, PhD; the late Michael Korczynski, PhD; John Lindsay; David Matsuhira; Kenneth Muhvich, PhD; and the various task force members for revision 1 and 2 of PDA's Technical Report Number 13. You have my utmost thanks and appreciation for your help in my understanding of this topic.

#### REFERENCES

1. Halls N. Risk management: practicalities and problems in pharmaceutical manufacture. In: Halls N, ed. *Pharmaceutical Contamination Control*. Bethesda, MD and River Grove, IL: PDA/DHI Publishers, 2007:171-204.
2. FDA. *Guidance for Industry: Sterile Drug Products Produced by Aseptic Processing Good Manufacturing Practice*. Department of Health and Human Services, United States Food and Drug Administration, CDER/CBER/ORA, 2004.
3. Sutton SVW. *Pharmaceutical Quality Control Microbiology: A Guidebook to the Basics*. Bethesda, MD and River Grove, IL: PDA/DHI Publishers, 91-108.
4. Austin PR. *Encyclopedia of Cleanrooms, Bio Cleanrooms, and Aseptic Areas*. Contamination Control Seminars. Livonia, Michigan, 1995:1-38.
5. ISO 14644-1. *Cleanrooms and Associated Controlled Environments. Part 1: Classification of Air Cleanliness*. International Standardisation Organization, 1999.
6. Eudralex. *Volume 4 Good Manufacturing Practice, Annex 1 Manufacture of Sterile Medicinal Products*, 2003.
7. Moldenhauer J. Personnel monitoring and certification. In: Moldenhauer, J. ed. *Environmental Monitoring: A Comprehensive Handbook*. Vol 1. Bethesda, MD and River Grove, IL: PDA/DHI Publishers, 2005:315-328.
8. Hallworth M. Particle counting applications in the pharmaceutical environment. In: Moldenhauer J, ed. *Environmental Monitoring: A Comprehensive Handbook*. Vol 1. Bethesda, MD and River Grove, IL: PDA/DHI Publishers, 2005:119-138.
9. Moldenhauer J, Yvon P. Environmental monitoring using the ScanRDI, polym'air. In: Moldenhauer J, ed. *Environmental Monitoring: A Comprehensive Handbook*. Vol 2. Bethesda, MD and River Grove, IL: PDA/DHI Publishers, 2005:325-337.
10. Vellutato A Jr. Presentation at the Environmental Monitoring/Microbiology Interest Group Meeting at the PDA Annual Meeting in Boulder Colorado, April 2008.



11. Jiang JP. Environmental monitoring using an instantaneous microbial detector. In: Moldenhauer J, ed. *Environmental Monitoring: A Comprehensive Handbook*. Vol 2. Bethesda, MD and River Grove, IL: PDA/DHI Publishers, 2005:403-412.
12. Battelle. Targeted Product Specifications for Rapid, Enumerated Bioidentification System (REBS). Labeled with the following identifications, 800.201.2011, 2008, Available at: solutions@battelle.org, and www.battelle.org.
13. Austin PR. *Encyclopedia of Cleanrooms, Bio Cleanrooms, and Aseptic Areas*. Contamination Control Seminars. Livonia, Michigan, 1995:1-38.
14. Reinmuller B, Ljungqvist B. Modern cleanroom clothing systems as a contamination source. *PDA J Pharm Sci Technol* 2003; 57(2):114-125.
15. Austin PR. *Encyclopedia of Cleanrooms, Bio Cleanrooms, and Aseptic Areas*. Contamination Control Seminars. Livonia, Michigan, 1995:1-38.
16. Whyte W, Hamblin D, Kelley L, et al. An investigation of occlusive polyester surgical clothing. *J Hosp Infect* 1990;15(4):363-374.
17. Ljungqvist B, Reinmüller B. *Cleanroom Clothing Systems: People as a Contamination Source*. Bethesda, MD, River Grove, IL: PDA/DHI Publishers, 2004.
18. Eudralex. Volume 4 Good Manufacturing Practice, Annex 1 Manufacture of Sterile Medicinal Products, 2003.
19. FDA. *Good Manufacturing Practices*. Code of Federal Regulations, §210 and 211, Government Printing Offices, 1996.
20. ISO 14644 5. *Cleanrooms and associated controlled environments. Part 5: Cleanroom Operations*. International Standardisation Organization, 2002.
21. Lowery SA, Mueller M. Designing and validating a contamination control program. In: Prince R, ed. *Microbiology in Pharmaceutical Manufacturing*. Vol 1. Bethesda, MD and River Grove, IL: PDA/DHI Publishers, 2008:305-369.
22. Moldenhauer J. Personnel gowning. In: Moldenhauer J, ed. *Environmental Monitoring: A Comprehensive Handbook*. Vol 1. Bethesda, MD and River Grove, IL: PDA/DHI Publishers, 2005:307-315.
23. Moldenhauer J. Isolators/Barriers. In: Moldenhauer J, ed. *Environmental Monitoring: A Comprehensive Handbook*. Vol 1. Bethesda, MD and River Grove, IL: PDA/DHI Publishers, 2005:89-97.
24. Akers JE. Current challenges in isolation technology. In: Wagner CM, Akers, JE, eds. *Isolator Technology: Applications in the Pharmaceutical and Biotechnology Industries*. Buffalo Grove, IL: Interpharm Press, Inc., 1995:1-36.

#### AUTHOR BIOGRAPHY

Jeanne Moldenhauer, vice president of Excellent Pharma Consulting, has more than 25 years experience in the pharmaceutical industry. She chairs the Environmental Monitoring/Microbiology Interest Group of PDA, serves on the Scientific Advisory Board of PDA, founded the Rapid Microbiology User's Group™, and is a member of ASQ and RAPS. She is the author of *Steam Sterilization: A Practitioner's Guide*, *Laboratory Validation: A Practitioner's Guide*, *Environmental Monitoring: A Comprehensive Handbook*, *System's Based Inspections for Pharmaceutical Manufacturers*, co author of *Biological Indicators*, and numerous publications.

# 3 | The fundamentals of an environmental control program

William H. Miele

## INTRODUCTION

This chapter is intended to assist the reader in developing an understanding of current thinking regarding environmental monitoring and control and its application in aseptic processing. Some background historical information will be discussed to describe the journey from where we came and where we are in an effort to appreciate the nuances of the journey forward. Of course it is our present situation that dictates how we function on a day to day basis and it is the vision of where we want to be that drives our thoughts and processes through the challenges presented by continual change.

Continual change has not always been the accepted mode of operation. A minimalist mind set was once pervasive throughout the industry. The development of technologies applied to aseptic processing from the HVAC (Heating, Ventilation, and Air Conditioning) systems and facility engineering to the technologies directed at the detection and identification of contamination have changed the way we approach our business. This along with the ever-escalating industry standards and the evolution of risk- and science-based approaches to regulatory compliance have driven environmental monitoring and control practices to a new level of performance and expectation. It is this combination of events that requires us as leaders in aseptic manufacturing to know and understand the continuum to scope out the future.

## TRADITIONAL APPROACH TO MONITORING, PRESCRIPTIVE CONTROL

### Origins of Monitoring

Looking at the history of drug control and enforcement in the United States, it is evident that sterile drug product review was superficial at best and lacking in the details required to minimize risk to the public prior to 1970s. Prior to this era drug applications were not sufficiently detailed for government reviewers to determine exactly how sterile products were manufactured. From this was spawned the 1976 CFR rule on LVPs and Good Manufacturing Practices for sterile drugs that gradually gave way to the FDA guidance on sterile drug manufacture of 1987. We are all familiar with the 2004 update of that document. In the period of the 1990s much attention would be given to aseptic processing because of events that transpired in the generic drug industry, which flourished after the Hatch-Waxman Act of 1984. As a result there was a corresponding response at regulation and enforcement by the U.S. Food and Drug Administration through the Office of Generic Drugs and Center for Drug Evaluation and Research. A plethora of guidance documents flooded the industry covering how to do and what to do in various aspects of sterile drug manufacturing. The frame work of aseptic processing was being cast including the support of documents such as Federal Standard 209E addressing airborne particulate cleanliness in clean rooms. At the same time there was the explosion of contributions from industry organizations as well, such as the Parenteral Drug Association Technical Report 13 and from the United States Pharmacopeial Convention with the advent of Informational Chapter <1116> (14).

### Reliance on Numbers

During this time period, pursuing their missions to protect the safety of the public, the regulatory bodies produced more and more documents to fulfill their role. These documents may have taken the form of guidances directed to their own inspectional efforts or to the industry, companies under their inspection. The USP established General Information Chapter <1116> USP 26. This offering referenced U.S. Federal Standard 209E (September 11, 1992) (1) for airborne particulate classes and offered frequencies for sampling and limits for classes to the decimal place in particles per cubic foot. Microbial considerations were listed in colony-forming



units (CFUs) for equipment surfaces and floors in class 100 and class 10,000 including a prescribed limit for floors. One can only speculate that the microbial data presented originated with a 1967 NASA (2) document referenced in the 1984 USFDA aseptic guidance and promulgated through various regulatory documents and guidances in the United States and in Europe. With each iteration or unique perspective greater and greater specificity based on "what is considered attainable and desirable" emerged. Rather than emphasizing how processes were being engineered and managed to be compliant and gain new product approvals to the marketplace, the industry responded by producing an avalanche of data for drug submissions and review based on the flood of often confusing and sometimes conflicting guidance information available. The response by industry was not one of integration of best practices into processes but the response was additive to the processes, not the intent of the regulatory agencies but the result of the response by industry.

Simultaneously, there was an explosion of commerce taking place on a global level that few envisioned or were prepared to address regarding approaches to regulatory compliance. This further exacerbated the situation by overlaying geographically dispersed regulatory requirements upon already burgeoning seemingly endless amounts of descriptive information to assimilate and put into practice. The c in cGMP had figuratively moved from a lower case c to an uppercase C. Company's marketing their products globally were forced to do a "juggling act" to balance manufacturing operations to encompass all the variables for the intended areas of marketing. One example of a regulatory document of geographical origin but global significance was the "EC Guide to Manufacturing Practice for Medicinal Products and Active Pharmaceutical Ingredients" and in particular the supplementary guideline known as Annex 1, which addresses sterile product manufacture. It appeared that each regulatory body interpreted regulations in an independent manner as if drafted with little consideration of the other. This included the USFDA aseptic guidance document of 1987.

All this was happening in a rapidly changing environment. The knowledge of quality management principles as developed and fostered by Demming, Juran, and others were taking hold and producing significant gains in product reliability and manufacturing efficiencies in other industries. But the perception of quality and how to go about integrating the "new" quality management principles into processes long driven primarily by law/regulation seemed out of the grasp of the pharmaceutical industry. As a result the industry found itself behind the learning curve compared to other highly focused engineering and technology concentrated industries. It appeared the pharmaceutical industry had its feet cemented in the detail and seemingly inflexible mindset of the past and had not embraced the changes that were occurring all around it. What the industry did do was mire itself in detail and redundancy to try and attach quality to its terminal processes. This apparent conundrum led the industry to claim the regulations restricted their ability to change, while regulators claimed the industry had not adopted change, as had been the case in other industries also heavily technology and engineering oriented. For some period of time the reliance on details and numbers stuck and what appeared to be a standoff persisted.

#### **A CALL FOR CHANGE New Paradigm of Control**

The global nature of the rapidly developing industry stimulated the pursuit and expansion of global harmonization. The need to harmonize was recognized because of the growth of the European Union and the establishment and contributions from organizations such as the International Congress on Harmonisation (formed in 1990) and the American National Standards Institute to name but a couple. The diversity of interests and the global development of the industry emphasized the need for geographically different approaches to embrace regulatory initiatives and harmonize.

In the United States things were not standing still. Great change was occurring because of the tremendous growth of pharmaceutical manufacturing in the areas of drugs, devices, biologicals, and the new and exploding biotech industry. Events brought on by the apparent inability of the industry to adapt the current regulations to their day-to-day operations resulted in significant encounters between government regulators and certain segments of the industry. Two such examples might exemplify these activities, the "Barr decision" (1993) (3) and the



resulting drafting of the guidance for industry on out of specification results and the advent of Team Biologics (1997). The latter was created in an effort to more broadly harmonize regulation and compliance between CDER and CBER. A revolution, if you wish, was developing. The seeds of change were being planted and were fertilized by documents such as 21 CFR Part 820, Quality System Regulation (1997), and the FDA Guide to Inspections of Quality Systems (1999). Then in 2002 the USFDA published "Pharmaceutical cGMPs for the 21st Century: A Risk-Based Approach, A science- and risk-based approach to product quality regulation incorporating an integrated quality systems approach" (4). It represented a giant departure from an approach to regulation that could have been described as inflexible and protracted, while now advocating a systematic, integrated approach with science and risk as the basis for decision making. This was not introduced to replace regulation as published but was intended to augment, supplement, or facilitate the attainment of compliance to the regulations as written. This new holistic approach supported communication and harmonization across areas both geographic and technical never before communicated no less previously supported. The document endorsed the concept of collaboration with regulatory authorities in a variety of unofficial venues utilizing industry organizations and collaborative initiatives such as ICH. With this came the support of the trilogy, ICH, Q8 Pharmaceutical Development, Q9 Quality Risk Management, and Q10 Pharmaceutical Quality System, and a new paradigm was borne (5).

Initially on publication there were more questions than answers and more naysayers than advocates. Change takes time but through what appears to be a remarkably well-orchestrated initiative, the word went out to both agency and industry organizations and then collaboratively through industry participation. Selected salient publications authored or coauthored by both agency and industry professionals included Friedman et al., "Risk Factors in Aseptic Processing" (6) and Hussong, "Environmental Monitoring for Aseptic Processing" (7). In these articles both the myths and truths in aseptic processing and control of aseptic environments were discussed in an unprecedented manner. As the discussions surrounding the 21st century risk- and science-based approach continued the support for the ICH Q8, 9, and the draft ICH Q10 became the topics of the day and the dialogue still continues. Just as important a path forward and a vision for the future were being characterized. These publications were written during the drafting and comments stage of the 2004 revision of the USFDA 1987 "Guideline on Sterile Drug Products Produced by Aseptic Processing" (8,9). Parallel developments occurring in the European Union involved the revision of Annex 1, Manufacture of Sterile Medicinal Products, of the EC Guide to Good Manufacturing Practice for Medicinal Products and Active Pharmaceutical Ingredients in 2008 (10). This document also emphasized the theme of good science and assessment of risk. The European Union went as far as adopting ICH Q9 as an informational annex, Annex 20. The recognized need and willingness for harmonization was spreading through organizations addressing global development of harmonization. The Pharmaceutical Inspection Convention, Pharmaceutical Inspection Co-operation Scheme, PIC/S, is an organization whose mission is to facilitate international harmonization of good manufacturing standards. It is composed of regulatory bodies for their benefit and the countries and patients they serve. The USFDA is not currently a member but has applied for membership.

There has been a shift in philosophy on how to achieve compliance with the regulations. It has not been "out with the old and in with the new," but it has encompassed a change in how to respond to an environment that is in continual change. This is an acknowledgement of how one goes about the process of compliance and that compliance with the regulations is an evolutionary endeavor due to the introduction of new technologies and new management approaches. This represents a significant change and a lot of change in a relatively short time span for many stakeholders. Each stakeholder trying to understand the changes and at the same time formulate implementation plans to cover the perceived change.

The mode of operation is new and challenging, but not impossible. It emphasizes a "holistic" or systems approach rather than a prescribed approach to compliance. In saying that there must be emphasis on the underlying intent of the regulations rather than the absolute adoption of the prescriptive requirements, there needs to be some clarification. Historically, the "black or white" approach to compliance is thought by some to be the cause of compliance



problems rather than a solution and thought to be a contributor to the lack technological innovation by the industry. With the advent of modern theories for the integration of quality into manufacturing processes in conjunction with the advent of new technologies, a shift to equivalent or better is immersing as the "new paradigm."

#### **The Uncertainty Principle and Microbiological Control**

Akers and Moore (11) published an article about 10 years ago, which turned out to be quite prophetic and framed the dilemma that is currently developing. It is risky to cite the famous Heisenberg Principle to this application but it does represent a scenario that suggests a parallel. The changes occurring in aseptic processing control do have implications to the uncertainty of the situation. The inability to measure accurately will limit our ability to predict or document an event as it is occurring and to determine its impact. Currently, the engineering and clean room technology used in the 21st century to control manufacturing processing is far superior to the environmental monitoring/microbiological technology and methods in use and their abilities to detect and quantify microbiological contamination in a relevant time frame. This disparity between engineering technology and microbiological measurement and control has highlighted the lack of our current capabilities and forced the decision making process to focus on a "holistic" approach to control, most probably where it belonged in the first place. Not to detract from the holistic as being appropriate and correct but the identified disparity places a greater reliance on that approach because of the paucity of exact on the spot data.

As microbiologists supporting aseptic control and environmental monitoring in aseptic processing we are using 200-year-old technology and trying to keep pace with processing in the 21st century. Add to that the disparity are the myths we as people harbor for considering and assessing microorganisms we cannot even see and are only capable of detecting by relatively crude and inaccurate means. As scientists we thrive on our ability to measure, quantify, qualify, and describe, and we respond to those expectations. As a result many of the quantitative assumptions and qualitative descriptions we have embedded in our guidance documents have become part of our "body of knowledge" and are laced with notions that may be inaccurate and only serve to mislead us. Although we would like to take numbers of CFUs generated from microbiological media as representative of a defined microbial population, it can not categorically be stated that a microbial event(s) captured on microbiological media actually represents the status of product quality or for that matter process quality. Some firms have positioned themselves in such a manner as to have no recourse but to use EM data for the release of product. It is probable that the regulations as written were never intended to force companies into such a position.

#### **A Sound Approach**

Environmental control of any production operation is the objective, while environmental monitoring is just one set of tools in the arsenal employed. There is no one correct approach, but the consensus says best results can be obtained when you approach environmental control from a holistic perspective starting with the general and working toward the specific, essentially building quality into the process. This approach is taken in our more ardently followed guidances and regulations. Both the FDA guidance for industry and the EU guide to GMP practice, including Annex 1 offer that approach, each includes buildings and facilities for grounding of their recommendations for necessary control measures. Prior to discussion of the utility of microbiological monitoring and counting colonies as being effective for its intended use, we would be remiss if we did not stress the fundamentals of a control program.

There are specific circumstances or situations within the manufacturing process that may allow for a microbial hazard to occur. A review of such areas would be essential to identifying issues and maintaining control such as

- Facility design
- Warehousing/storage of raw materials (API and excipients)
- Pre/post manufacturing storage and transport conditions
- Manufacturing equipment

- Cleaning and sanitization methods
- Water/utilities
- Processing conditions
- Personnel behaviors

Monitoring programs as outlined in regulatory and industry documents were designed for use in clean environments (aseptic processing). However, monitoring, as such, has been taken by some and applied to every thing from assessing microbial levels in uncontrolled nonsterile manufacturing areas to monitoring warehouses. There have even been suggestions, presumably seriously offered, that request the outside environment be monitored to determine the local microflora. In my opinion this exemplifies our apparent need to try and quantify, qualify or describe without consideration to the value of the information. The monitoring programs or there components described in guidances and regulation for aseptic manufacturing operations are not intended for use to control microbial contamination in a nonsterile setting or nonsterile manufacturing process. A program of contamination control for nonsterile application can be developed through a documented risk assessment that incorporates an evaluation of the steps in the nonsterile process. Similarly a risk assessment process should also be applied to aseptic program development to fill in and connect the prescribed portions of an aseptic program. From the risk assessment process potential microbial hazards can be identified. After the microbial hazards are identified, the existing control measures in the process, if any, are evaluated to determine their efficacy. If adequate controls are not present, controls are put in place to prevent or minimize the introduction of microbial contamination. These controls may be physical (e.g., temperature, holding times), chemical (e.g., pH), procedural (e.g., cleanliness, dryness), or microbiological (raw material acceptability, microbial reduction steps). A program can be established that will monitor (by observation or by measurement, physical or microbiological) the controls to assess the process and subsequently reduce risk of microbial contamination.

Without presenting a primer on quality risk management it might be useful to define a few basic terms for understanding. Risk is defined in ICH Q9 as the combination of the probability of occurrence of harm and the severity of that harm. A hazard being defined in ICH Q9 as “a potential source of harm” and harm being defined as “damage to health, including the damage that can occur from loss of product quality or availability.” There are specific circumstances or situations within the manufacturing process that may allow for a microbial hazard to occur. Microbial hazards may originate from improper facility design. Such hazards could include deficient control of humidity and temperature in manufacturing areas, improperly balanced or maintained air cleanliness levels both at rest and in operation, and proper room construction and design to permit effective cleaning and maintenance. Inappropriate layout of rooms could facilitate cross-contamination or recontamination of an area due to personnel, materials, or equipment flow. Inappropriately maintained and controlled warehouse and storage areas may precipitate potential microbial hazards. Some raw materials are very hygroscopic; high humidity and/or improper container closure could cause microbial ingress and/or proliferation. Microbial hazards may be introduced into a manufacturing process because of improper sanitary design of the manufacturing equipment, especially equipment used for aqueous processing steps. For example, microbial contamination can arise from entrapped water drainage or product residues that remain hidden from procedural cleaning processes due to threaded pipe fittings, nonsanitary valves, piping dead legs, nonsloping pipes, equipment crevices, recessed access ports, bottom discharge valves, and pocket flow meters. Inadequate equipment maintenance may also serve as a potential hazard. For example, misaligned, damaged, or over torqued gaskets between piping connections may harbor a reservoir of trapped microorganisms.

Inadequate or inappropriate cleaning and sanitization of the equipment and manufacturing areas can potentially serve as a major source of microbial hazards. Other examples of potential microbial hazards could include the following:

- Cleaned equipment that is not properly dried and stored wet.
- Cleaned equipment that is not properly stored.



- Manufacturing areas that are not adequately or routinely cleaned before use (e.g., standing pools of water, construction materials, cardboard, or other debris).
- Cleaning utensils such as mops, buckets, and brushes that are not stored dry or clean.
- Intervals between manufacturing runs with no cleaning or variable time limits before cleaning with no consideration for the potential for microbial contamination.

Water, a major component of many dosage forms or for equipment or facility cleaning, is a potential source of contamination. It is essential to use water of the proper purity standard for its intended use. Unless sterile and used in a sterile environment, a lesser quality of water will foster microbial contamination with time and exposure. For example, if maximum hold times for in-process materials with appreciable water content are not properly validated and used within that validated period, microbial proliferation could occur.

Personnel may be the single most significant contributor to contamination, particularly as the environmental and microbial control of an area becomes more stringent. Putting people in an aseptically controlled area is the greatest challenge to contamination control to process and product. Not only the direct involvement of people within the manufacturing process is important but also the movement of people between various stages of the work processes. People flow between areas of differing microbial control, including nonclassified areas into controlled and classified areas is critical. There is also acknowledgement that personnel activities outside of work do influence control efforts within the plant environs, and it can also be influenced by seasonal variations.

This is just an overview of areas to be considered as a foundation for a total environmental control program. It is recommended that a risk assessment of the work flow, locations and movements of materials, equipment and personnel be performed to identify the potential hazards encountered and assess existing controls and their levels of effectiveness. An action plan can be formulated with a rationale supporting the decisions and changes. Without this strong foundation the efforts of more focused initiatives for environmental control will face a greater challenge and may not be sustainable.

#### **Aseptic Control, The Devil Is in the Details**

It is well documented and accepted that aseptic processing presents the highest safety risk, that is, risk to the patient, than any form of commercial drug manufacture. For the manufacture of sterile parenteral products terminal sterilization is the process of choice, and aseptic processing is only acceptable when there is no other means to process the particular drug product. Given the complexity of the aseptic manufacturing process, individually sterilizing component parts and then assembling and dosing product in an aseptic "clean," but yet not sterile environment, presents a challenge to the manufacturer to establish controls and develop a monitoring program in response to the risk level. The regimen is a fine-tuned array of engineering prowess and management oversight, and diligent operation of the program to ensure all established parameters and acceptance criteria are met on a continual basis. This necessitates a rigorous program of planning, actions, checks, and rechecks. As indicated earlier, this pursuit is made more arduous because of the limited precision and accuracy of the monitoring methods we employ today.

#### **ENVIRONMENTAL CONTROL AND MONITORING, A HOLISTIC APPROACH**

##### **Facility Design, HVAC Engineering, Layout, and Process Flow**

The design of the aseptic areas and the supporting rooms is of utmost importance. For most applications there is a core area, positioned with supporting rooms leading to the core and allowing for exit. The most critical activities take place in the core that is the most "clean," and supporting areas to the core being held to lesser cleanliness standards. The core areas where the most critical activities take place include filling, lyophilization when done, and supporting operations to prepare and make available to the process sterile containers and stoppers, etc. The location/positioning of crimping equipment when applicable is flexible based on regulatory requirements and operational setup. This basic layout provides for sterile components, glass, drug substance, and stoppers to be fed directly into the core. Other "stuff" to enter the core not capable of being heat or filter sterilized such as some equipment,