

Abbreviations	
HE	holoenzyme complex
pol	DNA polymerase
pol V Mut	pol V mutasome
SBB	DNA single-stranded binding protein
TLS	translesion synthesis
XPV	Xeroderma pigmentosum variant gene product

Introduction

The first DNA polymerase (pol), *Escherichia coli* pol I, was discovered in 1957 by Arthur Kornberg (for review, see [1]). Twelve years later John Cairns [2] isolated a strain of *E. coli* containing a mutant pol I enzyme leading to the discoveries of pol II and pol III (for review, see [1]). Pol III is responsible primarily for replicating the bacterial genome, while pol I plays a major role in UV damage repair and in Okazaki fragment processing (for review, see [1]). The enigmatic pol II was recently shown to be involved in the reactivation of replication complexes stalled at DNA template lesions [3]. Thirty years have now passed since the discovery of the pol I mutant. Remarkably, the past 18 months have witnessed the discovery of a variety of new procaryotic and eucaryotic DNA polymerases, including two more in *E. coli*.

This review discusses these new DNA-damage tolerant polymerases with special emphasis placed on the role of the error-prone UmuD₂C complex (*E. coli* pol V) in the well-documented SOS mutagenic response in *E. coli*. We provide an overview of the relationships between the novel

plex, which, in the presence of activated RecA protein filament (RecA*), catalyzes ‘error-prone’ translesion synthesis (TLS) causing mutations at DNA damage sites [11]. RecA plays a direct biochemical role during SOS mutagenesis that is distinct from generalized recombination and coproteolysis [10,12,13] and that is apparently responsible for targeting UmuD₂C to a template-lesion site proximal to the tip of the RecA* filament [14,15].

Mutagenically inactive complexes formed with UmuD₂C and UmuD₂DC are thought to act as a regulatory switch to turn off mutagenesis once DNA damage sites have been either repaired or bypassed [16]. Early reviews on SOS were written by Witkin [17] and Walker [4], and Friedberg *et al.* [18] provide a recent comprehensive review of the SOS regulatory system, written prior to the discoveries of error-prone *E. coli* pol IV and pol V.

SOS translesion synthesis reconstituted

in vitro

A replication fork stalled at a DNA damage site results in the formation of a replication fork with a DNA damage site. The form of a DNA damage site that can be copied by DNA polymerases is induced that can copy damaged template sites, making errors along the way. The proteins required for SOS-induced mutation (also called SOS error-prone repair)

Columbia Ex. 2085
 Illumina, Inc. v. The Trustees
 of Columbia University in the
 City of New York
 IPR2020-00988, -01065,
 -01177, -01125, -01323

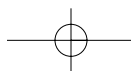

Abbreviations	
HE	holoenzyme complex
pol	DNA polymerase
pol V Mut	pol V mutasome
SBB	DNA single-stranded binding protein
TLS	translesion synthesis
XPV	Xeroderma pigmentosum variant gene product

Introduction

The first DNA polymerase (pol), *Escherichia coli* pol I, was discovered in 1957 by Arthur Kornberg (for review, see [1]). Twelve years later John Cairns [2] isolated a strain of *E. coli* containing a mutant pol I enzyme leading to the discoveries of pol II and pol III (for review, see [1]). Pol III is responsible primarily for replicating the bacterial genome, while pol I plays a major role in UV damage repair and in Okazaki fragment processing (for review, see [1]). The enigmatic pol II was recently shown to be involved in the reactivation of replication complexes stalled at DNA template lesions [3]. Thirty years have now passed since the discovery of the pol I mutant. Remarkably, the past 18 months have witnessed the discovery of a variety of new prokaryotic and eucaryotic DNA polymerases, including two more in *E. coli*.

This review discusses these new DNA-damage tolerant polymerases with special emphasis placed on the role of the error-prone UmuD₂C complex (*E. coli* pol V) in the well-documented SOS mutagenic response in *E. coli*. We provide an overview of the relationships between the novel

plex, which, in the presence of activated RecA protein filament (RecA*), catalyzes 'error-prone' translesion synthesis (TLS) causing mutations at DNA damage sites [11]. RecA plays a direct biochemical role during SOS mutagenesis that is distinct from generalized recombination and coproteolysis [10,12,13] and that is apparently responsible for targeting UmuD₂C to a template-lesion site proximal to the tip of the RecA* filament [14,15].

Mutagenically inactive complexes formed with UmuD₂C and UmuD₂DC are thought to act as a regulatory switch to turn off mutagenesis once DNA damage sites have been either repaired or bypassed [16]. Early reviews on SOS were written by Witkin [17] and Walker [4], and Friedberg *et al.* [18] provide a recent comprehensive review of the SOS regulatory system, written prior to the discoveries of error-prone *E. coli* pol IV and pol V.

SOS translesion synthesis reconstituted *in vitro*

A replication complex confronting a damaged DNA template strand may be likened to a major train wreck resulting in 'derailment' of the core polymerase and its accessory subunits. When faced with excessive amounts of DNA damage, the cell sends out an SOS signal, perhaps in the form of a segment of single-stranded chromosomal DNA bound by RecA protein. A specialized group of proteins are induced that can copy damaged template sites, making errors along the way. The proteins required for SOS-induced mutation (also called SOS error-prone repair)

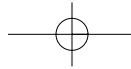

genetic data from many different laboratories [18]. These proteins include UmuC, UmuD', RecA, and pol III holoenzyme complex (HE).

In contrast to the extensive progress made in identifying the genetic elements required for SOS-induced mutation, attempts to identify biochemical roles for the SOS proteins were stymied by the insolubility of UmuC protein in aqueous solution. Nevertheless, Harrison Echols and co-workers [19] succeeded in purifying a denatured form of UmuC that, following renaturation, gave rise to low-level bypass of a site-directed abasic DNA-template lesion *in vitro* in the presence of UmuD', RecA, and pol III HE. There remained considerable difficulties, however, obtaining reproducible yields and TLS activity using the denatured-renatured UmuC protein [20]. These difficulties were alleviated following purification of a soluble, native UmuD'₂C complex [21]. This complex actively catalyzed TLS [22**], as did a maltose-binding protein-UmuC (MBP-UmuC) fusion protein [23]. Both systems required RecA protein to catalyze TLS, with one surprising difference: the native UmuD'₂C complex did not require the presence of pol III core to carry out TLS suggesting that it might contain an intrinsic DNA polymerase activity [22**].

UmuD'₂C is a novel error-prone DNA polymerase, *E. coli* pol V

To resolve the discrepancy between the two studies, UmuD'₂C was purified from a pol III temperature-sensitive strain containing a pol II deletion [24**] and was found

but required RecA to carry out TLS. A purified mutant complex, UmuD'₂C104 (Asp101→Asn), failed to catalyze TLS. These data demonstrated that UmuD'₂C contained an intrinsic error-prone DNA polymerase activity, *E. coli* pol V. It was subsequently confirmed that the MBP-UmuC fusion protein also contained polymerase activity in the absence of the pol III core [25].

Biochemical basis of SOS mutagenesis

Having an *in vitro* assay available enables the following four basic questions to be addressed. What are the roles of each of the proteins required to catalyze TLS and most importantly what is the biochemical mechanism of pol V in relation to RecA protein? What are the efficiencies for bypassing diverse types of template DNA damage? How does the specificity of nucleotide incorporation measured *in vitro* compare with *in vivo* mutation spectra for different DNA lesions? What can be said about UmuD'₂C-catalyzed mutations at undamaged template sites?

The proteins involved in lesion bypass are pol V (UmuD'₂C), RecA, β processivity clamp, γ clamp-loading complex, and DNA single-stranded binding protein (SSB) [22**,24**]. Although pol V alone can form W-C base pairs with relatively low efficiency opposite undamaged template sites, it cannot catalyze incorporation opposite the commonly occurring abasic, *cis-syn* T-T dimer, or 6-4 T-T photoproduct lesions (M Tang, MF Goodman, unpublished data). While addition of RecA, β processivity clamp, γ clamp-loading complex, or SSB stimulates pol V activity,

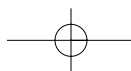

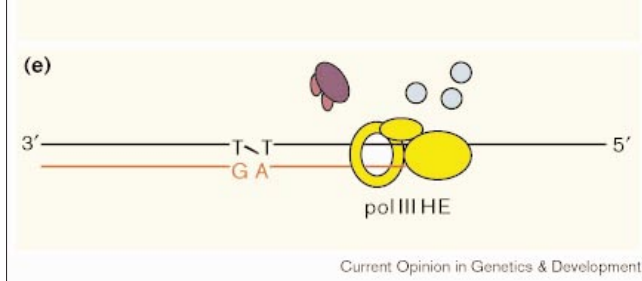

Pol V (UmuD'₂C) error-prone lesion bypass. Immediately following DNA damage and induction of the SOS response, *E. coli* attempt to repair their genome by various error-free mechanisms. **(a)** If any damage escapes these pathways and the replicative pol III HE complex encounters a DNA lesion, the pol III core is effectively blocked from further DNA synthesis and **(b)** dissociates from the DNA leading to uncoupling of the replication fork. Activated RecA* forms a filament on the damaged template and **(c)** ~40 minutes post-induction of SOS, the mutagenically active (UmuD'₂C) pol V is formed. The assembly of (UmuD'₂C) pol V on the 3'-OH vacated by pol III core at the site of the lesion is believed to be targeted by RecA*. **(d)** Pol V Mut, consisting of UmuD'₂C, RecA, β sliding clamp, γ clamp loading complex, and SSB (not shown), subsequently catalyzes error-prone TLS past a 6-4 T-T photoproduct incorporating G preferentially at the 3' T leading to T→C transitions, consistent with genetic data. **(e)** Synthesis by pol V is distributive in the presence of RecA leading to its dissociation following the incorporation of only a few nucleotides beyond the lesion. Pol III core can then re-assemble on the primer terminus and resume replication of the remaining chromosome.

TLS requires the presence of all of the above proteins [22••,24••]. We will refer to the UmuD'₂C, RecA, β processivity clamp, γ clamp-loading complex, SSB protein

together for these three lesions suggest that pol V Mut is responsible for generating most, if not all, SOS mutations targeted at DNA damage sites.

Pol V Mut also exhibits remarkably low fidelity when copying undamaged DNA, with error rates of about 10⁻³ for most transition and transversion base mispairs [26••]. This observation is consistent with the requirement for UmuD' and C in order to observe mutations in the absence of DNA damage in RecA730 cells with constitutive induction of SOS [27]. The recently discovered pol IV (encoded by *dinB*) is also induced as part of the SOS regulon but its only known phenotype is in causing an increase in simple frameshift mutations on undamaged lambda phage DNA [28]. A deletion of the gene encoding pol IV (Δ *dinB*) has no measurable effect on either targeted or untargeted chromosomal mutations; however, an increase in F' episomal frameshift mutations accompanying the overproduction of pol IV [29] suggests that pol IV might also act on chromosomal DNA. A recent *in vitro* study shows that pol IV is able to extend mismatched primer 3'-ends with unusually high efficiency [30••], a property also exhibited by pol V Mut [22••].

Like pol V, pol IV can utilize the β processivity clamp and γ clamp-loading complex resulting in a 3000 fold increase in pol IV activity [26••]. *E. coli* pol IV (DinB) and pol V (UmuD'₂C) share common sequence elements with two yeast polymerases, Rev1 and Rad30, and with their animal cell counterparts. These 'parent' enzymes make up a

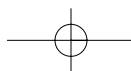

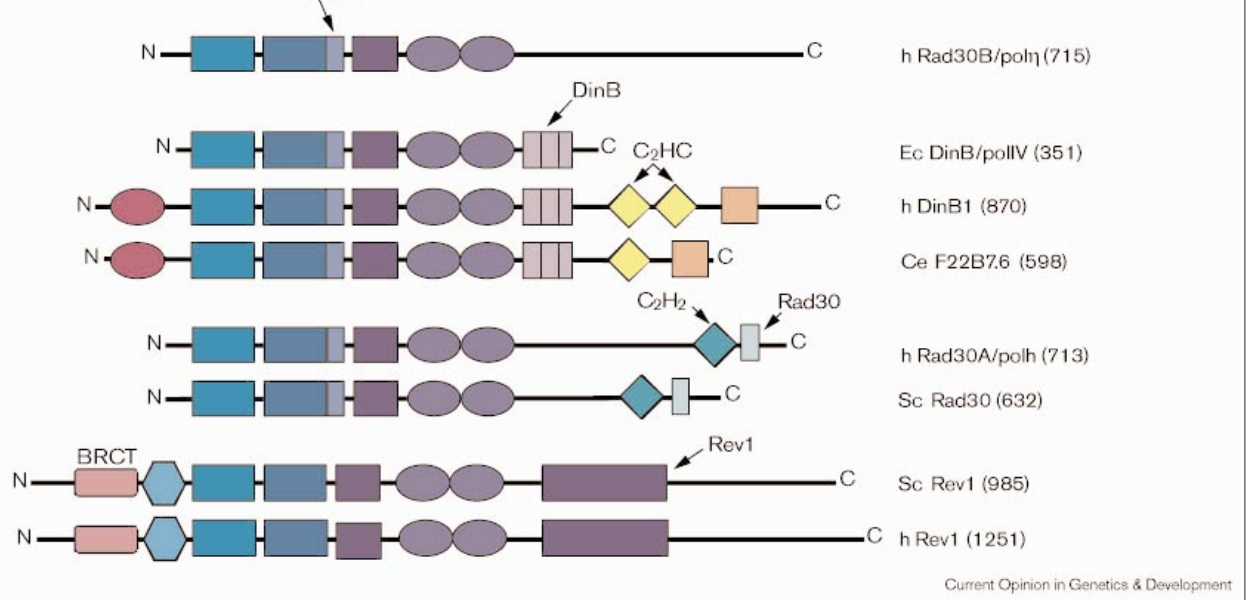

Alignment of some members of the UmuC/DinB/Rev1/Rad30 superfamily. A schematic representation of the conserved and unique domains present in the UmuC/DinB/Rev1/Rad30 superfamily is shown. The highly conserved domains I–V containing probable catalytic residues that have been mutated in several studies and helix-hairpin-helix DNA-binding motifs are denoted above by Roman numerals. *E. coli* UmuC is the least conserved family member followed by the newly discovered human Rad30B, which shares the small extra region of homology (light blue) found in both the DinB and Rad30 subgroups. UmuC and human Rad30B both have unique carboxy-terminal ends (thin black lines). The DinB subgroup shows remarkable

conservation of three short motifs (shown in purple), which are present from *E. coli* to humans. The C_2H_2 and C_2HC zinc binding motifs (shown as green and yellow diamonds respectively) are presumed to be involved in DNA binding and perhaps in selective targeting. The BRCT domain is shown (pink oval) at the amino-terminal end of the Rev1 subgroup. Conserved regions of unknown function are found in the amino (pink ovals) and carboxyl termini (peach squares) of human and *C. elegans* DinB. Additional motifs conserved within subgroups are indicated by arrows. Amino acid lengths are indicated in parenthesis. Ce (*C. elegans*), Ec (*E. coli*), h (human), Sc (*S. cerevisiae*).

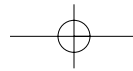

Explore Litigation Insights

Docket Alarm provides insights to develop a more informed litigation strategy and the peace of mind of knowing you're on top of things.

Real-Time Litigation Alerts



Keep your litigation team up-to-date with **real-time alerts** and advanced team management tools built for the enterprise, all while greatly reducing PACER spend.

Our comprehensive service means we can handle Federal, State, and Administrative courts across the country.

Advanced Docket Research



With over 230 million records, Docket Alarm's cloud-native docket research platform finds what other services can't. Coverage includes Federal, State, plus PTAB, TTAB, ITC and NLRB decisions, all in one place.

Identify arguments that have been successful in the past with full text, pinpoint searching. Link to case law cited within any court document via Fastcase.

Analytics At Your Fingertips



Learn what happened the last time a particular judge, opposing counsel or company faced cases similar to yours.

Advanced out-of-the-box PTAB and TTAB analytics are always at your fingertips.

API

Docket Alarm offers a powerful API (application programming interface) to developers that want to integrate case filings into their apps.

LAW FIRMS

Build custom dashboards for your attorneys and clients with live data direct from the court.

Automate many repetitive legal tasks like conflict checks, document management, and marketing.

FINANCIAL INSTITUTIONS

Litigation and bankruptcy checks for companies and debtors.

E-DISCOVERY AND LEGAL VENDORS

Sync your system to PACER to automate legal marketing.