



# United States Patent [19]

[11] **Patent Number:** 5,572,573

Sylvan et al.

[45] **Date of Patent:** Nov. 5, 1996

[54] **REMOVABLE USER INTERFACE FOR USE WITH INTERACTIVE ELECTRONIC DEVICES**

4,885,580	12/1989	Noto et al. ....	341/23
4,908,845	3/1990	Little .....	379/52
5,059,960	10/1991	Rosenberg et al. ....	345/174
5,113,041	5/1992	Blonder et al. ....	178/18
5,223,677	6/1993	Kapp et al. ....	178/18
5,422,656	6/1995	Allard et al. ....	345/173

[75] Inventors: **Loren M. Sylvan**, Westminster; **Adam N. Marx**, Boulder, both of Colo.

[73] Assignee: **U S West Advanced Technologies, Inc.**, Boulder, Colo.

*Primary Examiner*—Curtis Kuntz  
*Assistant Examiner*—Michael B. Chernoff  
*Attorney, Agent, or Firm*—Brooks & Kushman

[21] Appl. No.: **186,202**

[22] Filed: **Jan. 25, 1994**

[51] **Int. Cl.<sup>6</sup>** ..... **H04Q 7/32; G09G 5/00; G06F 7/00; H03K 17/94**

[52] **U.S. Cl.** ..... **379/61; 455/89; 345/173; 364/709.1; 341/23**

[58] **Field of Search** ..... 379/61, 58, 355, 379/52; 455/89, 90; 395/155, 156, 159, 161, 162; 345/173, 168, 169, 173, 174; 364/709.1, 709.11, 709.12, 709.13; 178/18, 19, 20; 341/20, 22, 23, 173

[57] **ABSTRACT**

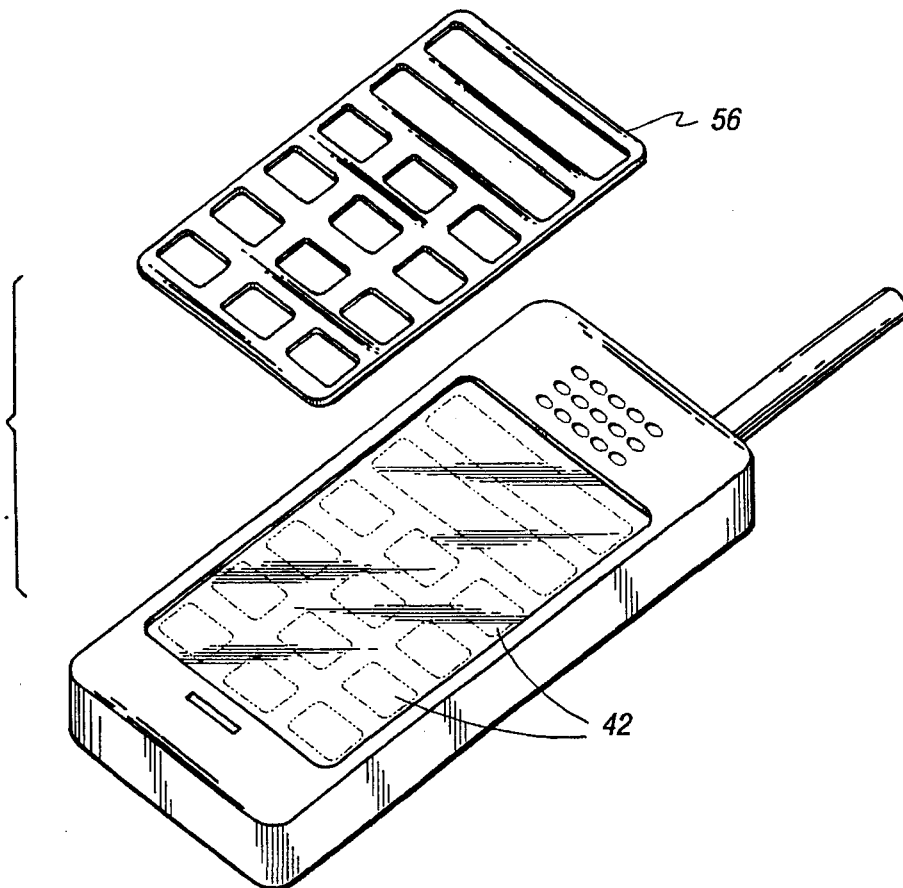
An improved user interface for use in interactive electronic devices. The user interface eliminates the complexity and ambiguity problems encountered in conventional interfaces through the incorporation of a physical overlay designed for use in cooperation with a contiguous touch screen or a plurality of individual touch screens. The physical overlay delineates the touch screen or screens into a plurality of context sensitive task and information display regions which may be accessed by direct user manipulation.

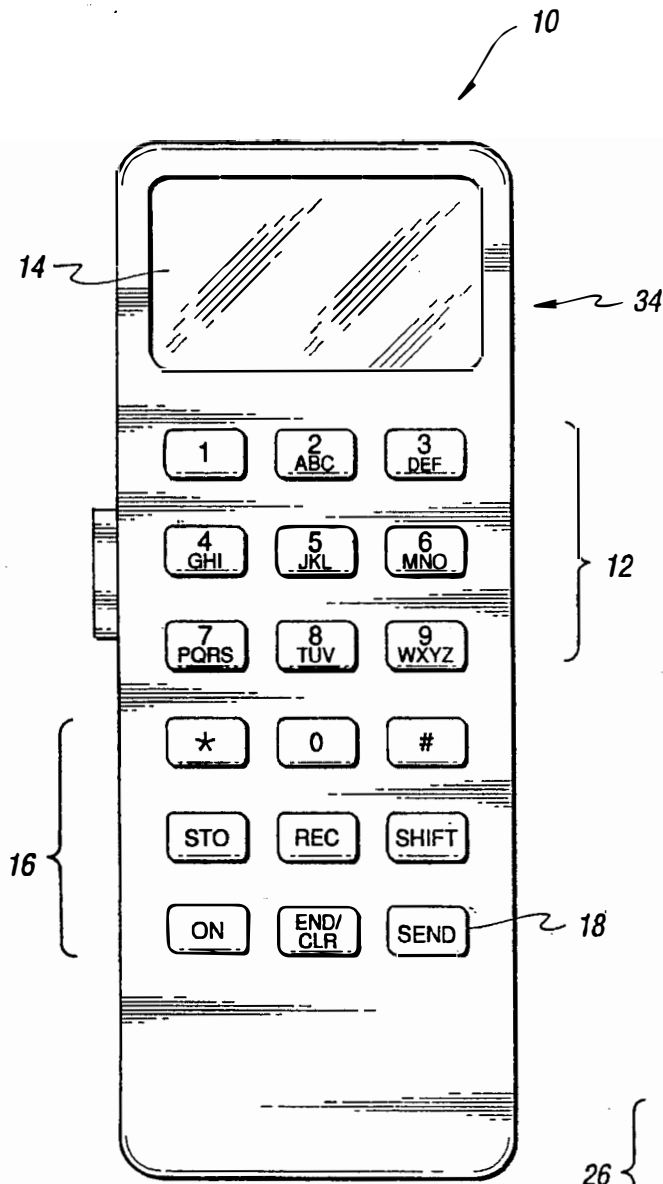
[56] **References Cited**

**U.S. PATENT DOCUMENTS**

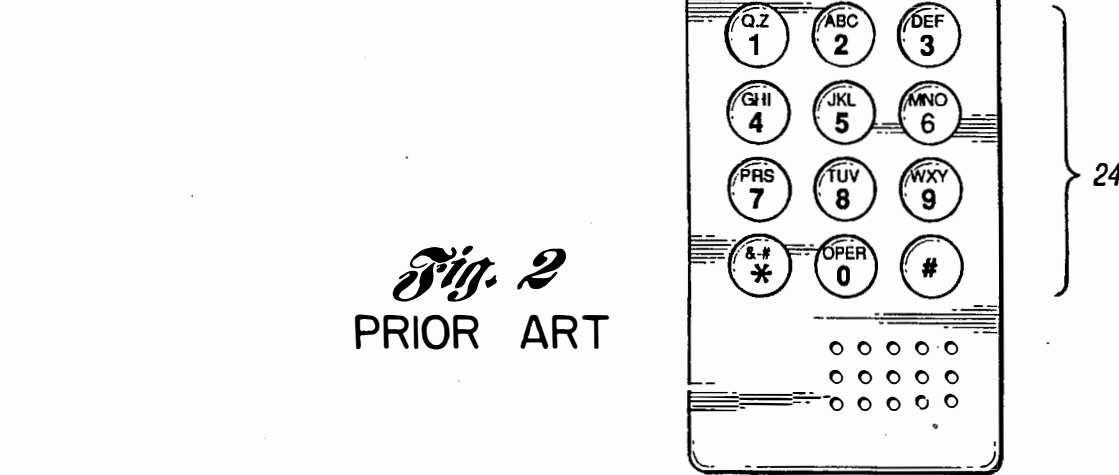
4,870,677 9/1989 Di Santo et al. .... 379/355

**10 Claims, 4 Drawing Sheets**

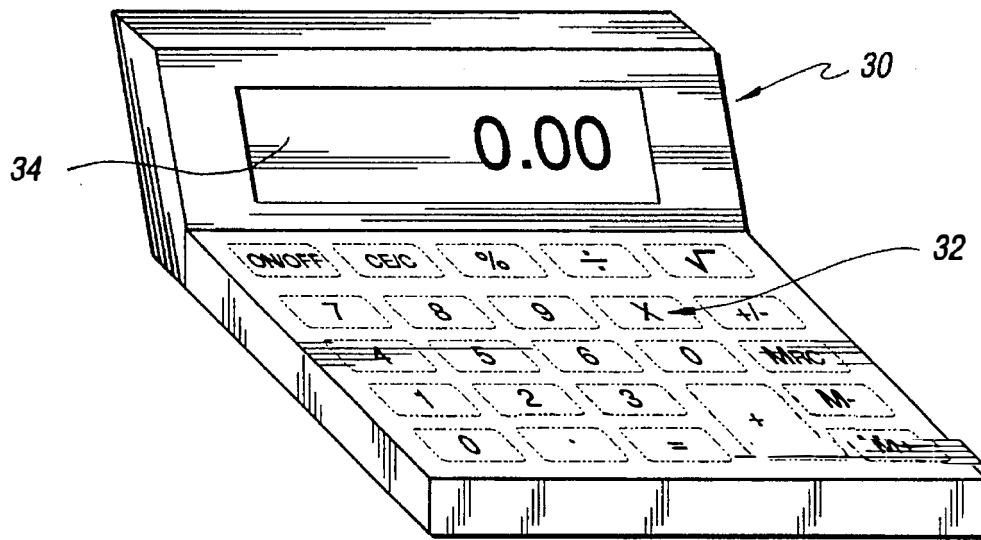




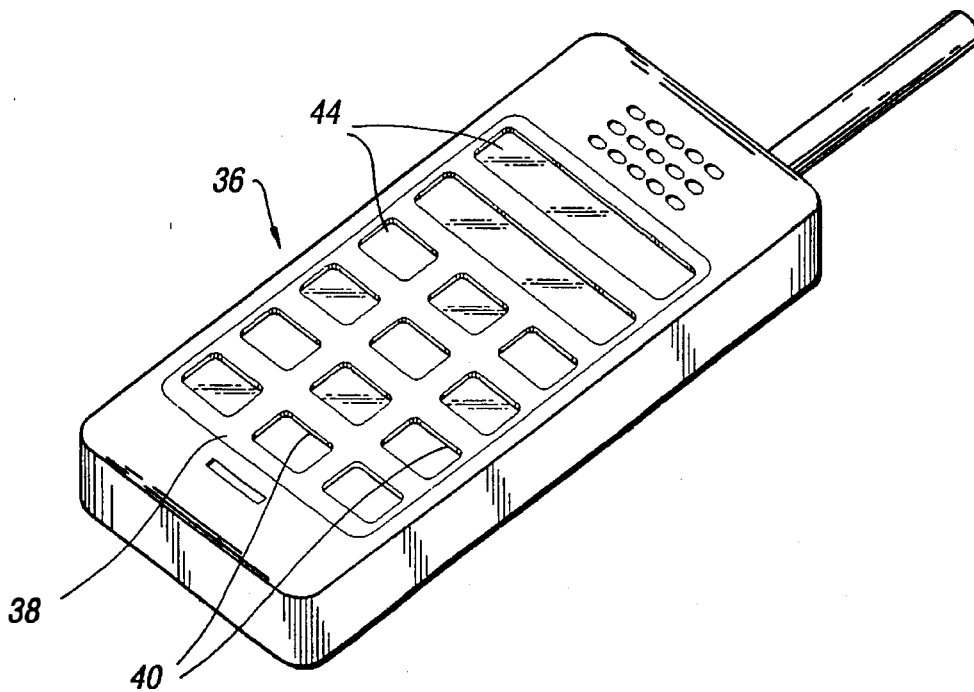
*Fig. 1*  
PRIOR ART



*Fig. 2*  
PRIOR ART

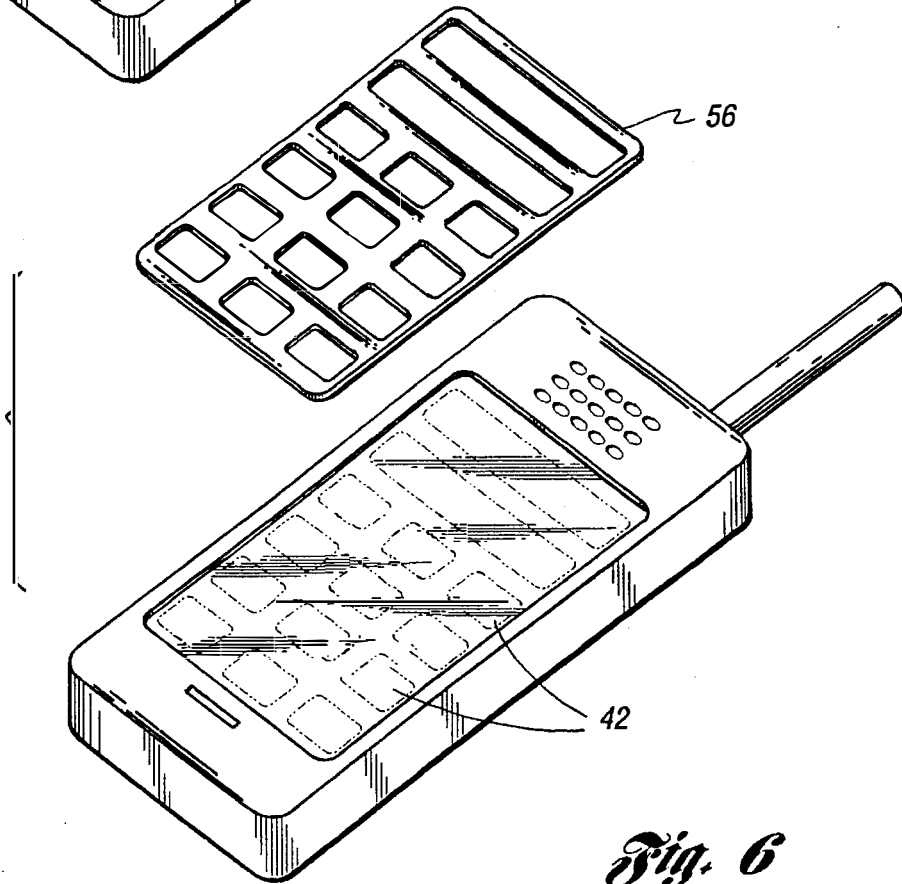
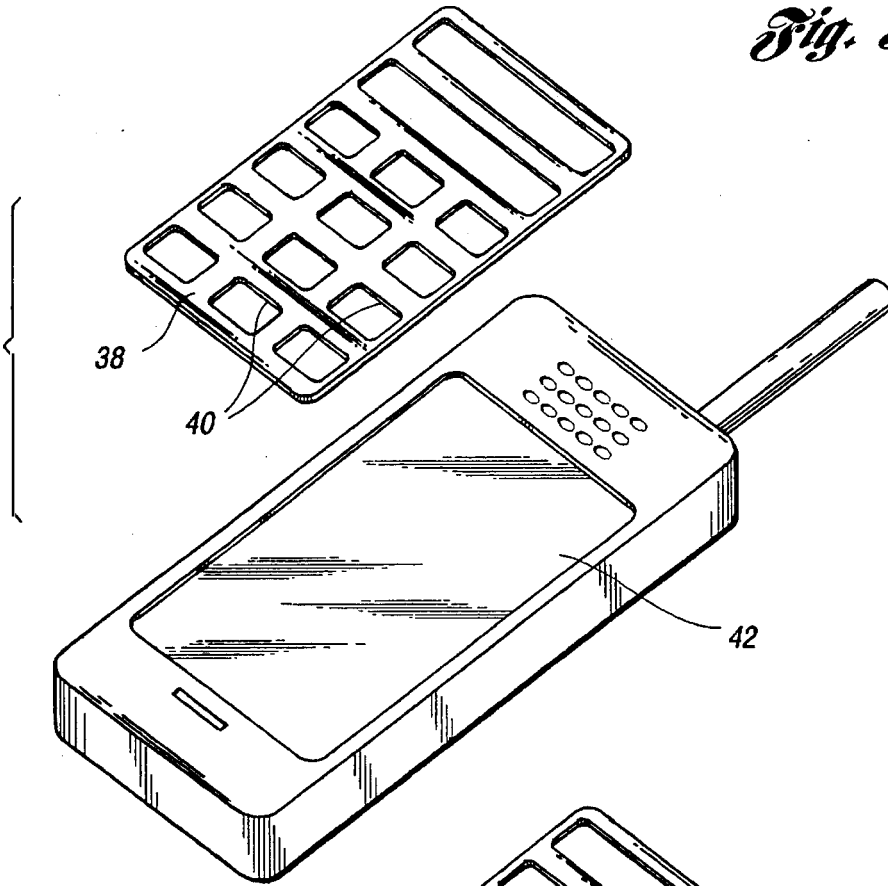


*Fig. 3*  
PRIOR ART

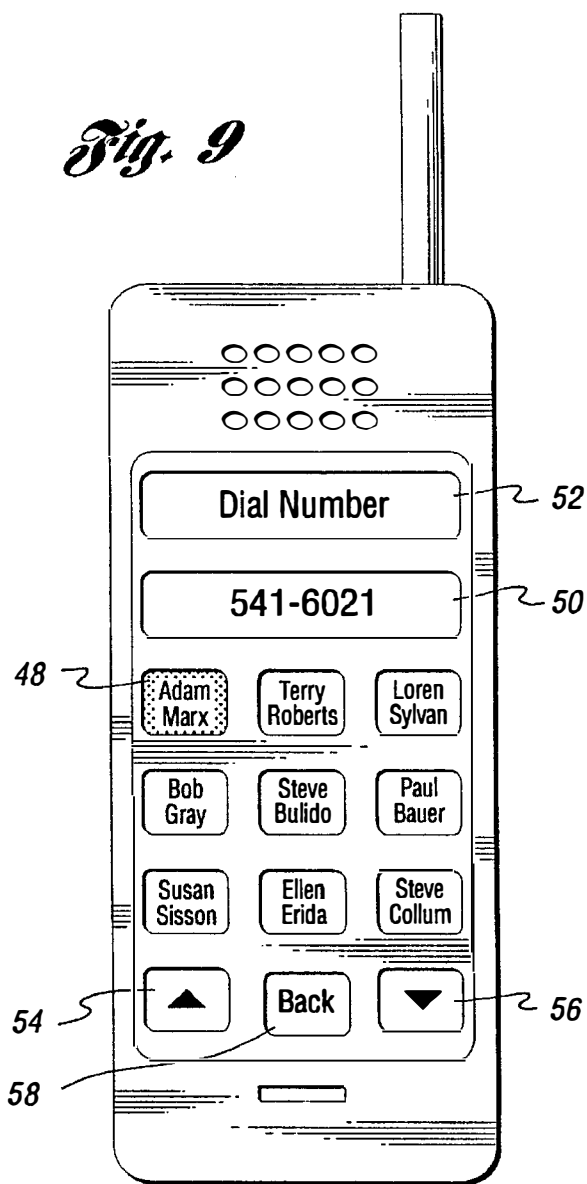
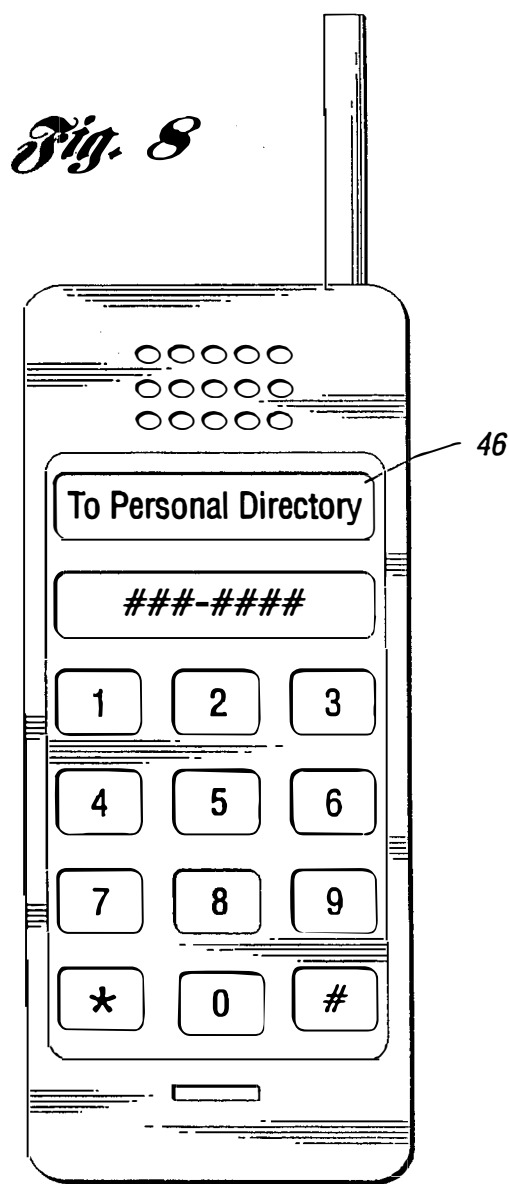
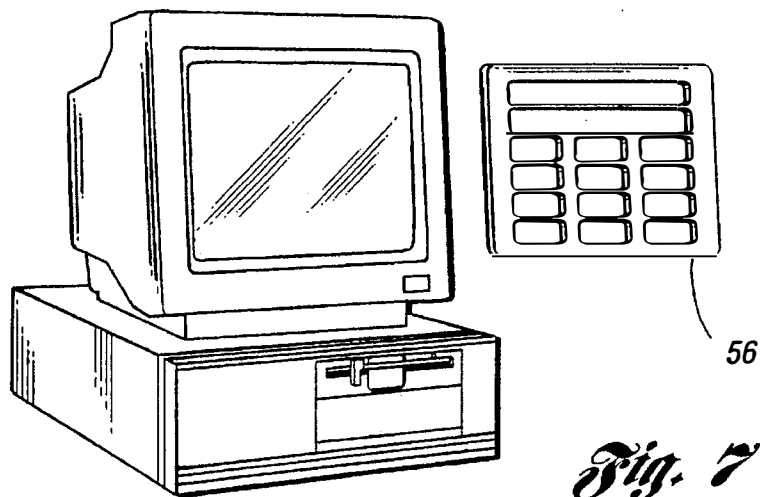


*Fig. 4*

*Fig. 5*



*Fig. 6*



# Explore Litigation Insights

Docket Alarm provides insights to develop a more informed litigation strategy and the peace of mind of knowing you're on top of things.

## Real-Time Litigation Alerts



Keep your litigation team up-to-date with **real-time alerts** and advanced team management tools built for the enterprise, all while greatly reducing PACER spend.

Our comprehensive service means we can handle Federal, State, and Administrative courts across the country.

## Advanced Docket Research



With over 230 million records, Docket Alarm's cloud-native docket research platform finds what other services can't. Coverage includes Federal, State, plus PTAB, TTAB, ITC and NLRB decisions, all in one place.

Identify arguments that have been successful in the past with full text, pinpoint searching. Link to case law cited within any court document via Fastcase.

## Analytics At Your Fingertips



Learn what happened the last time a particular judge, opposing counsel or company faced cases similar to yours.

Advanced out-of-the-box PTAB and TTAB analytics are always at your fingertips.

## API

Docket Alarm offers a powerful API (application programming interface) to developers that want to integrate case filings into their apps.

## LAW FIRMS

Build custom dashboards for your attorneys and clients with live data direct from the court.

Automate many repetitive legal tasks like conflict checks, document management, and marketing.

## FINANCIAL INSTITUTIONS

Litigation and bankruptcy checks for companies and debtors.

## E-DISCOVERY AND LEGAL VENDORS

Sync your system to PACER to automate legal marketing.