

Indexing terms: Optimal control, Optimisation, Algorithms, Mathematical techniques

Abstract: The paper examines the potential of hybrid electric vehicles and, in particular, a hybrid electric passenger car. Two operating objectives are identified, one for energy saving and the other for substituting petroleum fuel by electrical energy. The way in which the power train control and component rating can be optimised to meet these particular operating objectives is discussed. In the final part of the paper the performance of the optimised hybrid vehicles are compared with both IC engine and electric vehicles and the petroleum substitution design is shown to warrant further development.

1 Introduction

A hybrid vehicle can be defined as a vehicle which utilises two or more energy storage mediums within its drive train, any of which is capable of driving the vehicle when connected to the road wheels through a suitable prime mover. In this paper, the hybrid electric vehicle is considered with energy being stored in petroleum fuel and an electric traction battery. The associated prime movers are

engine power and speed to be controlled independently of the power and speed demand at the road wheels. In contrast, the second basic arrangement connects both prime movers in parallel, as shown in Fig. 2. In such a parallel arrangement, both prime movers are capable of driving the road wheels directly with the 'mix' of power at any instant being controlled.

The first hybrid vehicles appeared in the early part of this century when the electric traction motor was used to augment the power output of the then limited IC engine [1]. However, the rapid development of the IC engine soon made the electric traction motor unnecessary and hybrid vehicles were not again considered seriously until the 1960s. At this time, concern was being expressed at the level of exhaust emissions from conventional IC engine vehicles, and the hybrid emerged as one possible way in which exhaust emissions could be dramatically reduced [2]. However, with the oil crises of 1974 and 1979 there became immediate concern about the dependence of the Western World on oil-based fuels. The hybrid vehicle now became one possible way of reducing the dependency of the transport sector on petroleum-based fuels, either by reducing the amount of energy used [3] or by substituting petroleum fuel by broader based electrical energy [4]. These latter objectives are equally

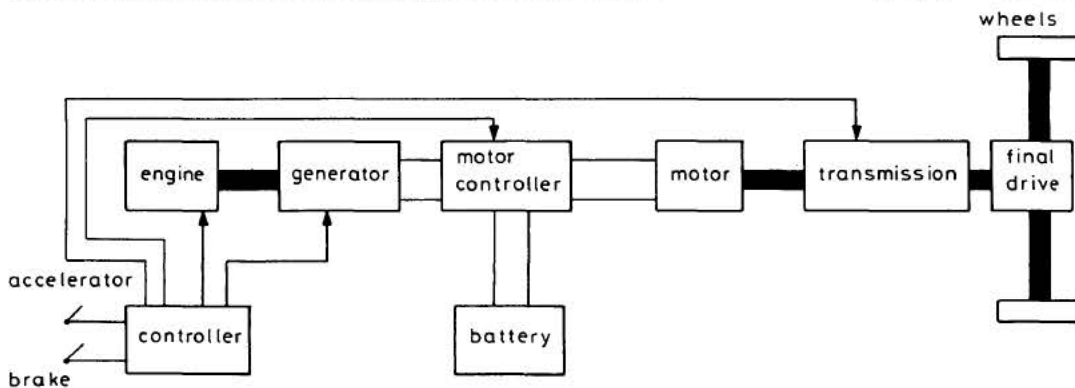

Fig. 1 Series hybrid electric vehicle drive train

an internal combustion (IC) engine and electric traction motor, respectively. To utilise the prime movers, a number of different power train configurations are possible, but, in general, fall into one of two basic categories. In the series arrangement of Fig. 1, the IC engine does not drive the road wheels directly, but is connected indirectly through an electric generator and electric traction motor. Introducing a traction battery between the generator and motor buffers the engine output, allowing the

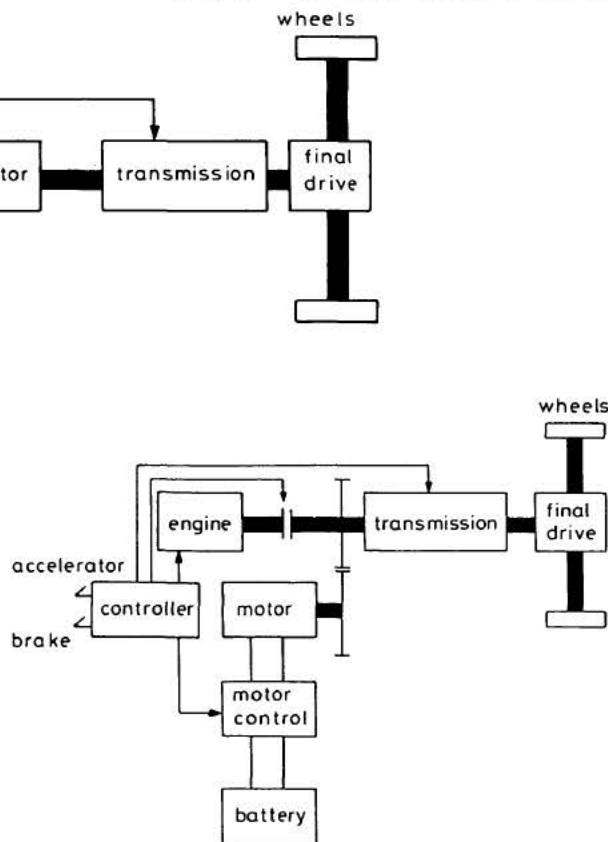

Fig. 2 Parallel hybrid electric vehicle drive train

Paper 5621D (C12, S1) received 24th February 1986

The authors are with the Department of Engineering, University of Durham, Science Laboratories, South Road, Durham DH1 3LE, United Kingdom

that this paper addresses.

To achieve the objectives outlined so far, both series and parallel hybrid arrangements have been evaluated in the past. Although the series arrangement allows great flexibility in component positioning, it is not a generally favoured arrangement. The main reason for this is that the acceleration and maximum continuous speed requirements of most vehicles necessitates the use of a large, heavy and expensive traction motor rated to meet both the maximum torque and maximum continuous power demand of the vehicle. Consequently, when the vehicle is used over mild urban driving cycles, the traction motor operates at part load with a relatively low efficiency. When this is combined with the efficiency of the generator, controller and IC engine, the result is reduced energy performance when compared with the parallel arrangement [5]. However, if a vehicle is to be designed for a specific duty cycle, for example a city bus, then the potential of the series arrangement increases. Indeed, it is for this particular use that the series hybrid has seen most development [6, 7].

As a result of these considerations, it is the parallel hybrid arrangement that offers most potential. However, even within this framework, the component arrangement, rating and control offers innumerable possible alternatives. To develop a suitable control strategy, and decide on the appropriate component sizing and arrangement, a number of studies have been commissioned and published, for example see References 8 and 9. The most recent of the hybrid vehicle studies have been conducted during the feasibility stage of the Near Term Electric and Hybrid Vehicle Programme commissioned by the US Department of Energy [10]. The tendency in all of the most recent studies is to use some form of computer simulation to assess the performance of the vehicle over a predefined driving cycle. Parametric studies are then conducted to show how modifications in control strategy, component sizing and arrangement effect the vehicle performance. Typical of these studies are those conducted by the General Electric Company (USA) [11, 12], where computer simulation methods were used to evaluate and design a hybrid vehicle suitable for the American car market. The aim of this vehicle being to substitute petroleum fuel by 'wall plug electricity'.

In this paper, rather than postulating a number of control options and exploring their relative benefits, an optimisation process is used which seeks to minimise an energy-based objective function, the aim of which is to reduce the dependence of the vehicle on petroleum-based fuels. This process then leads to the definition of a control algorithm that can be used in a vehicle suitable for the European car market. Parametric studies are then conducted to optimise component ratings and further improve the vehicle performance. The final part of the paper compares the optimised hybrid design(s) with an IC engine vehicle and electric vehicle, and their relative features are discussed.

2 Base vehicle parameters

A previous analysis of the UK national energy statistics has shown that, in the road transport sector, cars between 1000cc and 2000cc ($\text{cc} \equiv \text{cm}^3$) are the major users of petroleum fuel, consuming approximately 40% of all the energy used [13]. They also represent a large market in potential sales, with approximately one million

from petroleum to electrical energy could be achieved within this market, there is significant potential for a reduction in the UK dependence on petroleum-based fuel.

Analysis of the usage pattern of the type of vehicle described here shows that 95% of all car journeys are less than 80 km and could, therefore, be satisfied by an electric vehicle. However, the usage pattern also shows that this type of vehicle is used regularly for journeys in excess of 80 km, for example at weekends and holidays. Consequently, although 95% of all journeys are under 80 km, any vehicle restricted to 80 km or less may only be useful 80% of the time [14] and would be unlikely to find general acceptance. For any hybrid vehicle to be accepted, it must achieve a reduction in the petroleum fuel used, while not suffering the range limitation of the electric vehicle.

An initial set of parameters representative of a parallel hybrid car able to meet these needs are outlined in Table 1. The size of the IC engine has been selected to give a maximum level cruise speed in excess of 120 km/h, while the electric traction motor augments this to provide the necessary acceleration performance and low-speed electric operation. The torque/speed envelope for the combined system is shown in Fig. 3. A set of parameters for

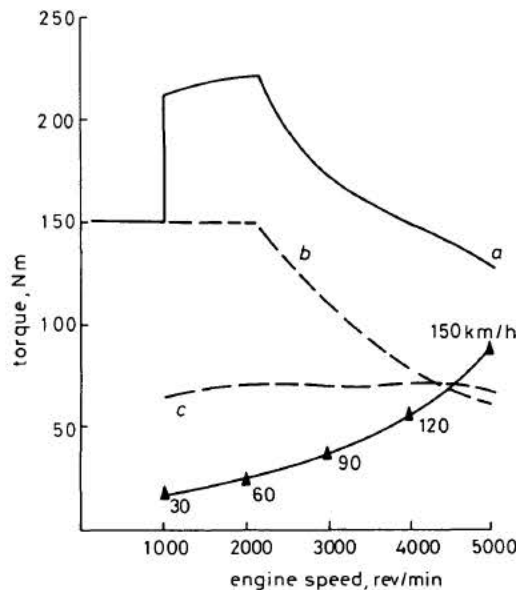

Fig. 3 Base hybrid electric performance curves

- a Combined maximum torque line
- b Traction motor torque
- c Engine full throttle torque
- ▲ constant speed road load

an equivalent IC engine car are also included in Table 1. In both cases, performance is comparable and, throughout the paper, vehicles will be compared assuming a similar performance criterion with component weight changes being automatically included. A weight propagation factor of 1.35 is used throughout the study. To achieve uniformity in terms of body performance, both the hybrid and the IC engine vehicle are assumed to have the same drag and rolling resistance characteristics. This ensures that any benefits accruing from the hybrid are identified as coming from the power train. The values used are typical of good present day vehicles.

In assessing the performance of the hybrid vehicle, the standard European urban driving cycle, ECE-15, is used along with 90 km/h and 120 km/h cruise results.

Vehicle weights:		
kerb weight	1640 kg	945 kg
test weight	1880 kg	1185 kg
battery	300 kg	
Vehicle parameters:		
C_D	0.35	0.35
C_R	0.01	0.01
A	1.95 m ²	1.95 m ²
Component sizes:		
IC engine	35 kW, 5000 rev/min	55 kW, 5000 r.p.m.
traction motor	35 kW, shunt	—
battery	lead/acid EV2-13	—
	$E_s = 150$ kJ/kg	
	(42 Wh/kg)	
final drive	3.5 : 1	3.5 : 1
transmissions	4-speed automatic	4-speed manual
gear ratios		
1st	3.5 : 1	3.5 : 1
2nd	2.4 : 1	2.4 : 1
3rd	1.3 : 1	1.3 : 1
4th	1.0 : 1	1.0 : 1
Performance		
0-60 mile/h (driver only)	14 s	12 s
Max. speed:		
IC engine only	130 km/h	145 km/h*
hybrid	145 km/h	

* at 5000 rev/min

The ECE-15 cycle is shown in Fig. 4A and, besides defining precisely the velocity time profile, gear change points are also defined. As will be seen in Section 6, the use of a different gear change schedule, optimised to the actual vehicle, can significantly reduce the urban fuel consumption. As the hybrid vehicle necessitates total control of the drive train, the ECE-15 gear change schedule will not be adhered to. This is similar to current testing practice for vehicles with automatic transmissions.

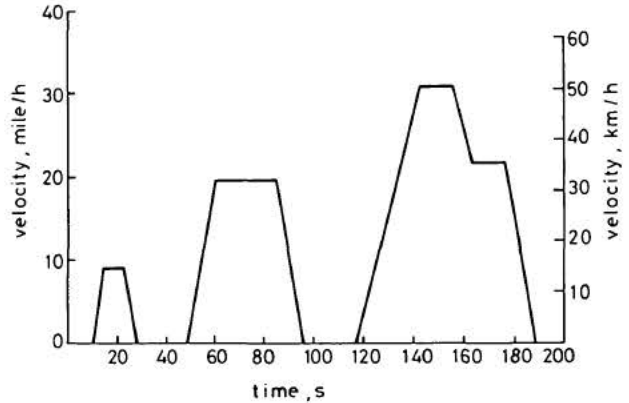

Fig. 4A ECE-15 urban driving cycle

The ECE-15 cycle is a relatively mild cycle and, because of this, some aspects of hybrid vehicle performance can be difficult to interpret clearly, while when a slightly more severe cycle is used these performance aspects are clarified. In such situations, ECE-15 results are augmented by simulations over the J227a-D urban cycle shown in Fig. 4B.

3 Hybrid vehicle control

3.1 Control optimisation

When two or more power sources are used in a vehicle power train, the way in which they are controlled is fundamental to the performance of the vehicle. However,

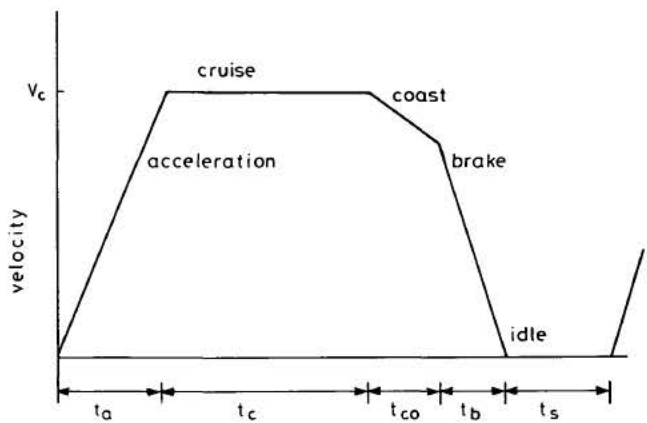

Fig. 4B J227 schedule 'a' series of driving cycles

Parameter	Driving cycle			
	A	B	C	D
Max. speed V_c , mile/h	10 ± 1	20 ± 1	30 ± 1	45 ± 1
Accel. time t_a , s	4 ± 1	19 ± 1	18 ± 2	28 ± 2
Cruise time t_c , s	0	19 ± 1	20 ± 1	50 ± 2
Coast time t_{co} , s	2 ± 1	4 ± 1	8 ± 1	10 ± 1
Brake time t_b , s	3 ± 1	5 ± 1	9 ± 1	9 ± 1
Idle time t_s , s	30 ± 2	25 ± 2	25 ± 2	25 ± 2
Total time, s	39 ± 2	72 ± 2	80 ± 2	122 ± 2

the main objective of the control may be to maximise the accelerative performance of the vehicle, minimise exhaust emissions or to minimise energy use. An alternative objective, and the subject of this paper, is to examine ways in which the dependence of the vehicle on petroleum-based fuels can be reduced. This objective can be achieved either by improving the overall energy consumption of the vehicle, or by transferring some of the energy demand to the electrical system. To examine the type of control policy that would achieve this, an energy-based objective function:

$$F = \lambda_1 E_1 + \lambda_2 E_2 \tag{1}$$

is defined, where E_1 and E_2 are the onboard petroleum and electrical energy requirements, respectively, and λ_1 and λ_2 are weighting factors.

The two energies E_1 and E_2 depend on the way in which the load is divided between two prime movers. Examination of Fig. 2 suggests that the demand torque could be supplied either by the IC engine or the electric motor alone, or from some appropriate combination of the two. Indeed, the IC engine could supply torque in excess of the value demanded at the road wheels, such that the excess energy is used to charge the traction batteries. These various possibilities can be rationalised by defining a torque split fraction, or ratio, which defines the percentage of the road torque supplied by the IC engine as shown in Fig. 5. At torque split values in excess of one, the IC engine supplies the full torque demand, and additional energy is used to charge the traction batteries.

Although E_1 and E_2 depend directly on the ratio in which the demand torque is divided between the two prime movers, they are also dependent on the efficiency of the prime movers and associated equipment. As the

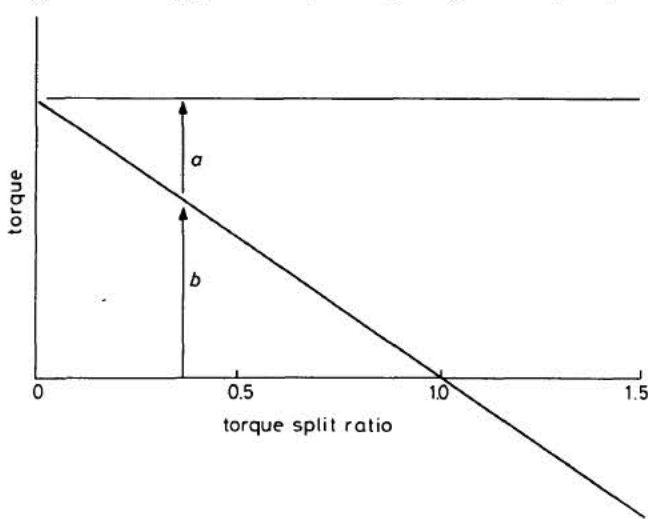

Fig. 5 Effect of torque split ratio on the torque distribution

a IC engine torque
b Electric motor torque
a + b Demand torque

torque split ratio and transmission gear ratio are the two control variables within the drive train that vary the value of the objective function at any given demand load. The aim of the control optimisation is therefore to minimise the objective function defined in eqn. 1, with torque split and gear ratio as the control variables.

During a driving cycle, the torque demand and operating speed of the prime movers is continually changing, and therefore it is necessary to minimise the objective function on a continuous basis. To implement the optimisation process, the hybrid vehicle is simulated over a defined driving cycle using the Janus road vehicle simulation program [15]. This program calculates the torque and speed requirement at the road wheels, at each second of the driving cycle, and then reflects this demand back through the power train to the energy source(s) to compute the net input energy required over that one second interval. Throughout this process, full account is taken of the losses associated with each of the drive train components. These losses vary both with load and speed and, within the prime movers, can be particularly complex. For these components, efficiency maps of actual components are used. By calculating the energy supplied from both the IC engine and the battery at each time instant, over a range of torque splits and for all gear ratios, a three-dimensional map can be generated with torque split ratio and gear ratio as the two independent variables and the objective function as the dependent variable. A direct search technique is then employed to find the minimum of the objective function. Repeating this process at each second throughout the cycle allows a minimum energy path through the driving cycle to be obtained.

Further examination of eqn. 1 shows that E_1 and E_2 are dependent on the efficiency and operating characteristics of all the power train components, while λ_1 and λ_2 allow a weighting to be placed on the relevant importance of the two energy sources. By varying the ratio of weighting factors, λ_1/λ_2 , the effect on the control of placing greater emphasis on one energy source relative to the other can be assessed. By selecting the correct ratio of weighting factors, the effect of the conversion efficiency to the raw energy source (e.g. power station), the effect of

energy use on the hybrid control can be qualitatively assessed.

When the torque split is greater than unity, battery charging is initiated and the flow of electrical energy becomes negative with all the energy being supplied from the petroleum fuel, E_2 now represents that proportion of the petroleum derived energy, less any conversion loss, that is converted to chemical energy and stored in the battery. To utilise this energy at a later time, account should be taken of the power train efficiency when this chemical energy is reconverted and appears at the torque split point. This reversion efficiency includes the battery discharge efficiency, motor and controller efficiency and the gear efficiency of the torque split. As this net efficiency varies with load and speed, an optimistic value of 90% is assumed implying a λ_2 value during this operating mode of 1.1 regardless of the value set on λ_1 . Throughout the optimisation process, although E_1 is directly related to the petroleum fuel used, E_2 is dependent on the rate at which the battery is discharged. E_2 is therefore calculated as the product of the incremental change in the battery state of charge and the battery five-hour energy capacity.

The optimisation process must also take into account any physical constraints imposed by the drive train. Fig. 2 shows a clutch between the engine and transmission and, although an operating condition where this clutch is continually slipped or modulated can be conceived, it is not particularly attractive. The optimisation process is therefore constrained not to allow this mode of operation.

3.2 Optimal control of the base hybrid vehicle

Implementing the above optimisation with the base hybrid vehicle parameters of Table 1 allows vehicle range (i.e. distance travelled until the battery is discharged) and petroleum use to be plotted against the ratio λ_1/λ_2 for the ECE-15 driving cycle as shown in Fig. 6. The full curve in this Figure refers to the base vehicle with a standard

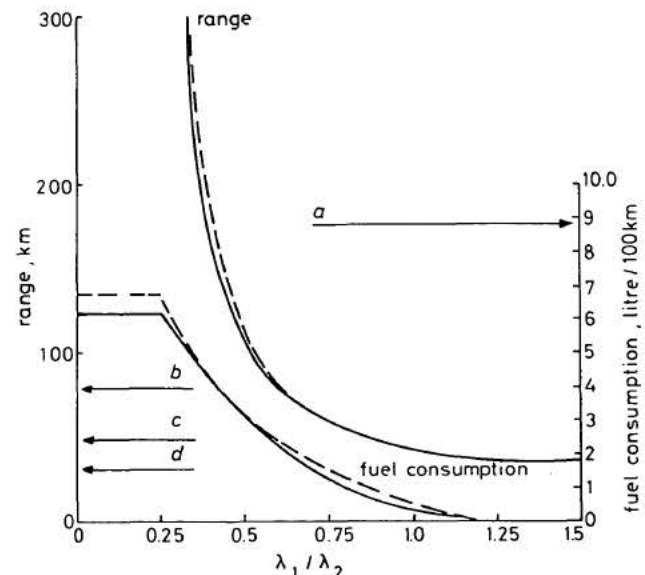

Fig. 6 Influence of weighting factor ratio on the performance of the base hybrid vehicle

— 4-speed transmission
- - - Continuously variable transmission
a Fuel consumption of base IC engine vehicle
b 80 km range, 95% of all journeys
c 50 km range, 90% of all journeys
d 30 km range, 80% of all journeys

(CVT). At low ratios of λ_1/λ_2 vehicle range is infinite, as the energy drained from the battery during motoring is replaced by energy recovered during regenerative braking. As λ_1/λ_2 increases, the petroleum consumption reduces with range remaining infinite. When $\lambda_1/\lambda_2 \approx 0.3$ to 0.35, all the energy recuperated during regenerative braking is used during the motoring phase, and the state of charge of the battery is the same at the end of the cycle as at the beginning. At the other extreme when λ_1/λ_2 is greater than one, the vehicle essentially operates as an electric vehicle with no petroleum fuel being used. In between these two extremes, as λ_1/λ_2 is increased, greater emphasis is placed on the electrical system with increasing substitution of petroleum fuel by electricity.

These observations lead to the specification of two types of hybrid vehicle. In the first vehicle, the battery state of charge is the same at the end of the cycle as at the beginning, with all the energy being supplied directly from the petroleum fuel. The electrical system now seeks to accept regenerative braking energy and provide propulsion power when the IC engine efficiency is low. This has the effect of increasing the average engine load factor and efficiency. Battery weight should be minimised to improve the hybrid performance, and, as a result, no significant all-electric range should be anticipated. Such a vehicle can be termed an 'energy saving hybrid'. In contrast, the second type of vehicle sacrifices urban range for reduced petroleum fuel consumption, thereby achieving significant petroleum displacement. This would ideally require a battery weight above that of the base vehicle, to achieve a range as an electric vehicle of typically 60 km. Such a vehicle may be described as a 'petroleum substitution hybrid'.

3.3 Energy saving hybrid

From an overall energy point of view λ_1 and λ_2 can be selected to represent minimisation of raw energy. If an efficiency of 25% is assumed, for power generation, transmission and battery charging and an efficiency of 90% for the petroleum production process, $\lambda_1/\lambda_2 \approx 0.28$. This implies energy minimisation will be achieved with the energy-saving hybrid. However, should petroleum be produced from coal, with a conversion efficiency of 60%, then energy minimisation would be obtained with $\lambda_1/\lambda_2 \approx 0.42$. This now points to mild hybrid operation.

Although the above argument indicates the type of hybrid design that would minimise energy use, an overall energy saving would only be achieved if a comparable IC engine vehicle had a higher fuel consumption. The urban fuel consumption for the base IC engine vehicle described in Table 1 is shown in Fig. 6, and is substantially higher than the fuel consumption of the energy-saving hybrid with optimal control.

The variation of the two control variables, torque split and gear ratio throughout the cycle are shown in Fig. 7 for the energy-saving hybrid with $\lambda_1/\lambda_2 \approx 0.3$ to 0.35. These results suggest that charging of the batteries from the IC engine is not a favoured option owing to the low conversion and reversion efficiency associated with this route, while operation on one or other of the two energy sources is generally favoured. When operating on the IC engine, the lowest gear ratio (highest gear) is selected to increase the engine output torque, reduce engine speed and hence increase engine efficiency. Greater detail of how the IC engine is used during the cycle is shown on the engine usage map of Fig. 8. In this Figure, the per-

centage of demand torque met by

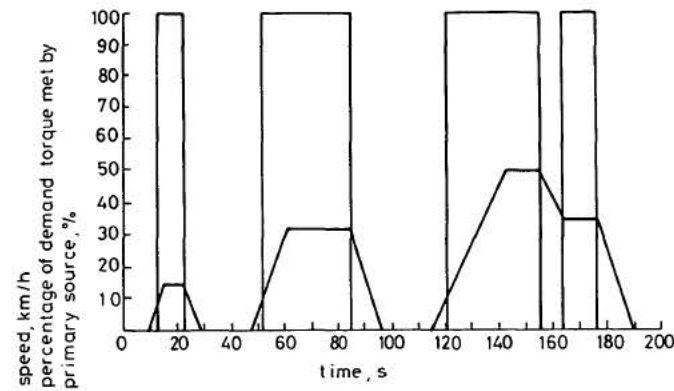

Fig. 7A Variation of torque split ratio (%) during the ECE-15 urban driving cycle for the optimally controlled energy saving hybrid

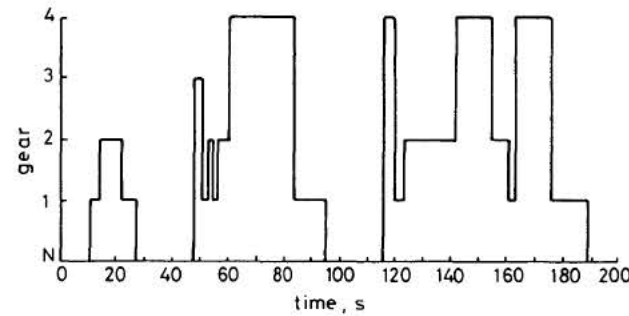

Fig. 7B Variation of gear during the ECE-15 urban driving cycle for the optimally controlled energy saving hybrid

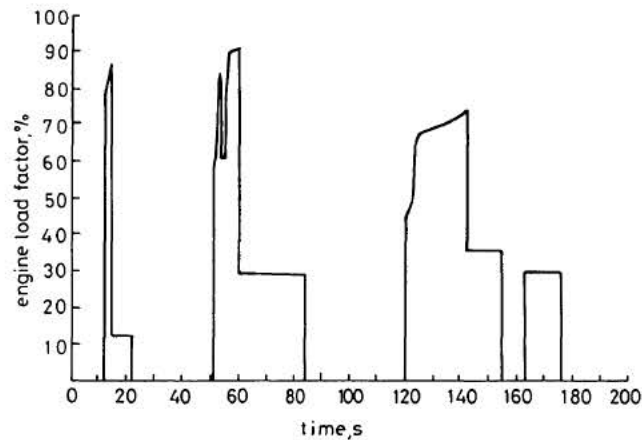

Fig. 7C Variation of engine load factor during the ECE-15 urban driving cycle for the optimally controlled energy saving hybrid

$$\text{engine load factor} = \frac{\text{torque}}{\text{maximum torque available}} \times 100\%$$

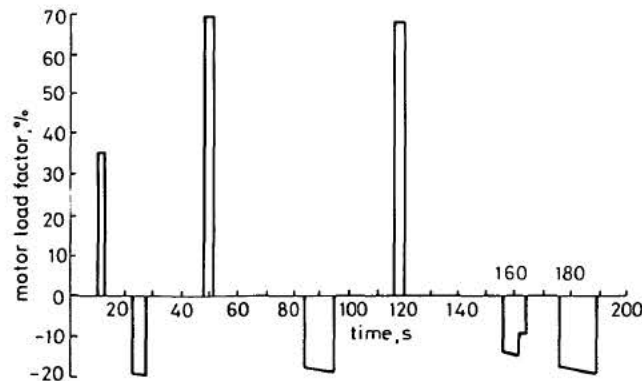

Fig. 7D Variation of motor load factor during the ECE-15 urban driving cycle for the optimally controlled energy saving hybrid vehicle

Explore Litigation Insights

Docket Alarm provides insights to develop a more informed litigation strategy and the peace of mind of knowing you're on top of things.

Real-Time Litigation Alerts



Keep your litigation team up-to-date with **real-time alerts** and advanced team management tools built for the enterprise, all while greatly reducing PACER spend.

Our comprehensive service means we can handle Federal, State, and Administrative courts across the country.

Advanced Docket Research



With over 230 million records, Docket Alarm's cloud-native docket research platform finds what other services can't. Coverage includes Federal, State, plus PTAB, TTAB, ITC and NLRB decisions, all in one place.

Identify arguments that have been successful in the past with full text, pinpoint searching. Link to case law cited within any court document via Fastcase.

Analytics At Your Fingertips



Learn what happened the last time a particular judge, opposing counsel or company faced cases similar to yours.

Advanced out-of-the-box PTAB and TTAB analytics are always at your fingertips.

API

Docket Alarm offers a powerful API (application programming interface) to developers that want to integrate case filings into their apps.

LAW FIRMS

Build custom dashboards for your attorneys and clients with live data direct from the court.

Automate many repetitive legal tasks like conflict checks, document management, and marketing.

FINANCIAL INSTITUTIONS

Litigation and bankruptcy checks for companies and debtors.

E-DISCOVERY AND LEGAL VENDORS

Sync your system to PACER to automate legal marketing.