



US 20100321511A1

(19) **United States**

(12) **Patent Application Publication**
Koskinen et al.

(10) **Pub. No.: US 2010/0321511 A1**

(43) **Pub. Date: Dec. 23, 2010**

(54) **LENSET CAMERA WITH ROTATED SENSORS**

(75) Inventors: **Samu T. Koskinen**, Tampere (FI);
Juha H. Alakarhu, Helsinki (FI);
Eero Salmelin, Tampere (FI)

Correspondence Address:
HARRINGTON & SMITH
4 RESEARCH DRIVE, Suite 202
SHELTON, CT 06484-6212 (US)

(73) Assignee: **Nokia Corporation**

(21) Appl. No.: **12/456,543**

(22) Filed: **Jun. 18, 2009**

Publication Classification

(51) **Int. Cl.**
H04N 5/225 (2006.01)
H04N 5/335 (2006.01)
(52) **U.S. Cl.** **348/218.1**; 348/E05.024; 348/311;
348/E05.091

(57) **ABSTRACT**

At a digital imaging system, a first set of samples of a scene are digitally captured with a first array of image sensing nodes while simultaneously a second set of samples of the scene are digitally captured with a second array of image sensing nodes. Image sensing nodes of the second array are oriented in a rotated position relative to the image sensing nodes of the first array. The first and second sets of samples are integrated with one another while correcting for the rotated orientation of the image sensing nodes of the second array relative to the image sensing nodes of the first array, and from that integration is output a high resolution image. In specific embodiments, there may be additional arrays of image sensing nodes, different arrays may sample different size portions of the scene, and be also rotated relative to other sensing node arrays.

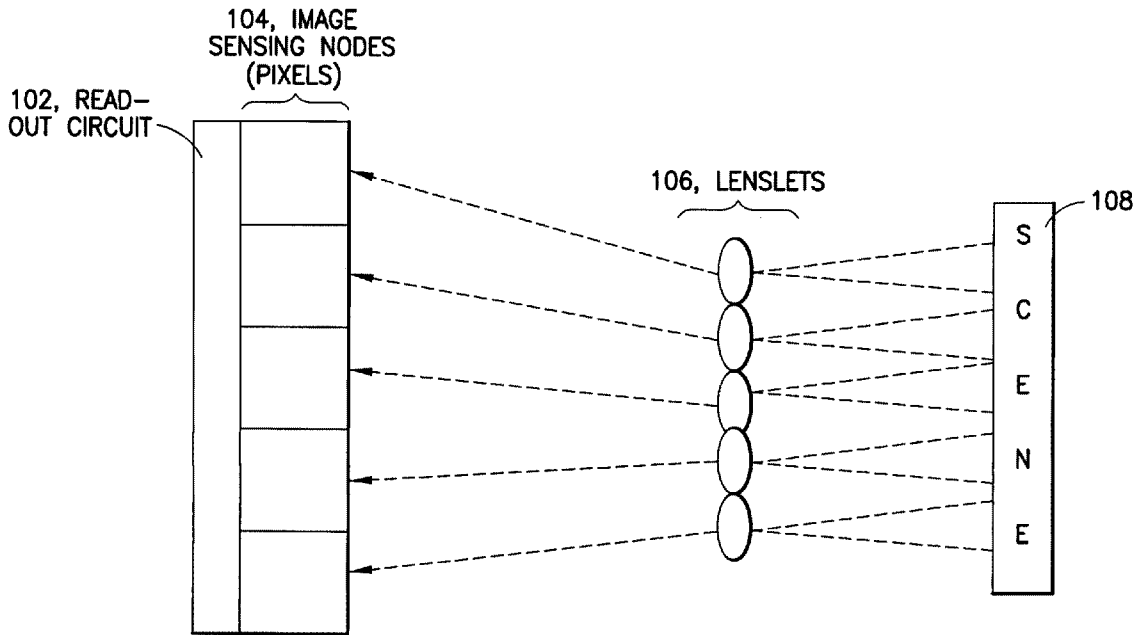

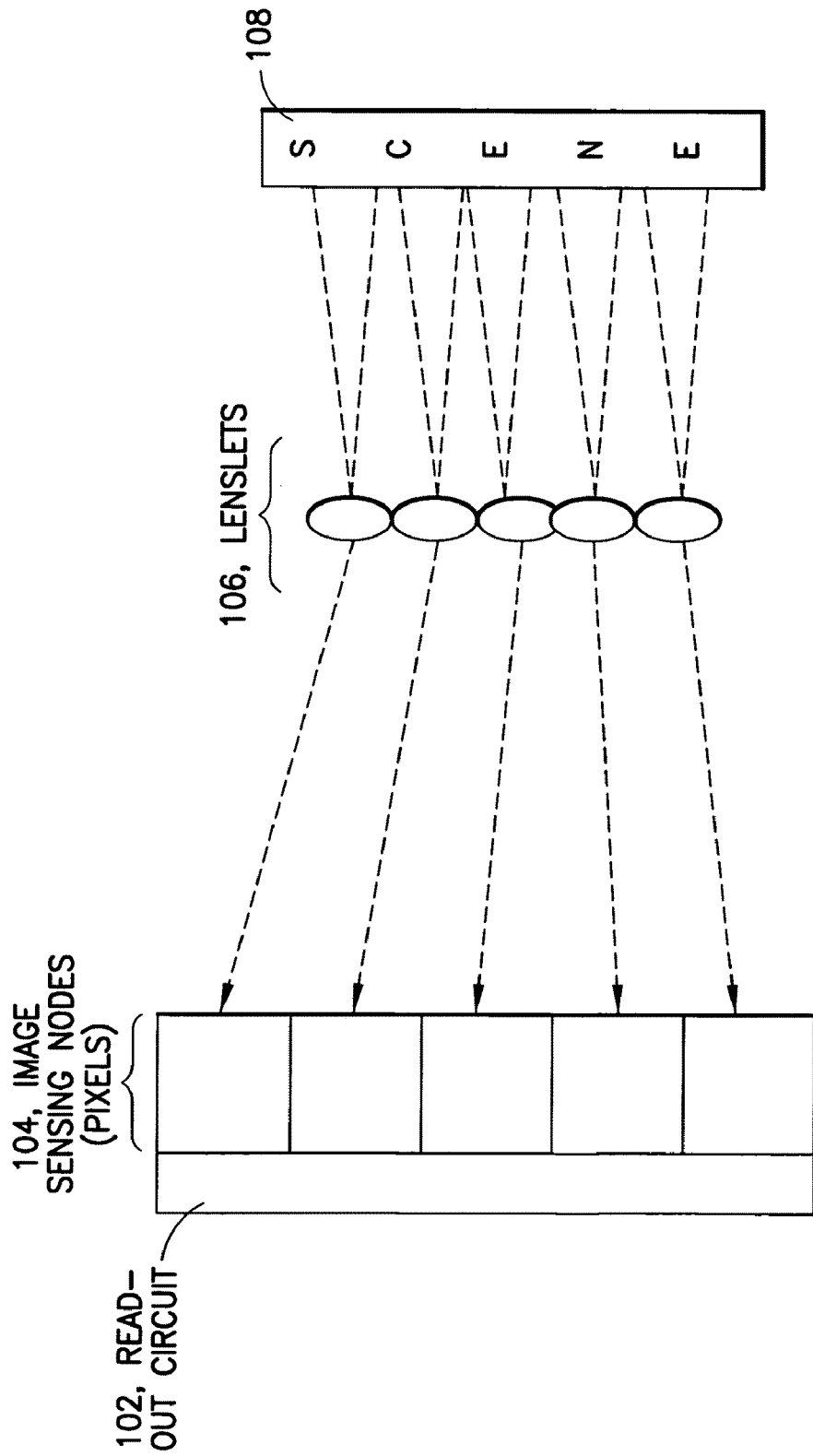

FIG.1

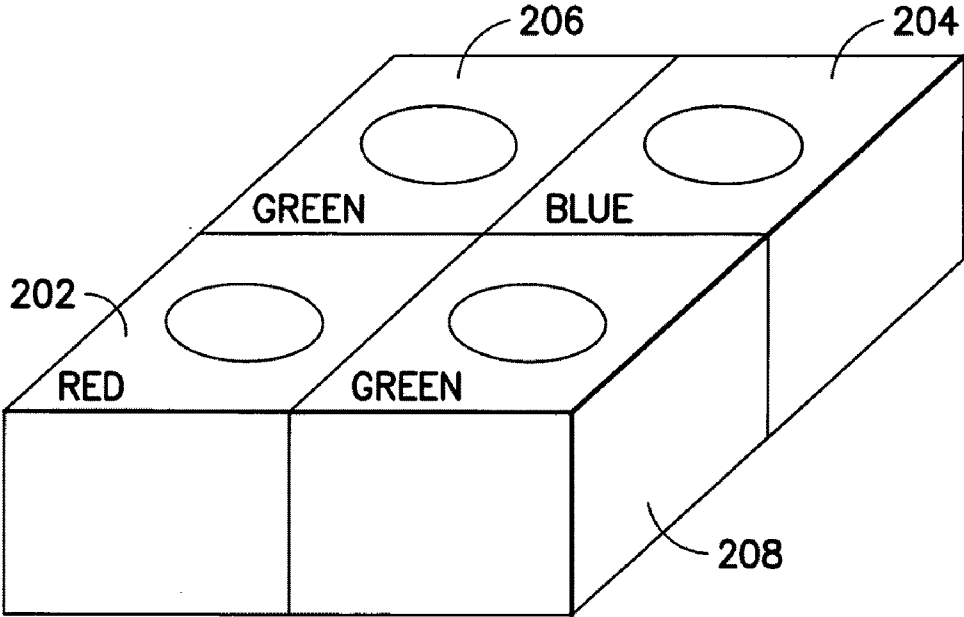

FIG. 2

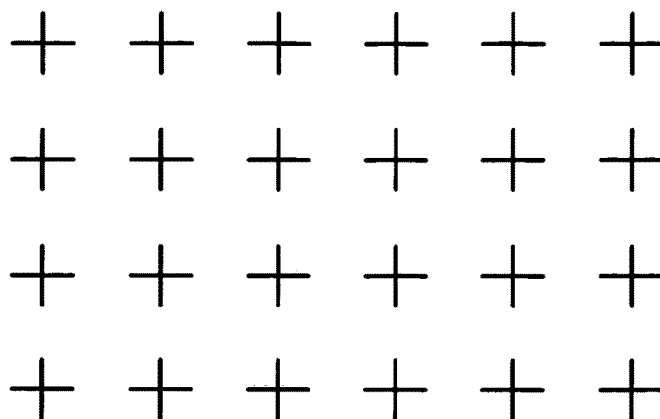

FIG.3A

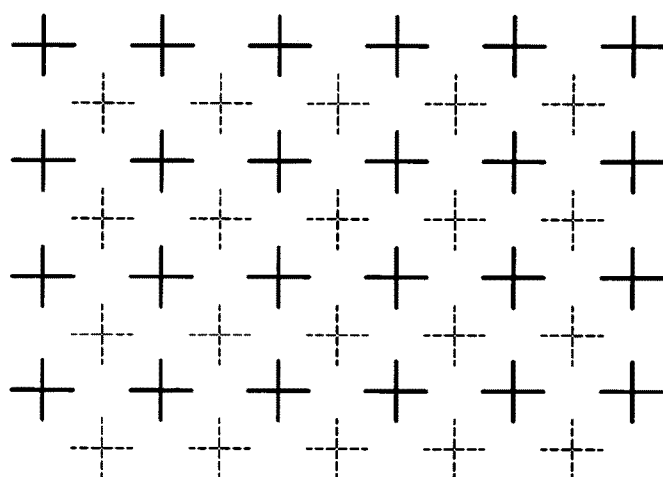

FIG.3B

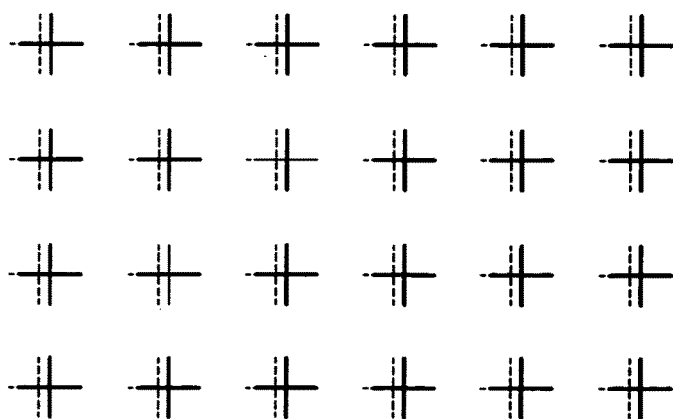

FIG.3C

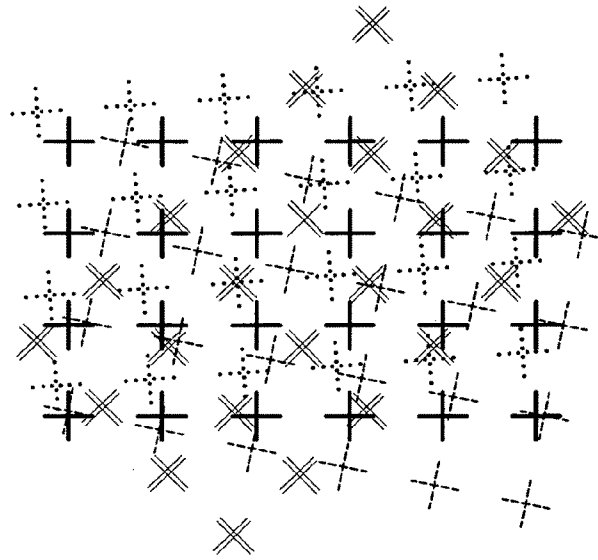

FIG. 4A

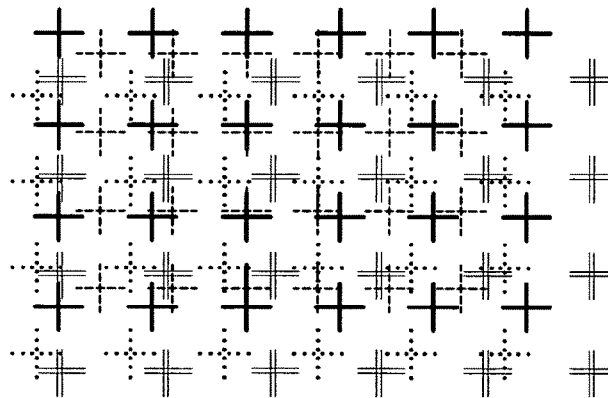

FIG. 4B

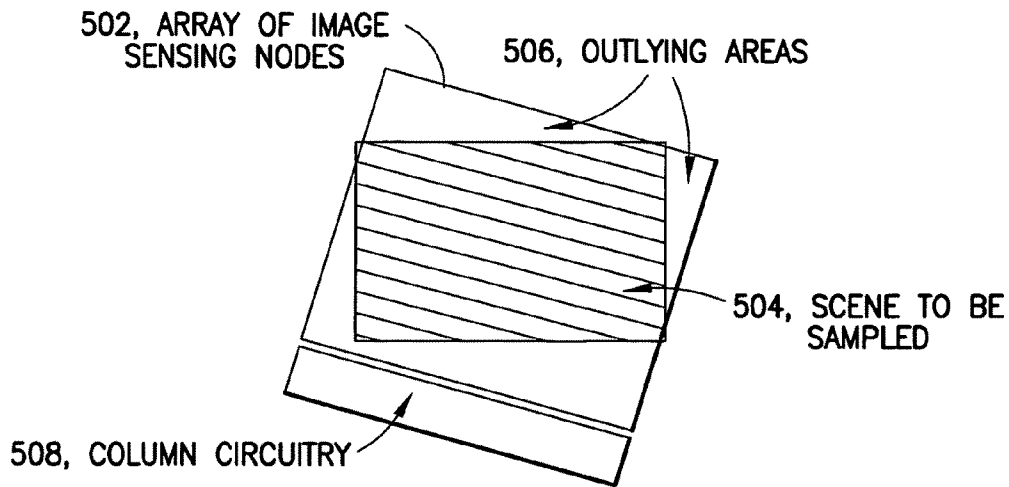

FIG. 5

Explore Litigation Insights

Docket Alarm provides insights to develop a more informed litigation strategy and the peace of mind of knowing you're on top of things.

Real-Time Litigation Alerts



Keep your litigation team up-to-date with **real-time alerts** and advanced team management tools built for the enterprise, all while greatly reducing PACER spend.

Our comprehensive service means we can handle Federal, State, and Administrative courts across the country.

Advanced Docket Research



With over 230 million records, Docket Alarm's cloud-native docket research platform finds what other services can't. Coverage includes Federal, State, plus PTAB, TTAB, ITC and NLRB decisions, all in one place.

Identify arguments that have been successful in the past with full text, pinpoint searching. Link to case law cited within any court document via Fastcase.

Analytics At Your Fingertips



Learn what happened the last time a particular judge, opposing counsel or company faced cases similar to yours.

Advanced out-of-the-box PTAB and TTAB analytics are always at your fingertips.

API

Docket Alarm offers a powerful API (application programming interface) to developers that want to integrate case filings into their apps.

LAW FIRMS

Build custom dashboards for your attorneys and clients with live data direct from the court.

Automate many repetitive legal tasks like conflict checks, document management, and marketing.

FINANCIAL INSTITUTIONS

Litigation and bankruptcy checks for companies and debtors.

E-DISCOVERY AND LEGAL VENDORS

Sync your system to PACER to automate legal marketing.