



United States Patent [19]

[11] Patent Number: **5,521,925**

Merakos et al.

[45] Date of Patent: **May 28, 1996**

[54] **METHOD AND APPARATUS FOR PROVIDING MIXED VOICE AND DATA COMMUNICATION IN A TIME DIVISION MULTIPLE ACCESS RADIO COMMUNICATION SYSTEM**

5,103,445	4/1992	Ostlund	370/95.2
5,121,385	6/1992	Tominaga et al.	370/80
5,200,956	4/1993	Pudney et al.	370/95.3
5,299,198	3/1994	Kay et al.	370/95.3

[75] Inventors: **Lazaros Merakos**, Arlington, Mass.; **Shrirang Jangi**, Germantown, Md.; **Fayu Li**, Waltham, Mass.

Primary Examiner—Benedict V. Safourek
Assistant Examiner—Ajit Patel
Attorney, Agent, or Firm—Gordon R. Lindeen, III; Wanda K. Denson-Low

[73] Assignee: **Hughes Aircraft Company**, Los Angeles, Calif.

[57] **ABSTRACT**

[21] Appl. No.: **118,709**

A system is described which integrates terminal traffic in a digital voice cellular radio communication system. Data is conveyed from remote data stations and remote radio telephone stations over a reverse channel TDMA frame. The allocation of time slots in the reverse channel TDMA frame is controlled at the base station. The base station provides priority to radio telephones having digitized voice traffic. The base station assigns time slots within the reverse channel TDMA frame based upon allocation requests received from radio telephone stations and remote data stations. Remote data stations may contend on a random access for a minority of a set of time slots in the reverse channel data frame. Additionally, they may request an assigned slot by inserting an allocation request in a control slot of the reverse channel data frame. The base station allocates time slots on a voice radio telephone priority, and assigns any excess time slots to data stations waiting for access to the reverse channel.

[22] Filed: **Sep. 9, 1993**

[51] Int. Cl.⁶ **H04J 3/16**

[52] U.S. Cl. **370/95.3; 379/63; 455/34.1; 455/54.2; 375/202**

[58] **Field of Search** 370/94.1, 95.1-95.3, 370/79, 80, 81, 85.8, 85.6, 85.7; 340/825.08; 379/63; 455/34.1, 54.2; 375/202

[56] **References Cited**

U.S. PATENT DOCUMENTS

4,528,659	7/1985	Jones, Jr.	370/80
4,646,294	2/1987	Eliscu et al.	370/60
4,736,371	4/1988	Tejima et al.	370/95.1
5,008,883	4/1991	Eizenhofer et al.	370/95.1

24 Claims, 7 Drawing Sheets

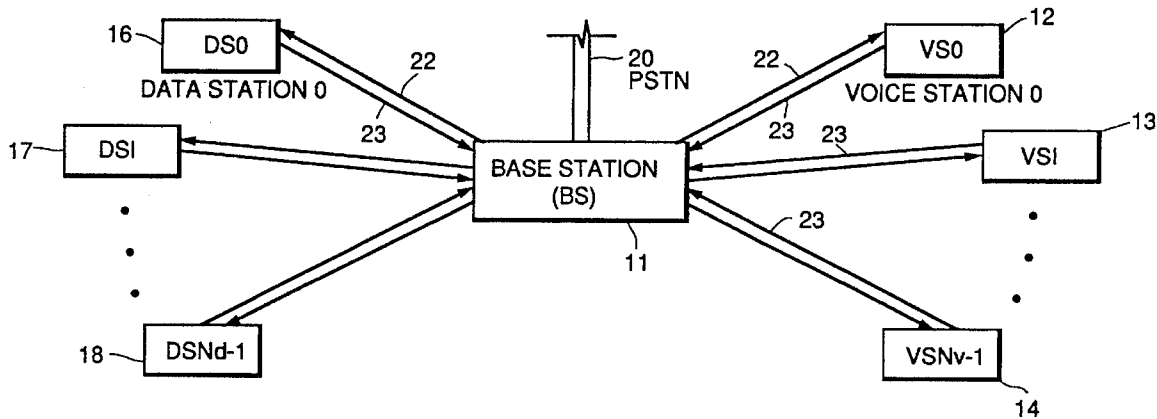

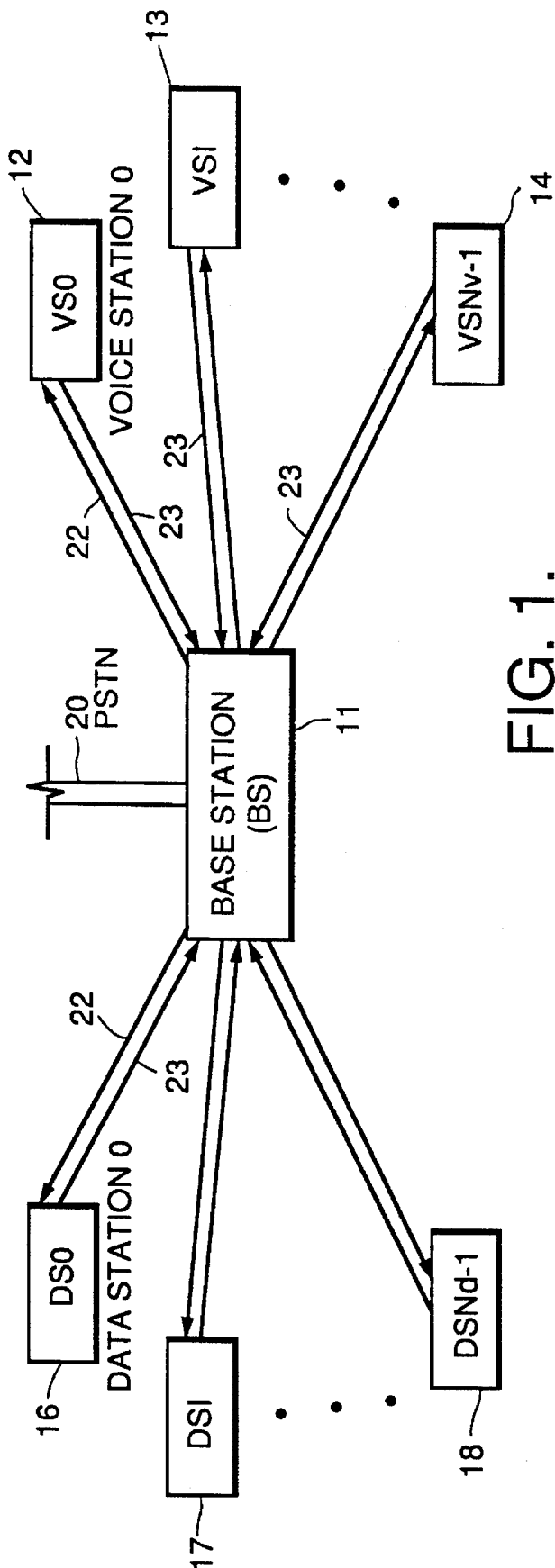
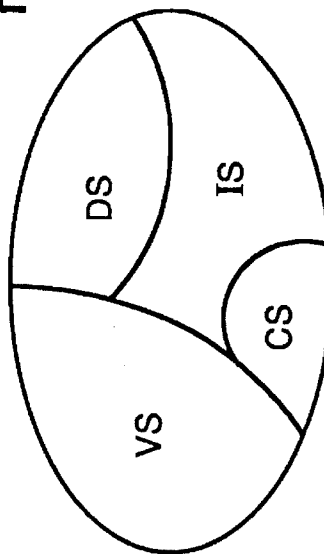

FIG. 1.

FIG. 2.



VS : SLOTS OCCUPIED BY VOICE STATION
DS : SLOTS OCCUPIED BY DATA STATION
CS : CONTROL SLOTS
IS : IDLE SLOTS

	SLOT 1			SLOT 2			SLOT 3			SLOT 4			SLOT 5			SLOT 6						
F1	RR 1	RA 2	RA 3	C ₁	C ₂	C ₃	C ₄	DATA			DATA			DATA								
F2	DATA			RA 4	RA 5	RR 2	RA 6	DATA			RANDOM			DATA								
F3	DATA			DATA			DATA			RR 3	RA 7	RA 8	RA 9	DATA			DATA					
F4	DATA			DATA			DATA			RA 10	RA 11	RR 4	RA 12	DATA			DATA					
F5	DATA			RANDOM			DATA			DATA			RR 5	RA 13	RA 14	RA 15	C ₅	C ₆	C ₇	C ₈		
F6	DATA			DATA			DATA			DATA			DATA			DATA			RA 16	RA 17	RR 6	RA 18

FIG. 3.

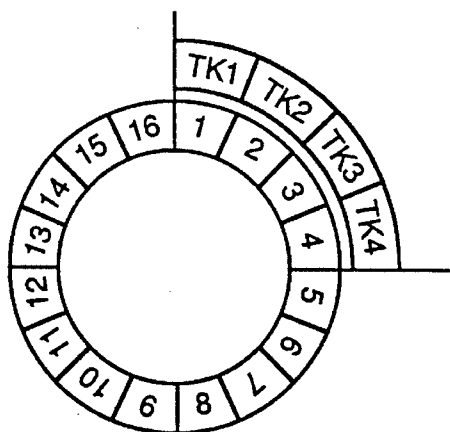

FIG. 4 a.
FRAME 1

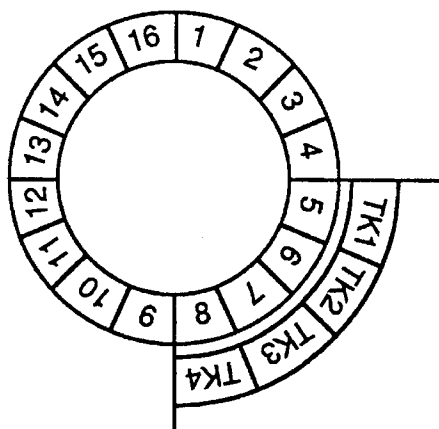

FIG. 4 b.
FRAME 2

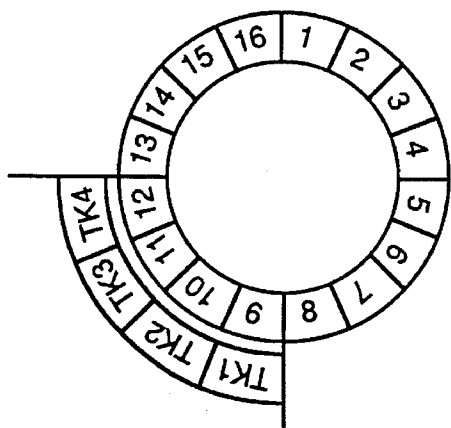

FIG. 4 c.
FRAME 3

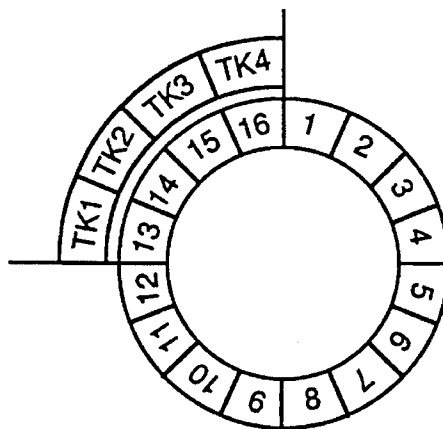

FIG. 4 d.
FRAME 4

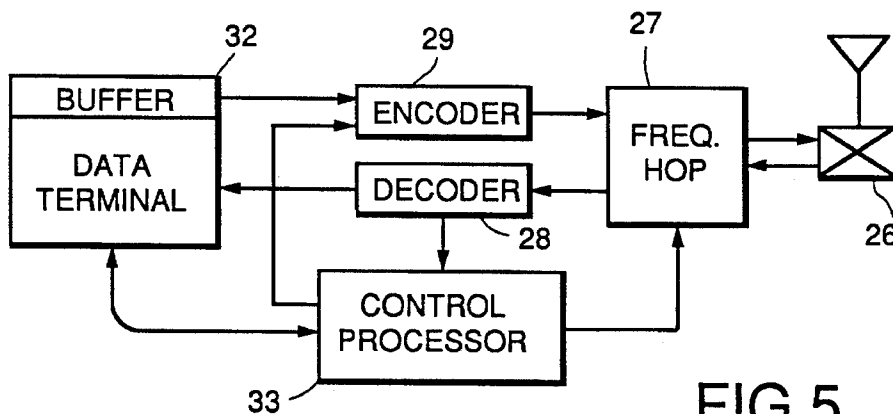

FIG. 5.

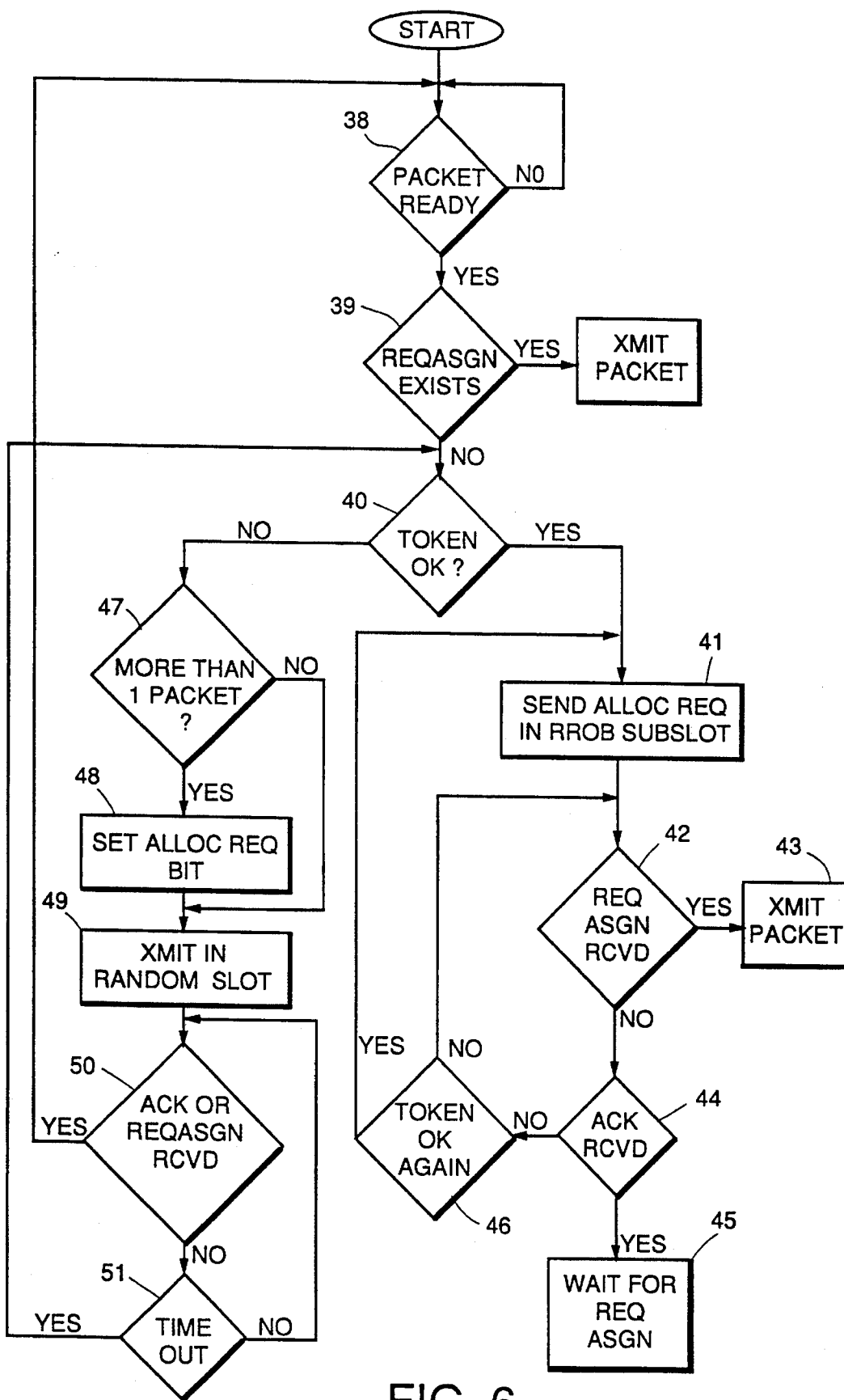

FIG. 6.

Explore Litigation Insights

Docket Alarm provides insights to develop a more informed litigation strategy and the peace of mind of knowing you're on top of things.

Real-Time Litigation Alerts



Keep your litigation team up-to-date with **real-time alerts** and advanced team management tools built for the enterprise, all while greatly reducing PACER spend.

Our comprehensive service means we can handle Federal, State, and Administrative courts across the country.

Advanced Docket Research



With over 230 million records, Docket Alarm's cloud-native docket research platform finds what other services can't. Coverage includes Federal, State, plus PTAB, TTAB, ITC and NLRB decisions, all in one place.

Identify arguments that have been successful in the past with full text, pinpoint searching. Link to case law cited within any court document via Fastcase.

Analytics At Your Fingertips



Learn what happened the last time a particular judge, opposing counsel or company faced cases similar to yours.

Advanced out-of-the-box PTAB and TTAB analytics are always at your fingertips.

API

Docket Alarm offers a powerful API (application programming interface) to developers that want to integrate case filings into their apps.

LAW FIRMS

Build custom dashboards for your attorneys and clients with live data direct from the court.

Automate many repetitive legal tasks like conflict checks, document management, and marketing.

FINANCIAL INSTITUTIONS

Litigation and bankruptcy checks for companies and debtors.

E-DISCOVERY AND LEGAL VENDORS

Sync your system to PACER to automate legal marketing.