



- [54] **GPS RELATIVE POSITION DETECTION SYSTEM**
- [75] Inventor: **Elwood G. Norris**, Poway, Calif.
- [73] Assignee: **American Technology Corporation**, Poway, Calif.
- [21] Appl. No.: **542,799**
- [22] Filed: **Oct. 13, 1995**

**Related U.S. Application Data**

- [63] Continuation-in-part of Ser. No. 377,973, Jan. 25, 1995, Pat. No. 5,689,269.
- [51] Int. Cl.<sup>6</sup> ..... **H04B 7/185; G01S 5/02**
- [52] U.S. Cl. .... **342/357; 342/419**
- [58] Field of Search ..... **342/357, 419; 455/12.1**

**References Cited**

**U.S. PATENT DOCUMENTS**

3,063,048	11/1962	Lehan et al. .	
4,021,807	5/1977	Culpepper et al. .	
4,593,273	6/1986	Narcisse .	
4,675,656	6/1987	Narcisse .	
5,021,794	6/1991	Lawrence .	
5,119,504	6/1992	Durboraw, III .	
5,146,231	9/1992	Ghaem et al. ....	342/419
5,172,110	12/1992	Tiefengraber .	
5,245,314	9/1993	Kah, Jr. .	
5,289,195	2/1994	Inoue .	
5,307,277	4/1994	Hirano .	
5,434,789	7/1995	Fraker et al. ....	364/460
5,506,587	4/1996	Lans ..... ..	342/357
5,539,398	7/1996	Hall et al. ....	340/907

**OTHER PUBLICATIONS**

- GPS Technology and Opportunities by Clyde Haris and Roy Sikorski.
- Utah Meeting Shows Amazing World of Navigation Satellites By Lee Siegel.

- A Marriage Made In Orbit: GPS and PCS by Francis X. Kane.
- A Sampling Of Global Positioning System Receivers by Don Herskovitz.
- How Mobile Computers Can Help You Find Yourself by Gerald Houston.
- This 'Remote' Shows Its Users Exactly Where Here Is by Liz Mullen.
- CAR 54. Where Are You? By Michael Puttre.
- United States Securities And Exchange Commission Form 10-K FRO Trimble Navigational Limited.

Primary Examiner—Theodore M. Blum  
Attorney, Agent, or Firm—Thorpe, North & Western, LLP

[57] **ABSTRACT**

A system of GPS devices which receive civilian GPS signals and provide an intuitive graphical interface for displaying the relative position of GPS devices in relation to each other, the relative position being accurate to several meters and defined as the distance to, direction of and height variance between GPS devices. A first GPS device with the person or object to be located transmits its GPS determined location to a second GPS device. This second GPS device includes a means for receiving the GPS determined position of the first GPS device, and also includes means for calculating the relative position of the first GPS device relative to the second GPS device based on a comparison of the received telemetry of the first GPS device and its own GPS determined position. The relative position of the first device is then graphically displayed on an interface of the second GPS device in a manner which eliminates the need for a map in order to travel to the location of the first GPS device. While providing an interface which displays a relative position of the first GPS device, this information remains accurate no matter how the orientation of the second GPS device changes with respect to a compass.

**13 Claims, 8 Drawing Sheets**

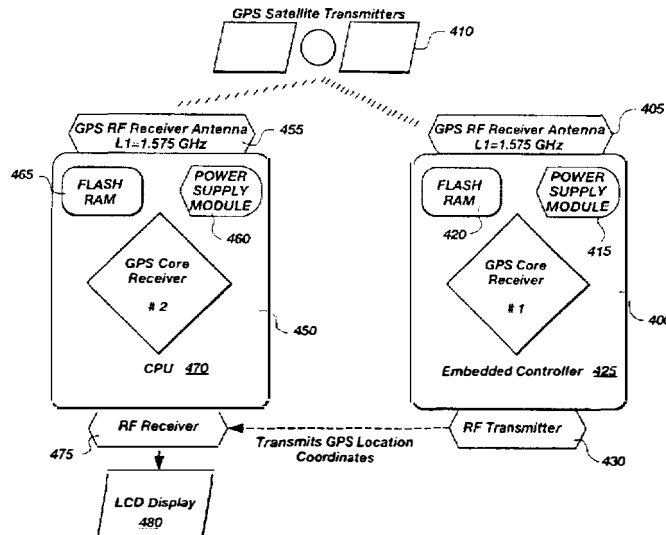

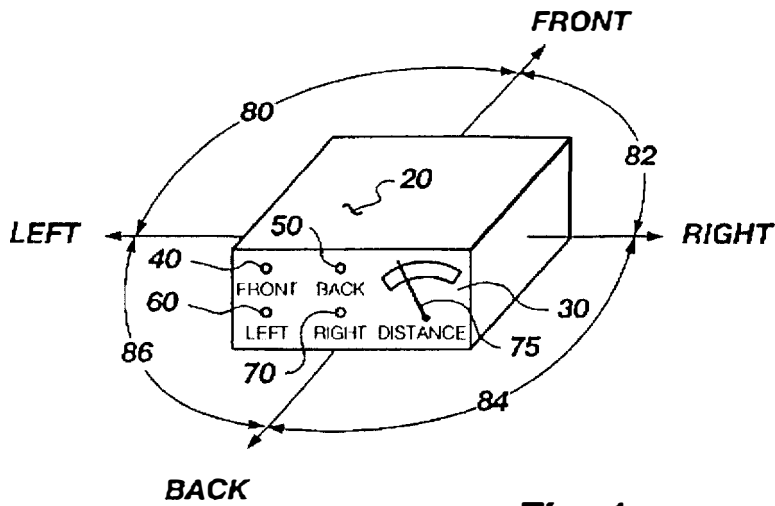

Fig. 1  
(PRIOR ART)

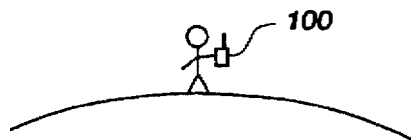
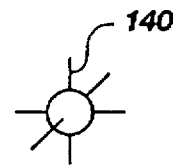
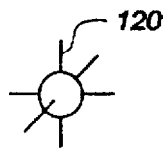
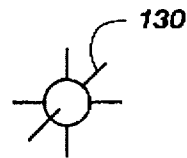
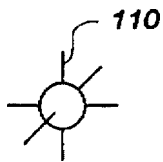
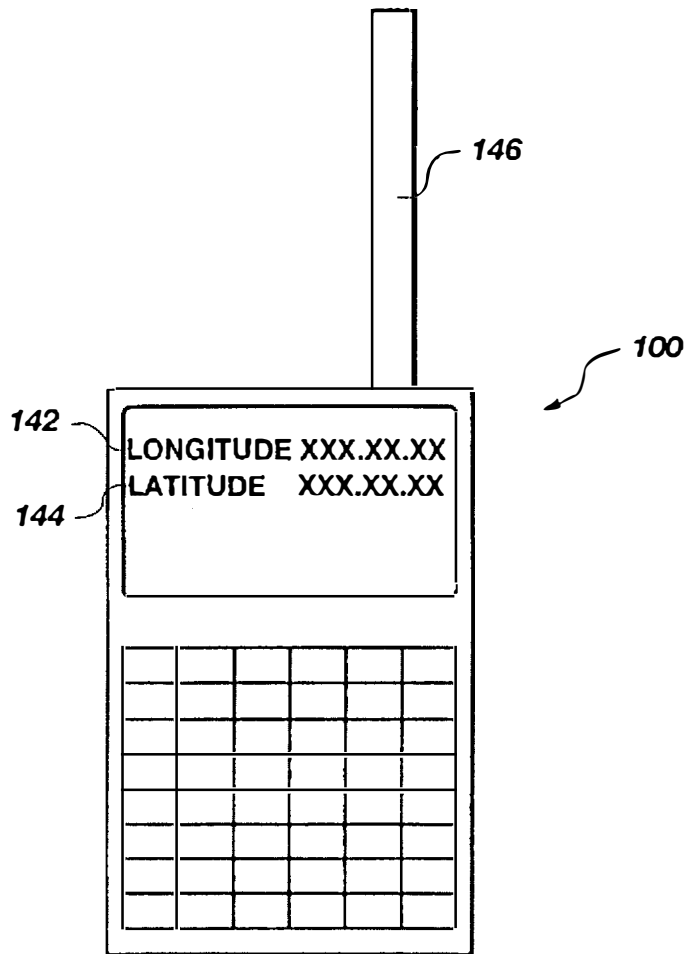

Fig. 2A



**Fig. 2B**

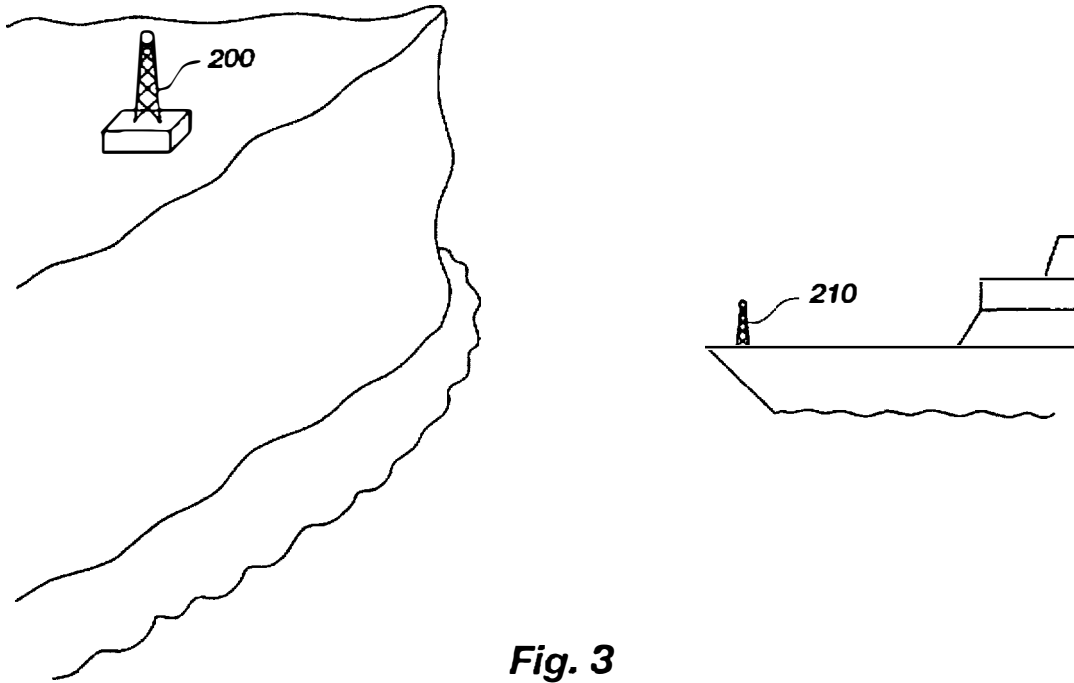

Fig. 3

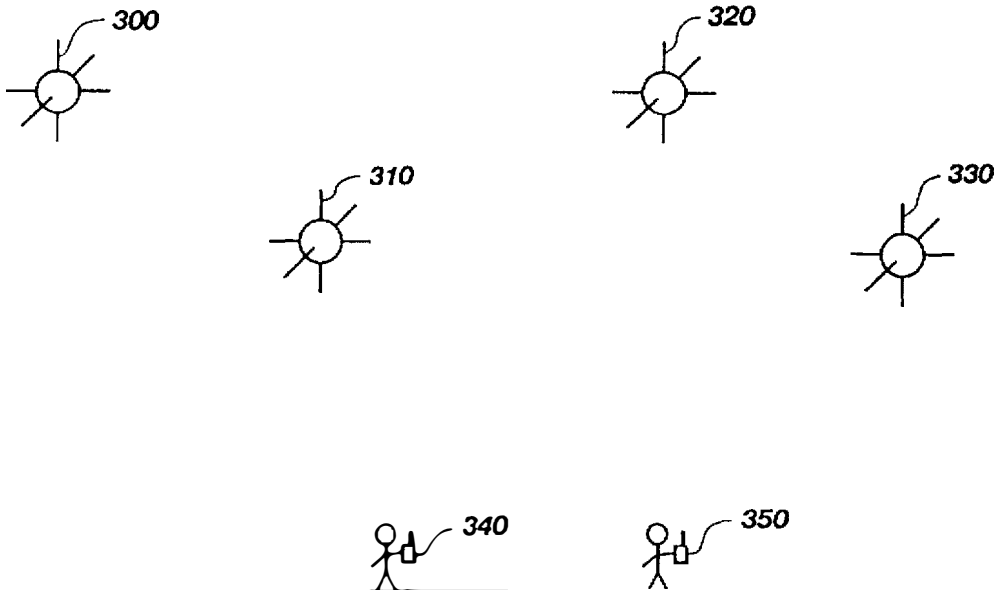

Fig. 4

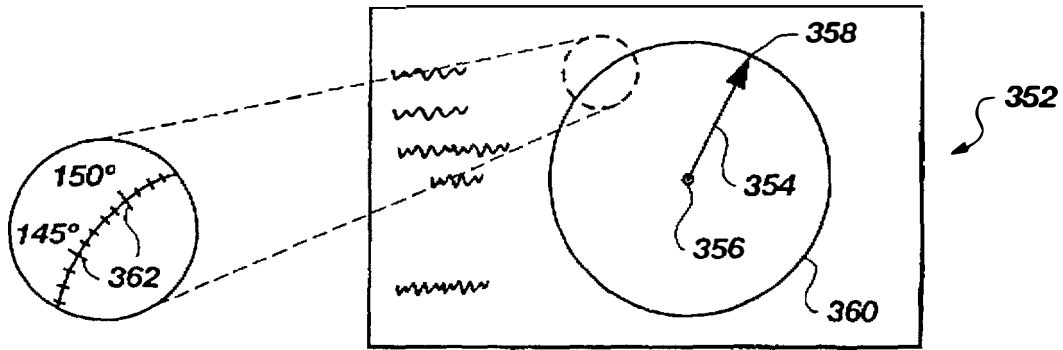

Fig. 5B

Fig. 5A

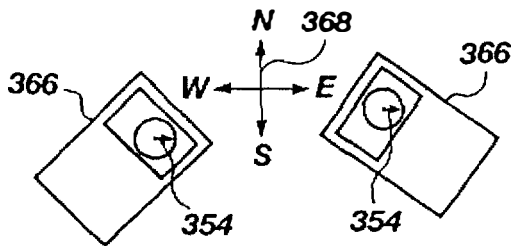

Fig. 5C

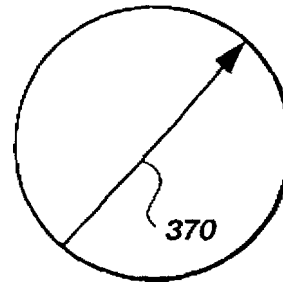

Fig. 5D

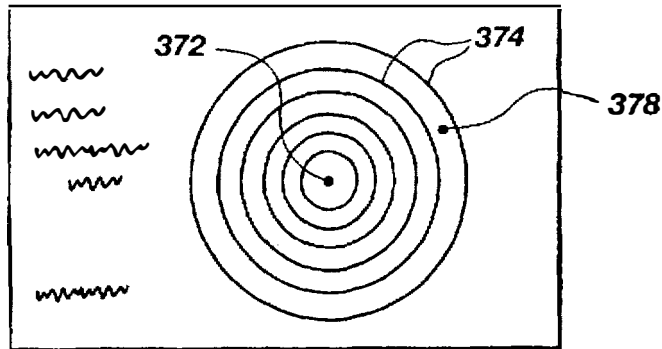

Fig. 6

# Explore Litigation Insights

Docket Alarm provides insights to develop a more informed litigation strategy and the peace of mind of knowing you're on top of things.

## Real-Time Litigation Alerts



Keep your litigation team up-to-date with **real-time alerts** and advanced team management tools built for the enterprise, all while greatly reducing PACER spend.

Our comprehensive service means we can handle Federal, State, and Administrative courts across the country.

## Advanced Docket Research



With over 230 million records, Docket Alarm's cloud-native docket research platform finds what other services can't. Coverage includes Federal, State, plus PTAB, TTAB, ITC and NLRB decisions, all in one place.

Identify arguments that have been successful in the past with full text, pinpoint searching. Link to case law cited within any court document via Fastcase.

## Analytics At Your Fingertips



Learn what happened the last time a particular judge, opposing counsel or company faced cases similar to yours.

Advanced out-of-the-box PTAB and TTAB analytics are always at your fingertips.

## API

Docket Alarm offers a powerful API (application programming interface) to developers that want to integrate case filings into their apps.

## LAW FIRMS

Build custom dashboards for your attorneys and clients with live data direct from the court.

Automate many repetitive legal tasks like conflict checks, document management, and marketing.

## FINANCIAL INSTITUTIONS

Litigation and bankruptcy checks for companies and debtors.

## E-DISCOVERY AND LEGAL VENDORS

Sync your system to PACER to automate legal marketing.