



[54] **LOOK-UP ENGINE FOR PACKET-BASED NETWORK**

[75] Inventors: **Jerome Gobuyan**, Kanata; **Wayne Burwell**, Ottawa; **Nutan Behki**, Nepean, all of Canada

[73] Assignee: **Newbridge Networks Corporation**, Kanata, Canada

[21] Appl. No.: **08/663,263**

[22] PCT Filed: **Dec. 21, 1994**

[86] PCT No.: **PCT/CA94/00695**

§ 371 Date: **Aug. 16, 1996**

§ 102(e) Date: **Aug. 16, 1996**

[87] PCT Pub. No.: **WO95/18497**

PCT Pub. Date: **Jul. 6, 1995**

[30] **Foreign Application Priority Data**

Dec. 24, 1993 [GB] United Kingdom ..... 9326476

[51] Int. Cl.<sup>6</sup> ..... **H04L 12/46**

[52] U.S. Cl. .... **370/392; 370/401**

[58] Field of Search ..... 370/392, 395, 370/400, 401-405, 465, 466, 351, 389, 396, 397, 474; 395/200.68

[56] **References Cited**

U.S. PATENT DOCUMENTS

5,095,480 3/1992 Fenner ..... 370/238  
5,463,777 10/1995 Bialkowski et al. .... 370/256

*Primary Examiner*—Chau Nguyen  
*Attorney, Agent, or Firm*—Marks & Clerk

[57] **ABSTRACT**

An arrangement is disclosed for parsing packets in a packet-based data transmission network. The packets include packet headers divided into fields having values representing information pertaining to the packet. The arrangement includes an input receiving fields from the packet headers of incoming packets, a memory for storing information related to possible values of said fields, and a device for retrieving the stored information appropriate to a received field value. The retrieving device comprises a look-up engine including at least one memory organized in a hierarchical tree structure, and a controller for controlling the operation of the memory. The arrangement is capable of performing fast look-up operations at a low cost of implementation.

**29 Claims, 11 Drawing Sheets**

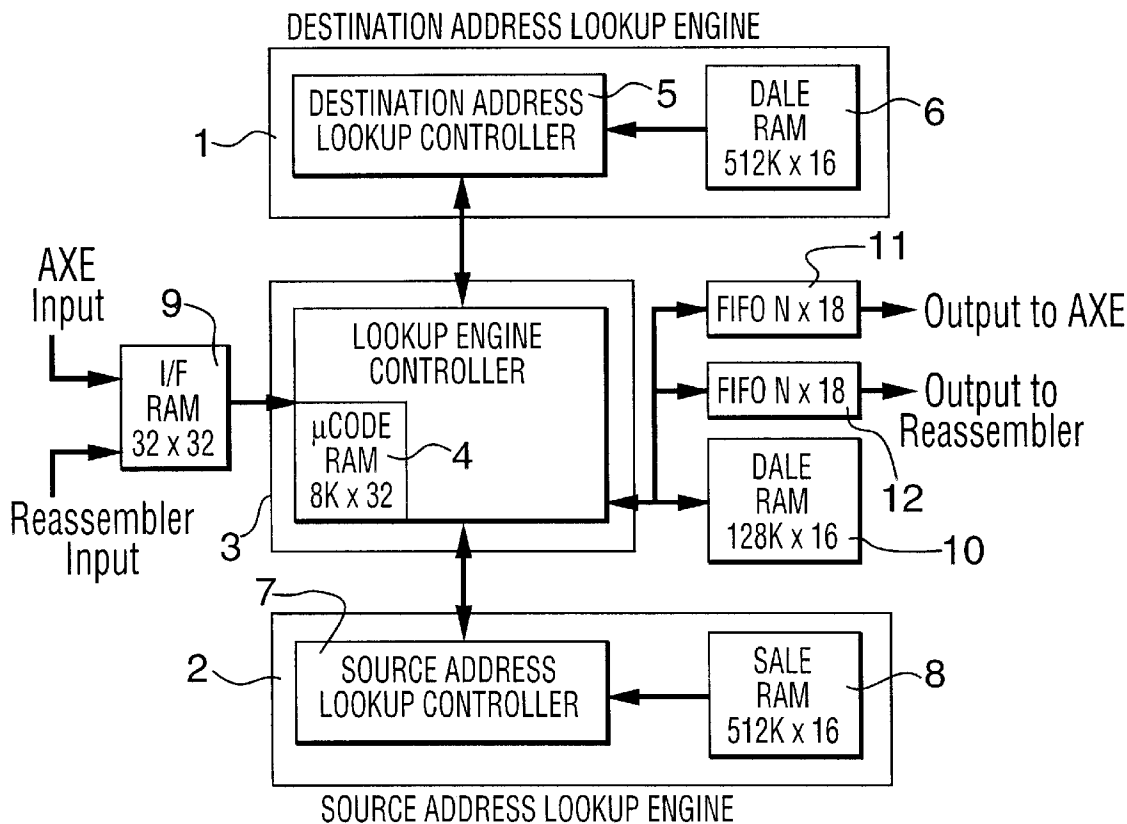

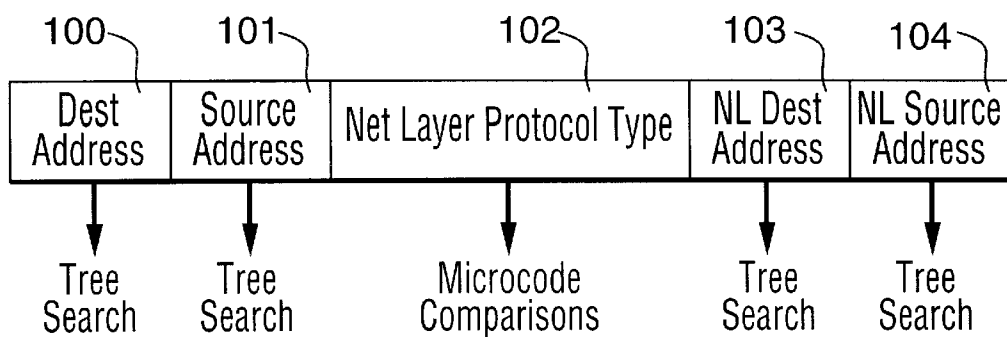

FIG. 1

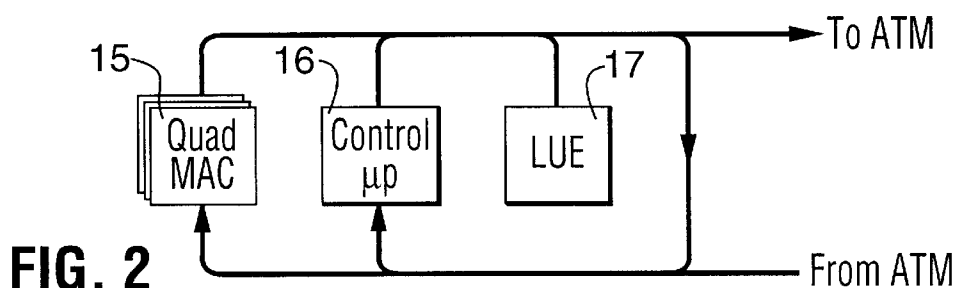

FIG. 2

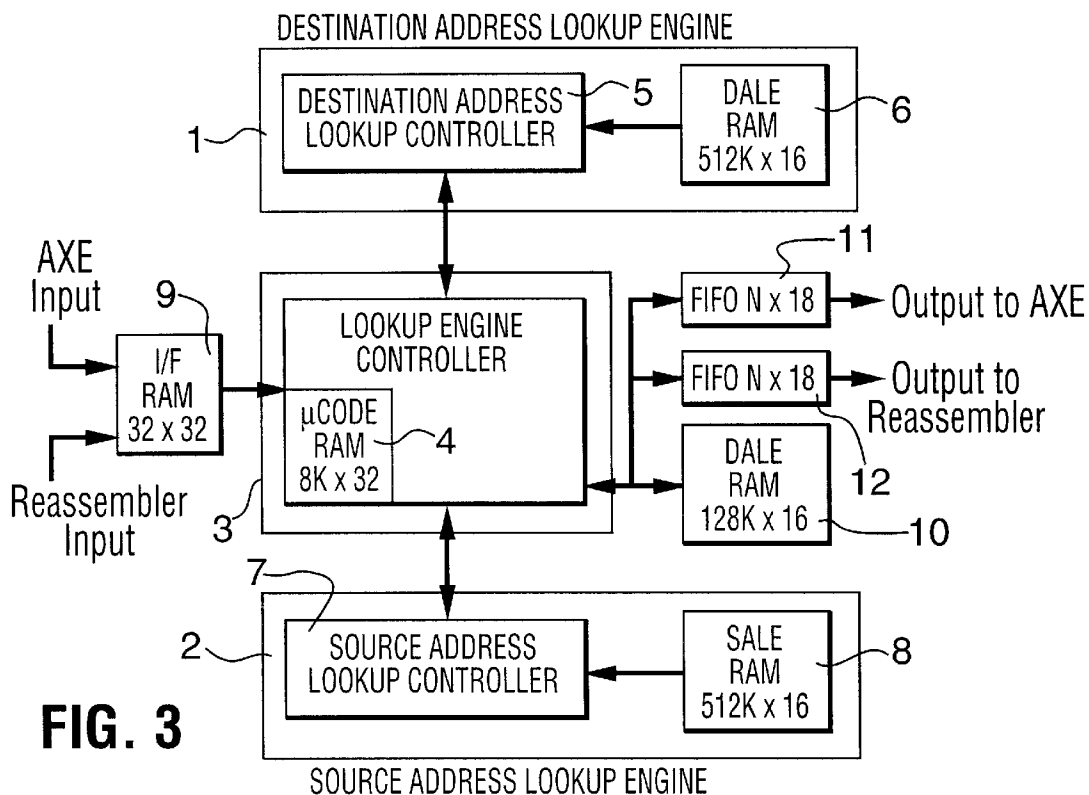

FIG. 3

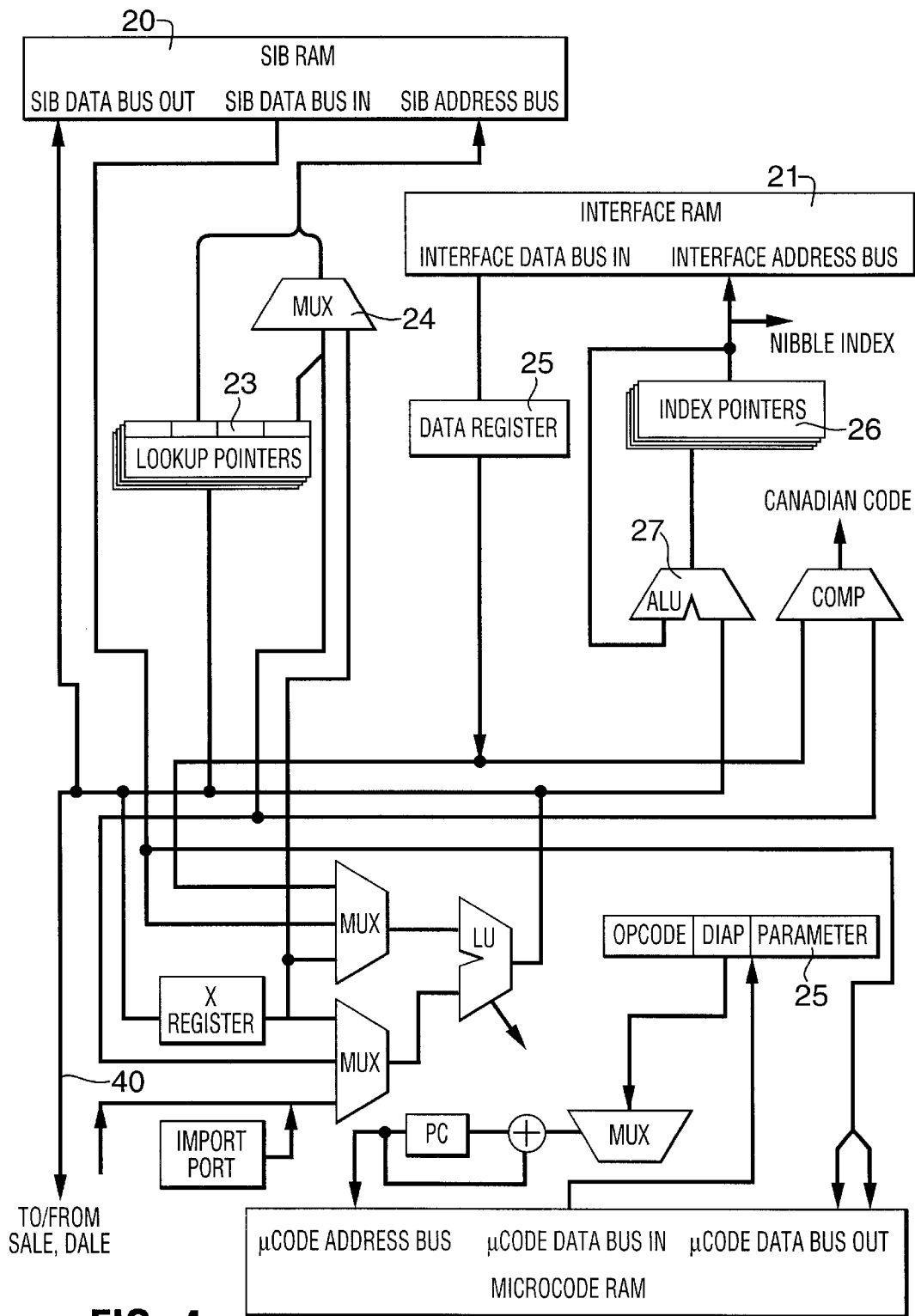

FIG. 4

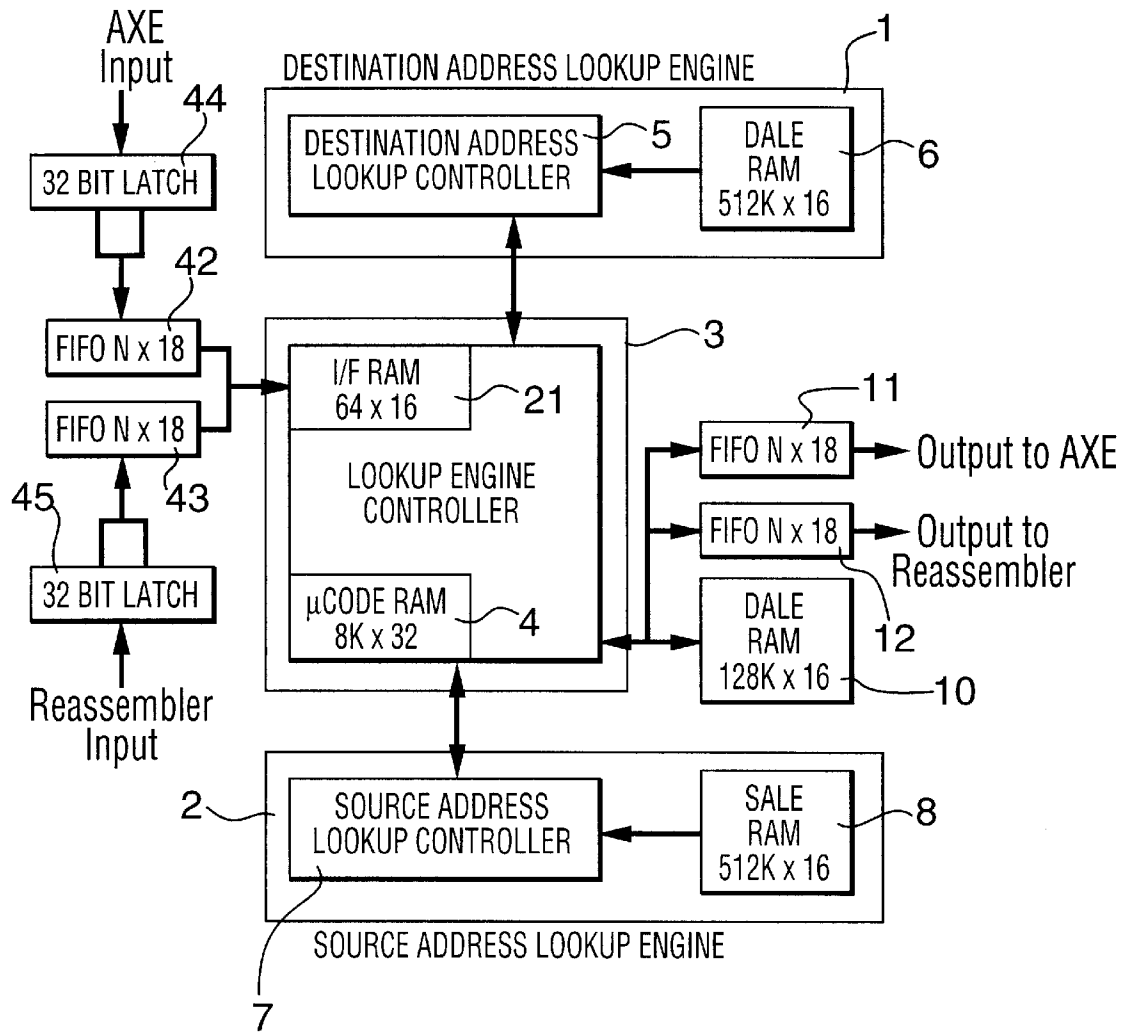

FIG. 5

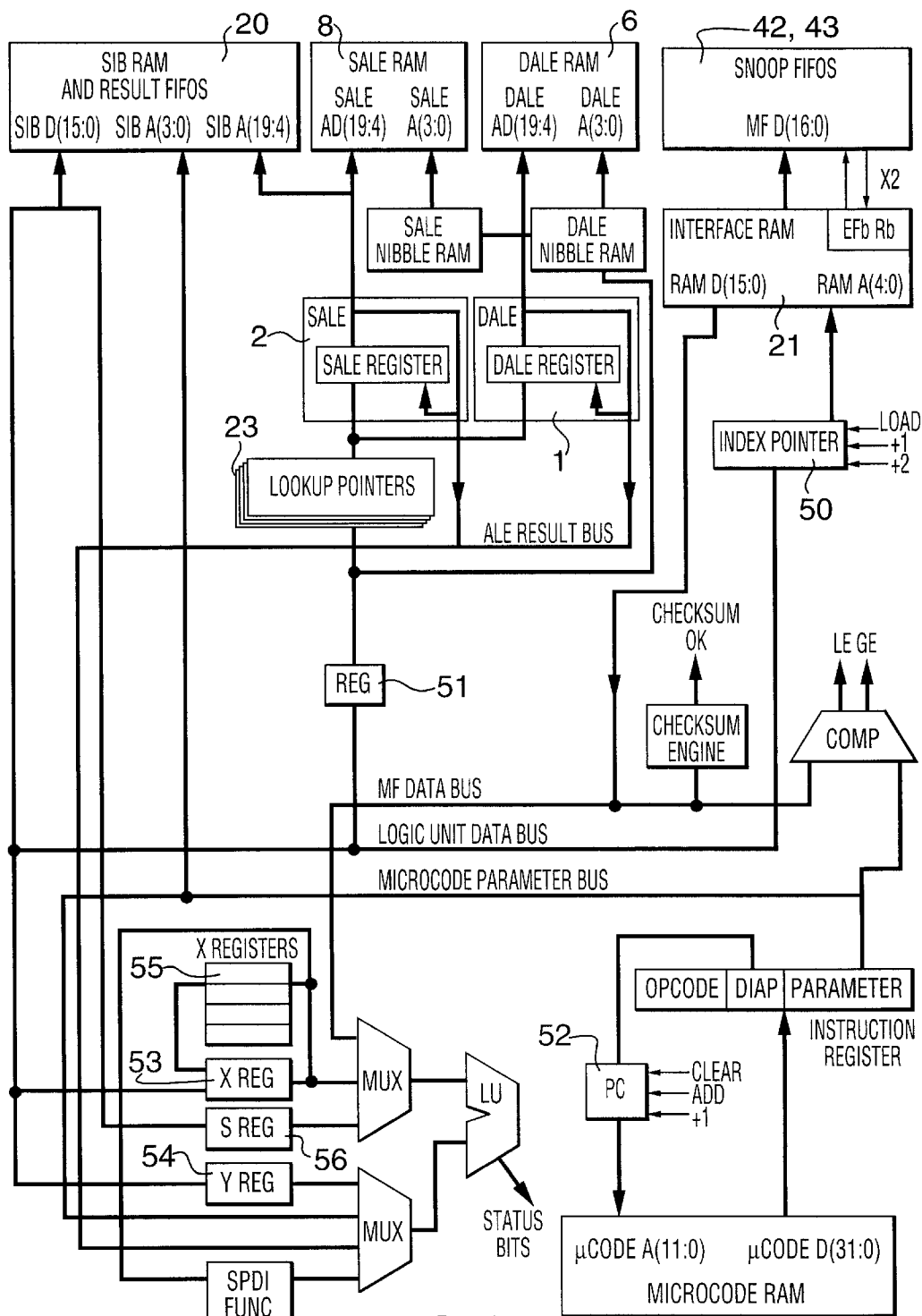

FIG. 6

# Explore Litigation Insights

Docket Alarm provides insights to develop a more informed litigation strategy and the peace of mind of knowing you're on top of things.

## Real-Time Litigation Alerts



Keep your litigation team up-to-date with **real-time alerts** and advanced team management tools built for the enterprise, all while greatly reducing PACER spend.

Our comprehensive service means we can handle Federal, State, and Administrative courts across the country.

## Advanced Docket Research



With over 230 million records, Docket Alarm's cloud-native docket research platform finds what other services can't. Coverage includes Federal, State, plus PTAB, TTAB, ITC and NLRB decisions, all in one place.

Identify arguments that have been successful in the past with full text, pinpoint searching. Link to case law cited within any court document via Fastcase.

## Analytics At Your Fingertips



Learn what happened the last time a particular judge, opposing counsel or company faced cases similar to yours.

Advanced out-of-the-box PTAB and TTAB analytics are always at your fingertips.

## API

Docket Alarm offers a powerful API (application programming interface) to developers that want to integrate case filings into their apps.

## LAW FIRMS

Build custom dashboards for your attorneys and clients with live data direct from the court.

Automate many repetitive legal tasks like conflict checks, document management, and marketing.

## FINANCIAL INSTITUTIONS

Litigation and bankruptcy checks for companies and debtors.

## E-DISCOVERY AND LEGAL VENDORS

Sync your system to PACER to automate legal marketing.