

Document code: WFEE

United States Patent and Trademark Office  
Sales Receipt for Accounting Date: 04/10/2019

GARIAS	SALE	#00000005	Mailroom Dt:	04/09/2019	14609189
		01	FC : 1599	7,320.00	OP

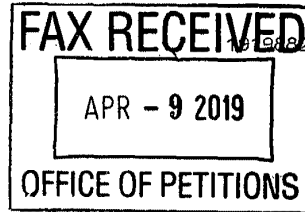

**COMMUNICATION TO THE UNITED STATES PATENT AND TRADEMARK OFFICE**

Application Number:	14/609,189	Correspondence Address Customer Number:	118194
Filing or 371 (c) Date:	01-29-2015	Status:	Patented Case
Application Type:	Utility	Status Date:	06-27-2018
Examiner Name:	CHOU, ALAN S	Location:	ELECTRONIC
Group Art Unit:	2451	Location Date:	
Confirmation Number:	5037	Earliest Publication No:	US 2015-0149575 A1
Attorney Docket Number:	455/006/8 UTIL	Earliest Publication Date:	05-28-2015
Class / Subclass:	709/206	Patent Number:	10,027,619
First Named Inventor:	Ari Backholm	Issue Date of Patent:	07-17-2018
AIA (First Inventor to File):	No		

Title of Invention: Messaging centre for forwarding e-mail

**USPTO**  
Commissioner for Patents  
P.O. Box 1450  
Alexandria, VA 22313-1450

**CORRECTION IN SMALL ENTITY STATUS**

It has been discovered that Applicant/Patentee (collectively "Applicant") may have lost entitlement to small entity status in regard to the above-referenced patent(s) and/or patent application(s) (the "Patents and Patent Applications") at some date on or after July 5, 2007. Applicant has paid fees for the Patents and Patent Application at the rate of a small entity, however, due to the uncertainty of small entity status after July 5, 2007, Applicant is choosing to pay large entity fees out of an abundance of caution. Applicants respectfully request that any fee deficiencies owed are charged to Deposit Account 50-6191 and Applicant files this letter in compliance with 37 CFR 1.28(c).

• Application No: 14/609,189  
 Reply Dated: April 9, 2019

Applicant provides a Table herewith that shows the date and the fee paid, what the fee was paid for (e.g. filing fee, claim fee, etc), the current fee or the undiscounted fee at that time, whichever is larger, and the fee deficiency owed.

Date	Fee Code	Fee Amount	Quantity	Total Amount	Corrected Amount	Deficiency
02-05-2018	2806	\$120.00	1	\$120.00	\$240	\$120
02-05-2018	2401	\$400.00	1	\$400.00	\$800	\$400
08-28-2017	2820	\$850.00	1	\$850.00	\$1,900	\$1,050
02-09-2017	2202	\$40.00	1	\$40.00	\$100	\$60
08-23-2016	2801	\$600.00	1	\$600.00	\$1,300	\$700
04-20-2016	2806	\$90.00	1	\$90.00	\$240	\$150
04-01-2016	2202	\$40.00	34	\$1,360.00	\$3,400	\$2,040
04-01-2016	2201	\$210.00	5	\$1,050.00	\$2,300	\$1,250
04-02-2016	2253	\$700.00	1	\$700.00	\$1,400	\$700
01-29-2015	2051	\$70.00	1	\$70.00	\$160	\$90
01-29-2015	2311	\$360.00	1	\$360.00	\$760	\$400
01-29-2015	2111	\$300.00	1	\$300.00	\$660	\$360

Applicant calculates the total deficiency payment owed of \$7,320 and submits the total deficiency payment herewith.

Applicant respectfully submits that if the claim to small entity status was an error, the payment of the small entity fee was made in good faith and without deceptive intent, and, therefore, should be excused pursuant to 37 CFR 1.28(c).

Respectfully submitted,

Date: April 9, 2019

/Justin R. Nifong/  
 Justin R. Nifong  
 Reg. No. 59,389

NK Patent Law, PLLC  
 4917 Waters Edge Drive, Suite 275  
 Raleigh, NC 27606  
 Telephone: (919) 348-2194  
 Facsimile: (919) 882-8195

Customer No. 118194

<b>INFORMATION DISCLOSURE STATEMENT BY APPLICANT</b> ( Not for submission under 37 CFR 1.99)	Application Number	14609189
	Filing Date	2015-01-29
	First Named Inventor	Ari Backholm
	Art Unit	2451
	Examiner Name	CHOU, ALAN S
	Attorney Docket Number	455/006/8 UTIL

U.S.PATENTS <span style="float: right;">Remove</span>						
Examiner Initial*	Cite No	Patent Number	Kind Code <sup>1</sup>	Issue Date	Name of Patentee or Applicant of cited Document	Pages, Columns, Lines where Relevant Passages or Relevant Figures Appear
	1	6078908		2000-06-20	Schmitz	
	2	6745326		2004-06-01	Wary	
	3	6993658		2006-01-31	Engberg et al.	
	4	7289792		2007-10-30	Turunen	

If you wish to add additional U.S. Patent citation information please click the Add button. Add

U.S.PATENT APPLICATION PUBLICATIONS <span style="float: right;">Remove</span>						
Examiner Initial*	Cite No	Publication Number	Kind Code <sup>1</sup>	Publication Date	Name of Patentee or Applicant of cited Document	Pages, Columns, Lines where Relevant Passages or Relevant Figures Appear
	1	20020147918	A1	2002-10-10	Osthoff Harro R. et al.	
	2	20040098597	A1	2004-05-20	Giobbi	

**INFORMATION DISCLOSURE  
STATEMENT BY APPLICANT**  
( Not for submission under 37 CFR 1.99)

Application Number	14609189
Filing Date	2015-01-29
First Named Inventor	Ari Backholm
Art Unit	2451
Examiner Name	CHOU, ALAN S
Attorney Docket Number	455/006/8 UTIL

3	20040205248	A1	2004-10-14	Little et al.
4	20050015432	A1	2005-01-20	Cohen
5	20050139680	A1	2005-06-30	Anttila et al.
6	20050152525	A1	2005-07-14	Kent Larry G. JR. et al.
7	20060031300	A1	2006-02-09	Kock et al.
8	20060085503	A1	2006-04-20	Stoye et al.
9	20060265595	A1	2006-11-23	Scottodiluzio
10	20130268384	A1	2013-10-10	SALONEN

If you wish to add additional U.S. Published Application citation information please click the Add button.

**FOREIGN PATENT DOCUMENTS**

Examiner Initial*	Cite No	Foreign Document Number <sup>3</sup>	Country Code <sup>2</sup> i	Kind Code <sup>4</sup>	Publication Date	Name of Patentee or Applicant of cited Document	Pages, Columns, Lines where Relevant Passages or Relevant Figures Appear	T <sup>5</sup>
	1							

If you wish to add additional Foreign Patent Document citation information please click the Add button.

<b>INFORMATION DISCLOSURE STATEMENT BY APPLICANT</b> ( Not for submission under 37 CFR 1.99)	Application Number	14609189
	Filing Date	2015-01-29
	First Named Inventor	Ari Backholm
	Art Unit	2451
	Examiner Name	CHOU, ALAN S
	Attorney Docket Number	455/006/8 UTIL

NON-PATENT LITERATURE DOCUMENTS			Remove
Examiner Initials*	Cite No	Include name of the author (in CAPITAL LETTERS), title of the article (when appropriate), title of the item (book, magazine, journal, serial, symposium, catalog, etc), date, pages(s), volume-issue number(s), publisher, city and/or country where published.	T <sup>5</sup>
	1		
If you wish to add additional non-patent literature document citation information please click the Add button			Add
EXAMINER SIGNATURE			
Examiner Signature		Date Considered	
*EXAMINER: Initial if reference considered, whether or not citation is in conformance with MPEP 609. Draw line through a citation if not in conformance and not considered. Include copy of this form with next communication to applicant.			
<small> <sup>1</sup> See Kind Codes of USPTO Patent Documents at <a href="http://www.USPTO.GOV">www.USPTO.GOV</a> or MPEP 901.04. <sup>2</sup> Enter office that issued the document, by the two-letter code (WIPO Standard ST.3). <sup>3</sup> For Japanese patent documents, the indication of the year of the reign of the Emperor must precede the serial number of the patent document. <sup>4</sup> Kind of document by the appropriate symbols as indicated on the document under WIPO Standard ST.16 if possible. <sup>5</sup> Applicant is to place a check mark here if English language translation is attached.           </small>			

<b>INFORMATION DISCLOSURE STATEMENT BY APPLICANT</b> ( Not for submission under 37 CFR 1.99)	Application Number	14609189
	Filing Date	2015-01-29
	First Named Inventor	Ari Backholm
	Art Unit	2451
	Examiner Name	CHOU, ALAN S
	Attorney Docket Number	455/006/8 UTIL

**CERTIFICATION STATEMENT**

Please see 37 CFR 1.97 and 1.98 to make the appropriate selection(s):

That each item of information contained in the information disclosure statement was first cited in any communication from a foreign patent office in a counterpart foreign application not more than three months prior to the filing of the information disclosure statement. See 37 CFR 1.97(e)(1).

**OR**

That no item of information contained in the information disclosure statement was cited in a communication from a foreign patent office in a counterpart foreign application, and, to the knowledge of the person signing the certification after making reasonable inquiry, no item of information contained in the information disclosure statement was known to any individual designated in 37 CFR 1.56(c) more than three months prior to the filing of the information disclosure statement. See 37 CFR 1.97(e)(2).

See attached certification statement.

The fee set forth in 37 CFR 1.17 (p) has been submitted herewith.

A certification statement is not submitted herewith.

**SIGNATURE**

A signature of the applicant or representative is required in accordance with CFR 1.33, 10.18. Please see CFR 1.4(d) for the form of the signature.

Signature	/Justin R. Nifong/	Date (YYYY-MM-DD)	2018-10-08
Name/Print	Justin R. Nifong	Registration Number	59389

This collection of information is required by 37 CFR 1.97 and 1.98. The information is required to obtain or retain a benefit by the public which is to file (and by the USPTO to process) an application. Confidentiality is governed by 35 U.S.C. 122 and 37 CFR 1.14. This collection is estimated to take 1 hour to complete, including gathering, preparing and submitting the completed application form to the USPTO. Time will vary depending upon the individual case. Any comments on the amount of time you require to complete this form and/or suggestions for reducing this burden, should be sent to the Chief Information Officer, U.S. Patent and Trademark Office, U.S. Department of Commerce, P.O. Box 1450, Alexandria, VA 22313-1450. **DO NOT SEND FEES OR COMPLETED FORMS TO THIS ADDRESS. SEND TO: Commissioner for Patents, P.O. Box 1450, Alexandria, VA 22313-1450.**

## Privacy Act Statement

The Privacy Act of 1974 (P.L. 93-579) requires that you be given certain information in connection with your submission of the attached form related to a patent application or patent. Accordingly, pursuant to the requirements of the Act, please be advised that: (1) the general authority for the collection of this information is 35 U.S.C. 2(b)(2); (2) furnishing of the information solicited is voluntary; and (3) the principal purpose for which the information is used by the U.S. Patent and Trademark Office is to process and/or examine your submission related to a patent application or patent. If you do not furnish the requested information, the U.S. Patent and Trademark Office may not be able to process and/or examine your submission, which may result in termination of proceedings or abandonment of the application or expiration of the patent.

The information provided by you in this form will be subject to the following routine uses:

1. The information on this form will be treated confidentially to the extent allowed under the Freedom of Information Act (5 U.S.C. 552) and the Privacy Act (5 U.S.C. 552a). Records from this system of records may be disclosed to the Department of Justice to determine whether the Freedom of Information Act requires disclosure of these records.
2. A record from this system of records may be disclosed, as a routine use, in the course of presenting evidence to a court, magistrate, or administrative tribunal, including disclosures to opposing counsel in the course of settlement negotiations.
3. A record in this system of records may be disclosed, as a routine use, to a Member of Congress submitting a request involving an individual, to whom the record pertains, when the individual has requested assistance from the Member with respect to the subject matter of the record.
4. A record in this system of records may be disclosed, as a routine use, to a contractor of the Agency having need for the information in order to perform a contract. Recipients of information shall be required to comply with the requirements of the Privacy Act of 1974, as amended, pursuant to 5 U.S.C. 552a(m).
5. A record related to an International Application filed under the Patent Cooperation Treaty in this system of records may be disclosed, as a routine use, to the International Bureau of the World Intellectual Property Organization, pursuant to the Patent Cooperation Treaty.
6. A record in this system of records may be disclosed, as a routine use, to another federal agency for purposes of National Security review (35 U.S.C. 181) and for review pursuant to the Atomic Energy Act (42 U.S.C. 218(c)).
7. A record from this system of records may be disclosed, as a routine use, to the Administrator, General Services, or his/her designee, during an inspection of records conducted by GSA as part of that agency's responsibility to recommend improvements in records management practices and programs, under authority of 44 U.S.C. 2904 and 2906. Such disclosure shall be made in accordance with the GSA regulations governing inspection of records for this purpose, and any other relevant (i.e., GSA or Commerce) directive. Such disclosure shall not be used to make determinations about individuals.
8. A record from this system of records may be disclosed, as a routine use, to the public after either publication of the application pursuant to 35 U.S.C. 122(b) or issuance of a patent pursuant to 35 U.S.C. 151. Further, a record may be disclosed, subject to the limitations of 37 CFR 1.14, as a routine use, to the public if the record was filed in an application which became abandoned or in which the proceedings were terminated and which application is referenced by either a published application, an application open to public inspections or an issued patent.
9. A record from this system of records may be disclosed, as a routine use, to a Federal, State, or local law enforcement agency, if the USPTO becomes aware of a violation or potential violation of law or regulation.



## Electronic Patent Application Fee Transmittal

<b>Application Number:</b>	14609189			
<b>Filing Date:</b>	29-Jan-2015			
<b>Title of Invention:</b>	Messaging centre for forwarding e-mail			
<b>First Named Inventor/Applicant Name:</b>	Ari Backholm			
<b>Filer:</b>	Justin Robert Nifong/Taylor Murphy			
<b>Attorney Docket Number:</b>	455/006/8 UTIL			
Filed as Large Entity				
<b>Filing Fees for Utility under 35 USC 111(a)</b>				
<b>Description</b>	<b>Fee Code</b>	<b>Quantity</b>	<b>Amount</b>	<b>Sub-Total in USD(\$)</b>
<b>Basic Filing:</b>				
<b>Pages:</b>				
<b>Claims:</b>				
<b>Miscellaneous-Filing:</b>				
<b>Petition:</b>				
<b>Patent-Appeals-and-Interference:</b>				
<b>Post-Allowance-and-Post-Issuance:</b>				
<b>Extension-of-Time:</b>				

Description	Fee Code	Quantity	Amount	Sub-Total in USD(\$)
<b>Miscellaneous:</b>				
SUBMISSION- INFORMATION DISCLOSURE STMT	1806	1	240	240
<b>Total in USD (\$)</b>				<b>240</b>

## Electronic Acknowledgement Receipt

<b>EFS ID:</b>	33942178
<b>Application Number:</b>	14609189
<b>International Application Number:</b>	
<b>Confirmation Number:</b>	5037
<b>Title of Invention:</b>	Messaging centre for forwarding e-mail
<b>First Named Inventor/Applicant Name:</b>	Ari Backholm
<b>Customer Number:</b>	118194
<b>Filer:</b>	Justin Robert Nifong/Taylor Murphy
<b>Filer Authorized By:</b>	Justin Robert Nifong
<b>Attorney Docket Number:</b>	455/006/8 UTIL
<b>Receipt Date:</b>	08-OCT-2018
<b>Filing Date:</b>	29-JAN-2015
<b>Time Stamp:</b>	14:05:23
<b>Application Type:</b>	Utility under 35 USC 111(a)

### Payment information:

Submitted with Payment	yes
Payment Type	DA
Payment was successfully received in RAM	\$240
RAM confirmation Number	100918INTEFSW00012075506191
Deposit Account	506191
Authorized User	Justin Nifong

The Director of the USPTO is hereby authorized to charge indicated fees and credit any overpayment as follows:  
 37 CFR 1.21 (Miscellaneous fees and charges)

--	--	--	--	--	--

**File Listing:**

Document Number	Document Description	File Name	File Size(Bytes)/ Message Digest	Multi Part /.zip	Pages (if appl.)
1	Information Disclosure Statement (IDS) Form (SB08)	455-006-8-20181008-IDS.pdf	1035375	no	5
			6404a33392225000c9d58b0e7b4c59a2b3faeb04		

**Warnings:**

**Information:**

2	Fee Worksheet (SB06)	fee-info.pdf	30575	no	2
			b93df5af61648498fac83d1bf2181de0387258ec		

**Warnings:**

**Information:**

<b>Total Files Size (in bytes):</b>	1065950
-------------------------------------	---------

**This Acknowledgement Receipt evidences receipt on the noted date by the USPTO of the indicated documents, characterized by the applicant, and including page counts, where applicable. It serves as evidence of receipt similar to a Post Card, as described in MPEP 503.**

**New Applications Under 35 U.S.C. 111**

**If a new application is being filed and the application includes the necessary components for a filing date (see 37 CFR 1.53(b)-(d) and MPEP 506), a Filing Receipt (37 CFR 1.54) will be issued in due course and the date shown on this Acknowledgement Receipt will establish the filing date of the application.**

**National Stage of an International Application under 35 U.S.C. 371**

**If a timely submission to enter the national stage of an international application is compliant with the conditions of 35 U.S.C. 371 and other applicable requirements a Form PCT/DO/EO/903 indicating acceptance of the application as a national stage submission under 35 U.S.C. 371 will be issued in addition to the Filing Receipt, in due course.**

**New International Application Filed with the USPTO as a Receiving Office**

**If a new international application is being filed and the international application includes the necessary components for an international filing date (see PCT Article 11 and MPEP 1810), a Notification of the International Application Number and of the International Filing Date (Form PCT/RO/105) will be issued in due course, subject to prescriptions concerning national security, and the date shown on this Acknowledgement Receipt will establish the international filing date of the application.**



UNITED STATES PATENT AND TRADEMARK OFFICE

UNITED STATES DEPARTMENT OF COMMERCE
United States Patent and Trademark Office
Address: COMMISSIONER FOR PATENTS
P. O. Box 1450
Alexandria, Virginia 22313-1450
www.uspto.gov

Table with 5 columns: APPLICATION NO., ISSUE DATE, PATENT NO., ATTORNEY DOCKET NO., CONFIRMATION NO.
Row 1: 14/609,189, 07/17/2018, 10027619, 455/006/8 UTIL, 5037

118194 7590 06/27/2018
NK Patent Law- Seven Networks
4917 Waters Edge Drive
Suite 275
Raleigh, NC 27606

ISSUE NOTIFICATION

The projected patent number and issue date are specified above.

Determination of Patent Term Adjustment under 35 U.S.C. 154 (b)
(application filed on or after May 29, 2000)

The Patent Term Adjustment is 0 day(s). Any patent to issue from the above-identified application will include an indication of the adjustment on the front page.

If a Continued Prosecution Application (CPA) was filed in the above-identified application, the filing date that determines Patent Term Adjustment is the filing date of the most recent CPA.

Applicant will be able to obtain more detailed information by accessing the Patent Application Information Retrieval (PAIR) WEB site (http://pair.uspto.gov).

Any questions regarding the Patent Term Extension or Adjustment determination should be directed to the Office of Patent Legal Administration at (571)-272-7702. Questions relating to issue and publication fee payments should be directed to the Application Assistance Unit (AAU) of the Office of Data Management (ODM) at (571)-272-4200.

APPLICANT(s) (Please see PAIR WEB site http://pair.uspto.gov for additional applicants):

- Ari Backholm, San Carlos, CA;
Seven Networks, LLC, Marshall, TX;
Seppo Salorinne, Helsinki, FINLAND;
Antti Saarihahti, Helsinki, FINLAND;
Marko Ketonen, Helsinki, FINLAND;
Lauri Vuornos, Helsinki, FINLAND;
Petri Salmi, Espoo, FINLAND;

The United States represents the largest, most dynamic marketplace in the world and is an unparalleled location for business investment, innovation, and commercialization of new technologies. The USA offers tremendous resources and advantages for those who invest and manufacture goods here. Through SelectUSA, our nation works to encourage and facilitate business investment. To learn more about why the USA is the best country in the world to develop technology, manufacture products, and grow your business, visit SelectUSA.gov.

Document Description: Issue Fee Payment (PTO-85B)

### Issue Fee Transmittal Form

Application Number	Filing Date	First Named Inventor	Atty. Docket No.	Confirmation No.
14609189	29-Jan-2015	Ari Backholm	455/006/8 UTIL	5037

**TITLE OF INVENTION :**

Messaging centre for forwarding e-mail

Entity Status		Application Type	Art Unit	Class - Subclass	EXAMINER	
Small	Regular Undiscounted	Utility under 35 USC 111(a)	2451	206000	ALAN CHOU	
Issue Fee Due		Publication Due	Total Fee(s) Due		Date Due	Prev. Paid Fee
\$500	\$1000	\$0	\$500	\$1000	18-Jun-2018	\$0

#### 1. Change of Correspondence Address and/or Indication Of Fee Address (37 CFR 1.33 & 1.363)

Current Correspondence Address:	Current Indicated Fee Address :
118194 NK Patent Law- Seven Networks  4917 Waters Edge Drive Suite 275 Raleigh NC 27606 UNITED STATES 7045625012 abackholm@seven.com	
<input type="checkbox"/> Change of correspondence address requested, system generated AIA/122-EFS form attached	<input type="checkbox"/> Fee Address indication requested, system generated SB/47-EFS form attached

#### 2. Entity Status

##### Change in Entity Status

Applicant certifying micro entity status; system generated Micro Entity certification form attached. See 37 CFR 1.29.

Note: Absent a valid certification of micro entity status, issue fee payment in the micro entity amount will not be accepted at the risk of application abandonment. If this box is checked, you will be prompted to choose a micro entity status on the gross income basis (37 CFR 1.29(a)) or the institution of higher education basis (37 CFR 1.29(d)), and make the applicable certification online.

Applicant asserting small entity status. See 37 CFR 1.27.

Note: If the application was previously under micro entity status, checking this box will be taken to be a notification of loss of entitlement to micro entity status.

Applicant changing to regular undiscounted fee status.

Note: Checking this box will be taken to be a notification of loss of entitlement to small or micro entity status, as applicable.

Document Description: Issue Fee Payment (PTO-85B)

**3.The Following Fee(s) Are Submitted:**

Issue Fee

I authorize USPTO to apply my previously paid issue fee to the current fees due

Publication Fee

The Director is hereby authorized to apply my previously paid issue fee to the current fee due and to charge deficient fees to Deposit Account Number \_\_\_\_\_

Advance Order - # of copies \_\_\_\_\_

If **in addition to** the payment of the issue fee amount submitted with this form, there are any discrepancies in any amount(s) due, the Director is authorized to charge any deficiency, or credit any overpayment, to Deposit Account Number 506191.  
 **The issue fee must be submitted with this form. If payment of the issue fee does not accompany this form, checking this box and providing a deposit account number will NOT be effective to satisfy full payment of the fee(s) due.**

**4.Firm and/or Attorney Names To Be Printed**

**NOTE: If no name is listed, no name will be printed**  
For printing on the patent front page, list to be displayed as entered

1. NK PATENT LAW, PLLC

2.

3.

**5.Assignee Name(s) and Residence Data To Be Printed**

PLEASE NOTE: Unless an assignee is identified below, no assignee data will appear on the patent. If an assignee is identified below, the document has been filed for recordation as set forth in 37 CFR 3.11. Completion of this form is NOT a substitute for filing an assignment.

Name	City	State	Country	Category
Seven Networks, LLC	Marshall	TEXAS	united states	corporation

**6.Signature**

I certify, in accordance with 37 CFR 1.4(d)(4) that I am an attorney or agent registered to practice before the Patent and Trademark Office who has filed and has been granted power of attorney in this application. I also certify that this Fee(s) Transmittal form is being transmitted to the USPTO via EFS-WEB on the date indicated below.

<b>Signature</b>	/Justin R. Nifong/	<b>Date</b>	06-14-2018
<b>Name</b>	Justin Robert Nifong	<b>Registration Number</b>	59389

## Electronic Patent Application Fee Transmittal

<b>Application Number:</b>	14609189			
<b>Filing Date:</b>	29-Jan-2015			
<b>Title of Invention:</b>	Messaging centre for forwarding e-mail			
<b>First Named Inventor/Applicant Name:</b>	Ari Backholm			
<b>Filer:</b>	Justin Robert Nifong/Sandra Hess			
<b>Attorney Docket Number:</b>	455/006/8 UTIL			
Filed as Large Entity				
<b>Filing Fees for Utility under 35 USC 111(a)</b>				
<b>Description</b>	<b>Fee Code</b>	<b>Quantity</b>	<b>Amount</b>	<b>Sub-Total in USD(\$)</b>
<b>Basic Filing:</b>				
UTILITY APPL ISSUE FEE	1501	1	1000	1000
PUBL. FEE- EARLY, VOLUNTARY, OR NORMAL	1504	1	0	0
<b>Pages:</b>				
<b>Claims:</b>				
<b>Miscellaneous-Filing:</b>				
<b>Petition:</b>				
<b>Patent-Appeals-and-Interference:</b>				



Description	Fee Code	Quantity	Amount	Sub-Total in USD(\$)
<b>Post-Allowance-and-Post-Issuance:</b>				
<b>Extension-of-Time:</b>				
<b>Miscellaneous:</b>				
<b>Total in USD (\$)</b>				<b>1000</b>

## Electronic Acknowledgement Receipt

<b>EFS ID:</b>	32901353
<b>Application Number:</b>	14609189
<b>International Application Number:</b>	
<b>Confirmation Number:</b>	5037
<b>Title of Invention:</b>	Messaging centre for forwarding e-mail
<b>First Named Inventor/Applicant Name:</b>	Ari Backholm
<b>Customer Number:</b>	118194
<b>Filer:</b>	Justin Robert Nifong/Sandra Hess
<b>Filer Authorized By:</b>	Justin Robert Nifong
<b>Attorney Docket Number:</b>	455/006/8 UTIL
<b>Receipt Date:</b>	14-JUN-2018
<b>Filing Date:</b>	29-JAN-2015
<b>Time Stamp:</b>	15:55:17
<b>Application Type:</b>	Utility under 35 USC 111(a)

### Payment information:

Submitted with Payment	yes
Payment Type	CARD
Payment was successfully received in RAM	\$1000
RAM confirmation Number	061518INTEFSW15551500
Deposit Account	506191
Authorized User	Justin Nifong
<p>The Director of the USPTO is hereby authorized to charge indicated fees and credit any overpayment as follows:</p> <ul style="list-style-type: none"> <li>37 CFR 1.20 (Post Issuance fees)</li> <li>37 CFR 1.21 (Miscellaneous fees and charges)</li> </ul>	

--	--	--	--	--	--

**File Listing:**

Document Number	Document Description	File Name	File Size(Bytes)/ Message Digest	Multi Part /.zip	Pages (if appl.)
1	Issue Fee Payment (PTO-85B)	Web85b.pdf	46844	no	2
			f33bcc6bd0f7a08e3ec9393012c172dc663a4e63		

**Warnings:**

**Information:**

2	Fee Worksheet (SB06)	fee-info.pdf	31957	no	2
			a4a3b632c0c0121e73b2c3a4bae5d566d27564fa		

**Warnings:**

**Information:**

<b>Total Files Size (in bytes):</b>	78801
-------------------------------------	-------

**This Acknowledgement Receipt evidences receipt on the noted date by the USPTO of the indicated documents, characterized by the applicant, and including page counts, where applicable. It serves as evidence of receipt similar to a Post Card, as described in MPEP 503.**

**New Applications Under 35 U.S.C. 111**

**If a new application is being filed and the application includes the necessary components for a filing date (see 37 CFR 1.53(b)-(d) and MPEP 506), a Filing Receipt (37 CFR 1.54) will be issued in due course and the date shown on this Acknowledgement Receipt will establish the filing date of the application.**

**National Stage of an International Application under 35 U.S.C. 371**

**If a timely submission to enter the national stage of an international application is compliant with the conditions of 35 U.S.C. 371 and other applicable requirements a Form PCT/DO/EO/903 indicating acceptance of the application as a national stage submission under 35 U.S.C. 371 will be issued in addition to the Filing Receipt, in due course.**

**New International Application Filed with the USPTO as a Receiving Office**

**If a new international application is being filed and the international application includes the necessary components for an international filing date (see PCT Article 11 and MPEP 1810), a Notification of the International Application Number and of the International Filing Date (Form PCT/RO/105) will be issued in due course, subject to prescriptions concerning national security, and the date shown on this Acknowledgement Receipt will establish the international filing date of the application.**



UNITED STATES PATENT AND TRADEMARK OFFICE

UNITED STATES DEPARTMENT OF COMMERCE
United States Patent and Trademark Office
Address: COMMISSIONER FOR PATENTS
P.O. Box 1450
Alexandria, Virginia 22313-1450
www.uspto.gov

Table with 7 columns: APPLICATION NUMBER, FILING or 371(c) DATE, GRP ART UNIT, FIL FEE REC'D, ATTY.DOCKET.NO, TOT CLAIMS, IND CLAIMS. Row 1: 14/609,189, 01/29/2015, 2451, 3250, 455/006/8 UTIL, 1, 1

CONFIRMATION NO. 5037
CORRECTED FILING RECEIPT

118194
NK Patent Law- Seven Networks
4917 Waters Edge Drive
Suite 275
Raleigh, NC 27606



Date Mailed: 03/20/2018

Receipt is acknowledged of this non-provisional patent application. The application will be taken up for examination in due course. Applicant will be notified as to the results of the examination. Any correspondence concerning the application must include the following identification information: the U.S. APPLICATION NUMBER, FILING DATE, NAME OF APPLICANT, and TITLE OF INVENTION. Fees transmitted by check or draft are subject to collection. Please verify the accuracy of the data presented on this receipt. If an error is noted on this Filing Receipt, please submit a written request for a Filing Receipt Correction. Please provide a copy of this Filing Receipt with the changes noted thereon. If you received a "Notice to File Missing Parts" for this application, please submit any corrections to this Filing Receipt with your reply to the Notice. When the USPTO processes the reply to the Notice, the USPTO will generate another Filing Receipt incorporating the requested corrections

Inventor(s)

Ari Backholm, San Carlos, CA;
Seppo Salorinne, Helsinki, FINLAND;
Antti Saarilahti, Helsinki, FINLAND;
Marko Ketonen, Helsinki, FINLAND;
Lauri Vuornos, Helsinki, FINLAND;
Petri Salmi, Espoo, FINLAND;

Applicant(s)

Seven Networks, LLC, Marshall, TX;

Power of Attorney: The patent practitioners associated with Customer Number 118194

Domestic Priority data as claimed by applicant

This application is a CON of 12/228,325 08/11/2008 ABN
which is a DIV of 11/282,950 11/21/2005 PAT 7643818
and claims benefit of 60/650,975 02/09/2005

Foreign Applications (You may be eligible to benefit from the Patent Prosecution Highway program at the USPTO. Please see http://www.uspto.gov for more information.)
FINLAND 20045451 11/22/2004 No Access Code Provided

Permission to Access Application via Priority Document Exchange: Yes

Permission to Access Search Results: No

Applicant may provide or rescind an authorization for access using Form PTO/SB/39 or Form PTO/SB/69 as appropriate.

**If Required, Foreign Filing License Granted:** 02/12/2015

The country code and number of your priority application, to be used for filing abroad under the Paris Convention, is **US 14/609,189**

**Projected Publication Date:** Not Applicable

**Non-Publication Request:** No

**Early Publication Request:** No

**\*\* SMALL ENTITY \*\***

**Title**

Messaging centre for forwarding e-mail

**Preliminary Class**

709

**Statement under 37 CFR 1.55 or 1.78 for AIA (First Inventor to File) Transition Applications:** No

## **PROTECTING YOUR INVENTION OUTSIDE THE UNITED STATES**

Since the rights granted by a U.S. patent extend only throughout the territory of the United States and have no effect in a foreign country, an inventor who wishes patent protection in another country must apply for a patent in a specific country or in regional patent offices. Applicants may wish to consider the filing of an international application under the Patent Cooperation Treaty (PCT). An international (PCT) application generally has the same effect as a regular national patent application in each PCT-member country. The PCT process **simplifies** the filing of patent applications on the same invention in member countries, but **does not result** in a grant of "an international patent" and does not eliminate the need of applicants to file additional documents and fees in countries where patent protection is desired.

Almost every country has its own patent law, and a person desiring a patent in a particular country must make an application for patent in that country in accordance with its particular laws. Since the laws of many countries differ in various respects from the patent law of the United States, applicants are advised to seek guidance from specific foreign countries to ensure that patent rights are not lost prematurely.

Applicants also are advised that in the case of inventions made in the United States, the Director of the USPTO must issue a license before applicants can apply for a patent in a foreign country. The filing of a U.S. patent application serves as a request for a foreign filing license. The application's filing receipt contains further information and guidance as to the status of applicant's license for foreign filing.

Applicants may wish to consult the USPTO booklet, "General Information Concerning Patents" (specifically, the section entitled "Treaties and Foreign Patents") for more information on timeframes and deadlines for filing foreign patent applications. The guide is available either by contacting the USPTO Contact Center at 800-786-9199, or it can be viewed on the USPTO website at <http://www.uspto.gov/web/offices/pac/doc/general/index.html>.

For information on preventing theft of your intellectual property (patents, trademarks and copyrights), you may wish to consult the U.S. Government website, <http://www.stopfakes.gov>. Part of a Department of Commerce initiative, this website includes self-help "toolkits" giving innovators guidance on how to protect intellectual property in specific

page 2 of 4

countries such as China, Korea and Mexico. For questions regarding patent enforcement issues, applicants may call the U.S. Government hotline at 1-866-999-HALT (1-866-999-4258).

**LICENSE FOR FOREIGN FILING UNDER**  
**Title 35, United States Code, Section 184**  
**Title 37, Code of Federal Regulations, 5.11 & 5.15**

**GRANTED**

The applicant has been granted a license under 35 U.S.C. 184, if the phrase "IF REQUIRED, FOREIGN FILING LICENSE GRANTED" followed by a date appears on this form. Such licenses are issued in all applications where the conditions for issuance of a license have been met, regardless of whether or not a license may be required as set forth in 37 CFR 5.15. The scope and limitations of this license are set forth in 37 CFR 5.15(a) unless an earlier license has been issued under 37 CFR 5.15(b). The license is subject to revocation upon written notification. The date indicated is the effective date of the license, unless an earlier license of similar scope has been granted under 37 CFR 5.13 or 5.14.

This license is to be retained by the licensee and may be used at any time on or after the effective date thereof unless it is revoked. This license is automatically transferred to any related applications(s) filed under 37 CFR 1.53(d). This license is not retroactive.

The grant of a license does not in any way lessen the responsibility of a licensee for the security of the subject matter as imposed by any Government contract or the provisions of existing laws relating to espionage and the national security or the export of technical data. Licensees should apprise themselves of current regulations especially with respect to certain countries, of other agencies, particularly the Office of Defense Trade Controls, Department of State (with respect to Arms, Munitions and Implements of War (22 CFR 121-128)); the Bureau of Industry and Security, Department of Commerce (15 CFR parts 730-774); the Office of Foreign Assets Control, Department of Treasury (31 CFR Parts 500+) and the Department of Energy.

**NOT GRANTED**

No license under 35 U.S.C. 184 has been granted at this time, if the phrase "IF REQUIRED, FOREIGN FILING LICENSE GRANTED" DOES NOT appear on this form. Applicant may still petition for a license under 37 CFR 5.12, if a license is desired before the expiration of 6 months from the filing date of the application. If 6 months has lapsed from the filing date of this application and the licensee has not received any indication of a secrecy order under 35 U.S.C. 181, the licensee may foreign file the application pursuant to 37 CFR 5.15(b).

---

***SelectUSA***

The United States represents the largest, most dynamic marketplace in the world and is an unparalleled location for business investment, innovation, and commercialization of new technologies. The U.S. offers tremendous resources and advantages for those who invest and manufacture goods here. Through SelectUSA, our nation works to promote and facilitate business investment. SelectUSA provides information assistance to the international investor community; serves as an ombudsman for existing and potential investors; advocates on behalf of U.S. cities, states, and regions competing for global investment; and counsels U.S. economic development organizations on investment attraction best practices. To learn more about why the United States is the best country in the world to develop

technology, manufacture products, deliver services, and grow your business, visit <http://www.SelectUSA.gov> or call +1-202-482-6800.



UNITED STATES PATENT AND TRADEMARK OFFICE

UNITED STATES DEPARTMENT OF COMMERCE
United States Patent and Trademark Office
Address: COMMISSIONER FOR PATENTS
P.O. Box 1450
Alexandria, Virginia 22313-1450
www.uspto.gov

NOTICE OF ALLOWANCE AND FEE(S) DUE

118194 7590 03/16/2018
NK Patent Law- Seven Networks
4917 Waters Edge Drive
Suite 275
Raleigh, NC 27606

EXAMINER

CHOU, ALAN S

ART UNIT PAPER NUMBER

2451

DATE MAILED: 03/16/2018

Table with 5 columns: APPLICATION NO., FILING DATE, FIRST NAMED INVENTOR, ATTORNEY DOCKET NO., CONFIRMATION NO.

14/609,189 01/29/2015 Ari Backholm 455/006/8 UTIL 5037

TITLE OF INVENTION: Messaging centre for forwarding e-mail

Table with 7 columns: APPLN. TYPE, ENTITY STATUS, ISSUE FEE DUE, PUBLICATION FEE DUE, PREV. PAID ISSUE FEE, TOTAL FEE(S) DUE, DATE DUE

nonprovisional SMALL \$500 \$0 \$0 \$500 06/18/2018

THE APPLICATION IDENTIFIED ABOVE HAS BEEN EXAMINED AND IS ALLOWED FOR ISSUANCE AS A PATENT. PROSECUTION ON THE MERITS IS CLOSED. THIS NOTICE OF ALLOWANCE IS NOT A GRANT OF PATENT RIGHTS. THIS APPLICATION IS SUBJECT TO WITHDRAWAL FROM ISSUE AT THE INITIATIVE OF THE OFFICE OR UPON PETITION BY THE APPLICANT. SEE 37 CFR 1.313 AND MPEP 1308.

THE ISSUE FEE AND PUBLICATION FEE (IF REQUIRED) MUST BE PAID WITHIN THREE MONTHS FROM THE MAILING DATE OF THIS NOTICE OR THIS APPLICATION SHALL BE REGARDED AS ABANDONED. THIS STATUTORY PERIOD CANNOT BE EXTENDED. SEE 35 U.S.C. 151. THE ISSUE FEE DUE INDICATED ABOVE DOES NOT REFLECT A CREDIT FOR ANY PREVIOUSLY PAID ISSUE FEE IN THIS APPLICATION. IF AN ISSUE FEE HAS PREVIOUSLY BEEN PAID IN THIS APPLICATION (AS SHOWN ABOVE), THE RETURN OF PART B OF THIS FORM WILL BE CONSIDERED A REQUEST TO REAPPLY THE PREVIOUSLY PAID ISSUE FEE TOWARD THE ISSUE FEE NOW DUE.

HOW TO REPLY TO THIS NOTICE:

I. Review the ENTITY STATUS shown above. If the ENTITY STATUS is shown as SMALL or MICRO, verify whether entitlement to that entity status still applies.

If the ENTITY STATUS is the same as shown above, pay the TOTAL FEE(S) DUE shown above.

If the ENTITY STATUS is changed from that shown above, on PART B - FEE(S) TRANSMITTAL, complete section number 5 titled "Change in Entity Status (from status indicated above)".

For purposes of this notice, small entity fees are 1/2 the amount of undiscounted fees, and micro entity fees are 1/2 the amount of small entity fees.

II. PART B - FEE(S) TRANSMITTAL, or its equivalent, must be completed and returned to the United States Patent and Trademark Office (USPTO) with your ISSUE FEE and PUBLICATION FEE (if required). If you are charging the fee(s) to your deposit account, section "4b" of Part B - Fee(s) Transmittal should be completed and an extra copy of the form should be submitted. If an equivalent of Part B is filed, a request to reapply a previously paid issue fee must be clearly made, and delays in processing may occur due to the difficulty in recognizing the paper as an equivalent of Part B.

III. All communications regarding this application must give the application number. Please direct all communications prior to issuance to Mail Stop ISSUE FEE unless advised to the contrary.

IMPORTANT REMINDER: Maintenance fees are due in utility patents issuing on applications filed on or after Dec. 12, 1980. It is patentee's responsibility to ensure timely payment of maintenance fees when due. More information is available at www.uspto.gov/PatentMaintenanceFees.



**PART B - FEE(S) TRANSMITTAL**

**Complete and send this form, together with applicable fee(s), to: Mail Mail Stop ISSUE FEE  
 Commissioner for Patents  
 P.O. Box 1450  
 Alexandria, Virginia 22313-1450  
 or Fax (571)-273-2885**

**INSTRUCTIONS:** This form should be used for transmitting the ISSUE FEE and PUBLICATION FEE (if required). Blocks 1 through 5 should be completed where appropriate. All further correspondence including the Patent, advance orders and notification of maintenance fees will be mailed to the current correspondence address as indicated unless corrected below or directed otherwise in Block 1, by (a) specifying a new correspondence address; and/or (b) indicating a separate "FEE ADDRESS" for maintenance fee notifications.

CURRENT CORRESPONDENCE ADDRESS (Note: Use Block 1 for any change of address)

118194                      7590                      03/16/2018  
 NK Patent Law- Seven Networks  
 4917 Waters Edge Drive  
 Suite 275  
 Raleigh, NC 27606

Note: A certificate of mailing can only be used for domestic mailings of the Fee(s) Transmittal. This certificate cannot be used for any other accompanying papers. Each additional paper, such as an assignment or formal drawing, must have its own certificate of mailing or transmission.

**Certificate of Mailing or Transmission**

I hereby certify that this Fee(s) Transmittal is being deposited with the United States Postal Service with sufficient postage for first class mail in an envelope addressed to the Mail Stop ISSUE FEE address above, or being facsimile transmitted to the USPTO (571) 273-2885, on the date indicated below.

_____ (Depositor's name)
_____ (Signature)
_____ (Date)

APPLICATION NO.	FILING DATE	FIRST NAMED INVENTOR	ATTORNEY DOCKET NO.	CONFIRMATION NO.
14/609,189	01/29/2015	Ari Backholm	455/006/8 UTIL	5037

TITLE OF INVENTION: Messaging centre for forwarding e-mail

APPLN. TYPE	ENTITY STATUS	ISSUE FEE DUE	PUBLICATION FEE DUE	PREV. PAID ISSUE FEE	TOTAL FEE(S) DUE	DATE DUE
nonprovisional	SMALL	\$500	\$0	\$0	\$500	06/18/2018

EXAMINER	ART UNIT	CLASS-SUBCLASS
CHOU, ALAN S	2451	709-206000

<p>1. Change of correspondence address or indication of "Fee Address" (37 CFR 1.363).</p> <p><input type="checkbox"/> Change of correspondence address (or Change of Correspondence Address form PTO/SB/122) attached.</p> <p><input type="checkbox"/> "Fee Address" indication (or "Fee Address" Indication form PTO/SB/47; Rev 03-02 or more recent) attached. <b>Use of a Customer Number is required.</b></p>	<p>2. For printing on the patent front page, list</p> <p>(1) The names of up to 3 registered patent attorneys or agents OR, alternatively, _____ 1</p> <p>(2) The name of a single firm (having as a member a registered attorney or agent) and the names of up to 2 registered patent attorneys or agents. If no name is listed, no name will be printed. _____ 2</p> <p>_____ 3</p>
---	---

3. ASSIGNEE NAME AND RESIDENCE DATA TO BE PRINTED ON THE PATENT (print or type)

PLEASE NOTE: Unless an assignee is identified below, no assignee data will appear on the patent. If an assignee is identified below, the document has been filed for recordation as set forth in 37 CFR 3.11. Completion of this form is NOT a substitute for filing an assignment.

(A) NAME OF ASSIGNEE \_\_\_\_\_

(B) RESIDENCE: (CITY and STATE OR COUNTRY) \_\_\_\_\_

Please check the appropriate assignee category or categories (will not be printed on the patent) :  Individual  Corporation or other private group entity  Government

<p>4a. The following fee(s) are submitted:</p> <p><input type="checkbox"/> Issue Fee</p> <p><input type="checkbox"/> Publication Fee (No small entity discount permitted)</p> <p><input type="checkbox"/> Advance Order - # of Copies _____</p>	<p>4b. Payment of Fee(s): (<b>Please first reapply any previously paid issue fee shown above</b>)</p> <p><input type="checkbox"/> A check is enclosed.</p> <p><input type="checkbox"/> Payment by credit card. Form PTO-2038 is attached.</p> <p><input type="checkbox"/> The director is hereby authorized to charge the required fee(s), any deficiency, or credits any overpayment, to Deposit Account Number _____ (enclose an extra copy of this form).</p>
---	--

5. **Change in Entity Status** (from status indicated above)

Applicant certifying micro entity status. See 37 CFR 1.29

Applicant asserting small entity status. See 37 CFR 1.27

Applicant changing to regular undiscounted fee status.

**NOTE:** Absent a valid certification of Micro Entity Status (see forms PTO/SB/15A and 15B), issue fee payment in the micro entity amount will not be accepted at the risk of application abandonment.

**NOTE:** If the application was previously under micro entity status, checking this box will be taken to be a notification of loss of entitlement to micro entity status.

**NOTE:** Checking this box will be taken to be a notification of loss of entitlement to small or micro entity status, as applicable.

**NOTE:** This form must be signed in accordance with 37 CFR 1.31 and 1.33. See 37 CFR 1.4 for signature requirements and certifications.

Authorized Signature _____	Date _____
Typed or printed name _____	Registration No. _____



UNITED STATES PATENT AND TRADEMARK OFFICE

UNITED STATES DEPARTMENT OF COMMERCE
United States Patent and Trademark Office
Address: COMMISSIONER FOR PATENTS
P.O. Box 1450
Alexandria, Virginia 22313-1450
www.uspto.gov

Table with 5 columns: APPLICATION NO., FILING DATE, FIRST NAMED INVENTOR, ATTORNEY DOCKET NO., CONFIRMATION NO.

118194 7590 03/16/2018
NK Patent Law- Seven Networks
4917 Waters Edge Drive
Suite 275
Raleigh, NC 27606

EXAMINER

CHOU, ALAN S

ART UNIT PAPER NUMBER

2451

DATE MAILED: 03/16/2018

Determination of Patent Term Adjustment under 35 U.S.C. 154 (b)
(Applications filed on or after May 29, 2000)

The Office has discontinued providing a Patent Term Adjustment (PTA) calculation with the Notice of Allowance.

Section 1(h)(2) of the AIA Technical Corrections Act amended 35 U.S.C. 154(b)(3)(B)(i) to eliminate the requirement that the Office provide a patent term adjustment determination with the notice of allowance. See Revisions to Patent Term Adjustment, 78 Fed. Reg. 19416, 19417 (Apr. 1, 2013). Therefore, the Office is no longer providing an initial patent term adjustment determination with the notice of allowance. The Office will continue to provide a patent term adjustment determination with the Issue Notification Letter that is mailed to applicant approximately three weeks prior to the issue date of the patent, and will include the patent term adjustment on the patent. Any request for reconsideration of the patent term adjustment determination (or reinstatement of patent term adjustment) should follow the process outlined in 37 CFR 1.705.

Any questions regarding the Patent Term Extension or Adjustment determination should be directed to the Office of Patent Legal Administration at (571)-272-7702. Questions relating to issue and publication fee payments should be directed to the Customer Service Center of the Office of Patent Publication at 1-(888)-786-0101 or (571)-272-4200.

## OMB Clearance and PRA Burden Statement for PTOL-85 Part B

The Paperwork Reduction Act (PRA) of 1995 requires Federal agencies to obtain Office of Management and Budget approval before requesting most types of information from the public. When OMB approves an agency request to collect information from the public, OMB (i) provides a valid OMB Control Number and expiration date for the agency to display on the instrument that will be used to collect the information and (ii) requires the agency to inform the public about the OMB Control Number's legal significance in accordance with 5 CFR 1320.5(b).

The information collected by PTOL-85 Part B is required by 37 CFR 1.311. The information is required to obtain or retain a benefit by the public which is to file (and by the USPTO to process) an application. Confidentiality is governed by 35 U.S.C. 122 and 37 CFR 1.14. This collection is estimated to take 12 minutes to complete, including gathering, preparing, and submitting the completed application form to the USPTO. Time will vary depending upon the individual case. Any comments on the amount of time you require to complete this form and/or suggestions for reducing this burden, should be sent to the Chief Information Officer, U.S. Patent and Trademark Office, U.S. Department of Commerce, P.O. Box 1450, Alexandria, Virginia 22313-1450. DO NOT SEND FEES OR COMPLETED FORMS TO THIS ADDRESS. SEND TO: Commissioner for Patents, P.O. Box 1450, Alexandria, Virginia 22313-1450. Under the Paperwork Reduction Act of 1995, no persons are required to respond to a collection of information unless it displays a valid OMB control number.

### Privacy Act Statement

**The Privacy Act of 1974 (P.L. 93-579)** requires that you be given certain information in connection with your submission of the attached form related to a patent application or patent. Accordingly, pursuant to the requirements of the Act, please be advised that: (1) the general authority for the collection of this information is 35 U.S.C. 2(b)(2); (2) furnishing of the information solicited is voluntary; and (3) the principal purpose for which the information is used by the U.S. Patent and Trademark Office is to process and/or examine your submission related to a patent application or patent. If you do not furnish the requested information, the U.S. Patent and Trademark Office may not be able to process and/or examine your submission, which may result in termination of proceedings or abandonment of the application or expiration of the patent.

The information provided by you in this form will be subject to the following routine uses:

1. The information on this form will be treated confidentially to the extent allowed under the Freedom of Information Act (5 U.S.C. 552) and the Privacy Act (5 U.S.C. 552a). Records from this system of records may be disclosed to the Department of Justice to determine whether disclosure of these records is required by the Freedom of Information Act.
2. A record from this system of records may be disclosed, as a routine use, in the course of presenting evidence to a court, magistrate, or administrative tribunal, including disclosures to opposing counsel in the course of settlement negotiations.
3. A record in this system of records may be disclosed, as a routine use, to a Member of Congress submitting a request involving an individual, to whom the record pertains, when the individual has requested assistance from the Member with respect to the subject matter of the record.
4. A record in this system of records may be disclosed, as a routine use, to a contractor of the Agency having need for the information in order to perform a contract. Recipients of information shall be required to comply with the requirements of the Privacy Act of 1974, as amended, pursuant to 5 U.S.C. 552a(m).
5. A record related to an International Application filed under the Patent Cooperation Treaty in this system of records may be disclosed, as a routine use, to the International Bureau of the World Intellectual Property Organization, pursuant to the Patent Cooperation Treaty.
6. A record in this system of records may be disclosed, as a routine use, to another federal agency for purposes of National Security review (35 U.S.C. 181) and for review pursuant to the Atomic Energy Act (42 U.S.C. 218(c)).
7. A record from this system of records may be disclosed, as a routine use, to the Administrator, General Services, or his/her designee, during an inspection of records conducted by GSA as part of that agency's responsibility to recommend improvements in records management practices and programs, under authority of 44 U.S.C. 2904 and 2906. Such disclosure shall be made in accordance with the GSA regulations governing inspection of records for this purpose, and any other relevant (i.e., GSA or Commerce) directive. Such disclosure shall not be used to make determinations about individuals.
8. A record from this system of records may be disclosed, as a routine use, to the public after either publication of the application pursuant to 35 U.S.C. 122(b) or issuance of a patent pursuant to 35 U.S.C. 151. Further, a record may be disclosed, subject to the limitations of 37 CFR 1.14, as a routine use, to the public if the record was filed in an application which became abandoned or in which the proceedings were terminated and which application is referenced by either a published application, an application open to public inspection or an issued patent.
9. A record from this system of records may be disclosed, as a routine use, to a Federal, State, or local law enforcement agency, if the USPTO becomes aware of a violation or potential violation of law or regulation.

<b>Notice of Allowability</b>	<b>Application No.</b> 14/609,189	<b>Applicant(s)</b> BACKHOLM ET AL.	
	<b>Examiner</b> ALAN S. CHOU	<b>Art Unit</b> 2451	<b>AIA (First Inventor to File) Status</b> No

**-- The MAILING DATE of this communication appears on the cover sheet with the correspondence address--**

All claims being allowable, PROSECUTION ON THE MERITS IS (OR REMAINS) CLOSED in this application. If not included herewith (or previously mailed), a Notice of Allowance (PTOL-85) or other appropriate communication will be mailed in due course. **THIS NOTICE OF ALLOWABILITY IS NOT A GRANT OF PATENT RIGHTS.** This application is subject to withdrawal from issue at the initiative of the Office or upon petition by the applicant. See 37 CFR 1.313 and MPEP 1308.

1.  This communication is responsive to 2/5/2018.  
 A declaration(s)/affidavit(s) under **37 CFR 1.130(b)** was/were filed on \_\_\_\_\_.
2.  An election was made by the applicant in response to a restriction requirement set forth during the interview on \_\_\_\_\_; the restriction requirement and election have been incorporated into this action.
3.  The allowed claim(s) is/are 1-19, 23-26, 28-39, 41-53, 55-58. As a result of the allowed claim(s), you may be eligible to benefit from the **Patent Prosecution Highway** program at a participating intellectual property office for the corresponding application. For more information, please see [http://www.uspto.gov/patents/init\\_events/pph/index.jsp](http://www.uspto.gov/patents/init_events/pph/index.jsp) or send an inquiry to PPHfeedback@uspto.gov.
4.  Acknowledgment is made of a claim for foreign priority under 35 U.S.C. § 119(a)-(d) or (f).

**Certified copies:**

- a)  All    b)  Some    \*c)  None of the:
1.  Certified copies of the priority documents have been received.
  2.  Certified copies of the priority documents have been received in Application No. \_\_\_\_\_.
  3.  Copies of the certified copies of the priority documents have been received in this national stage application from the International Bureau (PCT Rule 17.2(a)).

\* Certified copies not received: \_\_\_\_\_.

Applicant has THREE MONTHS FROM THE "MAILING DATE" of this communication to file a reply complying with the requirements noted below. Failure to timely comply will result in ABANDONMENT of this application.

**THIS THREE-MONTH PERIOD IS NOT EXTENDABLE.**

5.  CORRECTED DRAWINGS ( as "replacement sheets") must be submitted.  
 including changes required by the attached Examiner's Amendment / Comment or in the Office action of Paper No./Mail Date \_\_\_\_\_.  
**Identifying indicia such as the application number (see 37 CFR 1.84(c)) should be written on the drawings in the front (not the back) of each sheet. Replacement sheet(s) should be labeled as such in the header according to 37 CFR 1.121(d).**
6.  DEPOSIT OF and/or INFORMATION about the deposit of BIOLOGICAL MATERIAL must be submitted. Note the attached Examiner's comment regarding REQUIREMENT FOR THE DEPOSIT OF BIOLOGICAL MATERIAL.

**Attachment(s)**

- |   |   |
|---|---|
| <ol style="list-style-type: none"> <li>1. <input type="checkbox"/> Notice of References Cited (PTO-892)</li> <li>2. <input checked="" type="checkbox"/> Information Disclosure Statements (PTO/SB/08),<br/>Paper No./Mail Date _____</li> <li>3. <input type="checkbox"/> Examiner's Comment Regarding Requirement for Deposit<br/>of Biological Material</li> <li>4. <input type="checkbox"/> Interview Summary (PTO-413),<br/>Paper No./Mail Date _____.</li> </ol> | <ol style="list-style-type: none"> <li>5. <input checked="" type="checkbox"/> Examiner's Amendment/Comment</li> <li>6. <input checked="" type="checkbox"/> Examiner's Statement of Reasons for Allowance</li> <li>7. <input type="checkbox"/> Other _____.</li> </ol> |
|---|---|

/ALAN S CHOU/  
Primary Examiner, Art Unit 2451

The present application is being examined under the pre-AIA first to invent provisions.

**DETAILED ACTION**

Claims 1-19, 23-26, 28-39, 41-53, 55-58 are allowed.

**EXAMINER'S AMENDMENT**

1. An examiner's amendment to the record appears below. Should the changes and/or additions be unacceptable to applicant, an amendment may be filed as provided by 37 CFR 1.312. To ensure consideration of such an amendment, it **MUST** be submitted no later than the payment of the issue fee.

Authorization for this examiner's amendment was given in an interview with Mr. Justin Nifong Reg. #59,389 on February 26, 2018.

The application has been amended as follows:

In the claims:

1. (Currently Amended) A method for forwarding an e-mail message from one of a plurality of e-mail servers to a mobile terminal, the method comprising:

receiving, at an intermediary system, an e-mail message associated with an e-mail address of a user of a mobile terminal and sent by one of a plurality of e-mail servers,

wherein the e-mail address is associated with an identifier of the mobile terminal, wherein an email account, associated with the email address, is hosted by one of the plurality of e-mail servers, and

wherein the identifier is generated by the mobile terminal;

encrypting the e-mail message using encryption information associated with a temporary identifier,

wherein the temporary identifier is based on a connection to the mobile terminal; and transmitting the encrypted e-mail message to the mobile terminal;

receiving, at the intermediary system, an automatic control message from the mobile terminal indicating that the user has read the e-mail message; and

in response to receiving the automatic control message, signaling the one of a plurality of e-mail servers to mark the e-mail message as read.

12. (Currently Amended) A system for forwarding an e-mail message from one of a plurality of e-mail servers to a mobile terminal, the system comprising:

a memory configured for storing at least one of an e-mail address of a user of a mobile terminal, and an identifier;

wherein the e-mail address is associated with the identifier,

wherein an email account, associated with the email address, is hosted by one of the plurality of e-mail servers, and

wherein the mobile terminal generates the identifier, a processor configured for:

encrypting the e-mail message using encryption information associated with a temporary identifier, wherein the e-mail message is received from one of a plurality of e-mail servers;

identifying the mobile terminal based on the identifier of the mobile terminal; and  
transmitting the encrypted e-mail message to the identified mobile terminal, wherein the  
temporary identifier is based on a connection to the mobile terminal;

receiving, at the intermediary system, an automatic control message from the  
mobile terminal indicating that the user has read the e-mail message; and

in response to receiving the automatic control message, signaling the one of a  
plurality of e-mail servers to mark the e-mail message as read,

wherein the system is an intermediary system between the plurality of e-mail  
servers and the mobile terminal.

In the Specification:

On page 9 section [0035]:

[0035] Next in this scenario, the user decides that the e-mail message needs further  
attention when he/she is at the host system 100. The user may initiate another control  
message [3-22] 3-20 and 3-21 that causes the previously read message to be marked  
as unread at the e-mail server in step 3-22.

### **REASON FOR ALLOWANCE**

The following is an examiner's statement of reasons for allowance:

The prior art of record fails to teach neither singly nor in combination, the claimed limitation of the use of : “receiving,at the intermediary system, an automatic control message from the mobile terminal indicating that the user has read the e-mail message; and

in response to receiving the automatic control message, signaling the one of a plurality of e-mail servers to mark the e-mail message as read” as stated in claims 1 and 12.

The prior art of record fails to teach neither singly nor in combination, the claimed limitation of the use of : “optically receive information including a displayed service activation code from a remote device;

register the remote device for access to a messaging account using the service activation code;

receive a message for the messaging account; encrypt the message using an encryption key; and send the message to the remote device, wherein the device is authenticated to access the messaging account” as stated in claims 23, 37, and 55. This limitation, in conjunction with other limitation in the independent claims, is not specifically disclosed or remotely suggested in the prior art or record.



Any inquiry concerning this communication or earlier communications from the examiner should be directed to ALAN S. CHOU whose telephone number is (571)272-5779. The examiner can normally be reached on 9am-5pm.

Examiner interviews are available via telephone, in-person, and video conferencing using a USPTO supplied web-based collaboration tool. To schedule an interview, applicant is encouraged to use the USPTO Automated Interview Request (AIR) at <http://www.uspto.gov/interviewpractice>.

If attempts to reach the examiner by telephone are unsuccessful, the examiner's supervisor, Christopher L. Parry can be reached on (571)272-8328. The fax phone number for the organization where this application or proceeding is assigned is 571-273-8300.

Information regarding the status of an application may be obtained from the Patent Application Information Retrieval (PAIR) system. Status information for published applications may be obtained from either Private PAIR or Public PAIR. Status information for unpublished applications is available through Private PAIR only. For more information about the PAIR system, see <http://pair-direct.uspto.gov>. Should you have questions on access to the Private PAIR system, contact the Electronic Business Center (EBC) at 866-217-9197 (toll-free). If you would like assistance from a USPTO Customer Service Representative or access to the automated information system, call 800-786-9199 (IN USA OR CANADA) or 571-272-1000.

ALAN S CHOU  
Primary Examiner  
Art Unit 2451

Application/Control Number: 14/609,189  
Art Unit: 2451

Page 7

/ALAN S CHOU/  
Primary Examiner, Art Unit 2451



UNITED STATES PATENT AND TRADEMARK OFFICE

UNITED STATES DEPARTMENT OF COMMERCE  
 United States Patent and Trademark Office  
 Address: COMMISSIONER FOR PATENTS  
 P.O. Box 1450  
 Alexandria, Virginia 22313-1450  
 www.uspto.gov

BIB DATA SHEET

CONFIRMATION NO. 5037

SERIAL NUMBER	FILING or 371(c) DATE	CLASS	GROUP ART UNIT	ATTORNEY DOCKET NO.		
14/609,189	01/29/2015	709	2451	455/006/8 UTIL		
<b>APPLICANTS</b> Seven Networks, LLC, San Carlos, CA; <b>INVENTORS</b> Ari Backholm, San Carlos, CA; Seppo Salorinne, Helsinki, FINLAND; Antti Saarilahti, Helsinki, FINLAND; Marko Ketonen, Helsinki, FINLAND; Lauri Vuornos, Helsinki, FINLAND; Petri Salmi, Espoo, FINLAND; <b>** CONTINUING DATA *****</b> This application is a CON of 12/228,325 08/11/2008 ABN which is a DIV of 11/282,950 11/21/2005 PAT 7643818 and claims benefit of 60/650,975 02/09/2005 <b>** FOREIGN APPLICATIONS *****</b> FINLAND 20045451 11/22/2004 <b>** IF REQUIRED, FOREIGN FILING LICENSE GRANTED *** SMALL ENTITY **</b> 02/12/2015						
Foreign Priority claimed <input checked="" type="checkbox"/> Yes <input type="checkbox"/> No 35 USC 119(a-d) conditions met <input checked="" type="checkbox"/> Yes <input type="checkbox"/> No Verified and Acknowledged /ALAN S CHOU/ Examiner's Signature		<input checked="" type="checkbox"/> Met after Allowance AC Initials	<b>STATE OR COUNTRY</b> CA	<b>SHEETS DRAWINGS</b> 4	<b>TOTAL CLAIMS</b> 1	<b>INDEPENDENT CLAIMS</b> 1
<b>ADDRESS</b> NK Patent Law- Seven Networks 4917 Waters Edge Drive Suite 275 Raleigh, NC 27606 UNITED STATES						
<b>TITLE</b> Messaging centre for forwarding e-mail						
<b>FILING FEE RECEIVED</b> 3250	FEES: Authority has been given in Paper No. _____ to charge/credit DEPOSIT ACCOUNT No. _____ for following:			<input type="checkbox"/> All Fees <input type="checkbox"/> 1.16 Fees (Filing) <input type="checkbox"/> 1.17 Fees (Processing Ext. of time) <input type="checkbox"/> 1.18 Fees (Issue) <input type="checkbox"/> Other _____ <input type="checkbox"/> Credit		

Doc code: IDS

Doc description: Information Disclosure Statement (IDS) Filed

PTO/SB/08a (01-10)

Approved for use through 07/31/2012. OMB 0651-0031  
U.S. Patent and Trademark Office; U.S. DEPARTMENT OF COMMERCE

Under the Paperwork Reduction Act of 1995, no persons are required to respond to a collection of information unless it contains a valid OMB control number.

<b>INFORMATION DISCLOSURE STATEMENT BY APPLICANT</b> ( Not for submission under 37 CFR 1.99)	Application Number	14609189
	Filing Date	2015-01-29
	First Named Inventor	Ari Backholm
	Art Unit	2451
	Examiner Name	Alan S. Chou
	Attorney Docket Number	455/006/8 UTIL

U.S.PATENTS						Remove
Examiner Initial*	Cite No	Patent Number	Kind Code <sup>1</sup>	Issue Date	Name of Patentee or Applicant of cited Document	Pages,Columns,Lines where Relevant Passages or Relevant Figures Appear
	1	6078908	A	2000-06-20	Schmitz	
	2	6993658	B1	2006-01-31	Engberg, et al.	

If you wish to add additional U.S. Patent citation information please click the Add button.

Add

U.S.PATENT APPLICATION PUBLICATIONS						Remove
Examiner Initial*	Cite No	Publication Number	Kind Code <sup>1</sup>	Publication Date	Name of Patentee or Applicant of cited Document	Pages,Columns,Lines where Relevant Passages or Relevant Figures Appear
	1					

If you wish to add additional U.S. Published Application citation information please click the Add button.

Add

FOREIGN PATENT DOCUMENTS							Remove	
Examiner Initial*	Cite No	Foreign Document Number <sup>3</sup>	Country Code <sup>2i</sup>	Kind Code <sup>4</sup>	Publication Date	Name of Patentee or Applicant of cited Document	Pages,Columns,Lines where Relevant Passages or Relevant Figures Appear	T <sup>5</sup>
	1							

If you wish to add additional Foreign Patent Document citation information please click the Add button.

Add

NON-PATENT LITERATURE DOCUMENTS						Remove
---------------------------------	--	--	--	--	--	--------

<b>INFORMATION DISCLOSURE STATEMENT BY APPLICANT ( Not for submission under 37 CFR 1.99)</b>	Application Number		14609189
	Filing Date		2015-01-29
	First Named Inventor	Ari Backholm	
	Art Unit	2451	
	Examiner Name	Alan S. Chou	
	Attorney Docket Number	455/006/8 UTIL	

Examiner Initials*	Cite No	Include name of the author (in CAPITAL LETTERS), title of the article (when appropriate), title of the item (book, magazine, journal, serial, symposium, catalog, etc), date, pages(s), volume-issue number(s), publisher, city and/or country where published.	T5
	1	FAJMAN, R., RFC 2298 - An Extensible Message Format for Message Disposition Notifications, National Institutes of Health, March 1998, Pgs. 1-29, Network Working Group, 2998, Standard Track	
	2	CRISPIN, M., RFC 3501 - Internet Message Access Protocol - Version 4rev1, University of Washington, March 2003, Pgs. 1-109, Network Working Group, 3501, Obsoletes: 2060, Standard Track	
	3	HANSEN, Ed., T., et al., RFC 3798 - Message Disposition Notification, AT&T Laboratories, Lucent Technologies, May 2004, Pgs. 1-31, Network Working Group, 3798, Obsoletes: 2298, Standard Track	

If you wish to add additional non-patent literature document citation information please click the Add button

**EXAMINER SIGNATURE**

Examiner Signature	/ALAN S CHOU/	Date Considered	03/12/2018
--------------------	---------------	-----------------	------------

\*EXAMINER: Initial if reference considered, whether or not citation is in conformance with MPEP 609. Draw line through a citation if not in conformance and not considered. Include copy of this form with next communication to applicant.

<sup>1</sup> See Kind Codes of USPTO Patent Documents at [www.USPTO.GOV](http://www.USPTO.GOV) or MPEP 901.04. <sup>2</sup> Enter office that issued the document, by the two-letter code (WIPO Standard ST.3). <sup>3</sup> For Japanese patent documents, the indication of the year of the reign of the Emperor must precede the serial number of the patent document. <sup>4</sup> Kind of document by the appropriate symbols as indicated on the document under WIPO Standard ST.16 if possible. <sup>5</sup> Applicant is to place a check mark here if English language translation is attached.

<b>INFORMATION DISCLOSURE STATEMENT BY APPLICANT ( Not for submission under 37 CFR 1.99)</b>	Application Number		14609189
	Filing Date		2015-01-29
	First Named Inventor	Ari Backholm	
	Art Unit	2451	
	Examiner Name	Alan S. Chou	
	Attorney Docket Number	455/006/8 UTIL	

**CERTIFICATION STATEMENT**

Please see 37 CFR 1.97 and 1.98 to make the appropriate selection(s):

That each item of information contained in the information disclosure statement was first cited in any communication from a foreign patent office in a counterpart foreign application not more than three months prior to the filing of the information disclosure statement. See 37 CFR 1.97(e)(1).

**OR**

That no item of information contained in the information disclosure statement was cited in a communication from a foreign patent office in a counterpart foreign application, and, to the knowledge of the person signing the certification after making reasonable inquiry, no item of information contained in the information disclosure statement was known to any individual designated in 37 CFR 1.56(c) more than three months prior to the filing of the information disclosure statement. See 37 CFR 1.97(e)(2).

See attached certification statement.

- The fee set forth in 37 CFR 1.17 (p) has been submitted herewith.
- A certification statement is not submitted herewith.

**SIGNATURE**

A signature of the applicant or representative is required in accordance with CFR 1.33, 10.18. Please see CFR 1.4(d) for the form of the signature.

Signature	/Justin R. Nifong/	Date (YYYY-MM-DD)	2018-02-05
Name/Print	Justin R. Nifong	Registration Number	59389

This collection of information is required by 37 CFR 1.97 and 1.98. The information is required to obtain or retain a benefit by the public which is to file (and by the USPTO to process) an application. Confidentiality is governed by 35 U.S.C. 122 and 37 CFR 1.14. This collection is estimated to take 1 hour to complete, including gathering, preparing and submitting the completed application form to the USPTO. Time will vary depending upon the individual case. Any comments on the amount of time you require to complete this form and/or suggestions for reducing this burden, should be sent to the Chief Information Officer, U.S. Patent and Trademark Office, U.S. Department of Commerce, P.O. Box 1450, Alexandria, VA 22313-1450. **DO NOT SEND FEES OR COMPLETED FORMS TO THIS ADDRESS. SEND TO: Commissioner for Patents, P.O. Box 1450, Alexandria, VA 22313-1450.**

## Privacy Act Statement

The Privacy Act of 1974 (P.L. 93-579) requires that you be given certain information in connection with your submission of the attached form related to a patent application or patent. Accordingly, pursuant to the requirements of the Act, please be advised that: (1) the general authority for the collection of this information is 35 U.S.C. 2(b)(2); (2) furnishing of the information solicited is voluntary; and (3) the principal purpose for which the information is used by the U.S. Patent and Trademark Office is to process and/or examine your submission related to a patent application or patent. If you do not furnish the requested information, the U.S. Patent and Trademark Office may not be able to process and/or examine your submission, which may result in termination of proceedings or abandonment of the application or expiration of the patent.

The information provided by you in this form will be subject to the following routine uses:

1. The information on this form will be treated confidentially to the extent allowed under the Freedom of Information Act (5 U.S.C. 552) and the Privacy Act (5 U.S.C. 552a). Records from this system of records may be disclosed to the Department of Justice to determine whether the Freedom of Information Act requires disclosure of these records.
2. A record from this system of records may be disclosed, as a routine use, in the course of presenting evidence to a court, magistrate, or administrative tribunal, including disclosures to opposing counsel in the course of settlement negotiations.
3. A record in this system of records may be disclosed, as a routine use, to a Member of Congress submitting a request involving an individual, to whom the record pertains, when the individual has requested assistance from the Member with respect to the subject matter of the record.
4. A record in this system of records may be disclosed, as a routine use, to a contractor of the Agency having need for the information in order to perform a contract. Recipients of information shall be required to comply with the requirements of the Privacy Act of 1974, as amended, pursuant to 5 U.S.C. 552a(m).
5. A record related to an International Application filed under the Patent Cooperation Treaty in this system of records may be disclosed, as a routine use, to the International Bureau of the World Intellectual Property Organization, pursuant to the Patent Cooperation Treaty.
6. A record in this system of records may be disclosed, as a routine use, to another federal agency for purposes of National Security review (35 U.S.C. 181) and for review pursuant to the Atomic Energy Act (42 U.S.C. 218(c)).
7. A record from this system of records may be disclosed, as a routine use, to the Administrator, General Services, or his/her designee, during an inspection of records conducted by GSA as part of that agency's responsibility to recommend improvements in records management practices and programs, under authority of 44 U.S.C. 2904 and 2906. Such disclosure shall be made in accordance with the GSA regulations governing inspection of records for this purpose, and any other relevant (i.e., GSA or Commerce) directive. Such disclosure shall not be used to make determinations about individuals.
8. A record from this system of records may be disclosed, as a routine use, to the public after either publication of the application pursuant to 35 U.S.C. 122(b) or issuance of a patent pursuant to 35 U.S.C. 151. Further, a record may be disclosed, subject to the limitations of 37 CFR 1.14, as a routine use, to the public if the record was filed in an application which became abandoned or in which the proceedings were terminated and which application is referenced by either a published application, an application open to public inspections or an issued patent.
9. A record from this system of records may be disclosed, as a routine use, to a Federal, State, or local law enforcement agency, if the USPTO becomes aware of a violation or potential violation of law or regulation.

<b>Issue Classification</b> 	<b>Application/Control No.</b> 14609189	<b>Applicant(s)/Patent Under Reexamination</b> BACKHOLM ET AL.
	<b>Examiner</b> ALAN S CHOU	<b>Art Unit</b> 2451

CPC					
Symbol				Type	Version
H04L	51	38		F	2013-01-01
H04L	63	0428		I	2013-01-01
H04L	63	08		I	2013-01-01
H04L	63	18		I	2013-01-01
H04W	4	12		A	2013-01-01
H04W	8	26		A	2013-01-01
H04W	12	02		I	2013-01-01
H04W	12	06		I	2013-01-01

CPC Combination Sets				
Symbol	Type	Set	Ranking	Version

NONE		<b>Total Claims Allowed:</b>	
(Assistant Examiner)	(Date)	52	
/ALAN S CHOU/ Primary Examiner. Art Unit 2451	3/12/2018	O.G. Print Claim(s)	O.G. Print Figure
(Primary Examiner)	(Date)	1	1





<b>Issue Classification</b> 	<b>Application/Control No.</b> 14609189	<b>Applicant(s)/Patent Under Reexamination</b> BACKHOLM ET AL.
	<b>Examiner</b> ALAN S CHOU	<b>Art Unit</b> 2451

<input type="checkbox"/> <b>Claims renumbered in the same order as presented by applicant</b>																<input type="checkbox"/> <b>CPA</b>		<input type="checkbox"/> <b>T.D.</b>		<input type="checkbox"/> <b>R.1.47</b>	
Final	Original	Final	Original	Final	Original	Final	Original	Final	Original	Final	Original	Final	Original	Final	Original						
1	1	18	17	31	33	35	49														
2	2	19	18	32	34	48	50														
4	3	20	19	33	35	49	51														
5	4		20	34	36	12	52														
6	5		21	37	37	21	53														
3	6		22	38	38		54														
8	7	22	23	39	39	51	55														
9	8	23	24		40	36	56														
10	9	24	25	40	41	50	57														
11	10	25	26	41	42	52	58														
7	11		27	42	43																
13	12	26	28	43	44																
14	13	27	29	44	45																
15	14	28	30	45	46																
16	15	29	31	46	47																
17	16	30	32	47	48																

NONE		<b>Total Claims Allowed:</b>	
		52	
(Assistant Examiner)	(Date)		
/ALAN S CHOU/ Primary Examiner. Art Unit 2451	3/12/2018	O.G. Print Claim(s)	O.G. Print Figure
(Primary Examiner)	(Date)	1	1

<b>Search Notes</b>  	<b>Application/Control No.</b>  14609189	<b>Applicant(s)/Patent Under Reexamination</b>  BACKHOLM ET AL.
	<b>Examiner</b>  ALAN S CHOU	<b>Art Unit</b>  2451

<b>CPC- SEARCHED</b>		
Symbol	Date	Examiner
G06Q 10/107	9/24/2015	AC
H04L 12/585, 12/58	9/24/2015	AC

<b>CPC COMBINATION SETS - SEARCHED</b>		
Symbol	Date	Examiner

<b>US CLASSIFICATION SEARCHED</b>			
Class	Subclass	Date	Examiner
709	206	9/24/2015	AC

\* See search history printout included with this form or the SEARCH NOTES box below to determine the scope of the search.

<b>SEARCH NOTES</b>		
Search Notes	Date	Examiner
EAST Search	9/24/2015	AC
Consulted with SPE Chris Parry regarding 101 issues for claims 1-20	9/24/2015	AC
Consulted with Primary Saket Daftuar regarding ODP issues for claims 1-20	9/25/2015	AC
Consulted with Primary Saket Daftuar regarding 112 6th issue with claim 12-19	9/25/2015	AC
EAST Search	7/5/2016	AC
Consulted with SPE Chris Parry regarding 101 amendments temporary identifier to making the language significantly more	7/20/2016	AC
EAST Search	11/1/2016	AC
EAST Search	5/25/2017	AC
EAST Search	10/27/2017	AC
Pre-Appeal Conference with SPE Chris Parry and Primary John Walsh	2/26/2018	AC

--	--

**INTERFERENCE SEARCH**

<b>US Class/ CPC Symbol</b>	<b>US Subclass / CPC Group</b>	<b>Date</b>	<b>Examiner</b>
709	206	3/12/2018	AC
H04L	12/585, 12/58	3/12/2018	AC
G06Q	10/107	3/12/2018	AC

--	--

<b>Index of Claims</b> 	<b>Application/Control No.</b> 14609189	<b>Applicant(s)/Patent Under Reexamination</b> BACKHOLM ET AL.
	<b>Examiner</b> ALAN S CHOU	<b>Art Unit</b> 2451

✓	<b>Rejected</b>	-	<b>Cancelled</b>	N	<b>Non-Elected</b>	A	<b>Appeal</b>
=	<b>Allowed</b>	÷	<b>Restricted</b>	I	<b>Interference</b>	O	<b>Objected</b>

Claims renumbered in the same order as presented by applicant
  CPA
  T.D.
  R.1.47

CLAIM		DATE									
Final	Original	09/25/2015	07/06/2016	11/01/2016	05/25/2017	10/27/2017	03/12/2018				
1	1	✓	✓	✓	✓	✓	=				
2	2	✓	✓	✓	✓	✓	=				
4	3	✓	✓	✓	✓	✓	=				
5	4	✓	✓	✓	✓	✓	=				
6	5	✓	✓	✓	✓	✓	=				
3	6	✓	✓	✓	✓	✓	=				
8	7	✓	✓	✓	✓	✓	=				
9	8	✓	✓	✓	✓	✓	=				
10	9	✓	✓	✓	✓	✓	=				
11	10	✓	✓	✓	✓	✓	=				
7	11	✓	✓	✓	✓	✓	=				
13	12	✓	✓	✓	✓	✓	=				
14	13	✓	✓	✓	✓	✓	=				
15	14	✓	✓	✓	✓	✓	=				
16	15	✓	✓	✓	✓	✓	=				
17	16	✓	✓	✓	✓	✓	=				
18	17	✓	✓	✓	✓	✓	=				
19	18	✓	✓	✓	✓	✓	=				
20	19	✓	✓	✓	✓	✓	=				
	20	✓	-	-	-	-	-				
	21		✓	✓	✓	-	-				
	22		✓	✓	✓	-	-				
22	23		✓	✓	✓	✓	=				
23	24		✓	✓	✓	✓	=				
14	25		✓	✓	✓	✓	=				
25	26		✓	✓	✓	✓	=				
	27		✓	✓	-	-	-				
26	28		✓	✓	✓	✓	=				
27	29		✓	✓	✓	✓	=				
28	30		✓	✓	✓	✓	=				
29	31		✓	✓	✓	✓	=				
30	32		✓	✓	✓	✓	=				
31	33		✓	✓	✓	✓	=				
32	34		✓	✓	✓	✓	=				
33	35		✓	✓	✓	✓	=				
34	36		✓	✓	✓	✓	=				

<b>Index of Claims</b> 	<b>Application/Control No.</b> 14609189	<b>Applicant(s)/Patent Under Reexamination</b> BACKHOLM ET AL.
	<b>Examiner</b> ALAN S CHOU	<b>Art Unit</b> 2451

✓	<b>Rejected</b>	-	<b>Cancelled</b>	N	<b>Non-Elected</b>	A	<b>Appeal</b>
=	<b>Allowed</b>	÷	<b>Restricted</b>	I	<b>Interference</b>	O	<b>Objected</b>

Claims renumbered in the same order as presented by applicant
  CPA
  T.D.
  R.1.47

CLAIM		DATE									
Final	Original	09/25/2015	07/06/2016	11/01/2016	05/25/2017	10/27/2017	03/12/2018				
37	37		✓	✓	✓	✓	=				
38	38		✓	✓	✓	✓	=				
39	39		✓	✓	✓	✓	=				
	40		✓	✓	-	-	-				
40	41		✓	✓	✓	✓	=				
41	42		✓	✓	✓	✓	=				
42	43		✓	✓	✓	✓	=				
43	44		✓	✓	✓	✓	=				
44	45		✓	✓	✓	✓	=				
46	46		✓	✓	✓	✓	=				
46	47		✓	✓	✓	✓	=				
47	48		✓	✓	✓	✓	=				
35	49		✓	✓	✓	✓	=				
48	50		✓	✓	✓	✓	=				
49	51		✓	✓	✓	✓	=				
12	52		✓	✓	✓	✓	=				
21	53		✓	✓	✓	✓	=				
	54		✓	✓	✓	-	-				
51	55		✓	✓	✓	✓	=				
36	56				✓	✓	=				
50	57				✓	✓	=				
52	58				✓	✓	=				

**EAST Search History**

**EAST Search History (Prior Art)**

< This search history is empty >

**EAST Search History (Interference)**

Ref #	Hits	Search Query	DBs	Default Operator	Plurals	Time Stamp
L1	13	(automatic NEAR5 control NEAR5 message) AND (709/206.ccls. g06q10/107.cpc. h04112/585.cpc. h04112/58.cpc.)	USPAT	OR	OFF	2018/03/12 19:58
L2	423	(automatic NEAR5 control NEAR5 message)	USPAT	OR	OFF	2018/03/12 19:59
L3	2	(automatic NEAR5 control NEAR5 message) AND (intermediary NEAR5 system)	USPAT	OR	OFF	2018/03/12 19:59
L4	0	(optically NEAR5 receive NEAR5 information) AND (709/206.ccls. g06q10/107.cpc. h04112/585.cpc. h04112/58.cpc.)	USPAT	OR	OFF	2018/03/12 20:00
L5	110	(optically NEAR5 receive NEAR5 information)	USPAT	OR	OFF	2018/03/12 20:00
L6	2	(optically NEAR5 receive NEAR5 information) AND (activation NEAR5 code)	USPAT	OR	OFF	2018/03/12 20:01

**3/ 12/ 2018 8:30:16 PM**

**H:\ Workspaces\ 14609189.wsp**

**CORRECTED ADS FORM**

Application Number	14609189
Title of Invention	Messaging centre for forwarding e-mail

**Inventor Information**

**\*\*If no data is shown, no data has been corrected\*\***

	Data of Record	Updated Data
Order Number		
Name		

**Residence Information**

Residency		
City		
State		
Country of Residence		

**Mailing Address of Inventor**

Address 1		
Address 2		
City,State/Province, Postal Code		
Country		



**Application Information**

	Data of Record	Updated Data
Title of Invention	Messaging centre for forwarding e-mail	
Attorney Docket Number	455/006/8 UTIL	
Entity Type	Small	

**Domestic Benefit/National Stage Information**

**\*\*If no data is shown, no data has been corrected\*\***

This section allows for the applicant to either claim benefit under 35 U.S.C. 119(e), 120, 121,365(c), or 386(c) or indicate National Stage entry from a PCT application. Providing this information in the application data sheet constitutes the specific reference required by 35 U.S. C. 119(e) or 120, and 37 CFR 1.78(a).

	Data of Record	Updated Data
Prior Application Status		
Application Number		
Continuity Type		
Prior Application Number		
Filing Date (YYYY-MM-DD)		
Patent Number		
Issue Date (YYYY-MM-DD)		

**Foreign Priority Information**

**\*\*If no data is shown, no data has been corrected\*\***

This section allows for the applicant to claim priority to a foreign application. Providing this information in the application data sheet constitutes the claim for priority as required by 35 U.S.C. 119(b) and 37 CFR 1.55. When priority is claimed to a foreign application that is eligible for retrieval under the priority document exchange program (PDX) the information will be used by the Office to automatically attempt retrieval pursuant to 37 CFR 1.55(i)(1) and (2). Under the PDX program, applicant bears the ultimate responsibility for ensuring that a copy of the foreign application is received by the Office from the participating foreign intellectual property office, or a certified copy of the foreign priority application is filed, within the time period specified in 37 CFR 1.55(g)(1).

	Data of Record	Updated Data
Application Number		
Country		
Filing Date		
Access Code		

### Applicant Information

**\*\*If no data is shown, no data has been corrected\*\***

Providing assignment information in this section does not substitute for compliance with any requirement of part 3 of Title 37 of CFR to have an assignment recorded by the Office.

	Data of Record	Updated Data
Applicant Type	ASG	
If applicant is the legal representative, indicate the authority to file the patent application, the inventor is		
Name of the Deceased or Legally Incapacitated Inventor		
Applicant is an Organization	Yes	
Name		
Organization Name	Seven Networks, LLC	
Address 1		<u>2660 East End Boulevard South</u>
Address 2		

Document Description: Application Data Sheet to update/correct info  
 Doc Code: ADS.CORR

City,State/Province,Postal Code	San Carlos CA	Marshall TX 75672
Country	US	
Phone Number		
Fax Number		
Email Address		

**Assignee Information including Non-Applicant Assignee Information**

**\*\*If no data is shown, no data has been corrected\*\***

Providing this information in the application data sheet does not substitute for compliance with any requirement of part 3 of Title 37 of the CFR to have an assignment recorded in the Office

	Data of Record	Updated Data
Order		
Applicant is an Organization		
Name		
Organization Name		

**Mailing Address**

Address 1		
Address 2		
City,State/Province,Postal Code		
Country		
Phone Number		
Fax Number		
Email Address		

## Signature

NOTE: This Application Data Sheet must be signed in accordance with 37 CFR 1.33(b).

This Application Data Sheet **must** be signed by a patent practitioner if one or more of the applicants is a **juristic entity** (e.g., corporation or association). If the applicant is two or more joint inventors, this form must be signed by a patent practitioner, **all** joint inventors who are the applicant, or one or more joint inventor-applicants who have been given power of attorney (e.g., see USPTO Form PTO/AIA/81) on behalf of **all** joint inventor-applicants.

See 37 CFR 1.4(d) for the manner of making signatures and certifications.

Signature	/Justin R. Nifong/	Registration Number	59389
First Name	Justin	Last Name	Nifong

**IN THE UNITED STATES PATENT AND TRADEMARK OFFICE**

Application No. : 14/609,189 Confirmation No.: 5037  
Applicant : Seven Networks, LLC  
First Named Inventor : Ari Backholm  
Filing Date : Jan 29, 2015  
TC/A.U. : 2451  
Examiner : Alan S CHOU  
Docket No. : 455/006/8 UTIL  
Customer No. : 118194

---

Title of Invention: Messaging centre for forwarding e-mail

**Mail Stop Pre-Exam**

Commissioner for Patents  
P.O. Box 1450  
Alexandria, VA 22313-1450

**REQUEST FOR CORRECTED FILING RECEIPT**

Applicant hereby submits this Request for Corrected Filing Receipt. It is requested to update the applicants address to Marshall, TX. Please issue a corrected filing receipt in view of this request.

A replacement ADS in compliance with 37 CFR 1.76 is provided herewith to reflect this request.

Appl. No: 14/609,189  
Reply Dated: March 16, 2018

**DEPOSIT ACCOUNT**

It is not believed that any additional fees are due at this time; however, the Commissioner is hereby authorized to charge any otherwise unpaid fees associated with the filing of this correspondence to Deposit Account No. **50-6191**.

Respectfully submitted,

Date: March 16, 2018

/Justin R. Nifong/  
Justin R. Nifong  
Reg. No. 59,389

NK Patent Law, PLLC  
4917 Waters Edge Drive, Suite 275  
Raleigh, NC 27606  
Telephone: (919) 348-2194  
Facsimile: (919) 882-8195

Customer No. 118194

## Electronic Acknowledgement Receipt

<b>EFS ID:</b>	32071651
<b>Application Number:</b>	14609189
<b>International Application Number:</b>	
<b>Confirmation Number:</b>	5037
<b>Title of Invention:</b>	Messaging centre for forwarding e-mail
<b>First Named Inventor/Applicant Name:</b>	
<b>Customer Number:</b>	118194
<b>Filer:</b>	Justin Robert Nifong/Sandra Hess
<b>Filer Authorized By:</b>	Justin Robert Nifong
<b>Attorney Docket Number:</b>	455/006/8 UTIL
<b>Receipt Date:</b>	16-MAR-2018
<b>Filing Date:</b>	29-JAN-2015
<b>Time Stamp:</b>	09:55:51
<b>Application Type:</b>	Utility under 35 USC 111(a)

### Payment information:

Submitted with Payment	no
------------------------	----

### File Listing:

Document Number	Document Description	File Name	File Size(Bytes)/ Message Digest	Multi Part /.zip	Pages (if appl.)
1	Application Data Sheet to update/ correct info	CorrectedADS.pdf	64620 <small>8f38f69816209010144dbefa82f0b573c22716a4</small>	no	5

### Warnings:

<b>Information:</b>					
2	Request for Corrected Filing Receipt	455-006-8UTIL-20180316-RequestForCorrFilingReceipt.pdf	20214 2d8419d297b3a947e2c54b68b15ad185d0a84379	no	2
<b>Warnings:</b>					
<b>Information:</b>					
<b>Total Files Size (in bytes):</b>				84834	
<p><b>This Acknowledgement Receipt evidences receipt on the noted date by the USPTO of the indicated documents, characterized by the applicant, and including page counts, where applicable. It serves as evidence of receipt similar to a Post Card, as described in MPEP 503.</b></p> <p><b><u>New Applications Under 35 U.S.C. 111</u></b>  <b>If a new application is being filed and the application includes the necessary components for a filing date (see 37 CFR 1.53(b)-(d) and MPEP 506), a Filing Receipt (37 CFR 1.54) will be issued in due course and the date shown on this Acknowledgement Receipt will establish the filing date of the application.</b></p> <p><b><u>National Stage of an International Application under 35 U.S.C. 371</u></b>  <b>If a timely submission to enter the national stage of an international application is compliant with the conditions of 35 U.S.C. 371 and other applicable requirements a Form PCT/DO/EO/903 indicating acceptance of the application as a national stage submission under 35 U.S.C. 371 will be issued in addition to the Filing Receipt, in due course.</b></p> <p><b><u>New International Application Filed with the USPTO as a Receiving Office</u></b>  <b>If a new international application is being filed and the international application includes the necessary components for an international filing date (see PCT Article 11 and MPEP 1810), a Notification of the International Application Number and of the International Filing Date (Form PCT/RO/105) will be issued in due course, subject to prescriptions concerning national security, and the date shown on this Acknowledgement Receipt will establish the international filing date of the application.</b></p>					





UNITED STATES PATENT AND TRADEMARK OFFICE

UNITED STATES DEPARTMENT OF COMMERCE
United States Patent and Trademark Office
Address: COMMISSIONER FOR PATENTS
P. O. Box 1450
Alexandria, Virginia 22313-1450
www.uspto.gov

Table with columns: APPLICATION NO., FILING DATE, FIRST NAMED INVENTOR, ATTORNEY DOCKET NO., CONFIRMATION NO., EXAMINER, ART UNIT, PAPER NUMBER, NOTIFICATION DATE, DELIVERY MODE. Includes application details for Ari Backholm and examiner Chou, Alan S.

Please find below and/or attached an Office communication concerning this application or proceeding.

The time period for reply, if any, is set in the attached communication.

Notice of the Office communication was sent electronically on above-indicated "Notification Date" to the following e-mail address(es):

usptomail@nkpatentlaw.com
abackholm@seven.com
eofficeaction@apcoll.com

<b>Notice of Panel Decision from Pre-Appeal Brief Review</b>	<b>Application No.</b>	<b>Applicant(s)</b>
	14/609,189	BACKHOLM ET AL.
	<b>Examiner</b>	<b>Art Unit</b>
	ALAN S. CHOU	2451

This is in response to the Pre-Appeal Brief Request for Review filed 05 February, 2018.

1.  **Improper Request** – The Request is improper and a conference will not be held for the following reason(s):

- The Notice of Appeal has not been filed concurrent with the Pre-Appeal Brief Request.
- The request does not include reasons why a review is appropriate.
- A proposed amendment is included with the Pre-Appeal Brief request.
- Other: .

The time period for filing a response continues to run from the receipt date of the Notice of Appeal or from the mail date of the last Office communication, if no Notice of Appeal has been received.

2.  **Proceed to Board of Patent Appeals and Interferences** – A Pre-Appeal Brief conference has been held. The application remains under appeal because there is at least one actual issue for appeal. Applicant is required to submit an appeal brief in accordance with 37 CFR 41.37. The time period for filing an appeal brief will be reset to be one month from mailing this decision, or the balance of the two-month time period running from the receipt of the notice of appeal, whichever is greater. Further, the time period for filing of the appeal brief is extendible under 37 CFR 1.136 based upon the mail date of this decision or the receipt date of the notice of appeal, as applicable.

- The panel has determined the status of the claim(s) is as follows:  
 Claim(s) allowed: \_\_\_\_\_.  
 Claim(s) objected to: \_\_\_\_\_.  
 Claim(s) rejected: \_\_\_\_\_.  
 Claim(s) withdrawn from consideration: \_\_\_\_\_.

3.  **Allowable application** – A conference has been held. The rejection is withdrawn and a Notice of Allowance will be mailed. Prosecution on the merits remains closed. No further action is required by applicant at this time.

4.  **Reopen Prosecution** – A conference has been held. The rejection is withdrawn and a new Office action will be mailed. No further action is required by applicant at this time.

All participants:		
(1) <u>ALAN S. CHOU.</u>	(3) <u>CHRIS PARRY.</u>	
(2) <u>John B. Walsh.</u>	(4) _____.	
/ALAN S CHOU/ Primary Examiner, Art Unit 2451	/John B. Walsh/ Primary Examiner, Art Unit 2451	/CHRIS PARRY/ Supervisory Patent Examiner, Art Unit 2451

Under the Paperwork Reduction Act of 1995, no persons are required to respond to a collection of information unless it displays a valid OMB control number.

<b>PRE-APPEAL BRIEF REQUEST FOR REVIEW</b>	Docket Number (Optional) 455-006-8 UTIL	
I hereby certify that this correspondence is being facsimile transmitted to the USPTO, EFS-Web transmitted to the USPTO, or deposited with the United States Postal Service with sufficient postage as first class mail in an envelope addressed to "Mail Stop AF, Commissioner for Patents, P.O. Box 1450, Alexandria, VA 22313-1450" [37 CFR 1.8(a)] on _____  Signature _____  Typed or printed name _____	Application Number 14/609,189	Filed 2015-01-29
	First Named Inventor Ari Backholm	
	Art Unit 2451	Examiner Alan S. Chou

Applicant requests review of the final rejection in the above-identified application. No amendments are being filed with this request.

This request is being filed with a notice of appeal.

The review is requested for the reason(s) stated on the attached sheet(s).  
 Note: No more than five (5) pages may be provided.

I am the	/Justin R. Nifong/
<input type="checkbox"/> applicant.	_____ Signature
<input checked="" type="checkbox"/> attorney or agent of record. Registration number <u>59389</u>	Justin R. Nifong _____ Typed or printed name
<input type="checkbox"/> attorney or agent acting under 37 CFR 1.34. Registration number if acting under 37 CFR 1.34 _____	919-349-2194 _____ Telephone number
	February 5, 2018 _____ Date

NOTE: This form must be signed in accordance with 37 CFR 1.33. See 37 CFR 1.4 for signature requirements and certifications. Submit multiple forms if more than one signature is required, see below\*.

<input checked="" type="checkbox"/>	*Total of <u>1</u> forms are submitted.
-------------------------------------	---

This collection of information is required by 35 U.S.C. 132. The information is required to obtain or retain a benefit by the public which is to file (and by the USPTO to process) an application. Confidentiality is governed by 35 U.S.C. 122 and 37 CFR 1.11, 1.14 and 41.6. This collection is estimated to take 12 minutes to complete, including gathering, preparing, and submitting the completed application form to the USPTO. Time will vary depending upon the individual case. Any comments on the amount of time you require to complete this form and/or suggestions for reducing this burden, should be sent to the Chief Information Officer, U.S. Patent and Trademark Office, U.S. Department of Commerce, P.O. Box 1450, Alexandria, VA 22313-1450. DO NOT SEND FEES OR COMPLETED FORMS TO THIS ADDRESS. SEND TO: Mail Stop AF, Commissioner for Patents, P.O. Box 1450, Alexandria, VA 22313-1450.

If you need assistance in completing the form, call 1-800-PTO-9199 and select option 2.

## Privacy Act Statement

The **Privacy Act of 1974 (P.L. 93-579)** requires that you be given certain information in connection with your submission of the attached form related to a patent application or patent. Accordingly, pursuant to the requirements of the Act, please be advised that: (1) the general authority for the collection of this information is 35 U.S.C. 2(b)(2); (2) furnishing of the information solicited is voluntary; and (3) the principal purpose for which the information is used by the U.S. Patent and Trademark Office is to process and/or examine your submission related to a patent application or patent. If you do not furnish the requested information, the U.S. Patent and Trademark Office may not be able to process and/or examine your submission, which may result in termination of proceedings or abandonment of the application or expiration of the patent.

The information provided by you in this form will be subject to the following routine uses:

1. The information on this form will be treated confidentially to the extent allowed under the Freedom of Information Act (5 U.S.C. 552) and the Privacy Act (5 U.S.C. 552a). Records from this system of records may be disclosed to the Department of Justice to determine whether disclosure of these records is required by the Freedom of Information Act.
2. A record from this system of records may be disclosed, as a routine use, in the course of presenting evidence to a court, magistrate, or administrative tribunal, including disclosures to opposing counsel in the course of settlement negotiations.
3. A record in this system of records may be disclosed, as a routine use, to a Member of Congress submitting a request involving an individual, to whom the record pertains, when the individual has requested assistance from the Member with respect to the subject matter of the record.
4. A record in this system of records may be disclosed, as a routine use, to a contractor of the Agency having need for the information in order to perform a contract. Recipients of information shall be required to comply with the requirements of the Privacy Act of 1974, as amended, pursuant to 5 U.S.C. 552a(m).
5. A record related to an International Application filed under the Patent Cooperation Treaty in this system of records may be disclosed, as a routine use, to the International Bureau of the World Intellectual Property Organization, pursuant to the Patent Cooperation Treaty.
6. A record in this system of records may be disclosed, as a routine use, to another federal agency for purposes of National Security review (35 U.S.C. 181) and for review pursuant to the Atomic Energy Act (42 U.S.C. 218(c)).
7. A record from this system of records may be disclosed, as a routine use, to the Administrator, General Services, or his/her designee, during an inspection of records conducted by GSA as part of that agency's responsibility to recommend improvements in records management practices and programs, under authority of 44 U.S.C. 2904 and 2906. Such disclosure shall be made in accordance with the GSA regulations governing inspection of records for this purpose, and any other relevant (*i.e.*, GSA or Commerce) directive. Such disclosure shall not be used to make determinations about individuals.
8. A record from this system of records may be disclosed, as a routine use, to the public after either publication of the application pursuant to 35 U.S.C. 122(b) or issuance of a patent pursuant to 35 U.S.C. 151. Further, a record may be disclosed, subject to the limitations of 37 CFR 1.14, as a routine use, to the public if the record was filed in an application which became abandoned or in which the proceedings were terminated and which application is referenced by either a published application, an application open to public inspection or an issued patent.
9. A record from this system of records may be disclosed, as a routine use, to a Federal, State, or local law enforcement agency, if the USPTO becomes aware of a violation or potential violation of law or regulation.

Under the Paperwork Reduction Act of 1995, no persons are required to respond to a collection of information unless it displays a valid OMB control number.

<b>NOTICE OF APPEAL FROM THE EXAMINER TO THE PATENT TRIAL AND APPEAL BOARD</b>		Docket Number (Optional) <b>455/006/8 UTIL</b>
I hereby certify that this correspondence is being facsimile transmitted to the USPTO, EFS-Web transmitted to the USPTO, or deposited with the United States Postal Service with sufficient postage in an envelope addressed to "Commissioner for Patents, P.O. Box 1450, Alexandria, on Alexandria, VA 22313-1450" [37 CFR 1.8(a)] on _____. Signature _____ Typed or printed name _____	In re Application of Backholm et al. <hr/> Application Number 14/509,189 Filed 2015-01-29 <hr/> For Messaging centre for forwarding e-mail <hr/> Art Unit 2451 Examiner Alan S. Chou	
Applicant hereby <b>appeals</b> to the Patent Trial and Appeal Board from the last decision of the examiner.		
The fee for this Notice of Appeal is (37 CFR 41.20(b)(1)) <span style="float: right;">\$ 800 _____</span>		
<input checked="" type="checkbox"/> Applicant asserts small entity status. See 37 CFR 1.27. Therefore, the fee shown above is reduced by 50%, and the resulting fee is: <span style="float: right;">\$ 400 _____</span>		
<input type="checkbox"/> Applicant certifies micro entity status. See 37 CFR 1.29. Therefore, the fee shown above is reduced by 75%, and the resulting fee is: <span style="float: right;">\$ _____</span> Form PTO/SB/15A or B or equivalent must either be enclosed or have been submitted previously.		
<input type="checkbox"/> A check in the amount of the fee is enclosed.		
<input type="checkbox"/> Payment by credit card. Form PTO-2038 is attached.		
<input checked="" type="checkbox"/> The Director is hereby authorized to charge any fees which may be required, or credit any overpayment to Deposit Account No. <u>50-6191</u> .		
<input checked="" type="checkbox"/> Payment made via EFS-Web.		
<input type="checkbox"/> A petition for an extension of time under 37 CFR 1.136(a) (PTO/AIA/22 or equivalent) is enclosed. For extensions of time in reexamination proceedings, see 37 CFR 1.550.		
<b>WARNING: Information on this form may become public. Credit card information should not be included on this form. Provide credit card information and authorization on PTO-2038.</b>		
I am the		
<input type="checkbox"/> applicant <input checked="" type="checkbox"/> attorney or agent of record Registration number <u>59389</u> <input type="checkbox"/> attorney or agent acting under 37 CFR 1.34 Registration number _____		
Signature <u>/Justin R. Nifong/</u>		
Typed or printed name <u>Justin R. Nifong</u>		
Telephone Number <u>919-348-2194</u>		
Date <u>February 5, 2018</u>		
<b>NOTE:</b> This form must be signed in accordance with 37 CFR 1.33. See 37 CFR 1.4 for signature requirements and certifications. Submit multiple forms if more than one signature is required, see below*.		
<input checked="" type="checkbox"/> * Total of <u>1</u> forms are submitted.		

This collection of information is required by 37 CFR 41.20(b)(1) and 41.31. The information is required to obtain or retain a benefit by the public which is to file (and by the USPTO to process) an application. Confidentiality is governed by 35 U.S.C. 122 and 37 CFR 1.11, 1.14 and 41.6. This collection is estimated to take 12 minutes to complete, including gathering, preparing, and submitting the completed application form to the USPTO. Time will vary depending upon the individual case. Any comments on the amount of time you require to complete this form and/or suggestions for reducing this burden, should be sent to the Chief Information Officer, U.S. Patent and Trademark Office, U.S. Department of Commerce, P.O. Box 1450, Alexandria, VA 22313-1450. DO NOT SEND FEES OR COMPLETED FORMS TO THIS ADDRESS. **SEND TO: Commissioner for Patents, P.O. Box 1450, Alexandria, VA 22313-1450.**

*If you need assistance in completing the form, call 1-800-PTO-9199 and select option 2.*

## Privacy Act Statement

The **Privacy Act of 1974 (P.L. 93-579)** requires that you be given certain information in connection with your submission of the attached form related to a patent application or patent. Accordingly, pursuant to the requirements of the Act, please be advised that: (1) the general authority for the collection of this information is 35 U.S.C. 2(b)(2); (2) furnishing of the information solicited is voluntary; and (3) the principal purpose for which the information is used by the U.S. Patent and Trademark Office is to process and/or examine your submission related to a patent application or patent. If you do not furnish the requested information, the U.S. Patent and Trademark Office may not be able to process and/or examine your submission, which may result in termination of proceedings or abandonment of the application or expiration of the patent.

The information provided by you in this form will be subject to the following routine uses:

1. The information on this form will be treated confidentially to the extent allowed under the Freedom of Information Act (5 U.S.C. 552) and the Privacy Act (5 U.S.C. 552a). Records from this system of records may be disclosed to the Department of Justice to determine whether disclosure of these records is required by the Freedom of Information Act.
2. A record from this system of records may be disclosed, as a routine use, in the course of presenting evidence to a court, magistrate, or administrative tribunal, including disclosures to opposing counsel in the course of settlement negotiations.
3. A record in this system of records may be disclosed, as a routine use, to a Member of Congress submitting a request involving an individual, to whom the record pertains, when the individual has requested assistance from the Member with respect to the subject matter of the record.
4. A record in this system of records may be disclosed, as a routine use, to a contractor of the Agency having need for the information in order to perform a contract. Recipients of information shall be required to comply with the requirements of the Privacy Act of 1974, as amended, pursuant to 5 U.S.C. 552a(m).
5. A record related to an International Application filed under the Patent Cooperation Treaty in this system of records may be disclosed, as a routine use, to the International Bureau of the World Intellectual Property Organization, pursuant to the Patent Cooperation Treaty.
6. A record in this system of records may be disclosed, as a routine use, to another federal agency for purposes of National Security review (35 U.S.C. 181) and for review pursuant to the Atomic Energy Act (42 U.S.C. 218(c)).
7. A record from this system of records may be disclosed, as a routine use, to the Administrator, General Services, or his/her designee, during an inspection of records conducted by GSA as part of that agency's responsibility to recommend improvements in records management practices and programs, under authority of 44 U.S.C. 2904 and 2906. Such disclosure shall be made in accordance with the GSA regulations governing inspection of records for this purpose, and any other relevant (*i.e.*, GSA or Commerce) directive. Such disclosure shall not be used to make determinations about individuals.
8. A record from this system of records may be disclosed, as a routine use, to the public after either publication of the application pursuant to 35 U.S.C. 122(b) or issuance of a patent pursuant to 35 U.S.C. 151. Further, a record may be disclosed, subject to the limitations of 37 CFR 1.14, as a routine use, to the public if the record was filed in an application which became abandoned or in which the proceedings were terminated and which application is referenced by either a published application, an application open to public inspection or an issued patent.
9. A record from this system of records may be disclosed, as a routine use, to a Federal, State, or local law enforcement agency, if the USPTO becomes aware of a violation or potential violation of law or regulation.

**COMMUNICATION TO THE UNITED STATES PATENT AND TRADEMARK  
OFFICE**

Appl. No. : 14/609,189 Confirmation No. 5037  
Applicant : Seven Networks, LLC  
Inventor : Ari Backholm *et al.*  
Filed : 2015-01-29  
TC/A.U. : 2451  
Examiner : Chou, Alan S  
Docket No. : 455/006/8 UTIL  
Customer No. : 118194

Via EFS Web – Electronic Filing  
Mail Stop Amendment  
Commissioner for Patents  
P.O. Box 1450  
Alexandria, VA 22313-1450

**ARGUMENTS PRESENTED FOR PRE-APPEAL BRIEF REQUEST FOR REVIEW**

This paper is being filed in response to the non-final Office Action mailed November 3, 2017. Applicant submits the following five page brief in support of the Applicant's Pre-Appeal Brief. The Office is hereby authorized to charge any additional fees required for entry on this paper to Deposit Account number 50-6194.

Respectfully submitted,

Date: February 5, 2017

/Justin R. Nifong/  
Justin R. Nifong  
Reg. No. 59,389

NK Patent Law  
4917 Waters Edge Drive, Suite 275  
Raleigh, NC 27606  
Telephone: (919) 348-2194  
Facsimile: (919) 882-8195

**Brief**

Independent claim 1 recites a method for forwarding an e-mail message from one of a plurality of e-mail servers to a mobile terminal. The method includes receiving, at an intermediary system, an e-mail message associated with an e-mail address of a user of a mobile terminal and sent by one of a plurality of e-mail servers. The e-mail address is associated with an identifier of the mobile terminal and the identifier is generated by the mobile terminal. An email account, associated with the email address, is hosted by one of the plurality of e-mail servers. The method further includes encrypting the e-mail message using encryption information associated with a temporary identifier. The temporary identifier is based on a connection to the mobile terminal. The method further includes transmitting the encrypted e-mail message to the mobile terminal; receiving an automatic control message from the mobile terminal indicating that the user has read the e-mail message; and in response to receiving the automatic control message, signaling the one of a plurality of e-mail servers to mark the e-mail message as read. Independent claim 12 recites a corresponding system using the method of claim 1.

Claims 1-2, 6-10, 12-15, 18, 52-54 stand rejected under 35 USC 103(a) as being unpatentable over Little, in view of Turunen, in view of Osthoff, and further in view of Kent. Applicant respectfully traverses. The Patent Office has not presented a “*prima facie* conclusion of obviousness”. Specifically, Kent fails to teach, and actually teaches away from the feature of “*receiving an automatic control message indicating that the user has read the e-mail message; and in response to receiving the automatic control message, signaling the one of a plurality of e-mail servers to mark the e-mail message as read*” recited in independent claims 1 and 12. Claim support for this feature may be found in at least paragraph [0034] of the Applicant’s specification.

On page 6, the Office Action recites “see email server receiving signal or read receipt from mobile IP phone on page 3 section [0027]” of Kent as teaching *receiving an automatic control message indicating that the user has read the e-mail message*. The Office Action further recites “see call routing system 116 and presence engine 132, paragraph [0026], relay read receipt information from the email servers 154 to other servers such as SMS server 152 and SOAP server 156 on page 3 section [0027] and Figure 1A” of Kent as teaching *in response to receiving the automatic control message, signaling the one of a plurality of e-mail servers to mark the e-*



*mail message as read.* Paragraph [0026] of Kent does not appear to have relevant information to the rejection. The relevant text of paragraph [0027] of Kent is reproduced below:

*[0027] ... Furthermore, a short message service (SMS) server 152 could determine presence based upon whether the user has retrieved the message from the SMS server 152, and an e-mail server 154 could be equipped to determine presence based upon a read receipt, as known in the art. Furthermore, the internet call routing system 116 could communicate information to devices that cannot communicate bidirectionally such as, for example, using a simple object access protocol (SOAP) server 156 to communicate an XML-based message to a television 128 having a set-top box 158 via a base station 160 and satellite 162.*

Kent clearly recites *a read receipt, as known in the art.* A “read receipt as understood by a person of ordinary skill in the art at the time of the invention, is an email message notification returned to the sending party’s inbox upon approval (e.g. via privacy policy or by user prompt) of the receiving party. Furthermore the sending party of the email would need to request the “read receipt” such that it was included in the message header of the original message. See *Message Disposition Notification Internet Engineering Task Force (IETF) Request for Comments (RFC) 3798*<sup>1</sup> which was an *Internet Official Protocol Standard* at the time of the invention.

The “read receipt” of Kent is not an *automatic control message.* “Read receipt” is an email notification returned to the sender under approval from the receiver. The “read receipt” is used to notify the sender that the receiver of the email has opened the email. The “read receipt” travels within the email messaging system as a notification and is not a control message of the email system. Nowhere does Kent teach *in response to receiving the automatic control message, signaling the one of a plurality of e-mail servers to mark the e-mail message as read.*

The ICR system 116 of Kent teaches toward solving the problem of determining a presence status of a user. Paragraph [0005] of Kent recites *if a user is not present to receive the call, the value of caller ID feature is reduced.* Further in paragraph [0006], Kent recites: *sends an internet-based message to the called party at the registered communication device in response to the presence determination.* And further in paragraph [0007], Kent again recites

---

<sup>1</sup> <https://tools.ietf.org/html/rfc3798>

*sending a message to the called party via said at least one registered communication device responsive to the presence determination.*

The Applicant's specification teaches towards solving the problem of requiring a separate email account for a user's first terminal (e.g. office computer) and a user's second terminal (e.g. mobile device). See paragraphs [0006] through [0008]. As stated on page 5 of the Office Action, nowhere does Little, Turunen, or Osthoff disclose or suggest the above feature. Likewise, the other cited references of Giobbi, Solonen, Anttila, and Kock fail to disclose or suggest the above cited features. No other reference is used to render the deficiencies of Kent. As such, the rejection based on Kent is improper and independent claims 1 and 12 are patentable over the cited references. Claims 2-11, 13-19, and 52-53 depend, either directly or indirectly, from independent claims 1 and 12; and are allowable for at least the same reasons.

Independent claim 23 recites a device including a radio, a processor, and a memory. The memory contains instructions executable by the processor whereby the device is operable to receive information including a displayed service activation code from a remote device. The device is further operable to register the remote device for access to a messaging account using the service activation code; receive a message for the messaging account; encrypt the message using an encryption key; and send the message to the remote device and the device is authenticated to access the messaging account. Independent claim 37 recites a corresponding method according to the device of independent claim 1. Independent claim 55 recites a corresponding non-transient computer readable medium containing program instructions according to the device of independent claim 1.

In the Office Action, claims 23-24, 37-38, and 55 stand rejected under 35 USC 103(a) as being unpatentable over Little, in view of Turunen, further in view of Osthoff, and further in view of Anttila. Applicant respectfully traverses. The Patent Office has not presented a "*prima facie* conclusion of obviousness". Specifically Anttila fails to teach, and actually teaches away from the following feature of *optically receive information including a displayed service activation code from a remote device* recited in independent claims 23, 37, and 55. Claim support for this feature may be found in at least paragraph [0029] of the Applicant's specification.

On page 15, the Office Action recites "see generate and send a short range communication visual code from one device to another for transferring data on page 2 section

[0016] and see use of optical quick response (QR) code for security measure on page 2 section [0014]” of Anttila as teaching *optically receive information including a displayed service activation code from a remote device*. For reference paragraphs [0014] and [0016] of Anttila are reproduced below:

*[0014] The visual code generated may be chosen from among any conventional visual code, such as two-dimensional (2D) barcode, quick response (QR) code, data glyph, or any kind of proprietary encoding scheme or the like. The encoded address will be dictated by the communication application that is established and may, for example, be a Bluetooth. RTM. address, an IP address, a URL or the like. The data element location identifier may, for example, be a URL, a storage location or a file identifier. In addition to the device address and the location identifier of the data element, the visual code may encode other relevant information including, but not limited to, the communication application that is to be established, the type of transfer that is to occur, security measures and the like.*

*[0016] The invention is also embodied in a computer program product for establishing short-range communication between digital devices. The computer program product includes a computer readable storage medium having computer-readable program instructions embodied in the medium. The computer-readable program instructions include first instructions, implemented on a first digital device, for generating and displaying a visual code that encodes an address of the first digital device and a predetermined data element location identifier. The computer-readable program instructions also include second instructions, implemented on a second digital device, for capturing and decoding the visual code and initiating a short-range communication link between the second digital device and the first digital device for the purpose of transferring the data element from the first digital device to the second digital device.*

The “visual code” of Anttila is not a *service activation code*. Specifically the “visual code” of Anttila is not disclosed as a code that may activate a service, such as a messaging service. As further evidence of Anttila’s failings, Anttila teaches away from the claimed invention. In particular, Anttila teaches in paragraph [0016] towards *establishing short-range*

*communication between digital devices. Anttila further discloses in paragraph [0016] capturing and decoding the visual code and initiating a short-range communication link between the second digital device and the first digital device for the purpose of transferring the data element from the first digital device to the second digital device. The desired result of Anttila is to establish *short-range communication* for the purpose of *transferring the data element from the first digital device to the second digital device.* This is further evidenced by Anttila's disclosure of: *implemented on a first digital device, for generating and displaying a visual code that encodes an address of the first digital device and a predetermined data element location identifier.**

In contrast and as disclosed in paragraph [0029] of the Applicant's Specification (and currently claimed), a *displayed service activation code* is received and used to *register the remote device for access to a messaging account using the service activation code.* As further disclosed in paragraph [0029], to *register to a messaging account*, the *service activation code* must relay information to the host system *such as user name and password combination.* The claims 23, 37, and 55 recite *optically receives information including a displayed service activation code from a remote device and registers the remote device for access to a messaging account using the service activation code, the cited reference.* Anttila discloses a *visual code and initiating a short-range communication link ... for the purpose of transferring the data element from the first digital device to the second digital device.*

Summarizing, Anttila fails to disclose or suggest a device *whereby the device is operable to: optically receive information including a displayed service activation code from a remote device; and register the remote device for access to a messaging account using the service activation code.* Further, Anttila teaches away from receiving a *service activation code.* As such, claims 23, 37, and 55 are not rendered obvious in light of Anttila.

As stated on page 15 of the Office Action, nowhere does Little, Turunen, or Osthoff disclose or suggest the above feature. Likewise, the other cited references of Giobbi, Salonen, Anttila, and Kock fail to disclose or suggest the above cited features. No other reference is used to render the deficiencies of Anttila. As such, the rejection based on Anttila is improper and independent claims 23, 37, and 55 are patentable over the cited references. Claims 24-26, 28-36, 38-39, 41-51, and 56-58 depend, either directly or indirectly, from independent claims 23, 37, and 55; and are allowable for at least the same reasons.

<b>INFORMATION DISCLOSURE STATEMENT BY APPLICANT</b> ( Not for submission under 37 CFR 1.99)	Application Number	14609189
	Filing Date	2015-01-29
	First Named Inventor	Ari Backholm
	Art Unit	2451
	Examiner Name	Alan S. Chou
	Attorney Docket Number	455/006/8 UTIL

U.S.PATENTS							Remove
Examiner Initial*	Cite No	Patent Number	Kind Code <sup>1</sup>	Issue Date	Name of Patentee or Applicant of cited Document	Pages,Columns,Lines where Relevant Passages or Relevant Figures Appear	
	1	6078908	A	2000-06-20	Schmitz		
	2	6993658	B1	2006-01-31	Engberg, et al.		

If you wish to add additional U.S. Patent citation information please click the Add button. Add

U.S.PATENT APPLICATION PUBLICATIONS							Remove
Examiner Initial*	Cite No	Publication Number	Kind Code <sup>1</sup>	Publication Date	Name of Patentee or Applicant of cited Document	Pages,Columns,Lines where Relevant Passages or Relevant Figures Appear	
	1						

If you wish to add additional U.S. Published Application citation information please click the Add button. Add

FOREIGN PATENT DOCUMENTS								Remove
Examiner Initial*	Cite No	Foreign Document Number <sup>3</sup>	Country Code <sup>2i</sup>	Kind Code <sup>4</sup>	Publication Date	Name of Patentee or Applicant of cited Document	Pages,Columns,Lines where Relevant Passages or Relevant Figures Appear	T <sup>5</sup>
	1							

If you wish to add additional Foreign Patent Document citation information please click the Add button. Add

NON-PATENT LITERATURE DOCUMENTS								Remove
---------------------------------	--	--	--	--	--	--	--	--------

<b>INFORMATION DISCLOSURE STATEMENT BY APPLICANT ( Not for submission under 37 CFR 1.99)</b>	Application Number		14609189
	Filing Date		2015-01-29
	First Named Inventor	Ari Backholm	
	Art Unit	2451	
	Examiner Name	Alan S. Chou	
	Attorney Docket Number	455/006/8 UTIL	

Examiner Initials*	Cite No	Include name of the author (in CAPITAL LETTERS), title of the article (when appropriate), title of the item (book, magazine, journal, serial, symposium, catalog, etc), date, pages(s), volume-issue number(s), publisher, city and/or country where published.	T <sup>5</sup>
	1	FAJMAN, R., RFC 2298 - An Extensible Message Format for Message Disposition Notifications, National Institutes of Health, March 1998, Pgs. 1-29, Network Working Group, 2998, Standard Track	
	2	CRISPIN, M., RFC 3501 - Internet Message Access Protocol - Version 4rev1, University of Washington, March 2003, Pgs. 1-109, Network Working Group, 3501, Obsoletes: 2060, Standard Track	
	3	HANSEN, Ed., T., et al., RFC 3798 - Message Disposition Notification, AT&T Laboratories, Lucent Technologies, May 2004, Pgs. 1-31, Network Working Group, 3798, Obsoletes: 2298, Standard Track	

If you wish to add additional non-patent literature document citation information please click the Add button

**EXAMINER SIGNATURE**

Examiner Signature		Date Considered	
--------------------	--	-----------------	--

\*EXAMINER: Initial if reference considered, whether or not citation is in conformance with MPEP 609. Draw line through a citation if not in conformance and not considered. Include copy of this form with next communication to applicant.

<sup>1</sup> See Kind Codes of USPTO Patent Documents at [www.USPTO.GOV](http://www.USPTO.GOV) or MPEP 901.04. <sup>2</sup> Enter office that issued the document, by the two-letter code (WIPO Standard ST.3). <sup>3</sup> For Japanese patent documents, the indication of the year of the reign of the Emperor must precede the serial number of the patent document. <sup>4</sup> Kind of document by the appropriate symbols as indicated on the document under WIPO Standard ST.16 if possible. <sup>5</sup> Applicant is to place a check mark here if English language translation is attached.

<b>INFORMATION DISCLOSURE STATEMENT BY APPLICANT</b> ( Not for submission under 37 CFR 1.99)	Application Number	14609189
	Filing Date	2015-01-29
	First Named Inventor	Ari Backholm
	Art Unit	2451
	Examiner Name	Alan S. Chou
	Attorney Docket Number	455/006/8 UTIL

**CERTIFICATION STATEMENT**

Please see 37 CFR 1.97 and 1.98 to make the appropriate selection(s):

That each item of information contained in the information disclosure statement was first cited in any communication from a foreign patent office in a counterpart foreign application not more than three months prior to the filing of the information disclosure statement. See 37 CFR 1.97(e)(1).

**OR**

That no item of information contained in the information disclosure statement was cited in a communication from a foreign patent office in a counterpart foreign application, and, to the knowledge of the person signing the certification after making reasonable inquiry, no item of information contained in the information disclosure statement was known to any individual designated in 37 CFR 1.56(c) more than three months prior to the filing of the information disclosure statement. See 37 CFR 1.97(e)(2).

See attached certification statement.

- The fee set forth in 37 CFR 1.17 (p) has been submitted herewith.
- A certification statement is not submitted herewith.

**SIGNATURE**

A signature of the applicant or representative is required in accordance with CFR 1.33, 10.18. Please see CFR 1.4(d) for the form of the signature.

Signature	/Justin R. Nifong/	Date (YYYY-MM-DD)	2018-02-05
Name/Print	Justin R. Nifong	Registration Number	59389

This collection of information is required by 37 CFR 1.97 and 1.98. The information is required to obtain or retain a benefit by the public which is to file (and by the USPTO to process) an application. Confidentiality is governed by 35 U.S.C. 122 and 37 CFR 1.14. This collection is estimated to take 1 hour to complete, including gathering, preparing and submitting the completed application form to the USPTO. Time will vary depending upon the individual case. Any comments on the amount of time you require to complete this form and/or suggestions for reducing this burden, should be sent to the Chief Information Officer, U.S. Patent and Trademark Office, U.S. Department of Commerce, P.O. Box 1450, Alexandria, VA 22313-1450. **DO NOT SEND FEES OR COMPLETED FORMS TO THIS ADDRESS. SEND TO: Commissioner for Patents, P.O. Box 1450, Alexandria, VA 22313-1450.**

## Privacy Act Statement

The Privacy Act of 1974 (P.L. 93-579) requires that you be given certain information in connection with your submission of the attached form related to a patent application or patent. Accordingly, pursuant to the requirements of the Act, please be advised that: (1) the general authority for the collection of this information is 35 U.S.C. 2(b)(2); (2) furnishing of the information solicited is voluntary; and (3) the principal purpose for which the information is used by the U.S. Patent and Trademark Office is to process and/or examine your submission related to a patent application or patent. If you do not furnish the requested information, the U.S. Patent and Trademark Office may not be able to process and/or examine your submission, which may result in termination of proceedings or abandonment of the application or expiration of the patent.

The information provided by you in this form will be subject to the following routine uses:

1. The information on this form will be treated confidentially to the extent allowed under the Freedom of Information Act (5 U.S.C. 552) and the Privacy Act (5 U.S.C. 552a). Records from this system of records may be disclosed to the Department of Justice to determine whether the Freedom of Information Act requires disclosure of these records.
2. A record from this system of records may be disclosed, as a routine use, in the course of presenting evidence to a court, magistrate, or administrative tribunal, including disclosures to opposing counsel in the course of settlement negotiations.
3. A record in this system of records may be disclosed, as a routine use, to a Member of Congress submitting a request involving an individual, to whom the record pertains, when the individual has requested assistance from the Member with respect to the subject matter of the record.
4. A record in this system of records may be disclosed, as a routine use, to a contractor of the Agency having need for the information in order to perform a contract. Recipients of information shall be required to comply with the requirements of the Privacy Act of 1974, as amended, pursuant to 5 U.S.C. 552a(m).
5. A record related to an International Application filed under the Patent Cooperation Treaty in this system of records may be disclosed, as a routine use, to the International Bureau of the World Intellectual Property Organization, pursuant to the Patent Cooperation Treaty.
6. A record in this system of records may be disclosed, as a routine use, to another federal agency for purposes of National Security review (35 U.S.C. 181) and for review pursuant to the Atomic Energy Act (42 U.S.C. 218(c)).
7. A record from this system of records may be disclosed, as a routine use, to the Administrator, General Services, or his/her designee, during an inspection of records conducted by GSA as part of that agency's responsibility to recommend improvements in records management practices and programs, under authority of 44 U.S.C. 2904 and 2906. Such disclosure shall be made in accordance with the GSA regulations governing inspection of records for this purpose, and any other relevant (i.e., GSA or Commerce) directive. Such disclosure shall not be used to make determinations about individuals.
8. A record from this system of records may be disclosed, as a routine use, to the public after either publication of the application pursuant to 35 U.S.C. 122(b) or issuance of a patent pursuant to 35 U.S.C. 151. Further, a record may be disclosed, subject to the limitations of 37 CFR 1.14, as a routine use, to the public if the record was filed in an application which became abandoned or in which the proceedings were terminated and which application is referenced by either a published application, an application open to public inspections or an issued patent.
9. A record from this system of records may be disclosed, as a routine use, to a Federal, State, or local law enforcement agency, if the USPTO becomes aware of a violation or potential violation of law or regulation.



## Electronic Patent Application Fee Transmittal

<b>Application Number:</b>	14609189			
<b>Filing Date:</b>	29-Jan-2015			
<b>Title of Invention:</b>	Messaging centre for forwarding e-mail			
<b>First Named Inventor/Applicant Name:</b>	Ari Backholm			
<b>Filer:</b>	Justin Robert Nifong/Donna Donovan			
<b>Attorney Docket Number:</b>	455/006/8 UTIL			
Filed as Small Entity				
<b>Filing Fees for Utility under 35 USC 111(a)</b>				
<b>Description</b>	<b>Fee Code</b>	<b>Quantity</b>	<b>Amount</b>	<b>Sub-Total in USD(\$)</b>
<b>Basic Filing:</b>				
<b>Pages:</b>				
<b>Claims:</b>				
<b>Miscellaneous-Filing:</b>				
<b>Petition:</b>				
<b>Patent-Appeals-and-Interference:</b>				
NOTICE OF APPEAL	2401	1	400	400
<b>Post-Allowance-and-Post-Issuance:</b>				

Description	Fee Code	Quantity	Amount	Sub-Total in USD(\$)
<b>Extension-of-Time:</b>				
<b>Miscellaneous:</b>				
SUBMISSION- INFORMATION DISCLOSURE STMT	2806	1	120	120
<b>Total in USD (\$)</b>				<b>520</b>

## Electronic Acknowledgement Receipt

<b>EFS ID:</b>	31702023
<b>Application Number:</b>	14609189
<b>International Application Number:</b>	
<b>Confirmation Number:</b>	5037
<b>Title of Invention:</b>	Messaging centre for forwarding e-mail
<b>First Named Inventor/Applicant Name:</b>	Ari Backholm
<b>Customer Number:</b>	118194
<b>Filer:</b>	Justin Robert Nifong/Donna Donovan
<b>Filer Authorized By:</b>	Justin Robert Nifong
<b>Attorney Docket Number:</b>	455/006/8 UTIL
<b>Receipt Date:</b>	05-FEB-2018
<b>Filing Date:</b>	29-JAN-2015
<b>Time Stamp:</b>	15:32:38
<b>Application Type:</b>	Utility under 35 USC 111(a)

### Payment information:

Submitted with Payment	no
------------------------	----

### File Listing:

Document Number	Document Description	File Name	File Size(Bytes)/ Message Digest	Multi Part /.zip	Pages (if appl.)
1	Pre-Brief Conference request	455-006-8UTIL-20180205-PABRR.pdf	195330  b568a88dfd74e5e13876415d955203ca32b1b2de	no	2

### Warnings:

<b>Information:</b>					
2	Notice of Appeal Filed	455-006-8UTIL-20180205-Notice-of-Appeal.pdf	245660 54d3c2f6c8e6e5ed2a480eb584aff37590eba1f6	no	2
<b>Warnings:</b>					
<b>Information:</b>					
3	Amendment/Argument after Notice of Appeal	455-006-8UTIL-20180205Rsp-to-NFOA-dtd-11-03-2017.pdf	52129 773c0ee4764b3f074ff069d7b802dc6912a652a4	no	6
<b>Warnings:</b>					
<b>Information:</b>					
4	Information Disclosure Statement (IDS) Form (SB08)	455-006-8UTIL-20180250-IDS.pdf	612391 bc43dcb982d591344fcb1c9d4e9618f4e740576	no	4
<b>Warnings:</b>					
<b>Information:</b>					
5	Non Patent Literature	1-RFC-2298-An-Extensible-Message-Format-for-Message-Disposition-Notifications.pdf	253661 cfb3ad32bba834d6b53adf9b4b9fdfa50c70556	no	29
<b>Warnings:</b>					
<b>Information:</b>					
6	Non Patent Literature	2-RFC-3501-INTERNET-MESSAGE-ACCESS-PROTOCOL-VERSION.pdf	699719 497edad77b53d746df96b2438735e1112bbba80	no	109
<b>Warnings:</b>					
<b>Information:</b>					
7	Non Patent Literature	3-RFC-3798-Message-Disposition-Notification.pdf	262220 86f20700c14cbbbf6514ef5781d2ff0d526052f8	no	31
<b>Warnings:</b>					
<b>Information:</b>					
8	Fee Worksheet (SB06)	fee-info.pdf	32146 a01c2c061855b096b9a6623486ce70e703c3ffc2	no	2
<b>Warnings:</b>					
<b>Information:</b>					
<b>Total Files Size (in bytes):</b>				2353256	

**This Acknowledgement Receipt evidences receipt on the noted date by the USPTO of the indicated documents, characterized by the applicant, and including page counts, where applicable. It serves as evidence of receipt similar to a Post Card, as described in MPEP 503.**

**New Applications Under 35 U.S.C. 111**

**If a new application is being filed and the application includes the necessary components for a filing date (see 37 CFR 1.53(b)-(d) and MPEP 506), a Filing Receipt (37 CFR 1.54) will be issued in due course and the date shown on this Acknowledgement Receipt will establish the filing date of the application.**

**National Stage of an International Application under 35 U.S.C. 371**

**If a timely submission to enter the national stage of an international application is compliant with the conditions of 35 U.S.C. 371 and other applicable requirements a Form PCT/DO/EO/903 indicating acceptance of the application as a national stage submission under 35 U.S.C. 371 will be issued in addition to the Filing Receipt, in due course.**

**New International Application Filed with the USPTO as a Receiving Office**

**If a new international application is being filed and the international application includes the necessary components for an international filing date (see PCT Article 11 and MPEP 1810), a Notification of the International Application Number and of the International Filing Date (Form PCT/RO/105) will be issued in due course, subject to prescriptions concerning national security, and the date shown on this Acknowledgement Receipt will establish the international filing date of the application.**

## Electronic Patent Application Fee Transmittal

<b>Application Number:</b>	14609189			
<b>Filing Date:</b>	29-Jan-2015			
<b>Title of Invention:</b>	Messaging centre for forwarding e-mail			
<b>First Named Inventor/Applicant Name:</b>	Ari Backholm			
<b>Filer:</b>	Justin Robert Nifong/Donna Donovan			
<b>Attorney Docket Number:</b>	455/006/8 UTIL			
Filed as Small Entity				
<b>Filing Fees for Utility under 35 USC 111(a)</b>				
<b>Description</b>	<b>Fee Code</b>	<b>Quantity</b>	<b>Amount</b>	<b>Sub-Total in USD(\$)</b>
<b>Basic Filing:</b>				
<b>Pages:</b>				
<b>Claims:</b>				
<b>Miscellaneous-Filing:</b>				
<b>Petition:</b>				
<b>Patent-Appeals-and-Interference:</b>				
NOTICE OF APPEAL	2401	1	400	400
<b>Post-Allowance-and-Post-Issuance:</b>				

Description	Fee Code	Quantity	Amount	Sub-Total in USD(\$)
<b>Extension-of-Time:</b>				
<b>Miscellaneous:</b>				
SUBMISSION- INFORMATION DISCLOSURE STMT	2806	1	120	120
<b>Total in USD (\$)</b>				<b>520</b>

## Electronic Acknowledgement Receipt

<b>EFS ID:</b>	31702739
<b>Application Number:</b>	14609189
<b>International Application Number:</b>	
<b>Confirmation Number:</b>	5037
<b>Title of Invention:</b>	Messaging centre for forwarding e-mail
<b>First Named Inventor/Applicant Name:</b>	Ari Backholm
<b>Customer Number:</b>	118194
<b>Filer:</b>	Justin Robert Nifong/Donna Donovan
<b>Filer Authorized By:</b>	Justin Robert Nifong
<b>Attorney Docket Number:</b>	455/006/8 UTIL
<b>Receipt Date:</b>	05-FEB-2018
<b>Filing Date:</b>	29-JAN-2015
<b>Time Stamp:</b>	15:56:24
<b>Application Type:</b>	Utility under 35 USC 111(a)

### Payment information:

Submitted with Payment	yes
Payment Type	CARD
Payment was successfully received in RAM	\$520
RAM confirmation Number	020618INTEFSW15571300
Deposit Account	506191
Authorized User	Justin Nifong

The Director of the USPTO is hereby authorized to charge indicated fees and credit any overpayment as follows:

37 CFR 1.16 (National application filing, search, and examination fees)

37 CFR 1.17 (Patent application and reexamination processing fees)



37 CFR 1.19 (Document supply fees)  
 37 CFR 1.20 (Post Issuance fees)  
 37 CFR 1.21 (Miscellaneous fees and charges)

**File Listing:**

Document Number	Document Description	File Name	File Size(Bytes)/ Message Digest	Multi Part /.zip	Pages (if appl.)
1	Fee Worksheet (SB06)	fee-info.pdf	32147  e7a238baaf95808d6cc63b0e7ea16ef3ef8e5dcb	no	2

**Warnings:**

**Information:**

<b>Total Files Size (in bytes):</b>	32147
-------------------------------------	-------

**This Acknowledgement Receipt evidences receipt on the noted date by the USPTO of the indicated documents, characterized by the applicant, and including page counts, where applicable. It serves as evidence of receipt similar to a Post Card, as described in MPEP 503.**

**New Applications Under 35 U.S.C. 111**

**If a new application is being filed and the application includes the necessary components for a filing date (see 37 CFR 1.53(b)-(d) and MPEP 506), a Filing Receipt (37 CFR 1.54) will be issued in due course and the date shown on this Acknowledgement Receipt will establish the filing date of the application.**

**National Stage of an International Application under 35 U.S.C. 371**

**If a timely submission to enter the national stage of an international application is compliant with the conditions of 35 U.S.C. 371 and other applicable requirements a Form PCT/DO/EO/903 indicating acceptance of the application as a national stage submission under 35 U.S.C. 371 will be issued in addition to the Filing Receipt, in due course.**

**New International Application Filed with the USPTO as a Receiving Office**

**If a new international application is being filed and the international application includes the necessary components for an international filing date (see PCT Article 11 and MPEP 1810), a Notification of the International Application Number and of the International Filing Date (Form PCT/RO/105) will be issued in due course, subject to prescriptions concerning national security, and the date shown on this Acknowledgement Receipt will establish the international filing date of the application.**



UNITED STATES PATENT AND TRADEMARK OFFICE

UNITED STATES DEPARTMENT OF COMMERCE
United States Patent and Trademark Office
Address: COMMISSIONER FOR PATENTS
P. O. Box 1450
Alexandria, Virginia 22313-1450
www.uspto.gov

Table with columns: APPLICATION NO., FILING DATE, FIRST NAMED INVENTOR, ATTORNEY DOCKET NO., CONFIRMATION NO., EXAMINER, ART UNIT, PAPER NUMBER, NOTIFICATION DATE, DELIVERY MODE. Includes application details for Ari Backholm and examiner Chou, Alan S.

Please find below and/or attached an Office communication concerning this application or proceeding.

The time period for reply, if any, is set in the attached communication.

Notice of the Office communication was sent electronically on above-indicated "Notification Date" to the following e-mail address(es):

usptomail@nkpatentlaw.com
abackholm@seven.com
eofficeaction@apcoll.com

<b>Office Action Summary</b>	<b>Application No.</b> 14/609,189	<b>Applicant(s)</b> BACKHOLM ET AL.	
	<b>Examiner</b> ALAN S. CHOU	<b>Art Unit</b> 2451	<b>AIA (First Inventor to File) Status</b> No

**-- The MAILING DATE of this communication appears on the cover sheet with the correspondence address --**

**Period for Reply**

A SHORTENED STATUTORY PERIOD FOR REPLY IS SET TO EXPIRE 3 MONTHS FROM THE MAILING DATE OF THIS COMMUNICATION.

- Extensions of time may be available under the provisions of 37 CFR 1.136(a). In no event, however, may a reply be timely filed after SIX (6) MONTHS from the mailing date of this communication.
- If NO period for reply is specified above, the maximum statutory period will apply and will expire SIX (6) MONTHS from the mailing date of this communication.
- Failure to reply within the set or extended period for reply will, by statute, cause the application to become ABANDONED (35 U.S.C. § 133). Any reply received by the Office later than three months after the mailing date of this communication, even if timely filed, may reduce any earned patent term adjustment. See 37 CFR 1.704(b).

**Status**

- 1)  Responsive to communication(s) filed on 8/28/2017.  
 A declaration(s)/affidavit(s) under **37 CFR 1.130(b)** was/were filed on \_\_\_\_\_.
- 2a)  This action is **FINAL**.                      2b)  This action is non-final.
- 3)  An election was made by the applicant in response to a restriction requirement set forth during the interview on \_\_\_\_\_; the restriction requirement and election have been incorporated into this action.
- 4)  Since this application is in condition for allowance except for formal matters, prosecution as to the merits is closed in accordance with the practice under *Ex parte Quayle*, 1935 C.D. 11, 453 O.G. 213.

**Disposition of Claims\***

- 5)  Claim(s) 1-19, 23-26, 28-39, 41-53 and 55-58 is/are pending in the application.  
5a) Of the above claim(s) \_\_\_\_\_ is/are withdrawn from consideration.
- 6)  Claim(s) \_\_\_\_\_ is/are allowed.
- 7)  Claim(s) 1-19, 23-26, 28-39, 41-53, 55-58 is/are rejected.
- 8)  Claim(s) \_\_\_\_\_ is/are objected to.
- 9)  Claim(s) \_\_\_\_\_ are subject to restriction and/or election requirement.

\* If any claims have been determined allowable, you may be eligible to benefit from the **Patent Prosecution Highway** program at a participating intellectual property office for the corresponding application. For more information, please see [http://www.uspto.gov/patents/init\\_events/pph/index.jsp](http://www.uspto.gov/patents/init_events/pph/index.jsp) or send an inquiry to [PPHfeedback@uspto.gov](mailto:PPHfeedback@uspto.gov).

**Application Papers**

- 10)  The specification is objected to by the Examiner.
- 11)  The drawing(s) filed on \_\_\_\_\_ is/are: a)  accepted or b)  objected to by the Examiner.  
Applicant may not request that any objection to the drawing(s) be held in abeyance. See 37 CFR 1.85(a).  
Replacement drawing sheet(s) including the correction is required if the drawing(s) is objected to. See 37 CFR 1.121(d).

**Priority under 35 U.S.C. § 119**

- 12)  Acknowledgment is made of a claim for foreign priority under 35 U.S.C. § 119(a)-(d) or (f).

**Certified copies:**

- a)  All    b)  Some\*\*    c)  None of the:
1.  Certified copies of the priority documents have been received.
  2.  Certified copies of the priority documents have been received in Application No. \_\_\_\_\_.
  3.  Copies of the certified copies of the priority documents have been received in this National Stage application from the International Bureau (PCT Rule 17.2(a)).

\*\* See the attached detailed Office action for a list of the certified copies not received.

**Attachment(s)**

- 1)  Notice of References Cited (PTO-892)
- 2)  Information Disclosure Statement(s) (PTO/SB/08a and/or PTO/SB/08b)  
Paper No(s)/Mail Date \_\_\_\_\_.
- 3)  Interview Summary (PTO-413)  
Paper No(s)/Mail Date. \_\_\_\_\_.
- 4)  Other: \_\_\_\_\_.

The present application is being examined under the pre-AIA first to invent provisions.

### **DETAILED ACTION**

Claims 1-19, 23-26, 28-39, 41-53, 55-58 are presented for examination.

#### ***Continued Examination Under 37 CFR 1.114***

A request for continued examination under 37 CFR 1.114, including the fee set forth in 37 CFR 1.17(e), was filed in this application after final rejection. Since this application is eligible for continued examination under 37 CFR 1.114, and the fee set forth in 37 CFR 1.17(e) has been timely paid, the finality of the previous Office action has been withdrawn pursuant to 37 CFR 1.114. Applicant's submission filed on August 28, 2017 has been entered.

#### ***Claim Rejections - 35 USC § 103***

1. The following is a quotation of pre-AIA 35 U.S.C. 103(a) which forms the basis for all obviousness rejections set forth in this Office action:

(a) A patent may not be obtained though the invention is not identically disclosed or described as set forth in section 102 of this title, if the differences between the subject matter sought to be patented and the prior art are such that the subject matter as a whole would have been obvious at the time the invention was made to a person having ordinary skill in the art to which said subject matter pertains. Patentability shall not be negated by the manner in which the invention was made.

2. Claims 1-2, 6-10, 12-15, 18, 52-53 are rejected under pre-AIA 35 U.S.C. 103(a) as being unpatentable over Little et al. U.S. Patent Application Publication Number 2004/0205248 A1 (hereinafter Little), further in view of Turunen et al. U.S. Patent Number 7,289,792 B1 (hereinafter Turunen), further in view of Osthoff et al. U.S. Patent

Application Publication Number 2002/0147918 A1 (hereinafter Osthoff), and further in view of Kent, JR. et al. U.S. Patent Application Publication Number 2005/0152525 A1 (hereinafter Kent).

3. As per claims 1, 12, Little disclose a method for forwarding an e-mail message from an e-mail server to a mobile terminal (see forwarding email message 833 from message server 820 to mobile device 816 on page 9 section [0076] on Figure 8), the method comprising:

4. receiving, at an intermediary system (see wireless gateway 85 receiving email from e-mail sender 10 in Figure 1 and page 2 section [0025]), an e-mail message associated with an e-mail address of a user of a mobile terminal and sent by an e-mail servers (see message server 45 on Figure 1 and see receiving e-mail messages to a user identified by an e-mail address on page 9 section [0078]),

5. wherein the e-mail address is associated with an identifier of the mobile terminal (see specific e-mail address associated with the mobile device on page 2 section [0026]),

6. wherein an email, account associated with the email address, is hosted by an e-mail server (see email associated with an account on a message server on page 2 section [0024]),

7. encrypting the e-mail message (see encryption e-mail message to be send through a wireless VPN through a temporary transfer path on page 9 section [0081])

using encryption information associated with a temporary identifier (see encryption using private key on page 8 section [0070]),

8. and

9. transmitting the encrypted e-mail message to the mobile terminal (see sending encrypted message to mobile device on page 10 section [0082]).

10. Little do not disclose expressly: a plurality of e-mail servers.

11. wherein an email, account associated with the email address, is hosted by one of the plurality of e-mail servers.

12. wherein the identifier is generated by the mobile terminal;

13. wherein the temporary identifier is based on a connection to the mobile terminal.

14. Turunen teaches: a plurality of e-mail servers (see at least one multimedia message server MMSV in Abstract and multiple MMS such as Mowgli, WAP, and LDAP in Figure 2).

15. Turunen teaches: wherein an email, account associated with the email address, is hosted by one of the plurality of e-mail servers (see e-mail system typically comprise one or more e-mail servers on column 2 line 40-45).

16. Turunen teaches: wherein the temporary identifier is based on a connection to the mobile terminal (see temporary logical link identity TLLI provided to the mobile terminal by the serving packet service support node SGSN based on the temporary connection and channel on column 7 line 2-25 and see sending encryption parameters to setup connection on column 7 line 23-28).

17. Little and Turunen are analogous art because they are from the same field of endeavor, wireless email terminal system. At the time of the invention it would have been obvious to a person of ordinary skill in the art to also apply a temporary mobile terminal identifier for the connection to link the email to the individual mobile terminal. The motivation for doing so would have been to use link an email address that use the temporary connection address to an wireless mobile terminal that use wireless network system. Therefore, it would have been obvious to combine Little and Turunen for the benefit of using e-mail address of the mobile terminal is associated with a temporary connection identifier to obtain the invention as specified in claims 1, 12.

18. Little and Turunen do not disclose expressly: wherein the identifier is generated by the mobile terminal.

19. Osthoff teaches: wherein the identifier is generated by the mobile terminal (see using terminal identifier stored in the terminal device to create a temporary hash value to communicate with the server for authentication purposes on page 1 section [0011]).

20. Little and Osthoff are analogous art because they are from the same field of endeavor, wireless email terminal system. At the time of the invention it would have been obvious to a person of ordinary skill in the art to also apply a temporary mobile terminal identifier generated by the mobile terminal. The motivation for doing so would have been to authenticate a wireless mobile terminal that use wireless network system. Therefore, it would have been obvious to combine Little and Turunen and Osthoff for the benefit of generate a temporary connection identifier by the mobile terminal to obtain the invention as specified in claim 1, 12.

21. Little and Turunen and Osthoff do not disclose expressly: receiving an automatic control message from the mobile terminal indicating that the user has read the e-mail message; and

22. in response to receiving the automatic control message, signaling the one of a plurality of e-mail servers to mark the e-mail message as read.

23. Kent teaches: receiving an automatic control message from the mobile terminal indicating that the user has read the e-mail message (see email server receiving signal or read receipt from mobile IP phone on page 3 section [0027]); and

24. in response to receiving the automatic control message, signaling the one of a plurality of e-mail servers to mark the e-mail message as read (see call routing system 116 and presence engine 132, see page 3 section [0026], relay read receipt information from the email servers 154 to other servers such as SMS server 152 and SOAP server 156 on page 3 section [0027] and Figure 1A).

25. Little and Kent are analogous art because they are from the same field of endeavor, wireless email terminal system. At the time of the invention it would have been obvious to a person of ordinary skill in the art to forward email read receipt to other communication servers. The motivation for doing so would have been to allow user to set preference for call routing (see page 3 section [0026] on Kent). Therefore, it would have been obvious to combine Little and Turunen and Osthoff and Kent for the benefit of read receipt and response forwarding to obtain the invention as specified in claim 1, 12.



26. As per claim 2, Little and Turunen and Osthoff and Kent disclose the method of claim 1, further comprising identifying the mobile terminal based on the e-mail address of the e-mail message and the association with the identifier of the mobile terminal (see e-mail address of terminal is used to identify the wireless terminal as well as an permanent identification of wireless terminal using international mobile subscriber identity IMSI on column 8 line 20-35 and see e-mail address as well as the permanent identification of the wireless terminal such as a telephone number MSISDN and device identification IMSI are used to linking email address to the wireless terminal on column 8 line 29-37 in Turunen).

27. As per claim 6, Little and Turunen and Osthoff and Kent disclose the method of claim 2, further comprising adding the e-mail address to a reply message sent by the mobile terminal (see repacking allowing reply messages to delivered to addressed recipients on page 10 section [0083] in Little).

28. As per claim 7, Little and Turunen and Osthoff and Kent disclose the method of claim 1, further comprising receiving the encryption information generated by the mobile

terminal (see private key encryption information is shared to other systems and devices on page 8 section [0070] in Little).

29. As per claim 8, Little and Turunen and Osthoff and Kent disclose the method of claim 1, wherein the encryption information (see encryption information private key is used to identify mobile device entity on page 8 section [0070] in Little) is based on an activation code of the mobile terminal (see activation message from the wireless terminal to set up linking of the email address to the wireless terminal on column 8 line 29-37 in Turunen).

30. As per claim 9, Little and Turunen and Osthoff and Kent disclose the method of claim 1, wherein the messaging center transmits the e-mail message to the mobile terminal using the identifier of the mobile terminal (see temporary logical link identity TLLI to transmit data to wireless terminal over temporary wireless network on column 7 line 1-10 in Turunen).

31. As per claims 10, 18, Little and Turunen and Osthoff and Kent disclose the method of claim 1, wherein mobile terminal receives and decrypts the e-mail message (see wireless terminal decrypts the message on page 10 section [0082] in Little) using the encryption information (see decryption using shared private key on page 8 section [0070] in Little).

32. As per claim 13, Little and Turunen and Osthoff and Kent disclose the system of claim 12, wherein the processor is further configured to receive the e-mail message from the e-mail server (see wireless connector system 828 transfers data between mobile device 816 and email message server 820 on page 9 section [0079] in Little).

33. As per claim 14, Little and Turunen and Osthoff and Kent disclose the system of claim 12, wherein the processor (see wireless connector system 828 transfers data between mobile device 816 and email message server 820 on page 9 section [0079] in Little) is further configured to receive the encryption information and to provide the encryption information to the memory for storage (see receiving encryption information shared private key on page 8 section [0070] in Little).

34. As per claim 15, Little and Turunen and Osthoff and Kent disclose the system of claim 12, wherein the processor is further configured to pack the e-mail message (see repackaging the email message 833 such as compressing and encrypting the email message 833 on page 9 section [0081] in Little).

35. As per claims 52, 53, Little and Turunen and Osthoff and Kent disclose the method of claim 1, wherein the identifier (logon request contain wireless terminal identifier on column 8 line 55-62 in Turunen) is associated with the temporary identifier

(see temporary identifier temporary logical link identity TLLI used to connect wireless terminal with serving support node SGSN on column 7 line 4-21 in Turunen).

36. Claims 3-5, 11, 16-17, 19 are rejected under pre-AIA 35 U.S.C. 103(a) as being unpatentable over Little et al. U.S. Patent Application Publication Number 2004/0205248 A1 (hereinafter Little), further in view of Turunen et al. U.S. Patent Number 7,289,792 B1 (hereinafter Turunen), further in view of Osthoff et al. U.S. Patent Application Publication Number 2002/0147918 A1 (hereinafter Osthoff), further in view of Kent, JR. et al. U.S. Patent Application Publication Number 2005/0152525 A1 (hereinafter Kent), further in view of Kock et al. U.S. Patent Application Publication Number 2006/0031300 A1 (hereinafter Kock).

37. As per claims 3, 16, Little and Turunen and Osthoff and Kent do not disclose the method of claim 1: wherein encrypting the e-mail message further comprises packing the e-mail message by omitting at least part of the e-mail message when at least part of the e-mail message exceeds a predetermined size specification.

38. Kock teaches: packing the e-mail message by omitting at least part of the e-mail message when at least part of the e-mail message exceeds a predetermined size specification (see server transmitting the header the first N character of the body to the

terminal device, where N is a predetermined integer, while holding back any remaining body of the email on page 1 section [0008]).

39. Little and Kock are analogous art because they are from the same field of endeavor, wireless email terminal system. At the time of the invention it would have been obvious to a person of ordinary skill in the art to also apply an email message sending size. The motivation for doing so would have been to save bandwidth and only send email data that user requests. Therefore, it would have been obvious to combine Little and Turunen and Osthoff and Kent and Kock for the benefit of omitting at least part of the e-mail message when at least part of the e-mail message exceeds a predetermined size to obtain the invention as specified in claims 3, 16.

40. As per claims 4, 17, Little and Turunen and Osthoff and Kent and Kock disclose the method of claim 3, wherein size specification is set by a user of the mobile terminal (see number N is determined by a user of the terminal device on page 1 section [0014] in Kock).

41. As per claim 5, Little and Turunen and Osthoff and Kent and Kock disclose the method of claim 3, wherein the omitted part of the e-mail message is the e-mail address (see omitting any characters of the body including email address beyond the predetermined integer N on page 1 section [0008] in Kock).

42. As per claim 11, 19, Little and Turunen and Osthoff and Kent and Kock disclose the method of claim 3, wherein the mobile terminal unpacks the e-mail message (see mobile terminal repacking the email message by decompression and decryption on page 10 section [0082] in Little).

43. Claims 23-24, 37-38, 55 are rejected under pre-AIA 35 U.S.C. 103(a) as being unpatentable over Little et al. U.S. Patent Application Publication Number 2004/0205248 A1 (hereinafter Little), further in view of Turunen et al. U.S. Patent Number 7,289,792 B1 (hereinafter Turunen), further in view of Osthoff et al. U.S. Patent Application Publication Number 2002/0147918 A1 (hereinafter Osthoff), further in view of Anttila et al. U.S. Patent Application Publication Number 2005/0139680 A1 (hereinafter Anttila).

44. As per claims 23, 37, 55, Little discloses a device (see message server 820 on page 9 section [0076] and Figure 8) comprising:

45. a radio (see wireless connector system 828 on page 9 section [0079]);
46. a processor and memory (see message server 820 saving email messages to mail box 819 on page 9 section [0078]) containing instructions executable by the processor whereby the device is operable to:
  47. register the remote device for access to a messaging account (see registering remote devices using unique identification and using Subscriber Identity Module SIM on page 12 section [0105]);
  48. receive a message for the messaging account (see e-mail message 833 arrive at message server 820 and server determining which mailboxes 819 to be stored on page 9 section [0078]);
  49. encrypt the message using an encryption key (see encrypt e-mail message on page 9 section [0081]); and
  50. send the message to the remote device (see sending message to mobile devices on page 9 section [0081]),
  51. wherein the device is authenticated to access the messaging account (see e-mail address identifies a user account and mailbox 819 on page 9 section [0078]).
52. Little do not disclose expressly: receive information including a service activation code from a remote device.
53. Turunen teaches: receive information including a service activation code (see activation message from the wireless terminal to set up linking of the email address to the wireless terminal on column 8 line 29-37 and see activation message from the wireless terminal to set up linking of the email address to the wireless terminal on

column 8 line 29-37 and see activation call the message server to define the wireless terminal of the right recipient on the basis of the e-mail address on column 8 line 40-45).

54. Little and Turunen are analogous art because they are from the same field of endeavor, wireless email terminal system. At the time of the invention it would have been obvious to a person of ordinary skill in the art to also apply an activation code to link the email to the individual mobile terminal. The motivation for doing so would have been to link an email address to a wireless mobile terminal using an activation code that use wireless network system. Therefore, it would have been obvious to combine Little and Turunen for the benefit of using e-mail address of the mobile terminal is associated with an activation code to obtain the invention as specified in claim 23, 37, 55.

55. Little and Turunen do not disclose expressly: receive information including a service activation code from a remote device.

56. Osthoff teaches: receive information including a service activation code from a remote device (see using terminal identifier stored in the terminal device to create a temporary hash value to communicate with the server for authentication purposes on page 1 section [0011]).

57. Little and Osthoff are analogous art because they are from the same field of endeavor, wireless email terminal system. At the time of the invention it would have been obvious to a person of ordinary skill in the art to also apply a temporary mobile terminal identifier generated by the mobile terminal. The motivation for doing so would have been to authenticate a wireless mobile terminal that use wireless network system. Therefore, it would have been obvious to combine Little and Turunen and Osthoff for



the benefit of generate an identifier by the mobile terminal to obtain the invention as specified in claim 23, 37, 55.

58. Little and Turunen and Osthoff do not teach expressly: optically receive information including a displayed service activation code from a remote device.

59. Anttila teaches: optically receive information including a displayed service activation code from a remote device (see generate and send a short range communication visual code from one device to another for transferring data on page 2 section [0016] and see use of optical quick response (QR) code for security measure on page 2 section [0014]).

60. Little and Anttila are analogous art because they are from the same field of endeavor, wireless terminal data transfer system. At the time of the invention it would have been obvious to a person of ordinary skill in the art to use optical interface to transfer information. The motivation for doing so would have been to authenticate a wireless mobile terminal that use wireless network system using a well-known optical interface. Therefore, it would have been obvious to combine Little and Turunen and Osthoff and Anttila for the benefit of optical interface to transfer data to obtain the invention as specified in claim 23, 37, 55.

61. As per claims 24, 38, Little and Turunen and Osthoff and Anttila disclose the device of claim 23, wherein the information including the service activation code is received by the device in response to user input at the remote device (see user entering a password for decryption the message session on page 5 section [0044] in Little and

see activation request message received from the user wireless terminal containing encryption key and identification parameters and on column 7 line 55-65 in Turunen).

62. Claims 25-26, 28-36, 39, 41-51, 56-58 are rejected under pre-AIA 35 U.S.C. 103(a) as being unpatentable over Little et al. U.S. Patent Application Publication Number 2004/0205248 A1 (hereinafter Little), further in view of Turunen et al. U.S. Patent Number 7,289,792 B1 (hereinafter Turunen), further in view of Osthoff et al. U.S. Patent Application Publication Number 2002/0147918 A1 (hereinafter Osthoff), further in view of Anttila et al. U.S. Patent Application Publication Number 2005/0139680 A1 (hereinafter Anttila), further in view of Salonen U.S. Patent Application Publication Number 2013/0268384 A1 (hereinafter Salonen).

63. As per claims 25, 39, Little and Turunen and Osthoff and Anttila do not disclose expressly: wherein the information including the service activation code is received by the device in an off-line communication.

64. Salonen teaches: wherein the information including the service activation code is received by the device in an off-line communication (see using a secure SIM card in GSM devices as activation code to encrypt messages offline on the device without using network resources on page 6 section [0074]).

65. Little and Salonen are analogous art because they are from the same field of endeavor, wireless email terminal system. At the time of the invention it would have been obvious to a person of ordinary skill in the art to use off-line service activation code. The motivation for doing so would have been to use a secure physical means to encrypt message. Therefore, it would have been obvious to combine Little and Turunen and Osthoff and Anttila and Salonen for the benefit of using activation code in an off-line communication to obtain the invention as specified in claims 25, 39.

66. As per claim 26, Little and Turunen and Osthoff and Anttila and Salonen disclose the device of claim 25, wherein the off-line communication involves a local connection (see using a secure SIM card in GSM devices as activation code to encrypt messages locally using secure connection on page 6 section [0074] in Salonen).

67. As per claims 28, 41, Little and Turunen and Osthoff and Anttila and Salonen disclose the device of claim 25, wherein the off-line communication prevents eavesdropping of the service activation code (see using a secure SIM card in GSM devices as activation code to encrypt messages prevents eavesdropping of the encryption within the device on page 6 section [0074] in Salonen).

68. As per claims 29, 42, Little and Turunen and Osthoff and Anttila and Salonen disclose the device of claim 23, wherein the authentication of the device relies on the

authentication of the messaging account (see user enter password to authenticate device on page 5 section [0044] in Little).

69. As per claims 30, 43, Little and Turunen and Osthoff and Anttila and Salonen disclose the method of claim 29, wherein the authentication of the messaging account includes a username and password (see message account identified by user name on page 9 section [0078] and see user enter password to authenticate device on page 5 section [0044] in Little).

70. As per claims 31, 44, Little and Turunen and Osthoff and Anttila and Salonen disclose the device of claim 23, wherein the encryption key is the service activation code (see sending encryption key or private key on page 8 section [0070] in Little and see activation message on column 8 line 29-40 and see exchanging encryption parameters on column 7 line 20-28 in Turunen).

71. As per claims 32, 45, Little and Turunen and Osthoff and Anttila and Salonen disclose the device of claim 23, wherein the encryption key is derived from the service activation code (see private key is used to decrypt the session key to decrypt message body on page 4 section [0037] in Little).

72. As per claims 33, 46, Little and Turunen and Osthoff and Anttila and Salonen disclose the device of claim 23, wherein the encryption key is a subset of the service activation code (see encrypted session key embedded in message may be further encrypted with a public key on page 4 section [0040] in Little).

73. As per claims 34, 47, Little and Turunen and Osthoff and Anttila and Salonen disclose the device of claim 23, wherein the encryption key is closely related to the service activation code (see private key is used to decrypt the session key to decrypt message body on page 4 section [0037] in Little).

74. As per claims 35, 48, Little and Turunen and Osthoff and Anttila and Salonen disclose the device of claim 23, wherein the device is further operable to: store an association between at least two of the encryption key (see encryption key and session key on page 4 section [0037] in Little), the messaging account, an identifier of the remote device, and the service activation code (see storage storing user name, user account, mailbox identifier on page 9 section [0078] in Little).

75. As per claims 36, 50, Little and Turunen and Osthoff and Anttila and Salonen disclose the device of claim 23, wherein the message is sent to the remote device through an intermediate device (see wireless Gateway 85 on page 2 section [0027] and in Figure 1 in Little).

76. As per claims 49, 51, Little and Turunen and Osthoff and Anttila and Salonen disclose the device of claim 36, wherein the encryption key (see encryption key is used to generate request on column 6 line 55-65) is associated with a temporary identifier (see temporary identifier temporary logical link identity TLLI used to connect wireless terminal with serving support node SGSN on column 7 line 4-21 in Turunen), wherein the temporary identifier is based on a connection to the intermediate device (see wireless Gateway 85 on page 2 section [0027] and in Figure 1 in Little and see gateway support node GGSN on column 6 line 60-65 in Turunen).

77. As per claims 56-58, Little and Turunen and Osthoff and Anttila and Salonen disclose of claim 23, wherein a control message is received from the remote device upon user interaction with the message (see first device and second device initiate communication step 480 after authentication step 470 on page 6 section [0046] and Figure 3 in Anttila).

### ***Response to Arguments***

78. Applicant's arguments, see Remarks on page 10, filed August 28, 2017, with respect to nonstatutory double patenting have been fully considered and are persuasive. The double patenting rejections of claims 1-20 has been withdrawn.

79. Applicant's arguments, see Remarks on page 10, filed August 28, 2017, with respect to the rejection(s) of claim(s) 1 and 12 under 35 U.S.C 103 have been fully considered and are persuasive. Therefore, the rejection has been withdrawn. However, upon further consideration, a new ground(s) of rejection is made in view of Kent, JR. et al. U.S. Patent Application Publication Number 2005/0152525 A1 (hereinafter Kent).

80. Little and Turunen and Osthoff do not disclose expressly: receiving an automatic control message from the mobile terminal indicating that the user has read the e-mail message; and

81. in response to receiving the automatic control message, signaling the one of a plurality of e-mail servers to mark the e-mail message as read.

82. Kent teaches: receiving an automatic control message from the mobile terminal indicating that the user has read the e-mail message (see email server receiving signal or read receipt from mobile IP phone on page 3 section [0027]); and

83. in response to receiving the automatic control message, signaling the one of a plurality of e-mail servers to mark the e-mail message as read (see call routing system 116 and presence engine 132, see page 3 section [0026], relay read receipt information from the email servers 154 to other servers such as SMS server 152 and SOAP server 156 on page 3 section [0027] and Figure 1A).

84. Little and Kent are analogous art because they are from the same field of endeavor, wireless email terminal system. At the time of the invention it would have been obvious to a person of ordinary skill in the art to forward email read receipt to other communication servers. The motivation for doing so would have been to allow user to set preference for call routing (see page 3 section [0026] on Kent). Therefore, it would have been obvious to combine Little and Turunen and Osthoff and Kent for the benefit of read receipt and response forwarding to obtain the invention as specified in claim 1, 12.

85. Applicant's arguments filed on August 28, 2017 have been fully considered but they are not persuasive.

86. As per claims 23, 37, 55, the applicant asserts that Little and Turunen and Osthoff and Anttila do not disclose a "displayed service activation code" (see Remarks on page 12). The examiner respectfully disagrees.

87. Anttila teaches displaying optical visual code for short-range communication (see generate and send a short range communication visual code from one device to another for transferring data on page 2 section [0016] and see use of optical quick response (QR) code for security measure on page 2 section [0014]).

88. Turunen teaches receiving a service activation code (see activation message from the wireless terminal to set up linking of the email address to the wireless terminal on column 8 line 29-37 and see activation message from the wireless terminal to set up linking of the email address to the wireless terminal on column 8 line 29-37 and see



activation call the message server to define the wireless terminal of the right recipient on the basis of the e-mail address on column 8 line 40-45).

89. Anttila discloses “optically displaying” a “server activation code” as taught by Turunen as claimed.

Any inquiry concerning this communication or earlier communications from the examiner should be directed to ALAN S. CHOU whose telephone number is (571)272-5779. The examiner can normally be reached on 9am-5pm.

If attempts to reach the examiner by telephone are unsuccessful, the examiner’s supervisor, Christopher L. Parry can be reached on (571)272-8328. The fax phone number for the organization where this application or proceeding is assigned is 571-273-8300.

Information regarding the status of an application may be obtained from the Patent Application Information Retrieval (PAIR) system. Status information for published applications may be obtained from either Private PAIR or Public PAIR. Status information for unpublished applications is available through Private PAIR only. For more information about the PAIR system, see <http://pair-direct.uspto.gov>. Should you have questions on access to the Private PAIR system, contact the Electronic Business Center (EBC) at 866-217-9197 (toll-free). If you would like assistance from a USPTO Customer Service Representative or access to the automated information system, call 800-786-9199 (IN USA OR CANADA) or 571-272-1000.

ALAN S CHOU  
Examiner  
Art Unit 2451

/ALAN S CHOU/  
Primary Examiner, Art Unit 2451

<b>Notice of References Cited</b>	Application/Control No. 14/609,189	Applicant(s)/Patent Under Reexamination BACKHOLM ET AL.	
	Examiner ALAN S. CHOU	Art Unit 2451	Page 1 of 1

**U.S. PATENT DOCUMENTS**

*	Document Number Country Code-Number-Kind Code	Date MM-YYYY	Name	CPC Classification	US Classification	
*	A	US-2005/0152525 A1	07-2005	Kent, Larry G. JR.	H04M3/42374	379/207.02
	B	US-				
	C	US-				
	D	US-				
	E	US-				
	F	US-				
	G	US-				
	H	US-				
	I	US-				
	J	US-				
	K	US-				
	L	US-				
	M	US-				

**FOREIGN PATENT DOCUMENTS**

*	Document Number Country Code-Number-Kind Code	Date MM-YYYY	Country	Name	CPC Classification
	N				
	O				
	P				
	Q				
	R				
	S				
	T				

**NON-PATENT DOCUMENTS**

*	Include as applicable: Author, Title Date, Publisher, Edition or Volume, Pertinent Pages)
U	
V	
W	
X	

\*A copy of this reference is not being furnished with this Office action. (See MPEP § 707.05(a).)  
Dates in MM-YYYY format are publication dates. Classifications may be US or foreign.

<b>Index of Claims</b> 	<b>Application/Control No.</b> 14609189	<b>Applicant(s)/Patent Under Reexamination</b> BACKHOLM ET AL.
	<b>Examiner</b> ALAN S CHOU	<b>Art Unit</b> 2451

✓	<b>Rejected</b>
=	<b>Allowed</b>

-	<b>Cancelled</b>
÷	<b>Restricted</b>

N	<b>Non-Elected</b>
I	<b>Interference</b>

A	<b>Appeal</b>
O	<b>Objected</b>

Claims renumbered in the same order as presented by applicant
  CPA
  T.D.
  R.1.47

CLAIM		DATE								
Final	Original	09/25/2015	07/06/2016	11/01/2016	05/25/2017	10/27/2017				
	1	✓	✓	✓	✓	✓				
	2	✓	✓	✓	✓	✓				
	3	✓	✓	✓	✓	✓				
	4	✓	✓	✓	✓	✓				
	5	✓	✓	✓	✓	✓				
	6	✓	✓	✓	✓	✓				
	7	✓	✓	✓	✓	✓				
	8	✓	✓	✓	✓	✓				
	9	✓	✓	✓	✓	✓				
	10	✓	✓	✓	✓	✓				
	11	✓	✓	✓	✓	✓				
	12	✓	✓	✓	✓	✓				
	13	✓	✓	✓	✓	✓				
	14	✓	✓	✓	✓	✓				
	15	✓	✓	✓	✓	✓				
	16	✓	✓	✓	✓	✓				
	17	✓	✓	✓	✓	✓				
	18	✓	✓	✓	✓	✓				
	19	✓	✓	✓	✓	✓				
	20	✓	-	-	-	-				
	21		✓	✓	✓	-				
	22		✓	✓	✓	-				
	23		✓	✓	✓	✓				
	24		✓	✓	✓	✓				
	25		✓	✓	✓	✓				
	26		✓	✓	✓	✓				
	27		✓	✓	-	-				
	28		✓	✓	✓	✓				
	29		✓	✓	✓	✓				
	30		✓	✓	✓	✓				
	31		✓	✓	✓	✓				
	32		✓	✓	✓	✓				
	33		✓	✓	✓	✓				
	34		✓	✓	✓	✓				
	35		✓	✓	✓	✓				
	36		✓	✓	✓	✓				

<b><i>Index of Claims</i></b> 	<b>Application/Control No.</b> 14609189	<b>Applicant(s)/Patent Under Reexamination</b> BACKHOLM ET AL.
	<b>Examiner</b> ALAN S CHOU	<b>Art Unit</b> 2451

✓	<b>Rejected</b>	-	<b>Cancelled</b>	N	<b>Non-Elected</b>	A	<b>Appeal</b>
=	<b>Allowed</b>	÷	<b>Restricted</b>	I	<b>Interference</b>	O	<b>Objected</b>

Claims renumbered in the same order as presented by applicant
  CPA
  T.D.
  R.1.47

CLAIM		DATE										
Final	Original	09/25/2015	07/06/2016	11/01/2016	05/25/2017	10/27/2017						
	37		✓	✓	✓	✓						
	38		✓	✓	✓	✓						
	39		✓	✓	✓	✓						
	40		✓	✓	-	-						
	41		✓	✓	✓	✓						
	42		✓	✓	✓	✓						
	43		✓	✓	✓	✓						
	44		✓	✓	✓	✓						
	45		✓	✓	✓	✓						
	46		✓	✓	✓	✓						
	47		✓	✓	✓	✓						
	48		✓	✓	✓	✓						
	49		✓	✓	✓	✓						
	50		✓	✓	✓	✓						
	51		✓	✓	✓	✓						
	52		✓	✓	✓	✓						
	53		✓	✓	✓	✓						
	54		✓	✓	✓	-						
	55		✓	✓	✓	✓						
	56				✓	✓						
	57				✓	✓						
	58				✓	✓						

**EAST Search History**

**EAST Search History (Prior Art)**

Ref #	Hits	Search Query	DBs	Default Operator	Plurals	Time Stamp
L1	164	((Ari) near2 (Backholm)).INV.	US-PGPUB; USPAT	OR	OFF	2017/10/27 13:02
L2	1	"7706781".pn.	US-PGPUB; USPAT	OR	OFF	2017/10/27 13:02
L3	1	"7643818".pn.	US-PGPUB; USPAT	OR	OFF	2017/10/27 13:02
L4	2	"20040205248"	US-PGPUB; USPAT	OR	OFF	2017/10/27 13:02
L5	1	"7289792".pn.	US-PGPUB; USPAT	OR	OFF	2017/10/27 13:02
L6	1	"6745326".pn.	US-PGPUB; USPAT	OR	OFF	2017/10/27 13:02
L7	1	"20060265595"	US-PGPUB; USPAT	OR	OFF	2017/10/27 13:02
L8	10558	(709/206.ccls. g06q10/107.cpc. h04112/585.cpc. h04112/58.cpc.)AND (@AD<"20041122" @RLAD<"20041122")	US-PGPUB; USPAT	OR	OFF	2017/10/27 13:02
L9	9285	(email mail e-mail (electronic NEAR2 mail)) AND (709/206.ccls. g06q10/107.cpc. h04112/585.cpc. h04112/58.cpc.)AND (@AD<"20041122" @RLAD<"20041122")	US-PGPUB; USPAT	OR	OFF	2017/10/27 13:02
L10	1116	(encrypt\$6 AND decrypt\$6) AND (email mail e-mail (electronic NEAR2 mail)) AND (709/206.ccls. g06q10/107.cpc. h04112/585.cpc. h04112/58.cpc.)AND (@AD<"20041122" @RLAD<"20041122")	US-PGPUB; USPAT	OR	OFF	2017/10/27 13:02
L11	758	((terminal mobile client device phone) NEAR9 (code identifier id number)) AND (encrypt\$6 AND decrypt\$6) AND (email mail e-mail (electronic NEAR2 mail)) AND (709/206.ccls. g06q10/107.cpc. h04112/585.cpc. h04112/58.cpc.)AND (@AD<"20041122" @RLAD<"20041122")	US-PGPUB; USPAT	OR	OFF	2017/10/27 13:02
L12	55	(activat\$5 NEAR5 (code number identifier)) AND ((terminal mobile client device phone) NEAR9 (code identifier id number)) AND (encrypt\$6 AND decrypt\$6) AND (email mail e-mail (electronic NEAR2 mail)) AND (709/206.ccls. g06q10/107.cpc. h04112/585.cpc. h04112/58.cpc.)AND (@AD<"20041122" @RLAD<"20041122")	US-PGPUB; USPAT	OR	OFF	2017/10/27 13:02

L13	0	((temporary AND permanent) NEAR9 (code identifier id number)) AND (activat\$5 NEAR5 (code numberid identifier)) AND ((terminal mobile client device phone) NEAR9 (code identifier id number)) AND (encrypt\$6 AND decrypt\$6) AND (email mail e-mail (electronic NEAR2 mail)) AND (709/206.ccls. g06q10/107.cpc. h04112/585.cpc. h04112/58.cpc.)AND (@AD<"20041122" @RLAD<"20041122")	US-PGPUB; USPAT	OR	OFF	2017/10/27 13:02
L14	10	((temporary AND permanent) NEAR9 (code identifier id number)) AND (activat\$5 NEAR5 (code numberid identifier)) AND ((terminal mobile client device phone) NEAR9 (code identifier id number)) AND (encrypt\$6 AND decrypt\$6) AND (email mail e-mail (electronic NEAR2 mail)) AND (@AD<"20041122" @RLAD<"20041122")	US-PGPUB; USPAT	OR	OFF	2017/10/27 13:02
L15	21	((temporary AND permanent) NEAR9 (code identifier id number)) AND (activat\$5 NEAR5 (code number id identifier)) AND ((terminal mobile client device phone) NEAR9 (code identifier id number)) AND (encrypt\$6 AND decrypt\$6) AND (email mail e-mail (electronic NEAR2 mail)) AND (@AD<"20041122" @RLAD<"20041122")	US-PGPUB; USPAT	OR	OFF	2017/10/27 13:02
L16	1	"20150149575"	US-PGPUB; USPAT	OR	OFF	2017/10/27 13:02
L17	1	"20060031300"	US-PGPUB; USPAT	OR	OFF	2017/10/27 13:02
L18	1	"20130268384"	US-PGPUB; USPAT	OR	OFF	2017/10/27 13:02
L19	6	((temporary AND permanent) NEAR9 (encrypt\$6 AND decrypt\$6)) AND (email mail e-mail (electronic NEAR2 mail) )AND (@AD<"20041122" @RLAD<"20041122")	US-PGPUB; USPAT	OR	OFF	2017/10/27 13:02
L20	4	((temporary SAME (identifier id number)) NEAR9 (encrypt\$6 AND decrypt\$6)) AND (email mail e-mail (electronic NEAR2 mail) )AND (@AD<"20041122" @RLAD<"20041122")	US-PGPUB; USPAT	OR	OFF	2017/10/27 13:02
L21	292	((temp temporary tunnel) SAME (identifier id number)) SAME (client terminal) NEAR9 (encrypt\$6 decrypt\$6 creat\$4 generat\$4)) AND (email mail e-mail (electronic NEAR2 mail) )AND (@AD<"20041122" @RLAD<"20041122")	US-PGPUB; USPAT	OR	OFF	2017/10/27 13:02
L22	41	((temp temporary tunnel) NEAR9 (identifier id number)) NEAR9 (client terminal) NEAR9 (encrypt\$6 decrypt\$6 creat\$4 generat\$4)) AND (email mail e-mail (electronic NEAR2 mail) )AND (@AD<"20041122" @RLAD<"20041122")	US-PGPUB; USPAT	OR	OFF	2017/10/27 13:02
L23	0	((temp temporary tunnel) NEAR9 (identifier id number)) NEAR9 (client terminal) NEAR9 (encrypt\$6 decrypt\$6 creat\$4 generat\$4)) AND (bluetooth)AND (@AD<"20041122"	US-PGPUB; USPAT	OR	OFF	2017/10/27 13:02

		@RLAD<"20041122")				
L24	0	((activation) NEAR9 (identifier id number code)) NEAR9 (client terminal) NEAR9 (encrypt\$6 decrypt\$6 creat\$4 generat\$4)) AND (bluetooth) AND (@AD<"20041122" @RLAD<"20041122")	US-PGPUB; USPAT	OR	OFF	2017/10/27 13:02
L25	11	((activation) NEAR9 (identifier id number code)) NEAR9 (client terminal) NEAR9 (encrypt\$6 decrypt\$6 creat\$4 generat\$4)) AND (bluetooth bluetooth) AND (@AD<"20041122" @RLAD<"20041122")	US-PGPUB; USPAT	OR	OFF	2017/10/27 13:02
L26	1	"7289792".pn.	US-PGPUB; USPAT	OR	OFF	2017/10/27 13:02
L27	1	"20150149575"	US-PGPUB; USPAT	OR	OFF	2017/10/27 13:02
L28	647	(optical NEAR9 interface NEAR9 (client device)) AND (email mail e-mail (electronic NEAR2 mail) )AND (@AD<"20041122" @RLAD<"20041122")	US-PGPUB; USPAT	OR	OFF	2017/10/27 13:02
L29	641	(optical NEAR9 interface NEAR9 (device)) AND (email mail e-mail (electronic NEAR2 mail) )AND (@AD<"20041122" @RLAD<"20041122")	US-PGPUB; USPAT	OR	OFF	2017/10/27 13:02
L30	1	(optical NEAR9 interface NEAR9 (device) SAME (activation NEAR5 code)) AND (email mail e-mail (electronic NEAR2 mail) )AND (@AD<"20041122" @RLAD<"20041122")	US-PGPUB; USPAT	OR	OFF	2017/10/27 13:02
L31	1	(optical NEAR9 scanner SAME (activation NEAR5 code)) AND (email mail e-mail (electronic NEAR2 mail) )AND (@AD<"20041122" @RLAD<"20041122")	US-PGPUB; USPAT	OR	OFF	2017/10/27 13:02
L32	2	(optical NEAR9 interface SAME (activation NEAR5 code)) AND (email mail e-mail (electronic NEAR2 mail) )AND (@AD<"20041122" @RLAD<"20041122")	US-PGPUB; USPAT	OR	OFF	2017/10/27 13:02
L33	0	((QR NEAR9 code) SAME (activation NEAR5 code)) AND (email mail e-mail (electronic NEAR2 mail) )AND (@AD<"20041122" @RLAD<"20041122")	US-PGPUB; USPAT	OR	OFF	2017/10/27 13:02
L34	0	((quick NEAR5 response NEAR9 code) SAME (activation NEAR5 code)) AND (email mail e-mail (electronic NEAR2 mail) )AND (@AD<"20041122" @RLAD<"20041122")	US-PGPUB; USPAT	OR	OFF	2017/10/27 13:02
L35	0	((quick NEAR5 response NEAR9 code) SAME (activation)) AND (email mail e-mail (electronic NEAR2 mail) )AND (@AD<"20041122" @RLAD<"20041122")	US-PGPUB; USPAT	OR	OFF	2017/10/27 13:02
L36	59	((quick NEAR5 response NEAR9 code)) AND (email mail e-mail (electronic NEAR2 mail) )AND (@AD<"20041122" @RLAD<"20041122")	US-PGPUB; USPAT	OR	OFF	2017/10/27 13:02
L37	1	"8131572".pn.	US-PGPUB; USPAT	OR	OFF	2017/10/27 13:02
L38	113	"6496809"	US-PGPUB;	OR	OFF	2017/10/27 13:02



EAST Search History

			USPAT			
L39	1	"6496809".pn.	US-PGPUB; USPAT	OR	OFF	2017/10/27 13:02
L40	1	"9251518".pn.	US-PGPUB; USPAT	OR	OFF	2017/10/27 13:02
L41	3	(quick NEAR5 response NEAR9 code) SAME (email mail e-mail (electronic NEAR2 mail)) AND (@AD<"20041122" @RLAD<"20041122")	US-PGPUB; USPAT	OR	OFF	2017/10/27 13:02
L42	29	(quick NEAR5 response NEAR9 code) SAME (access security authoriz\$5 generat\$4) AND (@AD<"20041122" @RLAD<"20041122")	US-PGPUB; USPAT	OR	OFF	2017/10/27 13:02
L43	201	(read NEAR9 receipt ) NEAR9 (email mail e-mail (electronic NEAR2 mail) )AND (@AD<"20041122" @RLAD<"20041122")	US-PGPUB; USPAT	OR	OFF	2017/10/27 13:25
L44	35	((read NEAR9 receipt ) NEAR9 (email mail e-mail (electronic NEAR2 mail) ) SAME (mobile (terminal device)))AND (@AD<"20041122" @RLAD<"20041122")	US-PGPUB; USPAT	OR	OFF	2017/10/27 13:27
L45	35	((read NEAR9 receipt ) NEAR9 (email mail e-mail (electronic NEAR2 mail) ) SAME (mobile (terminal device))) AND (@AD<"20041122" @RLAD<"20041122")	US-PGPUB; USPAT	OR	OFF	2017/10/27 13:28

**EAST Search History (Interference)**

< This search history is empty >

**10/ 27/ 2017 2:38:22 PM**

**H:\ Workspaces\ 14609189.wsp**

<b>Search Notes</b>  	<b>Application/Control No.</b>  14609189	<b>Applicant(s)/Patent Under Reexamination</b>  BACKHOLM ET AL.
	<b>Examiner</b>  ALAN S CHOU	<b>Art Unit</b>  2451

<b>CPC- SEARCHED</b>		
Symbol	Date	Examiner
G06Q 10/107	9/24/2015	AC
H04L 12/585, 12/58	9/24/2015	AC

<b>CPC COMBINATION SETS - SEARCHED</b>		
Symbol	Date	Examiner

<b>US CLASSIFICATION SEARCHED</b>			
Class	Subclass	Date	Examiner
709	206	9/24/2015	AC

<b>SEARCH NOTES</b>		
Search Notes	Date	Examiner
EAST Search	9/24/2015	AC
Consulted with SPE Chris Parry regarding 101 issues for claims 1-20	9/24/2015	AC
Consulted with Primary Saket Daftuar regarding ODP issues for claims 1-20	9/25/2015	AC
Consulted with Primary Saket Daftuar regarding 112 6th issue with claim 12-19	9/25/2015	AC
EAST Search	7/5/2016	AC
Consulted with SPE Chris Parry regarding 101 amendments temporary identifier to making the language significantly more	7/20/2016	AC
EAST Search	11/1/2016	AC
EAST Search	5/25/2017	AC
EAST Search	10/27/2017	AC

<b>INTERFERENCE SEARCH</b>			
US Class/ CPC Symbol	US Subclass / CPC Group	Date	Examiner

--	--

**REQUEST FOR CONTINUED EXAMINATION(RCE)TRANSMITTAL  
 (Submitted Only via EFS-Web)**

Application Number	14609189	Filing Date	2015-01-29	Docket Number (if applicable)	455/006/8 UTIL	Art Unit	2451
First Named Inventor	Ari Backholm			Examiner Name	Chou, Alan S.		

**This is a Request for Continued Examination (RCE) under 37 CFR 1.114 of the above-identified application.** Request for Continued Examination (RCE) practice under 37 CFR 1.114 does not apply to any utility or plant application filed prior to June 8, 1995, to any international application that does not comply with the requirements of 35 U.S.C. 371, or to any design application. The Instruction Sheet for this form is located at WWW.USPTO.GOV.

**SUBMISSION REQUIRED UNDER 37 CFR 1.114**

Note: If the RCE is proper, any previously filed unentered amendments and amendments enclosed with the RCE will be entered in the order in which they were filed unless applicant instructs otherwise. If applicant does not wish to have any previously filed unentered amendment(s) entered, applicant must request non-entry of such amendment(s).

Previously submitted. If a final Office action is outstanding, any amendments filed after the final Office action may be considered as a submission even if this box is not checked.

Consider the arguments in the Appeal Brief or Reply Brief previously filed on \_\_\_\_\_

Other \_\_\_\_\_

Enclosed

Amendment/Reply

Information Disclosure Statement (IDS)

Affidavit(s)/ Declaration(s)

Other \_\_\_\_\_

**MISCELLANEOUS**

Suspension of action on the above-identified application is requested under 37 CFR 1.103(c) for a period of months \_\_\_\_\_ (Period of suspension shall not exceed 3 months; Fee under 37 CFR 1.17(i) required)

Other \_\_\_\_\_

**FEES**

**The RCE fee under 37 CFR 1.17(e) is required by 37 CFR 1.114 when the RCE is filed.**

The Director is hereby authorized to charge any underpayment of fees, or credit any overpayments, to Deposit Account No 506191

**SIGNATURE OF APPLICANT, ATTORNEY, OR AGENT REQUIRED**

Patent Practitioner Signature

Applicant Signature

Doc code: RCEX

Doc description: Request for Continued Examination (RCE)

PTO/SB/30EFS (07-14)

Approved for use through 07/31/2016. OMB 0651-0031

U.S. Patent and Trademark Office; U.S. DEPARTMENT OF COMMERCE

Under the Paperwork Reduction Act of 1995, no persons are required to respond to a collection of information unless it contains a valid OMB control number.

Signature of Registered U.S. Patent Practitioner			
Signature	Justin R. Nifong/	Date (YYYY-MM-DD)	2017-08-28
Name	Justin R. Nifong	Registration Number	59389

This collection of information is required by 37 CFR 1.114. The information is required to obtain or retain a benefit by the public which is to file (and by the USPTO to process) an application. Confidentiality is governed by 35 U.S.C. 122 and 37 CFR 1.11 and 1.14. This collection is estimated to take 12 minutes to complete, including gathering, preparing, and submitting the completed application form to the USPTO. Time will vary depending upon the individual case. Any comments on the amount of time you require to complete this form and/or suggestions for reducing this burden, should be sent to the Chief Information Officer, U.S. Patent and Trademark Office, U.S. Department of Commerce, P.O. Box 1450, Alexandria, VA 22313-1450.

*If you need assistance in completing the form, call 1-800-PTO-9199 and select option 2.*

## Privacy Act Statement

The Privacy Act of 1974 (P.L. 93-579) requires that you be given certain information in connection with your submission of the attached form related to a patent application or patent. Accordingly, pursuant to the requirements of the Act, please be advised that: (1) the general authority for the collection of this information is 35 U.S.C. 2(b)(2); (2) furnishing of the information solicited is voluntary; and (3) the principal purpose for which the information is used by the U.S. Patent and Trademark Office is to process and/or examine your submission related to a patent application or patent. If you do not furnish the requested information, the U.S. Patent and Trademark Office may not be able to process and/or examine your submission, which may result in termination of proceedings or abandonment of the application or expiration of the patent.

The information provided by you in this form will be subject to the following routine uses:

1. The information on this form will be treated confidentially to the extent allowed under the Freedom of Information Act (5 U.S.C. 552) and the Privacy Act (5 U.S.C. 552a). Records from this system of records may be disclosed to the Department of Justice to determine whether the Freedom of Information Act requires disclosure of these records.
2. A record from this system of records may be disclosed, as a routine use, in the course of presenting evidence to a court, magistrate, or administrative tribunal, including disclosures to opposing counsel in the course of settlement negotiations.
3. A record in this system of records may be disclosed, as a routine use, to a Member of Congress submitting a request involving an individual, to whom the record pertains, when the individual has requested assistance from the Member with respect to the subject matter of the record.
4. A record in this system of records may be disclosed, as a routine use, to a contractor of the Agency having need for the information in order to perform a contract. Recipients of information shall be required to comply with the requirements of the Privacy Act of 1974, as amended, pursuant to 5 U.S.C. 552a(m).
5. A record related to an International Application filed under the Patent Cooperation Treaty in this system of records may be disclosed, as a routine use, to the International Bureau of the World Intellectual Property Organization, pursuant to the Patent Cooperation Treaty.
6. A record in this system of records may be disclosed, as a routine use, to another federal agency for purposes of National Security review (35 U.S.C. 181) and for review pursuant to the Atomic Energy Act (42 U.S.C. 218(c)).
7. A record from this system of records may be disclosed, as a routine use, to the Administrator, General Services, or his/her designee, during an inspection of records conducted by GSA as part of that agency's responsibility to recommend improvements in records management practices and programs, under authority of 44 U.S.C. 2904 and 2906. Such disclosure shall be made in accordance with the GSA regulations governing inspection of records for this purpose, and any other relevant (i.e., GSA or Commerce) directive. Such disclosure shall not be used to make determinations about individuals.
8. A record from this system of records may be disclosed, as a routine use, to the public after either publication of the application pursuant to 35 U.S.C. 122(b) or issuance of a patent pursuant to 35 U.S.C. 151. Further, a record may be disclosed, subject to the limitations of 37 CFR 1.14, as a routine use, to the public if the record was filed in an application which became abandoned or in which the proceedings were terminated and which application is referenced by either a published application, an application open to public inspections or an issued patent.
9. A record from this system of records may be disclosed, as a routine use, to a Federal, State, or local law enforcement agency, if the USPTO becomes aware of a violation or potential violation of law or regulation.

**COMMUNICATION TO THE UNITED STATES PATENT AND TRADEMARK OFFICE**

Appl. No. : 14/609,189 Confirmation No. 5037  
Applicant : Seven Networks, LLC  
Inventor : Ari Backholm *et al.*  
Filed : 2015-01-29  
TC/A.U. : 2451  
Examiner : Chou, Alan S  
Docket No. : 455/006/8 UTIL  
Customer No. : 118194

Via EFS Web – Electronic Filing  
Mail Stop RCE  
Commissioner for Patents  
P.O. Box 1450  
Alexandria, VA 22313-1450

**REQUEST FOR CONTINUED EXAMINATION,**  
**AND, AMENDMENT AND RESPONSE TO FINAL OFFICE ACTION**  
**AND ADVISORY ACTION**

Examiner:

**Amendments to the Claims** begin on page 2 of this paper.

**Remarks** begin on page 10 of this paper.

**AMENDMENTS TO THE CLAIMS**

1. (Currently Amended) A method for forwarding an e-mail message from one of a plurality of e-mail servers to a mobile terminal, the method comprising:

receiving, at an intermediary system, an e-mail message associated with an e-mail address of a user of a mobile terminal and sent by one of a plurality of e-mail servers,

wherein the e-mail address is associated with an identifier of the mobile terminal,

wherein an email account, associated with the email address, is hosted by one of the plurality of e-mail servers, and

wherein the identifier is generated by the mobile terminal;

encrypting the e-mail message using encryption information associated with a temporary identifier,

wherein the temporary identifier is based on a connection to the mobile terminal; and

transmitting the encrypted e-mail message to the mobile terminal;

receiving an automatic control message from the mobile terminal indicating that the user has read the e-mail message; and

in response to receiving the automatic control message, signaling the one of a plurality of e-mail servers to mark the e-mail message as read.

2. (Previously Presented) The method of claim 1, further comprising identifying the mobile terminal based on the e-mail address of the e-mail message and the association with the identifier of the mobile terminal.

3. (Previously Presented) The method of claim 1, wherein encrypting the e-mail message further comprises packing the e-mail message by omitting at least part of the e-mail message when at least part of the e-mail message exceeds a predetermined size specification.

4. (Previously Presented) The method of claim 3, wherein size specification is set by a user of the mobile terminal.

5. (Previously Presented) The method of claim 3, wherein the omitted part of the e-mail

message is the e-mail address.

6. (Previously Presented) The method of claim 2, further comprising adding the e-mail address to a reply message sent by the mobile terminal.

7. (Previously Presented) The method of claim 1, further comprising receiving the encryption information generated by the mobile terminal.

8. (Previously Presented) The method of claim 1, wherein the encryption information is based on an activation code of the mobile terminal.

9. (Previously Presented) The method of claim 1, wherein a messaging center transmits the e-mail message to the mobile terminal using the identifier of the mobile terminal.

10. (Previously Presented) The method of claim 1, wherein mobile terminal receives and decrypts the e-mail message using the encryption information.

11. (Previously Presented) The method of claim 3, wherein the mobile terminal unpacks the e-mail message.

12. (Currently Amended) A system for forwarding an e-mail message from one of a plurality of e-mail servers to a mobile terminal, the system comprising:

a memory configured for storing at least one of an e-mail address of a user of a mobile terminal, and an identifier;

wherein the e-mail address is associated with the identifier,

wherein an email account, associated with the email address, is hosted by one of the plurality of e-mail servers, and

wherein the mobile terminal generates the identifier,

a processor configured for:

encrypting the e-mail message using encryption information associated with a temporary identifier, wherein the e-mail message is received from one of a plurality of e-



mail servers;

identifying the mobile terminal based on the identifier of the mobile terminal; and  
transmitting the encrypted e-mail message to the identified mobile terminal,

wherein the temporary identifier is based on a connection to the mobile terminal;

receiving an automatic control message from the mobile terminal indicating that  
the user has read the e-mail message; and

in response to receiving the automatic control message, signaling the one of a  
plurality of e-mail servers to mark the e-mail message as read,

wherein the system is an intermediary system between the plurality of e-mail  
servers and the mobile terminal.

13. (Previously Presented) The system of claim 12, wherein the processor is further  
configured to receive the e-mail message from the one of a plurality of e-mail servers.

14. (Previously Presented) The system of claim 12, wherein the processor is further  
configured to receive the encryption information and to provide the encryption information to the  
memory for storage.

15. (Previously Presented) The system of claim 12, wherein the processor is further  
configured to pack the e-mail message.

16. (Previously Presented) The system of claim 15, wherein the processor is further  
configured to omit at least part of the e-mail message when the at least part of the e-mail message  
exceeds a predetermined size specification.

17. (Previously Presented) The system of claim 16, wherein the processor is further  
configured to receive user input concerning the size specification.

18. (Previously Presented) The system of claim 12, wherein the mobile terminal receives  
and decrypts the e-mail message using the encryption information.

19. (Previously Presented) The system of claim 18, wherein the mobile terminal unpacks the message.

20. (Canceled)

21. (Canceled)

22. (Canceled)

23. (Previously Presented) A device comprising:  
a radio;  
a processor and memory containing instructions executable by the processor whereby the device is operable to:

optically receive information including a displayed service activation code from a remote device;

register the remote device for access to a messaging account using the service activation code;

receive a message for the messaging account;

encrypt the message using an encryption key; and

send the message to the remote device,

wherein the device is authenticated to access the messaging account.

24. (Previously Presented) The device of claim 23, wherein the information including the service activation code is received by the device in response to user input at the remote device.

25. (Previously Presented) The device of claim 23, wherein the information including the service activation code is received by the device in an off-line communication.

26. (Previously Presented) The device of claim 25, wherein the off-line communication involves a local connection.

27. (Canceled)

28. (Previously Presented) The device of claim 25, wherein the off-line communication prevents eavesdropping of the service activation code.

29. (Previously Presented) The device of claim 23, wherein the authentication of the device relies on the authentication of the messaging account.

30. (Previously Presented) The device of claim 29, wherein the authentication of the messaging account includes a username and password.

31. (Previously Presented) The device of claim 23, wherein the encryption key is the service activation code.

32. (Previously Presented) The device of claim 23, wherein the encryption key is derived from the service activation code.

33. (Previously Presented) The device of claim 23, wherein the encryption key is a subset of the service activation code.

34. (Previously Presented) The device of claim 23, wherein the encryption key is closely related to the service activation code.

35. (Previously Presented) The device of claim 23, wherein the device is further operable to:

store an association between at least two of the encryption key, the messaging account, an identifier of the remote device, and the service activation code.

36. (Previously Presented) The device of claim 23, wherein the message is sent to the remote device through an intermediate device.

37. (Previously Presented) A method for sharing a messaging account, the method comprising:

- authenticating a device for access to the messaging account;
- optically receiving information including a displayed service activation code from a remote device;
- registering the remote device for access to the messaging account using the service activation code;
- receiving a message for the messaging account;
- encrypting the message using an encryption key; and
- sending the message to the remote device.

38. (Previously Presented) The method of claim 37, wherein the information including the service activation code is received by the device in response to user input at the remote device.

39. (Previously Presented) The method of claim 38, wherein the information including the service activation code is received by the device in an off-line communication.

40. (Canceled)

41. (Previously Presented) The method of claim 39, wherein the off-line communication prevents eavesdropping of the service activation code.

42. (Previously Presented) The method of claim 37, wherein the authentication of the device relies on the authentication of the messaging system.

43. (Previously Presented) The method of claim 42, wherein the authentication of the messaging system includes a username and password.

44. (Previously Presented) The method of claim 37, wherein the encryption key is the service activation code.

45. (Previously Presented) The method of claim 37, wherein the encryption key is derived from the service activation code.

46. (Previously Presented) The method of claim 37, wherein the encryption key is a subset of the service activation code.

47. (Previously Presented) The method of claim 37, wherein the encryption key is closely related to the service activation code.

48. (Previously Presented) The method of claim 37, wherein the method further comprises:

storing an association between the encryption key, the messaging account, an identifier of the remote device, and the service activation code.

49. (Previously Presented) The device of claim 36, wherein the encryption key is associated with a temporary identifier, wherein the temporary identifier is based on a connection to the intermediate device.

50. (Previously Presented) The method of claim 37, wherein the message is sent to the remote device through an intermediate device.

51. (Previously Presented) The method of claim 37, wherein the encryption key is associated with a temporary identifier, wherein the temporary identifier is based on a connection to the intermediary device.

52. (Previously Presented) The method of claim 1, wherein the identifier is associated with the temporary identifier.

53. (Previously Presented) The system of claim 12, wherein the identifier is associated with the temporary identifier.

54. (Canceled)

55. (Previously Presented) A non-transient computer-readable medium containing program instructions for causing a device to perform a method, the method comprising:

optically receiving information including a displayed service activation code from a remote device;

registering the remote device for access to a messaging account using the service activation code;

receiving a message for the messaging account;

encrypting the message using an encryption key; and

sending the message to the remote device,

wherein the device is authenticated to access the messaging account.

56. (Previously Presented) The device of claim 23, wherein a control message is received from the remote device upon user interaction with the message.

57. (Previously Presented) The method of claim 37, wherein a control message is received from the remote device upon user interaction with the message.

58. (Previously Presented) The method of claim 55, wherein a control message is received from the remote device upon user interaction with the message.

### **REMARKS**

This paper is responsive to the final Office Action mailed June 1, 2017 and the Advisory Action mailed August 22, 2017. A Request for Continued Examination is submitted herewith.

Claims 1-19, 21-26, 28-39, and 41-58 were previously pending. Claim 20, 27, and 40 were previously canceled. Claims 21-22 and 54 are canceled herein. Claims 1 and 12 are amended herein. No new claims are added herein. Accordingly, claims 1-19, 23-26, 28-39, 41-53, and 55-58 remain pending.

### **Double Patenting**

In the Office Action, claims 1-20 stand rejected on the ground of nonstatutory double patenting as being unpatentable over claim 1 of U.S. Patent No. 7,706,781 and U.S. Patent No. 7,643,818. A Terminal Disclaimer was previously filed.

### **Claims Rejections under 35 U.S.C. § 103(a)**

In the Office Action, claims 1-2, 6-10, 12-15, 18, 21-22, 52-54 stand rejected under 35 USC 103(a) as being unpatentable over Little, in view of Turunen, and further in view of Osthoff.

Independent claim 1 has been amended herein to recite the following feature:

receiving an automatic control message indicating that the user has read the e-mail message; and

in response to receiving the automatic control message, signaling the one of a plurality of e-mail servers to mark the e-mail message as read.

Support for this amendment may be found in at least the following paragraph of the Applicant's specification:

*[0034] In step 3-16 the mobile terminal 102 sends the messaging centre 110 an automatic control message indicating that the user has read the e-mail message. In response to the control message, the messaging centre 110 signals the e-mail server 108 to mark the e-mail message as read in step 3-17, which act the e-mail server performs in step 3-18. The control message comprises some identification of the e-mail message but not its contents, whereby it loads the radio interface only lightly. A benefit of the control message is that the user, when beginning to*

*user the host system 100, immediately sees which messages he/she has already read and does not have to read them twice.*

Independent claim 12 has been amended to include features similar to claim 1.

Independent claims 21-22, and 54 have been canceled without prejudice to expedite prosecution.

Nowhere does Little, Turunen, or Osthoff disclose or suggest the above feature. Likewise, Giobbi, Solonen, Anttila, and Kock fail to disclose or suggest the above feature. Applicant submits that independent claims 1 and 12 are patentable over the cited references.

Claims 2, 6-10, 13-15, 18, 52, and 53 depend, either directly or indirectly, from independent claims 1 and 12; and are allowable for at least the same reasons.

Accordingly, it is respectfully submitted that the rejection of claims 1-2, 6-10, 12-15, 18, and 52-53 be withdrawn.

In the Office Action, claims 3-5, 11, 16-17, and 19 stand rejected under 35 USC 103(a) as being unpatentable over Little in view of Turunen, further in view of Osthoff, and further in view of Kock.

Claims 3-5, 11, 16-17, and 19 depend, either directly or indirectly, from independent claims 1 and 12; and are allowable for at least the same reasons.

Accordingly, it is respectfully submitted that the rejection of claims 3-5, 11, 16-17, and 19 be withdrawn.

In the Office Action, claims 23-24, 37-38, and 55 stand rejected under 35 USC 103(a) as being unpatentable over Little in view of Turunen, further in view of Osthoff, and further in view of Anttila. Applicant respectfully traverses.

The Patent Office has not presented a “*prima facie* conclusion of obviousness”. Instead Anttila fails to teach, and actually teaches away from the following features of independent claims 23, 37, and 55:

*optically receive information including a displayed service activation code from a remote device;*

*register the remote device for access to a messaging account using the service activation code;*



When rejecting a claim under 35 USC 103, the Patent Office must either show that the prior art references teach or suggest all limitations of the claim or explain the difference(s) between the prior art and the claimed invention would have been obvious to one of ordinary skill in the art. Anttila fails to teach *optically receive information including a displayed service activation code from a remote device*. No other reference is used to render the deficiencies of Anttila. The Patent Office cannot simply assert that this limitation would be obvious. The burden of proof is on the Patent Office, which has not provided any evidence that this limitation would be obvious in light of Anttila or any other reference for that matter. As such, the rejection based on Anttila is improper and should be withdrawn.

As further evidence of Anttila's failings, Anttila teaches away from the claimed invention. In particular, Anttila teaches in paragraph [0016] towards *establishing short-range communication between digital devices*. Anttila further discloses in paragraph [0016] *capturing and decoding the visual code and initiating a short-range communication link between the second digital device and the first digital device for the purpose of transferring the data element from the first digital device to the second digital device*. The desired result of Anttila is to establish *short-range communication for the purpose of transferring the data element from the first digital device to the second digital device*. This is further evidenced by Anttila's disclosure of: *implemented on a first digital device, for generating and displaying a visual code that encodes an address of the first digital device and a predetermined data element location identifier*.

In contrast and as disclosed in paragraph [0029] of the Applicant's Specification, a *displayed service activation code* is received and used to *register the remote device for access to a messaging account using the service activation code*. As further disclosed in paragraph [0029], to *register to a messaging account, the service activation code* must relay information to the host system *such as user name and password combination*. While the claims 23, 37, and 55 recite *optically receives information including a displayed service activation code from a remote device and registers the remote device for access to a messaging account using the service activation code, the cited reference Anttila discloses a visual code and initiating a short-range communication link ... for the purpose of transferring the data element from the first digital device to the second digital device*.

Summarizing, Anttila fails to provide a device *whereby the device is operable to: optically receive information including a displayed service activation code from a remote*

*device; and register the remote device for access to a messaging account using the service activation code.* There is no suggestion in Anttila to configure a device in this manner. Further, Anttila teaches away from receiving a *service activation code* and registering *the remote device for access to a messaging account using the service activation code.* As such, claims 23, 37, and 55 are not rendered obvious in light of Anttila.

Additionally the Patent Office has stated in the Office Action that previously cited references Little, Turunen, and Osthoff do not teach expressly: *optically receive information including a displayed service activation code from a remote device.* Likewise, Giobbi, Solonen, and Kock fail to disclose or suggest the above feature.

Applicant submits that claims 23, 37, and 55 are patentable over the cited references for at least the above reasons

Claims 24 and 38 depend directly from independent claims 23 and 37; and are allowable for at least the same reasons.

Accordingly, it is respectfully submitted that the rejection of claims 23-24, 37-38, and 55 be withdrawn.

In the Office Action, claims 25-26, 28-36, 39, 41-51, and 56-58 stand rejected under 35 USC 103(a) as being unpatentable over Little, in view of Turunen, further in view of Osthoff, further in view of Anttila, and further in view of Salonen.

Claims 25-26, 28-36, 39, 41-51, and 56-58 depend, either directly or indirectly, from independent claims 23, 37, and 55; and are allowable for at least the same reasons.

Further, in response to the rejection of claims 56-58, Applicant respectfully traverses. The Office Action states that *a control message is received from the remote device upon user interaction with the message* of claims 56-58 is disclosed in the following in Figure 3 and the following paragraph [0046] of Anttila:

*[0046] Once the communication link has been established between the devices, optional steps 460, 470 and 480 may ensue. At step 460, the second digital device initiates communication with the first digital device by automatically launching the requisite communication application. At step 470, a confirmation process may occur at the first device, whereby the first device confirms that the second device*

Response to FOA mailed June 1, 2017 and AA mailed August 22, 2017  
Appl. No. 14/609,189

*has been granted authorization to access the data element. At step 480, the data element is transferred from the first device to the second device. Transferring may entail moving the data element from the first device to the second device or it may entail copying the data element from the first device and subsequent communication to the second device.*

Nowhere does Anttila disclose *a control message is received from the remote device upon user interaction with the message*

Accordingly, it is respectfully submitted that the rejection of claims 25-26, 28-36, 39, 41-51, and 56-58 be withdrawn.

### **DEPOSIT ACCOUNT**

The Commissioner is hereby authorized to charge any otherwise unpaid fees associated with the filing of this correspondence to Deposit Account No. 50-6191.

Date: August 28, 2017

Respectfully submitted,

/Justin R. Nifong/  
Justin R. Nifong  
Reg. No. 59,389

NK Patent Law  
4917 Waters Edge Drive, Suite 275  
Raleigh, NC 27606  
Telephone: (919) 348-2194  
Facsimile: (919) 882-8195

Customer No. 118194

## Electronic Patent Application Fee Transmittal

<b>Application Number:</b>	14609189			
<b>Filing Date:</b>	29-Jan-2015			
<b>Title of Invention:</b>	Messaging centre for forwarding e-mail			
<b>First Named Inventor/Applicant Name:</b>	Ari Backholm			
<b>Filer:</b>	Justin Robert Nifong/Donna Donovan			
<b>Attorney Docket Number:</b>	455/006/8 UTIL			
Filed as Small Entity				
<b>Filing Fees for Utility under 35 USC 111(a)</b>				
<b>Description</b>	<b>Fee Code</b>	<b>Quantity</b>	<b>Amount</b>	<b>Sub-Total in USD(\$)</b>
<b>Basic Filing:</b>				
<b>Pages:</b>				
<b>Claims:</b>				
<b>Miscellaneous-Filing:</b>				
<b>Petition:</b>				
<b>Patent-Appeals-and-Interference:</b>				
<b>Post-Allowance-and-Post-Issuance:</b>				
<b>Extension-of-Time:</b>				

Description	Fee Code	Quantity	Amount	Sub-Total in USD(\$)
<b>Miscellaneous:</b>				
RCE- 2ND AND SUBSEQUENT REQUEST	2820	1	850	850
<b>Total in USD (\$)</b>				<b>850</b>

<b>Electronic Acknowledgement Receipt</b>	
<b>EFS ID:</b>	30194284
<b>Application Number:</b>	14609189
<b>International Application Number:</b>	
<b>Confirmation Number:</b>	5037
<b>Title of Invention:</b>	Messaging centre for forwarding e-mail
<b>First Named Inventor/Applicant Name:</b>	Ari Backholm
<b>Customer Number:</b>	118194
<b>Filer:</b>	Justin Robert Nifong/Donna Donovan
<b>Filer Authorized By:</b>	Justin Robert Nifong
<b>Attorney Docket Number:</b>	455/006/8 UTIL
<b>Receipt Date:</b>	28-AUG-2017
<b>Filing Date:</b>	29-JAN-2015
<b>Time Stamp:</b>	09:55:42
<b>Application Type:</b>	Utility under 35 USC 111(a)

**Payment information:**

Submitted with Payment	yes
Payment Type	CARD
Payment was successfully received in RAM	\$850
RAM confirmation Number	082817INTEFSW09561300
Deposit Account	506191
Authorized User	Justin Nifong

The Director of the USPTO is hereby authorized to charge indicated fees and credit any overpayment as follows:

37 CFR 1.16 (National application filing, search, and examination fees)

37 CFR 1.17 (Patent application and reexamination processing fees)

37 CFR 1.19 (Document supply fees)  
 37 CFR 1.20 (Post Issuance fees)  
 37 CFR 1.21 (Miscellaneous fees and charges)

**File Listing:**

Document Number	Document Description	File Name	File Size(Bytes)/ Message Digest	Multi Part /.zip	Pages (if appl.)
1	Request for Continued Examination (RCE)	455-006-8UTIL-20170828-RCE.pdf	1349859 597914737ddf1ca52d60e8a628a40025dec eb541	no	3

**Warnings:**

**Information:**

2		455-006-8UTIL-20170828-RCE_Rsp-to-FOA-dtd-06-01-2017.pdf	69533 48226b84c1e7a7b37c315d264391b44c416 7326a	yes	14
---	--	--	---	-----	----

**Multipart Description/PDF files in .zip description**

Document Description	Start	End
Response After Final Action	1	1
Claims	2	9
Applicant Arguments/Remarks Made in an Amendment	10	14

**Warnings:**

**Information:**

3	Fee Worksheet (SB06)	fee-info.pdf	30549 35d5f069b2a13207bf5bef8d8207cc0ea908 c92d	no	2
---	----------------------	--------------	---	----	---

**Warnings:**

**Information:**

**Total Files Size (in bytes):** 1449941

**This Acknowledgement Receipt evidences receipt on the noted date by the USPTO of the indicated documents, characterized by the applicant, and including page counts, where applicable. It serves as evidence of receipt similar to a Post Card, as described in MPEP 503.**

**New Applications Under 35 U.S.C. 111**

**If a new application is being filed and the application includes the necessary components for a filing date (see 37 CFR 1.53(b)-(d) and MPEP 506), a Filing Receipt (37 CFR 1.54) will be issued in due course and the date shown on this Acknowledgement Receipt will establish the filing date of the application.**

**National Stage of an International Application under 35 U.S.C. 371**

**If a timely submission to enter the national stage of an international application is compliant with the conditions of 35 U.S.C. 371 and other applicable requirements a Form PCT/DO/EO/903 indicating acceptance of the application as a national stage submission under 35 U.S.C. 371 will be issued in addition to the Filing Receipt, in due course.**

**New International Application Filed with the USPTO as a Receiving Office**

**If a new international application is being filed and the international application includes the necessary components for an international filing date (see PCT Article 11 and MPEP 1810), a Notification of the International Application Number and of the International Filing Date (Form PCT/RO/105) will be issued in due course, subject to prescriptions concerning national security, and the date shown on this Acknowledgement Receipt will establish the international filing date of the application.**



Under the Paperwork Reduction Act of 1995, no persons are required to respond to a collection of information unless it displays a valid OMB control number.

<b>PATENT APPLICATION FEE DETERMINATION RECORD</b> Substitute for Form PTO-875			Application or Docket Number <b>14/609,189</b>	Filing Date <b>01/29/2015</b>	<input type="checkbox"/> To be Mailed
ENTITY: <input type="checkbox"/> LARGE <input checked="" type="checkbox"/> SMALL <input type="checkbox"/> MICRO					
<b>APPLICATION AS FILED – PART I</b>					
(Column 1)		(Column 2)			
FOR	NUMBER FILED	NUMBER EXTRA	RATE (\$)	FEE (\$)	
<input type="checkbox"/> BASIC FEE <small>(37 CFR 1.16(a), (b), or (c))</small>	N/A	N/A	N/A		
<input type="checkbox"/> SEARCH FEE <small>(37 CFR 1.16(k), (l), or (m))</small>	N/A	N/A	N/A		
<input type="checkbox"/> EXAMINATION FEE <small>(37 CFR 1.16(o), (p), or (q))</small>	N/A	N/A	N/A		
TOTAL CLAIMS <small>(37 CFR 1.16(j))</small>	minus 20 =	*	X \$ =		
INDEPENDENT CLAIMS <small>(37 CFR 1.16(h))</small>	minus 3 =	*	X \$ =		
<input type="checkbox"/> APPLICATION SIZE FEE <small>(37 CFR 1.16(s))</small>	If the specification and drawings exceed 100 sheets of paper, the application size fee due is \$310 (\$155 for small entity) for each additional 50 sheets or fraction thereof. See 35 U.S.C. 41(a)(1)(G) and 37 CFR 1.16(s).				
<input type="checkbox"/> MULTIPLE DEPENDENT CLAIM PRESENT <small>(37 CFR 1.16(j))</small>					
* If the difference in column 1 is less than zero, enter "0" in column 2.			TOTAL		

<b>APPLICATION AS AMENDED – PART II</b>								
(Column 1)		(Column 2)		(Column 3)				
<b>AMENDMENT</b>	<b>08/28/2017</b>	CLAIMS REMAINING AFTER AMENDMENT		HIGHEST NUMBER PREVIOUSLY PAID FOR	PRESENT EXTRA	RATE (\$)	ADDITIONAL FEE (\$)	
	Total (37 CFR 1.16(i))	* 52	Minus	** 56	= 0	X \$40 =	0	
	Independent (37 CFR 1.16(h))	* 5	Minus	***8	= 0	X \$210 =	0	
	<input type="checkbox"/> Application Size Fee (37 CFR 1.16(s))							
	<input type="checkbox"/> FIRST PRESENTATION OF MULTIPLE DEPENDENT CLAIM (37 CFR 1.16(j))							
TOTAL ADD'L FEE						<b>0</b>		

(Column 1)		(Column 2)		(Column 3)				
<b>AMENDMENT</b>		CLAIMS REMAINING AFTER AMENDMENT		HIGHEST NUMBER PREVIOUSLY PAID FOR	PRESENT EXTRA	RATE (\$)	ADDITIONAL FEE (\$)	
	Total (37 CFR 1.16(i))	*	Minus	**	=	X \$ =		
	Independent (37 CFR 1.16(h))	*	Minus	***	=	X \$ =		
	<input type="checkbox"/> Application Size Fee (37 CFR 1.16(s))							
	<input type="checkbox"/> FIRST PRESENTATION OF MULTIPLE DEPENDENT CLAIM (37 CFR 1.16(j))							
TOTAL ADD'L FEE								
* If the entry in column 1 is less than the entry in column 2, write "0" in column 3.						LIE /JACQUELYN WILLIAMS/		
** If the "Highest Number Previously Paid For" IN THIS SPACE is less than 20, enter "20".								
*** If the "Highest Number Previously Paid For" IN THIS SPACE is less than 3, enter "3".								
The "Highest Number Previously Paid For" (Total or Independent) is the highest number found in the appropriate box in column 1.								

This collection of information is required by 37 CFR 1.16. The information is required to obtain or retain a benefit by the public which is to file (and by the USPTO to process) an application. Confidentiality is governed by 35 U.S.C. 122 and 37 CFR 1.14. This collection is estimated to take 12 minutes to complete, including gathering, preparing, and submitting the completed application form to the USPTO. Time will vary depending upon the individual case. Any comments on the amount of time you require to complete this form and/or suggestions for reducing this burden, should be sent to the Chief Information Officer, U.S. Patent and Trademark Office, U.S. Department of Commerce, P.O. Box 1450, Alexandria, VA 22313-1450. DO NOT SEND FEES OR COMPLETED FORMS TO THIS ADDRESS. **SEND TO: Commissioner for Patents, P.O. Box 1450, Alexandria, VA 22313-1450.**  
 If you need assistance in completing the form, call 1-800-PTO-9199 and select option 2.



UNITED STATES PATENT AND TRADEMARK OFFICE

UNITED STATES DEPARTMENT OF COMMERCE
United States Patent and Trademark Office
Address: COMMISSIONER FOR PATENTS
P. O. Box 1450
Alexandria, Virginia 22313-1450
www.uspto.gov

Table with columns: APPLICATION NO., FILING DATE, FIRST NAMED INVENTOR, ATTORNEY DOCKET NO., CONFIRMATION NO., EXAMINER, ART UNIT, PAPER NUMBER, NOTIFICATION DATE, DELIVERY MODE. Includes application details for Ari Backholm and examiner Chou, Alan S.

Please find below and/or attached an Office communication concerning this application or proceeding.

The time period for reply, if any, is set in the attached communication.

Notice of the Office communication was sent electronically on above-indicated "Notification Date" to the following e-mail address(es):

usptomail@nkpatentlaw.com
abackholm@seven.com
eofficeaction@apcoll.com

<b>Advisory Action Before the Filing of an Appeal Brief</b>	<b>Application No.</b> 14/609,189	<b>Applicant(s)</b> BACKHOLM ET AL.	
	<b>Examiner</b> ALAN S. CHOU	<b>Art Unit</b> 2451	<b>AIA (First Inventor to File) Status</b> No

**--The MAILING DATE of this communication appears on the cover sheet with the correspondence address --**

THE REPLY FILED 01 August 2017 FAILS TO PLACE THIS APPLICATION IN CONDITION FOR ALLOWANCE.  
NO NOTICE OF APPEAL FILED

1.  The reply was filed after a final rejection. No Notice of Appeal has been filed. To avoid abandonment of this application, applicant must timely file one of the following replies: (1) an amendment, affidavit, or other evidence, which places the application in condition for allowance;  
(2) a Notice of Appeal (with appeal fee) in compliance with 37 CFR 41.31; or (3) a Request for Continued Examination (RCE) in compliance with 37 CFR 1.114 if this is a utility or plant application. Note that RCEs are not permitted in design applications. The reply must be filed within one of the following time periods:
- a)  The period for reply expires \_\_\_\_\_ months from the mailing date of the final rejection.
- b)  The period for reply expires on: (1) the mailing date of this Advisory Action; or (2) the date set forth in the final rejection, whichever is later. In no event, however, will the statutory period for reply expire later than SIX MONTHS from the mailing date of the final rejection.
- c)  A prior Advisory Action was mailed more than 3 months after the mailing date of the final rejection in response to a first after-final reply filed within 2 months of the mailing date of the final rejection. The current period for reply expires \_\_\_\_\_ months from the mailing date of the prior Advisory Action or SIX MONTHS from the mailing date of the final rejection, whichever is earlier.

*Examiner Note:* If box 1 is checked, check either box (a), (b) or (c). ONLY CHECK BOX (b) WHEN THIS ADVISORY ACTION IS THE FIRST RESPONSE TO APPLICANT'S FIRST AFTER-FINAL REPLY WHICH WAS FILED WITHIN TWO MONTHS OF THE FINAL REJECTION. ONLY CHECK BOX (c) IN THE LIMITED SITUATION SET FORTH UNDER BOX (c). See MPEP 706.07(f).

Extensions of time may be obtained under 37 CFR 1.136(a). The date on which the petition under 37 CFR 1.136(a) and the appropriate extension fee have been filed is the date for purposes of determining the period of extension and the corresponding amount of the fee. The appropriate extension fee under 37 CFR 1.17(a) is calculated from: (1) the expiration date of the shortened statutory period for reply originally set in the final Office action; or (2) as set forth in (b) or (c) above, if checked. Any reply received by the Office later than three months after the mailing date of the final rejection, even if timely filed, may reduce any earned patent term adjustment. See 37 CFR 1.704(b).

NOTICE OF APPEAL

2.  The Notice of Appeal was filed on \_\_\_\_\_. A brief in compliance with 37 CFR 41.37 must be filed within two months of the date of filing the Notice of Appeal (37 CFR 41.37(a)), or any extension thereof (37 CFR 41.37(e)), to avoid dismissal of the appeal. Since a Notice of Appeal has been filed, any reply must be filed within the time period set forth in 37 CFR 41.37(a).

AMENDMENTS

3.  The proposed amendments filed after a final rejection, but prior to the date of filing a brief, will not be entered because
- a)  They raise new issues that would require further consideration and/or search (see NOTE below);
- b)  They raise the issue of new matter (see NOTE below);
- c)  They are not deemed to place the application in better form for appeal by materially reducing or simplifying the issues for appeal; and/or
- d)  They present additional claims without canceling a corresponding number of finally rejected claims.

NOTE: \_\_\_\_\_. (See 37 CFR 1.116 and 41.33(a)).

4.  The amendments are not in compliance with 37 CFR 1.121. See attached Notice of Non-Compliant Amendment (PTOL-324).
5.  Applicant's reply has overcome the following rejection(s): \_\_\_\_\_.
6.  Newly proposed or amended claim(s) \_\_\_\_\_ would be allowable if submitted in a separate, timely filed amendment canceling the non-allowable claim(s).
7.  For purposes of appeal, the proposed amendment(s): (a)  will not be entered, or (b)  will be entered, and an explanation of how the new or amended claims would be rejected is provided below or appended.

AFFIDAVIT OR OTHER EVIDENCE

8.  A declaration(s)/affidavit(s) under **37 CFR 1.130(b)** was/were filed on \_\_\_\_\_.
9.  The affidavit or other evidence filed after final action, but before or on the date of filing a Notice of Appeal will not be entered because applicant failed to provide a showing of good and sufficient reasons why the affidavit or other evidence is necessary and was not earlier presented. See 37 CFR 1.116(e).
10.  The affidavit or other evidence filed after the date of filing the Notice of Appeal, but prior to the date of filing a brief, will not be entered because the affidavit or other evidence failed to overcome all rejections under appeal and/or appellant fails to provide a showing of good and sufficient reasons why it is necessary and was not earlier presented. See 37 CFR 41.33(d)(1).
11.  The affidavit or other evidence is entered. An explanation of the status of the claims after entry is below or attached.

REQUEST FOR RECONSIDERATION/OTHER

12.  The request for reconsideration has been considered but does NOT place the application in condition for allowance because:  
See Continuation Sheet.

13.  Note the attached Information *Disclosure Statement(s)*. (PTO/SB/08) Paper No(s). \_\_\_\_\_

14.  Other: see attachment PTO-2323.

STATUS OF CLAIMS

15. The status of the claim(s) is (or will be) as follows:
- Claim(s) allowed: \_\_\_\_\_
- Claim(s) objected to: \_\_\_\_\_
- Claim(s) rejected: 1-19,21-26,28-39 and 41-58.
- Claim(s) withdrawn from consideration: \_\_\_\_\_

/ALAN S CHOU/  
Primary Examiner, Art Unit 2451

Continuation of 12. does NOT place the application in condition for allowance because: The new proposed claim amendment of user read the email message and in response to receiving the automatic control message, signaling the email server to mark the email message as read is beyond the time allow for AFCP 2.0 and requires further search and consideration.

# AFCP 2.0 Decision

**Application No.**

14/609,189

**Applicant(s)**

BACKHOLM ET AL.

**Examiner**

ALAN S. CHOU

**Art Unit**

2451

This is in response to the After Final Consideration Pilot request filed 8/1/2017.

1. **Improper Request** – The AFCP 2.0 request is improper for the following reason(s) and the after final amendment submitted with the request will be treated under pre-pilot procedure.

- An AFCP 2.0 request form PTO/SB/434 (or equivalent document) was not submitted.
- A non-broadening amendment to at least one independent claim was not submitted.
- A proper AFCP 2.0 request was submitted in response to the most recent final rejection.
- Other:

2. **Proper Request**

- A. After final amendment submitted with the request will not be treated under AFCP 2.0.

The after final amendment cannot be reviewed and a search conducted within the guidelines of the pilot program.

- The after final amendment will be treated under pre-pilot procedure.

- B. Updated search and/or completed additional consideration.

The examiner performed an updated search and/or completed additional consideration of the after final amendment within the time authorized for the pilot program. The result(s) of the updated search and/or completed additional consideration are:

- 1. All of the rejections in the most recent final Office action are overcome and a Notice of Allowance is issued herewith.
- 2. The after final amendment would not overcome all of the rejections in the most recent final Office action. See attached interview summary for further details.
- 3. The after final amendment was reviewed, and it raises a new issue(s). See attached interview summary for further details.
- 4. The after final amendment raises new issues, but would overcome all of the rejections in the most recent final Office action. A decision on determining allowability could not be made within the guidelines of the pilot. See attached interview summary for further details, including any newly discovered prior art.
- 5. Other:

Examiner Note: Please attach an interview summary when necessary as described above.

DO NOT ENTER: /A.S.C/

/ALAN S CHOU/

08/16/2015 COMMUNICATION TO THE UNITED STATES PATENT AND TRADEMARK OFFICE

Appl. No.	:	14/609,189	Confirmation No. 5037
Applicant	:	Seven Networks, LLC	
Inventor	:	Ari Backholm <i>et al.</i>	
Filed	:	2015-01-29	
TC/A.U.	:	2451	
Examiner	:	Chou, Alan S	
Docket No.	:	455/006/8 UTIL	
Customer No.	:	118194	

Via EFS Web – Electronic Filing  
Mail Stop After Final  
Commissioner for Patents  
P.O. Box 1450  
Alexandria, VA 22313-1450

**Response to Final Office Action**

Examiner:

**Amendments to the Claims** begin on page 2 of this paper.

**Remarks** begin on page 10 of this paper.

<b>Doc Code: DIST.E.FILE</b> <b>Document Description: Electronic Terminal Disclaimer - Filed</b>		PTO/SB/26 U.S. Patent and Trademark Office Department of Commerce
Electronic Petition Request	<b>TERMINAL DISCLAIMER TO OBTAIN A DOUBLE PATENTING REJECTION OVER A "PRIOR" PATENT</b>	
Application Number	14609189	
Filing Date	29-Jan-2015	
First Named Inventor	Ari Backholm	
Attorney Docket Number	455/006/8 UTIL	
Title of Invention	Messaging centre for forwarding e-mail	
<input checked="" type="checkbox"/> Filing of terminal disclaimer does not obviate requirement for response under 37 CFR 1.111 to outstanding Office Action  <input checked="" type="checkbox"/> This electronic Terminal Disclaimer is not being used for a Joint Research Agreement.		
Owner	Percent Interest	
Seven Networks, LLC	100%	
<p>The owner(s) with percent interest listed above in the instant application hereby disclaims, except as provided below, the terminal part of the statutory term of any patent granted on the instant application which would extend beyond the expiration date of the full statutory term of prior patent number(s)</p> <p>7706781 7643818</p> <p>as the term of said prior patent is presently shortened by any terminal disclaimer. The owner hereby agrees that any patent so granted on the instant application shall be enforceable only for and during such period that it and the prior patent are commonly owned. This agreement runs with any patent granted on the instant application and is binding upon the grantee, its successors or assigns.</p> <p>In making the above disclaimer, the owner does not disclaim the terminal part of the term of any patent granted on the instant application that would extend to the expiration date of the full statutory term of the prior patent, "as the term of said prior patent is presently shortened by any terminal disclaimer," in the event that said prior patent later:</p> <ul style="list-style-type: none"> <li>- expires for failure to pay a maintenance fee;</li> <li>- is held unenforceable;</li> <li>- is found invalid by a court of competent jurisdiction;</li> <li>- is statutorily disclaimed in whole or terminally disclaimed under 37 CFR 1.321;</li> <li>- has all claims canceled by a reexamination certificate;</li> <li>- is reissued; or</li> <li>- is in any manner terminated prior to the expiration of its full statutory term as presently shortened by any terminal disclaimer.</li> </ul>		

- Terminal disclaimer fee under 37 CFR 1.20(d) is included with Electronic Terminal Disclaimer request.
- I certify, in accordance with 37 CFR 1.4(d)(4), that the terminal disclaimer fee under 37 CFR 1.20(d) required for this terminal disclaimer has already been paid in the above-identified application.

Applicant claims the following fee status:

- Small Entity
- Micro Entity
- Regular Undiscounted

I hereby declare that all statements made herein of my own knowledge are true and that all statements made on information and belief are believed to be true; and further that these statements were made with the knowledge that willful false statements and the like so made are punishable by fine or imprisonment, or both, under Section 1001 of Title 18 of the United States Code and that such willful false statements may jeopardize the validity of the application or any patent issued thereon.

**THIS PORTION MUST BE COMPLETED BY THE SIGNATORY OR SIGNATORIES**

I certify, in accordance with 37 CFR 1.4(d)(4) that I am:

- An attorney or agent registered to practice before the Patent and Trademark Office who is of record in this application  
     Registration Number 59389
- A sole inventor
- A joint inventor; I certify that I am authorized to sign this submission on behalf of all of the inventors as evidenced by the power of attorney in the application
- A joint inventor; all of whom are signing this request

Signature	/Justin R. Nifong/
Name	Justin R. Nifong

\*Statement under 37 CFR 3.73(b) is required if terminal disclaimer is signed by the assignee (owner).  
 Form PTO/SB/96 may be used for making this certification. See MPEP § 324.



## Electronic Patent Application Fee Transmittal

<b>Application Number:</b>	14609189			
<b>Filing Date:</b>	29-Jan-2015			
<b>Title of Invention:</b>	Messaging centre for forwarding e-mail			
<b>First Named Inventor/Applicant Name:</b>	Ari Backholm			
<b>Filer:</b>	Justin Robert Nifong/Donna Donovan			
<b>Attorney Docket Number:</b>	455/006/8 UTIL			
Filed as Small Entity				
<b>Filing Fees for Utility under 35 USC 111(a)</b>				
<b>Description</b>	<b>Fee Code</b>	<b>Quantity</b>	<b>Amount</b>	<b>Sub-Total in USD(\$)</b>
<b>Basic Filing:</b>				
STATUTORY OR TERMINAL DISCLAIMER	2814	1	160	160
<b>Pages:</b>				
<b>Claims:</b>				
<b>Miscellaneous-Filing:</b>				
<b>Petition:</b>				
<b>Patent-Appeals-and-Interference:</b>				
<b>Post-Allowance-and-Post-Issuance:</b>				

Description	Fee Code	Quantity	Amount	Sub-Total in USD(\$)
<b>Extension-of-Time:</b>				
<b>Miscellaneous:</b>				
<b>Total in USD (\$)</b>				<b>160</b>

Doc Code: DISQ.E.FILE

Document Description: Electronic Terminal Disclaimer – Approved

Application No.: 14609189

Filing Date: 29-Jan-2015

Applicant/Patent under Reexamination: Backholm

Electronic Terminal Disclaimer filed on August 1, 2017

APPROVED

**This patent is subject to a terminal disclaimer**

DISAPPROVED

Approved/Disapproved by: Electronic Terminal Disclaimer automatically approved by EFS-Web

U.S. Patent and Trademark Office

## Electronic Acknowledgement Receipt

<b>EFS ID:</b>	29942876
<b>Application Number:</b>	14609189
<b>International Application Number:</b>	
<b>Confirmation Number:</b>	5037
<b>Title of Invention:</b>	Messaging centre for forwarding e-mail
<b>First Named Inventor/Applicant Name:</b>	Ari Backholm
<b>Customer Number:</b>	118194
<b>Filer:</b>	Justin Robert Nifong/Donna Donovan
<b>Filer Authorized By:</b>	Justin Robert Nifong
<b>Attorney Docket Number:</b>	455/006/8 UTIL
<b>Receipt Date:</b>	01-AUG-2017
<b>Filing Date:</b>	29-JAN-2015
<b>Time Stamp:</b>	08:16:23
<b>Application Type:</b>	Utility under 35 USC 111(a)

### Payment information:

Submitted with Payment	yes
Payment Type	CARD
Payment was successfully received in RAM	\$160
RAM confirmation Number	080117INTEFSW08162000
Deposit Account	506191
Authorized User	Justin Nifong

The Director of the USPTO is hereby authorized to charge indicated fees and credit any overpayment as follows:

37 CFR 1.16 (National application filing, search, and examination fees)

37 CFR 1.17 (Patent application and reexamination processing fees)

37 CFR 1.19 (Document supply fees)  
 37 CFR 1.20 (Post Issuance fees)  
 37 CFR 1.21 (Miscellaneous fees and charges)

**File Listing:**

Document Number	Document Description	File Name	File Size(Bytes)/ Message Digest	Multi Part /.zip	Pages (if appl.)
1	Terminal Disclaimer-Filed (Electronic)	eTerminal-Disclaimer.pdf	33407	no	2
			f1d91f9a09601a5c43ff4f5c6a8349d06bfb02c1		

**Warnings:**

**Information:**

2	Fee Worksheet (SB06)	fee-info.pdf	30563	no	2
			192d71ac1df73b935e45ac07b75c23e517939a4a		

**Warnings:**

**Information:**

**Total Files Size (in bytes):** 63970

**This Acknowledgement Receipt evidences receipt on the noted date by the USPTO of the indicated documents, characterized by the applicant, and including page counts, where applicable. It serves as evidence of receipt similar to a Post Card, as described in MPEP 503.**

**New Applications Under 35 U.S.C. 111**

**If a new application is being filed and the application includes the necessary components for a filing date (see 37 CFR 1.53(b)-(d) and MPEP 506), a Filing Receipt (37 CFR 1.54) will be issued in due course and the date shown on this Acknowledgement Receipt will establish the filing date of the application.**

**National Stage of an International Application under 35 U.S.C. 371**

**If a timely submission to enter the national stage of an international application is compliant with the conditions of 35 U.S.C. 371 and other applicable requirements a Form PCT/DO/EO/903 indicating acceptance of the application as a national stage submission under 35 U.S.C. 371 will be issued in addition to the Filing Receipt, in due course.**

**New International Application Filed with the USPTO as a Receiving Office**

**If a new international application is being filed and the international application includes the necessary components for an international filing date (see PCT Article 11 and MPEP 1810), a Notification of the International Application Number and of the International Filing Date (Form PCT/RO/105) will be issued in due course, subject to prescriptions concerning national security, and the date shown on this Acknowledgement Receipt will establish the international filing date of the application.**

<b>CERTIFICATION AND REQUEST FOR CONSIDERATION UNDER THE AFTER FINAL CONSIDERATION PILOT PROGRAM 2.0</b>		
Practitioner Docket No.:	Application No.:	Filing Date:
<b>455/006/8 util</b>	<b>14/609,189</b>	<b>2015-01-29</b>
First Named Inventor:	Title:	
<b>Ari Backholm</b>	<b>Messaging Centre for Forwarding E-mail</b>	
<p>APPLICANT HEREBY CERTIFIES THE FOLLOWING AND REQUESTS CONSIDERATION UNDER THE AFTER FINAL CONSIDERATION PILOT PROGRAM 2.0 (AFCP 2.0) OF THE ACCOMPANYING RESPONSE UNDER 37 CFR 1.116.</p> <ol style="list-style-type: none"> <li>1. The above-identified application is (i) an original utility, plant, or design nonprovisional application filed under 35 U.S.C. 111(a) [a continuing application (<i>e.g.</i>, a continuation or divisional application) is filed under 35 U.S.C. 111(a) and is eligible under (i)], or (ii) an international application that has entered the national stage in compliance with 35 U.S.C. 371(c).</li> <li>2. The above-identified application contains an outstanding final rejection.</li> <li>3. Submitted herewith is a response under 37 CFR 1.116 to the outstanding final rejection. The response includes an amendment to at least one independent claim, and the amendment does not broaden the scope of the independent claim in any aspect.</li> <li>4. This certification and request for consideration under AFCP 2.0 is the only AFCP 2.0 certification and request filed in response to the outstanding final rejection.</li> <li>5. Applicant is willing and available to participate in any interview requested by the examiner concerning the present response.</li> <li>6. This certification and request is being filed electronically using the Office's electronic filing system (EFS-Web).</li> <li>7. Any fees that would be necessary consistent with current practice concerning responses after final rejection under 37 CFR 1.116, <i>e.g.</i>, extension of time fees, are being concurrently filed herewith. [There is no additional fee required to request consideration under AFCP 2.0.]</li> <li>8. By filing this certification and request, applicant acknowledges the following:               <ul style="list-style-type: none"> <li>• Reissue applications and reexamination proceedings are not eligible to participate in AFCP 2.0.</li> <li>• The examiner will verify that the AFCP 2.0 submission is compliant, <i>i.e.</i>, that the requirements of the program have been met (see items 1 to 7 above). For compliant submissions:                   <ul style="list-style-type: none"> <li>○ The examiner will review the response under 37 CFR 1.116 to determine if additional search and/or consideration (i) is necessitated by the amendment and (ii) could be completed within the time allotted under AFCP 2.0. If additional search and/or consideration is required but cannot be completed within the allotted time, the examiner will process the submission consistent with current practice concerning responses after final rejection under 37 CFR 1.116, <i>e.g.</i>, by mailing an advisory action.</li> <li>○ If the examiner determines that the amendment does not necessitate additional search and/or consideration, or if the examiner determines that additional search and/or consideration is required and could be completed within the allotted time, then the examiner will consider whether the amendment places the application in condition for allowance (after completing the additional search and/or consideration, if required). If the examiner determines that the amendment does not place the application in condition for allowance, then the examiner will contact the applicant and request an interview.                       <ul style="list-style-type: none"> <li>▪ The interview will be conducted by the examiner, and if the examiner does not have negotiation authority, a primary examiner and/or supervisory patent examiner will also participate.</li> <li>▪ If the applicant declines the interview, or if the interview cannot be scheduled within ten (10) calendar days from the date that the examiner first contacts the applicant, then the examiner will proceed consistent with current practice concerning responses after final rejection under 37 CFR 1.116.</li> </ul> </li> </ul> </li> </ul> </li> </ol>		
Signature	Date	
/Justin R. Nifong/	<b>2017-08-01</b>	
Name (Print/Typed)	Practitioner Registration No.	
<b>Justin R. Nifong</b>	<b>59389</b>	
<p><b>Note:</b> This form must be signed in accordance with 37 CFR 1.33. See 37 CFR 1.4(d) for signature requirements and certifications. Submit multiple forms if more than one signature is required, see below*.</p>		
<p><input checked="" type="checkbox"/> * Total of <u>1</u> forms are submitted.</p>		

## Privacy Act Statement

The **Privacy Act of 1974 (P.L. 93-579)** requires that you be given certain information in connection with your submission of the attached form related to a patent application or patent. Accordingly, pursuant to the requirements of the Act, please be advised that: (1) the general authority for the collection of this information is 35 U.S.C. 2(b)(2); (2) furnishing of the information solicited is voluntary; and (3) the principal purpose for which the information is used by the U.S. Patent and Trademark Office is to process and/or examine your submission related to a patent application or patent. If you do not furnish the requested information, the U.S. Patent and Trademark Office may not be able to process and/or examine your submission, which may result in termination of proceedings or abandonment of the application or expiration of the patent.

The information provided by you in this form will be subject to the following routine uses:

1. The information on this form will be treated confidentially to the extent allowed under the Freedom of Information Act (5 U.S.C. 552) and the Privacy Act (5 U.S.C. 552a). Records from this system of records may be disclosed to the Department of Justice to determine whether disclosure of these records is required by the Freedom of Information Act.
2. A record from this system of records may be disclosed, as a routine use, in the course of presenting evidence to a court, magistrate, or administrative tribunal, including disclosures to opposing counsel in the course of settlement negotiations.
3. A record in this system of records may be disclosed, as a routine use, to a Member of Congress submitting a request involving an individual, to whom the record pertains, when the individual has requested assistance from the Member with respect to the subject matter of the record.
4. A record in this system of records may be disclosed, as a routine use, to a contractor of the Agency having need for the information in order to perform a contract. Recipients of information shall be required to comply with the requirements of the Privacy Act of 1974, as amended, pursuant to 5 U.S.C. 552a(m).
5. A record related to an International Application filed under the Patent Cooperation Treaty in this system of records may be disclosed, as a routine use, to the International Bureau of the World Intellectual Property Organization, pursuant to the Patent Cooperation Treaty.
6. A record in this system of records may be disclosed, as a routine use, to another federal agency for purposes of National Security review (35 U.S.C. 181) and for review pursuant to the Atomic Energy Act (42 U.S.C. 218(c)).
7. A record from this system of records may be disclosed, as a routine use, to the Administrator, General Services, or his/her designee, during an inspection of records conducted by GSA as part of that agency's responsibility to recommend improvements in records management practices and programs, under authority of 44 U.S.C. 2904 and 2906. Such disclosure shall be made in accordance with the GSA regulations governing inspection of records for this purpose, and any other relevant (*i.e.*, GSA or Commerce) directive. Such disclosure shall not be used to make determinations about individuals.
8. A record from this system of records may be disclosed, as a routine use, to the public after either publication of the application pursuant to 35 U.S.C. 122(b) or issuance of a patent pursuant to 35 U.S.C. 151. Further, a record may be disclosed, subject to the limitations of 37 CFR 1.14, as a routine use, to the public if the record was filed in an application which became abandoned or in which the proceedings were terminated and which application is referenced by either a published application, an application open to public inspection or an issued patent.
9. A record from this system of records may be disclosed, as a routine use, to a Federal, State, or local law enforcement agency, if the USPTO becomes aware of a violation or potential violation of law or regulation.

**COMMUNICATION TO THE UNITED STATES PATENT AND TRADEMARK OFFICE**

Appl. No. : 14/609,189 Confirmation No. 5037  
Applicant : Seven Networks, LLC  
Inventor : Ari Backholm *et al.*  
Filed : 2015-01-29  
TC/A.U. : 2451  
Examiner : Chou, Alan S  
Docket No. : 455/006/8 UTIL  
Customer No. : 118194

Via EFS Web – Electronic Filing  
Mail Stop After Final  
Commissioner for Patents  
P.O. Box 1450  
Alexandria, VA 22313-1450

**Response to Final Office Action**

Examiner:

**Amendments to the Claims** begin on page 2 of this paper.

**Remarks** begin on page 10 of this paper.



**AMENDMENTS TO THE CLAIMS**

1. (Currently Amended) A method for forwarding an e-mail message from one of a plurality of e-mail servers to a mobile terminal, the method comprising:

receiving, at an intermediary system, an e-mail message associated with an e-mail address of a user of a mobile terminal and sent by one of a plurality of e-mail servers,

wherein the e-mail address is associated with an identifier of the mobile terminal,

wherein an email account, associated with the email address, is hosted by one of the plurality of e-mail servers, and

wherein the identifier is generated by the mobile terminal;

encrypting the e-mail message using encryption information associated with a temporary identifier,

wherein the temporary identifier is based on a connection to the mobile terminal; and

transmitting the encrypted e-mail message to the mobile terminal;

receiving an automatic control message from the mobile terminal indicating that the user has read the e-mail message; and

in response to receiving the automatic control message, signaling the one of a plurality of e-mail servers to mark the e-mail message as read.

2. (Previously Presented) The method of claim 1, further comprising identifying the mobile terminal based on the e-mail address of the e-mail message and the association with the identifier of the mobile terminal.

3. (Previously Presented) The method of claim 1, wherein encrypting the e-mail message further comprises packing the e-mail message by omitting at least part of the e-mail message when at least part of the e-mail message exceeds a predetermined size specification.

4. (Previously Presented) The method of claim 3, wherein size specification is set by a user of the mobile terminal.

5. (Previously Presented) The method of claim 3, wherein the omitted part of the e-mail

message is the e-mail address.

6. (Previously Presented) The method of claim 2, further comprising adding the e-mail address to a reply message sent by the mobile terminal.

7. (Previously Presented) The method of claim 1, further comprising receiving the encryption information generated by the mobile terminal.

8. (Previously Presented) The method of claim 1, wherein the encryption information is based on an activation code of the mobile terminal.

9. (Previously Presented) The method of claim 1, wherein a messaging center transmits the e-mail message to the mobile terminal using the identifier of the mobile terminal.

10. (Previously Presented) The method of claim 1, wherein mobile terminal receives and decrypts the e-mail message using the encryption information.

11. (Previously Presented) The method of claim 3, wherein the mobile terminal unpacks the e-mail message.

12. (Currently Amended) A system for forwarding an e-mail message from one of a plurality of e-mail servers to a mobile terminal, the system comprising:

a memory configured for storing at least one of an e-mail address of a user of a mobile terminal, and an identifier;

wherein the e-mail address is associated with the identifier,

wherein an email account, associated with the email address, is hosted by one of the plurality of e-mail servers, and

wherein the mobile terminal generates the identifier,

a processor configured for:

encrypting the e-mail message using encryption information associated with a temporary identifier, wherein the e-mail message is received from one of a plurality of e-

mail servers;

identifying the mobile terminal based on the identifier of the mobile terminal; and  
transmitting the encrypted e-mail message to the identified mobile terminal,

wherein the temporary identifier is based on a connection to the mobile terminal;

receiving an automatic control message from the mobile terminal indicating that the user has read the e-mail message; and

in response to receiving the automatic control message, signaling the one of a plurality of e-mail servers to mark the e-mail message as read,

wherein the system is an intermediary system between the plurality of e-mail servers and the mobile terminal.

13. (Previously Presented) The system of claim 12, wherein the processor is further configured to receive the e-mail message from the one of a plurality of e-mail servers.

14. (Previously Presented) The system of claim 12, wherein the processor is further configured to receive the encryption information and to provide the encryption information to the memory for storage.

15. (Previously Presented) The system of claim 12, wherein the processor is further configured to pack the e-mail message.

16. (Previously Presented) The system of claim 15, wherein the processor is further configured to omit at least part of the e-mail message when the at least part of the e-mail message exceeds a predetermined size specification.

17. (Previously Presented) The system of claim 16, wherein the processor is further configured to receive user input concerning the size specification.

18. (Previously Presented) The system of claim 12, wherein the mobile terminal receives and decrypts the e-mail message using the encryption information.

19. (Previously Presented) The system of claim 18, wherein the mobile terminal unpacks the message.

20. (Canceled)

21. (Canceled)

22. (Canceled)

23. (Previously Presented) A device comprising:  
a radio;  
a processor and memory containing instructions executable by the processor whereby the device is operable to:

optically receive information including a displayed service activation code from a remote device;

register the remote device for access to a messaging account using the service activation code;

receive a message for the messaging account;

encrypt the message using an encryption key; and

send the message to the remote device,

wherein the device is authenticated to access the messaging account.

24. (Previously Presented) The device of claim 23, wherein the information including the service activation code is received by the device in response to user input at the remote device.

25. (Previously Presented) The device of claim 23, wherein the information including the service activation code is received by the device in an off-line communication.

26. (Previously Presented) The device of claim 25, wherein the off-line communication involves a local connection.

27. (Canceled)

28. (Previously Presented) The device of claim 25, wherein the off-line communication prevents eavesdropping of the service activation code.

29. (Previously Presented) The device of claim 23, wherein the authentication of the device relies on the authentication of the messaging account.

30. (Previously Presented) The device of claim 29, wherein the authentication of the messaging account includes a username and password.

31. (Previously Presented) The device of claim 23, wherein the encryption key is the service activation code.

32. (Previously Presented) The device of claim 23, wherein the encryption key is derived from the service activation code.

33. (Previously Presented) The device of claim 23, wherein the encryption key is a subset of the service activation code.

34. (Previously Presented) The device of claim 23, wherein the encryption key is closely related to the service activation code.

35. (Previously Presented) The device of claim 23, wherein the device is further operable to:

store an association between at least two of the encryption key, the messaging account, an identifier of the remote device, and the service activation code.

36. (Previously Presented) The device of claim 23, wherein the message is sent to the remote device through an intermediate device.

37. (Previously Presented) A method for sharing a messaging account, the method comprising:

- authenticating a device for access to the messaging account;
- optically receiving information including a displayed service activation code from a remote device;
- registering the remote device for access to the messaging account using the service activation code;
- receiving a message for the messaging account;
- encrypting the message using an encryption key; and
- sending the message to the remote device.

38. (Previously Presented) The method of claim 37, wherein the information including the service activation code is received by the device in response to user input at the remote device.

39. (Previously Presented) The method of claim 38, wherein the information including the service activation code is received by the device in an off-line communication.

40. (Canceled)

41. (Previously Presented) The method of claim 39, wherein the off-line communication prevents eavesdropping of the service activation code.

42. (Previously Presented) The method of claim 37, wherein the authentication of the device relies on the authentication of the messaging system.

43. (Previously Presented) The method of claim 42, wherein the authentication of the messaging system includes a username and password.

44. (Previously Presented) The method of claim 37, wherein the encryption key is the service activation code.

45. (Previously Presented) The method of claim 37, wherein the encryption key is derived from the service activation code.

46. (Previously Presented) The method of claim 37, wherein the encryption key is a subset of the service activation code.

47. (Previously Presented) The method of claim 37, wherein the encryption key is closely related to the service activation code.

48. (Previously Presented) The method of claim 37, wherein the method further comprises:

storing an association between the encryption key, the messaging account, an identifier of the remote device, and the service activation code.

49. (Previously Presented) The device of claim 36, wherein the encryption key is associated with a temporary identifier, wherein the temporary identifier is based on a connection to the intermediate device.

50. (Previously Presented) The method of claim 37, wherein the message is sent to the remote device through an intermediate device.

51. (Previously Presented) The method of claim 37, wherein the encryption key is associated with a temporary identifier, wherein the temporary identifier is based on a connection to the intermediary device.

52. (Previously Presented) The method of claim 1, wherein the identifier is associated with the temporary identifier.

53. (Previously Presented) The system of claim 12, wherein the identifier is associated with the temporary identifier.

54. (Canceled)

55. (Previously Presented) A non-transient computer-readable medium containing program instructions for causing a device to perform a method, the method comprising:

optically receiving information including a displayed service activation code from a remote device;

registering the remote device for access to a messaging account using the service activation code;

receiving a message for the messaging account;

encrypting the message using an encryption key; and

sending the message to the remote device,

wherein the device is authenticated to access the messaging account.

56. (Previously Presented) The device of claim 23, wherein a control message is received from the remote device upon user interaction with the message.

57. (Previously Presented) The method of claim 37, wherein a control message is received from the remote device upon user interaction with the message.

58. (Previously Presented) The method of claim 55, wherein a control message is received from the remote device upon user interaction with the message.



### **REMARKS**

This paper is responsive to the final Office Action mailed June 1, 2017. A request under the After Final Consideration Program is submitted herewith.

Claims 1-19, 21-26, 28-39, and 41-58 were previously pending. Claim 20, 27, and 40 were previously canceled. Claims 21-22 and 54 are canceled herein. Claims 1 and 12 are amended herein. No new claims are added herein. Accordingly, claims 1-19, 23-26, 28-39, 41-53, and 55-58 remain pending.

### **Double Patenting**

In the Office Action, claims 1-20 stand rejected on the ground of nonstatutory double patenting as being unpatentable over claim 1 of U.S. Patent No. 7,706,781 and U.S. Patent No. 7,643,818. A Terminal Disclaimer is being submitted herewith.

### **Claims Rejections under 35 U.S.C. § 103(a)**

In the Office Action, claims 1-2, 6-10, 12-15, 18, 21-22, 52-54 stand rejected under 35 USC 103(a) as being unpatentable over Little, in view of Turunen, and further in view of Osthoff.

Independent claim 1 has been amended herein to recite the following feature:

receiving an automatic control message indicating that the user has read the e-mail message; and

in response to receiving the automatic control message, signaling the one of a plurality of e-mail servers to mark the e-mail message as read.

Support for this amendment may be found in at least the following paragraph of the Applicant's specification:

*[0034] In step 3-16 the mobile terminal 102 sends the messaging centre 110 an automatic control message indicating that the user has read the e-mail message. In response to the control message, the messaging centre 110 signals the e-mail server 108 to mark the e-mail message as read in step 3-17, which act the e-mail server performs in step 3-18. The control message comprises some identification of the e-mail message but not its contents, whereby it loads the radio interface only lightly. A benefit of the control message is that the user, when beginning to*

*user the host system 100, immediately sees which messages he/she has already read and does not have to read them twice.*

Independent claim 12 has been amended to include features similar to claim 1.

Independent claims 21-22, and 54 have been canceled without prejudice to expedite prosecution under “After Final Consideration Program”.

Nowhere does Little, Turunen, or Osthoff disclose or suggest the above feature. Likewise, Giobbi, Solonen, Anttila, and Kock fail to disclose or suggest the above feature. Applicant submits that independent claims 1 and 12 are patentable over the cited references.

Claims 2, 6-10, 13-15, 18, 52, and 53 depend, either directly or indirectly, from independent claims 1 and 12; and are allowable for at least the same reasons.

Accordingly, it is respectfully submitted that the rejection of claims 1-2, 6-10, 12-15, 18, and 52-53 be withdrawn.

In the Office Action, claims 3-5, 11, 16-17, and 19 stand rejected under 35 USC 103(a) as being unpatentable over Little in view of Turunen, further in view of Osthoff, and further in view of Kock.

Claims 3-5, 11, 16-17, and 19 depend, either directly or indirectly, from independent claims 1 and 12; and are allowable for at least the same reasons.

Accordingly, it is respectfully submitted that the rejection of claims 3-5, 11, 16-17, and 19 be withdrawn.

In the Office Action, claims 23-24, 37-38, and 55 stand rejected under 35 USC 103(a) as being unpatentable over Little in view of Turunen, further in view of Osthoff, and further in view of Anttila. Applicant respectfully traverses.

The Patent Office has not presented a “*prima facie* conclusion of obviousness”. Instead Anttila fails to teach, and actually teaches away from the following features of independent claims 23, 37, and 55:

*optically receive information including a displayed service activation code from a remote device;*

*register the remote device for access to a messaging account using the service activation code;*

When rejecting a claim under 35 USC 103, the Patent Office must either show that the prior art references teach or suggest all limitations of the claim or explain the difference(s) between the prior art and the claimed invention would have been obvious to one of ordinary skill in the art. Anttila fails to teach *optically receive information including a displayed service activation code from a remote device*. No other reference is used to render the deficiencies of Anttila. The Patent Office cannot simply assert that this limitation would be obvious. The burden of proof is on the Patent Office, which has not provided any evidence that this limitation would be obvious in light of Anttila or any other reference for that matter. As such, the rejection based on Anttila is improper and should be withdrawn.

As further evidence of Anttila's failings, Anttila teaches away from the claimed invention. In particular, Anttila teaches in paragraph [0016] towards *establishing short-range communication between digital devices*. Anttila further discloses in paragraph [0016] *capturing and decoding the visual code and initiating a short-range communication link between the second digital device and the first digital device for the purpose of transferring the data element from the first digital device to the second digital device*. The desired result of Anttila is to establish *short-range communication for the purpose of transferring the data element from the first digital device to the second digital device*. This is further evidenced by Anttila's disclosure of: *implemented on a first digital device, for generating and displaying a visual code that encodes an address of the first digital device and a predetermined data element location identifier*.

In contrast and as disclosed in paragraph [0029] of the Applicant's Specification, a *displayed service activation code* is received and used to *register the remote device for access to a messaging account using the service activation code*. As further disclosed in paragraph [0029], to *register to a messaging account, the service activation code* must relay information to the host system *such as user name and password combination*. While the claims 23, 37, and 55 recite *optically receives information including a displayed service activation code from a remote device and registers the remote device for access to a messaging account using the service activation code, the cited reference Anttila discloses a visual code and initiating a short-range communication link ... for the purpose of transferring the data element from the first digital device to the second digital device*.

Summarizing, Anttila fails to provide a device *whereby the device is operable to: optically receive information including a displayed service activation code from a remote*

*device; and register the remote device for access to a messaging account using the service activation code.* There is no suggestion in Anttila to configure a device in this manner. Further, Anttila teaches away from receiving a *service activation code* and registering *the remote device for access to a messaging account using the service activation code.* As such, claims 23, 37, and 55 are not rendered obvious in light of Anttila.

Additionally the Patent Office has stated in the Office Action that previously cited references Little, Turunen, and Osthoff do not teach expressly: *optically receive information including a displayed service activation code from a remote device.* Likewise, Giobbi, Solonen, and Kock fail to disclose or suggest the above feature.

Applicant submits that claims 23, 37, and 55 are patentable over the cited references for at least the above reasons

Claims 24 and 38 depend directly from independent claims 23 and 37; and are allowable for at least the same reasons.

Accordingly, it is respectfully submitted that the rejection of claims 23-24, 37-38, and 55 be withdrawn.

In the Office Action, claims 25-26, 28-36, 39, 41-51, and 56-58 stand rejected under 35 USC 103(a) as being unpatentable over Little, in view of Turunen, further in view of Osthoff, further in view of Anttila, and further in view of Salonen.

Claims 25-26, 28-36, 39, 41-51, and 56-58 depend, either directly or indirectly, from independent claims 23, 37, and 55; and are allowable for at least the same reasons.

Further, in response to the rejection of claims 56-58, Applicant respectfully traverses. The Office Action states that *a control message is received from the remote device upon user interaction with the message* of claims 56-58 is disclosed in the following in Figure 3 and the following paragraph [0046] of Anttila:

*[0046] Once the communication link has been established between the devices, optional steps 460, 470 and 480 may ensue. At step 460, the second digital device initiates communication with the first digital device by automatically launching the requisite communication application. At step 470, a confirmation process may occur at the first device, whereby the first device confirms that the second device*

Response to FOA dated June 1, 2017  
Appl. No. 14/609,189

*has been granted authorization to access the data element. At step 480, the data element is transferred from the first device to the second device. Transferring may entail moving the data element from the first device to the second device or it may entail copying the data element from the first device and subsequent communication to the second device.*

Nowhere does Anttila disclose *a control message is received from the remote device upon user interaction with the message*

Accordingly, it is respectfully submitted that the rejection of claims 25-26, 28-36, 39, 41-51, and 56-58 be withdrawn.

### **DEPOSIT ACCOUNT**

The Commissioner is hereby authorized to charge any otherwise unpaid fees associated with the filing of this correspondence to Deposit Account No. 50-6191.

Date: August 1, 2017

Respectfully submitted,

/Justin R. Nifong/  
Justin R. Nifong  
Reg. No. 59,389

NK Patent Law  
4917 Waters Edge Drive, Suite 275  
Raleigh, NC 27606  
Telephone: (919) 348-2194  
Facsimile: (919) 882-8195

Customer No. 118194

## Electronic Acknowledgement Receipt

<b>EFS ID:</b>	29942889
<b>Application Number:</b>	14609189
<b>International Application Number:</b>	
<b>Confirmation Number:</b>	5037
<b>Title of Invention:</b>	Messaging centre for forwarding e-mail
<b>First Named Inventor/Applicant Name:</b>	Ari Backholm
<b>Customer Number:</b>	118194
<b>Filer:</b>	Justin Robert Nifong/Donna Donovan
<b>Filer Authorized By:</b>	Justin Robert Nifong
<b>Attorney Docket Number:</b>	455/006/8 UTIL
<b>Receipt Date:</b>	01-AUG-2017
<b>Filing Date:</b>	29-JAN-2015
<b>Time Stamp:</b>	08:18:07
<b>Application Type:</b>	Utility under 35 USC 111(a)

### Payment information:

Submitted with Payment	no
------------------------	----

### File Listing:

Document Number	Document Description	File Name	File Size(Bytes)/ Message Digest	Multi Part /.zip	Pages (if appl.)
1	After Final Consideration Program Request	455-006-8UTIL-20170801-After-Final-Consideration-Pilot-Program.pdf	226391  9fea20cb6be9f8926c386f918ceb8988a08d4fff	no	2

### Warnings:

Information:				
2		455-006-8UTIL-20170801-Rsp-to-FOA-dtd-06-01-2017.pdf	68568 5cd133b6f2d90f1c6b467800d9566173b6b8a5a5	yes 14
<b>Multipart Description/PDF files in .zip description</b>				
		<b>Document Description</b>	<b>Start</b>	<b>End</b>
		Request under Rule 48 correcting inventorship	1	1
		Claims	2	9
		Applicant Arguments/Remarks Made in an Amendment	10	14
Warnings:				
Information:				
<b>Total Files Size (in bytes):</b>			294959	
<p><b>This Acknowledgement Receipt evidences receipt on the noted date by the USPTO of the indicated documents, characterized by the applicant, and including page counts, where applicable. It serves as evidence of receipt similar to a Post Card, as described in MPEP 503.</b></p> <p><b><u>New Applications Under 35 U.S.C. 111</u></b>  <b>If a new application is being filed and the application includes the necessary components for a filing date (see 37 CFR 1.53(b)-(d) and MPEP 506), a Filing Receipt (37 CFR 1.54) will be issued in due course and the date shown on this Acknowledgement Receipt will establish the filing date of the application.</b></p> <p><b><u>National Stage of an International Application under 35 U.S.C. 371</u></b>  <b>If a timely submission to enter the national stage of an international application is compliant with the conditions of 35 U.S.C. 371 and other applicable requirements a Form PCT/DO/EO/903 indicating acceptance of the application as a national stage submission under 35 U.S.C. 371 will be issued in addition to the Filing Receipt, in due course.</b></p> <p><b><u>New International Application Filed with the USPTO as a Receiving Office</u></b>  <b>If a new international application is being filed and the international application includes the necessary components for an international filing date (see PCT Article 11 and MPEP 1810), a Notification of the International Application Number and of the International Filing Date (Form PCT/RO/105) will be issued in due course, subject to prescriptions concerning national security, and the date shown on this Acknowledgement Receipt will establish the international filing date of the application.</b></p>				

Under the Paperwork Reduction Act of 1995, no persons are required to respond to a collection of information unless it displays a valid OMB control number.

<b>PATENT APPLICATION FEE DETERMINATION RECORD</b> Substitute for Form PTO-875			Application or Docket Number <b>14/609,189</b>	Filing Date <b>01/29/2015</b>	<input type="checkbox"/> To be Mailed
ENTITY: <input type="checkbox"/> LARGE <input checked="" type="checkbox"/> SMALL <input type="checkbox"/> MICRO					
<b>APPLICATION AS FILED – PART I</b>					
(Column 1)		(Column 2)			
FOR	NUMBER FILED	NUMBER EXTRA	RATE (\$)	FEE (\$)	
<input type="checkbox"/> BASIC FEE <small>(37 CFR 1.16(a), (b), or (c))</small>	N/A	N/A	N/A		
<input type="checkbox"/> SEARCH FEE <small>(37 CFR 1.16(k), (i), or (m))</small>	N/A	N/A	N/A		
<input type="checkbox"/> EXAMINATION FEE <small>(37 CFR 1.16(o), (p), or (q))</small>	N/A	N/A	N/A		
TOTAL CLAIMS <small>(37 CFR 1.16(j))</small>	minus 20 =	*	X \$ =		
INDEPENDENT CLAIMS <small>(37 CFR 1.16(h))</small>	minus 3 =	*	X \$ =		
<input type="checkbox"/> APPLICATION SIZE FEE <small>(37 CFR 1.16(s))</small>	If the specification and drawings exceed 100 sheets of paper, the application size fee due is \$310 (\$155 for small entity) for each additional 50 sheets or fraction thereof. See 35 U.S.C. 41(a)(1)(G) and 37 CFR 1.16(s).				
<input type="checkbox"/> MULTIPLE DEPENDENT CLAIM PRESENT <small>(37 CFR 1.16(j))</small>					
* If the difference in column 1 is less than zero, enter "0" in column 2.			TOTAL		

<b>APPLICATION AS AMENDED – PART II</b>								
(Column 1)		(Column 2)		(Column 3)				
<b>AMENDMENT</b>	<b>08/01/2017</b>	CLAIMS REMAINING AFTER AMENDMENT		HIGHEST NUMBER PREVIOUSLY PAID FOR	PRESENT EXTRA	RATE (\$)	ADDITIONAL FEE (\$)	
	Total (37 CFR 1.16(i))	* 52	Minus	** 56	= 0	X \$40 =	0	
	Independent (37 CFR 1.16(h))	* 5	Minus	***8	= 0	X \$210 =	0	
	<input type="checkbox"/> Application Size Fee (37 CFR 1.16(s))							
	<input type="checkbox"/> FIRST PRESENTATION OF MULTIPLE DEPENDENT CLAIM (37 CFR 1.16(j))							
TOTAL ADD'L FEE						<b>0</b>		

(Column 1)		(Column 2)		(Column 3)				
<b>AMENDMENT</b>		CLAIMS REMAINING AFTER AMENDMENT		HIGHEST NUMBER PREVIOUSLY PAID FOR	PRESENT EXTRA	RATE (\$)	ADDITIONAL FEE (\$)	
	Total (37 CFR 1.16(i))	*	Minus	**	=	X \$ =		
	Independent (37 CFR 1.16(h))	*	Minus	***	=	X \$ =		
	<input type="checkbox"/> Application Size Fee (37 CFR 1.16(s))							
	<input type="checkbox"/> FIRST PRESENTATION OF MULTIPLE DEPENDENT CLAIM (37 CFR 1.16(j))							
TOTAL ADD'L FEE								

\* If the entry in column 1 is less than the entry in column 2, write "0" in column 3.  
 \*\* If the "Highest Number Previously Paid For" IN THIS SPACE is less than 20, enter "20".  
 \*\*\* If the "Highest Number Previously Paid For" IN THIS SPACE is less than 3, enter "3".  
 The "Highest Number Previously Paid For" (Total or Independent) is the highest number found in the appropriate box in column 1.

LIE  
GAIL WOOTEN

This collection of information is required by 37 CFR 1.16. The information is required to obtain or retain a benefit by the public which is to file (and by the USPTO to process) an application. Confidentiality is governed by 35 U.S.C. 122 and 37 CFR 1.14. This collection is estimated to take 12 minutes to complete, including gathering, preparing, and submitting the completed application form to the USPTO. Time will vary depending upon the individual case. Any comments on the amount of time you require to complete this form and/or suggestions for reducing this burden, should be sent to the Chief Information Officer, U.S. Patent and Trademark Office, U.S. Department of Commerce, P.O. Box 1450, Alexandria, VA 22313-1450. DO NOT SEND FEES OR COMPLETED FORMS TO THIS ADDRESS. **SEND TO: Commissioner for Patents, P.O. Box 1450, Alexandria, VA 22313-1450.**

*If you need assistance in completing the form, call 1-800-PTO-9199 and select option 2.*





UNITED STATES PATENT AND TRADEMARK OFFICE

UNITED STATES DEPARTMENT OF COMMERCE
United States Patent and Trademark Office
Address: COMMISSIONER FOR PATENTS
P. O. Box 1450
Alexandria, Virginia 22313-1450
www.uspto.gov

Table with columns: APPLICATION NO., FILING DATE, FIRST NAMED INVENTOR, ATTORNEY DOCKET NO., CONFIRMATION NO., EXAMINER, ART UNIT, PAPER NUMBER, NOTIFICATION DATE, DELIVERY MODE. Includes application details for Ari Backholm and examiner Chou, Alan S.

Please find below and/or attached an Office communication concerning this application or proceeding.

The time period for reply, if any, is set in the attached communication.

Notice of the Office communication was sent electronically on above-indicated "Notification Date" to the following e-mail address(es):

usptomail@nkpatentlaw.com
abackholm@seven.com
eofficeaction@apcoll.com

<b>Office Action Summary</b>	<b>Application No.</b> 14/609,189	<b>Applicant(s)</b> BACKHOLM ET AL.	
	<b>Examiner</b> ALAN S. CHOU	<b>Art Unit</b> 2451	<b>AIA (First Inventor to File) Status</b> No

**-- The MAILING DATE of this communication appears on the cover sheet with the correspondence address --**

**Period for Reply**

A SHORTENED STATUTORY PERIOD FOR REPLY IS SET TO EXPIRE 3 MONTHS FROM THE MAILING DATE OF THIS COMMUNICATION.

- Extensions of time may be available under the provisions of 37 CFR 1.136(a). In no event, however, may a reply be timely filed after SIX (6) MONTHS from the mailing date of this communication.
- If NO period for reply is specified above, the maximum statutory period will apply and will expire SIX (6) MONTHS from the mailing date of this communication.
- Failure to reply within the set or extended period for reply will, by statute, cause the application to become ABANDONED (35 U.S.C. § 133). Any reply received by the Office later than three months after the mailing date of this communication, even if timely filed, may reduce any earned patent term adjustment. See 37 CFR 1.704(b).

**Status**

- 1)  Responsive to communication(s) filed on 2/9/2017.  
 A declaration(s)/affidavit(s) under **37 CFR 1.130(b)** was/were filed on \_\_\_\_\_.
- 2a)  This action is **FINAL**.                      2b)  This action is non-final.
- 3)  An election was made by the applicant in response to a restriction requirement set forth during the interview on \_\_\_\_\_; the restriction requirement and election have been incorporated into this action.
- 4)  Since this application is in condition for allowance except for formal matters, prosecution as to the merits is closed in accordance with the practice under *Ex parte Quayle*, 1935 C.D. 11, 453 O.G. 213.

**Disposition of Claims\***

- 5)  Claim(s) 1-19,21-26,28-39 and 41-58 is/are pending in the application.  
5a) Of the above claim(s) \_\_\_\_\_ is/are withdrawn from consideration.
- 6)  Claim(s) \_\_\_\_\_ is/are allowed.
- 7)  Claim(s) 1-19,21-26,28-39 and 41-58 is/are rejected.
- 8)  Claim(s) \_\_\_\_\_ is/are objected to.
- 9)  Claim(s) \_\_\_\_\_ are subject to restriction and/or election requirement.

\* If any claims have been determined allowable, you may be eligible to benefit from the **Patent Prosecution Highway** program at a participating intellectual property office for the corresponding application. For more information, please see [http://www.uspto.gov/patents/init\\_events/pph/index.jsp](http://www.uspto.gov/patents/init_events/pph/index.jsp) or send an inquiry to [PPHfeedback@uspto.gov](mailto:PPHfeedback@uspto.gov).

**Application Papers**

- 10)  The specification is objected to by the Examiner.
- 11)  The drawing(s) filed on \_\_\_\_\_ is/are: a)  accepted or b)  objected to by the Examiner.  
Applicant may not request that any objection to the drawing(s) be held in abeyance. See 37 CFR 1.85(a).  
Replacement drawing sheet(s) including the correction is required if the drawing(s) is objected to. See 37 CFR 1.121(d).

**Priority under 35 U.S.C. § 119**

- 12)  Acknowledgment is made of a claim for foreign priority under 35 U.S.C. § 119(a)-(d) or (f).

**Certified copies:**

- a)  All    b)  Some\*\*    c)  None of the:
1.  Certified copies of the priority documents have been received.
  2.  Certified copies of the priority documents have been received in Application No. \_\_\_\_\_.
  3.  Copies of the certified copies of the priority documents have been received in this National Stage application from the International Bureau (PCT Rule 17.2(a)).

\*\* See the attached detailed Office action for a list of the certified copies not received.

**Attachment(s)**

- 1)  Notice of References Cited (PTO-892)
- 2)  Information Disclosure Statement(s) (PTO/SB/08a and/or PTO/SB/08b)  
Paper No(s)/Mail Date \_\_\_\_\_.
- 3)  Interview Summary (PTO-413)  
Paper No(s)/Mail Date. \_\_\_\_\_.
- 4)  Other: \_\_\_\_\_.

The present application is being examined under the pre-AIA first to invent provisions.

### **DETAILED ACTION**

This action is in response to amendments filed on February 9, 2017.

Claims 1-19, 21-26, 28-39, 41-58 are presented for examination.

#### ***Double Patenting***

1. The nonstatutory double patenting rejection is based on a judicially created doctrine grounded in public policy (a policy reflected in the statute) so as to prevent the unjustified or improper timewise extension of the “right to exclude” granted by a patent and to prevent possible harassment by multiple assignees. A nonstatutory double patenting rejection is appropriate where the claims at issue are not identical, but at least one examined application claim is not patentably distinct from the reference claim(s) because the examined application claim is either anticipated by, or would have been obvious over, the reference claim(s). See, e.g., *In re Berg*, 140 F.3d 1428, 46 USPQ2d 1226 (Fed. Cir. 1998); *In re Goodman*, 11 F.3d 1046, 29 USPQ2d 2010 (Fed. Cir. 1993); *In re Longi*, 759 F.2d 887, 225 USPQ 645 (Fed. Cir. 1985); *In re Van Ornum*, 686 F.2d 937, 214 USPQ 761 (CCPA 1982); *In re Vogel*, 422 F.2d 438, 164 USPQ 619 (CCPA 1970); and *In re Thorington*, 418 F.2d 528, 163 USPQ 644 (CCPA 1969).

2. Timely filed terminal disclaimer in compliance with 37 CFR 1.321(c) or 1.321(d) may be used to overcome an actual or provisional rejection based on a nonstatutory double patenting ground provided the reference application or patent either is shown to be commonly owned with this application, or claims an invention made as a result of

activities undertaken within the scope of a joint research agreement. A terminal disclaimer must be signed in compliance with 37 CFR 1.321(b).

3. The USPTO internet Web site contains terminal disclaimer forms which may be used. Please visit <http://www.uspto.gov/forms/>. The filing date of the application will determine what form should be used. A web-based eTerminal Disclaimer may be filled out completely online using web-screens. An eTerminal Disclaimer that meets all requirements is auto-processed and approved immediately upon submission. For more information about eTerminal Disclaimers, refer to <http://www.uspto.gov/patents/process/file/efs/guidance/eTD-info-I.jsp>.

4. Claims 1-20 are rejected on the ground of nonstatutory double patenting as being unpatentable over claim 1 of U.S. Patent No. 7,706,781 B2 and claim 1 of U.S. Patent 7,643,818 B2. Although the claims at issue are not identical, they are not patentably distinct from each other because both independent claims have the similar steps such as: e-mail address of the mobile terminal is associated with an identifier and encryption information (see claims 1 in U.S. Patent 7,706,871 B2 and U.S. Patent 7,643,818 B2), encrypting an email message using the encryption information (see claims 1 in U.S. Patent 7,706,871 B2 and U.S. Patent 7,643,818 B2), and transmitting the encrypted e-mail message (see claims 1 in U.S. Patent 7,706,871 B2 and U.S. Patent 7,643,818 B2).

5. The current independent claim 1 is a broader version of claim 1 of U.S. Patent 7,643,818 B2, without the limitation of establishing a tunnel and permanent terminal identity and temporary identity.

6. The current independent claim 1 is a broader version of claim 1 of U.S. Patent 7,706,781 B2, without the limitation of activation code, permanent terminal identity, and encrypted data channel. The limitation of activation code can be found in the dependent claim 8 of the current application.

7. Thus the current independent claims 1, 12, 20 have similar limitation as the parent claim in the U.S. Patent 7,706,871 B2 and U.S. Patent 7,643,818 B2.

***Claim Rejections - 35 USC § 103***

8. The following is a quotation of pre-AIA 35 U.S.C. 103(a) which forms the basis for all obviousness rejections set forth in this Office action:

(a) A patent may not be obtained though the invention is not identically disclosed or described as set forth in section 102 of this title, if the differences between the subject matter sought to be patented and the prior art are such that the subject matter as a whole would have been obvious at the time the invention was made to a person having ordinary skill in the art to which said subject matter pertains. Patentability shall not be negated by the manner in which the invention was made.

9. Claims 1-2, 6-10, 12-15, 18, 21-22, 52-54 are rejected under pre-AIA 35 U.S.C. 103(a) as being unpatentable over Little et al. U.S. Patent Application Publication Number 2004/0205248 A1 (hereinafter Little), further in view of Turunen et al. U.S. Patent Number 7,289,792 B1 (hereinafter Turunen), and further in view of Osthoff et al. U.S. Patent Application Publication Number 2002/0147918 A1 (hereinafter Osthoff).

10. As per claims 1, 12, Little disclose a method for forwarding an e-mail message from an e-mail server to a mobile terminal (see forwarding email message 833 from

message server 820 to mobile device 816 on page 9 section [0076] on Figure 8), the method comprising:

11. receiving, at an intermediary system (see wireless gateway 85 receiving email from e-mail sender 10 in Figure 1 and page 2 section [0025]), an e-mail message associated with an e-mail address of a user of a mobile terminal and sent by an e-mail servers (see message server 45 on Figure 1 and see receiving e-mail messages to a user identified by an e-mail address on page 9 section [0078]),

12. wherein the e-mail address is associated with an identifier of the mobile terminal (see specific e-mail address associated with the mobile device on page 2 section [0026]),

13. wherein an email, account associated with the email address, is hosted by an e-mail server (see email associated with an account on a message server on page 2 section [0024]),

14. encrypting the e-mail message (see encryption e-mail message to be send through a wireless VPN through a temporary transfer path on page 9 section [0081]) using encryption information associated with a temporary identifier (see encryption using private key on page 8 section [0070]),

15. and

16. transmitting the encrypted e-mail message to the mobile terminal (see sending encrypted message to mobile device on page 10 section [0082]).

17. Little do not disclose expressly: a plurality of e-mail servers.

18. wherein an email, account associated with the email address, is hosted by one of the plurality of e-mail servers.

19. wherein the identifier is generated by the mobile terminal;

20. wherein the temporary identifier is based on a connection to the mobile terminal.

21. Turunen teaches: a plurality of e-mail servers (see at least one multimedia message server MMSV in Abstract and multiple MMS such as Mowgli, WAP, and LDAP in Figure 2).

22. Turunen teaches: wherein an email, account associated with the email address, is hosted by one of the plurality of e-mail servers (see e-mail system typically comprise one or more e-mail servers on column 2 line 40-45).

23. Turunen teaches: wherein the temporary identifier is based on a connection to the mobile terminal (see temporary logical link identity TLLI provided to the mobile terminal by the serving packet service support node SGSN based on the temporary connection and channel on column 7 line 2-25 and see sending encryption parameters to setup connection on column 7 line 23-28).

24. Little and Turunen are analogous art because they are from the same field of endeavor, wireless email terminal system. At the time of the invention it would have been obvious to a person of ordinary skill in the art to also apply a temporary mobile terminal identifier for the connection to link the email to the individual mobile terminal. The motivation for doing so would have been to use link an email address that use the temporary connection address to an wireless mobile terminal that use wireless network system. Therefore, it would have been obvious to combine Little and Turunen for the

benefit of using e-mail address of the mobile terminal is associated with a temporary connection identifier to obtain the invention as specified in claims 1, 12.

25. Little and Turunen do not disclose expressly: wherein the identifier is generated by the mobile terminal.

26. Osthoff teaches: wherein the identifier is generated by the mobile terminal (see using terminal identifier stored in the terminal device to create a temporary hash value to communicate with the server for authentication purposes on page 1 section [0011]).

27. Little and Osthoff are analogous art because they are from the same field of endeavor, wireless email terminal system. At the time of the invention it would have been obvious to a person of ordinary skill in the art to also apply a temporary mobile terminal identifier generated by the mobile terminal. The motivation for doing so would have been to authenticate a wireless mobile terminal that use wireless network system. Therefore, it would have been obvious to combine Little and Turunen and Osthoff for the benefit of generate a temporary connection identifier by the mobile terminal to obtain the invention as specified in claim 1, 12.

28. As per claim 2, Little and Turunen and Osthoff disclose the method of claim 1, further comprising identifying the mobile terminal based on the e-mail address of the e-mail message and the association with the identifier of the mobile terminal (see e-mail address of terminal is used to identify the wireless terminal as well as an permanent identification of wireless terminal using international mobile subscriber identity IMSI on column 8 line 20-35 and see e-mail address as well as the permanent identification of



the wireless terminal such as a telephone number MSISDN and device identification IMSI are used to linking email address to the wireless terminal on column 8 line 29-37 in Turunen).

29. As per claim 6, Little and Turunen and Osthoff disclose the method of claim 2, further comprising adding the e-mail address to a reply message sent by the mobile terminal (see repacking allowing reply messages to delivered to addressed recipients on page 10 section [0083] in Little).

30. As per claim 7, Little and Turunen and Osthoff disclose the method of claim 1, further comprising receiving the encryption information generated by the mobile terminal (see private key encryption information is shared to other systems and devices on page 8 section [0070] in Little).

31. As per claim 8, Little and Turunen and Osthoff disclose the method of claim 1, wherein the encryption information (see encryption information private key is used to identify mobile device entity on page 8 section [0070] in Little) is based on an activation code of the mobile terminal (see activation message from the wireless terminal to set up linking of the email address to the wireless terminal on column 8 line 29-37 in Turunen).

32. As per claim 9, Little and Turunen and Osthoff disclose the method of claim 1, wherein the messaging center transmits the e-mail message to the mobile terminal

using the identifier of the mobile terminal (see temporary logical link identity TLLI to transmit data to wireless terminal over temporary wireless network on column 7 line 1-10 in Turunen).

33. As per claims 10, 18, Little and Turunen and Osthoff disclose the method of claim 1, wherein mobile terminal receives and decrypts the e-mail message (see wireless terminal decrypts the message on page 10 section [0082] in Little) using the encryption information (see decryption using shared private key on page 8 section [0070] in Little).

34. As per claim 13, Little and Turunen and Osthoff disclose the system of claim 12, wherein the processor is further configured to receive the e-mail message from the e-mail server (see wireless connector system 828 transfers data between mobile device 816 and email message server 820 on page 9 section [0079] in Little).

35. As per claim 14, Little and Turunen and Osthoff disclose the system of claim 12, wherein the processor (see wireless connector system 828 transfers data between mobile device 816 and email message server 820 on page 9 section [0079] in Little) is further configured to receive the encryption information and to provide the encryption information to the memory for storage (see receiving encryption information shared private key on page 8 section [0070] in Little).

36. As per claim 15, Little and Turunen and Osthoff disclose the system of claim 12, wherein the processor is further configured to pack the e-mail message (see repackaging the email message 833 such as compressing and encrypting the email message 833 on page 9 section [0081] in Little).

37. As per claims 21, 22, 54, Little disclose a mobile device (see mobile device 100 on page 12 section [0099] and Figure 11) comprising:

38. a radio (see transceiver 1111 on page 12 section [0099]);

39. a memory (see random access memory 1126 on page 12 section [0099]);

40. a processor (see microprocessor 1138 on page 12 section [0099]) configured for controlling a mobile device to:

41. receive, from a server, an encrypted e-mail message associated with an e-mail address of a user of the mobile device (see receiving encrypted message on page 10 section [0082]), wherein the e-mail address is associated with the identifier and wherein an email account, associated with the email address, is hosted by an e-mail server (see e-mail address corresponding to a user account and mailbox on page 9 section [0078] and see email account hosted by mail server on page 2 section [0024]),

42. decrypt the e-mail message using encryption information associated with a temporary identifier (see decrypt using session key on page 1 section [0007] and page 4 section [0037]),

43. Little do not disclose expressly: generate an identifier; and

44. wherein the temporary identifier is based on a connection to the server.
45. Little do not disclose expressly: a plurality of e-mail servers.
46. wherein an email, account associated with the email address, is hosted by one of the plurality of e-mail servers.
47. Turunen teaches : wherein the temporary identifier is based on a connection to the server (see temporary logical link identity TLLI provided to the mobile terminal by the serving packet service support node SGSN based on the temporary connection and channel on column 7 line 2-25 and see sending encryption parameters to setup connection on column 7 line 23-28).
48. Turunen teaches: a plurality of e-mail servers (see at least one multimedia message server MMSV in Abstract and multiple MMS such as Mowgli, WAP, and LDAP in Figure 2).
49. Turunen teaches: wherein an email, account associated with the email address, is hosted by one of the plurality of e-mail servers (see e-mail system typically comprise one or more e-mail servers on column 2 line 40-45).
50. Little and Turunen are analogous art because they are from the same field of endeavor, wireless email terminal system. At the time of the invention it would have been obvious to a person of ordinary skill in the art to also apply a temporary mobile terminal identifier for the connection to link the email to the individual mobile terminal. The motivation for doing so would have been to use link an email address that use the temporary connection address to an wireless mobile terminal that use wireless network system. Therefore, it would have been obvious to combine Little and Turunen for the

benefit of using e-mail address of the mobile terminal is associated with a temporary connection identifier to obtain the invention as specified in claim 21, 22, 54.

51. Little and Turunen do not disclose expressly: generate an identifier.

52. Osthoff teaches: generate an identifier (see using terminal identifier stored in the terminal device to create a temporary hash value to communicate with the server for authentication purposes on page 1 section [0011]).

53. Little and Osthoff are analogous art because they are from the same field of endeavor, wireless email terminal system. At the time of the invention it would have been obvious to a person of ordinary skill in the art to also apply a temporary mobile terminal identifier generated by the mobile terminal. The motivation for doing so would have been to authenticate a wireless mobile terminal that use wireless network system. Therefore, it would have been obvious to combine Little and Turunen and Osthoff for the benefit of generate an identifier by the mobile terminal to obtain the invention as specified in claim 21, 22, 54.

54. As per claims 52, 53, Little and Turunen and Osthoff disclose the method of claim 1, wherein the identifier (logon request contain wireless terminal identifier on column 8 line 55-62 in Turunen) is associated with the temporary identifier (see temporary identifier temporary logical link identity TLLI used to connect wireless terminal with serving support node SGSN on column 7 line 4-21 in Turunen).

55. Claims 3-5, 11, 16-17, 19 are rejected under pre-AIA 35 U.S.C. 103(a) as being unpatentable over Little et al. U.S. Patent Application Publication Number 2004/0205248 A1 (hereinafter Little), further in view of Turunen et al. U.S. Patent Number 7,289,792 B1 (hereinafter Turunen), further in view of Osthoff et al. U.S. Patent Application Publication Number 2002/0147918 A1 (hereinafter Osthoff), further in view of Kock et al. U.S. Patent Application Publication Number 2006/0031300 A1 (hereinafter Kock).

56. As per claims 3, 16, Little and Turunen and Osthoff do not disclose the method of claim 1: wherein encrypting the e-mail message further comprises packing the e-mail message by omitting at least part of the e-mail message when at least part of the e-mail message exceeds a predetermined size specification.

57. Kock teaches: packing the e-mail message by omitting at least part of the e-mail message when at least part of the e-mail message exceeds a predetermined size specification (see server transmitting the header the first N character of the body to the terminal device, where N is a predetermined integer, while holding back any remaining body of the email on page 1 section [0008]).

58. Little and Kock are analogous art because they are from the same field of endeavor, wireless email terminal system. At the time of the invention it would have been obvious to a person of ordinary skill in the art to also apply an email message sending size. The motivation for doing so would have been to save bandwidth and only send email data that user requests. Therefore, it would have been obvious to combine Little and Turunen and Osthoff and Kock for the benefit of omitting at least part of the e-mail message when at least part of the e-mail message exceeds a predetermined size to obtain the invention as specified in claims 3, 16.

59. As per claims 4, 17, Little and Turunen and Osthoff and Kock disclose the method of claim 3, wherein size specification is set by a user of the mobile terminal (see number N is determined by a user of the terminal device on page 1 section [0014] in Kock).

60. As per claim 5, Little and Turunen and Osthoff and Kock disclose the method of claim 3, wherein the omitted part of the e-mail message is the e-mail address (see omitting any characters of the body including email address beyond the predetermined integer N on page 1 section [0008] in Kock).

61. As per claim 11, 19, Little and Turunen and Osthoff and Kock disclose the method of claim 3, wherein the mobile terminal unpacks the e-mail message (see

mobile terminal repacking the email message by decompression and decryption on page 10 section [0082] in Little).

62. Claims 23-24, 37-38, 55 are rejected under pre-AIA 35 U.S.C. 103(a) as being unpatentable over Little et al. U.S. Patent Application Publication Number 2004/0205248 A1 (hereinafter Little), further in view of Turunen et al. U.S. Patent Number 7,289,792 B1 (hereinafter Turunen), further in view of Osthoff et al. U.S. Patent Application Publication Number 2002/0147918 A1 (hereinafter Osthoff), further in view of Anttila et al. U.S. Patent Application Publication Number 2005/0139680 A1 (hereinafter Anttila).

63. As per claims 23, 37, 55, Little discloses a device (see message server 820 on page 9 section [0076] and Figure 8) comprising:

64. a radio (see wireless connector system 828 on page 9 section [0079]);



65. a processor and memory (see message server 820 saving email messages to mail box 819 on page 9 section [0078]) containing instructions executable by the processor whereby the device is operable to:
  66. register the remote device for access to a messaging account (see registering remote devices using unique identification and using Subscriber Identity Module SIM on page 12 section [0105]);
  67. receive a message for the messaging account (see e-mail message 833 arrive at message server 820 and server determining which mailboxes 819 to be stored on page 9 section [0078]);
  68. encrypt the message using an encryption key (see encrypt e-mail message on page 9 section [0081]); and
  69. send the message to the remote device (see sending message to mobile devices on page 9 section [0081]),
  70. wherein the device is authenticated to access the messaging account (see e-mail address identifies a user account and mailbox 819 on page 9 section [0078]).
71. Little do not disclose expressly: receive information including a service activation code from a remote device.
72. Turunen teaches: receive information including a service activation code (see activation message from the wireless terminal to set up linking of the email address to the wireless terminal on column 8 line 29-37 and see activation message from the wireless terminal to set up linking of the email address to the wireless terminal on

column 8 line 29-37 and see activation call the message server to define the wireless terminal of the right recipient on the basis of the e-mail address on column 8 line 40-45).

73. Little and Turunen are analogous art because they are from the same field of endeavor, wireless email terminal system. At the time of the invention it would have been obvious to a person of ordinary skill in the art to also apply an activation code to link the email to the individual mobile terminal. The motivation for doing so would have been to link an email address to a wireless mobile terminal using an activation code that use wireless network system. Therefore, it would have been obvious to combine Little and Turunen for the benefit of using e-mail address of the mobile terminal is associated with an activation code to obtain the invention as specified in claim 23, 37, 55.

74. Little and Turunen do not disclose expressly: receive information including a service activation code from a remote device.

75. Osthoff teaches: receive information including a service activation code from a remote device (see using terminal identifier stored in the terminal device to create a temporary hash value to communicate with the server for authentication purposes on page 1 section [0011]).

76. Little and Osthoff are analogous art because they are from the same field of endeavor, wireless email terminal system. At the time of the invention it would have been obvious to a person of ordinary skill in the art to also apply a temporary mobile terminal identifier generated by the mobile terminal. The motivation for doing so would have been to authenticate a wireless mobile terminal that use wireless network system. Therefore, it would have been obvious to combine Little and Turunen and Osthoff for

the benefit of generate an identifier by the mobile terminal to obtain the invention as specified in claim 23, 37, 55.

77. Little and Turunen and Osthoff do not teach expressly: optically receive information including a displayed service activation code from a remote device.

78. Anttila teaches: optically receive information including a displayed service activation code from a remote device (see generate and send a short range communication visual code from one device to another for transferring data on page 2 section [0016] and see use of optical quick response (QR) code for security measure on page 2 section [0014]).

79. Little and Anttila are analogous art because they are from the same field of endeavor, wireless terminal data transfer system. At the time of the invention it would have been obvious to a person of ordinary skill in the art to use optical interface to transfer information. The motivation for doing so would have been to authenticate a wireless mobile terminal that use wireless network system using a well-known optical interface. Therefore, it would have been obvious to combine Little and Turunen and Osthoff and Anttila for the benefit of optical interface to transfer data to obtain the invention as specified in claim 23, 37, 55.

80. As per claims 24, 38, Little and Turunen and Osthoff and Anttila disclose the device of claim 23, wherein the information including the service activation code is received by the device in response to user input at the remote device (see user entering a password for decryption the message session on page 5 section [0044] in Little and

see activation request message received from the user wireless terminal containing encryption key and identification parameters and on column 7 line 55-65 in Turunen).

81. Claims 25-26, 28-36, 39, 41-51, 56-58 are rejected under pre-AIA 35 U.S.C. 103(a) as being unpatentable over Little et al. U.S. Patent Application Publication Number 2004/0205248 A1 (hereinafter Little), further in view of Turunen et al. U.S. Patent Number 7,289,792 B1 (hereinafter Turunen), further in view of Osthoff et al. U.S. Patent Application Publication Number 2002/0147918 A1 (hereinafter Osthoff), further in view of Anttila et al. U.S. Patent Application Publication Number 2005/0139680 A1 (hereinafter Anttila), further in view of Salonen U.S. Patent Application Publication Number 2013/0268384 A1 (hereinafter Salonen).

82. As per claims 25, 39, Little and Turunen and Osthoff and Anttila do not disclose expressly: wherein the information including the service activation code is received by the device in an off-line communication.

83. Salonen teaches: wherein the information including the service activation code is received by the device in an off-line communication (see using a secure SIM card in GSM devices as activation code to encrypt messages offline on the device without using network resources on page 6 section [0074]).

84. Little and Salonen are analogous art because they are from the same field of endeavor, wireless email terminal system. At the time of the invention it would have been obvious to a person of ordinary skill in the art to use off-line service activation code. The motivation for doing so would have been to use a secure physical means to encrypt message. Therefore, it would have been obvious to combine Little and Turunen and Osthoff and Anttila and Salonen for the benefit of using activation code in an off-line communication to obtain the invention as specified in claims 25, 39.

85. As per claim 26, Little and Turunen and Osthoff and Anttila and Salonen disclose the device of claim 25, wherein the off-line communication involves a local connection (see using a secure SIM card in GSM devices as activation code to encrypt messages locally using secure connection on page 6 section [0074] in Salonen).

86. As per claims 28, 41, Little and Turunen and Osthoff and Anttila and Salonen disclose the device of claim 25, wherein the off-line communication prevents eavesdropping of the service activation code (see using a secure SIM card in GSM devices as activation code to encrypt messages prevents eavesdropping of the encryption within the device on page 6 section [0074] in Salonen).

87. As per claims 29, 42, Little and Turunen and Osthoff and Anttila and Salonen disclose the device of claim 23, wherein the authentication of the device relies on the

authentication of the messaging account (see user enter password to authenticate device on page 5 section [0044] in Little).

88. As per claims 30, 43, Little and Turunen and Osthoff and Anttila and Salonen disclose the method of claim 29, wherein the authentication of the messaging account includes a username and password (see message account identified by user name on page 9 section [0078] and see user enter password to authenticate device on page 5 section [0044] in Little).

89. As per claims 31, 44, Little and Turunen and Osthoff and Anttila and Salonen disclose the device of claim 23, wherein the encryption key is the service activation code (see sending encryption key or private key on page 8 section [0070] in Little and see activation message on column 8 line 29-40 and see exchanging encryption parameters on column 7 line 20-28 in Turunen).

90. As per claims 32, 45, Little and Turunen and Osthoff and Anttila and Salonen disclose the device of claim 23, wherein the encryption key is derived from the service activation code (see private key is used to decrypt the session key to decrypt message body on page 4 section [0037] in Little).

91. As per claims 33, 46, Little and Turunen and Osthoff and Anttila and Salonen disclose the device of claim 23, wherein the encryption key is a subset of the service activation code (see encrypted session key embedded in message may be further encrypted with a public key on page 4 section [0040] in Little).

92. As per claims 34, 47, Little and Turunen and Osthoff and Anttila and Salonen disclose the device of claim 23, wherein the encryption key is closely related to the service activation code (see private key is used to decrypt the session key to decrypt message body on page 4 section [0037] in Little).

93. As per claims 35, 48, Little and Turunen and Osthoff and Anttila and Salonen disclose the device of claim 23, wherein the device is further operable to: store an association between at least two of the encryption key (see encryption key and session key on page 4 section [0037] in Little), the messaging account, an identifier of the remote device, and the service activation code (see storage storing user name, user account, mailbox identifier on page 9 section [0078] in Little).

94. As per claims 36, 50, Little and Turunen and Osthoff and Anttila and Salonen disclose the device of claim 23, wherein the message is sent to the remote device through an intermediate device (see wireless Gateway 85 on page 2 section [0027] and in Figure 1 in Little).

95. As per claims 49, 51, Little and Turunen and Osthoff and Anttila and Salonen disclose the device of claim 36, wherein the encryption key (see encryption key is used to generate request on column 6 line 55-65) is associated with a temporary identifier (see temporary identifier temporary logical link identity TLLI used to connect wireless terminal with serving support node SGSN on column 7 line 4-21 in Turunen), wherein the temporary identifier is based on a connection to the intermediate device (see wireless Gateway 85 on page 2 section [0027] and in Figure 1 in Little and see gateway support node GGSN on column 6 line 60-65 in Turunen).

96. As per claims 56-58, Little and Turunen and Osthoff and Anttila and Salonen disclose of claim 23, wherein a control message is received from the remote device upon user interaction with the message (see first device and second device initiate communication step 480 after authentication step 470 on page 6 section [0046] and Figure 3 in Anttila).

### ***Response to Arguments***

97. Applicant's arguments filed on February 9, 2017 have been fully considered but they are not persuasive. As per claims 1, 12, 21, 22, 54, applicant asserts that Little and Turunen and Osthoff do to teach expressly: wherein an email account, associated with



the email address, is hosted by one of the plurality of e-mail servers (see Remarks on page 11). The examiner respectfully disagrees.

98. Little teaches: wherein an email, account associated with the email address, is hosted by an e-mail server (see email associated with an account on a message server on page 2 section [0024]).

99. Turunen teaches: wherein an email, account associated with the email address, is *hosted by one of the plurality of e-mail servers* (see e-mail system typically comprise one or more e-mail servers on column 2 line 40-45).

100. Applicant's arguments, see Remarks on page 12, filed February 9, 2017, with respect to the rejection(s) of claim(s) 23, 37, 55 under 35 U.S.C. 103(a) have been fully considered and are persuasive. Therefore, the rejection has been withdrawn.

However, upon further consideration, a new ground(s) of rejection is made in view of Anttila et al. U.S. Patent Application Publication Number 2005/0139680 A1 (hereinafter Anttila).

101. Little and Turunen and Osthoff do not teach expressly: optically receive information including a displayed service activation code from a remote device.

102. Anttila teaches: optically receive information including a displayed service activation code from a remote device (see generate and send a short range communication visual code from one device to another for transferring data on page 2

section [0016] and see use of optical quick response (QR) code for security measure on page 2 section [0014]).

103. Little and Anttila are analogous art because they are from the same field of endeavor, wireless terminal data transfer system. At the time of the invention it would have been obvious to a person of ordinary skill in the art to use optical interface to transfer information. The motivation for doing so would have been to authenticate a wireless mobile terminal that use wireless network system using a well-known optical interface. Therefore, it would have been obvious to combine Little and Turunen and Osthoff and Anttila for the benefit of optical interface to transfer data to obtain the invention as specified in claim 23, 37, 55.

### ***Conclusion***

Applicant's amendment necessitated the new ground(s) of rejection presented in this Office action. Accordingly, **THIS ACTION IS MADE FINAL**. See MPEP § 706.07(a). Applicant is reminded of the extension of time policy as set forth in 37 CFR 1.136(a).

A shortened statutory period for reply to this final action is set to expire THREE MONTHS from the mailing date of this action. In the event a first reply is filed within TWO MONTHS of the mailing date of this final action and the advisory action is not mailed until after the end of the THREE-MONTH shortened statutory period, then the shortened statutory period will expire on the date the advisory action is mailed, and any

extension fee pursuant to 37 CFR 1.136(a) will be calculated from the mailing date of the advisory action. In no event, however, will the statutory period for reply expire later than SIX MONTHS from the date of this final action.

Any inquiry concerning this communication or earlier communications from the examiner should be directed to ALAN S. CHOU whose telephone number is (571)272-5779. The examiner can normally be reached on 9am-5pm.

If attempts to reach the examiner by telephone are unsuccessful, the examiner's supervisor, Christopher L. Parry can be reached on (571)272-8328. The fax phone number for the organization where this application or proceeding is assigned is 571-273-8300.

Information regarding the status of an application may be obtained from the Patent Application Information Retrieval (PAIR) system. Status information for published applications may be obtained from either Private PAIR or Public PAIR. Status information for unpublished applications is available through Private PAIR only. For more information about the PAIR system, see <http://pair-direct.uspto.gov>. Should you have questions on access to the Private PAIR system, contact the Electronic Business Center (EBC) at 866-217-9197 (toll-free). If you would like assistance from a USPTO Customer Service Representative or access to the automated information system, call 800-786-9199 (IN USA OR CANADA) or 571-272-1000.

ALAN S CHOU  
Examiner  
Art Unit 2451

/ALAN S CHOU/  
Examiner, Art Unit 2451

<b>Notice of References Cited</b>	Application/Control No. 14/609,189	Applicant(s)/Patent Under Reexamination BACKHOLM ET AL.	
	Examiner ALAN S. CHOU	Art Unit 2451	Page 1 of 1

**U.S. PATENT DOCUMENTS**

*	Document Number Country Code-Number-Kind Code	Date MM-YYYY	Name	CPC Classification	US Classification
*	A US-2005/0139680 A1	06-2005	Anttila, Akseli	G06K1/18	235/462.46
B	US-				
C	US-				
D	US-				
E	US-				
F	US-				
G	US-				
H	US-				
I	US-				
J	US-				
K	US-				
L	US-				
M	US-				

**FOREIGN PATENT DOCUMENTS**

*	Document Number Country Code-Number-Kind Code	Date MM-YYYY	Country	Name	CPC Classification
N					
O					
P					
Q					
R					
S					
T					

**NON-PATENT DOCUMENTS**

*	Include as applicable: Author, Title Date, Publisher, Edition or Volume, Pertinent Pages)
U	
V	
W	
X	

\*A copy of this reference is not being furnished with this Office action. (See MPEP § 707.05(a).)  
Dates in MM-YYYY format are publication dates. Classifications may be US or foreign.

<b>Index of Claims</b> 	<b>Application/Control No.</b> 14609189	<b>Applicant(s)/Patent Under Reexamination</b> BACKHOLM ET AL.
	<b>Examiner</b> ALAN S CHOU	<b>Art Unit</b> 2451

✓	<b>Rejected</b>
=	<b>Allowed</b>

-	<b>Cancelled</b>
÷	<b>Restricted</b>

N	<b>Non-Elected</b>
I	<b>Interference</b>

A	<b>Appeal</b>
O	<b>Objected</b>

Claims renumbered in the same order as presented by applicant
  CPA
  T.D.
  R.1.47

CLAIM		DATE							
Final	Original	09/25/2015	07/06/2016	11/01/2016	05/25/2017				
	1	✓	✓	✓	✓				
	2	✓	✓	✓	✓				
	3	✓	✓	✓	✓				
	4	✓	✓	✓	✓				
	5	✓	✓	✓	✓				
	6	✓	✓	✓	✓				
	7	✓	✓	✓	✓				
	8	✓	✓	✓	✓				
	9	✓	✓	✓	✓				
	10	✓	✓	✓	✓				
	11	✓	✓	✓	✓				
	12	✓	✓	✓	✓				
	13	✓	✓	✓	✓				
	14	✓	✓	✓	✓				
	15	✓	✓	✓	✓				
	16	✓	✓	✓	✓				
	17	✓	✓	✓	✓				
	18	✓	✓	✓	✓				
	19	✓	✓	✓	✓				
	20	✓	-	-	-				
	21		✓	✓	✓				
	22		✓	✓	✓				
	23		✓	✓	✓				
	24		✓	✓	✓				
	25		✓	✓	✓				
	26		✓	✓	✓				
	27		✓	✓	-				
	28		✓	✓	✓				
	29		✓	✓	✓				
	30		✓	✓	✓				
	31		✓	✓	✓				
	32		✓	✓	✓				
	33		✓	✓	✓				
	34		✓	✓	✓				
	35		✓	✓	✓				
	36		✓	✓	✓				

<b><i>Index of Claims</i></b> 	<b>Application/Control No.</b> 14609189	<b>Applicant(s)/Patent Under Reexamination</b> BACKHOLM ET AL.
	<b>Examiner</b> ALAN S CHOU	<b>Art Unit</b> 2451

✓	<b>Rejected</b>
=	<b>Allowed</b>

-	<b>Cancelled</b>
÷	<b>Restricted</b>

N	<b>Non-Elected</b>
I	<b>Interference</b>

A	<b>Appeal</b>
O	<b>Objected</b>

Claims renumbered in the same order as presented by applicant
  CPA
  T.D.
  R.1.47

CLAIM		DATE							
Final	Original	09/25/2015	07/06/2016	11/01/2016	05/25/2017				
	37		✓	✓	✓				
	38		✓	✓	✓				
	39		✓	✓	✓				
	40		✓	✓	-				
	41		✓	✓	✓				
	42		✓	✓	✓				
	43		✓	✓	✓				
	44		✓	✓	✓				
	45		✓	✓	✓				
	46		✓	✓	✓				
	47		✓	✓	✓				
	48		✓	✓	✓				
	49		✓	✓	✓				
	50		✓	✓	✓				
	51		✓	✓	✓				
	52		✓	✓	✓				
	53		✓	✓	✓				
	54		✓	✓	✓				
	55		✓	✓	✓				
	56				✓				
	57				✓				
	58				✓				

Doc code: IDS

Doc description: Information Disclosure Statement (IDS) Filed

PTO/SB/08a (01-10)

Approved for use through 07/31/2012. OMB 0651-0031  
U.S. Patent and Trademark Office; U.S. DEPARTMENT OF COMMERCE

Under the Paperwork Reduction Act of 1995, no persons are required to respond to a collection of information unless it contains a valid OMB control number.

<b>INFORMATION DISCLOSURE STATEMENT BY APPLICANT</b> ( Not for submission under 37 CFR 1.99)	Application Number	14609189
	Filing Date	2015-01-29
	First Named Inventor	Backholm
	Art Unit	2651
	Examiner Name	CHOU, ALAN S.
	Attorney Docket Number	455/006/8 UTIL

U.S.PATENTS							Remove
Examiner Initial*	Cite No	Patent Number	Kind Code <sup>1</sup>	Issue Date	Name of Patentee or Applicant of cited Document	Pages,Columns,Lines where Relevant Passages or Relevant Figures Appear	
	1						

If you wish to add additional U.S. Patent citation information please click the Add button. Add

U.S.PATENT APPLICATION PUBLICATIONS							Remove
Examiner Initial*	Cite No	Publication Number	Kind Code <sup>1</sup>	Publication Date	Name of Patentee or Applicant of cited Document	Pages,Columns,Lines where Relevant Passages or Relevant Figures Appear	
	1						

If you wish to add additional U.S. Published Application citation information please click the Add button. Add

FOREIGN PATENT DOCUMENTS								Remove
Examiner Initial*	Cite No	Foreign Document Number <sup>3</sup>	Country Code <sup>2i</sup>	Kind Code <sup>4</sup>	Publication Date	Name of Patentee or Applicant of cited Document	Pages,Columns,Lines where Relevant Passages or Relevant Figures Appear	T <sup>5</sup>
	1							

If you wish to add additional Foreign Patent Document citation information please click the Add button. Add

NON-PATENT LITERATURE DOCUMENTS							Remove
Examiner Initials*	Cite No	Include name of the author (in CAPITAL LETTERS), title of the article (when appropriate), title of the item (book, magazine, journal, serial, symposium, catalog, etc), date, pages(s), volume-issue number(s), publisher, city and/or country where published.					T <sup>5</sup>



<b>INFORMATION DISCLOSURE STATEMENT BY APPLICANT</b> ( Not for submission under 37 CFR 1.99)	Application Number		14609189
	Filing Date		2015-01-29
	First Named Inventor	Backholm	
	Art Unit	2651	
	Examiner Name	CHOU, ALAN S.	
	Attorney Docket Number	455/006/8 UTIL	

1	WILLIS, WILL, et al, Implementing and Managing Microsoft EXCHANGE SERVER 2003, Self-Paced Training Kit, Microsoft, <a href="http://www.post.ir/_ITCenter/Documents/c4b0ff43-0235-4e62-a615-818f6834989a.pdf">http://www.post.ir/_ITCenter/Documents/c4b0ff43-0235-4e62-a615-818f6834989a.pdf</a> , Pages 1-826, Microsoft Press, Redmond, WA
2	MICROSOFT, Exchange Server 2003 Features Comparison, <a href="https://www.microsoft.com/middleeast/windowsserversystem/exchange/evaluation/features/ex_compare.aspx">https://www.microsoft.com/middleeast/windowsserversystem/exchange/evaluation/features/ex_compare.aspx</a> , Updated: 2004-05-25, Pages 1-6
3	MICROSOFT EXCHANGE, Exchange Server Version and Features - TechNet Articles - United States (English) - TechNet Wiki, <a href="https://social.technet.microsoft.com/wiki/contents/articles/346.exchange-server-version-and-features.aspx">https://social.technet.microsoft.com/wiki/contents/articles/346.exchange-server-version-and-features.aspx</a> , First Published: 2010-03-09; Last Revision: 2016-12-11, Pages 1-3
4	MICROSOFT, Exchange Documentation Team, Exchange Server 2003 Administrative Guide, Microsoft Windows Server System, <a href="http://www.pc-hulp-online.nl/upload/Microsoft_Exchange_Server_2003_Administration_Guide.pdf">http://www.pc-hulp-online.nl/upload/Microsoft_Exchange_Server_2003_Administration_Guide.pdf</a> , September 2003, Pages 1-503

If you wish to add additional non-patent literature document citation information please click the Add button

**EXAMINER SIGNATURE**

Examiner Signature	/ALAN S CHOU/	Date Considered	05/25/2017
--------------------	---------------	-----------------	------------

\*EXAMINER: Initial if reference considered, whether or not citation is in conformance with MPEP 609. Draw line through a citation if not in conformance and not considered. Include copy of this form with next communication to applicant.

<sup>1</sup> See Kind Codes of USPTO Patent Documents at [www.USPTO.GOV](http://www.USPTO.GOV) or MPEP 901.04. <sup>2</sup> Enter office that issued the document, by the two-letter code (WIPO Standard ST.3). <sup>3</sup> For Japanese patent documents, the indication of the year of the reign of the Emperor must precede the serial number of the patent document. <sup>4</sup> Kind of document by the appropriate symbols as indicated on the document under WIPO Standard ST.16 if possible. <sup>5</sup> Applicant is to place a check mark here if English language translation is attached.

<b>INFORMATION DISCLOSURE STATEMENT BY APPLICANT</b> ( Not for submission under 37 CFR 1.99)	Application Number		14609189
	Filing Date		2015-01-29
	First Named Inventor	Backholm	
	Art Unit		2651
	Examiner Name	CHOU, ALAN S.	
	Attorney Docket Number		455/006/8 UTIL

**CERTIFICATION STATEMENT**

Please see 37 CFR 1.97 and 1.98 to make the appropriate selection(s):

That each item of information contained in the information disclosure statement was first cited in any communication from a foreign patent office in a counterpart foreign application not more than three months prior to the filing of the information disclosure statement. See 37 CFR 1.97(e)(1).

**OR**

That no item of information contained in the information disclosure statement was cited in a communication from a foreign patent office in a counterpart foreign application, and, to the knowledge of the person signing the certification after making reasonable inquiry, no item of information contained in the information disclosure statement was known to any individual designated in 37 CFR 1.56(c) more than three months prior to the filing of the information disclosure statement. See 37 CFR 1.97(e)(2).

See attached certification statement.

- The fee set forth in 37 CFR 1.17 (p) has been submitted herewith.
- A certification statement is not submitted herewith.

**SIGNATURE**

A signature of the applicant or representative is required in accordance with CFR 1.33, 10.18. Please see CFR 1.4(d) for the form of the signature.

Signature	/Justin R. Nifong/	Date (YYYY-MM-DD)	2017-01-26
Name/Print	Justin R. Nifong	Registration Number	59389

This collection of information is required by 37 CFR 1.97 and 1.98. The information is required to obtain or retain a benefit by the public which is to file (and by the USPTO to process) an application. Confidentiality is governed by 35 U.S.C. 122 and 37 CFR 1.14. This collection is estimated to take 1 hour to complete, including gathering, preparing and submitting the completed application form to the USPTO. Time will vary depending upon the individual case. Any comments on the amount of time you require to complete this form and/or suggestions for reducing this burden, should be sent to the Chief Information Officer, U.S. Patent and Trademark Office, U.S. Department of Commerce, P.O. Box 1450, Alexandria, VA 22313-1450. **DO NOT SEND FEES OR COMPLETED FORMS TO THIS ADDRESS. SEND TO: Commissioner for Patents, P.O. Box 1450, Alexandria, VA 22313-1450.**

## Privacy Act Statement

The Privacy Act of 1974 (P.L. 93-579) requires that you be given certain information in connection with your submission of the attached form related to a patent application or patent. Accordingly, pursuant to the requirements of the Act, please be advised that: (1) the general authority for the collection of this information is 35 U.S.C. 2(b)(2); (2) furnishing of the information solicited is voluntary; and (3) the principal purpose for which the information is used by the U.S. Patent and Trademark Office is to process and/or examine your submission related to a patent application or patent. If you do not furnish the requested information, the U.S. Patent and Trademark Office may not be able to process and/or examine your submission, which may result in termination of proceedings or abandonment of the application or expiration of the patent.

The information provided by you in this form will be subject to the following routine uses:

1. The information on this form will be treated confidentially to the extent allowed under the Freedom of Information Act (5 U.S.C. 552) and the Privacy Act (5 U.S.C. 552a). Records from this system of records may be disclosed to the Department of Justice to determine whether the Freedom of Information Act requires disclosure of these records.
2. A record from this system of records may be disclosed, as a routine use, in the course of presenting evidence to a court, magistrate, or administrative tribunal, including disclosures to opposing counsel in the course of settlement negotiations.
3. A record in this system of records may be disclosed, as a routine use, to a Member of Congress submitting a request involving an individual, to whom the record pertains, when the individual has requested assistance from the Member with respect to the subject matter of the record.
4. A record in this system of records may be disclosed, as a routine use, to a contractor of the Agency having need for the information in order to perform a contract. Recipients of information shall be required to comply with the requirements of the Privacy Act of 1974, as amended, pursuant to 5 U.S.C. 552a(m).
5. A record related to an International Application filed under the Patent Cooperation Treaty in this system of records may be disclosed, as a routine use, to the International Bureau of the World Intellectual Property Organization, pursuant to the Patent Cooperation Treaty.
6. A record in this system of records may be disclosed, as a routine use, to another federal agency for purposes of National Security review (35 U.S.C. 181) and for review pursuant to the Atomic Energy Act (42 U.S.C. 218(c)).
7. A record from this system of records may be disclosed, as a routine use, to the Administrator, General Services, or his/her designee, during an inspection of records conducted by GSA as part of that agency's responsibility to recommend improvements in records management practices and programs, under authority of 44 U.S.C. 2904 and 2906. Such disclosure shall be made in accordance with the GSA regulations governing inspection of records for this purpose, and any other relevant (i.e., GSA or Commerce) directive. Such disclosure shall not be used to make determinations about individuals.
8. A record from this system of records may be disclosed, as a routine use, to the public after either publication of the application pursuant to 35 U.S.C. 122(b) or issuance of a patent pursuant to 35 U.S.C. 151. Further, a record may be disclosed, subject to the limitations of 37 CFR 1.14, as a routine use, to the public if the record was filed in an application which became abandoned or in which the proceedings were terminated and which application is referenced by either a published application, an application open to public inspections or an issued patent.
9. A record from this system of records may be disclosed, as a routine use, to a Federal, State, or local law enforcement agency, if the USPTO becomes aware of a violation or potential violation of law or regulation.

## EAST Search History

## EAST Search History (Prior Art)

Ref #	Hits	Search Query	DBs	Default Operator	Plurals	Time Stamp
L1	148	((Ari) near2 (Backholm)).INV.	US-PGPUB; USPAT	OR	OFF	2017/05/25 15:27
L2	1	"7706781".pn.	US-PGPUB; USPAT	OR	OFF	2017/05/25 15:27
L3	1	"7643818".pn.	US-PGPUB; USPAT	OR	OFF	2017/05/25 15:27
L4	2	"20040205248"	US-PGPUB; USPAT	OR	OFF	2017/05/25 15:27
L5	1	"7289792".pn.	US-PGPUB; USPAT	OR	OFF	2017/05/25 15:27
L6	1	"6745326".pn.	US-PGPUB; USPAT	OR	OFF	2017/05/25 15:27
L7	1	"20060265595"	US-PGPUB; USPAT	OR	OFF	2017/05/25 15:27
L8	10525	(709/206.ccls. g06q10/107.cpc. h04112/585.cpc. h04112/58.cpc.)AND (@AD<"20041122" @RLAD<"20041122")	US-PGPUB; USPAT	OR	OFF	2017/05/25 15:27
L9	9252	(email mail e-mail (electronic NEAR2 mail)) AND (709/206.ccls. g06q10/107.cpc. h04112/585.cpc. h04112/58.cpc.)AND (@AD<"20041122" @RLAD<"20041122")	US-PGPUB; USPAT	OR	OFF	2017/05/25 15:27
L10	1107	(encrypt\$6 AND decrypt\$6) AND (email mail e-mail (electronic NEAR2 mail)) AND (709/206.ccls. g06q10/107.cpc. h04112/585.cpc. h04112/58.cpc.)AND (@AD<"20041122" @RLAD<"20041122")	US-PGPUB; USPAT	OR	OFF	2017/05/25 15:27
L11	750	((terminal mobile client device phone) NEAR9 (code identifier id number)) AND (encrypt\$6 AND decrypt\$6) AND (email mail e-mail (electronic NEAR2 mail)) AND (709/206.ccls. g06q10/107.cpc. h04112/585.cpc. h04112/58.cpc.)AND (@AD<"20041122" @RLAD<"20041122")	US-PGPUB; USPAT	OR	OFF	2017/05/25 15:27
L12	55	(activat\$5 NEAR5 (code number identifier)) AND ((terminal mobile client device phone) NEAR9 (code identifier id number)) AND (encrypt\$6 AND decrypt\$6) AND (email mail e-mail (electronic NEAR2 mail)) AND (709/206.ccls. g06q10/107.cpc. h04112/585.cpc. h04112/58.cpc.)AND (@AD<"20041122" @RLAD<"20041122")	US-PGPUB; USPAT	OR	OFF	2017/05/25 15:27

L13	0	((temporary AND permanent) NEAR9 (code identifier id number)) AND (activat\$5 NEAR5 (code numberid identifier)) AND ((terminal mobile client device phone) NEAR9 (code identifier id number)) AND (encrypt\$6 AND decrypt\$6) AND (email mail e-mail (electronic NEAR2 mail)) AND (709/206.ccls. g06q10/107.cpc. h04112/585.cpc. h04112/58.cpc.)AND (@AD<"20041122" @RLAD<"20041122")	US-PGPUB; USPAT	OR	OFF	2017/05/25 15:27
L14	10	((temporary AND permanent) NEAR9 (code identifier id number)) AND (activat\$5 NEAR5 (code numberid identifier)) AND ((terminal mobile client device phone) NEAR9 (code identifier id number)) AND (encrypt\$6 AND decrypt\$6) AND (email mail e-mail (electronic NEAR2 mail)) AND (@AD<"20041122" @RLAD<"20041122")	US-PGPUB; USPAT	OR	OFF	2017/05/25 15:27
L15	21	((temporary AND permanent) NEAR9 (code identifier id number)) AND (activat\$5 NEAR5 (code number id identifier)) AND ((terminal mobile client device phone) NEAR9 (code identifier id number)) AND (encrypt\$6 AND decrypt\$6) AND (email mail e-mail (electronic NEAR2 mail)) AND (@AD<"20041122" @RLAD<"20041122")	US-PGPUB; USPAT	OR	OFF	2017/05/25 15:27
L16	1	"20150149575"	US-PGPUB; USPAT	OR	OFF	2017/05/25 15:27
L17	1	"20060031300"	US-PGPUB; USPAT	OR	OFF	2017/05/25 15:27
L18	1	"20130268384"	US-PGPUB; USPAT	OR	OFF	2017/05/25 15:27
L19	6	((temporary AND permanent) NEAR9 (encrypt\$6 AND decrypt\$6)) AND (email mail e-mail (electronic NEAR2 mail) )AND (@AD<"20041122" @RLAD<"20041122")	US-PGPUB; USPAT	OR	OFF	2017/05/25 15:27
L20	4	((temporary SAME (identifier id number)) NEAR9 (encrypt\$6 AND decrypt\$6)) AND (email mail e-mail (electronic NEAR2 mail) )AND (@AD<"20041122" @RLAD<"20041122")	US-PGPUB; USPAT	OR	OFF	2017/05/25 15:27
L21	292	((temp temporary tunnel) SAME (identifier id number)) SAME (client terminal) NEAR9 (encrypt\$6 decrypt\$6 creat\$4 generat\$4)) AND (email mail e-mail (electronic NEAR2 mail) )AND (@AD<"20041122" @RLAD<"20041122")	US-PGPUB; USPAT	OR	OFF	2017/05/25 15:27
L22	41	((temp temporary tunnel) NEAR9 (identifier id number)) NEAR9 (client terminal) NEAR9 (encrypt\$6 decrypt\$6 creat\$4 generat\$4)) AND (email mail e-mail (electronic NEAR2 mail) )AND (@AD<"20041122" @RLAD<"20041122")	US-PGPUB; USPAT	OR	OFF	2017/05/25 15:27
L23	0	((temp temporary tunnel) NEAR9 (identifier id number)) NEAR9 (client terminal) NEAR9 (encrypt\$6 decrypt\$6 creat\$4 generat\$4)) AND (bluetooth)AND (@AD<"20041122")	US-PGPUB; USPAT	OR	OFF	2017/05/25 15:27

		@RLAD<"20041122")				
L24	0	((activation) NEAR9 (identifier id number code)) NEAR9 (client terminal) NEAR9 (encrypt\$6 decrypt\$6 creat\$4 generat\$4)) AND (bluetooth) AND (@AD<"20041122" @RLAD<"20041122")	US-PGPUB; USPAT	OR	OFF	2017/05/25 15:27
L25	11	((activation) NEAR9 (identifier id number code)) NEAR9 (client terminal) NEAR9 (encrypt\$6 decrypt\$6 creat\$4 generat\$4)) AND (bluetooth bluetooth) AND (@AD<"20041122" @RLAD<"20041122")	US-PGPUB; USPAT	OR	OFF	2017/05/25 15:27
L26	1	"7289792".pn.	US-PGPUB; USPAT	OR	OFF	2017/05/25 15:27
L27	1	"20150149575"	US-PGPUB; USPAT	OR	OFF	2017/05/25 16:08
L28	647	(optical NEAR9 interface NEAR9 (client device)) AND (email mail e-mail (electronic NEAR2 mail) )AND (@AD<"20041122" @RLAD<"20041122")	US-PGPUB; USPAT	OR	OFF	2017/05/25 16:18
L29	641	(optical NEAR9 interface NEAR9 (device)) AND (email mail e-mail (electronic NEAR2 mail) )AND (@AD<"20041122" @RLAD<"20041122")	US-PGPUB; USPAT	OR	OFF	2017/05/25 16:18
L30	1	(optical NEAR9 interface NEAR9 (device) SAME (activation NEAR5 code)) AND (email mail e-mail (electronic NEAR2 mail) )AND (@AD<"20041122" @RLAD<"20041122")	US-PGPUB; USPAT	OR	OFF	2017/05/25 16:20
L31	1	(optical NEAR9 scanner SAME (activation NEAR5 code)) AND (email mail e-mail (electronic NEAR2 mail) )AND (@AD<"20041122" @RLAD<"20041122")	US-PGPUB; USPAT	OR	OFF	2017/05/25 16:24
L32	2	(optical NEAR9 interface SAME (activation NEAR5 code)) AND (email mail e-mail (electronic NEAR2 mail) )AND (@AD<"20041122" @RLAD<"20041122")	US-PGPUB; USPAT	OR	OFF	2017/05/25 16:24
L33	0	((QR NEAR9 code) SAME (activation NEAR5 code)) AND (email mail e-mail (electronic NEAR2 mail) )AND (@AD<"20041122" @RLAD<"20041122")	US-PGPUB; USPAT	OR	OFF	2017/05/25 16:26
L34	0	((quick NEAR5 response NEAR9 code) SAME (activation NEAR5 code)) AND (email mail e-mail (electronic NEAR2 mail) )AND (@AD<"20041122" @RLAD<"20041122")	US-PGPUB; USPAT	OR	OFF	2017/05/25 16:26
L35	0	((quick NEAR5 response NEAR9 code) SAME (activation)) AND (email mail e-mail (electronic NEAR2 mail) )AND (@AD<"20041122" @RLAD<"20041122")	US-PGPUB; USPAT	OR	OFF	2017/05/25 16:27
L36	49	((quick NEAR5 response NEAR9 code)) AND (email mail e-mail (electronic NEAR2 mail) )AND (@AD<"20041122" @RLAD<"20041122")	US-PGPUB; USPAT	OR	OFF	2017/05/25 16:27
L37	1	"8131572".pn.	US-PGPUB; USPAT	OR	OFF	2017/05/25 16:43
L38	108	"6496809"	US-PGPUB;	OR	OFF	2017/05/25 16:44

EAST Search History

			USPAT			
L39	1	"6496809".pn.	US-PGPUB; USPAT	OR	OFF	2017/05/25 16:44
L40	1	"9251518".pn.	US-PGPUB; USPAT	OR	OFF	2017/05/25 16:45
L41	0	(quick NEAR5 response NEAR9 code) SAME (email mail e-mail (electronic NEAR2 mail)) AND (@AD<"20041122" @RLAD<"20041122")	US-PGPUB; USPAT	OR	OFF	2017/05/25 16:47
L42	19	(quick NEAR5 response NEAR9 code) SAME (access security authoriz\$5 generat\$4) AND (@AD<"20041122" @RLAD<"20041122")	US-PGPUB; USPAT	OR	OFF	2017/05/25 16:47

**EAST Search History (Interference)**

< This search history is empty >

**5/ 25/ 2017 6:39:30 PM**

**H:\ Workspaces\ 14609189.wsp**

<b>Search Notes</b>  	<b>Application/Control No.</b>  14609189	<b>Applicant(s)/Patent Under Reexamination</b>  BACKHOLM ET AL.
	<b>Examiner</b>  ALAN S CHOU	<b>Art Unit</b>  2451

<b>CPC- SEARCHED</b>		
Symbol	Date	Examiner
G06Q 10/107	9/24/2015	AC
H04L 12/585, 12/58	9/24/2015	AC

<b>CPC COMBINATION SETS - SEARCHED</b>		
Symbol	Date	Examiner

<b>US CLASSIFICATION SEARCHED</b>			
Class	Subclass	Date	Examiner
709	206	9/24/2015	AC

<b>SEARCH NOTES</b>		
Search Notes	Date	Examiner
EAST Search	9/24/2015	AC
Consulted with SPE Chris Parry regarding 101 issues for claims 1-20	9/24/2015	AC
Consulted with Primary Saket Daftuar regarding ODP issues for claims 1-20	9/25/2015	AC
Consulted with Primary Saket Daftuar regarding 112 6th issue with claim 12-19	9/25/2015	AC
EAST Search	7/5/2016	AC
Consulted with SPE Chris Parry regarding 101 amendments temporary identifier to making the language significantly more	7/20/2016	AC
EAST Search	11/1/2016	AC
EAST Search	5/25/2017	AC

<b>INTERFERENCE SEARCH</b>			
US Class/ CPC Symbol	US Subclass / CPC Group	Date	Examiner

--	--



**COMMUNICATION TO THE UNITED STATES PATENT AND TRADEMARK OFFICE**

Appl. No. : 14/609,189 Confirmation No. 5037  
Applicant : Seven Networks, LLC  
Inventor : Ari Backholm *et al.*  
Filed : 2015-01-29  
TC/A.U. : 2451  
Examiner : Chou, Alan S  
Docket No. : 455/006/8 UTIL  
Customer No. : 118194

Mail Stop RCE  
Commissioner for Patents  
P.O. Box 1450  
Alexandria, VA 22313-1450

**Response to Non-Final Office Action**

Examiner:

**Amendments to the Claims** begin on page 2 of this paper.

**Remarks** begin on page 11 of this paper.

## Electronic Patent Application Fee Transmittal

<b>Application Number:</b>	14609189			
<b>Filing Date:</b>	29-Jan-2015			
<b>Title of Invention:</b>	Messaging centre for forwarding e-mail			
<b>First Named Inventor/Applicant Name:</b>	Ari Backholm			
<b>Filer:</b>	Justin Robert Nifong/Donna Donovan			
<b>Attorney Docket Number:</b>	455/006/8 UTIL			
Filed as Small Entity				
<b>Filing Fees for Utility under 35 USC 111(a)</b>				
<b>Description</b>	<b>Fee Code</b>	<b>Quantity</b>	<b>Amount</b>	<b>Sub-Total in USD(\$)</b>
<b>Basic Filing:</b>				
<b>Pages:</b>				
<b>Claims:</b>				
CLAIMS IN EXCESS OF 20	2202	1	40	40
<b>Miscellaneous-Filing:</b>				
<b>Petition:</b>				
<b>Patent-Appeals-and-Interference:</b>				
<b>Post-Allowance-and-Post-Issuance:</b>				

Description	Fee Code	Quantity	Amount	Sub-Total in USD(\$)
<b>Extension-of-Time:</b>				
<b>Miscellaneous:</b>				
<b>Total in USD (\$)</b>				<b>40</b>

## Electronic Acknowledgement Receipt

<b>EFS ID:</b>	28308437
<b>Application Number:</b>	14609189
<b>International Application Number:</b>	
<b>Confirmation Number:</b>	5037
<b>Title of Invention:</b>	Messaging centre for forwarding e-mail
<b>First Named Inventor/Applicant Name:</b>	Ari Backholm
<b>Customer Number:</b>	118194
<b>Filer:</b>	Justin Robert Nifong/Donna Donovan
<b>Filer Authorized By:</b>	Justin Robert Nifong
<b>Attorney Docket Number:</b>	455/006/8 UTIL
<b>Receipt Date:</b>	09-FEB-2017
<b>Filing Date:</b>	29-JAN-2015
<b>Time Stamp:</b>	18:21:10
<b>Application Type:</b>	Utility under 35 USC 111(a)

### Payment information:

Submitted with Payment	yes
Payment Type	CARD
Payment was successfully received in RAM	\$40
RAM confirmation Number	021017INTEFSW18220500
Deposit Account	506191
Authorized User	Justin Nifong

The Director of the USPTO is hereby authorized to charge indicated fees and credit any overpayment as follows:

37 CFR 1.16 (National application filing, search, and examination fees)

37 CFR 1.17 (Patent application and reexamination processing fees)

37 CFR 1.19 (Document supply fees)  
 37 CFR 1.20 (Post Issuance fees)  
 37 CFR 1.21 (Miscellaneous fees and charges)

**File Listing:**

Document Number	Document Description	File Name	File Size(Bytes)/ Message Digest	Multi Part /.zip	Pages (if appl.)
1		455-006-8UTIL-20170209-Rsp-to-NFOA-dtd-11-09-2016.pdf	58299  359e66c0dd2d574806ea712d4d62da31cffadff9	yes	13
<b>Multipart Description/PDF files in .zip description</b>					
	<b>Document Description</b>		<b>Start</b>		<b>End</b>
	Applicant Arguments/Remarks Made in an Amendment		11		13
	Claims		2		10
	Amendment/Req. Reconsideration-After Non-Final Reject		1		1
<b>Warnings:</b>					
<b>Information:</b>					
2	Fee Worksheet (SB06)	fee-info.pdf	30526  a0901a01bc559bdc890e56a2da2527811682630d	no	2
<b>Warnings:</b>					
<b>Information:</b>					
<b>Total Files Size (in bytes):</b>			88825		

**This Acknowledgement Receipt evidences receipt on the noted date by the USPTO of the indicated documents, characterized by the applicant, and including page counts, where applicable. It serves as evidence of receipt similar to a Post Card, as described in MPEP 503.**

**New Applications Under 35 U.S.C. 111**

**If a new application is being filed and the application includes the necessary components for a filing date (see 37 CFR 1.53(b)-(d) and MPEP 506), a Filing Receipt (37 CFR 1.54) will be issued in due course and the date shown on this Acknowledgement Receipt will establish the filing date of the application.**

**National Stage of an International Application under 35 U.S.C. 371**

**If a timely submission to enter the national stage of an international application is compliant with the conditions of 35 U.S.C. 371 and other applicable requirements a Form PCT/DO/EO/903 indicating acceptance of the application as a national stage submission under 35 U.S.C. 371 will be issued in addition to the Filing Receipt, in due course.**

**New International Application Filed with the USPTO as a Receiving Office**

**If a new international application is being filed and the international application includes the necessary components for an international filing date (see PCT Article 11 and MPEP 1810), a Notification of the International Application Number and of the International Filing Date (Form PCT/RO/105) will be issued in due course, subject to prescriptions concerning national security, and the date shown on this Acknowledgement Receipt will establish the international filing date of the application.**

**REMARKS**

This paper is in response to the Office Action mailed November 9, 2016.

Claims 1-19 and 21-55 were previously pending. Claim 20 was previously canceled. Claims 1, 12-13, 21-23, 37, and 54-55 are amended herein. Claims 27 and 40 are canceled herein. Claims 56-58 are added herein. Accordingly, claims 1-19, 21-26, 28-39, and 41-58 remain pending.

**Double Patenting**

In the Office Action, claims 1-20 stand rejected on the ground of nonstatutory double patenting as being unpatentable over claim 1 of U.S. Patent No. 7,706,781 and U.S. Patent No. 7,643,818. Applicant is choosing to delay treatment of this double patenting rejection at this time.

**Claims Rejections under 35 U.S.C. § 103(a)**

In the Office Action, claims 1-2, 6-10, 12-15, 18, 21-24, 29-38, 42-55 stand rejected under 35 USC 103(a) as being unpatentable over Little, in view of Turunen, and further in view of Osthoff.

Independent claim 1 has been amended herein to recite the following feature:

*wherein an email account, associated with the email address, is hosted by one of the plurality of e-mail servers,*

Support for this amendment may be found in at least paragraphs [0021] and [0036] of the Applicant's specification.

Independent claims 12, 21-22, and 54 have been amended to include features similar to claim 1.

Nowhere does Little, Turunen, or Osthoff disclose or suggest the above feature. Likewise, Giobbi, Solonen, and Kock fail to disclose or suggest the above feature. Applicant submits that independent claims 1, 12, 21-22, and 54 are patentable over the cited references.

Claims 2, 6-10, 14-15, 18, 52 and 53 depend, either directly or indirectly, from independent claims 1 and 12; and are allowable for at least the same reasons.

Independent claim 23 is amended herein to recite the following feature:

*optically receive information including a displayed service activation code  
from a remote device;*

Support for this amendment may be found in at least paragraph [0029] of the Applicant's specification.

Independent claims 37 and 55 have been amended to include features similar to claim 23.

Nowhere does Little, Turunen, or Osthoff disclose or suggest the above feature. Likewise, Giobbi, Solonen, and Kock fail to disclose or suggest the above feature.

Applicant submits that independent claims 23, 37, and 55 are patentable over the cited references.

Claims 24, 29-36, 38, and 42-51 depend, either directly or indirectly, from independent claims 23 and 37; and are allowable for at least the same reasons.

In the Office Action, claims 3-5, 11, 16-17, and 19 stand rejected under 35 USC 103(a) as being unpatentable over Little in view of Turunen, further in view of Osthoff, and further in view of Kock.

Claims 3-5, 11, 16-17, and 19 depend, either directly or indirectly, from independent claims 1 and 12; and are allowable for at least the same reasons.

Accordingly, it is respectfully submitted that the rejection of claims 3-5, 11, 16-17, and 19 be withdrawn.

In the Office Action, claims 25-26, 28, 39, and 41 stand rejected under 35 USC 103(a) as being unpatentable over Little, in view of Turunen, further in view of Osthoff, and further in view of Salonen.

Claims 25-26, 28, 39, and 41 depend, either directly or indirectly, from independent claims 23 and 37; and are allowable for at least the same reasons.

Accordingly, it is respectfully submitted that the rejection of claims 25-26, 28, 39, and 41 be withdrawn.

In the Office Action, claims 27 and 40 stand rejected under 35 USC 103(a) as being unpatentable over Little, in view of Turunen, further in view of Osthoff, further in view of Salonen, and further in view of Giobbi.



Response to NFOA dated November 9, 2016  
Appl. No. 14/609,189

Claims 27 and 40 have been canceled rendering the rejection to these claims moot.

#### **New Claims**

New claims 56, 57, and 58 recite:

*wherein a control message is received from the remote device upon user interaction with the message.*

Support for claims 56, 57, and 58 may be found in at least paragraph [0034] of the Applicant's specification.

Claims 56, 57, and 58 depend directly from allowable claims 23, 37, and 55.

#### **DEPOSIT ACCOUNT**

The Commissioner is hereby authorized to charge any otherwise unpaid fees associated with the filing of this correspondence to Deposit Account No. 50-6191.

Date: February 9, 2017

Respectfully submitted,

/Justin R. Nifong/  
Justin R. Nifong  
Reg. No. 59,389

NK Patent Law  
4917 Waters Edge Drive, Suite 275  
Raleigh, NC 27606  
Telephone: (919) 348-2194  
Facsimile: (919) 882-8195

Customer No. 118194

**AMENDMENTS TO THE CLAIMS**

1. (Currently amended) A method for forwarding an e-mail message from one of a plurality of e-mail servers to a mobile terminal, the method comprising:

receiving, at an intermediary system, an e-mail message associated with an e-mail address of a user of a mobile terminal and sent by one of a plurality of e-mail servers,

wherein the e-mail address is associated with an identifier of the mobile terminal,

wherein an email account, associated with the email address, is hosted by one of the plurality of e-mail servers, and

wherein the identifier is generated by the mobile terminal;

encrypting the e-mail message using encryption information associated with a temporary identifier,

wherein the temporary identifier is based on a connection to the mobile terminal; and

transmitting the encrypted e-mail message to the mobile terminal.

2. (Previously Presented) The method of claim 1, further comprising identifying the mobile terminal based on the e-mail address of the e-mail message and the association with the identifier of the mobile terminal.

3. (Previously Presented) The method of claim 1, wherein encrypting the e-mail message further comprises packing the e-mail message by omitting at least part of the e-mail message when at least part of the e-mail message exceeds a predetermined size specification.

4. (Previously Presented) The method of claim 3, wherein size specification is set by a user of the mobile terminal.

5. (Previously Presented) The method of claim 3, wherein the omitted part of the e-mail message is the e-mail address.

6. (Previously Presented) The method of claim 2, further comprising adding the e-mail address to a reply message sent by the mobile terminal.

7. (Previously Presented) The method of claim 1, further comprising receiving the encryption information generated by the mobile terminal.

8. (Previously Presented) The method of claim 1, wherein the encryption information is based on an activation code of the mobile terminal.

9. (Previously Presented) The method of claim 1, wherein a messaging center transmits the e-mail message to the mobile terminal using the identifier of the mobile terminal.

10. (Previously Presented) The method of claim 1, wherein mobile terminal receives and decrypts the e-mail message using the encryption information.

11. (Previously Presented) The method of claim 3, wherein the mobile terminal unpacks the e-mail message.

12. (Currently Amended) A system for forwarding an e-mail message from one of a plurality of e-mail servers to a mobile terminal, the system comprising:

a memory configured for storing at least one of an e-mail address of a user of a mobile terminal, and an identifier;

wherein the e-mail address is associated with the identifier,

wherein an email account, associated with the email address, is hosted by one of the plurality of e-mail servers, and

wherein the mobile terminal generates the identifier,

a processor configured for:

encrypting the e-mail message using encryption information associated with a temporary identifier, wherein the e-mail message is received from one of a plurality of e-mail servers;

identifying the mobile terminal based on the identifier of the mobile terminal; and transmitting the encrypted e-mail message to the identified mobile terminal,

wherein the temporary identifier is based on a connection to the mobile terminal,

wherein the system is an intermediary system between the plurality of e-mail servers and the mobile terminal.

13. (Currently Amended) The system of claim 12, wherein the processor is further configured to receive the e-mail message from the one of a plurality of e-mail servers.

14. (Previously Presented) The system of claim 12, wherein the processor is further configured to receive the encryption information and to provide the encryption information to the memory for storage.

15. (Previously Presented) The system of claim 12, wherein the processor is further configured to pack the e-mail message.

16. (Previously Presented) The system of claim 15, wherein the processor is further configured to omit at least part of the e-mail message when the at least part of the e-mail message exceeds a predetermined size specification.

17. (Previously Presented) The system of claim 16, wherein the processor is further configured to receive user input concerning the size specification.

18. (Previously Presented) The system of claim 12, wherein the mobile terminal receives and decrypts the e-mail message using the encryption information.

19. (Previously Presented) The system of claim 18, wherein the mobile terminal unpacks the message.

20. (Canceled)

21. (Currently Amended) A mobile device comprising:  
a radio;  
a memory;

a processor configured for controlling a mobile device to:

generate an identifier; and

receive, from [[a]]one of a plurality of e-mail servers, an encrypted e-mail message associated with an e-mail address of a user of the mobile device, wherein the e-mail address is associated with the identifier and wherein an email account, associated with the email address, is hosted by one of the plurality of e-mail servers,

decrypt the e-mail message using encryption information associated with a temporary identifier,

wherein the temporary identifier is based on a connection to the one of the plurality of e-mail servers.

22. (Currently Amended) A method for forwarding an e-mail message from an e-mail server to a mobile terminal, the method comprising:

generating an identifier associated with an e-mail address of a user of a mobile terminal;

receiving an e-mail message associated with the e-mail address and sent by [[an]]one of a plurality of e-mail servers, wherein an email account, associated with the email address, is hosted by one of the plurality of e-mail servers;

encrypting the e-mail message using encryption information associated with a temporary identifier; and

transmitting the encrypted e-mail message to the mobile terminal,

wherein the temporary identifier is based on a connection the mobile terminal.

23. (Currently Amended) A device comprising:

a radio;

a processor and memory containing instructions executable by the processor whereby the device is operable to:

optically receive information including a displayed service activation code from a remote device;

register the remote device for access to a messaging account using the service activation code;

receive a message for the messaging account;  
encrypt the message using an encryption key; and  
send the message to the remote device,  
wherein the device is authenticated to access the messaging account.

24. (Previously Presented) The device of claim 23, wherein the information including the service activation code is received by the device in response to user input at the remote device.

25. (Previously Presented) The device of claim 23, wherein the information including the service activation code is received by the device in an off-line communication.

26. (Previously Presented) The device of claim 25, wherein the off-line communication involves a local connection.

27. (Canceled)

28. (Previously Presented) The device of claim 25, wherein the off-line communication prevents eavesdropping of the service activation code.

29. (Previously Presented) The device of claim 23, wherein the authentication of the device relies on the authentication of the messaging account.

30. (Previously Presented) The device of claim 29, wherein the authentication of the messaging account includes a username and password.

31. (Previously Presented) The device of claim 23, wherein the encryption key is the service activation code.

32. (Previously Presented) The device of claim 23, wherein the encryption key is derived from the service activation code.

33. (Previously Presented) The device of claim 23, wherein the encryption key is a subset of the service activation code.

34. (Previously Presented) The device of claim 23, wherein the encryption key is closely related to the service activation code.

35. (Previously Presented) The device of claim 23, wherein the device is further operable to:

store an association between at least two of the encryption key, the messaging account, an identifier of the remote device, and the service activation code.

36. (Previously Presented) The device of claim 23, wherein the message is sent to the remote device through an intermediate device.

37. (Currently Amended) A method for sharing a messaging account, the method comprising:

authenticating a device for access to the messaging account;

optically receiving information including a displayed service activation code from a remote device;

registering the remote device for access to the messaging account using the service activation code;

receiving a message for the messaging account;

encrypting the message using an encryption key; and

sending the message to the remote device.

38. (Previously Presented) The method of claim 37, wherein the information including the service activation code is received by the device in response to user input at the remote device.

39. (Previously Presented) The method of claim 38, wherein the information including the service activation code is received by the device in an off-line communication.

40. (Canceled)

41. (Previously Presented) The method of claim 39, wherein the off-line communication prevents eavesdropping of the service activation code.

42. (Previously Presented) The method of claim 37, wherein the authentication of the device relies on the authentication of the messaging system.

43. (Previously Presented) The method of claim 42, wherein the authentication of the messaging system includes a username and password.

44. (Previously Presented) The method of claim 37, wherein the encryption key is the service activation code.

45. (Previously Presented) The method of claim 37, wherein the encryption key is derived from the service activation code.

46. (Previously Presented) The method of claim 37, wherein the encryption key is a subset of the service activation code.

47. (Previously Presented) The method of claim 37, wherein the encryption key is closely related to the service activation code.

48. (Previously Presented) The method of claim 37, wherein the method further comprises:

storing an association between the encryption key, the messaging account, an identifier of the remote device, and the service activation code.

49. (Previously Presented) The device of claim 36, wherein the encryption key is associated with a temporary identifier, wherein the temporary identifier is based on a connection to the intermediate device.



50. (Previously Presented) The method of claim 37, wherein the message is sent to the remote device through an intermediate device.

51. (Previously Presented) The method of claim 37, wherein the encryption key is associated with a temporary identifier, wherein the temporary identifier is based on a connection to the intermediary device.

52. (Previously Presented) The method of claim 1, wherein the identifier is associated with the temporary identifier.

53. (Previously Presented) The system of claim 12, wherein the identifier is associated with the temporary identifier.

54. (Currently Amended) A non-transient computer-readable medium containing program instructions for causing a device to perform a method, the method comprising:

generating an identifier; and

receiving, from [[a]]one of a plurality of email servers, an encrypted e-mail message associated with an e-mail address of a user of the mobile device, wherein the e-mail address is associated with the identifier and wherein an email account, associated with the email address, is hosted by one of the plurality of e-mail servers,

decrypting the e-mail message using encryption information associated with a temporary identifier,

wherein the temporary identifier is based on a connection to the server.

55. (Currently Amended) A non-transient computer-readable medium containing program instructions for causing a device to perform a method, the method comprising:

optically receiving information including a displayed service activation code from a remote device;

registering the remote device for access to a messaging account using the service

activation code;

receiving a message for the messaging account;  
encrypting the message using an encryption key; and  
sending the message to the remote device,  
wherein the device is authenticated to access the messaging account.

56. (New) The device of claim 23, wherein a control message is received from the remote device upon user interaction with the message.

57. (New) The method of claim 37, wherein a control message is received from the remote device upon user interaction with the message.

58. (New) The method of claim 55, wherein a control message is received from the remote device upon user interaction with the message.

Under the Paperwork Reduction Act of 1995, no persons are required to respond to a collection of information unless it displays a valid OMB control number.

<b>PATENT APPLICATION FEE DETERMINATION RECORD</b> Substitute for Form PTO-875			Application or Docket Number 14/609,189	Filing Date 01/29/2015	<input type="checkbox"/> To be Mailed		
ENTITY: <input type="checkbox"/> LARGE <input checked="" type="checkbox"/> SMALL <input type="checkbox"/> MICRO							
<b>APPLICATION AS FILED – PART I</b>							
(Column 1)		(Column 2)					
FOR	NUMBER FILED	NUMBER EXTRA	RATE (\$)	FEE (\$)			
<input type="checkbox"/> BASIC FEE (37 CFR 1.16(a), (b), or (c))	N/A	N/A	N/A				
<input type="checkbox"/> SEARCH FEE (37 CFR 1.16(k), (i), or (m))	N/A	N/A	N/A				
<input type="checkbox"/> EXAMINATION FEE (37 CFR 1.16(o), (p), or (q))	N/A	N/A	N/A				
TOTAL CLAIMS (37 CFR 1.16(j))	minus 20 =	*	X \$ =				
INDEPENDENT CLAIMS (37 CFR 1.16(h))	minus 3 =	*	X \$ =				
<input type="checkbox"/> APPLICATION SIZE FEE (37 CFR 1.16(s))	If the specification and drawings exceed 100 sheets of paper, the application size fee due is \$310 (\$155 for small entity) for each additional 50 sheets or fraction thereof. See 35 U.S.C. 41(a)(1)(G) and 37 CFR 1.16(s).						
<input type="checkbox"/> MULTIPLE DEPENDENT CLAIM PRESENT (37 CFR 1.16(j))							
* If the difference in column 1 is less than zero, enter "0" in column 2.			TOTAL				
<b>APPLICATION AS AMENDED – PART II</b>							
(Column 1)		(Column 2)	(Column 3)				
AMENDMENT	<b>02/09/2017</b>	CLAIMS REMAINING AFTER AMENDMENT	HIGHEST NUMBER PREVIOUSLY PAID FOR	PRESENT EXTRA	RATE (\$)	ADDITIONAL FEE (\$)	
	Total (37 CFR 1.16(i))	* 56	Minus	** 54	= 2	X \$40 = 80	
	Independent (37 CFR 1.16(h))	* 8	Minus	***8	= 0	X \$210 = 0	
	<input type="checkbox"/> Application Size Fee (37 CFR 1.16(s))						
	<input type="checkbox"/> FIRST PRESENTATION OF MULTIPLE DEPENDENT CLAIM (37 CFR 1.16(j))						
			TOTAL ADD'L FEE	<b>80</b>			
(Column 1)		(Column 2)	(Column 3)				
AMENDMENT		CLAIMS REMAINING AFTER AMENDMENT	HIGHEST NUMBER PREVIOUSLY PAID FOR	PRESENT EXTRA	RATE (\$)	ADDITIONAL FEE (\$)	
	Total (37 CFR 1.16(i))	*	Minus	**	=	X \$ =	
	Independent (37 CFR 1.16(h))	*	Minus	***	=	X \$ =	
	<input type="checkbox"/> Application Size Fee (37 CFR 1.16(s))						
	<input type="checkbox"/> FIRST PRESENTATION OF MULTIPLE DEPENDENT CLAIM (37 CFR 1.16(j))						
			TOTAL ADD'L FEE				
<p>* If the entry in column 1 is less than the entry in column 2, write "0" in column 3.                  ** If the "Highest Number Previously Paid For" IN THIS SPACE is less than 20, enter "20".                  *** If the "Highest Number Previously Paid For" IN THIS SPACE is less than 3, enter "3".                  The "Highest Number Previously Paid For" (Total or Independent) is the highest number found in the appropriate box in column 1.</p>							
LIE TAMMY D. MCBETH BROWN							

This collection of information is required by 37 CFR 1.16. The information is required to obtain or retain a benefit by the public which is to file (and by the USPTO to process) an application. Confidentiality is governed by 35 U.S.C. 122 and 37 CFR 1.14. This collection is estimated to take 12 minutes to complete, including gathering, preparing, and submitting the completed application form to the USPTO. Time will vary depending upon the individual case. Any comments on the amount of time you require to complete this form and/or suggestions for reducing this burden, should be sent to the Chief Information Officer, U.S. Patent and Trademark Office, U.S. Department of Commerce, P.O. Box 1450, Alexandria, VA 22313-1450. DO NOT SEND FEES OR COMPLETED FORMS TO THIS ADDRESS. **SEND TO: Commissioner for Patents, P.O. Box 1450, Alexandria, VA 22313-1450.**

If you need assistance in completing the form, call 1-800-PTO-9199 and select option 2.

<b>INFORMATION DISCLOSURE STATEMENT BY APPLICANT</b> ( Not for submission under 37 CFR 1.99)	Application Number	14609189
	Filing Date	2015-01-29
	First Named Inventor	Backholm
	Art Unit	2651
	Examiner Name	CHOU, ALAN S.
	Attorney Docket Number	455/006/8 UTIL

U.S.PATENTS							Remove
Examiner Initial*	Cite No	Patent Number	Kind Code <sup>1</sup>	Issue Date	Name of Patentee or Applicant of cited Document	Pages,Columns,Lines where Relevant Passages or Relevant Figures Appear	
	1						

If you wish to add additional U.S. Patent citation information please click the Add button.

U.S.PATENT APPLICATION PUBLICATIONS							Remove
Examiner Initial*	Cite No	Publication Number	Kind Code <sup>1</sup>	Publication Date	Name of Patentee or Applicant of cited Document	Pages,Columns,Lines where Relevant Passages or Relevant Figures Appear	
	1						

If you wish to add additional U.S. Published Application citation information please click the Add button.

FOREIGN PATENT DOCUMENTS								Remove
Examiner Initial*	Cite No	Foreign Document Number <sup>3</sup>	Country Code <sup>2</sup> i	Kind Code <sup>4</sup>	Publication Date	Name of Patentee or Applicant of cited Document	Pages,Columns,Lines where Relevant Passages or Relevant Figures Appear	T <sup>5</sup>
	1							

If you wish to add additional Foreign Patent Document citation information please click the Add button.

NON-PATENT LITERATURE DOCUMENTS								Remove
Examiner Initials*	Cite No	Include name of the author (in CAPITAL LETTERS), title of the article (when appropriate), title of the item (book, magazine, journal, serial, symposium, catalog, etc), date, pages(s), volume-issue number(s), publisher, city and/or country where published.						T <sup>5</sup>

<b>INFORMATION DISCLOSURE STATEMENT BY APPLICANT</b> ( Not for submission under 37 CFR 1.99)	Application Number	14609189
	Filing Date	2015-01-29
	First Named Inventor	Backholm
	Art Unit	2651
	Examiner Name	CHOU, ALAN S.
	Attorney Docket Number	455/006/8 UTIL

1	WILLIS, WILL, et al, Implementing and Managing Microsoft EXCHANGE SERVER 2003, Self-Paced Training Kit, Microsoft, <a href="http://www.post.ir/_ITCenter/Documents/c4b0ff43-0235-4e62-a615-818f6834989a.pdf">http://www.post.ir/_ITCenter/Documents/c4b0ff43-0235-4e62-a615-818f6834989a.pdf</a> , Pages 1-826, Microsoft Press, Redmond, WA
2	MICROSOFT, Exchange Server 2003 Features Comparison, <a href="https://www.microsoft.com/middleeast/windowsserversystem/exchange/evaluation/features/ex_compare.aspx">https://www.microsoft.com/middleeast/windowsserversystem/exchange/evaluation/features/ex_compare.aspx</a> , Updated: 2004-05-25, Pages 1-6
3	MICROSOFT EXCHANGE, Exchange Server Version and Features - TechNet Articles - United States (English) - TechNet Wiki, <a href="https://social.technet.microsoft.com/wiki/contents/articles/346.exchange-server-version-and-features.aspx">https://social.technet.microsoft.com/wiki/contents/articles/346.exchange-server-version-and-features.aspx</a> , First Published: 2010-03-09; Last Revision: 2016-12-11, Pages 1-3
4	MICROSOFT, Exchange Documentation Team, Exchange Server 2003 Administrative Guide, Microsoft Windows Server System, <a href="http://www.pc-hulp-online.nl/upload/Microsoft_Exchange_Server_2003_Administration_Guide.pdf">http://www.pc-hulp-online.nl/upload/Microsoft_Exchange_Server_2003_Administration_Guide.pdf</a> , September 2003, Pages 1-503

If you wish to add additional non-patent literature document citation information please click the Add button

**EXAMINER SIGNATURE**

Examiner Signature		Date Considered	
--------------------	--	-----------------	--

\*EXAMINER: Initial if reference considered, whether or not citation is in conformance with MPEP 609. Draw line through a citation if not in conformance and not considered. Include copy of this form with next communication to applicant.

<sup>1</sup> See Kind Codes of USPTO Patent Documents at [www.USPTO.GOV](http://www.USPTO.GOV) or MPEP 901.04. <sup>2</sup> Enter office that issued the document, by the two-letter code (WIPO Standard ST.3). <sup>3</sup> For Japanese patent documents, the indication of the year of the reign of the Emperor must precede the serial number of the patent document. <sup>4</sup> Kind of document by the appropriate symbols as indicated on the document under WIPO Standard ST.16 if possible. <sup>5</sup> Applicant is to place a check mark here if English language translation is attached.

<b>INFORMATION DISCLOSURE STATEMENT BY APPLICANT</b> ( Not for submission under 37 CFR 1.99)	Application Number	14609189
	Filing Date	2015-01-29
	First Named Inventor	Backholm
	Art Unit	2651
	Examiner Name	CHOU, ALAN S.
	Attorney Docket Number	455/006/8 UTIL

**CERTIFICATION STATEMENT**

Please see 37 CFR 1.97 and 1.98 to make the appropriate selection(s):

That each item of information contained in the information disclosure statement was first cited in any communication from a foreign patent office in a counterpart foreign application not more than three months prior to the filing of the information disclosure statement. See 37 CFR 1.97(e)(1).

**OR**

That no item of information contained in the information disclosure statement was cited in a communication from a foreign patent office in a counterpart foreign application, and, to the knowledge of the person signing the certification after making reasonable inquiry, no item of information contained in the information disclosure statement was known to any individual designated in 37 CFR 1.56(c) more than three months prior to the filing of the information disclosure statement. See 37 CFR 1.97(e)(2).

See attached certification statement.

- The fee set forth in 37 CFR 1.17 (p) has been submitted herewith.
- A certification statement is not submitted herewith.

**SIGNATURE**

A signature of the applicant or representative is required in accordance with CFR 1.33, 10.18. Please see CFR 1.4(d) for the form of the signature.

Signature	/Justin R. Nifong/	Date (YYYY-MM-DD)	2017-01-26
Name/Print	Justin R. Nifong	Registration Number	59389

This collection of information is required by 37 CFR 1.97 and 1.98. The information is required to obtain or retain a benefit by the public which is to file (and by the USPTO to process) an application. Confidentiality is governed by 35 U.S.C. 122 and 37 CFR 1.14. This collection is estimated to take 1 hour to complete, including gathering, preparing and submitting the completed application form to the USPTO. Time will vary depending upon the individual case. Any comments on the amount of time you require to complete this form and/or suggestions for reducing this burden, should be sent to the Chief Information Officer, U.S. Patent and Trademark Office, U.S. Department of Commerce, P.O. Box 1450, Alexandria, VA 22313-1450. **DO NOT SEND FEES OR COMPLETED FORMS TO THIS ADDRESS. SEND TO: Commissioner for Patents, P.O. Box 1450, Alexandria, VA 22313-1450.**

## Privacy Act Statement

The Privacy Act of 1974 (P.L. 93-579) requires that you be given certain information in connection with your submission of the attached form related to a patent application or patent. Accordingly, pursuant to the requirements of the Act, please be advised that: (1) the general authority for the collection of this information is 35 U.S.C. 2(b)(2); (2) furnishing of the information solicited is voluntary; and (3) the principal purpose for which the information is used by the U.S. Patent and Trademark Office is to process and/or examine your submission related to a patent application or patent. If you do not furnish the requested information, the U.S. Patent and Trademark Office may not be able to process and/or examine your submission, which may result in termination of proceedings or abandonment of the application or expiration of the patent.

The information provided by you in this form will be subject to the following routine uses:

1. The information on this form will be treated confidentially to the extent allowed under the Freedom of Information Act (5 U.S.C. 552) and the Privacy Act (5 U.S.C. 552a). Records from this system of records may be disclosed to the Department of Justice to determine whether the Freedom of Information Act requires disclosure of these records.
2. A record from this system of records may be disclosed, as a routine use, in the course of presenting evidence to a court, magistrate, or administrative tribunal, including disclosures to opposing counsel in the course of settlement negotiations.
3. A record in this system of records may be disclosed, as a routine use, to a Member of Congress submitting a request involving an individual, to whom the record pertains, when the individual has requested assistance from the Member with respect to the subject matter of the record.
4. A record in this system of records may be disclosed, as a routine use, to a contractor of the Agency having need for the information in order to perform a contract. Recipients of information shall be required to comply with the requirements of the Privacy Act of 1974, as amended, pursuant to 5 U.S.C. 552a(m).
5. A record related to an International Application filed under the Patent Cooperation Treaty in this system of records may be disclosed, as a routine use, to the International Bureau of the World Intellectual Property Organization, pursuant to the Patent Cooperation Treaty.
6. A record in this system of records may be disclosed, as a routine use, to another federal agency for purposes of National Security review (35 U.S.C. 181) and for review pursuant to the Atomic Energy Act (42 U.S.C. 218(c)).
7. A record from this system of records may be disclosed, as a routine use, to the Administrator, General Services, or his/her designee, during an inspection of records conducted by GSA as part of that agency's responsibility to recommend improvements in records management practices and programs, under authority of 44 U.S.C. 2904 and 2906. Such disclosure shall be made in accordance with the GSA regulations governing inspection of records for this purpose, and any other relevant (i.e., GSA or Commerce) directive. Such disclosure shall not be used to make determinations about individuals.
8. A record from this system of records may be disclosed, as a routine use, to the public after either publication of the application pursuant to 35 U.S.C. 122(b) or issuance of a patent pursuant to 35 U.S.C. 151. Further, a record may be disclosed, subject to the limitations of 37 CFR 1.14, as a routine use, to the public if the record was filed in an application which became abandoned or in which the proceedings were terminated and which application is referenced by either a published application, an application open to public inspections or an issued patent.
9. A record from this system of records may be disclosed, as a routine use, to a Federal, State, or local law enforcement agency, if the USPTO becomes aware of a violation or potential violation of law or regulation.

## Electronic Patent Application Fee Transmittal

<b>Application Number:</b>	14609189			
<b>Filing Date:</b>	29-Jan-2015			
<b>Title of Invention:</b>	Messaging centre for forwarding e-mail			
<b>First Named Inventor/Applicant Name:</b>	Ari Backholm			
<b>Filer:</b>	Justin Robert Nifong/Donna Donovan			
<b>Attorney Docket Number:</b>	455/006/8 UTIL			
Filed as Large Entity				
<b>Filing Fees for Utility under 35 USC 111(a)</b>				
<b>Description</b>	<b>Fee Code</b>	<b>Quantity</b>	<b>Amount</b>	<b>Sub-Total in USD(\$)</b>
<b>Basic Filing:</b>				
<b>Pages:</b>				
<b>Claims:</b>				
<b>Miscellaneous-Filing:</b>				
<b>Petition:</b>				
<b>Patent-Appeals-and-Interference:</b>				
<b>Post-Allowance-and-Post-Issuance:</b>				
<b>Extension-of-Time:</b>				



Description	Fee Code	Quantity	Amount	Sub-Total in USD(\$)
<b>Miscellaneous:</b>				
Submission- Information Disclosure Stmt	1806	1	180	180
<b>Total in USD (\$)</b>				<b>180</b>

## Electronic Acknowledgement Receipt

<b>EFS ID:</b>	28171830
<b>Application Number:</b>	14609189
<b>International Application Number:</b>	
<b>Confirmation Number:</b>	5037
<b>Title of Invention:</b>	Messaging centre for forwarding e-mail
<b>First Named Inventor/Applicant Name:</b>	Ari Backholm
<b>Customer Number:</b>	118194
<b>Filer:</b>	Justin Robert Nifong/Donna Donovan
<b>Filer Authorized By:</b>	Justin Robert Nifong
<b>Attorney Docket Number:</b>	455/006/8 UTIL
<b>Receipt Date:</b>	26-JAN-2017
<b>Filing Date:</b>	29-JAN-2015
<b>Time Stamp:</b>	09:28:49
<b>Application Type:</b>	Utility under 35 USC 111(a)

### Payment information:

Submitted with Payment	yes
Payment Type	CARD
Payment was successfully received in RAM	\$180
RAM confirmation Number	012617INTEFSW09293500
Deposit Account	506191
Authorized User	Justin Nifong

The Director of the USPTO is hereby authorized to charge indicated fees and credit any overpayment as follows:

37 CFR 1.16 (National application filing, search, and examination fees)

37 CFR 1.17 (Patent application and reexamination processing fees)

37 CFR 1.19 (Document supply fees)  
 37 CFR 1.20 (Post Issuance fees)  
 37 CFR 1.21 (Miscellaneous fees and charges)

**File Listing:**

Document Number	Document Description	File Name	File Size(Bytes)/ Message Digest	Multi Part /.zip	Pages (if appl.)
1	Information Disclosure Statement (IDS) Form (SB08)	455-006-8UTIL-20170126-IDS.pdf	612508 a5807562325fd5c6744cd4b9034e02b21a2f70ae	no	4
<b>Warnings:</b>					
<b>Information:</b>					
A U.S. Patent Number Citation or a U.S. Publication Number Citation is required in the Information Disclosure Statement (IDS) form for autoloading of data into USPTO systems. You may remove the form to add the required data in order to correct the Informational Message if you are citing U.S. References. If you chose not to include U.S. References, the image of the form will be processed and be made available within the Image File Wrapper (IFW) system. However, no data will be extracted from this form. Any additional data such as Foreign Patent Documents or Non Patent Literature will be manually reviewed and keyed into USPTO systems.					
2	Non Patent Literature	ExchangeServerVersionandFeatures.pdf	486068 841f440b7aa5609c43e1a6f74374ce48010c63e5	no	3
<b>Warnings:</b>					
<b>Information:</b>					
3	Non Patent Literature	ExchangeServer2003TrainingKit.pdf	9479183 a83da28ee5939305e6169e0e3be34c49f97f4328	no	826
<b>Warnings:</b>					
<b>Information:</b>					
4	Non Patent Literature	MicrosoftExchangeServer2003AdministrationGuide.pdf	7488324 30bdc8a4a9e0b08905d81d1ee43a6bf4068f7e2b	no	503
<b>Warnings:</b>					
<b>Information:</b>					
5	Non Patent Literature	MicrosoftExchangeServer2003FeaturesComparison.pdf	1146416 44a31890c20f21583c2c7da3f1a66337ec6f9709	no	6
<b>Warnings:</b>					
<b>Information:</b>					

6	Fee Worksheet (SB06)	fee-info.pdf	30378	no	2
			934752003d845aac9f4e5d1fd1ea794d718ba72f		
<b>Warnings:</b>					
<b>Information:</b>					
<b>Total Files Size (in bytes):</b>				19242877	
<p><b>This Acknowledgement Receipt evidences receipt on the noted date by the USPTO of the indicated documents, characterized by the applicant, and including page counts, where applicable. It serves as evidence of receipt similar to a Post Card, as described in MPEP 503.</b></p> <p><b><u>New Applications Under 35 U.S.C. 111</u></b>  <b>If a new application is being filed and the application includes the necessary components for a filing date (see 37 CFR 1.53(b)-(d) and MPEP 506), a Filing Receipt (37 CFR 1.54) will be issued in due course and the date shown on this Acknowledgement Receipt will establish the filing date of the application.</b></p> <p><b><u>National Stage of an International Application under 35 U.S.C. 371</u></b>  <b>If a timely submission to enter the national stage of an international application is compliant with the conditions of 35 U.S.C. 371 and other applicable requirements a Form PCT/DO/EO/903 indicating acceptance of the application as a national stage submission under 35 U.S.C. 371 will be issued in addition to the Filing Receipt, in due course.</b></p> <p><b><u>New International Application Filed with the USPTO as a Receiving Office</u></b>  <b>If a new international application is being filed and the international application includes the necessary components for an international filing date (see PCT Article 11 and MPEP 1810), a Notification of the International Application Number and of the International Filing Date (Form PCT/RO/105) will be issued in due course, subject to prescriptions concerning national security, and the date shown on this Acknowledgement Receipt will establish the international filing date of the application.</b></p>					



UNITED STATES PATENT AND TRADEMARK OFFICE

UNITED STATES DEPARTMENT OF COMMERCE
United States Patent and Trademark Office
Address: COMMISSIONER FOR PATENTS
P. O. Box 1450
Alexandria, Virginia 22313-1450
www.uspto.gov

Table with columns: APPLICATION NO., FILING DATE, FIRST NAMED INVENTOR, ATTORNEY DOCKET NO., CONFIRMATION NO., EXAMINER, ART UNIT, PAPER NUMBER, NOTIFICATION DATE, DELIVERY MODE. Includes application details for Ari Backholm and examiner Chou, Alan S.

Please find below and/or attached an Office communication concerning this application or proceeding.

The time period for reply, if any, is set in the attached communication.

Notice of the Office communication was sent electronically on above-indicated "Notification Date" to the following e-mail address(es):

usptomail@nkpatentlaw.com
abackholm@seven.com
eofficeaction@apcoll.com

<b>Office Action Summary</b>	<b>Application No.</b> 14/609,189	<b>Applicant(s)</b> BACKHOLM ET AL.	
	<b>Examiner</b> ALAN S. CHOU	<b>Art Unit</b> 2451	<b>AIA (First Inventor to File) Status</b> No

**-- The MAILING DATE of this communication appears on the cover sheet with the correspondence address --**

**Period for Reply**

A SHORTENED STATUTORY PERIOD FOR REPLY IS SET TO EXPIRE 3 MONTHS FROM THE MAILING DATE OF THIS COMMUNICATION.

- Extensions of time may be available under the provisions of 37 CFR 1.136(a). In no event, however, may a reply be timely filed after SIX (6) MONTHS from the mailing date of this communication.
- If NO period for reply is specified above, the maximum statutory period will apply and will expire SIX (6) MONTHS from the mailing date of this communication.
- Failure to reply within the set or extended period for reply will, by statute, cause the application to become ABANDONED (35 U.S.C. § 133). Any reply received by the Office later than three months after the mailing date of this communication, even if timely filed, may reduce any earned patent term adjustment. See 37 CFR 1.704(b).

**Status**

- 1)  Responsive to communication(s) filed on 8/23/2016.  
 A declaration(s)/affidavit(s) under **37 CFR 1.130(b)** was/were filed on \_\_\_\_\_.
- 2a)  This action is **FINAL**.                      2b)  This action is non-final.
- 3)  An election was made by the applicant in response to a restriction requirement set forth during the interview on \_\_\_\_\_; the restriction requirement and election have been incorporated into this action.
- 4)  Since this application is in condition for allowance except for formal matters, prosecution as to the merits is closed in accordance with the practice under *Ex parte Quayle*, 1935 C.D. 11, 453 O.G. 213.

**Disposition of Claims\***

- 5)  Claim(s) 1-19 and 21-55 is/are pending in the application.  
5a) Of the above claim(s) \_\_\_\_\_ is/are withdrawn from consideration.
- 6)  Claim(s) \_\_\_\_\_ is/are allowed.
- 7)  Claim(s) 1-19 and 21-55 is/are rejected.
- 8)  Claim(s) \_\_\_\_\_ is/are objected to.
- 9)  Claim(s) \_\_\_\_\_ are subject to restriction and/or election requirement.

\* If any claims have been determined allowable, you may be eligible to benefit from the **Patent Prosecution Highway** program at a participating intellectual property office for the corresponding application. For more information, please see [http://www.uspto.gov/patents/init\\_events/pph/index.jsp](http://www.uspto.gov/patents/init_events/pph/index.jsp) or send an inquiry to [PPHfeedback@uspto.gov](mailto:PPHfeedback@uspto.gov).

**Application Papers**

- 10)  The specification is objected to by the Examiner.
- 11)  The drawing(s) filed on \_\_\_\_\_ is/are: a)  accepted or b)  objected to by the Examiner.  
Applicant may not request that any objection to the drawing(s) be held in abeyance. See 37 CFR 1.85(a).  
Replacement drawing sheet(s) including the correction is required if the drawing(s) is objected to. See 37 CFR 1.121(d).

**Priority under 35 U.S.C. § 119**

- 12)  Acknowledgment is made of a claim for foreign priority under 35 U.S.C. § 119(a)-(d) or (f).

**Certified copies:**

- a)  All    b)  Some\*\*    c)  None of the:
1.  Certified copies of the priority documents have been received.
  2.  Certified copies of the priority documents have been received in Application No. \_\_\_\_\_.
  3.  Copies of the certified copies of the priority documents have been received in this National Stage application from the International Bureau (PCT Rule 17.2(a)).

\*\* See the attached detailed Office action for a list of the certified copies not received.

**Attachment(s)**

- 1)  Notice of References Cited (PTO-892)
- 2)  Information Disclosure Statement(s) (PTO/SB/08a and/or PTO/SB/08b)  
Paper No(s)/Mail Date \_\_\_\_\_.
- 3)  Interview Summary (PTO-413)  
Paper No(s)/Mail Date. \_\_\_\_\_.
- 4)  Other: \_\_\_\_\_.

The present application is being examined under the pre-AIA first to invent provisions.

### **DETAILED ACTION**

Claims 1-19, 21-55 are presented for examination.

#### ***Continued Examination Under 37 CFR 1.114***

A request for continued examination under 37 CFR 1.114, including the fee set forth in 37 CFR 1.17(e), was filed in this application after final rejection. Since this application is eligible for continued examination under 37 CFR 1.114, and the fee set forth in 37 CFR 1.17(e) has been timely paid, the finality of the previous Office action has been withdrawn pursuant to 37 CFR 1.114. Applicant's submission filed on August 23, 2016 has been entered.

#### ***Double Patenting***

1. The nonstatutory double patenting rejection is based on a judicially created doctrine grounded in public policy (a policy reflected in the statute) so as to prevent the unjustified or improper timewise extension of the "right to exclude" granted by a patent and to prevent possible harassment by multiple assignees. A nonstatutory double patenting rejection is appropriate where the claims at issue are not identical, but at least one examined application claim is not patentably distinct from the reference claim(s) because the examined application claim is either anticipated by, or would have been obvious over, the reference claim(s). See, e.g., *In re Berg*, 140 F.3d 1428, 46 USPQ2d 1226 (Fed. Cir. 1998); *In re Goodman*, 11 F.3d 1046, 29 USPQ2d 2010 (Fed. Cir. 1993); *In re Longi*, 759 F.2d 887, 225 USPQ 645 (Fed. Cir. 1985); *In re Van Ornum*,

686 F.2d 937, 214 USPQ 761 (CCPA 1982); *In re Vogel*, 422 F.2d 438, 164 USPQ 619 (CCPA 1970); and *In re Thorington*, 418 F.2d 528, 163 USPQ 644 (CCPA 1969).

2. Timely filed terminal disclaimer in compliance with 37 CFR 1.321(c) or 1.321(d) may be used to overcome an actual or provisional rejection based on a nonstatutory double patenting ground provided the reference application or patent either is shown to be commonly owned with this application, or claims an invention made as a result of activities undertaken within the scope of a joint research agreement. A terminal disclaimer must be signed in compliance with 37 CFR 1.321(b).

3. The USPTO internet Web site contains terminal disclaimer forms which may be used. Please visit <http://www.uspto.gov/forms/>. The filing date of the application will determine what form should be used. A web-based eTerminal Disclaimer may be filled out completely online using web-screens. An eTerminal Disclaimer that meets all requirements is auto-processed and approved immediately upon submission. For more information about eTerminal Disclaimers, refer to <http://www.uspto.gov/patents/process/file/efs/guidance/eTD-info-I.jsp>.

4. Claims 1-20 are rejected on the ground of nonstatutory double patenting as being unpatentable over claim 1 of U.S. Patent No. 7,706,781 B2 and claim 1 of U.S. Patent 7,643,818 B2. Although the claims at issue are not identical, they are not patentably distinct from each other because both independent claims have the similar steps such as: e-mail address of the mobile terminal is associated with an identifier and encryption information (see claims 1 in U.S. Patent 7,706,871 B2 and U.S. Patent 7,643,818 B2), encrypting an email message using the encryption information (see claims 1 in U.S.



Patent 7,706,871 B2 and U.S. Patent 7,643,818 B2), and transmitting the encrypted e-mail message (see claims 1 in U.S. Patent 7,706,871 B2 and U.S. Patent 7,643,818 B2).

5. The current independent claim 1 is a broader version of claim 1 of U.S. Patent 7,643,818 B2, without the limitation of establishing a tunnel and permanent terminal identity and temporary identity.

6. The current independent claim 1 is a broader version of claim 1 of U.S. Patent 7,706,781 B2, without the limitation of activation code, permanent terminal identity, and encrypted data channel. The limitation of activation code can be found in the dependent claim 8 of the current application.

7. Thus the current independent claims 1, 12, 20 have similar limitation as the parent claim in the U.S. Patent 7,706,871 B2 and U.S. Patent 7,643,818 B2.

### ***Claim Rejections - 35 USC § 103***

8. The following is a quotation of pre-AIA 35 U.S.C. 103(a) which forms the basis for all obviousness rejections set forth in this Office action:

(a) A patent may not be obtained though the invention is not identically disclosed or described as set forth in section 102 of this title, if the differences between the subject matter sought to be patented and the prior art are such that the subject matter as a whole would have been obvious at the time the invention was made to a person having ordinary skill in the art to which said subject matter pertains. Patentability shall not be negated by the manner in which the invention was made.

9. Claims 1-2, 6-10, 12-15, 18, 21-24, 29-38, 42-55 are rejected under pre-AIA 35 U.S.C. 103(a) as being unpatentable over Little et al. U.S. Patent Application

Publication Number 2004/0205248 A1 (hereinafter Little), further in view of Turunen et al. U.S. Patent Number 7,289,792 B1 (hereinafter Turunen), and further in view of Osthoff et al. U.S. Patent Application Publication Number 2002/0147918 A1 (hereinafter Osthoff).

10. As per claims 1, 12, Little disclose a method for forwarding an e-mail message from an e-mail server to a mobile terminal (see forwarding email message 833 from message server 820 to mobile device 816 on page 9 section [0076] on Figure 8), the method comprising:

11. receiving, at an intermediary system (see wireless gateway 85 receiving email from e-mail sender 10 in Figure 1 and page 2 section [0025]), an e-mail message associated with an e-mail address of a user of a mobile terminal and sent by an e-mail servers (see message server 45 on Figure 1 and see receiving e-mail messages to a user identified by an e-mail address on page 9 section [0078]),

12. wherein the e-mail address is associated with an identifier of the mobile terminal (see specific e-mail address associated with the mobile device on page 2 section [0026]),

13. encrypting the e-mail message (see encryption e-mail message to be send through a wireless VPN through a temporary transfer path on page 9 section [0081]) using encryption information associated with a temporary identifier (see encryption using private key on page 8 section [0070]),

14. and

15. transmitting the encrypted e-mail message to the mobile terminal (see sending encrypted message to mobile device on page 10 section [0082]).
16. Little do not disclose expressly: a plurality of e-mail servers.
17. wherein the identifier is generated by the mobile terminal;
18. wherein the temporary identifier is based on a connection to the mobile terminal.
19. Turunen teaches: a plurality of e-mail servers (see at least one multimedia message server MMSV in Abstract and multiple MMS such as Mowgli, WAP, and LDAP in Figure 2).
20. Turunen teaches: wherein the temporary identifier is based on a connection to the mobile terminal (see temporary logical link identity TLLI provided to the mobile terminal by the serving packet service support node SGSN based on the temporary connection and channel on column 7 line 2-25 and see sending encryption parameters to setup connection on column 7 line 23-28).
21. Little and Turunen are analogous art because they are from the same field of endeavor, wireless email terminal system. At the time of the invention it would have been obvious to a person of ordinary skill in the art to also apply a temporary mobile terminal identifier for the connection to link the email to the individual mobile terminal. The motivation for doing so would have been to use link an email address that use the temporary connection address to an wireless mobile terminal that use wireless network system. Therefore, it would have been obvious to combine Little and Turunen for the benefit of using e-mail address of the mobile terminal is associated with a temporary connection identifier to obtain the invention as specified in claims 1, 12.

22. Little and Turunen do not disclose expressly: wherein the identifier is generated by the mobile terminal.

23. Osthoff teaches: wherein the identifier is generated by the mobile terminal (see using terminal identifier stored in the terminal device to create a temporary hash value to communicate with the server for authentication purposes on page 1 section [0011]).

24. Little and Osthoff are analogous art because they are from the same field of endeavor, wireless email terminal system. At the time of the invention it would have been obvious to a person of ordinary skill in the art to also apply a temporary mobile terminal identifier generated by the mobile terminal. The motivation for doing so would have been to authenticate a wireless mobile terminal that use wireless network system. Therefore, it would have been obvious to combine Little and Turunen and Osthoff for the benefit of generate a temporary connection identifier by the mobile terminal to obtain the invention as specified in claim 1, 12.

25. As per claim 2, Little and Turunen and Osthoff disclose the method of claim 1, further comprising identifying the mobile terminal based on the e-mail address of the e-mail message and the association with the identifier of the mobile terminal (see e-mail address of terminal is used to identify the wireless terminal as well as an permanent identification of wireless terminal using international mobile subscriber identity IMSI on column 8 line 20-35 and see e-mail address as well as the permanent identification of the wireless terminal such as a telephone number MSISDN and device identification

IMSI are used to linking email address to the wireless terminal on column 8 line 29-37 in Turunen).

26. As per claim 6, Little and Turunen and Osthoff disclose the method of claim 2, further comprising adding the e-mail address to a reply message sent by the mobile terminal (see repacking allowing reply messages to delivered to addressed recipients on page 10 section [0083] in Little).

27. As per claim 7, Little and Turunen and Osthoff disclose the method of claim 1, further comprising receiving the encryption information generated by the mobile terminal (see private key encryption information is shared to other systems and devices on page 8 section [0070] in Little).

28. As per claim 8, Little and Turunen and Osthoff disclose the method of claim 1, wherein the encryption information (see encryption information private key is used to identify mobile device entity on page 8 section [0070] in Little) is based on an activation code of the mobile terminal (see activation message from the wireless terminal to set up linking of the email address to the wireless terminal on column 8 line 29-37 in Turunen).

29. As per claim 9, Little and Turunen and Osthoff disclose the method of claim 1, wherein the messaging center transmits the e-mail message to the mobile terminal using the identifier of the mobile terminal (see temporary logical link identity TLLI to

transmit data to wireless terminal over temporary wireless network on column 7 line 1-10 in Turunen).

30. As per claims 10, 18, Little and Turunen and Osthoff disclose the method of claim 1, wherein mobile terminal receives and decrypts the e-mail message (see wireless terminal decrypts the message on page 10 section [0082] in Little) using the encryption information (see decryption using shared private key on page 8 section [0070] in Little).

31. As per claim 13, Little and Turunen and Osthoff disclose the system of claim 12, wherein the processor is further configured to receive the e-mail message from the e-mail server (see wireless connector system 828 transfers data between mobile device 816 and email message server 820 on page 9 section [0079] in Little).

32. As per claim 14, Little and Turunen and Osthoff disclose the system of claim 12, wherein the processor (see wireless connector system 828 transfers data between mobile device 816 and email message server 820 on page 9 section [0079] in Little) is further configured to receive the encryption information and to provide the encryption information to the memory for storage (see receiving encryption information shared private key on page 8 section [0070] in Little).

33. As per claim 15, Little and Turunen and Osthoff disclose the system of claim 12, wherein the processor is further configured to pack the e-mail message (see repackaging the email message 833 such as compressing and encrypting the email message 833 on page 9 section [0081] in Little).

34. As per claims 21, 22, 54, Little disclose a mobile device (see mobile device 100 on page 12 section [0099] and Figure 11) comprising:

35. a radio (see transceiver 1111 on page 12 section [0099]);

36. a memory (see random access memory 1126 on page 12 section [0099]);

37. a processor (see microprocessor 1138 on page 12 section [0099]) configured for controlling a mobile device to:

38. receive, from a server, an encrypted e-mail message associated with an e-mail address of a user of the mobile device (see receiving encrypted message on page 10 section [0082]), wherein the e-mail address is associated with the identifier (see e-mail address corresponding to a user account and mailbox on page 9 section [0078]),

39. decrypt the e-mail message using encryption information associated with a temporary identifier (see decrypt using session key on page 1 section [0007] and page 4 section [0037]),

40. Little do not disclose expressly: generate an identifier; and

41. wherein the temporary identifier is based on a connection to the server.

42. Turunen teaches : wherein the temporary identifier is based on a connection to the server (see temporary logical link identity TLLI provided to the mobile terminal by the serving packet service support node SGSN based on the temporary connection and channel on column 7 line 2-25 and see sending encryption parameters to setup connection on column 7 line 23-28).

43. Little and Turunen are analogous art because they are from the same field of endeavor, wireless email terminal system. At the time of the invention it would have been obvious to a person of ordinary skill in the art to also apply a temporary mobile terminal identifier for the connection to link the email to the individual mobile terminal. The motivation for doing so would have been to use link an email address that use the temporary connection address to an wireless mobile terminal that use wireless network system. Therefore, it would have been obvious to combine Little and Turunen for the benefit of using e-mail address of the mobile terminal is associated with a temporary connection identifier to obtain the invention as specified in claim 21, 22, 54.

44. Little and Turunen do not disclose expressly: generate an identifier.

45. Osthoff teaches: generate an identifier (see using terminal identifier stored in the terminal device to create a temporary hash value to communicate with the server for authentication purposes on page 1 section [0011]).

46. Little and Osthoff are analogous art because they are from the same field of endeavor, wireless email terminal system. At the time of the invention it would have been obvious to a person of ordinary skill in the art to also apply a temporary mobile terminal identifier generated by the mobile terminal. The motivation for doing so would



have been to authenticate a wireless mobile terminal that use wireless network system. Therefore, it would have been obvious to combine Little and Turunen and Osthoff for the benefit of generate an identifier by the mobile terminal to obtain the invention as specified in claim 21, 22, 54.

47. As per claims 23, 37, 55, Little discloses a device (see message server 820 on page 9 section [0076] and Figure 8) comprising:

48. a radio (see wireless connector system 828 on page 9 section [0079]);

49. a processor and memory (see message server 820 saving email messages to mail box 819 on page 9 section [0078]) containing instructions executable by the processor whereby the device is operable to:

50. register the remote device for access to a messaging account (see registering remote devices using unique identification and using Subscriber Identity Module SIM on page 12 section [0105]);

51. receive a message for the messaging account (see e-mail message 833 arrive at message server 820 and server determining which mailboxes 819 to be stored on page 9 section [0078]);

52. encrypt the message using an encryption key (see encrypt e-mail message on page 9 section [0081]); and

53. send the message to the remote device (see sending message to mobile devices on page 9 section [0081]),

54. wherein the device is authenticated to access the messaging account (see e-mail address identifies a user account and mailbox 819 on page 9 section [0078]).

55. Little do not disclose expressly: receive information including a service activation code from a remote device.

56. Turunen teaches: receive information including a service activation code (see activation message from the wireless terminal to set up linking of the email address to the wireless terminal on column 8 line 29-37 and see activation message from the wireless terminal to set up linking of the email address to the wireless terminal on column 8 line 29-37 and see activation call the message server to define the wireless terminal of the right recipient on the basis of the e-mail address on column 8 line 40-45).

57. Little and Turunen are analogous art because they are from the same field of endeavor, wireless email terminal system. At the time of the invention it would have been obvious to a person of ordinary skill in the art to also apply an activation code to link the email to the individual mobile terminal. The motivation for doing so would have been to link an email address to a wireless mobile terminal using an activation code that use wireless network system. Therefore, it would have been obvious to combine Little and Turunen for the benefit of using e-mail address of the mobile terminal is associated with an activation code to obtain the invention as specified in claim 23, 37, 55.

58. Little and Turunen do not disclose expressly: receive information including a service activation code from a remote device.

59. Osthoff teaches: receive information including a service activation code from a remote device (see using terminal identifier stored in the terminal device to create a

temporary hash value to communicate with the server for authentication purposes on page 1 section [0011]).

60. Little and Osthoff are analogous art because they are from the same field of endeavor, wireless email terminal system. At the time of the invention it would have been obvious to a person of ordinary skill in the art to also apply a temporary mobile terminal identifier generated by the mobile terminal. The motivation for doing so would have been to authenticate a wireless mobile terminal that use wireless network system. Therefore, it would have been obvious to combine Little and Turunen and Osthoff for the benefit of generate an identifier by the mobile terminal to obtain the invention as specified in claim 23, 37, 55.

61. As per claims 24, 38, Little and Turunen and Osthoff disclose the device of claim 23, wherein the information including the service activation code is received by the device in response to user input at the remote device (see user entering a password for decryption the message session on page 5 section [0044] in Little and see activation request message received from the user wireless terminal containing encryption key and identification parameters and on column 7 line 55-65 in Turunen).

62. As per claims 29, 42, Little and Turunen and Osthoff disclose the device of claim 23, wherein the authentication of the device relies on the authentication of the messaging account (see user enter password to authenticate device on page 5 section [0044] in Little).

63. As per claims 30, 43, Little and Turunen and Osthoff disclose the method of claim 29, wherein the authentication of the messaging account includes a username and password (see message account identified by user name on page 9 section [0078] and see user enter password to authenticate device on page 5 section [0044] in Little).

64. As per claims 31, 44, Little and Turunen and Osthoff disclose the device of claim 23, wherein the encryption key is the service activation code (see sending encryption key or private key on page 8 section [0070] in Little and see activation message on column 8 line 29-40 and see exchanging encryption parameters on column 7 line 20-28 in Turunen).

65. As per claims 32, 45, Little and Turunen and Osthoff disclose the device of claim 23, wherein the encryption key is derived from the service activation code (see private key is used to decrypt the session key to decrypt message body on page 4 section [0037] in Little).

66. As per claims 33, 46, Little and Turunen and Osthoff disclose the device of claim 23, wherein the encryption key is a subset of the service activation code (see encrypted session key embedded in message may be further encrypted with a public key on page 4 section [0040] in Little).

67. As per claims 34, 47, Little and Turunen and Osthoff disclose the device of claim 23, wherein the encryption key is closely related to the service activation code (see private key is used to decrypt the session key to decrypt message body on page 4 section [0037] in Little).

68. As per claims 35, 48, Little and Turunen and Osthoff disclose the device of claim 23, wherein the device is further operable to: store an association between at least two of the encryption key (see encryption key and session key on page 4 section [0037] in Little), the messaging account, an identifier of the remote device, and the service activation code (see storage storing user name, user account, mailbox identifier on page 9 section [0078] in Little).

69. As per claims 36, 50, Little and Turunen and Osthoff disclose the device of claim 23, wherein the message is sent to the remote device through an intermediate device (see wireless Gateway 85 on page 2 section [0027] and in Figure 1 in Little).

70. As per claims 49, 51, Little and Turunen and Osthoff disclose the device of claim 36, wherein the encryption key (see encryption key is used to generate request on column 6 line 55-65) is associated with a temporary identifier (see temporary identifier temporary logical link identity TLLI used to connect wireless terminal with serving support node SGSN on column 7 line 4-21 in Turunen), wherein the temporary identifier is based on a connection to the intermediate device (see wireless Gateway 85 on page

2 section [0027] and in Figure 1 in Little and see gateway support node GGSN on column 6 line 60-65 in Turunen).

71. As per claims 52, 53, Little and Turunen and Osthoff disclose the method of claim 1, wherein the identifier (logon request contain wireless terminal identifier on column 8 line 55-62 in Turunen) is associated with the temporary identifier (see temporary identifier temporary logical link identity TLLI used to connect wireless terminal with serving support node SGSN on column 7 line 4-21 in Turunen).

72. Claims 3-5, 11, 16-17, 19 are rejected under pre-AIA 35 U.S.C. 103(a) as being unpatentable over Little et al. U.S. Patent Application Publication Number 2004/0205248 A1 (hereinafter Little), further in view of Turunen et al. U.S. Patent Number 7,289,792 B1 (hereinafter Turunen), further in view of Osthoff et al. U.S. Patent Application Publication Number 2002/0147918 A1 (hereinafter Osthoff), further in view of Kock et al. U.S. Patent Application Publication Number 2006/0031300 A1 (hereinafter Kock).

73. As per claims 3, 16, Little and Turunen and Osthoff do not disclose the method of claim 1: wherein encrypting the e-mail message further comprises packing the e-mail

message by omitting at least part of the e-mail message when at least part of the e-mail message exceeds a predetermined size specification.

74. Kock teaches: packing the e-mail message by omitting at least part of the e-mail message when at least part of the e-mail message exceeds a predetermined size specification (see server transmitting the header the first N character of the body to the terminal device, where N is a predetermined integer, while holding back any remaining body of the email on page 1 section [0008]).

75. Little and Kock are analogous art because they are from the same field of endeavor, wireless email terminal system. At the time of the invention it would have been obvious to a person of ordinary skill in the art to also apply an email message sending size. The motivation for doing so would have been to save bandwidth and only send email data that user requests. Therefore, it would have been obvious to combine Little and Turunen and Osthoff and Kock for the benefit of omitting at least part of the e-mail message when at least part of the e-mail message exceeds a predetermined size to obtain the invention as specified in claims 3, 16.

76. As per claims 4, 17, Little and Turunen and Osthoff and Kock disclose the method of claim 3, wherein size specification is set by a user of the mobile terminal (see number N is determined by a user of the terminal device on page 1 section [0014] in Kock).

77. As per claim 5, Little and Turunen and Osthoff and Kock disclose the method of claim 3, wherein the omitted part of the e-mail message is the e-mail address (see omitting any characters of the body including email address beyond the predetermined integer N on page 1 section [0008] in Kock).

78. As per claim 11, 19, Little and Turunen and Osthoff and Kock disclose the method of claim 3, wherein the mobile terminal unpacks the e-mail message (see mobile terminal repacking the email message by decompression and decryption on page 10 section [0082] in Little).

79. Claims 25-26, 28, 39, 41 are rejected under pre-AIA 35 U.S.C. 103(a) as being unpatentable over Little et al. U.S. Patent Application Publication Number 2004/0205248 A1 (hereinafter Little), further in view of Turunen et al. U.S. Patent Number 7,289,792 B1 (hereinafter Turunen), further in view of Osthoff et al. U.S. Patent Application Publication Number 2002/0147918 A1 (hereinafter Osthoff), further in view of Salonen U.S. Patent Application Publication Number 2013/0268384 A1 (hereinafter Salonen).



80. As per claims 25, 39, Little and Turunen and Osthoff do not disclose expressly: wherein the information including the service activation code is received by the device in an off-line communication.

81. Salonen teaches: wherein the information including the service activation code is received by the device in an off-line communication (see using a secure SIM card in GSM devices as activation code to encrypt messages offline on the device without using network resources on page 6 section [0074]).

82. Little and Salonen are analogous art because they are from the same field of endeavor, wireless email terminal system. At the time of the invention it would have been obvious to a person of ordinary skill in the art to use off-line service activation code. The motivation for doing so would have been to use a secure physical means to encrypt message. Therefore, it would have been obvious to combine Little and Turunen and Osthoff and Salonen for the benefit of using activation code in an off-line communication to obtain the invention as specified in claims 25, 39.

83. As per claim 26, Little and Turunen and Osthoff and Salonen disclose the device of claim 25, wherein the off-line communication involves a local connection (see using a secure SIM card in GSM devices as activation code to encrypt messages locally using secure connection on page 6 section [0074] in Salonen).

84. As per claims 28, 41, Little and Turunen and Osthoff and Salonen disclose the device of claim 25, wherein the off-line communication prevents eavesdropping of the

service activation code (see using a secure SIM card in GSM devices as activation code to encrypt messages prevents eavesdropping of the encryption within the device on page 6 section [0074] in Salonen).

85. Claims 27, 40 are rejected under pre-AIA 35 U.S.C. 103(a) as being unpatentable over Little et al. U.S. Patent Application Publication Number 2004/0205248 A1 (hereinafter Little), further in view of Turunen et al. U.S. Patent Number 7,289,792 B1 (hereinafter Turunen), further in view of Osthoff et al. U.S. Patent Application Publication Number 2002/0147918 A1 (hereinafter Osthoff), further in view of Salonen U.S. Patent Application Publication Number 2013/0268384 A1 (hereinafter Salonen), and further in view of Giobbi U.S. Patent Application Publication Number 2004/0098597 A1 (hereinafter Giobbi).

86. As per claims 27, 40, Little and Turunen and Osthoff and Salonen do not disclose: wherein the local connection is one of a short range wireless interface, Bluetooth TM, or an optical interface (see using wired interface, or secure SIM card wired interface in GSM devices as activation code to encrypt messages on page 6 section [0074] in Salonen).

87. Giobbi teaches: wherein the local connection is one of a short range wireless interface, Bluetooth TM, or an optical interface (see wireless connection such as Bluetooth on page 3 section [0039-0040] as activation code to encrypt messages on page 6 section [0067]).

88. Little and Giobbi are analogous art because they are from the same field of endeavor, wireless email terminal system. At the time of the invention it would have been obvious to a person of ordinary skill in the art to use off-line service activation code via Bluetooth. The motivation for doing so would have been to use a secure physical means to encrypt message. Therefore, it would have been obvious to combine Little and Turunen and Osthoff and Salonen and Giobbi for the benefit of using activation code in an off-line communication via Bluetooth to obtain the invention as specified in claims 27, 40.

### ***Response to Arguments***

89. Applicant's arguments, see Remarks on page 10, filed August 23, 2016, with respect to the rejection(s) of claim(s) 1, 12 under 35 U.S.C. 103(a) have been fully considered and are persuasive. Therefore, the rejection has been withdrawn. However, upon further consideration, a new ground(s) of rejection is made in view of Turunen et al. U.S. Patent Number 7,289,792 B1 (hereinafter Turunen).

90. Little do not disclose expressly: a plurality of e-mail servers.

91. Turunen teaches: a plurality of e-mail servers (see at least one multimedia message server MMSV in Abstract and multiple MMS such as Mowgli, WAP, and LDAP in Figure 2).

92. Applicant's arguments, see Remarks on page 10, filed August 23, 2016, with respect to the rejection(s) of claim(s) 1, 12, 21-23, 37, 54-55 under 35 U.S.C. 103(a) have been fully considered and are persuasive. Therefore, the rejection has been withdrawn. However, upon further consideration, a new ground(s) of rejection is made in view of Osthoff et al. U.S. Patent Application Publication Number 2002/0147918 A1 (hereinafter Osthoff).

93. Little and Turunen do not disclose expressly: wherein the identifier is generated by the mobile terminal.

94. Osthoff teaches: wherein the identifier is generated by the mobile terminal (see using terminal identifier stored in the terminal device to create a temporary hash value to communicate with the server for authentication purposes on page 1 section [0011]).

95. Little and Osthoff are analogous art because they are from the same field of endeavor, wireless email terminal system. At the time of the invention it would have been obvious to a person of ordinary skill in the art to also apply a temporary mobile terminal identifier generated by the mobile terminal. The motivation for doing so would have been to authenticate a wireless mobile terminal that use wireless network system. Therefore, it would have been obvious to combine Little and Turunen and Osthoff for

the benefit of generate a temporary connection identifier by the mobile terminal to obtain the invention as specified in the claims.

96. Applicant's arguments, see Remarks on page 17, filed August 23, 2016, with respect to the rejection(s) of claim(s) 27, 40 under 35 U.S.C. 103(a) have been fully considered and are persuasive. Therefore, the rejection has been withdrawn.

However, upon further consideration, a new ground(s) of rejection is made in view of Giobbi U.S. Patent Application Publication Number 2004/0098597 A1 (hereinafter Giobbi).

97. As per claims 27, 40, Little and Turunen and Osthoff and Salonen do not disclose: wherein the local connection is one of a short range wireless interface, Bluetooth TM, or an optical interface (see using wired interface, or secure SIM card wired interface in GSM devices as activation code to encrypt messages on page 6 section [0074] in Salonen).

98. Giobbi teaches: wherein the local connection is one of a short range wireless interface, Bluetooth TM, or an optical interface (see wireless connection such as Bluetooth on page 3 section [0039-0040] as activation code to encrypt messages on page 6 section [0067]).

99. Little and Giobbi are analogous art because they are from the same field of endeavor, wireless email terminal system. At the time of the invention it would have been obvious to a person of ordinary skill in the art to use off-line service activation code via Bluetooth. The motivation for doing so would have been to use a secure

Art Unit: 2451

physical means to encrypt message. Therefore, it would have been obvious to combine Little and Turunen and Osthoff and Salonen and Giobbi for the benefit of using activation code in an off-line communication via Bluetooth to obtain the invention as specified in claims 27, 40.

Any inquiry concerning this communication or earlier communications from the examiner should be directed to ALAN S. CHOU whose telephone number is (571)272-5779. The examiner can normally be reached on 9am-5pm.

If attempts to reach the examiner by telephone are unsuccessful, the examiner's supervisor, Christopher L. Parry can be reached on (571)272-8328. The fax phone number for the organization where this application or proceeding is assigned is 571-273-8300.

Information regarding the status of an application may be obtained from the Patent Application Information Retrieval (PAIR) system. Status information for published applications may be obtained from either Private PAIR or Public PAIR. Status information for unpublished applications is available through Private PAIR only. For more information about the PAIR system, see <http://pair-direct.uspto.gov>. Should you have questions on access to the Private PAIR system, contact the Electronic Business Center (EBC) at 866-217-9197 (toll-free). If you would like assistance from a USPTO Customer Service Representative or access to the automated information system, call 800-786-9199 (IN USA OR CANADA) or 571-272-1000.

ALAN S CHOU  
Examiner  
Art Unit 2451

/ALAN S CHOU/  
Examiner, Art Unit 2451

<b>Notice of References Cited</b>	Application/Control No. 14/609,189	Applicant(s)/Patent Under Reexamination BACKHOLM ET AL.	
	Examiner ALAN S. CHOU	Art Unit 2451	Page 1 of 1

**U.S. PATENT DOCUMENTS**

*		Document Number Country Code-Number-Kind Code	Date MM-YYYY	Name	CPC Classification	US Classification
*	A	US-2004/0098597 A1	05-2004	Giobbi, John J.	G06F21/10	713/185
*	B	US-2002/0147918 A1	10-2002	Osthoff, Harro R.	G06F21/71	713/193
	C	US-				
	D	US-				
	E	US-				
	F	US-				
	G	US-				
	H	US-				
	I	US-				
	J	US-				
	K	US-				
	L	US-				
	M	US-				

**FOREIGN PATENT DOCUMENTS**

*		Document Number Country Code-Number-Kind Code	Date MM-YYYY	Country	Name	CPC Classification
	N					
	O					
	P					
	Q					
	R					
	S					
	T					

**NON-PATENT DOCUMENTS**

*		Include as applicable: Author, Title Date, Publisher, Edition or Volume, Pertinent Pages)
	U	
	V	
	W	
	X	

\*A copy of this reference is not being furnished with this Office action. (See MPEP § 707.05(a).)  
Dates in MM-YYYY format are publication dates. Classifications may be US or foreign.



<b>Search Notes</b>  	<b>Application/Control No.</b>  14609189	<b>Applicant(s)/Patent Under Reexamination</b>  BACKHOLM ET AL.
	<b>Examiner</b>  ALAN S CHOU	<b>Art Unit</b>  2451

CPC- SEARCHED		
Symbol	Date	Examiner
G06Q 10/107	9/24/2015	AC
H04L 12/585, 12/58	9/24/2015	AC

CPC COMBINATION SETS - SEARCHED		
Symbol	Date	Examiner

US CLASSIFICATION SEARCHED			
Class	Subclass	Date	Examiner
709	206	9/24/2015	AC

SEARCH NOTES		
Search Notes	Date	Examiner
EAST Search	9/24/2015	AC
Consulted with SPE Chris Parry regarding 101 issues for claims 1-20	9/24/2015	AC
Consulted with Primary Saket Daftuar regarding ODP issues for claims 1-20	9/25/2015	AC
Consulted with Primary Saket Daftuar regarding 112 6th issue with claim 12-19	9/25/2015	AC
EAST Search	7/5/2016	AC
Consulted with SPE Chris Parry regarding 101 amendments temporary identifier to making the language significantly more	7/20/2016	AC
EAST Search	11/1/2016	AC

INTERFERENCE SEARCH			
US Class/ CPC Symbol	US Subclass / CPC Group	Date	Examiner

--	--

## EAST Search History

## EAST Search History (Prior Art)

Ref #	Hits	Search Query	DBs	Default Operator	Plurals	Time Stamp
L1	128	((Ari) near2 (Backholm)).INV.	US-PGPUB; USPAT	OR	OFF	2016/11/01 14:46
L2	1	"7706781".pn.	US-PGPUB; USPAT	OR	OFF	2016/11/01 14:46
L3	1	"7643818".pn.	US-PGPUB; USPAT	OR	OFF	2016/11/01 14:46
L4	1	"20040205248"	US-PGPUB; USPAT	OR	OFF	2016/11/01 14:46
L5	1	"7289792".pn.	US-PGPUB; USPAT	OR	OFF	2016/11/01 14:46
L6	1	"6745326".pn.	US-PGPUB; USPAT	OR	OFF	2016/11/01 14:46
L7	1	"20060265595"	US-PGPUB; USPAT	OR	OFF	2016/11/01 14:46
L8	12343	(709/206.ccls. g06q10/107.cpc. h04112/585.cpc. h04112/58.cpc.)AND (@AD<"20041122" @RLAD<"20041122")	US-PGPUB; USPAT	OR	OFF	2016/11/01 14:46
L9	10923	(email mail e-mail (electronic NEAR2 mail)) AND (709/206.ccls. g06q10/107.cpc. h04112/585.cpc. h04112/58.cpc.)AND (@AD<"20041122" @RLAD<"20041122")	US-PGPUB; USPAT	OR	OFF	2016/11/01 14:46
L10	1491	(encrypt\$6 AND decrypt\$6) AND (email mail e-mail (electronic NEAR2 mail)) AND (709/206.ccls. g06q10/107.cpc. h04112/585.cpc. h04112/58.cpc.)AND (@AD<"20041122" @RLAD<"20041122")	US-PGPUB; USPAT	OR	OFF	2016/11/01 14:46
L11	1037	((terminal mobile client device phone) NEAR9 (code identifier id number)) AND (encrypt\$6 AND decrypt\$6) AND (email mail e-mail (electronic NEAR2 mail)) AND (709/206.ccls. g06q10/107.cpc. h04112/585.cpc. h04112/58.cpc.)AND (@AD<"20041122" @RLAD<"20041122")	US-PGPUB; USPAT	OR	OFF	2016/11/01 14:46
L12	74	(activat\$5 NEAR5 (code number identifier)) AND ((terminal mobile client device phone) NEAR9 (code identifier id number)) AND (encrypt\$6 AND decrypt\$6) AND (email mail e-mail (electronic NEAR2 mail)) AND (709/206.ccls. g06q10/107.cpc. h04112/585.cpc. h04112/58.cpc.)AND (@AD<"20041122" @RLAD<"20041122")	US-PGPUB; USPAT	OR	OFF	2016/11/01 14:46

L13	0	((temporary AND permanent) NEAR9 (code identifier id number)) AND (activat\$5 NEAR5 (code numberid identifier)) AND ((terminal mobile client device phone) NEAR9 (code identifier id number)) AND (encrypt\$6 AND decrypt\$6) AND (email mail e-mail (electronic NEAR2 mail)) AND (709/206.ccls. g06q10/107.cpc. h04112/585.cpc. h04112/58.cpc.)AND (@AD<"20041122" @RLAD<"20041122")	US-PGPUB; USPAT	OR	OFF	2016/11/01 14:46
L14	10	((temporary AND permanent) NEAR9 (code identifier id number)) AND (activat\$5 NEAR5 (code numberid identifier)) AND ((terminal mobile client device phone) NEAR9 (code identifier id number)) AND (encrypt\$6 AND decrypt\$6) AND (email mail e-mail (electronic NEAR2 mail)) AND (@AD<"20041122" @RLAD<"20041122")	US-PGPUB; USPAT	OR	OFF	2016/11/01 14:46
L15	21	((temporary AND permanent) NEAR9 (code identifier id number)) AND (activat\$5 NEAR5 (code number id identifier)) AND ((terminal mobile client device phone) NEAR9 (code identifier id number)) AND (encrypt\$6 AND decrypt\$6) AND (email mail e-mail (electronic NEAR2 mail)) AND (@AD<"20041122" @RLAD<"20041122")	US-PGPUB; USPAT	OR	OFF	2016/11/01 14:46
L16	1	"20150149575"	US-PGPUB; USPAT	OR	OFF	2016/11/01 14:46
L17	1	"20060031300"	US-PGPUB; USPAT	OR	OFF	2016/11/01 14:46
L18	1	"20130268384"	US-PGPUB; USPAT	OR	OFF	2016/11/01 14:46
L19	6	((temporary AND permanent) NEAR9 (encrypt\$6 AND decrypt\$6)) AND (email mail e-mail (electronic NEAR2 mail) )AND (@AD<"20041122" @RLAD<"20041122")	US-PGPUB; USPAT	OR	OFF	2016/11/01 14:46
L20	4	((temporary SAME (identifier id number)) NEAR9 (encrypt\$6 AND decrypt\$6)) AND (email mail e-mail (electronic NEAR2 mail) )AND (@AD<"20041122" @RLAD<"20041122")	US-PGPUB; USPAT	OR	OFF	2016/11/01 14:46
L21	292	((temp temporary tunnel) SAME (identifier id number)) SAME (client terminal) NEAR9 (encrypt\$6 decrypt\$6 creat\$4 generat\$4)) AND (email mail e-mail (electronic NEAR2 mail) )AND (@AD<"20041122" @RLAD<"20041122")	US-PGPUB; USPAT	OR	OFF	2016/11/01 17:26
L22	41	((temp temporary tunnel) NEAR9 (identifier id number)) NEAR9 (client terminal) NEAR9 (encrypt\$6 decrypt\$6 creat\$4 generat\$4)) AND (email mail e-mail (electronic NEAR2 mail) )AND (@AD<"20041122" @RLAD<"20041122")	US-PGPUB; USPAT	OR	OFF	2016/11/01 17:26
L23	0	((temp temporary tunnel) NEAR9 (identifier id number)) NEAR9 (client terminal) NEAR9 (encrypt\$6 decrypt\$6 creat\$4 generat\$4)) AND (bluetooth)AND (@AD<"20041122")	US-PGPUB; USPAT	OR	OFF	2016/11/01 18:20

EAST Search History

		@RLAD<"20041122")				
L24	0	((activation) NEAR9 (identifier id number code) NEAR9 (client terminal) NEAR9 (encrypt\$6 decrypt\$6 creat\$4 generat\$4)) AND (bluetooth) AND (@AD<"20041122" @RLAD<"20041122")	US-PGPUB; USPAT	OR	OFF	2016/11/01 18:21
L25	11	((activation) NEAR9 (identifier id number code) NEAR9 (client terminal) NEAR9 (encrypt\$6 decrypt\$6 creat\$4 generat\$4)) AND (bluetooth bluetooth) AND (@AD<"20041122" @RLAD<"20041122")	US-PGPUB; USPAT	OR	OFF	2016/11/01 18:21
L26	1	"7289792".pn.	US-PGPUB; USPAT	OR	OFF	2016/11/01 18:54

**EAST Search History (Interference)**

<This search history is empty>

**11/ 1/ 2016 7:15:04 PM**

**H:\ Workspaces\ 14609189.wsp**

<b>Index of Claims</b> 	<b>Application/Control No.</b> 14609189	<b>Applicant(s)/Patent Under Reexamination</b> BACKHOLM ET AL.
	<b>Examiner</b> ALAN S CHOU	<b>Art Unit</b> 2451

✓	<b>Rejected</b>
=	<b>Allowed</b>

-	<b>Cancelled</b>
÷	<b>Restricted</b>

N	<b>Non-Elected</b>
I	<b>Interference</b>

A	<b>Appeal</b>
O	<b>Objected</b>

Claims renumbered in the same order as presented by applicant
  CPA
  T.D.
  R.1.47

CLAIM		DATE							
Final	Original	09/25/2015	07/06/2016	11/01/2016					
	1	✓	✓	✓					
	2	✓	✓	✓					
	3	✓	✓	✓					
	4	✓	✓	✓					
	5	✓	✓	✓					
	6	✓	✓	✓					
	7	✓	✓	✓					
	8	✓	✓	✓					
	9	✓	✓	✓					
	10	✓	✓	✓					
	11	✓	✓	✓					
	12	✓	✓	✓					
	13	✓	✓	✓					
	14	✓	✓	✓					
	15	✓	✓	✓					
	16	✓	✓	✓					
	17	✓	✓	✓					
	18	✓	✓	✓					
	19	✓	✓	✓					
	20	✓	-	-					
	21		✓	✓					
	22		✓	✓					
	23		✓	✓					
	24		✓	✓					
	25		✓	✓					
	26		✓	✓					
	27		✓	✓					
	28		✓	✓					
	29		✓	✓					
	30		✓	✓					
	31		✓	✓					
	32		✓	✓					
	33		✓	✓					
	34		✓	✓					
	35		✓	✓					
	36		✓	✓					

<b><i>Index of Claims</i></b> 	<b>Application/Control No.</b> 14609189	<b>Applicant(s)/Patent Under Reexamination</b> BACKHOLM ET AL.
	<b>Examiner</b> ALAN S CHOU	<b>Art Unit</b> 2451

✓	<b>Rejected</b>
=	<b>Allowed</b>

-	<b>Cancelled</b>
÷	<b>Restricted</b>

N	<b>Non-Elected</b>
I	<b>Interference</b>

A	<b>Appeal</b>
O	<b>Objected</b>

Claims renumbered in the same order as presented by applicant
  CPA
  T.D.
  R.1.47

CLAIM		DATE							
Final	Original	09/25/2015	07/06/2016	11/01/2016					
	37		✓	✓					
	38		✓	✓					
	39		✓	✓					
	40		✓	✓					
	41		✓	✓					
	42		✓	✓					
	43		✓	✓					
	44		✓	✓					
	45		✓	✓					
	46		✓	✓					
	47		✓	✓					
	48		✓	✓					
	49		✓	✓					
	50		✓	✓					
	51		✓	✓					
	52		✓	✓					
	53		✓	✓					
	54		✓	✓					
	55		✓	✓					

**DECLARATION (37 CFR 1.63) FOR UTILITY OR DESIGN APPLICATION USING AN APPLICATION DATA SHEET (37 CFR 1.76)**

Title of Invention: **E-MAIL MESSAGING TO/FROM A MOBILE TERMINAL**

As the below named inventor, I hereby declare that:

This declaration is directed to:  The attached application, or  
 United States application or PCT international application number \_\_\_\_\_  
 filed on \_\_\_\_\_

The above-identified application was made or authorized to be made by me.

I believe that I am the original inventor or an original joint inventor of a claimed invention in the application.

I hereby acknowledge that any willful false statement made in this declaration is punishable under 18 U.S.C. 1001 by fine or imprisonment of not more than five (5) years, or both.

**WARNING:**

Petitioner/applicant is cautioned to avoid submitting personal information in documents filed in a patent application that may contribute to identity theft. Personal information such as social security numbers, bank account numbers, or credit card numbers (other than a check or credit card authorization form PTO-2038 submitted for payment purposes) is never required by the USPTO to support a petition or an application. If this type of personal information is included in documents submitted to the USPTO, petitioners/applicants should consider redacting such personal information from the documents before submitting them to the USPTO. Petitioner/applicant is advised that the record of a patent application is available to the public after publication of the application (unless a non-publication request in compliance with 37 CFR 1.213(a) is made in the application) or issuance of a patent. Furthermore, the record from an abandoned application may also be available to the public if the application is referenced in a published application or an issued patent (see 37 CFR 1.14). Checks and credit card authorization forms PTO-2038 submitted for payment purposes are not retained in the application file and therefore are not publicly available.

**LEGAL NAME OF INVENTOR**

Inventor: Antti Saarilahti Date (Optional): 01/21/2015  
 Signature: *[Handwritten Signature]*

Note: An application data sheet (PTO/SB/14 or equivalent), including naming the entire inventive entity, must accompany this form or must have been previously filed. Use an additional PTO/AIA/01 form for each additional inventor.

This collection of information is required by 35 U.S.C. 115 and 37 CFR 1.63. The information is required to obtain or retain a benefit by the public, which is or the (and by the USPTO to process) an application. Confidentiality is governed by 35 U.S.C. 122 and 37 CFR 1.11 and 1.14. This collection is estimated to take 1 minute to complete, including gathering, preparing, and submitting the completed application form to the USPTO. Time will vary depending upon the individual case. Any comments on the amount of time you require to complete this form and/or suggestions for reducing this burden, should be sent to the Chief Information Officer, U.S. Patent and Trademark Office, U.S. Department of Commerce, P.O. Box 1450, Alexandria, VA 22312-1450. DO NOT SEND FEES OR COMPLETED FORMS TO THIS ADDRESS. SEND TO: Commissioner for Patents, P.O. Box 1450, Alexandria, VA 22312-1450.  
 If you need assistance in completing the form, call 1-800-PTO or visit [www.uspto.gov](http://www.uspto.gov).

Under the Paperwork Reduction Act of 1995, no persons are required to respond to a collection of information unless it displays a valid OMB control number.

**DECLARATION (37 CFR 1.63) FOR UTILITY OR DESIGN APPLICATION USING AN APPLICATION DATA SHEET (37 CFR 1.76)**

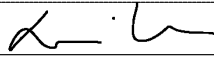
<b>Title of Invention</b>	MESSAGING CENTRE FOR FORWARDING E-MAIL
As the below named inventor, I hereby declare that:	
This declaration is directed to: <input type="checkbox"/> The attached application, or	
<input checked="" type="checkbox"/> United States application or PCT international application number <u>14/609,189</u>	
filed on <u>1/29/2015</u> .	
The above-identified application was made or authorized to be made by me.	
I believe that I am the original inventor or an original joint inventor of a claimed invention in the application.	
I hereby acknowledge that any willful false statement made in this declaration is punishable under 18 U.S.C. 1001 by fine or imprisonment of not more than five (5) years, or both.	
<b>WARNING:</b>	
Petitioner/applicant is cautioned to avoid submitting personal information in documents filed in a patent application that may contribute to identity theft. Personal information such as social security numbers, bank account numbers, or credit card numbers (other than a check or credit card authorization form PTO-2038 submitted for payment purposes) is never required by the USPTO to support a petition or an application. If this type of personal information is included in documents submitted to the USPTO, petitioners/applicants should consider redacting such personal information from the documents before submitting them to the USPTO. Petitioner/applicant is advised that the record of a patent application is available to the public after publication of the application (unless a non-publication request in compliance with 37 CFR 1.213(a) is made in the application) or issuance of a patent. Furthermore, the record from an abandoned application may also be available to the public if the application is referenced in a published application or an issued patent (see 37 CFR 1.14). Checks and credit card authorization forms PTO-2038 submitted for payment purposes are not retained in the application file and therefore are not publicly available.	
LEGAL NAME OF INVENTOR	
Inventor: <u>Lauri Vuornos</u>	Date (Optional): <u>Aug 19, 2016</u>
Signature: 	
Note: An application data sheet (PTO/SB/14 or equivalent), including naming the entire inventive entity, must accompany this form or must have been previously filed. Use an additional PTO/AIA/01 form for each additional inventor.	

This collection of information is required by 35 U.S.C. 115 and 37 CFR 1.63. The information is required to obtain or retain a benefit by the public which is to file (and by the USPTO to process) an application. Confidentiality is governed by 35 U.S.C. 122 and 37 CFR 1.11 and 1.14. This collection is estimated to take 1 minute to complete, including gathering, preparing, and submitting the completed application form to the USPTO. Time will vary depending upon the individual case. Any comments on the amount of time you require to complete this form and/or suggestions for reducing this burden, should be sent to the Chief Information Officer, U.S. Patent and Trademark Office, U.S. Department of Commerce, P.O. Box 1450, Alexandria, VA 22313-1450. DO NOT SEND FEES OR COMPLETED FORMS TO THIS ADDRESS. **SEND TO: Commissioner for Patents, P.O. Box 1450, Alexandria, VA 22313-1450.**

*If you need assistance in completing the form, call 1-800-PTO-9199 and select option 2.*



Under the Paperwork Reduction Act of 1995, no persons are required to respond to a collection of information unless it displays a valid OMB control number.

**DECLARATION (37 CFR 1.63) FOR UTILITY OR DESIGN APPLICATION USING AN APPLICATION DATA SHEET (37 CFR 1.76)**

Title of Invention	Messaging centre for forwarding e-mail
<p>As the below named inventor, I hereby declare that:</p> <p>This declaration is directed to: <input type="checkbox"/> The attached application, or <input checked="" type="checkbox"/> United States application or PCT international application number <u>14/609,189</u> filed on <u>1/29/2015</u>.</p> <p>The above-identified application was made or authorized to be made by me.</p> <p>I believe that I am the original inventor or an original joint inventor of a claimed invention in the application.</p> <p>I hereby acknowledge that any willful false statement made in this declaration is punishable under 18 U.S.C. 1001 by fine or imprisonment of not more than five (5) years, or both.</p> <p style="text-align: center;"><b>WARNING:</b></p> <p>Petitioner/applicant is cautioned to avoid submitting personal information in documents filed in a patent application that may contribute to identity theft. Personal information such as social security numbers, bank account numbers, or credit card numbers (other than a check or credit card authorization form PTO-2038 submitted for payment purposes) is never required by the USPTO to support a petition or an application. If this type of personal information is included in documents submitted to the USPTO, petitioners/applicants should consider redacting such personal information from the documents before submitting them to the USPTO. Petitioner/applicant is advised that the record of a patent application is available to the public after publication of the application (unless a non-publication request in compliance with 37 CFR 1.213(a) is made in the application) or issuance of a patent. Furthermore, the record from an abandoned application may also be available to the public if the application is referenced in a published application or an issued patent (see 37 CFR 1.14). Checks and credit card authorization forms PTO-2038 submitted for payment purposes are not retained in the application file and therefore are not publicly available.</p>	
<p>LEGAL NAME OF INVENTOR</p> <p>Inventor: <u>Marko Ketonen</u> Date (Optional): <u>2016/8/16</u></p> <p>Signature: </p>	
<p>Note: An application data sheet (PTO/SB/14 or equivalent), including naming the entire inventive entity, must accompany this form or must have been previously filed. Use an additional PTO/AIA/01 form for each additional inventor.</p>	

This collection of information is required by 35 U.S.C. 115 and 37 CFR 1.63. The information is required to obtain or retain a benefit by the public which is to file (and by the USPTO to process) an application. Confidentiality is governed by 35 U.S.C. 122 and 37 CFR 1.11 and 1.14. This collection is estimated to take 1 minute to complete, including gathering, preparing, and submitting the completed application form to the USPTO. Time will vary depending upon the individual case. Any comments on the amount of time you require to complete this form and/or suggestions for reducing this burden, should be sent to the Chief Information Officer, U.S. Patent and Trademark Office, U.S. Department of Commerce, P.O. Box 1450, Alexandria, VA 22313-1450. DO NOT SEND FEES OR COMPLETED FORMS TO THIS ADDRESS. SEND TO: Commissioner for Patents, P.O. Box 1450, Alexandria, VA 22313-1450.

If you need assistance in completing the form, call 1-800-PTO-9199 and select option 2.

Under the Paperwork Reduction Act of 1995, no persons are required to respond to a collection of information unless it displays a valid OMB control number.

**DECLARATION (37 CFR 1.63) FOR UTILITY OR DESIGN APPLICATION USING AN APPLICATION DATA SHEET (37 CFR 1.76)**

<b>Title of Invention</b>	Messaging centre for forwarding e-mail
---------------------------	--

As the below named inventor, I hereby declare that:

This declaration is directed to:  The attached application, or  United States application or PCT international application number 14/609,189  
filed on 01/29/2015.

The above-identified application was made or authorized to be made by me.

I believe that I am the original inventor or an original joint inventor of a claimed invention in the application.

I hereby acknowledge that any willful false statement made in this declaration is punishable under 18 U.S.C. 1001 by fine or imprisonment of not more than five (5) years, or both.

**WARNING:**

Petitioner/applicant is cautioned to avoid submitting personal information in documents filed in a patent application that may contribute to identity theft. Personal information such as social security numbers, bank account numbers, or credit card numbers (other than a check or credit card authorization form PTO-2038 submitted for payment purposes) is never required by the USPTO to support a petition or an application. If this type of personal information is included in documents submitted to the USPTO, petitioners/applicants should consider redacting such personal information from the documents before submitting them to the USPTO. Petitioner/applicant is advised that the record of a patent application is available to the public after publication of the application (unless a non-publication request in compliance with 37 CFR 1.213(a) is made in the application) or issuance of a patent. Furthermore, the record from an abandoned application may also be available to the public if the application is referenced in a published application or an issued patent (see 37 CFR 1.14). Checks and credit card authorization forms PTO-2038 submitted for payment purposes are not retained in the application file and therefore are not publicly available.

LEGAL NAME OF INVENTOR

Inventor: Petri Salmi Date (Optional) : \_\_\_\_\_

Signature: 

Note: An application data sheet (PTO/SB/14 or equivalent), including naming the entire inventive entity, must accompany this form or must have been previously filed. Use an additional PTO/AIA/01 form for each additional inventor.

This collection of information is required by 35 U.S.C. 115 and 37 CFR 1.63. The information is required to obtain or retain a benefit by the public which is to file (and by the USPTO to process) an application. Confidentiality is governed by 35 U.S.C. 122 and 37 CFR 1.11 and 1.14. This collection is estimated to take 1 minute to complete, including gathering, preparing, and submitting the completed application form to the USPTO. Time will vary depending upon the individual case. Any comments on the amount of time you require to complete this form and/or suggestions for reducing this burden, should be sent to the Chief Information Officer, U.S. Patent and Trademark Office, U.S. Department of Commerce, P.O. Box 1450, Alexandria, VA 22313-1450. DO NOT SEND FEES OR COMPLETED FORMS TO THIS ADDRESS. **SEND TO: Commissioner for Patents, P.O. Box 1450, Alexandria, VA 22313-1450.**  
*If you need assistance in completing the form, call 1-800-PTO-9199 and select option 2.*

## DECLARATION (37 CFR 1.63) FOR UTILITY OR DESIGN APPLICATION USING AN APPLICATION DATA SHEET (37 CFR 1.76)

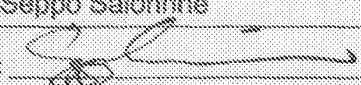
<b>Title of Invention</b>	Messaging centre for forwarding e-mail
As the below named inventor, I hereby declare that:	
This declaration is directed to:	<input type="checkbox"/> The attached application, or <input checked="" type="checkbox"/> United States application or PCT international application number <u>14/609,189</u> filed on <u>01/29/2015</u>
The above-identified application was made or authorized to be made by me.	
I believe that I am the original inventor or an original joint inventor of a claimed invention in the application.	
I hereby acknowledge that any willful false statement made in this declaration is punishable under 18 U.S.C. 1001 by fine or imprisonment of not more than five (5) years, or both.	
<b>WARNING:</b>	
<p>Petitioner/applicant is cautioned to avoid submitting personal information in documents filed in a patent application that may contribute to identity theft. Personal information such as social security numbers, bank account numbers, or credit card numbers (other than a check or credit card authorization form PTO-2038 submitted for payment purposes) is never required by the USPTO to support a petition or an application. If this type of personal information is included in documents submitted to the USPTO, petitioners/applicants should consider redacting such personal information from the documents before submitting them to the USPTO. Petitioner/applicant is advised that the record of a patent application is available to the public after publication of the application (unless a non-publication request in compliance with 37 CFR 1.213(a) is made in the application) or issuance of a patent. Furthermore, the record from an abandoned application may also be available to the public if the application is referenced in a published application or an issued patent (see 37 CFR 1.14). Checks and credit card authorization forms PTO-2038 submitted for payment purposes are not retained in the application file and therefore are not publicly available.</p>	
<b>LEGAL NAME OF INVENTOR</b>	
Inventor: <u>Seppo Salorinne</u>	Date (Optional): _____
Signature: 	
<p>Note: An application data sheet (PTO/SB/14 or equivalent), including naming the entire inventive entity, must accompany this form or must have been previously filed. Use an additional PTO/AIA/01 form for each additional inventor.</p>	

This collection of information is required by 35 U.S.C. 115 and 37 CFR 1.63. The information is required to obtain or retain a benefit by the public which is to file (and by the USPTO to process) an application. Confidentiality is governed by 35 U.S.C. 122 and 37 CFR 1.11 and 1.14. This collection is estimated to take 1 minute to complete, including gathering, preparing, and submitting the completed application form to the USPTO. Time will vary depending upon the individual case. Any comments on the amount of time you require to complete this form and/or suggestions for reducing this burden, should be sent to the Chief Information Officer, U.S. Patent and Trademark Office, U.S. Department of Commerce, P.O. Box 1450, Alexandria, VA 22313-1450. DO NOT SEND FEES OR COMPLETED FORMS TO THIS ADDRESS. SEND TO: Commissioner for Patents, P.O. Box 1450, Alexandria, VA 22313-1450.

*If you need assistance in completing the form, call 1-800-PTO-0198 and select option 2.*

## Electronic Acknowledgement Receipt

<b>EFS ID:</b>	26853486
<b>Application Number:</b>	14609189
<b>International Application Number:</b>	
<b>Confirmation Number:</b>	5037
<b>Title of Invention:</b>	Messaging centre for forwarding e-mail
<b>First Named Inventor/Applicant Name:</b>	Ari Backholm
<b>Customer Number:</b>	118194
<b>Filer:</b>	Justin Robert Nifong/Sandra Hess
<b>Filer Authorized By:</b>	Justin Robert Nifong
<b>Attorney Docket Number:</b>	455/006/8 UTIL
<b>Receipt Date:</b>	07-SEP-2016
<b>Filing Date:</b>	29-JAN-2015
<b>Time Stamp:</b>	13:30:53
<b>Application Type:</b>	Utility under 35 USC 111(a)

### Payment information:

Submitted with Payment	no
------------------------	----

### File Listing:

Document Number	Document Description	File Name	File Size(Bytes)/ Message Digest	Multi Part /.zip	Pages (if appl.)
1		455-006-8UTIL-Decs-Binder.pdf	4282061 8d942b5c642041f3e37a5fa817fca58838611ab8	yes	5

<b>Multipart Description/PDF files in .zip description</b>		
<b>Document Description</b>	<b>Start</b>	<b>End</b>
Oath or Declaration filed	1	1
Oath or Declaration filed	2	2
Oath or Declaration filed	3	3
Oath or Declaration filed	4	4
Oath or Declaration filed	5	5
<b>Warnings:</b>		
<b>Information:</b>		
<b>Total Files Size (in bytes):</b>	4282061	
<p><b>This Acknowledgement Receipt evidences receipt on the noted date by the USPTO of the indicated documents, characterized by the applicant, and including page counts, where applicable. It serves as evidence of receipt similar to a Post Card, as described in MPEP 503.</b></p> <p><b><u>New Applications Under 35 U.S.C. 111</u></b>  <b>If a new application is being filed and the application includes the necessary components for a filing date (see 37 CFR 1.53(b)-(d) and MPEP 506), a Filing Receipt (37 CFR 1.54) will be issued in due course and the date shown on this Acknowledgement Receipt will establish the filing date of the application.</b></p> <p><b><u>National Stage of an International Application under 35 U.S.C. 371</u></b>  <b>If a timely submission to enter the national stage of an international application is compliant with the conditions of 35 U.S.C. 371 and other applicable requirements a Form PCT/DO/EO/903 indicating acceptance of the application as a national stage submission under 35 U.S.C. 371 will be issued in addition to the Filing Receipt, in due course.</b></p> <p><b><u>New International Application Filed with the USPTO as a Receiving Office</u></b>  <b>If a new international application is being filed and the international application includes the necessary components for an international filing date (see PCT Article 11 and MPEP 1810), a Notification of the International Application Number and of the International Filing Date (Form PCT/RO/105) will be issued in due course, subject to prescriptions concerning national security, and the date shown on this Acknowledgement Receipt will establish the international filing date of the application.</b></p>		

**REQUEST FOR CONTINUED EXAMINATION(RCE)TRANSMITTAL  
 (Submitted Only via EFS-Web)**

Application Number	14/609,189	Filing Date	2015-01-29	Docket Number (if applicable)	455/006/8 UTIL	Art Unit	2451
First Named Inventor	Ari Backholm			Examiner Name	CHOU, ALAN S		

**This is a Request for Continued Examination (RCE) under 37 CFR 1.114 of the above-identified application.** Request for Continued Examination (RCE) practice under 37 CFR 1.114 does not apply to any utility or plant application filed prior to June 8, 1995, to any international application that does not comply with the requirements of 35 U.S.C. 371, or to any design application. The Instruction Sheet for this form is located at WWW.USPTO.GOV.

**SUBMISSION REQUIRED UNDER 37 CFR 1.114**

Note: If the RCE is proper, any previously filed unentered amendments and amendments enclosed with the RCE will be entered in the order in which they were filed unless applicant instructs otherwise. If applicant does not wish to have any previously filed unentered amendment(s) entered, applicant must request non-entry of such amendment(s).

Previously submitted. If a final Office action is outstanding, any amendments filed after the final Office action may be considered as a submission even if this box is not checked.

Consider the arguments in the Appeal Brief or Reply Brief previously filed on \_\_\_\_\_

Other \_\_\_\_\_

Enclosed

Amendment/Reply

Information Disclosure Statement (IDS)

Affidavit(s)/ Declaration(s)

Other \_\_\_\_\_

**MISCELLANEOUS**

Suspension of action on the above-identified application is requested under 37 CFR 1.103(c) for a period of months \_\_\_\_\_  
 (Period of suspension shall not exceed 3 months; Fee under 37 CFR 1.17(i) required)

Other \_\_\_\_\_

**FEES**

**The RCE fee under 37 CFR 1.17(e) is required by 37 CFR 1.114 when the RCE is filed.**

The Director is hereby authorized to charge any underpayment of fees, or credit any overpayments, to Deposit Account No 506191

**SIGNATURE OF APPLICANT, ATTORNEY, OR AGENT REQUIRED**

<input checked="" type="checkbox"/> Patent Practitioner Signature
<input type="checkbox"/> Applicant Signature

Doc code: RCEX

Doc description: Request for Continued Examination (RCE)

PTO/SB/30EFS (07-14)

Approved for use through 07/31/2016. OMB 0651-0031

U.S. Patent and Trademark Office; U.S. DEPARTMENT OF COMMERCE

Under the Paperwork Reduction Act of 1995, no persons are required to respond to a collection of information unless it contains a valid OMB control number.

Signature of Registered U.S. Patent Practitioner			
Signature	Justin R. Nifong/	Date (YYYY-MM-DD)	2016-08-23
Name	Justin R. Nifong	Registration Number	59389

This collection of information is required by 37 CFR 1.114. The information is required to obtain or retain a benefit by the public which is to file (and by the USPTO to process) an application. Confidentiality is governed by 35 U.S.C. 122 and 37 CFR 1.11 and 1.14. This collection is estimated to take 12 minutes to complete, including gathering, preparing, and submitting the completed application form to the USPTO. Time will vary depending upon the individual case. Any comments on the amount of time you require to complete this form and/or suggestions for reducing this burden, should be sent to the Chief Information Officer, U.S. Patent and Trademark Office, U.S. Department of Commerce, P.O. Box 1450, Alexandria, VA 22313-1450.

*If you need assistance in completing the form, call 1-800-PTO-9199 and select option 2.*

## Privacy Act Statement

The Privacy Act of 1974 (P.L. 93-579) requires that you be given certain information in connection with your submission of the attached form related to a patent application or patent. Accordingly, pursuant to the requirements of the Act, please be advised that: (1) the general authority for the collection of this information is 35 U.S.C. 2(b)(2); (2) furnishing of the information solicited is voluntary; and (3) the principal purpose for which the information is used by the U.S. Patent and Trademark Office is to process and/or examine your submission related to a patent application or patent. If you do not furnish the requested information, the U.S. Patent and Trademark Office may not be able to process and/or examine your submission, which may result in termination of proceedings or abandonment of the application or expiration of the patent.

The information provided by you in this form will be subject to the following routine uses:

1. The information on this form will be treated confidentially to the extent allowed under the Freedom of Information Act (5 U.S.C. 552) and the Privacy Act (5 U.S.C. 552a). Records from this system of records may be disclosed to the Department of Justice to determine whether the Freedom of Information Act requires disclosure of these records.
2. A record from this system of records may be disclosed, as a routine use, in the course of presenting evidence to a court, magistrate, or administrative tribunal, including disclosures to opposing counsel in the course of settlement negotiations.
3. A record in this system of records may be disclosed, as a routine use, to a Member of Congress submitting a request involving an individual, to whom the record pertains, when the individual has requested assistance from the Member with respect to the subject matter of the record.
4. A record in this system of records may be disclosed, as a routine use, to a contractor of the Agency having need for the information in order to perform a contract. Recipients of information shall be required to comply with the requirements of the Privacy Act of 1974, as amended, pursuant to 5 U.S.C. 552a(m).
5. A record related to an International Application filed under the Patent Cooperation Treaty in this system of records may be disclosed, as a routine use, to the International Bureau of the World Intellectual Property Organization, pursuant to the Patent Cooperation Treaty.
6. A record in this system of records may be disclosed, as a routine use, to another federal agency for purposes of National Security review (35 U.S.C. 181) and for review pursuant to the Atomic Energy Act (42 U.S.C. 218(c)).
7. A record from this system of records may be disclosed, as a routine use, to the Administrator, General Services, or his/her designee, during an inspection of records conducted by GSA as part of that agency's responsibility to recommend improvements in records management practices and programs, under authority of 44 U.S.C. 2904 and 2906. Such disclosure shall be made in accordance with the GSA regulations governing inspection of records for this purpose, and any other relevant (i.e., GSA or Commerce) directive. Such disclosure shall not be used to make determinations about individuals.
8. A record from this system of records may be disclosed, as a routine use, to the public after either publication of the application pursuant to 35 U.S.C. 122(b) or issuance of a patent pursuant to 35 U.S.C. 151. Further, a record may be disclosed, subject to the limitations of 37 CFR 1.14, as a routine use, to the public if the record was filed in an application which became abandoned or in which the proceedings were terminated and which application is referenced by either a published application, an application open to public inspections or an issued patent.
9. A record from this system of records may be disclosed, as a routine use, to a Federal, State, or local law enforcement agency, if the USPTO becomes aware of a violation or potential violation of law or regulation.



**COMMUNICATION TO THE UNITED STATES PATENT AND TRADEMARK OFFICE**

Appl. No. : 14/609,189 Confirmation No. 5037  
Applicant : Seven Networks, LLC  
Inventor : Ari Backholm *et al.*  
Filed : 2015-01-29  
TC/A.U. : 2451  
Examiner : Chou, Alan S  
Docket No. : 455/006/8 UTIL  
Customer No. : 118194

Mail Stop RCE  
Commissioner for Patents  
P.O. Box 1450  
Alexandria, VA 22313-1450

**Response to Final Office Action with RCE**

Examiner:

**Amendments to the Claims** begin on page 2 of this paper.

**Remarks** begin on page 10 of this paper.

**AMENDMENTS TO THE CLAIMS**

1. (Currently Amended) A method for forwarding an e-mail message from [[an]] one of a plurality of e-mail servers to a mobile terminal, the method comprising:

receiving, at an intermediary system, an e-mail message associated with an e-mail address of a user of a mobile terminal and sent by [[an]] one of a plurality of e-mail servers,

wherein the e-mail address is associated with an identifier of the mobile terminal,

wherein the identifier is generated by the mobile terminal;

encrypting the e-mail message using encryption information associated with a temporary identifier,

wherein the temporary identifier is based on a connection to the mobile terminal; and

transmitting the encrypted e-mail message to the mobile terminal.

2. (Previously Presented) The method of claim 1, further comprising identifying the mobile terminal based on the e-mail address of the e-mail message and the association with the identifier of the mobile terminal.

3. (Previously Presented) The method of claim 1, wherein encrypting the e-mail message further comprises packing the e-mail message by omitting at least part of the e-mail message when at least part of the e-mail message exceeds a predetermined size specification.

4. (Previously Presented) The method of claim 3, wherein size specification is set by a user of the mobile terminal.

5. (Previously Presented) The method of claim 3, wherein the omitted part of the e-mail message is the e-mail address.

6. (Previously Presented) The method of claim 2, further comprising adding the e-mail address to a reply message sent by the mobile terminal.

7. (Previously Presented) The method of claim 1, further comprising receiving the

encryption information generated by the mobile terminal.

8. (Previously Presented) The method of claim 1, wherein the encryption information is based on an activation code of the mobile terminal.

9. (Previously Presented) The method of claim 1, wherein a messaging center transmits the e-mail message to the mobile terminal using the identifier of the mobile terminal.

10. (Previously Presented) The method of claim 1, wherein mobile terminal receives and decrypts the e-mail message using the encryption information.

11. (Previously Presented) The method of claim 3, wherein the mobile terminal unpacks the e-mail message.

12. (Currently Amended) A system for forwarding an e-mail message from [[an]] one of a plurality of e-mail servers to a mobile terminal, the system comprising:

a memory configured for storing at least one of an e-mail address of a user of a mobile terminal, and an identifier;

wherein the e-mail address is associated with the identifier,

wherein the mobile terminal generates the identifier,

a processor configured for:

encrypting the e-mail message using encryption information associated with a temporary identifier, wherein the e-mail message is received from [[the]] one of a plurality of e-mail servers;

identifying the mobile terminal based on the identifier of the mobile terminal; and

transmitting the encrypted e-mail message to the identified mobile terminal,

wherein the temporary identifier is based on a connection to the mobile terminal,

wherein the system is an intermediary system between the plurality of e-mail servers and the mobile terminal.

13. (Previously Presented) The system of claim 12, wherein the processor is further

configured to receive the e-mail message from the e-mail server.

14. (Previously Presented) The system of claim 12, wherein the processor is further configured to receive the encryption information and to provide the encryption information to the memory for storage.

15. (Previously Presented) The system of claim 12, wherein the processor is further configured to pack the e-mail message.

16. (Previously Presented) The system of claim 15, wherein the processor is further configured to omit at least part of the e-mail message when the at least part of the e-mail message exceeds a predetermined size specification.

17. (Previously Presented) The system of claim 16, wherein the processor is further configured to receive user input concerning the size specification.

18. (Previously Presented) The system of claim 12, wherein the mobile terminal receives and decrypts the e-mail message using the encryption information.

19. (Previously Presented) The system of claim 18, wherein the mobile terminal unpacks the message.

20. (Canceled)

21. (Previously Presented) A mobile device comprising:

a radio;

a memory;

a processor configured for controlling a mobile device to:

generate an identifier; and

receive, from a server, an encrypted e-mail message associated with an e-mail address of a user of the mobile device, wherein the e-mail address is associated with the

identifier,

decrypt the e-mail message using encryption information associated with a temporary identifier,

wherein the temporary identifier is based on a connection to the server.

22. (Previously Presented) A method for forwarding an e-mail message from an e-mail server to a mobile terminal, the method comprising:

generating an identifier associated with an e-mail address of a user of a mobile terminal;

receiving an e-mail message associated with the e-mail address and sent by an e-mail server;

encrypting the e-mail message using encryption information associated with a temporary identifier; and

transmitting the encrypted e-mail message to the mobile terminal,

wherein the temporary identifier is based on a connection the mobile terminal.

23. (Currently Amended) A device comprising:

a radio;

~~a control system communicatively coupled to the radio and comprising~~ a processor and memory containing instructions executable by the processor whereby the device is operable to:

receive information including a service activation code from a remote device;

register the remote device for access to a messaging account using the service activation code;

receive a message for the messaging account;

encrypt the message using an encryption key; and

send the message to the remote device,

wherein the device is authenticated to access the messaging account.

24. (Previously Presented) The device of claim 23, wherein the information including the service activation code is received by the device in response to user input at the remote device.

25. (Previously Presented) The device of claim 23, wherein the information including the service activation code is received by the device in an off-line communication.

26. (Previously Presented) The device of claim 25, wherein the off-line communication involves a local connection.

27. (Currently Amended) The device of claim 26, wherein the local connection is one of a ~~wired interface~~, a short range wireless interface, Bluetooth<sup>TM</sup>, or an optical interface.

28. (Previously Presented) The device of claim 25, wherein the off-line communication prevents eavesdropping of the service activation code.

29. (Previously Presented) The device of claim 23, wherein the authentication of the device relies on the authentication of the messaging account.

30. (Previously Presented) The device of claim 29, wherein the authentication of the messaging account includes a username and password.

31. (Previously Presented) The device of claim 23, wherein the encryption key is the service activation code.

32. (Previously Presented) The device of claim 23, wherein the encryption key is derived from the service activation code.

33. (Previously Presented) The device of claim 23, wherein the encryption key is a subset of the service activation code.

34. (Previously Presented) The device of claim 23, wherein the encryption key is closely related to the service activation code.

35. (Previously Presented) The device of claim 23, wherein the device is further operable to:

store an association between at least two of the encryption key, the messaging account, an identifier of the remote device, and the service activation code.

36. (Previously Presented) The device of claim 23, wherein the message is sent to the remote device through an intermediate device.

37. (Previously Presented) A method for sharing a messaging account, the method comprising:

authenticating a device for access to the messaging account;  
receiving information including a service activation code from a remote device;  
registering the remote device for access to the messaging account using the service activation code;  
receiving a message for the messaging account;  
encrypting the message using an encryption key; and  
sending the message to the remote device.

38. (Previously Presented) The method of claim 37, wherein the information including the service activation code is received by the device in response to user input at the remote device.

39. (Previously Presented) The method of claim 38, wherein the information including the service activation code is received by the device in an off-line communication.

40. (Previously Presented) The method of claim 39, wherein the off-line communication involves one of a local connection, a wired interface, a short range wireless interface, Bluetooth™, or an optical interface.

41. (Previously Presented) The method of claim 39, wherein the off-line communication prevents eavesdropping of the service activation code.

42. (Previously Presented) The method of claim 37, wherein the authentication of the device relies on the authentication of the messaging system.

43. (Previously Presented) The method of claim 42, wherein the authentication of the messaging system includes a username and password.

44. (Previously Presented) The method of claim 37, wherein the encryption key is the service activation code.

45. (Previously Presented) The method of claim 37, wherein the encryption key is derived from the service activation code.

46. (Previously Presented) The method of claim 37, wherein the encryption key is a subset of the service activation code.

47. (Previously Presented) The method of claim 37, wherein the encryption key is closely related to the service activation code.

48. (Previously Presented) The method of claim 37, wherein the method further comprises:

storing an association between the encryption key, the messaging account, an identifier of the remote device, and the service activation code.

49. (Previously Presented) The device of claim 36, wherein the encryption key is associated with a temporary identifier, wherein the temporary identifier is based on a connection to the intermediate device.

50. (Previously Presented) The method of claim 37, wherein the message is sent to the remote device through an intermediate device.



51. (Previously Presented) The method of claim 37, wherein the encryption key is associated with a temporary identifier, wherein the temporary identifier is based on a connection to the intermediary device.

52. (Previously Presented) The method of claim 1, wherein the identifier is associated with the temporary identifier.

53. (Previously Presented) The system of claim 12, wherein the identifier is associated with the temporary identifier.

54. (Previously Presented) A non-transient computer-readable medium containing program instructions for causing a device to perform a method, the method comprising:  
generating an identifier; and  
receiving, from a server, an encrypted e-mail message associated with an e-mail address of a user of the mobile device, wherein the e-mail address is associated with the identifier,  
decrypting the e-mail message using encryption information associated with a temporary identifier,  
wherein the temporary identifier is based on a connection to the server.

55. (Previously Presented) A non-transient computer-readable medium containing program instructions for causing a device to perform a method, the method comprising:  
receiving information including a service activation code from a remote device;  
registering the remote device for access to a messaging account using the service activation code;  
receiving a message for the messaging account;  
encrypting the message using an encryption key; and  
sending the message to the remote device,  
wherein the device is authenticated to access the messaging account.

**REMARKS**

This is in response to the Office Action mailed July 25, 2016.

Claims 1-20 stand rejected on the ground of nonstatutory double patenting as being unpatentable over claim 1 of U.S. Patent No. 7,706,781 and U.S. Patent No. 7,643,818. Applicant is choosing to delay treatment of this double patenting rejection at this time.

Claims 1-2, 6-10, 12-15, 18, 21-24, 29-38, 42-55 stand rejected under 35 USC 103(a) as being unpatentable over Little in view of Turunen.

Claims 3-5, 11, 16-17, and 19 stand rejected under 35 USC 103(a) as being unpatentable over Little in view of Turunen and further in view of Kock.

Claims 25-28 and 39-41 stand rejected under 35 USC 103(a) as being unpatentable over Little in view of Turunen and further in view of Salonen.

**CLAIMS 1, 12 ARE PATENTABLE OVER THE REFERENCES OF RECORD**

Amended claim 1 recites:

*1. A method for forwarding an e-mail message from [[an]] one of a plurality of e-mail servers to a mobile terminal, the method comprising:*

*receiving, at an intermediary system, an e-mail message associated with an e-mail address of a user of a mobile terminal and sent by [[an]] one of a plurality of e-mail servers,*

*wherein the e-mail address is associated with an identifier of the mobile terminal,  
wherein the identifier is generated by the mobile terminal;*

*encrypting the e-mail message using encryption information associated with a temporary identifier,*

*wherein the temporary identifier is based on a connection to the mobile terminal;*

*and*

*transmitting the encrypted e-mail message to the mobile terminal.*

Regarding Little, Little teaches a system for forwarding from a single messaging server to one or more mobile devices. (See for example FIG. 1, message server 40, and claim 3 of Little

which states that “a message server transmits the encrypted message through the wireless infrastructure and the wireless network to the wireless mobile communication device.”)

In contrast to Little, claim 1 recites receiving, at an intermediary system, an e-mail message associated with an e-mail address of a user of a mobile terminal and sent by one of a plurality of e-mail servers. For example, the intermediary system may connect to multiple messaging servers, (e.g., Exchange servers). Forwarding from a single messaging server to one or more mobile devices is different from an intermediary system that connects to multiple messaging servers.

Additionally, Little fails to disclose a temporary identifier. In the section cited by the Office Action, it is unclear whether the examiner analogizes the “private key” with the claimed encryption information or with the temporary identifier which is associated with the encryption information. (See page 5 of the Office Action.) If the private key of Little is to be analogous to the claimed encryption information, then it is unclear what in the VPN route the examiner intends to be analogous to the claimed temporary identifier because there does not appear to be any disclosure, teaching, or suggestion of “identity” referred to in paragraph [0081] of Little. Similarly, there does not appear to be any reference to “an association” between any identifier and the “private key” in the cited portion of Little. In short, while Little may teach sending an encrypted message, claim 1 recites something more specific – namely encrypting the email message **using encryption information associated with a temporary identifier**.

Regarding Turunen, Turunen fails to teach an identifier that identifies the mobile terminal that is generated by the mobile terminal. Instead, Turunen teaches identifiers that are not generated by the mobile device (for example, an IMSI or phone number). For example, a portion of Turunen cited by the Office Action as teaching an identifier that is generated by the mobile terminal states that, “the Wireless terminal MS1 transmits a logon request for packet services to the serving packet service support node SGSN (stage 405). The request contains, for instance, the identification of the Wireless terminal MS1 and parameter data for encryption.” “This e-mail address, as well as **the identification of the wireless terminal, such as a telephone number MSISDN and/or a device identification IMSI**.” (See page 5 of the Office Action; col. 6, lines 50-66 and col. 8, lines 29-31 of Turunen.) (emphasis added.)

The referred to “telephone number MSISDN” or “device identification IMSI” in Turunen **are not generated by the mobile device**, but are instead assigned to the mobile device by the

network operator. The technical advantage of having the mobile device generate the identifier is improved security of the mobile device and encryption. This allows a developer to identify your users without having to gain access to identifiers generated by others (such as the IMSI of Tuneran, which requires knowing the IMSI as provided by the mobile device manufacturer).

Applicant submits that amended claim 12 is patentable over the references of record for the same reason as Applicant submitted with relation to amended claim 1 as discussed *supra*.

### **CLAIMS 9 AND 21 ARE PATENTABLE OVER THE REFERENCES OF RECORD**

Claims 9 and 21 recite:

9. *The method of claim 1, wherein a messaging center transmits the e-mail message to the mobile terminal using **the identifier** of the mobile terminal.*

21. *A mobile device comprising:*  
*a radio;*  
*a memory;*  
*a processor configured for controlling a mobile device to:*  
*generate **an identifier**; and*  
*receive, from a server, an encrypted e-mail message associated with an e-mail address of a user of the mobile device, wherein the e-mail address is associated with the identifier,*  
*decrypt the e-mail message using encryption information associated with **a temporary identifier**,*  
*wherein the temporary identifier is based on a connection to the server.*

The Office Action refers to the **temporary** logical link identity TLLI in Turunen as teaching the claimed identifier. (See pages 8 and 10 of the Office Action.) However, Applicant notes that the identifier recited in claims 9 and 21 are different from the *temporary* identifier, also claimed. The identifier is generated by the mobile terminal. Applicant respectfully requests

clarification as to whether the examiner believes the **temporary** logical link identity of Turunen teaches the claimed identifier or the claimed temporary identifier.

For this reason, it is respectfully submitted that the rejection of claims 9 and 21 should be withdrawn.

**CLAIM 23, 24, 31, 32, 33, AND 34 ARE PATENTABLE OVER THE REFERENCES OF  
RECORD**

Claims 23 and 24 recite:

*23. A device comprising:*

*a radio;*

*~~a control system communicatively coupled to the radio and comprising a processor~~  
and memory containing instructions executable by the processor whereby the device is operable to:*

*receive information including a service **activation code from a remote device**;*

*register the remote device for access to a messaging account using the service **activation code**;*

*receive a message for the messaging account;*

*encrypt the message using an encryption key; and*

*send the message to the remote device,*

*wherein the device is authenticated to access the messaging account.*

*24. The device of claim 23, wherein the information including the service **activation code** is received by the device in response to user input at the remote device.*

Amended claims 31-34 recite:

*31. The device of claim 23, wherein the encryption key is the service **activation code**.*

32. *The device of claim 23, wherein the encryption key is derived from the service activation code.*

33. *The device of claim 23, wherein the encryption key is a subset of the service activation code.*

34. *The device of claim 23, wherein the encryption key is closely related to the service activation code.*

None of the cited references teach the claimed service activation code. The Office Action concedes that Little does not disclose receiving information including a service activation code from a remote device. (See page 11 of the Office Action.) The Office Action, however, contends that Turunen teaches this feature. (See page 12 of the Office Action.) Applicant respectfully disagrees.

The Office Action contends that the activation message sent from the wireless terminal to set up linking of the email address to the wireless terminal is the same as the claimed service activation code received from a remote device. The activation message in Turunen, however, is sent from GGSN to the MMSV, whereas the *encryption parameters* are exchanged between the mobile terminal (MS1) and SGSN. For example, “the gateway support node GGSN further transmits an identification of the wireless terminal MS1, such as the international mobile subscriber identity IMSI, and the IP address of the wireless terminal to the multimedia message server MMSV (stage 506),” and “the serving support node SGSN authenticates the wireless terminal MS1 and exchanges the encryption key (stage 502).” (See col. 8, lines 21-26 and col. 7, lines 58-60 of Turunen.) If the activation message of Turunen is to be analogous to the claimed service activation code, then the activation message of Turunen is different from the claimed service activation code because the activation message is not sent between the mobile terminal and a remote device, but rather is sent between two different network nodes (i.e., GGSN to the MMSV).

For these reasons, it is respectfully submitted that the rejection of claims 23, 24, 31, 32, 33, and 34 should be withdrawn.

**CLAIM 35 IS PATENTABLE OVER THE REFERENCES OF RECORD**

Claim 35 recites:

*35. The device of claim 23, wherein the device is further operable to:  
store an association between at least two of the encryption key, the messaging account, an identifier of the remote device, and the service activation code.*

The Office Action argues that Little teaches storing the claimed association (between at least two of the encryption key, the messaging account, an identifier of the remote device, and the service activation code) at the device (of claim 23). Therefore, Applicant understands the Office Action to analogize either the wireless connector system or messaging server of Little as “the device.” However, there is no disclosure, teaching, or suggestion in Little that the encryption key is handled in either the wireless connector system or messaging server, or that the encryption key associated with users, accounts, and/or devices.

According to Little, such association happens in “the remote device” rather than at an intermediary device between one of a plurality of e-mail servers and a mobile terminal, as claimed.

For these reasons, it is respectfully submitted that the rejection of claim 35 should be withdrawn.

**CLAIMS 25-28, 39-41 ARE PATENTABLE OVER THE REFERENCES OF RECORD**

Claim 23 and 37 recite:

*23. A device comprising:  
a radio;  
a control system communicatively coupled to the radio and comprising a processor and memory containing instructions executable by the processor whereby the device is operable to:  
receive information including a service activation code from a remote device;*

*register the remote device for access to a messaging account using the service activation code;*  
*receive a message for the messaging account;*  
*encrypt the message using an encryption key; and*  
*send the message to the remote device,*  
*wherein the device is authenticated to access the messaging account.*

37. *A method for sharing a messaging account, the method comprising:*  
*authenticating a device for access to the messaging account;*  
***receiving information including a service activation code from a remote device;***  
*registering the remote device for access to the messaging account using the service activation code;*  
*receiving a message for the messaging account;*  
*encrypting the message using an encryption key; and*  
*sending the message to the remote device.*

Claims 25, 26, and 27 recite:

25. *The device of claim 23, wherein the information including the service activation code is received by the device in an off-line communication.*

26. *The device of claim 25, wherein the off-line communication involves a local connection.*

27. *The device of claim 26, wherein the local connection is one of ~~a wired interface~~, a short range wireless interface, Bluetooth<sup>TM</sup>, or an optical interface.*

The Office Action concedes that Little and Turunen do not expressly disclose “wherein the information including the service activation code is received by the device in an off-line communication.” (See page 18 of the Office Action.) The Office Action, however, cites Salonen as teaching this feature. Applicant respectfully disagrees.



First, the examiner appears to argue that “using a secure SIM card in GSM devices as activation code to encrypt messages offline on the device without using network resources” is the same as receiving information including a service activation code from a remote device, wherein the information is received by the device in an off-line communication that involves a local connection. Based on the examiner’s rejection of claim 27, it appears to the Applicant that the examiner’s interpretation of the “receiving” includes the mobile device receiving something from the secure SIM card. In other words, receiving something within the device itself.

In contrast to receiving something from the secure SIM card within the device itself, the claims recite that the activation code is received **from a remote device**. Moreover, a secure SIM card within a mobile phone is not a remote device because the SIM card is integrated with / physically located within the mobile device.

Claim 37 has been amended to further clarify that the local connection is different from the connection between a secure SIM card and the mobile phone within which it is used. For example, “in step 2-3 the service activation code is then conveyed off-line to the host system 100. The idea of the off-line communication is to eliminate any chance of eavesdropping before secure a communication channel can be established. For instance, the service activation code may be entered manually or via a local connection, such as a wired or optical interface or a short-range wireless interface, such as Bluetooth.” (See paragraph [0029] of the Specification.) By eliminating the phrase “wired interface” from claim 37, it is clear that Little fails to teach the claimed local connection.

Second, it is not clear to the Applicant what the examiner considers to be “the device” in Salonen. It appears that the examiner analogizes the claimed device with the mobile device of Salonen. However, in such case, Applicant submits that the other aspects of the independent claim not taught by Salonen because they are not taught as being in the mobile device itself.

Finally, it is not clear to the Applicant what the examiner considers the meaning of “receiving” (i.e., “receiving information including a service activation code from a remote device”) to be in Salonen because Salonen does not disclose anything about receiving with respect to the secure SIM.

For these reasons, it is respectfully submitted that the rejection of claims 25-28 and 39-41 should be withdrawn.

Response to FOA dated July 25 2016  
Appl. No. 14/609,189

**DEPOSIT ACCOUNT**

The Commissioner is hereby authorized to charge any otherwise unpaid fees associated with the filing of this correspondence to Deposit Account No. 50-6191.

Date: August 23, 2016

Respectfully submitted,

/Justin R. Nifong/  
Justin R. Nifong  
Reg. No. 59,389

NK Patent Law  
4917 Waters Edge Drive, Suite 275  
Raleigh, NC 27606  
Telephone: (919) 348-2194  
Facsimile: (919) 882-8195

Customer No. 118194

## Electronic Patent Application Fee Transmittal

<b>Application Number:</b>	14609189			
<b>Filing Date:</b>	29-Jan-2015			
<b>Title of Invention:</b>	Messaging centre for forwarding e-mail			
<b>First Named Inventor/Applicant Name:</b>	Ari Backholm			
<b>Filer:</b>	Justin Robert Nifong/Sandra Hess			
<b>Attorney Docket Number:</b>	455/006/8 UTIL			
Filed as Small Entity				
<b>Filing Fees for Utility under 35 USC 111(a)</b>				
<b>Description</b>	<b>Fee Code</b>	<b>Quantity</b>	<b>Amount</b>	<b>Sub-Total in USD(\$)</b>
<b>Basic Filing:</b>				
<b>Pages:</b>				
<b>Claims:</b>				
<b>Miscellaneous-Filing:</b>				
<b>Petition:</b>				
<b>Patent-Appeals-and-Interference:</b>				
<b>Post-Allowance-and-Post-Issuance:</b>				
<b>Extension-of-Time:</b>				

Description	Fee Code	Quantity	Amount	Sub-Total in USD(\$)
<b>Miscellaneous:</b>				
Request for Continued Examination	2801	1	600	600
<b>Total in USD (\$)</b>				<b>600</b>

<b>Electronic Acknowledgement Receipt</b>	
<b>EFS ID:</b>	26718557
<b>Application Number:</b>	14609189
<b>International Application Number:</b>	
<b>Confirmation Number:</b>	5037
<b>Title of Invention:</b>	Messaging centre for forwarding e-mail
<b>First Named Inventor/Applicant Name:</b>	Ari Backholm
<b>Customer Number:</b>	118194
<b>Filer:</b>	Justin Robert Nifong/Sandra Hess
<b>Filer Authorized By:</b>	Justin Robert Nifong
<b>Attorney Docket Number:</b>	455/006/8 UTIL
<b>Receipt Date:</b>	23-AUG-2016
<b>Filing Date:</b>	29-JAN-2015
<b>Time Stamp:</b>	11:35:28
<b>Application Type:</b>	Utility under 35 USC 111(a)

**Payment information:**

Submitted with Payment	yes
Payment Type	Credit Card
Payment was successfully received in RAM	\$600
RAM confirmation Number	9808
Deposit Account	506191
Authorized User	NIFONG, JUSTIN

The Director of the USPTO is hereby authorized to charge indicated fees and credit any overpayment as follows:

Charge any Additional Fees required under 37 CFR 1.16 (National application filing, search, and examination fees)

Charge any Additional Fees required under 37 CFR 1.17 (Patent application and reexamination processing fees)

Charge any Additional Fees required under 37 CFR 1.19 (Document supply fees)  
 Charge any Additional Fees required under 37 CFR 1.20 (Post Issuance fees)  
 Charge any Additional Fees required under 37 CFR 1.21 (Miscellaneous fees and charges)

**File Listing:**

Document Number	Document Description	File Name	File Size(Bytes)/ Message Digest	Multi Part /.zip	Pages (if appl.)
1	Request for Continued Examination (RCE)	455-006-8UTIL-20160823-RCE-Trans.pdf	1349525  3333701d53daaa92cb294207f6d6bfa161c7d93	no	3

**Warnings:**

**Information:**

2		455-006-8UTIL-20160823-Rsp-to-FOA-dtd-7-25-2016.pdf	86758  5a3526df4c1cb324187cdd9ae694a029b9a5a34b	yes	18
---	--	---	---	-----	----

**Multipart Description/PDF files in .zip description**

Document Description	Start	End
Response After Final Action	1	1
Claims	2	9
Applicant Arguments/Remarks Made in an Amendment	10	18

**Warnings:**

**Information:**

3	Fee Worksheet (SB06)	fee-info.pdf	30496  71b1c47b8082e018e901e51ad5d77e55e9028cd6	no	2
---	----------------------	--------------	---	----	---

**Warnings:**

**Information:**

**Total Files Size (in bytes):** 1466779

**This Acknowledgement Receipt evidences receipt on the noted date by the USPTO of the indicated documents, characterized by the applicant, and including page counts, where applicable. It serves as evidence of receipt similar to a Post Card, as described in MPEP 503.**

**New Applications Under 35 U.S.C. 111**

**If a new application is being filed and the application includes the necessary components for a filing date (see 37 CFR 1.53(b)-(d) and MPEP 506), a Filing Receipt (37 CFR 1.54) will be issued in due course and the date shown on this Acknowledgement Receipt will establish the filing date of the application.**

**National Stage of an International Application under 35 U.S.C. 371**

**If a timely submission to enter the national stage of an international application is compliant with the conditions of 35 U.S.C. 371 and other applicable requirements a Form PCT/DO/EO/903 indicating acceptance of the application as a national stage submission under 35 U.S.C. 371 will be issued in addition to the Filing Receipt, in due course.**

**New International Application Filed with the USPTO as a Receiving Office**

**If a new international application is being filed and the international application includes the necessary components for an international filing date (see PCT Article 11 and MPEP 1810), a Notification of the International Application Number and of the International Filing Date (Form PCT/RO/105) will be issued in due course, subject to prescriptions concerning national security, and the date shown on this Acknowledgement Receipt will establish the international filing date of the application.**

Under the Paperwork Reduction Act of 1995, no persons are required to respond to a collection of information unless it displays a valid OMB control number.

<b>PATENT APPLICATION FEE DETERMINATION RECORD</b> Substitute for Form PTO-875				Application or Docket Number <b>14/609,189</b>	Filing Date <b>01/29/2015</b>	<input type="checkbox"/> To be Mailed		
ENTITY: <input type="checkbox"/> LARGE <input checked="" type="checkbox"/> SMALL <input type="checkbox"/> MICRO								
<b>APPLICATION AS FILED – PART I</b>								
(Column 1)			(Column 2)					
FOR	NUMBER FILED	NUMBER EXTRA	RATE (\$)	FEE (\$)				
<input type="checkbox"/> BASIC FEE <small>(37 CFR 1.16(a), (b), or (c))</small>	N/A	N/A	N/A					
<input type="checkbox"/> SEARCH FEE <small>(37 CFR 1.16(k), (i), or (m))</small>	N/A	N/A	N/A					
<input type="checkbox"/> EXAMINATION FEE <small>(37 CFR 1.16(o), (p), or (q))</small>	N/A	N/A	N/A					
TOTAL CLAIMS <small>(37 CFR 1.16(j))</small>	53 minus 20 =	*	X \$ =					
INDEPENDENT CLAIMS <small>(37 CFR 1.16(h))</small>	8 minus 3 =	*	X \$ =					
<input type="checkbox"/> APPLICATION SIZE FEE <small>(37 CFR 1.16(s))</small>	If the specification and drawings exceed 100 sheets of paper, the application size fee due is \$310 (\$155 for small entity) for each additional 50 sheets or fraction thereof. See 35 U.S.C. 41(a)(1)(G) and 37 CFR 1.16(s).							
<input type="checkbox"/> MULTIPLE DEPENDENT CLAIM PRESENT <small>(37 CFR 1.16(j))</small>								
* If the difference in column 1 is less than zero, enter "0" in column 2.			TOTAL					
<b>APPLICATION AS AMENDED – PART II</b>								
(Column 1)		(Column 2)		(Column 3)				
AMENDMENT	<b>08/23/2016</b>	CLAIMS REMAINING AFTER AMENDMENT		HIGHEST NUMBER PREVIOUSLY PAID FOR	PRESENT EXTRA	RATE (\$)	ADDITIONAL FEE (\$)	
	Total (37 CFR 1.16(i))	* 54	Minus	** 54	=	X \$ =		
	Independent (37 CFR 1.16(h))	* 8	Minus	***8	=	X \$ =		
	<input type="checkbox"/> Application Size Fee (37 CFR 1.16(s))							
	<input type="checkbox"/> FIRST PRESENTATION OF MULTIPLE DEPENDENT CLAIM (37 CFR 1.16(j))							
				TOTAL ADD'L FEE				
(Column 1)		(Column 2)		(Column 3)				
AMENDMENT		CLAIMS REMAINING AFTER AMENDMENT		HIGHEST NUMBER PREVIOUSLY PAID FOR	PRESENT EXTRA	RATE (\$)	ADDITIONAL FEE (\$)	
	Total (37 CFR 1.16(i))	*	Minus	**	=	X \$ =		
	Independent (37 CFR 1.16(h))	*	Minus	***	=	X \$ =		
	<input type="checkbox"/> Application Size Fee (37 CFR 1.16(s))							
	<input type="checkbox"/> FIRST PRESENTATION OF MULTIPLE DEPENDENT CLAIM (37 CFR 1.16(j))							
				TOTAL ADD'L FEE				
<p>* If the entry in column 1 is less than the entry in column 2, write "0" in column 3.                  ** If the "Highest Number Previously Paid For" IN THIS SPACE is less than 20, enter "20".                  *** If the "Highest Number Previously Paid For" IN THIS SPACE is less than 3, enter "3".                  The "Highest Number Previously Paid For" (Total or Independent) is the highest number found in the appropriate box in column 1.</p>								
LIE PEGGY S. YARBOROUGH								

This collection of information is required by 37 CFR 1.16. The information is required to obtain or retain a benefit by the public which is to file (and by the USPTO to process) an application. Confidentiality is governed by 35 U.S.C. 122 and 37 CFR 1.14. This collection is estimated to take 12 minutes to complete, including gathering, preparing, and submitting the completed application form to the USPTO. Time will vary depending upon the individual case. Any comments on the amount of time you require to complete this form and/or suggestions for reducing this burden, should be sent to the Chief Information Officer, U.S. Patent and Trademark Office, U.S. Department of Commerce, P.O. Box 1450, Alexandria, VA 22313-1450. DO NOT SEND FEES OR COMPLETED FORMS TO THIS ADDRESS. **SEND TO: Commissioner for Patents, P.O. Box 1450, Alexandria, VA 22313-1450.**

If you need assistance in completing the form, call 1-800-PTO-9199 and select option 2.





UNITED STATES PATENT AND TRADEMARK OFFICE

UNITED STATES DEPARTMENT OF COMMERCE
United States Patent and Trademark Office
Address: COMMISSIONER FOR PATENTS
P. O. Box 1450
Alexandria, Virginia 22313-1450
www.uspto.gov

Table with columns: APPLICATION NO., FILING DATE, FIRST NAMED INVENTOR, ATTORNEY DOCKET NO., CONFIRMATION NO., EXAMINER, ART UNIT, PAPER NUMBER, NOTIFICATION DATE, DELIVERY MODE. Includes application details for Ari Backholm and examiner Chou, Alan S.

Please find below and/or attached an Office communication concerning this application or proceeding.

The time period for reply, if any, is set in the attached communication.

Notice of the Office communication was sent electronically on above-indicated "Notification Date" to the following e-mail address(es):

usptomail@nkpatentlaw.com
abackholm@seven.com
eofficeaction@apcoll.com

<b>Office Action Summary</b>	<b>Application No.</b> 14/609,189	<b>Applicant(s)</b> BACKHOLM ET AL.	
	<b>Examiner</b> ALAN S. CHOU	<b>Art Unit</b> 2451	<b>AIA (First Inventor to File) Status</b> No

**-- The MAILING DATE of this communication appears on the cover sheet with the correspondence address --**

**Period for Reply**

A SHORTENED STATUTORY PERIOD FOR REPLY IS SET TO EXPIRE 3 MONTHS FROM THE MAILING DATE OF THIS COMMUNICATION.

- Extensions of time may be available under the provisions of 37 CFR 1.136(a). In no event, however, may a reply be timely filed after SIX (6) MONTHS from the mailing date of this communication.
- If NO period for reply is specified above, the maximum statutory period will apply and will expire SIX (6) MONTHS from the mailing date of this communication.
- Failure to reply within the set or extended period for reply will, by statute, cause the application to become ABANDONED (35 U.S.C. § 133). Any reply received by the Office later than three months after the mailing date of this communication, even if timely filed, may reduce any earned patent term adjustment. See 37 CFR 1.704(b).

**Status**

- 1)  Responsive to communication(s) filed on 4/1/2016.  
 A declaration(s)/affidavit(s) under **37 CFR 1.130(b)** was/were filed on \_\_\_\_\_.
- 2a)  This action is **FINAL**.                      2b)  This action is non-final.
- 3)  An election was made by the applicant in response to a restriction requirement set forth during the interview on \_\_\_\_\_; the restriction requirement and election have been incorporated into this action.
- 4)  Since this application is in condition for allowance except for formal matters, prosecution as to the merits is closed in accordance with the practice under *Ex parte Quayle*, 1935 C.D. 11, 453 O.G. 213.

**Disposition of Claims\***

- 5)  Claim(s) 1-19 and 21-55 is/are pending in the application.  
5a) Of the above claim(s) \_\_\_\_\_ is/are withdrawn from consideration.
- 6)  Claim(s) \_\_\_\_\_ is/are allowed.
- 7)  Claim(s) 1-19 and 21-55 is/are rejected.
- 8)  Claim(s) \_\_\_\_\_ is/are objected to.
- 9)  Claim(s) \_\_\_\_\_ are subject to restriction and/or election requirement.

\* If any claims have been determined allowable, you may be eligible to benefit from the **Patent Prosecution Highway** program at a participating intellectual property office for the corresponding application. For more information, please see [http://www.uspto.gov/patents/init\\_events/pph/index.jsp](http://www.uspto.gov/patents/init_events/pph/index.jsp) or send an inquiry to [PPHfeedback@uspto.gov](mailto:PPHfeedback@uspto.gov).

**Application Papers**

- 10)  The specification is objected to by the Examiner.
- 11)  The drawing(s) filed on \_\_\_\_\_ is/are: a)  accepted or b)  objected to by the Examiner.  
Applicant may not request that any objection to the drawing(s) be held in abeyance. See 37 CFR 1.85(a).  
Replacement drawing sheet(s) including the correction is required if the drawing(s) is objected to. See 37 CFR 1.121(d).

**Priority under 35 U.S.C. § 119**

- 12)  Acknowledgment is made of a claim for foreign priority under 35 U.S.C. § 119(a)-(d) or (f).

**Certified copies:**

- a)  All    b)  Some\*\*    c)  None of the:
1.  Certified copies of the priority documents have been received.
  2.  Certified copies of the priority documents have been received in Application No. \_\_\_\_\_.
  3.  Copies of the certified copies of the priority documents have been received in this National Stage application from the International Bureau (PCT Rule 17.2(a)).

\*\* See the attached detailed Office action for a list of the certified copies not received.

**Attachment(s)**

- 1)  Notice of References Cited (PTO-892)
- 2)  Information Disclosure Statement(s) (PTO/SB/08a and/or PTO/SB/08b)  
Paper No(s)/Mail Date \_\_\_\_\_.
- 3)  Interview Summary (PTO-413)  
Paper No(s)/Mail Date. \_\_\_\_\_.
- 4)  Other: \_\_\_\_\_.

The present application is being examined under the pre-AIA first to invent provisions.

This action is in response to amendments filed on April 1, 2016.

### **DETAILED ACTION**

Claims 1-19, 21-55 are presented for examination.

#### ***Double Patenting***

1. The nonstatutory double patenting rejection is based on a judicially created doctrine grounded in public policy (a policy reflected in the statute) so as to prevent the unjustified or improper timewise extension of the “right to exclude” granted by a patent and to prevent possible harassment by multiple assignees. A nonstatutory double patenting rejection is appropriate where the claims at issue are not identical, but at least one examined application claim is not patentably distinct from the reference claim(s) because the examined application claim is either anticipated by, or would have been obvious over, the reference claim(s). See, e.g., *In re Berg*, 140 F.3d 1428, 46 USPQ2d 1226 (Fed. Cir. 1998); *In re Goodman*, 11 F.3d 1046, 29 USPQ2d 2010 (Fed. Cir. 1993); *In re Longi*, 759 F.2d 887, 225 USPQ 645 (Fed. Cir. 1985); *In re Van Ornum*, 686 F.2d 937, 214 USPQ 761 (CCPA 1982); *In re Vogel*, 422 F.2d 438, 164 USPQ 619 (CCPA 1970); and *In re Thorington*, 418 F.2d 528, 163 USPQ 644 (CCPA 1969).

2. Timely filed terminal disclaimer in compliance with 37 CFR 1.321(c) or 1.321(d) may be used to overcome an actual or provisional rejection based on a nonstatutory double patenting ground provided the reference application or patent either is shown to be commonly owned with this application, or claims an invention made as a result of

activities undertaken within the scope of a joint research agreement. A terminal disclaimer must be signed in compliance with 37 CFR 1.321(b).

3. The USPTO internet Web site contains terminal disclaimer forms which may be used. Please visit <http://www.uspto.gov/forms/>. The filing date of the application will determine what form should be used. A web-based eTerminal Disclaimer may be filled out completely online using web-screens. An eTerminal Disclaimer that meets all requirements is auto-processed and approved immediately upon submission. For more information about eTerminal Disclaimers, refer to <http://www.uspto.gov/patents/process/file/efs/guidance/eTD-info-l.jsp>.

4. Claims 1-20 are rejected on the ground of nonstatutory double patenting as being unpatentable over claim 1 of U.S. Patent No. 7,706,781 B2 and claim 1 of U.S. Patent 7,643,818 B2. Although the claims at issue are not identical, they are not patentably distinct from each other because both independent claims have the similar steps such as: e-mail address of the mobile terminal is associated with an identifier and encryption information (see claims 1 in U.S. Patent 7,706,871 B2 and U.S. Patent 7,643,818 B2), encrypting an email message using the encryption information (see claims 1 in U.S. Patent 7,706,871 B2 and U.S. Patent 7,643,818 B2), and transmitting the encrypted e-mail message (see claims 1 in U.S. Patent 7,706,871 B2 and U.S. Patent 7,643,818 B2).

5. The current independent claim 1 is a broader version of claim 1 of U.S. Patent 7,643,818 B2, without the limitation of establishing a tunnel and permanent terminal identity and temporary identity.

6. The current independent claim 1 is a broader version of claim 1 of U.S. Patent 7,706,781 B2, without the limitation of activation code, permanent terminal identity, and encrypted data channel. The limitation of activation code can be found in the dependent claim 8 of the current application.

7. Thus the current independent claims 1, 12, 20 have similar limitation as the parent claim in the U.S. Patent 7,706,871 B2 and U.S. Patent 7,643,818 B2.

***Claim Rejections - 35 USC § 103***

8. The following is a quotation of pre-AIA 35 U.S.C. 103(a) which forms the basis for all obviousness rejections set forth in this Office action:

(a) A patent may not be obtained though the invention is not identically disclosed or described as set forth in section 102 of this title, if the differences between the subject matter sought to be patented and the prior art are such that the subject matter as a whole would have been obvious at the time the invention was made to a person having ordinary skill in the art to which said subject matter pertains. Patentability shall not be negated by the manner in which the invention was made.

9. Claims 1-2, 6-10, 12-15, 18, 21-24, 29-38, 42-55 are rejected under pre-AIA 35 U.S.C. 103(a) as being unpatentable over Little et al. U.S. Patent Application Publication Number 2004/0205248 A1 (hereinafter Little), further in view of Turunen et al. U.S. Patent Number 7,289,792 B1 (hereinafter Turunen).

10. As per claims 1, 12, Little disclose a method for forwarding an e-mail message from an e-mail server to a mobile terminal (see forwarding email message 833 from

message server 820 to mobile device 816 on page 9 section [0076] on Figure 8), the method comprising:

11. receiving an e-mail message associated with an e-mail address of a user of a mobile terminal and sent by an e-mail server (see receiving e-mail messages to a user identified by an e-mail address on page 9 section [0078]),

12. wherein the e-mail address is associated with an identifier of the mobile terminal (see specific e-mail address associated with the mobile device on page 2 section [0026]),

13. encrypting the e-mail message (see encryption e-mail message to be send through a wireless VPN through a temporary transfer path on page 9 section [0081]) using encryption information associated with a temporary identifier (see encryption using private key on page 8 section [0070]),

14. and

15. transmitting the encrypted e-mail message to the mobile terminal (see sending encrypted message to mobile device on page 10 section [0082]).

16. Little do not disclose expressly: wherein the identifier is generated by the mobile terminal;

wherein the temporary identifier is based on a connection to the mobile terminal.

17. Turunen teaches: wherein the identifier is generated by the mobile terminal (see wireless terminal provide a logon request with identification of wireless terminal SM1 and parameter data for encryption step 405, which is encrypted or generated by the mobile terminal, on column 6 line 50-66 and Figure 4 and see identification of the

wireless terminal such as telephone number MSISDN and device identification IMSI that link to the e-mail address of the wireless terminal on column 8 line 22-35);

18. wherein the temporary identifier is based on a connection to the mobile terminal (see temporary logical link identity TLLI provided to the mobile terminal by the serving packet service support node SGSN based on the temporary connection and channel on column 7 line 2-25 and see sending encryption parameters to setup connection on column 7 line 23-28).

19. Little and Turunen are analogous art because they are from the same field of endeavor, wireless email terminal system. At the time of the invention it would have been obvious to a person of ordinary skill in the art to also apply a temporary mobile terminal identifier for the connection to link the email to the individual mobile terminal. The motivation for doing so would have been to use link an email address that use the temporary connection address to an wireless mobile terminal that use wireless network system. Therefore, it would have been obvious to combine Little and Turunen for the benefit of using e-mail address of the mobile terminal is associated with a temporary connection identifier to obtain the invention as specified in claim 1.

20. As per claim 2, Little and Turunen disclose the method of claim 1, further comprising identifying the mobile terminal based on the e-mail address of the e-mail message and the association with the identifier of the mobile terminal (see e-mail address of terminal is used to identify the wireless terminal as well as an permanent identification of wireless terminal using international mobile subscriber identity IMSI on

column 8 line 20-35 and see e-mail address as well as the permanent identification of the wireless terminal such as a telephone number MSISDN and device identification IMSI are used to linking email address to the wireless terminal on column 8 line 29-37 in Turunen).

21. As per claim 6, Little and Turunen disclose the method of claim 2, further comprising adding the e-mail address to a reply message sent by the mobile terminal (see repacking allowing reply messages to delivered to addressed recipients on page 10 section [0083] in Little).

22. As per claim 7, Little and Turunen disclose the method of claim 1, further comprising receiving the encryption information generated by the mobile terminal (see private key encryption information is shared to other systems and devices on page 8 section [0070] in Little).

23. As per claim 8, Little and Turunen disclose the method of claim 1, wherein the encryption information (see encryption information private key is used to identify mobile device entity on page 8 section [0070] in Little) is based on an activation code of the mobile terminal (see activation message from the wireless terminal to set up linking of the email address to the wireless terminal on column 8 line 29-37 in Turunen).



24. As per claim 9, Little and Turunen disclose the method of claim 1, wherein the messaging center transmits the e-mail message to the mobile terminal using the identifier of the mobile terminal (see temporary logical link identity TLLI to transmit data to wireless terminal over temporary wireless network on column 7 line 1-10 in Turunen).

25. As per claims 10, 18, Little and Turunen disclose the method of claim 1, wherein mobile terminal receives and decrypts the e-mail message (see wireless terminal decrypts the message on page 10 section [0082] in Little) using the encryption information (see decryption using shared private key on page 8 section [0070] in Little).

26. As per claim 13, Little and Turunen disclose the system of claim 12, wherein the processor is further configured to receive the e-mail message from the e-mail server (see wireless connector system 828 transfers data between mobile device 816 and email message server 820 on page 9 section [0079] in Little).

27. As per claim 14, Little and Turunen disclose the system of claim 12, wherein the processor (see wireless connector system 828 transfers data between mobile device 816 and email message server 820 on page 9 section [0079] in Little) is further configured to receive the encryption information and to provide the encryption information to the memory for storage (see receiving encryption information shared private key on page 8 section [0070] in Little).

28. As per claim 15, Little and Turunen disclose the system of claim 12, wherein the processor is further configured to pack the e-mail message (see repackaging the email message 833 such as compressing and encrypting the email message 833 on page 9 section [0081] in Little).

29. As per claims 21, 22, 54, Little disclose a mobile device (see mobile device 100 on page 12 section [0099] and Figure 11) comprising:

30. a radio (see transceiver 1111 on page 12 section [0099]);

31. a memory (see random access memory 1126 on page 12 section [0099]);

32. a processor (see microprocessor 1138 on page 12 section [0099]) configured for controlling a mobile device to:

33. receive, from a server, an encrypted e-mail message associated with an e-mail address of a user of the mobile device (see receiving encrypted message on page 10 section [0082]), wherein the e-mail address is associated with the identifier (see e-mail address corresponding to a user account and mailbox on page 9 section [0078]),

34. decrypt the e-mail message using encryption information associated with a temporary identifier (see decrypt using session key on page 1 section [0007] and page 4 section [0037]),

35. Little do not disclose expressly: generate an identifier; and

36. wherein the temporary identifier is based on a connection to the server.

37. Turunen teaches : generate an identifier (see wireless terminal provide a logon request with identification of wireless terminal SM1 and parameter data for encryption step 405, which is encrypted or generated by the mobile terminal, on column 6 line 50-66 and Figure 4 and see identification of the wireless terminal such as telephone number MSISDN and device identification IMSI that link to the e-mail address of the wireless terminal on column 8 line 220-35); and

38. wherein the temporary identifier is based on a connection to the server (see temporary logical link identity TLLI provided to the mobile terminal by the serving packet service support node SGSN based on the temporary connection and channel on column 7 line 2-25 and see sending encryption parameters to setup connection on column 7 line 23-28).

39. Little and Turunen are analogous art because they are from the same field of endeavor, wireless email terminal system. At the time of the invention it would have been obvious to a person of ordinary skill in the art to also apply a temporary mobile terminal identifier for the connection to link the email to the individual mobile terminal. The motivation for doing so would have been to use link an email address that use the temporary connection address to an wireless mobile terminal that use wireless network system. Therefore, it would have been obvious to combine Little and Turunen for the benefit of using e-mail address of the mobile terminal is associated with a temporary connection identifier to obtain the invention as specified in claim 21, 22, 54.

40. As per claims 23, 37, 55, Little discloses a device (see message server 820 on page 9 section [0076] and Figure 8) comprising:
41. a radio (see wireless connector system 828 on page 9 section [0079]);
42. a control system communicatively coupled to the radio and comprising a processor and memory (see message server 820 saving email messages to mail box 819 on page 9 section [0078]) containing instructions executable by the processor whereby the device is operable to:
43. register the remote device for access to a messaging account (see registering remote devices using unique identification and using Subscriber Identity Module SIM on page 12 section [0105]);
44. receive a message for the messaging account (see e-mail message 833 arrive at message server 820 and server determining which mailboxes 819 to be stored on page 9 section [0078]);
45. encrypt the message using an encryption key (see encrypt e-mail message on page 9 section [0081]); and
46. send the message to the remote device (see sending message to mobile devices on page 9 section [0081]),
47. wherein the device is authenticated to access the messaging account (see e-mail address identifies a user account and mailbox 819 on page 9 section [0078]).
48. Little do not disclose expressly: receive information including a service activation code from a remote device.

49. Turunen teaches: receive information including a service activation code (see activation message from the wireless terminal to set up linking of the email address to the wireless terminal on column 8 line 29-37) from a remote device (see activation message from the wireless terminal to set up linking of the email address to the wireless terminal on column 8 line 29-37 and see activation call the message server to define the wireless terminal of the right recipient on the basis of the e-mail address on column 8 line 40-45).

50. Little and Turunen are analogous art because they are from the same field of endeavor, wireless email terminal system. At the time of the invention it would have been obvious to a person of ordinary skill in the art to also apply an activation code to link the email to the individual mobile terminal. The motivation for doing so would have been to link an email address to a wireless mobile terminal using an activation code that use wireless network system. Therefore, it would have been obvious to combine Little and Turunen for the benefit of using e-mail address of the mobile terminal is associated with an activation code to obtain the invention as specified in claim 23, 37, 55.

51. As per claims 24, 38, Little and Turunen disclose the device of claim 23, wherein the information including the service activation code is received by the device in response to user input at the remote device (see user entering a password for decryption the message session on page 5 section [0044] in Little and see activation request message received from the user wireless terminal containing encryption key and identification parameters and on column 7 line 55-65 in Turunen).

52. As per claims 29, 42, Little and Turunen disclose the device of claim 23, wherein the authentication of the device relies on the authentication of the messaging account (see user enter password to authenticate device on page 5 section [0044] in Little).

53. As per claims 30, 43, Little and Turunen disclose the method of claim 29, wherein the authentication of the messaging account includes a username and password (see message account identified by user name on page 9 section [0078] and see user enter password to authenticate device on page 5 section [0044] in Little).

54. As per claims 31, 44, Little and Turunen disclose the device of claim 23, wherein the encryption key is the service activation code (see sending encryption key or private key on page 8 section [0070] in Little and see activation message on column 8 line 29-40 and see exchanging encryption parameters on column 7 line 20-28 in Turunen).

55. As per claims 32, 45, Little and Turunen disclose the device of claim 23, wherein the encryption key is derived from the service activation code (see private key is used to decrypt the session key to decrypt message body on page 4 section [0037] in Little).

56. As per claims 33, 46, Little and Turunen disclose the device of claim 23, wherein the encryption key is a subset of the service activation code (see encrypted session key

embedded in message may be further encrypted with a public key on page 4 section [0040] in Little).

57. As per claims 34, 47, Little and Turunen disclose the device of claim 23, wherein the encryption key is closely related to the service activation code (see private key is used to decrypt the session key to decrypt message body on page 4 section [0037] in Little).

58. As per claims 35, 48, Little and Turunen disclose the device of claim 23, wherein the device is further operable to: store an association between at least two of the encryption key (see encryption key and session key on page 4 section [0037] in Little), the messaging account, an identifier of the remote device, and the service activation code (see storage storing user name, user account, mailbox identifier on page 9 section [0078] in Little).

59. As per claims 36, 50, Little and Turunen disclose the device of claim 23, wherein the message is sent to the remote device through an intermediate device (see wireless Gateway 85 on page 2 section [0027] and in Figure 1 in Little).

60. As per claims 49, 51, Little and Turunen disclose the device of claim 36, wherein the encryption key (see encryption key is used to generate request on column 6 line 55-65) is associated with a temporary identifier (see temporary identifier temporary logical

link identity TLLI used to connect wireless terminal with serving support node SGSN on column 7 line 4-21 in Turunen), wherein the temporary identifier is based on a connection to the intermediate device (see wireless Gateway 85 on page 2 section [0027] and in Figure 1 in Little and see gateway support node GGSN on column 6 line 60-65 in Turunen).

61. As per claims 52, 53, Little and Turunen disclose the method of claim 1, wherein the identifier (logon request contain wireless terminal identifier on column 8 line 55-62 in Turunen) is associated with the temporary identifier (see temporary identifier temporary logical link identity TLLI used to connect wireless terminal with serving support node SGSN on column 7 line 4-21 in Turunen).

62. Claims 3-5, 11, 16-17, 19 are rejected under pre-AIA 35 U.S.C. 103(a) as being unpatentable over Little et al. U.S. Patent Application Publication Number 2004/0205248 A1 (hereinafter Little), further in view of Turunen et al. U.S. Patent Number 7,289,792 B1 (hereinafter Turunen), further in view of Kock et al. U.S. Patent Application Publication Number 2006/0031300 A1 (hereinafter Kock).



63. As per claims 3, 16, Little and Turunen do not disclose the method of claim 1: wherein encrypting the e-mail message further comprises packing the e-mail message by omitting at least part of the e-mail message when at least part of the e-mail message exceeds a predetermined size specification.

64. Kock teaches: packing the e-mail message by omitting at least part of the e-mail message when at least part of the e-mail message exceeds a predetermined size specification (see server transmitting the header the first N character of the body to the terminal device, where N is a predetermined integer, while holding back any remaining body of the email on page 1 section [0008]).

65. Little and Kock are analogous art because they are from the same field of endeavor, wireless email terminal system. At the time of the invention it would have been obvious to a person of ordinary skill in the art to also apply an email message sending size. The motivation for doing so would have been to save bandwidth and only send email data that user requests. Therefore, it would have been obvious to combine Little and Turunen and Kock for the benefit of omitting at least part of the e-mail message when at least part of the e-mail message exceeds a predetermined size to obtain the invention as specified in claims 3, 16.

66. As per claims 4, 17, Little and Turunen and Kock disclose the method of claim 3, wherein size specification is set by a user of the mobile terminal (see number N is determined by a user of the terminal device on page 1 section [0014] in Kock).

67. As per claim 5, Little and Turunen and Kock disclose the method of claim 3, wherein the omitted part of the e-mail message is the e-mail address (see omitting any characters of the body including email address beyond the predetermined integer N on page 1 section [0008] in Kock).

68. As per claim 11, 19, Little and Turunen and Kock disclose the method of claim 3, wherein the mobile terminal unpacks the e-mail message (see mobile terminal repacking the email message by decompression and decryption on page 10 section [0082] in Little).

69. Claims 25-28, 39-41 are rejected under pre-AIA 35 U.S.C. 103(a) as being unpatentable over Little et al. U.S. Patent Application Publication Number 2004/0205248 A1 (hereinafter Little), further in view of Turunen et al. U.S. Patent Number 7,289,792 B1 (hereinafter Turunen), further in view of Salonen U.S. Patent Application Publication Number 2013/0268384 A1 (hereinafter Salonen).

70. As per claims 25, 39, Little and Turunen do not disclose expressly: wherein the information including the service activation code is received by the device in an off-line communication.

71. Salonen teaches: wherein the information including the service activation code is received by the device in an off-line communication (see using a secure SIM card in GSM devices as activation code to encrypt messages offline on the device without using network resources on page 6 section [0074]).

72. Little and Salonen are analogous art because they are from the same field of endeavor, wireless email terminal system. At the time of the invention it would have been obvious to a person of ordinary skill in the art to use off-line service activation code. The motivation for doing so would have been to use a secure physical means to encrypt message. Therefore, it would have been obvious to combine Little and Turunen and Salonen for the benefit of using activation code in an off-line communication to obtain the invention as specified in claims 25, 39.

73. As per claim 26, Little and Turunen and Salonen disclose the device of claim 25, wherein the off-line communication involves a local connection (see using a secure SIM card in GSM devices as activation code to encrypt messages locally using secure connection on page 6 section [0074] in Salonen).

74. As per claims 27, 40, Little and Turunen and Salonen disclose the device of claim 26, wherein the local connection is one of a wired interface, a short range wireless

interface, Bluetooth TM, or an optical interface (see using wired interface, or secure SIM card wired interface in GSM devices as activation code to encrypt messages on page 6 section [0074] in Salonen).

75. As per claims 28, 41, Little and Turunen and Salonen disclose the device of claim 25, wherein the off-line communication prevents eavesdropping of the service activation code (see using a secure SIM card in GSM devices as activation code to encrypt messages prevents eavesdropping of the encryption within the device on page 6 section [0074] in Salonen).

### ***Response to Arguments***

76. Applicant's arguments with respect to claims 1-19, 21-55 have been considered but are moot because the arguments do not apply to any of the references being used in the current rejection.

### ***Conclusion***

Applicant's amendment necessitated the new ground(s) of rejection presented in this Office action. Accordingly, **THIS ACTION IS MADE FINAL**. See MPEP § 706.07(a). Applicant is reminded of the extension of time policy as set forth in 37 CFR 1.136(a).

A shortened statutory period for reply to this final action is set to expire THREE MONTHS from the mailing date of this action. In the event a first reply is filed within TWO MONTHS of the mailing date of this final action and the advisory action is not mailed until after the end of the THREE-MONTH shortened statutory period, then the shortened statutory period will expire on the date the advisory action is mailed, and any extension fee pursuant to 37 CFR 1.136(a) will be calculated from the mailing date of the advisory action. In no event, however, will the statutory period for reply expire later than SIX MONTHS from the date of this final action.

Any inquiry concerning this communication or earlier communications from the examiner should be directed to ALAN S. CHOU whose telephone number is (571)272-5779. The examiner can normally be reached on 9am-5pm.

If attempts to reach the examiner by telephone are unsuccessful, the examiner's supervisor, Christopher L. Parry can be reached on (571)272-8328. The fax phone number for the organization where this application or proceeding is assigned is 571-273-8300.

Information regarding the status of an application may be obtained from the Patent Application Information Retrieval (PAIR) system. Status information for published applications may be obtained from either Private PAIR or Public PAIR. Status information for unpublished applications is available through Private PAIR only. For more information about the PAIR system, see <http://pair-direct.uspto.gov>. Should you have questions on access to the Private PAIR system, contact the Electronic Business Center (EBC) at 866-217-9197 (toll-free). If you would like assistance from a USPTO Customer Service Representative or access to the automated information system, call 800-786-9199 (IN USA OR CANADA) or 571-272-1000.

ALAN S CHOU  
Examiner  
Art Unit 2451

AC

/BACKHEAN TIV/  
Primary Examiner, Art Unit 2451

<b>Notice of References Cited</b>	Application/Control No. 14/609,189	Applicant(s)/Patent Under Reexamination BACKHOLM ET AL.	
	Examiner ALAN S. CHOU	Art Unit 2451	Page 1 of 1

**U.S. PATENT DOCUMENTS**

*		Document Number Country Code-Number-Kind Code	Date MM-YYYY	Name	CPC Classification	US Classification
*	A	US-2013/0268384 A1	10-2013	SALONEN; Jukka	G06Q10/02	705/26.1
	B	US-				
	C	US-				
	D	US-				
	E	US-				
	F	US-				
	G	US-				
	H	US-				
	I	US-				
	J	US-				
	K	US-				
	L	US-				
	M	US-				

**FOREIGN PATENT DOCUMENTS**

*		Document Number Country Code-Number-Kind Code	Date MM-YYYY	Country	Name	CPC Classification
	N					
	O					
	P					
	Q					
	R					
	S					
	T					

**NON-PATENT DOCUMENTS**

*		Include as applicable: Author, Title Date, Publisher, Edition or Volume, Pertinent Pages)
	U	
	V	
	W	
	X	

\*A copy of this reference is not being furnished with this Office action. (See MPEP § 707.05(a).)  
Dates in MM-YYYY format are publication dates. Classifications may be US or foreign.

<b>Search Notes</b>  	<b>Application/Control No.</b>  14609189	<b>Applicant(s)/Patent Under Reexamination</b>  BACKHOLM ET AL.
	<b>Examiner</b>  ALAN S CHOU	<b>Art Unit</b>  2451

<b>CPC- SEARCHED</b>		
Symbol	Date	Examiner
G06Q 10/107	9/24/2015	AC
H04L 12/585, 12/58	9/24/2015	AC

<b>CPC COMBINATION SETS - SEARCHED</b>		
Symbol	Date	Examiner

<b>US CLASSIFICATION SEARCHED</b>			
Class	Subclass	Date	Examiner
709	206	9/24/2015	AC

<b>SEARCH NOTES</b>		
Search Notes	Date	Examiner
EAST Search	9/24/2015	AC
Consulted with SPE Chris Parry regarding 101 issues for claims 1-20	9/24/2015	AC
Consulted with Primary Saket Daftuar regarding ODP issues for claims 1-20	9/25/2015	AC
Consulted with Primary Saket Daftuar regarding 112 6th issue with claim 12-19	9/25/2015	AC
EAST Search	7/5/2016	AC
Consulted with SPE Chris Parry regarding 101 amendments temporary identifier to making the language significantly more	7/20/2016	AC

<b>INTERFERENCE SEARCH</b>			
US Class/ CPC Symbol	US Subclass / CPC Group	Date	Examiner

--	--



Receipt date: 04/20/2016

14609189 - GAU: 2451

Doc code: IDS

PTO/SB/08a (01-10)

Doc description: Information Disclosure Statement (IDS) Filed

Approved for use through 07/31/2012. OMB 0651-0031

U.S. Patent and Trademark Office; U.S. DEPARTMENT OF COMMERCE

Under the Paperwork Reduction Act of 1995, no persons are required to respond to a collection of information unless it contains a valid OMB control number.

<b>INFORMATION DISCLOSURE STATEMENT BY APPLICANT</b> ( Not for submission under 37 CFR 1.99)	Application Number	14609189
	Filing Date	2015-01-29
	First Named Inventor	Backholm
	Art Unit	2642
	Examiner Name	CHOU, ALAN S.
	Attorney Docket Number	455/006/8 UTIL

**U.S. PATENTS** Remove

Examiner Initial*	Cite No	Patent Number	Kind Code <sup>1</sup>	Issue Date	Name of Patentee or Applicant of cited Document	Pages, Columns, Lines where Relevant Passages or Relevant Figures Appear
	1					

If you wish to add additional U.S. Patent citation information please click the Add button. Add

**U.S. PATENT APPLICATION PUBLICATIONS** Remove

Examiner Initial*	Cite No	Publication Number	Kind Code <sup>1</sup>	Publication Date	Name of Patentee or Applicant of cited Document	Pages, Columns, Lines where Relevant Passages or Relevant Figures Appear
	1					

If you wish to add additional U.S. Published Application citation information please click the Add button. Add

**FOREIGN PATENT DOCUMENTS** Remove

Examiner Initial*	Cite No	Foreign Document Number <sup>3</sup>	Country Code <sup>2i</sup>	Kind Code <sup>4</sup>	Publication Date	Name of Patentee or Applicant of cited Document	Pages, Columns, Lines where Relevant Passages or Relevant Figures Appear	T <sup>5</sup>
	1							

If you wish to add additional Foreign Patent Document citation information please click the Add button. Add

**NON-PATENT LITERATURE DOCUMENTS** Remove

Examiner Initials*	Cite No	Include name of the author (in CAPITAL LETTERS), title of the article (when appropriate), title of the item (book, magazine, journal, serial, symposium, catalog, etc), date, pages(s), volume-issue number(s), publisher, city and/or country where published.	T <sup>5</sup>

ALL REFERENCES CONSIDERED EXCEPT WHERE LINED THROUGH. /A.C./

Receipt date: 04/20/2016

14609189 - GAU: 2451

**INFORMATION DISCLOSURE  
STATEMENT BY APPLICANT  
( Not for submission under 37 CFR 1.99)**

Application Number	14609189
Filing Date	2015-01-29
First Named Inventor	Backholm
Art Unit	2642
Examiner Name	CHOU, ALAN S.
Attorney Docket Number	455/006/8 UTIL

1	EPO, Application No. 05813041.0, File history from 11-21-2005 to 04-07-2016.
2	EPO, Application No. 05813045.1, File history from 11-21-2005 to 04-07-2016.
3	
4	

If you wish to add additional non-patent literature document citation information please click the Add button

**EXAMINER SIGNATURE**

Examiner Signature	/Alan Chou/	Date Considered	07/19/2016
--------------------	-------------	-----------------	------------

\*EXAMINER: Initial if reference considered, whether or not citation is in conformance with MPEP 609. Draw line through a citation if not in conformance and not considered. Include copy of this form with next communication to applicant.

<sup>1</sup> See Kind Codes of USPTO Patent Documents at [www.USPTO.GOV](http://www.USPTO.GOV) or MPEP 901.04. <sup>2</sup> Enter office that issued the document, by the two-letter code (WIPO Standard ST.3). <sup>3</sup> For Japanese patent documents, the indication of the year of the reign of the Emperor must precede the serial number of the patent document. <sup>4</sup> Kind of document by the appropriate symbols as indicated on the document under WIPO Standard ST.16 if possible. <sup>5</sup> Applicant is to place a check mark here if English language translation is attached.

ALL REFERENCES CONSIDERED EXCEPT WHERE LINED THROUGH. /A.C./

Receipt date: 04/20/2016

14609189 - GAU: 2451

**INFORMATION DISCLOSURE  
STATEMENT BY APPLICANT  
( Not for submission under 37 CFR 1.99)**

Application Number	14609189
Filing Date	2015-01-29
First Named Inventor	Backholm
Art Unit	2642
Examiner Name	CHOU, ALAN S.
Attorney Docket Number	455/006/8 UTIL

**CERTIFICATION STATEMENT**

Please see 37 CFR 1.97 and 1.98 to make the appropriate selection(s):

That each item of information contained in the information disclosure statement was first cited in any communication from a foreign patent office in a counterpart foreign application not more than three months prior to the filing of the information disclosure statement. See 37 CFR 1.97(e)(1).

**OR**

That no item of information contained in the information disclosure statement was cited in a communication from a foreign patent office in a counterpart foreign application, and, to the knowledge of the person signing the certification after making reasonable inquiry, no item of information contained in the information disclosure statement was known to any individual designated in 37 CFR 1.56(c) more than three months prior to the filing of the information disclosure statement. See 37 CFR 1.97(e)(2).

See attached certification statement.

The fee set forth in 37 CFR 1.17 (p) has been submitted herewith.

A certification statement is not submitted herewith.

**SIGNATURE**

A signature of the applicant or representative is required in accordance with CFR 1.33, 10.18. Please see CFR 1.4(d) for the form of the signature.

Signature	/Justin R. Nifong/	Date (YYYY-MM-DD)	2016-04-20
Name/Print	Justin R. Nifong	Registration Number	59389

This collection of information is required by 37 CFR 1.97 and 1.98. The information is required to obtain or retain a benefit by the public which is to file (and by the USPTO to process) an application. Confidentiality is governed by 35 U.S.C. 122 and 37 CFR 1.14. This collection is estimated to take 1 hour to complete, including gathering, preparing and submitting the completed application form to the USPTO. Time will vary depending upon the individual case. Any comments on the amount of time you require to complete this form and/or suggestions for reducing this burden, should be sent to the Chief Information Officer, U.S. Patent and Trademark Office, U.S. Department of Commerce, P.O. Box 1450, Alexandria, VA 22313-1450. **DO NOT SEND FEES OR COMPLETED FORMS TO THIS ADDRESS. SEND TO: Commissioner for Patents, P.O. Box 1450, Alexandria, VA 22313-1450.**

ALL REFERENCES CONSIDERED EXCEPT WHERE LINED THROUGH. /A.C./

## Privacy Act Statement

The Privacy Act of 1974 (P.L. 93-579) requires that you be given certain information in connection with your submission of the attached form related to a patent application or patent. Accordingly, pursuant to the requirements of the Act, please be advised that: (1) the general authority for the collection of this information is 35 U.S.C. 2(b)(2); (2) furnishing of the information solicited is voluntary; and (3) the principal purpose for which the information is used by the U.S. Patent and Trademark Office is to process and/or examine your submission related to a patent application or patent. If you do not furnish the requested information, the U.S. Patent and Trademark Office may not be able to process and/or examine your submission, which may result in termination of proceedings or abandonment of the application or expiration of the patent.

The information provided by you in this form will be subject to the following routine uses:

1. The information on this form will be treated confidentially to the extent allowed under the Freedom of Information Act (5 U.S.C. 552) and the Privacy Act (5 U.S.C. 552a). Records from this system of records may be disclosed to the Department of Justice to determine whether the Freedom of Information Act requires disclosure of these records.
2. A record from this system of records may be disclosed, as a routine use, in the course of presenting evidence to a court, magistrate, or administrative tribunal, including disclosures to opposing counsel in the course of settlement negotiations.
3. A record in this system of records may be disclosed, as a routine use, to a Member of Congress submitting a request involving an individual, to whom the record pertains, when the individual has requested assistance from the Member with respect to the subject matter of the record.
4. A record in this system of records may be disclosed, as a routine use, to a contractor of the Agency having need for the information in order to perform a contract. Recipients of information shall be required to comply with the requirements of the Privacy Act of 1974, as amended, pursuant to 5 U.S.C. 552a(m).
5. A record related to an International Application filed under the Patent Cooperation Treaty in this system of records may be disclosed, as a routine use, to the International Bureau of the World Intellectual Property Organization, pursuant to the Patent Cooperation Treaty.
6. A record in this system of records may be disclosed, as a routine use, to another federal agency for purposes of National Security review (35 U.S.C. 181) and for review pursuant to the Atomic Energy Act (42 U.S.C. 218(c)).
7. A record from this system of records may be disclosed, as a routine use, to the Administrator, General Services, or his/her designee, during an inspection of records conducted by GSA as part of that agency's responsibility to recommend improvements in records management practices and programs, under authority of 44 U.S.C. 2904 and 2906. Such disclosure shall be made in accordance with the GSA regulations governing inspection of records for this purpose, and any other relevant (i.e., GSA or Commerce) directive. Such disclosure shall not be used to make determinations about individuals.
8. A record from this system of records may be disclosed, as a routine use, to the public after either publication of the application pursuant to 35 U.S.C. 122(b) or issuance of a patent pursuant to 35 U.S.C. 151. Further, a record may be disclosed, subject to the limitations of 37 CFR 1.14, as a routine use, to the public if the record was filed in an application which became abandoned or in which the proceedings were terminated and which application is referenced by either a published application, an application open to public inspections or an issued patent.
9. A record from this system of records may be disclosed, as a routine use, to a Federal, State, or local law enforcement agency, if the USPTO becomes aware of a violation or potential violation of law or regulation.

ALL REFERENCES CONSIDERED EXCEPT WHERE LINED THROUGH. /A.C./

## EAST Search History

## EAST Search History (Prior Art)

Ref #	Hits	Search Query	DBs	Default Operator	Plurals	Time Stamp
L1	119	((Ari) near2 (Backholm)).INV.	US-PGPUB; USPAT	OR	OFF	2016/07/06 13:10
L2	1	"7706781".pn.	US-PGPUB; USPAT	OR	OFF	2016/07/06 13:10
L3	1	"7643818".pn.	US-PGPUB; USPAT	OR	OFF	2016/07/06 13:10
L4	1	"20040205248"	US-PGPUB; USPAT	OR	OFF	2016/07/06 13:10
L5	1	"7289792".pn.	US-PGPUB; USPAT	OR	OFF	2016/07/06 13:10
L6	1	"6745326".pn.	US-PGPUB; USPAT	OR	OFF	2016/07/06 13:10
L7	1	"20060265595"	US-PGPUB; USPAT	OR	OFF	2016/07/06 13:10
L8	12286	(709/206.ccls. g06q10/107.cpc. h04112/585.cpc. h04112/58.cpc.)AND (@AD<"20041122" @RLAD<"20041122")	US-PGPUB; USPAT	OR	OFF	2016/07/06 13:10
L9	10895	(email mail e-mail (electronic NEAR2 mail)) AND (709/206.ccls. g06q10/107.cpc. h04112/585.cpc. h04112/58.cpc.)AND (@AD<"20041122" @RLAD<"20041122")	US-PGPUB; USPAT	OR	OFF	2016/07/06 13:10
L10	1490	(encrypt\$6 AND decrypt\$6) AND (email mail e-mail (electronic NEAR2 mail)) AND (709/206.ccls. g06q10/107.cpc. h04112/585.cpc. h04112/58.cpc.)AND (@AD<"20041122" @RLAD<"20041122")	US-PGPUB; USPAT	OR	OFF	2016/07/06 13:10
L11	1039	((terminal mobile client device phone) NEAR9 (code identifier id number)) AND (encrypt\$6 AND decrypt\$6) AND (email mail e-mail (electronic NEAR2 mail)) AND (709/206.ccls. g06q10/107.cpc. h04112/585.cpc. h04112/58.cpc.)AND (@AD<"20041122" @RLAD<"20041122")	US-PGPUB; USPAT	OR	OFF	2016/07/06 13:10
L12	74	(activat\$5 NEAR5 (code number identifier)) AND ((terminal mobile client device phone) NEAR9 (code identifier id number)) AND (encrypt\$6 AND decrypt\$6) AND (email mail e-mail (electronic NEAR2 mail)) AND (709/206.ccls. g06q10/107.cpc. h04112/585.cpc. h04112/58.cpc.)AND (@AD<"20041122" @RLAD<"20041122")	US-PGPUB; USPAT	OR	OFF	2016/07/06 13:10

EAST Search History

L13	0	((temporary AND permanent) NEAR9 (code identifier id number)) AND (activat\$5 NEAR5 (code numberid identifier)) AND ((terminal mobile client device phone) NEAR9 (code identifier id number)) AND (encrypt\$6 AND decrypt\$6) AND (email mail e-mail (electronic NEAR2 mail)) AND (709/206.ccls. g06q10/107.cpc. h04112/585.cpc. h04112/58.cpc.)AND (@AD<"20041122" @RLAD<"20041122")	US-PGPUB; USPAT	OR	OFF	2016/07/06 13:10
L14	10	((temporary AND permanent) NEAR9 (code identifier id number)) AND (activat\$5 NEAR5 (code numberid identifier)) AND ((terminal mobile client device phone) NEAR9 (code identifier id number)) AND (encrypt\$6 AND decrypt\$6) AND (email mail e-mail (electronic NEAR2 mail)) AND (@AD<"20041122" @RLAD<"20041122")	US-PGPUB; USPAT	OR	OFF	2016/07/06 13:10
L15	21	((temporary AND permanent) NEAR9 (code identifier id number)) AND (activat\$5 NEAR5 (code number id identifier)) AND ((terminal mobile client device phone) NEAR9 (code identifier id number)) AND (encrypt\$6 AND decrypt\$6) AND (email mail e-mail (electronic NEAR2 mail)) AND (@AD<"20041122" @RLAD<"20041122")	US-PGPUB; USPAT	OR	OFF	2016/07/06 13:10
L16	1	"20150149575"	US-PGPUB; USPAT	OR	OFF	2016/07/06 13:10
L17	1	"20060031300"	US-PGPUB; USPAT	OR	OFF	2016/07/06 13:10
L18	1	"20130268384"	US-PGPUB; USPAT	OR	OFF	2016/07/06 17:04

**EAST Search History (Interference)**

< This search history is empty >

**7/6/2016 8:00:50 PM**

**H:\Workspaces\14609189.wsp**

<b><i>Index of Claims</i></b> 	<b>Application/Control No.</b> 14609189	<b>Applicant(s)/Patent Under Reexamination</b> BACKHOLM ET AL.
	<b>Examiner</b> ALAN S CHOU	<b>Art Unit</b> 2451

✓	<b>Rejected</b>
=	<b>Allowed</b>

-	<b>Cancelled</b>
÷	<b>Restricted</b>

N	<b>Non-Elected</b>
I	<b>Interference</b>

A	<b>Appeal</b>
O	<b>Objected</b>

Claims renumbered in the same order as presented by applicant
  CPA
  T.D.
  R.1.47

CLAIM		DATE							
Final	Original	09/25/2015	07/06/2016						
	1	✓	✓						
	2	✓	✓						
	3	✓	✓						
	4	✓	✓						
	5	✓	✓						
	6	✓	✓						
	7	✓	✓						
	8	✓	✓						
	9	✓	✓						
	10	✓	✓						
	11	✓	✓						
	12	✓	✓						
	13	✓	✓						
	14	✓	✓						
	15	✓	✓						
	16	✓	✓						
	17	✓	✓						
	18	✓	✓						
	19	✓	✓						
	20	✓	-						
	21		✓						
	22		✓						
	23		✓						
	24		✓						
	25		✓						
	26		✓						
	27		✓						
	28		✓						
	29		✓						
	30		✓						
	31		✓						
	32		✓						
	33		✓						
	34		✓						
	35		✓						
	36		✓						

<b><i>Index of Claims</i></b> 	<b>Application/Control No.</b> 14609189	<b>Applicant(s)/Patent Under Reexamination</b> BACKHOLM ET AL.
	<b>Examiner</b> ALAN S CHOU	<b>Art Unit</b> 2451

✓	<b>Rejected</b>
=	<b>Allowed</b>

-	<b>Cancelled</b>
÷	<b>Restricted</b>

N	<b>Non-Elected</b>
I	<b>Interference</b>

A	<b>Appeal</b>
O	<b>Objected</b>

Claims renumbered in the same order as presented by applicant
  CPA
  T.D.
  R.1.47

CLAIM		DATE							
Final	Original	09/25/2015	07/06/2016						
	37		✓						
	38		✓						
	39		✓						
	40		✓						
	41		✓						
	42		✓						
	43		✓						
	44		✓						
	45		✓						
	46		✓						
	47		✓						
	48		✓						
	49		✓						
	50		✓						
	51		✓						
	52		✓						
	53		✓						
	54		✓						
	55		✓						





UNITED STATES PATENT AND TRADEMARK OFFICE

UNITED STATES DEPARTMENT OF COMMERCE
United States Patent and Trademark Office
Address: COMMISSIONER FOR PATENTS
P. O. Box 1450
Alexandria, Virginia 22313-1450
www.uspto.gov

Table with 5 columns: APPLICATION NO., FILING DATE, FIRST NAMED INVENTOR, ATTORNEY DOCKET NO., CONFIRMATION NO. Includes sub-tables for EXAMINER (CHOU, ALAN S), ART UNIT (2451), and NOTIFICATION DATE (07/07/2016) DELIVERY MODE (ELECTRONIC).

Please find below and/or attached an Office communication concerning this application or proceeding.

The time period for reply, if any, is set in the attached communication.

Notice of the Office communication was sent electronically on above-indicated "Notification Date" to the following e-mail address(es):

usptomail@nkpatentlaw.com
abackholm@seven.com
eofficeaction@apcoll.com

<b>Applicant-Initiated Interview Summary</b>	<b>Application No.</b> 14/609,189	<b>Applicant(s)</b> BACKHOLM ET AL.	
	<b>Examiner</b> ALAN S. CHOU	<b>Art Unit</b> 2451	

All participants (applicant, applicant's representative, PTO personnel):

(1) ALAN S. CHOU. (3)\_\_\_\_\_.

(2) Mr. Justin Nifong Reg # 59,389. (4)\_\_\_\_\_.

Date of Interview: 30 June 2016.

Type:  Telephonic  Video Conference  
 Personal [copy given to:  applicant  applicant's representative]

Exhibit shown or demonstration conducted:  Yes  No.  
If Yes, brief description: \_\_\_\_\_.

Issues Discussed 101 112 102 103 Others  
(For each of the checked box(es) above, please describe below the issue and detailed description of the discussion)

Claim(s) discussed: 1.

Identification of prior art discussed: N/A.

**Substance of Interview**  
(For each issue discussed, provide a detailed description and indicate if agreement was reached. Some topics may include: identification or clarification of a reference or a portion thereof, claim interpretation, proposed amendments, arguments of any applied references etc...)

The applicant discuss the newly amended limitation of: "temporary identifier based on a connection to the mobile terminal" as claimed. No agreement was reached. The examiner will respond after further search and consideration .

**Applicant recordation instructions:** The formal written reply to the last Office action must include the substance of the interview. (See MPEP section 713.04). If a reply to the last Office action has already been filed, applicant is given a non-extendable period of the longer of one month or thirty days from this interview date, or the mailing date of this interview summary form, whichever is later, to file a statement of the substance of the interview

**Examiner recordation instructions:** Examiners must summarize the substance of any interview of record. A complete and proper recordation of the substance of an interview should include the items listed in MPEP 713.04 for complete and proper recordation including the identification of the general thrust of each argument or issue discussed, a general indication of any other pertinent matters discussed regarding patentability and the general results or outcome of the interview, to include an indication as to whether or not agreement was reached on the issues raised.

Attachment

/ALAN S CHOU/  
Examiner, Art Unit 2451

## Summary of Record of Interview Requirements

### Manual of Patent Examining Procedure (MPEP), Section 713.04, Substance of Interview Must be Made of Record

A complete written statement as to the substance of any face-to-face, video conference, or telephone interview with regard to an application must be made of record in the application whether or not an agreement with the examiner was reached at the interview.

### Title 37 Code of Federal Regulations (CFR) § 1.133 Interviews

#### Paragraph (b)

In every instance where reconsideration is requested in view of an interview with an examiner, a complete written statement of the reasons presented at the interview as warranting favorable action must be filed by the applicant. An interview does not remove the necessity for reply to Office action as specified in §§ 1.111, 1.135. (35 U.S.C. 132)

#### 37 CFR §1.2 Business to be transacted in writing.

All business with the Patent or Trademark Office should be transacted in writing. The personal attendance of applicants or their attorneys or agents at the Patent and Trademark Office is unnecessary. The action of the Patent and Trademark Office will be based exclusively on the written record in the Office. No attention will be paid to any alleged oral promise, stipulation, or understanding in relation to which there is disagreement or doubt.

The action of the Patent and Trademark Office cannot be based exclusively on the written record in the Office if that record is itself incomplete through the failure to record the substance of interviews.

It is the responsibility of the applicant or the attorney or agent to make the substance of an interview of record in the application file, unless the examiner indicates he or she will do so. It is the examiner's responsibility to see that such a record is made and to correct material inaccuracies which bear directly on the question of patentability.

Examiners must complete an Interview Summary Form for each interview held where a matter of substance has been discussed during the interview by checking the appropriate boxes and filling in the blanks. Discussions regarding only procedural matters, directed solely to restriction requirements for which interview recordation is otherwise provided for in Section 812.01 of the Manual of Patent Examining Procedure, or pointing out typographical errors or unreadable script in Office actions or the like, are excluded from the interview recordation procedures below. Where the substance of an interview is completely recorded in an Examiners Amendment, no separate Interview Summary Record is required.

The Interview Summary Form shall be given an appropriate Paper No., placed in the right hand portion of the file, and listed on the "Contents" section of the file wrapper. In a personal interview, a duplicate of the Form is given to the applicant (or attorney or agent) at the conclusion of the interview. In the case of a telephone or video-conference interview, the copy is mailed to the applicant's correspondence address either with or prior to the next official communication. If additional correspondence from the examiner is not likely before an allowance or if other circumstances dictate, the Form should be mailed promptly after the interview rather than with the next official communication.

The Form provides for recordation of the following information:

- Application Number (Series Code and Serial Number)
- Name of applicant
- Name of examiner
- Date of interview
- Type of interview (telephonic, video-conference, or personal)
- Name of participant(s) (applicant, attorney or agent, examiner, other PTO personnel, etc.)
- An indication whether or not an exhibit was shown or a demonstration conducted
- An identification of the specific prior art discussed
- An indication whether an agreement was reached and if so, a description of the general nature of the agreement (may be by attachment of a copy of amendments or claims agreed as being allowable). Note: Agreement as to allowability is tentative and does not restrict further action by the examiner to the contrary.
- The signature of the examiner who conducted the interview (if Form is not an attachment to a signed Office action)

It is desirable that the examiner orally remind the applicant of his or her obligation to record the substance of the interview of each case. It should be noted, however, that the Interview Summary Form will not normally be considered a complete and proper recordation of the interview unless it includes, or is supplemented by the applicant or the examiner to include, all of the applicable items required below concerning the substance of the interview.

A complete and proper recordation of the substance of any interview should include at least the following applicable items:

- 1) A brief description of the nature of any exhibit shown or any demonstration conducted,
- 2) an identification of the claims discussed,
- 3) an identification of the specific prior art discussed,
- 4) an identification of the principal proposed amendments of a substantive nature discussed, unless these are already described on the Interview Summary Form completed by the Examiner,
- 5) a brief identification of the general thrust of the principal arguments presented to the examiner,  
(The identification of arguments need not be lengthy or elaborate. A verbatim or highly detailed description of the arguments is not required. The identification of the arguments is sufficient if the general nature or thrust of the principal arguments made to the examiner can be understood in the context of the application file. Of course, the applicant may desire to emphasize and fully describe those arguments which he or she feels were or might be persuasive to the examiner.)
- 6) a general indication of any other pertinent matters discussed, and
- 7) if appropriate, the general results or outcome of the interview unless already described in the Interview Summary Form completed by the examiner.

Examiners are expected to carefully review the applicant's record of the substance of an interview. If the record is not complete and accurate, the examiner will give the applicant an extendable one month time period to correct the record.

### Examiner to Check for Accuracy

If the claims are allowable for other reasons of record, the examiner should send a letter setting forth the examiner's version of the statement attributed to him or her. If the record is complete and accurate, the examiner should place the indication, "Interview Record OK" on the paper recording the substance of the interview along with the date and the examiner's initials.

<b>INFORMATION DISCLOSURE STATEMENT BY APPLICANT</b> ( Not for submission under 37 CFR 1.99)	Application Number	14609189
	Filing Date	2015-01-29
	First Named Inventor	Backholm
	Art Unit	2642
	Examiner Name	CHOU, ALAN S.
	Attorney Docket Number	455/006/8 UTIL

**U.S. PATENTS**

Examiner Initial*	Cite No	Patent Number	Kind Code <sup>1</sup>	Issue Date	Name of Patentee or Applicant of cited Document	Pages, Columns, Lines where Relevant Passages or Relevant Figures Appear
	1					

If you wish to add additional U.S. Patent citation information please click the Add button.

**U.S. PATENT APPLICATION PUBLICATIONS**

Examiner Initial*	Cite No	Publication Number	Kind Code <sup>1</sup>	Publication Date	Name of Patentee or Applicant of cited Document	Pages, Columns, Lines where Relevant Passages or Relevant Figures Appear
	1					

If you wish to add additional U.S. Published Application citation information please click the Add button.

**FOREIGN PATENT DOCUMENTS**

Examiner Initial*	Cite No	Foreign Document Number <sup>3</sup>	Country Code <sup>2</sup> i	Kind Code <sup>4</sup>	Publication Date	Name of Patentee or Applicant of cited Document	Pages, Columns, Lines where Relevant Passages or Relevant Figures Appear	T <sup>5</sup>
	1							

If you wish to add additional Foreign Patent Document citation information please click the Add button.

**NON-PATENT LITERATURE DOCUMENTS**

Examiner Initials*	Cite No	Include name of the author (in CAPITAL LETTERS), title of the article (when appropriate), title of the item (book, magazine, journal, serial, symposium, catalog, etc), date, pages(s), volume-issue number(s), publisher, city and/or country where published.	T <sup>5</sup>

<b>INFORMATION DISCLOSURE STATEMENT BY APPLICANT ( Not for submission under 37 CFR 1.99)</b>	Application Number	14609189
	Filing Date	2015-01-29
	First Named Inventor	Backholm
	Art Unit	2642
	Examiner Name	CHOU, ALAN S.
	Attorney Docket Number	455/006/8 UTIL

1	EPO, Application No. 05813041.0, File history from 11-21-2005 to 04-07-2016.
2	EPO, Application No. 05813045.1, File history from 11-21-2005 to 04-07-2016.
3	
4	

If you wish to add additional non-patent literature document citation information please click the Add button

**EXAMINER SIGNATURE**

Examiner Signature	<input type="text"/>	Date Considered	<input type="text"/>
--------------------	----------------------	-----------------	----------------------

\*EXAMINER: Initial if reference considered, whether or not citation is in conformance with MPEP 609. Draw line through a citation if not in conformance and not considered. Include copy of this form with next communication to applicant.

<sup>1</sup> See Kind Codes of USPTO Patent Documents at [www.USPTO.GOV](http://www.USPTO.GOV) or MPEP 901.04. <sup>2</sup> Enter office that issued the document, by the two-letter code (WIPO Standard ST.3). <sup>3</sup> For Japanese patent documents, the indication of the year of the reign of the Emperor must precede the serial number of the patent document. <sup>4</sup> Kind of document by the appropriate symbols as indicated on the document under WIPO Standard ST.16 if possible. <sup>5</sup> Applicant is to place a check mark here if English language translation is attached.

<b>INFORMATION DISCLOSURE STATEMENT BY APPLICANT</b> ( Not for submission under 37 CFR 1.99)	Application Number	14609189
	Filing Date	2015-01-29
	First Named Inventor	Backholm
	Art Unit	2642
	Examiner Name	CHOU, ALAN S.
	Attorney Docket Number	455/006/8 UTIL

**CERTIFICATION STATEMENT**

Please see 37 CFR 1.97 and 1.98 to make the appropriate selection(s):

That each item of information contained in the information disclosure statement was first cited in any communication from a foreign patent office in a counterpart foreign application not more than three months prior to the filing of the information disclosure statement. See 37 CFR 1.97(e)(1).

**OR**

That no item of information contained in the information disclosure statement was cited in a communication from a foreign patent office in a counterpart foreign application, and, to the knowledge of the person signing the certification after making reasonable inquiry, no item of information contained in the information disclosure statement was known to any individual designated in 37 CFR 1.56(c) more than three months prior to the filing of the information disclosure statement. See 37 CFR 1.97(e)(2).

See attached certification statement.

The fee set forth in 37 CFR 1.17 (p) has been submitted herewith.

A certification statement is not submitted herewith.

**SIGNATURE**

A signature of the applicant or representative is required in accordance with CFR 1.33, 10.18. Please see CFR 1.4(d) for the form of the signature.

Signature	/Justin R. Nifong/	Date (YYYY-MM-DD)	2016-04-20
Name/Print	Justin R. Nifong	Registration Number	59389

This collection of information is required by 37 CFR 1.97 and 1.98. The information is required to obtain or retain a benefit by the public which is to file (and by the USPTO to process) an application. Confidentiality is governed by 35 U.S.C. 122 and 37 CFR 1.14. This collection is estimated to take 1 hour to complete, including gathering, preparing and submitting the completed application form to the USPTO. Time will vary depending upon the individual case. Any comments on the amount of time you require to complete this form and/or suggestions for reducing this burden, should be sent to the Chief Information Officer, U.S. Patent and Trademark Office, U.S. Department of Commerce, P.O. Box 1450, Alexandria, VA 22313-1450. **DO NOT SEND FEES OR COMPLETED FORMS TO THIS ADDRESS. SEND TO: Commissioner for Patents, P.O. Box 1450, Alexandria, VA 22313-1450.**

## Privacy Act Statement

The Privacy Act of 1974 (P.L. 93-579) requires that you be given certain information in connection with your submission of the attached form related to a patent application or patent. Accordingly, pursuant to the requirements of the Act, please be advised that: (1) the general authority for the collection of this information is 35 U.S.C. 2(b)(2); (2) furnishing of the information solicited is voluntary; and (3) the principal purpose for which the information is used by the U.S. Patent and Trademark Office is to process and/or examine your submission related to a patent application or patent. If you do not furnish the requested information, the U.S. Patent and Trademark Office may not be able to process and/or examine your submission, which may result in termination of proceedings or abandonment of the application or expiration of the patent.

The information provided by you in this form will be subject to the following routine uses:

1. The information on this form will be treated confidentially to the extent allowed under the Freedom of Information Act (5 U.S.C. 552) and the Privacy Act (5 U.S.C. 552a). Records from this system of records may be disclosed to the Department of Justice to determine whether the Freedom of Information Act requires disclosure of these records.
2. A record from this system of records may be disclosed, as a routine use, in the course of presenting evidence to a court, magistrate, or administrative tribunal, including disclosures to opposing counsel in the course of settlement negotiations.
3. A record in this system of records may be disclosed, as a routine use, to a Member of Congress submitting a request involving an individual, to whom the record pertains, when the individual has requested assistance from the Member with respect to the subject matter of the record.
4. A record in this system of records may be disclosed, as a routine use, to a contractor of the Agency having need for the information in order to perform a contract. Recipients of information shall be required to comply with the requirements of the Privacy Act of 1974, as amended, pursuant to 5 U.S.C. 552a(m).
5. A record related to an International Application filed under the Patent Cooperation Treaty in this system of records may be disclosed, as a routine use, to the International Bureau of the World Intellectual Property Organization, pursuant to the Patent Cooperation Treaty.
6. A record in this system of records may be disclosed, as a routine use, to another federal agency for purposes of National Security review (35 U.S.C. 181) and for review pursuant to the Atomic Energy Act (42 U.S.C. 218(c)).
7. A record from this system of records may be disclosed, as a routine use, to the Administrator, General Services, or his/her designee, during an inspection of records conducted by GSA as part of that agency's responsibility to recommend improvements in records management practices and programs, under authority of 44 U.S.C. 2904 and 2906. Such disclosure shall be made in accordance with the GSA regulations governing inspection of records for this purpose, and any other relevant (i.e., GSA or Commerce) directive. Such disclosure shall not be used to make determinations about individuals.
8. A record from this system of records may be disclosed, as a routine use, to the public after either publication of the application pursuant to 35 U.S.C. 122(b) or issuance of a patent pursuant to 35 U.S.C. 151. Further, a record may be disclosed, subject to the limitations of 37 CFR 1.14, as a routine use, to the public if the record was filed in an application which became abandoned or in which the proceedings were terminated and which application is referenced by either a published application, an application open to public inspections or an issued patent.
9. A record from this system of records may be disclosed, as a routine use, to a Federal, State, or local law enforcement agency, if the USPTO becomes aware of a violation or potential violation of law or regulation.

## Electronic Patent Application Fee Transmittal

<b>Application Number:</b>	14609189			
<b>Filing Date:</b>	29-Jan-2015			
<b>Title of Invention:</b>	Messaging centre for forwarding e-mail			
<b>First Named Inventor/Applicant Name:</b>	Ari Backholm			
<b>Filer:</b>	Justin Robert Nifong/Heather Rowland			
<b>Attorney Docket Number:</b>	455/006/8 UTIL			
Filed as Small Entity				
<b>Filing Fees for Utility under 35 USC 111(a)</b>				
<b>Description</b>	<b>Fee Code</b>	<b>Quantity</b>	<b>Amount</b>	<b>Sub-Total in USD(\$)</b>
<b>Basic Filing:</b>				
<b>Pages:</b>				
<b>Claims:</b>				
<b>Miscellaneous-Filing:</b>				
<b>Petition:</b>				
<b>Patent-Appeals-and-Interference:</b>				
<b>Post-Allowance-and-Post-Issuance:</b>				
<b>Extension-of-Time:</b>				



Description	Fee Code	Quantity	Amount	Sub-Total in USD(\$)
<b>Miscellaneous:</b>				
Submission- Information Disclosure Stmt	2806	1	90	90
<b>Total in USD (\$)</b>				<b>90</b>

## Electronic Acknowledgement Receipt

<b>EFS ID:</b>	25548008
<b>Application Number:</b>	14609189
<b>International Application Number:</b>	
<b>Confirmation Number:</b>	5037
<b>Title of Invention:</b>	Messaging centre for forwarding e-mail
<b>First Named Inventor/Applicant Name:</b>	Ari Backholm
<b>Customer Number:</b>	118194
<b>Filer:</b>	Justin Robert Nifong/Heather Rowland
<b>Filer Authorized By:</b>	Justin Robert Nifong
<b>Attorney Docket Number:</b>	455/006/8 UTIL
<b>Receipt Date:</b>	20-APR-2016
<b>Filing Date:</b>	29-JAN-2015
<b>Time Stamp:</b>	15:57:11
<b>Application Type:</b>	Utility under 35 USC 111(a)

### Payment information:

Submitted with Payment	yes
Payment Type	Credit Card
Payment was successfully received in RAM	\$90
RAM confirmation Number	2723
Deposit Account	
Authorized User	

The Director of the USPTO is hereby authorized to charge indicated fees and credit any overpayment as follows:

<b>File Listing:</b>					
<b>Document Number</b>	<b>Document Description</b>	<b>File Name</b>	<b>File Size(Bytes)/ Message Digest</b>	<b>Multi Part /.zip</b>	<b>Pages (if appl.)</b>
1	Information Disclosure Statement (IDS) Form (SB08)	455-006-8UTIL-IDS-20160420.pdf	612219 12c5c3293690c43877fb1583a4a13e9fa542a5a2	no	4
<b>Warnings:</b>					
<b>Information:</b>					
A U.S. Patent Number Citation or a U.S. Publication Number Citation is required in the Information Disclosure Statement (IDS) form for autoloading of data into USPTO systems. You may remove the form to add the required data in order to correct the Informational Message if you are citing U.S. References. If you chose not to include U.S. References, the image of the form will be processed and be made available within the Image File Wrapper (IFW) system. However, no data will be extracted from this form. Any additional data such as Foreign Patent Documents or Non Patent Literature will be manually reviewed and keyed into USPTO systems.					
2	Non Patent Literature	File-history-455-006-EP01.pdf	6197242 404046160872b9753c22eb92dff82700d461406	no	128
<b>Warnings:</b>					
<b>Information:</b>					
3	Non Patent Literature	File-history-455-006-EP02.pdf	10620875 aeeb34831517e8799e1260dbe7f9a10ebba5c90b	no	216
<b>Warnings:</b>					
<b>Information:</b>					
4	Fee Worksheet (SB06)	fee-info.pdf	30341 6216e98d97dd832761a7a4e23b5849dad0f07814	no	2
<b>Warnings:</b>					
<b>Information:</b>					
<b>Total Files Size (in bytes):</b>			17460677		

**This Acknowledgement Receipt evidences receipt on the noted date by the USPTO of the indicated documents, characterized by the applicant, and including page counts, where applicable. It serves as evidence of receipt similar to a Post Card, as described in MPEP 503.**

**New Applications Under 35 U.S.C. 111**

**If a new application is being filed and the application includes the necessary components for a filing date (see 37 CFR 1.53(b)-(d) and MPEP 506), a Filing Receipt (37 CFR 1.54) will be issued in due course and the date shown on this Acknowledgement Receipt will establish the filing date of the application.**

**National Stage of an International Application under 35 U.S.C. 371**

**If a timely submission to enter the national stage of an international application is compliant with the conditions of 35 U.S.C. 371 and other applicable requirements a Form PCT/DO/EO/903 indicating acceptance of the application as a national stage submission under 35 U.S.C. 371 will be issued in addition to the Filing Receipt, in due course.**

**New International Application Filed with the USPTO as a Receiving Office**

**If a new international application is being filed and the international application includes the necessary components for an international filing date (see PCT Article 11 and MPEP 1810), a Notification of the International Application Number and of the International Filing Date (Form PCT/RO/105) will be issued in due course, subject to prescriptions concerning national security, and the date shown on this Acknowledgement Receipt will establish the international filing date of the application.**

## Electronic Patent Application Fee Transmittal

<b>Application Number:</b>	14609189			
<b>Filing Date:</b>	29-Jan-2015			
<b>Title of Invention:</b>	Messaging centre for forwarding e-mail			
<b>First Named Inventor/Applicant Name:</b>	Ari Backholm			
<b>Filer:</b>	Justin Robert Nifong			
<b>Attorney Docket Number:</b>	455/006/8 UTIL			
Filed as Small Entity				
<b>Filing Fees for Utility under 35 USC 111(a)</b>				
<b>Description</b>	<b>Fee Code</b>	<b>Quantity</b>	<b>Amount</b>	<b>Sub-Total in USD(\$)</b>
<b>Basic Filing:</b>				
<b>Pages:</b>				
<b>Claims:</b>				
<b>Miscellaneous-Filing:</b>				
<b>Petition:</b>				
<b>Patent-Appeals-and-Interference:</b>				
<b>Post-Allowance-and-Post-Issuance:</b>				
<b>Extension-of-Time:</b>				

Description	Fee Code	Quantity	Amount	Sub-Total in USD(\$)
Extension - 3 months with \$0 paid	2253	1	700	700
<b>Miscellaneous:</b>				
<b>Total in USD (\$)</b>				<b>700</b>

## Electronic Acknowledgement Receipt

<b>EFS ID:</b>	25380596
<b>Application Number:</b>	14609189
<b>International Application Number:</b>	
<b>Confirmation Number:</b>	5037
<b>Title of Invention:</b>	Messaging centre for forwarding e-mail
<b>First Named Inventor/Applicant Name:</b>	Ari Backholm
<b>Customer Number:</b>	118194
<b>Filer:</b>	Justin Robert Nifong
<b>Filer Authorized By:</b>	
<b>Attorney Docket Number:</b>	455/006/8 UTIL
<b>Receipt Date:</b>	02-APR-2016
<b>Filing Date:</b>	29-JAN-2015
<b>Time Stamp:</b>	00:05:03
<b>Application Type:</b>	Utility under 35 USC 111(a)

### Payment information:

Submitted with Payment	yes
Payment Type	Credit Card
Payment was successfully received in RAM	\$700
RAM confirmation Number	6248
Deposit Account	506191
Authorized User	NIFONG, JUSTIN

The Director of the USPTO is hereby authorized to charge indicated fees and credit any overpayment as follows:

Charge any Additional Fees required under 37 CFR 1.16 (National application filing, search, and examination fees)

Charge any Additional Fees required under 37 CFR 1.17 (Patent application and reexamination processing fees)

Charge any Additional Fees required under 37 CFR 1.19 (Document supply fees)  
 Charge any Additional Fees required under 37 CFR 1.20 (Post Issuance fees)  
 Charge any Additional Fees required under 37 CFR 1.21 (Miscellaneous fees and charges)

**File Listing:**

Document Number	Document Description	File Name	File Size(Bytes)/ Message Digest	Multi Part /.zip	Pages (if appl.)
1	Fee Worksheet (SB06)	fee-info.pdf	30614 <small>75b509fd375c319286452604f3c499f0464d1d68</small>	no	2

**Warnings:**

**Information:**

<b>Total Files Size (in bytes):</b>	30614
-------------------------------------	-------

**This Acknowledgement Receipt evidences receipt on the noted date by the USPTO of the indicated documents, characterized by the applicant, and including page counts, where applicable. It serves as evidence of receipt similar to a Post Card, as described in MPEP 503.**

**New Applications Under 35 U.S.C. 111**

If a new application is being filed and the application includes the necessary components for a filing date (see 37 CFR 1.53(b)-(d) and MPEP 506), a Filing Receipt (37 CFR 1.54) will be issued in due course and the date shown on this Acknowledgement Receipt will establish the filing date of the application.

**National Stage of an International Application under 35 U.S.C. 371**

If a timely submission to enter the national stage of an international application is compliant with the conditions of 35 U.S.C. 371 and other applicable requirements a Form PCT/DO/EO/903 indicating acceptance of the application as a national stage submission under 35 U.S.C. 371 will be issued in addition to the Filing Receipt, in due course.

**New International Application Filed with the USPTO as a Receiving Office**

If a new international application is being filed and the international application includes the necessary components for an international filing date (see PCT Article 11 and MPEP 1810), a Notification of the International Application Number and of the International Filing Date (Form PCT/RO/105) will be issued in due course, subject to prescriptions concerning national security, and the date shown on this Acknowledgement Receipt will establish the international filing date of the application.



**COMMUNICATION TO THE UNITED STATES PATENT AND TRADEMARK OFFICE**

Appl. No. : 14/609,189 Confirmation No. 5037  
Applicant : Seven Networks, LLC  
Filed : 2015-01-29  
TC/A.U. : 2447  
Examiner : Chou, Alan  
Docket No. : 455/006/8 UTIL  
Customer No. : 118194

Mail Stop Amendment  
Commissioner for Patents  
P.O. Box 1450  
Alexandria, VA 22313-1450

**Response to Office Action**

Examiner:

**Amendments to the Claims** begin on page 2 of this paper.

**Remarks** begin on page 11 of this paper.

**AMENDMENTS TO THE CLAIMS**

1. (Currently Amended) A method for forwarding an e-mail message from an e-mail server to a mobile terminal, the method comprising:

receiving an e-mail message associated with an e-mail address of a user of a mobile terminal and sent by an e-mail server,

wherein ~~[[an]]~~ the e-mail address of the mobile terminal is associated with an identifier and encryption information of the mobile terminal,

wherein the identifier is generated by the mobile terminal, ~~receiving the e-mail message associated with the e-mail address and sent by the e-mail server,~~

encrypting the e-mail message using ~~[[the]]~~ encryption information associated with a temporary identifier e-mail address,

wherein the temporary identifier is based on a connection to the mobile terminal; and transmitting the encrypted e-mail message to the mobile terminal.

2. (Currently Amended) The method of claim 1, further comprising identifying the mobile terminal based on the e-mail address of the e-mail message and the association with the ~~permanent~~ identifier of the mobile terminal.

3. (Previously Presented) The method of claim 1, wherein encrypting the e-mail message further comprises packing the e-mail message by omitting at least part of the e-mail message when at least part of the e-mail message exceeds a predetermined size specification.

4. (Previously Presented) The method of claim 3, wherein size specification is set by a user of the mobile terminal.

5. (Previously Presented) The method of claim 3, wherein the omitted part of the e-mail message is the e-mail address.

6. (Previously Presented) The method of claim 2, further comprising adding the e-mail address to a reply message sent by the mobile terminal.

7. (Previously Presented) The method of claim 1, further comprising receiving the encryption information generated by the mobile terminal.

8. (Previously Presented) The method of claim 1, wherein the encryption information is based on an activation code of the mobile terminal.

9. (Currently Amended) The method of claim 1, wherein ~~[[the]]~~ a messaging center ~~entre~~ transmits the e-mail message to the mobile terminal using ~~a temporary~~ the identifier of the mobile terminal.

10. (Previously Presented) The method of claim 1, wherein mobile terminal receives and decrypts the e-mail message using the encryption information.

11. (Previously Presented) The method of claim 3, wherein the mobile terminal unpacks the e-mail message.

12. (Currently Amended) A system for forwarding an e-mail message from an e-mail server to a mobile terminal, the system comprising:

~~wherein an e-mail address of the mobile terminal is associated with an identifier and encryption information;~~

a memory configured for storing at least one of ~~[[the]]~~ an e-mail address of ~~[[the]]~~ a user of a mobile terminal, ~~[[the]]~~ and an ~~associated identifier of the mobile terminal, and the associated encryption information;~~

wherein the e-mail address is associated with the identifier,

wherein the mobile terminal generates the identifier,

a processor configured for:

~~an encryption engine configured to encrypting~~ the e-mail message using ~~[[the]]~~ encryption information associated with a temporary identifier, wherein the e-mail message is received from the e-mail server;

~~a processor configured to execute software stored in memory, the execution of the~~

~~software resulting in the identification of~~ identifying the mobile terminal based on the e-mail address of the e-mail message and the association with identifier of the mobile terminal; and

~~a communications interface configured to~~ transmitting the encrypted e-mail message to the identified mobile terminal,

wherein the temporary identifier is based on a connection to the mobile terminal.

13. (Currently Amended) The system of claim 12, wherein the processor ~~communications interface~~ is further configured to receive the e-mail message from the e-mail server.

14. (Currently Amended) The system of claim 12, wherein the processor ~~communications interface~~ is further configured to receive the encryption information and to provide the encryption information to the memory for storage.

15. (Currently Amended) The system of claim 12, wherein the processor ~~encryption engine~~ is further configured to pack the e-mail message.

16. (Currently Amended) The system of claim 15, wherein the processor is further ~~comprising a packing filter~~ configured to omit at least part of the e-mail message when the at least part of the e-mail message exceeds a predetermined size specification.

17. (Currently Amended) The system of claim 16, wherein the processor ~~communications interface~~ is further configured to receive user input concerning the size specification.

18. (Previously Presented) The system of claim 12, wherein the mobile terminal receives and decrypts the e-mail message using the encryption information.

19. (Previously Presented) The system of claim 18, wherein the mobile terminal unpacks the message.

20. (Canceled)

21. (New) A mobile device comprising:  
a radio;  
a memory;  
a processor configured for controlling a mobile device to:  
    generate an identifier; and  
    receive, from a server, an encrypted e-mail message associated with an e-mail address of a user of the mobile device, wherein the e-mail address is associated with the identifier,  
    decrypt the e-mail message using encryption information associated with a temporary identifier,  
    wherein the temporary identifier is based on a connection to the server.
22. (New) A method for forwarding an e-mail message from an e-mail server to a mobile terminal, the method comprising:  
    generating an identifier associated with an e-mail address of a user of a mobile terminal;  
    receiving an e-mail message associated with the e-mail address and sent by an e-mail server;  
    encrypting the e-mail message using encryption information associated with a temporary identifier; and  
    transmitting the encrypted e-mail message to the mobile terminal,  
    wherein the temporary identifier is based on a connection the mobile terminal.
23. (New) A device comprising:  
a radio;  
a control system communicatively coupled to the radio and comprising a processor and memory containing instructions executable by the processor whereby the device is operable to:  
    receive information including a service activation code from a remote device;  
    register the remote device for access to a messaging account using the service activation code;

receive a message for the messaging account;  
encrypt the message using an encryption key; and  
send the message to the remote device,

wherein the device is authenticated to access the messaging account.

24. (New) The device of claim 23, wherein the information including the service activation code is received by the device in response to user input at the remote device.

25. (New) The device of claim 23, wherein the information including the service activation code is received by the device in an off-line communication.

26. (New) The device of claim 25, wherein the off-line communication involves a local connection.

27. (New) The device of claim 26, wherein the local connection is one of a wired interface, a short range wireless interface, Bluetooth™, or an optical interface.

28. (New) The device of claim 25, wherein the off-line communication prevents eavesdropping of the service activation code.

29. (New) The device of claim 23, wherein the authentication of the device relies on the authentication of the messaging account.

30. (New) The device of claim 29, wherein the authentication of the messaging account includes a username and password.

31. (New) The device of claim 23, wherein the encryption key is the service activation code.

32. (New) The device of claim 23, wherein the encryption key is derived from the service activation code.

33. (New) The device of claim 23, wherein the encryption key is a subset of the service activation code.

34. (New) The device of claim 23, wherein the encryption key is closely related to the service activation code.

35. (New) The device of claim 23, wherein the device is further operable to:  
store an association between at least two of the encryption key, the messaging account, an identifier of the remote device, and the service activation code.

36. (New) The device of claim 23, wherein the message is sent to the remote device through an intermediate device.

37. (New) A method for sharing a messaging account, the method comprising:  
authenticating a device for access to the messaging account;  
receiving information including a service activation code from a remote device;  
registering the remote device for access to the messaging account using the service activation code;  
receiving a message for the messaging account;  
encrypting the message using an encryption key; and  
sending the message to the remote device.

38. (New) The method of claim 37, wherein the information including the service activation code is received by the device in response to user input at the remote device.

39. (New) The method of claim 38, wherein the information including the service activation code is received by the device in an off-line communication.

40. (New) The method of claim 39, wherein the off-line communication involves one of a local connection, a wired interface, a short range wireless interface, Bluetooth™, or an optical interface.

41. (New) The method of claim 39, wherein the off-line communication prevents eavesdropping of the service activation code.

42. (New) The method of claim 37, wherein the authentication of the device relies on the authentication of the messaging system.

43. (New) The method of claim 42, wherein the authentication of the messaging system includes a username and password.

44. (New) The method of claim 37, wherein the encryption key is the service activation code.

45. (New) The method of claim 37, wherein the encryption key is derived from the service activation code.

46. (New) The method of claim 37, wherein the encryption key is a subset of the service activation code.

47. (New) The method of claim 37, wherein the encryption key is closely related to the service activation code.

48. (New) The method of claim 37, wherein the method further comprises:  
storing an association between the encryption key, the messaging account, an identifier of the remote device, and the service activation code.

49. (New) The device of claim 36, wherein the encryption key is associated with a temporary identifier, wherein the temporary identifier is based on a connection to the intermediate



device.

50. (New) The method of claim 37, wherein the message is sent to the remote device through an intermediate device.

51. (New) The method of claim 37, wherein the encryption key is associated with a temporary identifier, wherein the temporary identifier is based on a connection to the intermediary device.

52. (New) The method of claim 1, wherein the identifier is associated with the temporary identifier.

53. (New) The system of claim 12, wherein the identifier is associated with the temporary identifier.

54. (New) A non-transient computer-readable medium containing program instructions for causing a device to perform a method, the method comprising:  
generating an identifier; and  
receiving, from a server, an encrypted e-mail message associated with an e-mail address of a user of the mobile device, wherein the e-mail address is associated with the identifier,  
decrypting the e-mail message using encryption information associated with a temporary identifier,  
wherein the temporary identifier is based on a connection to the server.

55. (New) A non-transient computer-readable medium containing program instructions for causing a device to perform a method, the method comprising:  
receiving information including a service activation code from a remote device;  
registering the remote device for access to a messaging account using the service activation code;

Amdt. dated April 1 2016  
Appl. No. 14/609,189

receiving a message for the messaging account;  
encrypting the message using an encryption key; and  
sending the message to the remote device,  
wherein the device is authenticated to access the messaging account.

**REMARKS**

This is in response to the Office Action mailed October 1, 2015.

Claims 1-20 stand rejected on the ground of nonstatutory double patenting as being unpatentable over claim 1 of US Patent No. 7, 706,781 and US Patent No. 7,643,818. Applicant is choosing to delay treatment of this double patenting rejection at this time.

Claims 1-20 stand rejected under 35 USC 101 as allegedly being directed to non-statutory subject matter.

Claim 20 is further rejected under 35 USC 101 as being allegedly directed to non-statutory subject matter because the claim is directed towards computer-readable storage medium.

Claim 12 is being treated as means plus function. In furtherance of this, claims 12-29 stand rejected under 35 USC 112 as being indefinite for failing to provide written description support.

Claims 1-2, 6-10, 12-14, 18, and 20 stand rejected under 35 USC 103(a) as being unpatentable over Little in view of Turunen. Claims 3-5, 11, 16-17, and 19 stand rejected under 35 USC 103(a) as being unpatentable over Little in view of Turunen and further in view of Kock.

**AMENDED CLAIM 1 IS PATENTABLE OVER THE REFERENCES OF RECORD**

Amended claim 1 recites:

*A method for forwarding an e-mail message from an e-mail server to a mobile terminal, the method comprising:*

*receiving an e-mail message associated with an e-mail address of a user of a mobile terminal and sent by an e-mail server,*

*wherein ~~[[an]]~~ the e-mail address of the mobile terminal is associated with an identifier of the mobile terminal and encryption information and the mobile terminal generates the identifier, ~~receiving the e-mail message associated with the e-mail address and sent by the e-mail server;~~*

*encrypting the e-mail message using the encryption information associated with the e-mail address; and*

*transmitting the encrypted e-mail message to the mobile terminal.*

The prior art teaches identifiers that are not generated by the mobile device (for example, an IMSI or phone number). *[Furthermore, in the method according to a preferred embodiment of*

Amdt. dated April 1 2016  
Appl. No. 14/609,189

*the present invention, message communication of the activation of the packet data connection is performed preferably in such a way that the gateway support node GGSN further transmits an identification of the wireless terminal MSI, such as the international mobile subscriber identity IMSI, and the IP address of the wireless terminal to the multimedia message server MMSV (stage 506).]*

The technical advantage of having the mobile device generate the identifier is improved security of the mobile device and encryption. This allows a developer to identify your users without having to gain access to identifiers generated by others (such as the IMSI of Tuneran, which requires knowing the IMSI as provided by the mobile device manufacturer).

**THE REJECTION OF AMENDED CLAIM 1 OVER ALICE V CLS BANK IS  
IMPROPER**

Courts have long recognized that all inventions “involve” an abstract idea to some extent. The Supreme Court in *Alice* cautioned that “we tread carefully in construing this exclusionary principle lest it swallow all of patent law.” The Interim Guidance on Patent Subject Matter Eligibility, effective December 16, 2014 for all applications and the more recent July 2015 Update On Subject Matter Eligibility (referred to hereafter as “Guidance”) recognize this important aspect of the analysis and tells Examiners to consider whether a claim is “directed to” an abstract idea, and elaborates that Examiners must consider whether the abstract idea is “set forth or described” in the claim. Thus, the Office now demands examination of the actual claim language rather than relying on what is often an overbroad “gist” or caricature abstracting the claim as it appears that the Examiner has done in the present Office Action.

The Guidance further states that “claims... may recite a judicial exception, but are directed to inventions that clearly do not seek to tie up the judicial exception.” This is supported by the *Alice* and other court guidance teaching that the “judicial exception” is rooted in “preemption” of abstract ideas. This indicates that a “directed to inventions” analysis must be done and involve consideration of whether and how the invention improves over the prior art (or perhaps only long-standing, “routine” prior art).

The Guidance also instructs Examiners that: “It is important to consider the claim as

whole. Individual elements viewed on their own may not appear to add significantly more to the claim, but when combined may amount to significantly more than the exception.” Thus rejections indicating only that each claim feature aside from the “abstract idea” represents nothing more than a conventional computer operation are no longer sufficient as they do not meet the standards put forth by the Guidance.

Similarly, the Guidance instructs that claims do not violate Section 101 when “[a]dding a specific limitation other than what is well-understood, routine and conventional in the field, or adding unconventional steps that confine the claim to a particular useful application.” The Guidance additionally clarifies that a limitation may be enough to qualify as “significantly more” where the abstract idea is implemented “with, or by use of, a particular machine,” and further refers to the machine prong of the machine-or-transformation test of *Bilski*, which instructs that the “machine-or-transformation test” remains a “useful clue” to deciding whether a claim is abstract.

Although the Alice Court did not provide a definition of “abstract idea,” the Alice Court provided several clues as to what it considers to be an “abstract idea.” For example, the Alice Court referred to its *Bilski* decision and stated: “The Court explained that “[h]edging is a fundamental economic practice long prevalent in our system of commerce and taught in any introductory finance class.”[1] The concept of “hedging” as recited by the claims in suit was therefore a patent-ineligible “abstract idea, just like the algorithms at issue in *Benson and Flook*.”[2] The Alice Court also addressed the claims in *Alice*, stating: “[L]ike the risk hedging in *Bilski*, the concept of intermediated settlement is “a fundamental economic practice long prevalent in our system of commerce.” ... “The use of a third-party intermediary (or “clearing house”) is also a building block of the modern economy.” ... “Thus, intermediated settlement, like hedging, is an “abstract idea” beyond the scope of §101.”[3] The Alice Court’s statements strongly suggests or implies that it intended to limit the concept of “abstract ideas” to concepts which are fundamental and long prevalent, such as concepts which have been well-known and extensively used for hundreds of years – like the hedging of *Bilski* and the intermediated settlement of *Alice*.

The examiner uses the following rationale in applying the 101 rejection.

9. Claims 1-20 are rejected under 35 U.S.C. 101 because the claimed invention is directed to non-statutory subject matter. The claim(s) does/do not fall within at least one of the four categories of patent eligible subject matter because the claimed invention is directed to a judicial exception (i.e., a law of nature, a natural phenomenon, or an abstract idea) without significantly more. Claims 1-20 are directed to the abstract idea of associating e-mail address with an identifier and encryption information, encrypting the e-mail with the encryption information, and transmitting the encrypted e-mail. The claimed invention falls under the category to organize, store and retrieve email data with encryption as an extra step of processing the stored data. The claims do not include additional elements that are sufficient to amount to significantly more than the judicial exception because the claim has only generic computer components such as: mobile terminal, e-mail server, system with memory and processor, and thus are not sufficient to amount to significantly more.

Claim 1 has been further amended to recite that the mobile terminal generates the identifier. The claim features **do not embody “abstract ideas” as outlined by Alice**. For example, such operations neither embody nor are analogous to fundamental economic practices (e.g., intermediated settlement), methods of organizing human activities (e.g., steps to hedge risk), “an idea in itself” (e.g., principle, an original cause, a motive), or a mathematic relationship / formula. At a minimum, all reproduced claim features above are active steps. Applying Part II of the foregoing two-part analysis, it is clear that the elements of Applicants’ claims do recite “significantly more” than “the abstract idea of: mental steps” as characterized by the Examiner in the Final Office Action. In the instant application, the amended claims are not directed to the alleged judicial exception of “mental steps” or seek to tie up this alleged judicial exception. Claim 1 has been amended to clarify that the recited method is directed towards the server that sends e-mail messages to the mobile terminal, where the mobile terminal generates the identifier.

**THE TREATMENT OF CLAIM 12 AS FALLING UNDER 35 USC 112 PARAGRAPH 6  
(MEANS PLUS FUNCTION) IS IMPROPER IN VIEW OF THE AMENDMENTS  
PRESENTED TO CLAIM 12**

Claim 12 has been amended to recite:

12. (Currently Amended) *A system for forwarding an e-mail message from an e-mail server to a mobile terminal, the system comprising:*  
~~*wherein an e-mail address of the mobile terminal is associated with an identifier and encryption information;*~~  
*a memory configured for storing at least one of ~~[[the]]~~ an e-mail address of ~~[[the]]~~ a user of a mobile terminal, ~~[[the]]~~ an ~~associated-identifier of the mobile terminal~~, and ~~[[the]]~~ associated-encryption information;*  
~~*wherein the e-mail address of the mobile terminal is associated with the identifier and encryption information and the mobile terminal generates the identifier,*~~  
~~*a messaging center having a processor that is configured to:*~~  
~~*an encryption engine configured to encrypt the e-mail message using the encryption information, wherein the e-mail message is received from the e-mail server;*~~  
~~*a processor configured to execute software stored in memory, the execution of the software resulting in the identification of identify the mobile terminal based on the e-mail address of the e-mail message and the association with the identifier of the mobile terminal; and*~~  
~~*a communications interface configured to transmit the encrypted e-mail message to the identified mobile terminal.*~~

The encryption engine and communications interface language has been deleted. The messaging center is shown in FIG. 1 of the application as filed.

**AMENDED CLAIM 12 IS PATENTABLE OVER THE REFERENCES OF RECORD**

Applicant submits that amended claim 12 is patentable over the references of record for the same reason as Applicant submitted with relation to amended claim 1 as discussed *supra*.

**NEW CLAIM 21 IS PATENTABLE OVER THE REFERENCES OF RECORD**

New claim 21 recites:

*21. (New) A mobile device comprising:  
a radio;  
a memory;  
a processor configured for controlling a mobile device to:  
generate an identifier; and  
receive, from a server, an encrypted e-mail message associated with an e-mail address of a user of the mobile device, wherein the e-mail address is associated with the identifier,  
decrypt the e-mail message using encryption information associated with a temporary identifier,  
wherein the temporary identifier is based on a connection to the server.*

Applicant submits that the mobile device generating an identifier is not taught, suggested, or disclosed by the references of record and that claim 21 is thus patentable over the same.

**NEW CLAIM 22 IS PATENTABLE OVER THE REFERENCES OF RECORD**

New claim 22 recites:

*22. (New) A method for forwarding an e-mail message from an e-mail server to a mobile terminal, the method comprising:  
generating an identifier associated with an e-mail address of a user of a mobile terminal;  
receiving an e-mail message associated with the e-mail address and sent by an e-mail server;  
wherein the e-mail address is associated encryption information;  
encrypting the e-mail message using the encryption information associated with the e-mail address; and  
transmitting the encrypted e-mail message to the mobile terminal.*

Applicant submits that the mobile device generating an identifier is not taught, suggested, or disclosed by the references of record and that claim 22 is thus patentable over the same.

**NEW CLAIM 23 IS PATENTABLE OVER THE REFERENCES OF RECORD**



New claim 23 recites:

*23. A method for forwarding an e-mail message from an e-mail server to a mobile terminal, the method comprising:  
generating an identifier associated with an e-mail address of a user of a mobile terminal;  
receiving an e-mail message associated with the e-mail address and sent by an e-mail server;  
encrypting the e-mail message using encryption information associated with a temporary identifier; and  
transmitting the encrypted e-mail message to the mobile terminal,  
wherein the temporary identifier is based on a connection the mobile terminal.*

Applicant submits that these limitations are not taught, suggested, or disclosed by the references of record and that claim 23 is thus patentable over the same.

#### **NEW CLAIM 36 IS PATENTABLE OVER THE REFERENCES OF RECORD**

New claim 36 recites:

*36. A method for sharing a messaging account, the method comprising:  
authenticating a device for access to the messaging account;  
receiving information including a service activation code from a remote device;  
registering the remote device for access to the messaging account using the service activation code;  
receiving a message for the messaging account;  
encrypting the message using an encryption key; and  
sending the message to the remote device.*

Applicant submits that these limitations are not taught, suggested, or disclosed by the references of record and that claim 36 is thus patentable over the same.

#### **NEW CLAIM 54 IS PATENTABLE OVER THE REFERENCES OF RECORD**

New claim 54 recites:

54. *(New) A non-transient computer-readable medium containing program instructions for causing a device to perform a method, the method comprising:*  
*generating an identifier; and*  
*receiving, from a server, an encrypted e-mail message associated with an e-mail address of a user of the mobile device, wherein the e-mail address is associated with the identifier,*  
*decrypting the e-mail message using encryption information associated with a temporary identifier,*  
*wherein the temporary identifier is based on a connection to the server.*

Applicant submits that the mobile device generating an identifier is not taught, suggested, or disclosed by the references of record and that claim 54 is thus patentable over the same.

#### **NEW CLAIM 55 IS PATENTABLE OVER THE REFERENCES OF RECORD**

New claim 55 recites:

55. *(New) A non-transient computer-readable medium containing program instructions for causing a device to perform a method, the method comprising:*  
*receiving information including a service activation code from a remote device;*  
*registering the remote device for access to a messaging account using the service activation code;*  
*receiving a message for the messaging account;*  
*encrypting the message using an encryption key; and*  
*sending the message to the remote device,*  
*wherein the device is authenticated to access the messaging account.*

Applicant submits that these limitations are not taught, suggested, or disclosed by the references of record and that claim 55 is thus patentable over the same.

Amdt. dated April 1 2016  
Appl. No. 14/609,189

**DEPOSIT ACCOUNT**

The Commissioner is hereby authorized to charge any otherwise unpaid fees associated with the filing of this correspondence to Deposit Account No. 50-6191.

Date: April 1, 2016

Respectfully submitted,

/Justin R. Nifong/  
Justin R. Nifong  
Reg. No. 59,389

NK Patent Law  
4917 Waters Edge Drive, Suite 275  
Raleigh, NC 27606  
Telephone: (919) 348-2194  
Facsimile: (919) 882-8195

Customer No. 118194

## Electronic Patent Application Fee Transmittal

<b>Application Number:</b>	14609189			
<b>Filing Date:</b>	29-Jan-2015			
<b>Title of Invention:</b>	Messaging centre for forwarding e-mail			
<b>First Named Inventor/Applicant Name:</b>	Ari Backholm			
<b>Filer:</b>	Justin Robert Nifong			
<b>Attorney Docket Number:</b>	455/006/8 UTIL			
Filed as Small Entity				
<b>Filing Fees for Utility under 35 USC 111(a)</b>				
<b>Description</b>	<b>Fee Code</b>	<b>Quantity</b>	<b>Amount</b>	<b>Sub-Total in USD(\$)</b>
<b>Basic Filing:</b>				
<b>Pages:</b>				
<b>Claims:</b>				
Claims in excess of 20	2202	34	40	1360
Independent Claims in Excess of 3	2201	5	210	1050
<b>Miscellaneous-Filing:</b>				
<b>Petition:</b>				
<b>Patent-Appeals-and-Interference:</b>				

Description	Fee Code	Quantity	Amount	Sub-Total in USD(\$)
<b>Post-Allowance-and-Post-Issuance:</b>				
<b>Extension-of-Time:</b>				
<b>Miscellaneous:</b>				
			<b>Total in USD (\$)</b>	<b>2410</b>

## Electronic Acknowledgement Receipt

<b>EFS ID:</b>	25380591
<b>Application Number:</b>	14609189
<b>International Application Number:</b>	
<b>Confirmation Number:</b>	5037
<b>Title of Invention:</b>	Messaging centre for forwarding e-mail
<b>First Named Inventor/Applicant Name:</b>	Ari Backholm
<b>Customer Number:</b>	118194
<b>Filer:</b>	Justin Robert Nifong
<b>Filer Authorized By:</b>	
<b>Attorney Docket Number:</b>	455/006/8 UTIL
<b>Receipt Date:</b>	01-APR-2016
<b>Filing Date:</b>	29-JAN-2015
<b>Time Stamp:</b>	23:57:23
<b>Application Type:</b>	Utility under 35 USC 111(a)

### Payment information:

Submitted with Payment	yes
Payment Type	Credit Card
Payment was successfully received in RAM	\$2410
RAM confirmation Number	6242
Deposit Account	506191
Authorized User	NIFONG, JUSTIN

The Director of the USPTO is hereby authorized to charge indicated fees and credit any overpayment as follows:

Charge any Additional Fees required under 37 CFR 1.16 (National application filing, search, and examination fees)

Charge any Additional Fees required under 37 CFR 1.17 (Patent application and reexamination processing fees)

Charge any Additional Fees required under 37 CFR 1.19 (Document supply fees)  
 Charge any Additional Fees required under 37 CFR 1.20 (Post Issuance fees)  
 Charge any Additional Fees required under 37 CFR 1.21 (Miscellaneous fees and charges)

**File Listing:**

Document Number	Document Description	File Name	File Size(Bytes)/ Message Digest	Multi Part /.zip	Pages (if appl.)
1	Amendment/Req. Reconsideration-After Non-Final Reject	455-006-8UTIL-rsp-to-OA.pdf	485926 5d3228ec3333dc129306292ff5bb64e1e87cf3c1	no	19

**Warnings:**

**Information:**

2	Fee Worksheet (SB06)	fee-info.pdf	32054 8c1198e9587971a5f521a02a2b4995e3a111d716	no	2
---	----------------------	--------------	---	----	---

**Warnings:**

**Information:**

**Total Files Size (in bytes):** 517980

**This Acknowledgement Receipt evidences receipt on the noted date by the USPTO of the indicated documents, characterized by the applicant, and including page counts, where applicable. It serves as evidence of receipt similar to a Post Card, as described in MPEP 503.**

**New Applications Under 35 U.S.C. 111**

**If a new application is being filed and the application includes the necessary components for a filing date (see 37 CFR 1.53(b)-(d) and MPEP 506), a Filing Receipt (37 CFR 1.54) will be issued in due course and the date shown on this Acknowledgement Receipt will establish the filing date of the application.**

**National Stage of an International Application under 35 U.S.C. 371**

**If a timely submission to enter the national stage of an international application is compliant with the conditions of 35 U.S.C. 371 and other applicable requirements a Form PCT/DO/EO/903 indicating acceptance of the application as a national stage submission under 35 U.S.C. 371 will be issued in addition to the Filing Receipt, in due course.**

**New International Application Filed with the USPTO as a Receiving Office**

**If a new international application is being filed and the international application includes the necessary components for an international filing date (see PCT Article 11 and MPEP 1810), a Notification of the International Application Number and of the International Filing Date (Form PCT/RO/105) will be issued in due course, subject to prescriptions concerning national security, and the date shown on this Acknowledgement Receipt will establish the international filing date of the application.**

Under the Paperwork Reduction Act of 1995, no persons are required to respond to a collection of information unless it displays a valid OMB control number.

<b>PATENT APPLICATION FEE DETERMINATION RECORD</b> Substitute for Form PTO-875			Application or Docket Number 14/609,189	Filing Date 01/29/2015	<input type="checkbox"/> To be Mailed
ENTITY: <input type="checkbox"/> LARGE <input checked="" type="checkbox"/> SMALL <input type="checkbox"/> MICRO					
<b>APPLICATION AS FILED – PART I</b>					
(Column 1)		(Column 2)			
FOR	NUMBER FILED	NUMBER EXTRA	RATE (\$)	FEE (\$)	
<input type="checkbox"/> BASIC FEE <small>(37 CFR 1.16(a), (b), or (c))</small>	N/A	N/A	N/A		
<input type="checkbox"/> SEARCH FEE <small>(37 CFR 1.16(k), (l), or (m))</small>	N/A	N/A	N/A		
<input type="checkbox"/> EXAMINATION FEE <small>(37 CFR 1.16(o), (p), or (q))</small>	N/A	N/A	N/A		
TOTAL CLAIMS <small>(37 CFR 1.16(j))</small>	minus 20 =	*	X \$ =		
INDEPENDENT CLAIMS <small>(37 CFR 1.16(h))</small>	minus 3 =	*	X \$ =		
<input type="checkbox"/> APPLICATION SIZE FEE <small>(37 CFR 1.16(s))</small>	If the specification and drawings exceed 100 sheets of paper, the application size fee due is \$310 (\$155 for small entity) for each additional 50 sheets or fraction thereof. See 35 U.S.C. 41(a)(1)(G) and 37 CFR 1.16(s).				
<input type="checkbox"/> MULTIPLE DEPENDENT CLAIM PRESENT <small>(37 CFR 1.16(j))</small>					
* If the difference in column 1 is less than zero, enter "0" in column 2.			TOTAL		

<b>APPLICATION AS AMENDED – PART II</b>								
(Column 1)		(Column 2)		(Column 3)				
<b>AMENDMENT</b>	<b>04/01/2016</b>	CLAIMS REMAINING AFTER AMENDMENT		HIGHEST NUMBER PREVIOUSLY PAID FOR	PRESENT EXTRA	RATE (\$)	ADDITIONAL FEE (\$)	
	Total (37 CFR 1.16(i))	* 53	Minus	** 20	= 33	X \$40 =	1320	
	Independent (37 CFR 1.16(h))	* 8	Minus	***3	= 5	X \$210 =	1050	
	<input type="checkbox"/> Application Size Fee (37 CFR 1.16(s))							
	<input type="checkbox"/> FIRST PRESENTATION OF MULTIPLE DEPENDENT CLAIM (37 CFR 1.16(j))							
TOTAL ADD'L FEE						<b>2370</b>		

(Column 1)		(Column 2)		(Column 3)				
<b>AMENDMENT</b>		CLAIMS REMAINING AFTER AMENDMENT		HIGHEST NUMBER PREVIOUSLY PAID FOR	PRESENT EXTRA	RATE (\$)	ADDITIONAL FEE (\$)	
	Total (37 CFR 1.16(i))	*	Minus	**	=	X \$ =		
	Independent (37 CFR 1.16(h))	*	Minus	***	=	X \$ =		
	<input type="checkbox"/> Application Size Fee (37 CFR 1.16(s))							
	<input type="checkbox"/> FIRST PRESENTATION OF MULTIPLE DEPENDENT CLAIM (37 CFR 1.16(j))							
TOTAL ADD'L FEE								

\* If the entry in column 1 is less than the entry in column 2, write "0" in column 3.  
 \*\* If the "Highest Number Previously Paid For" IN THIS SPACE is less than 20, enter "20".  
 \*\*\* If the "Highest Number Previously Paid For" IN THIS SPACE is less than 3, enter "3".  
 The "Highest Number Previously Paid For" (Total or Independent) is the highest number found in the appropriate box in column 1.

LIE  
/PATRICIA F. LEWIS/

This collection of information is required by 37 CFR 1.16. The information is required to obtain or retain a benefit by the public which is to file (and by the USPTO to process) an application. Confidentiality is governed by 35 U.S.C. 122 and 37 CFR 1.14. This collection is estimated to take 12 minutes to complete, including gathering, preparing, and submitting the completed application form to the USPTO. Time will vary depending upon the individual case. Any comments on the amount of time you require to complete this form and/or suggestions for reducing this burden, should be sent to the Chief Information Officer, U.S. Patent and Trademark Office, U.S. Department of Commerce, P.O. Box 1450, Alexandria, VA 22313-1450. DO NOT SEND FEES OR COMPLETED FORMS TO THIS ADDRESS. **SEND TO: Commissioner for Patents, P.O. Box 1450, Alexandria, VA 22313-1450.**  
 If you need assistance in completing the form, call 1-800-PTO-9199 and select option 2.





UNITED STATES PATENT AND TRADEMARK OFFICE

UNITED STATES DEPARTMENT OF COMMERCE  
United States Patent and Trademark Office  
Address: COMMISSIONER FOR PATENTS  
P.O. Box 1450  
Alexandria, Virginia 22313-1450  
www.uspto.gov

APPLICATION NUMBER	FILING OR 371(C) DATE	FIRST NAMED APPLICANT	ATTY. DOCKET NO./TITLE
14/609,189	01/29/2015	Ari Backholm	455/006/8 UTIL

**CONFIRMATION NO. 5037**

**POA ACCEPTANCE LETTER**

118194  
NK Patent Law- Seven Networks  
4917 Waters Edge Drive  
Suite 275  
Raleigh, NC 27606



Date Mailed: 01/11/2016

**NOTICE OF ACCEPTANCE OF POWER OF ATTORNEY**

This is in response to the Power of Attorney filed 12/30/2015.

The Power of Attorney in this application is accepted. Correspondence in this application will be mailed to the above address as provided by 37 CFR 1.33.

Questions about the contents of this notice and the requirements it sets forth should be directed to the Office of Data Management, Application Assistance Unit, at (571) 272-4000 or (571) 272-4200 or 1-888-786-0101.

/dtdinh/



UNITED STATES PATENT AND TRADEMARK OFFICE

UNITED STATES DEPARTMENT OF COMMERCE
United States Patent and Trademark Office
Address: COMMISSIONER FOR PATENTS
P.O. Box 1450
Alexandria, Virginia 22313-1450
www.uspto.gov

Table with 7 columns: APPLICATION NUMBER, FILING or 371(c) DATE, GRP ART UNIT, FIL FEE REC'D, ATTY. DOCKET NO, TOT CLAIMS, IND CLAIMS. Row 1: 14/609,189, 01/29/2015, 2451, 800, 455/006/8 UTIL, 1, 1

CONFIRMATION NO. 5037
REPLACEMENT FILING RECEIPT

118194
NK Patent Law- Seven Networks
4917 Waters Edge Drive
Suite 275
Raleigh, NC 27606



Date Mailed: 01/11/2016

Receipt is acknowledged of this non-provisional patent application. The application will be taken up for examination in due course. Applicant will be notified as to the results of the examination. Any correspondence concerning the application must include the following identification information: the U.S. APPLICATION NUMBER, FILING DATE, NAME OF APPLICANT, and TITLE OF INVENTION. Fees transmitted by check or draft are subject to collection. Please verify the accuracy of the data presented on this receipt. If an error is noted on this Filing Receipt, please submit a written request for a Filing Receipt Correction. Please provide a copy of this Filing Receipt with the changes noted thereon. If you received a "Notice to File Missing Parts" for this application, please submit any corrections to this Filing Receipt with your reply to the Notice. When the USPTO processes the reply to the Notice, the USPTO will generate another Filing Receipt incorporating the requested corrections

Inventor(s)

Ari Backholm, San Carlos, CA;
Seppo Salorinne, Helsinki, FINLAND;
Antti Saarilahti, Helsinki, FINLAND;
Marko Ketonen, Helsinki, FINLAND;
Lauri Vuornos, Helsinki, FINLAND;
Petri Salmi, Espoo, FINLAND;

Applicant(s)

Seven Networks, LLC, San Carlos, CA;

Power of Attorney: The patent practitioners associated with Customer Number 118194

Domestic Priority data as claimed by applicant

This application is a CON of 12/228,325 08/11/2008
which is a DIV of 11/282,950 11/21/2005 PAT 7643818
and claims benefit of 60/650,975 02/09/2005

Foreign Applications (You may be eligible to benefit from the Patent Prosecution Highway program at the USPTO. Please see http://www.uspto.gov for more information.)
FINLAND 20045451 11/22/2004 No Access Code Provided

Permission to Access Application via Priority Document Exchange: Yes

Permission to Access Search Results: No

Applicant may provide or rescind an authorization for access using Form PTO/SB/39 or Form PTO/SB/69 as appropriate.

**If Required, Foreign Filing License Granted:** 02/12/2015

The country code and number of your priority application, to be used for filing abroad under the Paris Convention, is **US 14/609,189**

**Projected Publication Date:** Not Applicable

**Non-Publication Request:** No

**Early Publication Request:** No

**\*\* SMALL ENTITY \*\***

**Title**

Messaging centre for forwarding e-mail

**Preliminary Class**

709

**Statement under 37 CFR 1.55 or 1.78 for AIA (First Inventor to File) Transition Applications:** No

## **PROTECTING YOUR INVENTION OUTSIDE THE UNITED STATES**

Since the rights granted by a U.S. patent extend only throughout the territory of the United States and have no effect in a foreign country, an inventor who wishes patent protection in another country must apply for a patent in a specific country or in regional patent offices. Applicants may wish to consider the filing of an international application under the Patent Cooperation Treaty (PCT). An international (PCT) application generally has the same effect as a regular national patent application in each PCT-member country. The PCT process **simplifies** the filing of patent applications on the same invention in member countries, but **does not result** in a grant of "an international patent" and does not eliminate the need of applicants to file additional documents and fees in countries where patent protection is desired.

Almost every country has its own patent law, and a person desiring a patent in a particular country must make an application for patent in that country in accordance with its particular laws. Since the laws of many countries differ in various respects from the patent law of the United States, applicants are advised to seek guidance from specific foreign countries to ensure that patent rights are not lost prematurely.

Applicants also are advised that in the case of inventions made in the United States, the Director of the USPTO must issue a license before applicants can apply for a patent in a foreign country. The filing of a U.S. patent application serves as a request for a foreign filing license. The application's filing receipt contains further information and guidance as to the status of applicant's license for foreign filing.

Applicants may wish to consult the USPTO booklet, "General Information Concerning Patents" (specifically, the section entitled "Treaties and Foreign Patents") for more information on timeframes and deadlines for filing foreign patent applications. The guide is available either by contacting the USPTO Contact Center at 800-786-9199, or it can be viewed on the USPTO website at <http://www.uspto.gov/web/offices/pac/doc/general/index.html>.

For information on preventing theft of your intellectual property (patents, trademarks and copyrights), you may wish to consult the U.S. Government website, <http://www.stopfakes.gov>. Part of a Department of Commerce initiative, this website includes self-help "toolkits" giving innovators guidance on how to protect intellectual property in specific

page 2 of 4

countries such as China, Korea and Mexico. For questions regarding patent enforcement issues, applicants may call the U.S. Government hotline at 1-866-999-HALT (1-866-999-4258).

**LICENSE FOR FOREIGN FILING UNDER**  
**Title 35, United States Code, Section 184**  
**Title 37, Code of Federal Regulations, 5.11 & 5.15**

**GRANTED**

The applicant has been granted a license under 35 U.S.C. 184, if the phrase "IF REQUIRED, FOREIGN FILING LICENSE GRANTED" followed by a date appears on this form. Such licenses are issued in all applications where the conditions for issuance of a license have been met, regardless of whether or not a license may be required as set forth in 37 CFR 5.15. The scope and limitations of this license are set forth in 37 CFR 5.15(a) unless an earlier license has been issued under 37 CFR 5.15(b). The license is subject to revocation upon written notification. The date indicated is the effective date of the license, unless an earlier license of similar scope has been granted under 37 CFR 5.13 or 5.14.

This license is to be retained by the licensee and may be used at any time on or after the effective date thereof unless it is revoked. This license is automatically transferred to any related applications(s) filed under 37 CFR 1.53(d). This license is not retroactive.

The grant of a license does not in any way lessen the responsibility of a licensee for the security of the subject matter as imposed by any Government contract or the provisions of existing laws relating to espionage and the national security or the export of technical data. Licensees should apprise themselves of current regulations especially with respect to certain countries, of other agencies, particularly the Office of Defense Trade Controls, Department of State (with respect to Arms, Munitions and Implements of War (22 CFR 121-128)); the Bureau of Industry and Security, Department of Commerce (15 CFR parts 730-774); the Office of Foreign Assets Control, Department of Treasury (31 CFR Parts 500+) and the Department of Energy.

**NOT GRANTED**

No license under 35 U.S.C. 184 has been granted at this time, if the phrase "IF REQUIRED, FOREIGN FILING LICENSE GRANTED" DOES NOT appear on this form. Applicant may still petition for a license under 37 CFR 5.12, if a license is desired before the expiration of 6 months from the filing date of the application. If 6 months has lapsed from the filing date of this application and the licensee has not received any indication of a secrecy order under 35 U.S.C. 181, the licensee may foreign file the application pursuant to 37 CFR 5.15(b).

---

***SelectUSA***

The United States represents the largest, most dynamic marketplace in the world and is an unparalleled location for business investment, innovation, and commercialization of new technologies. The U.S. offers tremendous resources and advantages for those who invest and manufacture goods here. Through SelectUSA, our nation works to promote and facilitate business investment. SelectUSA provides information assistance to the international investor community; serves as an ombudsman for existing and potential investors; advocates on behalf of U.S. cities, states, and regions competing for global investment; and counsels U.S. economic development organizations on investment attraction best practices. To learn more about why the United States is the best country in the world to develop

technology, manufacture products, deliver services, and grow your business, visit <http://www.SelectUSA.gov> or call +1-202-482-6800.

Application No.: 14/609,189

**COMMUNICATION TO THE UNITED STATES PATENT AND TRADEMARK  
OFFICE**

**Application No.:** 14/609,189                      **Confirmation No.:** 5037  
**Inventor:**                      **BACKHOLM**                      **Art Unit:** 2451  
**Filing Date:** 2015-01/29                      **Examiner:** Chou, Alan S.  
**Title:**                      MESSAGING CENTRE FOR FORWARDING e-mail

**Docket No.:** 455/006/8 UTIL  
**Customer No:** 118194

**Office of Initial Patent Examination**  
Commissioner for Patents  
P.O. Box 1450  
Alexandria, VA 22313-1450

**Request for Corrected Filing Receipt**

Applicant hereby submits this Request for a Corrected Filing Receipt. Enclosed is a copy of the official Filing Receipt for the above-referenced patent application of which a corrected Filing Receipt is respectfully requested. Filed concurrently herewith is a Replacement Application Data Sheet in accordance with 37 CFR 1.78 correcting the applicant's name and residence.

The Filing Receipt is incorrect in that it states the applicant's name as Seven Networks, Inc., of San Carlos, CA. Therefore it is requested that a Corrected Filing Receipt be issued stating the applicant's name as Seven Networks, LLC., of San Carlos, CA.

Application No.: 14/609,189

### **CONCLUSION**

If any issues remain outstanding, or if a phone call could resolve any pending issues, the Examiner is encouraged to call the attorney identified below in order to expeditiously resolve these matters.

### **DEPOSIT ACCOUNT**

The Commissioner is hereby authorized to charge any otherwise unpaid fees or credit any overpayment of fees associated with the filing of this correspondence to Deposit Account No. 50-6191.

Respectfully submitted,

Date: December 30, 2015

/Justin R. Nifong/  
Justin R. Nifong  
Registration No. 59,389

NK Patent Law  
4917 Waters Edge Drive, Suite 275  
Raleigh, NC 27606  
Telephone: (919) 348-2194  
Facsimile: (919) 882-8195

Customer No. 118194

**POWER OF ATTORNEY FOR PATENT APPLICATIONS**

Under 37 CFR § 3.73(b) and/or (c), Seven Networks, LLC, hereby certifies that it is the Assignee of the entire right, title, and interest in and to the patent applications listed below. Each of the patent applications listed below is assigned to Seven Networks, LLC. As required by 37 CFR § 3.73(b)(1)(i) and/or (c)(1)(i), the documentary evidence of the chain of title from the original owner to the Assignee was submitted for recordation pursuant to 37 § CFR 3.11 as shown in the Reel/Frame numbers listed below:

Application No.	Docket No.	Filing Date	Title	Reel/Frame
14848189	455/136/3 UTIL	9/8/2015	MANAGING CACHE TO PREVENT OVERLOADING OF A WIRELESS NETWORK DUE TO USER ACTIVITY	029819/0603 dated 02/15/2013 036485/0059 dated 8/27/2015
14847697	455/194 UTIL	9/8/2015	DEVICE ACTIVITY AND DATA TRAFFIC SIGNATURE-BASED DETECTION OF MOBILE DEVICE HEALTH	036709/0767 dated 10/02/2015 037229/0605 Dated 12/07/2015
14833052	455/193 UTIL	8/22/2015	Mobile device equipped with mobile network congestion recognition to make intelligent decisions regarding connecting to an operator network for optimize user experience	036709/0664 dated 10/02/2015 037229/0605 dated 12/07/2015
14832955	455/192 UTIL	8/21/2015	MODELING NETWORK SIGNALING IN A MOBILE NETWORK BASED ON ELAPSED TIME	036709/0304 dated 10/02/2015 037229/0605 dated 12/07/2015
14803019	455/306/2 UTIL	7/17/2015	ADAPTIVE DOWNLOADING OR STREAMING TO CONSERVE MOBILE DEVICE OR NETWORK RESOURCES	036458 / 0976 dated 08/31/2015 036485/0059 Dated 08/27/2015
14748226	455/178/3 PCT/CON	6/23/2015	BLOCKING/UNBLOCKING ALGORITHMS FOR SIGNALING OPTIMIZATION IN A WIRELESS NETWORK FOR TRAFFIC UTILIZING PROPRIETARY AND NON-PROPRIETARY PROTOCOLS	036302 / 0023 dated 08/11/2015; 036485 / 0059 dated 08/27/2015
14748218	455/105/2 UTIL	6/23/2015	Mobile traffic optimization and coordination and user experience enhancement	037072/0978 dated 11/18/2015 037229/0605 12/07/2015



14745796	455/102/5 UTIL	6/22/2015	MOBILE TRAFFIC OPTIMIZATION AND COORDINATION AND USER EXPERIENCE ENHANCEMENT	036301 / 0112 dated 08/11/2015; 036485 / 0059 dated 08/27/2015
14744993	455/305/3 UTIL	6/19/2015	PROVIDING DATA TO A MOBILE APPLICATION ACCESSIBLE AT A MOBILE DEVICE VIA DIFFERENT NETWORK CONNECTIONS WITHOUT INTERRUPTION	036324 / 0100 dated 08/13/2015; 036485 / 0059 dated 08/27/2015
14726594	455/010/3 UTIL	5/31/2015	INTELLIGENT RENDERING OF INFORMATION IN A LIMITED DISPLAY ENVIRONMENT	035808 / 0585 dated 06/09/2015; 036485 / 0059 dated 08/27/2015
14714257	455/150/2 UTIL	5/16/2015	SELECTIVE DATA COMPRESSION BY A DISTRIBUTED TRAFFIC MANAGEMENT SYSTEM TO REDUCE MOBILE DATA TRAFFIC AND SIGNALING TRAFFIC	035866 / 0171 dated 06/09/2015; 036485 / 0059 dated 08/27/2015
14710167	455/102/4 UTIL	5/12/2015	Mobile traffic optimization and coordination and user experience enhancement	035866 / 0171 dated 06/09/2015; 035866 / 0267 dated 06/09/2015; 036485 / 0059 08/27/2015
14708253	455/017/3 UTIL	5/10/2015	LOCATION-BASED OPERATIONS AND MESSAGING	037125/0343 dated 11/17/2015; 035866/0097 dated 06/09/2015;

				036485/0059 dated 08/27/2015;
14691373	455/148/4 UTIL	4/20/2015	SYSTEM AND METHOD FOR GENERATING A REPORT TO A NETWORK OPERATOR BY DISTRIBUTING AGGREGATION OF DATA	035666 / 0984 dated 05/19/2015; 036485 / 0059 08/27/2015
14690690	455/101/2 UTIL	4/20/2015	3D MOBILE USER INTERFACE WITH CONFIGURABLE WORKSPACE MANAGEMENT	035666 / 0399 dated 05/19/2015; 036485 / 0059 dated 08/27/2015
14673788	455/119/2 UTIL	3/30/2015	Device resources sharing network resource conservation	035667 / 0200 dated 05/19/2015; 036485 / 0059 dated 08/27/2015
14673775	455/016/3 UTIL	3/30/2015	NETWORK-INITIATED DATA TRANSFER IN A MOBILE NETWORK	035671 / 0532 dated 05/19/2015; 036485 / 0059 dated 08/27/2015
14662161	455/015/6 UTIL	3/18/2015	DYNAMIC ADJUSTMENT OF KEEP-ALIVE MESSAGES FOR EFFICIENT BATTERY USAGE IN A MOBILE NETWORK	035671 / 0532 dated 05/19/2015; 036485 / 0059 dated 08/27/2015
62129046	455/198 PROV	3/6/2015	PASSIVE QUALITY OF EXPERIENCE ENHANCEMENT FOR WIRELESS NETWORKS BASED ON RECEIVED SIGNAL STRENGTH AT A MOBILE DEVICE	035327 / 0442 dated 04/03/2015; 036485 / 0059 dated 08/27/2015
14629520	455/112/3 UTIL	2/24/2015	OPTIMIZATION OF RESOURCE POLLING INTERVALS TO SATISFY	035112 / 0798 dated 03/09/2015;

			MOBILE DEVICE REQUESTS	036485 / 0059 dated 08/27/2015
14625471	455/179/1 UTIL	2/18/2015	POLICY MANAGEMENT FOR SIGNALING OPTIMIZATION IN A WIRELESS NETWORK FOR TRAFFIC UTILIZING PROPRIETARY AND NON-PROPRIETARY PROTOCOLS	035113 / 0226 dated 03/09/2015; 036485 / 0059 dated 08/27/2015
14623522	455/013/4 UTIL	2/17/2015	UNIVERSAL DATA AGGREGATION	035004 / 0110 dated 02/23/2015; 036485 / 0059 dated 08/27/2015
14623518	455/039/2 UTIL	2/17/2015	PREDICTIVE CONTENT DELIVERY	035004 / 0049 dated 02/23/2015; 036485 / 0059 dated 08/27/2015
14623514	455/002/4 UTIL	2/17/2015	CONNECTION ARCHITECTURE FOR A MOBILE NETWORK	034969 / 0665 dated 02/17/2015; 036485 / 0059 dated 08/27/2015
14623467	455/308/2 UTIL	2/16/2015	QUALITY OF EXPERIENCE ENHANCEMENT FOR WIRELESS NETWORKS BASED ON RECEIVED SIGNAL STRENGTH AT A MOBILE DEVICE	034969 / 0411 dated 02/17/2015; 036485 / 0059 dated 08/27/2015
62110457	455/196/3 PROV	1/30/2015	COLLABORATIVE POLICY MANAGEMENT STRATEGIES AT A MOBILE DEVICE WITH OFFLOADING	034868 / 0626 dated 02/02/2015; 036485 / 0059 dated: 08/27/2015
14609189	455/006/8 UTIL	1/29/2015	Messaging centre for forwarding e-mail	034865 / 0639 dated 02/02/2015; 036485 / 0059 dated 08/27/2015

14608181	455/145/3 UTIL	1/28/2015	SYSTEM OF REDUNDANTLY CLUSTERED MACHINES TO PROVIDE FAILOVER MECHANISMS FOR MOBILE TRAFFIC MANAGEMENT AND NETWORK RESOURCE CONSERVATION	034859 / 0916 dated: 01/31/2015; 034865 / 0278 dated: 02/02/2015
14602808	455/188 UTIL	1/22/2015	METHOD FOR POWER SAVING IN MOBILE DEVICES BY OPTIMIZING WAKELOCKS	034865 / 0352 dated 02/02/2015; 036485 / 0059 dated 08/27/2015

The undersigned, acting as the Assignee and under the authority of the Assignee, hereby revokes all prior powers of attorney, if applicable, and appoints the practitioners associated with the customer number 118194 as my/our attorney(s) or agent(s) to prosecute the patent(s) and/or patent application(s) and transact all business in the United States Patent and Trademark Office connected therewith.

By: 

Date: December 3, 2015

Dr. Ross Bott, President and CEO

Seven Networks, LLC.



UNITED STATES PATENT AND TRADEMARK OFFICE

UNITED STATES DEPARTMENT OF COMMERCE
United States Patent and Trademark Office
Address: COMMISSIONER FOR PATENTS
P.O. Box 1450
Alexandria, Virginia 22313-1450
www.uspto.gov

Table with 7 columns: APPLICATION NUMBER, FILING or 371(c) DATE, GRP ART UNIT, FIL FEE REC'D, ATTY. DOCKET NO, TOT CLAIMS, IND CLAIMS. Row 1: 14/609,189, 01/29/2015, 2642, 800, 455/006/8 UTIL, 1, 1

CONFIRMATION NO. 5037

FILING RECEIPT



118194
NKK Patent Law- Seven Networks
4917 Waters Edge Drive
Suite 275
Raleigh, NC 27606

Date Mailed: 02/20/2015

Receipt is acknowledged of this non-provisional patent application. The application will be taken up for examination in due course. Applicant will be notified as to the results of the examination. Any correspondence concerning the application must include the following identification information: the U.S. APPLICATION NUMBER, FILING DATE, NAME OF APPLICANT, and TITLE OF INVENTION. Fees transmitted by check or draft are subject to collection. Please verify the accuracy of the data presented on this receipt. If an error is noted on this Filing Receipt, please submit a written request for a Filing Receipt Correction. Please provide a copy of this Filing Receipt with the changes noted thereon. If you received a "Notice to File Missing Parts" for this application, please submit any corrections to this Filing Receipt with your reply to the Notice. When the USPTO processes the reply to the Notice, the USPTO will generate another Filing Receipt incorporating the requested corrections

Inventor(s)

Ari Backholm, San Carlos, CA;
Seppo Salorinne, Helsinki, FINLAND;
Antti Saarilahti, Helsinki, FINLAND;
Marko Ketonen, Helsinki, FINLAND;
Lauri Vuornos, Helsinki, FINLAND;
Petri Salmi, Espoo, FINLAND;

Applicant(s)

Seven Networks, Inc., San Carlos, CA

Power of Attorney: None

Domestic Priority data as claimed by applicant

This application is a CON of 12/228,325 08/11/2008
which is a DIV of 11/282,950 11/21/2005 PAT 7643818
and claims benefit of 60/650,975 02/09/2005

Foreign Applications (You may be eligible to benefit from the Patent Prosecution Highway program at the USPTO. Please see http://www.uspto.gov for more information.)
FINLAND 20045451 11/22/2004 No Access Code Provided

Permission to Access - A proper Authorization to Permit Access to Application by Participating Offices (PTO/SB/39 or its equivalent) has been received by the USPTO.

If Required, Foreign Filing License Granted: 02/12/2015

The country code and number of your priority application, to be used for filing abroad under the Paris Convention, is **US 14/609,189**

**Projected Publication Date:** 05/28/2015

**Non-Publication Request:** No

**Early Publication Request:** No

**\*\* SMALL ENTITY \*\***

**Title**

Messaging centre for forwarding e-mail

**Preliminary Class**

455

**Statement under 37 CFR 1.55 or 1.78 for AIA (First Inventor to File) Transition Applications:** No

## **PROTECTING YOUR INVENTION OUTSIDE THE UNITED STATES**

Since the rights granted by a U.S. patent extend only throughout the territory of the United States and have no effect in a foreign country, an inventor who wishes patent protection in another country must apply for a patent in a specific country or in regional patent offices. Applicants may wish to consider the filing of an international application under the Patent Cooperation Treaty (PCT). An international (PCT) application generally has the same effect as a regular national patent application in each PCT-member country. The PCT process **simplifies** the filing of patent applications on the same invention in member countries, but **does not result** in a grant of "an international patent" and does not eliminate the need of applicants to file additional documents and fees in countries where patent protection is desired.

Almost every country has its own patent law, and a person desiring a patent in a particular country must make an application for patent in that country in accordance with its particular laws. Since the laws of many countries differ in various respects from the patent law of the United States, applicants are advised to seek guidance from specific foreign countries to ensure that patent rights are not lost prematurely.

Applicants also are advised that in the case of inventions made in the United States, the Director of the USPTO must issue a license before applicants can apply for a patent in a foreign country. The filing of a U.S. patent application serves as a request for a foreign filing license. The application's filing receipt contains further information and guidance as to the status of applicant's license for foreign filing.

Applicants may wish to consult the USPTO booklet, "General Information Concerning Patents" (specifically, the section entitled "Treaties and Foreign Patents") for more information on timeframes and deadlines for filing foreign patent applications. The guide is available either by contacting the USPTO Contact Center at 800-786-9199, or it can be viewed on the USPTO website at <http://www.uspto.gov/web/offices/pac/doc/general/index.html>.

For information on preventing theft of your intellectual property (patents, trademarks and copyrights), you may wish to consult the U.S. Government website, <http://www.stopfakes.gov>. Part of a Department of Commerce initiative, this website includes self-help "toolkits" giving innovators guidance on how to protect intellectual property in specific countries such as China, Korea and Mexico. For questions regarding patent enforcement issues, applicants may call the U.S. Government hotline at 1-866-999-HALT (1-866-999-4258).

**LICENSE FOR FOREIGN FILING UNDER**  
**Title 35, United States Code, Section 184**  
**Title 37, Code of Federal Regulations, 5.11 & 5.15**

**GRANTED**

The applicant has been granted a license under 35 U.S.C. 184, if the phrase "IF REQUIRED, FOREIGN FILING LICENSE GRANTED" followed by a date appears on this form. Such licenses are issued in all applications where the conditions for issuance of a license have been met, regardless of whether or not a license may be required as set forth in 37 CFR 5.15. The scope and limitations of this license are set forth in 37 CFR 5.15(a) unless an earlier license has been issued under 37 CFR 5.15(b). The license is subject to revocation upon written notification. The date indicated is the effective date of the license, unless an earlier license of similar scope has been granted under 37 CFR 5.13 or 5.14.

This license is to be retained by the licensee and may be used at any time on or after the effective date thereof unless it is revoked. This license is automatically transferred to any related applications(s) filed under 37 CFR 1.53(d). This license is not retroactive.

The grant of a license does not in any way lessen the responsibility of a licensee for the security of the subject matter as imposed by any Government contract or the provisions of existing laws relating to espionage and the national security or the export of technical data. Licensees should apprise themselves of current regulations especially with respect to certain countries, of other agencies, particularly the Office of Defense Trade Controls, Department of State (with respect to Arms, Munitions and Implements of War (22 CFR 121-128)); the Bureau of Industry and Security, Department of Commerce (15 CFR parts 730-774); the Office of Foreign Assets Control, Department of Treasury (31 CFR Parts 500+) and the Department of Energy.

**NOT GRANTED**

No license under 35 U.S.C. 184 has been granted at this time, if the phrase "IF REQUIRED, FOREIGN FILING LICENSE GRANTED" DOES NOT appear on this form. Applicant may still petition for a license under 37 CFR 5.12, if a license is desired before the expiration of 6 months from the filing date of the application. If 6 months has lapsed from the filing date of this application and the licensee has not received any indication of a secrecy order under 35 U.S.C. 181, the licensee may foreign file the application pursuant to 37 CFR 5.15(b).

---

***SelectUSA***

The United States represents the largest, most dynamic marketplace in the world and is an unparalleled location for business investment, innovation, and commercialization of new technologies. The U.S. offers tremendous resources and advantages for those who invest and manufacture goods here. Through SelectUSA, our nation works to promote and facilitate business investment. SelectUSA provides information assistance to the international investor community; serves as an ombudsman for existing and potential investors; advocates on behalf of U.S. cities, states, and regions competing for global investment; and counsels U.S. economic development organizations on investment attraction best practices. To learn more about why the United States is the best country in the world to develop technology, manufacture products, deliver services, and grow your business, visit <http://www.SelectUSA.gov> or call +1-202-482-6800.

## Electronic Acknowledgement Receipt

<b>EFS ID:</b>	24491756
<b>Application Number:</b>	14609189
<b>International Application Number:</b>	
<b>Confirmation Number:</b>	5037
<b>Title of Invention:</b>	Messaging centre for forwarding e-mail
<b>First Named Inventor/Applicant Name:</b>	Ari Backholm
<b>Customer Number:</b>	118194
<b>Filer:</b>	Justin Robert Nifong/Joyce Adair
<b>Filer Authorized By:</b>	Justin Robert Nifong
<b>Attorney Docket Number:</b>	455/006/8 UTIL
<b>Receipt Date:</b>	30-DEC-2015
<b>Filing Date:</b>	29-JAN-2015
<b>Time Stamp:</b>	14:04:30
<b>Application Type:</b>	Utility under 35 USC 111(a)

### Payment information:

Submitted with Payment	no
------------------------	----

### File Listing:

Document Number	Document Description	File Name	File Size(Bytes)/ Message Digest	Multi Part /.zip	Pages (if appl.)
1	Assignee showing of ownership per 37 CFR 3.73	455-006-8UTIL_373_Statement_20151224.pdf	429678 <small>3dca7203ce6ab2c6e462a105d80efca71f226706</small>	no	2

### Warnings:

### Information:



2	Application Data Sheet	455-006-8-CorrectedADS.pdf	225866 5e418ef027ba59be74211734dc2a58cda504eaf1	no	9
<b>Warnings:</b>					
<b>Information:</b>					
This is not an USPTO supplied ADS fillable form					
3	Request for Corrected Filing Receipt	455-006-8-ReqCorrtFR-20151224.pdf	186771 3fd45097a1d517ffac099c0f4f867d1491cca1b5	no	2
<b>Warnings:</b>					
<b>Information:</b>					
4	Power of Attorney	455-006-8UTIL-POA-12-24-2015.pdf	178809 ee9b03d62b3787dd695728166feecfe3aa17c48b	no	5
<b>Warnings:</b>					
<b>Information:</b>					
5	Miscellaneous Incoming Letter	455-006-8UTIL-20150220-FilingReceipt.pdf	176034 2513242186739b1996990c6714592a6996ead22d	no	3
<b>Warnings:</b>					
<b>Information:</b>					
<b>Total Files Size (in bytes):</b>			1197158		
<p><b>This Acknowledgement Receipt evidences receipt on the noted date by the USPTO of the indicated documents, characterized by the applicant, and including page counts, where applicable. It serves as evidence of receipt similar to a Post Card, as described in MPEP 503.</b></p> <p><b><u>New Applications Under 35 U.S.C. 111</u></b>  <b>If a new application is being filed and the application includes the necessary components for a filing date (see 37 CFR 1.53(b)-(d) and MPEP 506), a Filing Receipt (37 CFR 1.54) will be issued in due course and the date shown on this Acknowledgement Receipt will establish the filing date of the application.</b></p> <p><b><u>National Stage of an International Application under 35 U.S.C. 371</u></b>  <b>If a timely submission to enter the national stage of an international application is compliant with the conditions of 35 U.S.C. 371 and other applicable requirements a Form PCT/DO/EO/903 indicating acceptance of the application as a national stage submission under 35 U.S.C. 371 will be issued in addition to the Filing Receipt, in due course.</b></p> <p><b><u>New International Application Filed with the USPTO as a Receiving Office</u></b>  <b>If a new international application is being filed and the international application includes the necessary components for an international filing date (see PCT Article 11 and MPEP 1810), a Notification of the International Application Number and of the International Filing Date (Form PCT/RO/105) will be issued in due course, subject to prescriptions concerning national security, and the date shown on this Acknowledgement Receipt will establish the international filing date of the application.</b></p>					

**STATEMENT UNDER 37 CFR 3.73(b)**Applicant/Patent Owner: Seven Networks, LLC (455/006/8 UTIL)Application No./Patent No.: 14/609,189 Filed/Issue Date: January 29, 2015Titled: MESSAGING CENTRE FOR FORWARDING e-mailSeven Networks, LLC, a corporation

(Name of Assignee)

(Type of Assignee, e.g., corporation, partnership, university, government agency, etc.)

states that it is:

1.  the assignee of the entire right, title, and interest in;
2.  an assignee of less than the entire right, title, and interest in  
(The extent (by percentage) of its ownership interest is \_\_\_\_\_ %); or
3.  the assignee of an undivided interest in the entirety of (a complete assignment from one of the joint inventors was made)

the patent application/patent identified above, by virtue of either:

- A.  An assignment from the inventor(s) of the patent application/patent identified above. The assignment was recorded in the United States Patent and Trademark Office at Reel \_\_\_\_\_, Frame \_\_\_\_\_, or for which a copy therefore is attached.

**OR**

- B.  A chain of title from the inventor(s), of the patent application/patent identified above, to the current assignee as follows:

1. From: Backholm, Salorinne, Saarilahti To: Seven Networks, Inc.

The document was recorded in the United States Patent and Trademark Office at  
Reel 034865, Frame 0639, or for which a copy thereof is attached.

2. From: Ketonen, Vuornos, Salmi To: Seven Networks, Inc

The document was recorded in the United States Patent and Trademark Office at  
Reel 034865, Frame 0639, or for which a copy thereof is attached.

3. From: Seven Networks, Inc. To: Seven Networks, LLC

The document was recorded in the United States Patent and Trademark Office at  
Reel 036485, Frame 0059, or for which a copy thereof is attached.

Additional documents in the chain of title are listed on a supplemental sheet(s).

- As required by 37 CFR 3.73(b)(1)(i), the documentary evidence of the chain of title from the original owner to the assignee was, or concurrently is being, submitted for recordation pursuant to 37 CFR 3.11.

[NOTE: A separate copy (i.e., a true copy of the original assignment document(s)) must be submitted to Assignment Division in accordance with 37 CFR Part 3, to record the assignment in the records of the USPTO. See MPEP 302.08]

The undersigned (whose title is supplied below) is authorized to act on behalf of the assignee.

/Justin R. Nifong/  
Signature

2015-12-30  
Date

Justin R. Nifong

Attorney

Printed or Typed Name

Title

This collection of information is required by 37 CFR 3.73(b). The information is required to obtain or retain a benefit by the public which is to file (and by the USPTO to process) an application. Confidentiality is governed by 35 U.S.C. 122 and 37 CFR 1.11 and 1.14. This collection is estimated to take 12 minutes to complete, including gathering, preparing, and submitting the completed application form to the USPTO. Time will vary depending upon the individual case. Any comments on the amount of time you require to complete this form and/or suggestions for reducing this burden, should be sent to the Chief Information Officer, U.S. Patent and Trademark Office, U.S. Department of Commerce, P.O. Box 1450, Alexandria, VA 22313-1450. DO NOT SEND FEES OR COMPLETED FORMS TO THIS ADDRESS. SEND TO: Commissioner for Patents, P.O. Box 1450, Alexandria, VA 22313-1450.

If you need assistance in completing the form, call 1-800-PTO-9199 and select option 2.

## Privacy Act Statement

The **Privacy Act of 1974 (P.L. 93-579)** requires that you be given certain information in connection with your submission of the attached form related to a patent application or patent. Accordingly, pursuant to the requirements of the Act, please be advised that: (1) the general authority for the collection of this information is 35 U.S.C. 2(b)(2); (2) furnishing of the information solicited is voluntary; and (3) the principal purpose for which the information is used by the U.S. Patent and Trademark Office is to process and/or examine your submission related to a patent application or patent. If you do not furnish the requested information, the U.S. Patent and Trademark Office may not be able to process and/or examine your submission, which may result in termination of proceedings or abandonment of the application or expiration of the patent.

The information provided by you in this form will be subject to the following routine uses:

1. The information on this form will be treated confidentially to the extent allowed under the Freedom of Information Act (5 U.S.C. 552) and the Privacy Act (5 U.S.C. 552a). Records from this system of records may be disclosed to the Department of Justice to determine whether disclosure of these records is required by the Freedom of Information Act.
2. A record from this system of records may be disclosed, as a routine use, in the course of presenting evidence to a court, magistrate, or administrative tribunal, including disclosures to opposing counsel in the course of settlement negotiations.
3. A record in this system of records may be disclosed, as a routine use, to a Member of Congress submitting a request involving an individual, to whom the record pertains, when the individual has requested assistance from the Member with respect to the subject matter of the record.
4. A record in this system of records may be disclosed, as a routine use, to a contractor of the Agency having need for the information in order to perform a contract. Recipients of information shall be required to comply with the requirements of the Privacy Act of 1974, as amended, pursuant to 5 U.S.C. 552a(m).
5. A record related to an International Application filed under the Patent Cooperation Treaty in this system of records may be disclosed, as a routine use, to the International Bureau of the World Intellectual Property Organization, pursuant to the Patent Cooperation Treaty.
6. A record in this system of records may be disclosed, as a routine use, to another federal agency for purposes of National Security review (35 U.S.C. 181) and for review pursuant to the Atomic Energy Act (42 U.S.C. 218(c)).
7. A record from this system of records may be disclosed, as a routine use, to the Administrator, General Services, or his/her designee, during an inspection of records conducted by GSA as part of that agency's responsibility to recommend improvements in records management practices and programs, under authority of 44 U.S.C. 2904 and 2906. Such disclosure shall be made in accordance with the GSA regulations governing inspection of records for this purpose, and any other relevant (*i.e.*, GSA or Commerce) directive. Such disclosure shall not be used to make determinations about individuals.
8. A record from this system of records may be disclosed, as a routine use, to the public after either publication of the application pursuant to 35 U.S.C. 122(b) or issuance of a patent pursuant to 35 U.S.C. 151. Further, a record may be disclosed, subject to the limitations of 37 CFR 1.14, as a routine use, to the public if the record was filed in an application which became abandoned or in which the proceedings were terminated and which application is referenced by either a published application, an application open to public inspection or an issued patent.
9. A record from this system of records may be disclosed, as a routine use, to a Federal, State, or local law enforcement agency, if the USPTO becomes aware of a violation or potential violation of law or regulation.

Under the Paperwork Reduction Act of 1995, no persons are required to respond to a collection of information unless it contains a valid OMB control number.

<b>Application Data Sheet 37 CFR 1.76</b>		Attorney Docket Number	455/006/8 UTIL
		Application Number	<u>14/609,189</u>
Title of Invention	Messaging centre for forwarding e-mail		
<p>The application data sheet is part of the provisional or nonprovisional application for which it is being submitted. The following form contains the bibliographic data arranged in a format specified by the United States Patent and Trademark Office as outlined in 37 CFR 1.76. This document may be completed electronically and submitted to the Office in electronic format using the Electronic Filing System (EFS) or the document may be printed and included in a paper filed application.</p>			

**Secrecy Order 37 CFR 5.2**

<input type="checkbox"/>	Portions or all of the application associated with this Application Data Sheet may fall under a Secrecy Order pursuant to 37 CFR 5.2 (Paper filers only. Applications that fall under Secrecy Order may not be filed electronically.)
--------------------------	---

**Inventor Information:**

Inventor 1					Remove	
Legal Name						
Prefix	Given Name	Middle Name	Family Name	Suffix		
	Ari		Backholm			
Residence Information (Select One) <input checked="" type="radio"/> US Residency <input type="radio"/> Non US Residency <input type="radio"/> Active US Military Service						
City	San Carlos	State/Province	CA	Country of Residence	US	
Mailing Address of Inventor:						
Address 1	959 Skyway Road					
Address 2	suite 100					
City	San Carlos	State/Province	CA			
Postal Code	94070	Country i	US			
Inventor 2					Remove	
Legal Name						
Prefix	Given Name	Middle Name	Family Name	Suffix		
	Seppo		Salorinne			
Residence Information (Select One) <input type="radio"/> US Residency <input checked="" type="radio"/> Non US Residency <input type="radio"/> Active US Military Service						
City	Helsinki	Country of Residence <sup>i</sup>	FI			
Mailing Address of Inventor:						
Address 1	959 Skyway Road					
Address 2	SUITE 100					
City	San Carlos	State/Province	CA			
Postal Code	94070	Country i	US			
Inventor 3					Remove	
Legal Name						
Prefix	Given Name	Middle Name	Family Name	Suffix		
	Antti		Saarlahti			

Under the Paperwork Reduction Act of 1995, no persons are required to respond to a collection of information unless it contains a valid OMB control number.

<b>Application Data Sheet 37 CFR 1.76</b>		Attorney Docket Number	455/006/8 UTIL	
		Application Number	14/609,189	
Title of Invention	Messaging centre for forwarding e-mail			
Residence Information (Select One) <input type="radio"/> US Residency <input checked="" type="radio"/> Non US Residency <input type="radio"/> Active US Military Service				
City	Helsinki	Country of Residence <sup>i</sup>	FI	
Mailing Address of Inventor:				
Address 1	959 Skyway Road			
Address 2	suite 100			
City	San Carlos	State/Province	CA	
Postal Code	94070	Country <sup>i</sup>	US	
Inventor 4				<input type="button" value="Remove"/>
Legal Name				
Prefix	Given Name	Middle Name	Family Name	Suffix
	Marko		Ketonen	
Residence Information (Select One) <input type="radio"/> US Residency <input checked="" type="radio"/> Non US Residency <input type="radio"/> Active US Military Service				
City	Helsinki	Country of Residence <sup>i</sup>	FI	
Mailing Address of Inventor:				
Address 1	959 Skyway Road			
Address 2	suite 100			
City	San Carlos	State/Province	CA	
Postal Code	94070	Country <sup>i</sup>	US	
Inventor 5				<input type="button" value="Remove"/>
Legal Name				
Prefix	Given Name	Middle Name	Family Name	Suffix
	Lauri		Vuomos	
Residence Information (Select One) <input type="radio"/> US Residency <input checked="" type="radio"/> Non US Residency <input type="radio"/> Active US Military Service				
City	Helsinki	Country of Residence <sup>i</sup>	FI	
Mailing Address of Inventor:				
Address 1	959 Skyway Road			
Address 2	suite 100			
City	San Carlos	State/Province	CA	
Postal Code	94070	Country <sup>i</sup>	US	
Inventor 6				<input type="button" value="Remove"/>
Legal Name				

Under the Paperwork Reduction Act of 1995, no persons are required to respond to a collection of information unless it contains a valid OMB control number.

<b>Application Data Sheet 37 CFR 1.76</b>		Attorney Docket Number	455/006/8 UTIL
		Application Number	<u>14/609,189</u>
Title of Invention	Messaging centre for forwarding e-mail		

Prefix	Given Name	Middle Name	Family Name	Suffix
	Petri		Salmi	
<b>Residence Information (Select One)</b> <input type="radio"/> US Residency <input checked="" type="radio"/> Non US Residency <input type="radio"/> Active US Military Service				
City	Espoo	Country of Residence <sup>i</sup>	FI	
<b>Mailing Address of Inventor:</b>				
Address 1	959 Skyway Road			
Address 2	suite 100			
City	San Carlos	State/Province	CA	
Postal Code	94070	Country <sup>i</sup>	US	
All Inventors Must Be Listed - Additional Inventor Information blocks may be generated within this form by selecting the <b>Add</b> button. <span style="float: right;"><input type="button" value="Add"/></span>				

**Correspondence Information:**

Enter either Customer Number or complete the Correspondence Information section below. For further information see 37 CFR 1.33(a).	
<input type="checkbox"/> An Address is being provided for the correspondence information of this application.	
Customer Number	118194
Email Address	jrnifong@nkkpatentlaw.com <span style="float: right;"><input type="button" value="Add Email"/> <input type="button" value="Remove Email"/></span>

**Application Information:**

Title of the Invention	Messaging centre for forwarding e-mail		
Attorney Docket Number	455/006/8 UTIL	Small Entity Status Claimed	<input checked="" type="checkbox"/>
Application Type	Nonprovisional		
Subject Matter	Utility		
Total Number of Drawing Sheets (if any)	4	Suggested Figure for Publication (if any)	1

**Filing By Reference :**

Only complete this section when filing an application by reference under 35 U.S.C. 111(c) and 37 CFR 1.57(a). Do not complete this section if application papers including a specification and any drawings are being filed. Any domestic benefit or foreign priority information must be provided in the appropriate section(s) below (i.e., "Domestic Benefit/National Stage Information" and "Foreign Priority Information").

For the purposes of a filing date under 37 CFR 1.53(b), the description and any drawings of the present application are replaced by this reference to the previously filed application, subject to conditions and requirements of 37 CFR 1.57(a).

Application number of the previously filed application	Filing date (YYYY-MM-DD)	Intellectual Property Authority or Country

Under the Paperwork Reduction Act of 1995, no persons are required to respond to a collection of information unless it contains a valid OMB control number.

<b>Application Data Sheet 37 CFR 1.76</b>		Attorney Docket Number	455/006/8 UTIL
		Application Number	<u>14/609,189</u>
Title of Invention	Messaging centre for forwarding e-mail		

**Publication Information:**

<input type="checkbox"/>	Request Early Publication (Fee required at time of Request 37 CFR 1.219)
<input type="checkbox"/>	<b>Request Not to Publish.</b> I hereby request that the attached application not be published under 35 U.S.C. 122(b) and certify that the invention disclosed in the attached application <b>has not and will not</b> be the subject of an application filed in another country, or under a multilateral international agreement, that requires publication at eighteen months after filing.

**Representative Information:**

Representative information should be provided for all practitioners having a power of attorney in the application. Providing this information in the Application Data Sheet does not constitute a power of attorney in the application (see 37 CFR 1.32). Either enter Customer Number or complete the Representative Name section below. If both sections are completed the customer number will be used for the Representative information during processing.			
Please Select One:	<input checked="" type="radio"/> Customer Number	<input type="radio"/> US Patent Practitioner	<input type="radio"/> Limited Recognition (37 CFR 11.9)
Customer Number	118194		

**Domestic Benefit/National Stage Information:**

This section allows for the applicant to either claim benefit under 35 U.S.C. 119(e), 120, 121, or 365(c) or indicate National Stage entry from a PCT application. Providing this information in the application data sheet constitutes the specific reference required by 35 U.S.C. 119(e) or 120, and 37 CFR 1.78.

When referring to the current application, please leave the application number blank.

Prior Application Status	Pending		<a href="#">Remove</a>		
Application Number	Continuity Type	Prior Application Number	Filing Date (YYYY-MM-DD)		
	Continuation of	12228325	2008-08-11		
Prior Application Status	Patented		<a href="#">Remove</a>		
Application Number	Continuity Type	Prior Application Number	Filing Date (YYYY-MM-DD)	Patent Number	Issue Date (YYYY-MM-DD)
12228325	Division of	11282950	2005-11-21	7643818	2010-01-05
Prior Application Status	Expired		<a href="#">Remove</a>		
Application Number	Continuity Type	Prior Application Number	Filing Date (YYYY-MM-DD)		
12228325	Claims benefit of provisional	60650975	2005-02-09		
Additional Domestic Benefit/National Stage Data may be generated within this form by selecting the <b>Add</b> button.					

**Foreign Priority Information:**

Under the Paperwork Reduction Act of 1995, no persons are required to respond to a collection of information unless it contains a valid OMB control number.

<b>Application Data Sheet 37 CFR 1.76</b>		Attorney Docket Number	455/006/8 UTIL
		Application Number	<u>14/609,189</u>
Title of Invention	Messaging centre for forwarding e-mail		

This section allows for the applicant to claim priority to a foreign application. Providing this information in the application data sheet constitutes the claim for priority as required by 35 U.S.C. 119(b) and 37 CFR 1.55(d). When priority is claimed to a foreign application that is eligible for retrieval under the priority document exchange program (PDX)<sup>1</sup> the information will be used by the Office to automatically attempt retrieval pursuant to 37 CFR 1.55(h)(1) and (2). Under the PDX program, applicant bears the ultimate responsibility for ensuring that a copy of the foreign application is received by the Office from the participating foreign intellectual property office, or a certified copy of the foreign priority application is filed, within the time period specified in 37 CFR 1.55(g)(1).

[Remove](#)

Application Number	Country <sup>1</sup>	Filing Date (YYYY-MM-DD)	Access Code <sup>1</sup> (if applicable)
20045451	FI	2004-11-22	

Additional Foreign Priority Data may be generated within this form by selecting the **Add** button.

## Statement under 37 CFR 1.55 or 1.78 for AIA (First Inventor to File) Transition Applications

This application (1) claims priority to or the benefit of an application filed before March 16, 2013 and (2) also contains, or contained at any time, a claim to a claimed invention that has an effective filing date on or after March 16, 2013.

NOTE: By providing this statement under 37 CFR 1.55 or 1.78, this application, with a filing date on or after March 16, 2013, will be examined under the first inventor to file provisions of the AIA.

## Authorization to Permit Access:

Authorization to Permit Access to the Instant Application by the Participating Offices



Under the Paperwork Reduction Act of 1995, no persons are required to respond to a collection of information unless it contains a valid OMB control number.

<b>Application Data Sheet 37 CFR 1.76</b>		Attorney Docket Number	455/006/8 UTIL
		Application Number	<u>14/609,189</u>
Title of Invention	Messaging centre for forwarding e-mail		

If checked, the undersigned hereby grants the USPTO authority to provide the European Patent Office (EPO), the Japan Patent Office (JPO), the Korean Intellectual Property Office (KIPO), the World Intellectual Property Office (WIPO), and any other intellectual property offices in which a foreign application claiming priority to the instant patent application is filed access to the instant patent application. See 37 CFR 1.14(c) and (h). This box should not be checked if the applicant does not wish the EPO, JPO, KIPO, WIPO, or other intellectual property office in which a foreign application claiming priority to the instant patent application is filed to have access to the instant patent application.

In accordance with 37 CFR 1.14(h)(3), access will be provided to a copy of the instant patent application with respect to: 1) the instant patent application-as-filed; 2) any foreign application to which the instant patent application claims priority under 35 U.S.C. 119(a)-(d) if a copy of the foreign application that satisfies the certified copy requirement of 37 CFR 1.55 has been filed in the instant patent application; and 3) any U.S. application-as-filed from which benefit is sought in the instant patent application.

In accordance with 37 CFR 1.14(c), access may be provided to information concerning the date of filing this Authorization.

## Applicant Information:

Providing assignment information in this section does not substitute for compliance with any requirement of part 3 of Title 37 of CFR to have an assignment recorded by the Office.			
<b>Applicant 1</b>			
If the applicant is the inventor (or the remaining joint inventor or inventors under 37 CFR 1.45), this section should not be completed. The information to be provided in this section is the name and address of the legal representative who is the applicant under 37 CFR 1.43; or the name and address of the assignee, person to whom the inventor is under an obligation to assign the invention, or person who otherwise shows sufficient proprietary interest in the matter who is the applicant under 37 CFR 1.46. If the applicant is an applicant under 37 CFR 1.46 (assignee, person to whom the inventor is obligated to assign, or person who otherwise shows sufficient proprietary interest) together with one or more joint inventors, then the joint inventor or inventors who are also the applicant should be identified in this section.			
<input type="button" value="Clear"/>			
<input checked="" type="radio"/> Assignee	<input type="radio"/> Legal Representative under 35 U.S.C. 117	<input type="radio"/> Joint Inventor	
<input type="radio"/> Person to whom the inventor is obligated to assign.		<input type="radio"/> Person who shows sufficient proprietary interest	
If applicant is the legal representative, indicate the authority to file the patent application, the inventor is:			
Name of the Deceased or Legally Incapacitated Inventor : <input type="text"/>			
If the Applicant is an Organization check here. <input checked="" type="checkbox"/>			
Organization Name	<del>Seven Networks, Inc.</del> <u>Seven Networks, LLC</u>		
<b>Mailing Address Information For Applicant:</b>			
Address 1	959 Skyway Road		
Address 2	Suite 100		
City	San Carlos	State/Province	CA
Country	US	Postal Code	94070
Phone Number		Fax Number	

Under the Paperwork Reduction Act of 1995, no persons are required to respond to a collection of information unless it contains a valid OMB control number.

<b>Application Data Sheet 37 CFR 1.76</b>		Attorney Docket Number	455/006/8 UTIL
		Application Number	<u>14/609,189</u>
Title of Invention	Messaging centre for forwarding e-mail		
Email Address			
Additional Applicant Data may be generated within this form by selecting the Add button.			

### Assignee Information including Non-Applicant Assignee Information:

Providing assignment information in this section does not substitute for compliance with any requirement of part 3 of Title 37 of CFR to have an assignment recorded by the Office.				
<b>Assignee 1</b>				
Complete this section if assignee information, including non-applicant assignee information, is desired to be included on the patent application publication. An assignee-applicant identified in the "Applicant Information" section will appear on the patent application publication as an applicant. For an assignee-applicant, complete this section only if identification as an assignee is also desired on the patent application publication.				
If the Assignee or Non-Applicant Assignee is an Organization check here. <input type="checkbox"/>				
Prefix	Given Name	Middle Name	Family Name	Suffix
<b>Mailing Address Information For Assignee including Non-Applicant Assignee:</b>				
Address 1				
Address 2				
City		State/Province		
Country <sup>i</sup>	Postal Code			
Phone Number		Fax Number		
Email Address				
Additional Assignee or Non-Applicant Assignee Data may be generated within this form by selecting the Add button.				

### Signature:

NOTE: This form must be signed in accordance with 37 CFR 1.33. See 37 CFR 1.4 for signature requirements and certifications.				
Signature	/Justin R. Nifong/		Date (YYYY-MM-DD)	2015-12-30
First Name	Justin	Last Name	Nifong	Registration Number
				59389
Additional Signature may be generated within this form by selecting the Add button.				

Under the Paperwork Reduction Act of 1995, no persons are required to respond to a collection of information unless it contains a valid OMB control number.

<b>Application Data Sheet 37 CFR 1.76</b>		Attorney Docket Number	455/006/8 UTIL
		Application Number	<u>14/609,189</u>
Title of Invention	Messaging centre for forwarding e-mail		

This collection of information is required by 37 CFR 1.76. The information is required to obtain or retain a benefit by the public which is to file (and by the USPTO to process) an application. Confidentiality is governed by 35 U.S.C. 122 and 37 CFR 1.14. This collection is estimated to take 23 minutes to complete, including gathering, preparing, and submitting the completed application data sheet form to the USPTO. Time will vary depending upon the individual case. Any comments on the amount of time you require to complete this form and/or suggestions for reducing this burden, should be sent to the Chief Information Officer, U.S. Patent and Trademark Office, U.S. Department of Commerce, P.O. Box 1450, Alexandria, VA 22313-1450. **DO NOT SEND FEES OR COMPLETED FORMS TO THIS ADDRESS. SEND TO: Commissioner for Patents, P.O. Box 1450, Alexandria, VA 22313-1450.**

## Privacy Act Statement

The Privacy Act of 1974 (P.L. 93-579) requires that you be given certain information in connection with your submission of the attached form related to a patent application or patent. Accordingly, pursuant to the requirements of the Act, please be advised that: (1) the general authority for the collection of this information is 35 U.S.C. 2(b)(2); (2) furnishing of the information solicited is voluntary; and (3) the principal purpose for which the information is used by the U.S. Patent and Trademark Office is to process and/or examine your submission related to a patent application or patent. If you do not furnish the requested information, the U.S. Patent and Trademark Office may not be able to process and/or examine your submission, which may result in termination of proceedings or abandonment of the application or expiration of the patent.

The information provided by you in this form will be subject to the following routine uses:

1. The information on this form will be treated confidentially to the extent allowed under the Freedom of Information Act (5 U.S.C. 552) and the Privacy Act (5 U.S.C. 552a). Records from this system of records may be disclosed to the Department of Justice to determine whether the Freedom of Information Act requires disclosure of these records.
2. A record from this system of records may be disclosed, as a routine use, in the course of presenting evidence to a court, magistrate, or administrative tribunal, including disclosures to opposing counsel in the course of settlement negotiations.
3. A record in this system of records may be disclosed, as a routine use, to a Member of Congress submitting a request involving an individual, to whom the record pertains, when the individual has requested assistance from the Member with respect to the subject matter of the record.
4. A record in this system of records may be disclosed, as a routine use, to a contractor of the Agency having need for the information in order to perform a contract. Recipients of information shall be required to comply with the requirements of the Privacy Act of 1974, as amended, pursuant to 5 U.S.C. 552a(m).
5. A record related to an International Application filed under the Patent Cooperation Treaty in this system of records may be disclosed, as a routine use, to the International Bureau of the World Intellectual Property Organization, pursuant to the Patent Cooperation Treaty.
6. A record in this system of records may be disclosed, as a routine use, to another federal agency for purposes of National Security review (35 U.S.C. 181) and for review pursuant to the Atomic Energy Act (42 U.S.C. 218(c)).
7. A record from this system of records may be disclosed, as a routine use, to the Administrator, General Services, or his/her designee, during an inspection of records conducted by GSA as part of that agency's responsibility to recommend improvements in records management practices and programs, under authority of 44 U.S.C. 2904 and 2906. Such disclosure shall be made in accordance with the GSA regulations governing inspection of records for this purpose, and any other relevant (i.e., GSA or Commerce) directive. Such disclosure shall not be used to make determinations about individuals.
8. A record from this system of records may be disclosed, as a routine use, to the public after either publication of the application pursuant to 35 U.S.C. 122(b) or issuance of a patent pursuant to 35 U.S.C. 151. Further, a record may be disclosed, subject to the limitations of 37 CFR 1.14, as a routine use, to the public if the record was filed in an application which became abandoned or in which the proceedings were terminated and which application is referenced by either a published application, an application open to public inspections or an issued patent.
9. A record from this system of records may be disclosed, as a routine use, to a Federal, State, or local law enforcement agency, if the USPTO becomes aware of a violation or potential violation of law or regulation.



UNITED STATES PATENT AND TRADEMARK OFFICE

UNITED STATES DEPARTMENT OF COMMERCE
United States Patent and Trademark Office
Address: COMMISSIONER FOR PATENTS
P. O. Box 1450
Alexandria, Virginia 22313-1450
www.uspto.gov

Table with 5 columns: APPLICATION NO., FILING DATE, FIRST NAMED INVENTOR, ATTORNEY DOCKET NO., CONFIRMATION NO. Includes sub-tables for EXAMINER, ART UNIT, PAPER NUMBER, NOTIFICATION DATE, and DELIVERY MODE.

Please find below and/or attached an Office communication concerning this application or proceeding.

The time period for reply, if any, is set in the attached communication.

Notice of the Office communication was sent electronically on above-indicated "Notification Date" to the following e-mail address(es):

usptomail@nkpatentlaw.com
docket@nkkpatentlaw.com
abackholm@seven.com

<b>Office Action Summary</b>	<b>Application No.</b> 14/609,189	<b>Applicant(s)</b> BACKHOLM ET AL.	
	<b>Examiner</b> ALAN S. CHOU	<b>Art Unit</b> 2451	<b>AIA (First Inventor to File) Status</b> No

-- The MAILING DATE of this communication appears on the cover sheet with the correspondence address --

**Period for Reply**

A SHORTENED STATUTORY PERIOD FOR REPLY IS SET TO EXPIRE 3 MONTHS FROM THE MAILING DATE OF THIS COMMUNICATION.

- Extensions of time may be available under the provisions of 37 CFR 1.136(a). In no event, however, may a reply be timely filed after SIX (6) MONTHS from the mailing date of this communication.
- If NO period for reply is specified above, the maximum statutory period will apply and will expire SIX (6) MONTHS from the mailing date of this communication.
- Failure to reply within the set or extended period for reply will, by statute, cause the application to become ABANDONED (35 U.S.C. § 133). Any reply received by the Office later than three months after the mailing date of this communication, even if timely filed, may reduce any earned patent term adjustment. See 37 CFR 1.704(b).

**Status**

- 1)  Responsive to communication(s) filed on 3/29/2015.  
 A declaration(s)/affidavit(s) under **37 CFR 1.130(b)** was/were filed on \_\_\_\_\_.
- 2a)  This action is **FINAL**.                      2b)  This action is non-final.
- 3)  An election was made by the applicant in response to a restriction requirement set forth during the interview on \_\_\_\_\_; the restriction requirement and election have been incorporated into this action.
- 4)  Since this application is in condition for allowance except for formal matters, prosecution as to the merits is closed in accordance with the practice under *Ex parte Quayle*, 1935 C.D. 11, 453 O.G. 213.

**Disposition of Claims\***

- 5)  Claim(s) 1-20 is/are pending in the application.  
5a) Of the above claim(s) \_\_\_\_\_ is/are withdrawn from consideration.
- 6)  Claim(s) \_\_\_\_\_ is/are allowed.
- 7)  Claim(s) 1-20 is/are rejected.
- 8)  Claim(s) \_\_\_\_\_ is/are objected to.
- 9)  Claim(s) \_\_\_\_\_ are subject to restriction and/or election requirement.

\* If any claims have been determined allowable, you may be eligible to benefit from the **Patent Prosecution Highway** program at a participating intellectual property office for the corresponding application. For more information, please see [http://www.uspto.gov/patents/init\\_events/pph/index.jsp](http://www.uspto.gov/patents/init_events/pph/index.jsp) or send an inquiry to [PPHfeedback@uspto.gov](mailto:PPHfeedback@uspto.gov).

**Application Papers**

- 10)  The specification is objected to by the Examiner.
- 11)  The drawing(s) filed on 1/29/2015 is/are: a)  accepted or b)  objected to by the Examiner.  
Applicant may not request that any objection to the drawing(s) be held in abeyance. See 37 CFR 1.85(a).  
Replacement drawing sheet(s) including the correction is required if the drawing(s) is objected to. See 37 CFR 1.121(d).

**Priority under 35 U.S.C. § 119**

- 12)  Acknowledgment is made of a claim for foreign priority under 35 U.S.C. § 119(a)-(d) or (f).

**Certified copies:**

- a)  All    b)  Some\*\*    c)  None of the:
1.  Certified copies of the priority documents have been received.
  2.  Certified copies of the priority documents have been received in Application No. 12/228325.
  3.  Copies of the certified copies of the priority documents have been received in this National Stage application from the International Bureau (PCT Rule 17.2(a)).

\*\* See the attached detailed Office action for a list of the certified copies not received.

**Attachment(s)**

- 1)  Notice of References Cited (PTO-892)
- 2)  Information Disclosure Statement(s) (PTO/SB/08a and/or PTO/SB/08b)  
Paper No(s)/Mail Date \_\_\_\_\_.
- 3)  Interview Summary (PTO-413)  
Paper No(s)/Mail Date. \_\_\_\_\_.
- 4)  Other: \_\_\_\_\_.

The present application is being examined under the pre-AIA first to invent provisions.

### **DETAILED ACTION**

Claims 1-20 are presented for examination.

#### ***Double Patenting***

1. The nonstatutory double patenting rejection is based on a judicially created doctrine grounded in public policy (a policy reflected in the statute) so as to prevent the unjustified or improper timewise extension of the “right to exclude” granted by a patent and to prevent possible harassment by multiple assignees. A nonstatutory double patenting rejection is appropriate where the claims at issue are not identical, but at least one examined application claim is not patentably distinct from the reference claim(s) because the examined application claim is either anticipated by, or would have been obvious over, the reference claim(s). See, e.g., *In re Berg*, 140 F.3d 1428, 46 USPQ2d 1226 (Fed. Cir. 1998); *In re Goodman*, 11 F.3d 1046, 29 USPQ2d 2010 (Fed. Cir. 1993); *In re Longi*, 759 F.2d 887, 225 USPQ 645 (Fed. Cir. 1985); *In re Van Ornum*, 686 F.2d 937, 214 USPQ 761 (CCPA 1982); *In re Vogel*, 422 F.2d 438, 164 USPQ 619 (CCPA 1970); and *In re Thorington*, 418 F.2d 528, 163 USPQ 644 (CCPA 1969).

2. Timely filed terminal disclaimer in compliance with 37 CFR 1.321(c) or 1.321(d) may be used to overcome an actual or provisional rejection based on a nonstatutory double patenting ground provided the reference application or patent either is shown to be commonly owned with this application, or claims an invention made as a result of activities undertaken within the scope of a joint research agreement. A terminal disclaimer must be signed in compliance with 37 CFR 1.321(b).

3. The USPTO internet Web site contains terminal disclaimer forms which may be used. Please visit <http://www.uspto.gov/forms/>. The filing date of the application will determine what form should be used. A web-based eTerminal Disclaimer may be filled out completely online using web-screens. An eTerminal Disclaimer that meets all requirements is auto-processed and approved immediately upon submission. For more information about eTerminal Disclaimers, refer to <http://www.uspto.gov/patents/process/file/efs/guidance/eTD-info-I.jsp>.

4. Claims 1-20 are rejected on the ground of nonstatutory double patenting as being unpatentable over claim 1 of U.S. Patent No. 7,706,781 B2 and claim 1 of U.S. Patent 7,643,818 B2. Although the claims at issue are not identical, they are not patentably distinct from each other because both independent claims have the similar steps such as: e-mail address of the mobile terminal is associated with an identifier and encryption information (see claims 1 in U.S. Patent 7,706,871 B2 and U.S. Patent 7,643,818 B2), encrypting an email message using the encryption information (see claims 1 in U.S. Patent 7,706,871 B2 and U.S. Patent 7,643,818 B2), and transmitting the encrypted e-mail message (see claims 1 in U.S. Patent 7,706,871 B2 and U.S. Patent 7,643,818 B2).

5. The current independent claim 1 is a broader version of claim 1 of U.S. Patent 7,643,818 B2, without the limitation of establishing a tunnel and permanent terminal identity and temporary identity.

6. The current independent claim 1 is a broader version of claim 1 of U.S. Patent 7,706,781 B2, without the limitation of activation code, permanent terminal identity, and



encrypted data channel. The limitation of activation code can be found in the dependent claim 8 of the current application.

7. Thus the current independent claims 1, 12, 20 have similar limitation as the parent claim in the U.S. Patent 7,706,871 B2 and U.S. Patent 7,643,818 B2.

***Claim Rejections - 35 USC § 101***

8. 35 U.S.C. 101 reads as follows:

Whoever invents or discovers any new and useful process, machine, manufacture, or composition of matter, or any new and useful improvement thereof, may obtain a patent therefor, subject to the conditions and requirements of this title.

9. Claims 1-20 are rejected under 35 U.S.C. 101 because the claimed invention is directed to non-statutory subject matter. The claim(s) does/do not fall within at least one of the four categories of patent eligible subject matter because the claimed invention is directed to a judicial exception (i.e., a law of nature, a natural phenomenon, or an abstract idea) without significantly more. Claims 1-20 are directed to the abstract idea of associating e-mail address with an identifier and encryption information, encrypting the e-mail with the encryption information, and transmitting the encrypted e-mail. The claimed invention falls under the category to organize, store and retrieve email data with encryption as an extra step of processing the stored data. The claims do not include additional elements that are sufficient to amount to significantly more than the judicial exception because the claim has only generic computer components

such as: mobile terminal, e-mail server, system with memory and processor, and thus are not sufficient to amount to significantly more.

10. Claim 20 is rejected under 35 U.S.C. 101 because the claimed invention is directed to non-statutory subject matter. The claim(s) does/do not fall within at least one of the four categories of patent eligible subject matter because the claim is directed to a "computer-readable storage medium". The specification is silent regarding the meaning of this term. Thus, applying the broadest reasonable interpretation in light of the specification and taking into account the meaning of the words in their ordinary usage as they would be understood by one of ordinary skill in the art (MPEP §2111), the claim as a whole covers both transitory and non-transitory media. A transitory medium does not fall into any of the 4 categories of invention (process, machine, manufacture, or composition of matter).

11. As per claim 12, claim limitation "encryption engine" and "communication interface" have been interpreted under 35 U.S.C. 112(f) or pre-AIA 35 U.S.C. 112, sixth paragraph, because it uses/they use a generic placeholder "engine" and "interface" coupled with functional language "configured to encrypt" and "configured to transmit" without reciting sufficient structure to achieve the function. Furthermore, the generic

placeholder is not preceded by a structural modifier. "Encryption" and "communication" are not a structural modifier.

12. The examiner is interpreting the "communication interface" as a wireless interface such as Bluetooth (see page 7 section [0029] in the Specification).

Since the claim limitation(s) invokes 35 U.S.C. 112(f) or pre-AIA 35 U.S.C. 112, sixth paragraph, claim(s) 12 has/have been interpreted to cover the corresponding structure described in the specification that achieves the claimed function, and equivalents thereof.

If applicant wishes to provide further explanation or dispute the examiner's interpretation of the corresponding structure, applicant must identify the corresponding structure with reference to the specification by page and line number, and to the drawing, if any, by reference characters in response to this Office action.

If applicant does not intend to have the claim limitation(s) treated under 35 U.S.C. 112(f) or pre-AIA 35 U.S.C. 112, sixth paragraph, applicant may amend the claim(s) so that it/they will clearly not invoke 35 U.S.C. 112(f) or pre-AIA 35 U.S.C. 112, sixth paragraph, or present a sufficient showing that the claim recites/recite sufficient structure, material, or acts for performing the claimed function to preclude application of 35 U.S.C. 112(f) or pre-AIA 35 U.S.C. 112, sixth paragraph.

For more information, see MPEP § 2173 *et seq.* and *Supplementary Examination Guidelines for Determining Compliance With 35 U.S.C. 112 and for Treatment of Related Issues in Patent Applications*, 76 FR 7162, 7167 (Feb. 9, 2011).

***Claim Rejections - 35 USC § 112***

13. The following is a quotation of 35 U.S.C. 112(b):  
(b) CONCLUSION.—The specification shall conclude with one or more claims particularly pointing out and distinctly claiming the subject matter which the inventor or a joint inventor regards as the invention.

The following is a quotation of 35 U.S.C. 112 (pre-AIA), second paragraph:  
The specification shall conclude with one or more claims particularly pointing out and distinctly claiming the subject matter which the applicant regards as his invention.

14. Claims 12-19 are rejected under 35 U.S.C. 112(b) or 35 U.S.C. 112 (pre-AIA), second paragraph, as being indefinite for failing to particularly point out and distinctly claim the subject matter which the inventor or a joint inventor, or for pre-AIA the applicant regards as the invention.

15. Claim element “encryption engine” limitation that invokes 35 U.S.C. 112(f) or pre-AIA 35 U.S.C. 112, sixth paragraph. However, the written description fails to disclose the corresponding structure, material, or acts for the claimed function. The specification is silent regarding how the statistical information generating module may be implemented.

Applicant may:

- (a) Amend the claim so that the claim limitation will no longer be interpreted as a limitation under 35 U.S.C. 112(f) or pre-AIA 35 U.S.C. 112, sixth paragraph; or

(b) Amend the written description of the specification such that it expressly recites what structure, material, or acts perform the claimed function, without introducing any new matter (35 U.S.C. 132(a)).

If applicant is of the opinion that the written description of the specification already implicitly or inherently discloses the corresponding structure, material, or acts so that one of ordinary skill in the art would recognize what structure, material, or acts perform the claimed function applicant should clarify the record by either:

(a) Amending the written description of the specification such that it expressly recites the corresponding structure, material, or acts for performing the claimed function and clearly links or associates the structure, material, or acts to the claimed function, without introducing any new matter (35 U.S.C. 132(a)); or

(b) Stating on the record what the corresponding structure, material, or acts, which are implicitly or inherently set forth in the written description of the specification, perform the claimed function. For more information, see 37 CFR 1.75(d) and MPEP §§ 608.01(o) and 2181.

### ***Claim Rejections - 35 USC § 103***

1. The following is a quotation of pre-AIA 35 U.S.C. 103(a) which forms the basis for all obviousness rejections set forth in this Office action:

(a) A patent may not be obtained though the invention is not identically disclosed or described as set forth in section 102 of this title, if the differences between the subject matter sought to be patented and the prior art are such that the subject matter as a whole would have been obvious at the time the invention was made to a person having ordinary skill in the art to which

said subject matter pertains. Patentability shall not be negated by the manner in which the invention was made.

2. Claims 1-2, 6-10, 12-14, 18, 20 are rejected under pre-AIA 35 U.S.C. 103(a) as being unpatentable over Little et al. U.S. Patent Application Publication Number 2004/0205248 A1 (hereinafter Little), further in view of Turunen et al. U.S. Patent Number 7,289,792 B1 (hereinafter Turunen).

16. As per claim 1, Little discloses a method for forwarding an e-mail message from an e-mail server to a mobile terminal (see forwarding email message 833 from message server 820 to mobile device 816 on page 9 section [0076] on Figure 8), the method comprising:

17. wherein an e-mail address is associated with an identifier (see email message with a user name and identifier on page 9 section [0078]) and encryption information (see encryption information as private key to identify entities and encryption on page 8 section [0070]), receiving the e-mail message associated with the e-mail address (see receiving email from computer system 812 addressed to one recipient email address on page 9 section [0076]) and sent by the e-mail server (see email received by email server 820 mailbox 819 on page 9 section [0078]);

18. encrypting the e-mail message using the encryption information associated with the e-mail address (see encrypting the email message before transfer on page 9 section [0081]); and

19. transmitting the encrypted e-mail message to the mobile terminal (see repackaged message arrives at a mobile terminal on page 10 section [0082]).

20. Little do not disclose expressly: e-mail address of the mobile terminal is associated with an identifier.

21. Turunen teaches: e-mail address of the mobile terminal is associated with an identifier (see e-mail address of terminal is used to identify the wireless terminal as well as an identification of wireless terminal using international mobile subscriber identity IMSI on column 8 line 20-35 and see e-mail address as well as the identification of the wireless terminal such as a telephone number MSISDN and device identification IMSI are used to linking email address to the wireless terminal on column 8 line 29-37).

22. Little and Turunen are analogous art because they are from the same field of endeavor, wireless email terminal system. At the time of the invention it would have been obvious to a person of ordinary skill in the art to also apply an mobile terminal identifier to link the email to the individual mobile terminal. The motivation for doing so would have been to use link an email address that use IP address to an wireless mobile terminal that use wireless network system. Therefore, it would have been obvious to combine Little and Turunen for the benefit of using e-mail address of the mobile terminal is associated with an identifier to obtain the invention as specified in claim 1.

23. As per claim 2, Little and Turunen disclose the method of claim 1, further comprising identifying the mobile terminal based on the e-mail address of the e-mail message and the association with the permanent identifier of the mobile terminal (see

e-mail address of terminal is used to identify the wireless terminal as well as an permanent identification of wireless terminal using international mobile subscriber identity IMSI on column 8 line 20-35 and see e-mail address as well as the permanent identification of the wireless terminal such as a telephone number MSISDN and device identification IMSI are used to linking email address to the wireless terminal on column 8 line 29-37 in Turunen).

24. As per claim 6, Little and Turunen disclose the method of claim 2, further comprising adding the e-mail address to a reply message sent by the mobile terminal (see repacking allowing reply messages to delivered to addressed recipients on page 10 section [0083] in Little).

25. As per claim 7, Little and Turunen disclose the method of claim 1, further comprising receiving the encryption information generated by the mobile terminal (see private key encryption information is shared to other systems and devices on page 8 section [0070] in Little).

26. As per claim 8, Little and Turunen disclose the method of claim 1, wherein the encryption information (see encryption information private key is used to identify mobile device entity on page 8 section [0070] in Little) is based on an activation code of the mobile terminal (see activation message from the wireless terminal to set up linking of the email address to the wireless terminal on column 8 line 29-37 in Turunen).



27. As per claim 9, Little and Turunen disclose the method of claim 1, wherein the messaging centre transmits the e-mail message to the mobile terminal using a temporary identifier of the mobile terminal (see temporary logical link identity TLLI to transmit data to wireless terminal over temporary wireless network on column 7 line 1-10 in Turunen).

28. As per claims 10, 18, Little and Turunen disclose the method of claim 1, wherein mobile terminal receives and decrypts the e-mail message (see wireless terminal decrypts the message on page 10 section [0082] in Little) using the encryption information (see decryption using shared private key on page 8 section [0070] in Little).

29. As per claim 12, Little discloses a system for forwarding an e-mail message from an e-mail server to a mobile terminal (see forwarding email message 833 from message server 820 to mobile device 816 on page 9 section [0076] on Figure 8), the system comprising:

30. wherein an e-mail address is associated with an identifier (see email message with a user name and identifier on page 9 section [0078]) and encryption information (see encryption information as private key to identify entities and encryption on page 8 section [0070]),

31. a memory configured for storing at least one of the e-mail address of the mobile terminal, the associated identifier, and the associated encryption information (see mail

server 820 stores email addresses corresponding to user account and mail box 819 on page 9 section [0078]); an

32. encryption engine configured to encrypt the e-mail message using the encryption information (see encrypting the email message before transfer on page 9 section [0081]), wherein the e-mail message is received from the e-mail server (see email received by email server 820 mailbox 819 on page 9 section [0078]);

33. a processor configured to execute software stored in memory, the execution of the software resulting in the identification of the mobile terminal based on the e-mail address of the e-mail message (see email identity using email address corresponding to a user account on page 9 section [0078]); and

34. a communications interface configured to transmit the encrypted e-mail message to the identified mobile terminal (see wiles connector system 828 transmitting data via wireless network on page 9 section [0079]).

35. Little do not disclose expressly: e-mail address of the mobile terminal is associated with an identifier and identify the terminal based on the terminal identifier.

36. Turunen teaches: e-mail address of the mobile terminal is associated with an identifier and identify the terminal based on the terminal identifier (see e-mail address of terminal is used to identify the wireless terminal as well as an identification of wireless terminal using international mobile subscriber identity IMSI on column 8 line 20-35 and see e-mail address as well as the identification of the wireless terminal such as a telephone number MSISDN and device identification IMSI are used to linking email address to the wireless terminal on column 8 line 29-37).

37. Little and Turunen are analogous art because they are from the same field of endeavor, wireless email terminal system. At the time of the invention it would have been obvious to a person of ordinary skill in the art to also apply an mobile terminal identifier to link the email to the individual mobile terminal. The motivation for doing so would have been to use link an email address that use IP address to an wireless mobile terminal that use wireless network system. Therefore, it would have been obvious to combine Little and Turunen for the benefit of using e-mail address of the mobile terminal is associated with an identifier to obtain the invention as specified in claim 12.

38. As per claim 13, Little and Turunen disclose the system of claim 12, wherein the communications interface is further configured to receive the e-mail message from the e-mail server (see wireless connector system 828 transfers data between mobile device 816 and email message server 820 on page 9 section [0079] in Little).

39. As per claim 14, Little and Turunen disclose the system of claim 12, wherein the communications interface (see wireless connector system 828 transfers data between mobile device 816 and email message server 820 on page 9 section [0079] in Little) is further configured to receive the encryption information and to provide the encryption information to the memory for storage (see receiving encryption information shared private key on page 8 section [0070] in Little).

40. As per claim 15, Little and Turunen disclose the system of claim 12, wherein the encryption engine is further configured to pack the e-mail message (see repackaging the email message 833 such as compressing and encrypting the email message 833 on page 9 section [0081] in Little).

41. As per claim 20, Little discloses computer-readable storage medium having embodied thereon a program, the program being executable by a processing device (see operating system used by the microprocessor 1138 storing in persistent store such as flash memory 1124 on page 13 section [0111]) to perform a method of forwarding an e-mail message from an e-mail server to a mobile terminal (see forwarding email message 833 from message server 820 to mobile device 816 on page 9 section [0076] on Figure 8), the method comprising:

42. wherein an e-mail address is associated with an identifier (see email message with a user name and identifier on page 9 section [0078]) and encryption information (see encryption information as private key to identify entities and encryption on page 8 section [0070]), storing at least one of the e-mail address of the mobile terminal (see mail server 820 stores email addresses corresponding to user account and mail box 819 on page 9 section [0078]), and the associated encryption information (see encryption information as private key to identify entities and encryption on page 8 section [0070]);

43. receiving the e-mail message associated with the e-mail address (see receiving email from computer system 812 addressed to one recipient email address on page 9 section [0076]) and sent by the e-mail server (see email received by email server 820 mailbox 819 on page 9 section [0078] to be transmitted to a mobile device on page 9 section [0079]);

44. encrypting the e-mail message using the encryption information (see encrypting the email message before transfer on page 9 section [0081]);

45. identifying the mobile terminal based on the e-mail address of the e-mail message (see identify the mobile terminal based on email address on page 9 section [0078]); and

46. transmitting the encrypted e-mail message to the identified mobile terminal (see repackaged message arrives at a mobile terminal on page 10 section [0082]).

Little do not disclose expressly: mobile terminal is associated with a permanent identifier of the mobile terminal and identifying a terminal with association with the permanent identifier of the mobile terminal.

47. Turunen teaches: mobile terminal is associated with a permanent identifier of the mobile terminal and identifying a terminal with association with the permanent identifier of the mobile terminal (see e-mail address of terminal is used to identify the wireless terminal as well as an identification of wireless terminal using international mobile subscriber identity IMSI on column 8 line 20-35 and see e-mail address as well as the identification of the wireless terminal such as a telephone number MSISDN and device

identification IMSI are used to linking email address to the wireless terminal on column 8 line 29-37).

48. Little and Turunen are analogous art because they are from the same field of endeavor, wireless email terminal system. At the time of the invention it would have been obvious to a person of ordinary skill in the art to also apply an mobile terminal a permanent identifier to link the email to the individual mobile terminal. The motivation for doing so would have been to use link an email address that use IP address to an wireless mobile terminal that use wireless network system. Therefore, it would have been obvious to combine Little and Turunen for the benefit of using e-mail address of the mobile terminal is associated with a permanent identifier to obtain the invention as specified in claim 20.

49. Claims 3-5, 11, 16-17, 19 are rejected under pre-AIA 35 U.S.C. 103(a) as being unpatentable over Little et al. U.S. Patent Application Publication Number 2004/0205248 A1 (hereinafter Little), further in view of Turunen et al. U.S. Patent Number 7,289,792 B1 (hereinafter Turunen), further in view of Kock et al. U.S. Patent Application Publication Number 2006/0031300 A1 (hereinafter Kock).

50. As per claims 3, 16, Little and Turunen do not disclose the method of claim 1: wherein encrypting the e-mail message further comprises packing the e-mail message

by omitting at least part of the e-mail message when at least part of the e-mail message exceeds a predetermined size specification.

51. Kock teaches: packing the e-mail message by omitting at least part of the e-mail message when at least part of the e-mail message exceeds a predetermined size specification (see server transmitting the header the first N character of the body to the terminal device, where N is a predetermined integer, while holding back any remaining body of the email on page 1 section [0008]).

52. Little and Kock are analogous art because they are from the same field of endeavor, wireless email terminal system. At the time of the invention it would have been obvious to a person of ordinary skill in the art to also apply an email message sending size. The motivation for doing so would have been to save bandwidth and only send email data that user requests. Therefore, it would have been obvious to combine Little and Turunen and Kock for the benefit of omitting at least part of the e-mail message when at least part of the e-mail message exceeds a predetermined size to obtain the invention as specified in claims 3, 16.

53. As per claims 4, 17, Little and Turunen and Kock disclose the method of claim 3, wherein size specification is set by a user of the mobile terminal (see number N is determined by a user of the terminal device on page 1 section [0014] in Kock).

54. As per claim 5, Little and Turunen and Kock disclose the method of claim 3, wherein the omitted part of the e-mail message is the e-mail address (see omitting any

characters of the body including email address beyond the predetermined integer N on page 1 section [0008] in Kock).

55. As per claim 11, 19, Little and Turunen and Kock disclose the method of claim 3, wherein the mobile terminal unpacks the e-mail message (see mobile terminal repacking the email message by decompression and decryption on page 10 section [0082] in Little).

Any inquiry concerning this communication or earlier communications from the examiner should be directed to ALAN S. CHOU whose telephone number is (571)272-5779. The examiner can normally be reached on 9am-5pm.

If attempts to reach the examiner by telephone are unsuccessful, the examiner's supervisor, Christopher L. Parry can be reached on (571)272-8328. The fax phone number for the organization where this application or proceeding is assigned is 571-273-8300.



Information regarding the status of an application may be obtained from the Patent Application Information Retrieval (PAIR) system. Status information for published applications may be obtained from either Private PAIR or Public PAIR. Status information for unpublished applications is available through Private PAIR only. For more information about the PAIR system, see <http://pair-direct.uspto.gov>. Should you have questions on access to the Private PAIR system, contact the Electronic Business Center (EBC) at 866-217-9197 (toll-free). If you would like assistance from a USPTO Customer Service Representative or access to the automated information system, call 800-786-9199 (IN USA OR CANADA) or 571-272-1000.

ALAN S CHOU  
Examiner  
Art Unit 2451

/ALAN S CHOU/  
Examiner, Art Unit 2451

<b>Notice of References Cited</b>	Application/Control No. 14/609,189	Applicant(s)/Patent Under Reexamination BACKHOLM ET AL.	
	Examiner ALAN S. CHOU	Art Unit 2451	Page 1 of 1

**U.S. PATENT DOCUMENTS**

*		Document Number Country Code-Number-Kind Code	Date MM-YYYY	Name	CPC Classification	US Classification
*	A	US-2004/0205248 A1	10-2004	Little, Herbert A	H04L63/0428	709/246
*	B	US-7,289,792 B1	10-2007	Turunen; Matti	H04L12/5895	370/254
*	C	US-2006/0031300 A1	02-2006	Kock; Martijn Willem Maria	G06Q10/107	709/206
	D	US-				
	E	US-				
	F	US-				
	G	US-				
	H	US-				
	I	US-				
	J	US-				
	K	US-				
	L	US-				
	M	US-				

**FOREIGN PATENT DOCUMENTS**

*		Document Number Country Code-Number-Kind Code	Date MM-YYYY	Country	Name	CPC Classification
	N					
	O					
	P					
	Q					
	R					
	S					
	T					

**NON-PATENT DOCUMENTS**

*		Include as applicable: Author, Title Date, Publisher, Edition or Volume, Pertinent Pages)
	U	
	V	
	W	
	X	

\*A copy of this reference is not being furnished with this Office action. (See MPEP § 707.05(a).)  
Dates in MM-YYYY format are publication dates. Classifications may be US or foreign.

Receipt date: 03/01/2015

Doc code: IDS

Doc description: Information Disclosure Statement (IDS) Filed

PTO/SB/08a (01-10)

Approved for use through 07/31/2012. OMB 0651-0031

U.S. Patent and Trademark Office; U.S. DEPARTMENT OF COMMERCE

Under the Paperwork Reduction Act of 1995, no persons are required to respond to a collection of information unless it contains a valid OMB control number.

<b>INFORMATION DISCLOSURE STATEMENT BY APPLICANT</b> ( Not for submission under 37 CFR 1.99)	Application Number	14609189
	Filing Date	2015-01-29
	First Named Inventor	Backholm
	Art Unit	2642
	Examiner Name	
	Attorney Docket Number	455/006/8 UTIL

U.S.PATENTS							Remove	
Examiner Initial*	Cite No	Patent Number	Kind Code <sup>1</sup>	Issue Date	Name of Patentee or Applicant of cited Document	Pages,Columns,Lines where Relevant Passages or Relevant Figures Appear		
	1	6745326	B1	2004-06-01	Wary			
	2	7289792	B1	2007-10-30	Turenen			
If you wish to add additional U.S. Patent citation information please click the Add button.							<b>Add</b>	
U.S.PATENT APPLICATION PUBLICATIONS							Remove	
Examiner Initial*	Cite No	Publication Number	Kind Code <sup>1</sup>	Publication Date	Name of Patentee or Applicant of cited Document	Pages,Columns,Lines where Relevant Passages or Relevant Figures Appear		
	1	20040205248	A1	2004-10-14	Little			
	2	20060265595	A1	2006-11-23	Scottodiluzio			
	3	20050015432	A1	2005-01-20	Cohen			
	4	20060085503	A1	2006-04-20	Stoye			
If you wish to add additional U.S. Published Application citation information please click the Add button.							<b>Add</b>	
FOREIGN PATENT DOCUMENTS							Remove	

<b>INFORMATION DISCLOSURE STATEMENT BY APPLICANT</b> ( Not for submission under 37 CFR 1.99)	Application Number		14609189	
	Filing Date		2015-01-29	
	First Named Inventor	Backholm		
	Art Unit	2642		
	Examiner Name			
	Attorney Docket Number	455/006/8 UTIL		

Examiner Initial*	Cite No	Foreign Document Number <sup>3</sup>	Country Code <sup>2</sup> j	Kind Code <sup>4</sup>	Publication Date	Name of Patentee or Applicant of cited Document	Pages, Columns, Lines where Relevant Passages or Relevant Figures Appear	T <sup>5</sup>
	1	0772327	EP	A2	2005-06-29	Kuki		<input type="checkbox"/>

If you wish to add additional Foreign Patent Document citation information please click the Add button **Add**

**NON-PATENT LITERATURE DOCUMENTS**

**Remove**

Examiner Initials*	Cite No	Include name of the author (in CAPITAL LETTERS), title of the article (when appropriate), title of the item (book, magazine, journal, serial, symposium, catalog, etc), date, pages(s), volume-issue number(s), publisher, city and/or country where published.	T <sup>5</sup>
	1	Final Office Action mailed 5/1/2009 for US Patent Application No. 11/282,607	<input type="checkbox"/>
	2	Non-final Office Action mailed 11/19/2008 for US Patent Application No. 11/282,607	<input type="checkbox"/>
	3	Non-final Office Action mailed 2/5/2008 for US Patent Application No. 11/282,607	<input type="checkbox"/>
	4	Final Office Action mailed 4/3/2009 for US Patent Application No. 11/282,950	<input type="checkbox"/>
	5	Non-final Office Action mailed 9/26/2008 for US Patent Application No. 11/282,950	<input type="checkbox"/>
	6	Final Office Action mailed 12/4/2013 for US Patent Application No. 12/205,747	<input type="checkbox"/>
	7	Non-final Office Action mailed 6/17/2013 for US Patent Application No. 12/205,747	<input type="checkbox"/>

<b>INFORMATION DISCLOSURE STATEMENT BY APPLICANT</b> ( Not for submission under 37 CFR 1.99)	Application Number	14609189
	Filing Date	2015-01-29
	First Named Inventor	Backholm
	Art Unit	2642
	Examiner Name	
	Attorney Docket Number	455/006/8 UTIL

8	Final Office Action mailed 11/8/2011 for US Patent Application No. 12/205,747	<input type="checkbox"/>
9	Non-final Office Action mailed 4/19/2011 for US Patent Application No. 12/205,747	<input type="checkbox"/>
10	Non-final Office Action mailed 1/15/2015 for US Patent Application No. 12/228,325	<input type="checkbox"/>
11	Final Office Action mailed 4/1/2014 for US Patent Application No. 12/228,325	<input type="checkbox"/>
12	Non-final Office Action mailed 6/3/2013 for US Patent Application No. 12/228,325	<input type="checkbox"/>
13	Final Office Action mailed 12/20/2012 for US Patent Application No. 12/228,325	<input type="checkbox"/>
14	Non-final Office Action mailed 5/16/2012 for US Patent Application No. 12/228,325	<input type="checkbox"/>
15	Final Office Action mailed 5/11/2011 for US Patent Application No. 12/228,325	<input type="checkbox"/>
16	Non-final Office Action mailed 11/4/2010 for US Patent Application No. 12/228,325	<input type="checkbox"/>
17	Final Office Action mailed 10/7/2009 for US Patent Application No. 12/228,424	<input type="checkbox"/>
18	Non-final Office Action mailed 6/2/2009 for US Patent Application No. 12/228,424	<input type="checkbox"/>

Receipt date: 03/01/2015

<b>INFORMATION DISCLOSURE STATEMENT BY APPLICANT</b> ( Not for submission under 37 CFR 1.99)	Application Number	14609189		
	Filing Date	2015-01-29		
	First Named Inventor	Backholm		
	Art Unit	2642		
	Examiner Name			
	Attorney Docket Number	455/006/8 UTIL		

If you wish to add additional non-patent literature document citation information please click the Add button **Add**

**EXAMINER SIGNATURE**

Examiner Signature	/Alan Chou/	Date Considered	09/25/2015
--------------------	-------------	-----------------	------------

\*EXAMINER: Initial if reference considered, whether or not citation is in conformance with MPEP 609. Draw line through a citation if not in conformance and not considered. Include copy of this form with next communication to applicant.

<sup>1</sup> See Kind Codes of USPTO Patent Documents at [www.USPTO.GOV](http://www.USPTO.GOV) or MPEP 901.04. <sup>2</sup> Enter office that issued the document, by the two-letter code (WIPO Standard ST.3). <sup>3</sup> For Japanese patent documents, the indication of the year of the reign of the Emperor must precede the serial number of the patent document. <sup>4</sup> Kind of document by the appropriate symbols as indicated on the document under WIPO Standard ST.16 if possible. <sup>5</sup> Applicant is to place a check mark here if English language translation is attached.

<b>INFORMATION DISCLOSURE STATEMENT BY APPLICANT</b> ( Not for submission under 37 CFR 1.99)	Application Number	14609189
	Filing Date	2015-01-29
	First Named Inventor	Backholm
	Art Unit	2642
	Examiner Name	
	Attorney Docket Number	455/006/8 UTIL

**CERTIFICATION STATEMENT**

Please see 37 CFR 1.97 and 1.98 to make the appropriate selection(s):

That each item of information contained in the information disclosure statement was first cited in any communication from a foreign patent office in a counterpart foreign application not more than three months prior to the filing of the information disclosure statement. See 37 CFR 1.97(e)(1).

**OR**

That no item of information contained in the information disclosure statement was cited in a communication from a foreign patent office in a counterpart foreign application, and, to the knowledge of the person signing the certification after making reasonable inquiry, no item of information contained in the information disclosure statement was known to any individual designated in 37 CFR 1.56(c) more than three months prior to the filing of the information disclosure statement. See 37 CFR 1.97(e)(2).

- See attached certification statement.
- The fee set forth in 37 CFR 1.17 (p) has been submitted herewith.
- A certification statement is not submitted herewith.

**SIGNATURE**

A signature of the applicant or representative is required in accordance with CFR 1.33, 10.18. Please see CFR 1.4(d) for the form of the signature.

Signature		Date (YYYY-MM-DD)	
Name/Print		Registration Number	

This collection of information is required by 37 CFR 1.97 and 1.98. The information is required to obtain or retain a benefit by the public which is to file (and by the USPTO to process) an application. Confidentiality is governed by 35 U.S.C. 122 and 37 CFR 1.14. This collection is estimated to take 1 hour to complete, including gathering, preparing and submitting the completed application form to the USPTO. Time will vary depending upon the individual case. Any comments on the amount of time you require to complete this form and/or suggestions for reducing this burden, should be sent to the Chief Information Officer, U.S. Patent and Trademark Office, U.S. Department of Commerce, P.O. Box 1450, Alexandria, VA 22313-1450. **DO NOT SEND FEES OR COMPLETED FORMS TO THIS ADDRESS. SEND TO: Commissioner for Patents, P.O. Box 1450, Alexandria, VA 22313-1450.**

## Privacy Act Statement

The Privacy Act of 1974 (P.L. 93-579) requires that you be given certain information in connection with your submission of the attached form related to a patent application or patent. Accordingly, pursuant to the requirements of the Act, please be advised that: (1) the general authority for the collection of this information is 35 U.S.C. 2(b)(2); (2) furnishing of the information solicited is voluntary; and (3) the principal purpose for which the information is used by the U.S. Patent and Trademark Office is to process and/or examine your submission related to a patent application or patent. If you do not furnish the requested information, the U.S. Patent and Trademark Office may not be able to process and/or examine your submission, which may result in termination of proceedings or abandonment of the application or expiration of the patent.

The information provided by you in this form will be subject to the following routine uses:

1. The information on this form will be treated confidentially to the extent allowed under the Freedom of Information Act (5 U.S.C. 552) and the Privacy Act (5 U.S.C. 552a). Records from this system of records may be disclosed to the Department of Justice to determine whether the Freedom of Information Act requires disclosure of these records.
2. A record from this system of records may be disclosed, as a routine use, in the course of presenting evidence to a court, magistrate, or administrative tribunal, including disclosures to opposing counsel in the course of settlement negotiations.
3. A record in this system of records may be disclosed, as a routine use, to a Member of Congress submitting a request involving an individual, to whom the record pertains, when the individual has requested assistance from the Member with respect to the subject matter of the record.
4. A record in this system of records may be disclosed, as a routine use, to a contractor of the Agency having need for the information in order to perform a contract. Recipients of information shall be required to comply with the requirements of the Privacy Act of 1974, as amended, pursuant to 5 U.S.C. 552a(m).
5. A record related to an International Application filed under the Patent Cooperation Treaty in this system of records may be disclosed, as a routine use, to the International Bureau of the World Intellectual Property Organization, pursuant to the Patent Cooperation Treaty.
6. A record in this system of records may be disclosed, as a routine use, to another federal agency for purposes of National Security review (35 U.S.C. 181) and for review pursuant to the Atomic Energy Act (42 U.S.C. 218(c)).
7. A record from this system of records may be disclosed, as a routine use, to the Administrator, General Services, or his/her designee, during an inspection of records conducted by GSA as part of that agency's responsibility to recommend improvements in records management practices and programs, under authority of 44 U.S.C. 2904 and 2906. Such disclosure shall be made in accordance with the GSA regulations governing inspection of records for this purpose, and any other relevant (i.e., GSA or Commerce) directive. Such disclosure shall not be used to make determinations about individuals.
8. A record from this system of records may be disclosed, as a routine use, to the public after either publication of the application pursuant to 35 U.S.C. 122(b) or issuance of a patent pursuant to 35 U.S.C. 151. Further, a record may be disclosed, subject to the limitations of 37 CFR 1.14, as a routine use, to the public if the record was filed in an application which became abandoned or in which the proceedings were terminated and which application is referenced by either a published application, an application open to public inspections or an issued patent.
9. A record from this system of records may be disclosed, as a routine use, to a Federal, State, or local law enforcement agency, if the USPTO becomes aware of a violation or potential violation of law or regulation.



**UNITED STATES PATENT AND TRADEMARK OFFICE**

UNITED STATES DEPARTMENT OF COMMERCE  
**United States Patent and Trademark Office**  
 Address: COMMISSIONER FOR PATENTS  
 P.O. Box 1450  
 Alexandria, Virginia 22313-1450  
 www.uspto.gov

**BIB DATA SHEET**
**CONFIRMATION NO. 5037**

SERIAL NUMBER	FILING or 371(c) DATE RULE	CLASS	GROUP ART UNIT	ATTORNEY DOCKET NO.		
14/609,189	01/29/2015	709	2451	455/006/8 UTIL		
<b>APPLICANTS</b> Seven Networks, Inc., San Carlos, CA;						
<b>INVENTORS</b> Ari Backholm, San Carlos, CA; Seppo Salorinne, Helsinki, FINLAND; Antti Saarilahti, Helsinki, FINLAND; Marko Ketonen, Helsinki, FINLAND; Lauri Vuornos, Helsinki, FINLAND; Petri Salmi, Espoo, FINLAND;						
<b>** CONTINUING DATA *****</b> This application is a CON of 12/228,325 08/11/2008 which is a DIV of 11/282,950 11/21/2005 PAT 7643818 and claims benefit of 60/650,975 02/09/2005						
<b>** FOREIGN APPLICATIONS *****</b> FINLAND 20045451 11/22/2004						
<b>** IF REQUIRED, FOREIGN FILING LICENSE GRANTED *** SMALL ENTITY **</b> 02/12/2015						
Foreign Priority claimed <input checked="" type="checkbox"/> Yes <input type="checkbox"/> No 35 USC 119(a-d) conditions met <input checked="" type="checkbox"/> Yes <input type="checkbox"/> No Verified and /ALAN S CHOU/ Acknowledged Examiner's Signature		<input checked="" type="checkbox"/> Met after Allowance AC Initials	<b>STATE OR COUNTRY</b> CA	<b>SHEETS DRAWINGS</b> 4	<b>TOTAL CLAIMS</b> 1	<b>INDEPENDENT CLAIMS</b> 1
<b>ADDRESS</b> NK Patent Law- Seven Networks 4917 Waters Edge Drive Suite 275 Raleigh, NC 27606 UNITED STATES						
<b>TITLE</b> Messaging centre for forwarding e-mail						
<b>FILING FEE RECEIVED</b> 800	FEES: Authority has been given in Paper No. _____ to charge/credit DEPOSIT ACCOUNT No. _____ for following:			<input type="checkbox"/> All Fees <input type="checkbox"/> 1.16 Fees (Filing) <input type="checkbox"/> 1.17 Fees (Processing Ext. of time) <input type="checkbox"/> 1.18 Fees (Issue) <input type="checkbox"/> Other _____ <input type="checkbox"/> Credit		

## EAST Search History

## EAST Search History (Prior Art)

Ref #	Hits	Search Query	DBs	Default Operator	Plurals	Time Stamp
L1	97	((Ari) near2 (Backholm)).INV.	US-PGPUB; USPAT	OR	OFF	2015/09/25 15:12
L2	1	"7706781".pn.	US-PGPUB; USPAT	OR	OFF	2015/09/25 15:12
L3	1	"7643818".pn.	US-PGPUB; USPAT	OR	OFF	2015/09/25 15:12
L4	1	"20040205248"	US-PGPUB; USPAT	OR	OFF	2015/09/25 15:12
L5	1	"7289792".pn.	US-PGPUB; USPAT	OR	OFF	2015/09/25 15:12
L6	1	"6745326".pn.	US-PGPUB; USPAT	OR	OFF	2015/09/25 15:12
L7	1	"20060265595"	US-PGPUB; USPAT	OR	OFF	2015/09/25 15:12
L8	12136	(709/206.ccls. g06q10/107.cpc. h04112/585.cpc. h04112/58.cpc.)AND (@AD<"20041122" @RLAD<"20041122")	US-PGPUB; USPAT	OR	OFF	2015/09/25 15:12
L9	10748	(email mail e-mail (electronic NEAR2 mail)) AND (709/206.ccls. g06q10/107.cpc. h04112/585.cpc. h04112/58.cpc.)AND (@AD<"20041122" @RLAD<"20041122")	US-PGPUB; USPAT	OR	OFF	2015/09/25 15:12
L10	1466	(encrypt\$6 AND decrypt\$6) AND (email mail e-mail (electronic NEAR2 mail)) AND (709/206.ccls. g06q10/107.cpc. h04112/585.cpc. h04112/58.cpc.)AND (@AD<"20041122" @RLAD<"20041122")	US-PGPUB; USPAT	OR	OFF	2015/09/25 15:12
L11	1022	((terminal mobile client device phone) NEAR9 (code identifier id number)) AND (encrypt\$6 AND decrypt\$6) AND (email mail e-mail (electronic NEAR2 mail)) AND (709/206.ccls. g06q10/107.cpc. h04112/585.cpc. h04112/58.cpc.)AND (@AD<"20041122" @RLAD<"20041122")	US-PGPUB; USPAT	OR	OFF	2015/09/25 15:12
L12	73	(activat\$5 NEAR5 (code number identifier)) AND ((terminal mobile client device phone) NEAR9 (code identifier id number)) AND (encrypt\$6 AND decrypt\$6) AND (email mail e-mail (electronic NEAR2 mail)) AND (709/206.ccls. g06q10/107.cpc. h04112/585.cpc. h04112/58.cpc.)AND (@AD<"20041122" @RLAD<"20041122")	US-PGPUB; USPAT	OR	OFF	2015/09/25 15:12

EAST Search History

L13	0	((temporary AND permanent) NEAR9 (code identifier id number)) AND (activat\$5 NEAR5 (code numberid identifier)) AND ((terminal mobile client device phone) NEAR9 (code identifier id number)) AND (encrypt\$6 AND decrypt\$6) AND (email mail e-mail (electronic NEAR2 mail)) AND (709/206.ccls. g06q10/107.cpc. h04112/585.cpc. h04112/58.cpc.)AND (@AD<"20041122" @RLAD<"20041122")	US-PGPUB; USPAT	OR	OFF	2015/09/25 15:12
L14	10	((temporary AND permanent) NEAR9 (code identifier id number)) AND (activat\$5 NEAR5 (code numberid identifier)) AND ((terminal mobile client device phone) NEAR9 (code identifier id number)) AND (encrypt\$6 AND decrypt\$6) AND (email mail e-mail (electronic NEAR2 mail)) AND (@AD<"20041122" @RLAD<"20041122")	US-PGPUB; USPAT	OR	OFF	2015/09/25 15:12
L15	21	((temporary AND permanent) NEAR9 (code identifier id number)) AND (activat\$5 NEAR5 (code number id identifier)) AND ((terminal mobile client device phone) NEAR9 (code identifier id number)) AND (encrypt\$6 AND decrypt\$6) AND (email mail e-mail (electronic NEAR2 mail)) AND (@AD<"20041122" @RLAD<"20041122")	US-PGPUB; USPAT	OR	OFF	2015/09/25 15:12
L16	1	"20150149575"	US-PGPUB; USPAT	OR	OFF	2015/09/25 16:22
L17	1	"20060031300"	US-PGPUB; USPAT	OR	OFF	2015/09/25 17:56

**EAST Search History (Interference)**

< This search history is empty >

**9/ 25/ 2015 7:04:49 PM**

**H:\ Workspaces\ 14609189.wsp**

Receipt date: 03/01/2015

Doc code: IDS

PTO/SB/08a (01-10)

Doc description: Information Disclosure Statement (IDS) Filed

Approved for use through 07/31/2012. OMB 0651-0031

U.S. Patent and Trademark Office; U.S. DEPARTMENT OF COMMERCE

Under the Paperwork Reduction Act of 1995, no persons are required to respond to a collection of information unless it contains a valid OMB control number.

<b>INFORMATION DISCLOSURE STATEMENT BY APPLICANT</b> ( Not for submission under 37 CFR 1.99)	Application Number		14609189	
	Filing Date		2015-01-29	
	First Named Inventor	Backholm		
	Art Unit		2642	
	Examiner Name			
	Attorney Docket Number		455/006/8 UTIL	

U.S. PATENTS						Remove
Examiner Initial*	Cite No	Patent Number	Kind Code <sup>1</sup>	Issue Date	Name of Patentee or Applicant of cited Document	Pages, Columns, Lines where Relevant Passages or Relevant Figures Appear
	1	6745326	B1	2004-06-01	Wary	
	2	7289792	B1	2007-10-30	Turenen	

If you wish to add additional U.S. Patent citation information please click the Add button.

**Add**

U.S. PATENT APPLICATION PUBLICATIONS						Remove
Examiner Initial*	Cite No	Publication Number	Kind Code <sup>1</sup>	Publication Date	Name of Patentee or Applicant of cited Document	Pages, Columns, Lines where Relevant Passages or Relevant Figures Appear
	1	20040205248	A1	2004-10-14	Little	
	2	20060265595	A1	2006-11-23	Scottodiluzio	
	3	20050015432	A1	2005-01-20	Cohen	
	4	20060085503	A1	2006-04-20	Stoye	

If you wish to add additional U.S. Published Application citation information please click the Add button.

**Add**

FOREIGN PATENT DOCUMENTS						Remove
--------------------------	--	--	--	--	--	--------

ALL REFERENCES CONSIDERED EXCEPT WHERE LINED THROUGH. /A.C./

<b>INFORMATION DISCLOSURE STATEMENT BY APPLICANT</b> ( Not for submission under 37 CFR 1.99)	Application Number	Receipt date: 03/01/2015 14609189
	Filing Date	2015-01-29
	First Named Inventor	Backholm
	Art Unit	2642
	Examiner Name	
	Attorney Docket Number	455/006/8 UTIL

Examiner Initial*	Cite No	Foreign Document Number <sup>3</sup>	Country Code <sup>2</sup> j	Kind Code <sup>4</sup>	Publication Date	Name of Patentee or Applicant of cited Document	Pages, Columns, Lines where Relevant Passages or Relevant Figures Appear	T <sup>5</sup>
	1	0772327	EP	A2	2005-06-29	Kuki		<input type="checkbox"/>

If you wish to add additional Foreign Patent Document citation information please click the Add button **Add**

**NON-PATENT LITERATURE DOCUMENTS** Remove

Examiner Initials*	Cite No	Include name of the author (in CAPITAL LETTERS), title of the article (when appropriate), title of the item (book, magazine, journal, serial, symposium, catalog, etc), date, pages(s), volume-issue number(s), publisher, city and/or country where published.	T <sup>5</sup>
	1	Final Office Action mailed 5/1/2009 for US Patent Application No. 11/282,607	<input type="checkbox"/>
	2	Non-final Office Action mailed 11/19/2008 for US Patent Application No. 11/282,607	<input type="checkbox"/>
	3	Non-final Office Action mailed 2/5/2008 for US Patent Application No. 11/282,607	<input type="checkbox"/>
	4	Final Office Action mailed 4/3/2009 for US Patent Application No. 11/282,950	<input type="checkbox"/>
	5	Non-final Office Action mailed 9/26/2008 for US Patent Application No. 11/282,950	<input type="checkbox"/>
	6	Final Office Action mailed 12/4/2013 for US Patent Application No. 12/205,747	<input type="checkbox"/>
	7	Non-final Office Action mailed 6/17/2013 for US Patent Application No. 12/205,747	<input type="checkbox"/>

ALL REFERENCES CONSIDERED EXCEPT WHERE LINED THROUGH. /A.C./

<b>INFORMATION DISCLOSURE STATEMENT BY APPLICANT</b> ( Not for submission under 37 CFR 1.99)	Application Number	Receipt date: 03/01/2015 14609189
	Filing Date	2015-01-29
	First Named Inventor	Backholm
	Art Unit	2642
	Examiner Name	
	Attorney Docket Number	455/006/8 UTIL

8	Final Office Action mailed 11/8/2011 for US Patent Application No. 12/205,747	<input type="checkbox"/>
9	Non-final Office Action mailed 4/19/2011 for US Patent Application No. 12/205,747	<input type="checkbox"/>
10	Non-final Office Action mailed 1/15/2015 for US Patent Application No. 12/228,325	<input type="checkbox"/>
11	Final Office Action mailed 4/1/2014 for US Patent Application No. 12/228,325	<input type="checkbox"/>
12	Non-final Office Action mailed 6/3/2013 for US Patent Application No. 12/228,325	<input type="checkbox"/>
13	Final Office Action mailed 12/20/2012 for US Patent Application No. 12/228,325	<input type="checkbox"/>
14	Non-final Office Action mailed 5/16/2012 for US Patent Application No. 12/228,325	<input type="checkbox"/>
15	Final Office Action mailed 5/11/2011 for US Patent Application No. 12/228,325	<input type="checkbox"/>
16	Non-final Office Action mailed 11/4/2010 for US Patent Application No. 12/228,325	<input type="checkbox"/>
17	Final Office Action mailed 10/7/2009 for US Patent Application No. 12/228,424	<input type="checkbox"/>
18	Non-final Office Action mailed 6/2/2009 for US Patent Application No. 12/228,424	<input type="checkbox"/>

ALL REFERENCES CONSIDERED EXCEPT WHERE LINED THROUGH. /A.C./

<b>INFORMATION DISCLOSURE STATEMENT BY APPLICANT</b> ( Not for submission under 37 CFR 1.99)	Application Number	14609189	Receipt date: 03/01/2015
	Filing Date	2015-01-29	
	First Named Inventor	Backholm	
	Art Unit	2642	
	Examiner Name		
	Attorney Docket Number	455/006/8 UTIL	

If you wish to add additional non-patent literature document citation information please click the Add button **Add**

**EXAMINER SIGNATURE**

Examiner Signature	<i>/Alan Chow/</i>	Date Considered	09/25/2015
--------------------	--------------------	-----------------	------------

\*EXAMINER: Initial if reference considered, whether or not citation is in conformance with MPEP 609. Draw line through a citation if not in conformance and not considered. Include copy of this form with next communication to applicant.

<sup>1</sup> See Kind Codes of USPTO Patent Documents at [www.USPTO.GOV](http://www.USPTO.GOV) or MPEP 901.04. <sup>2</sup> Enter office that issued the document, by the two-letter code (WIPO Standard ST.3). <sup>3</sup> For Japanese patent documents, the indication of the year of the reign of the Emperor must precede the serial number of the patent document. <sup>4</sup> Kind of document by the appropriate symbols as indicated on the document under WIPO Standard ST.16 if possible. <sup>5</sup> Applicant is to place a check mark here if English language translation is attached.

ALL REFERENCES CONSIDERED EXCEPT WHERE LINED THROUGH. /A.C./

<b>INFORMATION DISCLOSURE STATEMENT BY APPLICANT</b> ( Not for submission under 37 CFR 1.99)	Application Number	Receipt date: 03/01/2015 14609189
	Filing Date	2015-01-29
	First Named Inventor	Backholm
	Art Unit	2642
	Examiner Name	
	Attorney Docket Number	455/006/8 UTIL

**CERTIFICATION STATEMENT**

Please see 37 CFR 1.97 and 1.98 to make the appropriate selection(s):

That each item of information contained in the information disclosure statement was first cited in any communication from a foreign patent office in a counterpart foreign application not more than three months prior to the filing of the information disclosure statement. See 37 CFR 1.97(e)(1).

**OR**

That no item of information contained in the information disclosure statement was cited in a communication from a foreign patent office in a counterpart foreign application, and, to the knowledge of the person signing the certification after making reasonable inquiry, no item of information contained in the information disclosure statement was known to any individual designated in 37 CFR 1.56(c) more than three months prior to the filing of the information disclosure statement. See 37 CFR 1.97(e)(2).

See attached certification statement.

The fee set forth in 37 CFR 1.17 (p) has been submitted herewith.

A certification statement is not submitted herewith.

**SIGNATURE**

A signature of the applicant or representative is required in accordance with CFR 1.33, 10.18. Please see CFR 1.4(d) for the form of the signature.

Signature	/Justin R. Nifong/	Date (YYYY-MM-DD)	2015-03-01
Name/Print	Justin R. Nifong	Registration Number	59389

This collection of information is required by 37 CFR 1.97 and 1.98. The information is required to obtain or retain a benefit by the public which is to file (and by the USPTO to process) an application. Confidentiality is governed by 35 U.S.C. 122 and 37 CFR 1.14. This collection is estimated to take 1 hour to complete, including gathering, preparing and submitting the completed application form to the USPTO. Time will vary depending upon the individual case. Any comments on the amount of time you require to complete this form and/or suggestions for reducing this burden, should be sent to the Chief Information Officer, U.S. Patent and Trademark Office, U.S. Department of Commerce, P.O. Box 1450, Alexandria, VA 22313-1450. **DO NOT SEND FEES OR COMPLETED FORMS TO THIS ADDRESS. SEND TO: Commissioner for Patents, P.O. Box 1450, Alexandria, VA 22313-1450.**

ALL REFERENCES CONSIDERED EXCEPT WHERE LINED THROUGH. /A.C./



## Privacy Act Statement

The Privacy Act of 1974 (P.L. 93-579) requires that you be given certain information in connection with your submission of the attached form related to a patent application or patent. Accordingly, pursuant to the requirements of the Act, please be advised that: (1) the general authority for the collection of this information is 35 U.S.C. 2(b)(2); (2) furnishing of the information solicited is voluntary; and (3) the principal purpose for which the information is used by the U.S. Patent and Trademark Office is to process and/or examine your submission related to a patent application or patent. If you do not furnish the requested information, the U.S. Patent and Trademark Office may not be able to process and/or examine your submission, which may result in termination of proceedings or abandonment of the application or expiration of the patent.

The information provided by you in this form will be subject to the following routine uses:

1. The information on this form will be treated confidentially to the extent allowed under the Freedom of Information Act (5 U.S.C. 552) and the Privacy Act (5 U.S.C. 552a). Records from this system of records may be disclosed to the Department of Justice to determine whether the Freedom of Information Act requires disclosure of these records.
2. A record from this system of records may be disclosed, as a routine use, in the course of presenting evidence to a court, magistrate, or administrative tribunal, including disclosures to opposing counsel in the course of settlement negotiations.
3. A record in this system of records may be disclosed, as a routine use, to a Member of Congress submitting a request involving an individual, to whom the record pertains, when the individual has requested assistance from the Member with respect to the subject matter of the record.
4. A record in this system of records may be disclosed, as a routine use, to a contractor of the Agency having need for the information in order to perform a contract. Recipients of information shall be required to comply with the requirements of the Privacy Act of 1974, as amended, pursuant to 5 U.S.C. 552a(m).
5. A record related to an International Application filed under the Patent Cooperation Treaty in this system of records may be disclosed, as a routine use, to the International Bureau of the World Intellectual Property Organization, pursuant to the Patent Cooperation Treaty.
6. A record in this system of records may be disclosed, as a routine use, to another federal agency for purposes of National Security review (35 U.S.C. 181) and for review pursuant to the Atomic Energy Act (42 U.S.C. 218(c)).
7. A record from this system of records may be disclosed, as a routine use, to the Administrator, General Services, or his/her designee, during an inspection of records conducted by GSA as part of that agency's responsibility to recommend improvements in records management practices and programs, under authority of 44 U.S.C. 2904 and 2906. Such disclosure shall be made in accordance with the GSA regulations governing inspection of records for this purpose, and any other relevant (i.e., GSA or Commerce) directive. Such disclosure shall not be used to make determinations about individuals.
8. A record from this system of records may be disclosed, as a routine use, to the public after either publication of the application pursuant to 35 U.S.C. 122(b) or issuance of a patent pursuant to 35 U.S.C. 151. Further, a record may be disclosed, subject to the limitations of 37 CFR 1.14, as a routine use, to the public if the record was filed in an application which became abandoned or in which the proceedings were terminated and which application is referenced by either a published application, an application open to public inspections or an issued patent.
9. A record from this system of records may be disclosed, as a routine use, to a Federal, State, or local law enforcement agency, if the USPTO becomes aware of a violation or potential violation of law or regulation.

ALL REFERENCES CONSIDERED EXCEPT WHERE LINED THROUGH. /A.C./

<b><i>Index of Claims</i></b> 	<b>Application/Control No.</b> 14609189	<b>Applicant(s)/Patent Under Reexamination</b> BACKHOLM ET AL.
	<b>Examiner</b> ALAN S CHOU	<b>Art Unit</b> 2451

✓	<b>Rejected</b>
=	<b>Allowed</b>

-	<b>Cancelled</b>
÷	<b>Restricted</b>

N	<b>Non-Elected</b>
I	<b>Interference</b>

A	<b>Appeal</b>
O	<b>Objected</b>

Claims renumbered in the same order as presented by applicant
  CPA
  T.D.
  R.1.47

CLAIM		DATE							
Final	Original	09/25/2015							
	1	✓							
	2	✓							
	3	✓							
	4	✓							
	5	✓							
	6	✓							
	7	✓							
	8	✓							
	9	✓							
	10	✓							
	11	✓							
	12	✓							
	13	✓							
	14	✓							
	15	✓							
	16	✓							
	17	✓							
	18	✓							
	19	✓							
	20	✓							

<b>Search Notes</b>  	<b>Application/Control No.</b>  14609189	<b>Applicant(s)/Patent Under Reexamination</b>  BACKHOLM ET AL.
	<b>Examiner</b>  ALAN S CHOU	<b>Art Unit</b>  2451

CPC- SEARCHED		
Symbol	Date	Examiner
G06Q 10/107	9/24/2015	AC
H04L 12/585, 12/58	9/24/2015	AC

CPC COMBINATION SETS - SEARCHED		
Symbol	Date	Examiner

US CLASSIFICATION SEARCHED			
Class	Subclass	Date	Examiner
709	206	9/24/2015	AC

SEARCH NOTES		
Search Notes	Date	Examiner
EAST Search	9/24/2015	AC
Consulted with SPE Chris Parry regarding 101 issues for claims 1-20	9/24/2015	AC
Consulted with Primary Saket Daftuar regarding ODP issues for claims 1-20	9/25/2015	AC
Consulted with Primary Saket Daftuar regarding 112 6th issue with claim 12-19	9/25/2015	AC

INTERFERENCE SEARCH			
US Class/ CPC Symbol	US Subclass / CPC Group	Date	Examiner

--	--



UNITED STATES PATENT AND TRADEMARK OFFICE

UNITED STATES DEPARTMENT OF COMMERCE
United States Patent and Trademark Office
Address: COMMISSIONER FOR PATENTS
P.O. Box 1450
Alexandria, Virginia 22313-1450
www.uspto.gov

Table with 4 columns: APPLICATION NUMBER (14/609,189), FILING OR 371(C) DATE (01/29/2015), FIRST NAMED APPLICANT (Ari Backholm), ATTY. DOCKET NO./TITLE (455/006/8 UTIL)

CONFIRMATION NO. 5037

PUBLICATION NOTICE

118194
NKK Patent Law- Seven Networks
4917 Waters Edge Drive
Suite 275
Raleigh, NC 27606



Title: Messaging centre for forwarding e-mail

Publication No. US-2015-0149575-A1

Publication Date: 05/28/2015

NOTICE OF PUBLICATION OF APPLICATION

The above-identified application will be electronically published as a patent application publication pursuant to 37 CFR 1.211, et seq. The patent application publication number and publication date are set forth above.

The publication may be accessed through the USPTO's publically available Searchable Databases via the Internet at www.uspto.gov. The direct link to access the publication is currently http://www.uspto.gov/patft/.

The publication process established by the Office does not provide for mailing a copy of the publication to applicant. A copy of the publication may be obtained from the Office upon payment of the appropriate fee set forth in 37 CFR 1.19(a)(1). Orders for copies of patent application publications are handled by the USPTO's Office of Public Records. The Office of Public Records can be reached by telephone at (703) 308-9726 or (800) 972-6382, by facsimile at (703) 305-8759, by mail addressed to the United States Patent and Trademark Office, Office of Public Records, Alexandria, VA 22313-1450 or via the Internet.

In addition, information on the status of the application, including the mailing date of Office actions and the dates of receipt of correspondence filed in the Office, may also be accessed via the Internet through the Patent Electronic Business Center at www.uspto.gov using the public side of the Patent Application Information and Retrieval (PAIR) system. The direct link to access this status information is currently http://pair.uspto.gov/. Prior to publication, such status information is confidential and may only be obtained by applicant using the private side of PAIR.

Further assistance in electronically accessing the publication, or about PAIR, is available by calling the Patent Electronic Business Center at 1-866-217-9197.

Office of Data Management, Application Assistance Unit (571) 272-4000, or (571) 272-4200, or 1-888-786-0101

**COMMUNICATION TO THE UNITED STATES PATENT AND TRADEMARK OFFICE**

Appl. No. : 14/609,189 Confirmation No. 5037  
Applicant : Seven Networks, Inc.  
Filed : 2015-01-29  
TC/A.U. : 2447  
Examiner : N/A  
Docket No. : 455/006/8 UTIL  
Customer No. : 118194

Mail Stop Amendment  
Commissioner for Patents  
P.O. Box 1450  
Alexandria, VA 22313-1450

**Preliminary Amendment**

Examiner:

**Amendments to the Claims** begin on page 2 of this paper.

**Remarks** begin on page 6 of this paper.

**AMENDMENTS TO THE CLAIMS**

1. (Currently Amended) A method for forwarding an e-mail message from an e-mail server to a mobile terminal, the method comprising:

wherein an e-mail address of the mobile terminal is associated with an identifier and encryption information, receiving the e-mail message associated with the e-mail address and sent by the e-mail server;

encrypting the e-mail message using the encryption information associated with the e-mail address; and

transmitting the encrypted e-mail message to the mobile terminal.

2. (New) The method of claim 1, further comprising identifying the mobile terminal based on the e-mail address of the e-mail message and the association with the permanent identifier of the mobile terminal.

3. (New) The method of claim 1, wherein encrypting the e-mail message further comprises packing the e-mail message by omitting at least part of the e-mail message when at least part of the e-mail message exceeds a predetermined size specification.

4. (New) The method of claim 3, wherein size specification is set by a user of the mobile terminal.

5. (New) The method of claim 3, wherein the omitted part of the e-mail message is the e-mail address.

6. (New) The method of claim 2, further comprising adding the e-mail address to a reply message sent by the mobile terminal.

7. (New) The method of claim 1, further comprising receiving the encryption information generated by the mobile terminal.

8. (New) The method of claim 1, wherein the encryption information is based on an activation code of the mobile terminal.

9. (New) The method of claim 1, wherein the messaging centre transmits the e-mail message to the mobile terminal using a temporary identifier of the mobile terminal.

10. (New) The method of claim 1, wherein mobile terminal receives and decrypts the e-mail message using the encryption information.

11. (New) The method of claim 3, wherein the mobile terminal unpacks the e-mail message.

12. (New) A system for forwarding an e-mail message from an e-mail server to a mobile terminal, the system comprising:

wherein an e-mail address of the mobile terminal is associated with an identifier and encryption information,

a memory configured for storing at least one of the e-mail address of the mobile terminal, the associated identifier of the mobile terminal, and the associated encryption information;

an encryption engine configured to encrypt the e-mail message using the encryption information, wherein the e-mail message is received from the e-mail server;

a processor configured to execute software stored in memory, the execution of the software resulting in the identification of the mobile terminal based on the e-mail address of the e-mail message and the association with the identifier of the mobile terminal; and

a communications interface configured to transmit the encrypted e-mail message to the identified mobile terminal.

13. (New) The system of claim 12, wherein the communications interface is further configured to receive the e-mail message from the e-mail server.

14. (New) The system of claim 12, wherein the communications interface is further configured to receive the encryption information and to provide the encryption information to the

memory for storage.

15. (New) The system of claim 12, wherein the encryption engine is further configured to pack the e-mail message.

16. (New) The system of claim 15, further comprising a packing filter configured to omit at least part of the e-mail message when the at least part of the e-mail message exceeds a predetermined size specification.

17. (New) The system of claim 16, wherein the communications interface is further configured to receive user input concerning the size specification.

18. (New) The system of claim 12, wherein the mobile terminal receives and decrypts the e-mail message using the encryption information.

19. (New) The system of claim 18, wherein the mobile terminal unpacks the message.

20. (New) A computer-readable storage medium having embodied thereon a program, the program being executable by a processing device to perform a method of forwarding an e-mail message from an e-mail server to a mobile terminal, the method comprising:

wherein an e-mail address of the mobile terminal is associated with an identifier and encryption information, storing at least one of the e-mail address of the mobile terminal, the associated permanent identifier of the mobile terminal, and the associated encryption information;

receiving the e-mail message associated with the e-mail address and sent by the e-mail server;

encrypting the e-mail message using the encryption information;

identifying the mobile terminal based on the e-mail address of the e-mail message and the association with the permanent identifier of the mobile terminal; and

transmitting the encrypted e-mail message to the identified mobile terminal.



Amdt. dated March 29, 2015  
Appl. No. 14/609,189

Amdt. dated March 29, 2015  
Appl. No. 14/609,189

**REMARKS**

Applicant requests entry of the amendments presented herein. No new matter has been added because of these amendments.

**DEPOSIT ACCOUNT**

The Commissioner is hereby authorized to charge any otherwise unpaid fees associated with the filing of this correspondence to Deposit Account No. 50-6191.

Respectfully submitted,

Date: March 29, 2015

/Justin R. Nifong/  
Justin R. Nifong  
Reg. No. 59,389

NKK Patent Law  
4917 Waters Edge Drive, Suite 275  
Raleigh, NC 27606  
Telephone: (919) 348-2194  
Facsimile: (919) 882-8195

Customer No. 118194

## Electronic Acknowledgement Receipt

<b>EFS ID:</b>	21907964
<b>Application Number:</b>	14609189
<b>International Application Number:</b>	
<b>Confirmation Number:</b>	5037
<b>Title of Invention:</b>	Messaging centre for forwarding e-mail
<b>First Named Inventor/Applicant Name:</b>	Ari Backholm
<b>Customer Number:</b>	118194
<b>Filer:</b>	Justin Robert Nifong
<b>Filer Authorized By:</b>	
<b>Attorney Docket Number:</b>	455/006/8 UTIL
<b>Receipt Date:</b>	29-MAR-2015
<b>Filing Date:</b>	29-JAN-2015
<b>Time Stamp:</b>	16:25:02
<b>Application Type:</b>	Utility under 35 USC 111(a)

### Payment information:

Submitted with Payment	no
------------------------	----

### File Listing:

Document Number	Document Description	File Name	File Size(Bytes)/ Message Digest	Multi Part /.zip	Pages (if appl.)
1		455-006-8UTIL-PrelimAmend. pdf	189154 <small>1887347065881d6b0ab92ecdaa38a8c8d6c195</small>	yes	6

<b>Multipart Description/PDF files in .zip description</b>			
<b>Document Description</b>		<b>Start</b>	<b>End</b>
Preliminary Amendment		1	1
Claims		2	5
Applicant Arguments/Remarks Made in an Amendment		6	6

**Warnings:**

**Information:**

<b>Total Files Size (in bytes):</b>	189154
-------------------------------------	--------

This Acknowledgement Receipt evidences receipt on the noted date by the USPTO of the indicated documents, characterized by the applicant, and including page counts, where applicable. It serves as evidence of receipt similar to a Post Card, as described in MPEP 503.

**New Applications Under 35 U.S.C. 111**

If a new application is being filed and the application includes the necessary components for a filing date (see 37 CFR 1.53(b)-(d) and MPEP 506), a Filing Receipt (37 CFR 1.54) will be issued in due course and the date shown on this Acknowledgement Receipt will establish the filing date of the application.

**National Stage of an International Application under 35 U.S.C. 371**

If a timely submission to enter the national stage of an international application is compliant with the conditions of 35 U.S.C. 371 and other applicable requirements a Form PCT/DO/EO/903 indicating acceptance of the application as a national stage submission under 35 U.S.C. 371 will be issued in addition to the Filing Receipt, in due course.

**New International Application Filed with the USPTO as a Receiving Office**

If a new international application is being filed and the international application includes the necessary components for an international filing date (see PCT Article 11 and MPEP 1810), a Notification of the International Application Number and of the International Filing Date (Form PCT/RO/105) will be issued in due course, subject to prescriptions concerning national security, and the date shown on this Acknowledgement Receipt will establish the international filing date of the application.

Under the Paperwork Reduction Act of 1995, no persons are required to respond to a collection of information unless it displays a valid OMB control number.

<b>PATENT APPLICATION FEE DETERMINATION RECORD</b> Substitute for Form PTO-875			Application or Docket Number <b>14/609,189</b>	Filing Date <b>01/29/2015</b>	<input type="checkbox"/> To be Mailed
ENTITY: <input type="checkbox"/> LARGE <input checked="" type="checkbox"/> SMALL <input type="checkbox"/> MICRO					
<b>APPLICATION AS FILED – PART I</b>					
(Column 1)		(Column 2)			
FOR	NUMBER FILED	NUMBER EXTRA	RATE (\$)	FEE (\$)	
<input type="checkbox"/> BASIC FEE <small>(37 CFR 1.16(a), (b), or (c))</small>	N/A	N/A	N/A		
<input type="checkbox"/> SEARCH FEE <small>(37 CFR 1.16(k), (i), or (m))</small>	N/A	N/A	N/A		
<input type="checkbox"/> EXAMINATION FEE <small>(37 CFR 1.16(o), (p), or (q))</small>	N/A	N/A	N/A		
TOTAL CLAIMS <small>(37 CFR 1.16(j))</small>	minus 20 =	*	X \$	=	
INDEPENDENT CLAIMS <small>(37 CFR 1.16(h))</small>	minus 3 =	*	X \$	=	
<input type="checkbox"/> APPLICATION SIZE FEE <small>(37 CFR 1.16(s))</small>	If the specification and drawings exceed 100 sheets of paper, the application size fee due is \$310 (\$155 for small entity) for each additional 50 sheets or fraction thereof. See 35 U.S.C. 41(a)(1)(G) and 37 CFR 1.16(s).				
<input type="checkbox"/> MULTIPLE DEPENDENT CLAIM PRESENT <small>(37 CFR 1.16(j))</small>					
* If the difference in column 1 is less than zero, enter "0" in column 2.			TOTAL		

<b>APPLICATION AS AMENDED – PART II</b>								
(Column 1)		(Column 2)		(Column 3)				
<b>AMENDMENT</b>	<b>03/29/2015</b>	CLAIMS REMAINING AFTER AMENDMENT		HIGHEST NUMBER PREVIOUSLY PAID FOR	PRESENT EXTRA	RATE (\$)	ADDITIONAL FEE (\$)	
	<small>Total (37 CFR 1.16(i))</small>	* 20	Minus	** 20	= 0	X \$40 =	0	
	<small>Independent (37 CFR 1.16(h))</small>	* 3	Minus	***3	= 0	X \$210 =	0	
	<input type="checkbox"/> Application Size Fee (37 CFR 1.16(s))							
	<input type="checkbox"/> FIRST PRESENTATION OF MULTIPLE DEPENDENT CLAIM (37 CFR 1.16(j))							
TOTAL ADD'L FEE						<b>0</b>		

(Column 1)		(Column 2)		(Column 3)				
<b>AMENDMENT</b>		CLAIMS REMAINING AFTER AMENDMENT		HIGHEST NUMBER PREVIOUSLY PAID FOR	PRESENT EXTRA	RATE (\$)	ADDITIONAL FEE (\$)	
	<small>Total (37 CFR 1.16(i))</small>	*	Minus	**	=	X \$	=	
	<small>Independent (37 CFR 1.16(h))</small>	*	Minus	***	=	X \$	=	
	<input type="checkbox"/> Application Size Fee (37 CFR 1.16(s))							
	<input type="checkbox"/> FIRST PRESENTATION OF MULTIPLE DEPENDENT CLAIM (37 CFR 1.16(j))							
TOTAL ADD'L FEE								

\* If the entry in column 1 is less than the entry in column 2, write "0" in column 3.  
 \*\* If the "Highest Number Previously Paid For" IN THIS SPACE is less than 20, enter "20".  
 \*\*\* If the "Highest Number Previously Paid For" IN THIS SPACE is less than 3, enter "3".  
 The "Highest Number Previously Paid For" (Total or Independent) is the highest number found in the appropriate box in column 1.

LIE  
/SHARON HARRIS/

This collection of information is required by 37 CFR 1.16. The information is required to obtain or retain a benefit by the public which is to file (and by the USPTO to process) an application. Confidentiality is governed by 35 U.S.C. 122 and 37 CFR 1.14. This collection is estimated to take 12 minutes to complete, including gathering, preparing, and submitting the completed application form to the USPTO. Time will vary depending upon the individual case. Any comments on the amount of time you require to complete this form and/or suggestions for reducing this burden, should be sent to the Chief Information Officer, U.S. Patent and Trademark Office, U.S. Department of Commerce, P.O. Box 1450, Alexandria, VA 22313-1450. DO NOT SEND FEES OR COMPLETED FORMS TO THIS ADDRESS. **SEND TO: Commissioner for Patents, P.O. Box 1450, Alexandria, VA 22313-1450.**  
 If you need assistance in completing the form, call 1-800-PTO-9199 and select option 2.

<b>INFORMATION DISCLOSURE STATEMENT BY APPLICANT</b> ( Not for submission under 37 CFR 1.99)	Application Number		14609189	
	Filing Date		2015-01-29	
	First Named Inventor	Backholm		
	Art Unit	2642		
	Examiner Name			
	Attorney Docket Number	455/006/8 UTIL		

U.S.PATENTS							Remove	
Examiner Initial*	Cite No	Patent Number	Kind Code <sup>1</sup>	Issue Date	Name of Patentee or Applicant of cited Document	Pages,Columns,Lines where Relevant Passages or Relevant Figures Appear		
	1	6745326	B1	2004-06-01	Wary			
	2	7289792	B1	2007-10-30	Turenen			
If you wish to add additional U.S. Patent citation information please click the Add button.							<b>Add</b>	
U.S.PATENT APPLICATION PUBLICATIONS							Remove	
Examiner Initial*	Cite No	Publication Number	Kind Code <sup>1</sup>	Publication Date	Name of Patentee or Applicant of cited Document	Pages,Columns,Lines where Relevant Passages or Relevant Figures Appear		
	1	20040205248	A1	2004-10-14	Little			
	2	20060265595	A1	2006-11-23	Scottodiluzio			
	3	20050015432	A1	2005-01-20	Cohen			
	4	20060085503	A1	2006-04-20	Stoye			
If you wish to add additional U.S. Published Application citation information please click the Add button.							<b>Add</b>	
FOREIGN PATENT DOCUMENTS							Remove	

<b>INFORMATION DISCLOSURE STATEMENT BY APPLICANT</b> ( Not for submission under 37 CFR 1.99)	Application Number	14609189
	Filing Date	2015-01-29
	First Named Inventor	Backholm
	Art Unit	2642
	Examiner Name	
	Attorney Docket Number	455/006/8 UTIL

Examiner Initial*	Cite No	Foreign Document Number <sup>3</sup>	Country Code <sup>2</sup> j	Kind Code <sup>4</sup>	Publication Date	Name of Patentee or Applicant of cited Document	Pages, Columns, Lines where Relevant Passages or Relevant Figures Appear	T <sup>5</sup>
	1	0772327	EP	A2	2005-06-29	Kuki		<input type="checkbox"/>

If you wish to add additional Foreign Patent Document citation information please click the Add button **Add**

**NON-PATENT LITERATURE DOCUMENTS**

**Remove**

Examiner Initials*	Cite No	Include name of the author (in CAPITAL LETTERS), title of the article (when appropriate), title of the item (book, magazine, journal, serial, symposium, catalog, etc), date, pages(s), volume-issue number(s), publisher, city and/or country where published.	T <sup>5</sup>
	1	Final Office Action mailed 5/1/2009 for US Patent Application No. 11/282,607	<input type="checkbox"/>
	2	Non-final Office Action mailed 11/19/2008 for US Patent Application No. 11/282,607	<input type="checkbox"/>
	3	Non-final Office Action mailed 2/5/2008 for US Patent Application No. 11/282,607	<input type="checkbox"/>
	4	Final Office Action mailed 4/3/2009 for US Patent Application No. 11/282,950	<input type="checkbox"/>
	5	Non-final Office Action mailed 9/26/2008 for US Patent Application No. 11/282,950	<input type="checkbox"/>
	6	Final Office Action mailed 12/4/2013 for US Patent Application No. 12/205,747	<input type="checkbox"/>
	7	Non-final Office Action mailed 6/17/2013 for US Patent Application No. 12/205,747	<input type="checkbox"/>

<b>INFORMATION DISCLOSURE STATEMENT BY APPLICANT</b> ( Not for submission under 37 CFR 1.99)	Application Number	14609189
	Filing Date	2015-01-29
	First Named Inventor	Backholm
	Art Unit	2642
	Examiner Name	
	Attorney Docket Number	455/006/8 UTIL

8	Final Office Action mailed 11/8/2011 for US Patent Application No. 12/205,747	<input type="checkbox"/>
9	Non-final Office Action mailed 4/19/2011 for US Patent Application No. 12/205,747	<input type="checkbox"/>
10	Non-final Office Action mailed 1/15/2015 for US Patent Application No. 12/228,325	<input type="checkbox"/>
11	Final Office Action mailed 4/1/2014 for US Patent Application No. 12/228,325	<input type="checkbox"/>
12	Non-final Office Action mailed 6/3/2013 for US Patent Application No. 12/228,325	<input type="checkbox"/>
13	Final Office Action mailed 12/20/2012 for US Patent Application No. 12/228,325	<input type="checkbox"/>
14	Non-final Office Action mailed 5/16/2012 for US Patent Application No. 12/228,325	<input type="checkbox"/>
15	Final Office Action mailed 5/11/2011 for US Patent Application No. 12/228,325	<input type="checkbox"/>
16	Non-final Office Action mailed 11/4/2010 for US Patent Application No. 12/228,325	<input type="checkbox"/>
17	Final Office Action mailed 10/7/2009 for US Patent Application No. 12/228,424	<input type="checkbox"/>
18	Non-final Office Action mailed 6/2/2009 for US Patent Application No. 12/228,424	<input type="checkbox"/>



<b>INFORMATION DISCLOSURE STATEMENT BY APPLICANT</b> ( Not for submission under 37 CFR 1.99)	Application Number	14609189
	Filing Date	2015-01-29
	First Named Inventor	Backholm
	Art Unit	2642
	Examiner Name	
	Attorney Docket Number	455/006/8 UTIL

If you wish to add additional non-patent literature document citation information please click the Add button **Add**

**EXAMINER SIGNATURE**

Examiner Signature		Date Considered	
--------------------	--	-----------------	--

\*EXAMINER: Initial if reference considered, whether or not citation is in conformance with MPEP 609. Draw line through a citation if not in conformance and not considered. Include copy of this form with next communication to applicant.

<sup>1</sup> See Kind Codes of USPTO Patent Documents at [www.USPTO.GOV](http://www.USPTO.GOV) or MPEP 901.04. <sup>2</sup> Enter office that issued the document, by the two-letter code (WIPO Standard ST.3). <sup>3</sup> For Japanese patent documents, the indication of the year of the reign of the Emperor must precede the serial number of the patent document. <sup>4</sup> Kind of document by the appropriate symbols as indicated on the document under WIPO Standard ST.16 if possible. <sup>5</sup> Applicant is to place a check mark here if English language translation is attached.

<b>INFORMATION DISCLOSURE STATEMENT BY APPLICANT</b> ( Not for submission under 37 CFR 1.99)	Application Number	14609189
	Filing Date	2015-01-29
	First Named Inventor	Backholm
	Art Unit	2642
	Examiner Name	
	Attorney Docket Number	455/006/8 UTIL

**CERTIFICATION STATEMENT**

Please see 37 CFR 1.97 and 1.98 to make the appropriate selection(s):

That each item of information contained in the information disclosure statement was first cited in any communication from a foreign patent office in a counterpart foreign application not more than three months prior to the filing of the information disclosure statement. See 37 CFR 1.97(e)(1).

**OR**

That no item of information contained in the information disclosure statement was cited in a communication from a foreign patent office in a counterpart foreign application, and, to the knowledge of the person signing the certification after making reasonable inquiry, no item of information contained in the information disclosure statement was known to any individual designated in 37 CFR 1.56(c) more than three months prior to the filing of the information disclosure statement. See 37 CFR 1.97(e)(2).

- See attached certification statement.
- The fee set forth in 37 CFR 1.17 (p) has been submitted herewith.
- A certification statement is not submitted herewith.

**SIGNATURE**

A signature of the applicant or representative is required in accordance with CFR 1.33, 10.18. Please see CFR 1.4(d) for the form of the signature.

Signature		Date (YYYY-MM-DD)	
Name/Print		Registration Number	

This collection of information is required by 37 CFR 1.97 and 1.98. The information is required to obtain or retain a benefit by the public which is to file (and by the USPTO to process) an application. Confidentiality is governed by 35 U.S.C. 122 and 37 CFR 1.14. This collection is estimated to take 1 hour to complete, including gathering, preparing and submitting the completed application form to the USPTO. Time will vary depending upon the individual case. Any comments on the amount of time you require to complete this form and/or suggestions for reducing this burden, should be sent to the Chief Information Officer, U.S. Patent and Trademark Office, U.S. Department of Commerce, P.O. Box 1450, Alexandria, VA 22313-1450. **DO NOT SEND FEES OR COMPLETED FORMS TO THIS ADDRESS. SEND TO: Commissioner for Patents, P.O. Box 1450, Alexandria, VA 22313-1450.**

## Privacy Act Statement

The Privacy Act of 1974 (P.L. 93-579) requires that you be given certain information in connection with your submission of the attached form related to a patent application or patent. Accordingly, pursuant to the requirements of the Act, please be advised that: (1) the general authority for the collection of this information is 35 U.S.C. 2(b)(2); (2) furnishing of the information solicited is voluntary; and (3) the principal purpose for which the information is used by the U.S. Patent and Trademark Office is to process and/or examine your submission related to a patent application or patent. If you do not furnish the requested information, the U.S. Patent and Trademark Office may not be able to process and/or examine your submission, which may result in termination of proceedings or abandonment of the application or expiration of the patent.

The information provided by you in this form will be subject to the following routine uses:

1. The information on this form will be treated confidentially to the extent allowed under the Freedom of Information Act (5 U.S.C. 552) and the Privacy Act (5 U.S.C. 552a). Records from this system of records may be disclosed to the Department of Justice to determine whether the Freedom of Information Act requires disclosure of these records.
2. A record from this system of records may be disclosed, as a routine use, in the course of presenting evidence to a court, magistrate, or administrative tribunal, including disclosures to opposing counsel in the course of settlement negotiations.
3. A record in this system of records may be disclosed, as a routine use, to a Member of Congress submitting a request involving an individual, to whom the record pertains, when the individual has requested assistance from the Member with respect to the subject matter of the record.
4. A record in this system of records may be disclosed, as a routine use, to a contractor of the Agency having need for the information in order to perform a contract. Recipients of information shall be required to comply with the requirements of the Privacy Act of 1974, as amended, pursuant to 5 U.S.C. 552a(m).
5. A record related to an International Application filed under the Patent Cooperation Treaty in this system of records may be disclosed, as a routine use, to the International Bureau of the World Intellectual Property Organization, pursuant to the Patent Cooperation Treaty.
6. A record in this system of records may be disclosed, as a routine use, to another federal agency for purposes of National Security review (35 U.S.C. 181) and for review pursuant to the Atomic Energy Act (42 U.S.C. 218(c)).
7. A record from this system of records may be disclosed, as a routine use, to the Administrator, General Services, or his/her designee, during an inspection of records conducted by GSA as part of that agency's responsibility to recommend improvements in records management practices and programs, under authority of 44 U.S.C. 2904 and 2906. Such disclosure shall be made in accordance with the GSA regulations governing inspection of records for this purpose, and any other relevant (i.e., GSA or Commerce) directive. Such disclosure shall not be used to make determinations about individuals.
8. A record from this system of records may be disclosed, as a routine use, to the public after either publication of the application pursuant to 35 U.S.C. 122(b) or issuance of a patent pursuant to 35 U.S.C. 151. Further, a record may be disclosed, subject to the limitations of 37 CFR 1.14, as a routine use, to the public if the record was filed in an application which became abandoned or in which the proceedings were terminated and which application is referenced by either a published application, an application open to public inspections or an issued patent.
9. A record from this system of records may be disclosed, as a routine use, to a Federal, State, or local law enforcement agency, if the USPTO becomes aware of a violation or potential violation of law or regulation.

(19)



Europäisches Patentamt  
European Patent Office  
Office européen des brevets



(11)

**EP 0 772 327 B1**

(12)

**EUROPEAN PATENT SPECIFICATION**

(45) Date of publication and mention  
of the grant of the patent:  
**29.06.2005 Bulletin 2005/26**

(51) Int Cl.7: **H04L 12/58, H04B 7/26**

(21) Application number: **96308063.5**

(22) Date of filing: **06.11.1996**

(54) **Electronic mail forwarding system**

System zum Weiterleiten von elektronischer Post  
Système de transport de courrier électronique

(84) Designated Contracting States:  
**DE FR GB**

(72) Inventor: **Kuki, Hikaru**  
**Yamatokoriyama-shi, Nara 639-11 (JP)**

(30) Priority: **06.11.1995 JP 28737795**

(74) Representative: **Brown, Kenneth Richard et al**  
**R.G.C. Jenkins & Co.**  
**26 Caxton Street**  
**London SW1H 0RJ (GB)**

(43) Date of publication of application:  
**07.05.1997 Bulletin 1997/19**

(73) Proprietor: **SHARP KABUSHIKI KAISHA**  
**Osaka 545 (JP)**

(56) References cited:  
**WO-A-90/14726**                      **WO-A-94/08419**

**EP 0 772 327 B1**

Note: Within nine months from the publication of the mention of the grant of the European patent, any person may give notice to the European Patent Office of opposition to the European patent granted. Notice of opposition shall be filed in a written reasoned statement. It shall not be deemed to have been filed until the opposition fee has been paid. (Art. 99(1) European Patent Convention).

## Description

### 1. Field of the Invention

**[0001]** The present invention relates to an electronic mail forwarding (transferring) system and, more particularly, to an electronic mail forwarding system between a mail communication terminal connected to a data communication network and a portable wireless communication terminal connected to a wireless data communication network.

### 2. Description of the Related Art

**[0002]** Recently, systems for forwarding electronic mails (herein referred to as mails) have been widely used to effect forwarding of messages or informations to individuals between personal computers or personal terminals by utilizing data communication network. There are various kinds of electronic mail forwarding systems.

**[0003]** It is known in the art that, as the most general mail forwarding system, a mail communication terminal A (host computer) is arranged to store an address of a mail of another mail communication terminal B (wireless communication terminal) whereby, when a mail is forwarded to the mail communication terminal A through the data communication network, the mail is automatically forwarded to the mail communication terminal B via the wireless data communication network. This system will be referred to as prior art 1.

**[0004]** It is also known that a mail host (host computer) is prepared independently of the mail communication terminals A and B to store a received mail, whereby the received mail can be read out from either of the mail communication terminals A and B. This system will be referred to as prior art 2.

**[0005]** In addition, an electronic mail system has been proposed in Japanese Laid Open Patent Application No. HEI 3(1991)-274,942 in which the electronic mail system comprises a plurality of mail communication terminals and a center device (mail server) having a mail storage exchange function in which individual mail boxes are prepared to perform a forwarding function between the individual mail boxes. Each of the mail communication terminals is arranged to enable polling (viz., a function to read out the mail box) for drawing the mail out therefrom. This system will be referred to as prior art 3.

**[0006]** In the prior art 1, however, each user is required to operate such as setting of the address for forwarding on the host computer (herein referred to as the mail communication terminal A) before his going out in order to have the mail forwarded. With this prior art system, the mail is forwarded to the wireless communication terminal (herein referred to as the mail communication terminal B) at the time of receipt of the mail in the host computer and the mail forwarding system is not provided with a function to set a mail forwarding time.

This is reflected by a drawback in that it is difficult to effect settings to stop forwarding of the mail by the host computer A during the user's going out time and to restart forwarding of the mail again at a later time, whereby the wireless communication terminal B is required to continue its communication function at all times for receiving the mail, thereby increasing a power consumption.

**[0007]** In the prior art 2, further, although it is not required to effect setting of the mail addressee on the host computer, it is necessary to confirm the inquiry of the presence or absence of the received mail even when there exists no unread mail addressed for the user since the received mail is stored in the host computer to enable reading out of the mail from the plurality of wireless communication terminals (which indicates the mail communication terminals A and B). In each inquiry, power consumption is increased by the wireless communication terminals A and B and, further, the communication cost is consequently increased.

**[0008]** In the prior art 3 of Japanese Laid Open Patent Application No. HEI 3(1991)-274,942, further, a center device (a mail server) having a mail storage exchange function is provided with a mail box corresponding to each mail communication terminal (a network terminal) and, hence, it is possible to read out the mail from the mail box to effect forwarding of the mail, whereby mail forwarding efficiency is improved between individual communication terminals.

**[0009]** However, although the aforementioned center device is arranged to realize the forwarding function between the mail box and each of the mail communication terminals, the mail drawn from the mail box to the mail communication terminal is not arranged to be forwarded to a wireless communication terminal of the portable type via a wireless data communication network.

**[0010]** For this reason, the mail received at the mail communication terminal can not be read out by the wireless communication terminal of the portable type through the use of wireless data communication network when the user is going out.

**[0011]** In order to realize a mail forwarding system of this type, a remarkable change or modification should be widely made not only in softwares in the host computers and the wireless communication terminals but also in softwares in the center device.

**[0012]** WO 97/08906, which forms part of the state of the art by virtue of Articles 54(3) and 158 EPC, discloses a system for transmitting e-mail over a mobile telephone network with the aid of short text message routing means existing in the network. Software in a computer decodes an agent in a modified short text message received by a mobile station and initiates the transmission of e-mail from a host arrangement

## SUMMARY OF THE INVENTION

**[0013]** The present invention has been made with a

view to overcoming the above circumstances. It is therefore an object of the present invention to provide an electronic mail forwarding system which is arranged to enable reading out a mail received at a mail communication terminal connected to a data communication network with the use of a portable wireless communication terminal located at outside via a wireless data communication network at any convenient time by transmitting a forwarding-request signal thereto.

[0014] The present invention provides an electric mail forwarding system comprising portable-type wireless communication terminal for a user and a mail communication terminal for the same user, the mail communication terminal capable of forwarding an electric mail via a wireless data communication network in response to a forwarding request signal for the electric mail, in which the wireless communication terminal comprises: a forwarding-request signal generating section for generating the forwarding-request signal which includes additional information designating a forwarding time and a forwarding time interval of a given electric mail; an electric mail processing section for transmitting the generated forwarding-request signal to the mail communication terminal via the wireless data communication network; an electric mail receiving section for receiving the electric mail from the mail communication terminal; and an electric mail storage section for storing the received electric mail, in which the mail communication terminal comprises: a mail box for storing the electric mail received from a mail communication terminal for another user via a data communication network; a forwarding-request signal recognizing section for recognizing the additional information contained in the forward-request signal received from the wireless communication terminal via the wireless data communication network; and a communication processing section for sequentially forwarding the electric mail stored in the mail box to the wireless communication terminal in accordance with the recognized forwarding time and forwarding time interval.

#### BRIEF DESCRIPTION OF THE DRAWINGS

##### [0015]

Fig. 1 is a block diagram showing a basic arrangement of an electronic mail forwarding system according to the present invention;

Fig. 2 is a block diagram showing a preferred embodiment of a mail forwarding system provided at a wireless communication terminal;

Fig. 3 is a block diagram showing a preferred embodiment of a mail forwarding system 1 provided at a host computer;

Fig. 4 is a block diagram showing a preferred embodiment of a mail forwarding system 2 provided at the host computer;

Fig. 5 is a schematic view showing a communication

processing between the wireless communication terminal and the host computer;

Fig. 6 is a view showing a signal format;

Fig. 7 is a view showing an example of relationship between a kind of signals and an example of various values appointed therefor;

Fig. 8 is a view showing an example of a forwarding-request signal;

Fig. 9 is a flow-chart showing start processing steps for mail forwarding at the wireless communication terminal;

Fig. 10 is a flow-chart showing end processing steps for mail forwarding at the wireless communication terminal; and

Fig. 11 is a flow-chart showing processing steps for mail forwarding at the host computer.

#### DESCRIPTION OF PREFERRED EMBODIMENTS

[0016] The present invention provides an electric mail forwarding system between a mail communication terminal and a portable-type wireless communication terminal, the mail communication terminal serving to receive an electric mail via a data communication network, and the wireless communication terminal serving to transmit a forwarding-request signal for the electric mail to the mail communication terminal via a wireless data communication network, in which the mail communication terminal comprises:

a mail box for storing the received electric mail;  
 a forwarding-request signal recognizing section for receiving the forwarding-request signal transmitted from the wireless communication terminal and for recognizing additional information contained in the forwarding-request signal; and  
 a wireless data communication processing section for sequentially forwarding the electric mail to the wireless communication terminal based on the recognized forwarding-request signal.

[0017] Also, the present invention provides an electric mail forwarding system in which the wireless communication terminal comprises: a forwarding-request signal generating section for generating the forwarding-request signal for the electric mail received in the mail communication terminal; an electric mail processing section for transmitting the generated forwarding-request signal to the mail communication terminal and for receiving the electric mail from the mail communication terminal; and an electric mail storage section for storing the received electric mail.

[0018] In the present invention, the wireless communication terminal is composed of a portable information unit having a wireless communication function. The mail communication terminal is composed of a personal computer having a communication function. Also, the wireless data communication network may, for example,

comprise a wireless telephone circuit. Further, the data communication network may, for example, comprise internal network, LAN (a Local Area Network) and WAN (a Wide Area Network).

**[0019]** According to the present invention, it is possible to read out the electronic mail received in the mail communication terminal connected to the data communication network by transmitting the forwarding-request signal from the portable wireless communication terminal at any place in the network at a convenient time via the wireless data communication network.

**[0020]** The forwarding-request signal generating section preferably generates the forwarding-request signal including additional information on designation of a forwarding time and a forwarding time interval of a given electric mail.

**[0021]** If the forwarding-request signal recognizing section recognizes the forwarding-request signal including the additional information on designation of a forwarding time and a forwarding time interval of a given electric mail, the wireless data communication processing section preferably forwards the electric mail to the wireless communication terminal at the designated forwarding time and for the designated forwarding time interval.

**[0022]** With the electronic mail forwarding system stated above, it is possible to transmit a signal to the mail communication terminal at the time and for time interval designated for a desired electronic mail to be forwarded to the wireless communication terminal and, thus, the user does not need to access the mail communication terminal with a single purpose of inquiring the presence of the received mail. Also, since the wireless communication terminal is not operated except during the designated time interval, it is possible to reduce power consumption of the wireless communication terminal and, at the same time, to minimize the communication cost.

**[0023]** The forwarding-request signal generating section preferably generates the forwarding-request signal including additional information on designation of a name of an electric mail sender, a title and an urgency level.

**[0024]** If the forwarding-request signal recognizing section recognizes the forwarding-request signal including the additional information on designation of a name of an electric mail sender, a title and an urgency level, the wireless data communication processing section preferably forwards the electric mail to the wireless communication terminal upon selection of the electronic mail sender, the title and the urgency level.

**[0025]** With the arrangement mentioned above, since it is possible to add the name of the sender of the electronic mail, the title and the urgency level for designation in the forwarding-request signal to be forwarded, it is possible to select and forward the desired mail from the mails received in the mail communication terminal to the wireless communication terminal at user's hand for

reading-out.

**[0026]** Further, the wireless communication terminal is preferably arranged to transmit the forwarding-request signal to the mail communication terminal at the start of the mail receiving function and to transmit the forwarding-end signal at the end of the mail receiving function whereby the mail communication terminal completes its forwarding of the electronic mail.

**[0027]** In addition, in the electronic mail forwarding system which is not provided with the electronic mail forwarding function between the mail communication terminal and the wireless communication terminal, it is possible to realize the electronic mail forwarding function between the mail communication terminal and the wireless communication terminal by mere change in software of the mail communication terminal (host computer) of the user and the wireless communication terminal.

**[0028]** A preferred embodiment of the present invention will now be described in detail with reference to the drawings. It is to be noted that the present invention is not limited by the detailed description which will be made hereinafter.

**[0029]** Also, it is to be noted that, according to the present invention, a portable wireless communication terminal to be used by a user who is going out or moving will be hereinafter referred to as a wireless communication terminal and, in addition, a mail communication terminal (a network terminal) connected to a wireless data communication network to be used for the user's normal business for transmitting and receiving an electronic mail will be hereinafter referred to as a host computer.

**[0030]** Fig. 1 is a block diagram showing a basic arrangement of an electronic mail forwarding system according to the present invention. In Fig. 1, the reference numeral 100 indicates a wireless communication terminal, the reference numeral 200 indicates a mail communication terminal (a host computer) having a mail box, the reference numeral 300 indicates a wireless data communication network for enabling data communication between the wireless communication terminal 100 and the mail communication terminal 200, and the reference numeral 400 indicates a data communication network for enabling data communication between the host computers 200.

**[0031]** The wireless communication terminal 100 has a mail receiver application programme which, when it is turned on, transmits the forwarding-request signal to the host computer 200. The host computer 200 judges the forwarding-request signal and sequentially forwards to the wireless communication terminal 100 unread mails stored in the mail box (the storage device) and subsequent mails delivered to the mail box of the host computer 200.

**[0032]** The forwarding-request signal is additionally provided with the designation of the forwarding time interval (e.g., five minutes or ten minutes) and, therefore, it becomes unnecessary to operate the communication

function at all times so that energy saving of the wireless communication terminal 100 becomes possible. Further, an arrangement may be made to forward the mail from the host computer 200 after the forwarding-request signal has been once transmitted to the host computer 200. This arrangement makes it unnecessary to make inquiry about the presence or absence of the received mail in the mail box, thereby enabling reduction of data communication cost due to the inquiry. In addition, the forwarding-request signal may be modified such that another wireless communication terminal is designated by completing the data forwarding and changing the addressee.

**[0033]** Fig. 2 is a block diagram showing one example of a mail forwarding system of the wireless communication terminal according to the present invention. In Fig. 2, the wireless communication terminal 100 comprises a control section 101, an input section 102, a display section 103, an electronic mail storage section 104, a clock section 105, a forwarding-request signal processing section (forwarding-request signal generating section) 106, an electronic mail processing section 107 and a wireless data communication processing section 108.

**[0034]** The control section 101, the electronic mail storage section 104, the clock section 105, the forwarding-request signal processing section 106, the electronic mail processing section 107 and the wireless data communication processing section 108 are usually composed of a micro-computer including CPU, ROM, RAM, timer and I/O port.

**[0035]** The input section 102 is composed of smaller panel switch or keyboard. The display section 103 is composed of a liquid crystal display (LCD) or EL display.

**[0036]** The input section 102 functions to start a mail receiving application programme to input a mail forwarding-request signal, and control information on mails to be forwarded. Further, the input section 102 serves as a timing information designation means for designating timing information such as forwarding time and forwarding time interval of a desired mail in the forwarding-request signal or an additional information designation means for designating an additional information such as address of the electronic mail sender, title and the degree of urgency in the forwarding-request signal.

**[0037]** The display section 103 functions to display the input mail or the received mail in the picture. The electronic mail storage section 104 stores the mails which are received. The clock section 105 functions to effect clocking of time for receiving the received mail for a certain time interval or at a certain time.

**[0038]** The wireless data communication processing section 108 is connected to a wireless data communication network 300 and functions to control communication protocol for wireless data communication such as modification of the wireless data and data communication control.

**[0039]** The wireless data communication processing section 108 makes it possible to select and use a suit-

able one of a plurality of communication protocols which are currently used as a standard.

**[0040]** Also, the wireless communication processing section 108 functions to effect judgement related to changeover of the mail forwarding and receiver processing and communication means in response to the input signal.

**[0041]** The wireless data communication network 300 may, for example, be performed by utilizing a wireless packet communication and wireless telephone or by the method of transmitting data instead of voice or by the utilization of infrared rays.

**[0042]** The forwarding-request signal processing section 106 serves to transmit a mail forwarding-request signal and a mail forwarding-end signal to the host computer 200, or to receive an acknowledgement (response) signal from the host computer 200 for judgement of the content thereof.

**[0043]** Also, the adjusting method in the forwarding-request signal processing section 106 is achieved by an optional method which is mostly suited at the time of adjusting. For example, it may be possible to employ the same method as the electronic mail processing section 107 in respect of signal transmitting or receiving method, or to utilize "a short message communication function" which is a subsidiary function of the digital portable telephone system.

**[0044]** Further, the mail forwarding-request signal may be provided with an appointment designation such as the time interval of the mail forwarding and the requested time for next mail forwarding, and a designation of the sender who intends to effect the mail forwarding, the title and the degree of urgency, etc.

**[0045]** The electronic mail processing section 107 serves to transmit or receive the normal electronic mail.

**[0046]** The electronic mail processing section 107 is selected arbitrarily depending on the electronic mail system employed by the user. However, the electronic mail processing section 107 should be able to receive the forwarded mail from the host computer 200.

**[0047]** The mail forwarding system of the host computer 200 will now be described in detail hereinafter. The mail forwarding system of the host computer 200 may be arranged in one of the two systems according to the connection method relative to the wireless data communication network 300 and the host computer 200 of the data communication network 400.

**[0048]** In one system, the host computer 200 is directly connected to the wireless data communication network 300 and data communication network 400, respectively. In this instance, the host computer 200 is arranged in a manner as shown in the block diagram of Fig. 3.

**[0049]** In the other system, the wireless data communication network 300 is connected to the data communication network 400 as shown in a manner of block diagram of Fig. 4.

**[0050]** Fig. 3 is the block diagram showing a preferred



embodiment of the mail forwarding system 1 of the host computer. In Fig. 3, the host computer 200 comprises a control section 201, an input section 202, a display section 203, an electronic mail storage section 204, a clock section 205, a forwarding-request signal processing section (forwarding-request signal recognizing section) 206, a first electronic mail processing section 207, a wireless mail communication processing section (wireless data communication processing section) 208, a second electronic mail processing section 209 and a network communication processing section 210.

[0051] The control section 201, the input section 202, the display section 203, the electronic mail storage section 204, the clock section 205, the forwarding-request signal processing section 206, the first electronic mail processing section 207, the wireless mail communication processing section (wireless data communication processing section) 208, the second electronic mail processing section 209 and the network communication processing section 210 are composed of a micro-computer including CPU, ROM, RAM and I/O part. The electronic mail storage section 204 comprises RAM, a hard disk drive, a floppy disk drive or an optical-magnetic disk drive etc.

[0052] The input section 202 comprises a keyboard or a mouse etc. The display section 203 comprises a CRT display or a liquid crystal display (LCD) etc. The control section 201 is connected to the display section 203 serving as the mail display means, the input section 202 serving as the information input means and the clock section 205 which provides time.

[0053] The first electronic mail processing section 207 should be designed to enable forwarding of the mail to the electronic mail processing section 107 of the wireless communication terminal 100.

[0054] The host computer 200 is provided with the wireless data communication processing section 208 which serves to process data communication relative to the wireless data communication network 300 which forwards the mail to the wireless communication terminal 100, and the network communication processing section 210 which serves to process data communication relative to the data communication network 400 which transmits or receives the mail to or from outside

[0055] In addition, the data communication network 400 is composed of an interval network, LAN (a Local Area Network) and WAN (a Wide Area Network) etc.

[0056] The mail is received via the network communication processing section 210 and the second electronic mail processing section 209 and, thereafter, stored in the electronic mail storage section 204. At this instant, if the host computer 200 is in use by the user, the mail can be read out on the host computer 200.

[0057] When the forwarding-request signal is transmitted from the wireless communication terminal 100, the forwarding-request signal is delivered to the forwarding-request signal processing section 206 via the wireless data communication processing section 208.

When the forwarding-request signal is confirmed by the forwarding-request signal processing section 206, the unread mail stored in the electronic mail storage section 204 is transmitted to the first electronic mail processing section 207 in accordance with conditions of the forwarding-request signal and forwarded to the wireless communication terminal 100 through the use of the same system as the normal electronic mail transmitting system.

[0058] If there exists no unread mail in the mail storage section 204 when the forwarding-request signal is received, the acknowledgement signal is transmitted by the wireless data communication processing section 208.

[0059] Thereafter, unread mails received in the electronic mail storage section 204 are kept being watched in accordance with the conditions of the forwarding-request signal until the forwarding-request signal is received, and are transmitted to the wireless communication terminal 100 via the first electronic mail processing section 207.

[0060] When the forwarding-end request of the electronic mail is transmitted from the wireless communication terminal 100, this signal is transmitted to the forwarding-request signal processing section 206 via the wireless data communication processing section 208. When the forwarding-end signal is confirmed by the forwarding-request signal processing section 206, the transmitting operation of the unread mails stored in the electronic mail storage section 202 relative to the wireless communication terminal 100 is completed, and the forwarding-request signal processing section 206 transmits the acknowledgement signal to the wireless communication terminal 100 via the wireless data communication network 300.

[0061] Fig. 4 is a block diagram showing a preferred embodiment of the mail forwarding system 2 of the host computer. In Fig. 4, the wireless data communication network 300 is connected to the data communication network 400. In this embodiment, the mail received from the external data communication terminal is forwarded to the wireless communication terminal 100 via the wireless data communication network 300 so that the electronic mail processing section 217 and the network communication processing section 218 can be provided in common. The other constituents of the mail forwarding system are similar to those of the other embodiments.

[0062] The electronic mail transmitted from outside via the network communication processing section 218 and the electronic mail processing section 217 is stored in the electronic mail storage section 214. When the forwarding-request of the electronic mail is received, the unread mail is read out from the electronic mail storage section 214 and forwarded to the wireless communication terminal 100 via the electronic mail processing section 217, the network communication processing section 218, the data communication network 400 and the wireless data network 300.

**[0063]** At present, the data communication network 400 may comprise either one of various networks such as the internal network, LAN (Local Area Network) and WAN (Wide Area Network) etc., which have different address system (viz., an address for electronic mail or an address for network), or different data forwarding system.

**[0064]** The terminal which performs the data communication with the use of the data communication network is arranged to employ the communication protocol depending on the kind of the terminal. Each of the communication processing sections described in this patent specification enables to use a plurality of communication protocols which are currently used as standard depending on the network to be connected. Describing the protocol in accordance with OSI (Open Systems Interconnection: International Standard Network Architecture) models defined by ITU-TS (Electric Communication Standardization Sector which is originated from CCITT (International telephone and Telegram Consultative Committee) and ISO (International Standardization Organization), each communication processing section comprises a first layer (a physical layer) to a fourth layer (a transport layer), and the electronic mail processing section and the forwarding-request processing section belong to fifth to seventh layers (application layers).

**[0065]** Each terminal and the host computer have a network address for its identification when the communication is performed on the data communication network and, normally, the address is principally defined by the third layer.

**[0066]** The electronic mail processing sections 207 and 217 may vary depending on the electronic mail forwarding system utilized by the operator, but may be any device as long as the device has a function to transmit or receive the mail to the terminal or the host computer.

**[0067]** In the present embodiment, a mail address is employed in order to designate a specific individual, with the mail address being different from the network address to designate the terminal on the network.

**[0068]** In a case where the forwarding function of the present invention is added to the existing electronic mail systems, the mail systems are further provided with the forwarding-request signal processing section, the electronic mail storage section serving to store the unread mails received therein, and the electronic mail processing section which serves to confirm the presence or the absence of the mail in the electronic mail storage section for forwarding the received mail to the communication processing section.

**[0069]** Fig. 5 is a diagram showing the communication processing steps to be carried out between the wireless communication terminal and the host computer.

**[0070]** In Fig. 5, a plurality of processing steps are indicated as follows,

Step a: normal mail transmitting and receiving, reading out and storing step.

**[0071]** The operator is able to read out the mail on the mail display application programme of the host computer 200 when the host computer 200 receives the mail during operation of the host computer 200 normally located in his office etc. The received mail is stored in the electronic mail storage section (the mail box) and the operator is able to draw the mail at any time to read the same on the mail display application programme.

Step b: a step in which the wireless communication terminal starts its application programme.

**[0072]** When the operator goes out from his office, he is able to forward the unread mail to the wireless communication terminal 100 from the host computer 200 at any time and to read out the mail on the wireless communication terminal 100.

**[0073]** When the electronic mail receiving application programme of the wireless communication terminal is started, the forwarding-request signal is transmitted to the host computer 200 from the wireless communication terminal 100 via the wireless data communication network 300. When the host computer 200 receives that signal, the host computer 200 forwards the mail stored therein to the wireless communication terminal 100.

**[0074]** At this time, even if there exists no stored mail, the host computer 200 sends the acknowledgement signal to indicate a situation of absence of the mail for informing the operator that the host computer 200 has received the signal from the wireless communication terminal.

Step c: mail forwarding step.

**[0075]** Forwarding of the mail is always performed by the host computer. The host computer employs the mail forwarding protocol specifically suited for the network as the mail transmitting protocol.

**[0076]** In a case where the forwarding-request signal is generated from the wireless communication terminal 100, the mail stored in the electronic mail storage section is forwarded to the wireless communication terminal 100 depending on the conditions (viz., time setting, time interval setting, operator designation, urgency level and title designation) until the host computer receives the forwarding-end signal.

Step d: a step in which the forwarding is impossible or in which an error has occurred.

**[0077]** In a case where no acknowledgement of data transmitted from the host computer 200 or from the wireless communication terminal 100 is found, or in which an error has occurred, the forwarding of data is repeatedly tried at certain time intervals and the forwarding of

data is repeated for certain times until it succeeds. If the forwarding of data does not succeed, the forwarding of data is stopped and, in a case in which there is the time designation or the time interval designation, the forwarding of data is tried again at the next designated time.

Step e: a step for changing the forwarding condition.

**[0078]** The wireless communication terminal 100 enables the designation of the condition for forwarding the mail to the host computer 200. The condition to be designated includes a mail forwarding time interval designation, a forwarding time setting, a desired transmitter, title and urgency level, etc.

**[0079]** In order to change the forwarding condition, a new forwarding-request signal including condition to be changed is transmitted and the same steps as those performed at the start of forwarding are repeated.

Step f: a step in which the forwarding of data is interrupted and a resuming step is performed.

**[0080]** When it is required to temporarily interrupt the forwarding of data from the wireless communication terminal 100, the user is required to operate the same step as that of the forwarding-end. In order to resume the temporary interruption of forwarding the data, the forwarding-request signal is transmitted and the user operates the same steps as those performed at the start of forwarding.

Step g: a step for ending the application programme.

**[0081]** The wireless communication terminal 100 enables to transmit the forwarding-end signal to the host computer 200 for ending the forwarding of the mail. In this instance, the host computer 200 sends the acknowledgement signal to the wireless communication terminal 100.

**[0082]** Fig. 6 is a diagram which shows a signal format. The signal format shown in Fig. 6 is for the application layers in OSI model described above, and, in the actual forwarding of data, the data is forwarded to the addressee after the modification process or the adding process of the data format is performed by the lower layer.

**[0083]** The signal format is composed of a service identification number 501, a transmitter number 502, a forwarding address number 503, a signal identification number 504, a forwarding number 505, an option number 506 and an option value 507.

**[0084]** The signals 501 to 507 are previously decided with respect to an appropriate data size. However, the signals related to the option have no constant data size to provide an end signal.

**[0085]** The service identification number 501 is intended to indicate a signal related to the forwarding-request for the wireless communication terminal 100 and

the communication processing section of the host computer 200. The data communication processing section delivers the data to the forwarding-request signal processing section when the signal has a certain value.

**[0086]** The sender number 502 is used for specifying the sender who uses the host computer 200. For example, when the host computer 200 has received mails from a plurality of senders, the sender number 502 is needed for forwarding only the mail requested by the user.

**[0087]** The addressee number 503 is used for specifying the user who uses the wireless communication terminal 100. For example, when one company employs a plurality of wireless communication terminals 100, the addressee number 503 is needed for forwarding the mail to the wireless communication terminal 100 which is requesting for forwarding of the data.

**[0088]** The signal identification number 504 is used for identifying a kind (viz., the forwarding-request signal, the forwarding-end signal and the acknowledgement signals etc.) of the forwarding-request signal. This identification is performed in the forwarding-request signal processing section.

**[0089]** The forwarding number 505 is a serial number for numbering the forwarding-request signals and the forwarding-end signals and the same forwarding number is used for the acknowledgement signal corresponding to the request signal.

**[0090]** The option identification number 506 indicates that the data following subsequently is an option and also indicates a kind of option.

**[0091]** The option value 507 is described by formats suited for respective options to be set.

**[0092]** Fig. 7 is a diagram showing one example of a kind of the signals and their respective values. In Fig. 7, an actual assignment of the number is performed at the most effective method at the time of setting data.

**[0093]** The signal identification number 504 is composed of the forwarding-request signal 504a, the forwarding-end signal 504b and the acknowledgement signal 504c, with each of the signals having a value assigned for identification.

**[0094]** The forwarding-request signal 504a is used for starting the forwarding of the mail from the wireless communication terminal 100 to the host computer 200 and, also, to set the forwarding condition in the host computer 200.

**[0095]** The forwarding-end signal 504b is used to complete forwarding of the mail from the wireless communication terminal 100 to the host computer 200.

**[0096]** The acknowledgement signal 504c is used to enable the host computer 200 to inform the wireless communication terminal 100 that the host computer 200 has received the forwarding-request signal 504a or the forwarding-end signal 504b.

**[0097]** The option identification number 506 has a plurality of kinds of items to be set, such as a time interval designation 506a, a time designation 506b, a transmitter

designation 506c, a title designation 506d, an urgency level 506e, the operator's name 506f who receives the mail at the wireless communication terminal 100, a password 506g, a message 506h and a check sum 506i etc., with the respective signals having their respective values assigned for identification. Among these signals, only the desired signal is selected and forwarded.

**[0098]** The option identification number 506 has specifically appointed values for canceling the previously input setting, with the appointed values being commonly used in each of the option signals.

**[0099]** The time interval designation 506a enables to set the time interval during which the host computer 200 forwards the mail to the wireless communication terminal 100. The reference time is set to be equal to the time at which the signal is forwarded in a case in which there is no special time designation.

**[0100]** The time designation 506b enables the designation of time for forwarding the mail to the wireless communication terminal 100 from the host computer 200 for the next time. If it is necessary, a plurality of times can be set.

**[0101]** The transmitter designation 506c is used to forward only one of the unread mails received from the certain transmitters to the host computer.

**[0102]** The title designation 506d is used for designating so as to forward only the mail having a certain title.

**[0103]** The urgency level 506e is used for forwarding only the mail having a designation of urgency in a header of the mail. In a case where the mail system has grades in the information of the urgency on the header, the designation is made to the mails of which urgency level is above certain grade.

**[0104]** The user address 506f is used for specifying the user at the wireless communication terminal 100. This address is, for example, used for specifying one of a plurality of users who are assigned to single wireless communication terminal 100.

**[0105]** The password 506g is used for maintaining a security in the forwarding-request signal. This password is checked for verification at the forwarding-request signal processing section and the forwarding process is performed only when the password is correct.

**[0106]** The message 506h is mainly used as an acknowledgement signal which enables the host computer 200 to send information of absence of forwarded mails or information of impossible forwarding of the data to the wireless communication terminal 100 with respect to the forwarding-request signal.

**[0107]** The check sum 506i indicates a value equal to the count of the check sum of whole the transmitted data and the use of this signal enables the confirmation of validity of the data.

**[0108]** Also, when all of the conditions with respect to the operator designation 506c, the title designation 506c, the urgency level 506e are simultaneously designated, the mail satisfying all of the conditions is forwarded from the host computer 200.

**[0109]** Further, it is possible to set a plurality of conditions with the same items with respect to the time designation 506b, the operator designation 506c, the title designation 506d and the urgency level 506e for thereby enabling the forwarding of the mail which satisfies either one of the conditions.

**[0110]** Fig. 8 is a view showing one example of the forwarding-request signal. In Fig. 8, the forwarding-request signal has an option such as designation of forwarding time interval setting and urgency level.

**[0111]** Fig. 9 is a flow chart showing a starting process steps of the mail forwarding of the wireless communication terminal. In Fig. 9, when the communication application programme is turned on, the forwarding-request signal is transmitted (see step S101) and the reception of the forwarded mail is waited for certain interval (see step S102). In a case where the mail is not received for the certain time interval (see step S103), the second forwarding is tried and, if there is no acknowledgement even when repeated forwarding is made more than certain times (see step S104), an error message is returned to indicate the state of no connection with the host computer (see step S106). When the mail is received within the certain time interval (see step S103), the wireless communication terminal is kept under the state of waiting for reception of mails (see step S104).

**[0112]** Under the state of waiting for reception of mails, the terminal remains in its normal mail reception waiting condition. If the forwarding time interval and the forwarding time are designated, the mail reception is waited only for time interval during the data forwarding.

**[0113]** When the mail is not received at the forwarding time, it may be arranged so as to start a special process or to display non-arrival of the message.

**[0114]** When it is required to change the message forwarding condition, the contents to be changed are designated in the forwarding-request signal and the same steps are taken as in the starting step.

**[0115]** Further, when it is required to urgently receive the message, the same process is performed as in the starting step.

**[0116]** Also, the message forwarding step may be made at any time irrespective of waiting operation for the data forwarding.

**[0117]** Fig. 10 is a flow chart showing a mail forwarding-end processing step of the wireless communication terminal. In Fig. 10, when the communication application programme is turned off, the forwarding-end signal is transmitted (see step S201), and the acknowledgement signal reception is awaited for a certain interval (see step S202). when the acknowledgement signal is not received within the certain time interval (see step S203), the forwarding-end signal is transmitted again and, if there is no acknowledgement even after repeated transmissions above a certain number of times (see step S205), an error message is returned to indicate no connection with the host computer 200. It is arbitrary to process after sending the error message.

[0118] When the acknowledgement signal is received within the certain time interval (see step S203), the operation is normally ended (see step S204).

[0119] Fig. 11 is a flow chart indicating the mail forwarding process of the host computer. In Fig. 11, the host computer 200 stores the unread mails received in the absence of the operator in the mail storage section. Also, the host computer 200 remains waiting for the forwarding-request signal from the wireless communication terminal (see step S301).

[0120] When a signal related to the forwarding-request signal is received from the wireless communication terminal 100, the kind of this signal is checked (see step S302).

[0121] If the signal is not the forwarding-request signal, the host computer 200 checks whether that signal is the forwarding-end signal (see step S303) and, if that signal is the forwarding-end signal, the forwarding mode for stored mails is ended (see step S304). The host computer 200 then transmits an acknowledgement signal irrespective of the state of the host computer (see step S305).

[0122] When the forwarding-request signal is received, the value contained in that signal is drawn out (see step S306).

[0123] If there exists the check sum designation in the forwarding-request signal (see step S307), the host computer 200 confirms whether the check sum is correct (see step S308), and invalidates the received signal if the check sum is not correct (see step S309). When the check sum is correct, the user from whom the forwarding-request was sent is confirmed (see step S310) and, subsequently, if the host computer 200 requests the password for security maintenance (see step S311), the host computer 200 invalidates the received signal when the forwarding-request signal does not include the password or when an incorrect password is included in the forwarding-request signal (see step S313). If the password is correct, the forwarding address (such as host address and mail address) of the mail is stored and set (see step S314).

[0124] Subsequently, the option of the forwarding-request signal is checked (see step S315). When the sender is designated, the host computer 200 is set so as to forward only the mails received from that sender (see step S316).

[0125] Next, when the title of the mail to be forwarded is designated (see step S317), the host computer 200 is set to forward only the mails having the specified title (see step S318).

[0126] Also, when the urgency level designation exists (see step S319), the host computer 200 is set to forward only the mails having a designated urgency level (see step S320).

[0127] After these conditions have been set, the mail satisfying these conditions is searched for within the stored mails and transmitted to the terminal. If the mail satisfying the conditions is not found, the message in-

dicative of no forwarded mails is transmitted (see step S321).

[0128] Subsequently, the option of the request signal is checked (see step S322). If there is a forwarding time designation, the forwarding time is stored (see step S322). Also, if there is a forwarding time interval designation (see step S324), the forwarding time interval is set (see step S325).

[0129] Thereafter, the forwarding mode is initiated and the mail is forwarded in accordance with the required conditions (see step S326). At the same time, the operation of waiting for the forwarding-request signal and the forwarding-end signal is continued and, when these signals are received, the same process will be repeated in a manner described above.

[0130] It will now be appreciated that the present invention has the following advantages:

- (1) By transmitting a forwarding-request signal to a mail communication terminal via a wireless data communication network with the use of a portable wireless communication terminal at any place in the network, it is possible to forward and read out a mail received at the mail communication terminal from the wireless communication terminal at any convenient time;
- (2) The wireless communication terminal enables the forwarding-request signal having the designation such as mail forwarding time and forwarding time interval to be transmitted so that a mail is transmitted to the mail communication terminal in accordance with that designation whereby it becomes unnecessary to regularly access the mail communication terminal with the only purpose of inquiring for the received mail from the wireless communication terminal and the operation of a wireless data communication processing section is not needed except during the time designated by the forwarding-request signal, thereby reducing electric power consumption of the wireless communication terminal while minimizing the communication costs;
- (3) The wireless communication terminal enables the transmission of the forwarding-request signal designating an electronic mail sender, a title and urgency level etc, so that it is possible to forward and read out an intended mail among mails received in the mail communication terminal with the use of the wireless communication terminal on hand; and
- (4) A modification may be made in the electronic mail forwarding system which has no electronic mail forwarding function between the mail communication terminal and the wireless communication terminal by only changing the software in the user's mail communication terminal (viz., host computer) and the wireless communication terminal, thereby realizing an electronic mail forwarding function between the mail communication terminal and the wireless communication terminal.

**Claims**

1. An electric mail forwarding system comprising portable-type wireless communication terminal (100) for a user and a mail communication terminal (200) for the same user, the mail communication terminal capable of forwarding an electric mail via a wireless data communication network (300) in response to a forwarding request signal for the electric mail, in which the wireless communication terminal comprises:

a forwarding-request signal generating section (106) for generating the forwarding-request signal which includes additional information designating a forwarding time and a forwarding time interval of a given electric mail;  
 an electric mail processing section (107, 108) for transmitting the generated forwarding-request signal to the mail communication terminal via the wireless data communication network;  
 an electric mail receiving section for receiving the electric mail from the mail communication terminal; and  
 an electric mail storage section (104) for storing the received electric mail,

in which the mail communication terminal comprises:

a mail box (204; 214) for storing the electric mail received from a mail communication terminal for another user via a data communication network (400);  
 a forwarding-request signal recognizing section (206; 216) for recognizing the additional information contained in the forward-request signal received from the wireless communication terminal via the wireless data communication network; and  
 a communication processing section (208; 218) for sequentially forwarding the electric mail stored in the mail box to the wireless communication terminal in accordance with the recognized forwarding time and forwarding time interval.

2. An electric mail forwarding system as claimed in claim 1, in which the forwarding-request signal generating section (106) is arranged to generate the forward-request signal so as to designate a name of an electric mail sender, a title and an urgency level, and wherein the mail communication terminal is arranged so that, if the forwarding-request signal recognizing section recognizes the additional information designating a name of an electric mail sender, a title and an urgency level, the wireless data communication processing section forwards the

electric mail to the wireless communication terminal in accordance with a selection of the electronic mail sender, the title and the urgency level.

3. An electronic mail forwarding system as claimed in claim 1 or claim 2, wherein the wireless data communication network (300) is connected to the data communication network (400) and wherein the communication section (218) is arranged to forward the electronic mail via the data communication network and the wireless data communication network.

**Patentansprüche**

1. System zum Weiterleiten elektronischer Post, mit einem drahtlosen Kommunikationsendgerät (100) des tragbaren Typs für einen Anwender und einem Postkommunikationsendgerät (200) für denselben Anwender, wobei das Postkommunikationsendgerät in Reaktion auf ein Weiterleitungsanforderungssignal für elektronische Post die elektronische Post über ein drahtloses Datenkommunikationsnetz (300) weiterleiten kann, wobei das drahtlose Kommunikationsendgerät versehen ist mit:

einem Weiterleitungsanforderungssignal-Erzeugungsabschnitt (106) zum Erzeugen des Weiterleitungsanforderungssignals, das zusätzliche Informationen enthält, die einen Weiterleitungszeitpunkt und ein Weiterleitungszeitintervall für eine gegebene elektronische Post angeben;  
 einem Verarbeitungsabschnitt (107, 108) für elektronische Post, der das erzeugte Weiterleitungsanforderungssignal über das drahtlose Datenkommunikationsnetz zu dem Postkommunikationsendgerät sendet;  
 einem Empfangsabschnitt für elektronische Post, der die elektronische Post von dem Postkommunikationsendgerät empfängt; und  
 einem Speicherabschnitt (104) für elektronische Post, der die empfangene elektronische Post speichert,

wobei das Postkommunikationsendgerät versehen ist mit:

einem Postkasten (204; 214), der die von dem Postkommunikationsendgerät für einen weiteren Anwender über das Datenkommunikationsnetz (400) empfangene elektronische Post speichert;  
 einem Weiterleitungsanforderungssignal-Erkennungsabschnitt (206; 216), der die zusätzlichen Informationen erkennt, die in dem Weiterleitungsanforderungssignal enthalten sind,

das von dem drahtlosen Kommunikationsendgerät über das drahtlose Datenkommunikationsnetz empfangen wird; und einem Kommunikationsverarbeitungsabschnitt (208; 218), der die in dem Postkasten gespeicherte elektronische Post in Übereinstimmung mit dem erkannten Weiterleitungszeitpunkt und dem erkannten Weiterleitungszeitintervall an das drahtlose Kommunikationsendgerät sequentiell weiterleitet.

2. System zum Weiterleiten elektronischer Post nach Anspruch 1, bei dem der Weiterleitungsanforderungssignal-Erzeugungsabschnitt (106) so beschaffen ist, dass er das Weiterleitungsanforderungssignal erzeugt, um so den Namen eines Absenders elektronischer Post, einen Titel und eine Dringlichkeitsstufe anzugeben, und bei dem das Postkommunikationsendgerät so beschaffen ist, dass der Verarbeitungsabschnitt für die drahtlose Datenkommunikation dann, wenn der Weiterleitungsanforderungssignal-Erkennungsabschnitt die zusätzlichen Informationen erkennt, die einen Namen eines Absenders elektronischer Post, einen Titel und eine Dringlichkeitsstufe angeben, die elektronische Post in Übereinstimmung mit einer Wahl des Absenders der elektronischen Post, des Titels und der Dringlichkeitsstufe an das drahtlose Kommunikationsendgerät weiterleitet.
3. System zum Weiterleiten elektronischer Post nach Anspruch 1 oder Anspruch 2, bei dem das drahtlose Datenkommunikationsnetz (300) mit dem Datenkommunikationsnetz (400) verbunden ist und bei dem der Kommunikationsabschnitt (218) so beschaffen ist, dass er die elektronische Post über das Datenkommunikationsnetz und das drahtlose Datenkommunikationsnetz weiterleitet.

## Revendications

1. Système de transfert de courrier électronique comprenant un terminal de communication sans fil de type portable (100) pour un utilisateur et un terminal mobile de communication de courrier (200) pour le même utilisateur, le terminal de communication de courrier étant capable de transférer un courrier électronique via un réseau de communication de données sans fil (300) en réponse à un signal de demande de transfert pour le courrier électronique, dans lequel le terminal de communication sans fil comprend :
  - une section de génération de signal de demande de transfert (106) pour générer le signal de demande de transfert qui inclut une information supplémentaire désignant un temps de trans-

fert et un intervalle de temps de transfert d'un courrier électronique donné ;  
 une section de traitement de courrier électronique (107, 108) pour transmettre le signal de demande de transfert généré au terminal de communication de courrier via le réseau de communication de données sans fil ;  
 une section de réception de courrier électronique pour recevoir le courrier électronique provenant du terminal de communication de courrier ; et  
 une section de stockage de courrier électronique (104) pour stocker le courrier électronique reçu,

dans lequel le terminal de communication de courrier comprend :

- une boîte aux lettres (204 ; 214) pour stocker le courrier électronique reçu d'un terminal de communication de courrier pour un autre utilisateur via un réseau de communication de données (400) ;
- une section de reconnaissance de signal de demande de transfert (206 ; 216) pour reconnaître l'information supplémentaire contenue dans le signal de demande de transfert reçu du terminal de communication sans fil via le réseau de communication de données sans fil ; et
- une section de traitement de communication (208 ; 218) pour transférer séquentiellement le courrier électronique stocké dans la boîte aux lettres au terminal de communication sans fil conformément au temps de transfert et à l'intervalle de temps de transfert reconnu.

2. Système de transfert de courrier électronique selon la revendication 1, dans lequel la section de génération de signal de demande de transfert (106) est disposée pour générer le signal de demande de transfert afin de désigner un nom d'expéditeur de courrier électronique, un titre et un niveau d'urgence, et dans lequel le terminal de communication de courrier est disposé de sorte que, si la section de reconnaissance de signal de demande de transfert reconnaît l'information supplémentaire désignant un nom d'expéditeur de courrier électronique, un titre et un niveau d'urgence, la section de traitement de communication de données sans fil transfère le courrier électronique au terminal de communication sans fil conformément à une sélection de l'expéditeur du courrier électronique, du titre et du niveau d'urgence.
3. Système de transfert de courrier électronique selon la revendication 1 ou la revendication 2, dans lequel le réseau de communication de données sans fil (300) est connecté au réseau de communication de

données (400) et dans lequel la section de communication (218) est disposée pour transférer le courrier électronique via le réseau de communication de données et le réseau de communication de données sans fil.

5

10

15

20

25

30

35

40

45

50

55

13

472



FIG.1

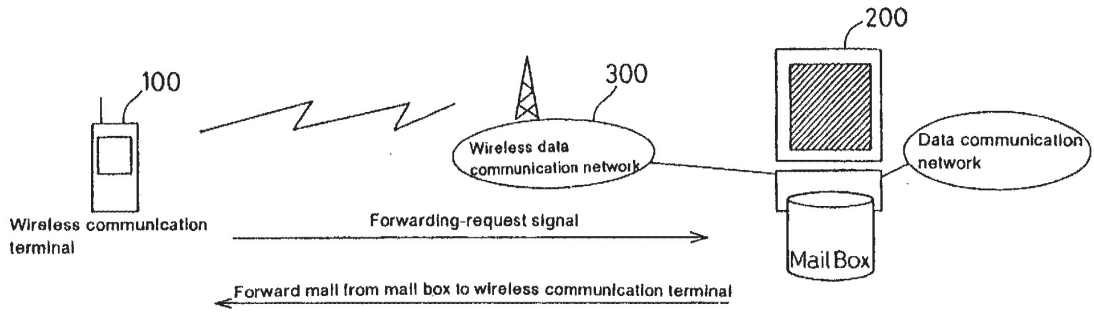
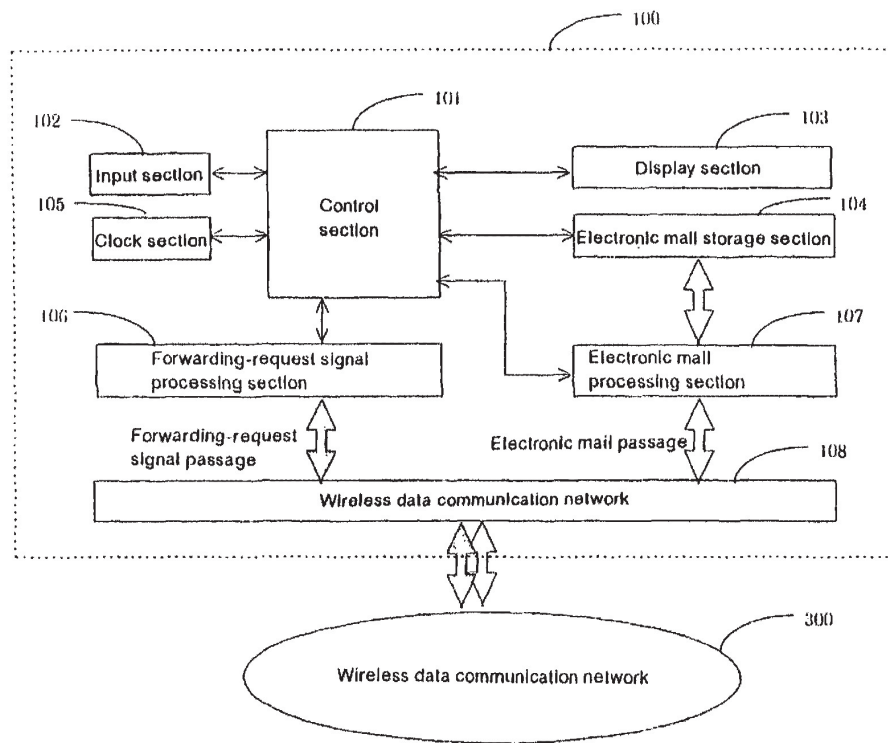

FIG. 2



EP 0 772 327 B1

FIG.3

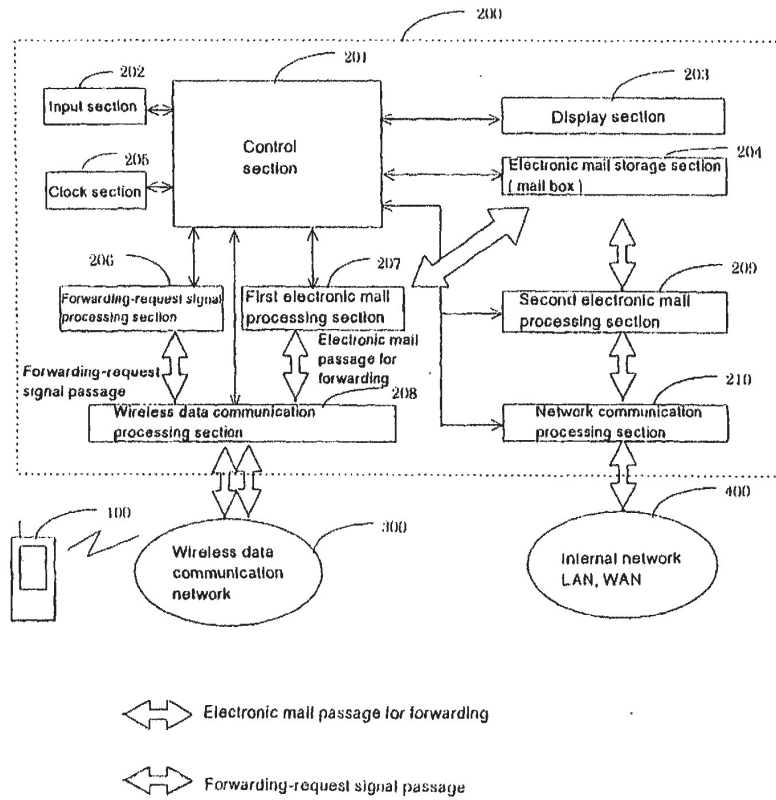
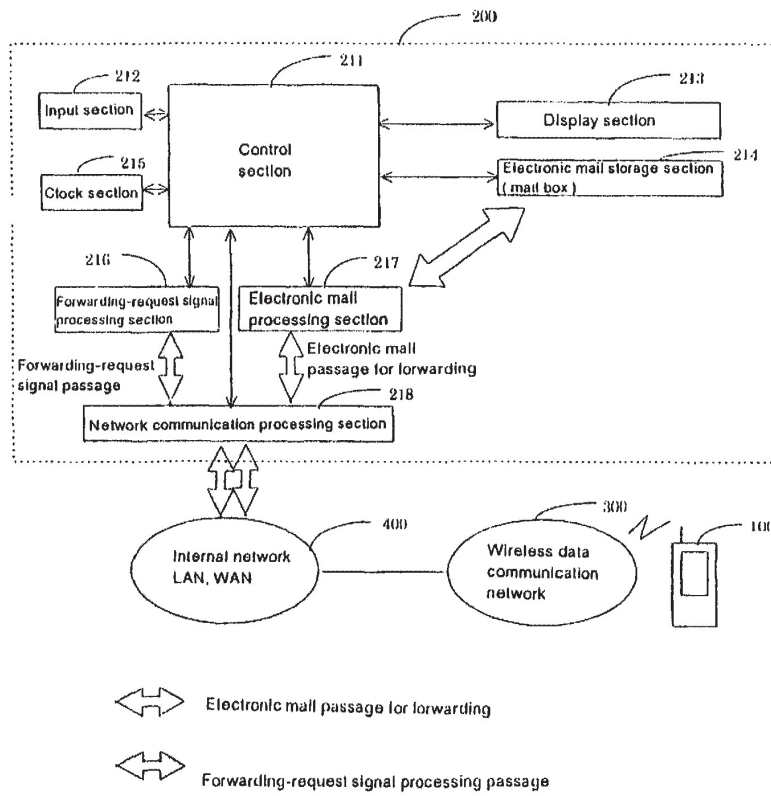

FIG. 4



EP 0 772 327 B1

FIG. 5

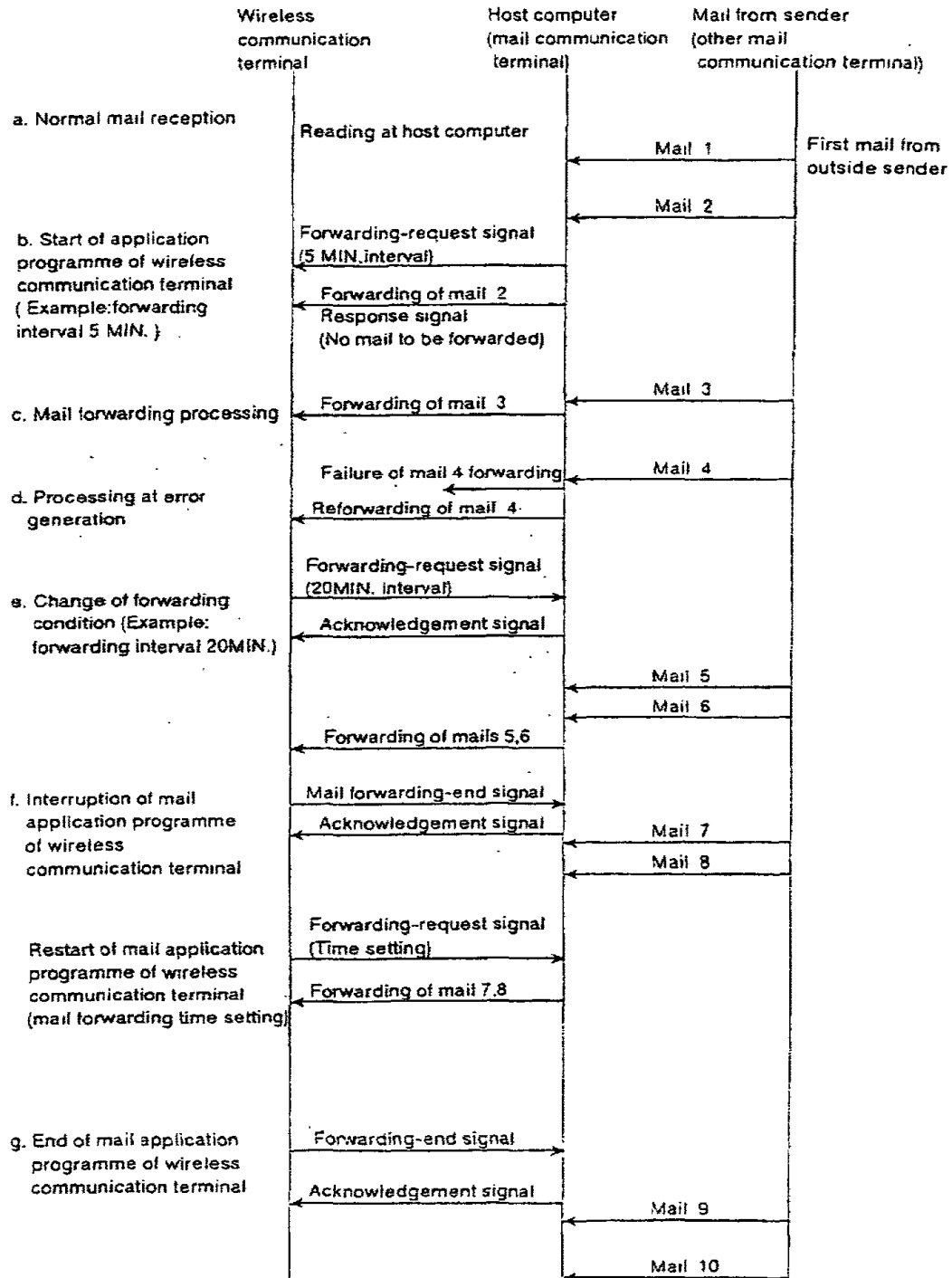

FIG.6

Service Identification number 501	: To be used for judgement of data related to mail forwarding-request.
Sender number 502	: To specify operator of forwarding function such as sender's mail address etc.
Addressee number 503	: To specify forwarding address of addressee terminal.
Signal Identification number 504	: Number to identify kind of signal.
Transmission number 505	: Number assigned to each forwarding-request signal and forwarding-end signal and in pair with acknowledgement signal.
Option Identification number 506	: Number to be assigned to each kind of options.
Option value 507	: Kind of options.
: : :	

EP 0 772 327 B1

FIG.7

Signal format	Kind of signal	Value (example) to be assigned to signal
Service identification number 501	Forwarding-request identification signal	0 1
	Other signal	0 0
Sender number 502		(example:) name @ abc.com
Addressee number 503		(example 1:) 1002.144.2.33 (example 2:) name @ abc.com
Signal identification number 504	Forwarding-request signal	01
	Forwarding-end signal	02
	Acknowledgement signal	03
Transmission number 505	Serial number assigned to each signal transmission	0 - 255
Option identification number 506	Time interval designation	01
	Time designation	02
	Sender designation for forwarding	03
	Title designation for forwarding	04
	Urgency level for forwarding	05
	Name of operator	06
	Password	07
	Message	08
	Check sum	09
Option value 507	Time interval, Time setting, Name of sender etc.	-1: Common value for cancellation

FIG.8

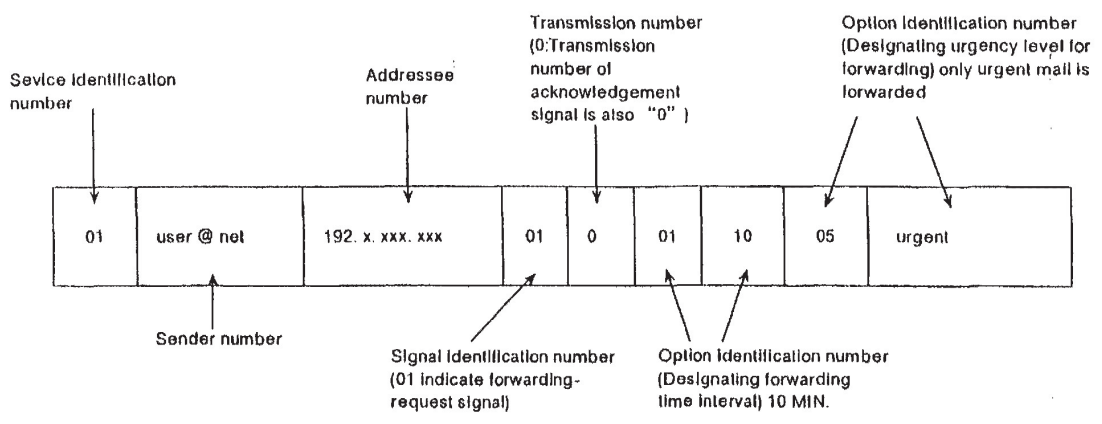

EP 0 772 327 B1

21



FIG.9

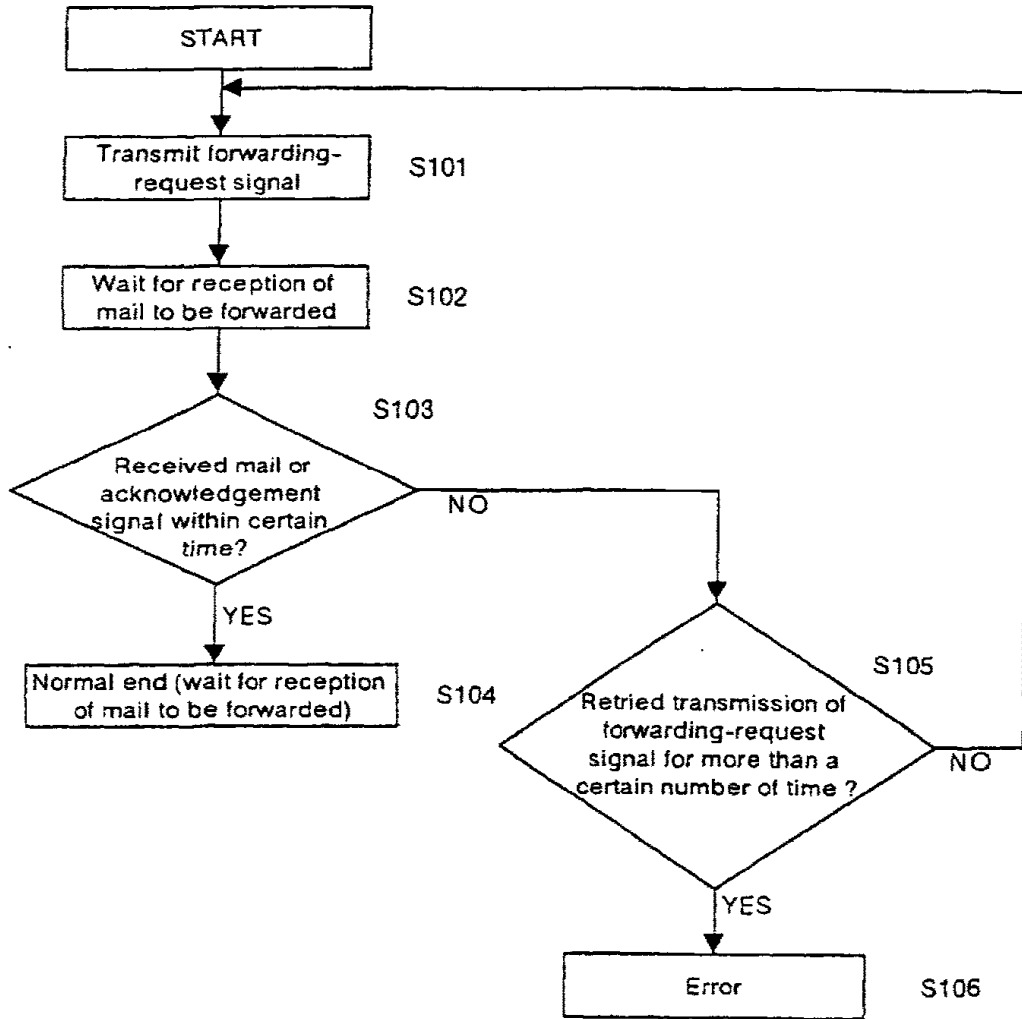

FIG. 10

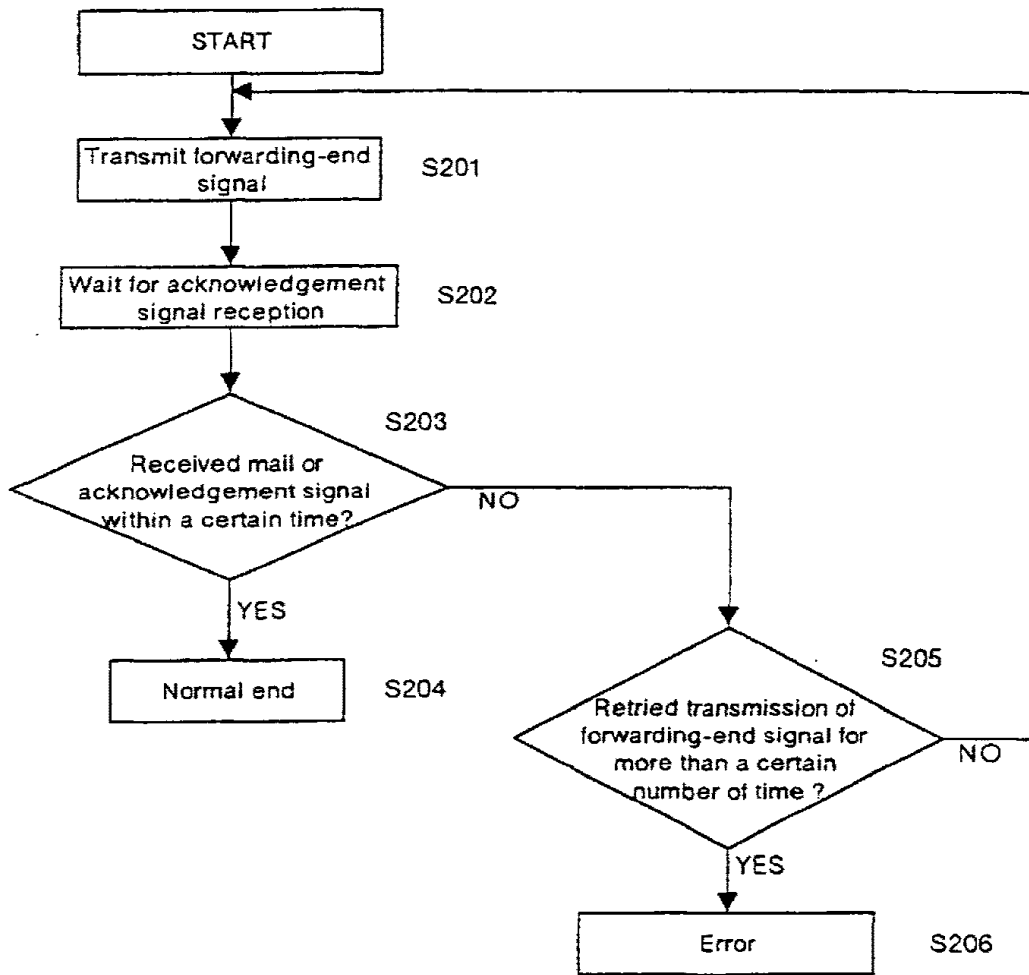
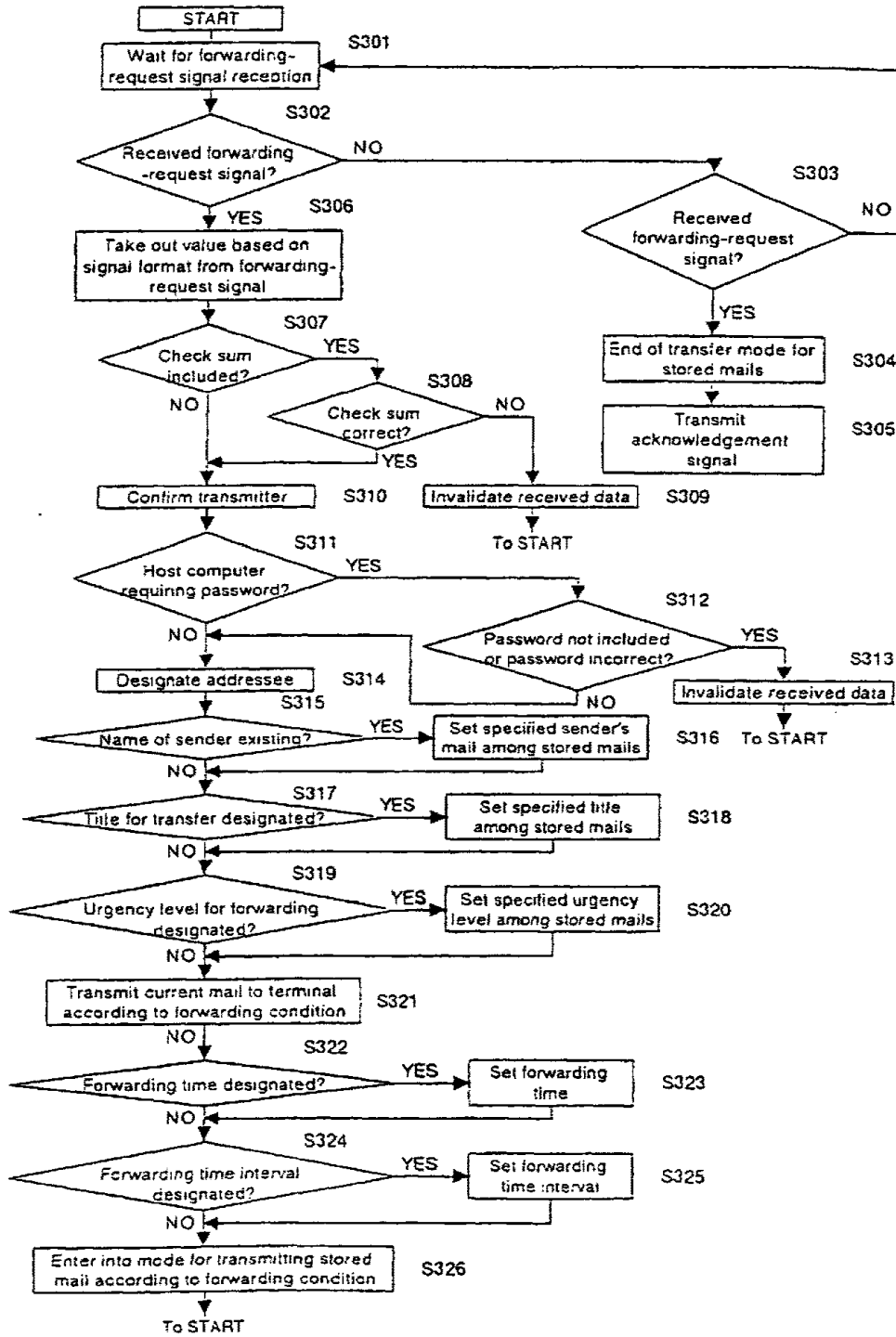

FIG. 11



## Electronic Acknowledgement Receipt

<b>EFS ID:</b>	21631432
<b>Application Number:</b>	14609189
<b>International Application Number:</b>	
<b>Confirmation Number:</b>	5037
<b>Title of Invention:</b>	Messaging centre for forwarding e-mail
<b>First Named Inventor/Applicant Name:</b>	Ari Backholm
<b>Customer Number:</b>	118194
<b>Filer:</b>	Justin Robert Nifong
<b>Filer Authorized By:</b>	
<b>Attorney Docket Number:</b>	455/006/8 UTIL
<b>Receipt Date:</b>	01-MAR-2015
<b>Filing Date:</b>	29-JAN-2015
<b>Time Stamp:</b>	14:08:20
<b>Application Type:</b>	Utility under 35 USC 111(a)

### Payment information:

Submitted with Payment	no
------------------------	----

### File Listing:

Document Number	Document Description	File Name	File Size(Bytes)/ Message Digest	Multi Part /.zip	Pages (if appl.)
1	Information Disclosure Statement (IDS) Form (SB08)	455-006-8-ids-filed-3-1-2015.pdf	613095 <small>b6d6f772c0f938abb859e09bcb1046184b4ff3</small>	no	6

### Warnings:

### Information:

2	Non Patent Literature	EP0772327B1.pdf	837060	no	24
			3aec3fa0eefb71273de042f5b9be5945aa98a56d		
<b>Warnings:</b>					
<b>Information:</b>					
3	Non Patent Literature	Binder1.pdf	6933960	no	192
			7eb21eb1f71ebbab7f29213f8692bab2750066b2		
<b>Warnings:</b>					
<b>Information:</b>					
<b>Total Files Size (in bytes):</b>				8384115	
<p><b>This Acknowledgement Receipt evidences receipt on the noted date by the USPTO of the indicated documents, characterized by the applicant, and including page counts, where applicable. It serves as evidence of receipt similar to a Post Card, as described in MPEP 503.</b></p> <p><b><u>New Applications Under 35 U.S.C. 111</u></b>  <b>If a new application is being filed and the application includes the necessary components for a filing date (see 37 CFR 1.53(b)-(d) and MPEP 506), a Filing Receipt (37 CFR 1.54) will be issued in due course and the date shown on this Acknowledgement Receipt will establish the filing date of the application.</b></p> <p><b><u>National Stage of an International Application under 35 U.S.C. 371</u></b>  <b>If a timely submission to enter the national stage of an international application is compliant with the conditions of 35 U.S.C. 371 and other applicable requirements a Form PCT/DO/EO/903 indicating acceptance of the application as a national stage submission under 35 U.S.C. 371 will be issued in addition to the Filing Receipt, in due course.</b></p> <p><b><u>New International Application Filed with the USPTO as a Receiving Office</u></b>  <b>If a new international application is being filed and the international application includes the necessary components for an international filing date (see PCT Article 11 and MPEP 1810), a Notification of the International Application Number and of the International Filing Date (Form PCT/RO/105) will be issued in due course, subject to prescriptions concerning national security, and the date shown on this Acknowledgement Receipt will establish the international filing date of the application.</b></p>					

<b>INFORMATION DISCLOSURE STATEMENT BY APPLICANT</b> ( Not for submission under 37 CFR 1.99)	Application Number		14609189	
	Filing Date		2015-01-29	
	First Named Inventor	Backholm		
	Art Unit	2642		
	Examiner Name			
	Attorney Docket Number	455/006/8 UTIL		

U.S.PATENTS						Remove
Examiner Initial*	Cite No	Patent Number	Kind Code <sup>1</sup>	Issue Date	Name of Patentee or Applicant of cited Document	Pages,Columns,Lines where Relevant Passages or Relevant Figures Appear
	1	6745326	B1	2004-06-01	Wary	
	2	7289792	B1	2007-10-30	Turenen	

If you wish to add additional U.S. Patent citation information please click the Add button. **Add**

U.S.PATENT APPLICATION PUBLICATIONS						Remove
Examiner Initial*	Cite No	Publication Number	Kind Code <sup>1</sup>	Publication Date	Name of Patentee or Applicant of cited Document	Pages,Columns,Lines where Relevant Passages or Relevant Figures Appear
	1	20040205248	A1	2004-10-14	Little	
	2	20060265595	A1	2006-11-23	Scottodiluzio	
	3	20050015432	A1	2005-01-20	Cohen	
	4	20060085503	A1	2006-04-20	Stoye	

If you wish to add additional U.S. Published Application citation information please click the Add button. **Add**

FOREIGN PATENT DOCUMENTS						Remove
--------------------------	--	--	--	--	--	--------

<b>INFORMATION DISCLOSURE STATEMENT BY APPLICANT</b> ( Not for submission under 37 CFR 1.99)	Application Number	14609189
	Filing Date	2015-01-29
	First Named Inventor	Backholm
	Art Unit	2642
	Examiner Name	
	Attorney Docket Number	455/006/8 UTIL

Examiner Initial*	Cite No	Foreign Document Number <sup>3</sup>	Country Code <sup>2</sup> j	Kind Code <sup>4</sup>	Publication Date	Name of Patentee or Applicant of cited Document	Pages, Columns, Lines where Relevant Passages or Relevant Figures Appear	T <sup>5</sup>
	1	0772327	EP	A2	2005-06-29	Kuki		<input type="checkbox"/>

If you wish to add additional Foreign Patent Document citation information please click the Add button **Add**

**NON-PATENT LITERATURE DOCUMENTS**

**Remove**

Examiner Initials*	Cite No	Include name of the author (in CAPITAL LETTERS), title of the article (when appropriate), title of the item (book, magazine, journal, serial, symposium, catalog, etc), date, pages(s), volume-issue number(s), publisher, city and/or country where published.	T <sup>5</sup>
	1	Final Office Action mailed 5/1/2009 for US Patent Application No. 11/282,607	<input type="checkbox"/>
	2	Non-final Office Action mailed 11/19/2008 for US Patent Application No. 11/282,607	<input type="checkbox"/>
	3	Non-final Office Action mailed 2/5/2008 for US Patent Application No. 11/282,607	<input type="checkbox"/>
	4	Final Office Action mailed 4/3/2009 for US Patent Application No. 11/282,950	<input type="checkbox"/>
	5	Non-final Office Action mailed 9/26/2008 for US Patent Application No. 11/282,950	<input type="checkbox"/>
	6	Final Office Action mailed 12/4/2013 for US Patent Application No. 12/205,747	<input type="checkbox"/>
	7	Non-final Office Action mailed 6/17/2013 for US Patent Application No. 12/205,747	<input type="checkbox"/>

<b>INFORMATION DISCLOSURE STATEMENT BY APPLICANT</b> ( Not for submission under 37 CFR 1.99)	Application Number	14609189
	Filing Date	2015-01-29
	First Named Inventor	Backholm
	Art Unit	2642
	Examiner Name	
	Attorney Docket Number	455/006/8 UTIL

8	Final Office Action mailed 11/8/2011 for US Patent Application No. 12/205,747	<input type="checkbox"/>
9	Non-final Office Action mailed 4/19/2011 for US Patent Application No. 12/205,747	<input type="checkbox"/>
10	Non-final Office Action mailed 1/15/2015 for US Patent Application No. 12/228,325	<input type="checkbox"/>
11	Final Office Action mailed 4/1/2014 for US Patent Application No. 12/228,325	<input type="checkbox"/>
12	Non-final Office Action mailed 6/3/2013 for US Patent Application No. 12/228,325	<input type="checkbox"/>
13	Final Office Action mailed 12/20/2012 for US Patent Application No. 12/228,325	<input type="checkbox"/>
14	Non-final Office Action mailed 5/16/2012 for US Patent Application No. 12/228,325	<input type="checkbox"/>
15	Final Office Action mailed 5/11/2011 for US Patent Application No. 12/228,325	<input type="checkbox"/>
16	Non-final Office Action mailed 11/4/2010 for US Patent Application No. 12/228,325	<input type="checkbox"/>
17	Final Office Action mailed 10/7/2009 for US Patent Application No. 12/228,424	<input type="checkbox"/>
18	Non-final Office Action mailed 6/2/2009 for US Patent Application No. 12/228,424	<input type="checkbox"/>



<b>INFORMATION DISCLOSURE STATEMENT BY APPLICANT</b> ( Not for submission under 37 CFR 1.99)	Application Number	14609189
	Filing Date	2015-01-29
	First Named Inventor	Backholm
	Art Unit	2642
	Examiner Name	
	Attorney Docket Number	455/006/8 UTIL

If you wish to add additional non-patent literature document citation information please click the Add button **Add**

**EXAMINER SIGNATURE**

Examiner Signature		Date Considered	
--------------------	--	-----------------	--

\*EXAMINER: Initial if reference considered, whether or not citation is in conformance with MPEP 609. Draw line through a citation if not in conformance and not considered. Include copy of this form with next communication to applicant.

<sup>1</sup> See Kind Codes of USPTO Patent Documents at [www.USPTO.GOV](http://www.USPTO.GOV) or MPEP 901.04. <sup>2</sup> Enter office that issued the document, by the two-letter code (WIPO Standard ST.3). <sup>3</sup> For Japanese patent documents, the indication of the year of the reign of the Emperor must precede the serial number of the patent document. <sup>4</sup> Kind of document by the appropriate symbols as indicated on the document under WIPO Standard ST.16 if possible. <sup>5</sup> Applicant is to place a check mark here if English language translation is attached.

<b>INFORMATION DISCLOSURE STATEMENT BY APPLICANT</b> ( Not for submission under 37 CFR 1.99)	Application Number	14609189
	Filing Date	2015-01-29
	First Named Inventor	Backholm
	Art Unit	2642
	Examiner Name	
	Attorney Docket Number	455/006/8 UTIL

**CERTIFICATION STATEMENT**

Please see 37 CFR 1.97 and 1.98 to make the appropriate selection(s):

That each item of information contained in the information disclosure statement was first cited in any communication from a foreign patent office in a counterpart foreign application not more than three months prior to the filing of the information disclosure statement. See 37 CFR 1.97(e)(1).

**OR**

That no item of information contained in the information disclosure statement was cited in a communication from a foreign patent office in a counterpart foreign application, and, to the knowledge of the person signing the certification after making reasonable inquiry, no item of information contained in the information disclosure statement was known to any individual designated in 37 CFR 1.56(c) more than three months prior to the filing of the information disclosure statement. See 37 CFR 1.97(e)(2).

See attached certification statement.

The fee set forth in 37 CFR 1.17 (p) has been submitted herewith.

A certification statement is not submitted herewith.

**SIGNATURE**

A signature of the applicant or representative is required in accordance with CFR 1.33, 10.18. Please see CFR 1.4(d) for the form of the signature.

Signature	/Justin R. Nifong/	Date (YYYY-MM-DD)	2015-03-01
Name/Print	Justin R. Nifong	Registration Number	59389

This collection of information is required by 37 CFR 1.97 and 1.98. The information is required to obtain or retain a benefit by the public which is to file (and by the USPTO to process) an application. Confidentiality is governed by 35 U.S.C. 122 and 37 CFR 1.14. This collection is estimated to take 1 hour to complete, including gathering, preparing and submitting the completed application form to the USPTO. Time will vary depending upon the individual case. Any comments on the amount of time you require to complete this form and/or suggestions for reducing this burden, should be sent to the Chief Information Officer, U.S. Patent and Trademark Office, U.S. Department of Commerce, P.O. Box 1450, Alexandria, VA 22313-1450. **DO NOT SEND FEES OR COMPLETED FORMS TO THIS ADDRESS. SEND TO: Commissioner for Patents, P.O. Box 1450, Alexandria, VA 22313-1450.**

## Privacy Act Statement

The Privacy Act of 1974 (P.L. 93-579) requires that you be given certain information in connection with your submission of the attached form related to a patent application or patent. Accordingly, pursuant to the requirements of the Act, please be advised that: (1) the general authority for the collection of this information is 35 U.S.C. 2(b)(2); (2) furnishing of the information solicited is voluntary; and (3) the principal purpose for which the information is used by the U.S. Patent and Trademark Office is to process and/or examine your submission related to a patent application or patent. If you do not furnish the requested information, the U.S. Patent and Trademark Office may not be able to process and/or examine your submission, which may result in termination of proceedings or abandonment of the application or expiration of the patent.

The information provided by you in this form will be subject to the following routine uses:

1. The information on this form will be treated confidentially to the extent allowed under the Freedom of Information Act (5 U.S.C. 552) and the Privacy Act (5 U.S.C. 552a). Records from this system of records may be disclosed to the Department of Justice to determine whether the Freedom of Information Act requires disclosure of these records.
2. A record from this system of records may be disclosed, as a routine use, in the course of presenting evidence to a court, magistrate, or administrative tribunal, including disclosures to opposing counsel in the course of settlement negotiations.
3. A record in this system of records may be disclosed, as a routine use, to a Member of Congress submitting a request involving an individual, to whom the record pertains, when the individual has requested assistance from the Member with respect to the subject matter of the record.
4. A record in this system of records may be disclosed, as a routine use, to a contractor of the Agency having need for the information in order to perform a contract. Recipients of information shall be required to comply with the requirements of the Privacy Act of 1974, as amended, pursuant to 5 U.S.C. 552a(m).
5. A record related to an International Application filed under the Patent Cooperation Treaty in this system of records may be disclosed, as a routine use, to the International Bureau of the World Intellectual Property Organization, pursuant to the Patent Cooperation Treaty.
6. A record in this system of records may be disclosed, as a routine use, to another federal agency for purposes of National Security review (35 U.S.C. 181) and for review pursuant to the Atomic Energy Act (42 U.S.C. 218(c)).
7. A record from this system of records may be disclosed, as a routine use, to the Administrator, General Services, or his/her designee, during an inspection of records conducted by GSA as part of that agency's responsibility to recommend improvements in records management practices and programs, under authority of 44 U.S.C. 2904 and 2906. Such disclosure shall be made in accordance with the GSA regulations governing inspection of records for this purpose, and any other relevant (i.e., GSA or Commerce) directive. Such disclosure shall not be used to make determinations about individuals.
8. A record from this system of records may be disclosed, as a routine use, to the public after either publication of the application pursuant to 35 U.S.C. 122(b) or issuance of a patent pursuant to 35 U.S.C. 151. Further, a record may be disclosed, subject to the limitations of 37 CFR 1.14, as a routine use, to the public if the record was filed in an application which became abandoned or in which the proceedings were terminated and which application is referenced by either a published application, an application open to public inspections or an issued patent.
9. A record from this system of records may be disclosed, as a routine use, to a Federal, State, or local law enforcement agency, if the USPTO becomes aware of a violation or potential violation of law or regulation.

## Electronic Acknowledgement Receipt

<b>EFS ID:</b>	21631487
<b>Application Number:</b>	14609189
<b>International Application Number:</b>	
<b>Confirmation Number:</b>	5037
<b>Title of Invention:</b>	Messaging centre for forwarding e-mail
<b>First Named Inventor/Applicant Name:</b>	Ari Backholm
<b>Customer Number:</b>	118194
<b>Filer:</b>	Justin Robert Nifong
<b>Filer Authorized By:</b>	
<b>Attorney Docket Number:</b>	455/006/8 UTIL
<b>Receipt Date:</b>	01-MAR-2015
<b>Filing Date:</b>	29-JAN-2015
<b>Time Stamp:</b>	15:20:45
<b>Application Type:</b>	Utility under 35 USC 111(a)

### Payment information:

Submitted with Payment	no
------------------------	----

### File Listing:

Document Number	Document Description	File Name	File Size(Bytes)/ Message Digest	Multi Part /.zip	Pages (if appl.)
1	Information Disclosure Statement (IDS) Form (SB08)	455-006-8-ids-filed-3-1-2015.pdf	612950 <small>871f482c8248ae4c968c75c76760fa4a087f65d8</small>	no	6

### Warnings:

### Information:

Total Files Size (in bytes):

612950

This Acknowledgement Receipt evidences receipt on the noted date by the USPTO of the indicated documents, characterized by the applicant, and including page counts, where applicable. It serves as evidence of receipt similar to a Post Card, as described in MPEP 503.

**New Applications Under 35 U.S.C. 111**

If a new application is being filed and the application includes the necessary components for a filing date (see 37 CFR 1.53(b)-(d) and MPEP 506), a Filing Receipt (37 CFR 1.54) will be issued in due course and the date shown on this Acknowledgement Receipt will establish the filing date of the application.

**National Stage of an International Application under 35 U.S.C. 371**

If a timely submission to enter the national stage of an international application is compliant with the conditions of 35 U.S.C. 371 and other applicable requirements a Form PCT/DO/EO/903 indicating acceptance of the application as a national stage submission under 35 U.S.C. 371 will be issued in addition to the Filing Receipt, in due course.

**New International Application Filed with the USPTO as a Receiving Office**

If a new international application is being filed and the international application includes the necessary components for an international filing date (see PCT Article 11 and MPEP 1810), a Notification of the International Application Number and of the International Filing Date (Form PCT/RO/105) will be issued in due course, subject to prescriptions concerning national security, and the date shown on this Acknowledgement Receipt will establish the international filing date of the application.

<b>PATENT APPLICATION FEE DETERMINATION RECORD</b> Substitute for Form PTO-875	Application or Docket Number 14/609,189
---	--

APPLICATION AS FILED - PART I			SMALL ENTITY		OR	OTHER THAN SMALL ENTITY	
	(Column 1)	(Column 2)					
FOR	NUMBER FILED	NUMBER EXTRA	RATE(\$)	FEE(\$)		RATE(\$)	FEE(\$)
BASIC FEE <small>(37 CFR 1.16(a), (b), or (c))</small>	N/A	N/A	N/A	70		N/A	
SEARCH FEE <small>(37 CFR 1.16(k), (l), or (m))</small>	N/A	N/A	N/A	300		N/A	
EXAMINATION FEE <small>(37 CFR 1.16(o), (p), or (q))</small>	N/A	N/A	N/A	360		N/A	
TOTAL CLAIMS <small>(37 CFR 1.16(i))</small>	1	minus 20 = *	x 40 =	0.00	OR		
INDEPENDENT CLAIMS <small>(37 CFR 1.16(h))</small>	1	minus 3 = *	x 210 =	0.00			
APPLICATION SIZE FEE <small>(37 CFR 1.16(s))</small>	If the specification and drawings exceed 100 sheets of paper, the application size fee due is \$310 (\$155 for small entity) for each additional 50 sheets or fraction thereof. See 35 U.S.C. 41(a)(1)(G) and 37 CFR 1.16(s).			0.00			
MULTIPLE DEPENDENT CLAIM PRESENT <small>(37 CFR 1.16(j))</small>				0.00			
* If the difference in column 1 is less than zero, enter "0" in column 2.			TOTAL	730		TOTAL	

APPLICATION AS AMENDED - PART II					SMALL ENTITY		OR	OTHER THAN SMALL ENTITY		
	(Column 1)	(Column 2)	(Column 3)							
AMENDMENT A	CLAIMS REMAINING AFTER AMENDMENT	MINUS	HIGHEST NUMBER PREVIOUSLY PAID FOR	PRESENT EXTRA	RATE(\$)	ADDITIONAL FEE(\$)		RATE(\$)	ADDITIONAL FEE(\$)	
	Total <small>(37 CFR 1.16(i))</small>	*	Minus	**	=	x	=	OR	x	=
	Independent <small>(37 CFR 1.16(h))</small>	*	Minus	***	=	x	=	OR	x	=
	Application Size Fee <small>(37 CFR 1.16(s))</small>							OR		
	FIRST PRESENTATION OF MULTIPLE DEPENDENT CLAIM <small>(37 CFR 1.16(j))</small>							OR		
TOTAL ADD'L FEE							OR	TOTAL ADD'L FEE		
AMENDMENT B	CLAIMS REMAINING AFTER AMENDMENT	MINUS	HIGHEST NUMBER PREVIOUSLY PAID FOR	PRESENT EXTRA	RATE(\$)	ADDITIONAL FEE(\$)		RATE(\$)	ADDITIONAL FEE(\$)	
	Total <small>(37 CFR 1.16(i))</small>	*	Minus	**	=	x	=	OR	x	=
	Independent <small>(37 CFR 1.16(h))</small>	*	Minus	***	=	x	=	OR	x	=
	Application Size Fee <small>(37 CFR 1.16(s))</small>							OR		
	FIRST PRESENTATION OF MULTIPLE DEPENDENT CLAIM <small>(37 CFR 1.16(j))</small>							OR		
TOTAL ADD'L FEE							OR	TOTAL ADD'L FEE		
<p>* If the entry in column 1 is less than the entry in column 2, write "0" in column 3.</p> <p>** If the "Highest Number Previously Paid For" IN THIS SPACE is less than 20, enter "20".</p> <p>*** If the "Highest Number Previously Paid For" IN THIS SPACE is less than 3, enter "3".</p> <p>The "Highest Number Previously Paid For" (Total or Independent) is the highest found in the appropriate box in column 1.</p>										



UNITED STATES PATENT AND TRADEMARK OFFICE

UNITED STATES DEPARTMENT OF COMMERCE  
United States Patent and Trademark Office  
Address: COMMISSIONER FOR PATENTS  
P.O. Box 1450  
Alexandria, Virginia 22313-1450  
www.uspto.gov

APPLICATION NUMBER	FILING OR 371(C) DATE	FIRST NAMED APPLICANT	ATTY. DOCKET NO./TITLE
14/609,189	01/29/2015	Ari Backholm	455/006/8 UTIL

**CONFIRMATION NO. 5037**

118194  
NKK Patent Law- Seven Networks  
4917 Waters Edge Drive  
Suite 275  
Raleigh, NC 27606

**NOTICE**



Date Mailed: 02/20/2015

**INFORMATIONAL NOTICE TO APPLICANT**

Applicant is notified that the above-identified application contains the deficiencies noted below. No period for reply is set forth in this notice for correction of these deficiencies. However, if a deficiency relates to the inventor's oath or declaration, the applicant must file an oath or declaration in compliance with 37 CFR 1.63, or a substitute statement in compliance with 37 CFR 1.64, executed by or with respect to each actual inventor no later than the expiration of the time period set in the "Notice of Allowability" to avoid abandonment. See 37 CFR 1.53(f).

The item(s) indicated below are also required and should be submitted with any reply to this notice to avoid further processing delays.

- A properly executed inventor's oath or declaration has not been received for the following inventor(s):  
Petri Salmi



UNITED STATES PATENT AND TRADEMARK OFFICE

UNITED STATES DEPARTMENT OF COMMERCE
United States Patent and Trademark Office
Address: COMMISSIONER FOR PATENTS
P.O. Box 1450
Alexandria, Virginia 22313-1450
www.uspto.gov

Table with 7 columns: APPLICATION NUMBER, FILING or 371(c) DATE, GRP ART UNIT, FIL FEE REC'D, ATTY. DOCKET NO, TOT CLAIMS, IND CLAIMS. Row 1: 14/609,189, 01/29/2015, 2642, 800, 455/006/8 UTIL, 1, 1

CONFIRMATION NO. 5037

FILING RECEIPT



118194
NKK Patent Law- Seven Networks
4917 Waters Edge Drive
Suite 275
Raleigh, NC 27606

Date Mailed: 02/20/2015

Receipt is acknowledged of this non-provisional patent application. The application will be taken up for examination in due course. Applicant will be notified as to the results of the examination. Any correspondence concerning the application must include the following identification information: the U.S. APPLICATION NUMBER, FILING DATE, NAME OF APPLICANT, and TITLE OF INVENTION. Fees transmitted by check or draft are subject to collection. Please verify the accuracy of the data presented on this receipt. If an error is noted on this Filing Receipt, please submit a written request for a Filing Receipt Correction. Please provide a copy of this Filing Receipt with the changes noted thereon. If you received a "Notice to File Missing Parts" for this application, please submit any corrections to this Filing Receipt with your reply to the Notice. When the USPTO processes the reply to the Notice, the USPTO will generate another Filing Receipt incorporating the requested corrections

Inventor(s)

Ari Backholm, San Carlos, CA;
Seppo Salorinne, Helsinki, FINLAND;
Antti Saarilahti, Helsinki, FINLAND;
Marko Ketonen, Helsinki, FINLAND;
Lauri Vuornos, Helsinki, FINLAND;
Petri Salmi, Espoo, FINLAND;

Applicant(s)

Seven Networks, Inc., San Carlos, CA

Power of Attorney: None

Domestic Priority data as claimed by applicant

This application is a CON of 12/228,325 08/11/2008
which is a DIV of 11/282,950 11/21/2005 PAT 7643818
and claims benefit of 60/650,975 02/09/2005

Foreign Applications (You may be eligible to benefit from the Patent Prosecution Highway program at the USPTO. Please see http://www.uspto.gov for more information.)
FINLAND 20045451 11/22/2004 No Access Code Provided

Permission to Access - A proper Authorization to Permit Access to Application by Participating Offices (PTO/SB/39 or its equivalent) has been received by the USPTO.

If Required, Foreign Filing License Granted: 02/12/2015



The country code and number of your priority application, to be used for filing abroad under the Paris Convention, is **US 14/609,189**

**Projected Publication Date:** 05/28/2015

**Non-Publication Request:** No

**Early Publication Request:** No

**\*\* SMALL ENTITY \*\***

**Title**

Messaging centre for forwarding e-mail

**Preliminary Class**

455

**Statement under 37 CFR 1.55 or 1.78 for AIA (First Inventor to File) Transition Applications:** No

## **PROTECTING YOUR INVENTION OUTSIDE THE UNITED STATES**

Since the rights granted by a U.S. patent extend only throughout the territory of the United States and have no effect in a foreign country, an inventor who wishes patent protection in another country must apply for a patent in a specific country or in regional patent offices. Applicants may wish to consider the filing of an international application under the Patent Cooperation Treaty (PCT). An international (PCT) application generally has the same effect as a regular national patent application in each PCT-member country. The PCT process **simplifies** the filing of patent applications on the same invention in member countries, but **does not result** in a grant of "an international patent" and does not eliminate the need of applicants to file additional documents and fees in countries where patent protection is desired.

Almost every country has its own patent law, and a person desiring a patent in a particular country must make an application for patent in that country in accordance with its particular laws. Since the laws of many countries differ in various respects from the patent law of the United States, applicants are advised to seek guidance from specific foreign countries to ensure that patent rights are not lost prematurely.

Applicants also are advised that in the case of inventions made in the United States, the Director of the USPTO must issue a license before applicants can apply for a patent in a foreign country. The filing of a U.S. patent application serves as a request for a foreign filing license. The application's filing receipt contains further information and guidance as to the status of applicant's license for foreign filing.

Applicants may wish to consult the USPTO booklet, "General Information Concerning Patents" (specifically, the section entitled "Treaties and Foreign Patents") for more information on timeframes and deadlines for filing foreign patent applications. The guide is available either by contacting the USPTO Contact Center at 800-786-9199, or it can be viewed on the USPTO website at <http://www.uspto.gov/web/offices/pac/doc/general/index.html>.

For information on preventing theft of your intellectual property (patents, trademarks and copyrights), you may wish to consult the U.S. Government website, <http://www.stopfakes.gov>. Part of a Department of Commerce initiative, this website includes self-help "toolkits" giving innovators guidance on how to protect intellectual property in specific countries such as China, Korea and Mexico. For questions regarding patent enforcement issues, applicants may call the U.S. Government hotline at 1-866-999-HALT (1-866-999-4258).

**LICENSE FOR FOREIGN FILING UNDER**  
**Title 35, United States Code, Section 184**  
**Title 37, Code of Federal Regulations, 5.11 & 5.15**

**GRANTED**

The applicant has been granted a license under 35 U.S.C. 184, if the phrase "IF REQUIRED, FOREIGN FILING LICENSE GRANTED" followed by a date appears on this form. Such licenses are issued in all applications where the conditions for issuance of a license have been met, regardless of whether or not a license may be required as set forth in 37 CFR 5.15. The scope and limitations of this license are set forth in 37 CFR 5.15(a) unless an earlier license has been issued under 37 CFR 5.15(b). The license is subject to revocation upon written notification. The date indicated is the effective date of the license, unless an earlier license of similar scope has been granted under 37 CFR 5.13 or 5.14.

This license is to be retained by the licensee and may be used at any time on or after the effective date thereof unless it is revoked. This license is automatically transferred to any related applications(s) filed under 37 CFR 1.53(d). This license is not retroactive.

The grant of a license does not in any way lessen the responsibility of a licensee for the security of the subject matter as imposed by any Government contract or the provisions of existing laws relating to espionage and the national security or the export of technical data. Licensees should apprise themselves of current regulations especially with respect to certain countries, of other agencies, particularly the Office of Defense Trade Controls, Department of State (with respect to Arms, Munitions and Implements of War (22 CFR 121-128)); the Bureau of Industry and Security, Department of Commerce (15 CFR parts 730-774); the Office of Foreign Assets Control, Department of Treasury (31 CFR Parts 500+) and the Department of Energy.

**NOT GRANTED**

No license under 35 U.S.C. 184 has been granted at this time, if the phrase "IF REQUIRED, FOREIGN FILING LICENSE GRANTED" DOES NOT appear on this form. Applicant may still petition for a license under 37 CFR 5.12, if a license is desired before the expiration of 6 months from the filing date of the application. If 6 months has lapsed from the filing date of this application and the licensee has not received any indication of a secrecy order under 35 U.S.C. 181, the licensee may foreign file the application pursuant to 37 CFR 5.15(b).

---

***SelectUSA***

The United States represents the largest, most dynamic marketplace in the world and is an unparalleled location for business investment, innovation, and commercialization of new technologies. The U.S. offers tremendous resources and advantages for those who invest and manufacture goods here. Through SelectUSA, our nation works to promote and facilitate business investment. SelectUSA provides information assistance to the international investor community; serves as an ombudsman for existing and potential investors; advocates on behalf of U.S. cities, states, and regions competing for global investment; and counsels U.S. economic development organizations on investment attraction best practices. To learn more about why the United States is the best country in the world to develop technology, manufacture products, deliver services, and grow your business, visit <http://www.SelectUSA.gov> or call +1-202-482-6800.

Under the Paperwork Reduction Act of 1995, no persons are required to respond to a collection of information unless it contains a valid OMB control number.

<b>Application Data Sheet 37 CFR 1.76</b>		Attorney Docket Number	455/006/8 UTIL
		Application Number	
Title of Invention	Messaging centre for forwarding e-mail		
<p>The application data sheet is part of the provisional or nonprovisional application for which it is being submitted. The following form contains the bibliographic data arranged in a format specified by the United States Patent and Trademark Office as outlined in 37 CFR 1.76. This document may be completed electronically and submitted to the Office in electronic format using the Electronic Filing System (EFS) or the document may be printed and included in a paper filed application.</p>			

**Secrecy Order 37 CFR 5.2**

Portions or all of the application associated with this Application Data Sheet may fall under a Secrecy Order pursuant to 37 CFR 5.2. (Paper filers only. Applications that fall under Secrecy Order may not be filed electronically.)

**Inventor Information:**

<b>Inventor 1</b>					<input type="button" value="Remove"/>
<b>Legal Name</b>					
<b>Prefix</b>	<b>Given Name</b>	<b>Middle Name</b>	<b>Family Name</b>	<b>Suffix</b>	
	Ari		Backholm		
<b>Residence Information (Select One)</b> <input checked="" type="radio"/> US Residency <input type="radio"/> Non US Residency <input type="radio"/> Active US Military Service					
<b>City</b>	San Carlos	<b>State/Province</b>	CA	<b>Country of Residence i</b>	US
<b>Mailing Address of Inventor:</b>					
<b>Address 1</b>	959 Skyway Road				
<b>Address 2</b>	suite 100				
<b>City</b>	San Carlos	<b>State/Province</b>	CA		
<b>Postal Code</b>	94070	<b>Country i</b>	US		
<b>Inventor 2</b>					<input type="button" value="Remove"/>
<b>Legal Name</b>					
<b>Prefix</b>	<b>Given Name</b>	<b>Middle Name</b>	<b>Family Name</b>	<b>Suffix</b>	
	Seppo		Salorinne		
<b>Residence Information (Select One)</b> <input type="radio"/> US Residency <input checked="" type="radio"/> Non US Residency <input type="radio"/> Active US Military Service					
<b>City</b>	Helsinki	<b>Country of Residence i</b>	FI		
<b>Mailing Address of Inventor:</b>					
<b>Address 1</b>	959 Skyway Road				
<b>Address 2</b>	SUITE 100				
<b>City</b>	San Carlos	<b>State/Province</b>	CA		
<b>Postal Code</b>	94070	<b>Country i</b>	US		
<b>Inventor 3</b>					<input type="button" value="Remove"/>
<b>Legal Name</b>					
<b>Prefix</b>	<b>Given Name</b>	<b>Middle Name</b>	<b>Family Name</b>	<b>Suffix</b>	
	Antti		Saarilahti		

Under the Paperwork Reduction Act of 1995, no persons are required to respond to a collection of information unless it contains a valid OMB control number.

<b>Application Data Sheet 37 CFR 1.76</b>		Attorney Docket Number	455/006/8 UTIL	
		Application Number		
Title of Invention	Messaging centre for forwarding e-mail			
<b>Residence Information (Select One)</b> <input type="radio"/> US Residency <input checked="" type="radio"/> Non US Residency <input type="radio"/> Active US Military Service				
City	Helsinki	Country of Residence i	FI	
<b>Mailing Address of Inventor:</b>				
Address 1	959 Skyway Road			
Address 2	suite 100			
City	San Carlos	State/Province	CA	
Postal Code	94070	Country i	US	
Inventor 4				<input type="button" value="Remove"/>
Legal Name				
Prefix	Given Name	Middle Name	Family Name	Suffix
	Marko		Ketonen	
<b>Residence Information (Select One)</b> <input type="radio"/> US Residency <input checked="" type="radio"/> Non US Residency <input type="radio"/> Active US Military Service				
City	Helsinki	Country of Residence i	FI	
<b>Mailing Address of Inventor:</b>				
Address 1	959 Skyway Road			
Address 2	suite 100			
City	San Carlos	State/Province	CA	
Postal Code	94070	Country i	US	
Inventor 5				<input type="button" value="Remove"/>
Legal Name				
Prefix	Given Name	Middle Name	Family Name	Suffix
	Lauri		Vuornos	
<b>Residence Information (Select One)</b> <input type="radio"/> US Residency <input checked="" type="radio"/> Non US Residency <input type="radio"/> Active US Military Service				
City	Helsinki	Country of Residence i	FI	
<b>Mailing Address of Inventor:</b>				
Address 1	959 Skyway Road			
Address 2	suite 100			
City	San Carlos	State/Province	CA	
Postal Code	94070	Country i	US	
Inventor 6				<input type="button" value="Remove"/>
Legal Name				

Under the Paperwork Reduction Act of 1995, no persons are required to respond to a collection of information unless it contains a valid OMB control number.

<b>Application Data Sheet 37 CFR 1.76</b>		Attorney Docket Number	455/006/8 UTIL
		Application Number	
Title of Invention	Messaging centre for forwarding e-mail		

<b>Prefix</b>	<b>Given Name</b>	<b>Middle Name</b>	<b>Family Name</b>	<b>Suffix</b>
	Petri		Salmi	
<b>Residence Information (Select One)</b> <input type="radio"/> US Residency <input checked="" type="radio"/> Non US Residency <input type="radio"/> Active US Military Service				
<b>City</b>	Espoo	<b>Country of Residence i</b>	FI	
<b>Mailing Address of Inventor:</b>				
<b>Address 1</b>	959 Skyway Road			
<b>Address 2</b>	suite 100			
<b>City</b>	San Carlos	<b>State/Province</b>	CA	
<b>Postal Code</b>	94070	<b>Country i</b>	US	
All Inventors Must Be Listed - Additional Inventor Information blocks may be generated within this form by selecting the <b>Add</b> button.				<input type="button" value="Add"/>

**Correspondence Information:**

Enter either <b>Customer Number</b> or complete the <b>Correspondence Information</b> section below. For further information see 37 CFR 1.33(a).	
<input type="checkbox"/> An Address is being provided for the correspondence Information of this application.	
<b>Customer Number</b>	118194
<b>Email Address</b>	jrnifong@nkkpatentlaw.com <input type="button" value="Add Email"/> <input type="button" value="Remove Email"/>

**Application Information:**

<b>Title of the Invention</b>	Messaging centre for forwarding e-mail		
<b>Attorney Docket Number</b>	455/006/8 UTIL	<b>Small Entity Status Claimed</b>	<input checked="" type="checkbox"/>
<b>Application Type</b>	Nonprovisional		
<b>Subject Matter</b>	Utility		
<b>Total Number of Drawing Sheets (if any)</b>	4	<b>Suggested Figure for Publication (if any)</b>	1

**Filing By Reference :**

Only complete this section when filing an application by reference under 35 U.S.C. 111(c) and 37 CFR 1.57(a). Do not complete this section if application papers including a specification and any drawings are being filed. Any domestic benefit or foreign priority information must be provided in the appropriate section(s) below (i.e., "Domestic Benefit/National Stage Information" and "Foreign Priority Information").

For the purposes of a filing date under 37 CFR 1.53(b), the description and any drawings of the present application are replaced by this reference to the previously filed application, subject to conditions and requirements of 37 CFR 1.57(a).

Application number of the previously filed application	Filing date (YYYY-MM-DD)	Intellectual Property Authority or Country i

<b>Application Data Sheet 37 CFR 1.76</b>		Attorney Docket Number	455/006/8 UTIL
		Application Number	
Title of Invention	Messaging centre for forwarding e-mail		

**Publication Information:**

<input type="checkbox"/>	Request Early Publication (Fee required at time of Request 37 CFR 1.219)
<input type="checkbox"/>	<b>Request Not to Publish.</b> I hereby request that the attached application not be published under 35 U.S.C. 122(b) and certify that the invention disclosed in the attached application <b>has not and will not be</b> the subject of an application filed in another country, or under a multilateral international agreement, that requires publication at eighteen months after filing.

**Representative Information:**

Representative information should be provided for all practitioners having a power of attorney in the application. Providing this information in the Application Data Sheet does not constitute a power of attorney in the application (see 37 CFR 1.32). Either enter Customer Number or complete the Representative Name section below. If both sections are completed the customer Number will be used for the Representative Information during processing.			
Please Select One:	<input checked="" type="radio"/> Customer Number	<input type="radio"/> US Patent Practitioner	<input type="radio"/> Limited Recognition (37 CFR 11.9)
Customer Number	118194		

**Domestic Benefit/National Stage Information:**

This section allows for the applicant to either claim benefit under 35 U.S.C. 119(e), 120, 121, or 365(c) or indicate National Stage entry from a PCT application. Providing this information in the application data sheet constitutes the specific reference required by 35 U.S.C. 119(e) or 120, and 37 CFR 1.78.

When referring to the current application, please leave the application number blank.

Prior Application Status	Pending	<a href="#">Remove</a>			
Application Number	Continuity Type	Prior Application Number	Filing Date (YYYY-MM-DD)		
	Continuation of	12228325	2008-08-11		
Prior Application Status	Patented	<a href="#">Remove</a>			
Application Number	Continuity Type	Prior Application Number	Filing Date (YYYY-MM-DD)	Patent Number	Issue Date (YYYY-MM-DD)
12228325	Division of	11282950	2005-11-21	7643818	2010-01-05
Prior Application Status	Expired	<a href="#">Remove</a>			
Application Number	Continuity Type	Prior Application Number	Filing Date (YYYY-MM-DD)		
12228325	Claims benefit of provisional	60650975	2005-02-09		
Additional Domestic Benefit/National Stage Data may be generated within this form by selecting the <b>Add</b> button.					<a href="#">Add</a>

**Foreign Priority Information:**

Under the Paperwork Reduction Act of 1995, no persons are required to respond to a collection of information unless it contains a valid OMB control number.

<b>Application Data Sheet 37 CFR 1.76</b>		Attorney Docket Number	455/006/8 UTIL
		Application Number	
Title of Invention	Messaging centre for forwarding e-mail		

This section allows for the applicant to claim priority to a foreign application. Providing this information in the application data sheet constitutes the claim for priority as required by 35 U.S.C. 119(b) and 37 CFR 1.55(d). When priority is claimed to a foreign application that is eligible for retrieval under the priority document exchange program (PDX) the information will be used by the Office to automatically attempt retrieval pursuant to 37 CFR 1.55(h)(1) and (2). Under the PDX program, applicant bears the ultimate responsibility for ensuring that a copy of the foreign application is received by the Office from the participating foreign intellectual property office, or a certified copy of the foreign priority application is filed, within the time period specified in 37 CFR 1.55(g)(1).

Remove

Application Number	Country <sup>i</sup>	Filing Date (YYYY-MM-DD)	Access Code <sup>i</sup> (if applicable)
20045451	FI	2004-11-22	

Additional Foreign Priority Data may be generated within this form by selecting the Add button.

Add

## Statement under 37 CFR 1.55 or 1.78 for AIA (First Inventor to File) Transition Applications

- This application (1) claims priority to or the benefit of an application filed before March 16, 2013 and (2) also contains, or contained at any time, a claim to a claimed invention that has an effective filing date on or after March 16, 2013.
- NOTE: By providing this statement under 37 CFR 1.55 or 1.78, this application, with a filing date on or after March 16, 2013, will be examined under the first inventor to file provisions of the AIA.

## Authorization to Permit Access:

Authorization to Permit Access to the Instant Application by the Participating Offices

Under the Paperwork Reduction Act of 1995, no persons are required to respond to a collection of information unless it contains a valid OMB control number.

<b>Application Data Sheet 37 CFR 1.76</b>		Attorney Docket Number	455/006/8 UTIL
		Application Number	
Title of Invention	Messaging centre for forwarding e-mail		

If checked, the undersigned hereby grants the USPTO authority to provide the European Patent Office (EPO), the Japan Patent Office (JPO), the Korean Intellectual Property Office (KIPO), the World Intellectual Property Office (WIPO), and any other intellectual property offices in which a foreign application claiming priority to the instant patent application is filed access to the instant patent application. See 37 CFR 1.14(c) and (h). This box should not be checked if the applicant does not wish the EPO, JPO, KIPO, WIPO, or other intellectual property office in which a foreign application claiming priority to the instant patent application is filed to have access to the instant patent application.

In accordance with 37 CFR 1.14(h)(3), access will be provided to a copy of the instant patent application with respect to: 1) the instant patent application-as-filed; 2) any foreign application to which the instant patent application claims priority under 35 U.S.C. 119(a)-(d) if a copy of the foreign application that satisfies the certified copy requirement of 37 CFR 1.55 has been filed in the instant patent application; and 3) any U.S. application-as-filed from which benefit is sought in the instant patent application.

In accordance with 37 CFR 1.14(c), access may be provided to information concerning the date of filing this Authorization.

## Applicant Information:

Providing assignment information in this section does not substitute for compliance with any requirement of part 3 of Title 37 of CFR to have an assignment recorded by the Office.			
<b>Applicant 1</b>			<input type="button" value="Remove"/>
If the applicant is the inventor (or the remaining joint inventor or inventors under 37 CFR 1.45), this section should not be completed. The information to be provided in this section is the name and address of the legal representative who is the applicant under 37 CFR 1.43; or the name and address of the assignee, person to whom the inventor is under an obligation to assign the invention, or person who otherwise shows sufficient proprietary interest in the matter who is the applicant under 37 CFR 1.46. If the applicant is an applicant under 37 CFR 1.46 (assignee, person to whom the inventor is obligated to assign, or person who otherwise shows sufficient proprietary interest) together with one or more joint inventors, then the joint inventor or inventors who are also the applicant should be identified in this section.			
			<input type="button" value="Clear"/>
<input checked="" type="radio"/> Assignee	<input type="radio"/> Legal Representative under 35 U.S.C. 117	<input type="radio"/> Joint Inventor	
<input type="radio"/> Person to whom the inventor is obligated to assign.		<input type="radio"/> Person who shows sufficient proprietary interest	
If applicant is the legal representative, indicate the authority to file the patent application, the inventor is:			
Name of the Deceased or Legally Incapacitated Inventor : <input type="text"/>			
If the Applicant is an Organization check here. <input checked="" type="checkbox"/>			
Organization Name	Seven Networks, Inc.		
<b>Mailing Address Information:</b>			
Address 1	959 Skyway Road		
Address 2	Suite 100		
City	San Carlos	State/Province	CA
Country <sup>i</sup>	US	Postal Code	94070
Phone Number		Fax Number	



Under the Paperwork Reduction Act of 1995, no persons are required to respond to a collection of information unless it contains a valid OMB control number.

<b>Application Data Sheet 37 CFR 1.76</b>		Attorney Docket Number	455/006/8 UTIL
		Application Number	
Title of Invention	Messaging centre for forwarding e-mail		
Email Address			
Additional Applicant Data may be generated within this form by selecting the Add button.			<input type="button" value="Add"/>

**Assignee Information including Non-Applicant Assignee Information:**

Providing assignment information in this section does not substitute for compliance with any requirement of part 3 of Title 37 of CFR to have an assignment recorded by the Office.				
<b>Assignee 1</b>				
Complete this section if assignee information, including non-applicant assignee information, is desired to be included on the patent application publication. An assignee-applicant identified in the "Applicant Information" section will appear on the patent application publication as an applicant. For an assignee-applicant, complete this section only if identification as an assignee is also desired on the patent application publication.				
				<input type="button" value="Remove"/>
If the Assignee or Non-Applicant Assignee is an Organization check here.				<input type="checkbox"/>
Prefix	Given Name	Middle Name	Family Name	Suffix
<b>Mailing Address Information For Assignee including Non-Applicant Assignee:</b>				
Address 1				
Address 2				
City		State/Province		
Country i		Postal Code		
Phone Number		Fax Number		
Email Address				
Additional Assignee or Non-Applicant Assignee Data may be generated within this form by selecting the Add button.				<input type="button" value="Add"/>

**Signature:**

NOTE: This form must be signed in accordance with 37 CFR 1.33. See 37 CFR 1.4 for signature requirements and certifications				
Signature	/Justin R. Nifong/		Date (YYYY-MM-DD)	2015-01-29
First Name	Justin	Last Name	Nifong	Registration Number
Additional Signature may be generated within this form by selecting the Add button.				<input type="button" value="Add"/>

Under the Paperwork Reduction Act of 1995, no persons are required to respond to a collection of information unless it contains a valid OMB control number.

<b>Application Data Sheet 37 CFR 1.76</b>		Attorney Docket Number	455/006/8 UTIL
		Application Number	
Title of Invention	Messaging centre for forwarding e-mail		

This collection of information is required by 37 CFR 1.76. The information is required to obtain or retain a benefit by the public which is to file (and by the USPTO to process) an application. Confidentiality is governed by 35 U.S.C. 122 and 37 CFR 1.14. This collection is estimated to take 23 minutes to complete, including gathering, preparing, and submitting the completed application data sheet form to the USPTO. Time will vary depending upon the individual case. Any comments on the amount of time you require to complete this form and/or suggestions for reducing this burden, should be sent to the Chief Information Officer, U.S. Patent and Trademark Office, U.S. Department of Commerce, P.O. Box 1450, Alexandria, VA 22313-1450. DO NOT SEND FEES OR COMPLETED FORMS TO THIS ADDRESS. **SEND TO: Commissioner for Patents, P.O. Box 1450, Alexandria, VA 22313-1450.**

## Privacy Act Statement

The Privacy Act of 1974 (P.L. 93-579) requires that you be given certain information in connection with your submission of the attached form related to a patent application or patent. Accordingly, pursuant to the requirements of the Act, please be advised that: (1) the general authority for the collection of this information is 35 U.S.C. 2(b)(2); (2) furnishing of the information solicited is voluntary; and (3) the principal purpose for which the information is used by the U.S. Patent and Trademark Office is to process and/or examine your submission related to a patent application or patent. If you do not furnish the requested information, the U.S. Patent and Trademark Office may not be able to process and/or examine your submission, which may result in termination of proceedings or abandonment of the application or expiration of the patent.

The information provided by you in this form will be subject to the following routine uses:

1. The information on this form will be treated confidentially to the extent allowed under the Freedom of Information Act (5 U.S.C. 552) and the Privacy Act (5 U.S.C. 552a). Records from this system of records may be disclosed to the Department of Justice to determine whether the Freedom of Information Act requires disclosure of these records.
2. A record from this system of records may be disclosed, as a routine use, in the course of presenting evidence to a court, magistrate, or administrative tribunal, including disclosures to opposing counsel in the course of settlement negotiations.
3. A record in this system of records may be disclosed, as a routine use, to a Member of Congress submitting a request involving an individual, to whom the record pertains, when the individual has requested assistance from the Member with respect to the subject matter of the record.
4. A record in this system of records may be disclosed, as a routine use, to a contractor of the Agency having need for the information in order to perform a contract. Recipients of information shall be required to comply with the requirements of the Privacy Act of 1974, as amended, pursuant to 5 U.S.C. 552a(m).
5. A record related to an International Application filed under the Patent Cooperation Treaty in this system of records may be disclosed, as a routine use, to the International Bureau of the World Intellectual Property Organization, pursuant to the Patent Cooperation Treaty.
6. A record in this system of records may be disclosed, as a routine use, to another federal agency for purposes of National Security review (35 U.S.C. 181) and for review pursuant to the Atomic Energy Act (42 U.S.C. 218(c)).
7. A record from this system of records may be disclosed, as a routine use, to the Administrator, General Services, or his/her designee, during an inspection of records conducted by GSA as part of that agency's responsibility to recommend improvements in records management practices and programs, under authority of 44 U.S.C. 2904 and 2906. Such disclosure shall be made in accordance with the GSA regulations governing inspection of records for this purpose, and any other relevant (i.e., GSA or Commerce) directive. Such disclosure shall not be used to make determinations about individuals.
8. A record from this system of records may be disclosed, as a routine use, to the public after either publication of the application pursuant to 35 U.S.C. 122(b) or issuance of a patent pursuant to 35 U.S.C. 151. Further, a record may be disclosed, subject to the limitations of 37 CFR 1.14, as a routine use, to the public if the record was filed in an application which became abandoned or in which the proceedings were terminated and which application is referenced by either a published application, an application open to public inspections or an issued patent.
9. A record from this system of records may be disclosed, as a routine use, to a Federal, State, or local law enforcement agency, if the USPTO becomes aware of a violation or potential violation of law or regulation.

Fig. 1

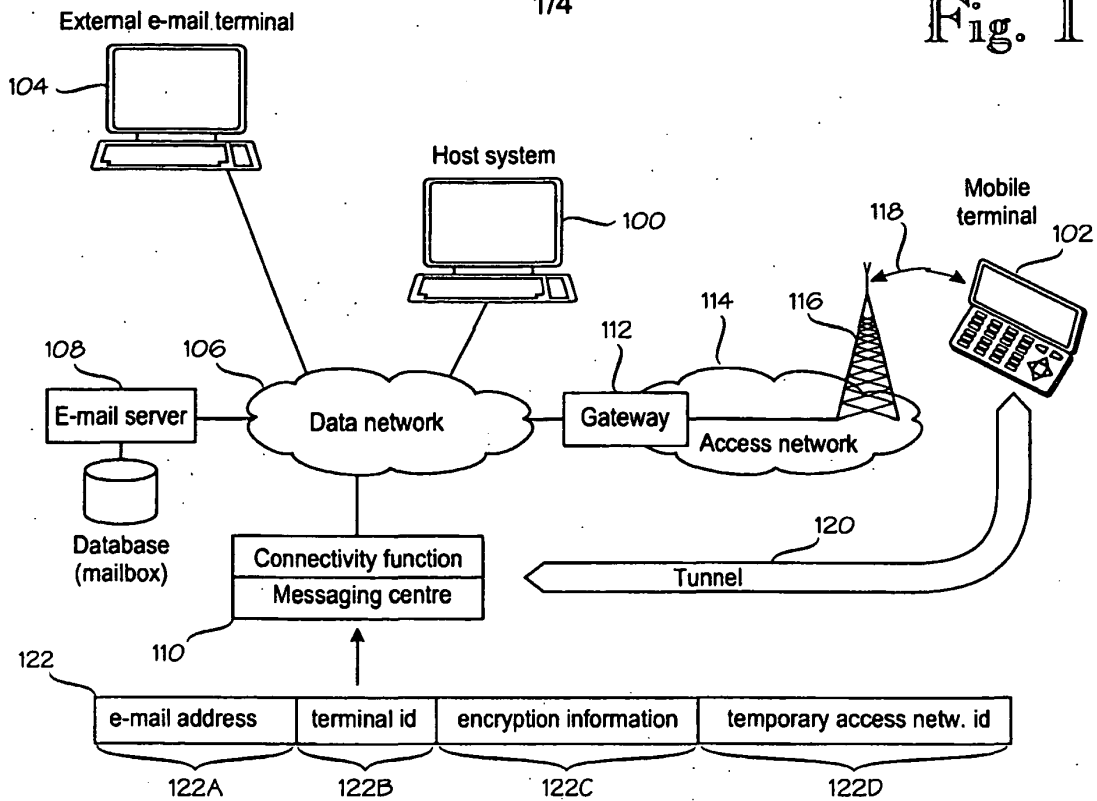

Fig. 2

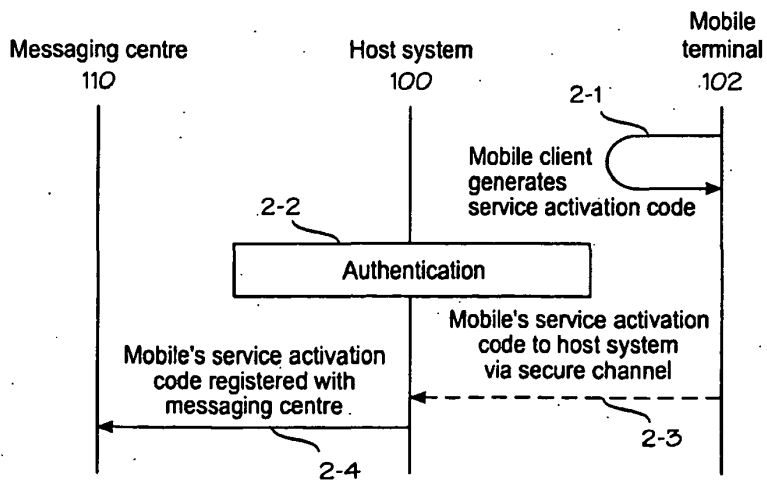
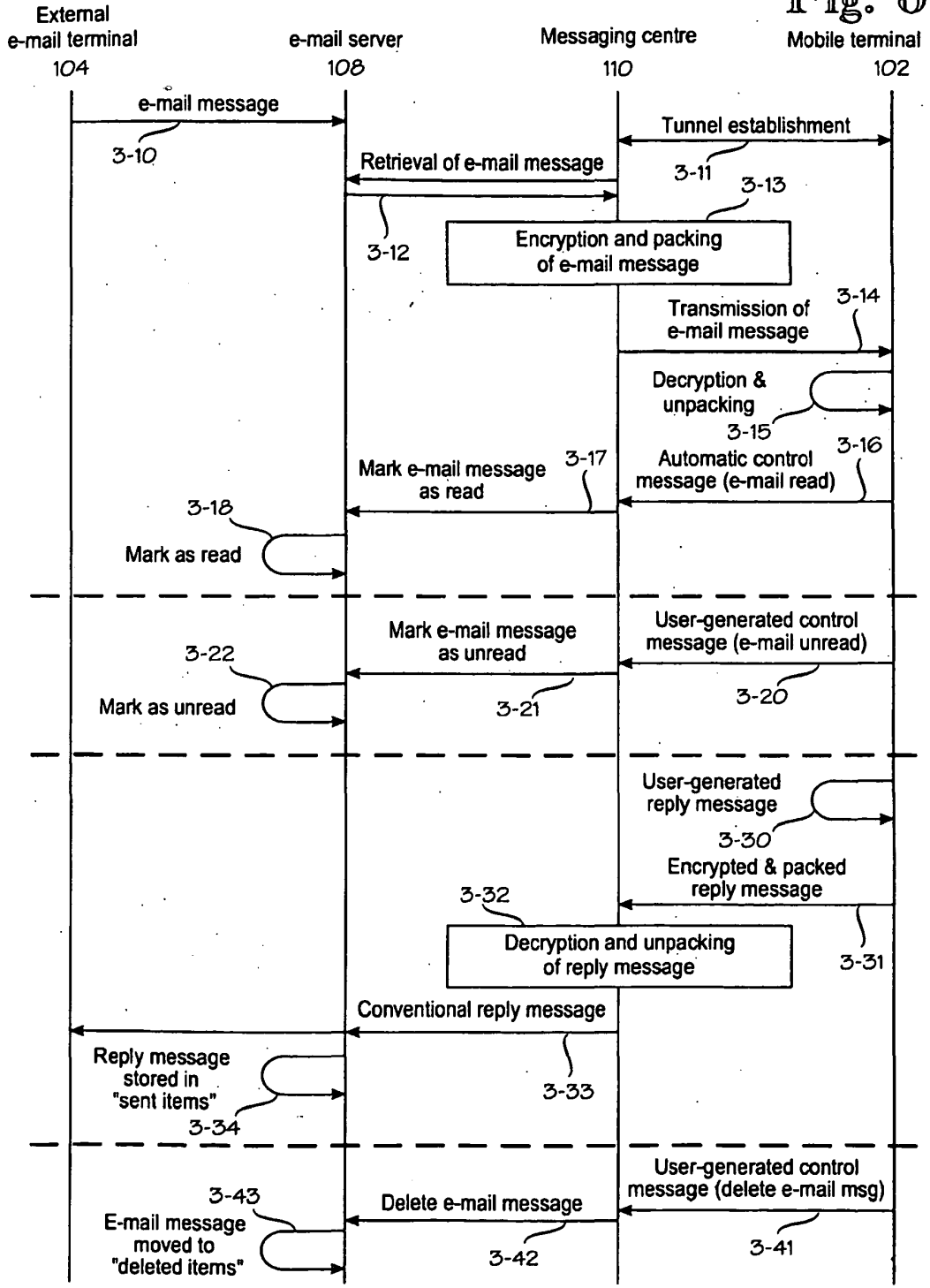
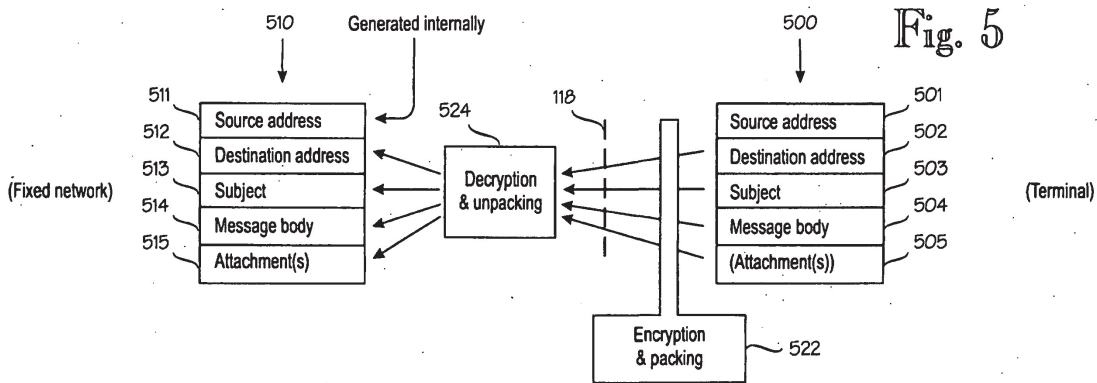
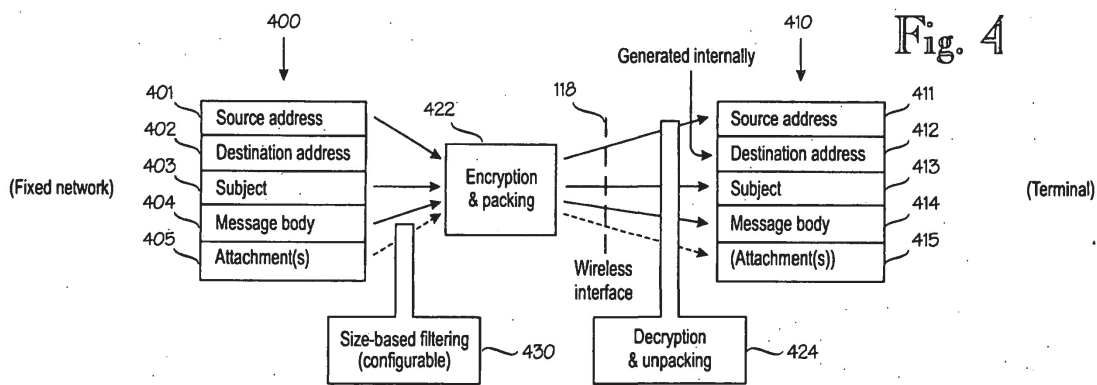
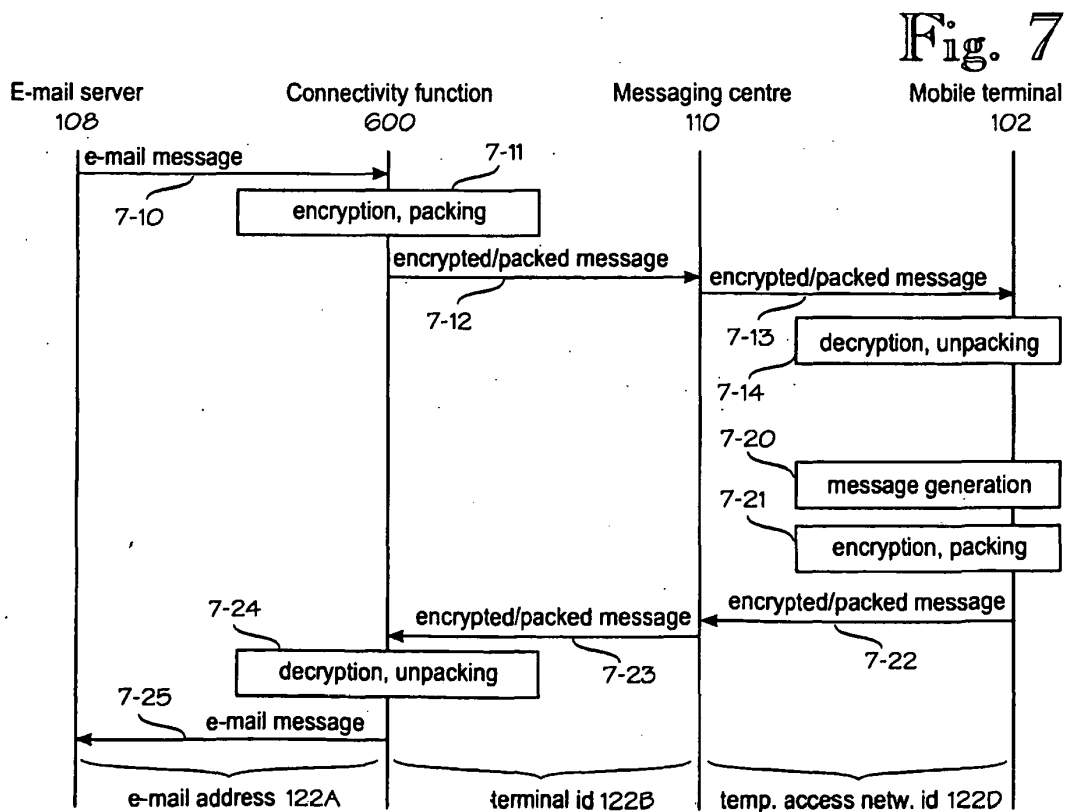
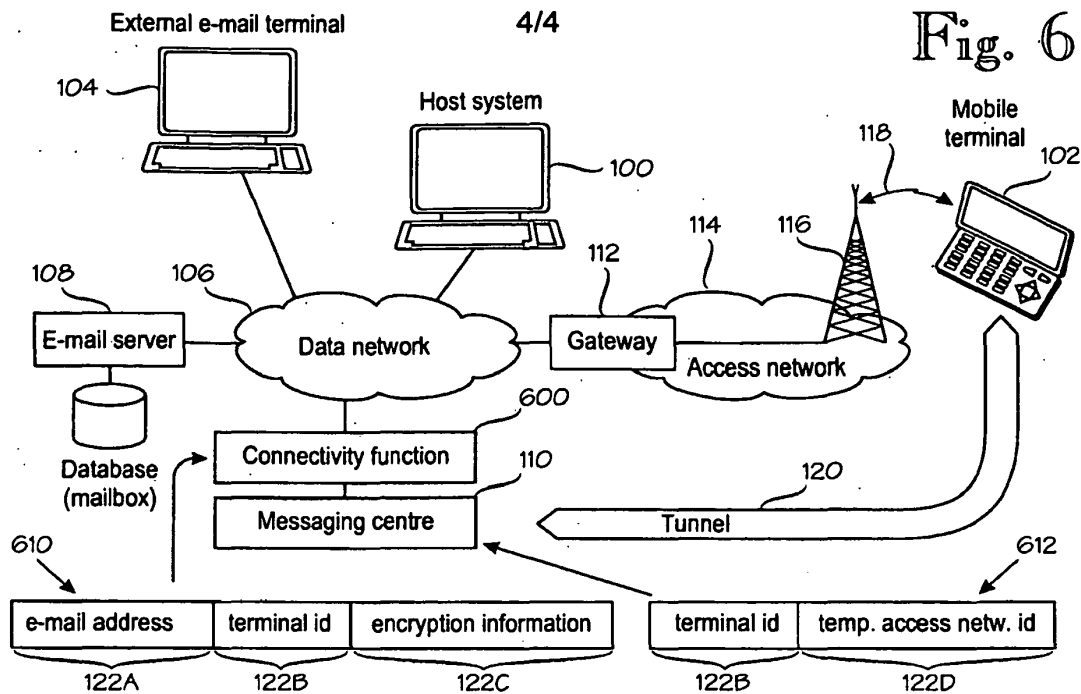

Fig. 3





3/4



Under the Paperwork Reduction Act of 1995, no persons are required to respond to a collection of information unless it displays a valid OMB control number.

**DECLARATION (37 CFR 1.63) FOR UTILITY OR DESIGN APPLICATION USING AN APPLICATION DATA SHEET (37 CFR 1.76)**

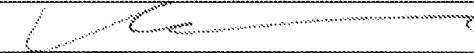
<b>Title of Invention</b>	E-MAIL MESSAGING TO/FROM A MOBILE TERMINAL
<p>As the below named inventor, I hereby declare that:</p> <p>This declaration is directed to: <input checked="" type="checkbox"/> The attached application, or <input type="checkbox"/> United States application or PCT international application number _____ filed on _____</p> <p>The above-identified application was made or authorized to be made by me.</p> <p>I believe that I am the original inventor or an original joint inventor of a claimed invention in the application.</p> <p>I hereby acknowledge that any willful false statement made in this declaration is punishable under 18 U.S.C. 1001 by fine or imprisonment of not more than five (5) years, or both.</p> <p style="text-align: center;"><b>WARNING:</b></p> <p>Petitioner/applicant is cautioned to avoid submitting personal information in documents filed in a patent application that may contribute to identity theft. Personal information such as social security numbers, bank account numbers, or credit card numbers (other than a check or credit card authorization form PTO-2038 submitted for payment purposes) is never required by the USPTO to support a petition or an application. If this type of personal information is included in documents submitted to the USPTO, petitioners/applicants should consider redacting such personal information from the documents before submitting them to the USPTO. Petitioner/applicant is advised that the record of a patent application is available to the public after publication of the application (unless a non-publication request in compliance with 37 CFR 1.213(a) is made in the application) or issuance of a patent. Furthermore, the record from an abandoned application may also be available to the public if the application is referenced in a published application or an issued patent (see 37 CFR 1.14). Checks and credit card authorization forms PTO-2038 submitted for payment purposes are not retained in the application file and therefore are not publicly available.</p>	
<p>LEGAL NAME OF INVENTOR</p> <p>Inventor: <u>Ari Backholm</u> Date (Optional): <u>1/22/15</u></p> <p>Signature: </p>	
<p>Note: An application data sheet (PTO/SB/14 or equivalent), including naming the entire inventive entity, must accompany this form or must have been previously filed. Use an additional PTO/AIA/01 form for each additional inventor.</p>	

This collection of information is required by 35 U.S.C. 115 and 37 CFR 1.63. The information is required to obtain or retain a benefit by the public which is to file (and by the USPTO to process) an application. Confidentiality is governed by 35 U.S.C. 122 and 37 CFR 1.11 and 1.14. This collection is estimated to take 1 minute to complete, including gathering, preparing, and submitting the completed application form to the USPTO. Time will vary depending upon the individual case. Any comments on the amount of time you require to complete this form and/or suggestions for reducing this burden, should be sent to the Chief Information Officer, U.S. Patent and Trademark Office, U.S. Department of Commerce, P.O. Box 1450, Alexandria, VA 22313-1450. DO NOT SEND FEES OR COMPLETED FORMS TO THIS ADDRESS. SEND TO: Commissioner for Patents, P.O. Box 1450, Alexandria, VA 22313-1450.

If you need assistance in completing the form, call 1-800-PTO-9199 and select option 2.



Under the Paperwork Reduction Act of 1995, no persons are required to respond to a collection of information unless it displays a valid OMB control number.

**SUBSTITUTE STATEMENT IN LIEU OF AN OATH OR DECLARATION FOR UTILITY OR DESIGN PATENT APPLICATION (35 U.S.C. 115(d) AND 37 CFR 1.64)**

Title of Invention	E-MAIL MESSAGING TO/FROM A MOBILE TERMINAL
--------------------	--

This statement is directed to:

The attached application,

OR

United States application or PCT international application number \_\_\_\_\_ filed on \_\_\_\_\_.

**LEGAL NAME of inventor to whom this substitute statement applies:**

(E.g., Given Name (first and middle (if any)) and Family Name or Surname)  
**Seppo Salorinne**

Residence (except for a deceased or legally incapacitated inventor):

City	<b>Helsinki</b>	State		Country	<b>FI</b>
------	-----------------	-------	--	---------	-----------

Mailing Address (except for a deceased or legally incapacitated inventor):

**959 Skyway Road, Suite 100**

City	<b>San Carlos</b>	State	<b>CA</b>	Zip	<b>94070</b>	Country	<b>US</b>
------	-------------------	-------	-----------	-----	--------------	---------	-----------

I believe the above-named inventor or joint inventor to be the original inventor or an original joint inventor of a claimed invention in the application.

The above-identified application was made or authorized to be made by me.

I hereby acknowledge that any willful false statement made in this statement is punishable under 18 U.S.C. 1001 by fine or imprisonment of not more than five (5) years, or both.

**Relationship to the inventor to whom this substitute statement applies:**

- Legal Representative (for deceased or legally incapacitated inventor only),
- Assignee,
- Person to whom the inventor is under an obligation to assign,
- Person who otherwise shows a sufficient proprietary interest in the matter (petition under 37 CFR 1.46 is required), or
- Joint Inventor.

This collection of information is required by 35 U.S.C. 115 and 37 CFR 1.63. The information is required to obtain or retain a benefit by the public which is to file (and by the USPTO to process) an application. Confidentiality is governed by 35 U.S.C. 122 and 37 CFR 1.11 and 1.14. This collection is estimated to take 1 minute to complete, including gathering, preparing, and submitting the completed application form to the USPTO. Time will vary depending upon the individual case. Any comments on the amount of time you require to complete this form and/or suggestions for reducing this burden, should be sent to the Chief Information Officer, U.S. Patent and Trademark Office, U.S. Department of Commerce, P.O. Box 1450, Alexandria, VA 22313-1450. DO NOT SEND FEES OR COMPLETED FORMS TO THIS ADDRESS. SEND TO: Commissioner for Patents, P.O. Box 1450, Alexandria, VA 22313-1450.

If you need assistance in completing the form, call 1-800-PTO-9199 and select option 2.

Under the Paperwork Reduction Act of 1995, no persons are required to respond to a collection of information unless it displays a valid OMB control number.

**SUBSTITUTE STATEMENT**

Circumstances permitting execution of this substitute statement:

- Inventor is deceased,
- Inventor is under legal incapacity,
- Inventor cannot be found or reached after diligent effort, or
- Inventor has refused to execute the oath or declaration under 37 CFR 1.63.

If there are joint inventors, please check the appropriate box below:

- An application data sheet under 37 CFR 1.76 (PTO/AIA/14 or equivalent) naming the entire inventive entity has been or is currently submitted.

OR

- An application data sheet under 37 CFR 1.76 (PTO/AIA/14 or equivalent) has not been submitted. Thus, a Substitute Statement Supplemental Sheet (PTO/AIA/11 or equivalent) naming the entire inventive entity and providing inventor information is attached. See 37 CFR 1.64(b).

**WARNING:**

Petitioner/applicant is cautioned to avoid submitting personal information in documents filed in a patent application that may contribute to identity theft. Personal information such as social security numbers, bank account numbers, or credit card numbers (other than a check or credit card authorization form PTO-2038 submitted for payment purposes) is never required by the USPTO to support a petition or an application. If this type of personal information is included in documents submitted to the USPTO, petitioners/applicants should consider redacting such personal information from the documents before submitting them to the USPTO. Petitioner/applicant is advised that the record of a patent application is available to the public after publication of the application (unless a non-publication request in compliance with 37 CFR 1.213(a) is made in the application) or issuance of a patent. Furthermore, the record from an abandoned application may also be available to the public if the application is referenced in a published application or an issued patent (see 37 CFR 1.14). Checks and credit card authorization forms PTO-2038 submitted for payment purposes are not retained in the application file and therefore are not publicly available.

**PERSON EXECUTING THIS SUBSTITUTE STATEMENT:**Name: **Ross Bott**

Date (Optional):

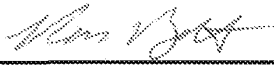
Signature: **APPLICANT NAME AND TITLE OF PERSON EXECUTING THIS SUBSTITUTE STATEMENT:**

If the applicant is a juristic entity, list the applicant name and the title of the signer:

**Seven Networks, Inc.**

Applicant Name:

Title of Person Executing  
This Substitute Statement: **President and CEO**

The signer, whose title is supplied above, is authorized to act on behalf of the applicant.

**Residence of the signer (unless provided in an application data sheet, PTO/AIA/14 or equivalent):**City **San Carlos**State **CA**Country **US****Mailing Address of the signer (unless provided in an application data sheet, PTO/AIA/14 or equivalent)**

959 Skyway Road, Suite 100

City **San Carlos**State **CA**Zip **US**Country **94070**

Note: Use an additional PTO/AIA/02 form for each inventor who is deceased, legally incapacitated, cannot be found or reached after diligent effort, or has refused to execute the oath or declaration under 37 CFR 1.63.

Under the Paperwork Reduction Act of 1995, no persons are required to respond to a collection of information unless it displays a valid OMB control number.

**SUBSTITUTE STATEMENT IN LIEU OF AN OATH OR DECLARATION FOR UTILITY OR DESIGN PATENT APPLICATION (35 U.S.C. 115(d) AND 37 CFR 1.64)**

Title of Invention	E-MAIL MESSAGING TO/FROM A MOBILE TERMINAL
--------------------	--

This statement is directed to:

The attached application,

OR

United States application or PCT international application number \_\_\_\_\_ filed on \_\_\_\_\_.

**LEGAL NAME of inventor to whom this substitute statement applies:**

(E.g., Given Name (first and middle (if any)) and Family Name or Surname)

**Marko Ketonen**

Residence (except for a deceased or legally incapacitated inventor):

City	<b>Helsinki</b>	State		Country	<b>FI</b>
------	-----------------	-------	--	---------	-----------

Mailing Address (except for a deceased or legally incapacitated inventor):

**959 Skyway Road, Suite 100**

City	<b>San Carlos</b>	State	<b>CA</b>	Zip	<b>94070</b>	Country	<b>US</b>
------	-------------------	-------	-----------	-----	--------------	---------	-----------

I believe the above-named inventor or joint inventor to be the original inventor or an original joint inventor of a claimed invention in the application.

The above-identified application was made or authorized to be made by me.

I hereby acknowledge that any willful false statement made in this statement is punishable under 18 U.S.C. 1001 by fine or imprisonment of not more than five (5) years, or both.

**Relationship to the inventor to whom this substitute statement applies:**

- Legal Representative (for deceased or legally incapacitated inventor only),
- Assignee,
- Person to whom the inventor is under an obligation to assign,
- Person who otherwise shows a sufficient proprietary interest in the matter (petition under 37 CFR 1.46 is required), or
- Joint Inventor.

This collection of information is required by 35 U.S.C. 115 and 37 CFR 1.63. The information is required to obtain or retain a benefit by the public which is to file (and by the USPTO to process) an application. Confidentiality is governed by 35 U.S.C. 122 and 37 CFR 1.11 and 1.14. This collection is estimated to take 1 minute to complete, including gathering, preparing, and submitting the completed application form to the USPTO. Time will vary depending upon the individual case. Any comments on the amount of time you require to complete this form and/or suggestions for reducing this burden, should be sent to the Chief Information Officer, U.S. Patent and Trademark Office, U.S. Department of Commerce, P.O. Box 1450, Alexandria, VA 22313-1450. DO NOT SEND FEES OR COMPLETED FORMS TO THIS ADDRESS. SEND TO: Commissioner for Patents, P.O. Box 1450, Alexandria, VA 22313-1450.

If you need assistance in completing the form, call 1-800-PTO-9199 and select option 2.

Under the Paperwork Reduction Act of 1995, no persons are required to respond to a collection of information unless it displays a valid OMB control number.

**SUBSTITUTE STATEMENT**

Circumstances permitting execution of this substitute statement:

- Inventor is deceased,
- Inventor is under legal incapacity,
- Inventor cannot be found or reached after diligent effort, or
- Inventor has refused to execute the oath or declaration under 37 CFR 1.63.

If there are joint inventors, please check the appropriate box below:

- An application data sheet under 37 CFR 1.76 (PTO/AIA/14 or equivalent) naming the entire inventive entity has been or is currently submitted.

OR

- An application data sheet under 37 CFR 1.76 (PTO/AIA/14 or equivalent) has not been submitted. Thus, a Substitute Statement Supplemental Sheet (PTO/AIA/11 or equivalent) naming the entire inventive entity and providing inventor information is attached. See 37 CFR 1.64(b).

**WARNING:**

Petitioner/applicant is cautioned to avoid submitting personal information in documents filed in a patent application that may contribute to identity theft. Personal information such as social security numbers, bank account numbers, or credit card numbers (other than a check or credit card authorization form PTO-2038 submitted for payment purposes) is never required by the USPTO to support a petition or an application. If this type of personal information is included in documents submitted to the USPTO, petitioners/applicants should consider redacting such personal information from the documents before submitting them to the USPTO. Petitioner/applicant is advised that the record of a patent application is available to the public after publication of the application (unless a non-publication request in compliance with 37 CFR 1.213(a) is made in the application) or issuance of a patent. Furthermore, the record from an abandoned application may also be available to the public if the application is referenced in a published application or an issued patent (see 37 CFR 1.14). Checks and credit card authorization forms PTO-2038 submitted for payment purposes are not retained in the application file and therefore are not publicly available.

**PERSON EXECUTING THIS SUBSTITUTE STATEMENT:**Name: **Ross Bott**

Date (Optional):

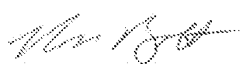
Signature: **APPLICANT NAME AND TITLE OF PERSON EXECUTING THIS SUBSTITUTE STATEMENT:**

If the applicant is a juristic entity, list the applicant name and the title of the signer:

**Seven Networks, Inc.**

Applicant Name:

Title of Person Executing  
This Substitute Statement: **President and CEO**

The signer, whose title is supplied above, is authorized to act on behalf of the applicant.

**Residence of the signer (unless provided in an application data sheet, PTO/AIA/14 or equivalent):**City **San Carlos**State **CA**Country **US****Mailing Address of the signer (unless provided in an application data sheet, PTO/AIA/14 or equivalent)**

959 Skyway Road, Suite 100

City **San Carlos**State **CA**Zip **US**Country **94070**

Note: Use an additional PTO/AIA/02 form for each inventor who is deceased, legally incapacitated, cannot be found or reached after diligent effort, or has refused to execute the oath or declaration under 37 CFR 1.63.

Under the Paperwork Reduction Act of 1995, no persons are required to respond to a collection of information unless it displays a valid OMB control number.

**SUBSTITUTE STATEMENT IN LIEU OF AN OATH OR DECLARATION FOR UTILITY  
 OR DESIGN PATENT APPLICATION (35 U.S.C. 115(d) AND 37 CFR 1.64)**

<b>Title of Invention</b>	<b>E-MAIL MESSAGING TO/FROM A MOBILE TERMINAL</b>
---------------------------	---

This statement is directed to:

The attached application,

OR

United States application or PCT international application number \_\_\_\_\_ filed on \_\_\_\_\_

**LEGAL NAME of inventor to whom this substitute statement applies:**

(E.g., Given Name (first and middle (if any)) and Family Name or Surname)

**Lauri Vuornos**

**Residence (except for a deceased or legally incapacitated inventor):**

<b>Helsinki</b> <small>City</small>	 <small>State</small>	<b>FI</b> <small>Country</small>
--	--------------------------	-------------------------------------

**Mailing Address (except for a deceased or legally incapacitated inventor):**

**959 Skyway Road, Suite 100**

<b>San Carlos</b> <small>City</small>	<b>CA</b> <small>State</small>	<b>94070</b> <small>Zip</small>	<b>US</b> <small>Country</small>
--	-----------------------------------	------------------------------------	-------------------------------------

I believe the above-named inventor or joint inventor to be the original inventor or an original joint inventor of a claimed invention in the application.

The above-identified application was made or authorized to be made by me.

I hereby acknowledge that any willful false statement made in this statement is punishable under 18 U.S.C. 1001 by fine or imprisonment of not more than five (5) years, or both.

**Relationship to the inventor to whom this substitute statement applies:**

- Legal Representative (for deceased or legally incapacitated inventor only),
- Assignee,
- Person to whom the inventor is under an obligation to assign,
- Person who otherwise shows a sufficient proprietary interest in the matter (petition under 37 CFR 1.46 is required), or
- Joint Inventor.

This collection of information is required by 35 U.S.C. 115 and 37 CFR 1.63. The information is required to obtain or retain a benefit by the public which is to file (and by the USPTO to process) an application. Confidentiality is governed by 35 U.S.C. 122 and 37 CFR 1.11 and 1.14. This collection is estimated to take 1 minute to complete, including gathering, preparing, and submitting the completed application form to the USPTO. Time will vary depending upon the individual case. Any comments on the amount of time you require to complete this form and/or suggestions for reducing this burden, should be sent to the Chief Information Officer, U.S. Patent and Trademark Office, U.S. Department of Commerce, P.O. Box 1450, Alexandria, VA 22313-1450. DO NOT SEND FEES OR COMPLETED FORMS TO THIS ADDRESS. SEND TO: Commissioner for Patents, P.O. Box 1450, Alexandria, VA 22313-1450.

If you need assistance in completing the form, call 1-800-PTO-9199 and select option 2.

Under the Paperwork Reduction Act of 1995, no persons are required to respond to a collection of information unless it displays a valid OMB control number.

## SUBSTITUTE STATEMENT

Circumstances permitting execution of this substitute statement:

- Inventor is deceased,  
 Inventor is under legal incapacity,  
 Inventor cannot be found or reached after diligent effort, or  
 Inventor has refused to execute the oath or declaration under 37 CFR 1.63.

If there are joint inventors, please check the appropriate box below:

- An application data sheet under 37 CFR 1.76 (PTO/AIA/14 or equivalent) naming the entire inventive entity has been or is currently submitted.  
 OR  
 An application data sheet under 37 CFR 1.76 (PTO/AIA/14 or equivalent) has not been submitted. Thus, a Substitute Statement Supplemental Sheet (PTO/AIA/11 or equivalent) naming the entire inventive entity and providing inventor information is attached. See 37 CFR 1.64(b).

### WARNING:

Petitioner/applicant is cautioned to avoid submitting personal information in documents filed in a patent application that may contribute to identity theft. Personal information such as social security numbers, bank account numbers, or credit card numbers (other than a check or credit card authorization form PTO-2038 submitted for payment purposes) is never required by the USPTO to support a petition or an application. If this type of personal information is included in documents submitted to the USPTO, petitioners/applicants should consider redacting such personal information from the documents before submitting them to the USPTO. Petitioner/applicant is advised that the record of a patent application is available to the public after publication of the application (unless a non-publication request in compliance with 37 CFR 1.213(a) is made in the application) or issuance of a patent. Furthermore, the record from an abandoned application may also be available to the public if the application is referenced in a published application or an issued patent (see 37 CFR 1.14). Checks and credit card authorization forms PTO-2038 submitted for payment purposes are not retained in the application file and therefore are not publicly available.

### PERSON EXECUTING THIS SUBSTITUTE STATEMENT:

Name: **Ross Bott**

Date (Optional):

Signature: 

### APPLICANT NAME AND TITLE OF PERSON EXECUTING THIS SUBSTITUTE STATEMENT:

If the applicant is a juristic entity, list the applicant name and the title of the signer:

**Seven Networks, Inc.**

Applicant Name:

Title of Person Executing This Substitute Statement: **President and CEO**

The signer, whose title is supplied above, is authorized to act on behalf of the applicant.

Residence of the signer (unless provided in an application data sheet, PTO/AIA/14 or equivalent):

City **San Carlos**State **CA**Country **US**

Mailing Address of the signer (unless provided in an application data sheet, PTO/AIA/14 or equivalent)

959 Skyway Road, Suite 100

City **San Carlos**State **CA**Zip **US**Country **94070**

Note: Use an additional PTO/AIA/02 form for each inventor who is deceased, legally incapacitated, cannot be found or reached after diligent effort, or has refused to execute the oath or declaration under 37 CFR 1.63.

Under the Paperwork Reduction Act of 1995, no persons are required to respond to a collection of information unless it displays a valid OMB control number.

**SUBSTITUTE STATEMENT IN LIEU OF AN OATH OR DECLARATION FOR UTILITY OR DESIGN PATENT APPLICATION (35 U.S.C. 115(d) AND 37 CFR 1.64)**

Title of Invention	E-MAIL MESSAGING TO/FROM A MOBILE TERMINAL
--------------------	--

This statement is directed to:

The attached application,

OR

United States application or PCT international application number \_\_\_\_\_ filed on \_\_\_\_\_.

**LEGAL NAME of inventor to whom this substitute statement applies:**

(E.g., Given Name (first and middle (if any)) and Family Name or Surname)  
**Antii Saarilahti**

Residence (except for a deceased or legally incapacitated inventor):

City	<b>Helsinki</b>	State		Country	<b>FI</b>
------	-----------------	-------	--	---------	-----------

Mailing Address (except for a deceased or legally incapacitated inventor):

**959 Skyway Road, Suite 100**

City	<b>San Carlos</b>	State	<b>CA</b>	Zip	<b>94070</b>	Country	<b>US</b>
------	-------------------	-------	-----------	-----	--------------	---------	-----------

I believe the above-named inventor or joint inventor to be the original inventor or an original joint inventor of a claimed invention in the application.

The above-identified application was made or authorized to be made by me.

I hereby acknowledge that any willful false statement made in this statement is punishable under 18 U.S.C. 1001 by fine or imprisonment of not more than five (5) years, or both.

Relationship to the inventor to whom this substitute statement applies:

- Legal Representative (for deceased or legally incapacitated inventor only),
- Assignee,
- Person to whom the inventor is under an obligation to assign,
- Person who otherwise shows a sufficient proprietary interest in the matter (petition under 37 CFR 1.46 is required), or
- Joint Inventor.

This collection of information is required by 35 U.S.C. 115 and 37 CFR 1.63. The information is required to obtain or retain a benefit by the public which is to file (and by the USPTO to process) an application. Confidentiality is governed by 35 U.S.C. 122 and 37 CFR 1.11 and 1.14. This collection is estimated to take 1 minute to complete, including gathering, preparing, and submitting the completed application form to the USPTO. Time will vary depending upon the individual case. Any comments on the amount of time you require to complete this form and/or suggestions for reducing this burden, should be sent to the Chief Information Officer, U.S. Patent and Trademark Office, U.S. Department of Commerce, P.O. Box 1450, Alexandria, VA 22313-1450. DO NOT SEND FEES OR COMPLETED FORMS TO THIS ADDRESS. SEND TO: Commissioner for Patents, P.O. Box 1450, Alexandria, VA 22313-1450.

If you need assistance in completing the form, call 1-800-PTO-9199 and select option 2.

Under the Paperwork Reduction Act of 1995, no persons are required to respond to a collection of information unless it displays a valid OMB control number.

**SUBSTITUTE STATEMENT**

Circumstances permitting execution of this substitute statement:

- Inventor is deceased,
- Inventor is under legal incapacity,
- Inventor cannot be found or reached after diligent effort, or
- Inventor has refused to execute the oath or declaration under 37 CFR 1.63.

If there are joint inventors, please check the appropriate box below:

- An application data sheet under 37 CFR 1.76 (PTO/AIA/14 or equivalent) naming the entire inventive entity has been or is currently submitted.
- OR
- An application data sheet under 37 CFR 1.76 (PTO/AIA/14 or equivalent) has not been submitted. Thus, a Substitute Statement Supplemental Sheet (PTO/AIA/11 or equivalent) naming the entire inventive entity and providing inventor information is attached. See 37 CFR 1.64(b).

**WARNING:**

Petitioner/applicant is cautioned to avoid submitting personal information in documents filed in a patent application that may contribute to identity theft. Personal information such as social security numbers, bank account numbers, or credit card numbers (other than a check or credit card authorization form PTO-2038 submitted for payment purposes) is never required by the USPTO to support a petition or an application. If this type of personal information is included in documents submitted to the USPTO, petitioners/applicants should consider redacting such personal information from the documents before submitting them to the USPTO. Petitioner/applicant is advised that the record of a patent application is available to the public after publication of the application (unless a non-publication request in compliance with 37 CFR 1.213(a) is made in the application) or issuance of a patent. Furthermore, the record from an abandoned application may also be available to the public if the application is referenced in a published application or an issued patent (see 37 CFR 1.14). Checks and credit card authorization forms PTO-2038 submitted for payment purposes are not retained in the application file and therefore are not publicly available.

**PERSON EXECUTING THIS SUBSTITUTE STATEMENT:**Name: **Ross Bott**

Date (Optional):

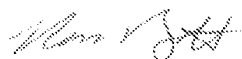
Signature: **APPLICANT NAME AND TITLE OF PERSON EXECUTING THIS SUBSTITUTE STATEMENT:**

If the applicant is a juristic entity, list the applicant name and the title of the signer:

**Seven Networks, Inc.**

Applicant Name:

Title of Person Executing  
This Substitute Statement: **President and CEO**

The signer, whose title is supplied above, is authorized to act on behalf of the applicant.

Residence of the signer (unless provided in an application data sheet, PTO/AIA/14 or equivalent):

City **San Carlos**State **CA**Country **US**

Mailing Address of the signer (unless provided in an application data sheet, PTO/AIA/14 or equivalent)

959 Skyway Road, Suite 100

City **San Carlos**State **CA**Zip **US**Country **94070**

Note: Use an additional PTO/AIA/02 form for each inventor who is deceased, legally incapacitated, cannot be found or reached after diligent effort, or has refused to execute the oath or declaration under 37 CFR 1.63.



455/006/8 UTIL

MESSAGING CENTRE FOR FORWARDING E-MAIL

CROSS-REFERENCE TO RELATED APPLICATIONS

[0001] This application is a continuation of U.S. patent application Ser. No. 12/228,325 filed August 11, 2008, which is a divisional and claims the priority benefit of U.S. patent application Ser. No. 11/282,950 filed Nov. 21, 2005, which claims the priority benefit of U.S. provisional patent application No. 60/650,975 filed Feb. 9, 2005 and the priority benefit of Finnish patent application number 20045451 filed Nov. 22, 2004, the disclosures of the aforementioned applications being incorporated herein by reference.

BACKGROUND OF THE INVENTION

[0002] Field of the Invention

[0003] The invention relates to methods and equipment for transmitting electronic mail (e-mail) messages to or from a mobile terminal. More specifically, the present invention relates to a messaging centre for transmitting e-mail messages to and from a mobile terminal.

[0004] Description of the Related Art

[0005] U.S. Pat. No. 6,701,378 to Barry Gilhuly et al. discloses a system and method for pushing information, such as e-mail messages, from a host system to a mobile data communication device (mobile terminal). The technique permits e-mail processing at a mobile terminal in addition to a more stationary computer, referred to as a host system in the Gilhuly patent. Specifically, a redirector program operating at the host system enables a user to continuously redirect certain user-selected data items from the host system to the user's mobile data communication device upon detecting that one or more user-defined triggering events has occurred. The redirector program operates in connection with event-generating applications and repackaging systems at the host system to configure and detect a particular user-defined event,

and then to repackage the user-selected data items in an electronic wrapper prior to pushing the data items to the mobile device. The mobile data communication device may originate new messages or reply messages to previously received information, such messages being transmitted to a wireless redirector host system, which then transmits a copy of the messages to both the intended recipient and a first electronic mail account associated with the mobile data communication device.

[0006] The above-described prior art technique suffers from certain limitations. For example, the host system, such as an office computer, and the mobile terminal require separate e-mail accounts. Some e-mail systems support a forward-type file for forwarding e-mail messages from a first e-mail account to a second e-mail account, but some systems do not support it. It is difficult to set up e-mail systems that do not support such forwarding techniques.

[0007] Furthermore, the Gilhuly patent does not address issues that relate to manipulating e-mail messages at the second e-mail account (at the mobile terminal). For instance, it is difficult or impossible to use the terminal to arrange incoming e-mail messages into different folders at the host system. Also, if the terminal user deletes an incoming e-mail message at the terminal, a copy of the deleted message is not present in a "deleted items" folder at the host system, which typically is the case in e-mail systems. Likewise, when the terminal sends an e-mail message, a copy of the message is not added to the host system's "sent items" folder. A further related problem is that e-mail messages that the user has read at the terminal may appear as unread messages at the host system.

[0008] Yet another problem is that configuring an e-mail client software at the mobile terminal is difficult because of user interface restrictions in typical mobile terminals.

#### SUMMARY OF THE INVENTION

[0009] Embodiments of the present invention provide for methods and systems for messaging centres for forwarding an e-mail message from an e-mail server. A permanent terminal identifier of the mobile-terminal and an associated temporary identifier of the mobile terminal may be

stored. An e-mail message including an indication of a permanent identifier of the mobile terminal may be received. The e-mail message may then be transmitted to the mobile terminal using the temporary identifier associated with the permanent identifier of the mobile terminal.

[0010] Various embodiments of the present invention include methods for forwarding an e-mail message from an e-mail server to a mobile terminal. Such methods may include storing a permanent terminal identifier of the mobile terminal and an associated temporary identifier of the mobile terminal, receiving the e-mail message, wherein the e-mail message includes an indication of the permanent terminal identifier, and transmitting the e-mail address to the mobile terminal using the temporary identifier associated with the permanent identifier of the mobile terminal. Some embodiments may further include storing the e-mail address of the e-mail message in association with the stored permanent and temporary identifier of the mobile terminal. The message may have been encrypted, packed, and received from a connectivity application in some embodiments of the present invention. The mobile terminal receiving the e-mail message may decrypt and unpack the message.

[0011] Some embodiments of the present invention further include a system of a memory for storing a permanent identifier of the mobile terminal and an associated temporary identifier of the mobile terminal, a processor configured to execute software stored in memory, the execution of the software resulting in the identification of the mobile terminal based on a received e-mail message including an indication of the permanent identifier of the mobile terminal and the stored association between the permanent identifier and the temporary identifier of the mobile terminal, and a communications interface configured to transmit the e-mail message to the identified mobile terminal.

[0012] Some embodiments may further include a computer-readable storage media upon which is embodied programs including instructions for performing methods for forwarding an e-mail message from an e-mail server.

## BRIEF DESCRIPTION OF THE DRAWINGS

455/006/8 UTIL

[0013] In the following the invention will be described in greater detail by means of preferred embodiments with reference to the attached drawings, in which

[0014] FIG. 1 shows an exemplary system architecture in which the invention can be used;

[0015] FIG. 2 shows provisioning of an e-mail system;

[0016] FIG. 3 shows a hypothetical scenario in which the e-mail system is used;

[0017] FIG. 4 shows information flows in mobile-terminated e-mail transmission;

[0018] FIG. 5 shows information flows in mobile-originated e-mail transmission;

[0019] FIG. 6 shows an enhanced embodiment in which some of the functions of the messaging centre are performed by a separate connectivity function;

[0020] FIG. 7 shows traffic flow in the embodiment shown in FIG. 6.

#### DETAILED DESCRIPTION

[0021] FIG. 1 shows an exemplary system architecture in which the invention can be used. Reference numeral 100 denotes a host system that is able to send and receive e-mail messages. Reference numeral 102 denotes a mobile terminal, also able to send and receive e-mail messages. The e-mail messages may originate or terminate at external e-mail terminals, one of which is denoted by reference numeral 104. The invention aims at improving cooperation between the host system 100 and mobile terminal 102 such that they can use a single e-mail account as transparently as possible. This means, for example, that the users of the external e-mail terminals 104, when sending or receiving e-mail, do not need to know if the user of the host system 100 actually uses the host system 100 or the mobile terminal 102 to communicate via e-mail. The transparency also means that e-mail manipulation at the mobile terminal 102 has, as far as possible, the same effect as the corresponding e-mail manipulation at the host system 100. For

example, e-mail messages read at the mobile terminal 102 should preferably be marked as read at the host system.

[0022] Reference numeral 106 denotes a data network, such as an IP (Internet Protocol) network, which may be the common Internet or its closed subnetworks, commonly called intranets or extranets. Reference numeral 108 denotes an e-mail server and its associated database. The database stores an e-mail account, addressable by means of an e-mail address, that appears as a mailbox to the owner of the e-mail account. In order to communicate with mobile terminals 102, the data network 106 is connected, via a gateway 112 to an access network 114. The access network comprises a set of base stations 116 to provide wireless coverage over a wireless interface 118 to the mobile terminals 102.

[0023] Reference numeral 110 denotes a messaging centre that is largely responsible for providing the above-mentioned transparency between the host system 100 and the mobile terminal 102. The system architecture also comprises a connectivity function, whose task is to push e-mail messages to the mobile terminal. In the embodiment shown in FIG. 1, the connectivity function is considered a physically integral but logically distinct element of the messaging centre 110. Later, in connection with FIGS. 6 and 7, an enhanced embodiment will be described that explicitly assigns the security-related functions to the connectivity function and traffic-related functions to the messaging centre 110.

[0024] The mobile terminal 102 may be a pocket or laptop computer with a radio interface, a smart cellular telephone, or the like. Depending on implementation, the host system 100, if present, may have different roles. In some implementations the host system 100 is optional and may be a conventional office computer that merely acts as the mobile terminal user's principal computer and e-mail terminal. In other implementations the host system may act as a platform for a single user's connectivity function, in addition to being an office computer. In yet other implementations the host system 100 may comprise the connectivity function for several users. Thus it is a server instead of a normal office computer.

[0025] We assume here that the access network 114 is able to establish and maintain a tunnel

120 between the messaging centre 110 and the mobile terminal 102. For instance, the tunnel may be set up using GPRS Tunneling Protocol (GTP) or its later derivatives, or any other suitable tunneling protocol.

[0026] In a real system, there are naturally a large number of mobile terminals 102 and tunnels 120. In order to keep track of which e-mail account and which tunnel belongs to which mobile terminal, the messaging centre 110 maintains an association 122 for each mobile terminal supported by it. Each association 122 joins three fields, namely an e-mail address 122A assigned to the mobile terminal or its user, encryption information 122C and a temporary wireless identity 122D of the mobile terminal in the access network. The embodiment shown in FIG. 1 also employs a terminal identifier 122B which may be the same as the e-mail address 122A of the mobile terminal 102, in which case the association 122 actually associates three information items. Alternatively, the terminal identifier 122B may be an identifier arbitrarily assigned to the mobile terminal. In a preferred implementation the terminal identifier 122B is the mobile terminal's equipment identifier or its derivative. The encryption information 122C will be generated by the mobile terminal, as described later in connection with FIG. 2. The temporary wireless identity 122D may be the identifier of the tunnel to the mobile station. Of course, the tunnel identifier is not permanent and is only known when a tunnel exists. The creation and use of the association 122 will be further described in connection with FIGS. 2, 3 and 6.

[0027] FIG. 2 shows provisioning of an e-mail system in a system as shown in FIG. 1. The e-mail provisioning phase comprises the following steps. In a preparatory step (not shown), appropriate e-mail software is installed in the host system 100 (if present) and mobile terminal 102, as well as in the e-mail server 108. For instance, the host system 100, the mobile terminal 102 and the e-mail server 108 may comprise and execute conventional e-mail software, such as Microsoft.RTM. Outlook, which may be augmented by inventive client software that will be described in more detail whenever necessary.

[0028] After the software installation, the next task is to create a secure binding between the connectivity function and the mobile terminal 102. The idea is to ensure that, in addition to the host system 100, only the mobile terminal 102 used in the binding process can be used to access

and manipulate e-mail addressed to the mobile terminal's e-mail address. The binding operation faces two types of security risks. First, the communication used during binding must be secured against eavesdropping or other types of hacking. Second, the only the user of the bound terminal 102 may access e-mail addressed to the e-mail address. The eavesdropping problem is not trivial in a phase in which no trust exists between the mobile terminal 102 and the rest of the system. Yet another problem is that the e-mail server 108 and the messaging centre 110 typically have user interfaces that are only accessible to dedicated support persons.

[0029] FIG. 2 shows a secure e-mail provisioning technique in which the host system 100 authenticates the user of the mobile terminal 102. In step 2-1 the client software in the mobile terminal 102 generates and displays a service activation code. In step 2-2 the host system 100 authenticates the person who enters the service activation code. Instead of a dedicated authentication step, the technique may rely on the authentication of the underlying e-mail system, such as user name and password combination. After all, the e-mail provisioning need not be more secure than the underlying e-mail system. In step 2-3 the service activation code is then conveyed off-line to the host system 100. The idea of the off-line communication is to eliminate any chance of eavesdropping before secure a communication channel can be established. For instance, the service activation code may be entered manually or via a local connection, such as a wired or optical interface or a short-range wireless interface, such as Bluetooth.TM.. Finally, in step 2-4, the mobile terminal's service activation code is registered with the connectivity function in the messaging centre 110.

[0030] The service activation code is closely related to an encryption key to be used in future communications between the connectivity function in the messaging centre 110 and the mobile terminal 102. The service activation code and the encryption key may be identical, or one may be a subset of the other, or the encryption key may be derived from the service activation code by means of some, preferably unpublished, algorithm. The fact that the service activation code and the encryption key are closely related to each other ensures that the terminal used in the authentication process is the terminal used to access the e-mail service afterwards.

[0031] Thus the idea of conveying the service activation code to the messaging centre 110 via

the host system 100 solves both the security-related and user interface-related problems mentioned above. If there is no host system 100 that can authenticate the mobile terminal and its user. Instead, the user may enter the provisioning data to the connectivity function via some suitable connection. The provisioning data entered by the user may be checked by sending a trial e-mail message and attempting to read it. If the check succeeds, it is regarded as the authentication. Yet another way is to convey the service activation code to a dedicated support person who performs the authentication (eg by recognizing the person's face or voice) and enters the service activation code into the connectivity function in the messaging centre 110. The messaging centre/connectivity function 110 now stores an association (item 122 in FIG. 1) between the e-mail address 122A and encryption information 122C.

[0032] FIG. 3 shows a hypothetical scenario in which the e-mail system is used. This scenario comprises four events, which are delineated by thick dashed lines. The first event, steps 3-10 through 3-16, relate to incoming e-mail. In step 3-10 the external e-mail terminal 104 sends an e-mail message to the e-mail server 108. The e-mail message is addressed to the user of the host system 100. Accordingly, a notification of the incoming e-mail is sent to the host system 100, but that step is omitted from FIG. 3 as purely conventional. In step 3-11 the mobile terminal 102 requests the access network to establish a tunnel between itself and the messaging centre 110. Step 3-11 may take place before or after step 3-10. After the tunnel establishment, the messaging centre 110 now stores a complete association triplet (item 122 in FIG. 1) that joins the e-mail address 122A of the host system 100, the service activation code 122C of the mobile terminal 102 and the tunnel identifier 122D of the tunnel to the mobile terminal 102.

[0033] In step 3-12 the messaging centre 110 detects and retrieves the incoming e-mail from the e-mail server 108. For instance, the messaging centre 110 may regularly poll the e-mail server 108 or it may register itself as a listener to the e-mail server. In step 3-13 the messaging centre 110 encrypts, and optionally packs, the e-mail message or parts of it. For instance, the messaging centre 110 may omit the destination address of the e-mail message because it is self-evident that the e-mail message is addressed to the user of the host system 100, who is also the user of the mobile terminal 102. The messaging centre 110 may also omit all attachments or large attachments, up to some threshold size, from the e-mail message to be conveyed to the mobile



terminal. The encryption process uses the mobile terminal's service activation code 122C, or its derivative, as the encryption key. In step 3-14 the messaging centre 110 transmits the encrypted and packed e-mail to the mobile terminal that decrypts and unpacks it in step 3-15. The messaging centre 110 knows the correct encryption key (service activation code) 122C and the tunnel identifier 122D on the basis of the association triplet 122.

[0034] In step 3-16 the mobile terminal 102 sends the messaging centre 110 an automatic control message indicating that the user has read the e-mail message. In response to the control message, the messaging centre 110 signals the e-mail server 108 to mark the e-mail message as read in step 3-17, which act the e-mail server performs in step 3-18. The control message comprises some identification of the e-mail message but not its contents, whereby it loads the radio interface only lightly. A benefit of the control message is that the user, when beginning to use the host system 100, immediately sees which messages he/she has already read and does not have to read them twice.

[0035] Next in this scenario, the user decides that the e-mail message needs further attention when he/she is at the host system 100. The user may initiate another control message 3-22 that causes the previously read message to be marked as unread at the e-mail server in step 3-22.

[0036] The next phase, steps 3-30 through 3-34, relates to e-mail message generation at the mobile terminal 102. We assume here, that the e-mail message to be generated is a reply message to the incoming message described above (steps 3-10 to 3-17), but the operation is very similar if the message to be generated is an original (non-reply) message. In step 3-30 the mobile terminal user generates a reply message. Since it is a reply message, its recipient is automatically the sender of the incoming message, and the subject field comprises the original subject with a prefix of "RE:" or something similar. If the message is not a reply message, the user will have to fill in the recipient and subject fields. In step 3-31 the client software at the mobile terminal 102 encrypts, and optionally packs, the outgoing e-mail message and transmits it via the tunnel to the messaging centre 110. The messaging centre 110 does not immediately know the sender of the e-mail message or the required decryption key. But the messaging centre 110 does know the identifier of the tunnel 120, and it employs the association triplet 122 to retrieve the decryption

key 122C and the mobile terminal user's e-mail address 122A. The latter is not included in the e-mail message transmitted over the wireless interface 118 in order to load the wireless interface as little as possible. In step 3-32, the messaging centre 110 employs the decryption key 122C to decrypt the e-mail message. It also inserts the mobile terminal user's e-mail address 122A, which is the same as the host system's e-mail address because they share the same e-mail account. In step 3-33 the messaging centre 110 signals the e-mail server 108 to send a conventional reply message. In step 3-34 the e-mail server 108 stores a copy of the message in its "sent items" folder. Because the messaging centre 110 signals the e-mail server 108 to send a conventional reply message, the recipient of the message has no way of knowing that the user actually used the mobile terminal to initiate the message, and the desired transparency is achieved. A benefit of the transparency is that when the external terminal 104 sends a further reply, its user does not need to decide whether to send the reply to the host system or to the mobile terminal.

[0037] The final phase, steps 3-41 to 3-43, relate to deletion of an e-mail message. In response to the mobile terminal user's deletion command, the mobile terminal 102 sends a control message in step 3-41 to the messaging centre 110. In step 3-42 it signals the e-mail server 108 to delete the message, and in step 3-43 the message is moved to the "deleted items" folder, again achieving complete transparency between the host system and the mobile terminal.

[0038] As a further example of control messages, the user of the mobile terminal 102 may wish to explicitly move an e-mail message to a particular folder. In this case the signalling is analogous to steps 3-41 to 3-43, except that the message is not deleted but moved to a different folder. Only the control message has to be sent via the wireless interface, not the actual e-mail message.

[0039] FIG. 4 shows information flows in mobile-terminated e-mail transmission. Reference numeral 400 denotes an e-mail message as it appears on the fixed network side of the wireless interface 118. The e-mail message 400 is sent by an external e-mail terminal 104 and processed by the host system 100, the e-mail server 108 and/or the messaging centre 110. For the purposes of this description it comprises a source address field 401, a destination address field 402, a subject field 403, a message body field 404 and, optionally, one or more attachments 405. There

may be other fields, such as cc (carbon copy) or bcc (blind carbon copy) but they can be ignored in this discussion.

[0040] The messaging centre 110 comprises an encryption and packing logic 422 that encrypts, and optionally packs (compresses), most of the fields of the e-mail message 400. However, the destination address field 402 is not processed because the mobile terminal will generate it internally. The mobile terminal comprises a decryption and unpacking logic 424 whose operation is inverse to the encryption and packing logic 422.

[0041] It is also advantageous to implement a filtering logic 430 that filters out attachments that exceed a threshold size, which is preferably user-settable. This means that the user is able to set an upper limit for attachments that will be sent to the mobile terminal. Omitting attachments saves resources in the wireless interface and the mobile terminal. Instead of filtering long attachments, or in addition to it, the filtering logic 430 may be configured to cut out portions of an e-mail message body that exceeds a threshold size. Reference numeral 410 denotes the e-mail message as received and processed by the mobile terminal. Instead of size-based filtering, or in addition to it, the filtering logic may employ type-based filtering that filters out attachment types that the mobile terminal is not able to process. For instance, if the mobile terminal does not have a suitable codec for certain types of video clips, it is pointless to send such video clips to the mobile terminal.

[0042] FIG. 5 shows information flows in mobile-originated e-mail transmission. Reference numeral 500 denotes an e-mail message generated at the mobile terminal in response to a user input received via the terminal's user interface. The e-mail message 500 is encrypted, and optionally packed, by an encryption and packing logic 522 that operates similarly to the logic 422 in the messaging centre. Reference numeral 510 denotes the same e-mail message after processing by a decryption and unpacking logic 524 that reverses the encryption and packing by the logic 522.

[0043] The information flows in FIG. 5 are largely analogous to those in FIG. 4, and a detailed description is omitted. However, in this direction the source address, instead of the destination

address, is omitted from the packet sent over the wireless interface. In either direction, the e-mail address shared between the host system 100 and the mobile terminal 102 is not transmitted over the wireless interface. Another difference to FIG. 4 is absence of the size/type-based filtering logic 430, because in mobile-originated messages the user can each time make the decision whether or not to include attachments.

[0044] FIG. 6 shows an enhanced embodiment in which some of the functions of the messaging centre are performed by a separate connectivity function. In the embodiments described so far the messaging centre 110 was responsible for data security issues and traffic coordination to/from the access network. In the embodiment shown in FIG. 6 a dedicated connectivity function 600 is responsible for the data security issues. FIG. 6 shows an arrangement in which the connectivity function 600 is physically attached to or co-located with the messaging centre 110, but they are logically separate elements. Indeed, a definite advantage of the separate connectivity function 600 is that it can be detached from the messaging centre, for instance, within the company that owns the host system 100 or the e-mail server 108. For a small number of users, the connectivity function 600 can be installed in each host system 100, or the host system 100 can be interpreted as a separate server configured to support multiple users. It is even possible to implement some or all the above-mentioned options. This means, for example, that there is one or more messaging centres 110 that offer services to several network operators, or they may be a dedicated messaging centre for each network operator (somewhat analogous to short messaging centres). Each messaging centre 110 may have an integral connectivity function 600 to support users who don't wish to install a separate connectivity function in a host system 100. For users who do install a separate connectivity function 600 in their host systems 100, such connectivity functions bypass the connectivity function in the messaging centre 110 and address the messaging centre 110 directly.

[0045] In the embodiment shown in FIGS. 1 to 3, the messaging centre maintained an association 122 that joined the e-mail address 122A, terminal identifier 122B (which may or may not be the same as the e-mail address), encryption information 122C and the temporary wireless identity 122D of the mobile terminal. In the embodiment shown in FIGS. 6 and 7, the association is split into two, such that the connectivity function 600 maintains a first association 610 between

the e-mail address 122A, terminal identifier 122B and the encryption information 122C, while the messaging centre 110 maintains a second association 612 between the terminal identifier 122B (or e-mail address 122A) and the temporary wireless identity 122D of the mobile terminal. Thus in this embodiment the messaging centre 110 does not know or need to know the encryption information 122C, which means that it only forwards traffic without being able to interpret it.

[0046] A further change caused by the separation (at least logical and, optionally, physical separation) of the connectivity function 600 from the messaging centre 110 is the fact that in step 2-4 of FIG. 2, the mobile terminal's activation code (or any encryption information based on it) is not delivered to the messaging centre 110 but to the connectivity function 600.

[0047] FIG. 7 shows traffic flow in the embodiment shown in FIG. 6. An extensive messaging scenario was described in connection with FIG. 3, and the description of FIG. 7 is restricted to the differences caused by the separate connectivity function. In step 7-10, the e-mail server 108 sends an incoming e-mail message to the connectivity function 600 (cf. steps 3-10 and 3-12 in FIG. 3). In step 7-11, the connectivity function 600 encrypts, and optionally packs, the e-mail message. The packing comprises one or more of the following: data compression, omission of redundant fields, omission of long attachments and shortening message bodies (cf. step 3-13 in FIG. 3 and items 422 and 430 in FIG. 4). In step 7-12, the connectivity function 600 sends the encrypted and packed e-mail message to the messaging centre 110. Up to this point, the recipient of the e-mail message has been identified based on the e-mail address 122A. In step 7-13, the messaging centre 110 forwards the encrypted and packed e-mail message via the access network to the mobile terminal, but in this step the recipient of the e-mail message is identified based on the temporary wireless identity 122D of the mobile terminal. In step 7-14 the mobile terminal decrypts and unpacks the e-mail message. The unpacking comprises data decompression and/or regeneration of redundant fields (cf. step 3-15 in FIG. 3 and item 424 in FIG. 4). Steps 7-20 through 7-25 relate to mobile-originated e-mail transmission, and the steps performed are self-explanatory based on the above descriptions.

[0048] As shown on the bottom row of FIG. 7, between the e-mail server 108 and the

455/006/8 UTIL

connectivity function 600, traffic is identified based on the e-mail address 122A. Between the connectivity function 600 and the messaging centre 110 traffic is identified based on the terminal identifier 122B. Finally, between the messaging centre 110 and the mobile terminal 102, traffic is identified based on the temporary wireless identity 122D, such as the tunnel identifier, TLLI or TMSI.

[0049] It is readily apparent to a person skilled in the art that, as the technology advances, the inventive concept can be implemented in various ways. The invention and its embodiments are not limited to the examples described above but may vary within the scope of the claims.

455/006/8 UTIL

CLAIMS:

We claim:

1. A method for forwarding an e-mail message from an e-mail server to a mobile terminal, the method comprising:

wherein an e-mail address of the mobile terminal is associated with an identifier and encryption information, receiving the e-mail message associated with the e-mail address and sent by the e-mail server.

455/006/8 UTIL

ABSTRACT

A method for forwarding an e-mail message from an e-mail server to a mobile terminal is provided. An e-mail address of the mobile terminal is associated with an identifier and encryption information, receiving the e-mail message associated with the e-mail address and sent by the e-mail server. The method includes encrypting the e-mail message using the encryption information associated with the e-mail address and transmitting the encrypted e-mail message to the mobile terminal.



## Electronic Patent Application Fee Transmittal

<b>Application Number:</b>					
<b>Filing Date:</b>					
<b>Title of Invention:</b>	MESSAGING CENTRE FOR FORWARDING E-MAIL				
<b>First Named Inventor/Applicant Name:</b>	Ari Backholm				
<b>Filer:</b>	Justin Robert Nifong				
<b>Attorney Docket Number:</b>	455/006/8 UTIL				
Filed as Small Entity					
<b>Filing Fees for Utility under 35 USC 111(a)</b>					
<b>Description</b>	<b>Fee Code</b>	<b>Quantity</b>	<b>Amount</b>	<b>Sub-Total in USD(\$)</b>	
<b>Basic Filing:</b>					
Utility filing Fee (Electronic filing)	4011	1	70	70	
Utility Search Fee	2111	1	300	300	
Utility Examination Fee	2311	1	360	360	
<b>Pages:</b>					
<b>Claims:</b>					
<b>Miscellaneous-Filing:</b>					
<b>Petition:</b>					
<b>Patent-Appeals-and-Interference:</b>					

Description	Fee Code	Quantity	Amount	Sub-Total in USD(\$)
<b>Post-Allowance-and-Post-Issuance:</b>				
<b>Extension-of-Time:</b>				
<b>Miscellaneous:</b>				
<b>Total in USD (\$)</b>				<b>730</b>

## Electronic Acknowledgement Receipt

<b>EFS ID:</b>	21349859
<b>Application Number:</b>	14609189
<b>International Application Number:</b>	
<b>Confirmation Number:</b>	5037
<b>Title of Invention:</b>	MESSAGING CENTRE FOR FORWARDING E-MAIL
<b>First Named Inventor/Applicant Name:</b>	Ari Backholm
<b>Customer Number:</b>	118194
<b>Filer:</b>	Justin Robert Nifong
<b>Filer Authorized By:</b>	
<b>Attorney Docket Number:</b>	455/006/8 UTIL
<b>Receipt Date:</b>	29-JAN-2015
<b>Filing Date:</b>	
<b>Time Stamp:</b>	18:06:02
<b>Application Type:</b>	Utility under 35 USC 111(a)

### Payment information:

Submitted with Payment	yes
Payment Type	Credit Card
Payment was successfully received in RAM	\$730
RAM confirmation Number	5106
Deposit Account	506191
Authorized User	NIFONG, JUSTIN

The Director of the USPTO is hereby authorized to charge indicated fees and credit any overpayment as follows:

Charge any Additional Fees required under 37 C.F.R. Section 1.16 (National application filing, search, and examination fees)

Charge any Additional Fees required under 37 C.F.R. Section 1.17 (Patent application and reexamination processing fees)

Charge any Additional Fees required under 37 C.F.R. Section 1.19 (Document supply fees)  
 Charge any Additional Fees required under 37 C.F.R. Section 1.20 (Post Issuance fees)  
 Charge any Additional Fees required under 37 C.F.R. Section 1.21 (Miscellaneous fees and charges)

**File Listing:**

Document Number	Document Description	File Name	File Size(Bytes)/ Message Digest	Multi Part /.zip	Pages (if appl.)
1	Application Data Sheet	455-006-8-ADS.pdf	1562132 <small>c2ebde06eafa08852f21b83695ef2e21d1e4e850</small>	no	9
<b>Warnings:</b>					
<b>Information:</b>					
2	Drawings-only black and white line drawings	455-006-8-dwgs.pdf	103842 <small>691e3487b0d933761d901e95ba093a887e419428</small>	no	4
<b>Warnings:</b>					
<b>Information:</b>					
3	Oath or Declaration filed	455-006-8-decs.pdf	8225547 <small>63d75406e3d36363acdeb2bf239b638bc6716ff1e6</small>	no	9
<b>Warnings:</b>					
The page size in the PDF is too large. The pages should be 8.5 x 11 or A4. If this PDF is submitted, the pages will be resized upon entry into the Image File Wrapper and may affect subsequent processing					
<b>Information:</b>					
4		455-006-8-util.pdf	123392 <small>8a2071290be8238a3ad8279b75c421ef47c349a7</small>	yes	16
	<b>Multipart Description/PDF files in .zip description</b>				
	<b>Document Description</b>	<b>Start</b>	<b>End</b>		
	Specification	1	14		
	Claims	15	15		
	Abstract	16	16		
<b>Warnings:</b>					
<b>Information:</b>					
5	Fee Worksheet (SB06)	fee-info.pdf	35215 <small>9afb9a2a56fc3cf922830e1ac9111dba63cd33c</small>	no	2
<b>Warnings:</b>					
<b>Information:</b>					
<b>Total Files Size (in bytes):</b>			10050128		

**This Acknowledgement Receipt evidences receipt on the noted date by the USPTO of the indicated documents, characterized by the applicant, and including page counts, where applicable. It serves as evidence of receipt similar to a Post Card, as described in MPEP 503.**

**New Applications Under 35 U.S.C. 111**

**If a new application is being filed and the application includes the necessary components for a filing date (see 37 CFR 1.53(b)-(d) and MPEP 506), a Filing Receipt (37 CFR 1.54) will be issued in due course and the date shown on this Acknowledgement Receipt will establish the filing date of the application.**

**National Stage of an International Application under 35 U.S.C. 371**

**If a timely submission to enter the national stage of an international application is compliant with the conditions of 35 U.S.C. 371 and other applicable requirements a Form PCT/DO/EO/903 indicating acceptance of the application as a national stage submission under 35 U.S.C. 371 will be issued in addition to the Filing Receipt, in due course.**

**New International Application Filed with the USPTO as a Receiving Office**

**If a new international application is being filed and the international application includes the necessary components for an international filing date (see PCT Article 11 and MPEP 1810), a Notification of the International Application Number and of the International Filing Date (Form PCT/RO/105) will be issued in due course, subject to prescriptions concerning national security, and the date shown on this Acknowledgement Receipt will establish the international filing date of the application.**

Document code: WFEE

United States Patent and Trademark Office  
Sales Receipt for Accounting Date: 02/12/2015

MNGUYEN	SALE	#00000027	Mailroom Dt:	01/29/2015	506191	14609189
		01 FC : 2051		70.00 DA		