



US008363649B2

(12) **United States Patent**
Konda

(10) **Patent No.:** **US 8,363,649 B2**

(45) **Date of Patent:** ***Jan. 29, 2013**

(54) **FULLY CONNECTED GENERALIZED MULTI-LINK MULTI-STAGE NETWORKS**

(52) **U.S. Cl.** 370/388; 370/390; 370/419; 370/413

(58) **Field of Classification Search** 370/388, 370/389, 395.4, 462

See application file for complete search history.

(75) Inventor: **Venkat Konda**, San Jose, CA (US)

(73) Assignee: **Konda Technologies Inc.**, San Jose, CA (US)

(56) **References Cited**

U.S. PATENT DOCUMENTS

3,980,834	A *	9/1976	Akiyama et al.	379/327
5,724,352	A *	3/1998	Cloonan et al.	370/388
6,594,261	B1 *	7/2003	Boura et al.	370/389
2002/0031124	A1 *	3/2002	Li	370/390
2005/0078667	A1 *	4/2005	Brown	370/388
2011/0052191	A1 *	3/2011	Beshai	398/52

* cited by examiner

Primary Examiner — Dang Ton
Assistant Examiner — Mohamed Kamara

(*) Notice: Subject to any disclaimer, the term of this patent is extended or adjusted under 35 U.S.C. 154(b) by 297 days.

This patent is subject to a terminal disclaimer.

(21) Appl. No.: **12/601,274**

(22) PCT Filed: **May 22, 2008**

(86) PCT No.: **PCT/US2008/064604**

§ 371 (c)(1),
(2), (4) Date: **May 31, 2010**

(87) PCT Pub. No.: **WO2008/147927**

PCT Pub. Date: **Dec. 4, 2008**

(65) **Prior Publication Data**

US 2011/0044329 A1 Feb. 24, 2011

Related U.S. Application Data

(60) Provisional application No. 60/940,389, filed on May 25, 2007, provisional application No. 60/940,391, filed on May 25, 2007, provisional application No. 60/940,392, filed on May 25, 2007.

(51) **Int. Cl.**
H04L 12/50 (2006.01)

(57) **ABSTRACT**

A generalized multi-link multi-stage network comprising $(2 \times \log_2 N) - 1$ stages is operated in strictly nonblocking manner for unicast, also in rearrangeably nonblocking manner for arbitrary fan-out multicast when $s \geq 2$, and in strictly nonblocking manner for arbitrary fan-out multicast when $s \geq 3$, includes an input stage having N/d switches with each of them having d inlet links and $s \times d$ outgoing links connecting to second stage switches, an output stage having N/d switches with each of them having d outlet links and $s \times d$ incoming links connecting from switches in the penultimate stage. The network also has $(2 \times \log_2 N) - 3$ middle stages with each middle stage having N/d switches, and each switch in the middle stage has $s \times d$ incoming links connecting from the switches in its immediate preceding stage, and $s \times d$ outgoing links connecting to the switches in its immediate succeeding stage. Also each multicast connection is set up by use of at most two outgoing links from the input stage switch.

22 Claims, 125 Drawing Sheets

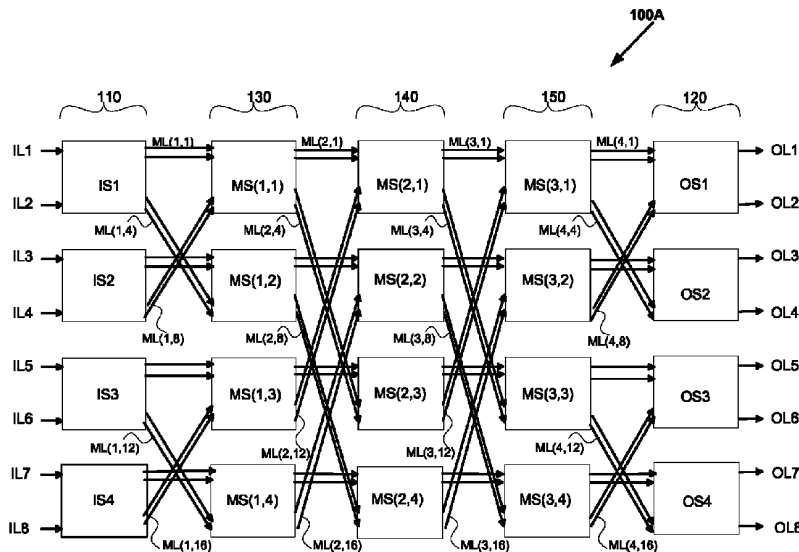

FIG. 1A

100A

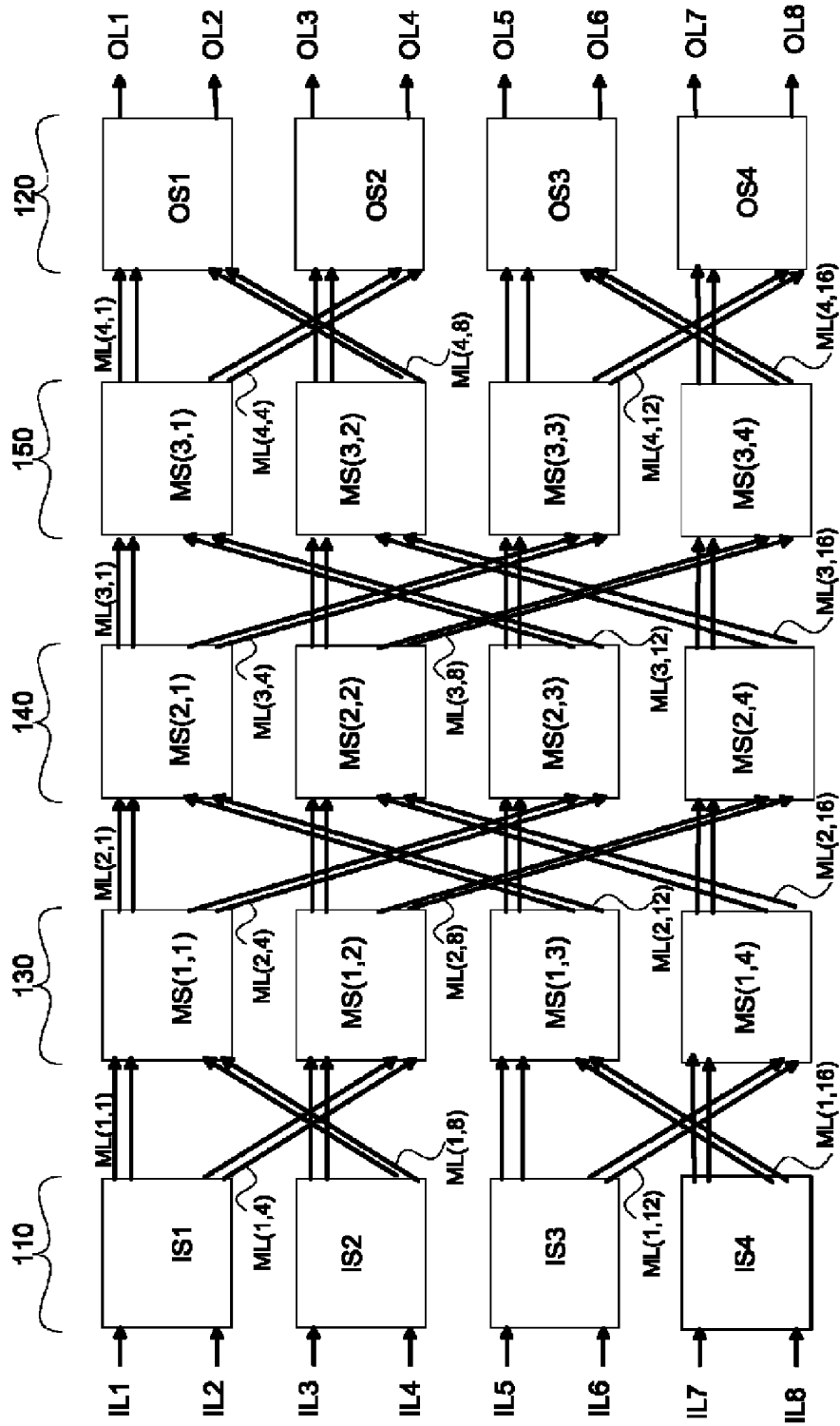

FIG. 1B

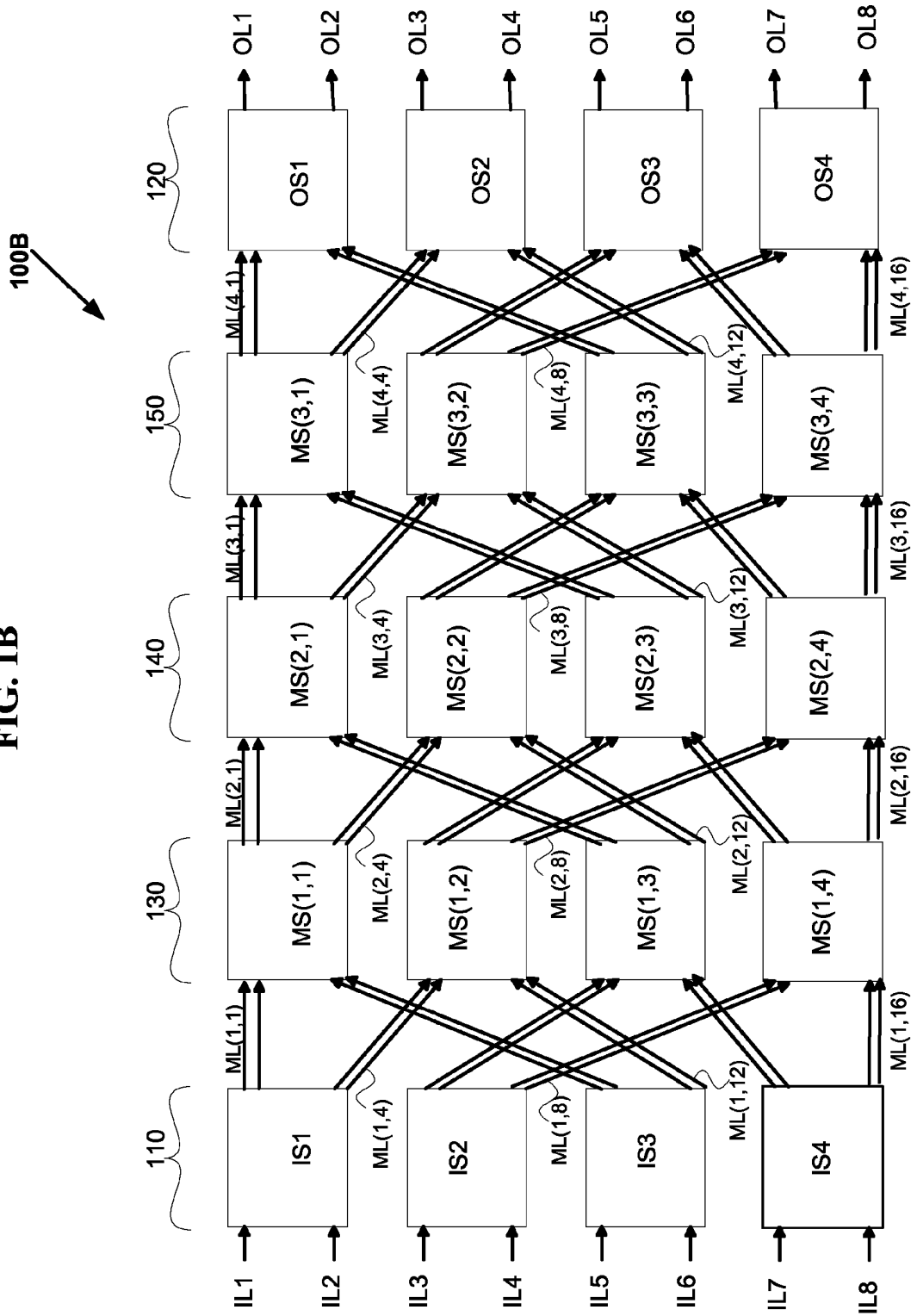

FIG. 1C

100C

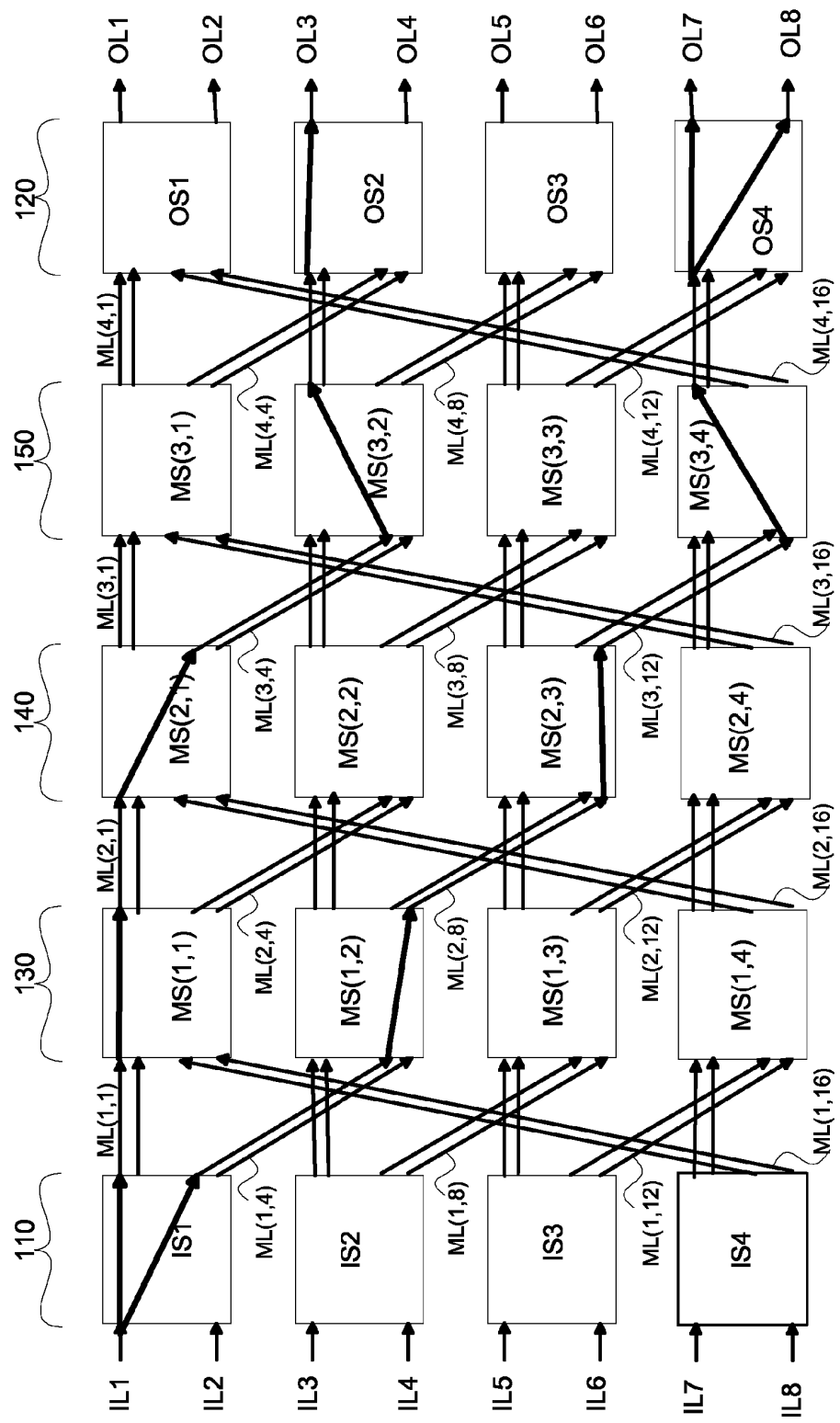

FIG. 1D

100D

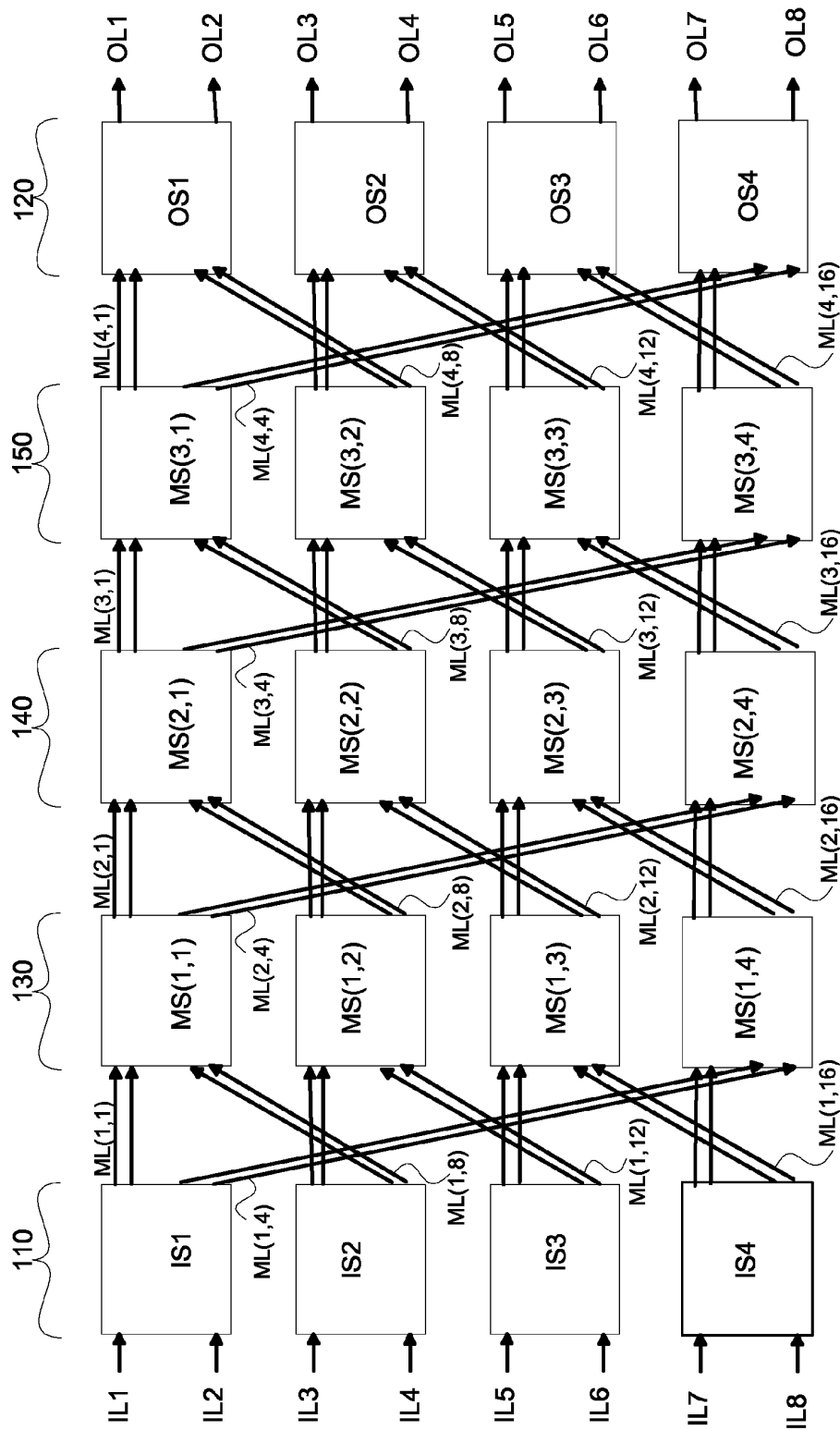

FIG. 1E

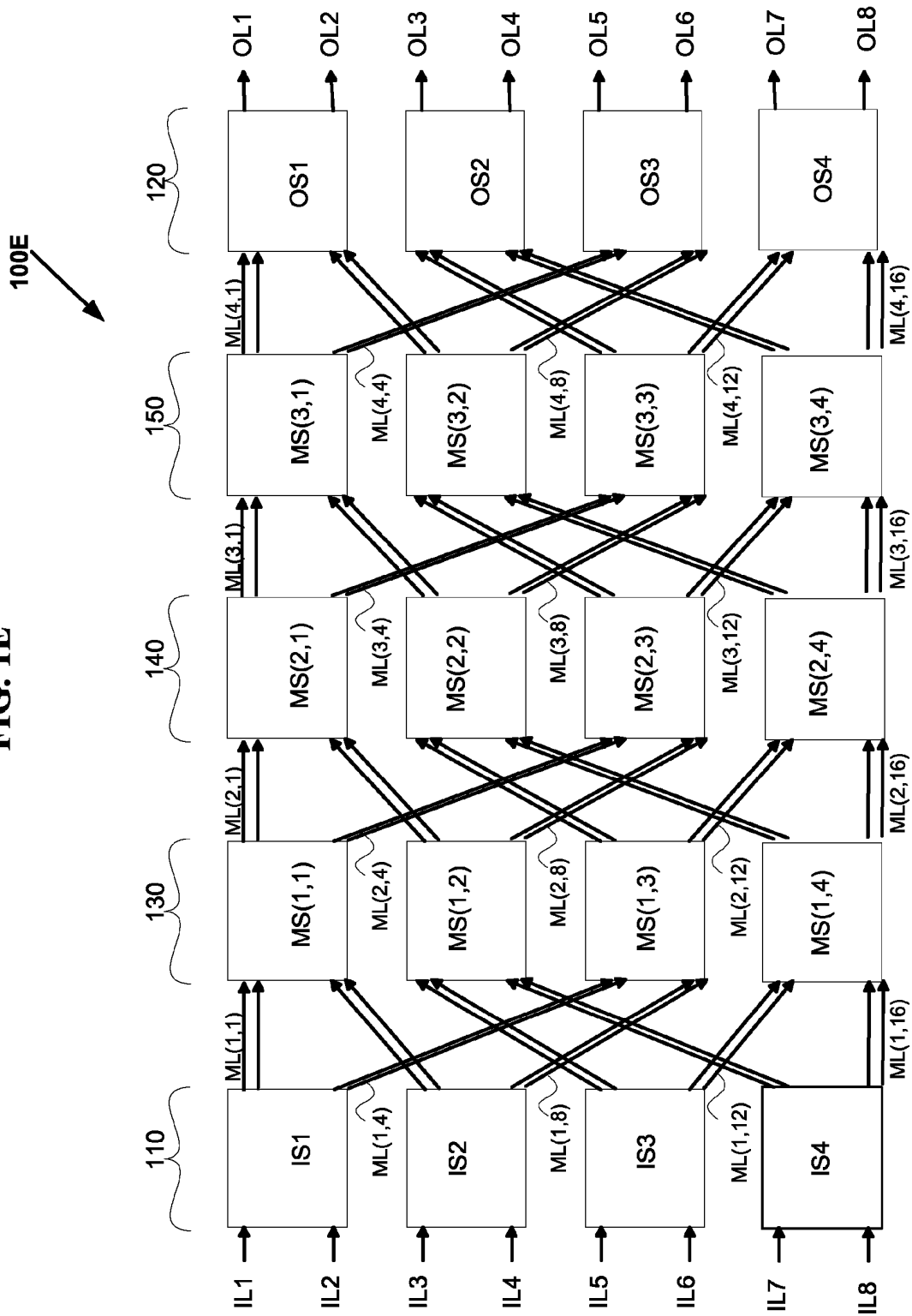

FIG. 1F

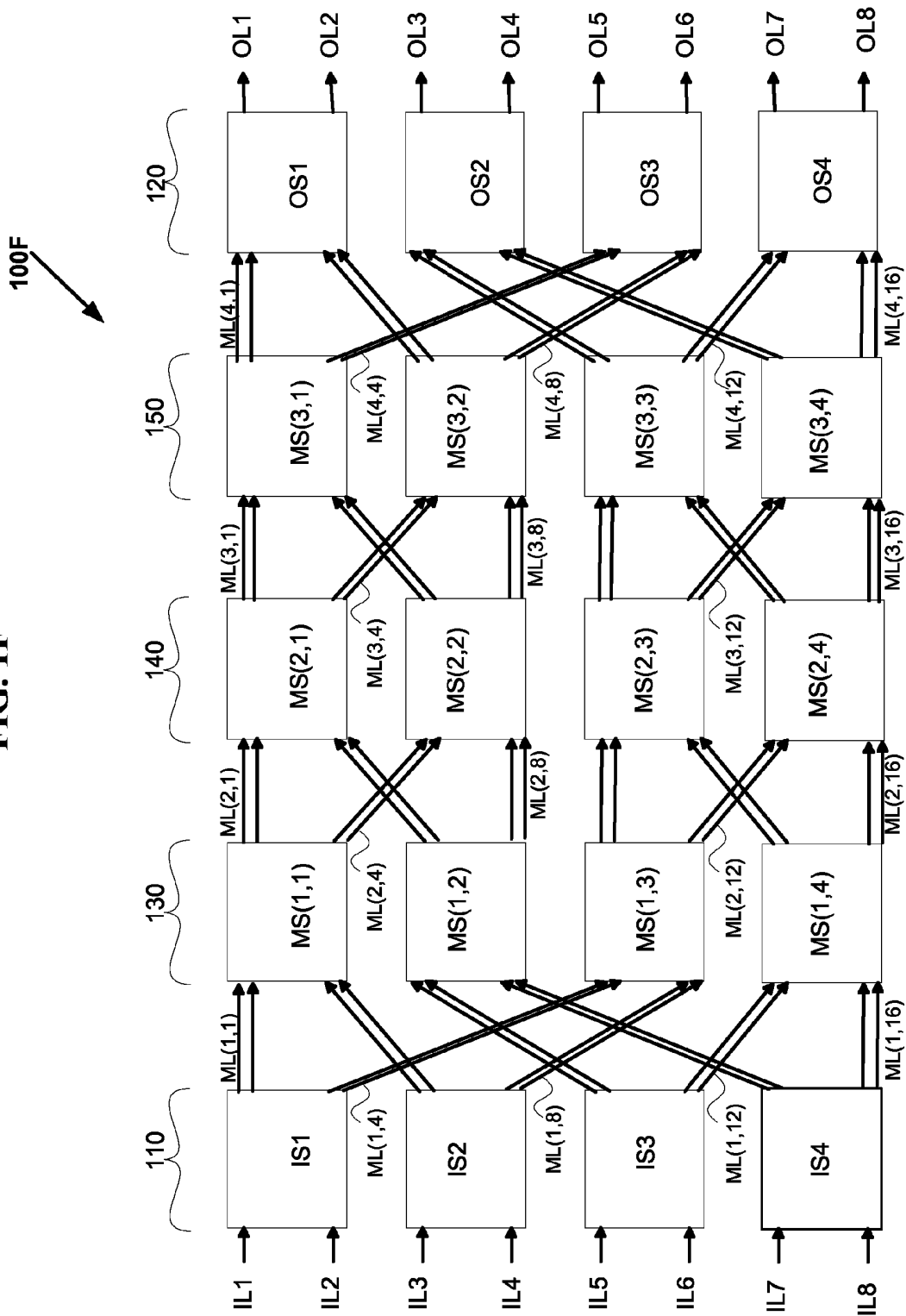

FIG. 1G

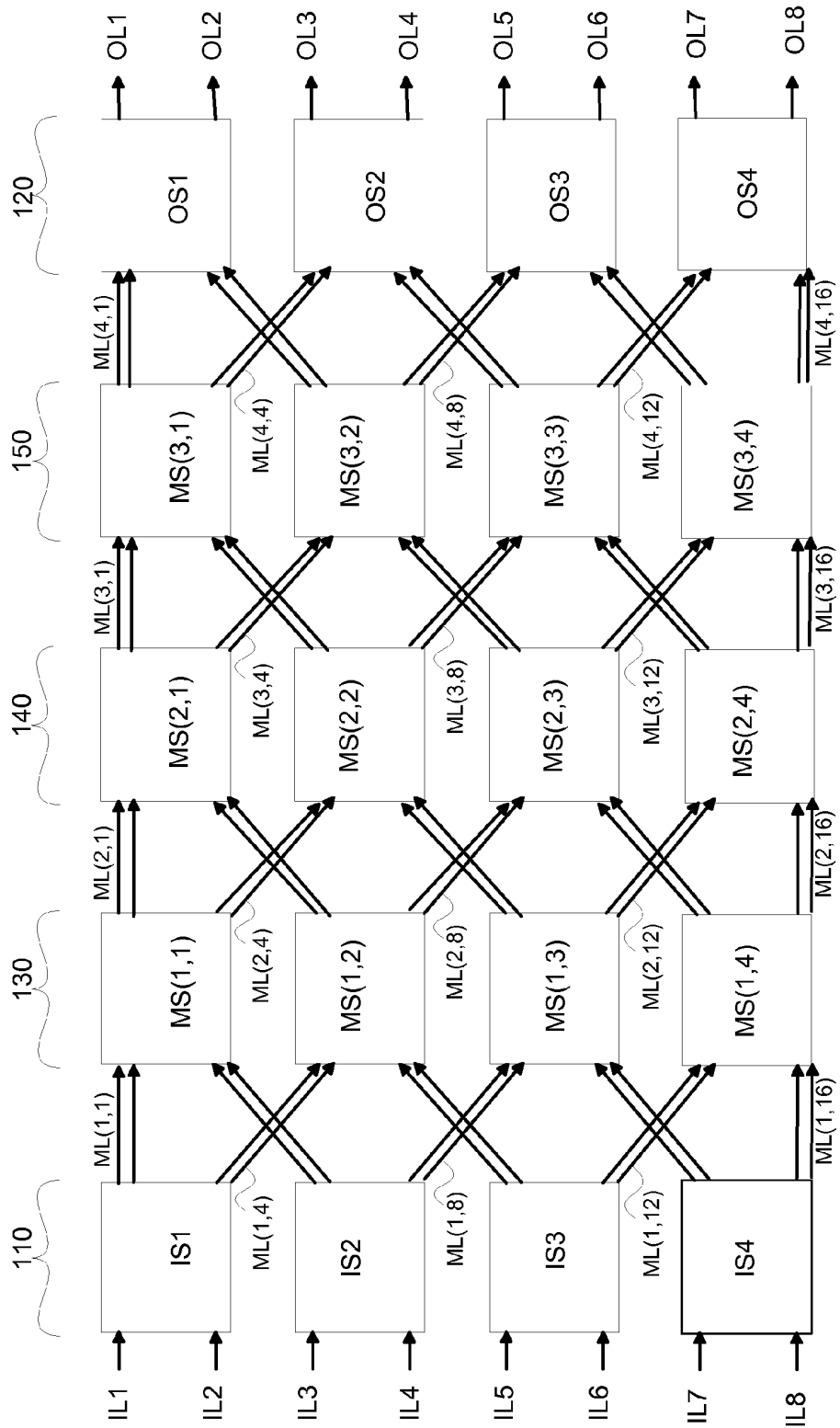
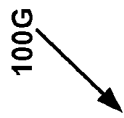

FIG. 1H

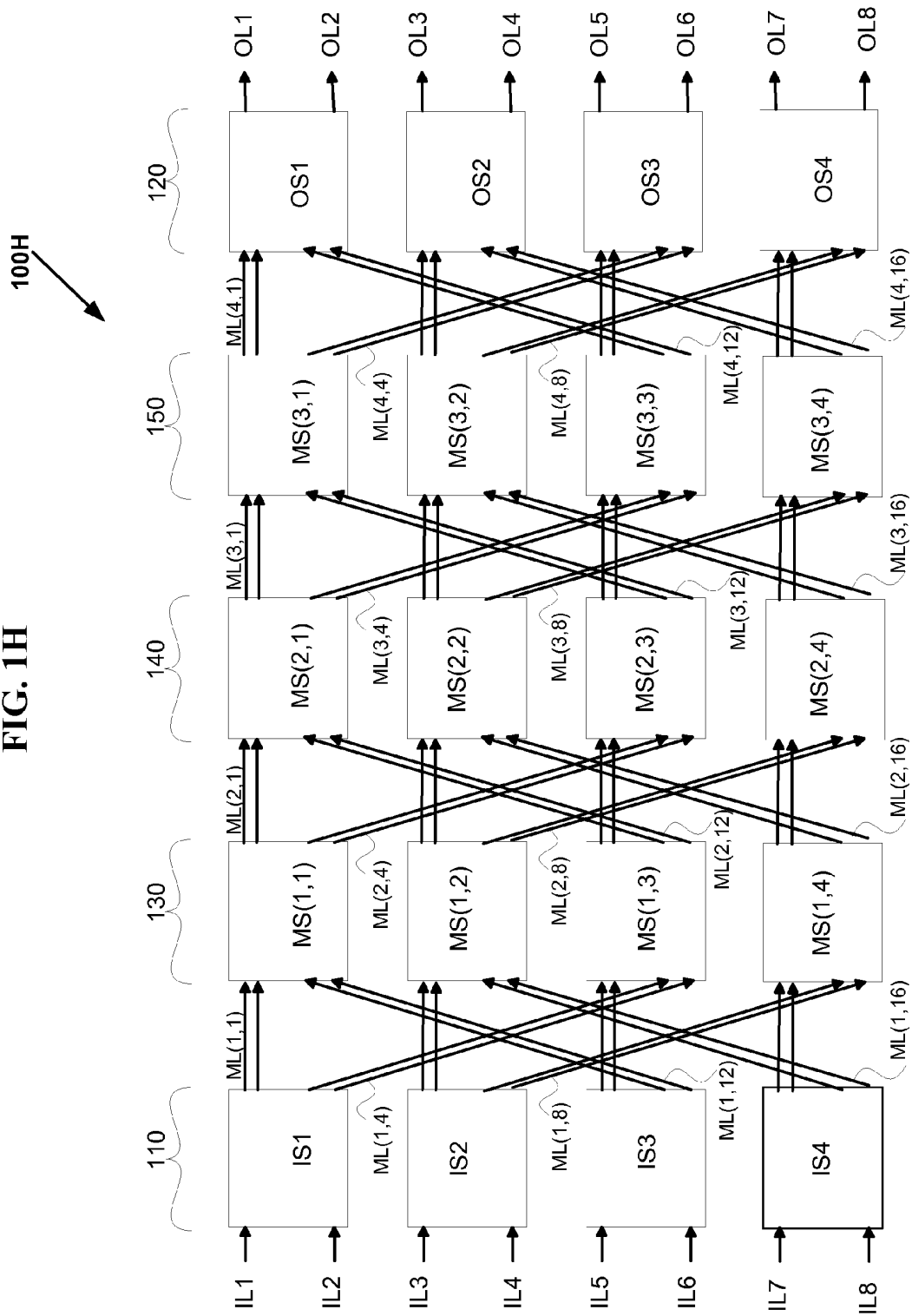

FIG. 1I

1001

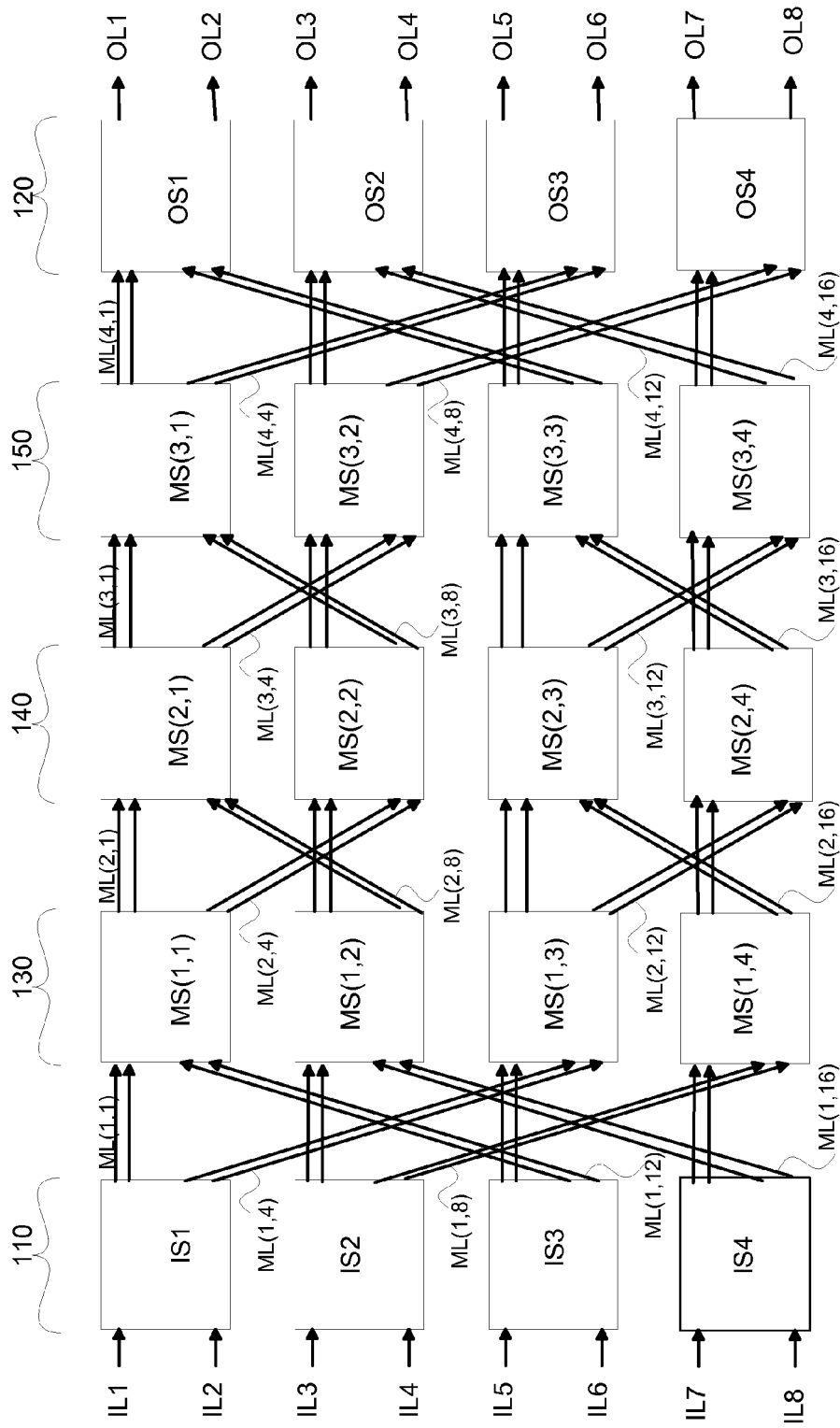

FIG. 1J

100J

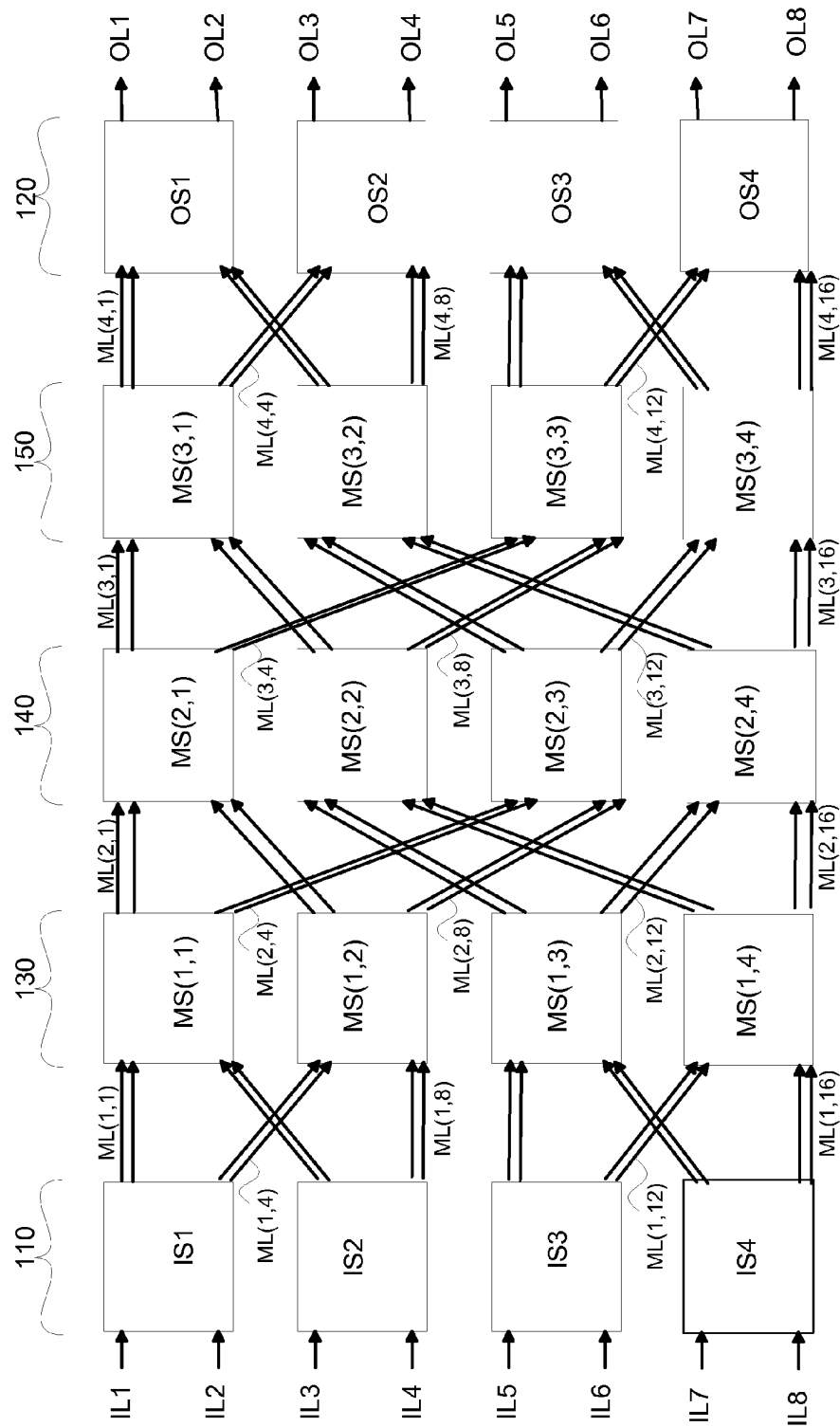

FIG. 1K

100K

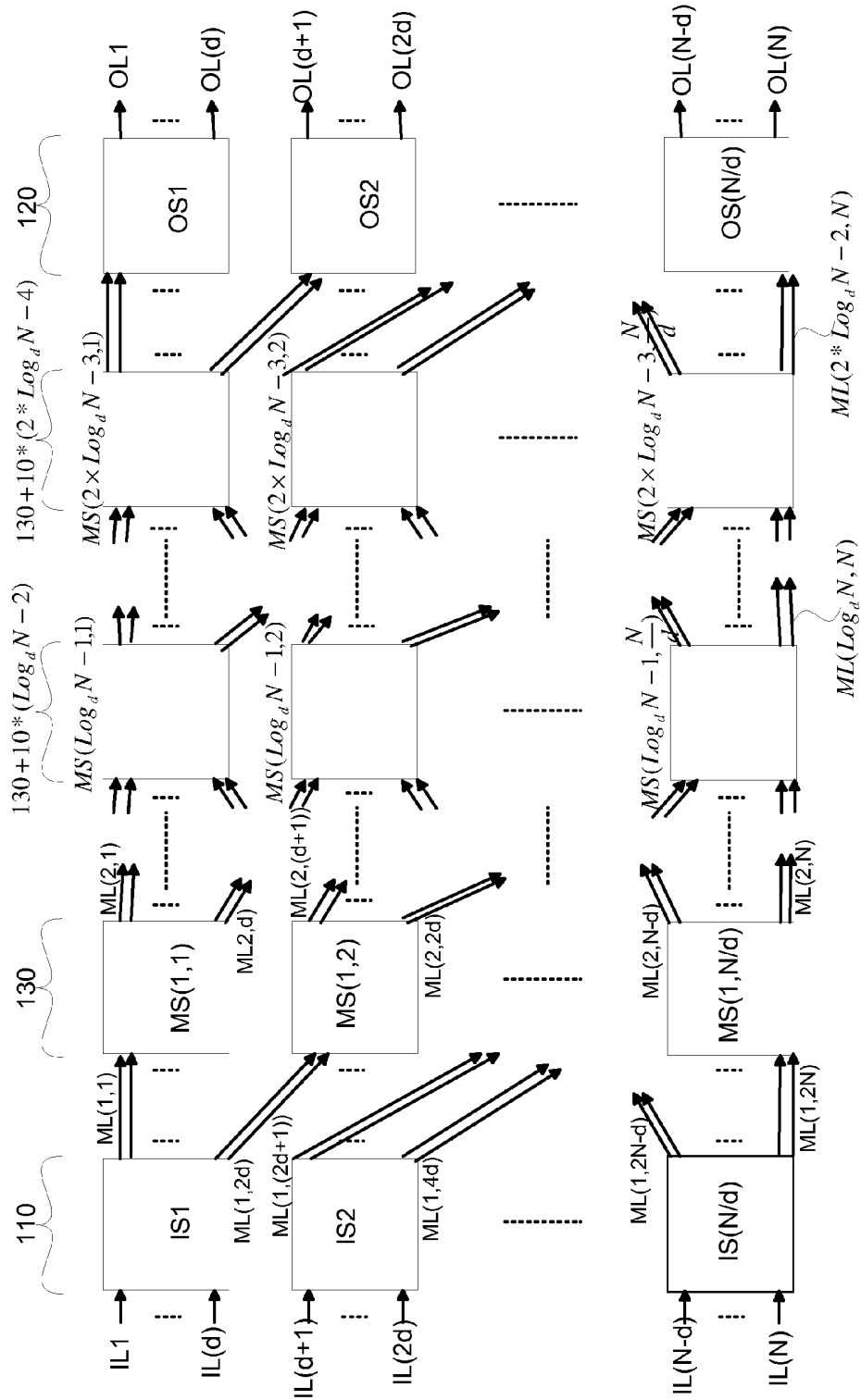

FIG. 1A1

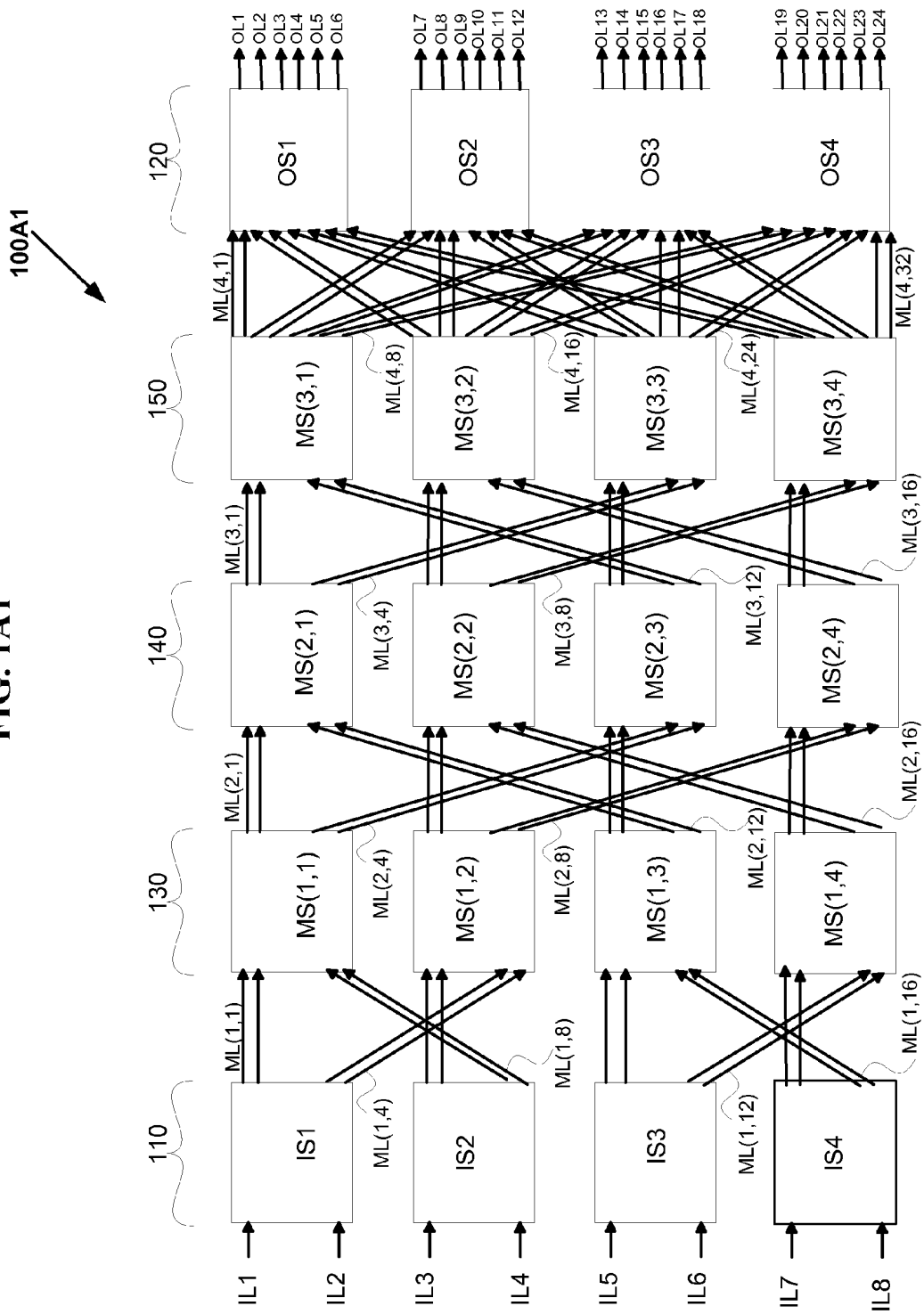

FIG. 1B1

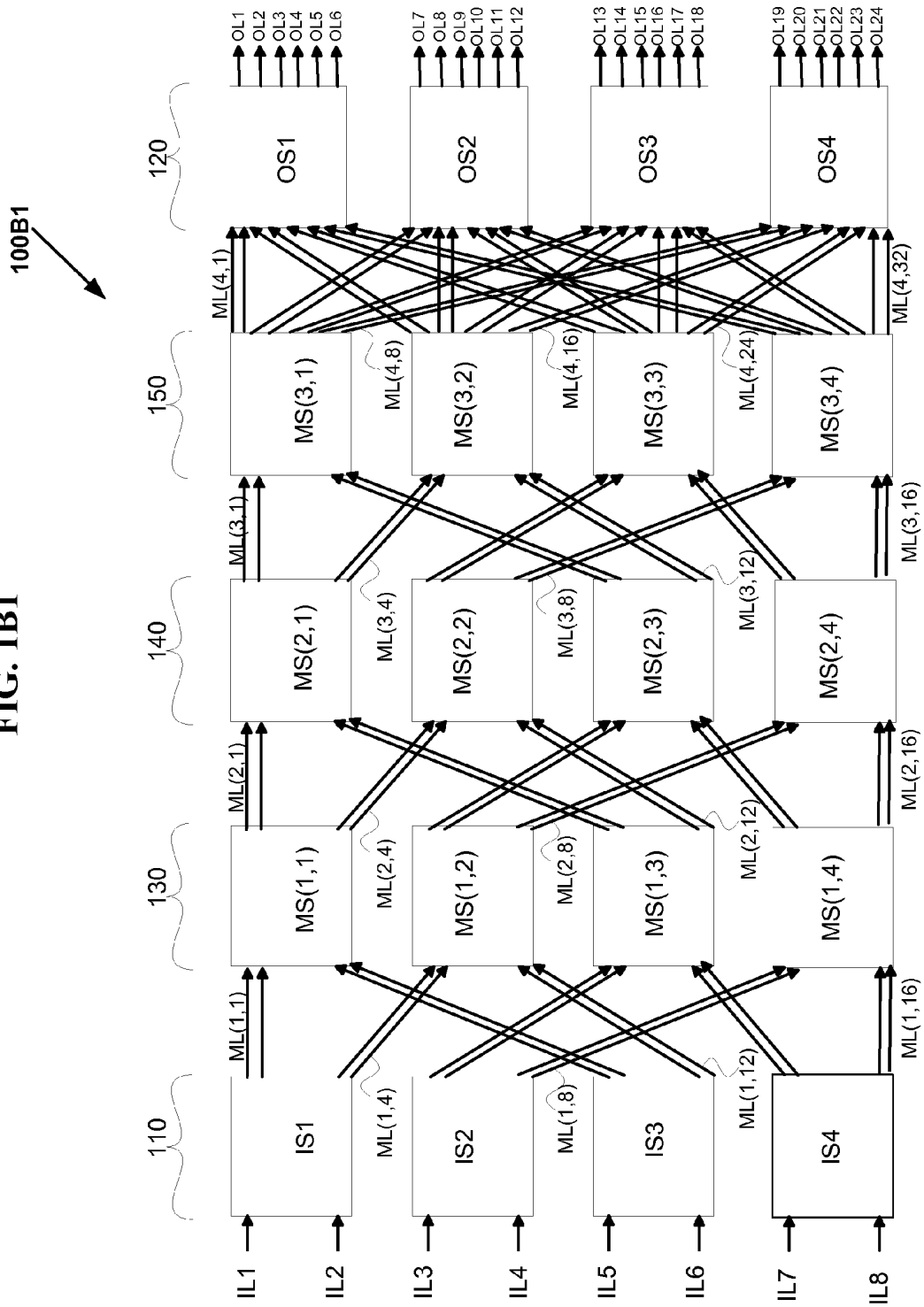

FIG. 1C1

100C1

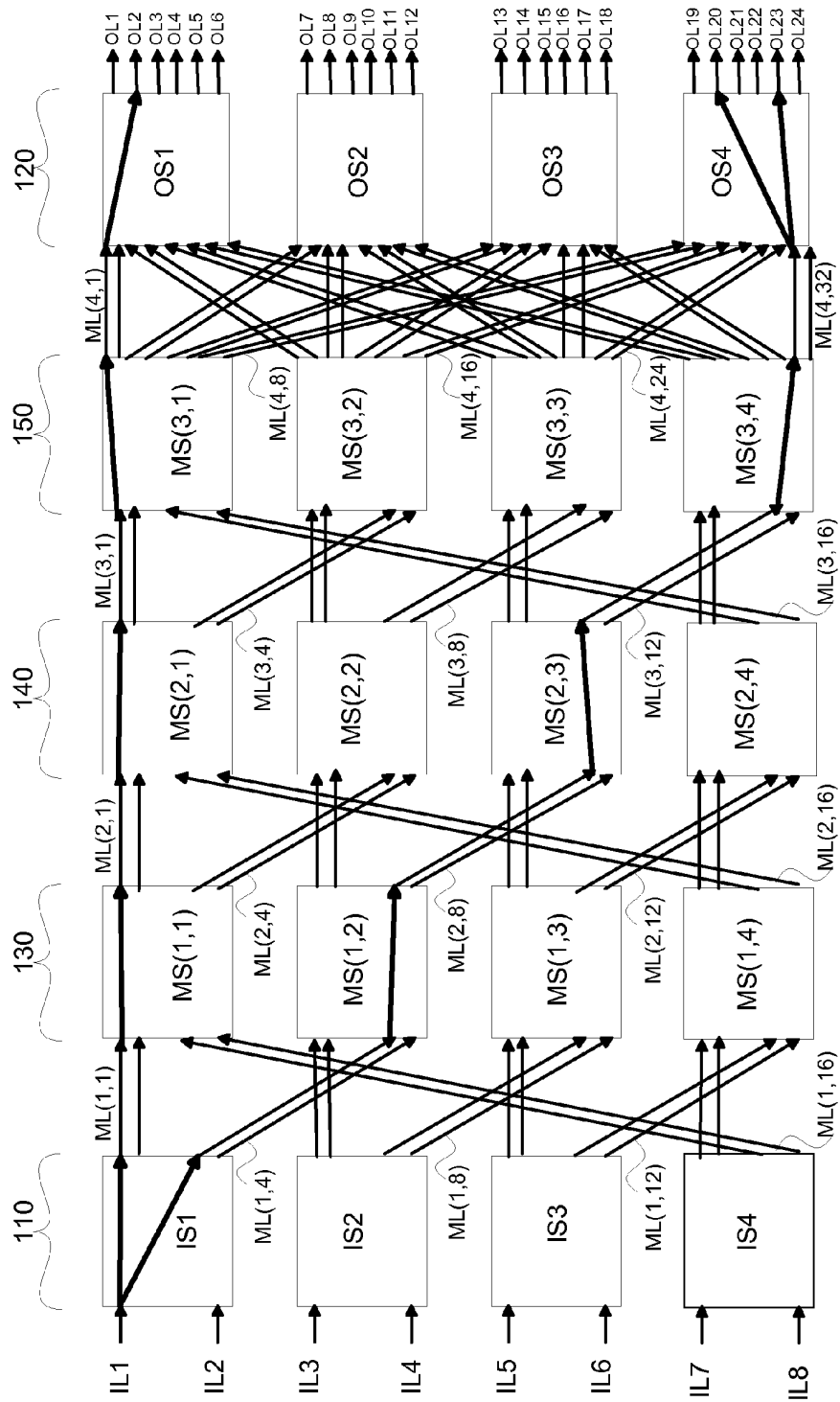

FIG. 1D1

100D1

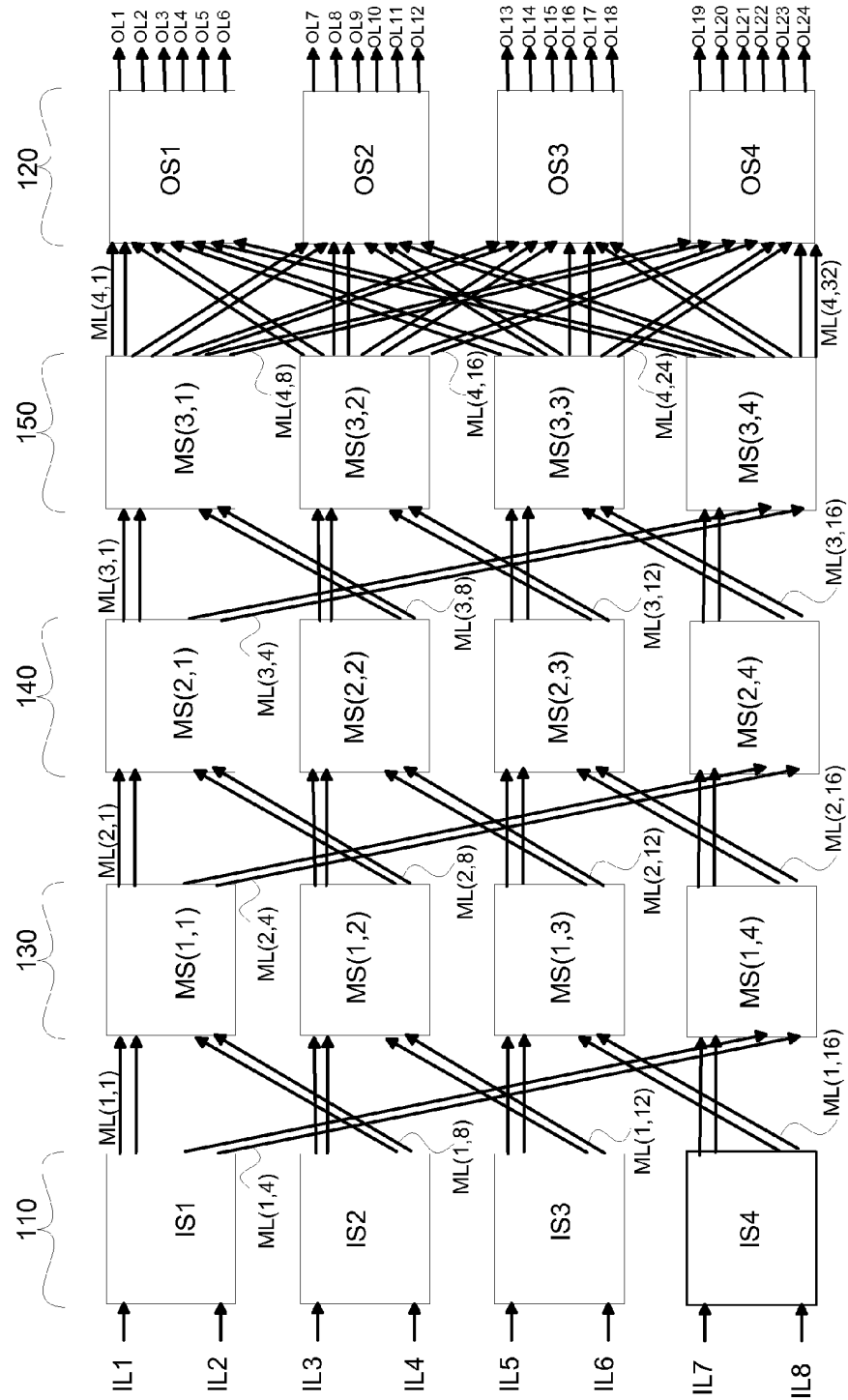

FIG. 1E1

100E1

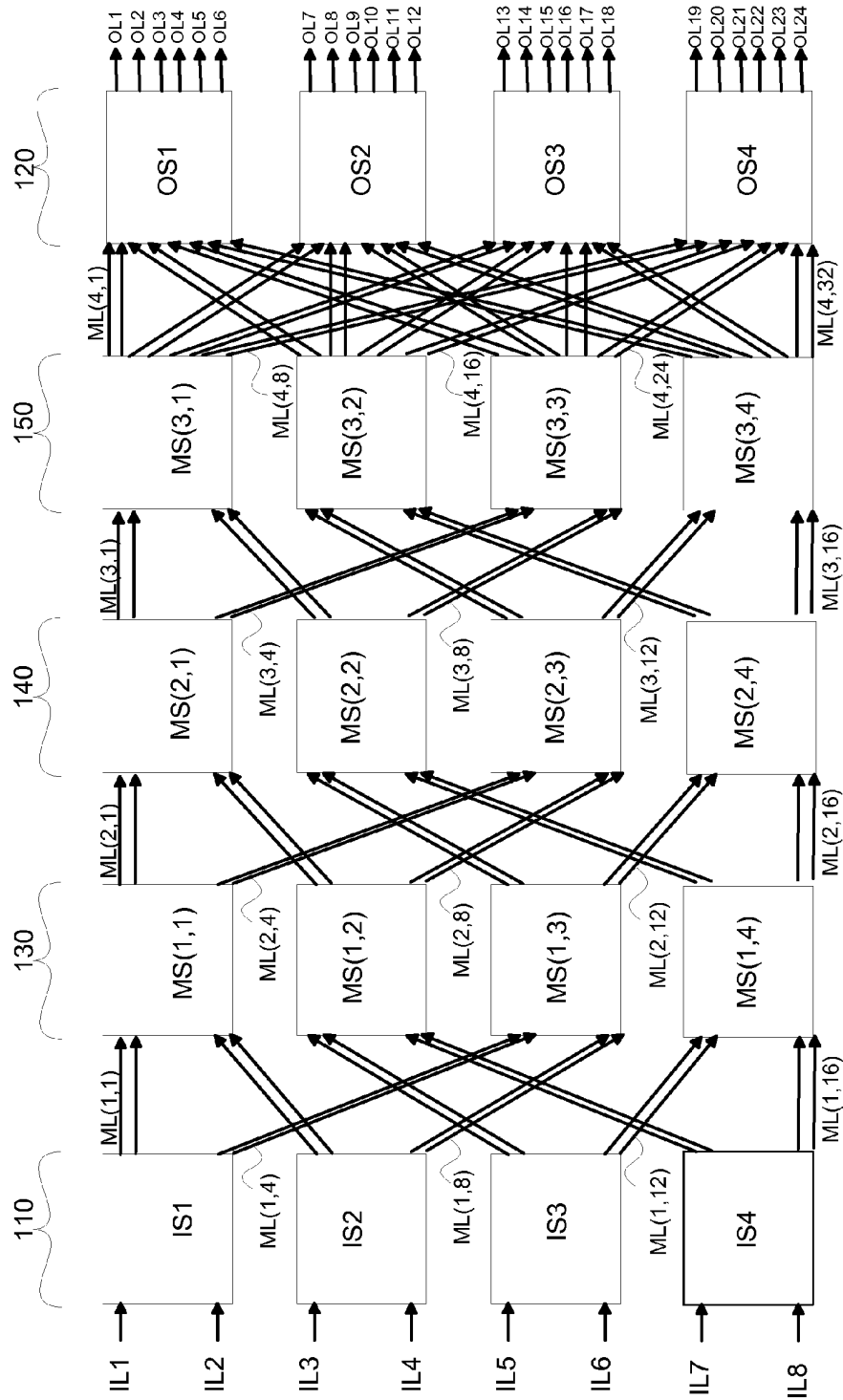

FIG. 1F1

100F1

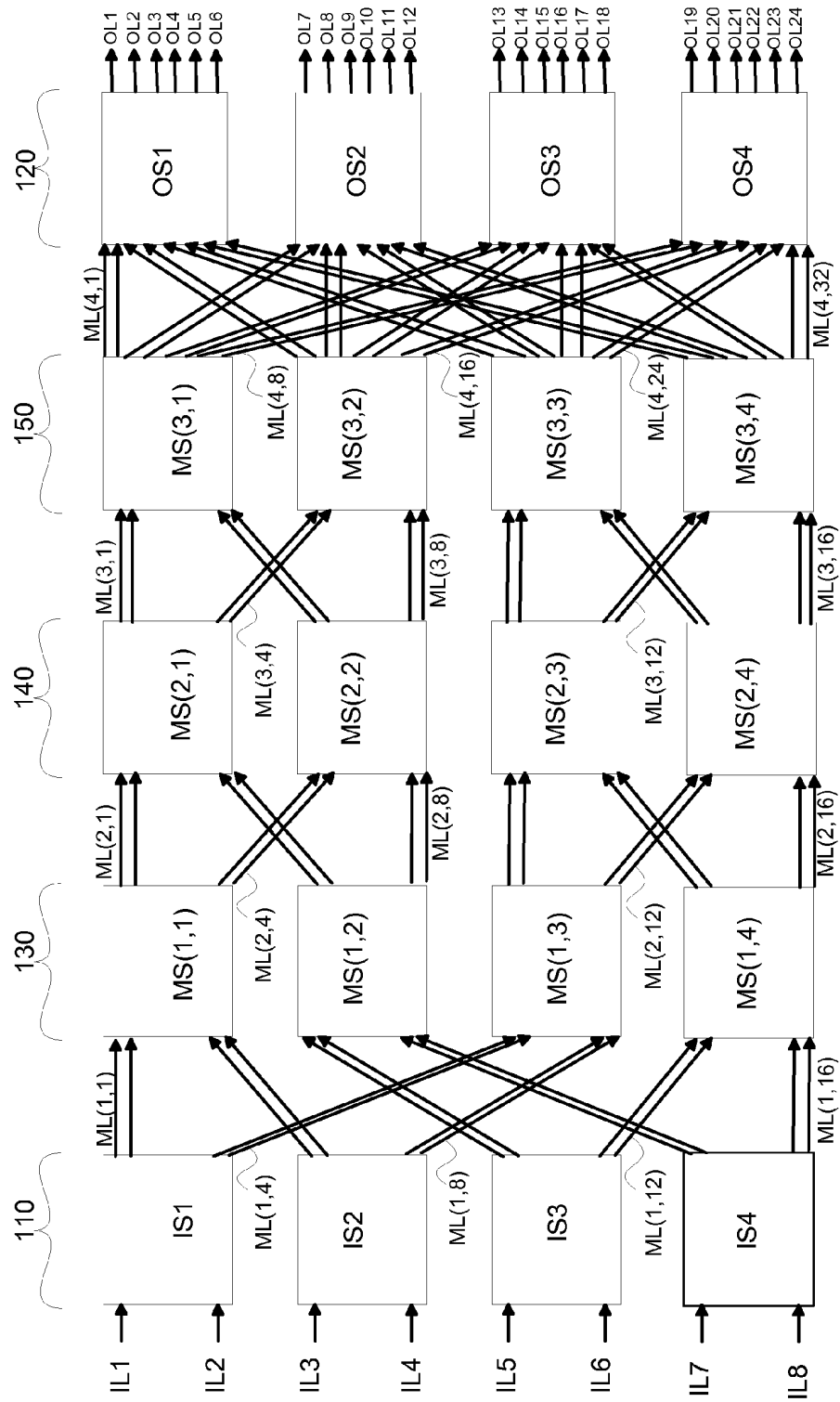

FIG. 1G1

100G1

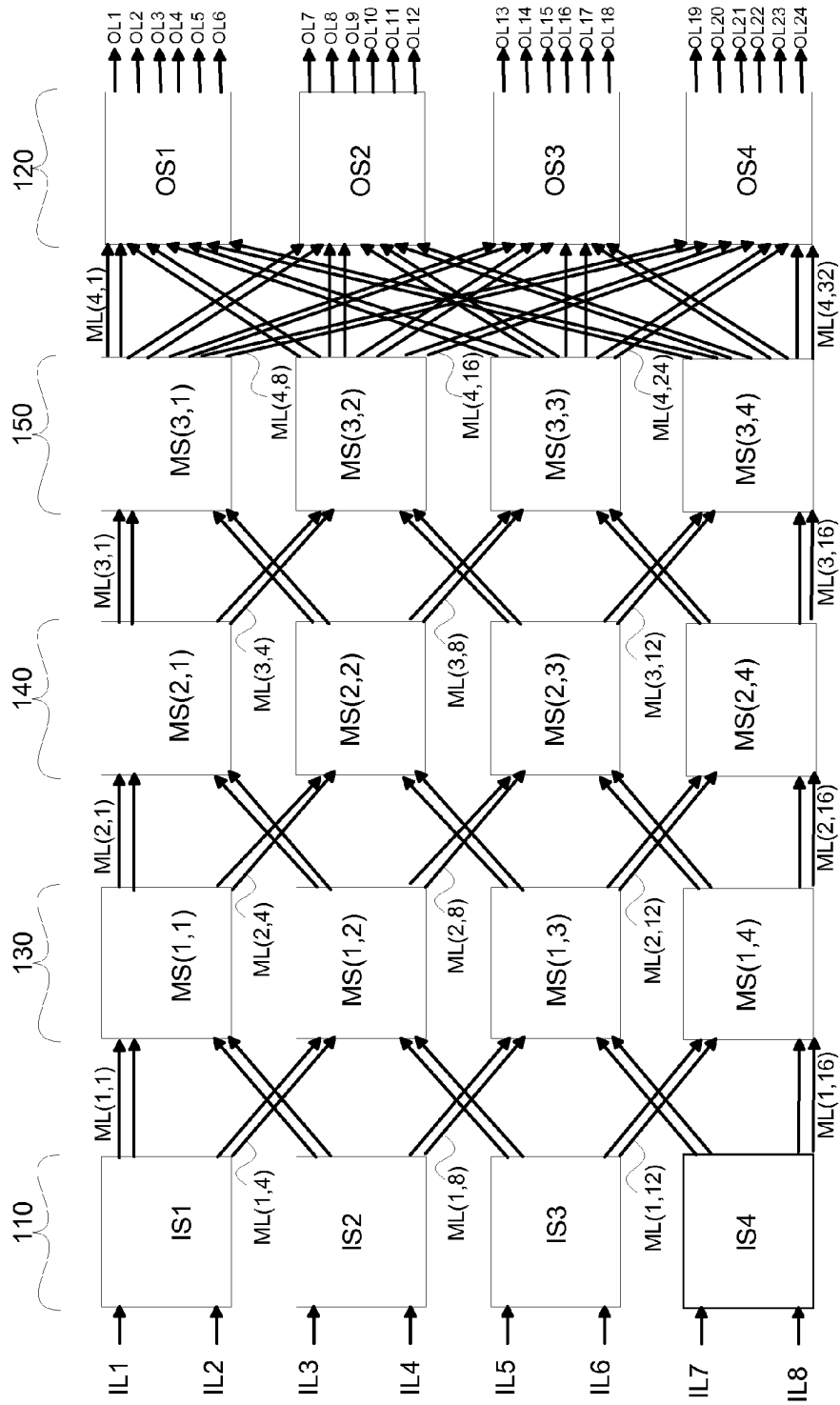

FIG. 1H1

100H1

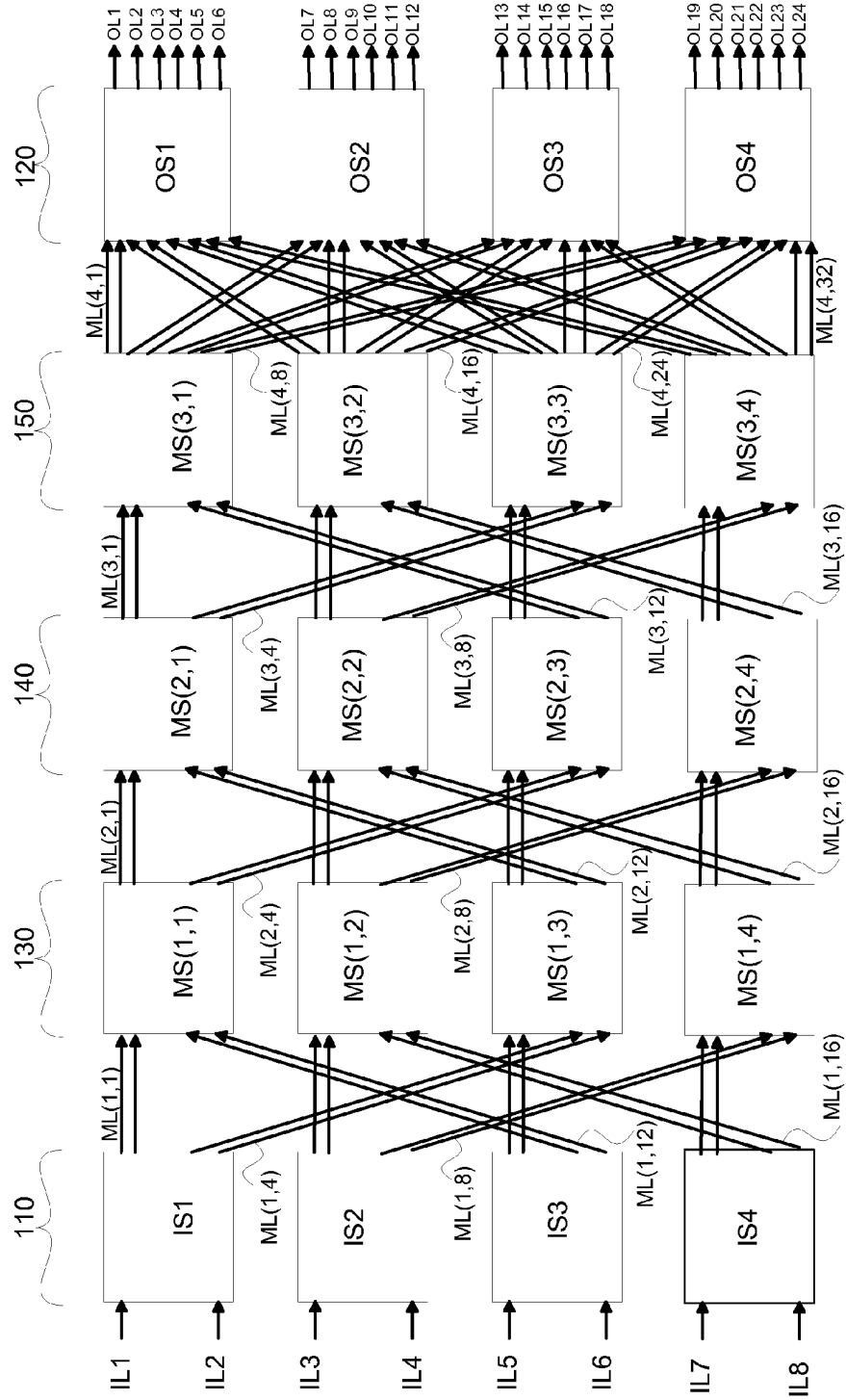

FIG. 111

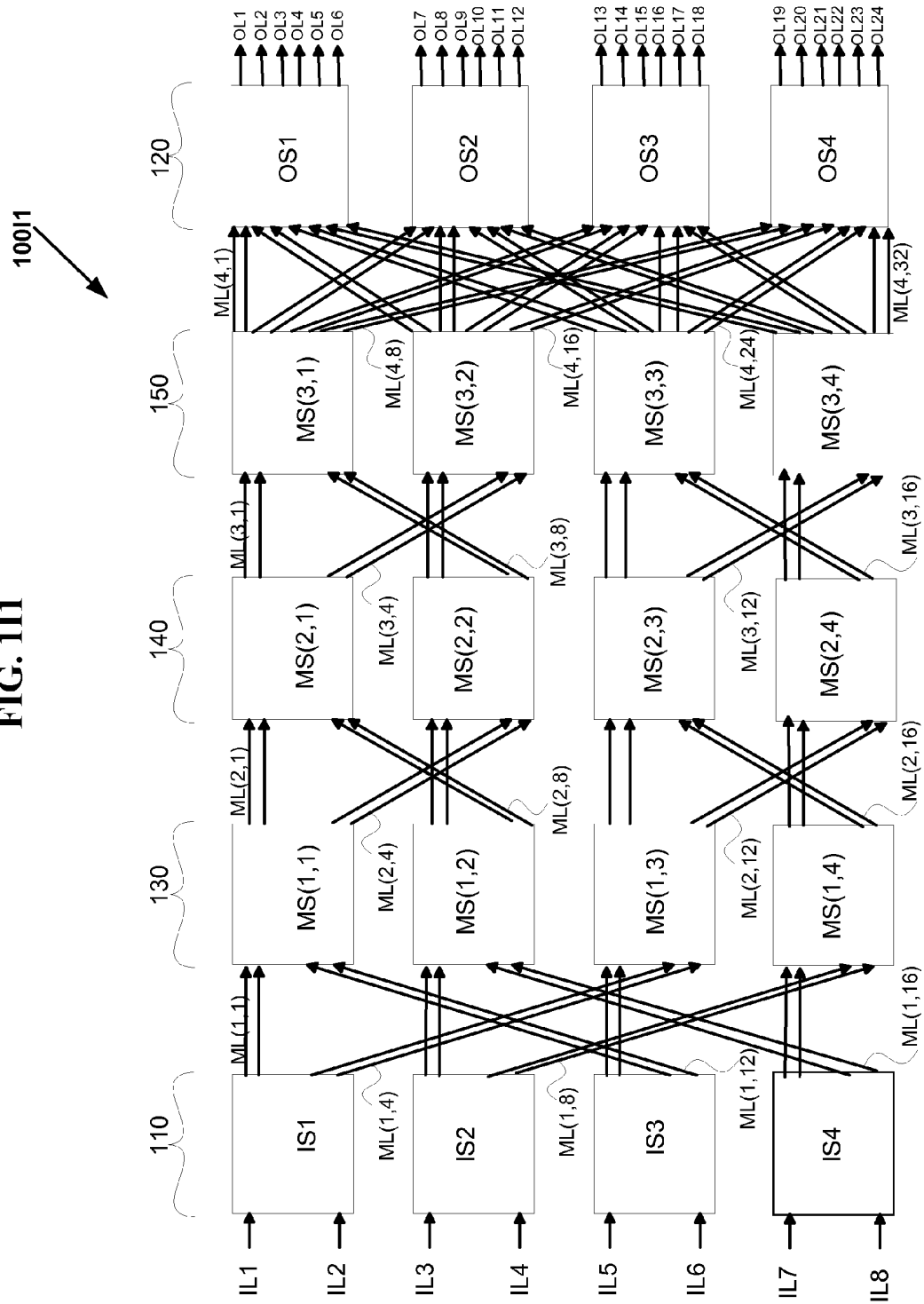

FIG. 1J1

100,J1

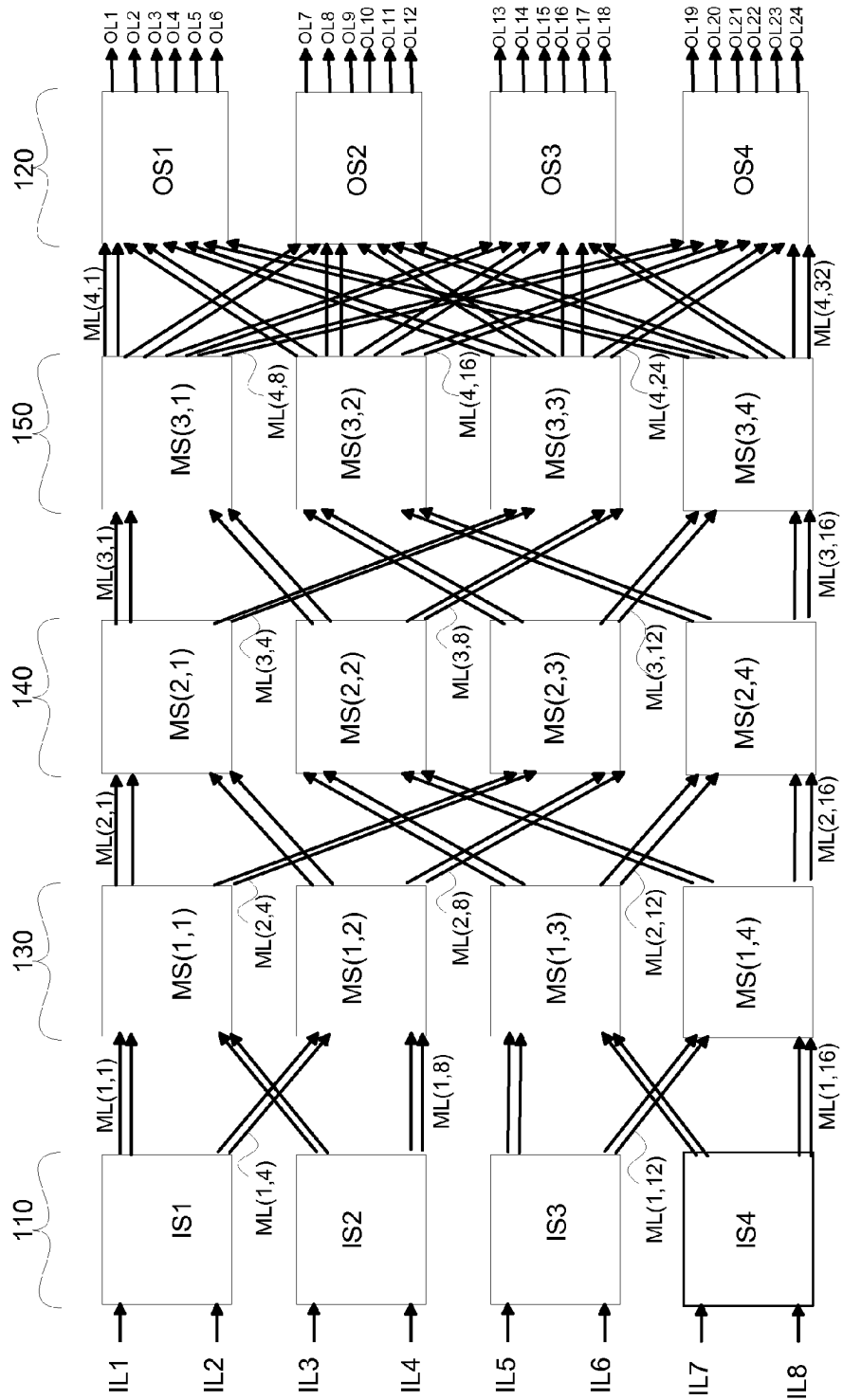

FIG. 1K1

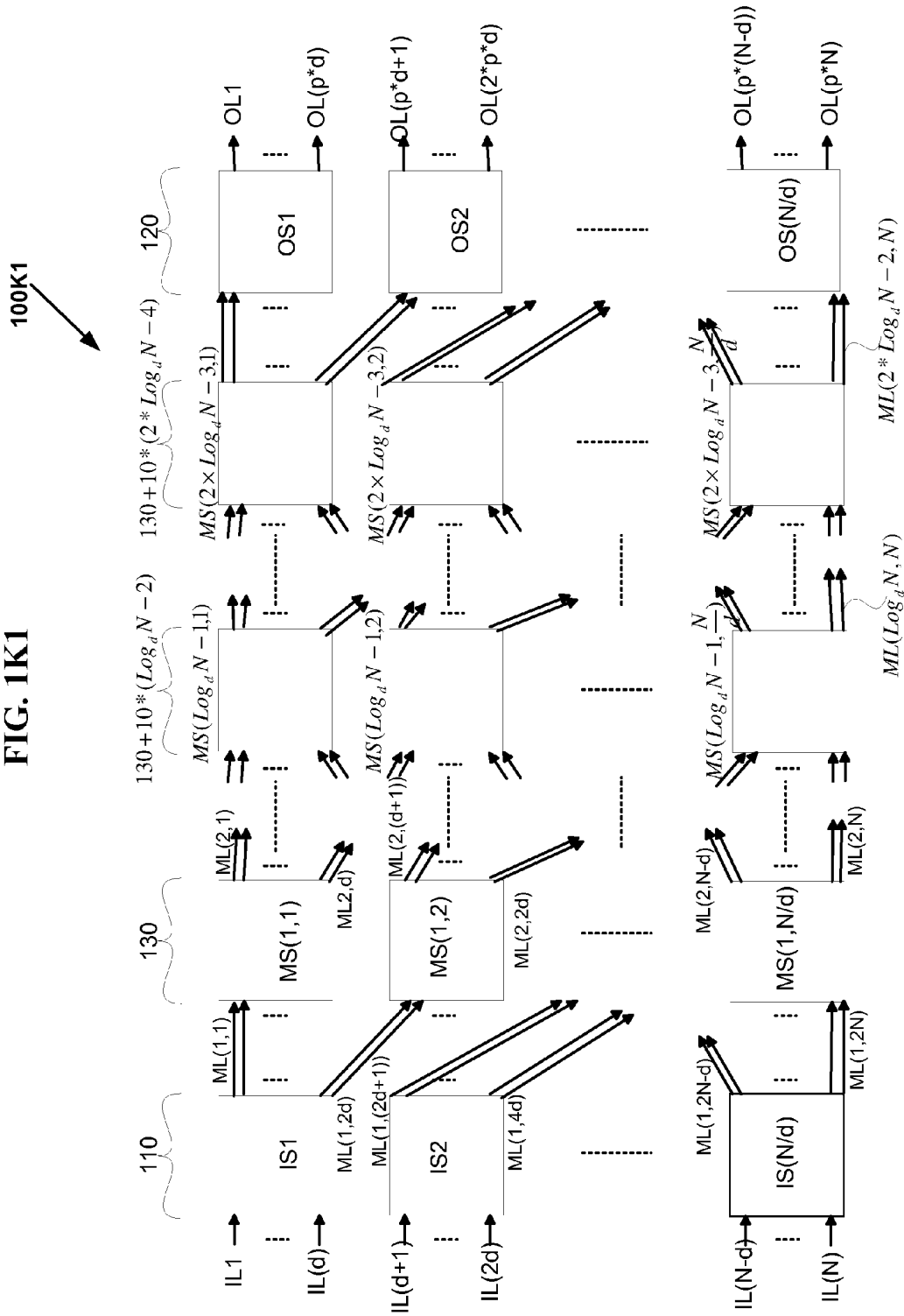

FIG. 1A2

100A2

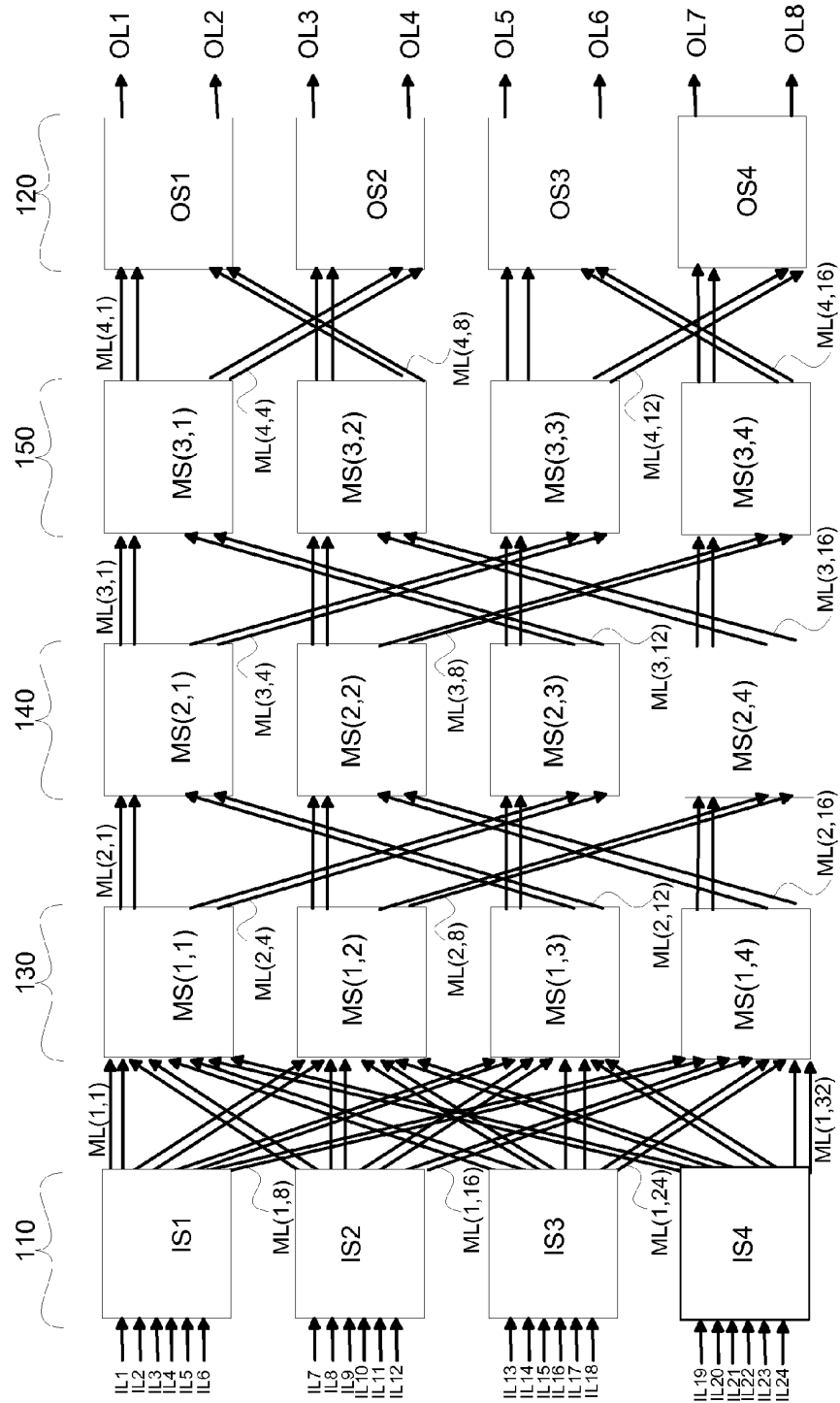

FIG. 1B2

100B2

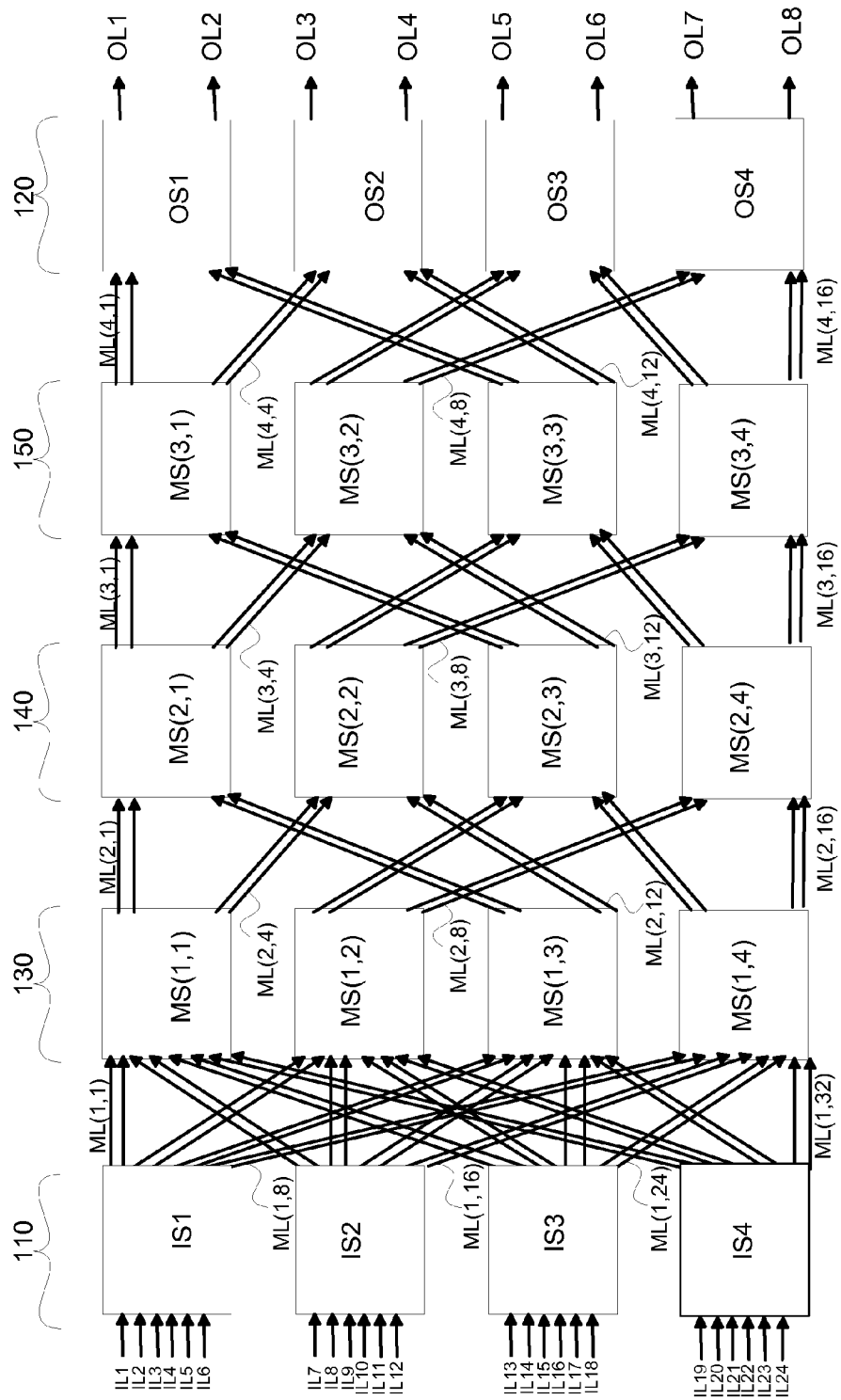

FIG. 1C2

100C2

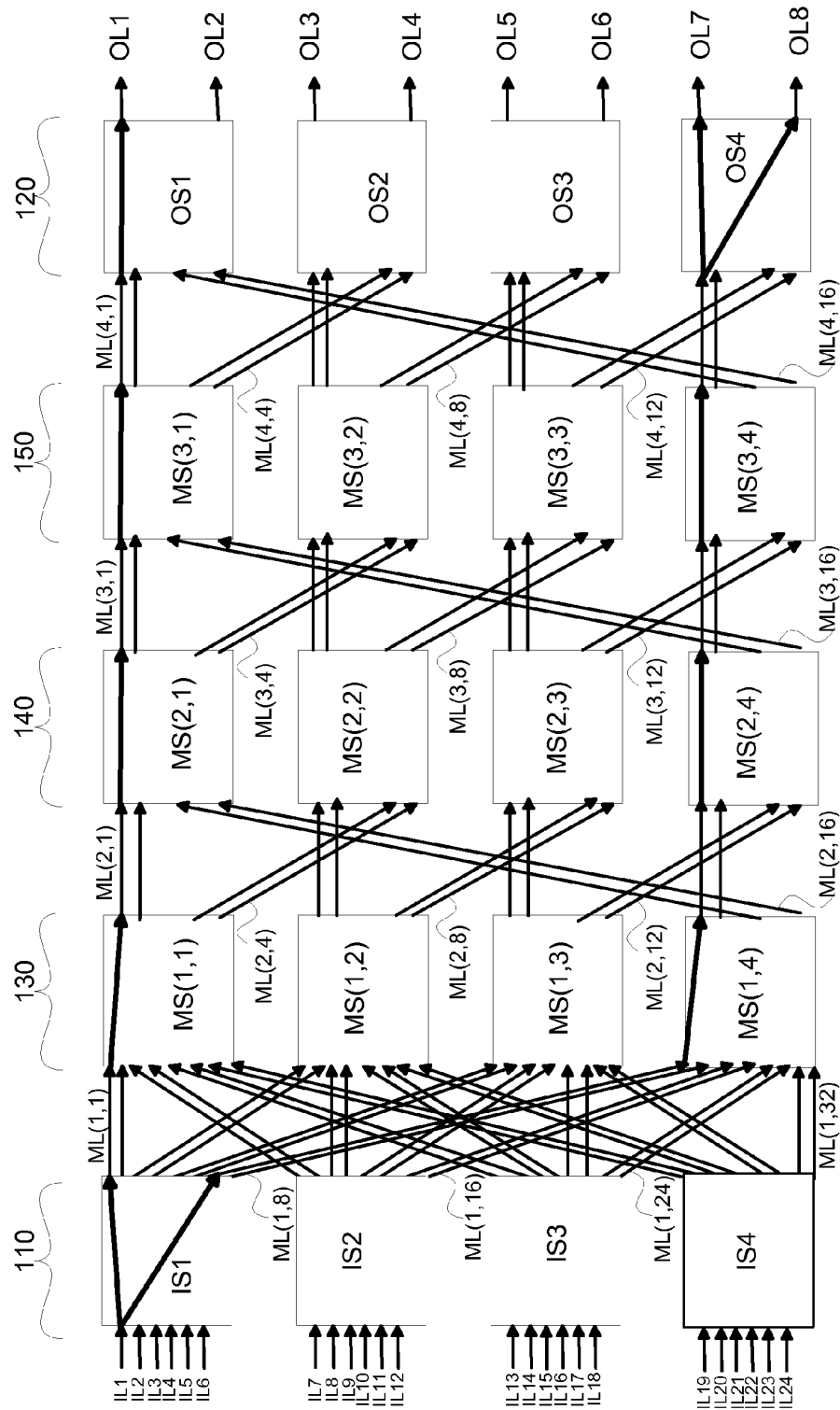

FIG. 1D2

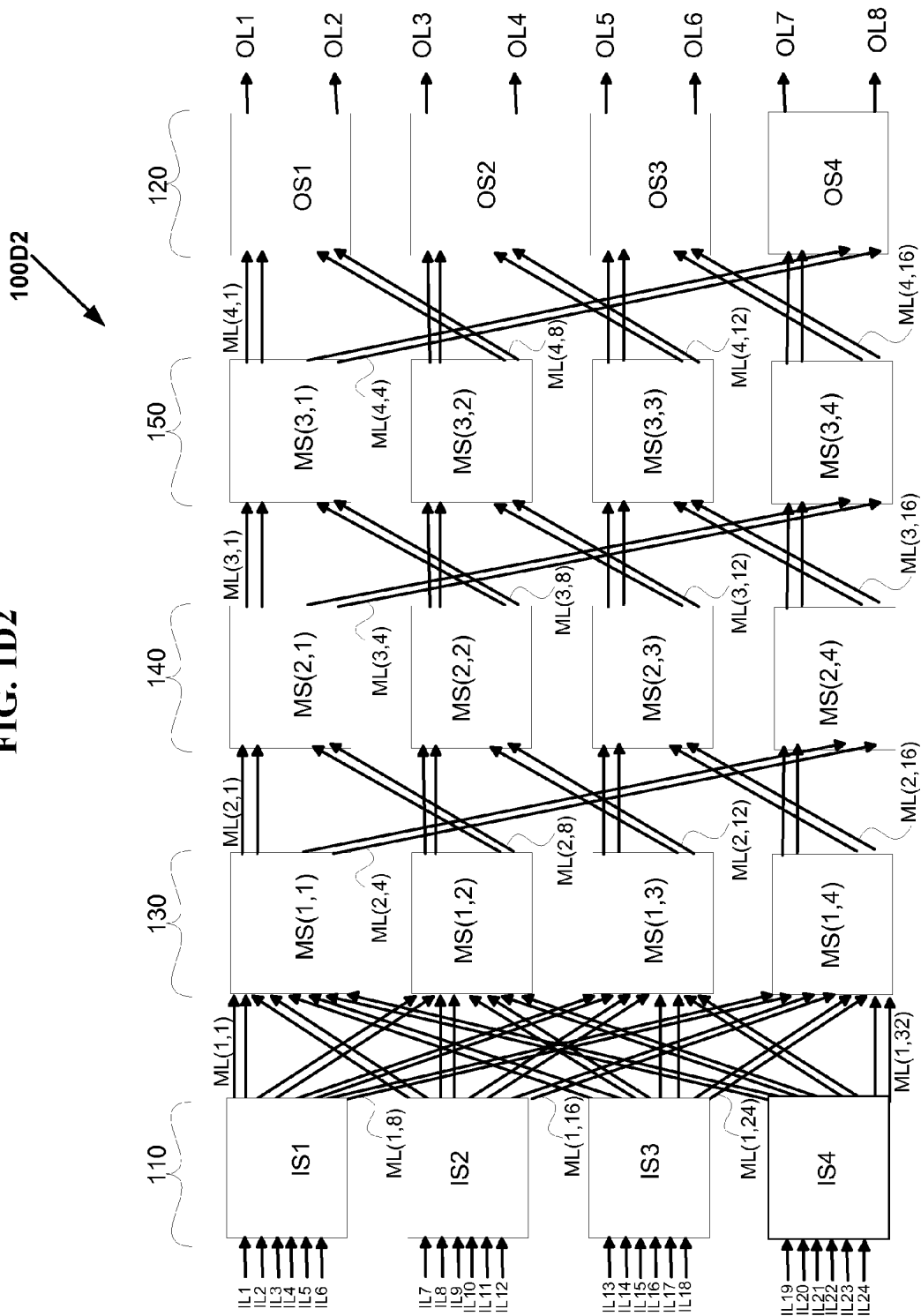

FIG. 1E2

100E2

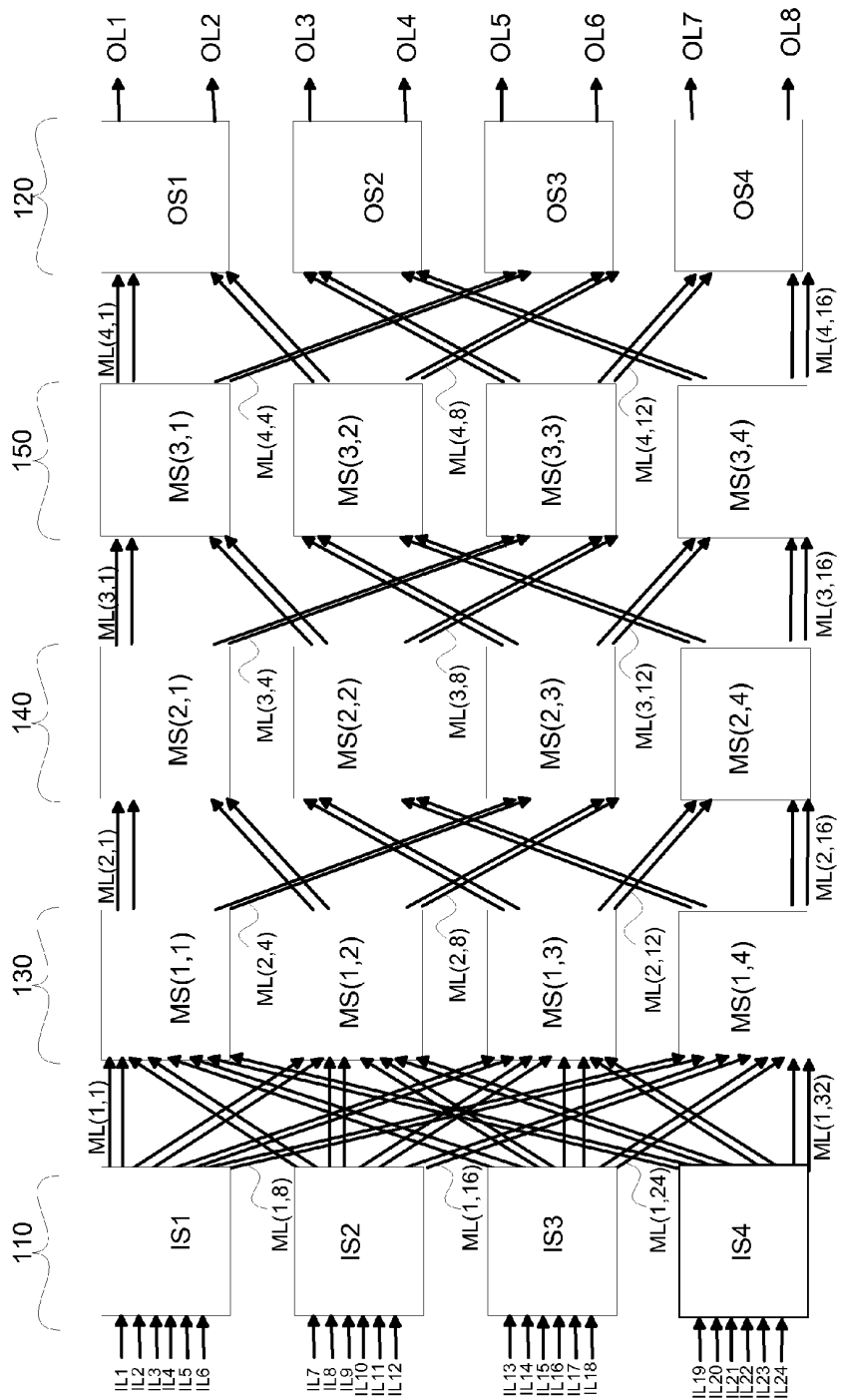

FIG. 1F2

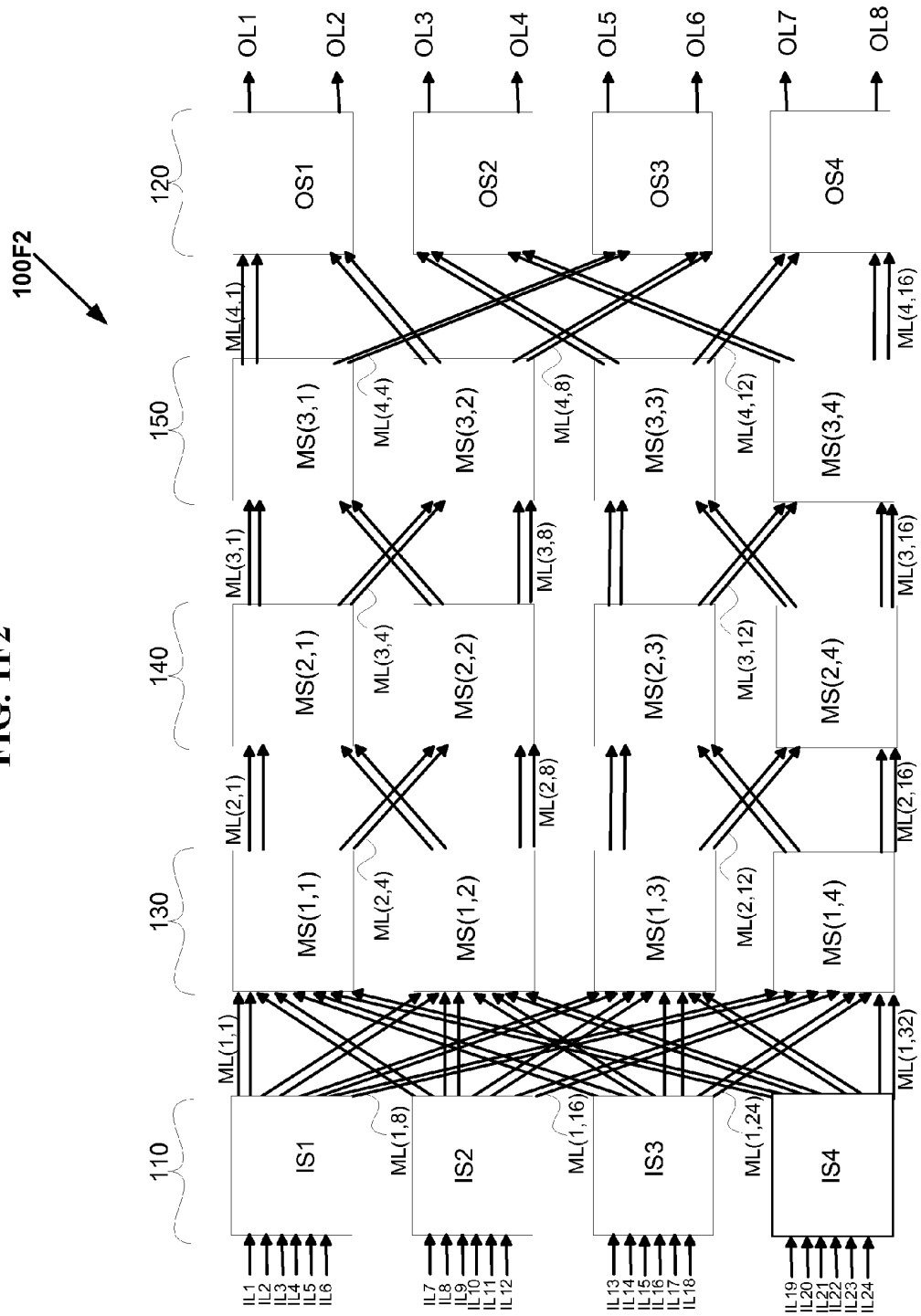

FIG. 1G2

100G2

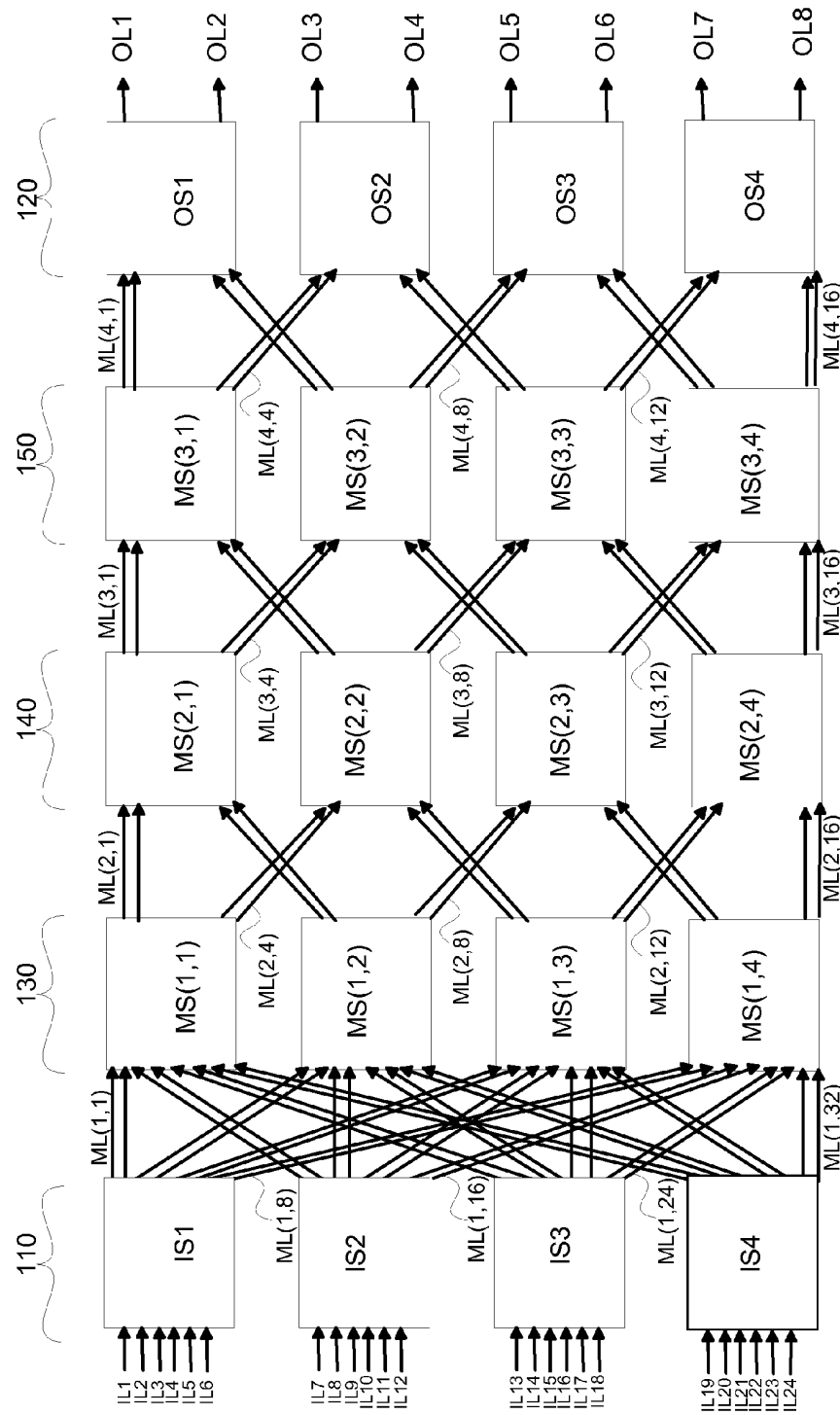

FIG. 1H2

100H2

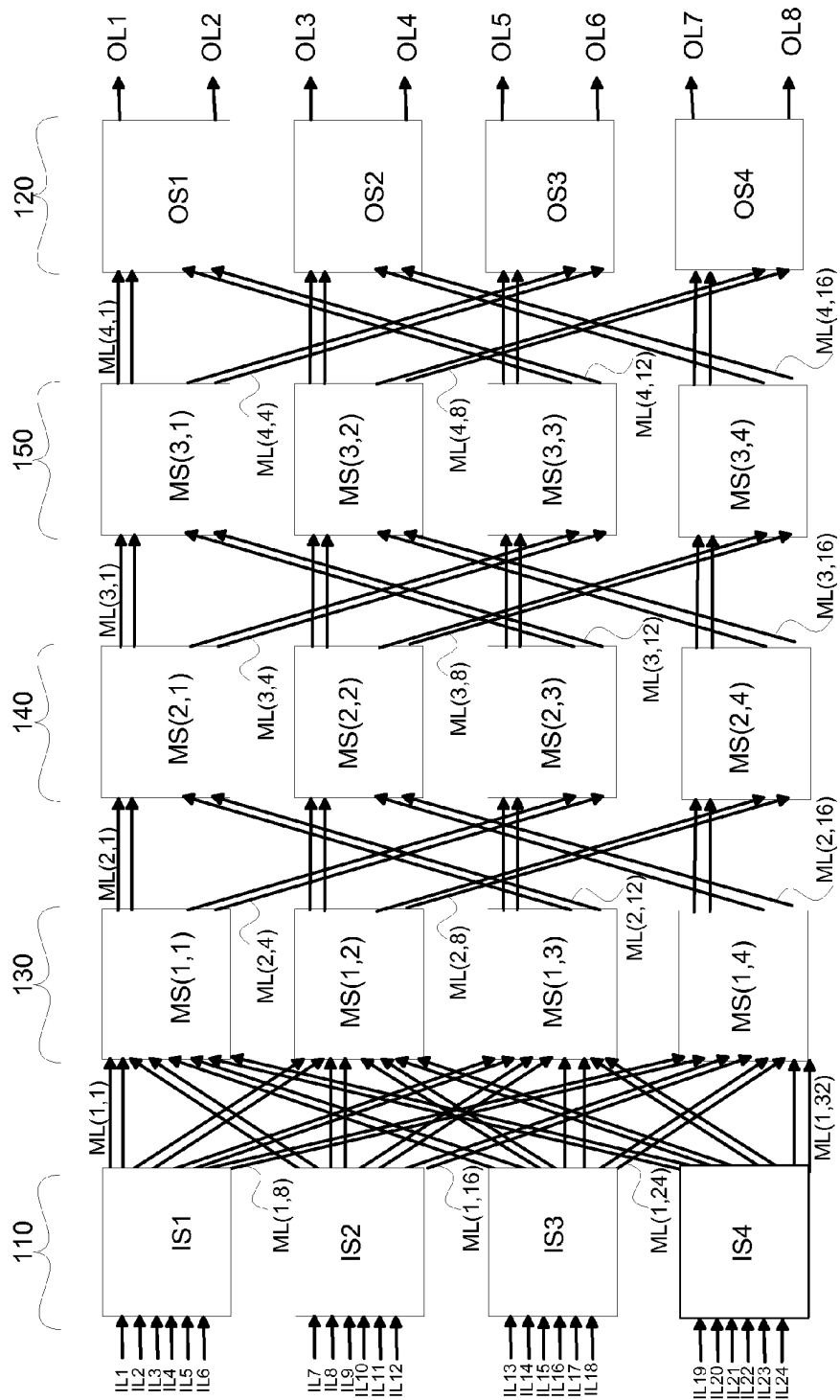

FIG. 112

10012

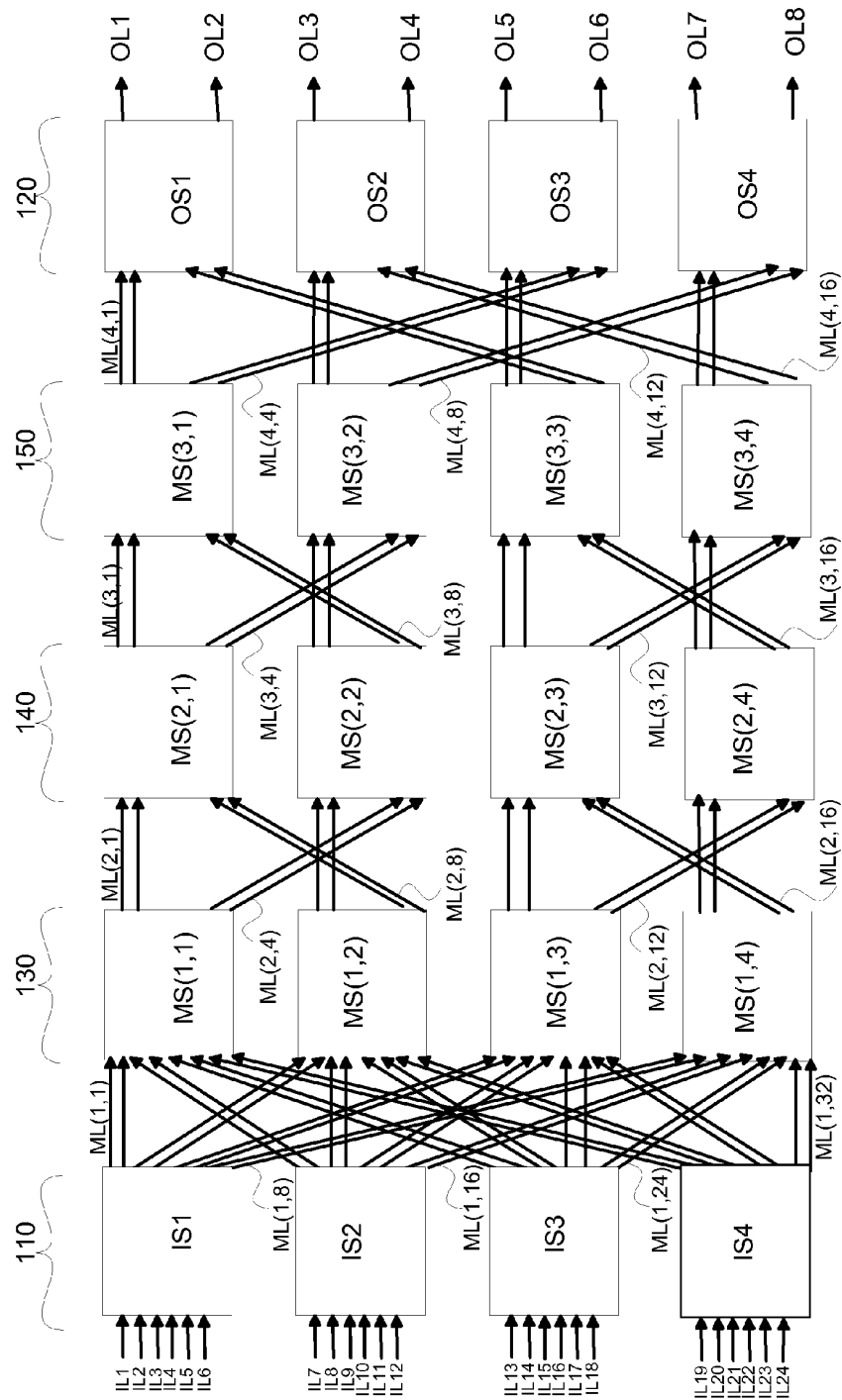

FIG. 1J2

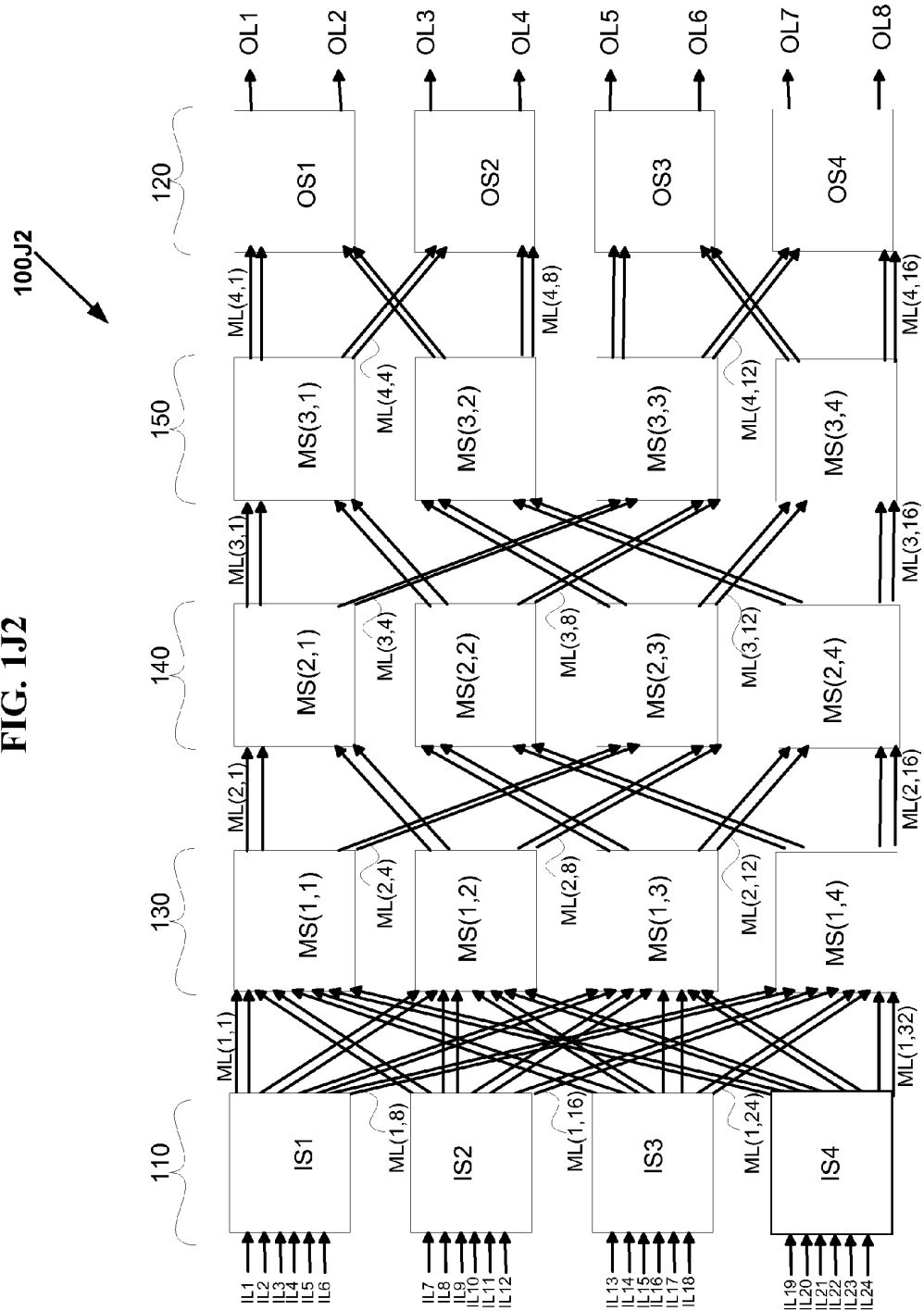
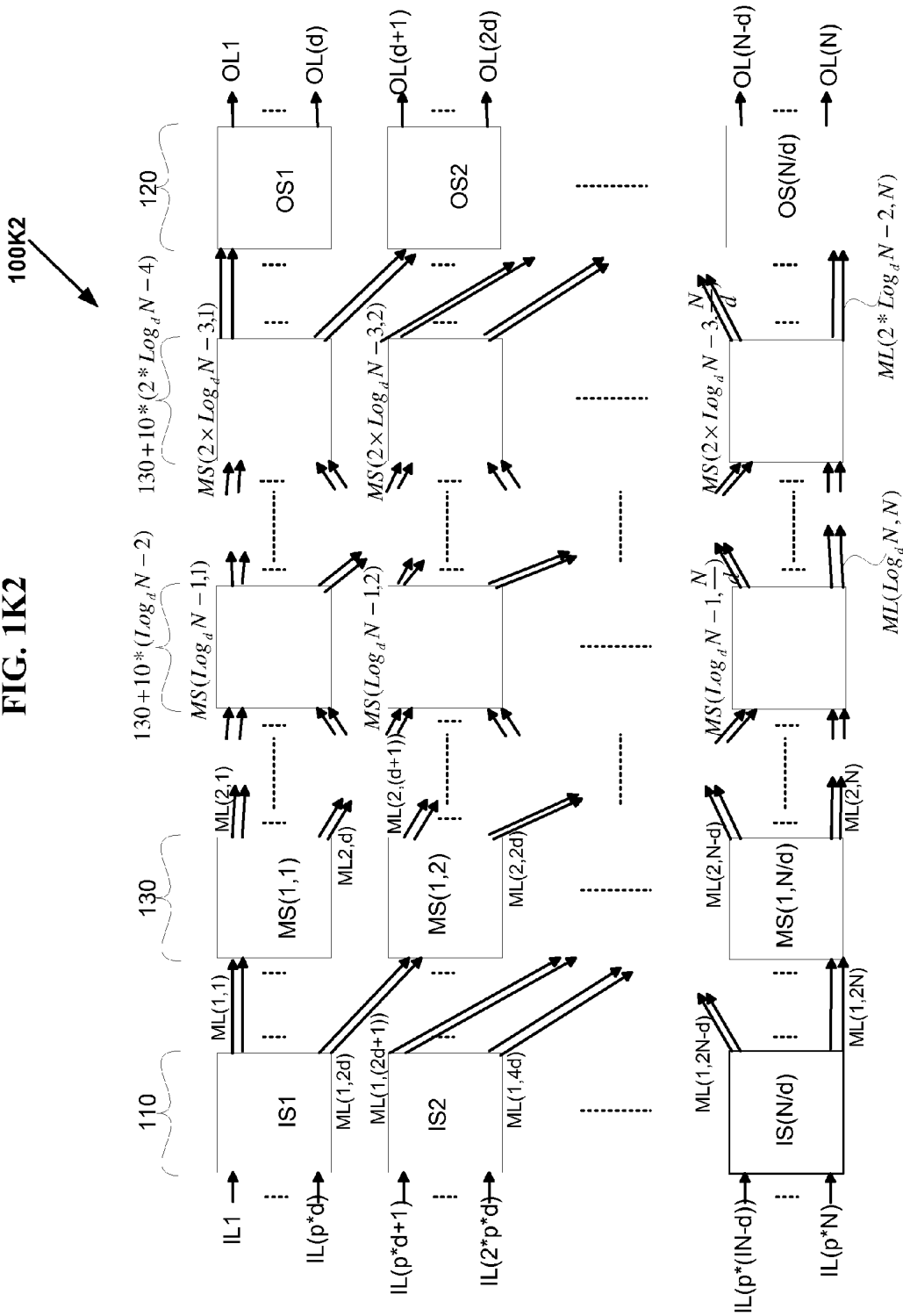

FIG. 1K2



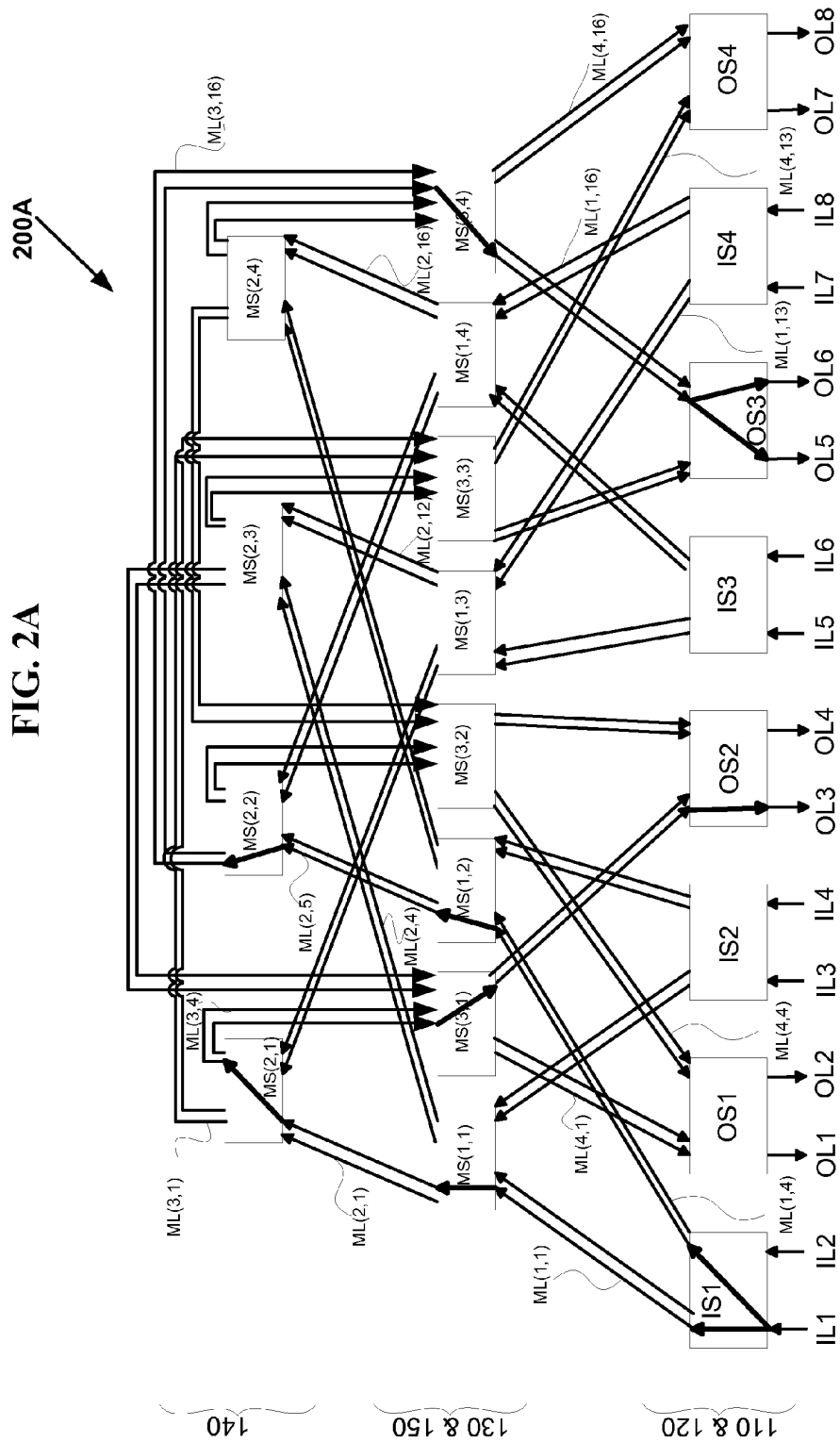

FIG. 2B

200B

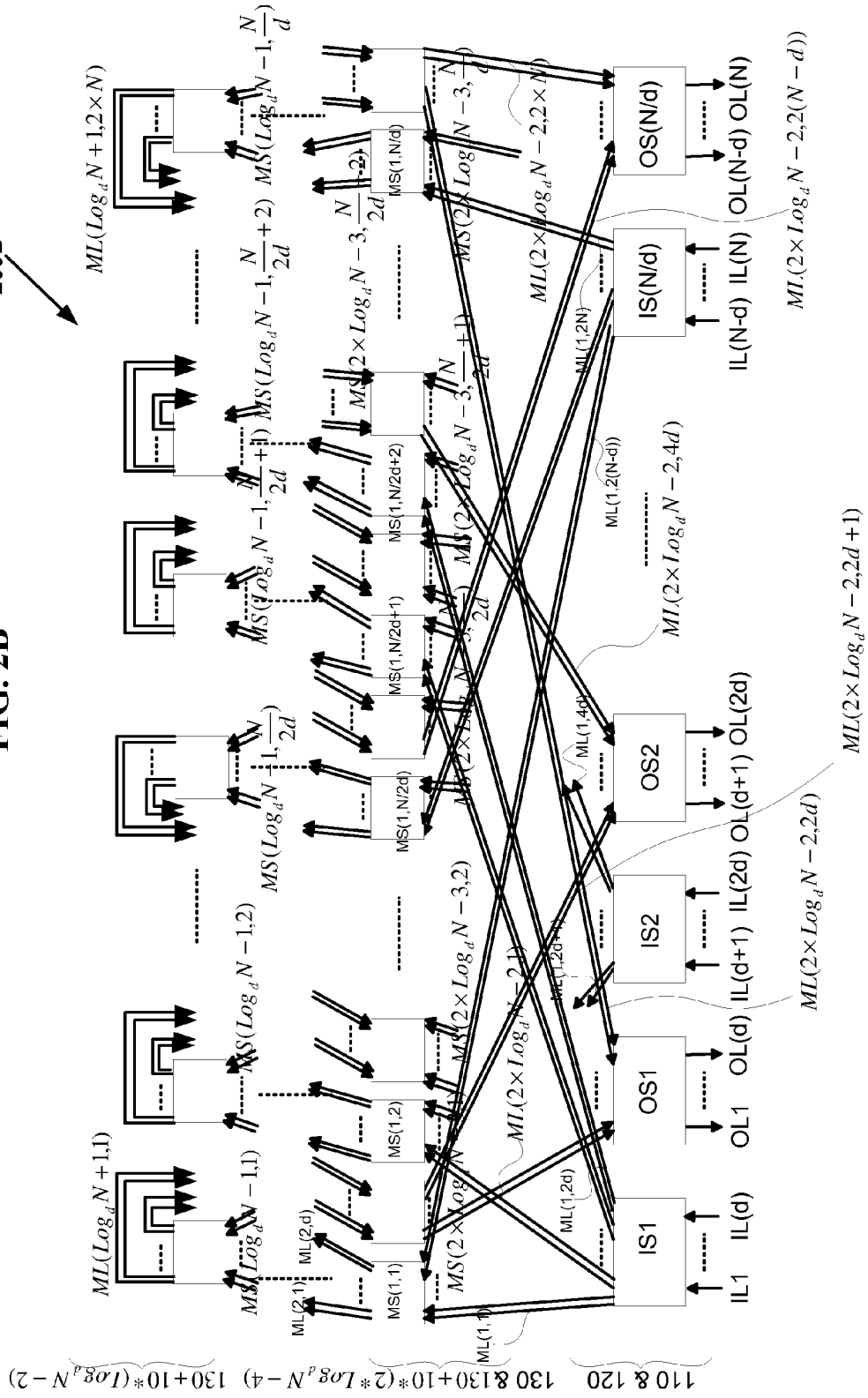

FIG. 2C

200C

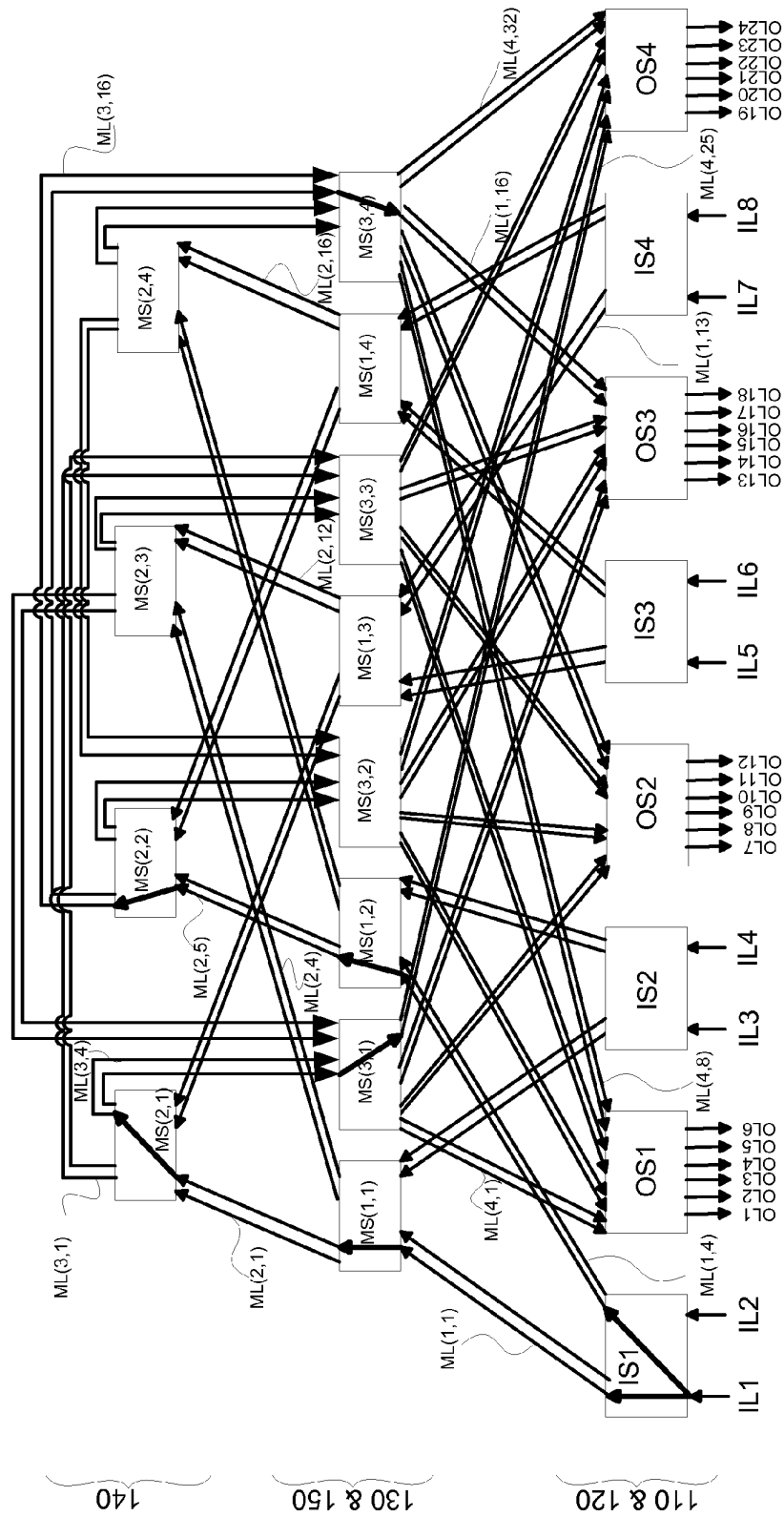

FIG. 2D

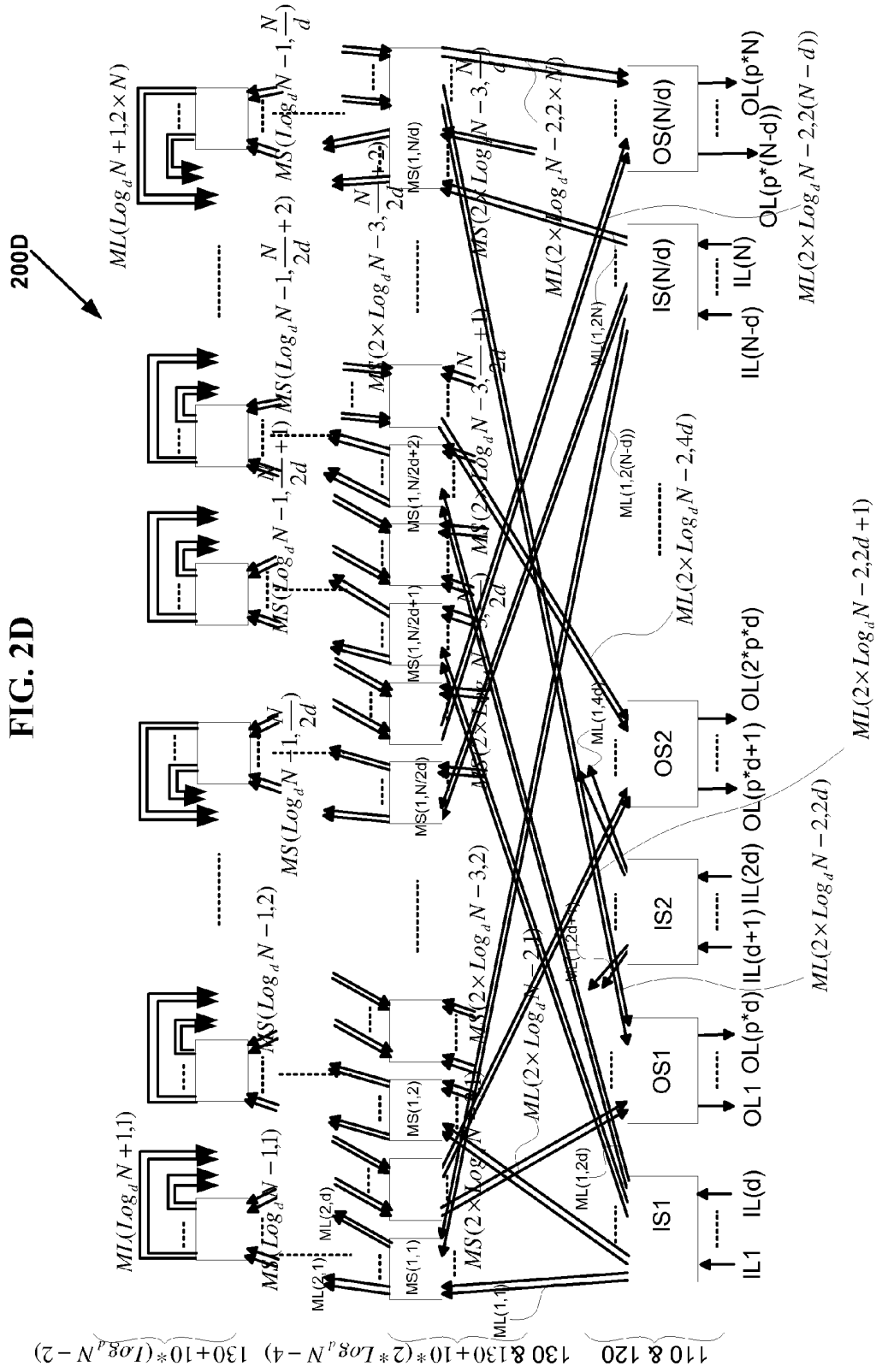

FIG. 2E
200E

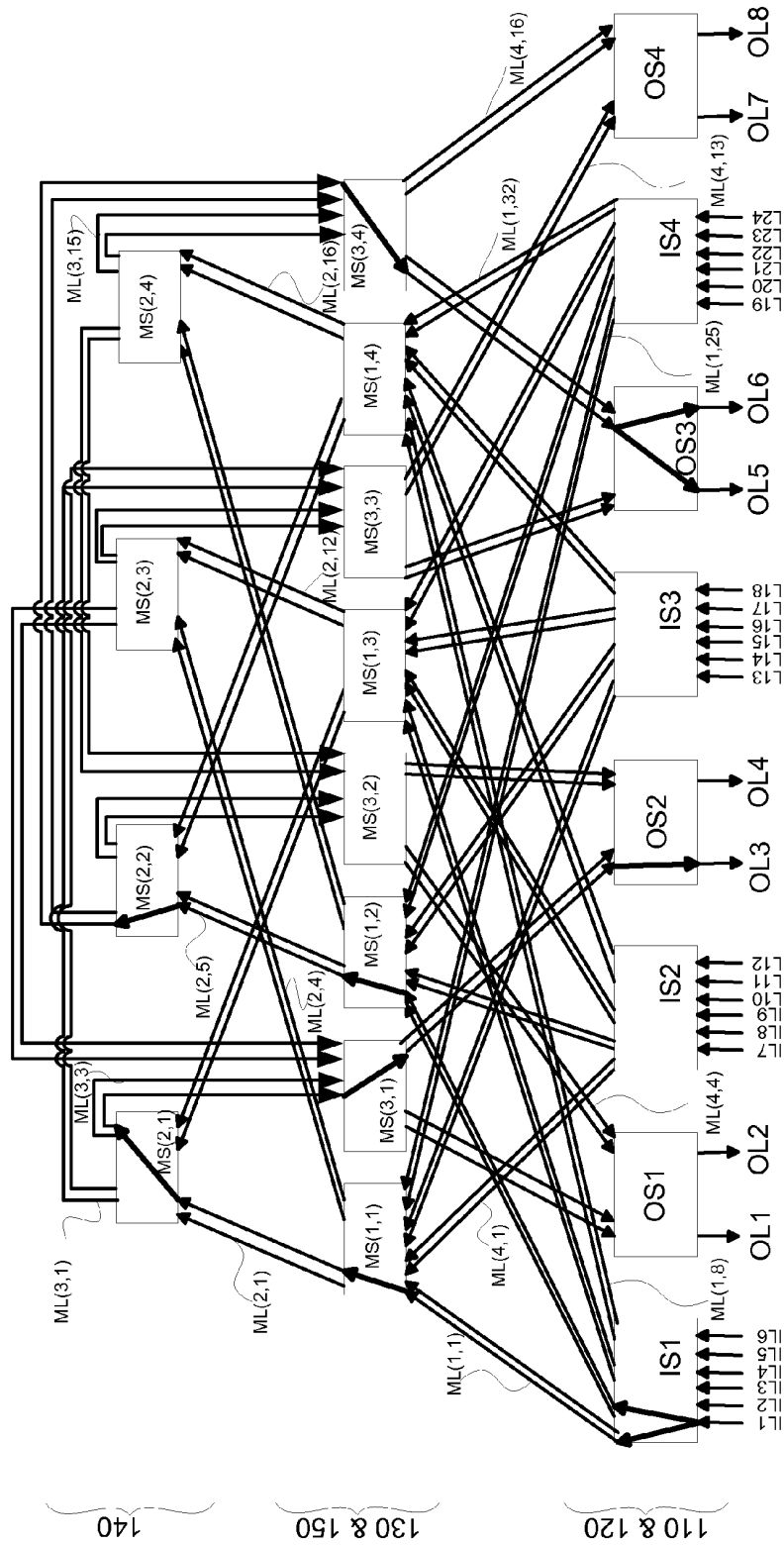

FIG. 2F

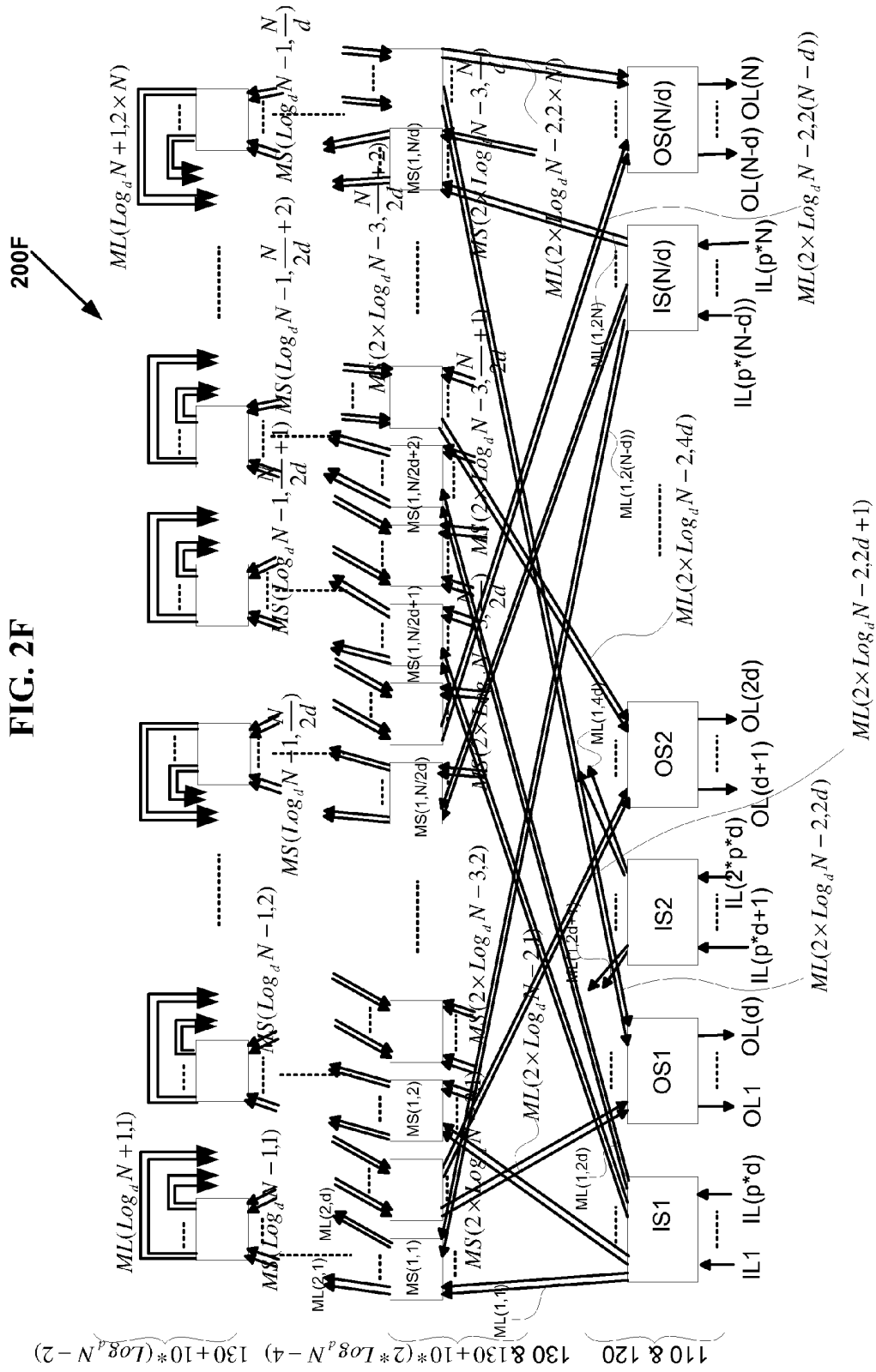

FIG. 3A

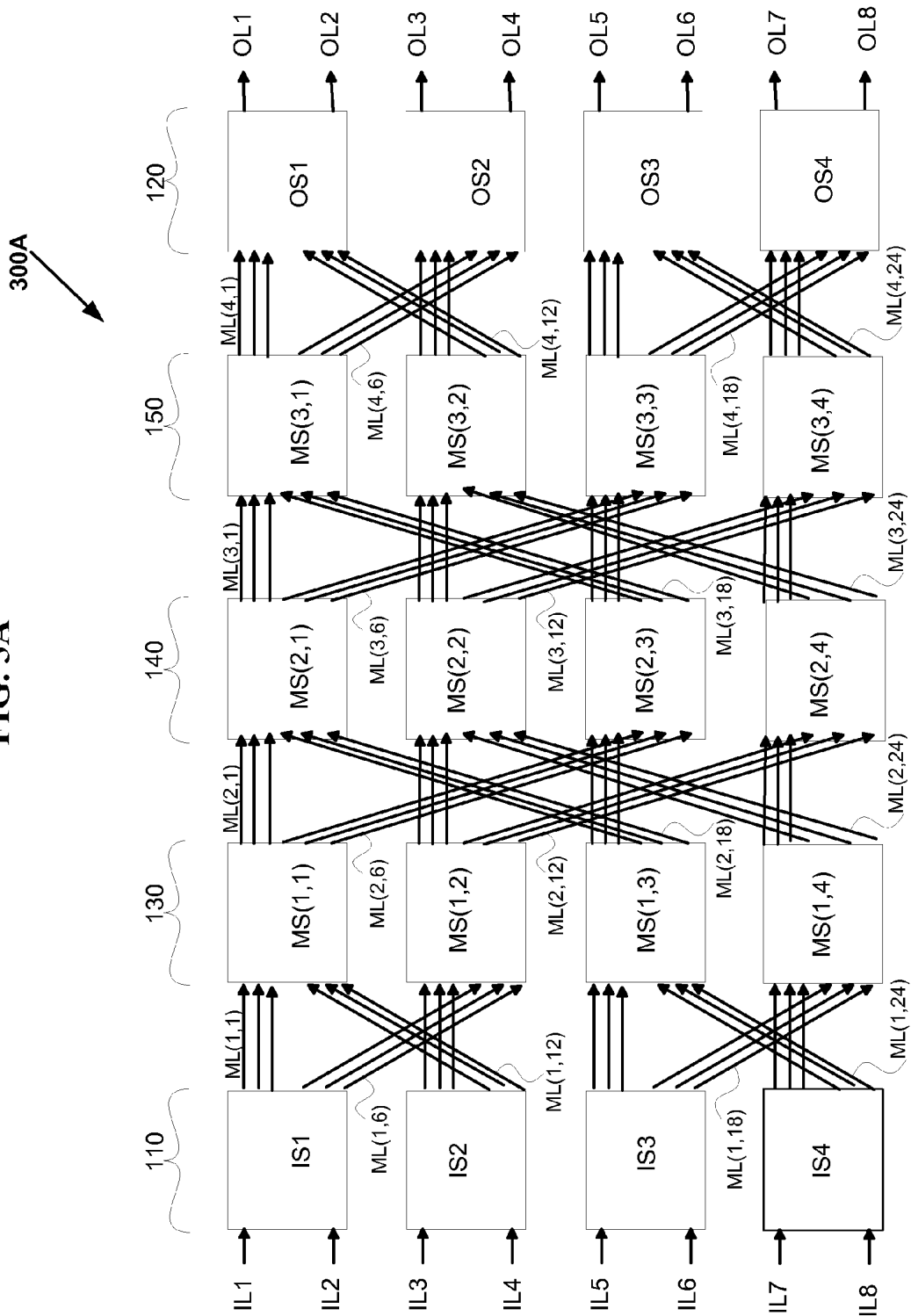

FIG. 3B

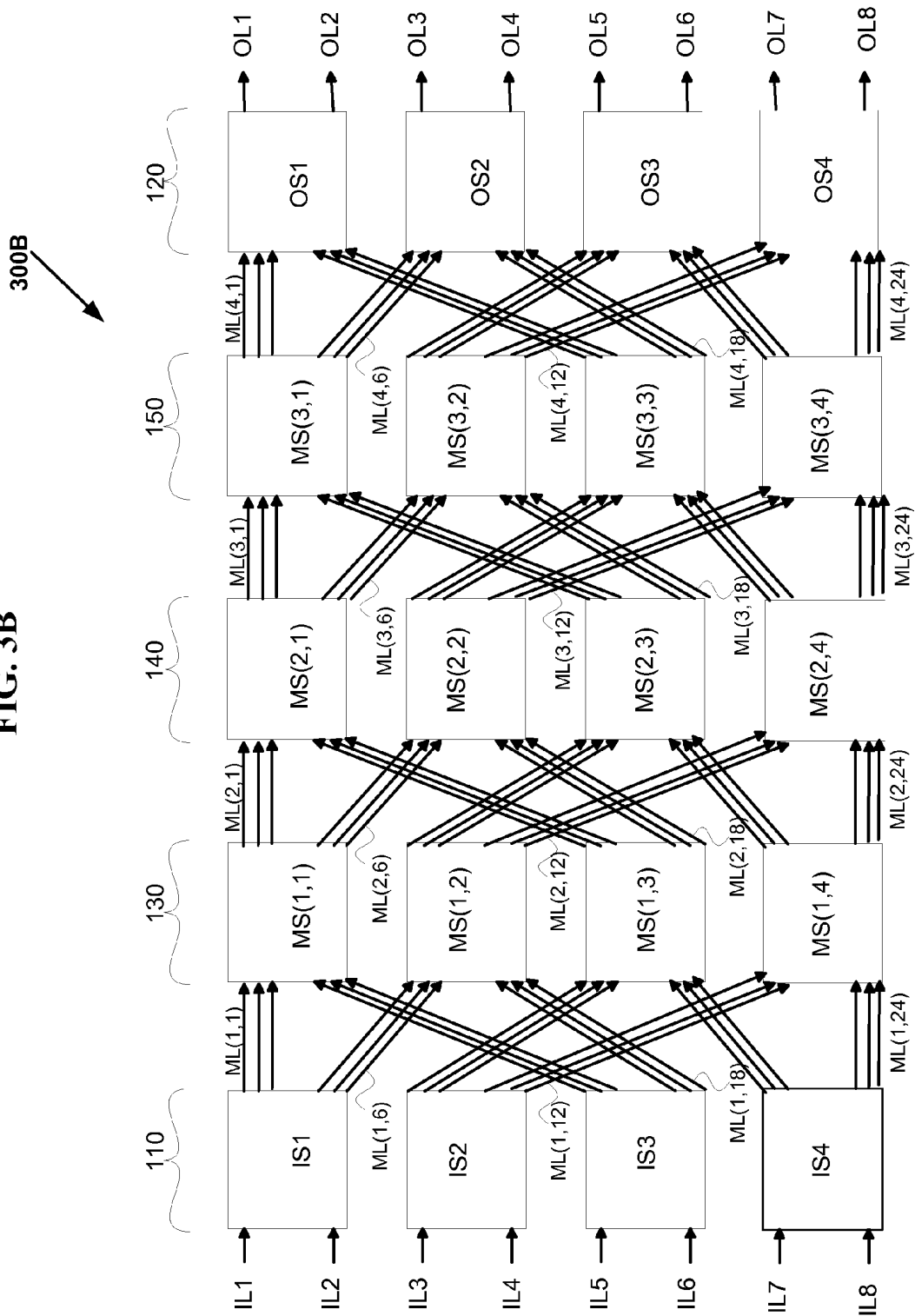

FIG. 3C

300C

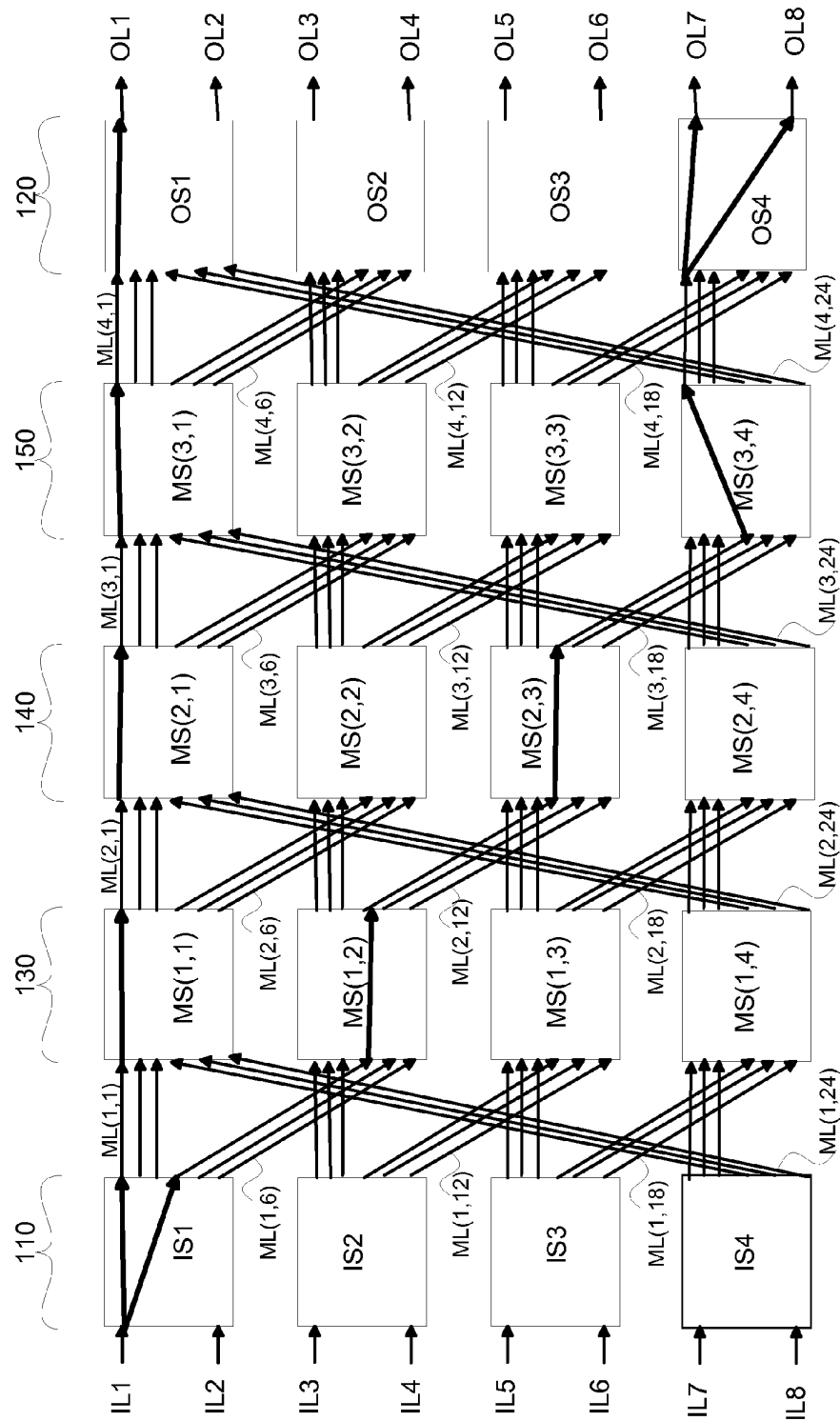

FIG. 3D

300D

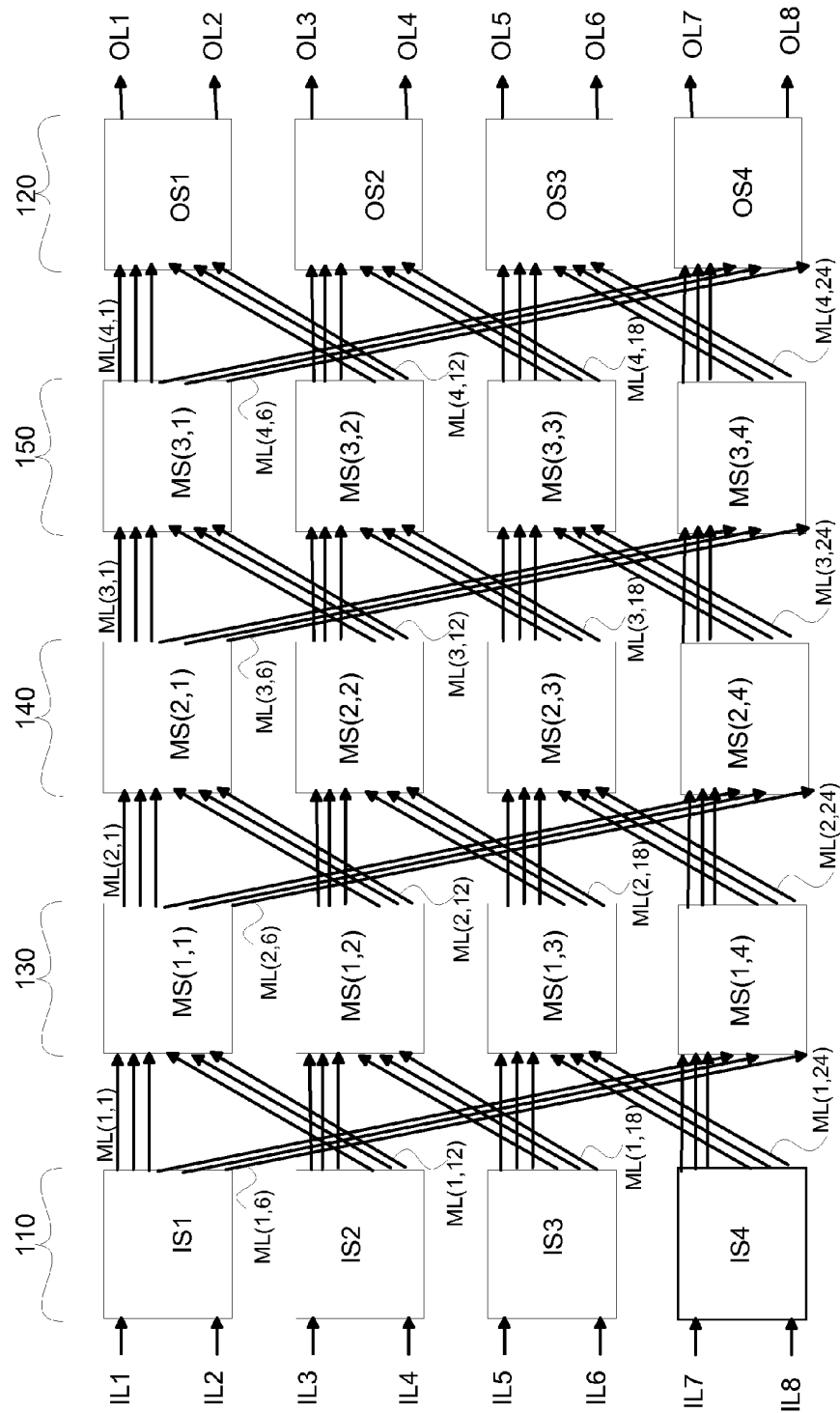

FIG. 3E

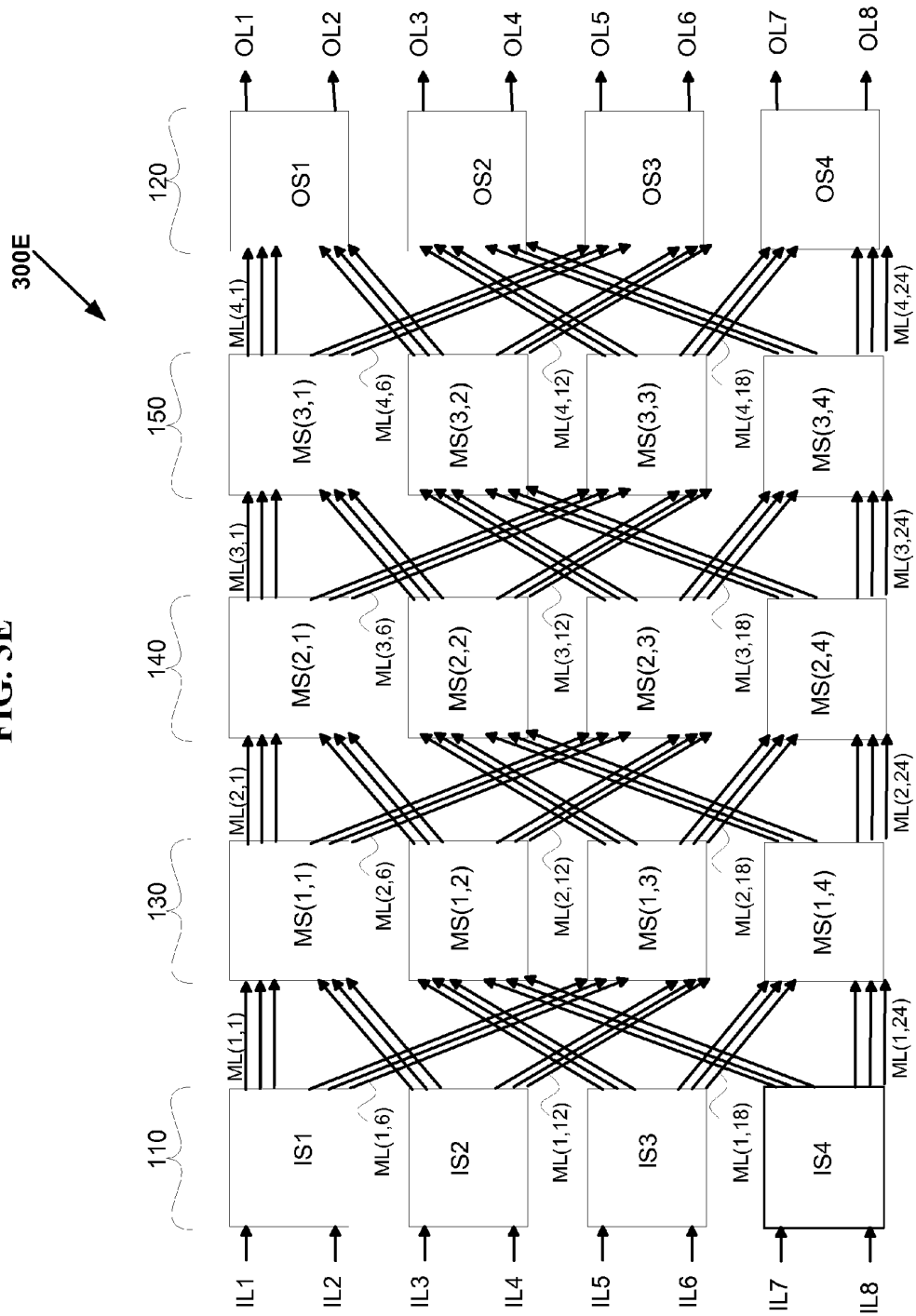

FIG. 3F

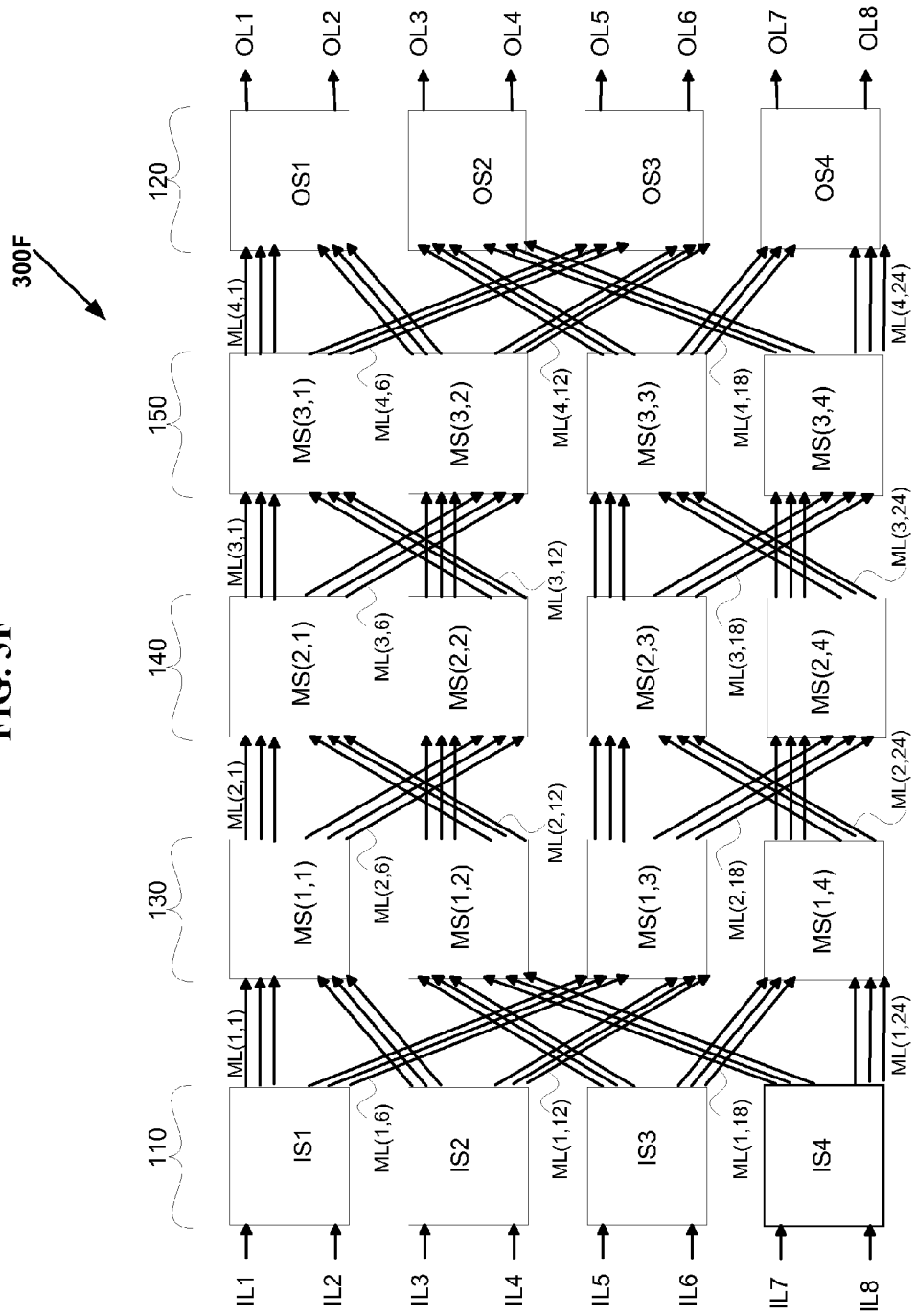

FIG. 3G

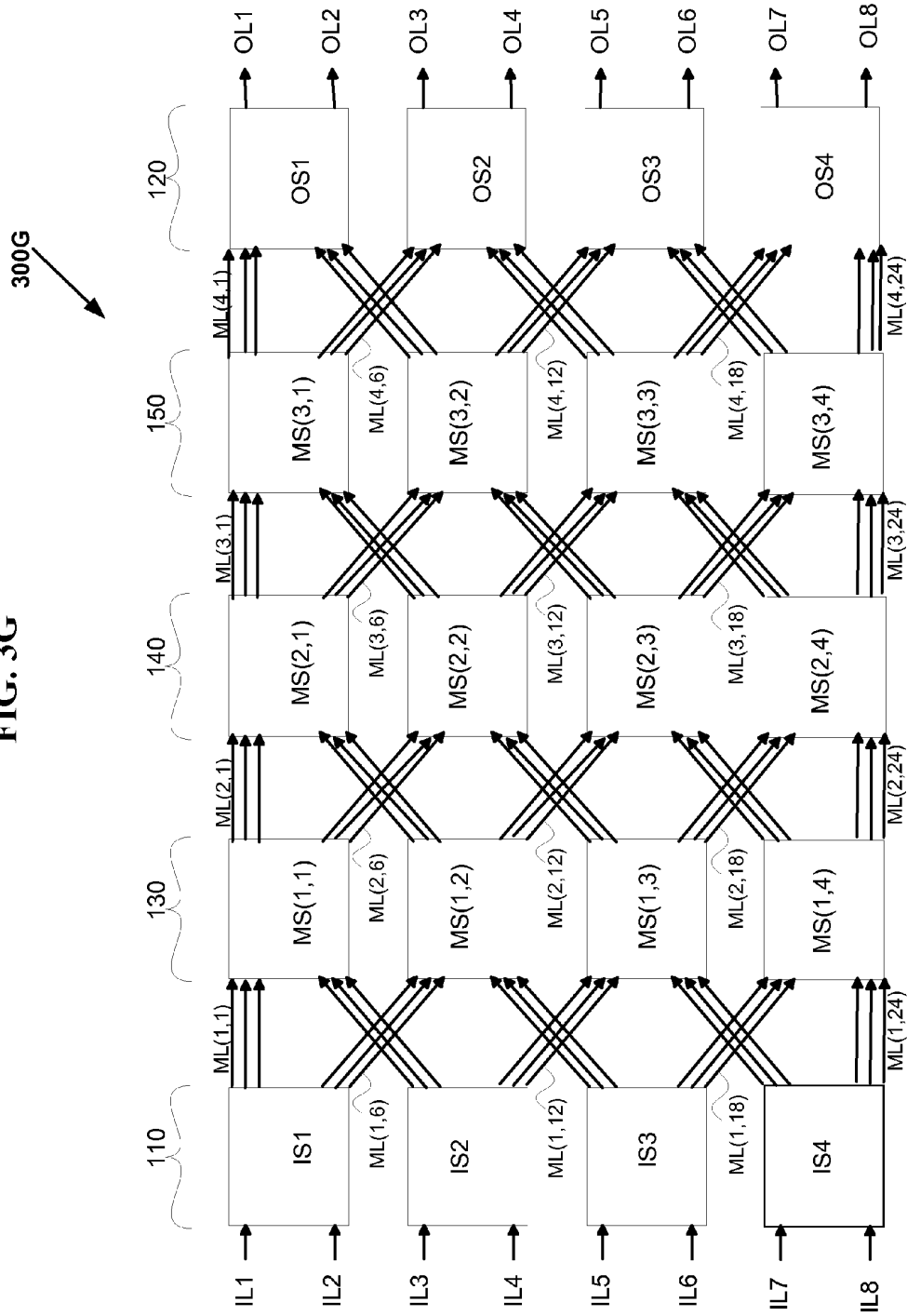

FIG. 3H

300H

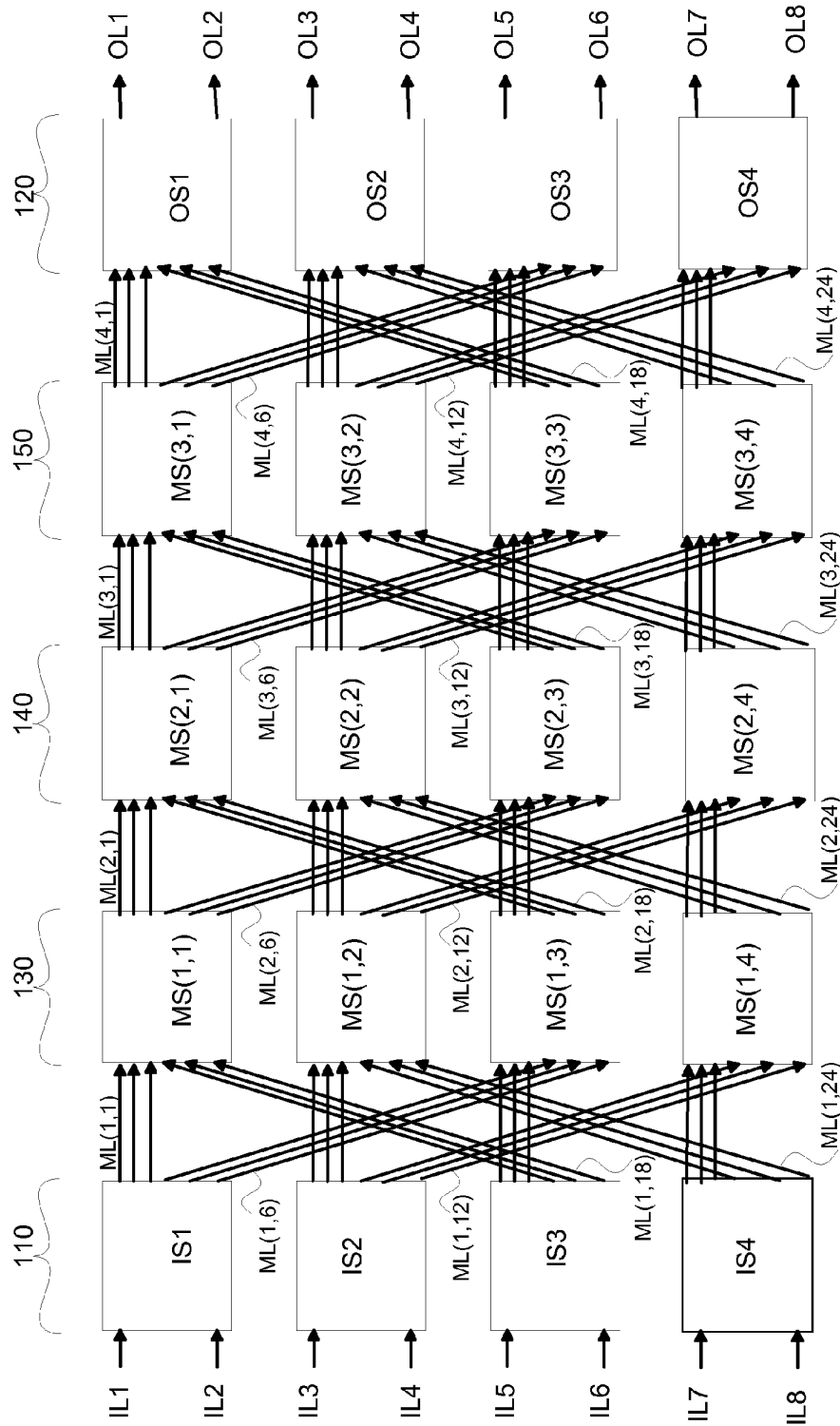

FIG. 3I

300I

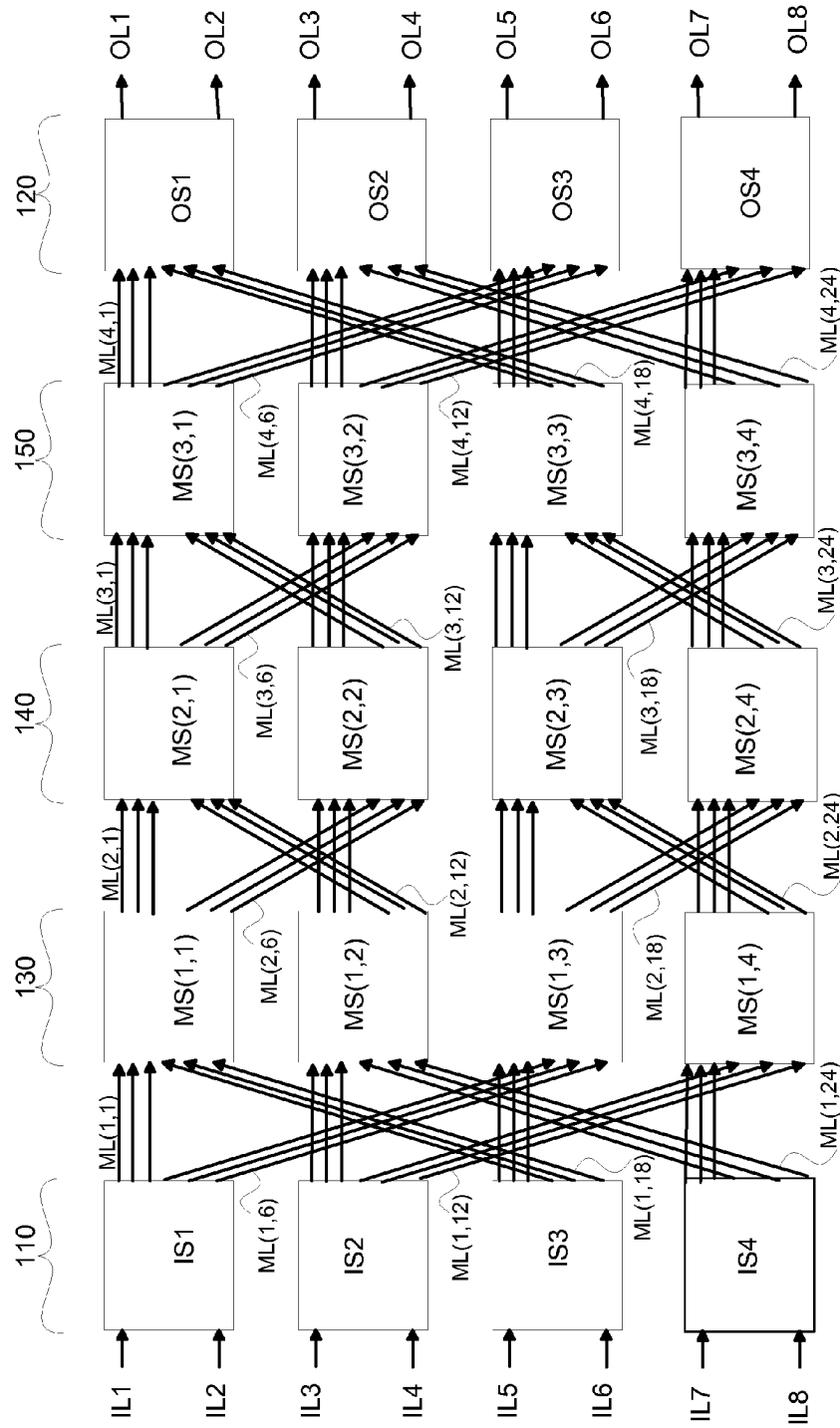

FIG. 3J

300J

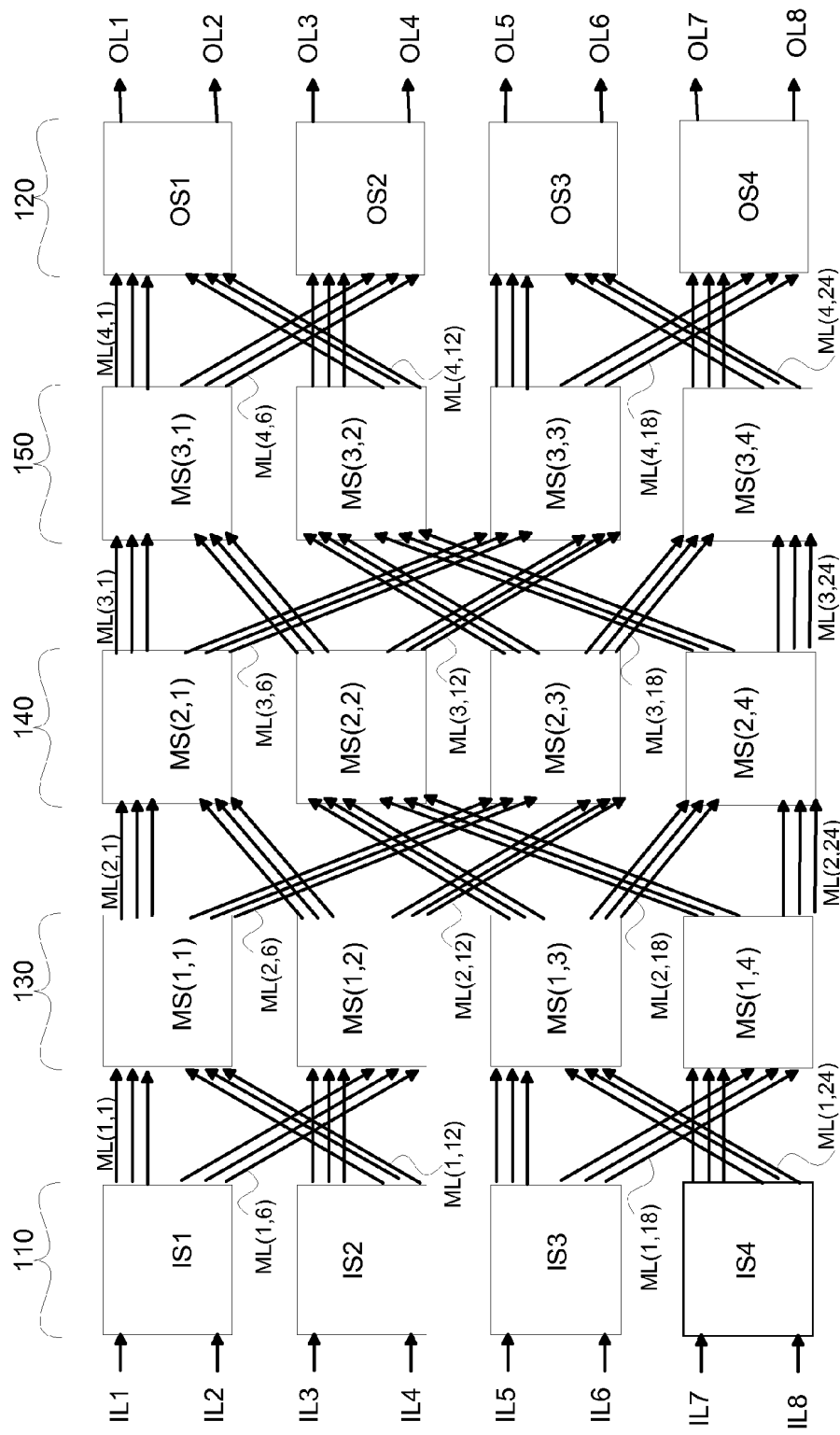

FIG. 3K

300K

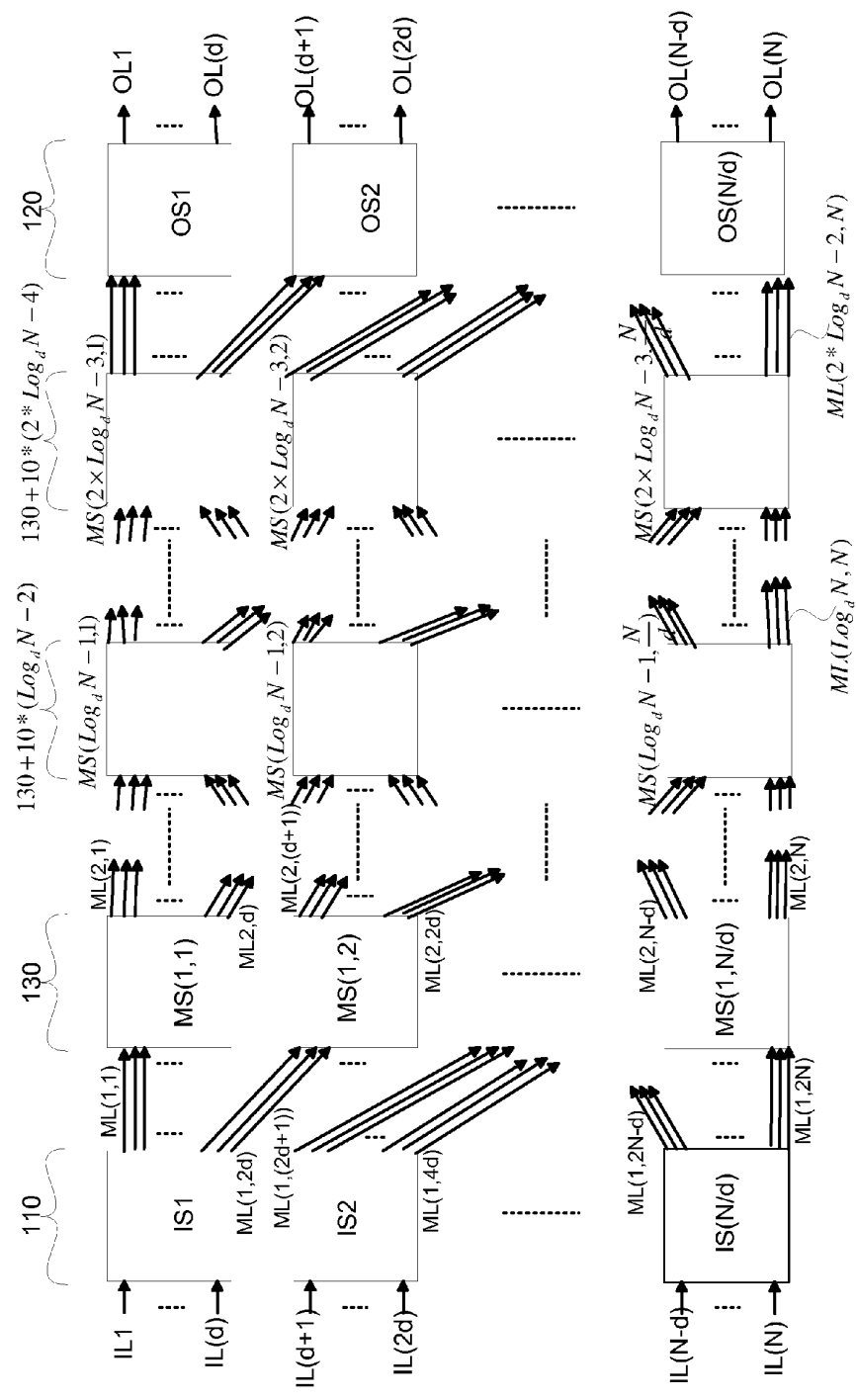

FIG. 3A1

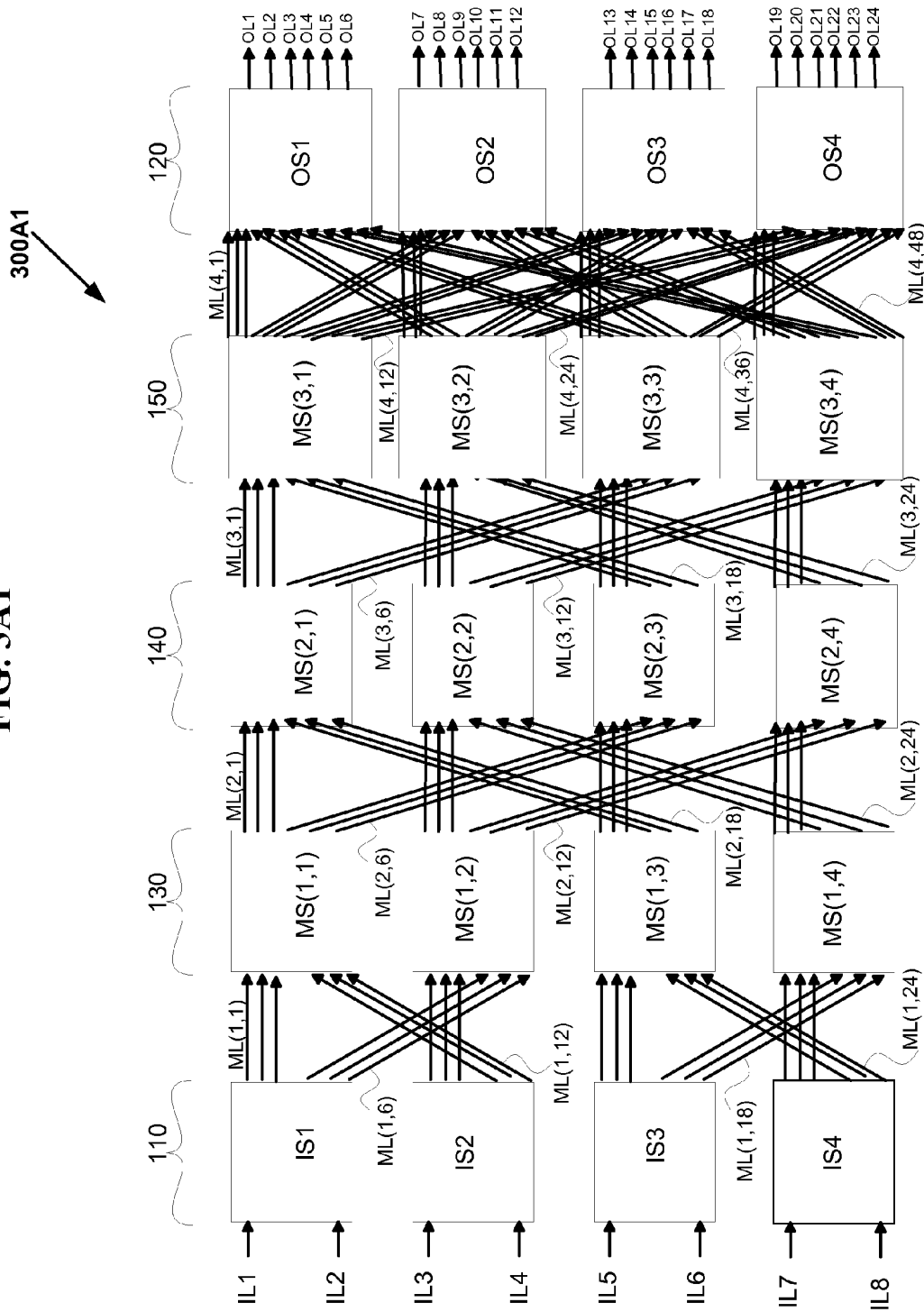

FIG. 3B1

300B1

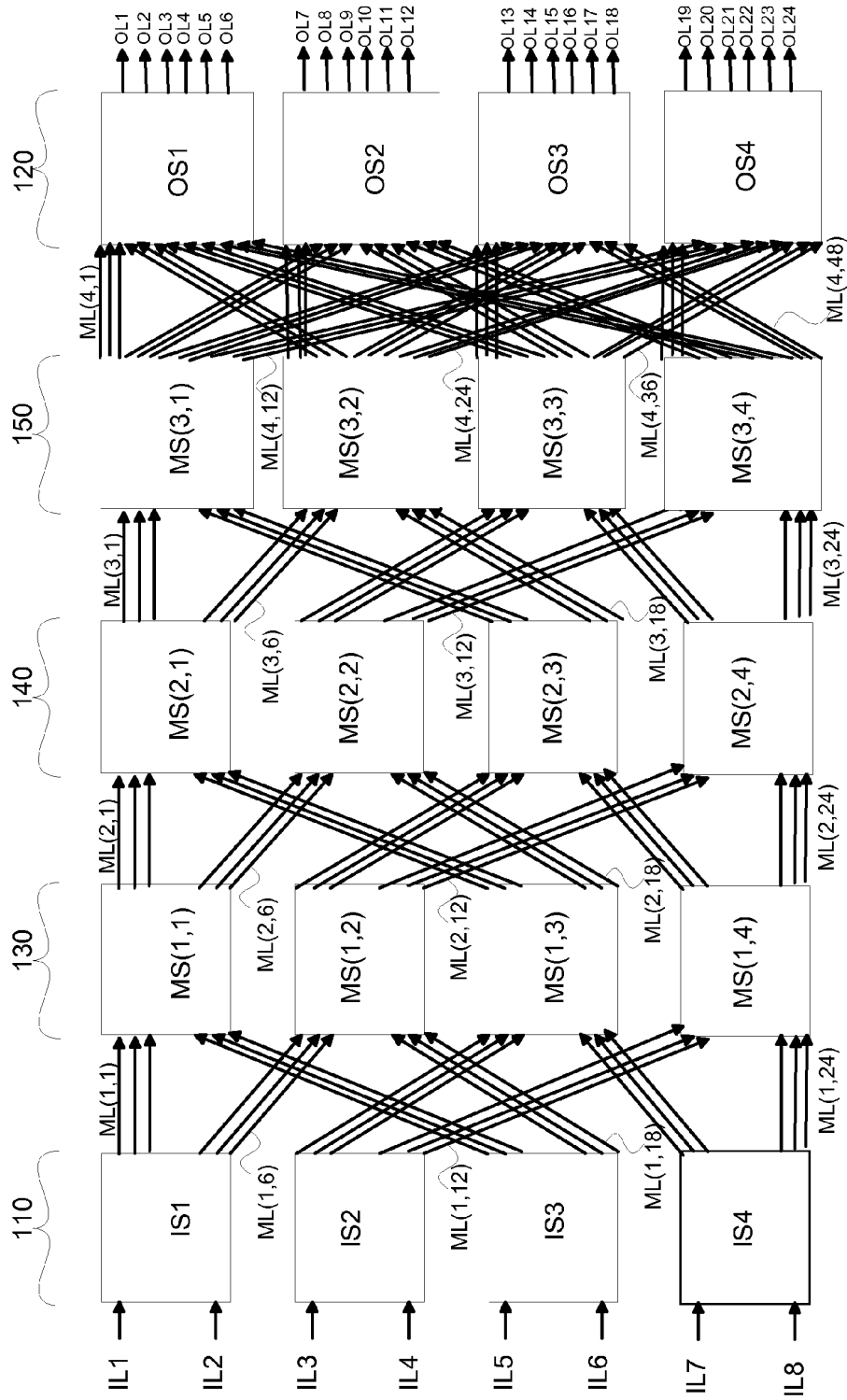

FIG. 3C1

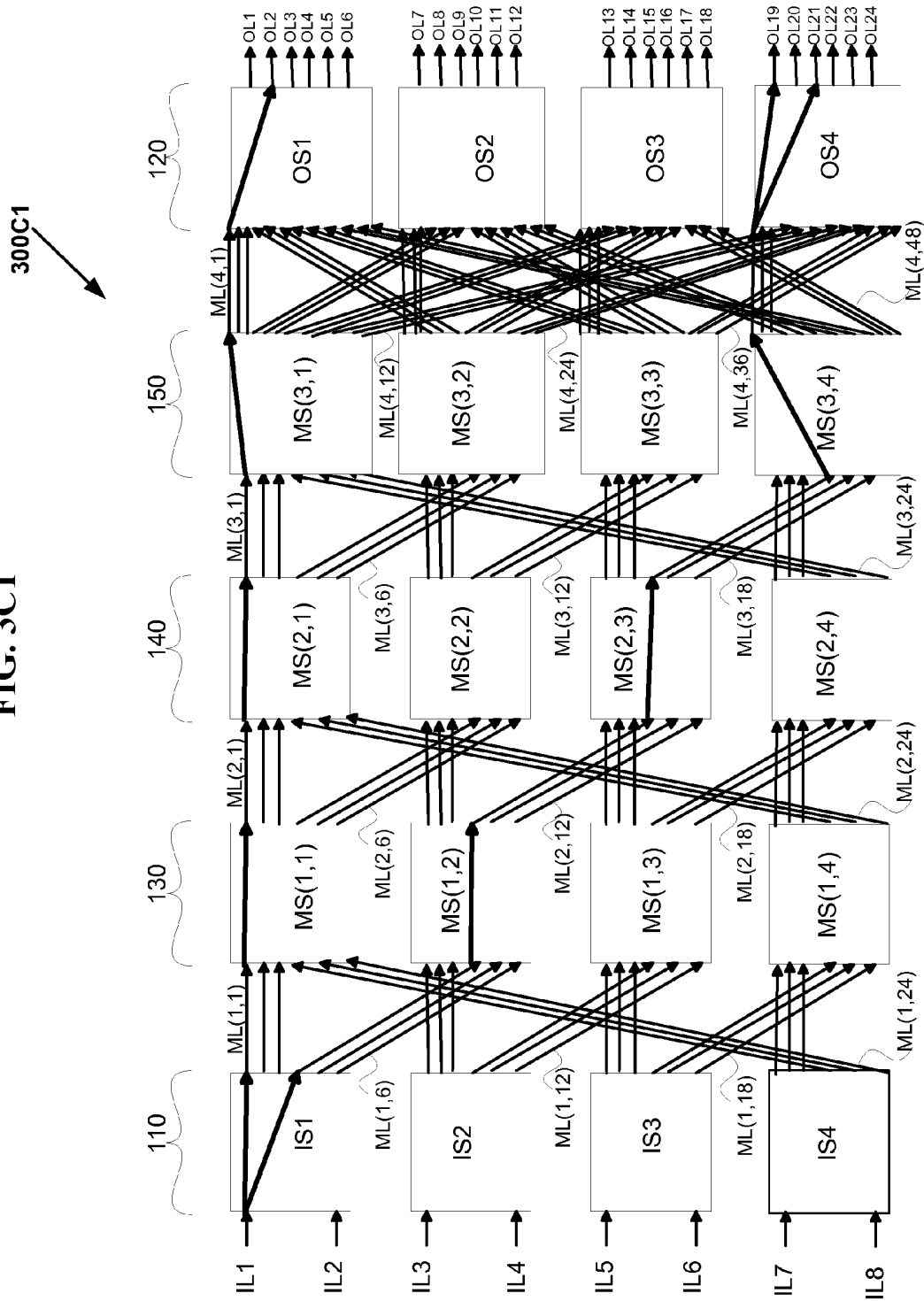

FIG. 3D1

300D1

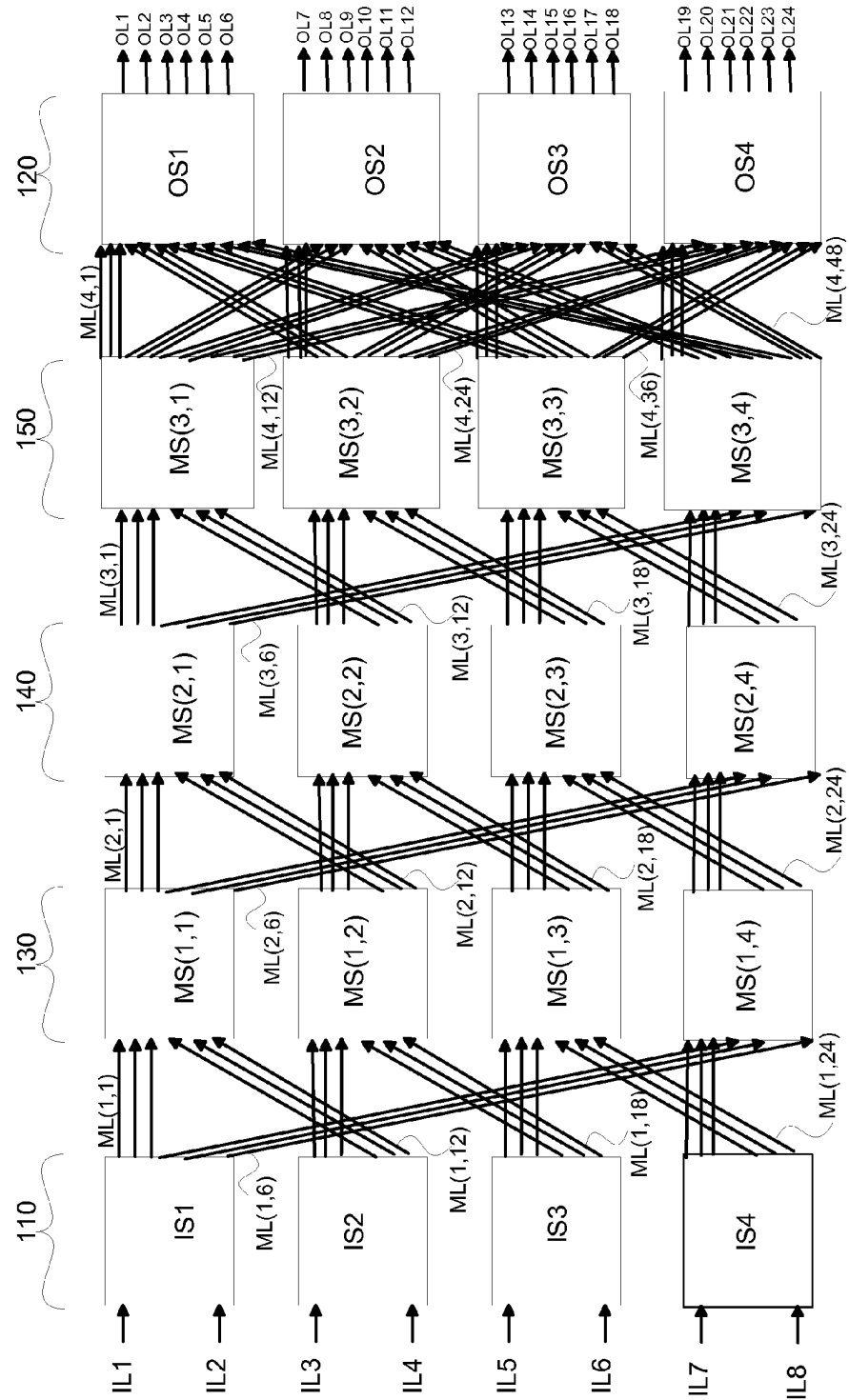

FIG. 3E1

300E1

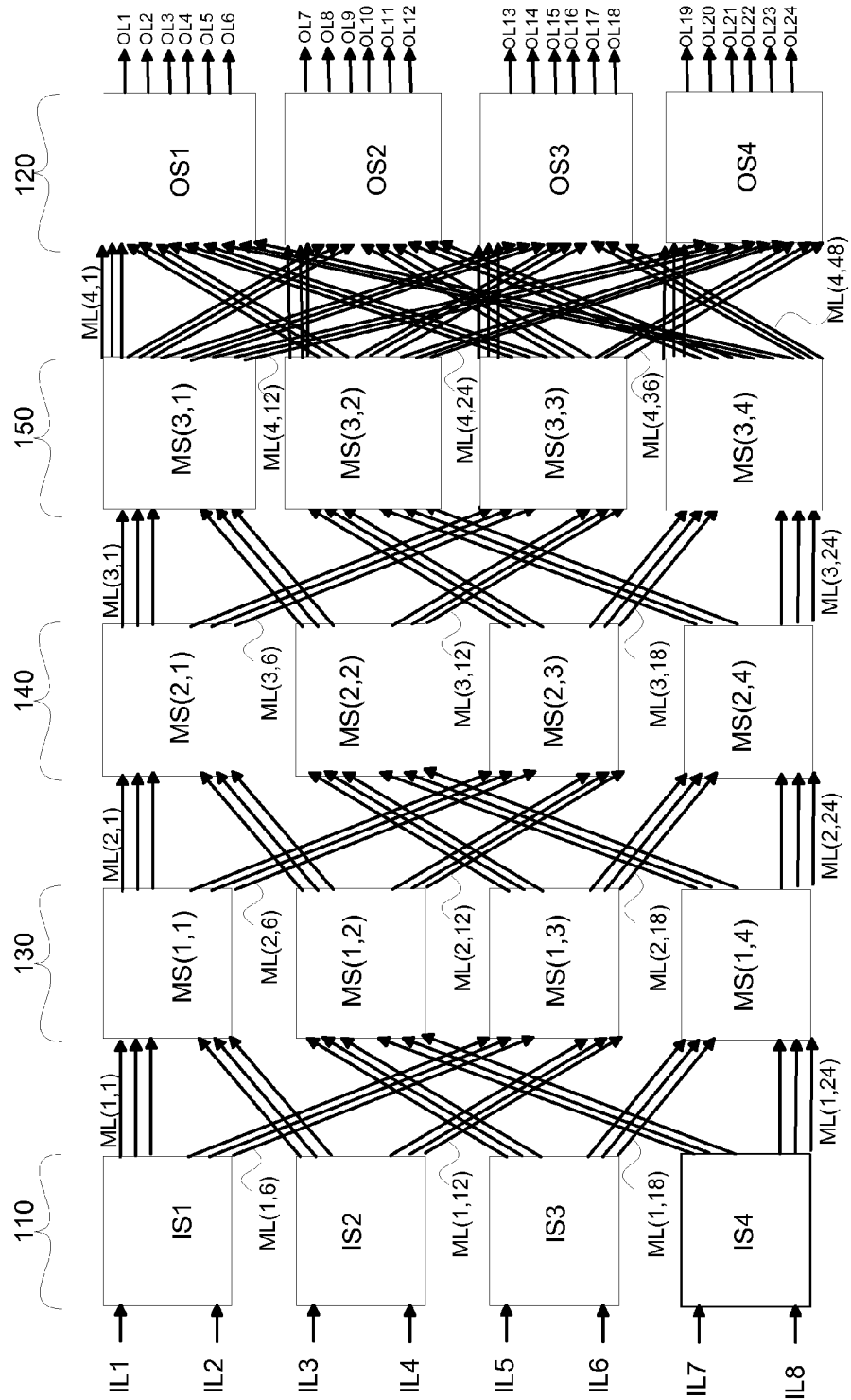

FIG. 3F1

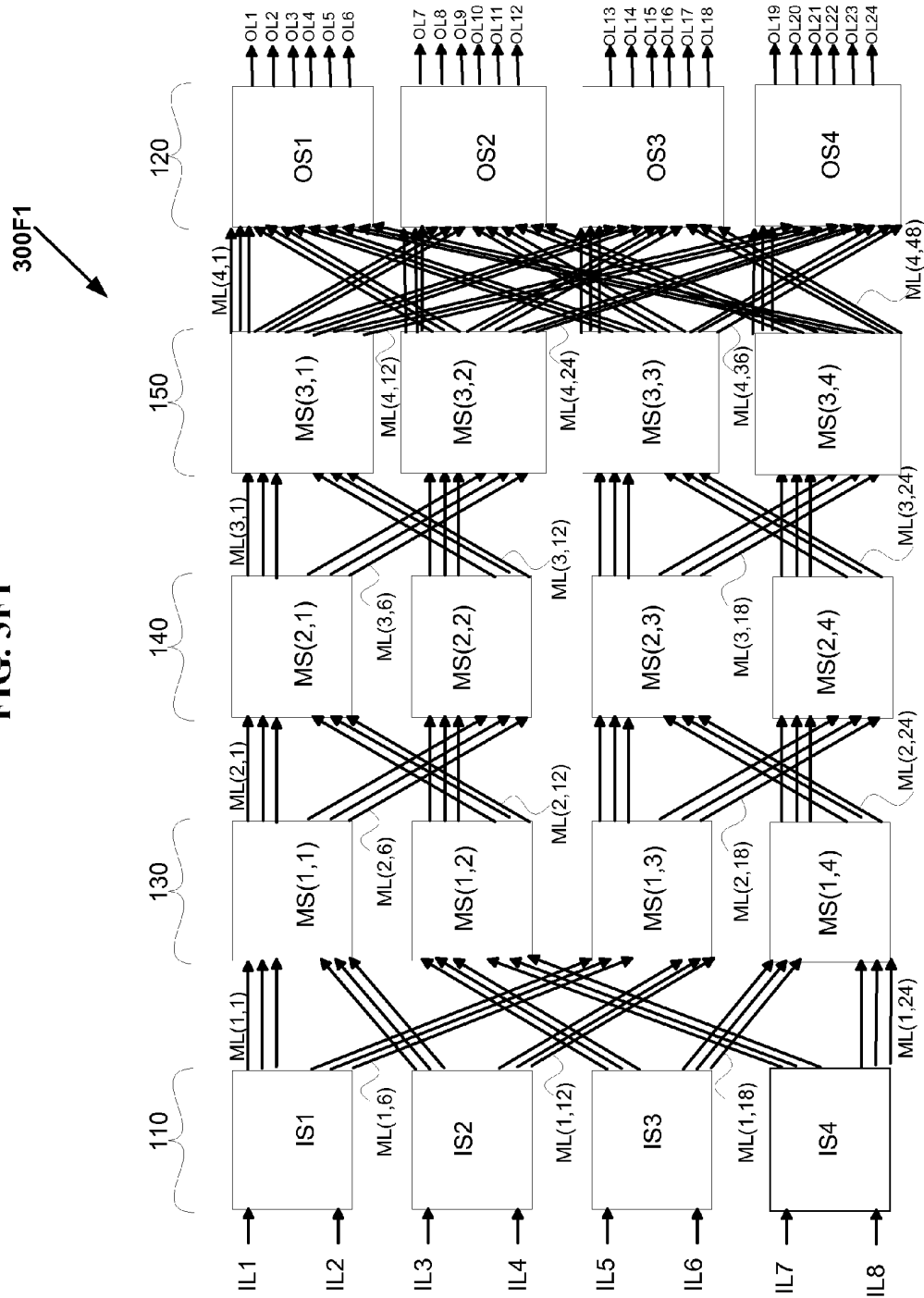

FIG. 3G1

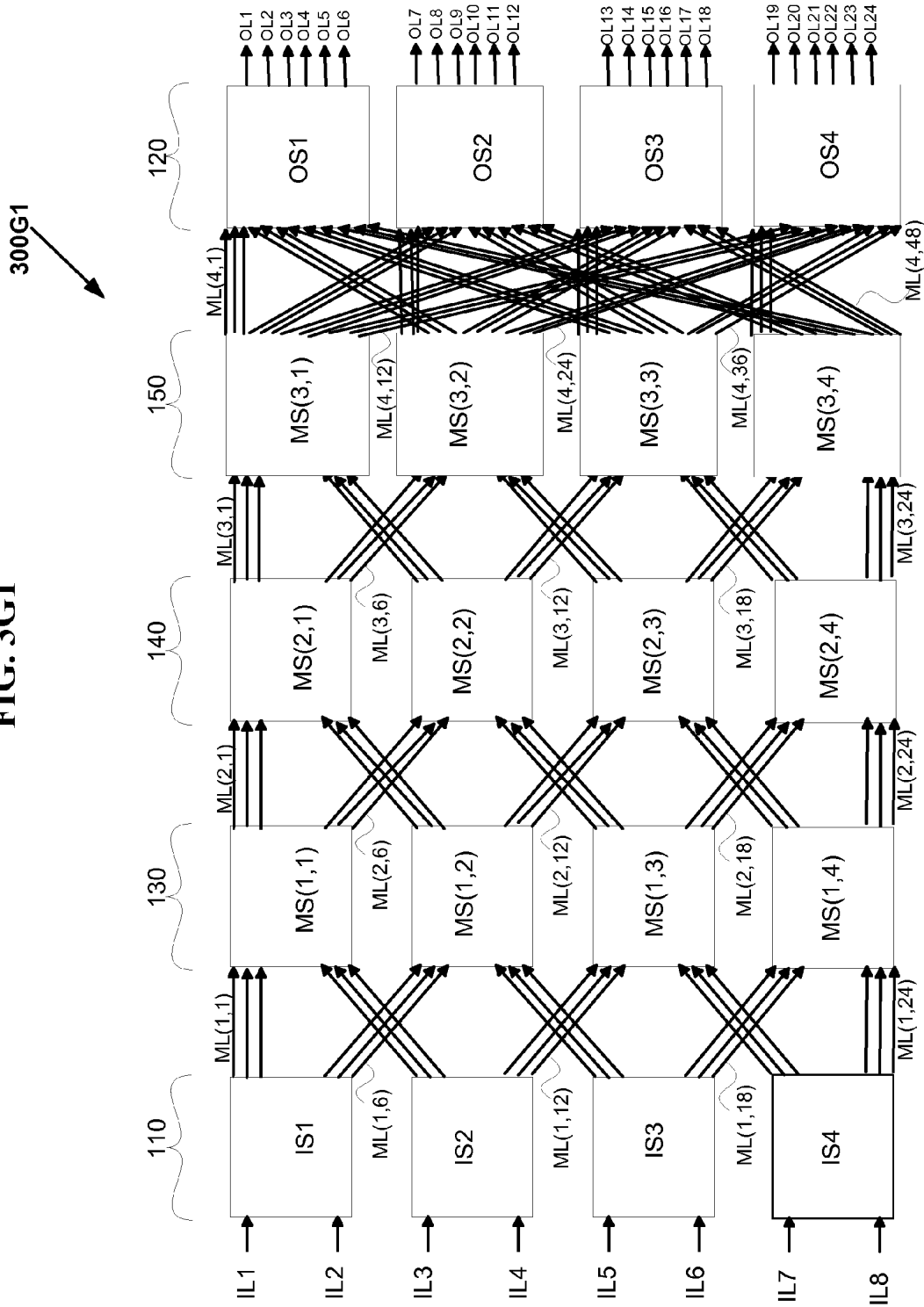

FIG. 3H1

300H1

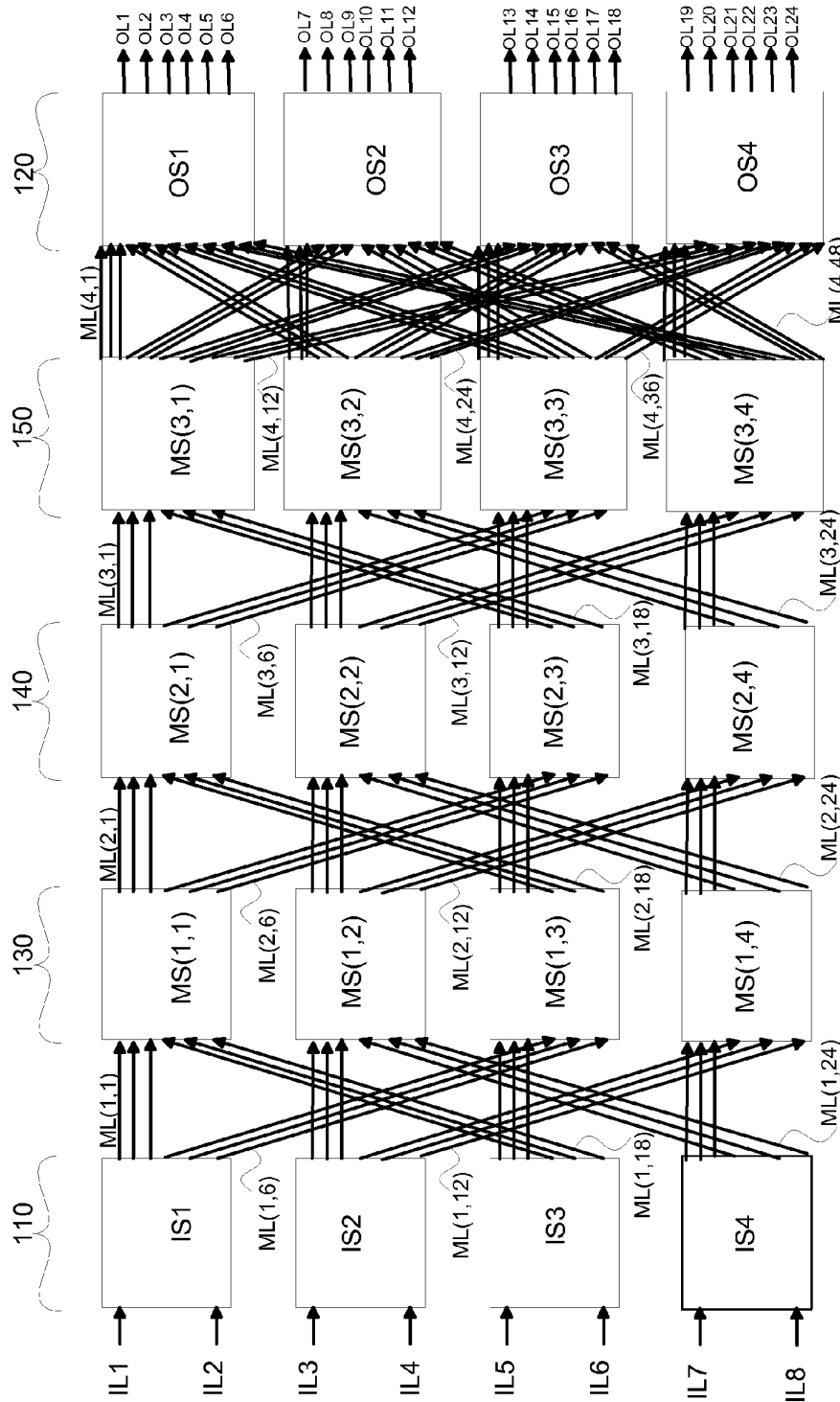

FIG. 311

30011

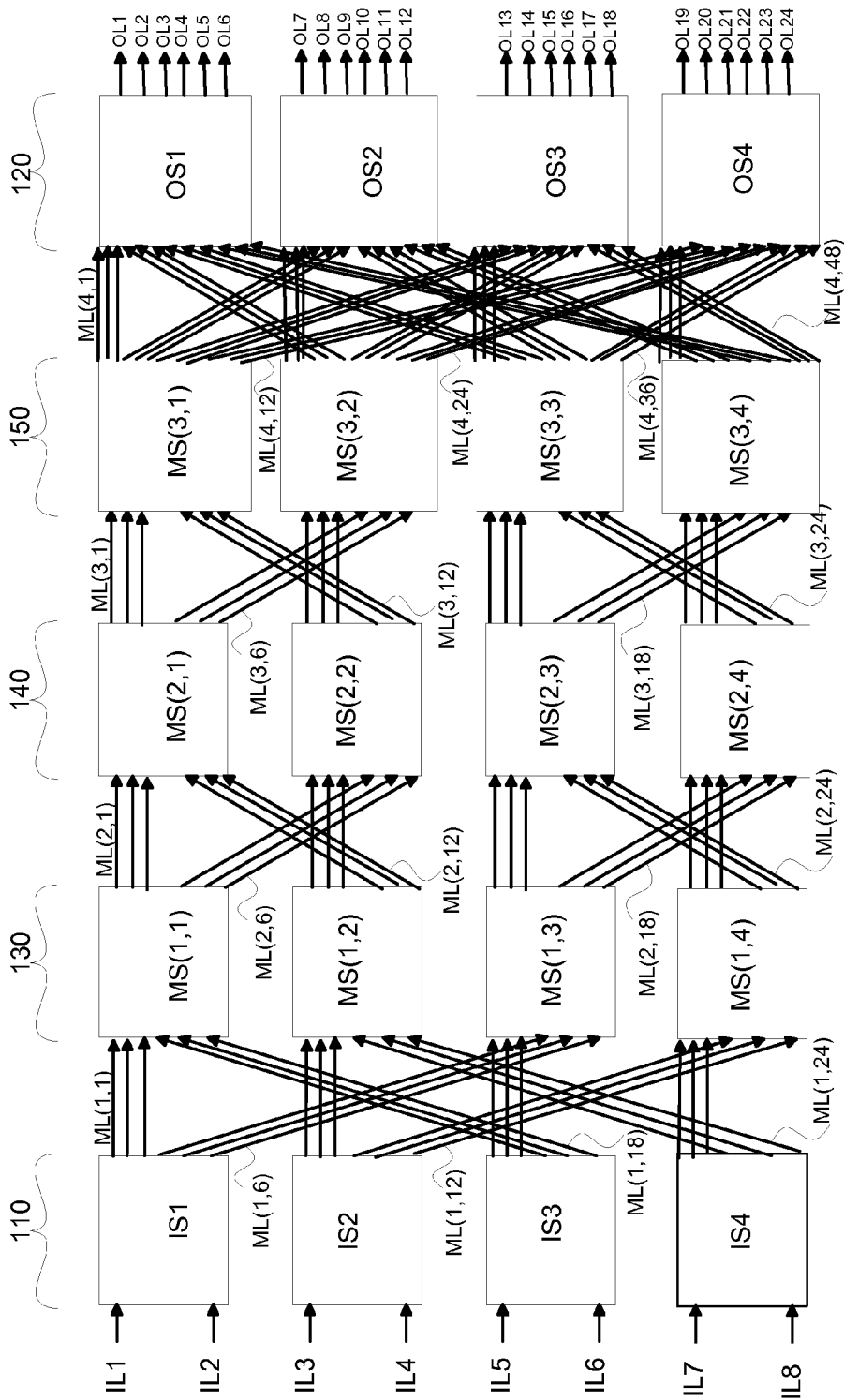

FIG. 3J1

300J1

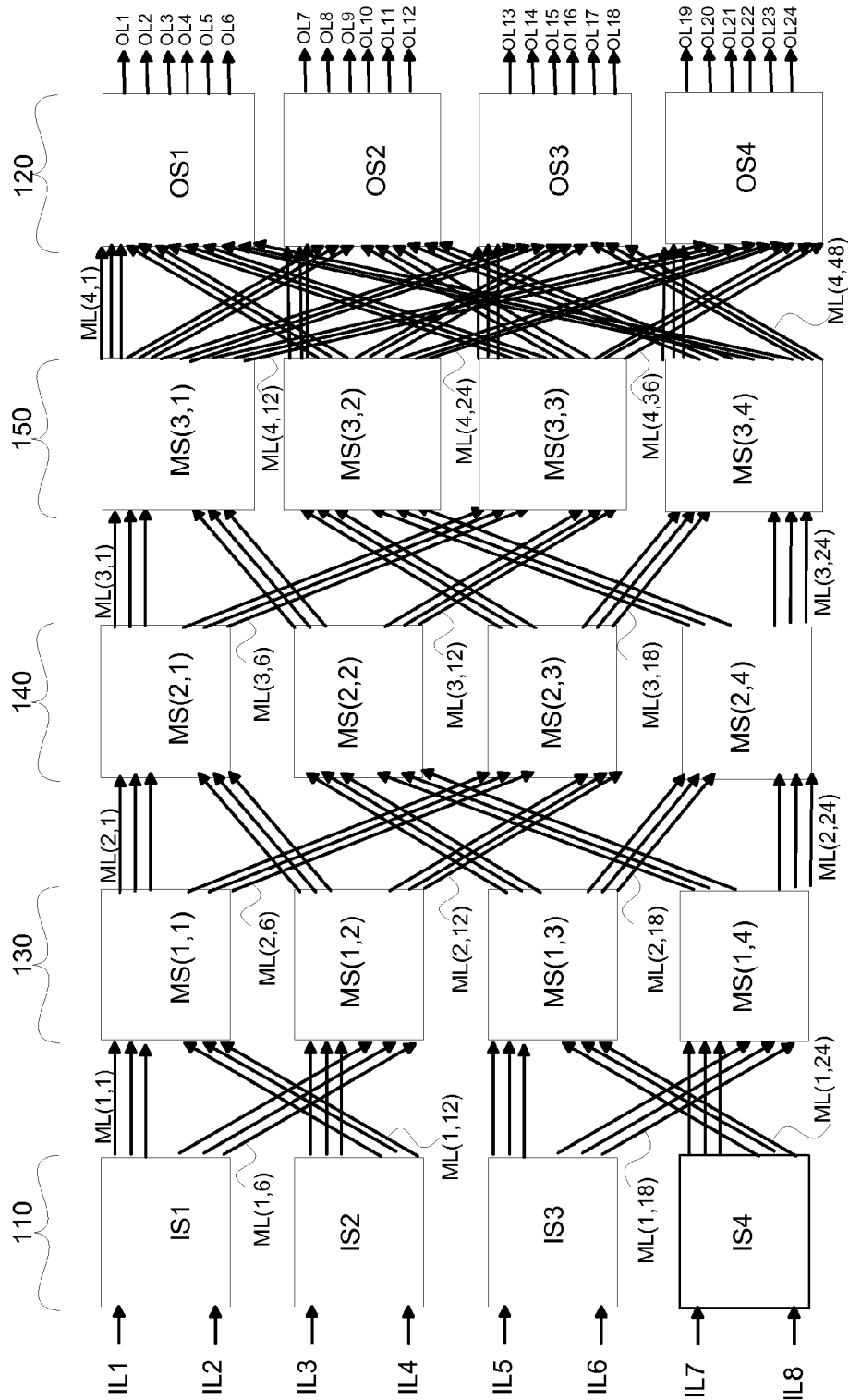

FIG. 3K1

300K1

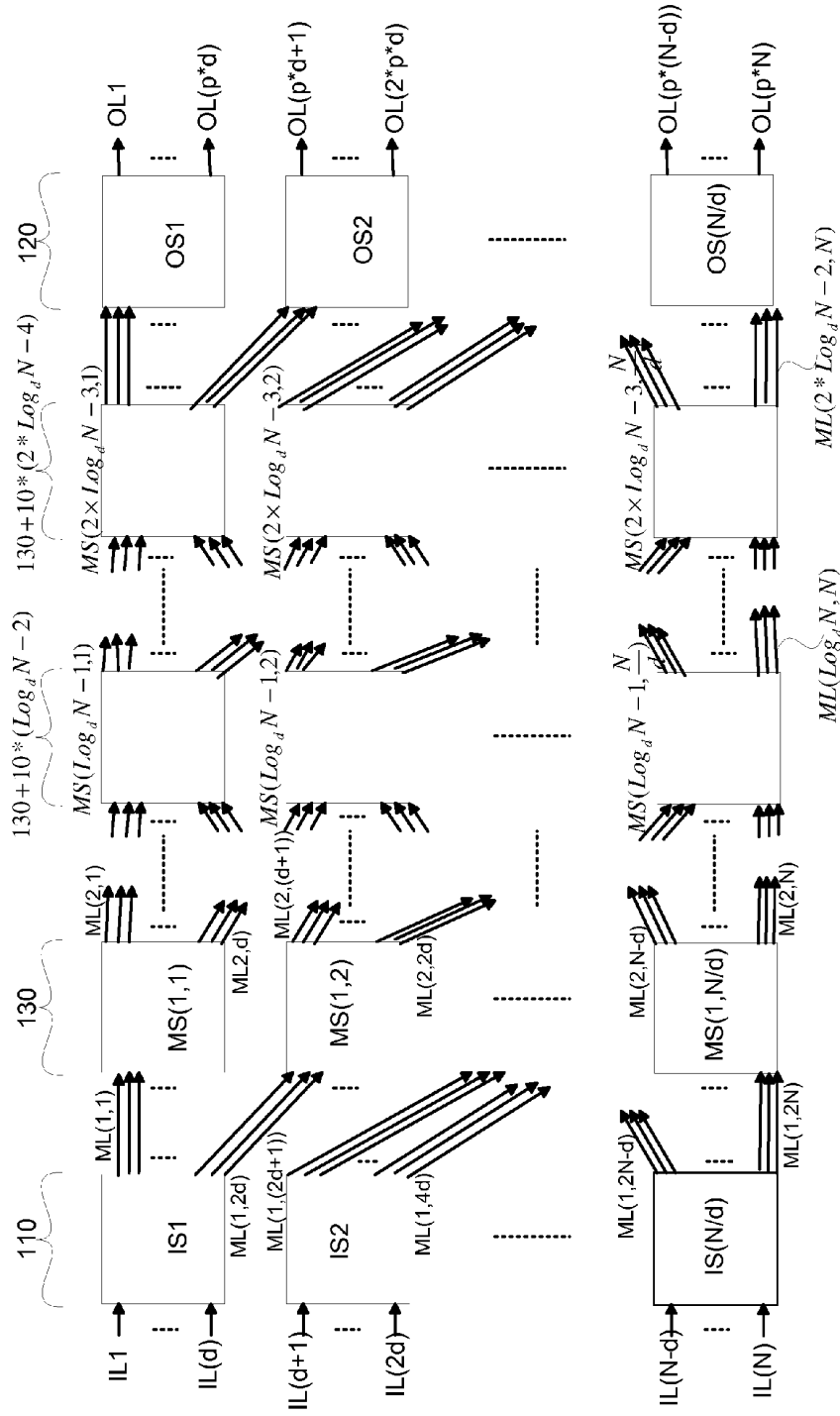

FIG. 3A2

300A2

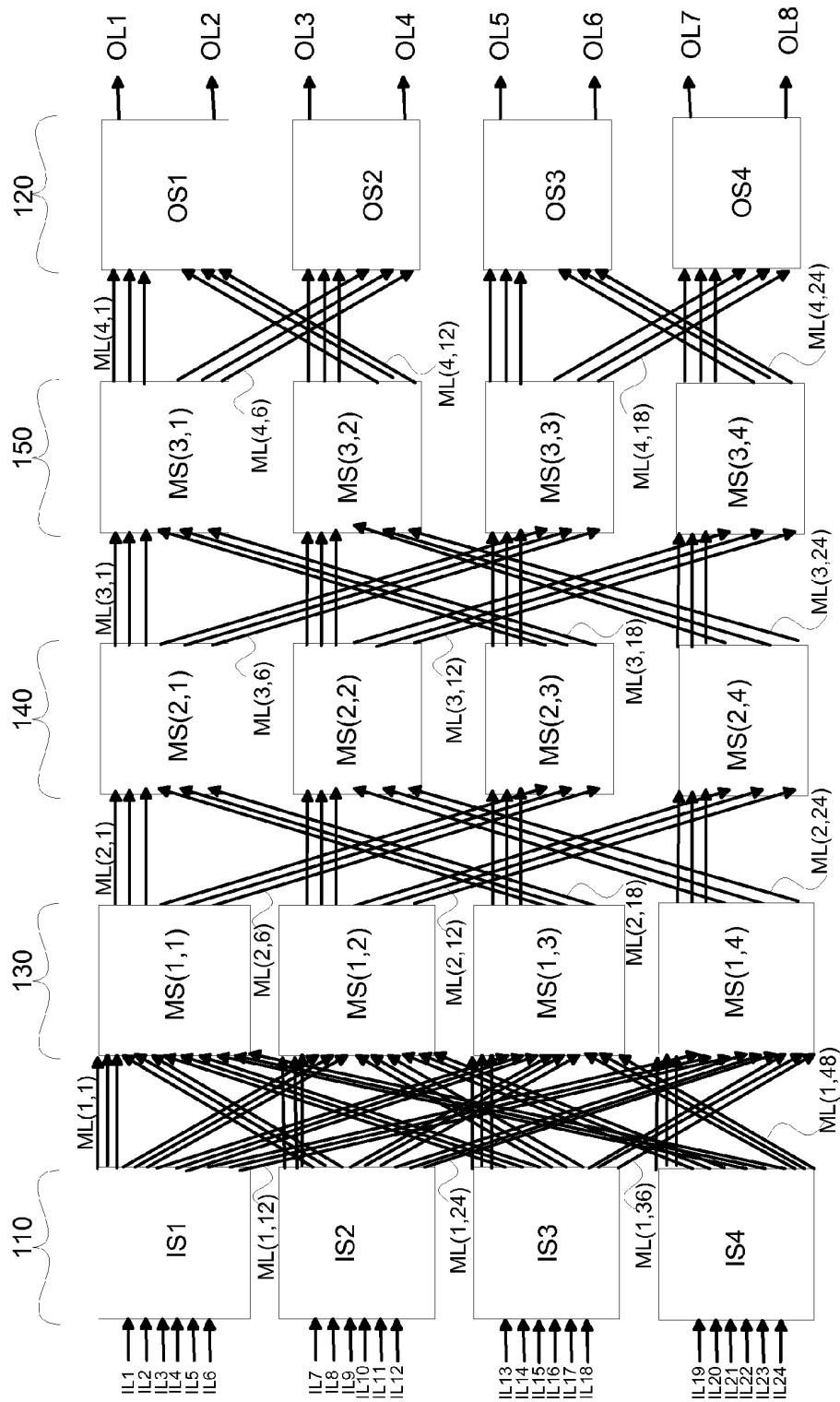

FIG. 3B2

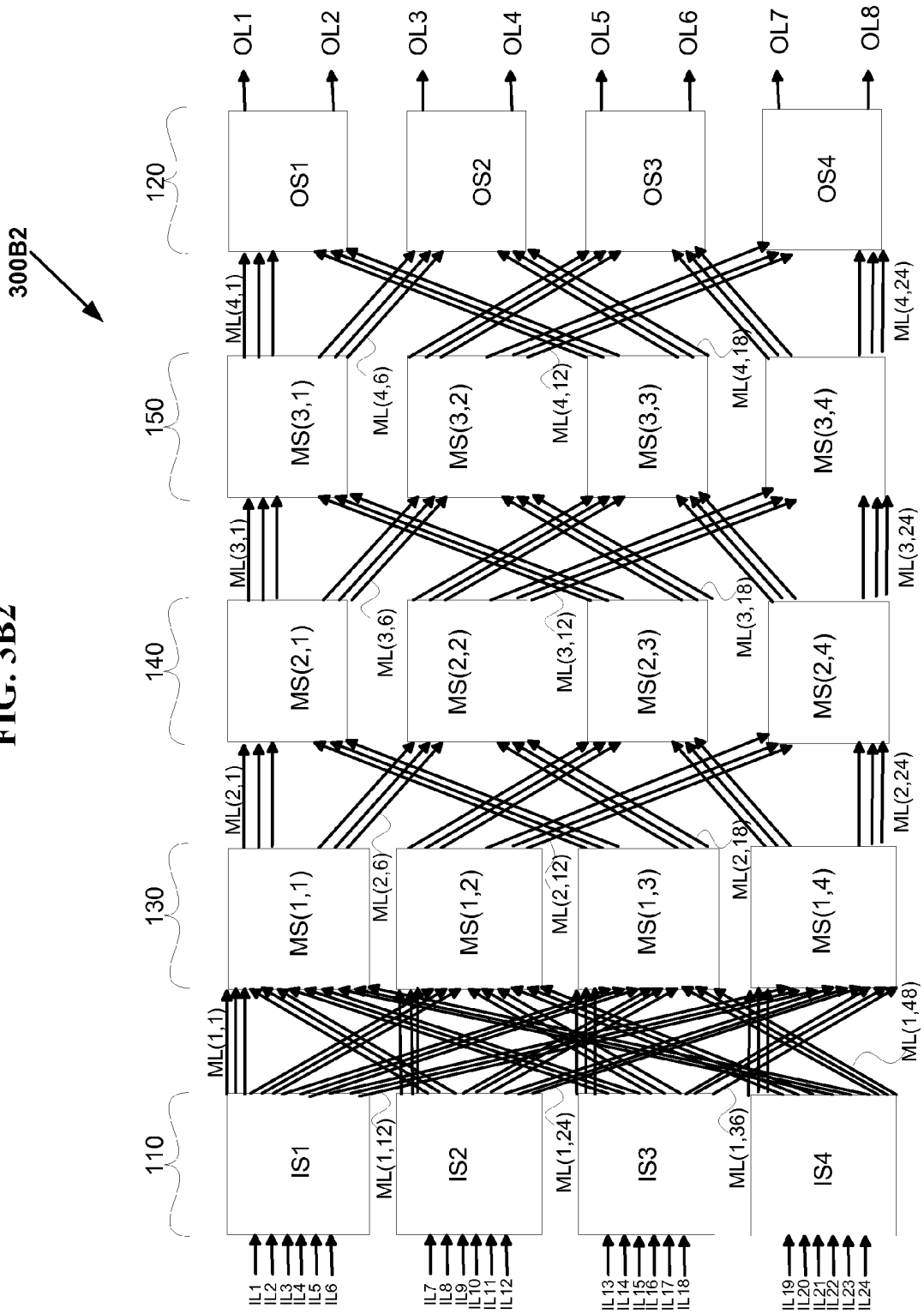

FIG. 3C2

300C2

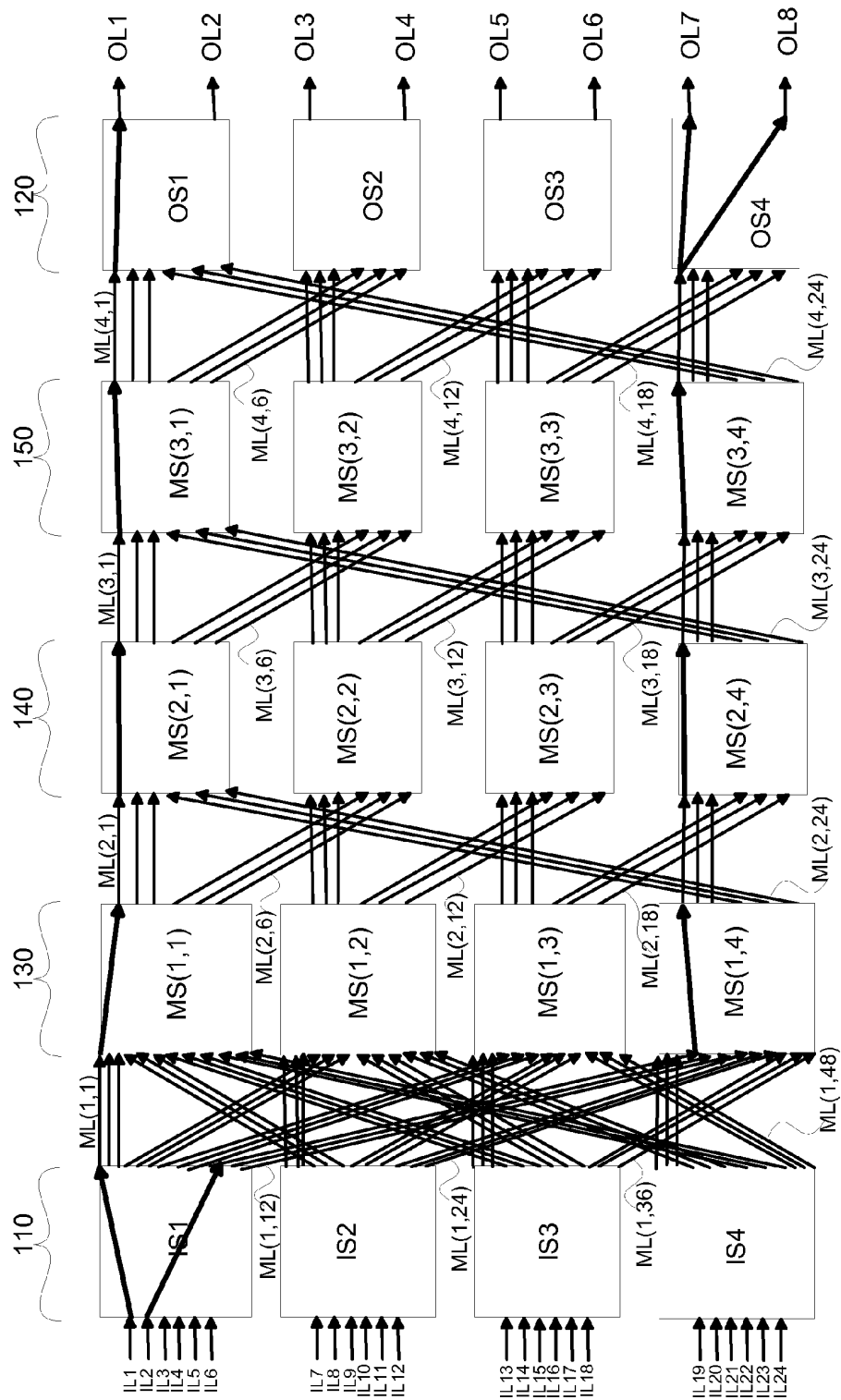

FIG. 3D2

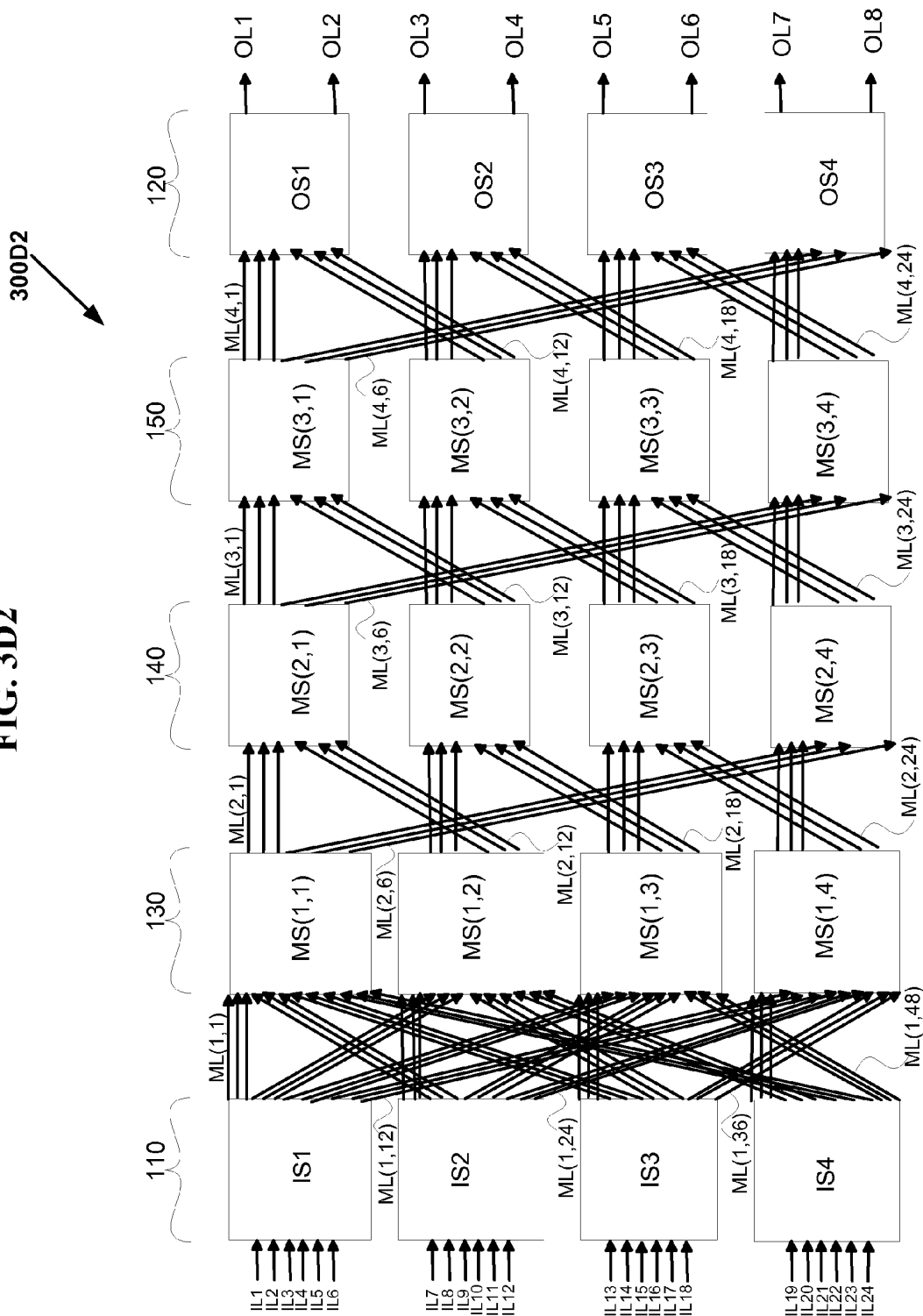

FIG. 3E2

300E2

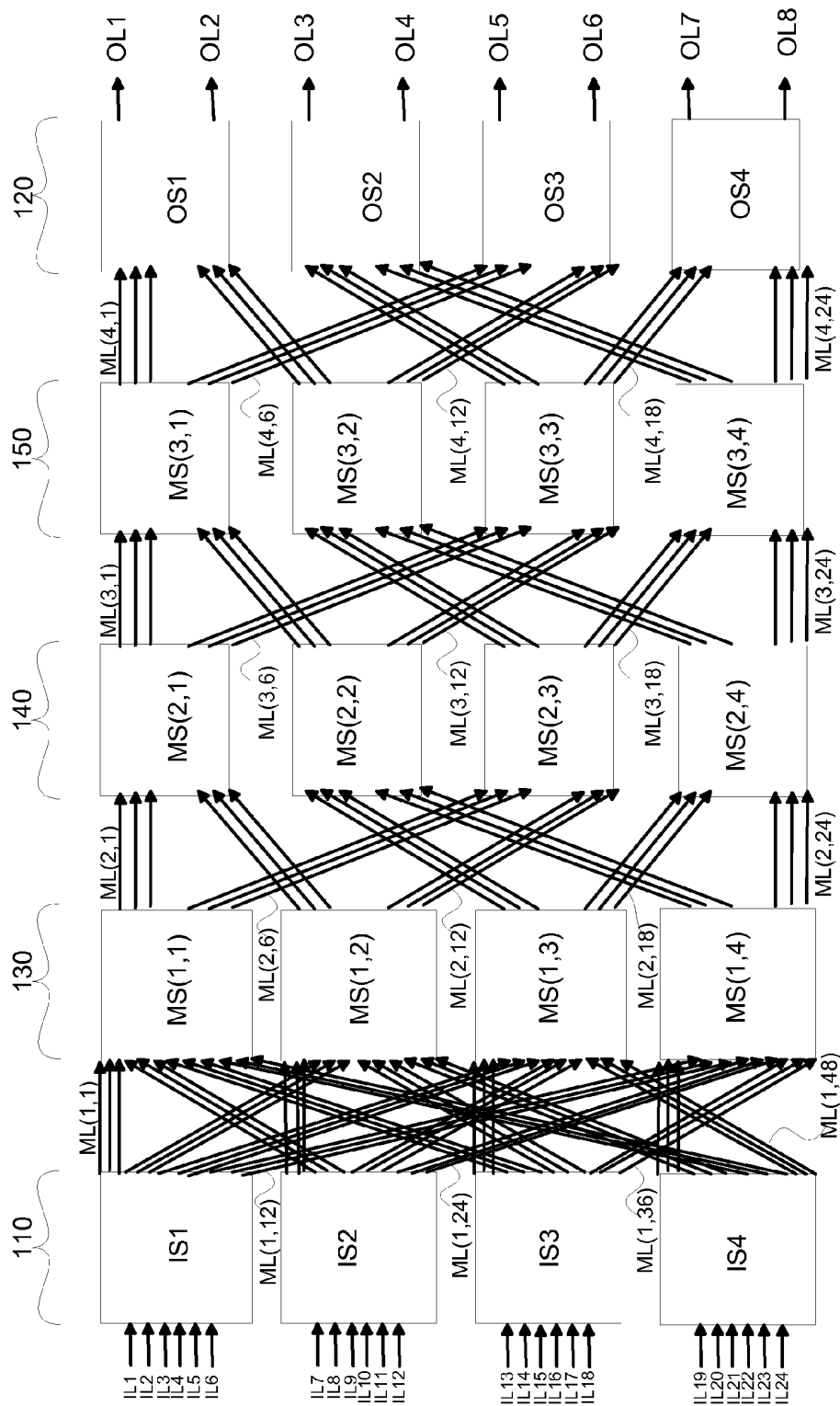

FIG. 3F2

300F2

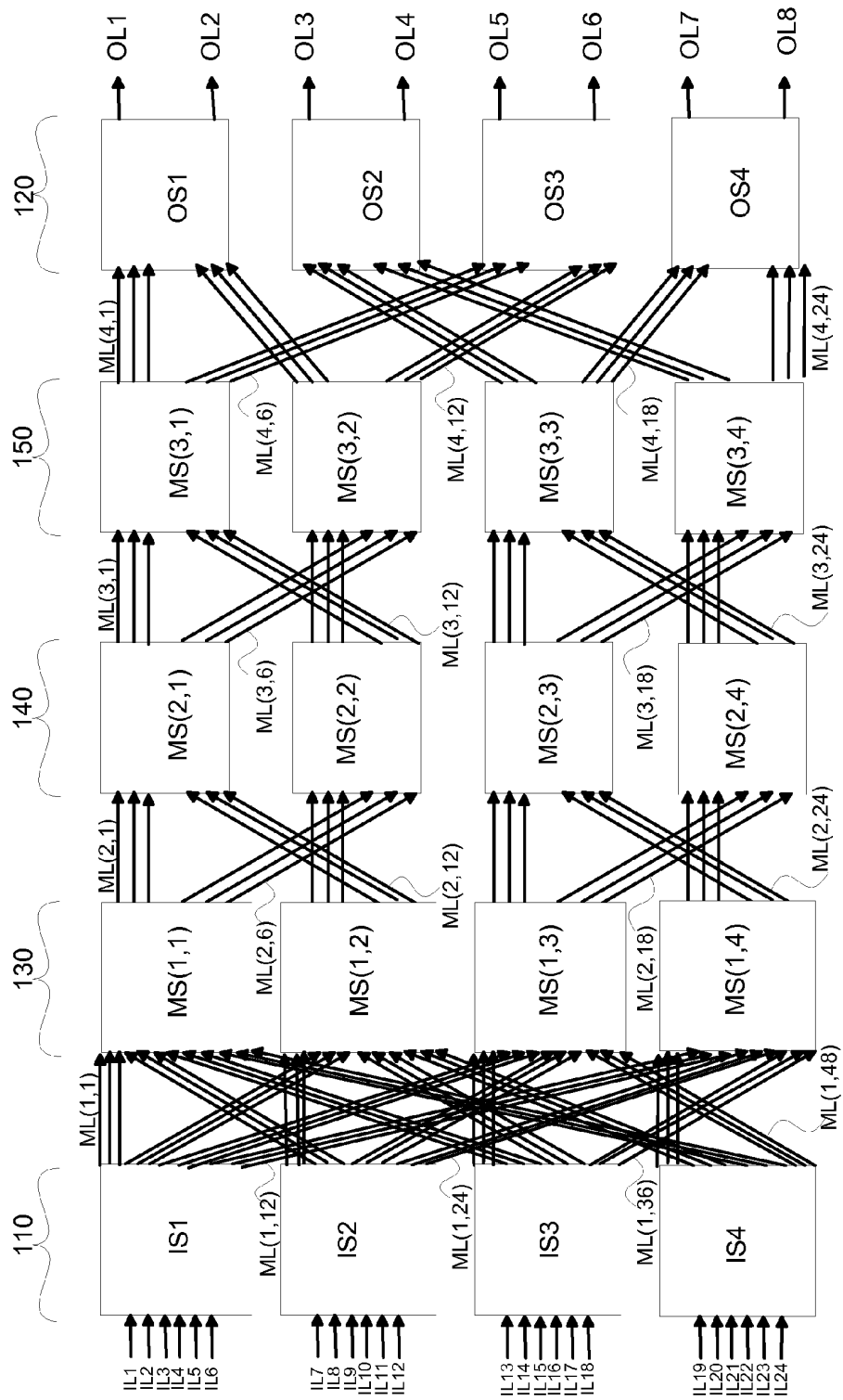

FIG. 3G2

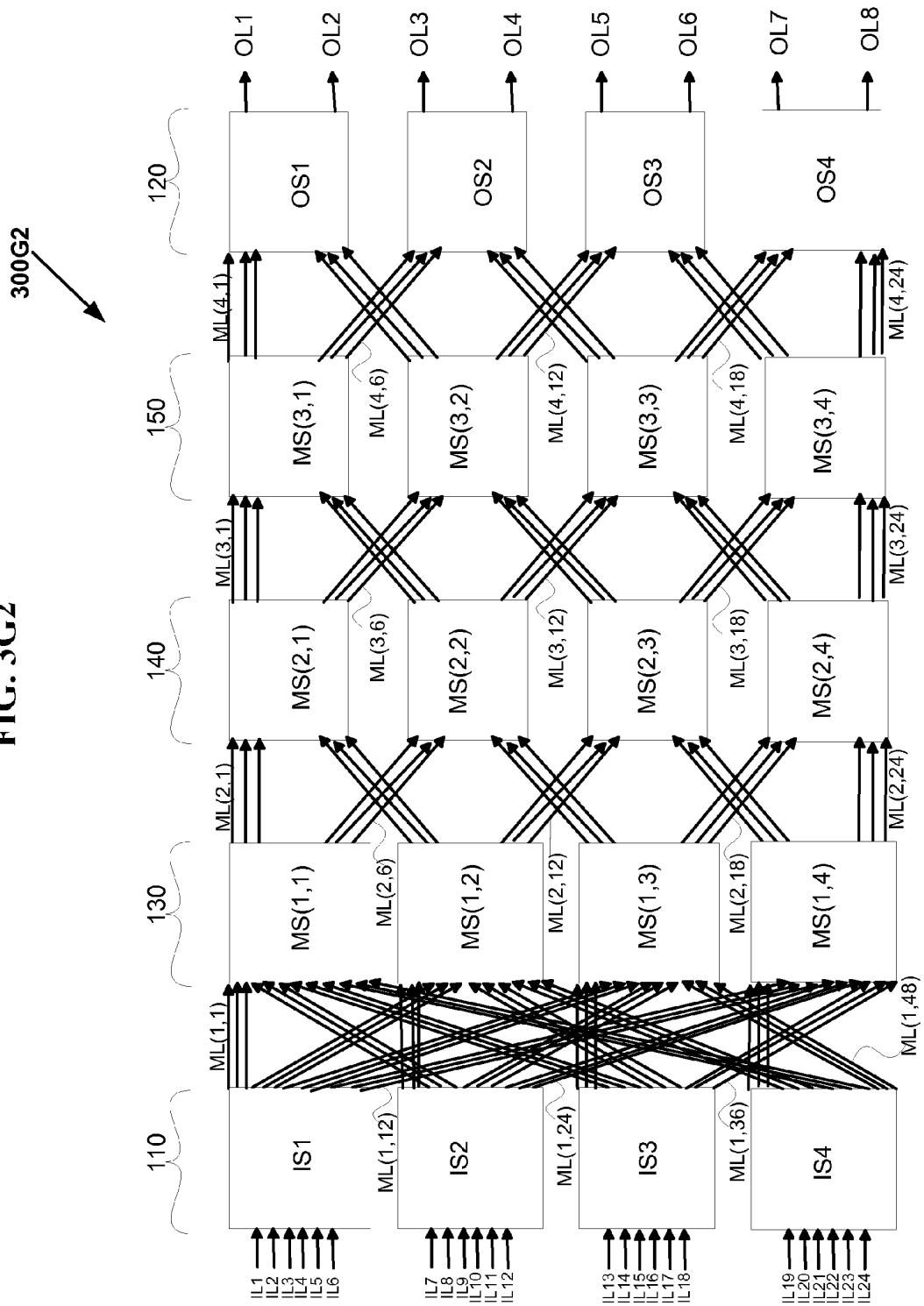

FIG. 3H2

300H2

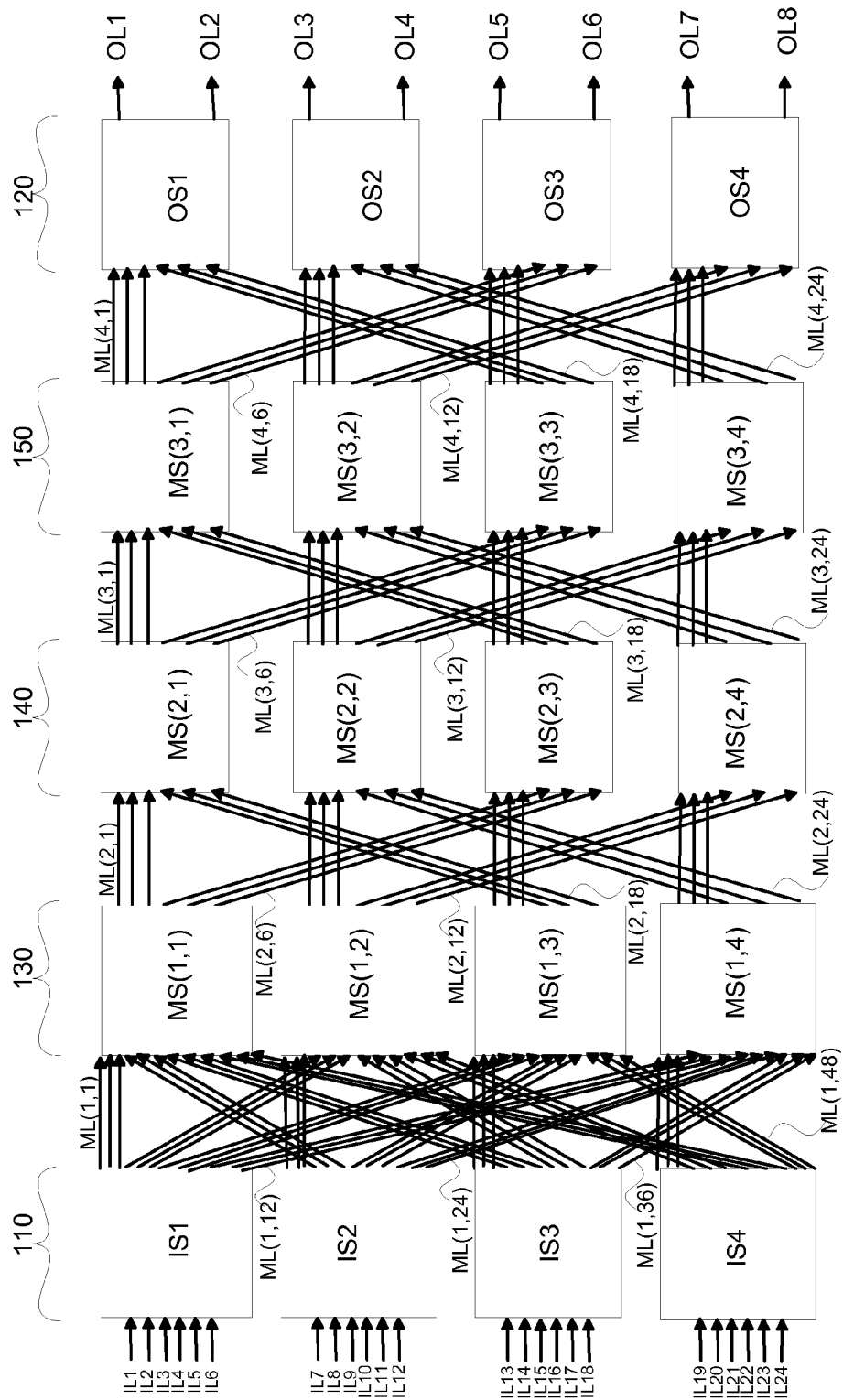

FIG. 3I2

300I2

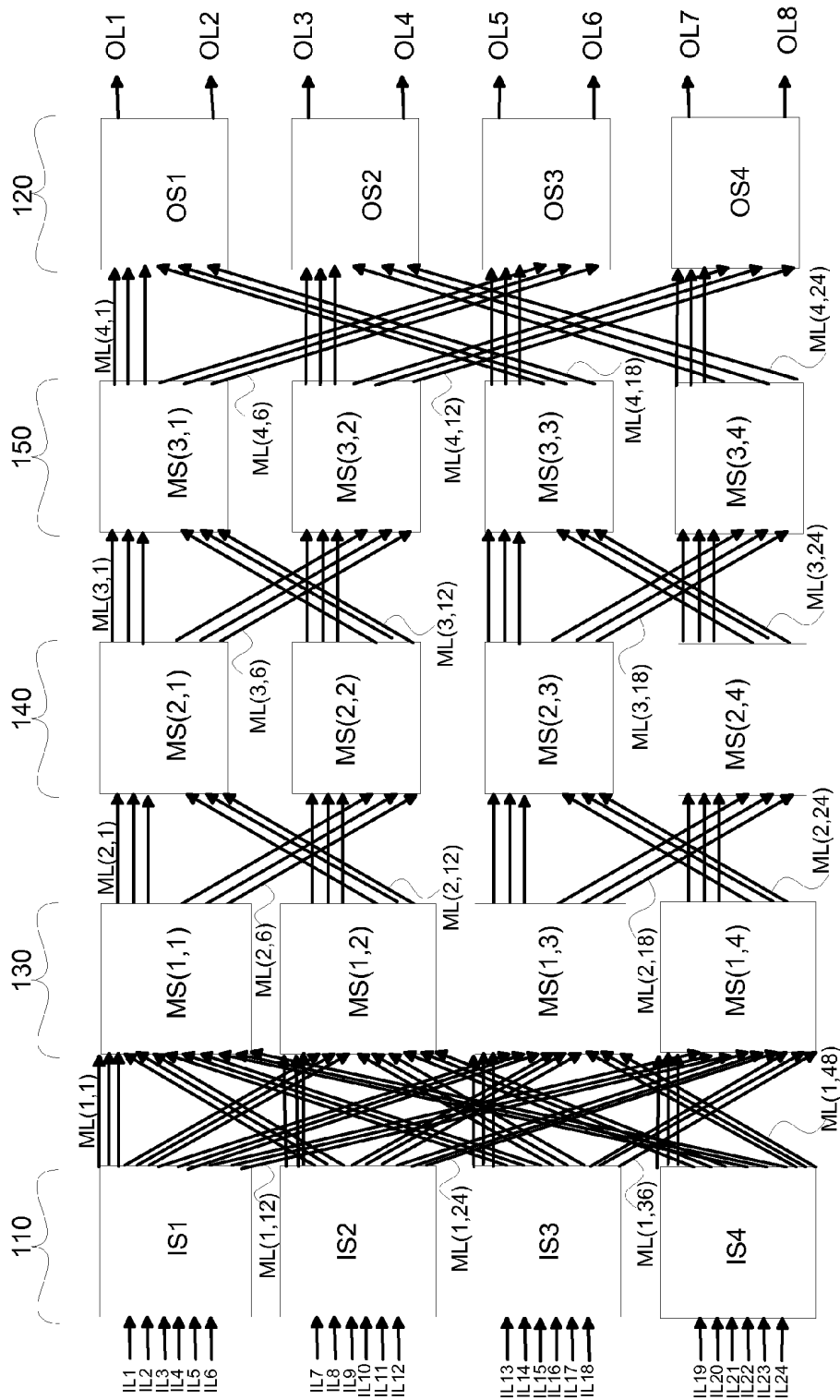

FIG. 3J2

300J2

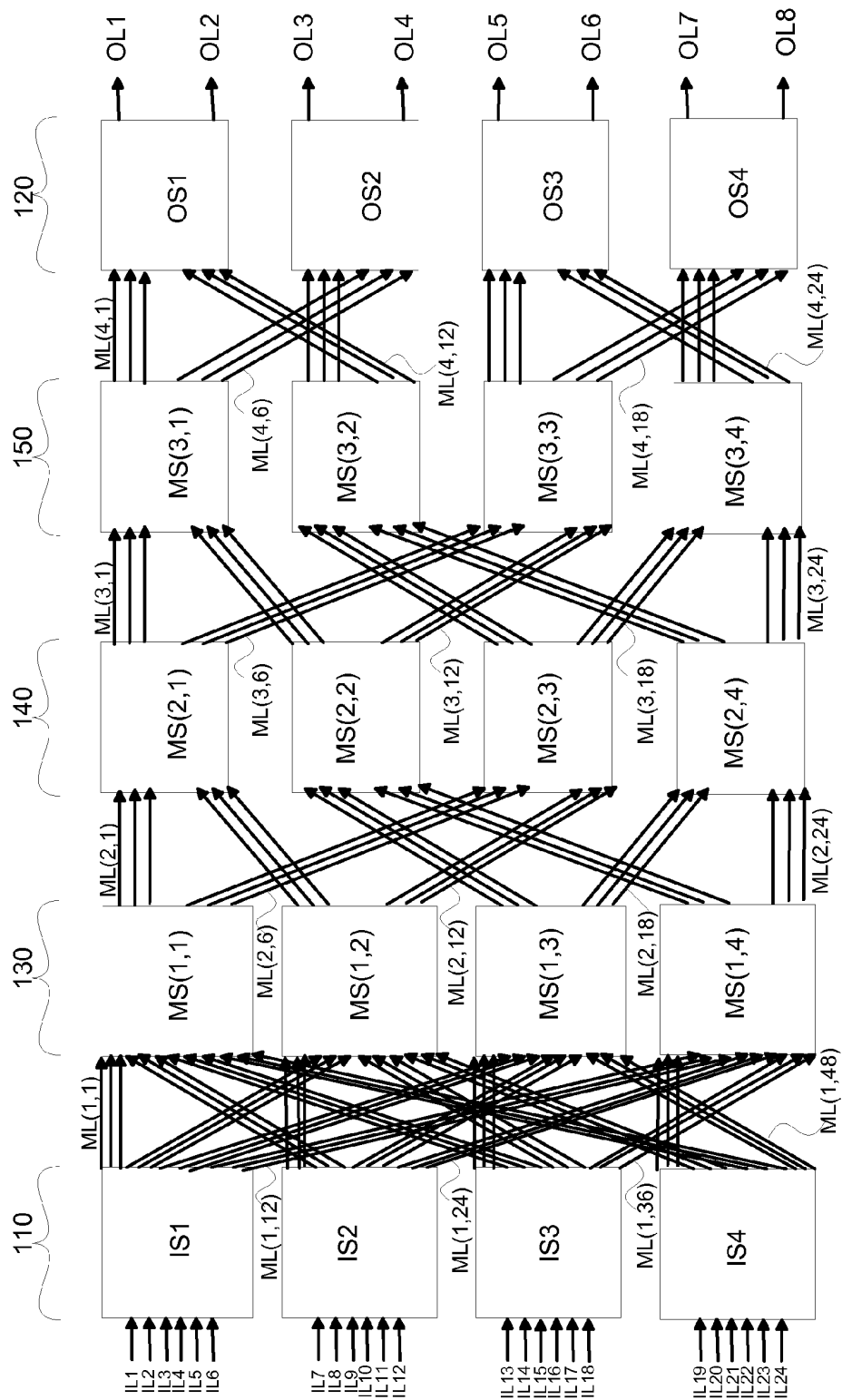

FIG. 3K2

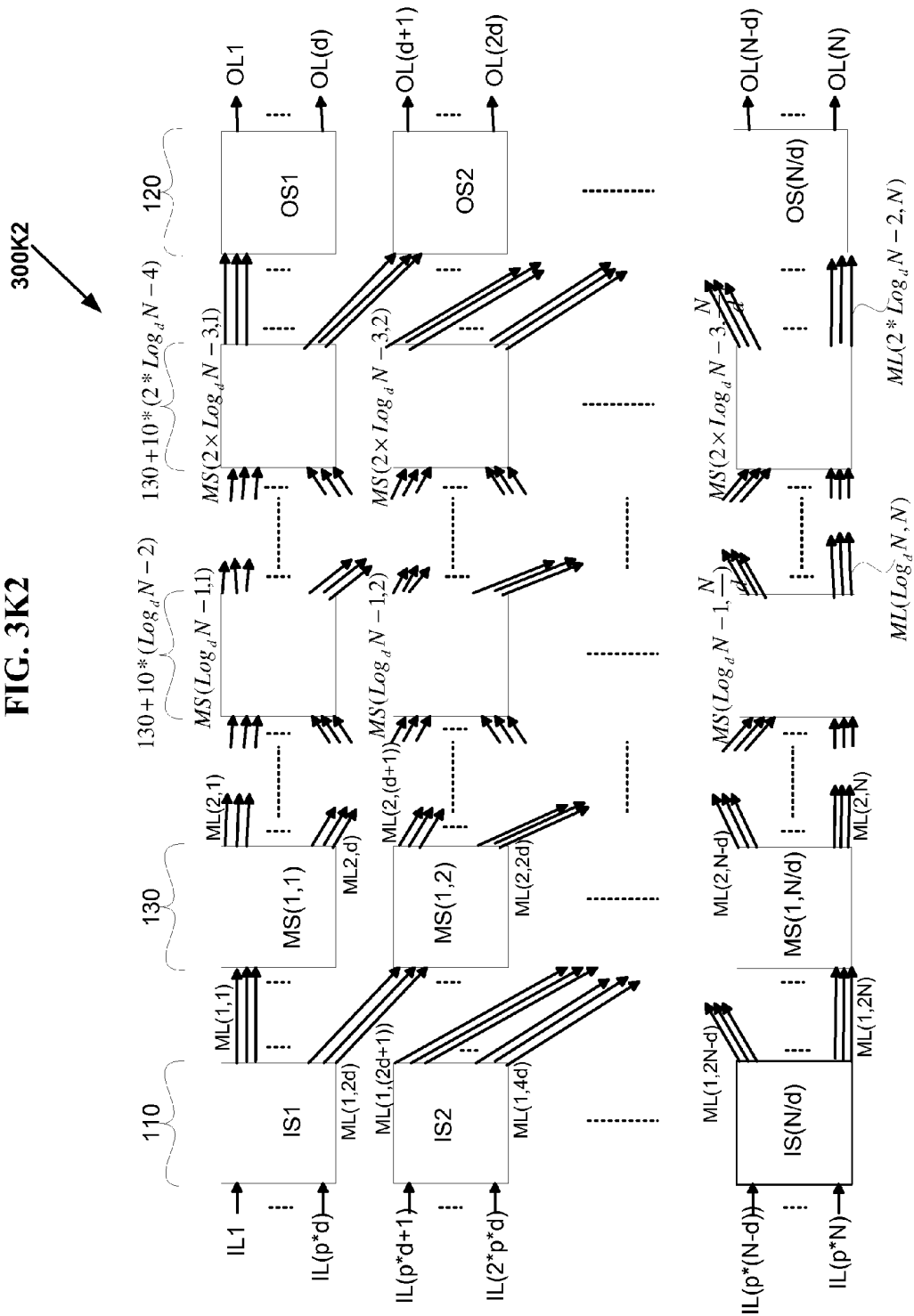

FIG. 4A

400A

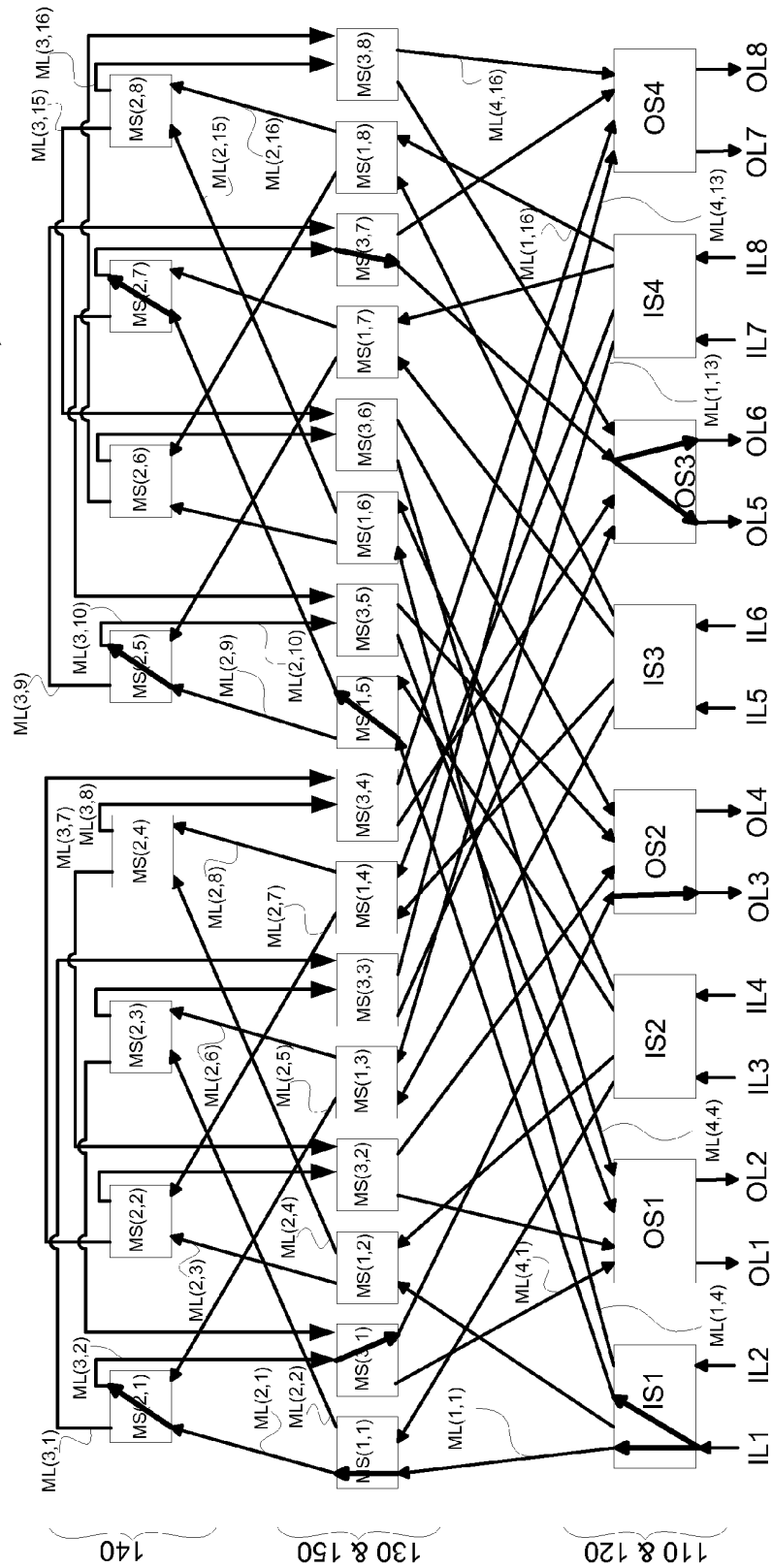
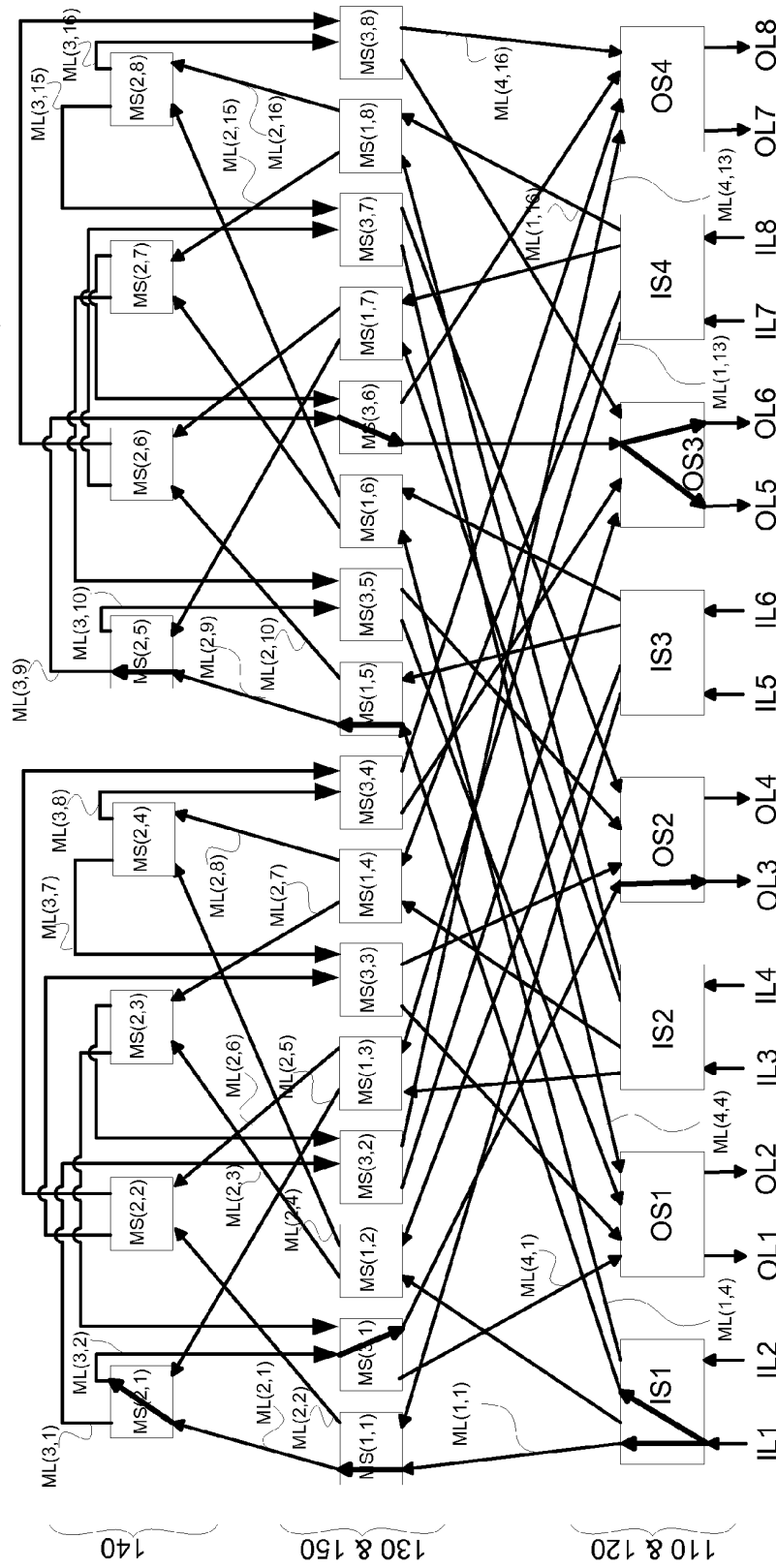

FIG. 4A1

400A1



400A2

FIG. 4A2

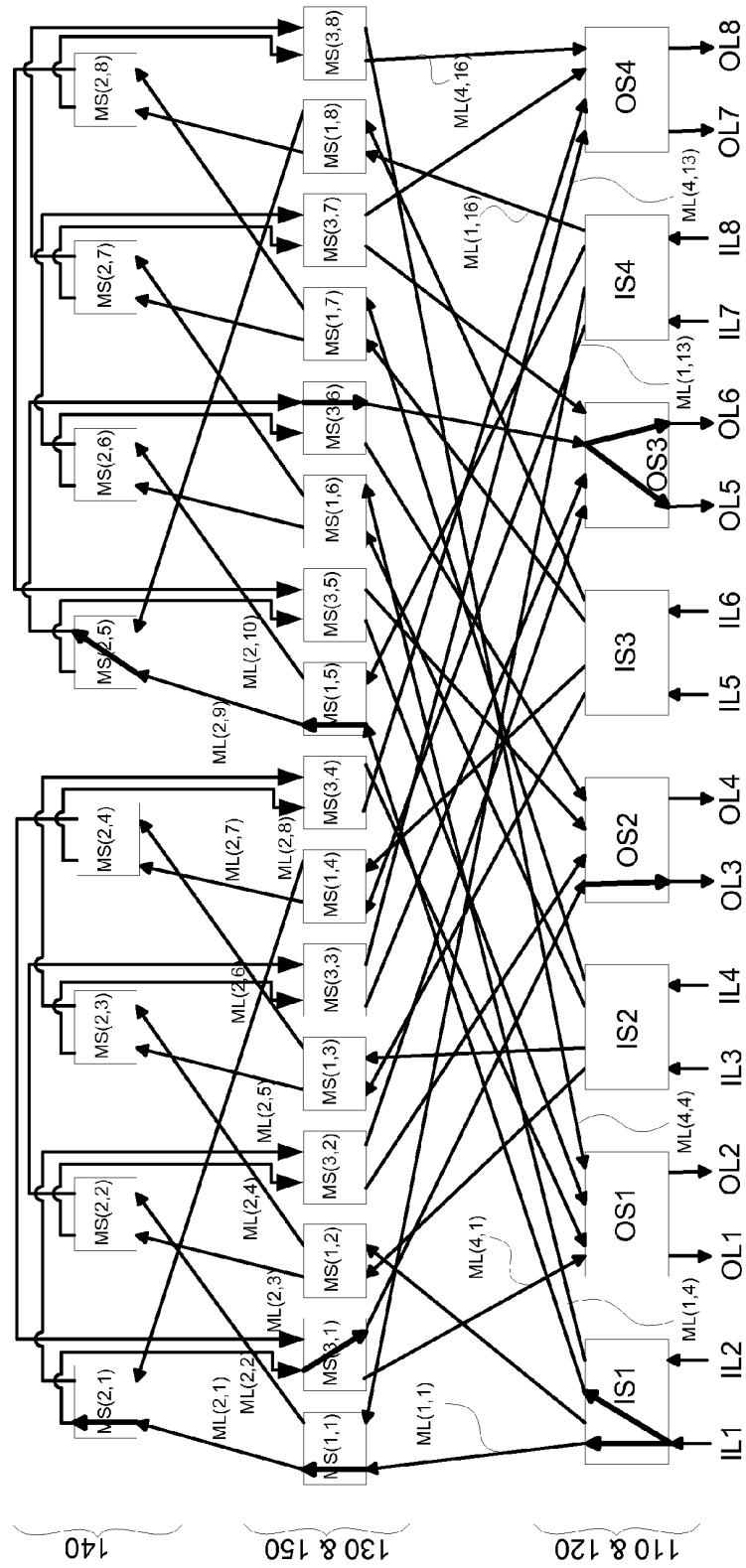

FIG. 4B

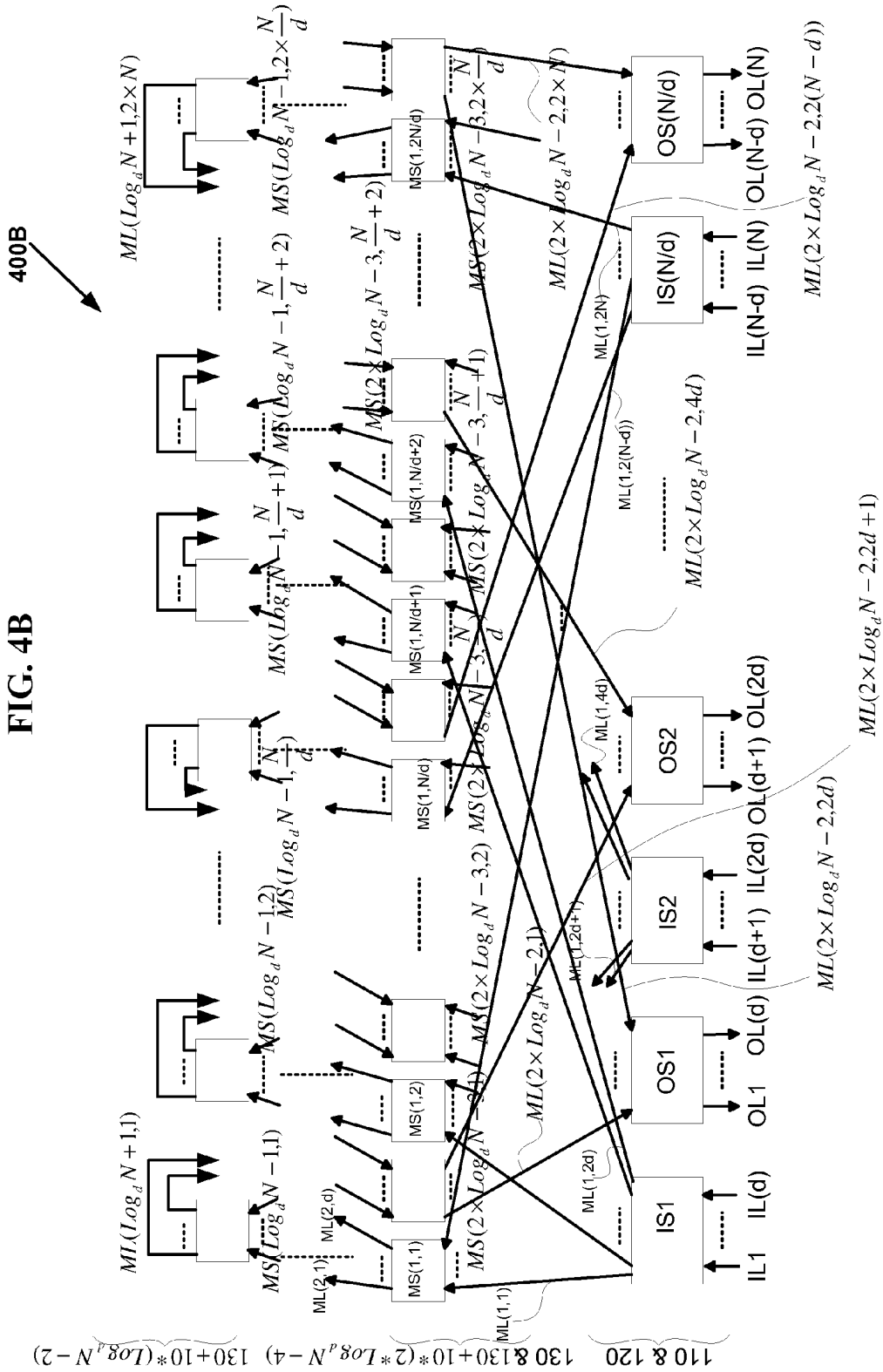

FIG. 4C

400C

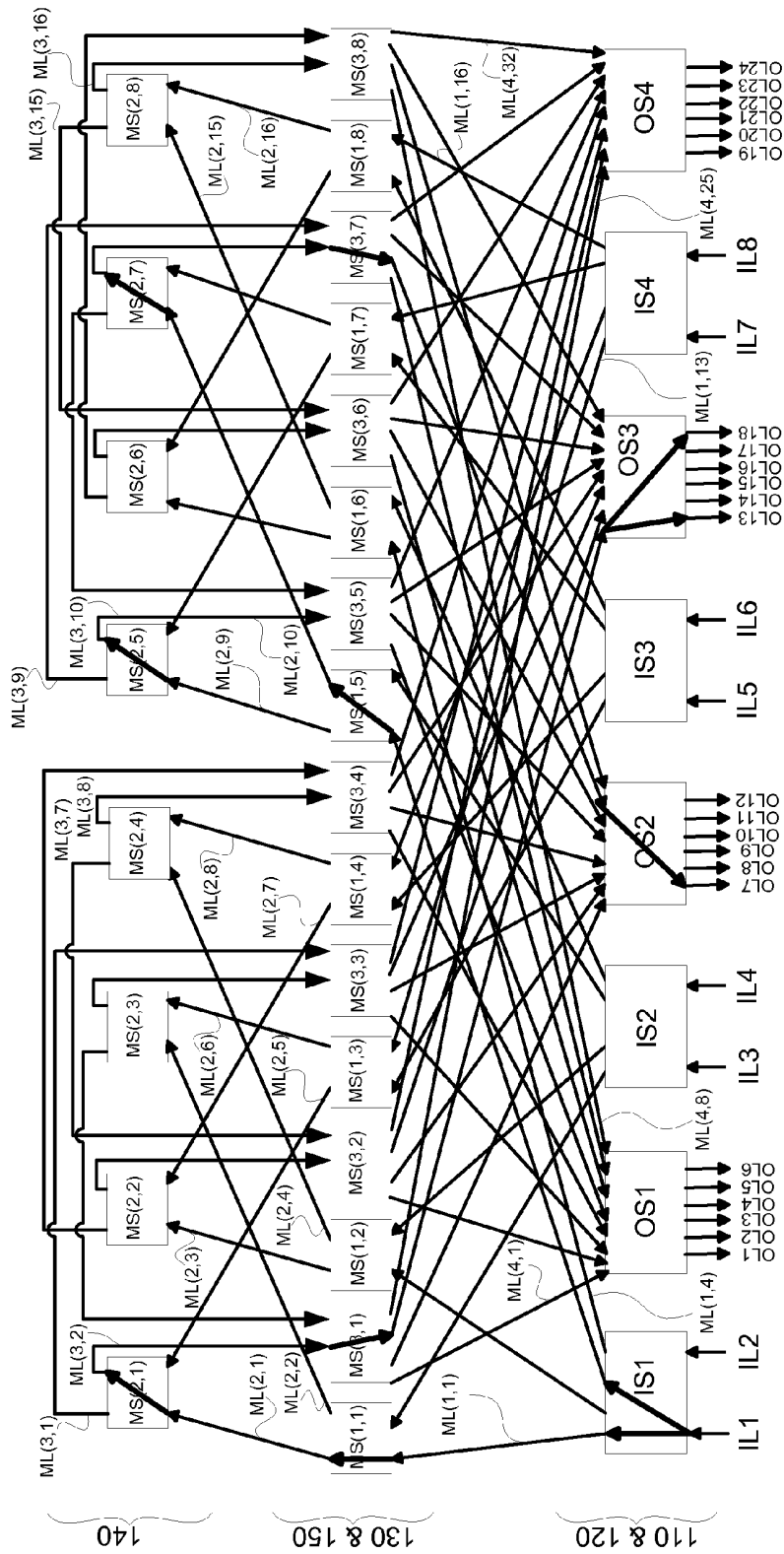
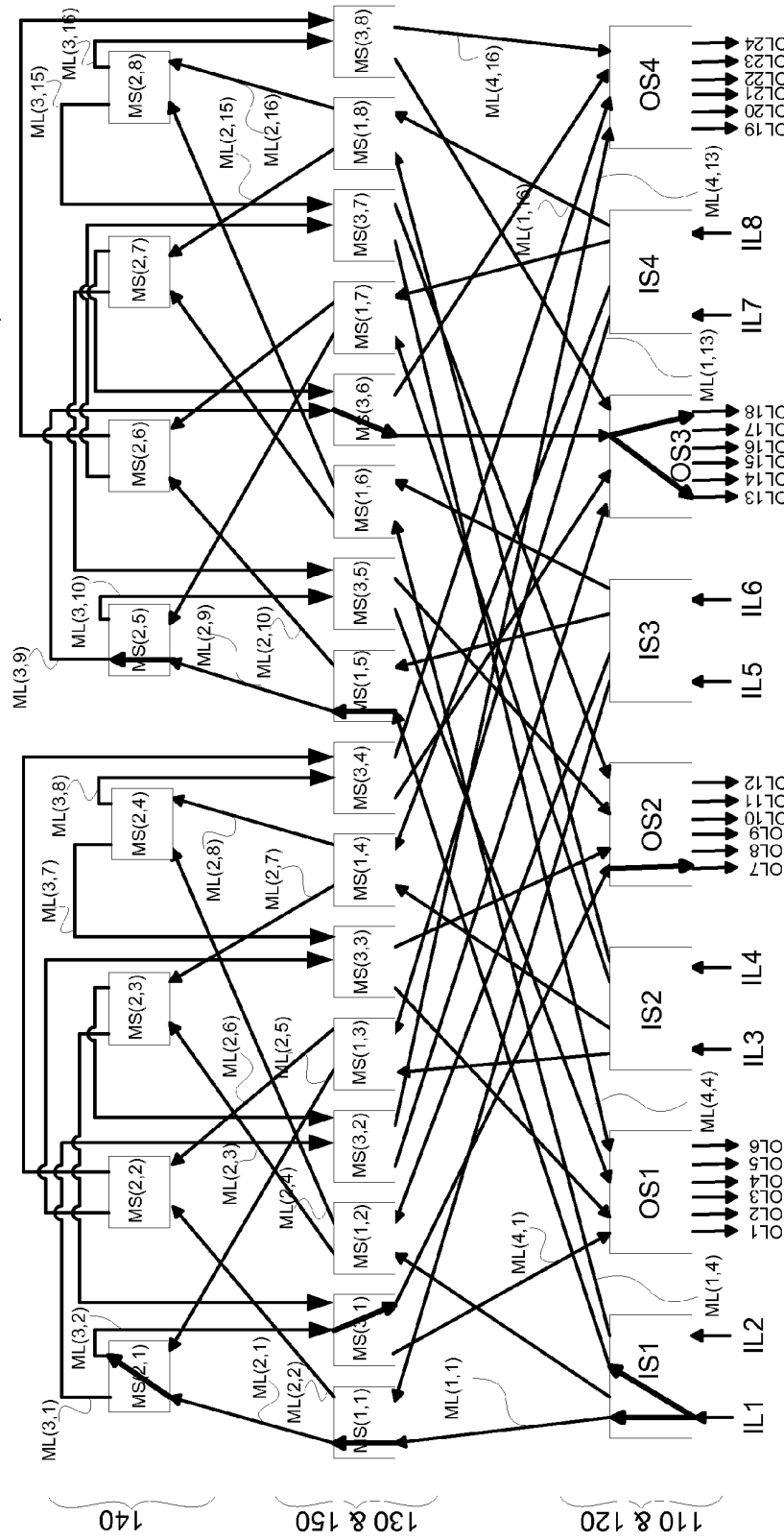

FIG. 4C1

400C1



400C2

FIG. 4C2

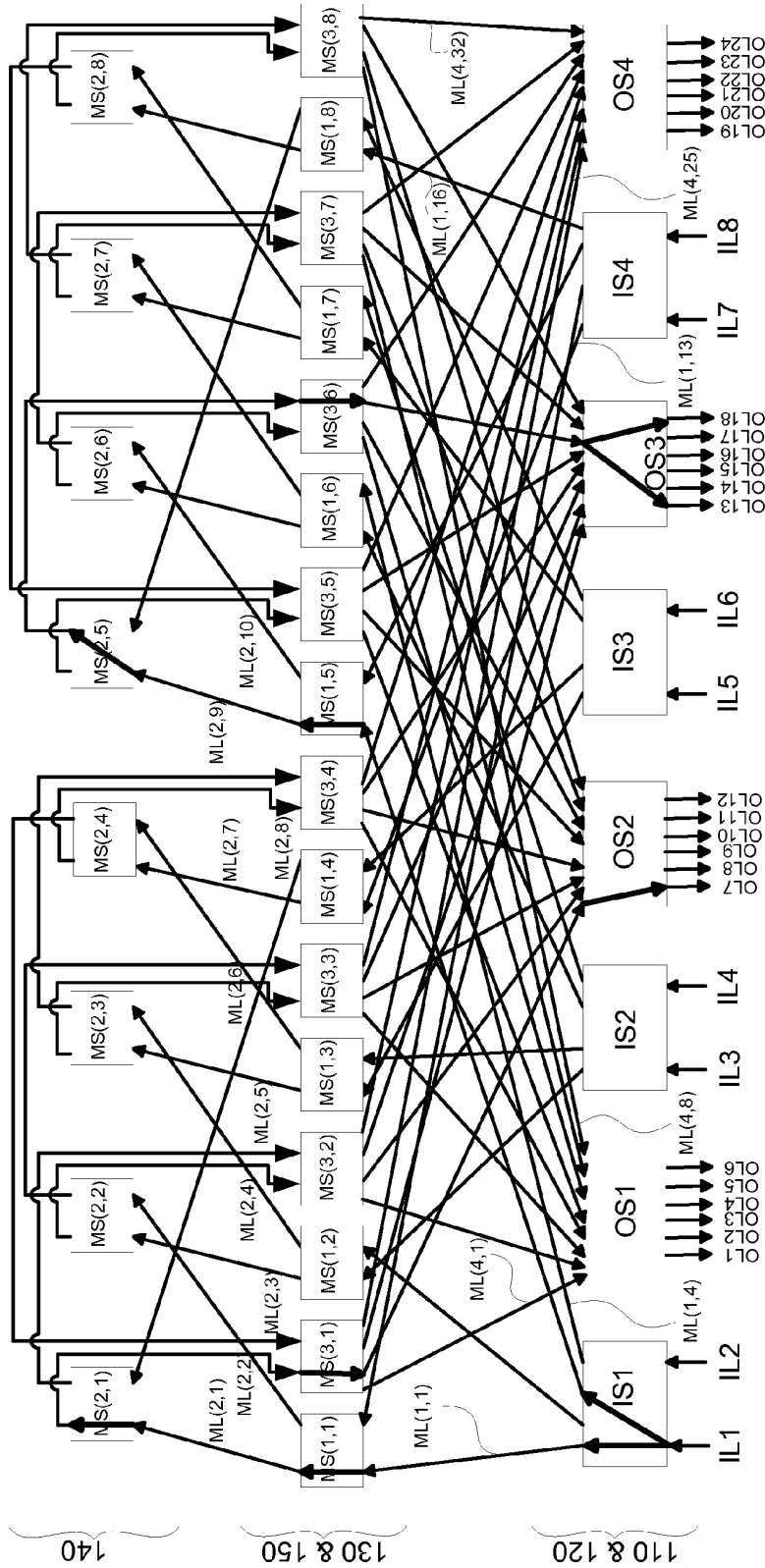

FIG. 4E

400E

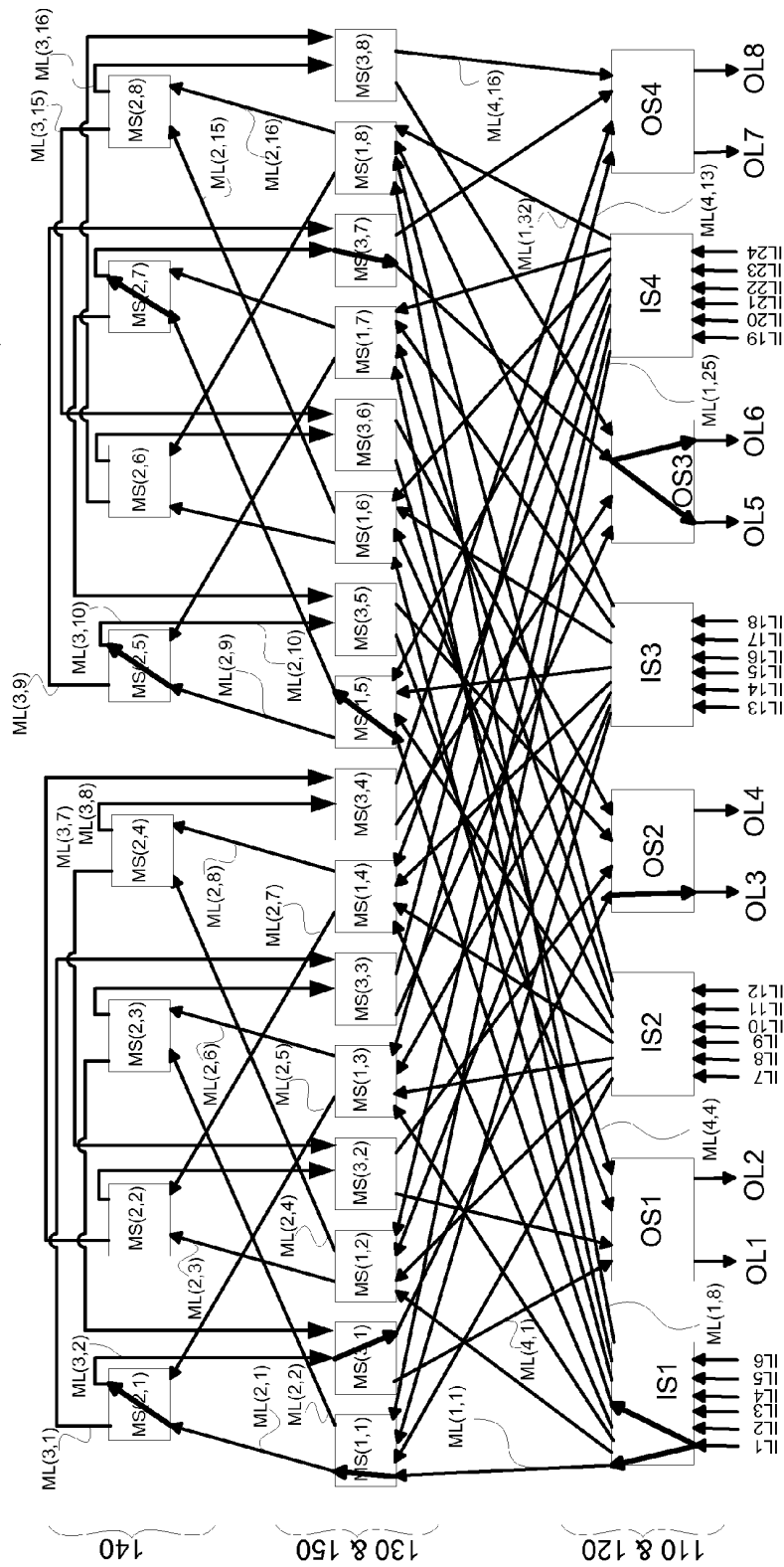

FIG. 4E1
400E1

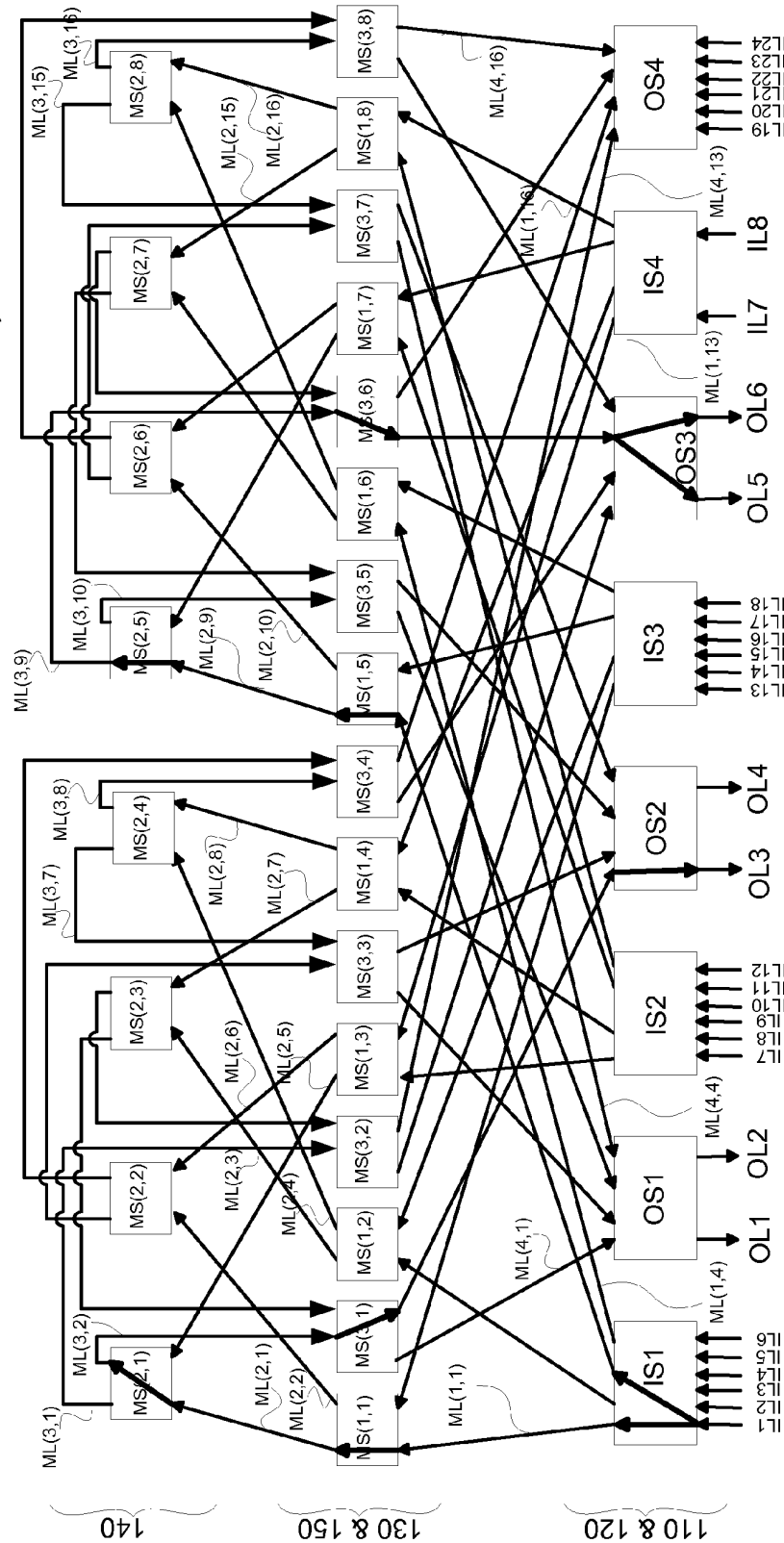

FIG. 4E2

400E2

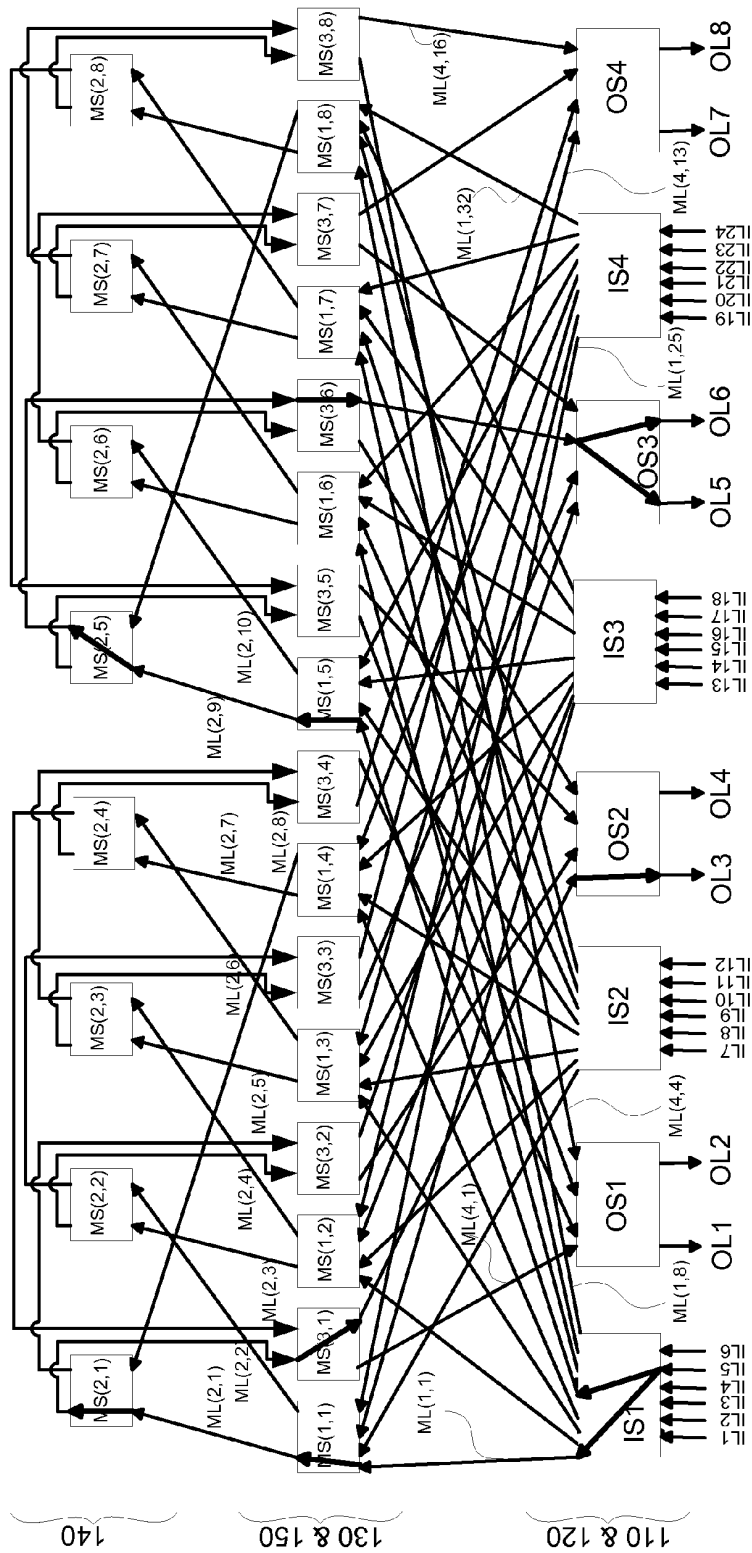

FIG. 4F

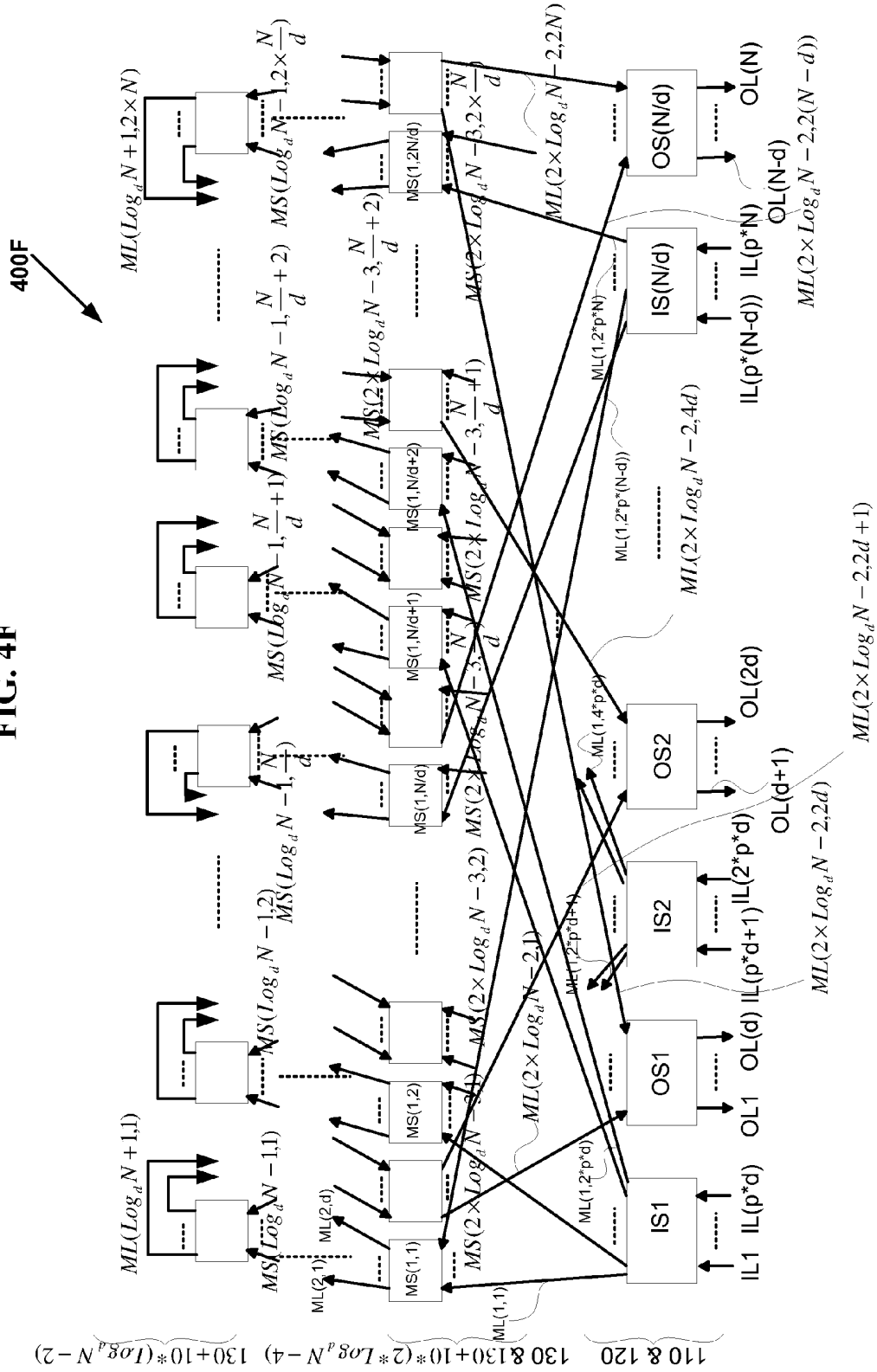

FIG. 5A

500A

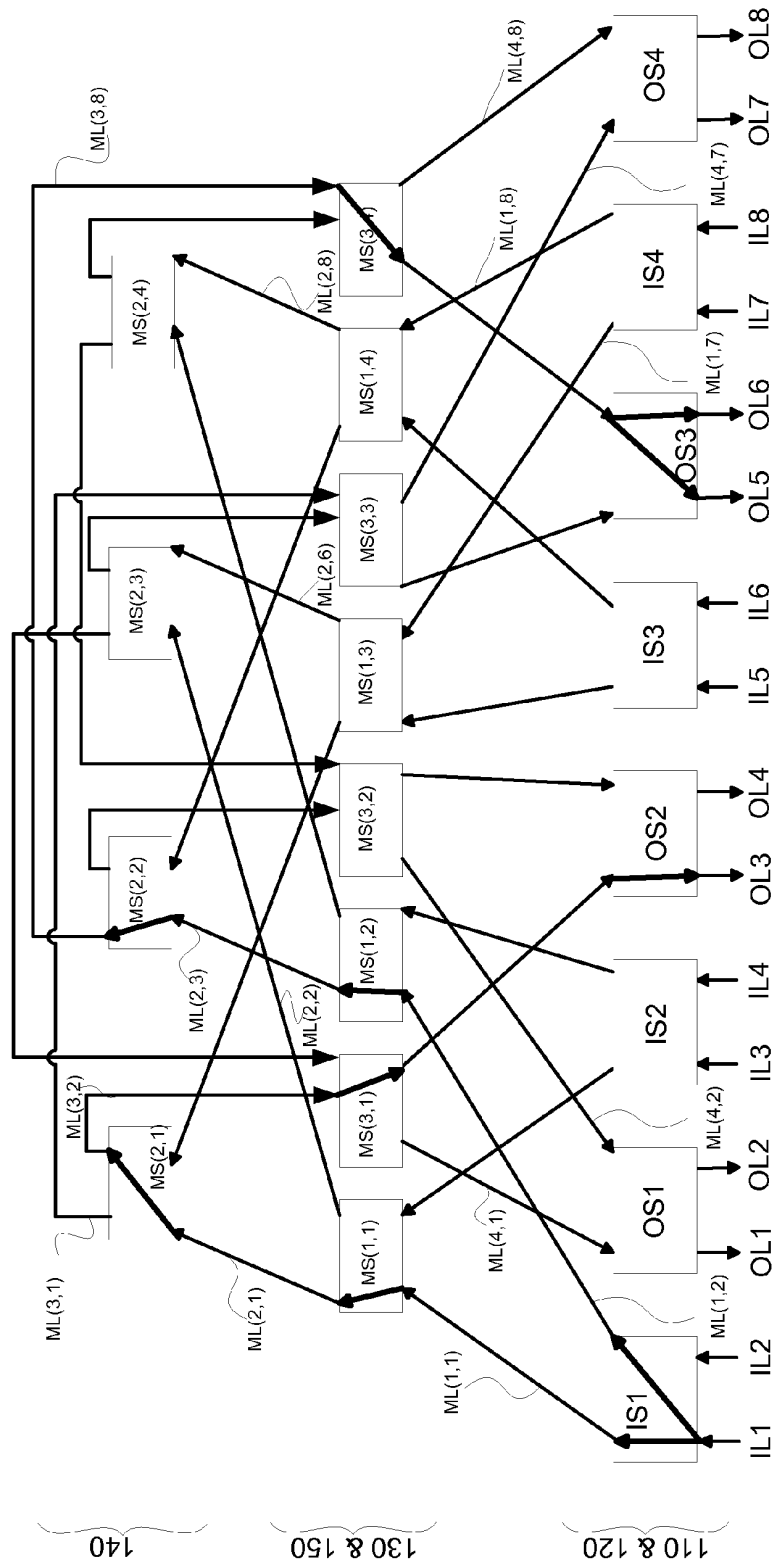

FIG. 5B

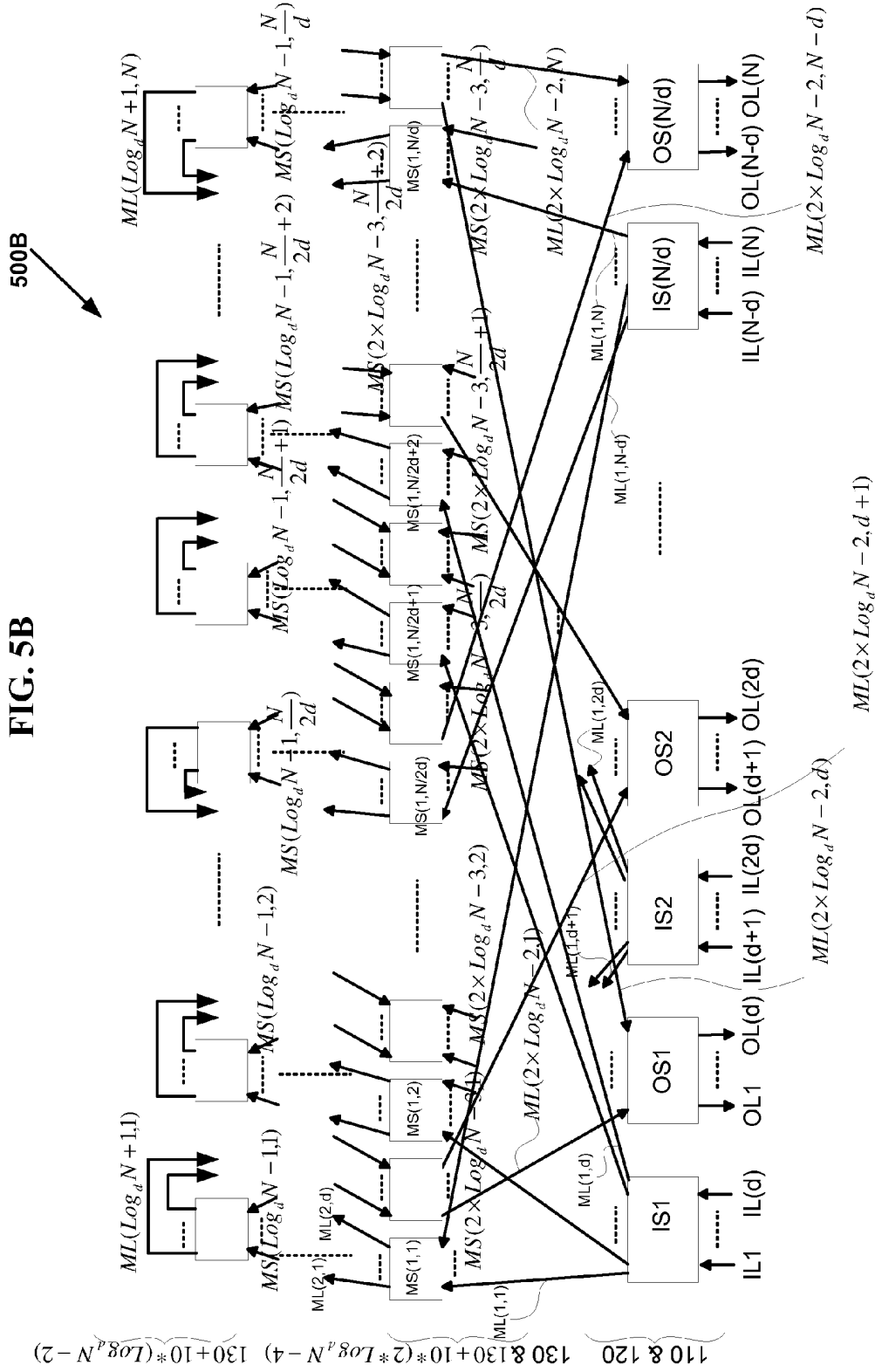

FIG. 5C

500C

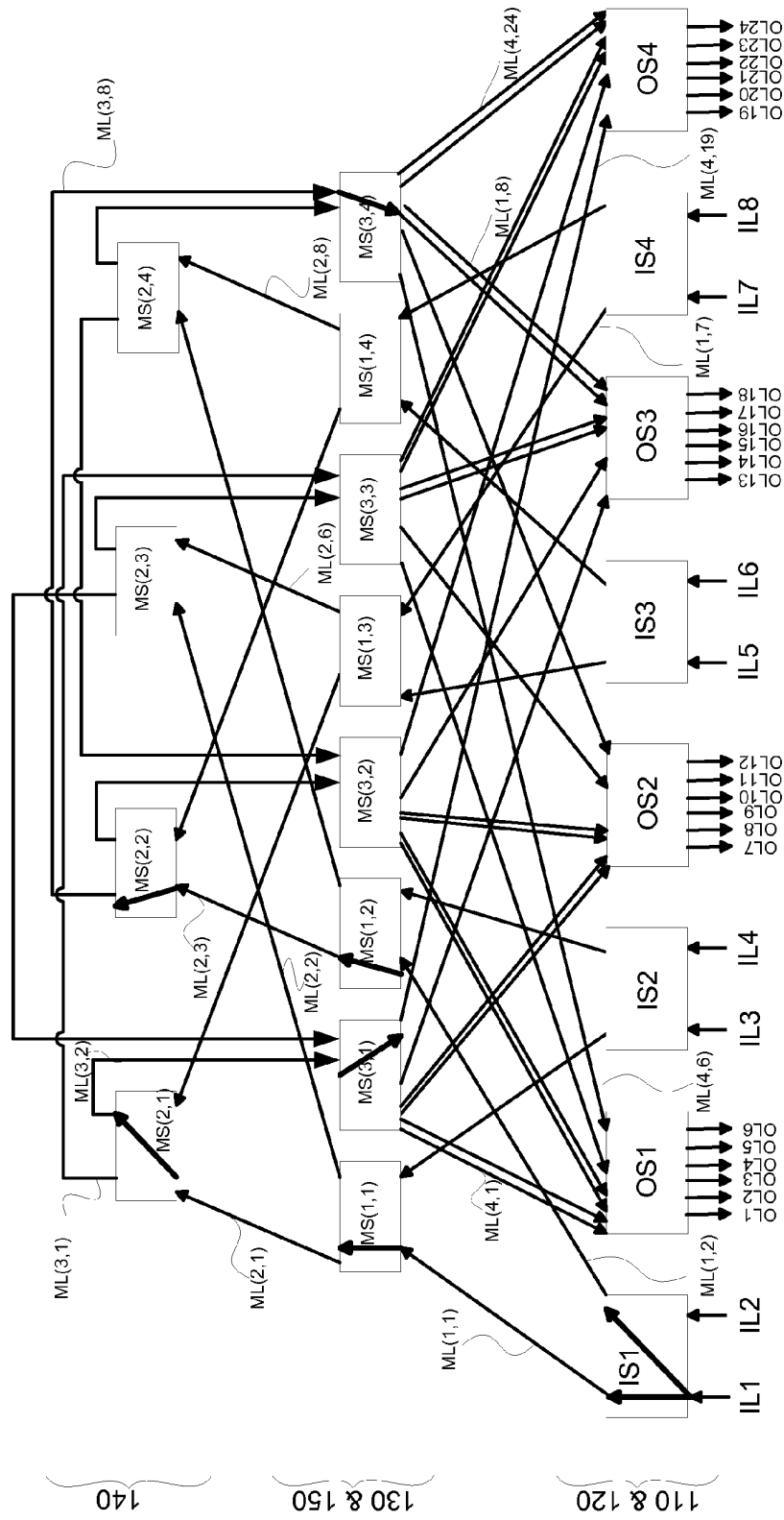

FIG. 5D

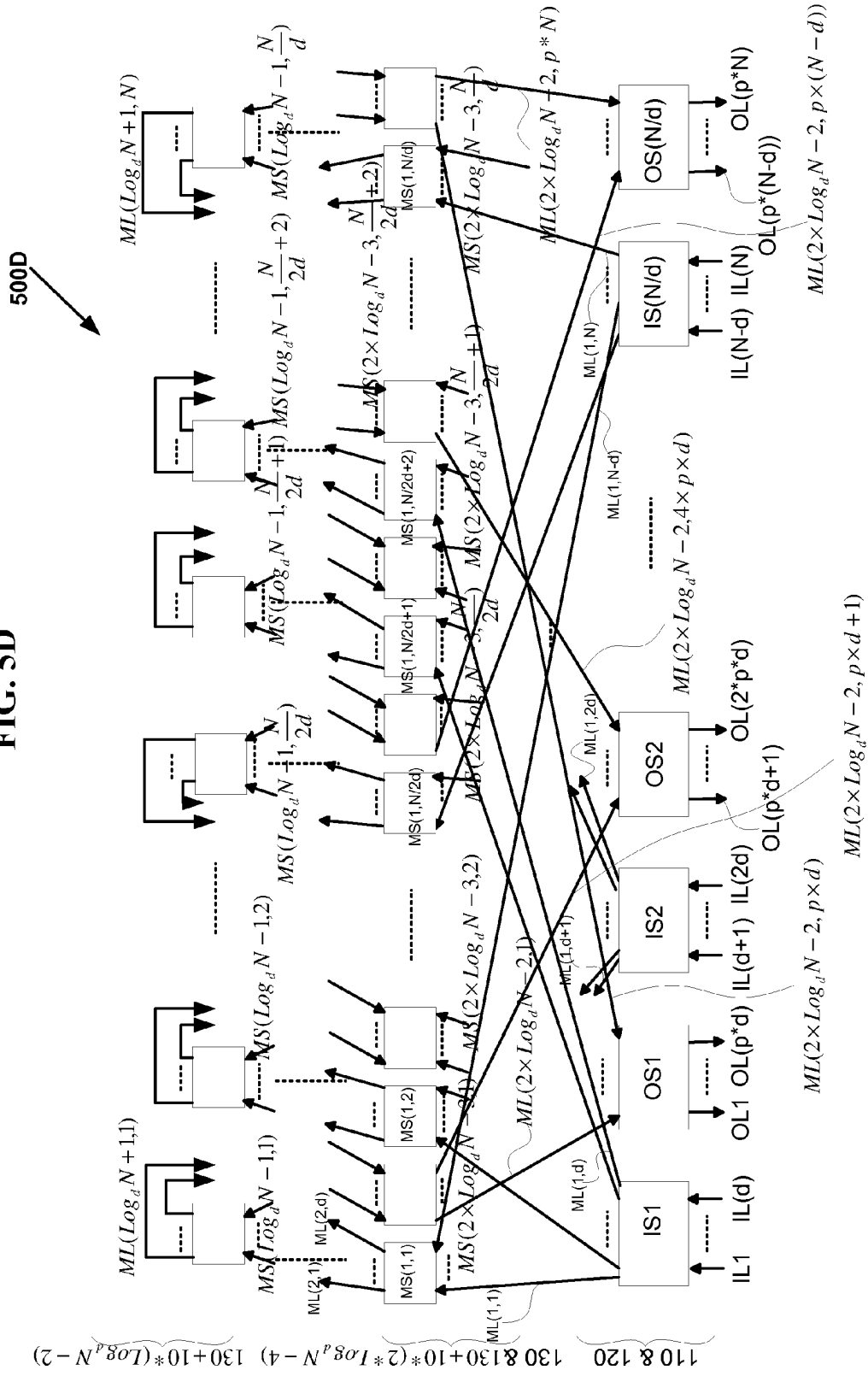

FIG. 5E

500E

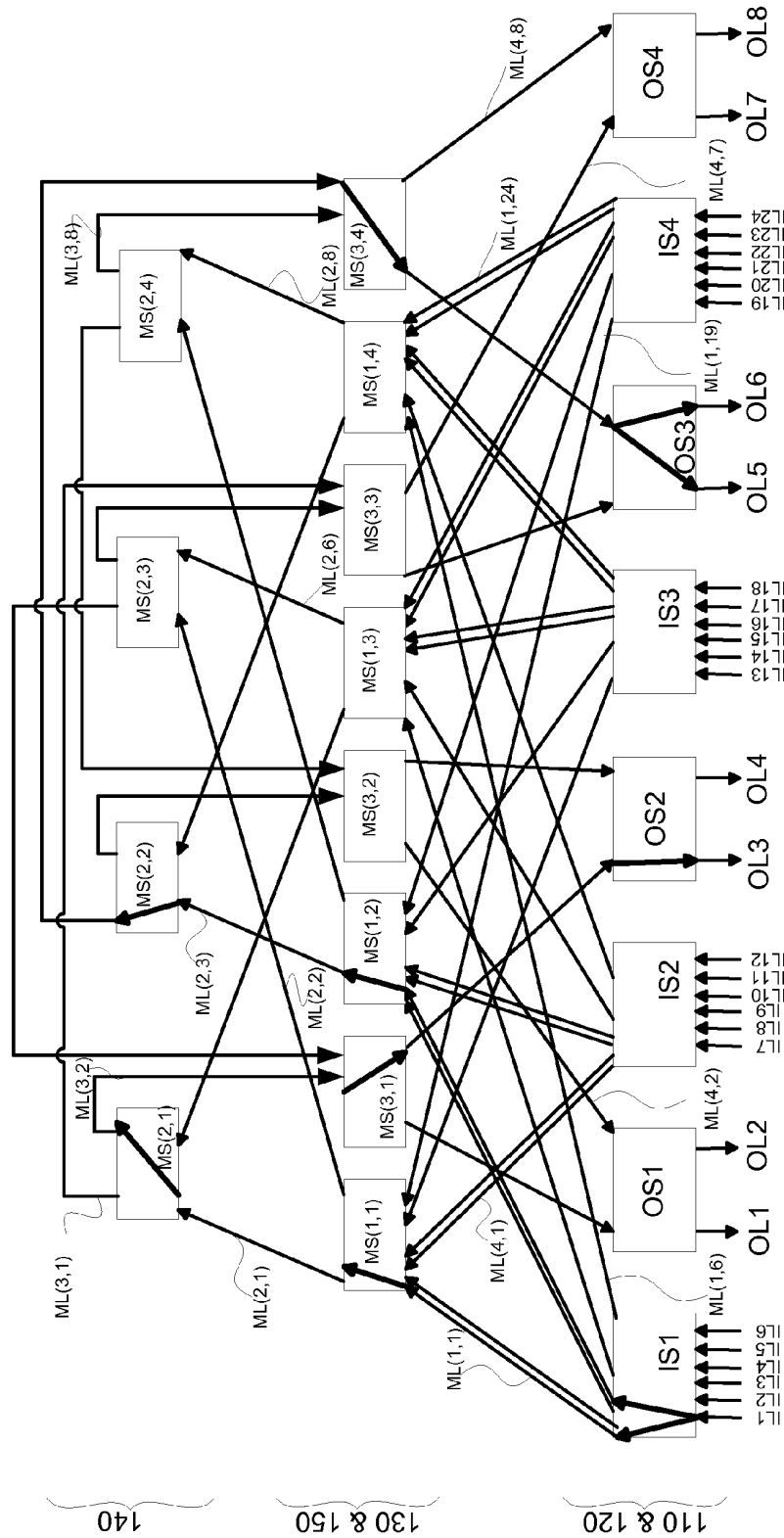

FIG. 5F

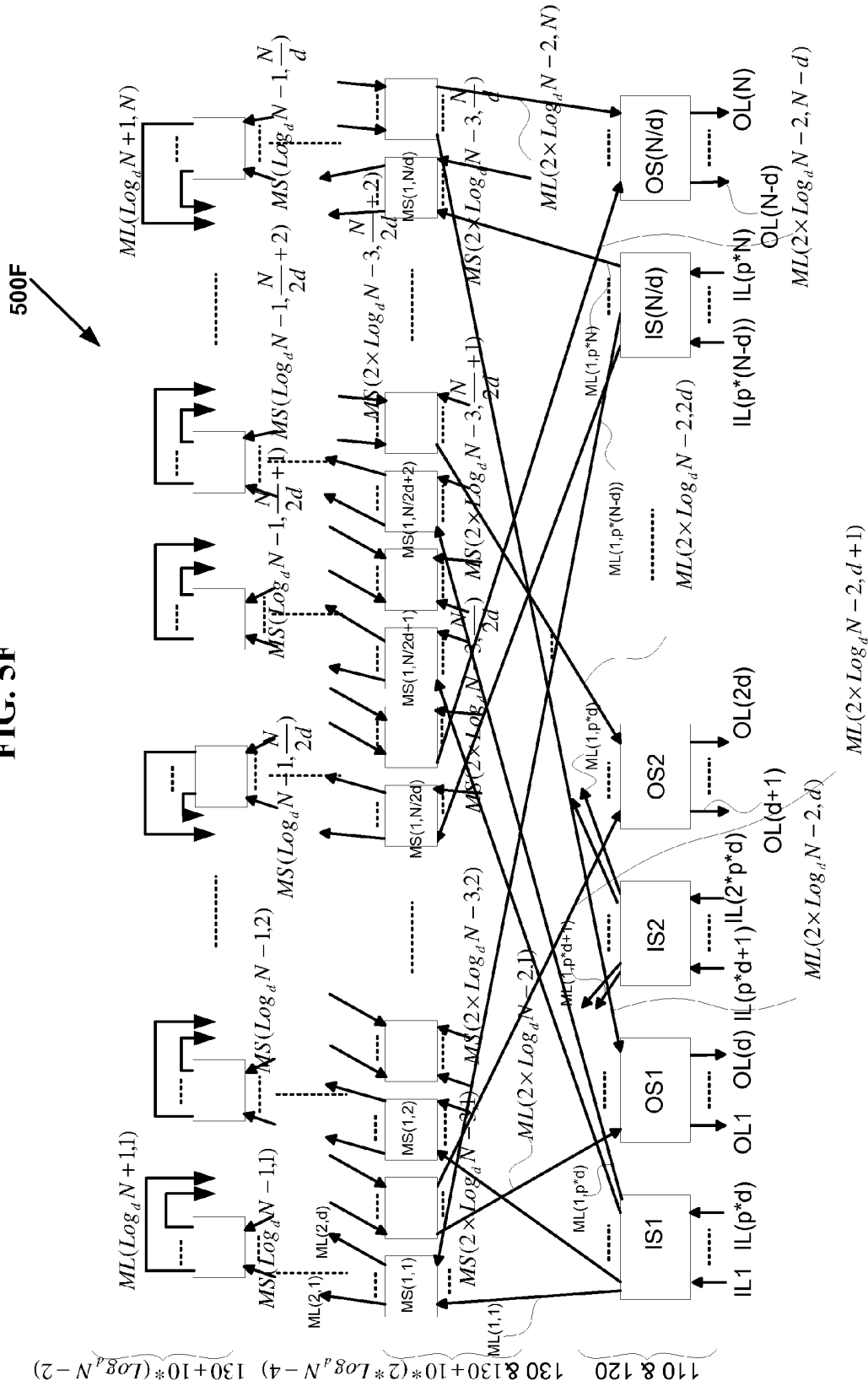

FIG. 6A

600A

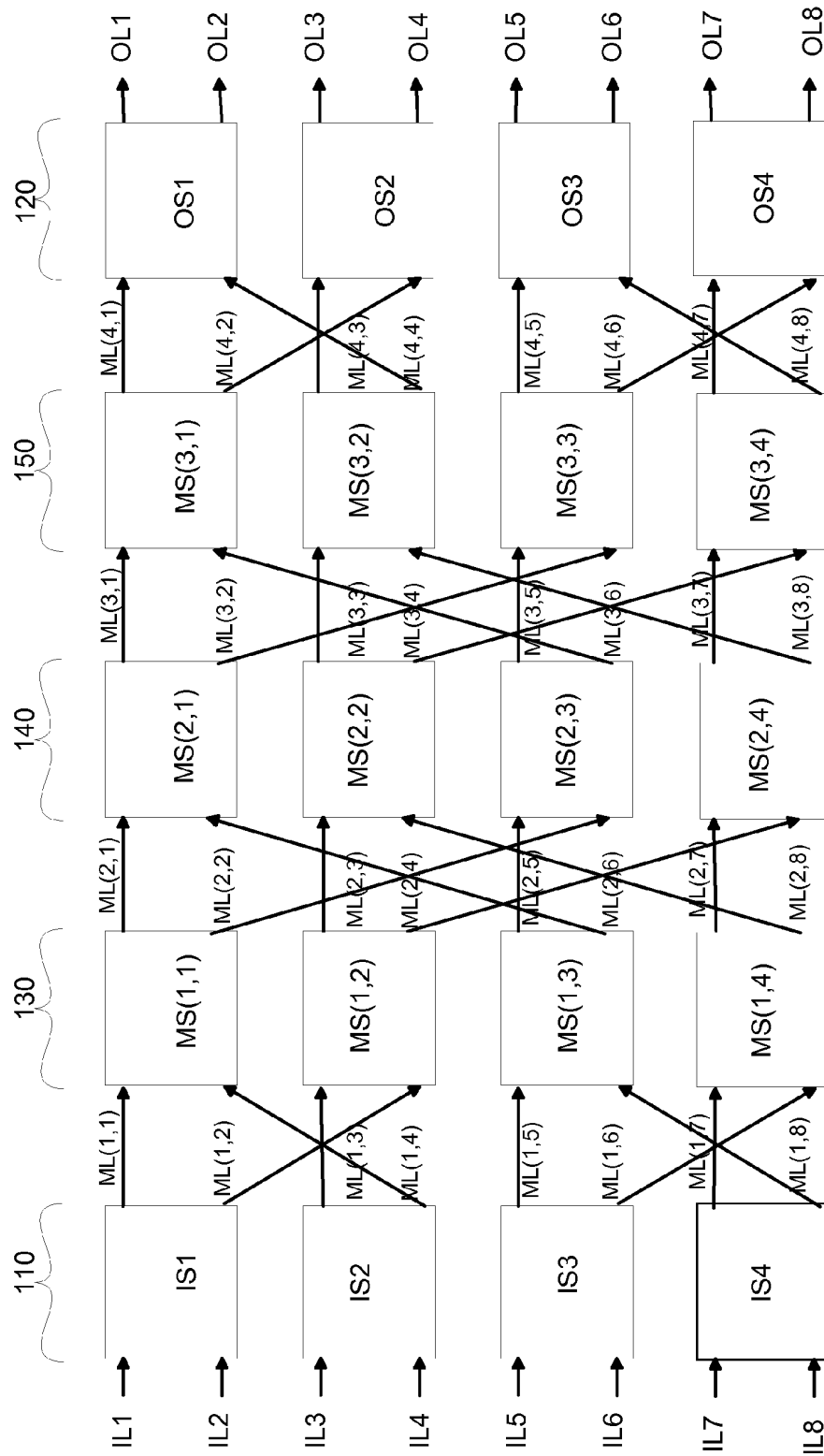

FIG. 6B

600B

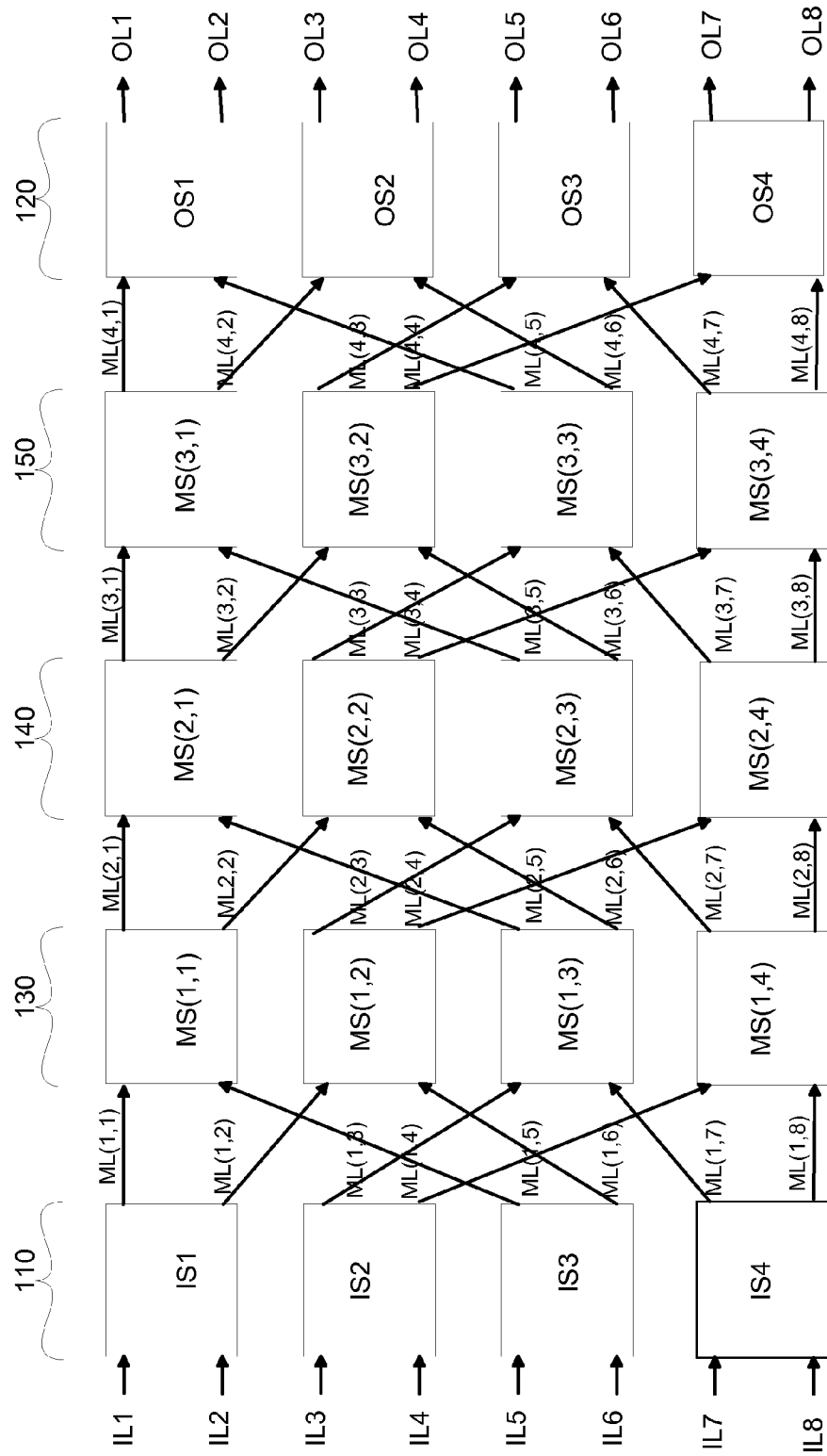

FIG. 6C

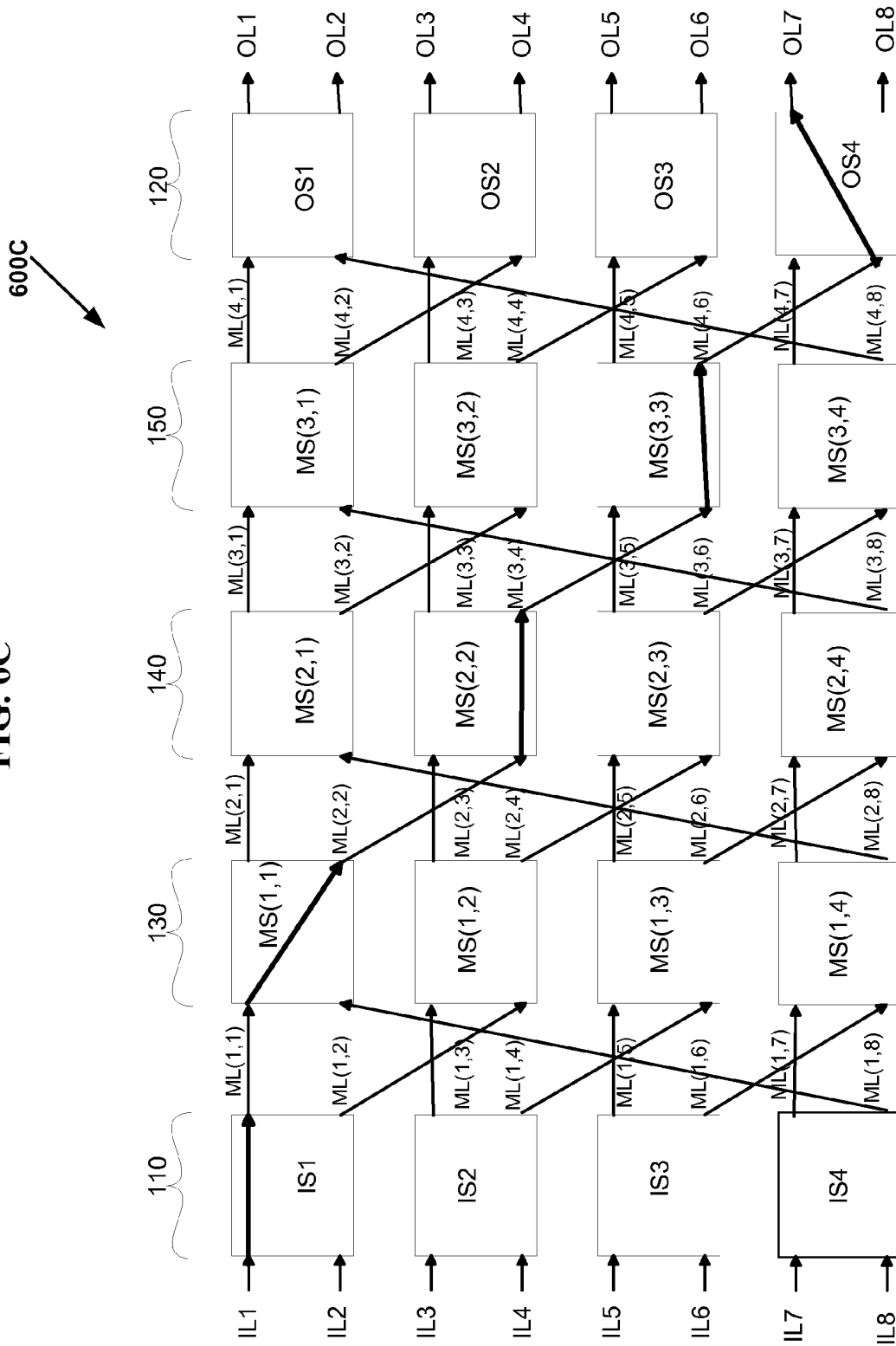

FIG. 6D

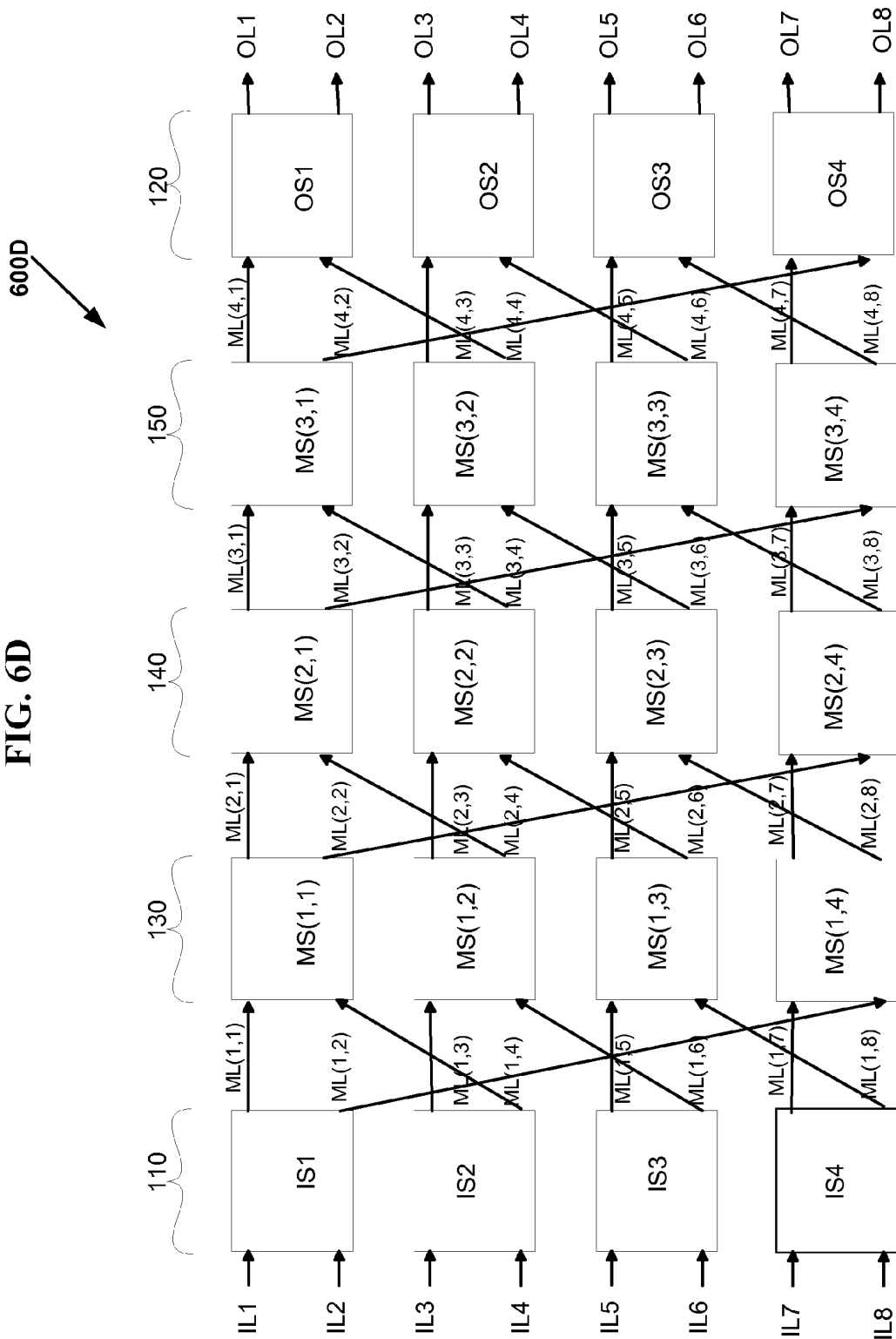

FIG. 6E

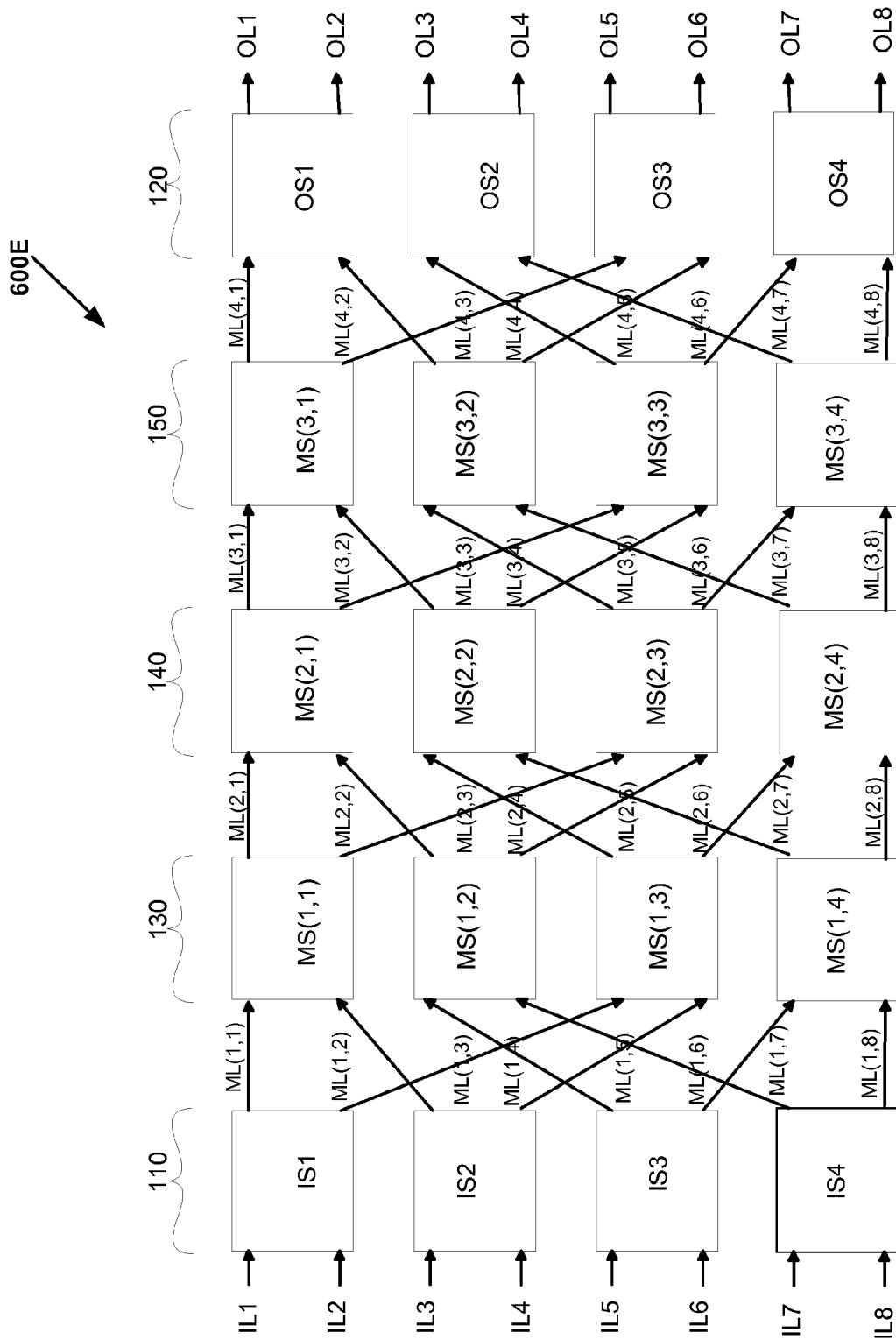

FIG. 6F

600F

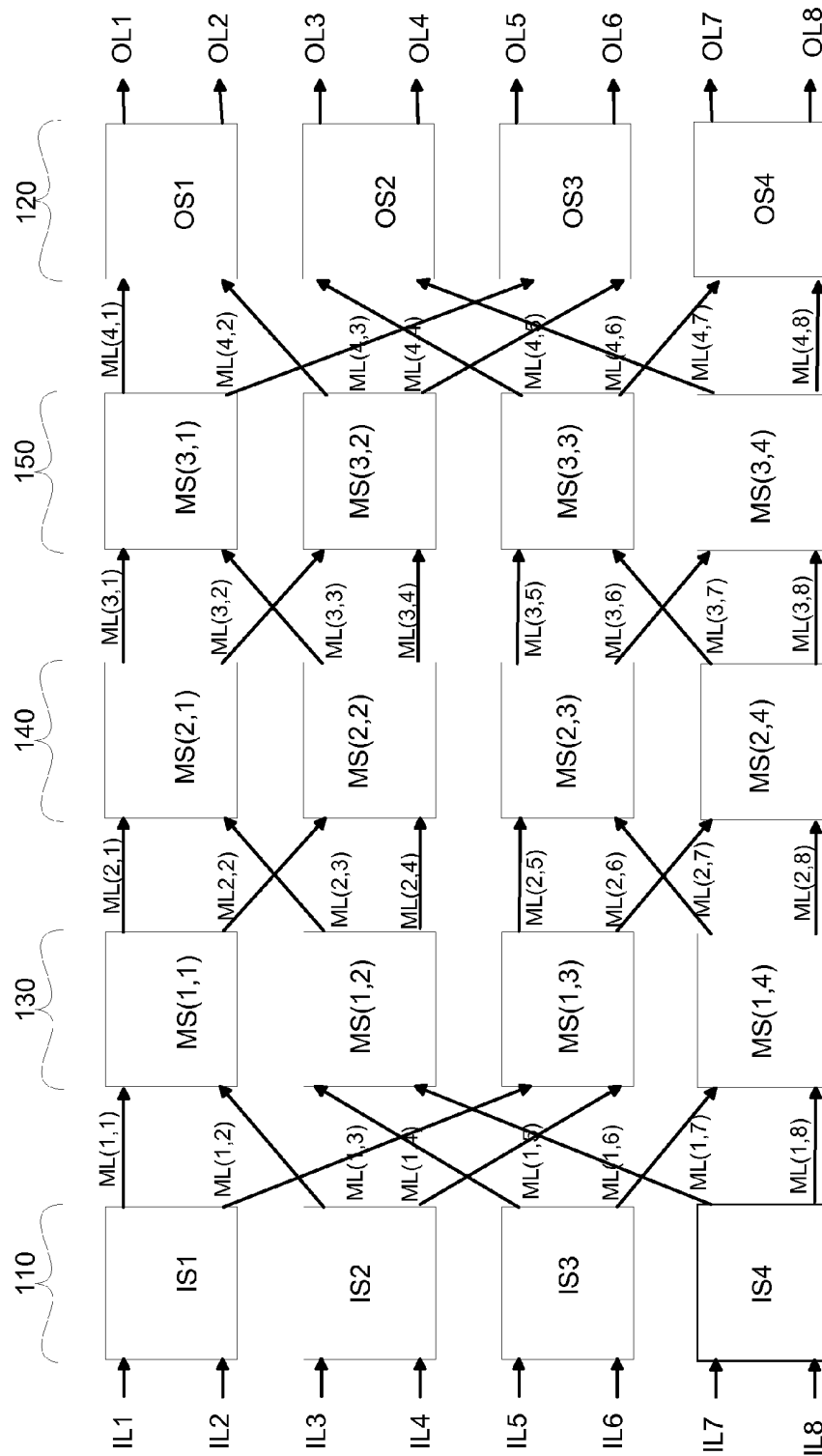

FIG. 6G

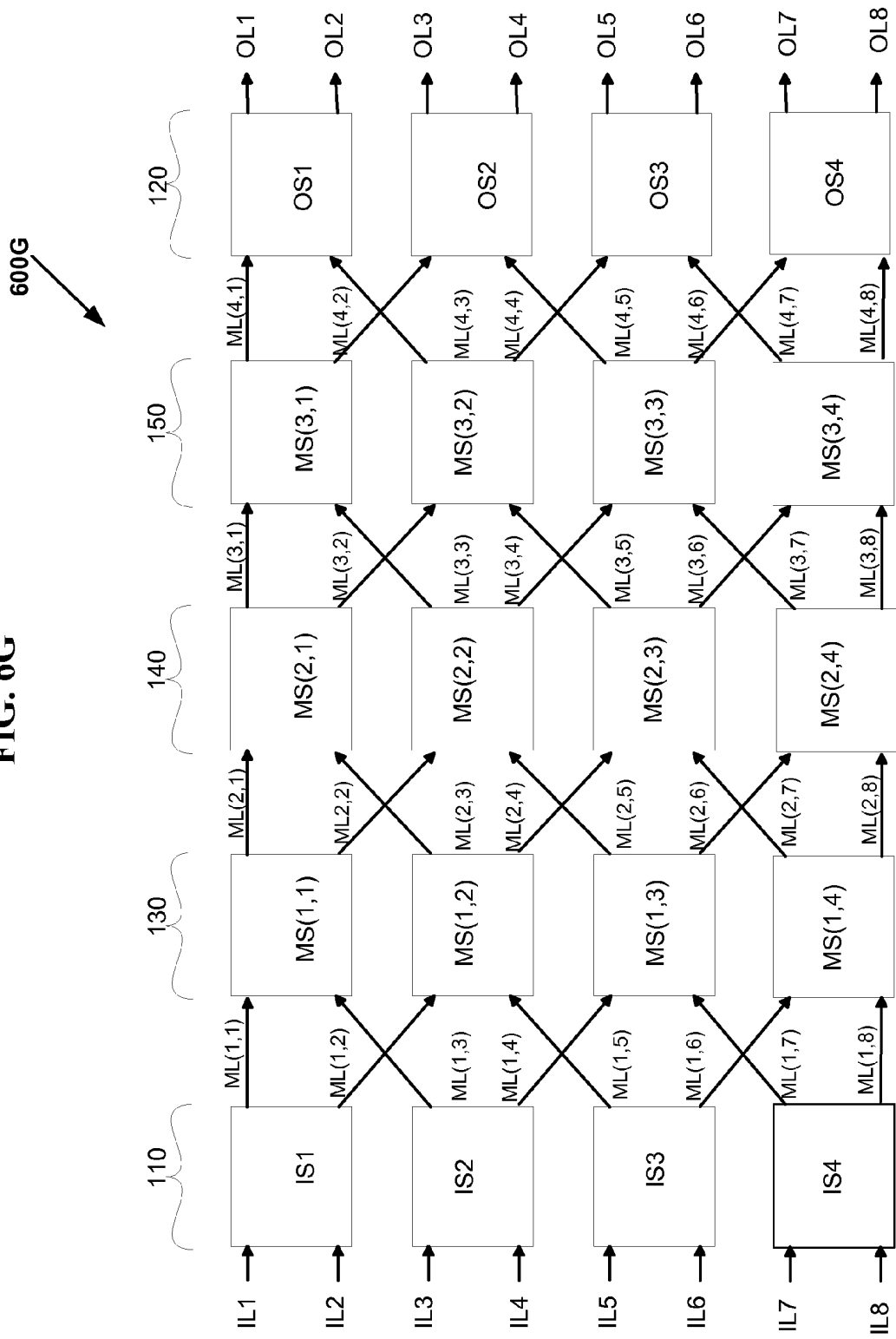

FIG. 6H

600H

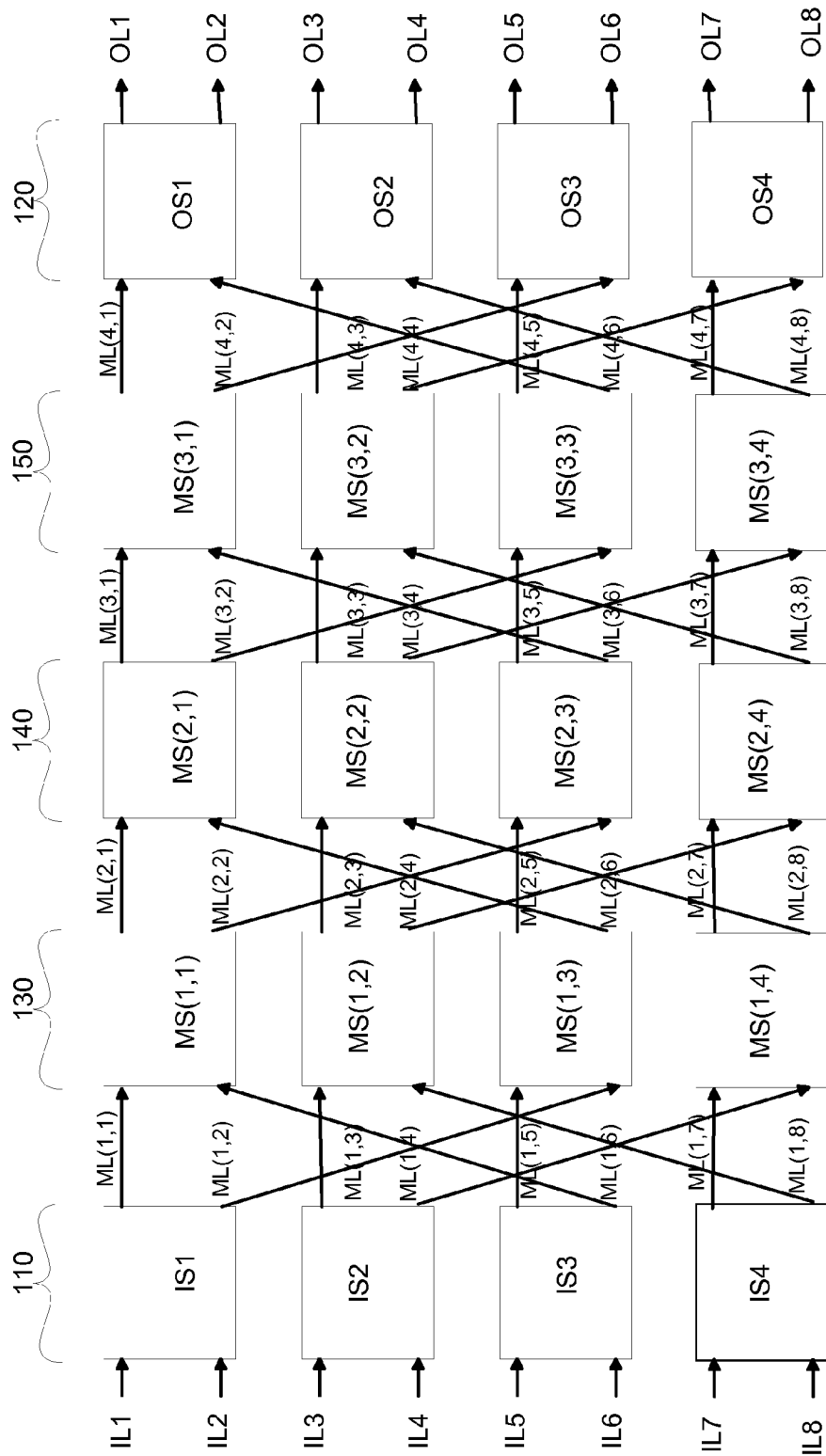

FIG. 6I

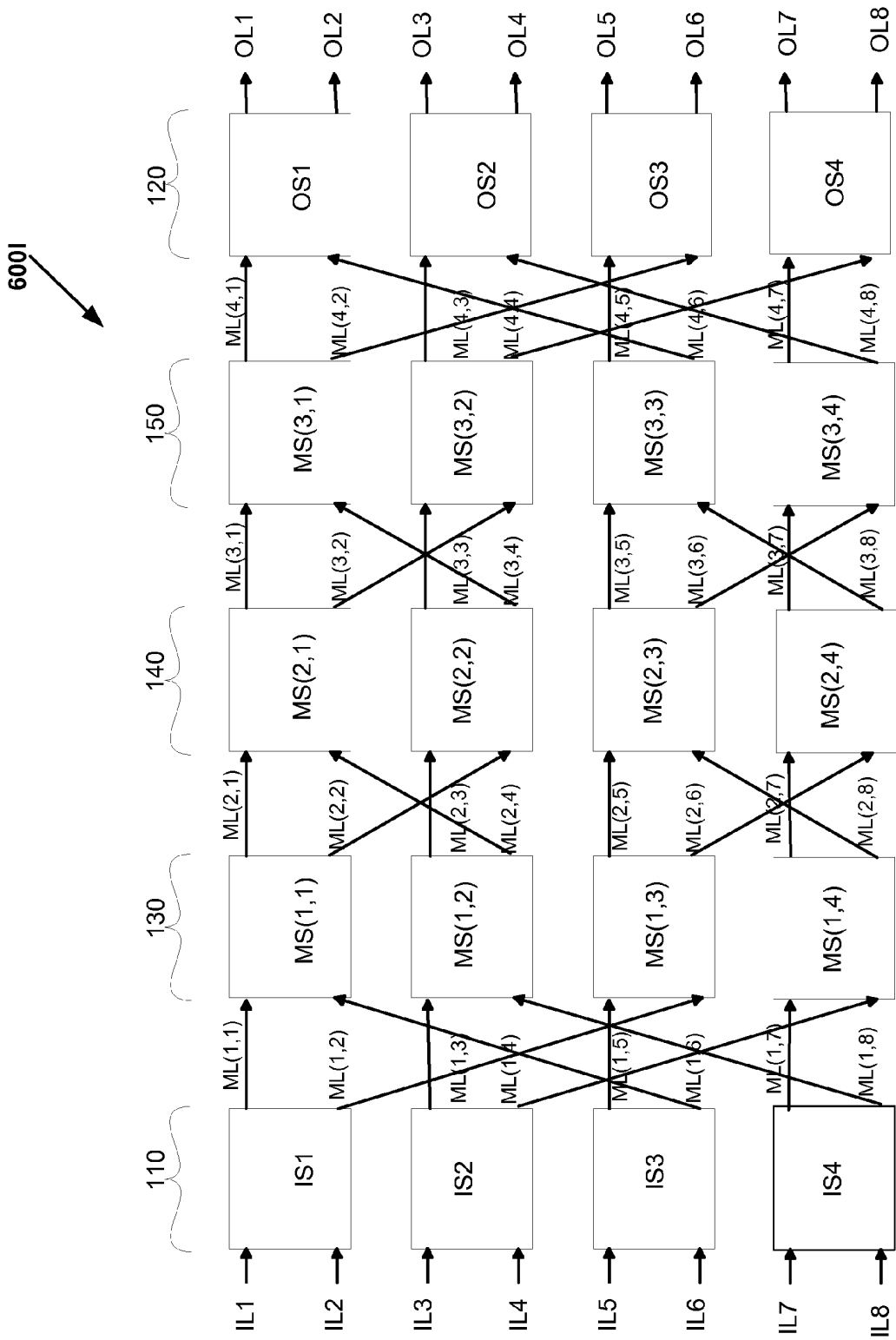

FIG. 6J

600J

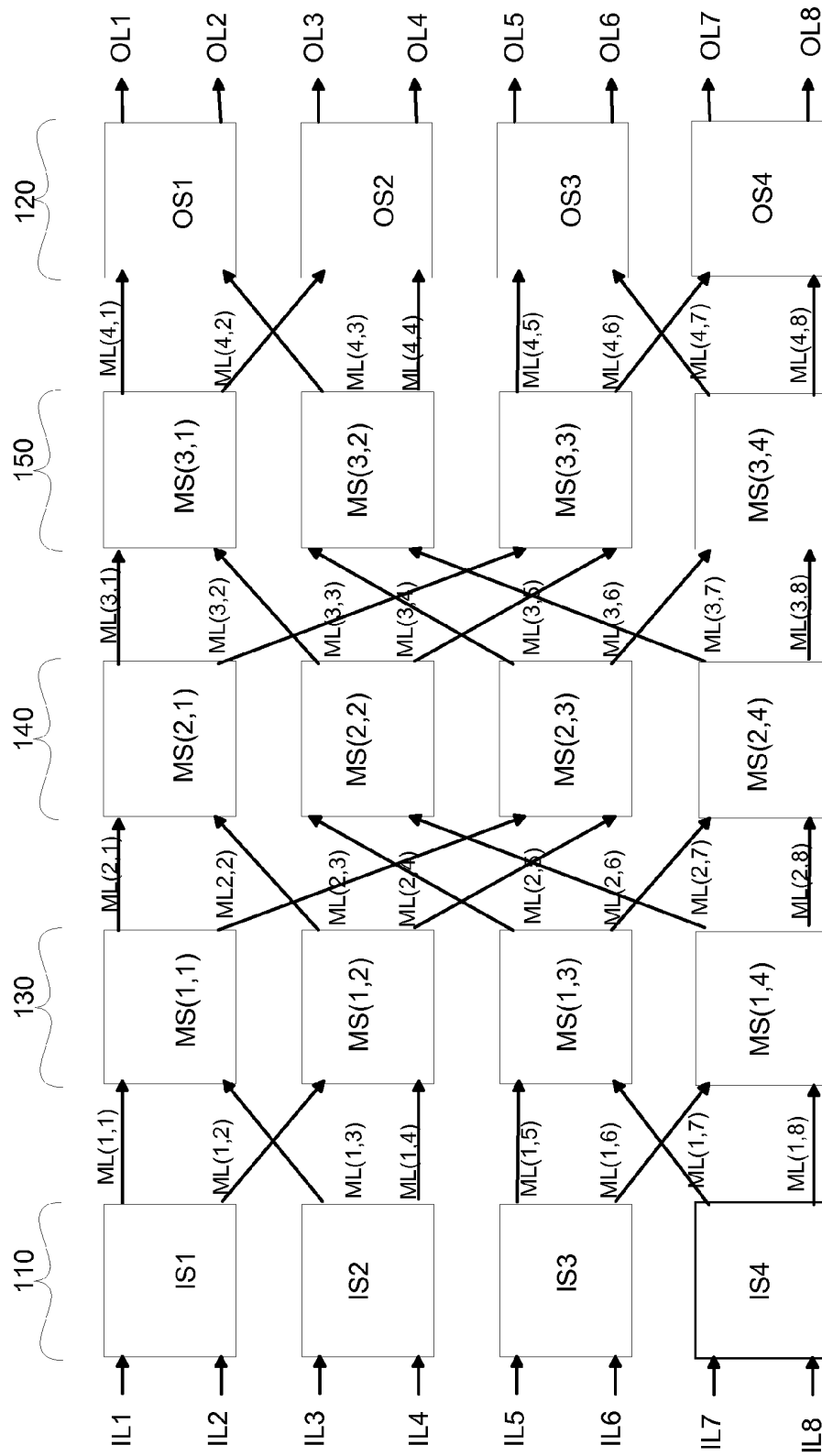

FIG. 6K

600K

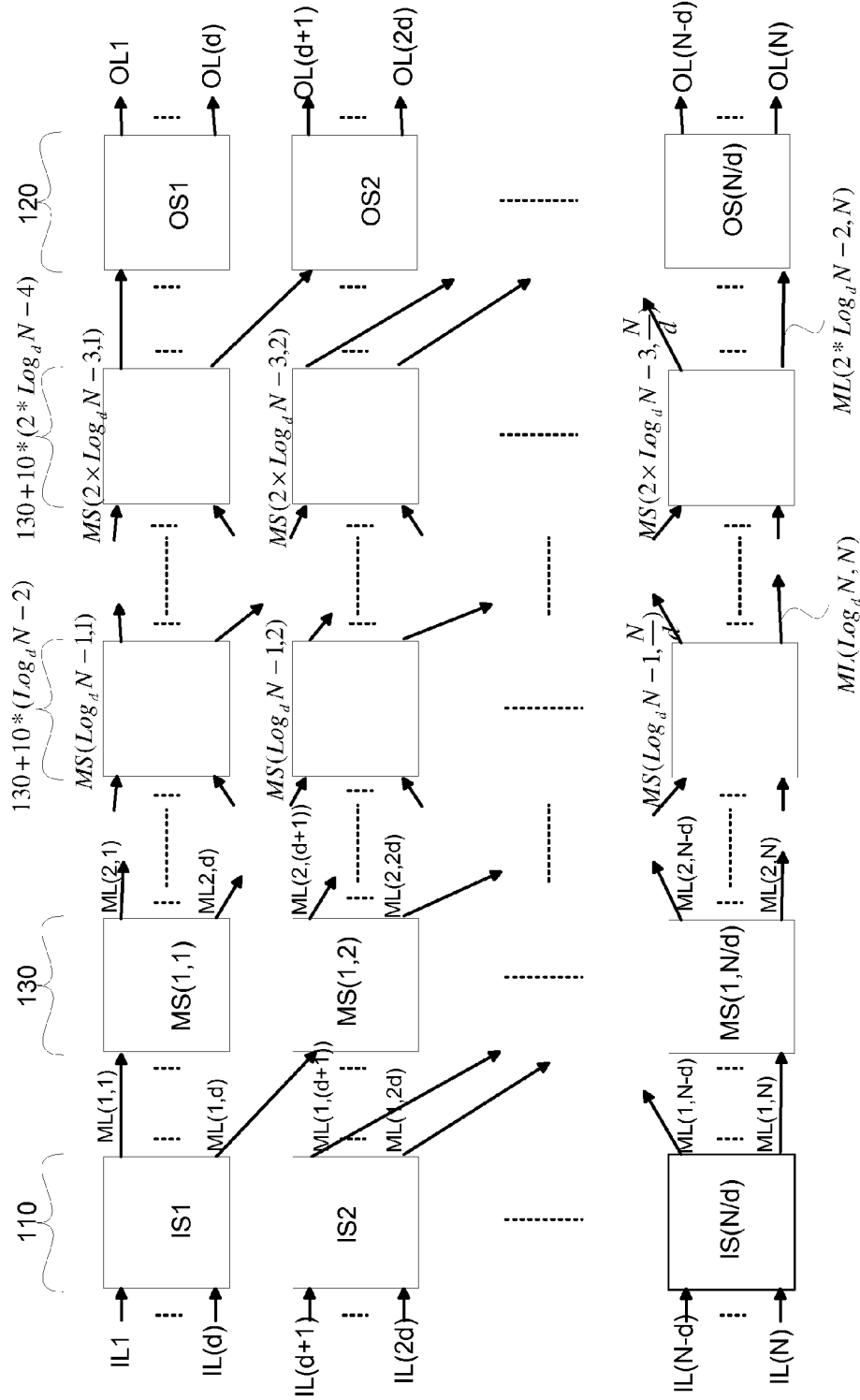

FIG. 6A1

600A1

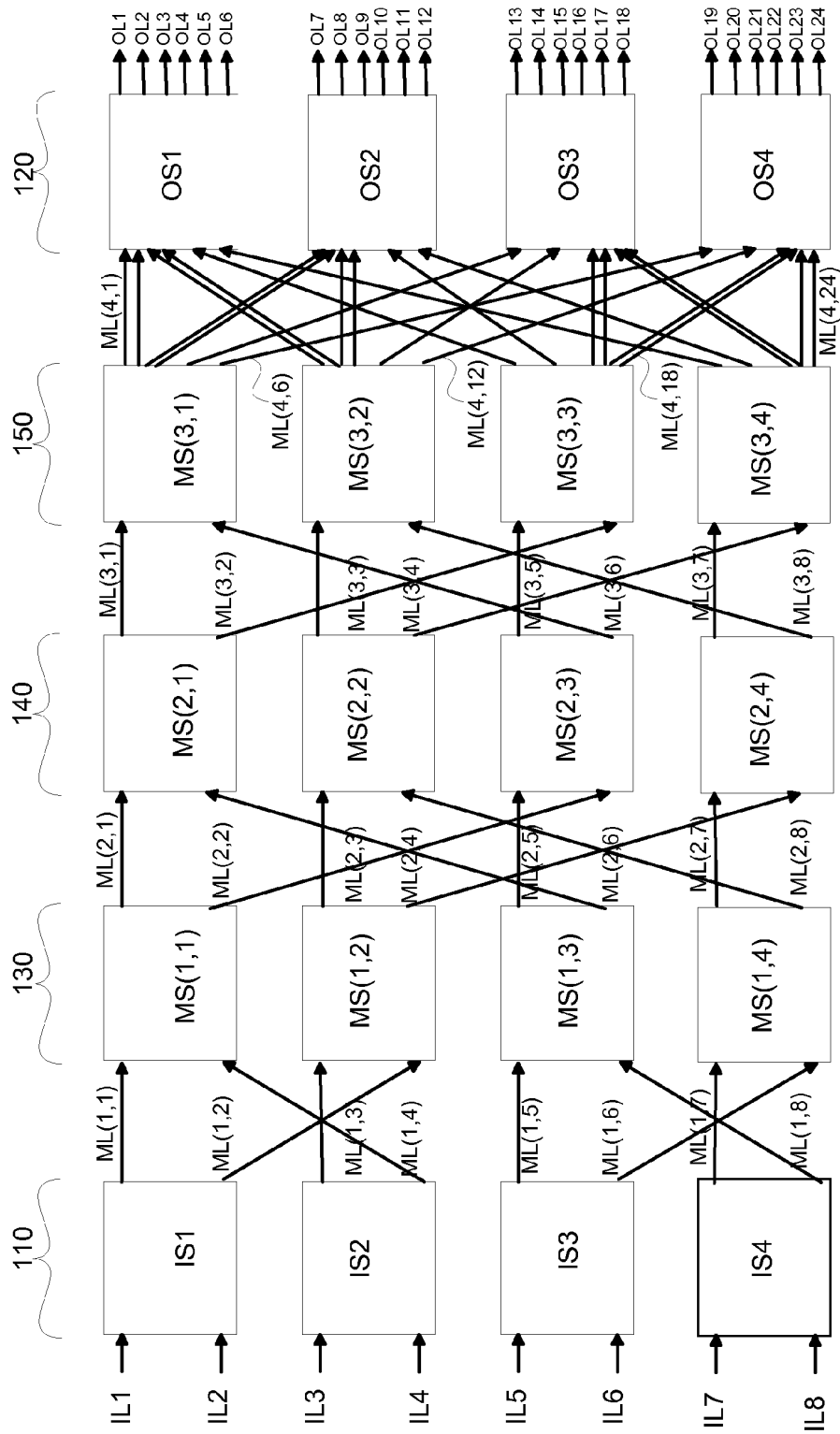

FIG. 6B1

600B1

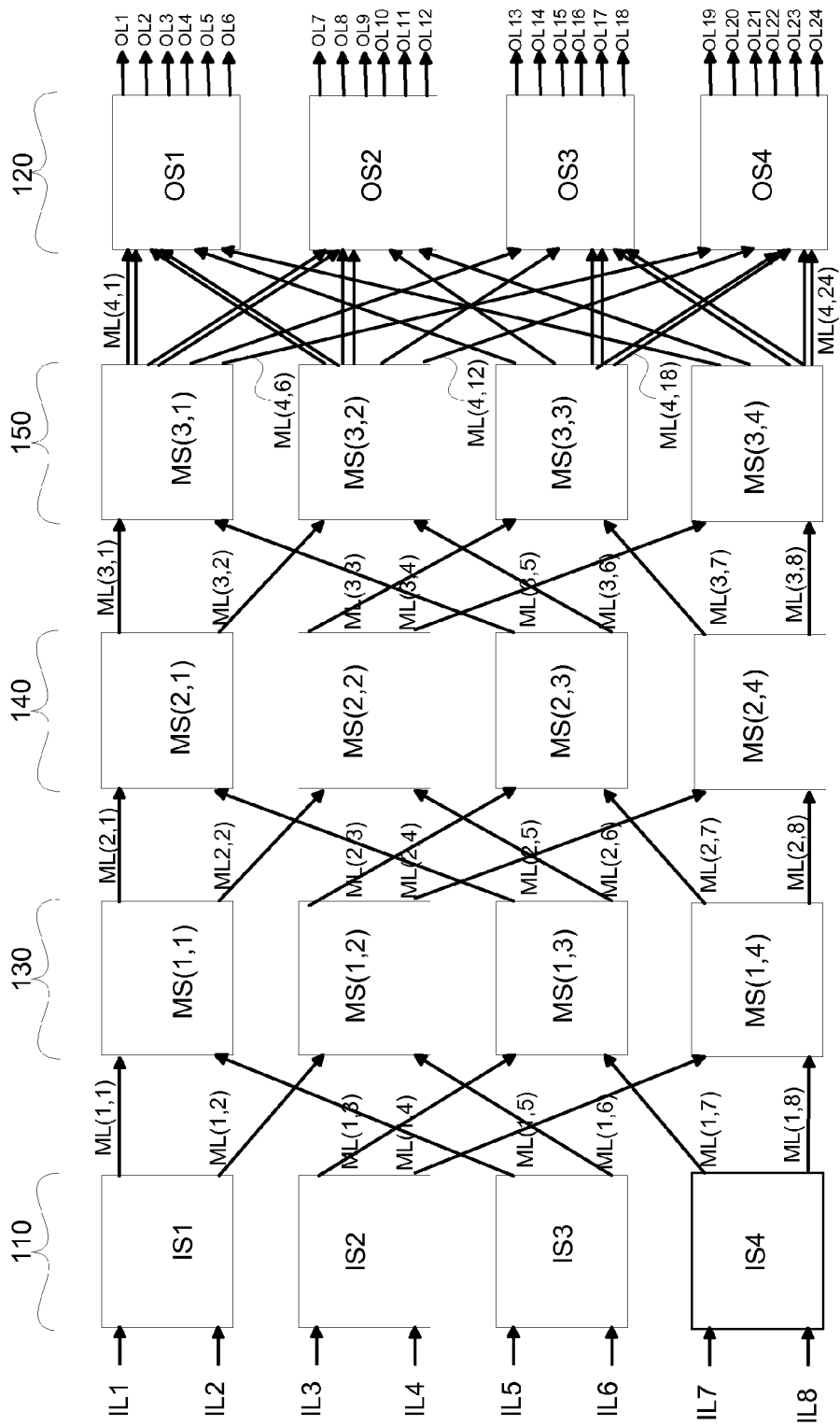

FIG. 6C1

600C1

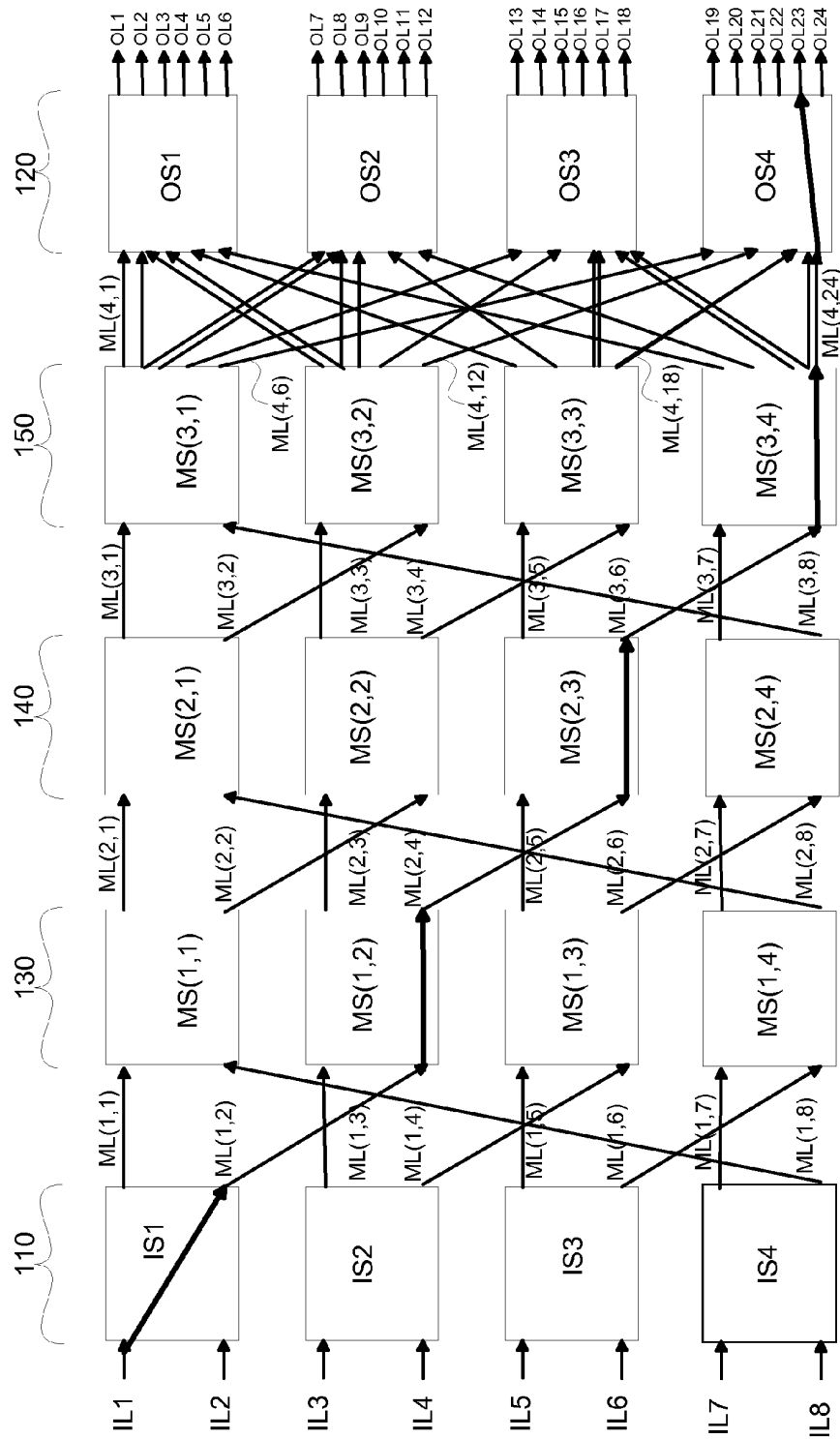

FIG. 6D1

600D1

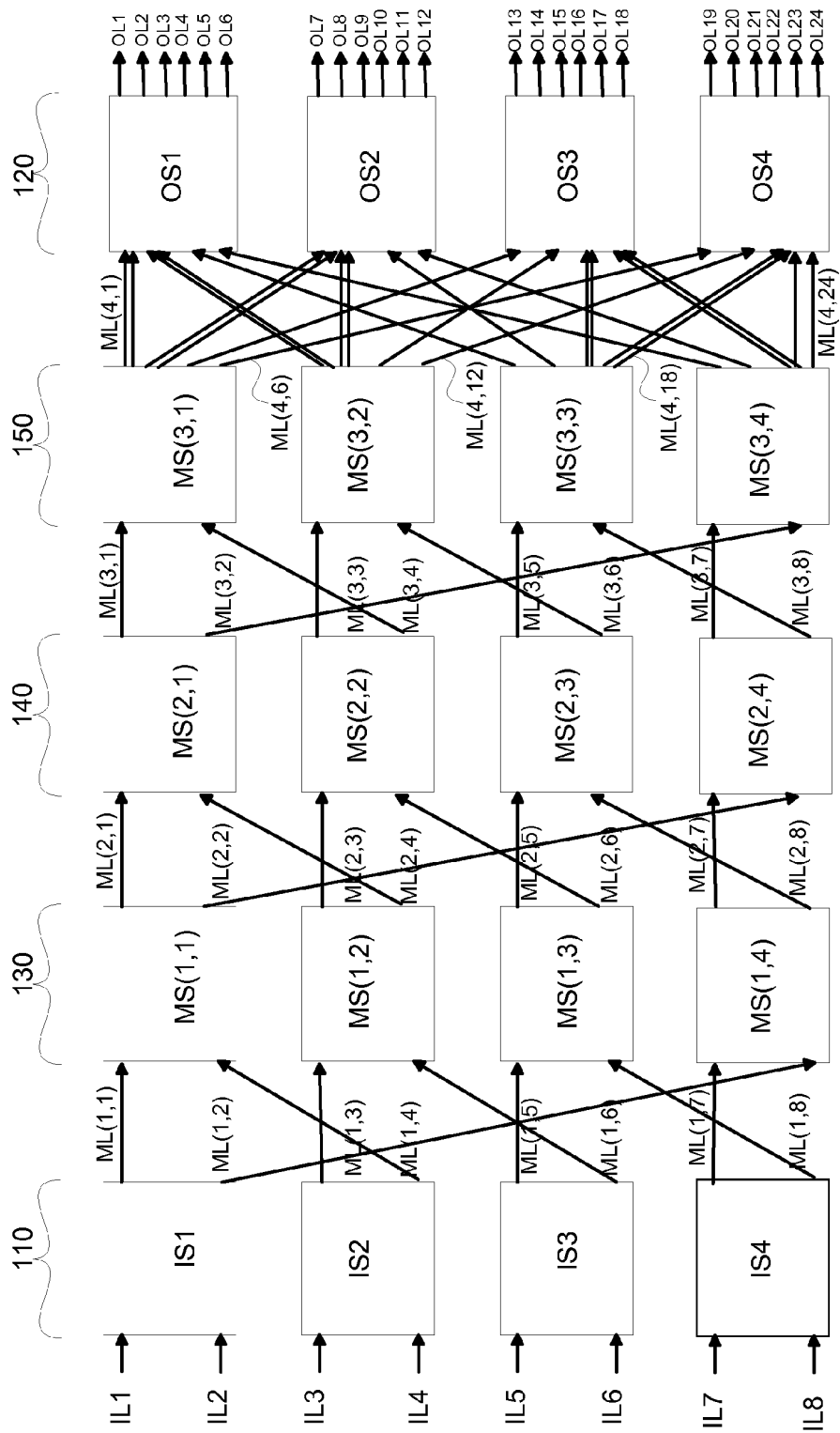

FIG. 6E1

600E1

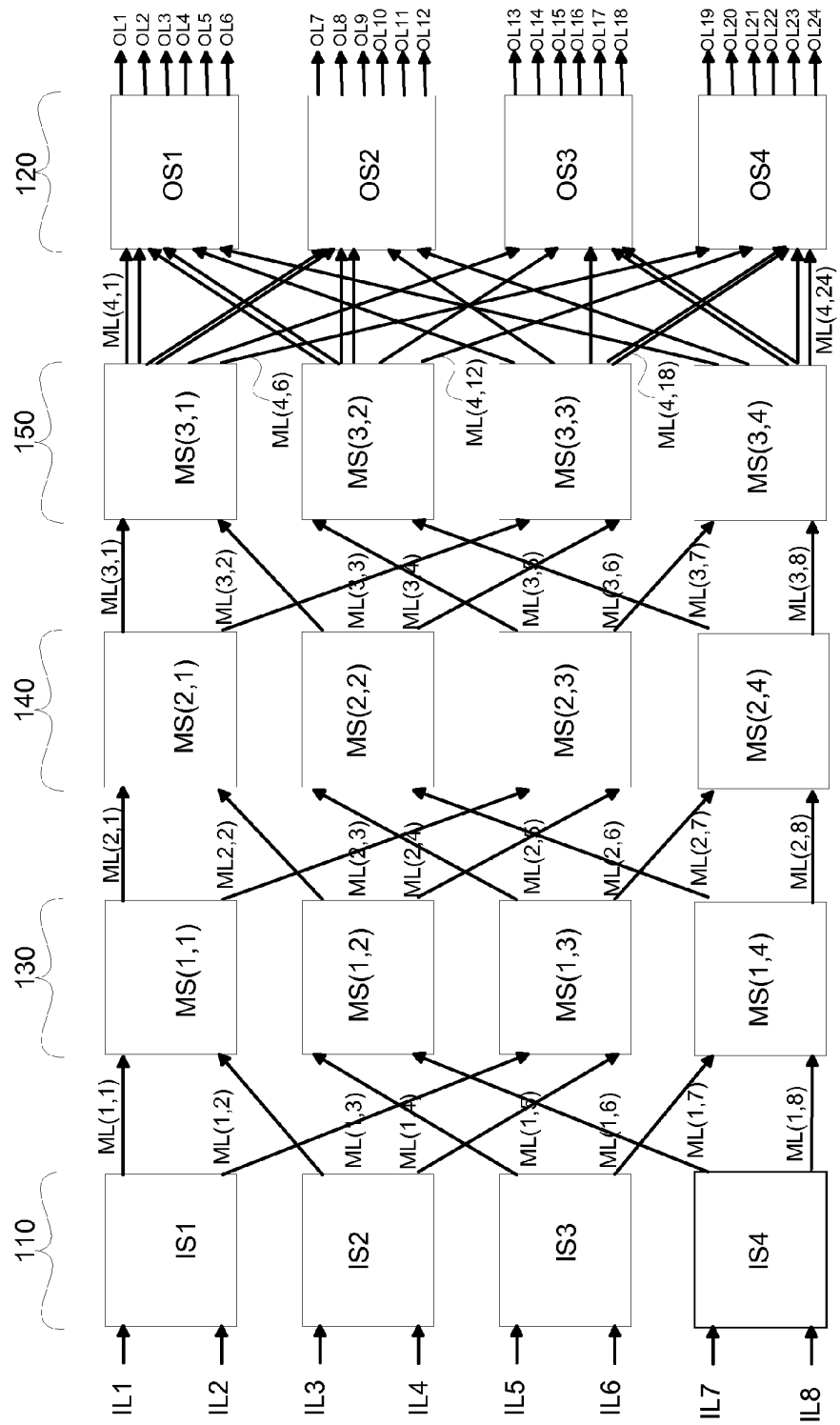

FIG. 6F1

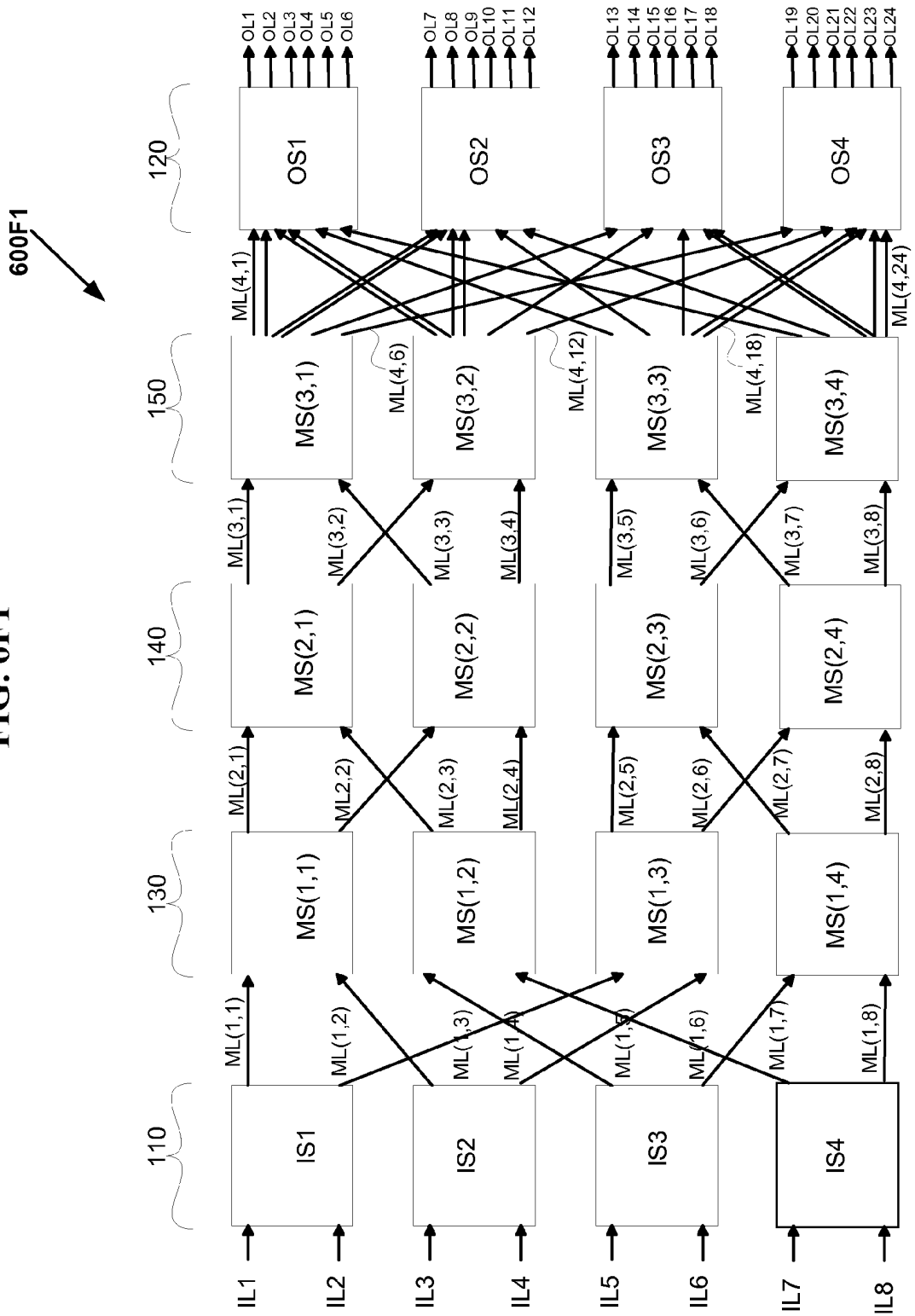

FIG. 6G1

600G1

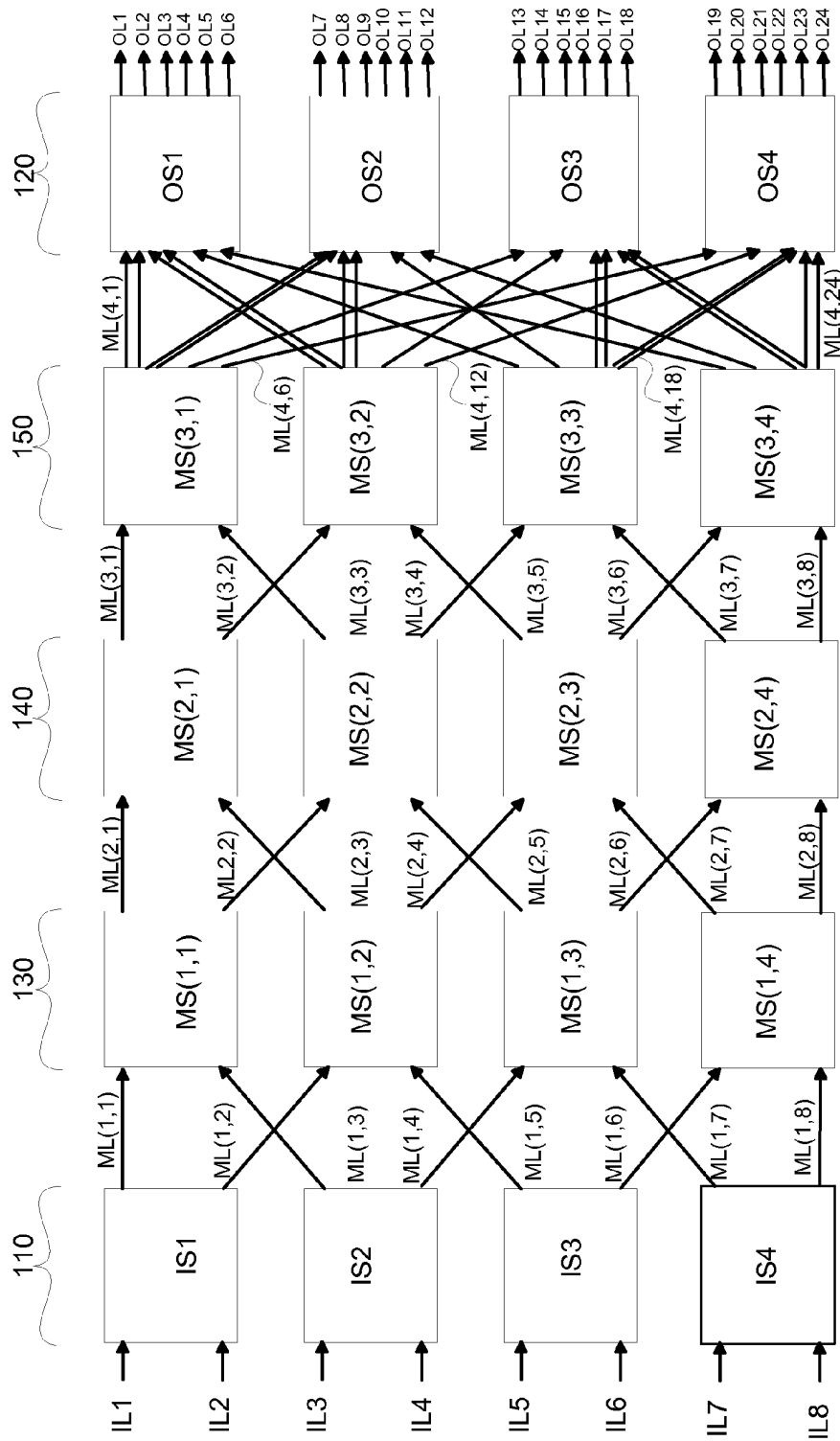

FIG. 6H1

600H1

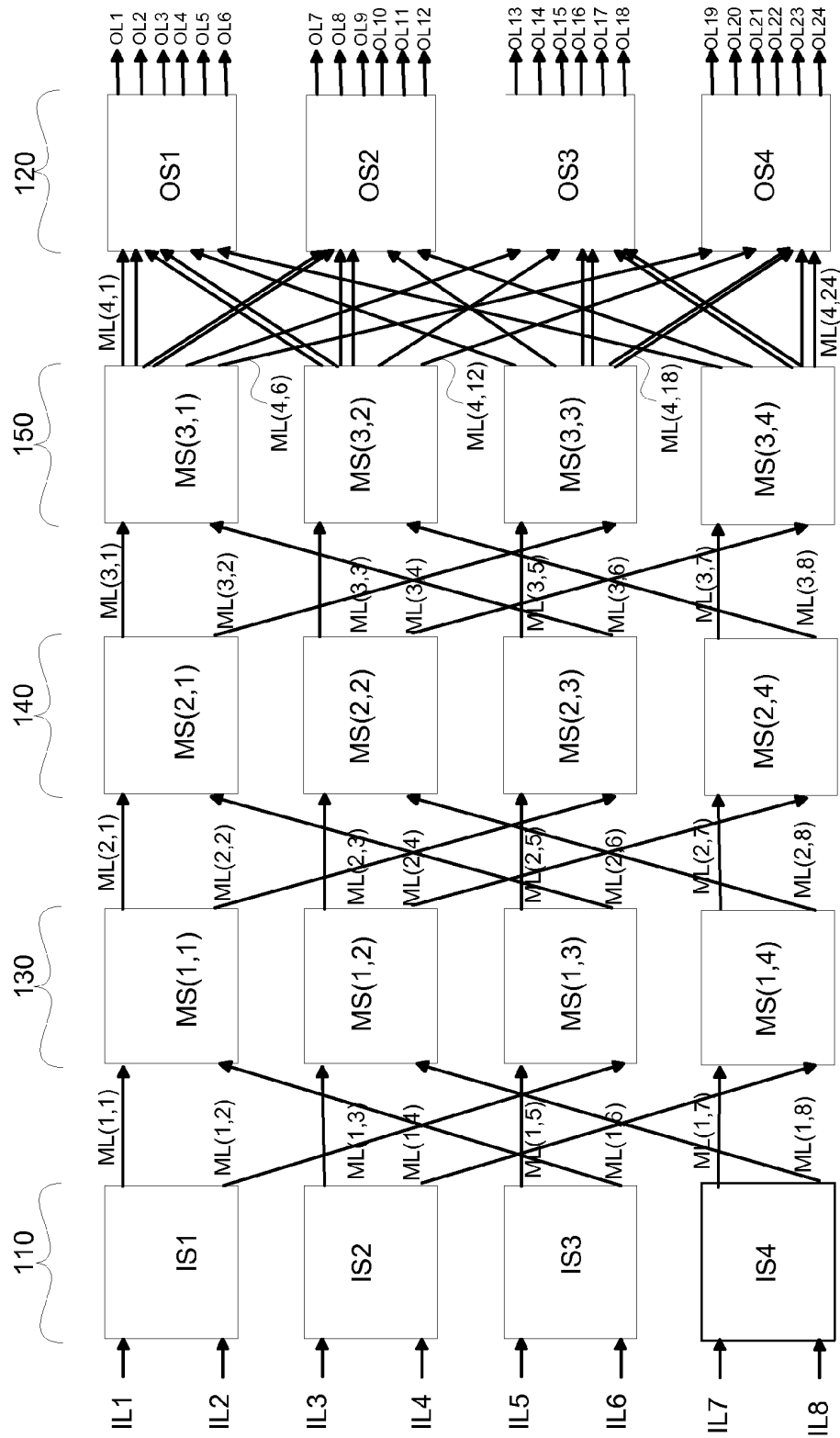

FIG. 6II

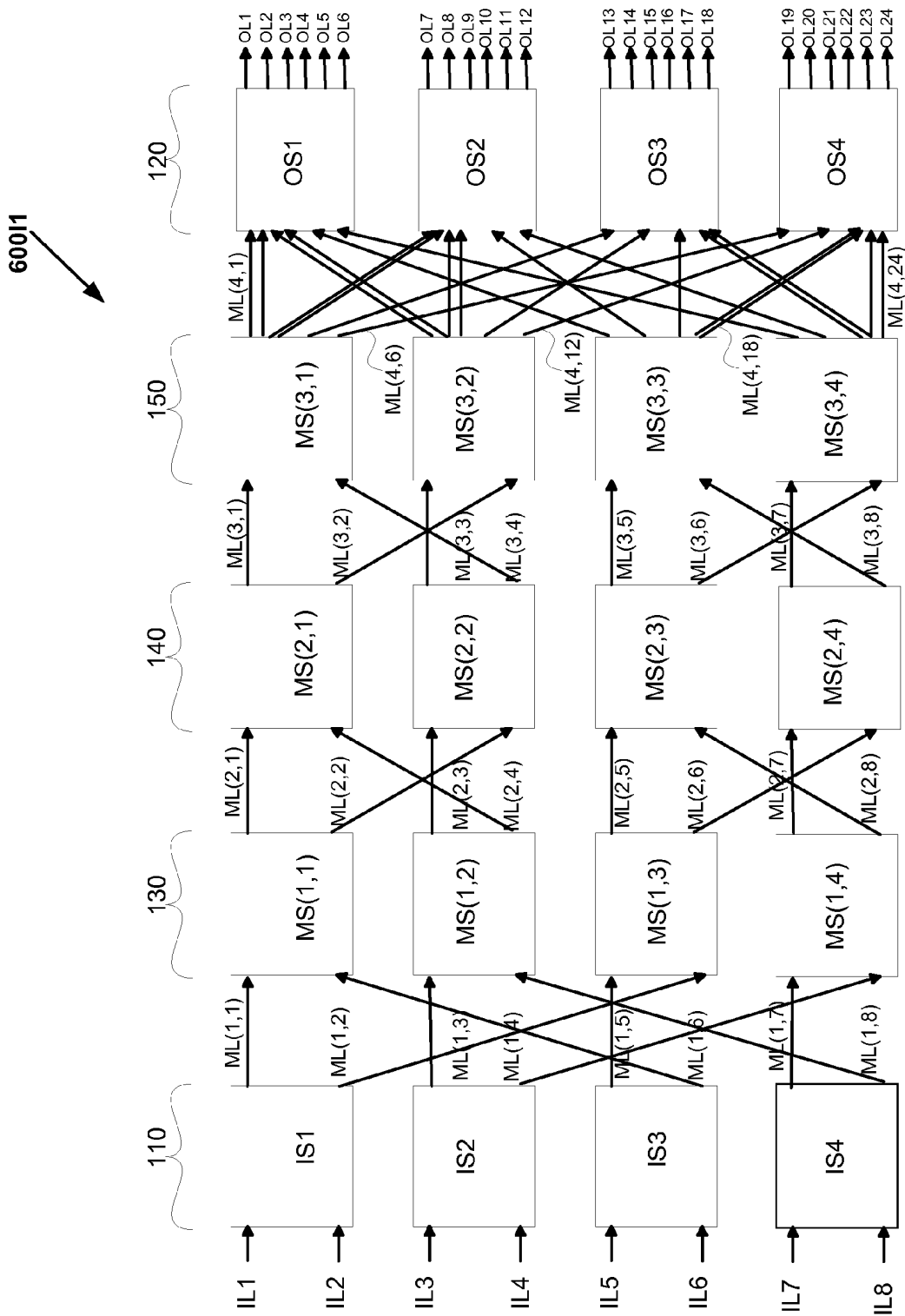

FIG. 6J1

600J1

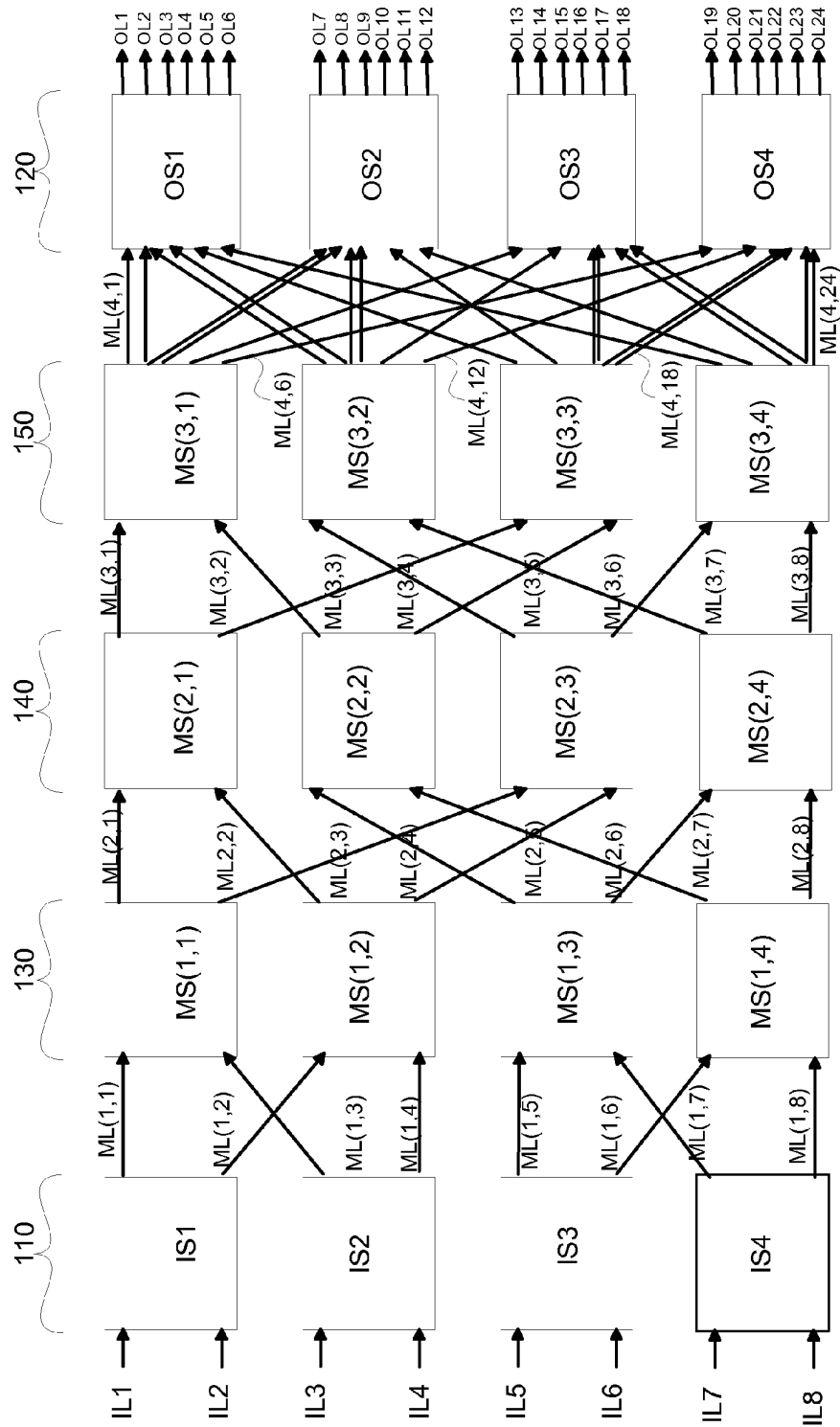

FIG. 6K1

600K1

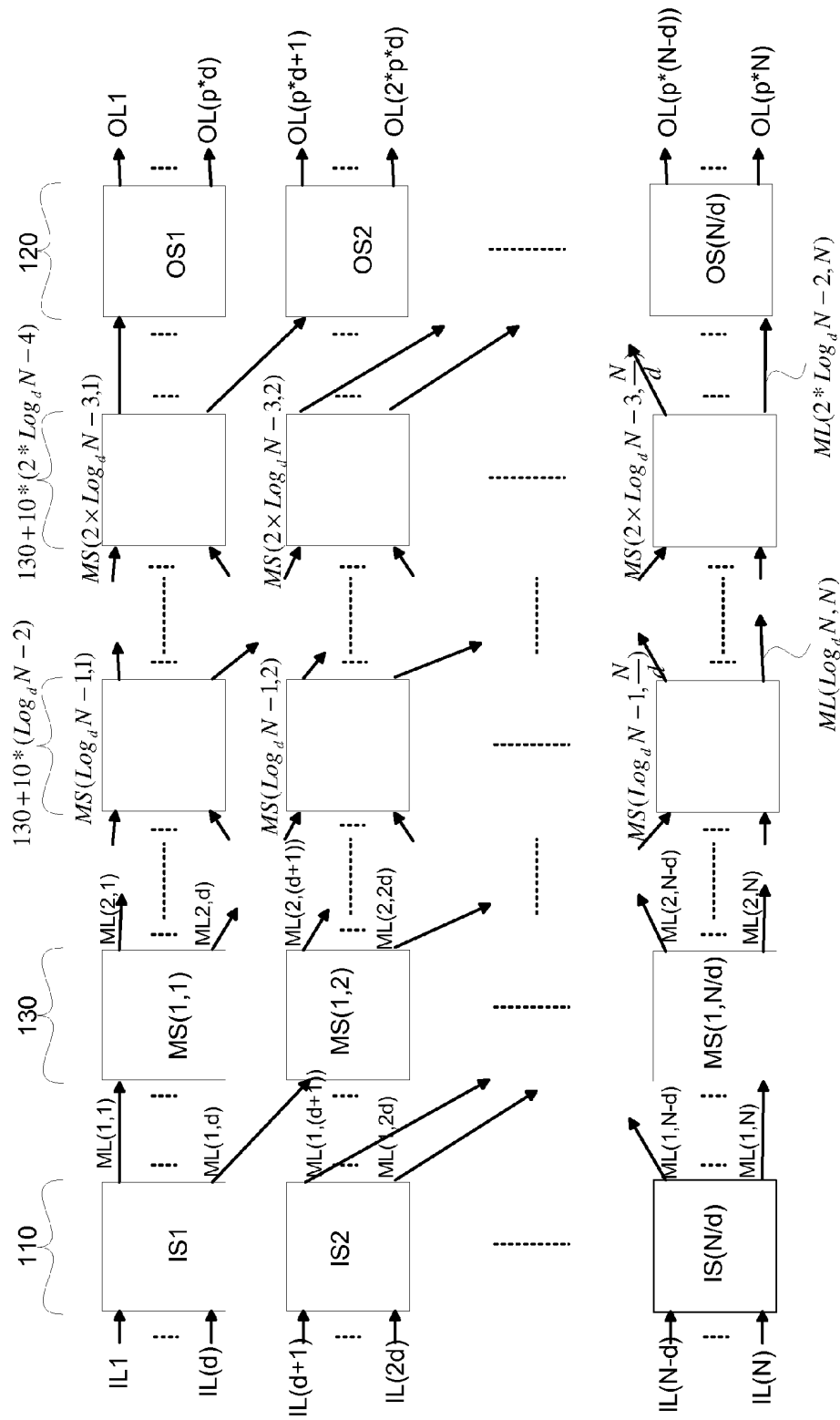

FIG. 6A2

600A2

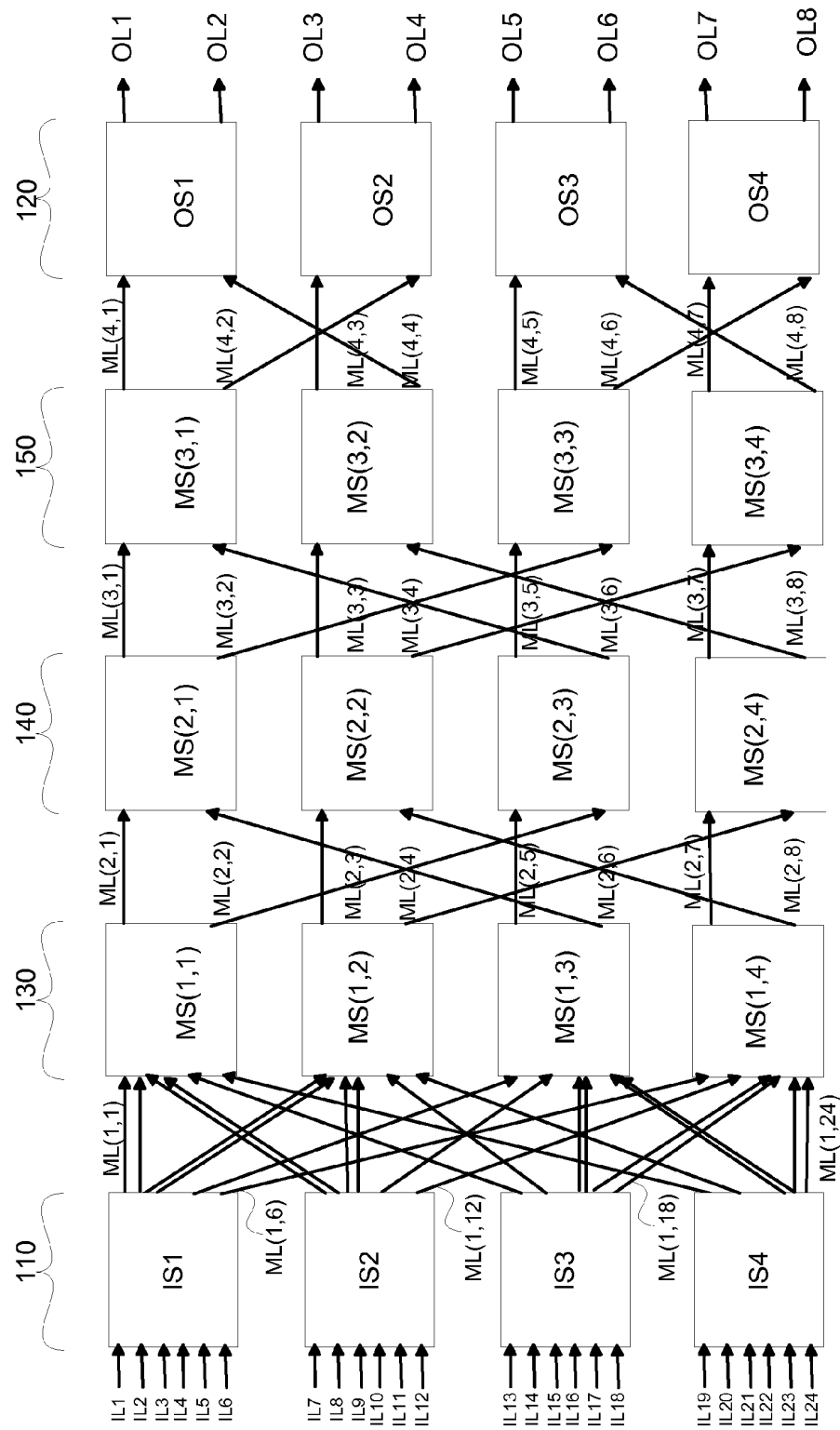

FIG. 6B2

600B2

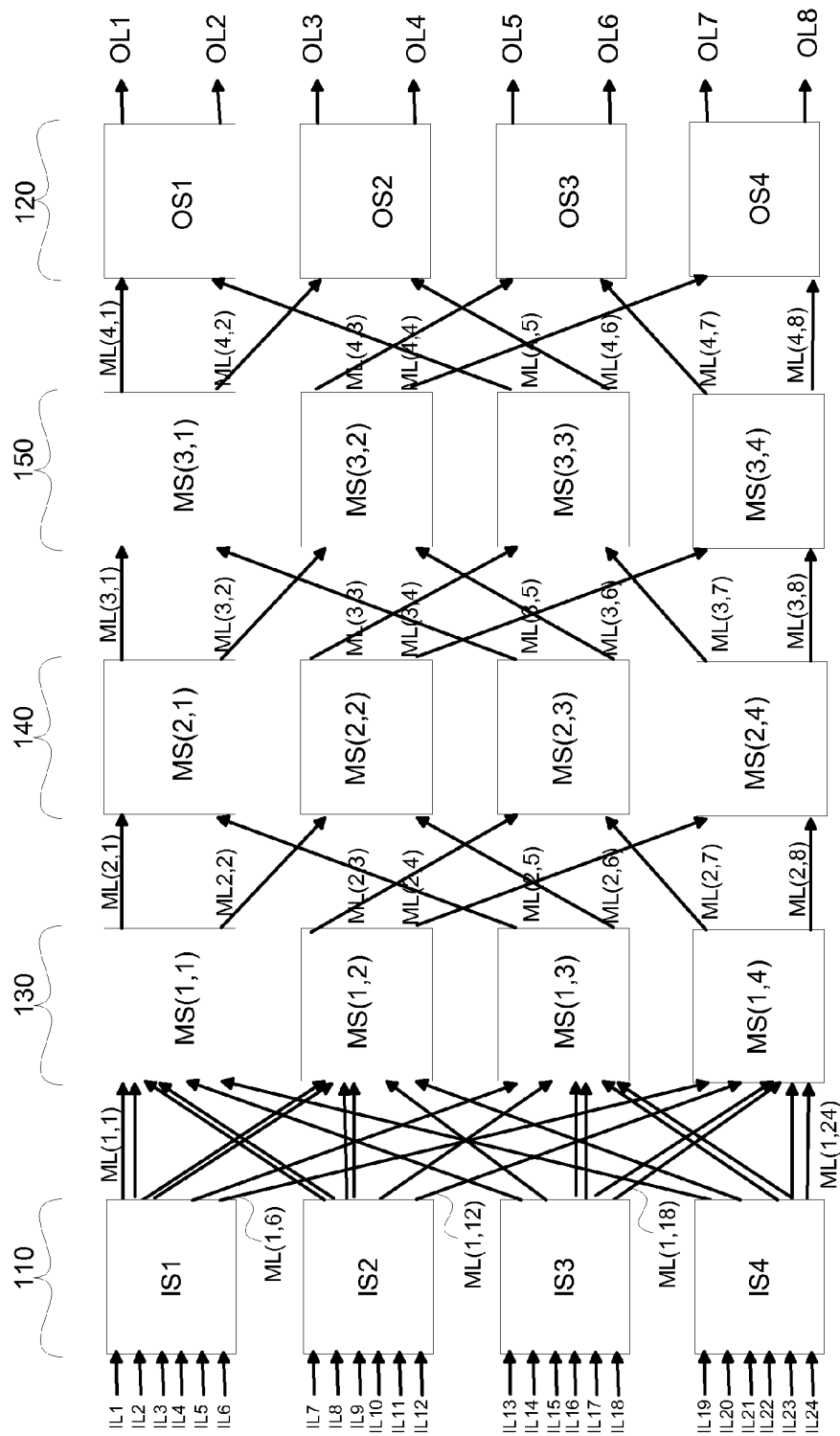

FIG. 6C2

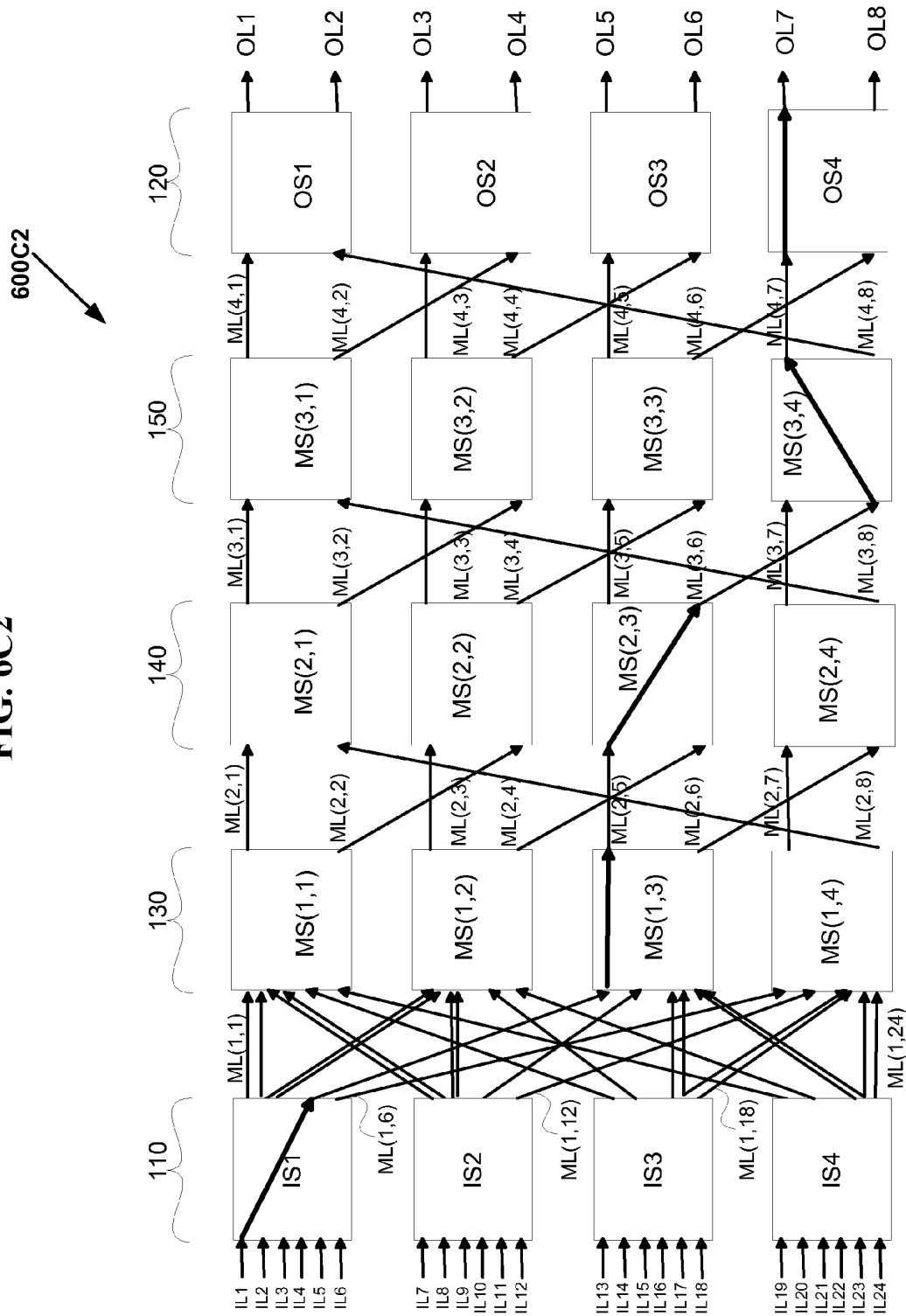

FIG. 6D2

600D2

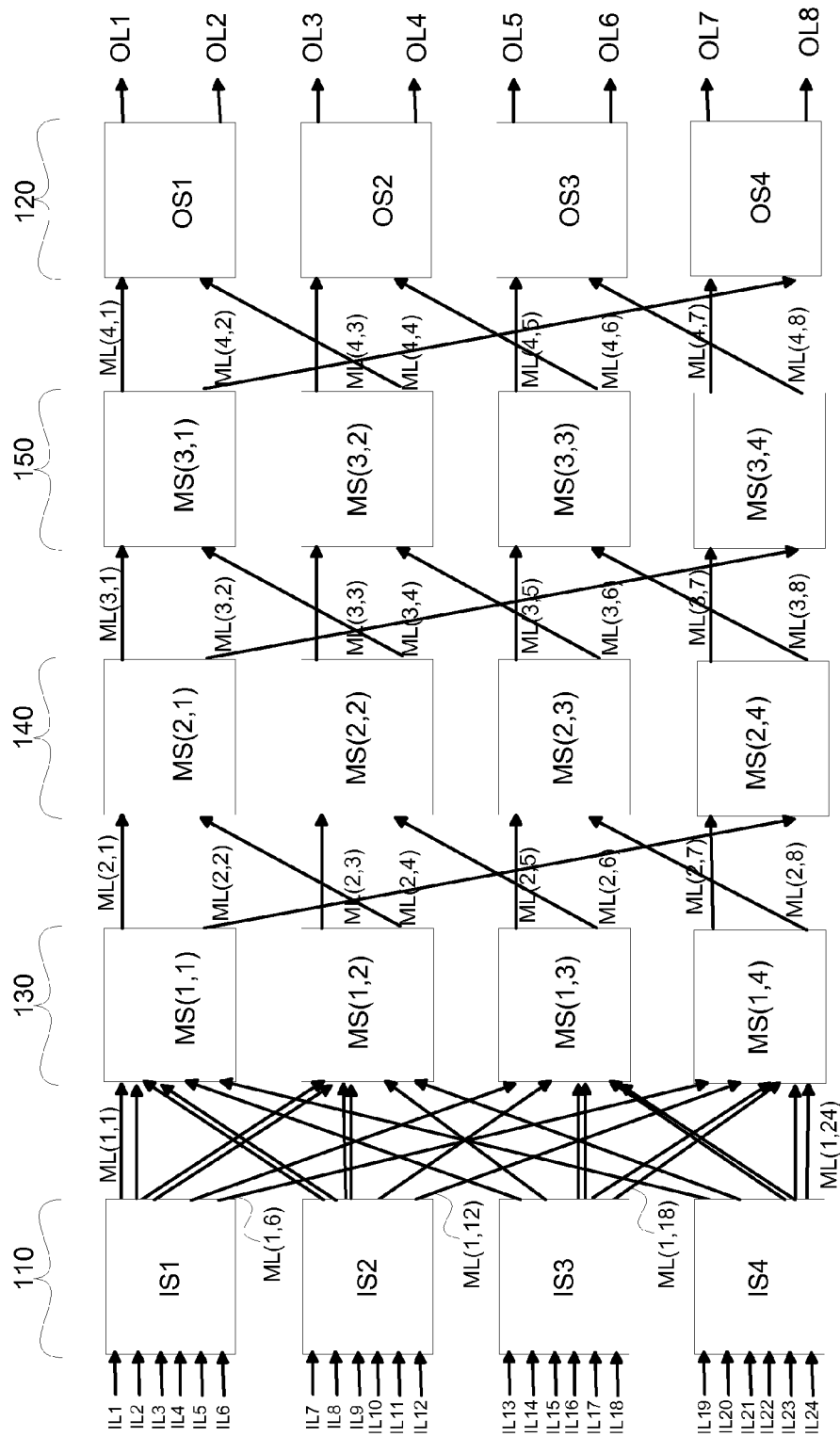

FIG. 6E2

600E2

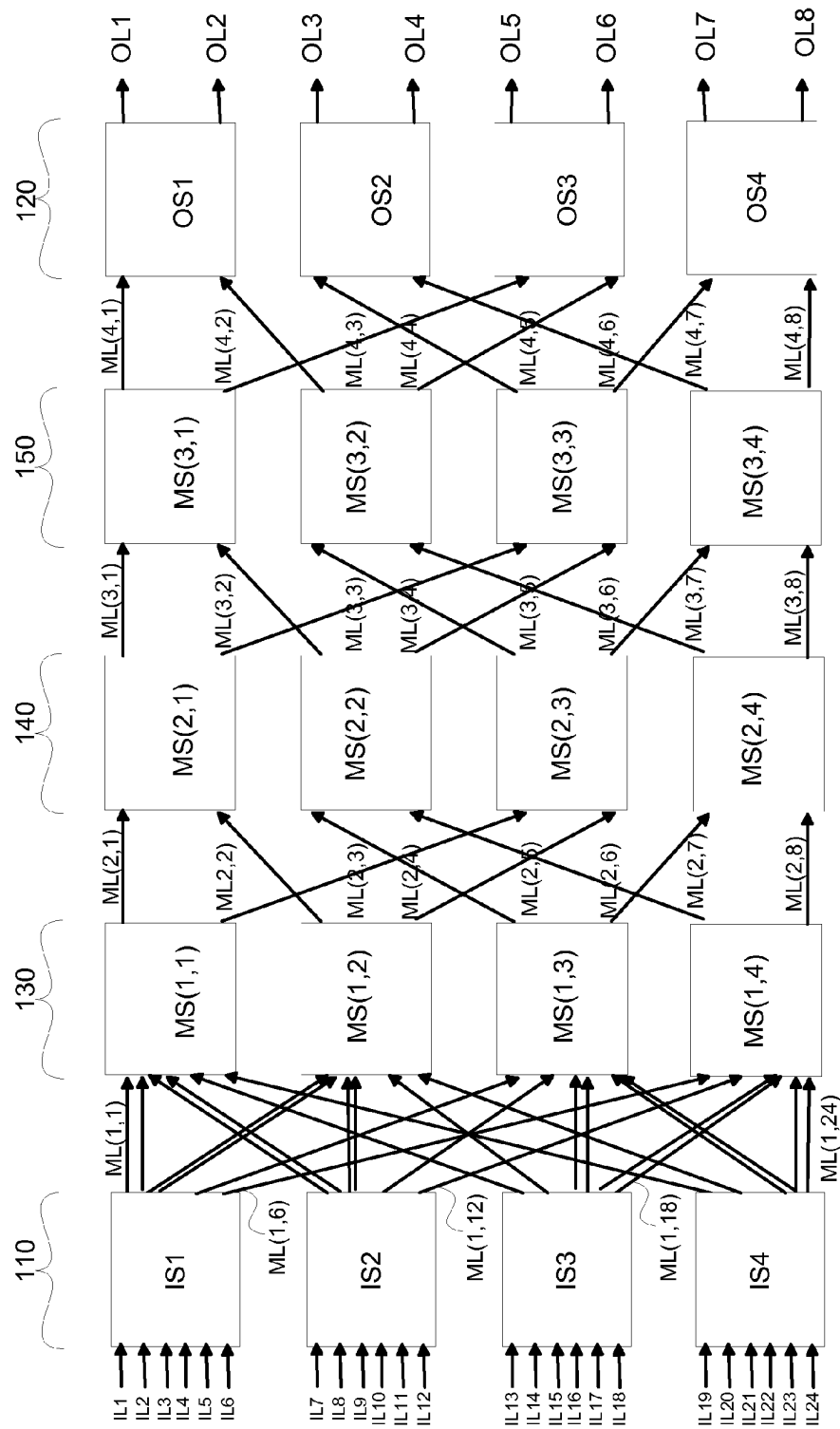

FIG. 6F2

600F2

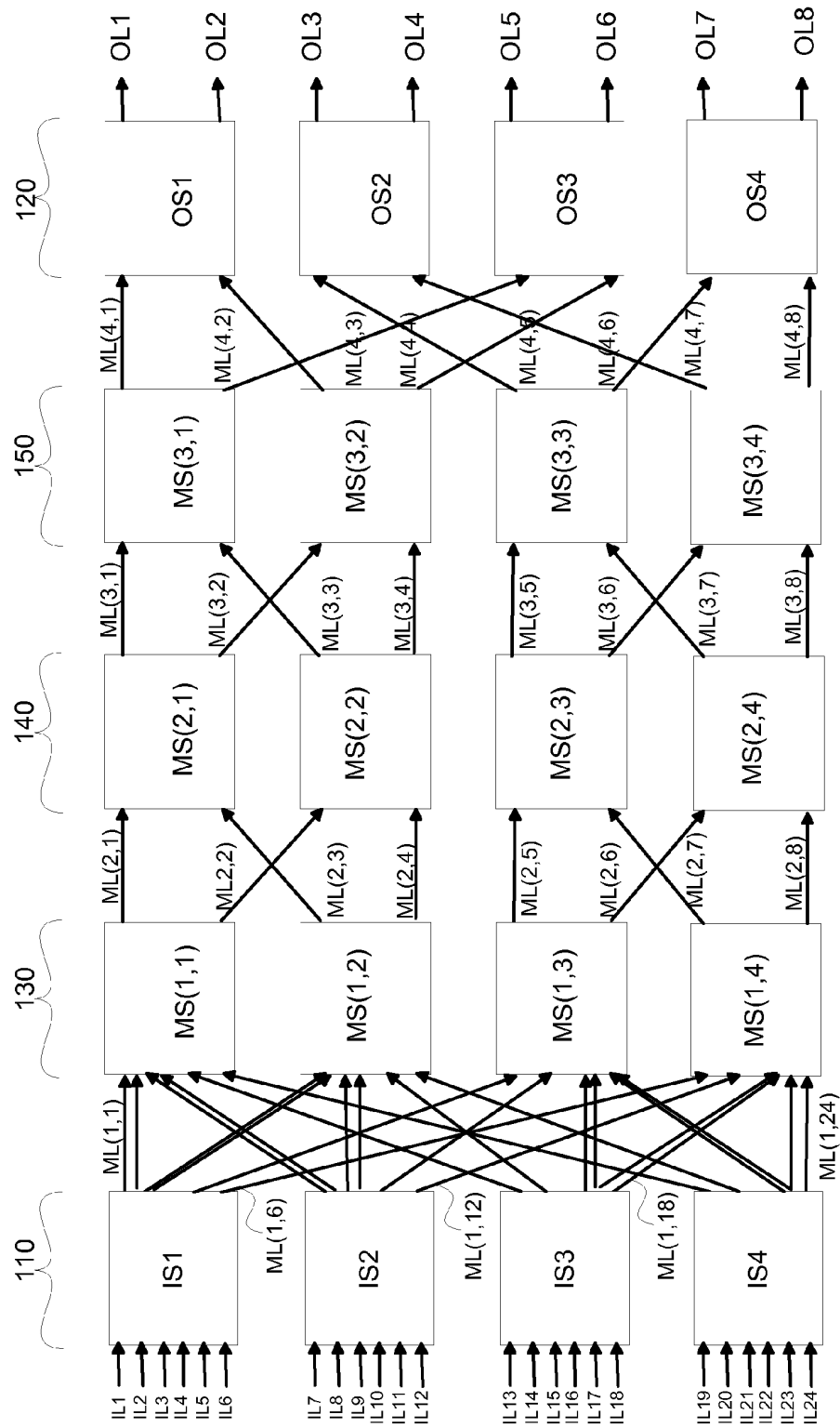

FIG. 6G2

600G2

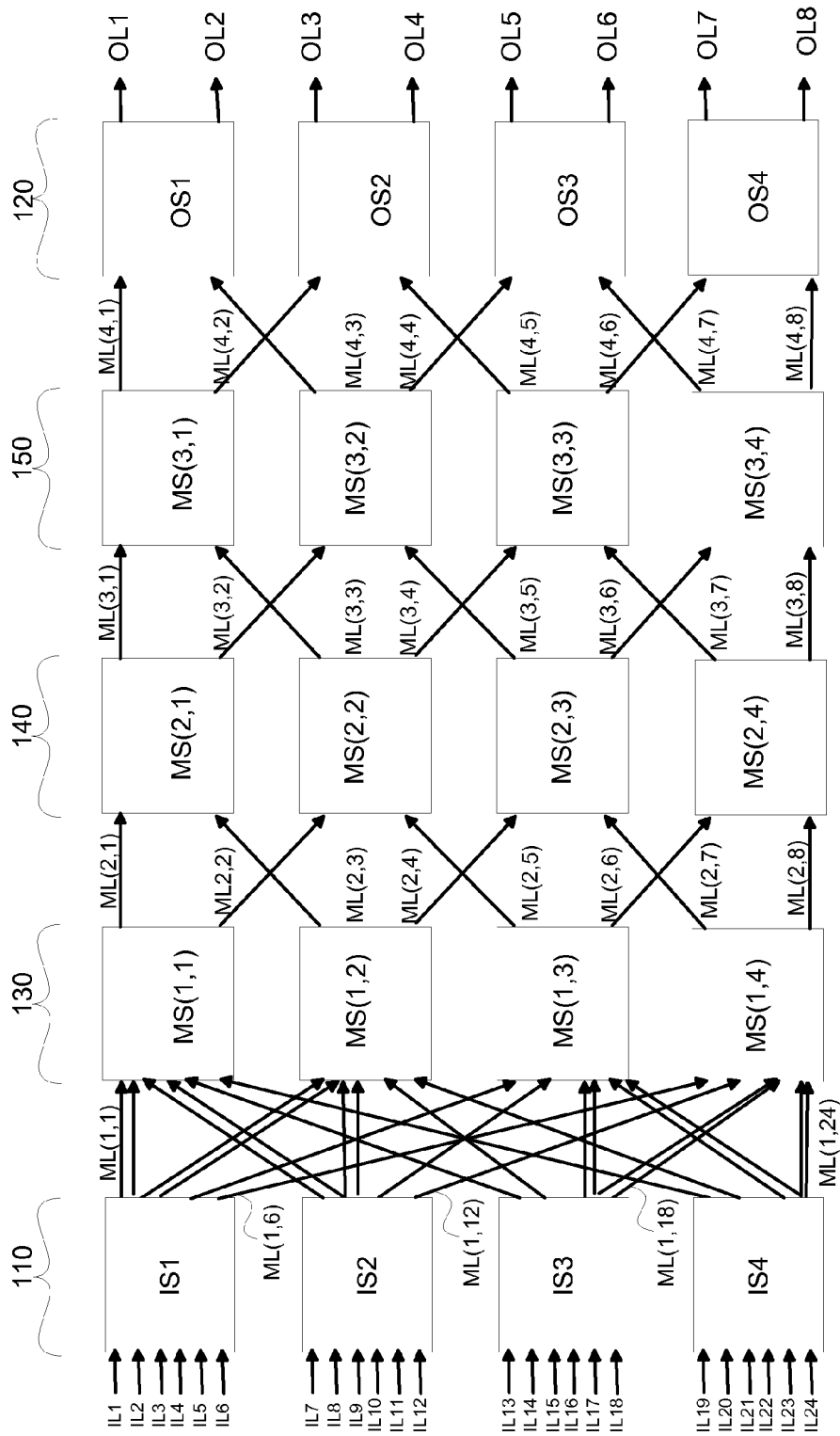

FIG. 6H2

600H2

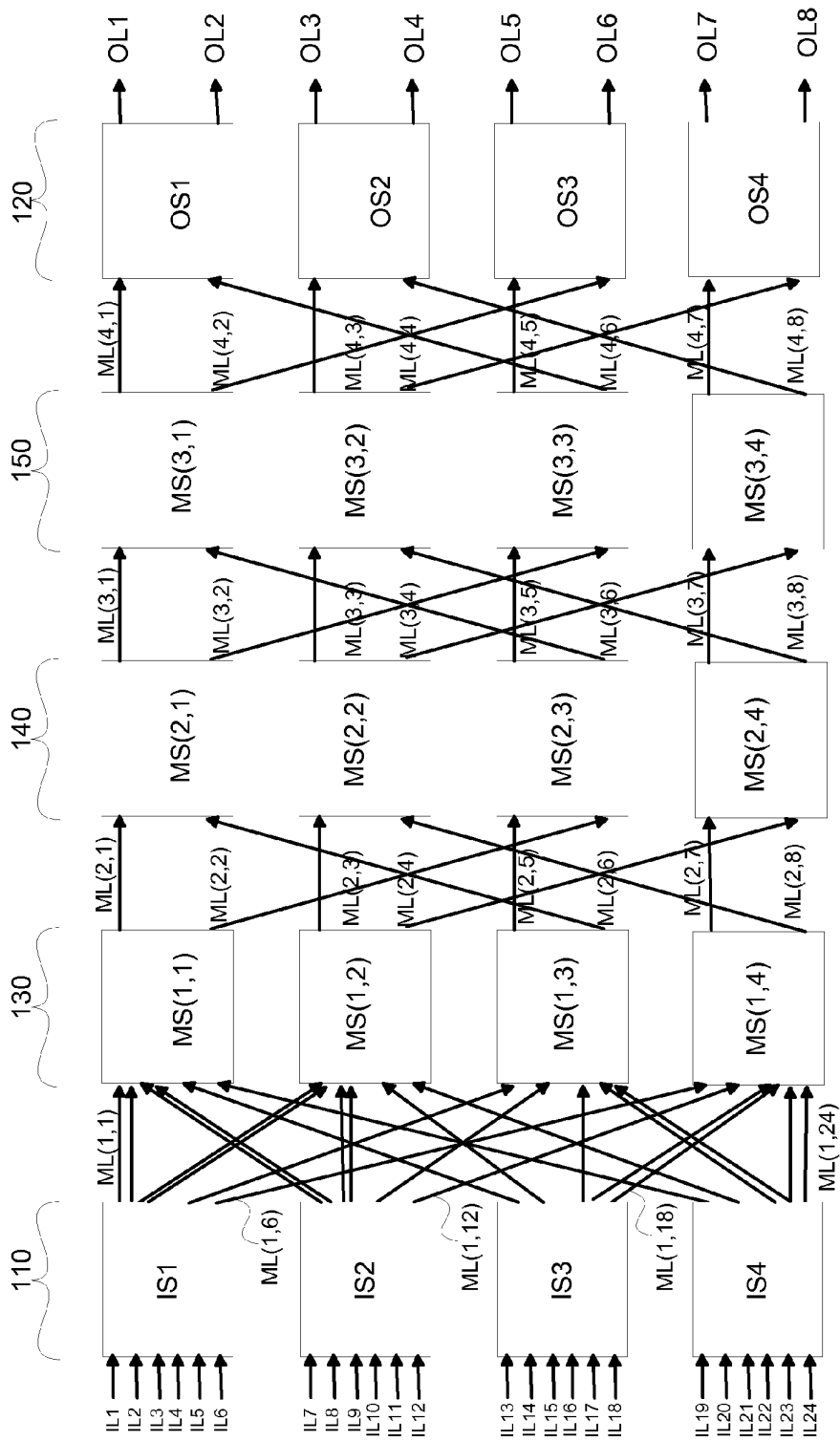

FIG. 6I2

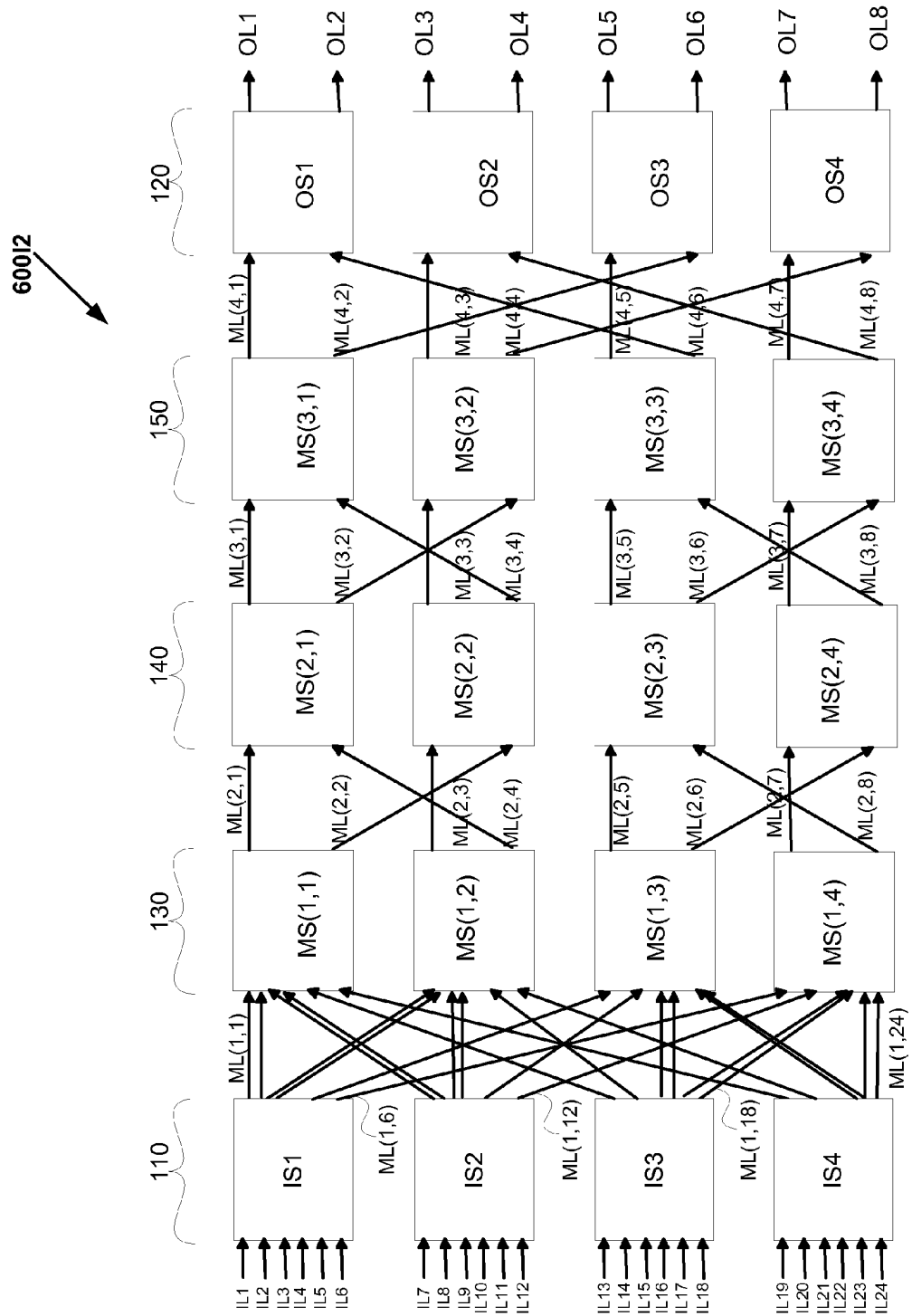

FIG. 6J2

600J2

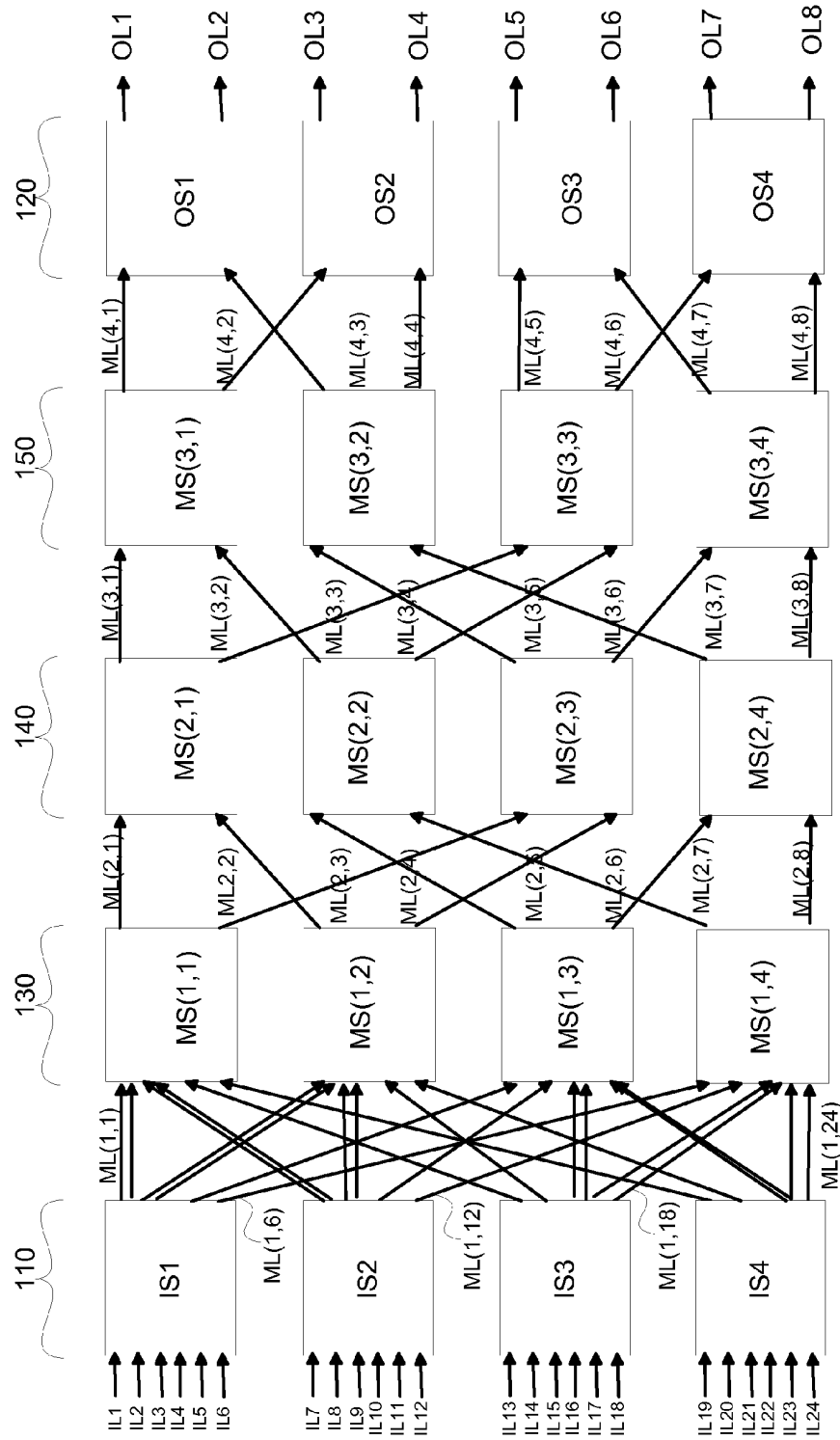
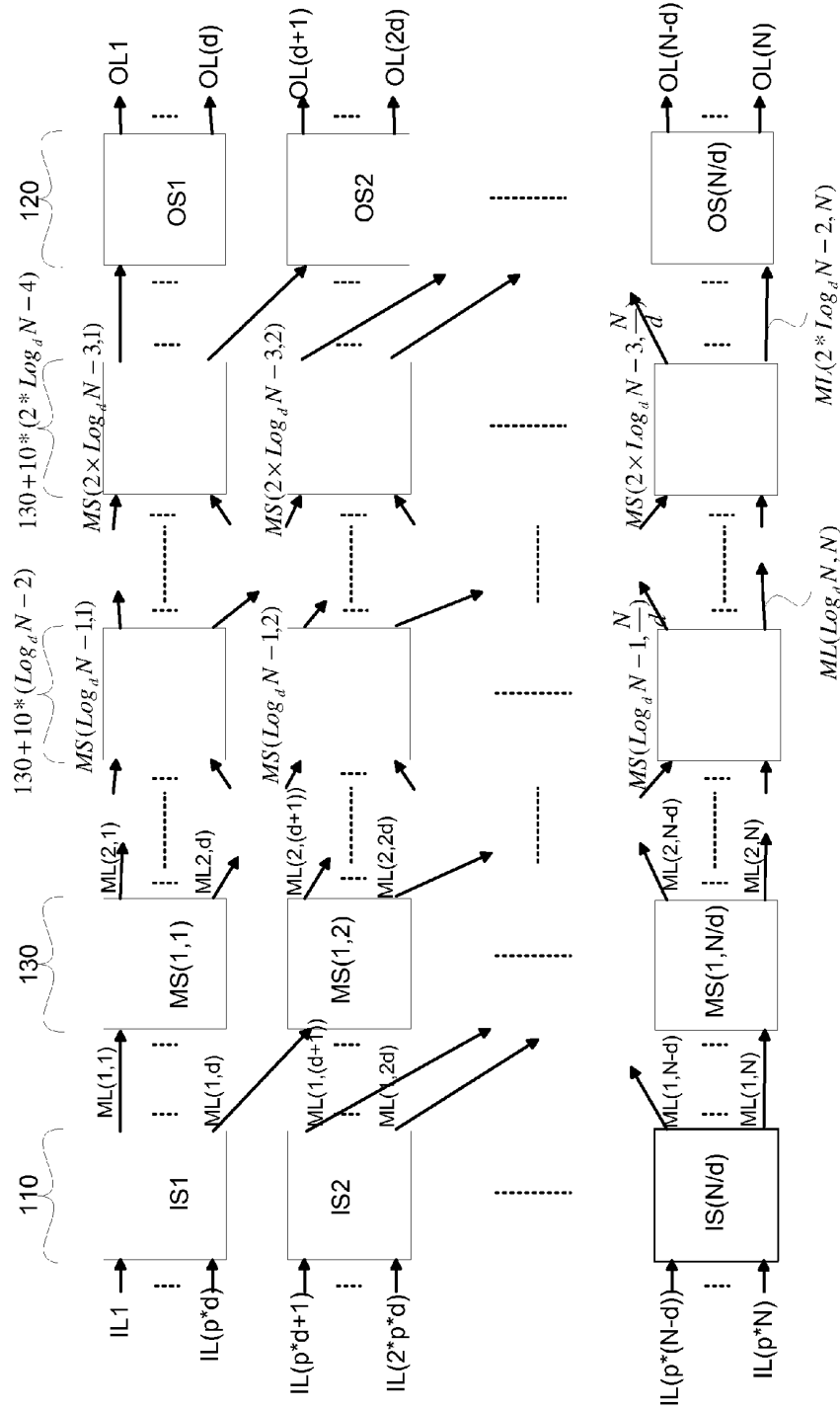

FIG. 6K2

600K2



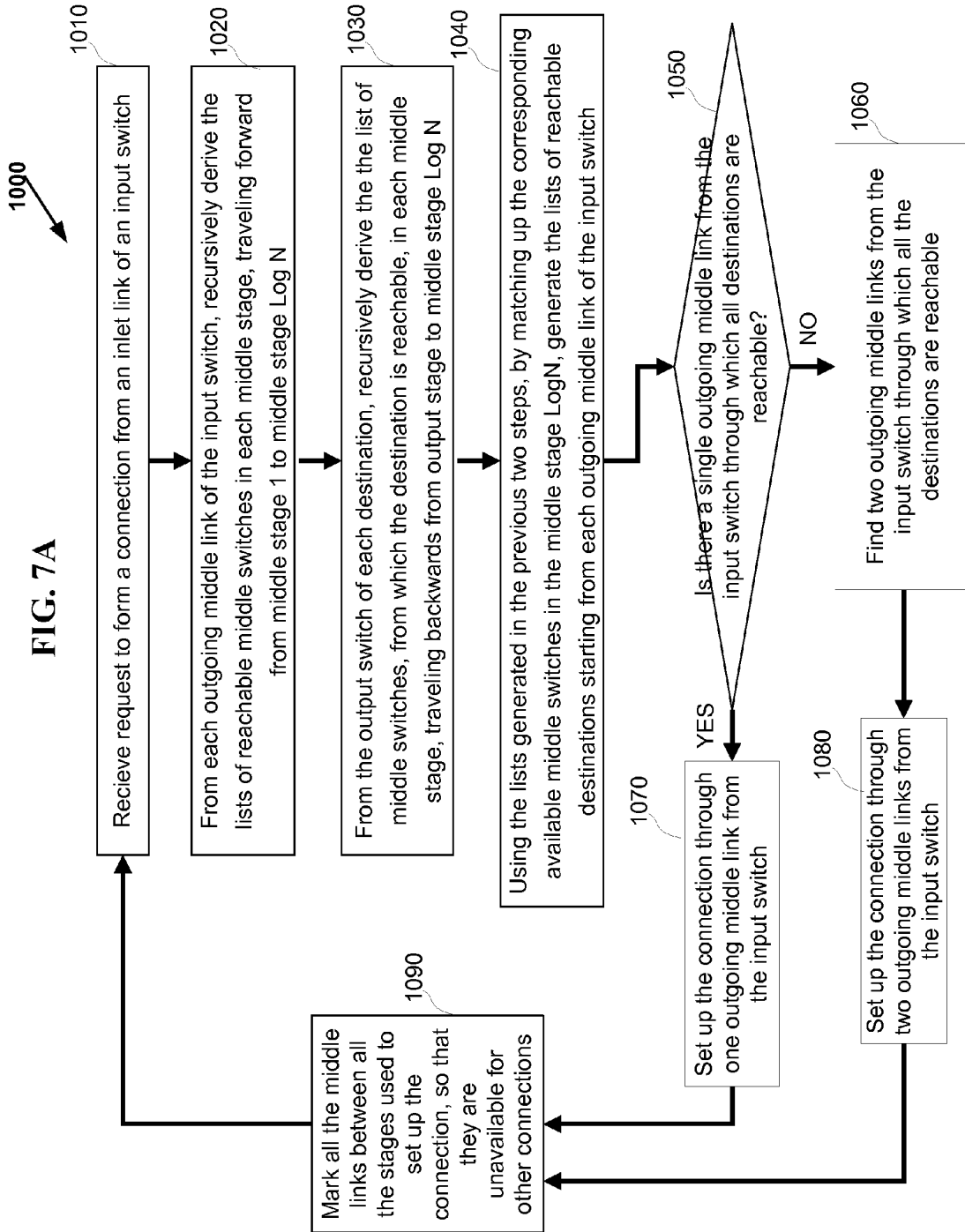

FIG. 8A

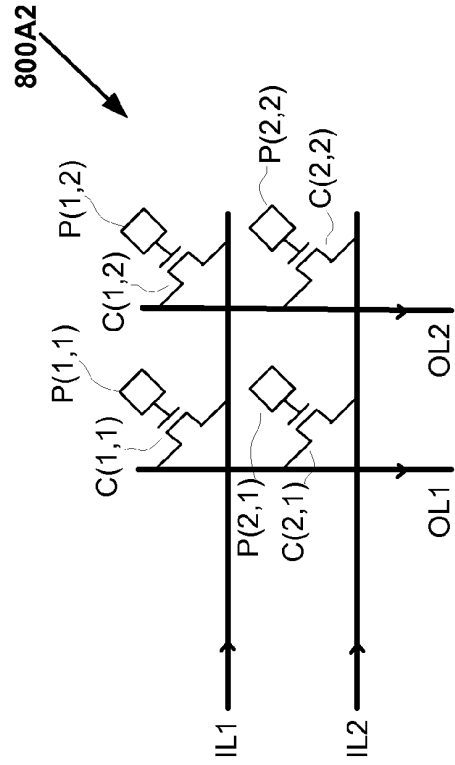

FIG. 8A2
(Prior Art)

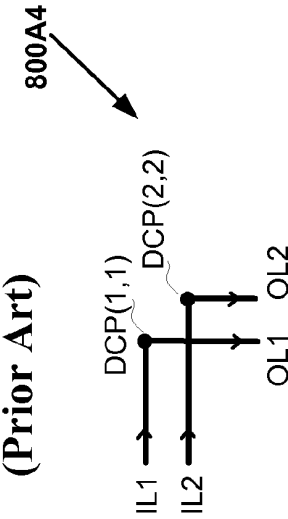

FIG. 8A4

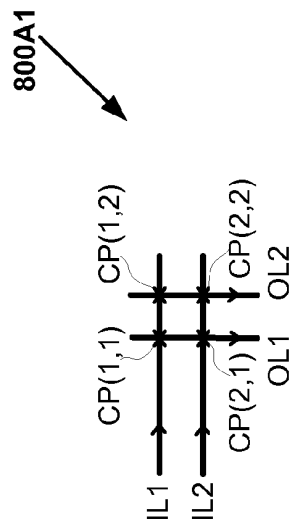

FIG. 8A1
(Prior Art)

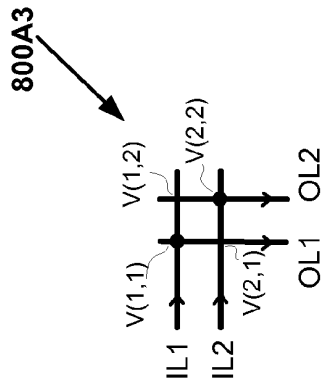

FIG. 8A3
(Prior Art)

FULLY CONNECTED GENERALIZED MULTI-LINK MULTI-STAGE NETWORKS

CROSS REFERENCE TO RELATED APPLICATIONS

This application is related to and claims priority of the PCT Application Serial No. PCT/US08/64604 entitled "FULLY CONNECTED GENERALIZED MULTI-LINK MULTI-STAGE NETWORKS" by Venkat Konda assigned to the same assignee as the current application, filed May 22, 2008, the U.S. Provisional Patent Application Ser. No. 60/940,389 entitled "FULLY CONNECTED GENERALIZED REARRANGEABLY NONBLOCKING MULTI-LINK MULTI-STAGE NETWORKS" by Venkat Konda assigned to the same assignee as the current application, filed May 25, 2007, the U.S. Provisional Patent Application Ser. No. 60/940,391 entitled "FULLY CONNECTED GENERALIZED FOLDED MULTI-STAGE NETWORKS" by Venkat Konda assigned to the same assignee as the current application, filed May 25, 2007 and the U.S. Provisional Patent Application Ser. No. 60/940,392 entitled "FULLY CONNECTED GENERALIZED STRICTLY NONBLOCKING MULTI-LINK MULTI-STAGE NETWORKS" by Venkat Konda assigned to the same assignee as the current application, filed May 25, 2007.

This application is related to and incorporates by reference in its entirety the U.S. application Ser. No. 12/530,207 entitled "FULLY CONNECTED GENERALIZED MULTI-STAGE NETWORKS" by Venkat Konda assigned to the same assignee as the current application, filed Sep. 6, 2009, the PCT Application Serial No. PCT/US08/56064 entitled "FULLY CONNECTED GENERALIZED MULTI-STAGE NETWORKS" by Venkat Konda assigned to the same assignee as the current application, filed Mar. 6, 2008, the U.S. Provisional Patent Application Ser. No. 60/905,526 entitled "LARGE SCALE CROSSPOINT REDUCTION WITH NONBLOCKING UNICAST & MULTICAST IN ARBITRARILY LARGE MULTI-STAGE NETWORKS" by Venkat Konda assigned to the same assignee as the current application, filed Mar. 6, 2007, and the U.S. Provisional Patent Application Ser. No. 60/940,383 entitled "FULLY CONNECTED GENERALIZED MULTI-STAGE NETWORKS" by Venkat Konda assigned to the same assignee as the current application, filed May 25, 2007.

This application is related to and incorporates by reference in its entirety the U.S. patent application Ser. No. 12/601,273 entitled "FULLY CONNECTED GENERALIZED BUTTERFLY FAT TREE NETWORKS" by Venkat Konda assigned to the same assignee as the current application filed concurrently, the PCT Application Serial No. PCT/US08/64603 entitled "FULLY CONNECTED GENERALIZED BUTTERFLY FAT TREE NETWORKS" by Venkat Konda assigned to the same assignee as the current application, filed May 22, 2008, the U.S. Provisional Patent Application Ser. No. 60/940,387 entitled "FULLY CONNECTED GENERALIZED BUTTERFLY FAT TREE NETWORKS" by Venkat Konda assigned to the same assignee as the current application, filed May 25, 2007, and the U.S. Provisional Patent Application Ser. No. 60/940,390 entitled "FULLY CONNECTED GENERALIZED MULTI-LINK BUTTERFLY FAT TREE NETWORKS" by Venkat Konda assigned to the same assignee as the current application, filed May 25, 2007.

This application is related to and incorporates by reference in its entirety the U.S. patent application Ser. No. 12/601,275 entitled "VLSI LAYOUTS OF FULLY CONNECTED GENERALIZED NETWORKS" by Venkat Konda assigned to the

same assignee as the current application filed concurrently, the PCT Application Serial No. PCT/US08/64605 entitled "VLSI LAYOUTS OF FULLY CONNECTED GENERALIZED NETWORKS" by Venkat Konda assigned to the same assignee as the current application, filed May 22, 2008, and the U.S. Provisional Patent Application Ser. No. 60/940,394 entitled "VLSI LAYOUTS OF FULLY CONNECTED GENERALIZED NETWORKS" by Venkat Konda assigned to the same assignee as the current application, filed May 25, 2007.

This application is related to and incorporates by reference in its entirety the U.S. Provisional Patent Application Ser. No. 61/252,603 entitled "VLSI LAYOUTS OF FULLY CONNECTED NETWORKS WITH LOCALITY EXPLOITATION" by Venkat Konda assigned to the same assignee as the current application, filed Oct. 16, 2009.

This application is related to and incorporates by reference in its entirety the U.S. Provisional Patent Application Ser. No. 61/252,609 entitled "VLSI LAYOUTS OF FULLY CONNECTED GENERALIZED AND PYRAMID NETWORKS" by Venkat Konda assigned to the same assignee as the current application, filed Oct. 16, 2009.

BACKGROUND OF INVENTION

Clos switching network, Benes switching network, and Cantor switching network are a network of switches configured as a multi-stage network so that fewer switching points are necessary to implement connections between its inlet links (also called "inputs") and outlet links (also called "outputs") than would be required by a single stage (e.g. crossbar) switch having the same number of inputs and outputs. Clos and Benes networks are very popularly used in digital cross-connects, switch fabrics and parallel computer systems. However Clos and Benes networks may block some of the connection requests.

There are generally three types of nonblocking networks: strictly nonblocking; wide sense nonblocking; and rearrangeably nonblocking (See V. E. Benes, "Mathematical Theory of Connecting Networks and Telephone Traffic" Academic Press, 1965 that is incorporated by reference, as background). In a rearrangeably nonblocking network, a connection path is guaranteed as a result of the networks ability to rearrange prior connections as new incoming calls are received. In strictly nonblocking network, for any connection request from an inlet link to some set of outlet links, it is always possible to provide a connection path through the network to satisfy the request without disturbing other existing connections, and if more than one such path is available, any path can be selected without being concerned about realization of future potential connection requests. In wide-sense nonblocking networks, it is also always possible to provide a connection path through the network to satisfy the request without disturbing other existing connections, but in this case the path used to satisfy the connection request must be carefully selected so as to maintain the nonblocking connecting capability for future potential connection requests.

Butterfly Networks, Banyan Networks, Batcher-Banyan Networks, Baseline Networks, Delta Networks, Omega Networks and Flip networks have been widely studied particularly for self routing packet switching applications. Also Benes Networks with radix of two have been widely studied and it is known that Benes Networks of radix two are shown to be built with back to back baseline networks which are rearrangeably nonblocking for unicast connections.

U.S. Pat. No. 5,451,936 entitled "Non-blocking Broadcast Network" granted to Yang et al. is incorporated by reference herein as background of the invention. This patent describes

a number of well known nonblocking multi-stage switching network designs in the background section at column 1, line 22 to column 3, 59. An article by Y. Yang, and G. M., Masson entitled, "Non-blocking Broadcast Switching Networks" IEEE Transactions on Computers, Vol. 40, No. 9, September 1991 that is incorporated by reference as background indicates that if the number of switches in the middle stage, m , of a three-stage network satisfies the relation $m \geq \min((n-1)(x+r^{1/x}))$ where $1 \leq x \leq \min(n-1, r)$, the resulting network is nonblocking for multicast assignments. In the relation, r is the number of switches in the input stage, and n is the number of inlet links in each input switch.

U.S. Pat. No. 6,885,669 entitled "Rearrangeably Non-blocking Multicast Multi-stage Networks" by Konda showed that three-stage Clos network is rearrangeably nonblocking for arbitrary fan-out multicast connections when $m \geq 2 \times n$. And U.S. Pat. No. 6,868,084 entitled "Strictly Nonblocking Multicast Multi-stage Networks" by Konda showed that three-stage Clos network is strictly nonblocking for arbitrary fan-out multicast connections when $m \geq 3 \times n - 1$.

In general multi-stage networks for stages of more than three and radix of more than two are not well studied. An article by Charles Clos entitled "A Study of Non-Blocking Switching Networks" The Bell Systems Technical Journal, Volume XXXII, January 1953, No. 1, pp. 406-424 showed a way of constructing large multi-stage networks by recursive substitution with a crosspoint complexity of $d^2 \times N \times (\log_d N)^{2.58}$ for strictly nonblocking unicast network. Similarly U.S. Pat. No. 6,885,669 entitled "Rearrangeably Nonblocking Multicast Multi-stage Networks" by Konda showed a way of constructing large multi-stage networks by recursive substitution for rearrangeably nonblocking multicast network. An article by D. G. Cantor entitled "On Non-Blocking Switching Networks" 1: pp. 367-377, 1972 by John Wiley and Sons, Inc., showed a way of constructing large multi-stage networks with a crosspoint complexity of $d^2 \times N \times (\log_d N)^2$ for strictly nonblocking unicast, (by using $\log_d N$ number of Benes Networks for $d=2$) and without counting the crosspoints in multiplexers and demultiplexers. Jonathan Turner studied the cascaded Benes Networks with radices larger than two, for nonblocking multicast with 10 times the crosspoint complexity of that of nonblocking unicast for a network of size $N=256$.

The crosspoint complexity of all these networks is prohibitively large to implement the interconnect for multicast connections particularly in field programmable gate array (FPGA) devices, programmable logic devices (PLDs), field programmable interconnect Chips (FPICs), digital crossconnects, switch fabrics and parallel computer systems.

SUMMARY OF INVENTION

A generalized multi-link multi-stage network comprising $(2 \times \log_d N) - 1$ stages is operated in strictly nonblocking manner for unicast includes an input stage having N/d switches with each of them having d inlet links and $2 \times d$ outgoing links connecting to second stage switches, an output stage having N/d switches with each of them having d outlet links and $2 \times d$ incoming links connecting from switches in the penultimate stage. The network also has $(2 \times \log_d N) - 3$ middle stages with each middle stage having N/d switches, and each switch in the middle stage has $2 \times d$ incoming links connecting from the switches in its immediate preceding stage, and $2 \times d$ outgoing links connecting to the switches in its immediate succeeding stage. Also the same generalized multi-link multi-stage network is operated in rearrangeably nonblocking manner for

arbitrary fan-out multicast and each multicast connection is set up by use of at most two outgoing links from the input stage switch.

A generalized multi-link multi-stage network comprising $(2 \times \log_d N) - 1$ stages is operated in strictly nonblocking manner for multicast includes an input stage having N/d switches with each of them having d inlet links and $3 \times d$ outgoing links connecting to second stage switches, an output stage having N/d switches with each of them having d outlet links and $3 \times d$ incoming links connecting from switches in the penultimate stage. The network also has $(2 \times \log_d N) - 3$ middle stages with each middle stage having N/d switches, and each switch in the middle stage has $3 \times d$ incoming links connecting from the switches in its immediate preceding stage, and $3 \times d$ outgoing links connecting to the switches in its immediate succeeding stage.

BRIEF DESCRIPTION OF DRAWINGS

FIG. 1A is a diagram 100A of an exemplary symmetrical multi-link multi-stage network $V_{mlink}(N, d, s)$ having inverse Benes connection topology of five stages with $N=8$, $d=2$ and $s=2$, strictly nonblocking network for unicast connections and rearrangeably nonblocking network for arbitrary fan-out multicast connections, in accordance with the invention.

FIG. 1B is a diagram 100B of an exemplary symmetrical multi-link multi-stage network $V_{mlink}(N, d, s)$ (having a connection topology built using back-to-back Omega Networks) of five stages with $N=8$, $d=2$ and $s=2$, strictly nonblocking network for unicast connections and rearrangeably nonblocking network for arbitrary fan-out multicast connections, in accordance with the invention.

FIG. 1C is a diagram 100C of an exemplary symmetrical multi-link multi-stage network $V_{mlink}(N, d, s)$ having an exemplary connection topology of five stages with $N=8$, $d=2$ and $s=2$, strictly nonblocking network for unicast connections and rearrangeably nonblocking network for arbitrary fan-out multicast connections, in accordance with the invention.

FIG. 1D is a diagram 100D of an exemplary symmetrical multi-link multi-stage network $V_{mlink}(N, d, s)$ having an exemplary connection topology of five stages with $N=8$, $d=2$ and $s=2$, strictly nonblocking network for unicast connections and rearrangeably nonblocking network for arbitrary fan-out multicast connections, in accordance with the invention.

FIG. 1E is a diagram 100E of an exemplary symmetrical multi-link multi-stage network $V_{mlink}(N, d, s)$ (having a connection topology called flip network and also known as inverse shuffle exchange network) of five stages with $N=8$, $d=2$ and $s=2$, strictly nonblocking network for unicast connections and rearrangeably nonblocking network for arbitrary fan-out multicast connections, in accordance with the invention.

FIG. 1F is a diagram 100F of an exemplary symmetrical multi-link multi-stage network $V_{mlink}(N, d, s)$ having Baseline connection topology of five stages with $N=8$, $d=2$ and $s=2$, strictly nonblocking network for unicast connections and rearrangeably nonblocking network for arbitrary fan-out multicast connections, in accordance with the invention.

FIG. 1G is a diagram 100G of an exemplary symmetrical multi-link multi-stage network $V_{mlink}(N, d, s)$ having an exemplary connection topology of five stages with $N=8$, $d=2$ and $s=2$, strictly nonblocking network for unicast connections and rearrangeably nonblocking network for arbitrary fan-out multicast connections, in accordance with the invention.

network for unicast connections and rearrangeably nonblocking network for arbitrary fan-out multicast connections, in accordance with the invention.

FIG. 1E2 is a diagram 100E2 of an exemplary asymmetrical multi-link multi-stage network $V_{mlink}(N_1, N_2, d, s)$ (having a connection topology called flip network and also known as inverse shuffle exchange network) of five stages with $N_2=8$, $N_1=p*N_2=24$, where $p=3$, $d=2$ and $s=2$, strictly nonblocking network for unicast connections and rearrangeably nonblocking network for arbitrary fan-out multicast connections, in accordance with the invention.

FIG. 1F2 is a diagram 100F2 of an exemplary asymmetrical multi-link multi-stage network $V_{mlink}(N_1, N_2, d, s)$ having Baseline connection topology of five stages with $N_2=8$, $N_1=p*N_2=24$, where $p=3$, $d=2$ and $s=2$, strictly nonblocking network for unicast connections and rearrangeably nonblocking network for arbitrary fan-out multicast connections, in accordance with the invention.

FIG. 1G2 is a diagram 100G2 of an exemplary asymmetrical multi-link multi-stage network $V_{mlink}(N_1, N_2, d, s)$ having an exemplary connection topology of five stages with $N_2=8$, $N_1=p*N_2=24$, where $p=3$, $d=2$ and $s=2$, strictly nonblocking network for unicast connections and rearrangeably nonblocking network for arbitrary fan-out multicast connections, in accordance with the invention.

FIG. 1H2 is a diagram 100H2 of an exemplary asymmetrical multi-link multi-stage network $V_{mlink}(N_1, N_2, d, s)$ having an exemplary connection topology of five stages with $N_2=8$, $N_1=p*N_2=24$, where $p=3$, $d=2$ and $s=2$, strictly nonblocking network for unicast connections and rearrangeably nonblocking network for arbitrary fan-out multicast connections, in accordance with the invention.

FIG. 1I2 is a diagram 100I2 of an exemplary asymmetrical multi-link multi-stage network $V_{mlink}(N_1, N_2, d, s)$ (having a connection topology built using back-to-back Banyan Networks or back-to-back Delta Networks or equivalently back-to-back Butterfly networks) of five stages with $N_2=8$, $N_1=p*N_2=24$, where $p=3$, $d=2$ and $s=2$, strictly nonblocking network for unicast connections and rearrangeably nonblocking network for arbitrary fan-out multicast connections, in accordance with the invention.

FIG. 1J2 is a diagram 100J2 of an exemplary asymmetrical multi-link multi-stage network $V_{mlink}(N_1, N_2, d, s)$ having an exemplary connection topology of five stages with $N_2=8$, $N_1=p*N_2=24$, where $p=3$, $d=2$ and $s=2$, strictly nonblocking network for unicast connections and rearrangeably nonblocking network for arbitrary fan-out multicast connections, in accordance with the invention.

FIG. 1K2 is a diagram 100K2 of a general asymmetrical multi-link multi-stage network $V_{mlink}(N_1, N_2, d, s)$ with $(2 \times \log_d N) - 1$ stages with $N_2 = p * N_1$ and $s = 2$, strictly nonblocking network for unicast connections and rearrangeably nonblocking network for arbitrary fan-out multicast connections, in accordance with the invention.

FIG. 2A is a diagram 200A of an exemplary symmetrical folded multi-link multi-stage network $V_{fold-mlink}(N, d, s)$ having inverse Benes connection topology of five stages with $N=8$, $d=2$ and $s=2$ with exemplary multicast connections, strictly nonblocking network for unicast connections and rearrangeably nonblocking network for arbitrary fan-out multicast connections, in accordance with the invention.

FIG. 2B is a diagram 200B of a general symmetrical folded multi-link multi-stage network $V_{fold-mlink}(N, d, 2)$ with $(2 \times \log_d N) - 1$ stages strictly nonblocking network for unicast connections and rearrangeably nonblocking network for arbitrary fan-out multicast connections in accordance with the invention.

FIG. 2C is a diagram 200C of an exemplary asymmetrical folded multi-link multi-stage network $V_{fold-mlink}(N_1, N_2, d, 2)$ having inverse Benes connection topology of five stages with $N_1=8$, $N_2=p*N_1=24$ where $p=3$, and $d=2$ with exemplary multicast connections, strictly nonblocking network for unicast connections and rearrangeably nonblocking network for arbitrary fan-out multicast connections, in accordance with the invention.

FIG. 2D is a diagram 200D of a general asymmetrical folded multi-link multi-stage network $V_{fold-mlink}(N_1, N_2, d, 2)$ with $N_2 = p * N_1$ and with $(2 \times \log_d N) - 1$ stages strictly nonblocking network for unicast connections and rearrangeably nonblocking network for arbitrary fan-out multicast connections in accordance with the invention.

FIG. 2E is a diagram 200E of an exemplary asymmetrical folded multi-link multi-stage network $V_{fold-mlink}(N_1, N_2, d, 2)$ having inverse Benes connection topology of five stages with $N_2=8$, $N_1=p*N_2=24$, where $p=3$, and $d=2$ with exemplary multicast connections, strictly nonblocking network for unicast connections and rearrangeably nonblocking network for arbitrary fan-out multicast connections, in accordance with the invention.

FIG. 2F is a diagram 200F of a general asymmetrical folded multi-link multi-stage network $V_{fold-mlink}(N_1, N_2, d, 2)$ with $N_1 = p * N_2$ and with $(2 \times \log_d N) - 1$ stages strictly nonblocking network for unicast connections and rearrangeably nonblocking network for arbitrary fan-out multicast connections in accordance with the invention.

FIG. 3A is a diagram 300A of an exemplary symmetrical multi-link multi-stage network $V_{mlink}(N, d, s)$ having inverse Benes connection topology of five stages with $N=8$, $d=2$ and $s=3$, strictly nonblocking network for arbitrary fan-out multicast connections, in accordance with the invention.

FIG. 3B is a diagram 300B of an exemplary symmetrical multi-link multi-stage network $V_{mlink}(N, d, s)$ (having a connection topology built using back-to-back Omega Networks) of five stages with $N=8$, $d=2$ and $s=3$, strictly nonblocking network for arbitrary fan-out multicast connections, in accordance with the invention.

FIG. 3C is a diagram 300C of an exemplary symmetrical multi-link multi-stage network $V_{mlink}(N, d, s)$ having an exemplary connection topology of five stages with $N=8$, $d=2$ and $s=3$, strictly nonblocking network for arbitrary fan-out multicast connections, in accordance with the invention.

FIG. 3D is a diagram 300D of an exemplary symmetrical multi-link multi-stage network $V_{mlink}(N, d, s)$ having an exemplary connection topology of five stages with $N=8$, $d=2$ and $s=3$, strictly nonblocking network for arbitrary fan-out multicast connections, in accordance with the invention.

FIG. 3E is a diagram 300E of an exemplary symmetrical multi-link multi-stage network $V_{mlink}(N, d, s)$ (having a connection topology called flip network and also known as inverse shuffle exchange network) of five stages with $N=8$, $d=2$ and $s=3$, strictly nonblocking network for arbitrary fan-out multicast connections, in accordance with the invention.

FIG. 3F is a diagram 300F of an exemplary symmetrical multi-link multi-stage network $V_{mlink}(N, d, s)$ having Baseline connection topology of five stages with $N=8$, $d=2$ and $s=3$, strictly nonblocking network for arbitrary fan-out multicast connections, in accordance with the invention.

FIG. 3G is a diagram 300G of an exemplary symmetrical multi-link multi-stage network $V_{mlink}(N, d, s)$ having an exemplary connection topology of five stages with $N=8$, $d=2$ and $s=3$, strictly nonblocking network for arbitrary fan-out multicast connections, in accordance with the invention.

FIG. 3H is a diagram 300H of an exemplary symmetrical multi-link multi-stage network $V_{mlink}(N, d, s)$ having an

11

FIG. 3H2 is a diagram 300H2 of an exemplary asymmetrical multi-link multi-stage network $V_{mlink}(N_1, N_2, d, s)$ having an exemplary connection topology of five stages with $N_2=8$, $N_1=p*N_2=24$, where $p=3$, $d=2$ and $s=3$, strictly nonblocking network for arbitrary fan-out multicast connections, in accordance with the invention.

FIG. 3I2 is a diagram 300I2 of an exemplary asymmetrical multi-link multi-stage network $V_{mlink}(N_1, N_2, d, s)$ (having a connection topology built using back-to-back Banyan Networks or back-to-back Delta Networks or equivalently back-to-back Butterfly networks) of five stages with $N_2=8$, $N_1=p*N_2=24$, where $p=3$, $d=2$ and $s=3$, strictly nonblocking network for arbitrary fan-out multicast connections, in accordance with the invention.

FIG. 3J2 is a diagram 300J2 of an exemplary asymmetrical multi-link multi-stage network $V_{mlink}(N_1, N_2, d, s)$ having an exemplary connection topology of five stages with $N_2=8$, $N_1=p*N_2=24$, where $p=3$, $d=2$ and $s=3$, strictly nonblocking network for arbitrary fan-out multicast connections, in accordance with the invention.

FIG. 3K2 is a diagram 300K2 of a general asymmetrical multi-link multi-stage network $V_{mlink}(N_1, N_2, d, s)$ with $(2 \times \log_d N)-1$ stages with $N_2=p*N_1$ and $s=3$, strictly nonblocking network for arbitrary fan-out multicast connections, in accordance with the invention.

FIG. 4A is a diagram 400A of an exemplary symmetrical folded multi-stage network $V_{fold}(N, d, s)$ having inverse Benes connection topology of five stages with $N=8$, $d=2$ and $s=2$ with exemplary multicast connections, strictly nonblocking network for unicast connections and rearrangeably nonblocking network for arbitrary fan-out multicast connections, in accordance with the invention.

FIG. 4A1 is a diagram 400A1 of an exemplary symmetrical folded multi-stage network $V_{fold}(N, d, 2)$ having Omega connection topology of five stages with $N=8$, $d=2$ and $s=2$ with exemplary multicast connections, strictly nonblocking network for unicast connections and rearrangeably nonblocking network for arbitrary fan-out multicast connections, in accordance with the invention.

FIG. 4A2 is a diagram 400A2 of an exemplary symmetrical folded multi-stage network $V_{fold}(N, d, 2)$ having nearest neighbor connection topology of five stages with $N=8$, $d=2$ and $s=2$ with exemplary multicast connections, strictly nonblocking network for unicast connections and rearrangeably nonblocking network for arbitrary fan-out multicast connections, in accordance with the invention.

FIG. 4B is a diagram 400B of a general symmetrical folded multi-stage network $V_{fold}(N, d, 2)$ with $(2 \times \log_d N)-1$ stages strictly nonblocking network for unicast connections and rearrangeably nonblocking network for arbitrary fan-out multicast connections in accordance with the invention.

FIG. 4C is a diagram 400C of an exemplary asymmetrical folded multi-stage network $V_{fold}(N_1, N_2, d, 2)$ having inverse Benes connection topology of five stages with $N_1=8$, $N_2=p*N_1=24$ where $p=3$, and $d=2$ with exemplary multicast connections, strictly nonblocking network for unicast connections and rearrangeably nonblocking network for arbitrary fan-out multicast connections, in accordance with the invention.

FIG. 4C1 is a diagram 400C1 of an exemplary asymmetrical folded multi-stage network $V_{fold}(N_1, N_2, d, 2)$ having Omega connection topology of five stages with $N_1=8$, $N_2=p*N_1=24$ where $p=3$, and $d=2$ with exemplary multicast connections, strictly nonblocking network for unicast connections and rearrangeably nonblocking network for arbitrary fan-out multicast connections, in accordance with the invention.

12

FIG. 4C2 is a diagram 400C2 of an exemplary asymmetrical folded multi-stage network $V_{fold}(N_1, N_2, d, 2)$ having nearest neighbor connection topology of five stages with $N_1=8$, $N_2=p*N_1=24$ where $p=3$, and $d=2$ with exemplary multicast connections, strictly nonblocking network for unicast connections and rearrangeably nonblocking network for arbitrary fan-out multicast connections, in accordance with the invention.

FIG. 4D is a diagram 400D of a general asymmetrical folded multi-stage network $V_{fold}(N_1, N_2, d, 2)$ with $N_2=p*N_1$ and with $(2 \times \log_d N)-1$ stages strictly nonblocking network for unicast connections and rearrangeably nonblocking network for arbitrary fan-out multicast connections in accordance with the invention.

FIG. 4E is a diagram 400E of an exemplary asymmetrical folded multi-stage network $V_{fold}(N_1, N_2, d, 2)$ having inverse Benes connection topology of five stages with $N_2=8$, $N_1=p*N_2=24$, where $p=3$, and $d=2$ with exemplary multicast connections, strictly nonblocking network for unicast connections and rearrangeably nonblocking network for arbitrary fan-out multicast connections, in accordance with the invention.

FIG. 4E1 is a diagram 400E1 of an exemplary asymmetrical folded multi-stage network $V_{fold}(N_1, N_2, d, 2)$ having Omega connection topology of five stages with $N_2=8$, $N_1=p*N_2=24$, where $p=3$, and $d=2$ with exemplary multicast connections, strictly nonblocking network for unicast connections and rearrangeably nonblocking network for arbitrary fan-out multicast connections, in accordance with the invention.

FIG. 4E2 is a diagram 400E2 of an exemplary asymmetrical folded multi-stage network $V_{fold}(N_1, N_2, d, 2)$ having nearest neighbor connection topology of five stages with $N_2=8$, $N_1=p*N_2=24$, where $p=3$, and $d=2$ with exemplary multicast connections, strictly nonblocking network for unicast connections and rearrangeably nonblocking network for arbitrary fan-out multicast connections, in accordance with the invention.

FIG. 4F is a diagram 400F of a general asymmetrical folded multi-stage network $V_{fold}(N_1, N_2, d, 2)$ with $N_1=p*N_2$ and with $(2 \times \log_d N)-1$ stages strictly nonblocking network for unicast connections and rearrangeably nonblocking network for arbitrary fan-out multicast connections in accordance with the invention.

FIG. 5A is a diagram 500A of an exemplary symmetrical folded multi-stage network $V_{fold}(N, d, s)$ having inverse Benes connection topology of five stages with $N=8$, $d=2$ and $s=1$ with exemplary unicast connections rearrangeably nonblocking network for unicast connections, in accordance with the invention.

FIG. 5B is a diagram 500B of a general symmetrical folded multi-stage network $V_{fold}(N, d, 1)$ with $(2 \times \log_d N)-1$ stages rearrangeably nonblocking network for unicast connections in accordance with the invention.

FIG. 5C is a diagram 500C of an exemplary asymmetrical folded multi-stage network $V_{fold}(N_1, N_2, d, 1)$ having inverse Benes connection topology of five stages with $N_1=8$, $N_2=p*N_1=24$ where $p=3$, and $d=2$ with exemplary unicast connections rearrangeably nonblocking network for unicast connections, in accordance with the invention.

FIG. 5D is a diagram 500D of a general asymmetrical folded multi-stage network $V_{fold}(N_1, N_2, d, 1)$ with $N_2=p*N_1$ and with $(2 \times \log_d N)-1$ stages rearrangeably nonblocking network for unicast connections in accordance with the invention.

FIG. 5E is a diagram 500E of an exemplary asymmetrical folded multi-stage network $V_{fold}(N_1, N_2, d, 1)$ having inverse

Benes connection topology of five stages with $N_2=8$, $N_1=p*N_2=24$, where $p=3$, and $d=2$ with exemplary unicast connections rearrangeably nonblocking network for unicast connections, in accordance with the invention.

FIG. 5F is a diagram 500F of a general asymmetrical folded multi-stage network $V_{fold}(N_1, N_2, d, 1)$ with $N_1=p*N_2$ and with $(2*\log_d N)-1$ stages rearrangeably nonblocking network for unicast connections in accordance with the invention.

FIG. 6A is a diagram 600A of an exemplary symmetrical multi-stage network $V(N, d, s)$ having inverse Benes connection topology of five stages with $N=8$, $d=2$ and $s=1$, rearrangeably nonblocking network for unicast connections, in accordance with the invention.

FIG. 6B is a diagram 600B of an exemplary symmetrical multi-stage network $V(N, d, s)$ (having a connection topology built using back-to-back Omega Networks) of five stages with $N=8$, $d=2$ and $s=1$, rearrangeably nonblocking network for unicast connections.

FIG. 6C is a diagram 600C of an exemplary symmetrical multi-stage network $V(N, d, s)$ having an exemplary connection topology of five stages with $N=8$, $d=2$ and $s=1$, rearrangeably nonblocking network for unicast connections, in accordance with the invention.

FIG. 6D is a diagram 600D of an exemplary symmetrical multi-stage network $V(N, d, s)$ having an exemplary connection topology of five stages with $N=8$, $d=2$ and $s=1$, rearrangeably nonblocking network for unicast connections, in accordance with the invention.

FIG. 6E is a diagram 600E of an exemplary symmetrical multi-stage network $V(N, d, s)$ (having a connection topology called flip network and also known as inverse shuffle exchange network) of five stages with $N=8$, $d=2$ and $s=1$, rearrangeably nonblocking network for unicast connections.

FIG. 6F is a diagram 600F of an exemplary symmetrical multi-stage network $V(N, d, s)$ having Baseline connection topology of five stages with $N=8$, $d=2$ and $s=1$, rearrangeably nonblocking network for unicast connections.

FIG. 6G is a diagram 600G of an exemplary symmetrical multi-stage network $V(N, d, s)$ having an exemplary connection topology of five stages with $N=8$, $d=2$ and $s=1$, rearrangeably nonblocking network for unicast connections, in accordance with the invention.

FIG. 6H is a diagram 600H of an exemplary symmetrical multi-stage network $V(N, d, s)$ having an exemplary connection topology of five stages with $N=8$, $d=2$ and $s=1$, rearrangeably nonblocking network for unicast connections, in accordance with the invention.

FIG. 6I is a diagram 600I of an exemplary symmetrical multi-stage network $V(N, d, s)$ (having a connection topology built using back-to-back Banyan Networks or back-to-back Delta Networks or equivalently back-to-back Butterfly networks) of five stages with $N=8$, $d=2$ and $s=1$, rearrangeably nonblocking network for unicast connections.

FIG. 6J is a diagram 600J of an exemplary symmetrical multi-stage network $V(N, d, s)$ having an exemplary connection topology of five stages with $N=8$, $d=2$ and $s=1$, rearrangeably nonblocking network for unicast connections.

FIG. 6K is a diagram 600K of a general symmetrical multi-stage network $V(N, d, s)$ with $(2*\log_d N)-1$ stages with $s=1$, rearrangeably nonblocking network for unicast connections in accordance with the invention.

FIG. 6A1 is a diagram 600A1 of an exemplary asymmetrical multi-stage network $V(N_1, N_2, d, s)$ having inverse Benes connection topology of five stages with $N_1=8$, $N_2=p*N_1=24$ where $p=3$, $d=2$ and $s=1$, rearrangeably nonblocking network for unicast connections, in accordance with the invention.

FIG. 6B1 is a diagram 600B1 of an exemplary asymmetrical multi-stage network $V(N_1, N_2, d, s)$ (having a connection topology built using back-to-back Omega Networks) of five stages with $N_1=8$, $N_2=p*N_1=24$ where $p=3$, $d=2$ and $s=1$, rearrangeably nonblocking network for unicast connections.

FIG. 6C1 is a diagram 600C1 of an exemplary asymmetrical multi-stage network $V(N_1, N_2, d, s)$ having an exemplary connection topology of five stages with $N_1=8$, $N_2=p*N_1=24$ where $p=3$, $d=2$ and $s=1$, rearrangeably nonblocking network for unicast connections, in accordance with the invention.

FIG. 6D1 is a diagram 600D1 of an exemplary asymmetrical multi-stage network $V(N_1, N_2, d, s)$ having an exemplary connection topology of five stages with $N_1=8$, $N_2=p*N_1=24$ where $p=3$, $d=2$ and $s=1$, rearrangeably nonblocking network for unicast connections, in accordance with the invention.

FIG. 6E1 is a diagram 600E1 of an exemplary asymmetrical multi-stage network $V(N_1, N_2, d, s)$ (having a connection topology called flip network and also known as inverse shuffle exchange network) of five stages with $N_1=8$, $N_2=p*N_1=24$ where $p=3$, $d=2$ and $s=1$, rearrangeably nonblocking network for unicast connections.

FIG. 6F1 is a diagram 600F1 of an exemplary asymmetrical multi-stage network $V(N_1, N_2, d, s)$ having Baseline connection topology of five stages with $N_1=8$, $N_2=p*N_1=24$ where $p=3$, $d=2$ and $s=1$, rearrangeably nonblocking network for unicast connections.

FIG. 6G1 is a diagram 600G1 of an exemplary asymmetrical multi-stage network $V(N_1, N_2, d, s)$ having an exemplary connection topology of five stages with $N_1=8$, $N_2=p*N_1=24$ where $p=3$, $d=2$ and $s=1$, rearrangeably nonblocking network for unicast connections, in accordance with the invention.

FIG. 6H1 is a diagram 600H1 of an exemplary asymmetrical multi-stage network $V(N_1, N_2, d, s)$ having an exemplary connection topology of five stages with $N_1=8$, $N_2=p*N_1=24$ where $p=3$, $d=2$ and $s=1$, rearrangeably nonblocking network for unicast connections, in accordance with the invention.

FIG. 6I1 is a diagram 600I1 of an exemplary asymmetrical multi-stage network $V(N_1, N_2, d, s)$ (having a connection topology built using back-to-back Banyan Networks or back-to-back Delta Networks or equivalently back-to-back Butterfly networks) of five stages with $N_1=8$, $N_2=p*N_1=24$ where $p=3$, $d=2$ and $s=1$, rearrangeably nonblocking network for unicast connections.

FIG. 6J1 is a diagram 600J1 of an exemplary asymmetrical multi-stage network $V(N_1, N_2, d, s)$ having an exemplary connection topology of five stages with $N_1=8$, $N_2=p*N_1=24$ where $p=3$, $d=2$ and $s=1$, rearrangeably nonblocking network for unicast connections.

FIG. 6K1 is a diagram 600K1 of a general asymmetrical multi-stage network $V(N_1, N_2, d, s)$ with $(2*\log_d N)-1$ stages with $N_1=p*N_2$ and $s=1$, rearrangeably nonblocking network for unicast connections in accordance with the invention.

FIG. 6A2 is a diagram 600A2 of an exemplary asymmetrical multi-stage network $V(N_1, N_2, d, s)$ having inverse Benes connection topology of five stages with $N_2=8$, $N_1=p*N_2=24$, where $p=3$, $d=2$ and $s=1$, rearrangeably nonblocking network for unicast connections, in accordance with the invention.

FIG. 6B2 is a diagram 600B2 of an exemplary asymmetrical multi-stage network $V(N_1, N_2, d, s)$ (having a connection topology built using back-to-back Omega Networks) of five stages with $N_2=8$, $N_1=p*N_2=24$, where $p=3$, $d=2$ and $s=1$, rearrangeably nonblocking network for unicast connections.

FIG. 6C2 is a diagram 600C2 of an exemplary asymmetrical multi-stage network $V(N_1, N_2, d, s)$ having an exemplary connection topology of five stages with $N_2=8$, $N_1=p*N_2=24$, where $p=3$, $d=2$ and $s=1$, rearrangeably nonblocking network for unicast connections, in accordance with the invention.

15

FIG. 6D2 is a diagram 600D2 of an exemplary asymmetrical multi-stage network $V(N_1, N_2, d, s)$ having an exemplary connection topology of five stages with $N_2=8$, $N_1=p*N_2=24$, where $p=3$, $d=2$ and $s=1$, rearrangeably nonblocking network for unicast connections, in accordance with the invention.

FIG. 6E2 is a diagram 600E2 of an exemplary asymmetrical multi-stage network $V(N_1, N_2, d, s)$ (having a connection topology called flip network and also known as inverse shuffle exchange network) of five stages with $N_2=8$, $N_1=p*N_2=24$, where $p=3$, $d=2$ and $s=1$, rearrangeably nonblocking network for unicast connections.

FIG. 6F2 is a diagram 600F2 of an exemplary asymmetrical multi-stage network $V(N_1, N_2, d, s)$ having Baseline connection topology of five stages with $N_2=8$, $N_1=p*N_2=24$, where $p=3$, $d=2$ and $s=1$, rearrangeably nonblocking network for unicast connections.

FIG. 6G2 is a diagram 600G2 of an exemplary asymmetrical multi-stage network $V(N_1, N_2, d, s)$ having an exemplary connection topology of five stages with $N_2=8$, $N_1=p*N_2=24$, where $p=3$, $d=2$ and $s=1$, rearrangeably nonblocking network for unicast connections, in accordance with the invention.

FIG. 6H2 is a diagram 600H2 of an exemplary asymmetrical multi-stage network $V(N_1, N_2, d, s)$ having an exemplary connection topology of five stages with $N_2=8$, $N_1=p*N_2=24$, where $p=3$, $d=2$ and $s=1$, rearrangeably nonblocking network for unicast connections, in accordance with the invention.

FIG. 6I2 is a diagram 600I2 of an exemplary asymmetrical multi-stage network $V(N_1, N_2, d, s)$ (having a connection topology built using back-to-back Banyan Networks or back-to-back Delta Networks or equivalently back-to-back Butterfly networks) of five stages with $N_2=8$, $N_1=p*N_2=24$, where $p=3$, $d=2$ and $s=1$, rearrangeably nonblocking network for unicast connections.

FIG. 6J2 is a diagram 600J2 of an exemplary asymmetrical multi-stage network $V(N_1, N_2, d, s)$ having an exemplary connection topology of five stages with $N_2=8$, $N_1=p*N_2=24$, where $p=3$, $d=2$ and $s=1$, rearrangeably nonblocking network for unicast connections.

FIG. 6K2 is a diagram 600K2 of a general asymmetrical multi-stage network $V(N_1, N_2, d, s)$ with $(2 \times \log_d N) - 1$ stages with $N_2=p*N_1$ and $s=1$, rearrangeably nonblocking network for unicast connections in accordance with the invention.

FIG. 7A is high-level flowchart of a scheduling method according to the invention, used to set up the multicast connections in all the networks disclosed in this invention.

FIG. 8A1 is a diagram 800A1 of an exemplary prior art implementation of a two by two switch; FIG. 8A2 is a diagram 800A2 for programmable integrated circuit prior art implementation of the diagram 800A1 of FIG. 8A1; FIG. 8A3 is a diagram 800A3 for one-time programmable integrated circuit prior art implementation of the diagram 800A1 of FIG. 8A1; FIG. 8A4 is a diagram 800A4 for integrated circuit placement and route implementation of the diagram 800A1 of FIG. 8A1.

DETAILED DESCRIPTION OF THE INVENTION

The present invention is concerned with the design and operation of large scale crosspoint reduction using arbitrarily large multi-link multi-stage switching networks for broadcast, unicast and multicast connections. Particularly multi-link multi-stage networks with stages more than three and radices greater than or equal to two offer large scale crosspoint reduction when configured with optimal links as disclosed in this invention.

When a transmitting device simultaneously sends information to more than one receiving device, the one-to-many con-

16

nection required between the transmitting device and the receiving devices is called a multicast connection. A set of multicast connections is referred to as a multicast assignment.

When a transmitting device sends information to one receiving device, the one-to-one connection required between the transmitting device and the receiving device is called unicast connection. When a transmitting device simultaneously sends information to all the available receiving devices, the one-to-all connection required between the transmitting device and the receiving devices is called a broadcast connection.

In general, a multicast connection is meant to be one-to-many connection, which includes unicast and broadcast connections. A multicast assignment in a switching network is nonblocking if any of the available inlet links can always be connected to any of the available outlet links.

In certain multi-link multi-stage networks, folded multi-link multi-stage networks, and folded multi-stage networks of the type described herein, any connection request of arbitrary fan-out, i.e. from an inlet link to a set of outlet links of the network, can be satisfied without blocking if necessary by rearranging some of the previous connection requests. In certain other multi-link multi-stage networks of the type described herein, any connection request of arbitrary fan-out, i.e. from an inlet link to a set of outlet links of the network, can be satisfied without blocking with never needing to rearrange any of the previous connection requests.

In certain multi-link multi-stage networks, folded multi-link multi-stage networks, and folded multi-stage networks of the type described herein, any connection request of unicast from an inlet link to an outlet link of the network, can be satisfied without blocking if necessary by rearranging some of the previous connection requests. In certain other multi-link multi-stage networks of the type described herein, any connection request of unicast from an inlet link to an outlet link of the network, can be satisfied without blocking with never needing to rearrange any of the previous connection requests.

Nonblocking configurations for other types of networks with numerous connection topologies and scheduling methods are disclosed as follows:

1) Strictly and rearrangeably nonblocking for arbitrary fan-out multicast and unicast for generalized multi-stage networks $V(N_1, N_2, d, s)$ with numerous connection topologies and the scheduling methods are described in detail in the U.S. application Ser. No. 12/530,207 that is incorporated by reference above.

2) Strictly and rearrangeably nonblocking for arbitrary fan-out multicast and unicast for generalized butterfly fat tree networks $V_{bft}(N_1, N_2, d, s)$ with numerous connection topologies and the scheduling methods are described in detail in PCT Application Serial No. PCT/US08/64603 that is incorporated by reference above.

3) Strictly and rearrangeably nonblocking for arbitrary fan-out multicast and unicast for generalized multi-link butterfly fat tree networks $V_{mink-bft}(N_1, N_2, d, s)$ with numerous connection topologies and the scheduling methods are described in detail in PCT Application Serial No. PCT/US08/64603 that is incorporated by reference above.

4) VLSI layouts of generalized multi-stage networks $V(N_1, N_2, d, s)$, generalized folded multi-stage networks $V_{fold}(N_1, N_2, d, s)$, generalized butterfly fat tree networks $V_{bft}(N_1, N_2, d, s)$, generalized multi-link multi-stage networks $V_{mink}(N_1, N_2, d, s)$, generalized folded multi-link multi-stage networks $V_{fold-mink}(N_1, N_2, d, s)$, generalized multi-link butterfly fat tree networks $V_{mink-bft}(N_1, N_2, d, s)$, and generalized hyper-

17

cube networks $V_{cube}(N_1, N_2, d, s)$ for $s=1, 2, 3$ or any number in general, are described in detail in the PCT Application Serial No. PCT/US08/64605 that is incorporated by reference above.

5) VLSI layouts of numerous types of multi-stage networks with locality exploitation are described in U.S. Provisional Patent Application Ser. No. 61/252,603 that is incorporated by reference above.

6) VLSI layouts of numerous types of multistage pyramid networks are described in U.S. Provisional Patent Application Ser. No. 61/252,609 that is incorporated by reference above.

RNB Multi-Link Multi-Stage Embodiments:
Symmetric RNB Embodiments:

Referring to FIG. 1A, in one embodiment, an exemplary symmetrical multi-link multi-stage network 100A with five stages of twenty switches for satisfying communication requests, such as setting up a telephone call or a data call, or a connection between configurable logic blocks, between an input stage 110 and output stage 120 via middle stages 130, 140, and 150 is shown where input stage 110 consists of four, two by four switches IS1-IS4 and output stage 120 consists of four, four by two switches OS1-OS4. And all the middle stages namely middle stage 130 consists of four, four by four switches MS(1,1)-MS(1,4), middle stage 140 consists of four, four by four switches MS(2,1)-MS(2,4), and middle stage 150 consists of four, four by four switches MS(3,1)-MS(3,4).

Such a network can be operated in strictly non-blocking manner for unicast connections, because the switches in the input stage 110 are of size two by four, the switches in output stage 120 are of size four by two, and there are four switches in each of middle stage 130, middle stage 140 and middle stage 150. Such a network can be operated in rearrangeably non-blocking manner for multicast connections, because the switches in the input stage 110 are of size two by four, the switches in output stage 120 are of size four by two, and there are four switches in each of middle stage 130, middle stage 140 and middle stage 150.

In one embodiment of this network each of the input switches IS1-IS4 and output switches OS1-OS4 are crossbar switches. The number of switches of input stage 110 and of output stage 120 can be denoted in general with the variable N/d , where N is the total number of inlet links or outlet links. The number of middle switches in each middle stage is denoted by N/d . The size of each input switch IS1-IS4 can be denoted in general with the notation $d*2d$ and each output switch OS1-OS4 can be denoted in general with the notation $2d*d$. Likewise, the size of each switch in any of the middle stages can be denoted as $2d*2d$. A switch as used herein can be either a crossbar switch, or a network of switches each of which in turn may be a crossbar switch or a network of switches. A symmetric multi-link multi-stage network can be represented with the notation $V_{mlink}(N, d, s)$, where N represents the total number of inlet links of all input switches (for example the links IL1-IL8), d represents the inlet links of each input switch or outlet links of each output switch, and s is the ratio of number of outgoing links from each input switch to the inlet links of each input switch. Although it is not necessary that there be the same number of inlet links IL1-IL8 as there are outlet links OL1-OL8, in a symmetrical network they are the same.

Each of the N/d input switches IS1-IS4 are connected to exactly $2xd$ switches in middle stage 130 through $2xd$ links (for example input switch IS1 is connected to middle switch

18

MS(1,1) through the links ML(1,1), ML(1,2), and also to middle switch MS(1,2) through the links ML(1,3) and ML(1,4)).

Each of the N/d middle switches MS(1,1)-MS(1,4) in the middle stage 130 are connected from exactly d input switches through $2xd$ links (for example the links ML(1,1) and ML(1,2) are connected to the middle switch MS(1,1) from input switch IS1, and the links ML(1,7) and ML(1,8) are connected to the middle switch MS(1,1) from input switch IS2) and also are connected to exactly d switches in middle stage 140 through $2xd$ links (for example the links ML(2,1) and ML(2,2) are connected from middle switch MS(1,1) to middle switch MS(2,1), and the links ML(2,3) and ML(2,4) are connected from middle switch MS(1,1) to middle switch MS(2,3)).

Similarly each of the N/d middle switches MS(2,1)-MS(2,4) in the middle stage 140 are connected from exactly d switches in middle stage 130 through $2xd$ links (for example the links ML(2,1) and ML(2,2) are connected to the middle switch MS(2,1) from middle switch MS(1,1), and the links ML(2,11) and ML(2,12) are connected to the middle switch MS(2,1) from middle switch MS(1,3)) and also are connected to exactly d switches in middle stage 150 through $2xd$ links (for example the links ML(3,1) and ML(3,2) are connected from middle switch MS(2,1) to middle switch MS(3,1), and the links ML(3,3) and ML(3,4) are connected from middle switch MS(2,1) to middle switch MS(3,3)).

Similarly each of the N/d middle switches MS(3,1)-MS(3,4) in the middle stage 150 are connected from exactly d switches in middle stage 140 through $2xd$ links (for example the links ML(3,1) and ML(3,2) are connected to the middle switch MS(3,1) from middle switch MS(2,1), and the links ML(3,11) and ML(3,12) are connected to the middle switch MS(3,1) from middle switch MS(2,3)) and also are connected to exactly d output switches in output stage 120 through $2xd$ links (for example the links ML(4,1) and ML(4,2) are connected to output switch OS1 from Middle switch MS(3,1), and the links ML(4,3) and ML(4,4) are connected to output switch OS2 from middle switch MS(3,1)).

Each of the N/d output switches OS1-OS4 are connected from exactly $2xd$ switches in middle stage 150 through $2xd$ links (for example output switch OS1 is connected from middle switch MS(3,1) through the links ML(4,1) and ML(4,2), and output switch OS1 is also connected from middle switch MS(3,2) through the links ML(4,7) and ML(4,8)).

Finally the connection topology of the network 100A shown in FIG. 1A is known to be back to back inverse Benes connection topology.

Referring to FIG. 1B, in another embodiment of network $V_{mlink}(N, d, s)$, an exemplary symmetrical multi-link multi-stage network 100B with five stages of twenty switches for satisfying communication requests, such as setting up a telephone call or a data call, or a connection between configurable logic blocks, between an input stage 110 and output stage 120 via middle stages 130, 140, and 150 is shown where input stage 110 consists of four, two by four switches IS1-IS4 and output stage 120 consists of four, four by two switches OS1-OS4. And all the middle stages namely middle stage 130 consists of four, four by four switches MS(1,1)-MS(1,4), middle stage 140 consists of four, four by four switches MS(2,1)-MS(2,4), and middle stage 150 consists of four, four by four switches MS(3,1)-MS(3,4).

Such a network can be operated in strictly non-blocking manner for unicast connections, because the switches in the input stage 110 are of size two by four, the switches in output stage 120 are of size four by two, and there are four switches in each of middle stage 130, middle stage 140 and middle

stage **150**. Such a network can be operated in rearrangeably non-blocking manner for multicast connections, because the switches in the input stage **110** are of size two by four, the switches in output stage **120** are of size four by two, and there are four switches in each of middle stage **130**, middle stage **140** and middle stage **150**.

In one embodiment of this network each of the input switches IS1-IS4 and output switches OS1-OS4 are crossbar switches. The number of switches of input stage **110** and of output stage **120** can be denoted in general with the variable N/d , where N is the total number of inlet links or outlet links. The number of middle switches in each middle stage is denoted by N/d . The size of each input switch IS1-IS4 can be denoted in general with the notation $d*2d$ and each output switch OS1-OS4 can be denoted in general with the notation $2d*d$. Likewise, the size of each switch in any of the middle stages can be denoted as $2d*2d$. A switch as used herein can be either a crossbar switch, or a network of switches each of which in turn may be a crossbar switch or a network of switches. The symmetric multi-link multi-stage network of FIG. 1B is also the network of the type $V_{link}(N, d, s)$, where N represents the total number of inlet links of all input switches (for example the links IL1-IL8), d represents the inlet links of each input switch or outlet links of each output switch, and s is the ratio of number of outgoing links from each input switch to the inlet links of each input switch. Although it is not necessary that there be the same number of inlet links IL1-IL8 as there are outlet links OL1-OL8, in a symmetrical network they are the same.

Each of the N/d input switches IS1-IS4 are connected to exactly $2xd$ switches in middle stage **130** through $2xd$ links (for example input switch IS1 is connected to middle switch MS(1,1) through the links ML(1,1), ML(1,2), and also to middle switch MS(1,2) through the links ML(1,3) and ML(1,4)).

Each of the N/d middle switches MS(1,1)-MS(1,4) in the middle stage **130** are connected from exactly d input switches through $2xd$ links (for example the links ML(1,1) and ML(1,2) are connected to the middle switch MS(1,1) from input switch IS1, and the links ML(1,9) and ML(1,10) are connected to the middle switch MS(1,1) from input switch IS3) and also are connected to exactly d switches in middle stage **140** through $2xd$ links (for example the links ML(2,1) and ML(2,2) are connected from middle switch MS(1,1) to middle switch MS(2,1), and the links ML(2,3) and ML(2,4) are connected from middle switch MS(1,1) to middle switch MS(2,2)).

Similarly each of the N/d middle switches MS(2,1)-MS(2,4) in the middle stage **140** are connected from exactly d switches in middle stage **130** through $2xd$ links (for example the links ML(2,1) and ML(2,2) are connected to the middle switch MS(2,1) from middle switch MS(1,1), and the links ML(2,9) and ML(2,10) are connected to the middle switch MS(2,1) from middle switch MS(1,3)) and also are connected to exactly d switches in middle stage **150** through $2xd$ links (for example the links ML(3,1) and ML(3,2) are connected from middle switch MS(2,1) to middle switch MS(3,1), and the links ML(3,3) and ML(3,4) are connected from middle switch MS(2,1) to middle switch MS(3,2)).

Similarly each of the N/d middle switches MS(3,1)-MS(3,4) in the middle stage **150** are connected from exactly d switches in middle stage **140** through $2xd$ links (for example the links ML(3,1) and ML(3,2) are connected to the middle switch MS(3,1) from middle switch MS(2,1), and the links ML(3,9) and ML(3,10) are connected to the middle switch MS(3,1) from middle switch MS(2,3)) and also are connected to exactly d output switches in output stage **120** through $2xd$

links (for example the links ML(4,1) and ML(4,2) are connected to output switch OS1 from Middle switch MS(3,1), and the links ML(4,3) and ML(4,4) are connected to output switch OS2 from middle switch MS(3,1)).

Each of the N/d output switches OS1-OS4 are connected from exactly $2xd$ switches in middle stage **150** through $2xd$ links (for example output switch OS1 is connected from middle switch MS(3,1) through the links ML(4,1) and ML(4,2), and output switch OS1 is also connected from middle switch MS(3,3) through the links ML(4,9) and ML(4,10)).

Finally the connection topology of the network **100B** shown in FIG. 1B is known to be back to back Omega connection topology.

Referring to FIG. 1C, in another embodiment of network $V_{mlink}(N, d, s)$, an exemplary symmetrical multi-link multi-stage network **100C** with five stages of twenty switches for satisfying communication requests, such as setting up a telephone call or a data call, or a connection between configurable logic blocks, between an input stage **110** and output stage **120** via middle stages **130**, **140**, and **150** is shown where input stage **110** consists of four, two by four switches IS1-IS4 and output stage **120** consists of four, four by two switches OS1-OS4. And all the middle stages namely middle stage **130** consists of four, four by four switches MS(1,1)-MS(1,4), middle stage **140** consists of four, four by four switches MS(2,1)-MS(2,4), and middle stage **150** consists of four, four by four switches MS(3,1)-MS(3,4).

Such a network can be operated in strictly non-blocking manner for unicast connections, because the switches in the input stage **110** are of size two by four, the switches in output stage **120** are of size four by two, and there are four switches in each of middle stage **130**, middle stage **140** and middle stage **150**. Such a network can be operated in rearrangeably non-blocking manner for multicast connections, because the switches in the input stage **110** are of size two by four, the switches in output stage **120** are of size four by two, and there are four switches in each of middle stage **130**, middle stage **140** and middle stage **150**.

In one embodiment of this network each of the input switches IS1-IS4 and output switches OS1-OS4 are crossbar switches. The number of switches of input stage **110** and of output stage **120** can be denoted in general with the variable N/d , where N is the total number of inlet links or outlet links. The number of middle switches in each middle stage is denoted by N/d . The size of each input switch IS1-IS4 can be denoted in general with the notation $d*2d$ and each output switch OS1-OS4 can be denoted in general with the notation $2d*d$. Likewise, the size of each switch in any of the middle stages can be denoted as $2d*2d$. A switch as used herein can be either a crossbar switch, or a network of switches each of which in turn may be a crossbar switch or a network of switches. The symmetric multi-link multi-stage network of FIG. 1C is also the network of the type $V_{mlink}(N, d, s)$, where N represents the total number of inlet links of all input switches (for example the links IL1-IL8), d represents the inlet links of each input switch or outlet links of each output switch, and s is the ratio of number of outgoing links from each input switch to the inlet links of each input switch. Although it is not necessary that there be the same number of inlet links IL1-IL8 as there are outlet links OL1-OL8, in a symmetrical network they are the same.

Each of the N/d input switches IS1-IS4 are connected to exactly $2xd$ switches in middle stage **130** through $2xd$ links (for example input switch IS1 is connected to middle switch MS(1,1) through the links ML(1,1), ML(1,2), and also to middle switch MS(1,2) through the links ML(1,3) and ML(1,4)).

Each of the N/d middle switches $MS(1,1)$ - $MS(1,4)$ in the middle stage **130** are connected from exactly d input switches through $2 \times d$ links (for example the links $ML(1,1)$ and $ML(1,2)$ are connected to the middle switch $MS(1,1)$ from input switch $IS1$, and the links $ML(1,15)$ and $ML(1,16)$ are connected to the middle switch $MS(1,1)$ from input switch $IS4$) and also are connected to exactly d switches in middle stage **140** through $2 \times d$ links (for example the links $ML(2,1)$ and $ML(2,2)$ are connected from middle switch $MS(1,1)$ to middle switch $MS(2,1)$, and the links $ML(2,3)$ and $ML(2,4)$ are connected from middle switch $MS(1,1)$ to middle switch $MS(2,2)$).

Similarly each of the N/d middle switches $MS(2,1)$ - $MS(2,4)$ in the middle stage **140** are connected from exactly d switches in middle stage **130** through $2 \times d$ links (for example the links $ML(2,1)$ and $ML(2,2)$ are connected to the middle switch $MS(2,1)$ from middle switch $MS(1,1)$, and the links $ML(2,15)$ and $ML(2,16)$ are connected to the middle switch $MS(2,1)$ from middle switch $MS(1,4)$) and also are connected to exactly d switches in middle stage **150** through $2 \times d$ links (for example the links $ML(3,1)$ and $ML(3,2)$ are connected from middle switch $MS(2,1)$ to middle switch $MS(3,1)$, and the links $ML(3,3)$ and $ML(3,4)$ are connected from middle switch $MS(2,1)$ to middle switch $MS(3,2)$).

Similarly each of the N/d middle switches $MS(3,1)$ - $MS(3,4)$ in the middle stage **150** are connected from exactly d switches in middle stage **140** through $2 \times d$ links (for example the links $ML(3,1)$ and $ML(3,2)$ are connected to the middle switch $MS(3,1)$ from middle switch $MS(2,1)$, and the links $ML(3,15)$ and $ML(3,16)$ are connected to the middle switch $MS(3,1)$ from middle switch $MS(2,4)$) and also are connected to exactly d output switches in output stage **120** through $2 \times d$ links (for example the links $ML(4,1)$ and $ML(4,2)$ are connected to output switch $OS1$ from middle switch $MS(3,1)$, and the links $ML(4,3)$ and $ML(4,4)$ are connected to output switch $OS2$ from middle switch $MS(3,1)$).

Each of the N/d output switches $OS1$ - $OS4$ are connected from exactly $2 \times d$ switches in middle stage **150** through $2 \times d$ links (for example output switch $OS1$ is connected from middle switch $MS(3,1)$ through the links $ML(4,1)$ and $ML(4,2)$, and output switch $OS1$ is also connected from middle switch $MS(3,4)$ through the links $ML(4,15)$ and $ML(4,16)$).

Finally the connection topology of the network **100C** shown in FIG. **1C** is hereinafter called nearest neighbor connection topology.

Similar to network **100A** of FIG. **1A**, **100B** of FIG. **1B**, and **100C** of FIG. **1C**, referring to FIG. **1D**, FIG. **1E**, FIG. **1F**, FIG. **1G**, FIG. **1H**, FIG. **1I** and FIG. **1J** with exemplary symmetrical multi-link multi-stage networks **100D**, **100E**, **100F**, **100G**, **100H**, **100I**, and **100J** respectively with five stages of twenty switches for satisfying communication requests, such as setting up a telephone call or a data call, or a connection between configurable logic blocks, between an input stage **110** and output stage **120** via middle stages **130**, **140**, and **150** is shown where input stage **110** consists of four, two by four switches $IS1$ - $IS4$ and output stage **120** consists of four, four by two switches $OS1$ - $OS4$. And all the middle stages namely middle stage **130** consists of four, four by four switches $MS(1,1)$ - $MS(1,4)$, middle stage **140** consists of four, four by four switches $MS(2,1)$ - $MS(2,4)$, and middle stage **150** consists of four, four by four switches $MS(3,1)$ - $MS(3,4)$.

Such networks can also be operated in strictly non-blocking manner for unicast connections, because the switches in the input stage **110** are of size two by four, the switches in output stage **120** are of size four by two, and there are four switches in each of middle stage **130**, middle stage **140** and middle stage **150**. Such a network can be operated in rear-

rangeably non-blocking manner for multicast connections, because the switches in the input stage **110** are of size two by four, the switches in output stage **120** are of size four by two, and there are four switches in each of middle stage **130**, middle stage **140** and middle stage **150**.

The networks **100D**, **100E**, **100F**, **100G**, **100H**, **100I** and **100J** of FIG. **1D**, FIG. **1E**, FIG. **1F**, FIG. **1G**, FIG. **1H**, FIG. **1I**, and FIG. **1J** are also embodiments of symmetric multi-link multi-stage network can be represented with the notation $V_{link}(N, d, s)$, where N represents the total number of inlet links of all input switches (for example the links $IL1$ - $IL8$), d represents the inlet links of each input switch or outlet links of each output switch, and s is the ratio of number of outgoing links from each input switch to the inlet links of each input switch. Although it is not necessary that there be the same number of inlet links $IL1$ - $IL8$ as there are outlet links $OL1$ - $OL8$, in a symmetrical network they are the same.

Just like networks of **100A**, **100B** and **100C**, for all the networks **100D**, **100E**, **100F**, **100G**, **100H**, **100I** and **100J** of FIG. **1D**, FIG. **1E**, FIG. **1F**, FIG. **1G**, FIG. **1H**, FIG. **1I**, and FIG. **1J**, each of the N/d input switches $IS1$ - $IS4$ are connected to exactly $2 \times d$ switches in middle stage **130** through $2 \times d$ links.

Each of the N/d middle switches $MS(1,1)$ - $MS(1,4)$ in the middle stage **130** are connected from exactly d input switches through $2 \times d$ links and also are connected to exactly d switches in middle stage **140** through $2 \times d$ links.

Similarly each of the N/d middle switches $MS(2,1)$ - $MS(2,4)$ in the middle stage **140** are connected from exactly d switches in middle stage **130** through $2 \times d$ links and also are connected to exactly d switches in middle stage **150** through $2 \times d$ links.

Similarly each of the N/d middle switches $MS(3,1)$ - $MS(3,4)$ in the middle stage **150** are connected from exactly d switches in middle stage **140** through $2 \times d$ links and also are connected to exactly d output switches in output stage **120** through $2 \times d$ links.

Each of the N/d output switches $OS1$ - $OS4$ are connected from exactly $2 \times d$ switches in middle stage **150** through $2 \times d$ links.

In all the ten embodiments of FIG. **1A** to FIG. **1J** the connection topology is different. That is the way the links $ML(1,1)$ - $ML(1,16)$, $ML(2,1)$ - $ML(2,16)$, $ML(3,1)$ - $ML(3,16)$, and $ML(4,1)$ - $ML(4,16)$ are connected between the respective stages is different. Even though only ten embodiments are illustrated, in general, the network $V_{mlink}(N, d, s)$ can comprise any arbitrary type of connection topology. For example the connection topology of the network $V_{mlink}(N, d, s)$ may be back to back Benes networks, Delta Networks and many more combinations. The applicant notes that the fundamental property of a valid connection topology of the $V_{mlink}(N, d, s)$ network is, when no connections are setup from any input link all the output links should be reachable. Based on this property numerous embodiments of the network $V_{mlink}(N, d, s)$ can be built. The ten embodiments of FIG. **1A** to FIG. **1J** are only three examples of network $V_{mlink}(N, d, s)$.

In all the ten embodiments of FIG. **1A** to FIG. **1J**, each of the links $ML(1,1)$ - $ML(1,16)$, $ML(2,1)$ - $ML(2,16)$, $ML(3,1)$ - $ML(3,16)$ and $ML(4,1)$ - $ML(4,16)$ are either available for use by a new connection or not available if currently used by an existing connection. The input switches $IS1$ - $IS4$ are also referred to as the network input ports. The input stage **110** is often referred to as the first stage. The output switches $OS1$ - $OS4$ are also referred to as the network output ports. The output stage **120** is often referred to as the last stage. The

middle stage switches MS(1,1)-MS(1,4), MS(2,1)-MS(2,4), and MS(3,1)-MS(3,4) are referred to as middle switches or middle ports.

In the example illustrated in FIG. 1A (or in FIG. 1B to FIG. 1J), a fan-out of four is possible to satisfy a multicast connection request if input switch is IS2, but only two switches in middle stage 130 will be used. Similarly, although a fan-out of three is possible for a multicast connection request if the input switch is IS1, again only a fan-out of two is used. The specific middle switches that are chosen in middle stage 130 when selecting a fan-out of two is irrelevant so long as at most two middle switches are selected to ensure that the connection request is satisfied. In essence, limiting the fan-out from input switch to no more than two middle switches permits the network 100A (or 100B to 100J), to be operated in rearrangeably nonblocking manner in accordance with the invention.

The connection request of the type described above can be unicast connection request, a multicast connection request or a broadcast connection request, depending on the example. In case of a unicast connection request, a fan-out of one is used, i.e. a single middle stage switch in middle stage 130 is used to satisfy the request. Moreover, although in the above-described embodiment a limit of two has been placed on the fan-out into the middle stage switches in middle stage 130, the limit can be greater depending on the number of middle stage switches in a network (while maintaining the rearrangeably nonblocking nature of operation of the network for multicast connections). However any arbitrary fan-out may be used within any of the middle stage switches and the output stage switches to satisfy the connection request.

Generalized Symmetric RNB Embodiments:

Network 100K of FIG. 1K is an example of general symmetrical multi-link multi-stage network $V_{mlink}(N, d, s)$ with $(2 \times \log_d N) - 1$ stages. The general symmetrical multi-link multi-stage network $V_{mlink}(N, d, s)$ can be operated in rearrangeably nonblocking manner for multicast when $s \geq 2$ according to the current invention. Also the general symmetrical multi-link multi-stage network $V_{mlink}(N, d, s)$ can be operated in strictly nonblocking manner for unicast if $s \geq 2$ according to the current invention. (And in the example of FIG. 1K, $s=2$). The general symmetrical multi-link multi-stage network $V_{mlink}(N, d, s)$ with $(2 \times \log_d N) - 1$ stages has d inlet links for each of N/d input switches IS1-IS(N/d) (for example the links IL1-IL(d) to the input switch IS1) and $2 \times d$ outgoing links for each of N/d input switches IS1-IS(N/d) (for example the links ML(1,1)-ML(1,2d) to the input switch IS1). There are d outlet links for each of N/d output switches OS1-OS(N/d) (for example the links OL1-OL(d) to the output switch OS1) and $2 \times d$ incoming links for each of N/d output switches OS1-OS(N/d) (for example ML($2 \times \log_d N - 2, 1$)-ML($2 \times \log_d N - 2, 2 \times d$) to the output switch OS1).

Each of the N/d input switches IS1-IS(N/d) are connected to exactly d switches in middle stage 130 through $2 \times d$ links.

Each of the N/d middle switches MS(1,1)-MS(1, N/d) in the middle stage 130 are connected from exactly d input switches through $2 \times d$ links and also are connected to exactly d switches in middle stage 140 through $2 \times d$ links.

Similarly each of the N/d middle switches

$$MS(\log_d N - 1, 1) - MS(\log_d N - 1, \frac{N}{d})$$

in the middle stage $130 + 10^*(\log_d N - 2)$ are connected from exactly d switches in middle stage $130 + 10^*(\log_d N - 3)$

through $2 \times d$ links and also are connected to exactly d switches in middle stage $130 + 10^*(\log_d N - 1)$ through $2 \times d$ links.

Similarly each of the N/d middle switches

$$MS(2 \times \log_d N - 3, 1) - MS(2 \times \log_d N - 3, \frac{N}{d})$$

in the middle stage $130 + 10^*(2 \times \log_d N - 4)$ are connected from exactly d switches in middle stage $130 + 10^*(2 \times \log_d N - 5)$ through $2 \times d$ links and also are connected to exactly d output switches in output stage 120 through $2 \times d$ links.

Each of the N/d output switches OS1-OS(N/d) are connected from exactly d switches in middle stage $130 + 10^*(2 \times \log_d N - 4)$ through $2 \times d$ links.

As described before, again the connection topology of a general $V_{mlink}(N, d, s)$ may be any one of the connection topologies. For example the connection topology of the network $V_{mlink}(N, d, s)$ may be back to back inverse Benes networks, back to back Omega networks, back to back Benes networks, Delta Networks and many more combinations. The applicant notes that the fundamental property of a valid connection topology of the general $V_{mlink}(N, d, s)$ network is, when no connections are setup from any input link if any output link should be reachable. Based on this property numerous embodiments of the network $V_{mlink}(N, d, s)$ can be built. The embodiments of FIG. 1A to FIG. 1J are ten examples of network $V_{mlink}(N, d, s)$.

The general symmetrical multi-link multi-stage network $V_{mlink}(N, d, s)$ can be operated in rearrangeably nonblocking manner for multicast when $s \geq 2$ according to the current invention. Also the general symmetrical multi-link multi-stage network $V_{mlink}(N, d, s)$ can be operated in strictly nonblocking manner for unicast if $s \geq 2$ according to the current invention.

Every switch in the multi-link multi-stage networks discussed herein has multicast capability. In a $V_{mlink}(N, d, s)$ network, if a network inlet link is to be connected to more than one outlet link on the same output switch, then it is only necessary for the corresponding input switch to have one path to that output switch. This follows because that path can be multicast within the output switch to as many outlet links as necessary. Multicast assignments can therefore be described in terms of connections between input switches and output switches. An existing connection or a new connection from an input switch to r' output switches is said to have fan-out r' . If all multicast assignments of a first type, wherein any inlet link of an input switch is to be connected in an output switch to at most one outlet link are realizable, then multicast assignments of a second type, wherein any inlet link of each input switch is to be connected to more than one outlet link in the same output switch, can also be realized. For this reason, the following discussion is limited to general multicast connections of the first type

$$\left(\text{with fan-out } r', 1 \leq r' \leq \frac{N}{d} \right)$$

although the same discussion is applicable to the second type.

25

To characterize a multicast assignment, for each inlet link

$$i \in \{1, 2, \dots, \frac{N_1}{d}\}, \quad 5$$

let $I_i=O$, where

$$O \subset \{1, 2, \dots, \frac{N_1}{d}\}, \quad 10$$

denote the subset of output switches to which inlet link i is to be connected in the multicast assignment. For example, the network of FIG. 1C shows an exemplary five-stage network, namely $V_{minik}(8,2,2)$, with the following multicast assignment $I_1=\{2,4\}$ and all other $I_j=\emptyset$ for $j=[2-8]$. It should be noted that the connection I_1 fans out in the first stage switch IS1 into middle switches MS(1,1) and MS(1,2) in middle stage 130, and fans out in middle switches MS(1,1) and MS(1,2) only once into middle switches MS(2,1) and MS(2,3) respectively in middle stage 140.

The connection I_1 also fans out in middle switches MS(2,1) and MS(2,3) only once into middle switches MS(3,2) and MS(3,4) respectively in middle stage 150. The connection I_1 also fans out in middle switches MS(3,2) and MS(3,4) only once into output switches OS2 and OS4 in output stage 120. Finally the connection I_1 fans out once in the output stage switch OS2 into outlet link OL3 and in the output stage switch OS4 twice into the outlet links OL7 and OL8. In accordance with the invention, each connection can fan out in the input stage switch into at most two middle stage switches in middle stage 130.

Asymmetric RNB ($N_2>N_1$) Embodiments:

Referring to FIG. 1A1, in one embodiment, an exemplary asymmetrical multi-link multi-stage network 100A1 with five stages of twenty switches for satisfying communication requests, such as setting up a telephone call or a data call, or a connection between configurable logic blocks, between an input stage 110 and output stage 120 via middle stages 130, 140, and 150 is shown where input stage 110 consists of four, two by four switches IS1-IS4 and output stage 120 consists of four, eight by six switches OS1-OS4. And all the middle stages namely middle stage 130 consists of four, four by four switches MS(1,1)-MS(1,4), middle stage 140 consists of four, four by four switches MS(2,1)-MS(2,4), and middle stage 150 consists of four, four by eight switches MS(3,1)-MS(3,4).

Such a network can be operated in strictly non-blocking manner for unicast connections, because the switches in the input stage 110 are of size two by four, the switches in output stage 120 are of size four by two, and there are four switches in each of middle stage 130, middle stage 140 and middle stage 150. Such a network can be operated in rearrangeably non-blocking manner for multicast connections, because the switches in the input stage 110 are of size two by four, the switches in output stage 120 are of size eight by six, and there are four switches in each of middle stage 130, middle stage 140 and middle stage 150.

In one embodiment of this network each of the input switches IS1-IS4 and output switches OS1-OS4 are crossbar

26

switches. The number of switches of input stage 110 and of output stage 120 can be denoted in general with the variable

$$\frac{N_1}{d},$$

where N_1 is the total number of inlet links or and N_2 is the total number of outlet links and $N_2>N_1$ and $N_2=p*N_1$, where $p>1$. The number of middle switches in each middle stage is denoted by

$$\frac{N_1}{d},$$

The size of each input switch IS1-IS4 can be denoted in general with the notation $d*2d$ and each output switch OS1-OS4 can be denoted in general with the notation $(d+d_2)*d_2$, where

$$d_2 = N_2 \times \frac{d}{N_1} = p \times d.$$

The size of each switch in any of the middle stages excepting the last middle stage can be denoted as $2d*2d$. The size of each switch in the last middle stage can be denoted as $2d*(d+d_2)$. A switch as used herein can be either a crossbar switch, or a network of switches each of which in turn may be a crossbar switch or a network of switches. An asymmetric multi-link multi-stage network can be represented with the notation $V_{minik}(N_1, N_2, d, s)$, where N_1 represents the total number of inlet links of all input switches (for example the links IL1-IL8), N_2 represents the total number of outlet links of all output switches (for example the links OL1-OL24), d represents the inlet links of each input switch where $N_2>N_1$, and s is the ratio of number of outgoing links from each input switch to the inlet links of each input switch.

Each of the

$$\frac{N_1}{d}$$

input switches IS1-IS4 are connected to exactly d switches in middle stage 130 through $2 \times d$ links (for example input switch IS1 is connected to middle switch MS(1,1) through the links ML(1,1), ML(1,2), and also to middle switch MS(1,2) through the links ML(1,3) and ML(1,4)).

Each of the

$$\frac{N_1}{d}$$

middle switches MS(1,1)-MS(1,4) in the middle stage 130 are connected from exactly d input switches through $2 \times d$ links (for example the links ML(1,1) and ML(1,2) are connected to the middle switch MS(1,1) from input switch IS1, and the links ML(1,7) and ML(1,8) are connected to the middle switch MS(1,1) from input switch IS2) and also are connected to exactly d switches in middle stage 140 through $2 \times d$ links (for example the links ML(2,1) and ML(2,2) are connected from middle switch MS(1,1) to middle switch MS(2,1), and the links ML(2,3) and ML(2,4) are connected from middle switch MS(1,1) to middle switch MS(2,3)).

27

Similarly each of the

$$\frac{N_1}{d}$$

middle switches MS(2,1)-MS(2,4) in the middle stage 140 are connected from exactly d switches in middle stage 130 through 2xd links (for example the links ML(2,1) and ML(2, 2) are connected to the middle switch MS(2,1) from middle switch MS(1,1), and the links ML(2,11) and ML(2,12) are connected to the middle switch MS(2,1) from middle switch MS(1,3)) and also are connected to exactly d switches in middle stage 150 through 2xd links (for example the links ML(3,1) and ML(3,2) are connected from middle switch MS(2,1) to middle switch MS(3,1), and the links ML(3,3) and ML(3,4) are connected from middle switch MS(2,1) to middle switch MS(3,3)).

Similarly each of the

$$\frac{N_1}{d}$$

middle switches MS(3,1)-MS(3,4) in the middle stage 150 are connected from exactly d switches in middle stage 140 through 2xd links (for example the links ML(3,1) and ML(3, 2) are connected to the middle switch MS(3,1) from middle switch MS(2,1), and the links ML(3,11) and ML(3,12) are connected to the middle switch MS(3,1) from middle switch MS(2,3)) and also are connected to exactly

$$\frac{d + d_2}{2}$$

output switches in output stage 120 through d+d₂ links (for example the links ML(4,1) and ML(4,2) are connected to output switch OS1 from Middle switch MS(3,1); the links ML(4,3) and ML(4,4) are connected to output switch OS2 from middle switch MS(3,1); the links ML(4,5) and ML(4,6) are connected to output switch OS3 from Middle switch MS(3,1); and the links ML(4,7) and ML(4,8) are connected to output switch OS4 from middle switch MS(3,1)).

Each of the

$$\frac{N_1}{d}$$

output switches OS1-OS4 are connected from exactly

$$\frac{d + d_2}{2}$$

switches in middle stage 150 through d+d₂ links (for example output switch OS1 is connected from middle switch MS(3,1) through the links ML(4,1) and ML(4,2); output switch OS1 is also connected from middle switch MS(3,2) through the links ML(4,9) and ML(4,10); output switch OS1 is connected from middle switch MS(3,3) through the links ML(4,17) and ML(4,18); and output switch OS1 is also connected from middle switch MS(3,4) through the links ML(4,25) and ML(4,26)).

28

Finally the connection topology of the network 100A1 shown in FIG. 1A1 is known to be back to back inverse Benes connection topology.

Referring to FIG. 1B1, in one embodiment, an exemplary asymmetrical multi-link multi-stage network 100B1 with five stages of twenty switches for satisfying communication requests, such as setting up a telephone call or a data call, or a connection between configurable logic blocks, between an input stage 110 and output stage 120 via middle stages 130, 140, and 150 is shown where input stage 110 consists of four, two by four switches IS1-IS4 and output stage 120 consists of four, eight by six switches OS1-OS4. And all the middle stages namely middle stage 130 consists of four, four by four switches MS(1,1)-MS(1,4), middle stage 140 consists of four, four by four switches MS(2,1)-MS(2,4), and middle stage 150 consists of four, four by eight switches MS(3,1)-MS(3,4).

Such a network can be operated in strictly non-blocking manner for unicast connections, because the switches in the input stage 110 are of size two by four, the switches in output stage 120 are of size four by two, and there are four switches in each of middle stage 130, middle stage 140 and middle stage 150. Such a network can be operated in rearrangeably non-blocking manner for multicast connections, because the switches in the input stage 110 are of size two by four, the switches in output stage 120 are of size eight by six, and there are four switches in each of middle stage 130, middle stage 140 and middle stage 150.

In one embodiment of this network each of the input switches IS1-IS4 and output switches OS1-OS4 are crossbar switches. The number of switches of input stage 110 and of output stage 120 can be denoted in general with the variable

$$\frac{N_1}{d}$$

where N₁ is the total number of inlet links or and N₂ is the total number of outlet links and N₂>N₁ and N₂=p*N₁, where p>1. The number of middle switches in each middle stage is denoted by

$$\frac{N_1}{d}$$

The size of each input switch IS1-IS4 can be denoted in general with the notation d*2d and each output switch OS1-OS4 can be denoted in general with the notation (d+d₂)*d₂, where

$$d_2 = N_2 \times \frac{d}{N_1} = p \times d.$$

The size of each switch in any of the middle stages excepting the last middle stage can be denoted as 2d*2d. The size of each switch in the last middle stage can be denoted as 2d*(d+d₂). A switch as used herein can be either a crossbar switch, or a network of switches each of which in turn may be a crossbar switch or a network of switches. An asymmetric multi-link multi-stage network can be represented with the notation V_{mlink}(N₁, N₂, d, s), where N₁ represents the total number of inlet links of all input switches (for example the links IL1-IL8), N₂ represents the total number of outlet links of all output switches (for example the links OL1-OL24), d repre-

29

sents the inlet links of each input switch where $N_2 > N_1$, and s is the ratio of number of outgoing links from each input switch to the inlet links of each input switch.

Each of the

$$\frac{N_1}{d}$$

input switches IS1-IS4 are connected to exactly $2 \times d$ switches in middle stage 130 through $2 \times d$ links (for example input switch IS1 is connected to middle switch MS(1,1) through the links ML(1,1), ML(1,2), and also to middle switch MS(1,2) through the links ML(1,3) and ML(1,4)).

Each of the

$$\frac{N_1}{d}$$

middle switches MS(1,1)-MS(1,4) in the middle stage 130 are connected from exactly d input switches through $2 \times d$ links (for example the links ML(1,1) and ML(1,2) are connected to the middle switch MS(1,1) from input switch IS1, and the links ML(1,9) and ML(1,10) are connected to the middle switch MS(1,1) from input switch IS3) and also are connected to exactly d switches in middle stage 140 through $2 \times d$ links (for example the links ML(2,1) and ML(2,2) are connected from middle switch MS(1,1) to middle switch MS(2,1), and the links ML(2,3) and ML(2,4) are connected from middle switch MS(1,1) to middle switch MS(2,2)).

Similarly each of the

$$\frac{N_1}{d}$$

middle switches MS(2,1)-MS(2,4) in the middle stage 140 are connected from exactly d switches in middle stage 130 through $2 \times d$ links (for example the links ML(2,1) and ML(2,2) are connected to the middle switch MS(2,1) from middle switch MS(1,1), and the links ML(2,9) and ML(2,10) are connected to the middle switch MS(2,1) from middle switch MS(1,3)) and also are connected to exactly d switches in middle stage 150 through $2 \times d$ links (for example the links ML(3,1) and ML(3,2) are connected from middle switch MS(2,1) to middle switch MS(3,1), and the links ML(3,3) and ML(3,4) are connected from middle switch MS(2,1) to middle switch MS(3,2)).

Similarly each of the

$$\frac{N_1}{d}$$

middle switches MS(3,1)-MS(3,4) in the middle stage 150 are connected from exactly d switches in middle stage 140 through $2 \times d$ links (for example the links ML(3,1) and ML(3,2) are connected to the middle switch MS(3,1) from middle switch MS(2,1), and the links ML(3,9) and ML(3,10) are

30

connected to the middle switch MS(3,1) from middle switch MS(2,3)) and also are connected to exactly

$$\frac{d + d_2}{2}$$

output switches in output stage 120 through $d + d_2$ links (for example the links ML(4,1) and ML(4,2) are connected to output switch OS1 from middle switch MS(3,1); the links ML(4,3) and ML(4,4) are connected to output switch OS2 from middle switch MS(3,1); the links ML(4,5) and ML(4,6) are connected to output switch OS3 from Middle switch MS(3,1); and the links ML(4,7) and ML(4,8) are connected to output switch OS4 from middle switch MS(3,1)).

Each of the

$$\frac{N_1}{d}$$

output switches OS1-OS4 are connected from exactly

$$\frac{d + d_2}{2}$$

switches in middle stage 150 through $d + d_2$ links (for example output switch OS1 is connected from middle switch MS(3,1) through the links ML(4,1) and ML(4,2); output switch OS1 is also connected from middle switch MS(3,2) through the links ML(4,9) and ML(4,10); output switch OS1 is connected from middle switch MS(3,3) through the links ML(4,17) and ML(4,18); and output switch OS1 is also connected from middle switch MS(3,4) through the links ML(4,25) and ML(4,26)).

Finally the connection topology of the network 100B1 shown in FIG. 1B1 is known to be back to back Omega connection topology.

Referring to FIG. 1C1, in one embodiment, an exemplary asymmetrical multi-link multi-stage network 100C1 with five stages of twenty switches for satisfying communication requests, such as setting up a telephone call or a data call, or a connection between configurable logic blocks, between an input stage 110 and output stage 120 via middle stages 130, 140, and 150 is shown where input stage 110 consists of four, two by four switches IS1-IS4 and output stage 120 consists of four, eight by six switches OS1-OS4. And all the middle stages namely middle stage 130 consists of four, four by four switches MS(1,1)-MS(1,4), middle stage 140 consists of four, four by four switches MS(2,1)-MS(2,4), and middle stage 150 consists of four, four by eight switches MS(3,1)-MS(3,4).

Such a network can be operated in strictly non-blocking manner for unicast connections, because the switches in the input stage 110 are of size two by four, the switches in output stage 120 are of size four by two, and there are four switches in each of middle stage 130, middle stage 140 and middle stage 150. Such a network can be operated in rearrangeably non-blocking manner for multicast connections, because the switches in the input stage 110 are of size two by four, the switches in output stage 120 are of size eight by six, and there are four switches in each of middle stage 130, middle stage 140 and middle stage 150.

In one embodiment of this network each of the input switches IS1-IS4 and output switches OS1-OS4 are crossbar

31

switches. The number of switches of input stage **110** and of output stage **120** can be denoted in general with the variable

$$\frac{N_1}{d},$$

where N_1 is the total number of inlet links or and N_2 is the total number of outlet links and $N_2 > N_1$ and $N_2 = p * N_1$, where $p > 1$. The number of middle switches in each middle stage is denoted by

$$\frac{N_1}{d}.$$

The size of each input switch IS1-IS4 can be denoted in general with the notation $d * 2d$ and each output switch OS1-OS4 can be denoted in general with the notation $(d+d_2) * d_2$, where

$$d_2 = N_2 \times \frac{d}{N_1} = p \times d.$$

The size of each switch in any of the middle stages excepting the last middle stage can be denoted as $2d * 2d$. The size of each switch in the last middle stage can be denoted as $2d * (d+d_2)$. A switch as used herein can be either a crossbar switch, or a network of switches each of which in turn may be a crossbar switch or a network of switches. An asymmetric multi-link multi-stage network can be represented with the notation $V_{link}(N_1, N_2, d, s)$, where N_1 represents the total number of inlet links of all input switches (for example the links IL1-IL8), N_2 represents the total number of outlet links of all output switches (for example the links OL1-OL24), d represents the inlet links of each input switch where $N_2 > N_1$, and s is the ratio of number of outgoing links from each input switch to the inlet links of each input switch.

Each of the

$$\frac{N_1}{d}$$

input switches IS1-IS4 are connected to exactly $2 \times d$ switches in middle stage **130** through $2 \times d$ links (for example input switch IS1 is connected to middle switch MS(1,1) through the links ML(1,1), ML(1,2), and also to middle switch MS(1,2) through the links ML(1,3) and ML(1,4)).

Each of the

$$\frac{N_1}{d}$$

middle switches MS(1,1)-MS(1,4) in the middle stage **130** are connected from exactly d input switches through $2 \times d$ links (for example the links ML(1,1) and ML(1,2) are connected to the middle switch MS(1,1) from input switch IS1, and the links ML(1,15) and ML(1,16) are connected to the middle switch MS(1,1) from input switch IS4) and also are connected to exactly d switches in middle stage **140** through $2 \times d$ links (for example the links ML(2,1) and ML(2,2) are connected from middle switch MS(1,1) to middle switch

32

MS(2,1), and the links ML(2,3) and ML(2,4) are connected from middle switch MS(1,1) to middle switch MS(2,2)).

Similarly each of the

$$\frac{N_1}{d}$$

middle switches MS(2,1)-MS(2,4) in the middle stage **140** are connected from exactly d switches in middle stage **130** through $2 \times d$ links (for example the links ML(2,1) and ML(2,2) are connected to the middle switch MS(2,1) from middle switch MS(1,1), and the links ML(2,15) and ML(2,16) are connected to the middle switch MS(2,1) from middle switch MS(1,4)) and also are connected to exactly d switches in middle stage **150** through $2 \times d$ links (for example the links ML(3,1) and ML(3,2) are connected from middle switch MS(2,1) to middle switch MS(3,1), and the links ML(3,3) and ML(3,4) are connected from middle switch MS(2,1) to middle switch MS(3,2)).

Similarly each of the

$$\frac{N_1}{d}$$

middle switches MS(3,1)-MS(3,4) in the middle stage **150** are connected from exactly d switches in middle stage **140** through $2 \times d$ links (for example the links ML(3,1) and ML(3,2) are connected to the middle switch MS(3,1) from middle switch MS(2,1), and the links ML(3,15) and ML(3,16) are connected to the middle switch MS(3,1) from middle switch MS(2,4)) and also are connected to exactly

$$\frac{d + d_2}{2}$$

output switches in output stage **120** through $d+d_2$ links (for example the links ML(4,1) and ML(4,2) are connected to output switch OS1 from middle switch MS(3,1); the links ML(4,3) and ML(4,4) are connected to output switch OS2 from middle switch MS(3,1); the links ML(4,5) and ML(4,6) are connected to output switch OS3 from middle switch MS(3,1); and the links ML(4,7) and ML(4,8) are connected to output switch OS4 from middle switch MS(3,1)).

Each of the

$$\frac{N_1}{d}$$

output switches OS1-OS4 are connected from exactly

$$\frac{d + d_2}{2}$$

switches in middle stage **150** through $d+d_2$ links (for example output switch OS1 is connected from middle switch MS(3,1) through the links ML(4,1) and ML(4,2); output switch OS1 is also connected from middle switch MS(3,2) through the links ML(4,9) and ML(4,10); output switch OS1 is connected from middle switch MS(3,3) through the links ML(4,17) and

ML(4,18); and output switch OS1 is also connected from middle switch MS(3,4) through the links ML(4,25) and ML(4,26)).

Finally the connection topology of the network 100C1 shown in FIG. 1C1 is hereinafter called nearest neighbor connection topology.

Similar to network 100A1 of FIG. 1A1, 100B1 of FIG. 1B1, and 100C1 of FIG. 1C1, referring to FIG. 1D1, FIG. 1E1, FIG. 1F1, FIG. 1G1, FIG. 1H1, FIG. 1I1 and FIG. 1J1 with exemplary asymmetrical multi-link multi-stage networks 100D1, 100E1, 100F1, 100G1, 100H1, 100I1, and 100J1 respectively with five stages of twenty switches for satisfying communication requests, such as setting up a telephone call or a data call, or a connection between configurable logic blocks, between an input stage 110 and output stage 120 via middle stages 130, 140, and 150 is shown where input stage 110 consists of four, two by four switches IS1-IS4 and output stage 120 consists of four, four by two switches OS1-OS4. And all the middle stages namely middle stage 130 consists of four, four by four switches MS(1,1)-MS(1,4), middle stage 140 consists of four, four by four switches MS(2,1)-MS(2,4), and middle stage 150 consists of four, four by four switches MS(3,1)-MS(3,4).

Such networks can also be operated in strictly non-blocking manner for unicast connections, because the switches in the input stage 110 are of size two by four, the switches in output stage 120 are of size four by two, and there are four switches in each of middle stage 130, middle stage 140 and middle stage 150. Such a network can be operated in rearrangeably non-blocking manner for multicast connections, because the switches in the input stage 110 are of size two by four, the switches in output stage 120 are of size four by two, and there are four switches in each of middle stage 130, middle stage 140 and middle stage 150.

The networks 100D1, 100E1, 100F1, 100G1, 100H1, 100I1 and 100J1 of FIG. 1D1, FIG. 1E1, FIG. 1F1, FIG. 1G1, FIG. 1H1, FIG. 1I1, and FIG. 1J1 are also embodiments of asymmetric multi-link multi-stage network can be represented with the notation $V_{mlink}(N_1, N_2, d, s)$, where N_1 represents the total number of inlet links of all input switches (for example the links IL1-IL8), N_2 represents the total number of outlet links of all output switches (for example the links OL1-OL24), d represents the inlet links of each input switch where $N_2 > N_1$, and s is the ratio of number of outgoing links from each input switch to the inlet links of each input switch.

Just like networks of 100A1, 100B1 and 100C1, for all the networks 100D1, 100E1, 100F1, 100G1, 100H1, 100I1 and 100J1 of FIG. 1D1, FIG. 1E1, FIG. 1F1, FIG. 1G1, FIG. 1H1, FIG. 1I1, and FIG. 1J1, each of the

$$\frac{N_1}{d}$$

input switches IS1-IS4 are connected to exactly d switches in middle stage 130 through $2 \times d$ links.

Each of the

$$\frac{N_1}{d}$$

middle switches MS(1,1)-MS(1,4) in the middle stage 130 are connected from exactly d input switches through $2 \times d$ links and also are connected to exactly d switches in middle stage 140 through $2 \times d$ links.

Similarly each of the

$$\frac{N_1}{d}$$

middle switches MS(2,1)-MS(2,4) in the middle stage 140 are connected from exactly d switches in middle stage 130 through $2 \times d$ links and also are connected to exactly d switches in middle stage 150 through $2 \times d$ links.

Similarly each of the

$$\frac{N_1}{d}$$

middle switches MS(3,1)-MS(3,4) in the middle stage 150 are connected from exactly d switches in middle stage 140 through $2 \times d$ links and also are connected to exactly

$$\frac{d + d_2}{2}$$

output switches in output stage 120 through $d + d_2$ links.

Each of the

$$\frac{N_1}{d}$$

output switches OS1-OS4 are connected from exactly

$$\frac{d + d_2}{2}$$

switches in middle stage 150 through $d + d_2$ links.

In all the ten embodiments of FIG. 1A1 to FIG. 1J1 the connection topology is different. That is the way the links ML(1,1)-ML(1,16), ML(2,1)-ML(2,16), ML(3,1)-ML(3,16), and ML(4,1)-ML(4,16) are connected between the respective stages is different. Even though only ten embodiments are illustrated, in general, the network $V_{mlink}(N_1, N_2, d, s)$ can comprise any arbitrary type of connection topology. For example the connection topology of the network $V_{mlink}(N_1, N_2, d, s)$ may be back to back Benes networks, Delta Networks and many more combinations. The applicant notes that the fundamental property of a valid connection topology of the $V_{mlink}(N_1, N_2, d, s)$ network is, when no connections are setup from any input link all the output links should be reachable. Based on this property numerous embodiments of the network $V_{mlink}(N_1, N_2, d, s)$ can be built. The ten embodiments of FIG. 1A1 to FIG. 1J1 are only three examples of network $V_{mlink}(N_1, N_2, d, s)$.

In all the ten embodiments of FIG. 1A1 to FIG. 1J1, each of the links ML(1,1)-ML(1,16), ML(2,1)-ML(2,16), ML(3,1)-ML(3,16) and ML(4,1)-ML(4,16) are either available for use by a new connection or not available if currently used by an existing connection. The input switches IS1-IS4 are also referred to as the network input ports. The input stage 110 is often referred to as the first stage. The output switches OS1-OS4 are also referred to as the network output ports. The output stage 120 is often referred to as the last stage. The

35

middle stage switches MS(1,1)-MS(1,4), MS(2,1)-MS(2,4), and MS(3,1)-MS(3,4) are referred to as middle switches or middle ports.

In the example illustrated in FIG. 1A1 (or in FIG. 1B1 to FIG. 1J1), a fan-out of four is possible to satisfy a multicast connection request if input switch is IS2, but only two switches in middle stage 130 will be used. Similarly, although a fan-out of three is possible for a multicast connection request if the input switch is IS1, again only a fan-out of two is used. The specific middle switches that are chosen in middle stage 130 when selecting a fan-out of two is irrelevant so long as at most two middle switches are selected to ensure that the connection request is satisfied. In essence, limiting the fan-out from input switch to no more than two middle switches permits the network 100A1 (or 100B1 to 100J1), to be operated in rearrangeably nonblocking manner in accordance with the invention.

The connection request of the type described above can be unicast connection request, a multicast connection request or a broadcast connection request, depending on the example. In case of a unicast connection request, a fan-out of one is used, i.e. a single middle stage switch in middle stage 130 is used to satisfy the request. Moreover, although in the above-described embodiment a limit of two has been placed on the fan-out into the middle stage switches in middle stage 130, the limit can be greater depending on the number of middle stage switches in a network (while maintaining the rearrangeably nonblocking nature of operation of the network for multicast connections). However any arbitrary fan-out may be used within any of the middle stage switches and the output stage switches to satisfy the connection request.

Generalized Asymmetric RNB ($N_2 > N_1$) Embodiments:

Network 100K1 of FIG. 1K1 is an example of general asymmetrical multi-link multi-stage network $V_{mlink}(N_1, N_2, d, s)$ with $(2 \times \log_d N_1) - 1$ stages where $N_2 > N_1$ and $N_2 = p \times N_1$, where $p > 1$. In network 100K1 of FIG. 1K1, $N_1 = N$ and $N_2 = p \times N$. The general asymmetrical multi-link multi-stage network $V_{mlink}(N_1, N_2, d, s)$ can be operated in rearrangeably nonblocking manner for multicast when $s \geq 2$ according to the current invention. Also the general asymmetrical multi-link multi-stage network $V_{mlink}(N_1, N_2, d, s)$ can be operated in strictly nonblocking manner for unicast if $s \geq 2$ according to the current invention. (And in the example of FIG. 1K1, $s = 2$). The general asymmetrical multi-link multi-stage network $V_{mlink}(N_1, N_2, d, s)$ with $(2 \times \log_d N_1) - 1$ stages has d inlet links for each of

$$\frac{N_1}{d}$$

input switches IS1-IS(N_1/d) (for example the links IL1-IL(d) to the input switch IS1) and $2 \times d$ outgoing links for each of

$$\frac{N_1}{d}$$

input switches IS1-IS(N_1/d) (for example the links ML(1,1)-ML(1,2d) to the input switch IS1). There are d_2

$$\left(\text{where } d_2 = N_2 \times \frac{d}{N_1} = p \times d \right)$$

36

outlet links for each of

$$\frac{N_1}{d}$$

output switches OS1-OS(N_1/d) (for example the links OL1-OL($p \times d$) to the output switch OS1) and $d + d_2 (= d + p \times d)$ incoming links for each of

$$\frac{N_1}{d}$$

output switches OS1-OS(N_1/d) (for example ML($2 \times \log_d N_1 - 2, 1$)-ML($2 \times \log_d N_1 - 2, d + d_2$) to the output switch OS1).

Each of the

$$\frac{N_1}{d}$$

input switches IS1-IS(N_1/d) are connected to exactly $2 \times d$ switches in middle stage 130 through $2 \times d$ links.

Each of the

$$\frac{N_1}{d}$$

middle switches MS(1,1)-MS(1, N_1/d) in the middle stage 130 are connected from exactly d input switches through $2 \times d$ links and also are connected to exactly d switches in middle stage 140 through $2 \times d$ links.

Similarly each of the

$$\frac{N_1}{d}$$

middle switches

$$MS(\log_d N_1 - 1, 1) - MS\left(\log_d N_1 - 1, \frac{N_1}{d}\right)$$

in the middle stage 130 $+ 10^*(\log_d N_1 - 2)$ are connected from exactly d switches in middle stage 130 $+ 10^*(\log_d N_1 - 3)$ through $2 \times d$ links and also are connected to exactly d switches in middle stage 130 $+ 10^*(\log_d N_1 - 1)$ through $2 \times d$ links.

Similarly each of the

$$\frac{N_1}{d}$$

middle switches

$$MS(2 \times \log_d N_1 - 3, 1) - MS\left(2 \times \log_d N_1 - 3, \frac{N_1}{d}\right)$$

37

in the middle stage **130**+10*(2*Log_d N₁-4) are connected from exactly d switches in middle stage **130**+10*(2*Log_d N₁-5) through 2×d links and also are connected to exactly

$$\frac{d + d_2}{2}$$

output switches in output stage **120** through d+d₂ links. Each of the

$$\frac{N_1}{d}$$

output switches OS1-OS(N₁/d) are connected from exactly

$$\frac{d + d_2}{2}$$

switches in middle stage **130**+10*(2*Log_d N₁-4) through d+d₂ links

As described before, again the connection topology of a general V_{mlink}(N₁, N₂, d, s) may be any one of the connection topologies. For example the connection topology of the network V_{mlink}(N₁, N₂, d, s) may be back to back inverse Benes networks, back to back Omega networks, back to back Benes networks, Delta Networks and many more combinations. The applicant notes that the fundamental property of a valid connection topology of the general V_{mlink}(N₁, N₂, d, s) network is, when no connections are setup from any input link if any output link should be reachable. Based on this property numerous embodiments of the network V_{mlink}(N₁, N₂, d, s) can be built. The embodiments of FIG. 1A1 to FIG. 1J1 are ten examples of network V_{mlink}(N₁, N₂, d, s) for s=2 and N₂>N₁.

The general symmetrical multi-link multi-stage network V_{mlink}(N₁, N₂, d, s) can be operated in rearrangeably non-blocking manner for multicast when s=2 according to the current invention. Also the general symmetrical multi-link multi-stage network V_{mlink}(N₁, N₂, d, s) can be operated in strictly nonblocking manner for unicast if s=2 according to the current invention.

For example, the network of FIG. 1C1 shows an exemplary five-stage network, namely V_{mlink}(**8,24,2,2**), with the following multicast assignment I₁={1,4} and all other I_j=∅ for j=[2-8]. It should be noted that the connection I₁ fans out in the first stage switch IS1 into middle switches MS(1,1) and MS(1,2) in middle stage **130**, and fans out in middle switches MS(1,1) and MS(1,2) only once into middle switches MS(2,1) and MS(2,3) respectively in middle stage **140**.

The connection I₁ also fans out in middle switches MS(2,1) and MS(2,3) only once into middle switches MS(3,1) and MS(3,4) respectively in middle stage **150**. The connection I₁ also fans out in middle switches MS(3,1) and MS(3,4) only once into output switches OS1 and OS4 in output stage **120**. Finally the connection I₁ fans out once in the output stage switch OS1 into outlet link OL2 and in the output stage switch OS4 twice into the outlet links OL20 and OL23. In accordance with the invention, each connection can fan out in the input stage switch into at most two middle stage switches in middle stage **130**.

Asymmetric RNB (N₁>N₂) Embodiments:

Referring to FIG. 1A2, in one embodiment, an exemplary asymmetrical multi-link multi-stage network **100A2** with

38

five stages of twenty switches for satisfying communication requests, such as setting up a telephone call or a data call, or a connection between configurable logic blocks, between an input stage **110** and output stage **120** via middle stages **130**, **140**, and **150** is shown where input stage **110** consists of four, six by eight switches IS1-IS4 and output stage **120** consists of four, four by two switches OS1-OS4. And all the middle stages namely middle stage **130** consists of four, eight by four switches MS(1,1)-MS(1,4), middle stage **140** consists of four, four by four switches MS(2,1)-MS(2,4), and middle stage **150** consists of four, four by four switches MS(3,1)-MS(3,4).

Such a network can be operated in strictly non-blocking manner for unicast connections, because the switches in the input stage **110** are of size six by eight, the switches in output stage **120** are of size four by two, and there are four switches in each of middle stage **130**, middle stage **140** and middle stage **150**. Such a network can be operated in rearrangeably non-blocking manner for multicast connections, because the switches in the input stage **110** are of size six by eight, the switches in output stage **120** are of size four by two, and there are four switches in each of middle stage **130**, middle stage **140** and middle stage **150**.

In one embodiment of this network each of the input switches IS1-IS4 and output switches OS1-OS4 are crossbar switches. The number of switches of input stage **110** and of output stage **120** can be denoted in general with the variable

$$\frac{N_2}{d}$$

where N₁ is the total number of inlet links or and N₂ is the total number of outlet links and N₁>N₂ and N₁=p*N₂ where p>1. The number of middle switches in each middle stage is denoted by

$$\frac{N_2}{d}$$

The size of each input switch IS1-IS4 can be denoted in general with the notation d₁*(d+d₁) and each output switch OS1-OS4 can be denoted in general with the notation (2×d*d), where

$$d_1 = N_1 \times \frac{d}{N_2} = p \times d.$$

The size of each switch in any of the middle stages excepting the first middle stage can be denoted as 2d*2d. The size of each switch in the first middle stage can be denoted as (d+d₁)*2d. A switch as used herein can be either a crossbar switch, or a network of switches each of which in turn may be a crossbar switch or a network of switches. An asymmetric multi-link multi-stage network can be represented with the notation V_{mlink}(N₁, N₂, d, s), where N₁ represents the total number of inlet links of all input switches (for example the links IL1-IL24), N₂ represents the total number of outlet links of all output switches (for example the links OL1-OL8), d represents the inlet links of each input switch where N₁>N₂, and s is the ratio of number of incoming links to each output switch to the outlet links of each output switch.

39

Each of the

$$\frac{N_2}{d}$$

input switches IS1-IS4 are connected to exactly

$$\frac{d + d_1}{2}$$

switches in middle stage 130 through $d+d_1$ links (for example input switch IS1 is connected to middle switch MS(1,1) through the links ML(1,1), ML(1,2); input switch IS1 is connected to middle switch MS(1,2) through the links ML(1,3) and ML(1,4); input switch IS1 is connected to middle switch MS(1,3) through the links ML(1,5), ML(1,6); and input switch IS1 is also connected to middle switch MS(1,4) through the links ML(1,7) and ML(1,8)).

Each of the

$$\frac{N_2}{d}$$

middle switches MS(1,1)-MS(1,4) in the middle stage 130 are connected from exactly

$$\frac{d + d_1}{2}$$

input switches through $d+d_1$ links (for example the links ML(1,1) and ML(1,2) are connected to the middle switch MS(1,1) from input switch IS1; the links ML(1,9) and ML(1,10) are connected to the middle switch MS(1,1) from input switch IS2; the links ML(1,17) and ML(1,18) are connected to the middle switch MS(1,1) from input switch IS3; and the links ML(1,25) and ML(1,26) are connected to the middle switch MS(1,1) from input switch IS4) and also are connected to exactly d switches in middle stage 140 through $2 \times d$ links (for example the links ML(2,1) and ML(2,2) are connected from middle switch MS(1,1) to middle switch MS(2,1), and the links ML(2,3) and ML(2,4) are connected from middle switch MS(1,1) to middle switch MS(2,3)).

Similarly each of the

$$\frac{N_2}{d}$$

middle switches MS(2,1)-MS(2,4) in the middle stage 140 are connected from exactly d switches in middle stage 130 through $2 \times d$ links (for example the links ML(2,1) and ML(2,2) are connected to the middle switch MS(2,1) from middle switch MS(1,1), and the links ML(2,11) and ML(2,12) are connected to the middle switch MS(2,1) from middle switch MS(1,3) and also are connected to exactly d switches in middle stage 150 through $2 \times d$ links (for example the links ML(3,1) and ML(3,2) are connected from middle switch MS(2,1) to middle switch MS(3,1), and the links ML(3,3) and ML(3,4) are connected from middle switch MS(2,1) to middle switch MS(3,3)).

40

Similarly each of the

$$\frac{N_2}{d}$$

5 middle switches MS(3,1)-MS(3,4) in the middle stage 150 are connected from exactly d switches in middle stage 140 through $2 \times d$ links (for example the links ML(3,1) and ML(3,2) are connected to the middle switch MS(3,1) from middle switch MS(2,1), and the links ML(3,11) and ML(3,12) are connected to the middle switch MS(3,1) from middle switch MS(2,3)) and also are connected to exactly d output switches in output stage 120 through $2 \times d$ links (for example the links ML(4,1) and ML(4,2) are connected to output switch OS1 from middle switch MS(3,1); and the links ML(4,3) and ML(4,4) are connected to output switch OS2 from middle switch MS(3,1)).

Each of the

$$\frac{N_2}{d}$$

25 output switches OS1-OS4 are connected from exactly d switches in middle stage 150 through $2 \times d$ links (for example output switch OS1 is connected from middle switch MS(3,1) through the links ML(4,1) and ML(4,2); and output switch OS1 is also connected from middle switch MS(3,2) through the links ML(4,7) and ML(4,8)).

30 Finally the connection topology of the network 100A2 shown in FIG. 1A2 is known to be back to back inverse Benes connection topology.

Referring to FIG. 1B2, in one embodiment, an exemplary asymmetrical multi-link multi-stage network 100B2 with five stages of twenty switches for satisfying communication requests, such as setting up a telephone call or a data call, or a connection between configurable logic blocks, between an input stage 110 and output stage 120 via middle stages 130, 140, and 150 is shown where input stage 110 consists of four, six by eight switches IS1-IS4 and output stage 120 consists of four, four by two switches OS1-OS4. And all the middle stages namely middle stage 130 consists of four, eight by four switches MS(1,1)-MS(1,4), middle stage 140 consists of four, four by four switches MS(2,1)-MS(2,4), and middle stage 150 consists of four, four by four switches MS(3,1)-MS(3,4).

Such a network can be operated in strictly non-blocking manner for unicast connections, because the switches in the input stage 110 are of size six by eight, the switches in output stage 120 are of size four by two, and there are four switches in each of middle stage 130, middle stage 140 and middle stage 150. Such a network can be operated in rearrangeably non-blocking manner for multicast connections, because the switches in the input stage 110 are of size six by eight, the switches in output stage 120 are of size four by two, and there are four switches in each of middle stage 130, middle stage 140 and middle stage 150.

In one embodiment of this network each of the input switches IS1-IS4 and output switches OS1-OS4 are crossbar switches. The number of switches of input stage 110 and of output stage 120 can be denoted in general with the variable

$$\frac{N_2}{d}$$

41

where N_1 is the total number of inlet links or and N_2 is the total number of outlet links and $N_1 > N_2$ and $N_1 = p * N_2$ where $p > 1$. The number of middle switches in each middle stage is denoted by

$$\frac{N_2}{d}$$

The size of each input switch IS1-IS4 can be denoted in general with the notation $d_1 * (d + d_1)$ and each output switch OS1-OS4 can be denoted in general with the notation $(2 * d * d)$, where

$$d_1 = N_1 \times \frac{d}{N_2} = p \times d$$

The size of each switch in any of the middle stages excepting the first middle stage can be denoted as $2d * 2d$. The size of each switch in the first middle stage can be denoted as $(d + d_1) * 2d$. A switch as used herein can be either a crossbar switch, or a network of switches each of which in turn may be a crossbar switch or a network of switches. An asymmetric multi-link multi-stage network can be represented with the notation $V_{link}(N_1, N_2, d, s)$, where N_1 represents the total number of inlet links of all input switches (for example the links IL1-IL24), N_2 represents the total number of outlet links of all output switches (for example the links OL1-OL8), d represents the inlet links of each input switch where $N_1 > N_2$, and s is the ratio of number of incoming links to each output switch to the outlet links of each output switch.

Each of the

$$\frac{N_2}{d}$$

input switches IS1-IS4 are connected to exactly

$$\frac{d + d_1}{2}$$

switches in middle stage 130 through $d + d_1$ links (for example input switch IS1 is connected to middle switch MS(1,1) through the links ML(1,1), ML(1,2); input switch IS1 is connected to middle switch MS(1,2) through the links ML(1,3) and ML(1,4); input switch IS1 is connected to middle switch MS(1,3) through the links ML(1,5), ML(1,6); and input switch IS1 is also connected to middle switch MS(1,4) through the links ML(1,7) and ML(1,8)).

Each of the

$$\frac{N_2}{d}$$

middle switches MS(1,1)-MS(1,4) in the middle stage 130 are connected from exactly

$$\frac{d + d_1}{2}$$

42

input switches through $d + d_1$ links (for example the links ML(1,1) and ML(1,2) are connected to the middle switch MS(1,1) from input switch IS1; the links ML(1,9) and ML(1,10) are connected to the middle switch MS(1,1) from input switch IS2; the links ML(1,17) and ML(1,18) are connected to the middle switch MS(1,1) from input switch IS3; and the links ML(1,25) and ML(1,26) are connected to the middle switch MS(1,1) from input switch IS4) and also are connected to exactly d switches in middle stage 140 through $2 * d$ links (for example the links ML(2,1) and ML(2,2) are connected from middle switch MS(1,1) to middle switch MS(2,1), and the links ML(2,3) and ML(2,4) are connected from middle switch MS(1,1) to middle switch MS(2,2)).

Similarly each of the

15

$$\frac{N_2}{d}$$

middle switches MS(2,1)-MS(2,4) in the middle stage 140 are connected from exactly d switches in middle stage 130 through $2 * d$ links (for example the links ML(2,1) and ML(2,2) are connected to the middle switch MS(2,1) from middle switch MS(1,1), and the links ML(2,9) and ML(2,10) are connected to the middle switch MS(2,1) from middle switch MS(1,3)) and also are connected to exactly d switches in middle stage 150 through $2 * d$ links (for example the links ML(3,1) and ML(3,2) are connected from middle switch MS(2,1) to middle switch MS(3,1), and the links ML(3,3) and ML(3,4) are connected from middle switch MS(2,1) to middle switch MS(3,2)).

Similarly each of the

35

$$\frac{N_2}{d}$$

middle switches MS(3,1)-MS(3,4) in the middle stage 150 are connected from exactly d switches in middle stage 140 through $2 * d$ links (for example the links ML(3,1) and ML(3,2) are connected to the middle switch MS(3,1) from middle switch MS(2,1), and the links ML(3,9) and ML(3,10) are connected to the middle switch MS(3,1) from middle switch MS(2,3)) and also are connected to exactly d output switches in output stage 120 through $2 * d$ links (for example the links ML(4,1) and ML(4,2) are connected to output switch OS1 from middle switch MS(3,1); and the links ML(4,3) and ML(4,4) are connected to output switch OS2 from middle switch MS(3,1)).

Each of the

55

$$\frac{N_2}{d}$$

output switches OS1-OS4 are connected from exactly d switches in middle stage 150 through $2 * d$ links (for example output switch OS1 is connected from middle switch MS(3,1) through the links ML(4,1) and ML(4,2); and output switch OS1 is also connected from middle switch MS(3,3) through the links ML(4,9) and ML(4,10)).

Finally the connection topology of the network 100B2 shown in FIG. 1B2 is known to be back to back Omega connection topology.

Referring to FIG. 1C2, in one embodiment, an exemplary asymmetrical multi-link multi-stage network 100C2 with five

65

43

stages of twenty switches for satisfying communication requests, such as setting up a telephone call or a data call, or a connection between configurable logic blocks, between an input stage 110 and output stage 120 via middle stages 130, 140, and 150 is shown where input stage 110 consists of four, six by eight switches IS1-IS4 and output stage 120 consists of four, four by two switches OS1-OS4. And all the middle stages namely middle stage 130 consists of four, eight by four switches MS(1,1)-MS(1,4), middle stage 140 consists of four, four by four switches MS(2,1)-MS(2,4), and middle stage 150 consists of four, four by four switches MS(3,1)-MS(3,4).

Such a network can be operated in strictly non-blocking manner for unicast connections, because the switches in the input stage 110 are of size six by eight, the switches in output stage 120 are of size four by two, and there are four switches in each of middle stage 130, middle stage 140 and middle stage 150. Such a network can be operated in rearrangeably non-blocking manner for multicast connections, because the switches in the input stage 110 are of size six by eight, the switches in output stage 120 are of size four by two, and there are four switches in each of middle stage 130, middle stage 140 and middle stage 150.

In one embodiment of this network each of the input switches IS1-IS4 and output switches OS1-OS4 are crossbar switches. The number of switches of input stage 110 and of output stage 120 can be denoted in general with the variable

$$\frac{N_2}{d},$$

where N_1 is the total number of inlet links or and N_2 is the total number of outlet links and $N_1 > N_2$ and $N_1 = p * N_2$ where $p > 1$. The number of middle switches in each middle stage is denoted by

$$\frac{N_2}{d}.$$

The size of each input switch IS1-IS4 can be denoted in general with the notation $d_1 * (d + d_1)$ and each output switch OS1-OS4 can be denoted in general with the notation $(2 * d * d)$, where

$$d_1 = N_1 * \frac{d}{N_2} = p * d.$$

The size of each switch in any of the middle stages excepting the first middle stage can be denoted as $2d * 2d$. The size of each switch in the first middle stage can be denoted as $(d + d_1) * 2d$. A switch as used herein can be either a crossbar switch, or a network of switches each of which in turn may be a crossbar switch or a network of switches. An asymmetric multi-link multi-stage network can be represented with the notation $V_{link}(N_1, N_2, d, s)$, where N_1 represents the total number of inlet links of all input switches (for example the links IL1-IL24), N_2 represents the total number of outlet links of all output switches (for example the links OL1-OL8), d represents the inlet links of each input switch where $N_1 > N_2$, and s is the ratio of number of incoming links to each output switch to the outlet links of each output switch.

44

Each of the

$$\frac{N_2}{d}$$

input switches IS1-IS4 are connected to exactly

$$\frac{d + d_1}{2}$$

switches in middle stage 130 through $d + d_1$ links (for example input switch IS1 is connected to middle switch MS(1,1) through the links ML(1,1), ML(1,2); input switch IS1 is connected to middle switch MS(1,2) through the links ML(1,3) and ML(1,4); input switch IS1 is connected to middle switch MS(1,3) through the links ML(1,5), ML(1,6); and input switch IS1 is also connected to middle switch MS(1,4) through the links ML(1,7) and ML(1,8)).

Each of the

$$\frac{N_2}{d}$$

middle switches MS(1,1)-MS(1,4) in the middle stage 130 are connected from exactly

$$\frac{d + d_1}{2}$$

input switches through $d + d_1$ links (for example the links ML(1,1) and ML(1,2) are connected to the middle switch MS(1,1) from input switch IS1; the links ML(1,9) and ML(1,10) are connected to the middle switch MS(1,1) from input switch IS2; the links ML(1,17) and ML(1,18) are connected to the middle switch MS(1,1) from input switch IS3; and the links ML(1,25) and ML(1,26) are connected to the middle switch MS(1,1) from input switch IS4) and also are connected to exactly d switches in middle stage 140 through $2 * d$ links (for example the links ML(2,1) and ML(2,2) are connected from middle switch MS(1,1) to middle switch MS(2,1), and the links ML(2,3) and ML(2,4) are connected from middle switch MS(1,1) to middle switch MS(2,2)).

Similarly each of the

$$\frac{N_2}{d}$$

middle switches MS(2,1)-MS(2,4) in the middle stage 140 are connected from exactly d switches in middle stage 130 through $2 * d$ links (for example the links ML(2,1) and ML(2,2) are connected to the middle switch MS(2,1) from middle switch MS(1,1), and the links ML(2,15) and ML(2,16) are connected to the middle switch MS(2,1) from middle switch MS(1,4) and also are connected to exactly d switches in middle stage 150 through $2 * d$ links (for example the links ML(3,1) and ML(3,2) are connected from middle switch MS(2,1) to middle switch MS(3,1), and the links ML(3,3) and ML(3,4) are connected from middle switch MS(2,1) to middle switch MS(3,2)).

45

Similarly each of the

$$\frac{N_2}{d}$$

middle switches MS(3,1)-MS(3,4) in the middle stage 150 are connected from exactly d switches in middle stage 140 through 2xd links (for example the links ML(3,1) and ML(3,2) are connected to the middle switch MS(3,1) from middle switch MS(2,1), and the links ML(3,15) and ML(3,16) are connected to the middle switch MS(3,1) from middle switch MS(2,4)) and also are connected to exactly d output switches in output stage 120 through 2xd links (for example the links ML(4,1) and ML(4,2) are connected to output switch OS1 from middle switch MS(3,1); and the links ML(4,3) and ML(4,4) are connected to output switch OS2 from middle switch MS(3,1)).

Each of the

$$\frac{N_2}{d}$$

output switches OS1-OS4 are connected from exactly d switches in middle stage 150 through 2xd links (for example output switch OS1 is connected from middle switch MS(3,1) through the links ML(4,1) and ML(4,2); and output switch OS1 is also connected from middle switch MS(3,4) through the links ML(4,15) and ML(4,16)).

Finally the connection topology of the network 100C2 shown in FIG. 1C2 is hereinafter called nearest neighbor connection topology.

Similar to network 100A2 of FIG. 1A2, 100B2 of FIG. 1B2, and 100C2 of FIG. 1C2, referring to FIG. 1D2, FIG. 1E2, FIG. 1F2, FIG. 1G2, FIG. 1H2, FIG. 1I2 and FIG. 1J2 with exemplary asymmetrical multi-link multi-stage networks 100D2, 100E2, 100F2, 100G2, 100H2, 100I2, and 100J2 respectively with five stages of twenty switches for satisfying communication requests, such as setting up a telephone call or a data call, or a connection between configurable logic blocks, between an input stage 110 and output stage 120 via middle stages 130, 140, and 150 is shown where input stage 110 consists of four, six by eight switches IS1-IS4 and output stage 120 consists of four, four by two switches OS1-OS4. And all the middle stages namely middle stage 130 consists of four, eight by four switches MS(1,1)-MS(1,4), middle stage 140 consists of four, four by four switches MS(2,1)-MS(2,4), and middle stage 150 consists of four, four by four switches MS(3,1)-MS(3,4).

Such networks can also be operated in strictly non-blocking manner for unicast connections, because the switches in the input stage 110 are of size two by four, the switches in output stage 120 are of size four by two, and there are four switches in each of middle stage 130, middle stage 140 and middle stage 150. Such a network can be operated in rearrangeably non-blocking manner for multicast connections, because the switches in the input stage 110 are of size six by eight, the switches in output stage 120 are of size four by two, and there are four switches in each of middle stage 130, middle stage 140 and middle stage 150.

The networks 100D2, 100E2, 100F2, 100G2, 100H2, 100I2 and 100J2 of FIG. 1D2, FIG. 1E2, FIG. 1F2, FIG. 1G2, FIG. 1H2, FIG. 1I2, and FIG. 1J2 are also embodiments of asymmetric multi-link multi-stage network can be represented with the notation $V_{min}(N_1, N_2, d, s)$, where N_1 rep-

46

resents the total number of inlet links of all input switches (for example the links IL1-IL8), N_2 represents the total number of outlet links of all output switches (for example the links OL1-OL24), d represents the inlet links of each input switch where $N_1 > N_2$, and s is the ratio of number of outgoing links from each input switch to the inlet links of each input switch.

Just like networks of 100A2, 100B2 and 100C2, for all the networks 100D2, 100E2, 100F2, 100G2, 100H2, 100I2 and 100J2 of FIG. 1D2, FIG. 1E2, FIG. 1F2, FIG. 1G2, FIG. 1H2, FIG. 1I2, and FIG. 1J2, each of the

$$\frac{N_2}{d}$$

input switches IS1-IS4 are connected to exactly

$$\frac{d + d_2}{2}$$

switches in middle stage 130 through $d+d_2$ links. Each of the

$$\frac{N_2}{d}$$

middle switches MS(1,1)-MS(1,4) in the middle stage 130 are connected from exactly

$$\frac{d + d_2}{2}$$

input switches through $d+d_2$ links and also are connected to exactly d switches in middle stage 140 through 2xd links.

Similarly each of the

$$\frac{N_2}{d}$$

middle switches MS(2,1)-MS(2,4) in the middle stage 140 are connected from exactly d switches in middle stage 130 through 2xd links and also are connected to exactly d switches in middle stage 150 through 2xd links.

Similarly each of the

$$\frac{N_2}{d}$$

middle switches MS(3,1)-MS(3,4) in the middle stage 150 are connected from exactly d switches in middle stage 140 through 2xd links and also are connected to exactly d output switches in output stage 120 through 2xd links.

Each of the

$$\frac{N_2}{d}$$

output switches OS1-OS4 are connected from exactly d switches in middle stage 150 through 2xd links.

In all the ten embodiments of FIG. 1A2 to FIG. 1J2 the connection topology is different. That is the way the links ML(1,1)-ML(1,16), ML(2,1)-ML(2,16), ML(3,1)-ML(3,16), and ML(4,1)-ML(4,16) are connected between the respective stages is different. Even though only ten embodiments are illustrated, in general, the network $V_{mlink}(N_1, N_2, d, s)$ can comprise any arbitrary type of connection topology. For example the connection topology of the network $V_{mlink}(N_1, N_2, d, s)$ may be back to back Benes networks, Delta Networks and many more combinations. The applicant notes that the fundamental property of a valid connection topology of the $V_{mlink}(N_1, N_2, d, s)$ network is, when no connections are setup from any input link all the output links should be reachable. Based on this property numerous embodiments of the network $V_{mlink}(N_1, N_2, d, s)$ can be built. The ten embodiments of FIG. 1A2 to FIG. 1J2 are only three examples of network $V_{mlink}(N_1, N_2, d, s)$.

In all the ten embodiments of FIG. 1A2 to FIG. 1J2, each of the links ML(1,1)-ML(1,16), ML(2,1)-ML(2,16), ML(3,1)-ML(3,16) and ML(4,1)-ML(4,16) are either available for use by a new connection or not available if currently used by an existing connection. The input switches IS1-IS4 are also referred to as the network input ports. The input stage 110 is often referred to as the first stage. The output switches OS1-OS4 are also referred to as the network output ports. The output stage 120 is often referred to as the last stage. The middle stage switches MS(1,1)-MS(1,4), MS(2,1)-MS(2,4), and MS(3,1)-MS(3,4) are referred to as middle switches or middle ports.

In the example illustrated in FIG. 1A2 (or in FIG. 1B2 to FIG. 1J2), a fan-out of four is possible to satisfy a multicast connection request if input switch is IS2, but only two switches in middle stage 130 will be used. Similarly, although a fan-out of three is possible for a multicast connection request if the input switch is IS1, again only a fan-out of two is used. The specific middle switches that are chosen in middle stage 130 when selecting a fan-out of two is irrelevant so long as at most two middle switches are selected to ensure that the connection request is satisfied. In essence, limiting the fan-out from input switch to no more than two middle switches permits the network 100A2 (or 100B2 to 100J2), to be operated in rearrangeably nonblocking manner in accordance with the invention.

The connection request of the type described above can be unicast connection request, a multicast connection request or a broadcast connection request, depending on the example. In case of a unicast connection request, a fan-out of one is used, i.e. a single middle stage switch in middle stage 130 is used to satisfy the request. Moreover, although in the above-described embodiment a limit of two has been placed on the fan-out into the middle stage switches in middle stage 130, the limit can be greater depending on the number of middle stage switches in a network (while maintaining the rearrangeably nonblocking nature of operation of the network for multicast connections). However any arbitrary fan-out may be used within any of the middle stage switches and the output stage switches to satisfy the connection request.

Generalized Asymmetric RNB ($N_2 > N_1$) Embodiments:

Network 1001K2 of FIG. 1K2 is an example of general asymmetrical multi-link multi-stage network $V_{mlink}(N_1, N_2, d, s)$ with $(2 \times \log_d N_2) - 1$ stages where $N_1 > N_2$ and $N_1 = p * N_2$ where $p > 1$. In network 100K2 of FIG. 1K2, $N_2 = N$ and $N_1 = p * N$. The general asymmetrical multi-link multi-stage network $V_{mlink}(N_1, N_2, d, s)$ can be operated in rearrangeably nonblocking manner for multicast when $s \geq 2$ according to the current invention. Also the general asymmetrical multi-link multi-stage network $V_{mlink}(N_1, N_2, d, s)$ can be operated in

strictly nonblocking manner for unicast if $S \geq 2$ according to the current invention. (And in the example of FIG. 1K2, $s=2$). The general asymmetrical multi-link multi-stage network $V_{mlink}(N_1, N_2, d, s)$ with $(2 \times \log_d N_2) - 1$ stages has d_1 (where

$$d_1 = N_1 \times \frac{d}{N_2} = p \times d$$

inlet links for each of

$$\frac{N_2}{d}$$

input switches IS1-IS(N_2/d) (for example the links IL1-IL($p*d$) to the input switch IS1) and $d+d_1$ ($=d+p*d$) outgoing links for each of

$$\frac{N_2}{d}$$

input switches IS1-IS(N_2/d) (for example the links ML(1,1)-ML(1, ($d+p*d$)) to the input switch IS1). There are d outlet links for each of

$$\frac{N_2}{d}$$

output switches OS1-OS(N_2/d) (for example the links OL1-OL(d) to the output switch OS1) and $2 \times d$ incoming links for each of

$$\frac{N_2}{d}$$

output switches OS1-OS(N_2/d) (for example ML($2 \times \log_d N_2, 1$)-ML($2 \times \log_d N_2 - 2, 2 \times d$) to the output switch OS1). Each of the

$$\frac{N_2}{d}$$

input switches IS1-IS(N_2/d) are connected to exactly

$$\frac{d + d_1}{2}$$

switches in middle stage 130 through $d+d_1$ links. Each of the

$$\frac{N_2}{d}$$

middle switches MS(1,1)-MS(1, N_2/d) in the middle stage 130 are connected from exactly d input switches through $2 \times d$ links and also are connected to exactly d switches in middle stage 140 through $2 \times d$ links.

Similarly each of the

$$\frac{N_2}{d}$$

middle switches

$$MS(\text{Log}_d N_2 - 1, 1) - MS\left(\text{Log}_d N_2 - 1, \frac{N_2}{d}\right)$$

in the middle stage $130+10*(\text{Log}_d N_2-2)$ are connected from exactly d switches in middle stage $130+10*(\text{Log}_d N_2-3)$ through $2 \times d$ links and also are connected to exactly d switches in middle stage $130+10*(\text{Log}_d N_2-1)$ through $2 \times d$ links.

Similarly each of the

$$\frac{N_2}{d}$$

middle switches

$$MS(2 \times \text{Log}_d N_2 - 3, 1) - MS\left(2 \times \text{Log}_d N_2 - 3, \frac{N_2}{d}\right)$$

in the middle stage $130+10*(2*\text{Log}_d N_2-4)$ are connected from exactly d switches in middle stage $130+10*(2*\text{Log}_d N_2-5)$ through $2 \times d$ links and also are connected to exactly d output switches in output stage 120 through $2 \times d$ links.

Each of the

$$\frac{N_2}{d}$$

output switches $OS1-OS(N_2/d)$ are connected from exactly d switches in middle stage $130+10*(2*\text{Log}_d N_2-4)$ through $2 \times d$ links.

As described before, again the connection topology of a general $V_{mlink}(N_1, N_2, d, s)$ may be any one of the connection topologies. For example the connection topology of the network $V_{mlink}(N_1, N_2, d, s)$ may be back to back inverse Benes networks, back to back Omega networks, back to back Benes networks, Delta Networks and many more combinations. The applicant notes that the fundamental property of a valid connection topology of the general $V_{mlink}(N_1, N_2, d, s)$ network is, when no connections are setup from any input link if any output link should be reachable. Based on this property numerous embodiments of the network $V_{mlink}(N_1, N_2, d, s)$ can be built. The embodiments of FIG. 1A2 to FIG. 1J2 are ten examples of network $V_{mlink}(N_1, N_2, d, s)$ for $s=2$ and $N_2 > N_1$.

The general symmetrical multi-link multi-stage network $V_{mlink}(N_1, N_2, d, s)$ can be operated in rearrangeably non-blocking manner for multicast when $s \geq 2$ according to the current invention. Also the general symmetrical multi-link multi-stage network $V_{mlink}(N_1, N_2, d, s)$ can be operated in strictly nonblocking manner for unicast if $S \geq 2$ according to the current invention.

For example, the network of FIG. 1C2 shows an exemplary five-stage network, namely $V_{mlink}(8, 24, 2, 2)$, with the following multicast assignment $I_1 = \{1, 4\}$ and all other $I_j = \emptyset$ for $j = [2-8]$. It should be noted that the connection I_1 fans out in the first stage switch IS1 into middle switches MS(1,1) and MS(1,4) in middle stage 130, and fans out in middle switches MS(1,1) and MS(1,4) only once into middle switches MS(2,1) and MS(2,4) respectively in middle stage 140.

The connection I_1 also fans out in middle switches MS(2,1) and MS(2,4) only once into middle switches MS(3,1) and MS(3,4) respectively in middle stage 150. The connection I_1 also fans out in middle switches MS(3,1) and MS(3,4) only once into output switches OS1 and OS4 in output stage 120. Finally the connection I_1 fans out once in the output stage switch OS1 into outlet link OL1 and in the output stage switch OS4 twice into the outlet links OL7 and OL8. In accordance with the invention, each connection can fan out in the input stage switch into at most two middle stage switches in middle stage 130.

20 Symmetric Folded RNB Embodiments:

The folded multi-link multi-stage network $V_{fold-mlink}(N_1, N_2, d, s)$ disclosed, in the current invention, is topologically exactly the same as the multi-link multi-stage network $V_{mlink}(N_1, N_2, d, s)$, disclosed in the current invention so far, excepting that in the illustrations folded network $V_{fold-mlink}(N_1, N_2, d, s)$ is shown as it is folded at middle stage $130+10*(\text{Log}_d N_2-2)$. This is true for all the embodiments presented in the current invention.

Referring to FIG. 2A, in one embodiment, an exemplary symmetrical folded multi-link multi-stage network 200A with five stages of twenty switches for satisfying communication requests, such as setting up a telephone call or a data call, or a connection between configurable logic blocks, between an input stage 110 and output stage 120 via middle stages 130, 140, and 150 is shown where input stage 110 consists of four, two by four switches IS1-IS4 and output stage 120 consists of four, four by two switches OS1-OS4. And all the middle stages namely middle stage 130 consists of four, four by four switches MS(1,1)-MS(1,4), middle stage 140 consists of four, four by four switches MS(2,1)-MS(2,4), and middle stage 150 consists of four, four by four switches MS(3,1)-MS(3,4).

Such a network can be operated in strictly non-blocking manner for unicast connections, because the switches in the input stage 110 are of size two by four, the switches in output stage 120 are of size four by two, and there are four switches in each of middle stage 130, middle stage 140 and middle stage 150. Such a network can be operated in rearrangeably non-blocking manner for multicast connections, because the switches in the input stage 110 are of size two by four, the switches in output stage 120 are of size four by two, and there are four switches in each of middle stage 130, middle stage 140 and middle stage 150.

In one embodiment of this network each of the input switches IS1-IS4 and output switches OS1-OS4 are crossbar switches. The number of switches of input stage 110 and of output stage 120 can be denoted in general with the variable N/d , where N is the total number of inlet links or outlet links. The number of middle switches in each middle stage is denoted by N/d . The size of each input switch IS1-IS4 can be denoted in general with the notation $d*2d$ and each output switch OS1-OS4 can be denoted in general with the notation $2d*d$. Likewise, the size of each switch in any of the middle stages can be denoted as $2d*2d$. A switch as used herein can be either a crossbar switch, or a network of switches each of which in turn may be a crossbar switch or a network of switches. A symmetric folded multi-link multi-stage network

can be represented with the notation $V_{fold-mlink}(N, d, s)$, where N represents the total number of inlet links of all input switches (for example the links IL1-IL8), d represents the inlet links of each input switch or outlet links of each output switch, and s is the ratio of number of outgoing links from each input switch to the inlet links of each input switch. Although it is not necessary that there be the same number of inlet links IL1-IL8 as there are outlet links OL1-OL8, in a symmetrical network they are the same.

Each of the N/d input switches IS1-IS4 are connected to exactly $2 \times d$ switches in middle stage 130 through $2 \times d$ links (for example input switch IS1 is connected to middle switch MS(1,1) through the links ML(1,1), ML(1,2), and also to middle switch MS(1,2) through the links ML(1,3) and ML(1,4)).

Each of the N/d middle switches MS(1,1)-MS(1,4) in the middle stage 130 are connected from exactly d input switches through $2 \times d$ links (for example the links ML(1,1) and ML(1,2) are connected to the middle switch MS(1,1) from input switch IS1, and the links ML(1,7) and ML(1,8) are connected to the middle switch MS(1,1) from input switch IS2) and also are connected to exactly d switches in middle stage 140 through $2 \times d$ links (for example the links ML(2,1) and ML(2,2) are connected from middle switch MS(1,1) to middle switch MS(2,1), and the links ML(2,3) and ML(2,4) are connected from middle switch MS(1,1) to middle switch MS(2,3)).

Similarly each of the N/d middle switches MS(2,1)-MS(2,4) in the middle stage 140 are connected from exactly d switches in middle stage 130 through $2 \times d$ links (for example the links ML(2,1) and ML(2,2) are connected to the middle switch MS(2,1) from middle switch MS(1,1), and the links ML(2,11) and ML(2,12) are connected to the middle switch MS(2,1) from middle switch MS(1,3)) and also are connected to exactly d switches in middle stage 150 through $2 \times d$ links (for example the links ML(3,1) and ML(3,2) are connected from middle switch MS(2,1) to middle switch MS(3,1), and the links ML(3,3) and ML(3,4) are connected from middle switch MS(2,1) to middle switch MS(3,3)).

Similarly each of the N/d middle switches MS(3,1)-MS(3,4) in the middle stage 150 are connected from exactly d switches in middle stage 140 through $2 \times d$ links (for example the links ML(3,1) and ML(3,2) are connected to the middle switch MS(3,1) from middle switch MS(2,1), and the links ML(3,11) and ML(3,12) are connected to the middle switch MS(3,1) from middle switch MS(2,3)) and also are connected to exactly d output switches in output stage 120 through $2 \times d$ links (for example the links ML(4,1) and ML(4,2) are connected to output switch OS1 from Middle switch MS(3,1), and the links ML(4,3) and ML(4,4) are connected to output switch OS2 from middle switch MS(3,1)).

Each of the N/d output switches OS1-OS4 are connected from exactly $2 \times d$ switches in middle stage 150 through $2 \times d$ links (for example output switch OS1 is connected from middle switch MS(3,1) through the links ML(4,1) and ML(4,2), and output switch OS1 is also connected from middle switch MS(3,2) through the links ML(4,7) and ML(4,8)).

Finally the connection topology of the network 200A shown in FIG. 2A is known to be back to back inverse Benes connection topology.

In other embodiments the connection topology may be different from the network 200A of FIG. 2A. That is the way the links ML(1,1)-ML(1,16), ML(2,1)-ML(2,16), ML(3,1)-ML(3,16), and ML(4,1)-ML(4,16) are connected between the respective stages is different. Even though only one embodiment is illustrated, in general, the network $V_{fold-mlink}(N, d, s)$ can comprise any arbitrary type of connection topology. For

example the connection topology of the network $V_{fold-mlink}(N, d, s)$ may be back to back Benes networks, Delta Networks and many more combinations. The applicant notes that the fundamental property of a valid connection topology of the $V_{fold-mlink}(N, d, s)$ network is, when no connections are setup from any input link all the output links should be reachable. Based on this property numerous embodiments of the network $V_{fold-mlink}(N, d, s)$ can be built. The embodiment of FIG. 2A is only one example of network $V_{fold-mlink}(N, d, s)$.

In the embodiment of FIG. 2A each of the links ML(1,1)-ML(1,16), ML(2,1)-ML(2,16), ML(3,1)-ML(3,16) and ML(4,1)-ML(4,16) are either available for use by a new connection or not available if currently used by an existing connection. The input switches IS1-IS4 are also referred to as the network input ports. The input stage 110 is often referred to as the first stage. The output switches OS1-OS4 are also referred to as the network output ports. The output stage 120 is often referred to as the last stage. The middle stage switches MS(1,1)-MS(1,4) and MS(2,1)-MS(2,4) are referred to as middle switches or middle ports. The middle stage 130 is also referred to as root stage and middle stage switches MS(2,1)-MS(2,4) are referred to as root stage switches.

In the example illustrated in FIG. 2A, a fan-out of four is possible to satisfy a multicast connection request if input switch is IS2, but only two switches in middle stage 130 will be used. Similarly, although a fan-out of three is possible for a multicast connection request if the input switch is IS1, again only a fan-out of two is used. The specific middle switches that are chosen in middle stage 130 when selecting a fan-out of two is irrelevant so long as at most two middle switches are selected to ensure that the connection request is satisfied. In essence, limiting the fan-out from input switch to no more than two middle switches permits the network 200A, to be operated in rearrangeably nonblocking manner in accordance with the invention.

The connection request of the type described above can be unicast connection request, a multicast connection request or a broadcast connection request, depending on the example. In case of a unicast connection request, a fan-out of one is used, i.e. a single middle stage switch in middle stage 130 is used to satisfy the request. Moreover, although in the above-described embodiment a limit of two has been placed on the fan-out into the middle stage switches in middle stage 130, the limit can be greater depending on the number of middle stage switches in a network (while maintaining the rearrangeably nonblocking nature of operation of the network for multicast connections). However any arbitrary fan-out may be used within any of the middle stage switches and the output stage switches to satisfy the connection request.

Generalized Symmetric Folded RNB Embodiments:

Network 200B of FIG. 2B is an example of general symmetrical folded multi-link multi-stage network $V_{fold-mlink}(N, d, s)$ with $(2 \times \log_d N) - 1$ stages. The general symmetrical folded multi-link multi-stage network $V_{fold-mlink}(N, d, s)$ can be operated in rearrangeably nonblocking manner for multicast when $s \geq 2$ according to the current invention. Also the general symmetrical folded multi-link multi-stage network $V_{fold-mlink}(N, d, s)$ can be operated in strictly nonblocking manner for unicast if $s \geq 2$ according to the current invention. (And in the example of FIG. 2B, $s=2$). The general symmetrical folded multi-link multi-stage network $V_{fold-mlink}(N, d, s)$ with $(2 \times \log_d N) - 1$ stages has d inlet links for each of N/d input switches IS1-IS(N/d) (for example the links IL1-IL(d) to the input switch IS1) and $2 \times d$ outgoing links for each of N/d input switches IS1-IS(N/d) (for example the links ML(1,1)-ML(1,2 d) to the input switch IS1). There are d outlet links for each of N/d output switches OS1-OS(N/d) (for example

the links OL1-OL(d) to the output switch OS1) and 2xd incoming links for each of N/d output switches OS1-OS(N/d) (for example ML(2xLog_dN-2,1)-ML(2xLog_dN-2,2xd) to the output switch OS1).

Each of the N/d input switches IS1-IS(N/d) are connected to exactly d switches in middle stage 130 through 2xd links.

Each of the N/d middle switches MS(1,1)-MS(1,N/d) in the middle stage 130 are connected from exactly d input switches through 2xd links and also are connected to exactly d switches in middle stage 140 through 2xd links.

Similarly each of the N/d middle switches

$$MS(\text{Log}_d N - 1, 1) - MS\left(\text{Log}_d N - 1, \frac{N}{d}\right)$$

in the middle stage 130+10*(Log_dN-2) are connected from exactly d switches in middle stage 130+10*(Log_dN-3) through 2xd links and also are connected to exactly d switches in middle stage 130+10*(Log_dN-1) through 2xd links.

Similarly each of the N/d middle switches

$$MS(2 \times \text{Log}_d N - 3, 1) - MS\left(2 \times \text{Log}_d N - 3, \frac{N}{d}\right)$$

in the middle stage 130+10*(2*Log_dN-4) are connected from exactly d switches in middle stage 130+10*(2*Log_dN-5) through 2xd links and also are connected to exactly d output switches in output stage 120 through 2xd links.

Each of the N/d output switches OS1-OS(N/d) are connected from exactly d switches in middle stage 130+10*(2*Log_dN-4) through 2xd links.

As described before, again the connection topology of a general V_{fold-mlink}(N, d, s) may be any one of the connection topologies. For example the connection topology of the network V_{fold-mlink}(N, d, s) may be back to back inverse Benes networks, back to back Omega networks, back to back Benes networks, Delta Networks and many more combinations. The applicant notes that the fundamental property of a valid connection topology of the general V_{fold-mlink}(N, d, s) network is, when no connections are setup from any input link if any output link should be reachable. Based on this property numerous embodiments of the network V_{fold-mlink}(N, d, s) can be built. The embodiment of FIG. 1A is one example of network V_{fold-mlink}(N, d, s).

The general symmetrical folded multi-link multi-stage network V_{fold-mlink}(N, d, s) can be operated in rearrangeably nonblocking manner for multicast when s ≥ 2 according to the current invention. Also the general symmetrical folded multi-link multi-stage network V_{fold-mlink}(N, d, s) can be operated in strictly nonblocking manner for unicast if s ≥ 2 according to the current invention.

Every switch in the folded multi-link multi-stage networks discussed herein has multicast capability. In a V_{fold-mlink}(N, d, s) network, if a network inlet link is to be connected to more than one outlet link on the same output switch, then it is only necessary for the corresponding input switch to have one path to that output switch. This follows because that path can be multicast within the output switch to as many outlet links as necessary. Multicast assignments can therefore be described in terms of connections between input switches and output switches. An existing connection or a new connection from an input switch to r' output switches is said to have fan-out r'. If

all multicast assignments of a first type, wherein any inlet link of an input switch is to be connected in an output switch to at most one outlet link are realizable, then multicast assignments of a second type, wherein any inlet link of each input switch is to be connected to more than one outlet link in the same output switch, can also be realized. For this reason, the following discussion is limited to general multicast connections of the first type

$$\left(\text{with fan-out } r', 1 \leq r' \leq \frac{N}{d} \right)$$

although the same discussion is applicable to the second type. To characterize a multicast assignment, for each inlet link

$$i \in \left\{ 1, 2, \dots, \frac{N}{d} \right\},$$

let I_i=O, where

$$O \subset \left\{ 1, 2, \dots, \frac{N}{d} \right\},$$

denote the subset of output switches to which inlet link i is to be connected in the multicast assignment. For example, the network of FIG. 1C shows an exemplary five-stage network, namely V_{minlink}(8,2,2), with the following multicast assignment I₁={2,4} and all other I_j=∅ for j=[2-8]. It should be noted that the connection I₁ fans out in the first stage switch IS1 into middle switches MS(1,1) and MS(1,2) in middle stage 130, and fans out in middle switches MS(1,1) and MS(1,2) only once into middle switches MS(2,1) and MS(2,3) respectively in middle stage 140.

The connection I₁ also fans out in middle switches MS(2,1) and MS(2,3) only once into middle switches MS(3,2) and MS(3,4) respectively in middle stage 150. The connection I₁ also fans out in middle switches MS(3,2) and MS(3,4) only once into output switches OS2 and OS4 in output stage 120. Finally the connection I₁ fans out once in the output stage switch OS2 into outlet link OL3 and in the output stage switch OS4 twice into the outlet links OL7 and OL8. In accordance with the invention, each connection can fan out in the input stage switch into at most two middle stage switches in middle stage 130.

Asymmetric Folded RNB (N₂>N₁) Embodiments:

Referring to FIG. 2C, in one embodiment, an exemplary asymmetrical folded multi-link multi-stage network 200C with five stages of twenty switches for satisfying communication requests, such as setting up a telephone call or a data call, or a connection between configurable logic blocks, between an input stage 110 and output stage 120 via middle stages 130, 140, and 150 is shown where input stage 110 consists of four, two by four switches IS1-IS4 and output stage 120 consists of four, eight by six switches OS1-OS4. And all the middle stages namely middle stage 130 consists of four, four by four switches MS(1,1)-MS(1,4), middle stage 140 consists of four, four by four switches MS(2,1)-MS(2,4), and middle stage 150 consists of four, four by eight switches MS(3,1)-MS(3,4).

Such a network can be operated in strictly non-blocking manner for unicast connections, because the switches in the input stage 110 are of size two by four, the switches in output

55

stage 120 are of size four by two, and there are four switches in each of middle stage 130, middle stage 140 and middle stage 150. Such a network can be operated in rearrangeably non-blocking manner for multicast connections, because the switches in the input stage 110 are of size two by four, the switches in output stage 120 are of size eight by six, and there are four switches in each of middle stage 130, middle stage 140 and middle stage 150.

In one embodiment of this network each of the input switches IS1-IS4 and output switches OS1-OS4 are crossbar switches. The number of switches of input stage 110 and of output stage 120 can be denoted in general with the variable

$$\frac{N_1}{d}$$

where N_1 is the total number of inlet links or and N_2 is the total number of outlet links and $N_2 > N_1$ and $N_2 = p * N_1$, where $p > 1$. The number of middle switches in each middle stage is denoted by

$$\frac{N_1}{d}$$

The size of each input switch IS1-IS4 can be denoted in general with the notation $d * 2d$ and each output switch OS1-OS4 can be denoted in general with the notation $(d+d_2) * d_2$, where

$$d_2 = N_2 \times \frac{d}{N_1} = p \times d.$$

The size of each switch in any of the middle stages excepting the last middle stage can be denoted as $2d * 2d$. The size of each switch in the last middle stage can be denoted as $2d * (d+d_2)$. A switch as used herein can be either a crossbar switch, or a network of switches each of which in turn may be a crossbar switch or a network of switches. An asymmetric folded multi-link multi-stage network can be represented with the notation $V_{fold-link}(N_1, N_2, d, s)$, where N_1 represents the total number of inlet links of all input switches (for example the links IL1-IL8), N_2 represents the total number of outlet links of all output switches (for example the links OL1-OL24), d represents the inlet links of each input switch where $N_2 > N_1$, and s is the ratio of number of outgoing links from each input switch to the inlet links of each input switch.

Each of the

$$\frac{N_1}{d}$$

input switches IS1-IS4 are connected to exactly d switches in middle stage 130 through $2 \times d$ links (for example input switch IS1 is connected to middle switch MS(1,1) through the links ML(1,1), ML(1,2), and also to middle switch MS(1,2) through the links ML(1,3) and ML(1,4)).

56

Each of the

$$\frac{N_1}{d}$$

middle switches MS(1,1)-MS(1,4) in the middle stage 130 are connected from exactly d input switches through $2 \times d$ links (for example the links ML(1,1) and ML(1,2) are connected to the middle switch MS(1,1) from input switch IS1, and the links ML(1,7) and ML(1,8) are connected to the middle switch MS(1,1) from input switch IS2) and also are connected to exactly d switches in middle stage 140 through $2 \times d$ links (for example the links ML(2,1) and ML(2,2) are connected from middle switch MS(1,1) to middle switch MS(2,1), and the links ML(2,3) and ML(2,4) are connected from middle switch MS(1,1) to middle switch MS(2,3)).

Similarly each of the

$$\frac{N_1}{d}$$

middle switches MS(2,1)-MS(2,4) in the middle stage 140 are connected from exactly d switches in middle stage 130 through $2 \times d$ links (for example the links ML(2,1) and ML(2,2) are connected to the middle switch MS(2,1) from middle switch MS(1,1), and the links ML(2,11) and ML(2,12) are connected to the middle switch MS(2,1) from middle switch MS(1,3)) and also are connected to exactly d switches in middle stage 150 through $2 \times d$ links (for example the links ML(3,1) and ML(3,2) are connected from middle switch MS(2,1) to middle switch MS(3,1), and the links ML(3,3) and ML(3,4) are connected from middle switch MS(2,1) to middle switch MS(3,3)).

Similarly each of the

$$\frac{N_1}{d}$$

middle switches MS(3,1)-MS(3,4) in the middle stage 150 are connected from exactly d switches in middle stage 140 through $2 \times d$ links (for example the links ML(3,1) and ML(3,2) are connected to the middle switch MS(3,1) from middle switch MS(2,1), and the links ML(3,11) and ML(3,12) are connected to the middle switch MS(3,1) from middle switch MS(2,3)) and also are connected to exactly

$$\frac{d+d_2}{2}$$

output switches in output stage 120 through $d+d_2$ links (for example the links ML(4,1) and ML(4,2) are connected to output switch OS1 from Middle switch MS(3,1); the links ML(4,3) and ML(4,4) are connected to output switch OS2 from middle switch MS(3,1); the links ML(4,5) and ML(4,6) are connected to output switch OS3 from Middle switch MS(3,1); and the links ML(4,7) and ML(4,8) are connected to output switch OS4 from middle switch MS(3,1)).

Each of the

$$\frac{N_1}{d}$$

output switches OS1-OS4 are connected from exactly

$$\frac{d+d_2}{2}$$

switches in middle stage 150 through $d+d_2$ links (for example output switch OS1 is connected from middle switch MS(3,1) through the links ML(4,1) and ML(4,2); output switch OS1 is also connected from middle switch MS(3,2) through the links ML(4,9) and ML(4,10); output switch OS1 is connected from middle switch MS(3,3) through the links ML(4,17) and ML(4,18); and output switch OS1 is also connected from middle switch MS(3,4) through the links ML(4,25) and ML(4,26)).

Finally the connection topology of the network 200C shown in FIG. 2C is known to be back to back inverse Benes connection topology.

In other embodiments the connection topology may be different from the network 200C of FIG. 2C. That is the way the links ML(1,1)-ML(1,16), ML(2,1)-ML(2,16), ML(3,1)-ML(3,16), and ML(4,1)-ML(4,16) are connected between the respective stages is different. Even though only one embodiment is illustrated, in general, the network $V_{fold-mlink}(N, d, s)$ can comprise any arbitrary type of connection topology. For example the connection topology of the network $V_{fold-mlink}(N, d, s)$ may be back to back Benes networks, Delta Networks and many more combinations. The applicant notes that the fundamental property of a valid connection topology of the $V_{fold-mlink}(N, d, s)$ network is, when no connections are setup from any input link all the output links should be reachable. Based on this property numerous embodiments of the network $V_{fold-mlink}(N, d, s)$ can be built. The embodiment of FIG. 2C is only one example of network $V_{fold-mlink}(N, d, s)$.

In the embodiment of FIG. 2C each of the links ML(1,1)-ML(1,16), ML(2,1)-ML(2,16), ML(3,1)-ML(3,16) and ML(4,1)-ML(4,16) are either available for use by a new connection or not available if currently used by an existing connection. The input switches IS1-IS4 are also referred to as the network input ports. The input stage 110 is often referred to as the first stage. The output switches OS1-OS4 are also referred to as the network output ports. The output stage 120 is often referred to as the last stage. The middle stage switches MS(1,1)-MS(1,4) and MS(2,1)-MS(2,4) are referred to as middle switches or middle ports. The middle stage 130 is also referred to as root stage and middle stage switches MS(2,1)-MS(2,4) are referred to as root stage switches.

In the example illustrated in FIG. 2C, a fan-out of four is possible to satisfy a multicast connection request if input switch is IS2, but only two switches in middle stage 130 will be used. Similarly, although a fan-out of three is possible for a multicast connection request if the input switch is IS1, again only a fan-out of two is used. The specific middle switches that are chosen in middle stage 130 when selecting a fan-out of two is irrelevant so long as at most two middle switches are selected to ensure that the connection request is satisfied. In essence, limiting the fan-out from input switch to no more than two middle switches permits the network 200C, to be operated in rearrangeably nonblocking manner in accordance with the invention.

The connection request of the type described above can be unicast connection request, a multicast connection request or a broadcast connection request, depending on the example. In case of a unicast connection request, a fan-out of one is used, i.e. a single middle stage switch in middle stage 130 is used to satisfy the request. Moreover, although in the above-de-

scribed embodiment a limit of two has been placed on the fan-out into the middle stage switches in middle stage 130, the limit can be greater depending on the number of middle stage switches in a network (while maintaining the rearrangeably nonblocking nature of operation of the network for multicast connections). However any arbitrary fan-out may be used within any of the middle stage switches and the output stage switches to satisfy the connection request.

5 Generalized Asymmetric Folded RNB ($N_2 > N_1$) Embodiments:

Network 200D of FIG. 2D is an example of general asymmetrical folded multi-link multi-stage network $V_{fold-mlink}(N_1, N_2, d, s)$ with $(2 \times \log_d N_1) - 1$ stages where $N_2 > N_1$ and $N_2 = p \times N_1$, where $p > 1$. In network 200D of FIG. 2D, $N_1 = N$ and $N_2 = p \times N$. The general asymmetrical folded multi-link multi-stage network $V_{fold-mlink}(N_1, N_2, d, s)$ can be operated in rearrangeably nonblocking manner for multicast when $s \geq 2$ according to the current invention. Also the general asymmetrical folded multi-link multi-stage network $V_{fold-mlink}(N_1, N_2, d, s)$ can be operated in strictly nonblocking manner for unicast if $s \geq 2$ according to the current invention. (And in the example of FIG. 2D, $s = 2$). The general asymmetrical folded multi-link multi-stage network $V_{fold-mlink}(N_1, N_2, d, s)$ with $(2 \times \log_d N_1) - 1$ stages has d inlet links for each of

$$\frac{N_1}{d}$$

input switches IS1-IS(N_1/d) (for example the links IL1-IL(d) to the input switch IS1) and $2 \times d$ outgoing links for each of

$$\frac{N_1}{d}$$

input switches IS1-IS(N_1/d) (for example the links ML(1,1)-ML(1,2d) to the input switch IS1). There are d_2

$$\left(\text{where } d_2 = N_2 \times \frac{d}{N_1} = p \times d \right)$$

outlet links for each of

$$\frac{N_1}{d}$$

output switches OS1-OS(N_1/d) (for example the links OL1-OL($p \times d$) to the output switch OS1) and $d+d_2$ ($=d+p \times d$) incoming links for each of

$$\frac{N_1}{d}$$

65 output switches OS1-OS(N_1/d) (for example ML($2 \times \log_d N_1 - 2, 1$)-ML($2 \times \log_d N_1 - 2, d+d_2$) to the output switch OS1).

59

Each of the

$$\frac{N_1}{d}$$

input switches IS1-IS(N₁/d) are connected to exactly 2×d switches in middle stage **130** through 2×d links.

Each of the

$$\frac{N_1}{d}$$

middle switches MS(1,1)-MS(1,N₁/d) in the middle stage **130** are connected from exactly d input switches through 2×d links and also are connected to exactly d switches in middle stage **140** through 2×d links.

Similarly each of the

$$\frac{N_1}{d}$$

middle switches

$$MS(\text{Log}_d N_1 - 1, 1) - MS\left(\text{Log}_d N_1 - 1, \frac{N_1}{d}\right)$$

in the middle stage **130**+10*(Log_d N₁-2) are connected from exactly d switches in middle stage **130**+10*(Log_d N₁-3) through 2×d links and also are connected to exactly d switches in middle stage **130**+10*(Log_d N₁-1) through 2×d links.

Similarly each of the

$$\frac{N_1}{d}$$

middle switches

$$MS(2 \times \text{Log}_d N_1 - 3, 1) - MS\left(2 \times \text{Log}_d N_1 - 3, \frac{N_1}{d}\right)$$

in the middle stage **130**+10*(2*Log_d N₁-4) are connected from exactly d switches in middle stage **130**+10*(2*Log_d N₁-5) through 2×d links and also are connected to exactly

$$\frac{d + d_2}{2}$$

output switches in output stage **120** through d+d₂ links.

Each of the

$$\frac{N_1}{d}$$

60

output switches OS1-OS(N₁/d) are connected from exactly

$$\frac{d + d_2}{2}$$

switches in middle stage **130**+10*(2*Log_d N₁-4) through d+d₂ links.

As described before, again the connection topology of a general V_{fold-mlink}(N₁, N₂, d, s) may be any one of the connection topologies. For example the connection topology of the network V_{fold-mlink}(N₁, N₂, d, s) may be back to back inverse Benes networks, back to back Omega networks, back to back Benes networks, Delta Networks and many more combinations. The applicant notes that the fundamental property of a valid connection topology of the general V_{fold-mlink}(N₁, N₂, d, s) network is, when no connections are setup from any input link if any output link should be reachable. Based on this property numerous embodiments of the network V_{fold-mlink}(N₁, N₂, d, s) can be built. The embodiment of FIG. 1C is one example of network V_{fold-mlink}(N₁, N₂, d, s) for s=2 and N₂>N₁.

The general symmetrical folded multi-link multi-stage network V_{fold-mlink}(N₁, N₂, d, s) can be operated in rearrangeably nonblocking manner for multicast when s≥2 according to the current invention. Also the general symmetrical folded multi-link multi-stage network V_{fold-mlink}(N₁, N₂, d, s) can be operated in strictly nonblocking manner for unicast if s≥2 according to the current invention.

For example, the network of FIG. 2C shows an exemplary five-stage network, namely V_{fold-mlink}(8,24,2,2), with the following multicast assignment I₁={1,4} and all other I_j=φ for j=[2-8]. It should be noted that the connection I₁ fans out in the first stage switch IS1 into middle switches MS(1,1) and MS(1,2) in middle stage **130**, and fans out in middle switches MS(1,1) and MS(1,2) only once into middle switches MS(2,1) and MS(2,3) respectively in middle stage **140**.

The connection I₁ also fans out in middle switches MS(2,1) and MS(2,3) only once into middle switches MS(3,1) and MS(3,4) respectively in middle stage **150**. The connection I₁ also fans out in middle switches MS(3,1) and MS(3,4) only once into output switches OS1 and OS4 in output stage **120**. Finally the connection I₁ fans out once in the output stage switch OS1 into outlet link OL2 and in the output stage switch OS4 twice into the outlet links OL20 and OL23. In accordance with the invention, each connection can fan out in the input stage switch into at most two middle stage switches in middle stage **130**.

50 Asymmetric Folded RNB (N₁>N₂) Embodiments:

Referring to FIG. 2E, in one embodiment, an exemplary asymmetrical folded multi-link multi-stage network **200E** with five stages of twenty switches for satisfying communication requests, such as setting up a telephone call or a data call, or a connection between configurable logic blocks, between an input stage **110** and output stage **120** via middle stages **130**, **140**, and **150** is shown where input stage **110** consists of four, six by eight switches IS1-IS4 and output stage **120** consists of four, four by two switches OS1-OS4. And all the middle stages namely middle stage **130** consists of four, eight by four switches MS(1,1)-MS(1,4), middle stage **140** consists of four, four by four switches MS(2,1)-MS(2,4), and middle stage **150** consists of four, four by four switches MS(3,1)-MS(3,4).

Such a network can be operated in strictly non-blocking manner for unicast connections, because the switches in the input stage **110** are of size six by eight, the switches in output

61

stage 120 are of size four by two, and there are four switches in each of middle stage 130, middle stage 140 and middle stage 150. Such a network can be operated in rearrangeably non-blocking manner for multicast connections, because the switches in the input stage 110 are of size six by eight, the switches in output stage 120 are of size four by two, and there are four switches in each of middle stage 130, middle stage 140 and middle stage 150.

In one embodiment of this network each of the input switches IS1-IS4 and output switches OS1-OS4 are crossbar switches. The number of switches of input stage 110 and of output stage 120 can be denoted in general with the variable

$$\frac{N_2}{d},$$

where N_1 is the total number of inlet links or and N_2 is the total number of outlet links and $N_1 > N_2$ and $N_1 = p * N_2$ where $p > 1$. The number of middle switches in each middle stage is denoted by

$$\frac{N_2}{d}.$$

The size of each input switch IS1-IS4 can be denoted in general with the notation $d_1 * (d + d_1)$ and each output switch OS1-OS4 can be denoted in general with the notation $(2 * d * d)$, where

$$d_1 = N_1 * \frac{d}{N_2} = p * d.$$

The size of each switch in any of the middle stages excepting the first middle stage can be denoted as $2d * 2d$. The size of each switch in the first middle stage can be denoted as $(d + d_1) * 2d$. A switch as used herein can be either a crossbar switch, or a network of switches each of which in turn may be a crossbar switch or a network of switches. An asymmetric folded multi-link multi-stage network can be represented with the notation $V_{fold-link}(N_1, N_2, d, s)$, where N_1 represents the total number of inlet links of all input switches (for example the links IL1-IL24), N_2 represents the total number of outlet links of all output switches (for example the links OL1-OL8), d represents the inlet links of each input switch where $N_1 > N_2$, and s is the ratio of number of incoming links to each output switch to the outlet links of each output switch.

Each of the

$$\frac{N_2}{d}$$

input switches IS1-IS4 are connected to exactly

$$\frac{d + d_1}{2}$$

switches in middle stage 130 through $d + d_1$ links (for example input switch IS1 is connected to middle switch MS(1,1) through the links ML(1,1), ML(1,2); input switch IS1 is connected to middle switch MS(1,2) through the links ML(1,3)

62

and ML(1,4); input switch IS1 is connected to middle switch MS(1,3) through the links ML(1,5), ML(1,6); and input switch IS1 is also connected to middle switch MS(1,4) through the links ML(1,7) and ML(1,8)).

Each of the

$$\frac{N_2}{d}$$

middle switches MS(1,1)-MS(1,4) in the middle stage 130 are connected from exactly

$$\frac{d + d_1}{2}$$

input switches through $d + d_1$ links (for example the links ML(1,1) and ML(1,2) are connected to the middle switch MS(1,1) from input switch IS1; the links ML(1,9) and ML(1,10) are connected to the middle switch MS(1,1) from input switch IS2; the links ML(1,17) and ML(1,18) are connected to the middle switch MS(1,1) from input switch IS3; and the links ML(1,25) and ML(1,26) are connected to the middle switch MS(1,1) from input switch IS4) and also are connected to exactly d switches in middle stage 140 through $2 * d$ links (for example the links ML(2,1) and ML(2,2) are connected from middle switch MS(1,1) to middle switch MS(2,1), and the links ML(2,3) and ML(2,4) are connected from middle switch MS(1,1) to middle switch MS(2,3)).

Similarly each of the

$$\frac{N_2}{d}$$

middle switches MS(2,1)-MS(2,4) in the middle stage 140 are connected from exactly d switches in middle stage 130 through $2 * d$ links (for example the links ML(2,1) and ML(2,2) are connected to the middle switch MS(2,1) from middle switch MS(1,1), and the links ML(2,11) and ML(2,12) are connected to the middle switch MS(2,1) from middle switch MS(1,3)) and also are connected to exactly d switches in middle stage 150 through $2 * d$ links (for example the links ML(3,1) and ML(3,2) are connected from middle switch MS(2,1) to middle switch MS(3,1), and the links ML(3,3) and ML(3,4) are connected from middle switch MS(2,1) to middle switch MS(3,3)).

Similarly each of the

$$\frac{N_2}{d}$$

middle switches MS(3,1)-MS(3,4) in the middle stage 150 are connected from exactly d switches in middle stage 140 through $2 * d$ links (for example the links ML(3,1) and ML(3,2) are connected to the middle switch MS(3,1) from middle switch MS(2,1), and the links ML(3,11) and ML(3,12) are connected to the middle switch MS(3,1) from middle switch MS(2,3)) and also are connected to exactly d output switches in output stage 120 through $2 * d$ links (for example the links ML(4,1) and ML(4,2) are connected to output switch OS1 from middle switch MS(3,1); and the links ML(4,3) and ML(4,4) are connected to output switch OS2 from middle switch MS(3,1)).

Each of the

$$\frac{N_2}{d}$$

output switches OS1-OS4 are connected from exactly d switches in middle stage 150 through 2xd links (for example output switch OS1 is connected from middle switch MS(3,1) through the links ML(4,1) and ML(4,2); and output switch OS1 is also connected from middle switch MS(3,2) through the links ML(4,7) and ML(4,8)).

Finally the connection topology of the network 200E shown in FIG. 2E is known to be back to back inverse Benes connection topology.

In other embodiments the connection topology may be different from the network 200E of FIG. 2E. That is the way the links ML(1,1)-ML(1,16), ML(2,1)-ML(2,16), ML(3,1)-ML(3,16), and ML(4,1)-ML(4,16) are connected between the respective stages is different. Even though only one embodiment is illustrated, in general, the network V_{fold-mlink}(N, d, s) can comprise any arbitrary type of connection topology. For example the connection topology of the network V_{fold-mlink}(N, d, s) may be back to back Benes networks, Delta Networks and many more combinations. The applicant notes that the fundamental property of a valid connection topology of the V_{fold-mlink}(N, d, s) network is, when no connections are setup from any input link all the output links should be reachable. Based on this property numerous embodiments of the network V_{fold-mlink}(N, d, s) can be built. The embodiment of FIG. 2E is only one example of network V_{fold-mlink}(N, d, s).

In the embodiment of FIG. 2E each of the links ML(1,1)-ML(1,16), ML(2,1)-ML(2,16), ML(3,1)-ML(3,16) and ML(4,1)-ML(4,16) are either available for use by a new connection or not available if currently used by an existing connection. The input switches IS1-IS4 are also referred to as the network input ports. The input stage 110 is often referred to as the first stage. The output switches OS1-OS4 are also referred to as the network output ports. The output stage 120 is often referred to as the last stage. The middle stage switches MS(1,1)-MS(1,4) and MS(2,1)-MS(2,4) are referred to as middle switches or middle ports. The middle stage 130 is also referred to as root stage and middle stage switches MS(2,1)-MS(2,4) are referred to as root stage switches.

In the example illustrated in FIG. 2E, a fan-out of four is possible to satisfy a multicast connection request if input switch is IS2, but only two switches in middle stage 130 will be used. Similarly, although a fan-out of three is possible for a multicast connection request if the input switch is IS1, again only a fan-out of two is used. The specific middle switches that are chosen in middle stage 130 when selecting a fan-out of two is irrelevant so long as at most two middle switches are selected to ensure that the connection request is satisfied. In essence, limiting the fan-out from input switch to no more than two middle switches permits the network 200E, to be operated in rearrangeably nonblocking manner in accordance with the invention.

The connection request of the type described above can be unicast connection request, a multicast connection request or a broadcast connection request, depending on the example. In case of a unicast connection request, a fan-out of one is used, i.e. a single middle stage switch is used to satisfy the request. Moreover, although in the above-described embodiment a limit of two has been placed on the fan-out into the middle stage switches in middle stage 130, the limit can be greater depending on the number of middle stage switches in a net-

work (while maintaining the rearrangeably nonblocking nature of operation of the network for multicast connections). However any arbitrary fan-out may be used within any of the middle stage switches and the output stage switches to satisfy the connection request.

Generalized Asymmetric Folded RNB (N₂>N₁) Embodiments:

Network 200F of FIG. 2F is an example of general asymmetrical folded multi-link multi-stage network V_{fold-mlink}(N₁, N₂, d, s) with (2xlog_d N₂)-1 stages where N₁>N₂ and N₁=p*N₂ where p>1. In network 200F of FIG. 2F, N₂=N and N₁=p*N. The general asymmetrical folded multi-link multi-stage network V_{fold-mlink}(N₁, N₂, d, s) can be operated in rearrangeably nonblocking manner for multicast when s≧2 according to the current invention. Also the general asymmetrical folded multi-link multi-stage network V_{fold-mlink}(N₁, N₂, d, s) can be operated in strictly nonblocking manner for unicast if s≧2 according to the current invention. (And in the example of FIG. 2F, s=2). The general asymmetrical folded multi-link multi-stage network V_{fold-mlink}(N₁, N₂, d, s) with (2xlog_d N₂)-1 stages has d, (where

$$d_1 = N_1 \times \frac{d}{N_2} = p \times d$$

inlet links for each of

$$\frac{N_2}{d}$$

input switches IS1-IS(N₂/d) (for example the links IL1-IL(p*d) to the input switch IS1) and d+d, (=d+p*d) outgoing links for each of

$$\frac{N_2}{d}$$

input switches IS1-IS(N₂/d) (for example the links ML(1,1)-ML(1,(d+p*d)) to the input switch IS1). There are d outlet links for each of

$$\frac{N_2}{d}$$

output switches OS1-OS(N₂/d) (for example the links OL1-OL(d) to the output switch OS1) and 2xd incoming links for each of

$$\frac{N_2}{d}$$

output switches OS1-OS(N₂/d) (for example ML(2xLog_d N₂-2,1)-ML(2xLog_d N₂-2,2xd) to the output switch OS1).

Each of the

$$\frac{N_2}{d}$$

65

input switches IS1-IS(N₂/d) are connected to exactly

$$\frac{d + d_1}{2}$$

switches in middle stage 130 through d+d₁ links.
Each of the

$$\frac{N_2}{d}$$

middle switches MS(1,1)-MS(1,N₂/d) in the middle stage 130 are connected from exactly d input switches through 2×d links and also are connected to exactly d switches in middle stage 140 through 2×d links.

Similarly each of the

$$\frac{N_2}{d}$$

middle switches

$$MS(\text{Log}_d N_2 - 1, 1) - MS\left(\text{Log}_d N_2 - 1, \frac{N_2}{d}\right)$$

in the middle stage 130+10*(Log_d N₂-2) are connected from exactly d switches in middle stage 130+10*(Log_d N₂-3) through 2×d links and also are connected to exactly d switches in middle stage 130+10*(Log_d N₂-1) through 2×d

Similarly each of the

$$\frac{N_2}{d}$$

middle switches

$$MS(2 \times \text{Log}_d N_2 - 3, 1) - MS\left(2 \times \text{Log}_d N_2 - 3, \frac{N_2}{d}\right)$$

in the middle stage 130+10*(2*Log_d N₂-4) are connected from exactly d switches in middle stage 130+10*(2*Log_d N₂-5) through 2×d links and also are connected to exactly d output switches in output stage 120 through 2×d links.

Each of the

$$\frac{N_2}{d}$$

output switches OS1-OS(N₂/d) are connected from exactly d switches in middle stage 130+10*(2*Log_d N₂-4) through 2×d links.

As described before, again the connection topology of a general V_{fold-mlink}(N₁, N₂, d, s) may be any one of the connection topologies. For example the connection topology of the network V_{fold-mlink}(N₁, N₂, d, s) may be back to back inverse Benes networks, back to back Omega networks, back

66

to back Benes networks, Delta Networks and many more combinations. The applicant notes that the fundamental property of a valid connection topology of the general V_{fold-mlink}(N₁, N₂, d, s) network is, when no connections are setup from any input link if any output link should be reachable. Based on this property numerous embodiments of the network V_{fold-mlink}(N₁, N₂, d, s) can be built. The embodiment of FIG. 2F is one example of network V_{fold-mlink}(N₁, N₂, d, s) for s=2 and N₂>N₁.

The general symmetrical folded multi-link multi-stage network V_{fold-mlink}(N₁, N₂, d, s) can be operated in rearrangeably nonblocking manner for multicast when s≥2 according to the current invention. Also the general symmetrical folded multi-link multi-stage network V_{fold-mlink}(N₁, N₂, d, s) can be operated in strictly nonblocking manner for unicast if s≥2 according to the current invention.

For example, the network of FIG. 2E shows an exemplary five-stage network, namely V_{fold-mlink}(8,24,2,2), with the following multicast assignment I₁={1,4} and all other I_j=φ for j=[2-8]. It should be noted that the connection I₁ fans out in the first stage switch IS1 into middle switches MS(1,1) and MS(1,4) in middle stage 130, and fans out in middle switches MS(1,1) and MS(1,4) only once into middle switches MS(2,1) and MS(2,4) respectively in middle stage 140.

The connection I₁ also fans out in middle switches MS(2,1) and MS(2,4) only once into middle switches MS(3,1) and MS(3,4) respectively in middle stage 150. The connection I₁ also fans out in middle switches MS(3,1) and MS(3,4) only once into output switches OS1 and OS4 in output stage 120. Finally the connection I₁ fans out once in the output stage switch OS1 into outlet link OL1 and in the output stage switch OS4 twice into the outlet links OL7 and OL8. In accordance with the invention, each connection can fan out in the input stage switch into at most two middle stage switches in middle stage 130.

SNB Multi-Link Multi-Stage Embodiments:
Symmetric SNB Embodiments:

Referring to FIG. 3A, in one embodiment, an exemplary symmetrical multi-link multi-stage network 300A with five stages of twenty switches for satisfying communication requests, such as setting up a telephone call or a data call, or a connection between configurable logic blocks, between an input stage 110 and output stage 120 via middle stages 130, 140, and 150 is shown where input stage 110 consists of four, two by six switches IS1-IS4 and output stage 120 consists of four, six by two switches OS1-OS4. And all the middle stages namely middle stage 130 consists of four, six by six switches MS(1,1)-MS(1,4), middle stage 140 consists of four, six by six switches MS(2,1)-MS(2,4), and middle stage 150 consists of four, six by six switches MS(3,1)-MS(3,4).

Such a network can be operated in strictly non-blocking manner for multicast connections, because the switches in the input stage 110 are of size two by six, the switches in output stage 120 are of size six by two, and there are four switches in each of middle stage 130, middle stage 140 and middle stage 150.

In one embodiment of this network each of the input switches IS1-IS4 and output switches OS1-OS4 are crossbar switches. The number of switches of input stage 110 and of output stage 120 can be denoted in general with the variable N/d, where N is the total number of inlet links or outlet links. The number of middle switches in each middle stage is denoted by N/d. The size of each input switch IS1-IS4 can be denoted in general with the notation d*3d and each output switch OS1-OS4 can be denoted in general with the notation 3d*d. Likewise, the size of each switch in any of the middle stages can be denoted as 3d*3d. A switch as used herein can

be either a crossbar switch, or a network of switches each of which in turn may be a crossbar switch or a network of switches. A symmetric multi-link multi-stage network can be represented with the notation $V_{mink}(N, d, s)$, where N represents the total number of inlet links of all input switches (for example the links IL1-IL8), d represents the inlet links of each input switch or outlet links of each output switch, and s is the ratio of number of outgoing links from each input switch to the inlet links of each input switch. Although it is not necessary that there be the same number of inlet links IL1-IL8 as there are outlet links OL1-OL8, in a symmetrical network they are the same.

Each of the N/d input switches IS1-IS4 are connected to exactly $3 \times d$ switches in middle stage 130 through $3 \times d$ links (for example input switch IS1 is connected to middle switch MS(1,1) through the links ML(1,1), ML(1,2), and ML(1,3); and also to middle switch MS(1,2) through the links ML(1,4), ML(1,5), and ML(1,6)).

Each of the N/d middle switches MS(1,1)-MS(1,4) in the middle stage 130 are connected from exactly d input switches through $3 \times d$ links (for example the links ML(1,1), ML(1,2), and ML(1,3) are connected to the middle switch MS(1,1) from input switch IS1, and the links ML(1,10), ML(1,11), and ML(1,12) are connected to the middle switch MS(1,1) from input switch IS2) and also are connected to exactly d switches in middle stage 140 through $3 \times d$ links (for example the links ML(2,1), ML(2,2), and ML(2,3) are connected from middle switch MS(1,1) to middle switch MS(2,1), and the links ML(2,4), ML(2,5), and ML(2,6) are connected from middle switch MS(1,1) to middle switch MS(2,3)).

Similarly each of the N/d middle switches MS(2,1)-MS(2,4) in the middle stage 140 are connected from exactly d switches in middle stage 130 through $3 \times d$ links (for example the links ML(2,1), ML(2,2), and ML(2,3) are connected to the middle switch MS(2,1) from middle switch MS(1,1), and the links ML(2,16), ML(2,17), and ML(2,18) are connected to the middle switch MS(2,1) from middle switch MS(1,3)) and also are connected to exactly d switches in middle stage 150 through $3 \times d$ links (for example the links ML(3,1), ML(3,2), and ML(3,3) are connected from middle switch MS(2,1) to middle switch MS(3,1), and the links ML(3,4), ML(3,5), and ML(3,6) are connected from middle switch MS(2,1) to middle switch MS(3,3)).

Similarly each of the N/d middle switches MS(3,1)-MS(3,4) in the middle stage 150 are connected from exactly d switches in middle stage 140 through $3 \times d$ links (for example the links ML(3,1), ML(3,2), and ML(3,3) are connected to the middle switch MS(3,1) from middle switch MS(2,1), and the links ML(3,16), ML(3,17), and ML(3,18) are connected to the middle switch MS(3,1) from middle switch MS(2,3)) and also are connected to exactly d output switches in output stage 120 through $3 \times d$ links (for example the links ML(4,1), ML(4,2), and ML(4,3) are connected to output switch OS1 from middle switch MS(3,1), and the links ML(4,10), ML(4,11), and ML(4,12) are connected to output switch OS2 from middle switch MS(3,1)).

Each of the N/d output switches OS1-OS4 are connected from exactly $3 \times d$ switches in middle stage 150 through $3 \times d$ links (for example output switch OS1 is connected from middle switch MS(3,1) through the links ML(4,1), ML(4,2), and ML(4,3), and output switch OS1 is also connected from middle switch MS(3,2) through the links ML(4,10), ML(4,11) and ML(4,12)).

Finally the connection topology of the network 300A shown in FIG. 3A is known to be back inverse Benes connection topology.

Referring to FIG. 3B, in another embodiment of network $V_{mink}(N, d, s)$, an exemplary symmetrical multi-link multi-stage network 300B with five stages of twenty switches for satisfying communication requests, such as setting up a telephone call or a data call, or a connection between configurable logic blocks, between an input stage 110 and output stage 120 via middle stages 130, 140, and 150 is shown where input stage 110 consists of four, two by six switches IS1-IS4 and output stage 120 consists of four, six by two switches OS1-OS4. And all the middle stages namely middle stage 130 consists of four, six by six switches MS(1,1)-MS(1,4), middle stage 140 consists of four, six by six switches MS(2,1)-MS(2,4), and middle stage 150 consists of four, six by six switches MS(3,1)-MS(3,4).

Such a network can be operated in strictly non-blocking manner for multicast connections, because the switches in the input stage 110 are of size two by six, the switches in output stage 120 are of size six by two, and there are four switches in each of middle stage 130, middle stage 140 and middle stage 150.

In one embodiment of this network each of the input switches IS1-IS4 and output switches OS1-OS4 are crossbar switches. The number of switches of input stage 110 and of output stage 120 can be denoted in general with the variable N/d , where N is the total number of inlet links or outlet links. The number of middle switches in each middle stage is denoted by N/d . The size of each input switch IS1-IS4 can be denoted in general with the notation $d \times 3d$ and each output switch OS1-OS4 can be denoted in general with the notation $3d \times d$. Likewise, the size of each switch in any of the middle stages can be denoted as $3d \times 3d$. A switch as used herein can be either a crossbar switch, or a network of switches each of which in turn may be a crossbar switch or a network of switches. The symmetric multi-link multi-stage network of FIG. 3B is also the network of the type $V_{mink}(N, d, s)$, where N represents the total number of inlet links of all input switches (for example the links IL1-IL8), d represents the inlet links of each input switch or outlet links of each output switch, and s is the ratio of number of outgoing links from each input switch to the inlet links of each input switch. Although it is not necessary that there be the same number of inlet links IL1-IL8 as there are outlet links OL1-OL8, in a symmetrical network they are the same.

Each of the N/d input switches IS1-IS4 are connected to exactly $3 \times d$ switches in middle stage 130 through $3 \times d$ links (for example input switch IS1 is connected to middle switch MS(1,1) through the links ML(1,1), ML(1,2), and ML(1,3); and also to middle switch MS(1,2) through the links ML(1,4), ML(1,5), and ML(1,6)).

Each of the N/d middle switches MS(1,1)-MS(1,4) in the middle stage 130 are connected from exactly d input switches through $3 \times d$ links (for example the links ML(1,1), ML(1,2), and ML(1,3) are connected to the middle switch MS(1,1) from input switch IS1, and the links ML(1,13), ML(1,14), and ML(1,15) are connected to the middle switch MS(1,1) from input switch IS3) and also are connected to exactly d switches in middle stage 140 through $3 \times d$ links (for example the links ML(2,1), ML(2,2), and ML(2,3) are connected from middle switch MS(1,1) to middle switch MS(2,1); and the links ML(2,4), ML(2,5), and ML(2,6) are connected from middle switch MS(1,1) to middle switch MS(2,2)).

Similarly each of the N/d middle switches MS(2,1)-MS(2,4) in the middle stage 140 are connected from exactly d switches in middle stage 130 through $3 \times d$ links (for example the links ML(2,1), ML(2,2), and ML(2,3) are connected to the middle switch MS(2,1) from middle switch MS(1,1), and the links ML(2,13), ML(2,14), and ML(2,15) are connected to

the middle switch MS(2,1) from middle switch MS(1,3)) and also are connected to exactly d switches in middle stage 150 through $3 \times d$ links (for example the links ML(3,1), ML(3,2), and ML(3,3) are connected from middle switch MS(2,1) to middle switch MS(3,1), and the links ML(3,4), ML(3,5) and ML(3,6) are connected from middle switch MS(2,1) to middle switch MS(3,2)).

Similarly each of the N/d middle switches MS(3,1)-MS(3,4) in the middle stage 150 are connected from exactly d switches in middle stage 140 through $3 \times d$ links (for example the links ML(3,1), ML(3,2), and ML(3,3) are connected to the middle switch MS(3,1) from middle switch MS(2,1), and the links ML(3,13), ML(3,14), and ML(3,15) are connected to the middle switch MS(3,1) from middle switch MS(2,3)) and also are connected to exactly d output switches in output stage 120 through $3 \times d$ links (for example the links ML(4,1), ML(4,2), and ML(4,3) are connected to output switch OS1 from Middle switch MS(3,1), and the links ML(4,4), ML(4,5), and ML(4,6) are connected to output switch OS2 from middle switch MS(3,1)).

Each of the N/d output switches OS1-OS4 are connected from exactly $3 \times d$ switches in middle stage 150 through $3 \times d$ links (for example output switch OS1 is connected from middle switch MS(3,1) through the links ML(4,1), ML(4,2), and ML(4,3), and output switch OS1 is also connected from middle switch MS(3,3) through the links ML(4,13), ML(4,14), and ML(4,15)).

Finally the connection topology of the network 300B shown in FIG. 3B is known to be back to back Omega connection topology.

Referring to FIG. 3C, in another embodiment of network $V_{\text{mlink}}(N, d, s)$, an exemplary symmetrical multi-link multi-stage network 300C with five stages of twenty switches for satisfying communication requests, such as setting up a telephone call or a data call, or a connection between configurable logic blocks, between an input stage 110 and output stage 120 via middle stages 130, 140, and 150 is shown where input stage 110 consists of four, two by six switches IS1-IS4 and output stage 120 consists of four, six by two switches OS1-OS4. And all the middle stages namely middle stage 130 consists of four, six by six switches MS(1,1)-MS(1,4), middle stage 140 consists of four, six by six switches MS(2,1)-MS(2,4), and middle stage 150 consists of four, six by six switches MS(3,1)-MS(3,4).

Such a network can be operated in strictly non-blocking manner for multicast connections, because the switches in the input stage 110 are of size two by six, the switches in output stage 120 are of size six by two, and there are four switches in each of middle stage 130, middle stage 140 and middle stage 150.

In one embodiment of this network each of the input switches IS1-IS4 and output switches OS1-OS4 are crossbar switches. The number of switches of input stage 110 and of output stage 120 can be denoted in general with the variable N/d , where N is the total number of inlet links or outlet links. The number of middle switches in each middle stage is denoted by N/d . The size of each input switch IS1-IS4 can be denoted in general with the notation $d \times 3d$ and each output switch OS1-OS4 can be denoted in general with the notation $3d \times d$. Likewise, the size of each switch in any of the middle stages can be denoted as $3d \times 3d$. A switch as used herein can be either a crossbar switch, or a network of switches each of which in turn may be a crossbar switch or a network of switches. The symmetric multi-link multi-stage network of FIG. 3C is also the network of the type $V_{\text{mlink}}(N, d, s)$, where N represents the total number of inlet links of all input switches (for example the links IL1-IL8), d represents the

inlet links of each input switch or outlet links of each output switch, and s is the ratio of number of outgoing links from each input switch to the inlet links of each input switch. Although it is not necessary that there be the same number of inlet links IL1-IL8 as there are outlet links OL1-OL8, in a symmetrical network they are the same.

Each of the N/d input switches IS1-IS4 are connected to exactly $3 \times d$ switches in middle stage 130 through $3 \times d$ links (for example input switch IS1 is connected to middle switch MS(1,1) through the links ML(1,1), ML(1,2), and ML(1,3); and also to middle switch MS(1,2) through the links ML(1,4), ML(1,5), and ML(1,6)).

Each of the N/d middle switches MS(1,1)-MS(1,4) in the middle stage 130 are connected from exactly d input switches through $3 \times d$ links (for example the links ML(1,1), ML(1,2), and ML(1,3) are connected to the middle switch MS(1,1) from input switch IS1, and the links ML(1,22), ML(1,23), and ML(1,24) are connected to the middle switch MS(1,1) from input switch IS4) and also are connected to exactly d switches in middle stage 140 through $3 \times d$ links (for example the links ML(2,1), ML(2,2), and ML(2,3) are connected from middle switch MS(1,1) to middle switch MS(2,1), and the links ML(2,4), ML(2,5), and ML(2,6) are connected from middle switch MS(1,1) to middle switch MS(2,2)).

Similarly each of the N/d middle switches MS(2,1)-MS(2,4) in the middle stage 140 are connected from exactly d switches in middle stage 130 through $3 \times d$ links (for example the links ML(2,1), ML(2,2), and ML(2,3) are connected to the middle switch MS(2,1) from middle switch MS(1,1), and the links ML(2,22), ML(2,23), and ML(2,24) are connected to the middle switch MS(2,1) from middle switch MS(1,4)) and also are connected to exactly d switches in middle stage 150 through $3 \times d$ links (for example the links ML(3,1), ML(3,2), and ML(3,3) are connected from middle switch MS(2,1) to middle switch MS(3,1), and the links ML(3,4), ML(3,5), and ML(3,6) are connected from middle switch MS(2,1) to middle switch MS(3,2)).

Similarly each of the N/d middle switches MS(3,1)-MS(3,4) in the middle stage 150 are connected from exactly d switches in middle stage 140 through $3 \times d$ links (for example the links ML(3,1), ML(3,2), and ML(3,3) are connected to the middle switch MS(3,1) from middle switch MS(2,1), and the links ML(3,22), ML(3,23), and ML(3,24) are connected to the middle switch MS(3,1) from middle switch MS(2,4)) and also are connected to exactly d output switches in output stage 120 through $3 \times d$ links (for example the links ML(4,1), ML(4,2), and ML(4,3) are connected to output switch OS1 from middle switch MS(3,1), and the links ML(4,4), ML(4,5), and ML(4,6) are connected to output switch OS2 from middle switch MS(3,1)).

Each of the N/d output switches OS1-OS4 are connected from exactly $3 \times d$ switches in middle stage 150 through $3 \times d$ links (for example output switch OS1 is connected from middle switch MS(3,1) through the links ML(4,1), ML(4,2), and ML(4,3), and output switch OS1 is also connected from middle switch MS(3,4) through the links ML(4,22), ML(4,23), and ML(4,24)).

Finally the connection topology of the network 300C shown in FIG. 3C is hereinafter called nearest neighbor connection topology.

Similar to network 300A of FIG. 3A, 300B of FIG. 3B, and 300C of FIG. 3C, referring to FIG. 3D, FIG. 3E, FIG. 3F, FIG. 3G, FIG. 3H, FIG. 3I and FIG. 3J with exemplary symmetrical multi-link multi-stage networks 300D, 300E, 300F, 300G, 300H, 300I, and 300J respectively with five stages of twenty switches for satisfying communication requests, such as setting up a telephone call or a data call, or a connection between

configurable logic blocks, between an input stage 110 and output stage 120 via middle stages 130, 140, and 150 is shown where input stage 110 consists of four, two by six switches IS1-IS4 and output stage 120 consists of four, six by two switches OS1-OS4. And all the middle stages namely middle stage 130 consists of four, six by six switches MS(1,1)-MS(1,4), middle stage 140 consists of four, six by six switches MS(2,1)-MS(2,4), and middle stage 150 consists of four, six by six switches MS(3,1)-MS(3,4).

Such a network can be operated in strictly non-blocking manner for multicast connections, because the switches in the input stage 110 are of size two by six, the switches in output stage 120 are of size six by two, and there are four switches in each of middle stage 130, middle stage 140 and middle stage 150.

The networks 300D, 300E, 300F, 300G, 300H, 300I and 300J of FIG. 3D, FIG. 3E, FIG. 3F, FIG. 3G, FIG. 3H, FIG. 3I, and FIG. 3J are also embodiments of symmetric multi-link multi-stage network can be represented with the notation $V_{mlink}(N, d, s)$, where N represents the total number of inlet links of all input switches (for example the links IL1-IL8), d represents the inlet links of each input switch or outlet links of each output switch, and s is the ratio of number of outgoing links from each input switch to the inlet links of each input switch. Although it is not necessary that there be the same number of inlet links IL1-IL8 as there are outlet links OL1-OL8, in a symmetrical network they are the same.

Just like networks of 300A, 300B and 300C, for all the networks 300D, 300E, 300F, 300G, 300H, 300I and 300J of FIG. 3D, FIG. 3E, FIG. 3F, FIG. 3G, FIG. 3H, FIG. 3I, and FIG. 3J, each of the N/d input switches IS1-IS4 are connected to exactly 3xd switches in middle stage 130 through 3xd links.

Each of the N/d middle switches MS(1,1)-MS(1,4) in the middle stage 130 are connected from exactly d input switches through 3xd links and also are connected to exactly d switches in middle stage 140 through 3xd links.

Similarly each of the N/d middle switches MS(2,1)-MS(2,4) in the middle stage 140 are connected from exactly d switches in middle stage 130 through 3xd links and also are connected to exactly d switches in middle stage 150 through 3xd links.

Similarly each of the N/d middle switches MS(3,1)-MS(3,4) in the middle stage 150 are connected from exactly d switches in middle stage 140 through 3xd links and also are connected to exactly d output switches in output stage 120 through 3xd links.

Each of the N/d output switches OS1-OS4 are connected from exactly 3xd switches in middle stage 150 through 3xd links.

In all the ten embodiments of FIG. 3A to FIG. 3J the connection topology is different. That is the way the links ML(1,1)-ML(1,24), ML(2,1)-ML(2,24), ML(3,1)-ML(3,24), and ML(4,1)-ML(4,24) are connected between the respective stages is different. Even though only ten embodiments are illustrated, in general, the network $V_{mlink}(N, d, s)$ can comprise any arbitrary type of connection topology. For example the connection topology of the network $V_{mlink}(N, d, s)$ may be back to back Benes networks, Delta Networks and many more combinations. The applicant notes that the fundamental property of a valid connection topology of the $V_{mlink}(N, d, s)$ network is, when no connections are setup from any input link all the output links should be reachable. Based on this property numerous embodiments of the network $V_{mlink}(N, d, s)$ can be built. The ten embodiments of FIG. 3A to FIG. 3J are only three examples of network $V_{mlink}(N, d, s)$.

In all the ten embodiments of FIG. 3A to FIG. 3J, each of the links ML(1,1)-ML(1,24), ML(2,1)-ML(2,24), ML(3,1)-ML(3,24) and ML(4,1)-ML(4,24) are either available for use by a new connection or not available if currently used by an existing connection. The input switches IS1-IS4 are also referred to as the network input ports. The input stage 110 is often referred to as the first stage. The output switches OS1-OS4 are also referred to as the network output ports. The output stage 120 is often referred to as the last stage. The middle stage switches MS(1,1)-MS(1,4), MS(2,1)-MS(2,4), and MS(3,1)-MS(3,4) are referred to as middle switches or middle ports.

In the example illustrated in FIG. 3A (or in FIG. 1B to FIG. 3J), a fan-out of four is possible to satisfy a multicast connection request if input switch is IS2, but only two switches in middle stage 130 will be used. Similarly, although a fan-out of three is possible for a multicast connection request if the input switch is IS1, again only a fan-out of two is used. The specific middle switches that are chosen in middle stage 130 when selecting a fan-out of two is irrelevant so long as at most two middle switches are selected to ensure that the connection request is satisfied. In essence, limiting the fan-out from input switch to no more than two middle switches permits the network 300A (or 300B to 300J), to be operated in strictly nonblocking manner in accordance with the invention.

The connection request of the type described above can be unicast connection request, a multicast connection request or a broadcast connection request, depending on the example. In case of a unicast connection request, a fan-out of one is used, i.e. a single middle stage switch in middle stage 130 is used to satisfy the request. Moreover, although in the above-described embodiment a limit of two has been placed on the fan-out into the middle stage switches in middle stage 130, the limit can be greater depending on the number of middle stage switches in a network (while maintaining the strictly nonblocking nature of operation of the network for multicast connections). However any arbitrary fan-out may be used within any of the middle stage switches and the output stage switches to satisfy the connection request.

Generalized Symmetric SNB Embodiments:

Network 300K of FIG. 3K is an example of general symmetrical multi-link multi-stage network $V_{mlink}(N, d, s)$ with $(2 \times \log_d N) - 1$ stages. The general symmetrical multi-link multi-stage network $V_{mlink}(N, d, s)$ can be operated in strictly nonblocking manner for multicast when $s \geq 3$ according to the current invention (and in the example of FIG. 3K, $s=3$). The general symmetrical multi-link multi-stage network $V_{mlink}(N, d, s)$ with $(2 \times \log_d N) - 1$ stages has d inlet links for each of N/d input switches IS1-IS(N/d) (for example the links IL1-IL(d) to the input switch IS1) and 3xd outgoing links for each of N/d input switches IS1-IS(N/d) (for example the links ML(1,1)-ML(1,3d) to the input switch IS1). There are d outlet links for each of N/d output switches OS1-OS(N/d) (for example the links OL1-OL(d) to the output switch OS1) and 3xd incoming links for each of N/d output switches OS1-OS(N/d) (for example ML(2xLog_dN-2,1)-ML(2xLog_dN-2,3xd) to the output switch OS1).

Each of the N/d input switches IS1-IS(N/d) are connected to exactly d switches in middle stage 130 through 3xd links.

Each of the N/d middle switches MS(1,1)-MS(1,N/d) in the middle stage 130 are connected from exactly d input switches through 3xd links and also are connected to exactly d switches in middle stage 140 through 3xd links.

Similarly each of the N/d middle switches

$$MS(\text{Log}_d N - 1, 1) - MS\left(\text{Log}_d N - 1, \frac{N}{d}\right)$$

in the middle stage **130**+10*(Log_d N-2) are connected from exactly d switches in middle stage **130**+10*(Log_d N-3) through 3×d links and also are connected to exactly d switches in middle stage **130**+10*(Log_d N-1) through 3×d links.

Similarly each of the N/d middle switches

$$MS(2 \times \text{Log}_d N - 3, 1) - MS\left(2 \times \text{Log}_d N - 3, \frac{N}{d}\right)$$

in the middle stage **130**+10*(2*Log_d N-4) are connected from exactly d switches in middle stage **130**+10*(2*Log_d N-5) through 3×d links and also are connected to exactly d output switches in output stage **120** through 3×d links.

Each of the N/d output switches OS1-OS(N/d) are connected from exactly d switches in middle stage **130**+10*(2*Log_d N-4) through 3×d links.

As described before, again the connection topology of a general V_{mlink}(N, d, s) may be any one of the connection topologies. For example the connection topology of the network V_{mlink}(N, d, s) may be back to back inverse Benes networks, back to back Omega networks, back to back Benes networks, Delta Networks and many more combinations. The applicant notes that the fundamental property of a valid connection topology of the general V_{mlink}(N, d, s) network is, when no connections are setup from any input link if any output link should be reachable. Based on this property numerous embodiments of the network V_{mlink}(N, d, s) can be built. The embodiments of FIG. 3A to FIG. 3J are ten examples of network V_{mlink}(N, d, s).

The general symmetrical multi-link multi-stage network V_{mlink}(N, d, s) can be operated in strictly nonblocking manner for multicast when s≥3 according to the current invention.

Every switch in the multi-link multi-stage networks discussed herein has multicast capability. In a V_{mlink}(N, d, s) network, if a network inlet link is to be connected to more than one outlet link on the same output switch, then it is only necessary for the corresponding input switch to have one path to that output switch. This follows because that path can be multicast within the output switch to as many outlet links as necessary. Multicast assignments can therefore be described in terms of connections between input switches and output switches. An existing connection or a new connection from an input switch to r' output switches is said to have fan-out r'. If all multicast assignments of a first type, wherein any inlet link of an input switch is to be connected in an output switch to at most one outlet link are realizable, then multicast assignments of a second type, wherein any inlet link of each input switch is to be connected to more than one outlet link in the same output switch, can also be realized. For this reason, the following discussion is limited to general multicast connections of the first type

$$\left(\text{with fan-out } r', 1 \leq r' \leq \frac{N}{d}\right)$$

although the same discussion is applicable to the second type.

To characterize a multicast assignment, for each inlet link

$$i \in \left\{1, 2, \dots, \frac{N}{d}\right\},$$

let I_i=O, where

$$o \in \left\{1, 2, \dots, \frac{N}{d}\right\},$$

denote the subset of output switches to which inlet link i is to be connected in the multicast assignment. For example, the network of FIG. 3C shows an exemplary five-stage network, namely V_{mlink}(**8,2,3**), with the following multicast assignment I₁=**{1,4}** and all other I_j=∅ for j=**[2-8]**. It should be noted that the connection I₁ fans out in the first stage switch IS1 into middle switches MS(1,1) and MS(1,2) in middle stage **130**, and fans out in middle switches MS(1,1) and MS(1,2) only once into middle switches MS(2,1) and MS(2,3) respectively in middle stage **140**.

The connection I₁ also fans out in middle switches MS(2,1) and MS(2,3) only once into middle switches MS(3,1) and MS(3,4) respectively in middle stage **150**. The connection I₁ also fans out in middle switches MS(3,1) and MS(3,4) only once into output switches OS1 and OS4 in output stage **120**. Finally the connection I₁ fans out once in the output stage switch OS1 into outlet link OL1 and in the output stage switch OS4 twice into the outlet links OL7 and OL8. In accordance with the invention, each connection can fan out in the input stage switch into at most two middle stage switches in middle stage **130**.

Asymmetric SNB (N₂>N₁) Embodiments:

Referring to FIG. 3A1, in one embodiment, an exemplary asymmetrical multi-link multi-stage network **300A1** with five stages of twenty switches for satisfying communication requests, such as setting up a telephone call or a data call, or a connection between configurable logic blocks, between an input stage **110** and output stage **120** via middle stages **130**, **140**, and **150** is shown where input stage **110** consists of four, two by six switches IS1-IS4 and output stage **120** consists of four, eight by six switches OS1-OS4. And all the middle stages namely middle stage **130** consists of four, six by six switches MS(1,1)-MS(1,4), middle stage **140** consists of four, six by six switches MS(2,1)-MS(2,4), and middle stage **150** consists of four, four by eight switches MS(3,1)-MS(3,4).

Such a network can be operated in strictly non-blocking manner for multicast connections, because the switches in the input stage **110** are of size two by six, the switches in output stage **120** are of size eight by six, and there are four switches in each of middle stage **130**, middle stage **140** and middle stage **150**.

In one embodiment of this network each of the input switches IS1-IS4 and output switches OS1-OS4 are crossbar switches. The number of switches of input stage **110** and of output stage **120** can be denoted in general with the variable

$$\frac{N_1}{d},$$

where N₁ is the total number of inlet links or and N₂ is the total number of outlet links and N₂>N₁ and N₂=p*N₁ where p>1.

75

The number of middle switches in each middle stage is denoted by

$$\frac{N_1}{d}$$

The size of each input switch IS1-IS4 can be denoted in general with the notation $d \times 3d$ and each output switch OS1-OS4 can be denoted in general with the notation $(2d+d_2) \times d_2$, where

$$d_2 = N_2 \times \frac{d}{N_1} = p \times d.$$

The size of each switch in any of the middle stages excepting the last middle stage can be denoted as $3d \times 3d$. The size of each switch in the last middle stage can be denoted as $3d \times (2d+d_2)$. A switch as used herein can be either a crossbar switch, or a network of switches each of which in turn may be a crossbar switch or a network of switches. An asymmetric multi-link multi-stage network can be represented with the notation $V_{link}(N_1, N_2, d, s)$, where N_1 represents the total number of inlet links of all input switches (for example the links IL1-IL8), N_2 represents the total number of outlet links of all output switches (for example the links OL1-OL24), d represents the inlet links of each input switch where $N_2 > N_1$, and s is the ratio of number of outgoing links from each input switch to the inlet links of each input switch.

Each of the

$$\frac{N_1}{d}$$

input switches IS1-IS4 are connected to exactly d switches in middle stage 130 through $3 \times d$ links (for example input switch IS1 is connected to middle switch MS(1,1) through the links ML(1,1), ML(1,2), and ML(1,3); and also to middle switch MS(1,2) through the links ML(1,4), ML(1,5), and ML(1,6)).

Each of the

$$\frac{N_1}{d}$$

middle switches MS(1,1)-MS(1,4) in the middle stage 130 are connected from exactly d input switches through $3 \times d$ links (for example the links ML(1,1), ML(1,2), and ML(1,3) are connected to the middle switch MS(1,1) from input switch IS1, and the links ML(1,13), ML(1,14), and ML(1,15) are connected to the middle switch MS(1,1) from input switch IS3) and also are connected to exactly d switches in middle stage 140 through $3 \times d$ links (for example the links ML(2,1), ML(2,2), and ML(2,3) are connected from middle switch MS(1,1) to middle switch MS(2,1); and the links ML(2,4), ML(2,5), and ML(2,6) are connected from middle switch MS(1,1) to middle switch MS(2,2)).

Similarly each of the

$$\frac{N_1}{d}$$

76

middle switches MS(2,1)-MS(2,4) in the middle stage 140 are connected from exactly d switches in middle stage 130 through $3 \times d$ links (for example the links ML(2,1), ML(2,2), and ML(2,3) are connected to the middle switch MS(2,1) from middle switch MS(1,1), and the links ML(2,13), ML(2,14), and ML(2,15) are connected to the middle switch MS(2,1) from middle switch MS(1,3)) and also are connected to exactly d switches in middle stage 150 through $3 \times d$ links (for example the links ML(3,1), ML(3,2), and ML(3,3) are connected from middle switch MS(2,1) to middle switch MS(3,1), and the links ML(3,4), ML(3,5) and ML(3,6) are connected from middle switch MS(2,1) to middle switch MS(3,2)).

Similarly each of the

$$\frac{N_1}{d}$$

middle switches MS(3,1)-MS(3,4) in the middle stage 150 are connected from exactly d switches in middle stage 140 through $3 \times d$ links (for example the links ML(3,1), ML(3,2), and ML(3,3) are connected to the middle switch MS(3,1) from middle switch MS(2,1), and the links ML(3,13), ML(3,14), and ML(3,15) are connected to the middle switch MS(3,1) from middle switch MS(2,3)) and also are connected to exactly

$$\frac{2d + d_2}{3}$$

output switches in output stage 120 through $2d+d_1$ links (For example the links ML(4,1), ML(4,2), and ML(4,3) are connected to output switch OS1 from Middle switch MS(3,1); the links ML(4,4), ML(4,5), and ML(4,6) are connected to output switch OS2 from middle switch MS(3,1); the links ML(4,7), ML(4,8), and ML(4,9) are connected to output switch OS3 from Middle switch MS(3,1); the links ML(4,10), ML(4,11), and ML(4,12) are connected to output switch OS2 from middle switch MS(3,1)).

Each of the

$$\frac{N_1}{d}$$

output switches ON1-OS4 are connected from exactly

$$\frac{2d + d_2}{3}$$

switches in middle stage 150 through $2d+d_2$ links (for example output switch OS1 is connected from middle switch MS(3,1) through the links ML(4,1), ML(4,2), and ML(4,3); output switch OS1 is also connected from middle switch MS(3,2) through the links ML(4,16), ML(4,17), and ML(4,18); output switch OS1 is connected from middle switch MS(3,3) through the links ML(4,28), ML(4,29), and ML(4,30); and output switch OS1 is also connected from middle switch MS(3,4) through the links ML(4,43), ML(4,44), and ML(4,45)).

Finally the connection topology of the network 300A1 shown in FIG. 3A1 is known to be back to back inverse Benes connection topology.

Referring to FIG. 3B1, in one embodiment, an exemplary asymmetrical multi-link multi-stage network 300B1 with five stages of twenty switches for satisfying communication requests, such as setting up a telephone call or a data call, or a connection between configurable logic blocks, between an input stage 110 and output stage 120 via middle stages 130, 140, and 150 is shown where input stage 110 consists of four, two by six switches IS1-IS4 and output stage 120 consists of four, eight by six switches OS1-OS4. And all the middle stages namely middle stage 130 consists of four, six by six switches MS(1,1)-MS(1,4), middle stage 140 consists of four, six by six switches MS(2,1)-MS(2,4), and middle stage 150 consists of four, four by eight switches MS(3,1)-MS(3,4).

Such a network can be operated in strictly non-blocking manner for multicast connections, because the switches in the input stage 110 are of size two by six, the switches in output stage 120 are of size eight by six, and there are four switches in each of middle stage 130, middle stage 140 and middle stage 150.

In one embodiment of this network each of the input switches IS1-IS4 and output switches OS1-OS4 are crossbar switches. The number of switches of input stage 110 and of output stage 120 can be denoted in general with the variable

$$\frac{N_1}{d},$$

where N_1 is the total number of inlet links or and N_2 is the total number of outlet links and $N_2 > N_1$ and $N_2 = p * N_1$ where $p > 1$. The number of middle switches in each middle stage is denoted by

$$\frac{N_1}{d}.$$

The size of each input switch IS1-IS4 can be denoted in general with the notation $d * 3d$ and each output switch OS1-OS4 can be denoted in general with the notation $(2d + d_2) * d_2$, where

$$d_2 = N_2 \times \frac{d}{N_1} = p \times d.$$

The size of each switch in any of the middle stages excepting the last middle stage can be denoted as $3d * 3d$. The size of each switch in the last middle stage can be denoted as $2d * (2d + d_2)$. A switch as used herein can be either a crossbar switch, or a network of switches each of which in turn may be a crossbar switch or a network of switches. An asymmetric multi-link multi-stage network can be represented with the notation $V_{mlink}(N_1, N_2, d, s)$, where N_1 represents the total number of inlet links of all input switches (for example the links IL1-IL8), N_2 represents the total number of outlet links of all output switches (for example the links OL1-OL24), d represents the inlet links of each input switch where $N_2 > N_1$, and s is the ratio of number of outgoing links from each input switch to the inlet links of each input switch.

Each of the

$$\frac{N_1}{d}$$

input switches IS1-IS4 are connected to exactly $3 \times d$ switches in middle stage 130 through $3 \times d$ links (for example input switch IS1 is connected to middle switch MS(1,1) through the links ML(1,1), ML(1,2), and ML(1,3); and also to middle switch MS(1,2) through the links ML(1,4), ML(1,5), and ML(1,6)).

Each of the

$$\frac{N_1}{d}$$

middle switches MS(1,1)-MS(1,4) in the middle stage 130 are connected from exactly d input switches through $3 \times d$ links (for example the links ML(1,1), ML(1,2), and ML(1,3) are connected to the middle switch MS(1,1) from input switch IS1, and the links ML(1,13), ML(1,14), and ML(1,15) are connected to the middle switch MS(1,1) from input switch IS3) and also are connected to exactly d switches in middle stage 140 through $3 \times d$ links (for example the links ML(2,1), ML(2,2), and ML(2,3) are connected from middle switch MS(1,1) to middle switch MS(2,1); and the links ML(2,4), ML(2,5), and ML(2,6) are connected from middle switch MS(1,1) to middle switch MS(2,2)).

Similarly each of the

$$\frac{N_1}{d}$$

middle switches MS(2,1)-MS(2,4) in the middle stage 140 are connected from exactly d switches in middle stage 130 through $3 \times d$ links (for example the links ML(2,1), ML(2,2), and ML(2,3) are connected to the middle switch MS(2,1) from middle switch MS(1,1), and the links ML(2,13), ML(2,14), and ML(2,15) are connected to the middle switch MS(2,1) from middle switch MS(1,3)) and also are connected to exactly d switches in middle stage 150 through $3 \times d$ links (for example the links ML(3,1), ML(3,2), and ML(3,3) are connected from middle switch MS(2,1) to middle switch MS(3,1), and the links ML(3,4), ML(3,5) and ML(3,6) are connected from middle switch MS(2,1) to middle switch MS(3,2)).

Similarly each of the

$$\frac{N_1}{d}$$

middle switches MS(3,1)-MS(3,4) in the middle stage 150 are connected from exactly d switches in middle stage 140 through $3 \times d$ links (for example the links ML(3,1), ML(3,2), and ML(3,3) are connected to the middle switch MS(3,1) from middle switch MS(2,1), and the links ML(3,13), ML(3,14), and ML(3,15) are connected to the middle switch MS(3,

79

1) from middle switch MS(2,3)) and also are connected to exactly

$$\frac{2d + d_2}{3}$$

output switches in output stage 120 through 2d+d₂ links (For example the links ML(4,1), ML(4,2), and ML(4,3) are connected to output switch OS1 from Middle switch MS(3,1); the links ML(4,4), ML(4,5), and ML(4,6) are connected to output switch OS2 from middle switch MS(3,1); the links ML(4,7), ML(4,8), and ML(4,9) are connected to output switch OS3 from Middle switch MS(3,1); the links ML(4,10), ML(4,11), and ML(4,12) are connected to output switch OS2 from middle switch MS(3,1)).

Each of the

$$\frac{N_1}{d}$$

output switches OS1-OS4 are connected from exactly

$$\frac{2d + d_2}{3}$$

switches in middle stage 150 through 2d+d₂ links (for example output switch OS1 is connected from middle switch MS(3,1) through the links ML(4,1), ML(4,2), and ML(4,3); output switch OS1 is also connected from middle switch MS(3,2) through the links ML(4,16), ML(4,17), and ML(4,18); output switch OS1 is connected from middle switch MS(3,3) through the links ML(4,28), ML(4,29), and ML(4,30); and output switch OS1 is also connected from middle switch MS(3,4) through the links ML(4,43), ML(4,44), and ML(4,45)).

Finally the connection topology of the network 300B1 shown in FIG. 3B1 is known to be back to back Omega connection topology.

Referring to FIG. 3C1, in one embodiment, an exemplary asymmetrical multi-link multi-stage network 300C1 with five stages of twenty switches for satisfying communication requests, such as setting up a telephone call or a data call, or a connection between configurable logic blocks, between an input stage 110 and output stage 120 via middle stages 130, 140, and 150 is shown where input stage 110 consists of four, two by six switches IS1-IS4 and output stage 120 consists of four, eight by six switches OS1-OS4. And all the middle stages namely middle stage 130 consists of four, six by six switches MS(1,1)-MS(1,4), middle stage 140 consists of four, six by six switches MS(2,1)-MS(2,4), and middle stage 150 consists of four, four by eight switches MS(3,1)-MS(3,4).

Such a network can be operated in strictly non-blocking manner for multicast connections, because the switches in the input stage 110 are of size two by six, the switches in output stage 120 are of size eight by six, and there are four switches in each of middle stage 130, middle stage 140 and middle stage 150.

In one embodiment of this network each of the input switches IS1-IS4 and output switches OS1-OS4 are crossbar

80

switches. The number of switches of input stage 110 and of output stage 120 can be denoted in general with the variable

$$\frac{N_1}{d}$$

where N₁ is the total number of inlet links or and N₂ is the total number of outlet links and N₂>N₁ and N₂=p*N₁ where p>1. The number of middle switches in each middle stage is denoted by

$$\frac{N_1}{d}$$

The size of each input switch IS1-IS4 can be denoted in general with the notation d*3d and each output switch OS1-OS4 can be denoted in general with the notation (2d+d₂)*d₂, where

$$d_2 = N_2 \times \frac{d}{N_1} = p \times d.$$

The size of each switch in any of the middle stages excepting the last middle stage can be denoted as 3d*3d. The size of each switch in the last middle stage can be denoted as 2d*(2d+d₂). A switch as used herein can be either a crossbar switch, or a network of switches each of which in turn may be a crossbar switch or a network of switches. An asymmetric multi-link multi-stage network can be represented with the notation V_{mlink}(N₁, N₂, d, s), where N₁ represents the total number of inlet links of all input switches (for example the links IL1-IL8), N₂ represents the total number of outlet links of all output switches (for example the links OL1-OL24), d represents the inlet links of each input switch where N₂>N₁, and s is the ratio of number of outgoing links from each input switch to the inlet links of each input switch.

Each of the

$$\frac{N_1}{d}$$

input switches IS1-IS4 are connected to exactly 3*d switches in middle stage 130 through 3*d links (for example input switch IS1 is connected to middle switch MS(1,1) through the links ML(1,1), ML(1,2), and ML(1,3); and also to middle switch MS(1,2) through the links ML(1,4), ML(1,5), and ML(1,6)).

Each of the

$$\frac{N_1}{d}$$

middle switches MS(1,1)-MS(1,4) in the middle stage 130 are connected from exactly d input switches through 3*d links (for example the links ML(1,1), ML(1,2), and ML(1,3) are connected to the middle switch MS(1,1) from input switch IS1, and the links ML(1,22), ML(1,23), and ML(1,24) are connected to the middle switch MS(1,1) from input switch IS4) and also are connected to exactly d switches in middle stage 140 through 3*d links (for example the links ML(2,1),

81

ML(2,2), and ML(2,3) are connected from middle switch MS(1,1) to middle switch MS(2,1), and the links ML(2,4), ML(2,5), and ML(2,6) are connected from middle switch MS(1,1) to middle switch MS(2,2)).

Similarly each of the

$$\frac{N_1}{d}$$

middle switches MS(2,1)-MS(2,4) in the middle stage 140 are connected from exactly d switches in middle stage 130 through 3xd links (for example the links ML(2,1), ML(2,2), and ML(2,3) are connected to the middle switch MS(2,1) from middle switch MS(1,1), and the links ML(2,22), ML(2,23), and ML(2,24) are connected to the middle switch MS(2,1) from middle switch MS(1,4)) and also are connected to exactly d switches in middle stage 150 through 3xd links (for example the links ML(3,1), ML(3,2), and ML(3,3) are connected from middle switch MS(2,1) to middle switch MS(3,1), and the links ML(3,4), ML(3,5), and ML(3,6) are connected from middle switch MS(2,1) to middle switch MS(3,2)).

Similarly each of the

$$\frac{N_1}{d}$$

middle switches MS(3,1)-MS(3,4) in the middle stage 150 are connected from exactly d switches in middle stage 140 through 3xd links (for example the links ML(3,1), ML(3,2), and ML(3,3) are connected to the middle switch MS(3,1) from middle switch MS(2,1), and the links ML(3,22), ML(3,23), and ML(3,24) are connected to the middle switch MS(3,1) from middle switch MS(2,4)) and also are connected to exactly

$$\frac{2d + d_2}{3}$$

output switches in output stage 120 through 2d+d₂ links

(For example the links ML(4,1), ML(4,2), and ML(4,3) are connected to output switch OS1 from Middle switch MS(3,1); the links ML(4,4), ML(4,5), and ML(4,6) are connected to output switch OS2 from middle switch MS(3,1); the links ML(4,7), ML(4,8), and ML(4,9) are connected to output switch OS3 from Middle switch MS(3,1); the links ML(4,10), ML(4,11), and ML(4,12) are connected to output switch OS2 from middle switch MS(3,1)).

Each of the

$$\frac{N_1}{d}$$

output switches OS1-OS4 are connected from exactly

$$\frac{2d + d_2}{3}$$

switches in middle stage 150 through 2d+d₂ links (for example output switch OS1 is connected from middle switch

82

MS(3,1) through the links ML(4,1), ML(4,2), and ML(4,3); output switch OS1 is also connected from middle switch MS(3,2) through the links ML(4,16), ML(4,17), and ML(4,18); output switch OS1 is connected from middle switch MS(3,3) through the links ML(4,28), ML(4,29), and ML(4,30); and output switch OS1 is also connected from middle switch MS(3,4) through the links ML(4,43), ML(4,44), and ML(4,45)).

Finally the connection topology of the network 300C1 shown in FIG. 3C1 is hereinafter called nearest neighbor connection topology.

Similar to network 300A1 of FIG. 3A1, 300B1 of FIG. 3B1, and 300C1 of FIG. 3C1, referring to FIG. 3D1, FIG. 3E1, FIG. 3F1, FIG. 3G1, FIG. 3H1, FIG. 3I1 and FIG. 3J1 with exemplary asymmetrical multi-link multi-stage networks 300D1, 300E1, 300F1, 300G1, 300H1, 300I1, and 300J1 respectively with five stages of twenty switches for satisfying communication requests, such as setting up a telephone call or a data call, or a connection between configurable logic blocks, between an input stage 110 and output stage 120 via middle stages 130, 140, and 150 is shown where input stage 110 consists of four, two by six switches IS1-IS4 and output stage 120 consists of four, six by two switches OS1-OS4. And all the middle stages namely middle stage 130 consists of four, six by six switches MS(1,1)-MS(1,4), middle stage 140 consists of four, six by six switches MS(2,1)-MS(2,4), and middle stage 150 consists of four, six by six switches MS(3,1)-MS(3,4).

Such a network can be operated in strictly non-blocking manner for multicast connections, because the switches in the input stage 110 are of size two by six, the switches in output stage 120 are of size six by two, and there are four switches in each of middle stage 130, middle stage 140 and middle stage 150.

The networks 300D1, 300E1, 300F1, 300G1, 300H1, 300I1 and 300J1 of FIG. 3D1, FIG. 3E1, FIG. 3F1, FIG. 3G1, FIG. 3H1, FIG. 3I1, and FIG. 3J1 are also embodiments of asymmetric multi-link multi-stage network can be represented with the notation $V_{min}(N_1, N_2, d, s)$, where N_1 represents the total number of inlet links of all input switches (for example the links IL1-IL8), N_2 represents the total number of outlet links of all output switches (for example the links OL1-OL24), d represents the inlet links of each input switch where $N_2 > N_1$, and s is the ratio of number of outgoing links from each input switch to the inlet links of each input switch.

Just like networks of 300A1, 300B1 and 300C1, for all the networks 300D1, 300E1, 300F1, 300G1, 300H1, 300I1 and 300J1 of FIG. 3D1, FIG. 3E1, FIG. 3F1, FIG. 3G1, FIG. 3H1, FIG. 3I1, and FIG. 3J1, each of the

$$\frac{N_1}{d}$$

input switches IS1-IS4 are connected to exactly d switches in middle stage 130 through 3xd links.

Each of the

$$\frac{N_1}{d}$$

middle switches MS(1,1)-MS(1,4) in the middle stage 130 are connected from exactly d input switches through 3xd links and also are connected to exactly d switches in middle stage 140 through 3xd links.

83

Similarly each of the

$$\frac{N_1}{d}$$

middle switches MS(2,1)-MS(2,4) in the middle stage 140 are connected from exactly d switches in middle stage 130 through 3xd links and also are connected to exactly d switches in middle stage 150 through 3xd links.

Similarly each of the

$$\frac{N_1}{d}$$

middle switches MS(3,1)-MS(3,4) in the middle stage 150 are connected from exactly d switches in middle stage 140 through 3xd links and also are connected to exactly

$$\frac{2d + d_2}{3}$$

output switches in output stage 120 through 2d+d links. Each of the

$$\frac{N_1}{d}$$

output switches OS1-OS4 are connected from exactly

$$\frac{2d + d_2}{3}$$

switches in middle stage 150 through 2d+d₂ links

In all the ten embodiments of FIG. 3A1 to FIG. 3J1 the connection topology is different. That is the way the links ML(1,1)-ML(1,24), ML(2,1)-ML(2,24), ML(3,1)-ML(3,24), and ML(4,1)-ML(4,48) are connected between the respective stages is different. Even though only ten embodiments are illustrated, in general, the network V_{mlink}(N₁, N₂, d, s) can comprise any arbitrary type of connection topology. For example the connection topology of the network V_{mlink}(N₁, N₂, d, s) may be back to back Benes networks, Delta Networks and many more combinations. The applicant notes that the fundamental property of a valid connection topology of the V_{mlink}(N₁, N₂, d, s) network is, when no connections are setup from any input link all the output links should be reachable. Based on this property numerous embodiments of the network V_{mlink}(N₁, N₂, d, s) can be built. The ten embodiments of FIG. 3A1 to FIG. 3J1 are only three examples of network V_{mlink}(N₁, N₂, d, s).

In all the ten embodiments of FIG. 3A1 to FIG. 3J1, each of the links ML(1,1)-ML(1,24), ML(2,1)-ML(2,24), ML(3,1)-ML(3,24) and ML(4,1)-ML(4,48) are either available for use by a new connection or not available if currently used by an existing connection. The input switches IS1-IS4 are also referred to as the network input ports. The input stage 110 is often referred to as the first stage. The output switches OS1-OS4 are also referred to as the network output ports. The output stage 120 is often referred to as the last stage. The

84

middle stage switches MS(1,1)-MS(1,4), MS(2,1)-MS(2,4), and MS(3,1)-MS(3,4) are referred to as middle switches or middle ports.

In the example illustrated in FIG. 3A1 (or in FIG. 3B1 to FIG. 3J1), a fan-out of four is possible to satisfy a multicast connection request if input switch is IS2, but only two switches in middle stage 130 will be used. Similarly, although a fan-out of three is possible for a multicast connection request if the input switch is IS1, again only a fan-out of two is used. The specific middle switches that are chosen in middle stage 130 when selecting a fan-out of two is irrelevant so long as at most two middle switches are selected to ensure that the connection request is satisfied. In essence, limiting the fan-out from input switch to no more than two middle switches permits the network 300A1 (or 300B1 to 300J1), to be operated in strictly nonblocking manner in accordance with the invention.

The connection request of the type described above can be unicast connection request, a multicast connection request or a broadcast connection request, depending on the example. In case of a unicast connection request, a fan-out of one is used, i.e. a single middle stage switch in middle stage 130 is used to satisfy the request. Moreover, although in the above-described embodiment a limit of two has been placed on the fan-out into the middle stage switches in middle stage 130, the limit can be greater depending on the number of middle stage switches in a network (while maintaining the strictly nonblocking nature of operation of the network for multicast connections). However any arbitrary fan-out may be used within any of the middle stage switches and the output stage switches to satisfy the connection request.

Generalized Asymmetric SNB (N₂>N₁) Embodiments:

Network 300K1 of FIG. 3K1 is an example of general asymmetrical multi-link multi-stage network V_{mlink}(N₁, N₂, d, s) with (2xlog_d N₁)-1 stages where N₂>N₁ and N=p*N₁ where p>1. In network 300K1 of FIG. 3K1, N₁=N and N₂=p*N. The general asymmetrical multi-link multi-stage network V_{mlink}(N₁, N₂, d, s) can be operated in strictly non-blocking manner for multicast when 3 according to the current invention (and in the example of FIG. 3K1, s=3). The general asymmetrical multi-link multi-stage network V_{mlink}(N₁, N₂, d, s) with (2xlog_d N₁)-1 stages has d inlet links for each of

$$\frac{N_1}{d}$$

input switches IS1-IS(N₁/d) (for example the links IL1-IL(d) to the input switch IS1) and 3xd outgoing links for each of

$$\frac{N_1}{d}$$

input switches IS1-IS(N₁/d) (for example the links ML(1,1)-ML(1,3d) to the input switch IS1). There are d₂

$$\left(\text{where } d_2 = N_2 \times \frac{d}{N_1} = p \times d \right)$$

85

outlet links for each of

$$\frac{N_1}{d}$$

output switches OS1-OS(N₁/d) (for example the links OL1-OL(p*d) to the output switch OS1) and 2d+d₂ (=2d+p*d) incoming links for each of

$$\frac{N_1}{d}$$

output switches OS1-OS(N₁/d) (for example ML(2*Log_d N₁-2,1)-ML(2*Log_d N₁-2,2d+d₂) to the output switch OS1).

Each of the

$$\frac{N_1}{d}$$

input switches IS1-IS(N₁/d) are connected to exactly 3*d switches in middle stage 130 through 3*d links.

Each of the

$$\frac{N_1}{d}$$

middle switches MS(1,1)-MS(1,N₁/d) in the middle stage 130 are connected from exactly d input switches through 3*d links and also are connected to exactly d switches in middle stage 140 through 3*d links.

Similarly each of the

$$\frac{N_1}{d}$$

middle switches

$$MS(\text{Log}_d N_1 - 1, 1) - MS\left(\text{Log}_d N_1 - 1, \frac{N_1}{d}\right)$$

in the middle stage 130+10*(Log_d N₁-2) are connected from exactly d switches in middle stage 130+10*(Log_d N₁-3) through 3*d links and also are connected to exactly d switches in middle stage 130+10*(Log_d N₁-1) through 3*d links.

Similarly each of the

$$\frac{N_1}{d}$$

middle switches

$$MS(2 \times \text{Log}_d N_1 - 3, 1) - MS\left(2 \times \text{Log}_d N_1 - 3, \frac{N_1}{d}\right)$$

86

in the middle stage 130+10*(2*Log_d N₁-4) are connected from exactly d switches in middle stage 130+10*(2*Log_d N₁-5) through 3*d links and also are connected to exactly

$$\frac{2d + d_2}{3}$$

output switches in output stage 120 through 2d+d₂ links. Each of the

$$\frac{N_1}{d}$$

output switches OS1-OS(N₁/d) are connected from exactly

$$\frac{2d + d_2}{3}$$

switches in middle stage 130+10*(2*Log_d N₁-4) through 2d+d₂ links.

As described before, again the connection topology of a general V_{mlink}(N₁, N₂, d, s) may be any one of the connection topologies. For example the connection topology of the network V_{mlink}(N₁, N₂, d, s) may be back to back inverse Benes networks, back to back Omega networks, back to back Benes networks, Delta Networks and many more combinations. The applicant notes that the fundamental property of a valid connection topology of the general V_{mlink}(N₁, N₂, d, s) network is, when no connections are setup from any input link if any output link should be reachable. Based on this property numerous embodiments of the network V_{mlink}(N₁, N₂, d, s) can be built. The embodiments of FIG. 3A1 to FIG. 3J1 are ten examples of network V_{mlink}(N₁, N₂, d, s) for s=3 and N₂>N₁.

The general symmetrical multi-link multi-stage network V_{mlink}(N₁, N₂, d, s) can be operated in strictly nonblocking manner for multicast when 3 according to the current invention.

For example, the network of FIG. 3C1 shows an exemplary five-stage network, namely V_{mlink}(8,24,2,3), with the following multicast assignment I₁={1,4} and all other I_j=∅ for j=[2-8]. It should be noted that the connection I₁ fans out in the first stage switch IS1 into middle switches MS(1,1) and MS(1,2) in middle stage 130, and fans out in middle switches MS(1,1) and MS(1,2) only once into middle switches MS(2,1) and MS(2,3) respectively in middle stage 140.

The connection I₁ also fans out in middle switches MS(2,1) and MS(2,3) only once into middle switches MS(3,1) and MS(3,4) respectively in middle stage 150. The connection I₁ also fans out in middle switches MS(3,1) and MS(3,4) only once into output switches OS1 and OS4 in output stage 120. Finally the connection I₁ fans out once in the output stage switch OS1 into outlet link OL2 and in the output stage switch OS4 twice into the outlet links OL19 and OL21. In accordance with the invention, each connection can fan out in the input stage switch into at most two middle stage switches in middle stage 130.

Asymmetric SNB (N₁>N₂) Embodiments:

Referring to FIG. 3A2, in one embodiment, an exemplary asymmetrical multi-link multi-stage network 300A2 with five stages of twenty switches for satisfying communication requests, such as setting up a telephone call or a data call, or a connection between configurable logic blocks, between an

87

input stage 110 and output stage 120 via middle stages 130, 140, and 150 is shown where input stage 110 consists of four, six by eight switches IS1-IS4 and output stage 120 consists of four, six by two switches OS1-OS4. And all the middle stages namely middle stage 130 consists of four, eight by four switches MS(1,1)-MS(1,4), middle stage 140 consists of four, six by six switches MS(2,1)-MS(2,4), and middle stage 150 consists of four, six by six switches MS(3,1)-MS(3,4).

Such a network can be operated in strictly non-blocking manner for multicast connections, because the switches in the input stage 110 are of size six by eight, the switches in output stage 120 are of size six by two, and there are four switches in each of middle stage 130, middle stage 140 and middle stage 150.

In one embodiment of this network each of the input switches IS1-IS4 and output switches OS1-OS4 are crossbar switches. The number of switches of input stage 110 and of output stage 120 can be denoted in general with the variable

$$\frac{N_2}{d},$$

where N_1 is the total number of inlet links or and N_2 is the total number of outlet links and $N_1 > N_2$ and $N_1 = p * N_2$ where $p > 1$. The number of middle switches in each middle stage is denoted by

$$\frac{N_2}{d}.$$

The size of each input switch IS1-IS4 can be denoted in general with the notation $d_1 * (2d + d_1)$ and each output switch OS1-OS4 can be denoted in general with the notation $3d * d$, where

$$d_1 = N_1 \times \frac{d}{N_2} = p \times d.$$

The size of each switch in any of the middle stages excepting the first middle stage can be denoted as $3d * 3d$. The size of each switch in the first middle stage can be denoted as $(2d + d_1) * 3d$. A switch as used herein can be either a crossbar switch, or a network of switches each of which in turn may be a crossbar switch or a network of switches. An asymmetric multi-link multi-stage network can be represented with the notation $V_{link}(N_1, N_2, d, s)$, where N_1 represents the total number of inlet links of all input switches (for example the links IL1-IL24), N_2 represents the total number of outlet links of all output switches (for example the links OL1-OL8), d represents the inlet links of each input switch where $N_1 > N_2$, and s is the ratio of number of incoming links to each output switch to the outlet links of each output switch.

Each of the

$$\frac{N_2}{d}$$

88

input switches IS1-IS4 are connected to exactly

$$\frac{2d + d_1}{3}$$

switches in middle stage 130 through $2d + d_1$ links (for example input switch IS1 is connected to middle switch MS(1,1) through the links ML(1,1), ML(1,2), and ML(1,3); input switch IS1 is also connected to middle switch MS(1,2) through the links ML(1,4), ML(1,5), and ML(1,6); input switch IS1 is connected to middle switch MS(1,3) through the links ML(1,7), ML(1,8), and ML(1,9); and input switch IS1 is also connected to middle switch MS(1,4) through the links ML(1,10), ML(1,11), and ML(1,12)).

Each of the

$$\frac{N_2}{d}$$

middle switches MS(1,1)-MS(1,4) in the middle stage 130 are connected from exactly

$$\frac{2d + d_1}{3}$$

input switches through $2d + d_1$ links (for example middle switch MS(1,1) is connected from input switch IS1 through the links ML(1,1), ML(1,2), and ML(1,3); middle switch MS(1,1) is connected from input switch IS2 through the links ML(1,16), ML(1,17), and ML(1,18); middle switch MS(1,1) is connected from input switch IS3 through the links ML(1,28), ML(1,29), and ML(1,30); and middle switch MS(1,1) is connected from input switch IS4 through the links ML(1,43), ML(1,44), and ML(1,45)) and also are connected to exactly d switches in middle stage 140 through $3 \times d$ links (for example the links ML(2,1), ML(2,2), and ML(2,3) are connected from middle switch MS(1,1) to middle switch MS(2,1), and the links ML(2,4), ML(2,5), and ML(2,6) are connected from middle switch MS(1,1) to middle switch MS(2,3)).

Similarly each of the

$$\frac{N_2}{d}$$

middle switches MS(2,1)-MS(2,4) in the middle stage 140 are connected from exactly d switches in middle stage 130 through $3 \times d$ links (for example the links ML(2,1), ML(2,2), and ML(2,3) are connected to the middle switch MS(2,1) from middle switch MS(1,1), and the links ML(2,16), ML(2,17), and ML(2,18) are connected to the middle switch MS(2,1) from middle switch MS(1,3)) and also are connected to exactly d switches in middle stage 150 through $3 \times d$ links (for example the links ML(3,1), ML(3,2), and ML(3,3) are connected from middle switch MS(2,1) to middle switch MS(3,1), and the links ML(3,4), ML(3,5), and ML(3,6) are connected from middle switch MS(2,1) to middle switch MS(3,3)).

Similarly each of the

$$\frac{N_2}{d}$$

89

middle switches MS(3,1)-MS(3,4) in the middle stage 150 are connected from exactly d switches in middle stage 140 through 3×d links (for example the links ML(3,1), ML(3,2), and ML(3,3) are connected to the middle switch MS(3,1) from middle switch MS(2,1), and the links ML(3,16), ML(3,17), and ML(3,18) are connected to the middle switch MS(3,1) from middle switch MS(2,3)) and also are connected to exactly d output switches in output stage 120 through 3×d links (for example the links ML(4,1), ML(4,2), and ML(4,3) are connected to output switch OS1 from Middle switch MS(3,1), and the links ML(4,10), ML(4,11), and ML(4,12) are connected to output switch OS2 from middle switch MS(3,1)).

Each of the

$$\frac{N_2}{d}$$

output switches OS1-OS4 are connected from exactly d switches in middle stage 150 through 3×d links (for example output switch OS1 is connected from middle switch MS(3,1) through the links ML(4,1), ML(4,2), and ML(4,3), and output switch OS1 is also connected from middle switch MS(3,2) through the links ML(4,10), ML(4,11) and ML(4,12)).

Finally the connection topology of the network 300A2 shown in FIG. 3A2 is known to be back to back inverse Benes connection topology.

Referring to FIG. 3B2, in one embodiment, an exemplary asymmetrical multi-link multi-stage network 300B2 with five stages of twenty switches for satisfying communication requests, such as setting up a telephone call or a data call, or a connection between configurable logic blocks, between an input stage 110 and output stage 120 via middle stages 130, 140, and 150 is shown where input stage 110 consists of four, six by eight switches IS1-IS4 and output stage 120 consists of four, six by two switches OS1-OS4. And all the middle stages namely middle stage 130 consists of four, eight by four switches MS(1,1)-MS(1,4), middle stage 140 consists of four, six by six switches MS(2,1)-MS(2,4), and middle stage 150 consists of four, six by six switches MS(3,1)-MS(3,4).

Such a network can be operated in strictly non-blocking manner for multicast connections, because the switches in the input stage 110 are of size six by eight, the switches in output stage 120 are of size six by two, and there are four switches in each of middle stage 130, middle stage 140 and middle stage 150.

In one embodiment of this network each of the input switches IS1-IS4 and output switches OS1-OS4 are crossbar switches. The number of switches of input stage 110 and of output stage 120 can be denoted in general with the variable

$$\frac{N_2}{d}$$

where N_1 is the total number of inlet links or and N_2 is the total number of outlet links and $N_1 > N_2$ and $N_1 = p * N_2$ where $p > 1$. The number of middle switches in each middle stage is denoted by

$$\frac{N_2}{d}$$

90

The size of each input switch IS1-IS4 can be denoted in general with the notation $d_1 * (2d + d_1)$ and each output switch OS1-OS4 can be denoted in general with the notation $3d * d$, where

$$d_1 = N_1 \times \frac{d}{N_2} = p \times d.$$

The size of each switch in any of the middle stages excepting the first middle stage can be denoted as $3d * 3d$. The size of each switch in the first middle stage can be denoted as $(2d + d_1) * 3d$. A switch as used herein can be either a crossbar switch, or a network of switches each of which in turn may be a crossbar switch or a network of switches. An asymmetric multi-link multi-stage network can be represented with the notation $V_{link}(N_1, N_2, d, s)$, where N_1 represents the total number of inlet links of all input switches (for example the links IL1-IL24), N_2 represents the total number of outlet links of all output switches (for example the links OL1-OL8), d represents the inlet links of each input switch where $N_1 > N_2$, and s is the ratio of number of incoming links to each output switch to the outlet links of each output switch.

Each of the

$$\frac{N_2}{d}$$

input switches IS1-IS4 are connected to exactly

$$\frac{2d + d_1}{3}$$

switches in middle stage 130 through $2d + d_1$ links (for example input switch IS1 is connected to middle switch MS(1,1) through the links ML(1,1), ML(1,2), and ML(1,3); input switch IS1 is also connected to middle switch MS(1,2) through the links ML(1,4), ML(1,5), and ML(1,6); input switch IS1 is connected to middle switch MS(1,3) through the links ML(1,7), ML(1,8), and ML(1,9); and input switch IS1 is also connected to middle switch MS(1,4) through the links ML(1,10), ML(1,11), and ML(1,12)).

Each of the

$$\frac{N_2}{d}$$

middle switches MS(1,1)-MS(1,4) in the middle stage 130 are connected from exactly

$$\frac{2d + d_1}{3}$$

input switches through $2d + d_1$ links (for example middle switch MS(1,1) is connected from input switch IS1 through the links ML(1,1), ML(1,2), and ML(1,3); middle switch MS(1,1) is connected from input switch IS2 through the links ML(1,16), ML(1,17), and ML(1,18); middle switch MS(1,1) is connected from input switch IS3 through the links ML(1,28), ML(1,29), and ML(1,30); and middle switch MS(1,1) is connected from input switch IS4 through the links ML(1,43),

91

ML(1,44), and ML(1,45)) and also are connected to exactly d switches in middle stage 140 through 2xd links (for example the links ML(2,1), ML(2,2), and ML(2,3) are connected from middle switch MS(1,1) to middle switch MS(2,1); and the links ML(2,4), ML(2,5), and ML(2,6) are connected from middle switch MS(1,1) to middle switch MS(2,2)).

Similarly each of the

$$\frac{N_2}{d}$$

middle switches MS(2,1)-MS(2,4) in the middle stage 140 are connected from exactly d switches in middle stage 130 through 3xd links (for example the links ML(2,1), ML(2,2), and ML(2,3) are connected to the middle switch MS(2,1) from middle switch MS(1,1), and the links ML(2,13), ML(2,14), and ML(2,15) are connected to the middle switch MS(2,1) from middle switch MS(1,3) and also are connected to exactly d switches in middle stage 150 through 3xd links (for example the links ML(3,1), ML(3,2), and ML(3,3) are connected from middle switch MS(2,1) to middle switch MS(3,1), and the links ML(3,4), ML(3,5) and ML(3,6) are connected from middle switch MS(2,1) to middle switch MS(3,2)).

Similarly each of the

$$\frac{N_2}{d}$$

middle switches MS(3,1)-MS(3,4) in the middle stage 150 are connected from exactly d switches in middle stage 140 through 3xd links (for example the links ML(3,1), ML(3,2), and ML(3,3) are connected to the middle switch MS(3,1) from middle switch MS(2,1), and the links ML(3,13), ML(3,14), and ML(3,15) are connected to the middle switch MS(3,1) from middle switch MS(2,3) and also are connected to exactly d output switches in output stage 120 through 3xd links (for example the links ML(4,1), ML(4,2), and ML(4,3) are connected to output switch OS1 from Middle switch MS(3,1), and the links ML(4,4), ML(4,5), and ML(4,6) are connected to output switch OS2 from middle switch MS(3,1)).

Each of the

$$\frac{N_2}{d}$$

output switches OS1-OS4 are connected from exactly d switches in middle stage 150 through 3xd links (for example output switch OS1 is connected from middle switch MS(3,1) through the links ML(4,1), ML(4,2), and ML(4,3), and output switch OS1 is also connected from middle switch MS(3,3) through the links ML(4,13), ML(4,14), and ML(4,15)).

Finally the connection topology of the network 300B2 shown in FIG. 3B2 is known to be back to back Omega connection topology.

Referring to FIG. 3C2, in one embodiment, an exemplary asymmetrical multi-link multi-stage network 300C2 with five stages of twenty switches for satisfying communication requests, such as setting up a telephone call or a data call, or a connection between configurable logic blocks, between an input stage 110 and output stage 120 via middle stages 130, 140, and 150 is shown where input stage 110 consists of four,

92

six by eight switches IS1-IS4 and output stage 120 consists of four, six by two switches OS1-OS4. And all the middle stages namely middle stage 130 consists of four, eight by four switches MS(1,1)-MS(1,4), middle stage 140 consists of four, six by six switches MS(2,1)-MS(2,4), and middle stage 150 consists of four, six by six switches MS(3,1)-MS(3,4).

Such a network can be operated in strictly non-blocking manner for multicast connections, because the switches in the input stage 110 are of size six by eight, the switches in output stage 120 are of size six by two, and there are four switches in each of middle stage 130, middle stage 140 and middle stage 150.

In one embodiment of this network each of the input switches IS1-IS4 and output switches OS1-OS4 are crossbar switches. The number of switches of input stage 110 and of output stage 120 can be denoted in general with the variable

$$\frac{N_2}{d}$$

where N_1 is the total number of inlet links or and N_2 is the total number of outlet links and $N_1 > N_2$ and $N_1 = p * N_2$ where $p > 1$. The number of middle switches in each middle stage is denoted by

$$\frac{N_2}{d}$$

The size of each input switch IS1-IS4 can be denoted in general with the notation $d_1 * (2d + d_1)$ and each output switch OS1-OS4 can be denoted in general with the notation $3d * d$, where

$$d_1 = N_1 \times \frac{d}{N_2} = p \times d.$$

The size of each switch in any of the middle stages excepting the first middle stage can be denoted as $3d * 3d$. The size of each switch in the first middle stage can be denoted as $(2d + d_1) * 3d$. A switch as used herein can be either a crossbar switch, or a network of switches each of which in turn may be a crossbar switch or a network of switches. An asymmetric multi-link multi-stage network can be represented with the notation $V_{mlink}(N_1, N_2, d, s)$, where N_1 represents the total number of inlet links of all input switches (for example the links IL1-IL24), N_2 represents the total number of outlet links of all output switches (for example the links OL1-OL8), d represents the inlet links of each input switch where $N_1 > N_2$, and s is the ratio of number of incoming links to each output switch to the outlet links of each output switch.

Each of the

$$\frac{N_2}{d}$$

input switches IS1-IS4 are connected to exactly

$$\frac{2d + d_1}{3}$$

93

switches in middle stage **130** through $2d+d_1$ links (for example input switch IS1 is connected to middle switch MS(1,1) through the links ML(1,1), ML(1,2), and ML(1,3); input switch IS1 is also connected to middle switch MS(1,2) through the links ML(1,4), ML(1,5), and ML(1,6); input switch IS1 is connected to middle switch MS(1,3) through the links ML(1,7), ML(1,8), and ML(1,9); and input switch IS1 is also connected to middle switch MS(1,4) through the links ML(1,10), ML(1,11), and ML(1,12)).

Each of the

$$\frac{N_2}{d}$$

middle switches MS(1,1)-MS(1,4) in the middle stage **130** are connected from exactly

$$\frac{2d + d_1}{3}$$

input switches through $2d+d_1$ links (for example middle switch MS(1,1) is connected from input switch IS1 through the links ML(1,1), ML(1,2), and ML(1,3); middle switch MS(1,1) is connected from input switch IS2 through the links ML(1,16), ML(1,17), and ML(1,18); middle switch MS(1,1) is connected from input switch IS3 through the links ML(1,28), ML(1,29), and ML(1,30); and middle switch MS(1,1) is connected from input switch IS4 through the links ML(1,43), ML(1,44), and ML(1,45)) and also are connected to exactly d switches in middle stage **140** through $3 \times d$ links (for example the links ML(2,1), ML(2,2), and ML(2,3) are connected from middle switch MS(1,1) to middle switch MS(2,1), and the links ML(2,4), ML(2,5), and ML(2,6) are connected from middle switch MS(1,1) to middle switch MS(2,2)).

Similarly each of the

$$\frac{N_2}{d}$$

middle switches MS(2,1)-MS(2,4) in the middle stage **140** are connected from exactly d switches in middle stage **130** through $3 \times d$ links (for example the links ML(2,1), ML(2,2), and ML(2,3) are connected to the middle switch MS(2,1) from middle switch MS(1,1), and the links ML(2,22), ML(2,23), and ML(2,24) are connected to the middle switch MS(2,1) from middle switch MS(1,4) and also are connected to exactly d switches in middle stage **150** through $3 \times d$ links (for example the links ML(3,1), ML(3,2), and ML(3,3) are connected from middle switch MS(2,1) to middle switch MS(3,1), and the links ML(3,4), ML(3,5), and ML(3,6) are connected from middle switch MS(2,1) to middle switch MS(3,2)).

Similarly each of the

$$\frac{N_2}{d}$$

middle switches MS(3,1)-MS(3,4) in the middle stage **150** are connected from exactly d switches in middle stage **140** through $3 \times d$ links (for example the links ML(3,1), ML(3,2), and ML(3,3) are connected to the middle switch MS(3,1)

94

from middle switch MS(2,1), and the links ML(3,22), ML(3,23), and ML(3,24) are connected to the middle switch MS(3,1) from middle switch MS(2,4)) and also are connected to exactly d output switches in output stage **120** through $3 \times d$ links (for example the links ML(4,1), ML(4,2), and ML(4,3) are connected to output switch OS1 from middle switch MS(3,1), and the links ML(4,4), ML(4,5), and ML(4,6) are connected to output switch OS2 from middle switch MS(3,1)).

Each of the

$$\frac{N_2}{d}$$

output switches OS1-OS4 are connected from exactly d switches in middle stage **150** through $3 \times d$ links (for example output switch OS1 is connected from middle switch MS(3,1) through the links ML(4,1), ML(4,2), and ML(4,3), and output switch OS1 is also connected from middle switch MS(3,4) through the links ML(4,22), ML(4,23), and ML(4,24)).

Finally the connection topology of the network **300C2** shown in FIG. 3C2 is hereinafter called nearest neighbor connection topology.

Similar to network **300A2** of FIG. 3A2, **300B2** of FIG. 3B2, and **300C2** of FIG. 3C2, referring to FIG. 3D2, FIG. 3E2, FIG. 3F2, FIG. 3G2, FIG. 3H2, FIG. 3I2 and FIG. 3J2 with exemplary asymmetrical multi-link multi-stage networks **300D2**, **300E2**, **300F2**, **300G2**, **300H2**, **300I2**, and **300J2** respectively with five stages of twenty switches for satisfying communication requests, such as setting up a telephone call or a data call, or a connection between configurable logic blocks, between an input stage **110** and output stage **120** via middle stages **130**, **140**, and **150** is shown where input stage **110** consists of four, six by eight switches IS1-IS4 and output stage **120** consists of four, six by two switches OS1-OS4. And all the middle stages namely middle stage **130** consists of four, eight by four switches MS(1,1)-MS(1,4), middle stage **140** consists of four, six by six switches MS(2,1)-MS(2,4), and middle stage **150** consists of four, six by six switches MS(3,1)-MS(3,4).

Such a network can be operated in strictly non-blocking manner for multicast connections, because the switches in the input stage **110** are of size six by eight, the switches in output stage **120** are of size six by two, and there are four switches in each of middle stage **130**, middle stage **140** and middle stage **150**.

The networks **300D2**, **300E2**, **300F2**, **300G2**, **300H2**, **300I2** and **300J2** of FIG. 3D2, FIG. 3E2, FIG. 3F2, FIG. 3G2, FIG. 3H2, FIG. 3I2, and FIG. 3J2 are also embodiments of asymmetric multi-link multi-stage network can be represented with the notation $V_{minik}(N_1, N_2, d, s)$, where N_1 represents the total number of inlet links of all input switches (for example the links IL1-IL8), N_2 represents the total number of outlet links of all output switches (for example the links OL1-OL24), d represents the inlet links of each input switch where $N_1 > N_2$, and s is the ratio of number of outgoing links from each input switch to the inlet links of each input switch.

Just like networks of **300A2**, **300B2** and **300C2**, for all the networks **300D2**, **300E2**, **300F2**, **300G2**, **300H2**, **300I2** and

300J2 of FIG. 3D2, FIG. 3E2, FIG. 3F2, FIG. 3G2, FIG. 3H2, FIG. 3I2, and FIG. 3J2, each of the

$$\frac{N_2}{d}$$

input switches IS1-IS4 are connected to exactly

$$\frac{2d + d_1}{3}$$

switches in middle stage 130 through $2d+d_2$ links.

Each of the

$$\frac{N_2}{d}$$

middle switches MS(1,1)-MS(1,4) in the middle stage 130 are connected from exactly

$$\frac{2d + d_1}{3}$$

input switches through $2d+d_2$ links and also are connected to exactly d switches in middle stage 140 through $3 \times d$ links.

Similarly each of the

$$\frac{N_2}{d}$$

middle switches MS(2,1)-MS(2,4) in the middle stage 140 are connected from exactly d switches in middle stage 130 through $3 \times d$ links and also are connected to exactly d switches in middle stage 150 through $3 \times d$ links.

Similarly each of the

$$\frac{N_2}{d}$$

middle switches MS(3,1)-MS(3,4) in the middle stage 150 are connected from exactly d switches in middle stage 140 through $3 \times d$ links and also are connected to exactly d output switches in output stage 120 through $3 \times d$ links.

Each of the

$$\frac{N_2}{d}$$

output switches OS1-OS4 are connected from exactly d switches in middle stage 150 through $3 \times d$ links.

In all the ten embodiments of FIG. 3A2 to FIG. 3J2 the connection topology is different. That is the way the links ML(1,1)-ML(1,48), ML(2,1)-ML(2,24), ML(3,1)-ML(3,24), and ML(4,1)-ML(4,24) are connected between the respective stages is different. Even though only ten embodiments are illustrated, in general, the network $V_{mlink}(N_1, N_2, d, s)$ can comprise any arbitrary type of connection topology.

For example the connection topology of the network $V_{mlink}(N_1, N_2, d, s)$ may be back to back Benes networks, Delta Networks and many more combinations. The applicant notes that the fundamental property of a valid connection topology of the $V_{mlink}(N_1, N_2, d, s)$ network is, when no connections are setup from any input link all the output links should be reachable. Based on this property numerous embodiments of the network $V_{mlink}(N_1, N_2, d, s)$ can be built. The ten embodiments of FIG. 3A2 to FIG. 3J2 are only three examples of network $V_{mlink}(N_1, N_2, d, s)$.

In all the ten embodiments of FIG. 3A2 to FIG. 3J2, each of the links ML(1,1)-ML(1,48), ML(2,1)-ML(2,24), ML(3,1)-ML(3,24) and ML(4,1)-ML(4,24) are either available for use by a new connection or not available if currently used by an existing connection. The input switches IS1-IS4 are also referred to as the network input ports. The input stage 110 is often referred to as the first stage. The output switches OS1-OS4 are also referred to as the network output ports. The output stage 120 is often referred to as the last stage. The middle stage switches MS(1,1)-MS(1,4), MS(2,1)-MS(2,4), and MS(3,1)-MS(3,4) are referred to as middle switches or middle ports.

In the example illustrated in FIG. 3A2 (or in FIG. 3B2 to FIG. 3J2), a fan-out of four is possible to satisfy a multicast connection request if input switch is IS2, but only two switches in middle stage 130 will be used. Similarly, although a fan-out of three is possible for a multicast connection request if the input switch is IS1, again only a fan-out of two is used. The specific middle switches that are chosen in middle stage 130 when selecting a fan-out of two is irrelevant so long as at most two middle switches are selected to ensure that the connection request is satisfied. In essence, limiting the fan-out from input switch to no more than two middle switches permits the network 300A2 (or 300B2 to 300J2), to be operated in strictly nonblocking manner in accordance with the invention.

The connection request of the type described above can be unicast connection request, a multicast connection request or a broadcast connection request, depending on the example. In case of a unicast connection request, a fan-out of one is used, i.e. a single middle stage switch in middle stage 130 is used to satisfy the request. Moreover, although in the above-described embodiment a limit of two has been placed on the fan-out into the middle stage switches in middle stage 130, the limit can be greater depending on the number of middle stage switches in a network (while maintaining the strictly nonblocking nature of operation of the network for strictly nonblocking connections). However any arbitrary fan-out may be used within any of the middle stage switches and the output stage switches to satisfy the connection request.

Generalized Asymmetric SNB ($N_2 > N_1$) Embodiments:

Network 3001K2 of FIG. 3K2 is an example of general asymmetrical multi-link multi-stage network $V_{mlink}(N_1, N_2, d, s)$ with $(2 \times \log_d N_2) - 1$ stages where $N_1 > N_2$ and $N_1 = p \times N_2$ where $p > 1$. In network 300K2 of FIG. 3K2, $N_2 = N$ and $N_1 = p \times N$. The general asymmetrical multi-link multi-stage network $V_{mlink}(N_1, N_2, d, s)$ can be operated in strictly nonblocking manner for multicast when $s=3$ according to the current invention (and in the example of FIG. 3K2, $s=3$). The general asymmetrical multi-link multi-stage network $V_{mlink}(N_1, N_2, d, s)$ with $(2 \times \log_d N_2) - 1$ stages has d_1 (where

$$d_1 = N_1 \times \frac{d}{N_2} = p \times d$$

inlet links for each of

$$\frac{N_2}{d}$$

input switches IS1-IS(N₂/d) (for example the links IL1-IL(p*d) to the input switch IS1) and 2d+d₁ (=2d+p*d) outgoing links for each of

$$\frac{N_2}{d}$$

input switches IS1-IS(N₂/d) (for example the links ML(1,1)-ML(1,(d+p*d)) to the input switch IS1). There are d outlet links for each of

$$\frac{N_2}{d}$$

output switches OS1-OS(N₂/d) (for example the links OL1-OL(d) to the output switch OS1) and 2*d incoming links for each of

$$\frac{N_2}{d}$$

output switches OS1-OS(N₂/d) (for example ML(2*Log_dN₂-2,1)-ML(2*Log_dN₂-2,3*d) to the output switch OS1).

Each of the

$$\frac{N_2}{d}$$

input switches IS1-IS(N₂/d) are connected to exactly

$$\frac{2d + d_1}{3}$$

switches in middle stage 130 through 2d+d₂ links.

Each of the

$$\frac{N_2}{d}$$

middle switches MS(1,1)-MS(1,N₂/d) in the middle stage 130 are connected from exactly d input switches through 3*d links and also are connected to exactly d switches in middle stage 140 through 3*d links.

Similarly each of the

$$\frac{N_2}{d}$$

middle switches

$$5 \quad MS(\text{Log}_d N_2 - 2) - MS\left(\text{Log}_d N_2 - 1, \frac{N_2}{d}\right)$$

in the middle stage 130+10*(Log_dN₂-2) are connected from exactly d switches in middle stage 130+10*(Log_dN₂-3) through 3*d links and also are connected to exactly d switches in middle stage 130+10*(Log_dN₂-1) through 3*d links.

Similarly each of the

$$15 \quad \frac{N_2}{d}$$

middle switches

$$20 \quad MS(\text{Log}_d N_2 - 3, 1) - MS\left(2 \times \text{Log}_d N_2 - 3, \frac{N_2}{d}\right)$$

in the middle stage 130+10*(2*Log_dN₂-4) are connected from exactly d switches in middle stage 130+10*(2*Log_dN₂-5) through 3*d links and also are connected to exactly d output switches in output stage 120 through 3*d links.

Each of the

$$30 \quad \frac{N_2}{d}$$

output switches OS1-OS(N₂/d) are connected from exactly d switches in middle stage 130+10*(2*Log_dN₂-4) through 2*d links.

As described before, again the connection topology of a general V_{mink}(N₁, N₂, d, s) may be any one of the connection topologies. For example the connection topology of the network V_{mink}(N₁, N₂, d, s) may be back to back inverse Benes networks, back to back Omega networks, back to back Benes networks, Delta Networks and many more combinations. The applicant notes that the fundamental property of a valid connection topology of the general V_{mink}(N₁, N₂, d, s) network is, when no connections are setup from any input link if any output link should be reachable. Based on this property numerous embodiments of the network V_{mink}(N₁, N₂, d, s) can be built. The embodiments of FIG. 3A2 to FIG. 3J2 are ten examples of network V_{mink}(N₁, N₂, d, s) for s=3 and N₂>N₁.

The general symmetrical multi-link multi-stage network V_{mink}(N₁, N₂, d, s) can be operated in strictly nonblocking 55 manner for multicast when s≥3 according to the current invention.

For example, the network of FIG. 3C2 shows an exemplary five-stage network, namely V_{mink}(8,24,2,3), with the following multicast assignment I₁={1,4} and all other I_j=∅ for j=[2-8]. It should be noted that the connection I₁ fans out in the first stage switch IS1 into middle switches MS(1,1) and MS(1,4) in middle stage 130, and fans out in middle switches MS(1,1) and MS(1,4) only once into middle switches MS(2,1) and MS(2,4) respectively in middle stage 140.

The connection I₁ also fans out in middle switches MS(2,1) and MS(2,4) only once into middle switches MS(3,1) and MS(3,4) respectively in middle stage 150. The connection I₁

also fans out in middle switches MS(3,1) and MS(3,4) only once into output switches OS1 and OS4 in output stage 120. Finally the connection I₁ fans out once in the output stage switch OS1 into outlet link OL1 and in the output stage switch OS4 twice into the outlet links OL7 and OL8. In accordance with the invention, each connection can fan out in the input stage switch into at most two middle stage switches in middle stage 130.

Folded Strictly Nonblocking Multi-link Multi-stage Networks:

The folded multi-link multi-stage network $V_{fold-mlink}(N_1, N_2, d, s)$, disclosed in the current invention, is topologically exactly the same as the multi-stage network $V_{mlink}(N_1, N_2, d, s)$, disclosed in U.S. Provisional Patent Application Ser. No. 60/940,392 that is incorporated by reference above, excepting that in the illustrations folded network $V_{fold-mlink}(N_1, N_2, d, s)$ is shown as it is folded at middle stage $130+10*(\text{Log}_d N_2-2)$.

The general symmetrical folded multi-link multi-stage network $V_{fold-mlink}(N_1, N_2, d, s)$ can also be operated in strictly nonblocking manner for multicast when $s \geq 3$ according to the current invention. Similarly the general asymmetrical folded multi-link multi-stage network $V_{fold-mlink}(N_1, N_2, d, s)$ can also be operated in strictly nonblocking manner for multicast when $s \geq 3$ according to the current invention.

Folded Multi-Stage Network Embodiments:

Symmetric Folded RNB Embodiments:

Referring to FIG. 4A, in one embodiment, an exemplary symmetrical folded multi-stage network 400A with five stages of thirty two switches for satisfying communication requests, such as setting up a telephone call or a data call, or a connection between configurable logic blocks, between an input stage 110 and output stage 120 via middle stages 130, 140, and 150 is shown where input stage 110 consists of four, two by four switches IS1-IS4 and output stage 120 consists of four, four by two switches OS1-OS4. And all the middle stages namely middle stage 130 consists of eight, two by two switches MS(1,1)-MS(1,8), middle stage 140 consists of eight, two by two switches MS(2,1)-MS(2,8), and middle stage 150 consists of eight, two by two switches MS(3,1)-MS(3,8).

Such a network can be operated in strictly non-blocking manner for unicast connections, because the switches in the input stage 110 are of size two by four, the switches in output stage 120 are of size four by two, and there are eight switches in each of middle stage 130, middle stage 140 and middle stage 150. Such a network can be operated in rearrangeably non-blocking manner for multicast connections, because the switches in the input stage 110 are of size two by four, the switches in output stage 120 are of size four by two, and there are eight switches in each of middle stage 130, middle stage 140 and middle stage 150.

In one embodiment of this network each of the input switches IS1-IS4 and output switches OS1-OS4 are crossbar switches. The number of switches of input stage 110 and of output stage 120 can be denoted in general with the variable N/d , where N is the total number of inlet links or outlet links. The number of middle switches in each middle stage is denoted by

$$2 \times \frac{N}{d}$$

The size of each input switch IS1-IS4 can be denoted in general with the notation d^2d and each output switch OS1-OS4 can be denoted in general with the notation $2d*d$. Like-

wise, the size of each switch in any of the middle stages can be denoted as $d*d$. A switch as used herein can be either a crossbar switch, or a network of switches each of which in turn may be a crossbar switch or a network of switches. A symmetric folded multi-stage network can be represented with the notation $V_{fold}(N, d, s)$, where N represents the total number of inlet links of all input switches (for example the links IL1-IL8), d represents the inlet links of each input switch or outlet links of each output switch, and s is the ratio of number of outgoing links from each input switch to the inlet links of each input switch. Although it is not necessary that there be the same number of inlet links IL1-IL8 as there are outlet links OL1-OL8, in a symmetrical network they are the same.

Each of the N/d input switches IS1-IS4 are connected to exactly $2 \times d$ switches in middle stage 130 through $2 \times d$ links (for example input switch IS1 is connected to middle switches MS(1,1), MS(1,2), MS(1,5) and MS(1,6) through the links ML(1,1), ML(1,2), ML(1,3) and ML(1,4) respectively).

Each of the

$$2 \times \frac{N}{d}$$

middle switches MS(1,1)-MS(1,8) in the middle stage 130 are connected from exactly d input switches through d links (for example the links ML(1,1) and ML(1,5) are connected to the middle switch MS(1,1) from input switch IS1 and IS2 respectively) and also are connected to exactly d switches in middle stage 140 through d links (for example the links ML(2,1) and ML(2,2) are connected from middle switch MS(1,1) to middle switch MS(2,1) and MS(2,3) respectively).

Similarly each of the

$$2 \times \frac{N}{d}$$

middle switches MS(2,1)-MS(2,8) in the middle stage 140 are connected from exactly d switches in middle stage 130 through d links (for example the links ML(2,1) and ML(2,6) are connected to the middle switch MS(2,1) from middle switches MS(1,1) and MS(1,3) respectively) and also are connected to exactly d switches in middle stage 150 through d links (for example the links ML(3,1) and ML(3,2) are connected from middle switch MS(2,1) to middle switch MS(3,1) and MS(3,3) respectively).

Similarly each of the

$$2 \times \frac{N}{d}$$

middle switches MS(3,1)-MS(3,8) in the middle stage 150 are connected from exactly d switches in middle stage 140 through d links (for example the links ML(3,1) and ML(3,6) are connected to the middle switch MS(3,1) from middle switches MS(2,1) and MS(2,3) respectively) and also are connected to exactly d output switches in output stage 120 through d links (for example the links ML(4,1) and ML(4,2) are connected to output switches OS1 and OS2 respectively from middle switches MS(3,1)).

Each of the N/d output switches OS1-OS4 are connected from exactly $2 \times d$ switches in middle stage 150 through $2 \times d$

101

links (for example output switch OS1 is connected from middle switches MS(3,1), MS(3,2), MS(3,5) and MS(3,6) through the links ML(4,1), ML(4,3), ML(4,9) and ML(4,11) respectively).

Finally the connection topology of the network 400A shown in FIG. 4A is known to be back to back inverse Benes connection topology.

Referring to FIG. 4A1, in another embodiment of network $V_{fold}(N, d, s)$, an exemplary symmetrical folded multi-stage network 400A1 with five stages of thirty two switches for satisfying communication requests, such as setting up a telephone call or a data call, or a connection between configurable logic blocks, between an input stage 110 and output stage 120 via middle stages 130, 140, and 150 is shown where input stage 110 consists of four, two by four switches IS1-IS4 and output stage 120 consists of four, four by two switches OS1-OS4. And all the middle stages namely middle stage 130 consists of eight, two by two switches MS(1,1)-MS(1,8), middle stage 140 consists of eight, two by two switches MS(2,1)-MS(2,8), and middle stage 150 consists of eight, two by two switches MS(3,1)-MS(3,8).

Such a network can be operated in strictly non-blocking manner for unicast connections, because the switches in the input stage 110 are of size two by four, the switches in output stage 120 are of size four by two, and there are eight switches in each of middle stage 130, middle stage 140 and middle stage 150. Such a network can be operated in rearrangeably non-blocking manner for multicast connections, because the switches in the input stage 110 are of size two by four, the switches in output stage 120 are of size four by two, and there are eight switches in each of middle stage 130, middle stage 140 and middle stage 150.

In one embodiment of this network each of the input switches IS1-IS4 and output switches OS1-OS4 are crossbar switches. The number of switches of input stage 110 and of output stage 120 can be denoted in general with the variable N/d , where N is the total number of inlet links or outlet links. The number of middle switches in each middle stage is denoted by

$$2 \times \frac{N}{d}$$

The size of each input switch IS1-IS4 can be denoted in general with the notation $d*2d$ and each output switch OS1-OS4 can be denoted in general with the notation $2d*d$. Likewise, the size of each switch in any of the middle stages can be denoted as $d*d$. A switch as used herein can be either a crossbar switch, or a network of switches each of which in turn may be a crossbar switch or a network of switches. The symmetric folded multi-stage network of FIG. 4A1 is also the network of the type $V_{fold}(N, d, s)$, where N represents the total number of inlet links of all input switches (for example the links IL1-IL8), d represents the inlet links of each input switch or outlet links of each output switch, and s is the ratio of number of outgoing links from each input switch to the inlet links of each input switch. Although it is not necessary that there be the same number of inlet links IL1-IL8 as there are outlet links OL1-OL8, in a symmetrical network they are the same.

Each of the N/d input switches IS1-IS4 are connected to exactly $2 \times d$ switches in middle stage 130 through $2 \times d$ links (for example input switch IS1 is connected to middle switches MS(1,1), MS(1,2), MS(1,5) and MS(1,6) through the links ML(1,1), ML(1,2), ML(1,3) and ML(1,4) respectively).

102

Each of the

$$2 \times \frac{N}{d}$$

middle switches MS(1,1)-MS(1,8) in the middle stage 130 are connected from exactly d input switches through d links (for example the links ML(1,1) and ML(1,9) are connected to the middle switch MS(1,1) from input switch IS1 and IS3 respectively) and also are connected to exactly d switches in middle stage 140 through d links (for example the links ML(2,1) and ML(2,2) are connected from middle switch MS(1,1) to middle switch MS(2,1) and MS(2,2) respectively).

Similarly each of the

$$2 \times \frac{N}{d}$$

middle switches MS(2,1)-MS(2,8) in the middle stage 140 are connected from exactly d switches in middle stage 130 through d links (for example the links ML(2,1) and ML(2,5) are connected to the middle switch MS(2,1) from middle switches MS(1,1) and MS(1,3) respectively) and also are connected to exactly d switches in middle stage 150 through d links (for example the links ML(3,1) and ML(3,2) are connected from middle switch MS(2,1) to middle switch MS(3,1) and MS(3,2) respectively).

Similarly each of the

$$2 \times \frac{N}{d}$$

middle switches MS(3,1)-MS(3,8) in the middle stage 150 are connected from exactly d switches in middle stage 140 through d links (for example the links ML(3,1) and ML(3,5) are connected to the middle switch MS(3,1) from middle switches MS(2,1) and MS(2,3) respectively) and also are connected to exactly d output switches in output stage 120 through d links (for example the links ML(4,1) and ML(4,2) are connected to output switches OS1 and OS2 respectively from middle switches MS(3,1)).

Each of the N/d output switches OS1-OS4 are connected from exactly $2 \times d$ switches in middle stage 150 through $2 \times d$ links (for example output switch OS1 is connected from middle switches MS(3,1), MS(3,3), MS(3,5) and MS(3,7) through the links ML(4,1), ML(4,5), ML(4,9) and ML(4,13) respectively).

Finally the connection topology of the network 400A1 shown in FIG. 4A1 is known to be back to back Omega connection topology.

Referring to FIG. 4A2, in another embodiment of network $V_{fold}(N, d, s)$, an exemplary symmetrical folded multi-stage network 400A2 with five stages of thirty two switches for satisfying communication requests, such as setting up a telephone call or

a data call, or a connection between configurable logic blocks, between an input stage 110 and output stage 120 via middle stages 130, 140, and 150 is shown where input stage 110 consists of four, two by four switches IS1-IS4 and output stage 120 consists of four, four by two switches OS1-OS4. And all the middle stages namely middle stage 130 consists of eight, two by two switches MS(1,1)-MS(1,8), middle stage

103

140 consists of eight, two by two switches MS(2,1)-MS(2,8), and middle stage 150 consists of eight, two by two switches MS(3,1)-MS(3,8).

Such a network can be operated in strictly non-blocking manner for unicast connections, because the switches in the input stage 110 are of size two by four, the switches in output stage 120 are of size four by two, and there are eight switches in each of middle stage 130, middle stage 140 and middle stage 150. Such a network can be operated in rearrangeably non-blocking manner for multicast connections, because the switches in the input stage 110 are of size two by four, the switches in output stage 120 are of size four by two, and there are eight switches in each of middle stage 130, middle stage 140 and middle stage 150.

In one embodiment of this network each of the input switches IS1-IS4 and output switches OS1-OS4 are crossbar switches. The number of switches of input stage 110 and of output stage 120 can be denoted in general with the variable N/d, where N is the total number of inlet links or outlet links. The number of middle switches in each middle stage is denoted by

$$2 \times \frac{N}{d}$$

The size of each input switch IS1-IS4 can be denoted in general with the notation d*2d and each output switch OS1-OS4 can be denoted in general with the notation 2d*d. Likewise, the size of each switch in any of the middle stages can be denoted as d*d. A switch as used herein can be either a crossbar switch, or a network of switches each of which in turn may be a crossbar switch or a network of switches. The symmetric folded multi-stage network of FIG. 4A2 is also the network of the type $V_{fold}(N, d, s)$, where N represents the total number of inlet links of all input switches (for example the links IL1-IL8), d represents the inlet links of each input switch or outlet links of each output switch, and s is the ratio of number of outgoing links from each input switch to the inlet links of each input switch. Although it is not necessary that there be the same number of inlet links IL1-IL8 as there are outlet links OL1-OL8, in a symmetrical network they are the same.

Each of the N/d input switches IS1-IS4 are connected to exactly 2xd switches in middle stage 130 through 2xd links (for example input switch IS1 is connected to middle switches MS(1,1), MS(1,2), MS(1,5) and MS(1,6) through the links ML(1,1), ML(1,2), ML(1,3) and ML(1,4) respectively).

Each of the

$$2 \times \frac{N}{d}$$

middle switches MS(1,1)-MS(1,8) in the middle stage 130 are connected from exactly d input switches through d links (for example the links ML(1,1) and ML(1,14) are connected to the middle switch MS(1,1) from input switch IS1 and IS4 respectively) and also are connected to exactly d switches in middle stage 140 through d links (for example the links ML(2,1) and ML(2,2) are connected from middle switch MS(1,1) to middle switch MS(2,1) and MS(2,2) respectively).

104

Similarly each of the

$$2 \times \frac{N}{d}$$

middle switches MS(2,1)-MS(2,8) in the middle stage 140 are connected from exactly d switches in middle stage 130 through d links (for example the links ML(2,1) and ML(2,8) are connected to the middle switch MS(2,1) from middle switches MS(1,1) and MS(1,4) respectively) and also are connected to exactly d switches in middle stage 150 through d links (for example the links ML(3,1) and ML(3,2) are connected from middle switch MS(2,1) to middle switch MS(3,1) and MS(3,2) respectively).

Similarly each of the

$$2 \times \frac{N}{d}$$

middle switches MS(3,1)-MS(3,8) in the middle stage 150 are connected from exactly d switches in middle stage 140 through d links (for example the links ML(3,1) and ML(3,8) are connected to the middle switch MS(3,1) from middle switches MS(2,1) and MS(2,4) respectively) and also are connected to exactly d output switches in output stage 120 through d links (for example the links ML(4,1) and ML(4,2) are connected to output switches OS1 and OS2 respectively from middle switches MS(3,1)).

Each of the N/d output switches OS1-OS4 are connected from exactly 2xd switches in middle stage 150 through 2xd links (for example output switch OS1 is connected from middle switches MS(3,1), MS(3,4), MS(3,5) and MS(3,8) through the links ML(4,1), ML(4,2), ML(4,3) and ML(4,4) respectively).

Finally the connection topology of the network 400A2 shown in FIG. 4A2 is hereinafter called nearest neighbor connection topology.

In the three embodiments of FIG. 4A, FIG. 4A1 and FIG. 4A2 the connection topology is different. That is the way the links ML(1,1)-ML(1,16), ML(2,1)-ML(2,16), ML(3,1)-ML(3,16), and ML(4,1)-ML(4,16) are connected between the respective stages is different. Even though only three embodiments are illustrated, in general, the network $V_{fold}(N, d, s)$ can comprise any arbitrary type of connection topology. For example the connection topology of the network $V_{fold}(N, d, s)$ may be back to back Benes networks, Delta Networks and many more combinations. The applicant notes that the fundamental property of a valid connection topology of the $V_{fold}(N, d, s)$ network is, when no connections are setup from any input link all the output links should be reachable. Based on this property numerous embodiments of the network $V_{fold}(N, d, s)$ can be built. The embodiments of FIG. 4A, FIG. 4A1, and FIG. 4A2 are only three examples of network $V_{fold}(N, d, s)$.

In the three embodiments of FIG. 4A, FIG. 4A1 and FIG. 4A2, each of the links ML(1,1)-ML(1,16), ML(2,1)-ML(2,16), ML(3,1)-ML(3,16) and ML(4,1)-ML(4,16) are either available for use by a new connection or not available if currently used by an existing connection. The input switches IS1-IS4 are also referred to as the network input ports. The input stage 110 is often referred to as the first stage. The output switches OS1-OS4 are also referred to as the network output ports. The output stage 120 is often referred to as the last stage. The middle stage switches MS(1,1)-MS(1,8),

MS(2,1)-MS(2,8), and MS(3,1)-MS(3,8) are referred to as middle switches or middle ports.

In the example illustrated in FIG. 4A (or in FIG. 1A1, or in FIG. 4A2), a fan-out of four is possible to satisfy a multicast connection request if input switch is IS2, but only two switches in middle stage 130 will be used. Similarly, although a fan-out of three is possible for a multicast connection request if the input switch is IS1, again only a fan-out of two is used. The specific middle switches that are chosen in middle stage 130 when selecting a fan-out of two is irrelevant so long as at most two middle switches are selected to ensure that the connection request is satisfied. In essence, limiting the fan-out from input switch to no more than two middle switches permits the network 400A (or 400A1, or 400A2), to be operated in rearrangeably nonblocking manner in accordance with the invention.

The connection request of the type described above can be unicast connection request, a multicast connection request or a broadcast connection request, depending on the example. In case of a unicast connection request, a fan-out of one is used, i.e. a single middle stage switch in middle stage 130 is used to satisfy the request. Moreover, although in the above-described embodiment a limit of two has been placed on the fan-out into the middle stage switches in middle stage 130, the limit can be greater depending on the number of middle stage switches in a network (while maintaining the rearrangeably nonblocking nature of operation of the network for multicast connections). However any arbitrary fan-out may be used within any of the middle stage switches and the output stage switches to satisfy the connection request.

Generalized Symmetrical Folded RNB Embodiments:

Network 400B of FIG. 4B is an example of general symmetrical folded multi-stage network $V_{fold}(N, d, s)$ with $(2 \times \log_d N) - 1$ stages. The general symmetrical folded multi-stage network $V_{fold}(N, d, s)$ can be operated in rearrangeably nonblocking manner for multicast when $s \geq 2$ according to the current invention. Also the general symmetrical folded multi-stage network $V_{fold}(N, d, s)$ can be operated in strictly nonblocking manner for unicast if $s \geq 2$ according to the current invention. (And in the example of FIG. 4B, $s=2$). The general symmetrical folded multi-stage network $V_{fold}(N, d, s)$ with $(2 \times \log_d N) - 1$ stages has d inlet links for each of N/d input switches IS1-IS(N/d) (for example the links IL1-IL(d) to the input switch IS1) and $2 \times d$ outgoing links for each of N/d input switches IS1-IS(N/d) (for example the links ML(1,1)-ML(1,2d) to the input switch IS1). There are d outlet links for each of N/d output switches OS1-OS(N/d) (for example the links OL1-OL(d) to the output switch OS1) and $2 \times d$ incoming links for each of N/d output switches OS1-OS(N/d) (for example ML($2 \times \log_d N - 2, 1$)-ML($2 \times \log_d N - 2, 2 \times d$) to the output switch OS1).

Each of the N/d input switches IS1-IS(N/d) are connected to exactly $2 \times d$ switches in middle stage 130 through $2 \times d$ links (for example input switch IS1 is connected to middle switches MS(1,1)-MS(1, d) through the links ML(1,1)-ML(1, d) and to middle switches MS(1, $N/d + 1$)-MS(1, $\{N/d\} + d$) through the links ML(1, $d + 1$)-ML(1, $2d$) respectively.

Each of the

$$2 \times \frac{N}{d}$$

middle switches MS(1,1)-MS(1, $2N/d$) in the middle stage 130 are connected from exactly d input switches through d links and also are connected to exactly d switches in middle stage 140 through d links.

Similarly each of the

$$2 \times \frac{N}{d}$$

middle switches

$$MS(\log_d N - 1, 1) - MS(\log_d N - 1, 2 \times \frac{N}{d})$$

in the middle stage $130 + 10^*(\log_d N - 2)$ are connected from exactly d switches in middle stage $130 + 10^*(\log_d N - 3)$ through d links and also are connected to exactly d switches in middle stage $130 + 10^*(\log_d N - 1)$ through d links.

Similarly each of the

$$2 \times \frac{N}{d}$$

middle switches

$$MS(2 \times \log_d N - 3, 1) - MS(2 \times \log_d N - 3, 2 \times \frac{N}{d})$$

in the middle stage $130 + 10^*(2 * \log_d N - 4)$ are connected from exactly d switches in middle stage $130 + 10^*(2 * \log_d N - 5)$ through d links and also are connected to exactly d output switches in output stage 120 through d links.

Each of the N/d output switches OS1-OS(N/d) are connected from exactly $2 \times d$ switches in middle stage $130 + 10^*(2 * \log_d N - 4)$ through $2 \times d$ links.

As described before, again the connection topology of a general $V_{fold}(N, d, s)$ may be any one of the connection topologies. For example the connection topology of the network $V_{fold}(N, d, s)$ may be back to back inverse Benes networks, back to back Omega networks, back to back Benes networks, Delta Networks and many more combinations. The applicant notes that the fundamental property of a valid connection topology of the general $V_{fold}(N, d, s)$ network is, when no connections are setup from any input link if any output link should be reachable. Based on this property numerous embodiments of the network $V_{fold}(N, d, s)$ can be built. The embodiments of FIG. 4A, FIG. 4A1, and FIG. 4A2 are three examples of network $V_{fold}(N, d, s)$.

The general symmetrical folded multi-stage network $V_{fold}(N, d, s)$ can be operated in rearrangeably nonblocking manner for multicast when $s \geq 2$ according to the current invention. Also the general symmetrical folded multi-stage network $V_{fold}(N, d, s)$ can be operated in strictly nonblocking manner for unicast if $s \geq 2$ according to the current invention.

Every switch in the folded multi-stage networks discussed herein has multicast capability. In a $V_{fold}(N, d, s)$ network, if a network inlet link is to be connected to more than one outlet link on the same output switch, then it is only necessary for the corresponding input switch to have one path to that output switch. This follows because that path can be multicast within the output switch to as many outlet links as necessary. Multicast assignments can therefore be described in terms of connections between input switches and output switches. An existing connection or a new connection from an input switch to r' output switches is said to have fan-out r' . If all multicast

assignments of a first type, wherein any inlet link of an input switch is to be connected in an output switch to at most one outlet link are realizable, then multicast assignments of a second type, wherein any inlet link of each input switch is to be connected to more than one outlet link in the same output switch, can also be realized. For this reason, the following discussion is limited to general multicast connections of the first type (with fan-out r' ,

$$\left(\text{With fan-out } r', 1 \leq r' \leq \frac{N}{d} \right)$$

although the same discussion is applicable to the second type.

To characterize a multicast assignment, for each inlet link

$$i \in \left\{ 1, 2, \dots, \frac{N}{d} \right\},$$

let $I_i=O$, where

$$O \subset \left\{ 1, 2, \dots, \frac{N}{d} \right\},$$

denote the subset of output switches to which inlet link i is to be connected in the multicast assignment. For example, the network of FIG. 4A shows an exemplary five-stage network, namely $V_{fold}(8,2,2)$, with the following multicast assignment $I_1=\{2,3\}$ and all other $I_j=\emptyset$ for $j=[2-8]$. It should be noted that the connection I_1 fans out in the first stage switch IS1 into middle switches MS(1,1) and MS(1,5) in middle stage 130, and fans out in middle switches MS(1,1) and MS(1,5) only once into middle switches MS(2,1) and MS(2,5) respectively in middle stage 140.

The connection I_1 also fans out in middle switches MS(2,1) and MS(2,5) only once into middle switches MS(3,1) and MS(3,7) respectively in middle stage 150. The connection I_1 also fans out in middle switches MS(3,1) and MS(3,7) only once into output switches OS2 and OS3 in output stage 120. Finally the connection I_1 fans out once in the output stage switch OS2 into outlet link OL3 and in the output stage switch OS3 twice into the outlet links OL5 and OL6. In accordance with the invention, each connection can fan out in the input stage switch into at most two middle stage switches in middle stage 130.

Asymmetric Folded RNB ($N_2>N_1$) Embodiments:

Referring to FIG. 4C, in one embodiment, an exemplary asymmetrical folded multi-stage network 400C with five stages of thirty two switches for satisfying communication requests, such as setting up a telephone call or a data call, or a connection between configurable logic blocks, between an input stage 110 and output stage 120 via middle stages 130, 140, and 150 is shown where input stage 110 consists of four, two by four switches IS1-IS4 and output stage 120 consists of four, eight by six switches OS1-OS4. And all the middle stages namely middle stage 130 consists of eight, two by two switches MS(1,1)-MS(1,8), middle stage 140 consists of eight, two by two switches MS(2,1)-MS(2,8), and middle stage 150 consists of eight, two by four switches MS(3,1)-MS(3,8).

Such a network can be operated in strictly non-blocking manner for unicast connections, because the switches in the input stage 110 are of size two by four, the switches in output

stage 120 are of size eight by six, and there are eight switches in each of middle stage 130, middle stage 140 and middle stage 150. Such a network can be operated in rearrangeably non-blocking manner for multicast connections, because the switches in the input stage 110 are of size two by four, the switches in output stage 120 are of size eight by six, and there are eight switches of size two by two in each of middle stage 130 and middle stage 140, and eight switches of size two by four in middle stage 150.

In one embodiment of this network each of the input switches IS1-IS4 and output switches OS1-OS4 are crossbar switches. The number of switches of input stage 110 and of output stage 120 can be denoted in general with the variable

$$\frac{N_1}{d},$$

where N_1 is the total number of inlet links or and N_2 is the total number of outlet links and $N_2>N_1$ and $N_2=p*N_1$ where $p>1$. The number of middle switches in each middle stage is denoted by

$$2 \times \frac{N_1}{d}.$$

The size of each input switch IS1-IS4 can be denoted in general with the notation $d*2d$ and each output switch OS1-OS4 can be denoted in general with the notation $(d+d_2)*d$, where

$$d_2 = N_2 \times \frac{d}{N_1} = p \times d.$$

The size of each switch in any of the middle stages excepting the last middle stage can be denoted as $d*d$. The size of each switch in the last middle stage can be denoted as

$$d * \frac{(d + d_2)}{2}.$$

A switch as used herein can be either a crossbar switch, or a network of switches each of which in turn may be a crossbar switch or a network of switches. An asymmetric folded multi-stage network can be represented with the notation $V_{fold}(N_1, N_1, d, s)$, where N_1 represents the total number of inlet links of all input switches (for example the links IL1-IL8), N_2 represents the total number of outlet links of all output switches (for example the links OL1-OL24), d represents the inlet links of each input switch where $N_2>N_1$, and s is the ratio of number of outgoing links from each input switch to the inlet links of each input switch.

Each of the

$$\frac{N_1}{d}$$

input switches IS1-IS4 are connected to exactly $2 \times d$ switches in middle stage 130 through $2 \times d$ links (for example input switch IS1 is connected to middle switches MS(1,1), MS(1,

109

2), MS(1,5) and MS(1,6) through the links ML(1,1), ML(1,2), ML(1,3) and ML(1,4) respectively).

Each of the

$$2 \times \frac{N_1}{d}$$

middle switches MS(1,1)-MS(1,8) in the middle stage 130 are connected from exactly d input switches through d links (for example the links ML(1,1) and ML(1,5) are connected to the middle switch MS(1,1) from input switch IS1 and IS2 respectively) and also are connected to exactly d switches in middle stage 140 through d links (for example the links ML(2,1) and ML(2,2) are connected from middle switch MS(1,1) to middle switch MS(2,1) and MS(2,3) respectively).

Similarly each of the

$$2 \times \frac{N_1}{d}$$

middle switches MS(2,1)-MS(2,8) in the middle stage 140 are connected from exactly d switches in middle stage 130 through d links (for example the links ML(2,1) and ML(2,6) are connected to the middle switch MS(2,1) from middle switches MS(1,1) and MS(1,3) respectively) and also are connected to exactly d switches in middle stage 150 through d links (for example the links ML(3,1) and ML(3,2) are connected from middle switch MS(2,1) to middle switch MS(3,1) and MS(3,3) respectively).

Similarly each of the

$$2 \times \frac{N_1}{d}$$

middle switches MS(3,1)-MS(3,8) in the middle stage 150 are connected from exactly d switches in middle stage 140 through d links (for example the links ML(3,1) and ML(3,6) are connected to the middle switch MS(3,1) from middle switches MS(2,1) and MS(2,3) respectively) and also are connected to exactly

$$\frac{d + d_2}{2}$$

output switches in output stage 120 through

$$\frac{d + d_2}{2}$$

links (for example the links ML(4,1), ML(4,2), ML(4,3) and ML(4,4) are connected to output switches OS1, OS2, OS3, and OS4 respectively from middle switches MS(3,1)).

Each of the

$$\frac{N_1}{d}$$

output switches OS1-OS4 are connected from exactly d+d₂ switches in middle stage 150 through d+d₂ links (for example

110

output switch OS1 is connected from middle switches MS(3,1), MS(3,2), MS(3,3), MS(3,4), MS(3,5), MS(3,6), MS(3,7), and MS(3,8) through the links ML(4,1), ML(4,5), ML(4,9), ML(4,13), ML(4,17), ML(4,21), ML(4,25) and ML(4,29) respectively).

Finally the connection topology of the network 400C shown in FIG. 4C is known to be back to back inverse Benes connection topology.

Referring to FIG. 4C1, in another embodiment of network V_{fold}(N₁, N₂, d, s), an exemplary asymmetrical folded multi-stage network 400C1 with five stages of thirty two switches for satisfying communication requests, such as setting up a telephone call or a data call, or a connection between configurable logic blocks, between an input stage 110 and output stage 120 via middle stages 130, 140, and 150 is shown where input stage 110 consists of four, two by four switches IS1-IS4 and output stage 120 consists of four, eight by six switches OS1-OS4. And all the middle stages namely middle stage 130 consists of eight, two by two switches MS(1,1)-MS(1,8), middle stage 140 consists of eight, two by two switches MS(2,1)-MS(2,8), and middle stage 150 consists of eight, two by four switches MS(3,1)-MS(3,8).

Such a network can be operated in strictly non-blocking manner for unicast connections, because the switches in the input stage 110 are of size two by four, the switches in output stage 120 are of size eight by six, and there are eight switches in each of middle stage 130, middle stage 140 and middle stage 150. Such a network can be operated in rearrangeably non-blocking manner for multicast connections, because the switches in the input stage 110 are of size two by four, the switches in output stage 120 are of size eight by six, and there are eight switches of size two by two in each of middle stage 130 and middle stage 140, and eight switches of size two by four in middle stage 150.

In one embodiment of this network each of the input switches IS1-IS4 and output switches OS1-OS4 are crossbar switches. The number of switches of input stage 110 and of output stage 120 can be denoted in general with the variable

$$\frac{N_1}{d}$$

where N₁ is the total number of inlet links or and N₂ is the total number of outlet links and N₂>N₁ and N₂=p*N₁ where p>1. The number of middle switches in each middle stage is denoted by

$$2 \times \frac{N_1}{d}$$

The size of each input switch IS1-IS4 can be denoted in general with the notation d*2d and each output switch OS1-OS4 can be denoted in general with the notation (d+d₂)*d, where

$$d_2 = N_2 \times \frac{d}{N_1} = p \times d.$$

The size of each switch in any of the middle stages excepting the last middle stage can be denoted as d*d. The size of each switch in the last middle stage can be denoted as

$$d * \frac{(d + d_2)}{2}.$$

A switch as used herein can be either a crossbar switch, or a network of switches each of which in turn may be a crossbar switch or a network of switches. The asymmetric folded multi-stage network of FIG. 4C1 is also the network of the

111

type $V_{fold}(N_1, N_2, d, s)$, where N_1 represents the total number of inlet links of all input switches (for example the links IL1-IL8), N_2 represents the total number of outlet links of all output switches (for example the links OL1-OL24), d represents the inlet links of each input switch where $N_2 > N_1$, and s is the ratio of number of outgoing links from each input switch to the inlet links of each input switch.

Each of the

$$\frac{N_1}{d}$$

input switches IS1-IS4 are connected to exactly $2 \times d$ switches in middle stage 130 through $2 \times d$ links (for example input switch IS1 is connected to middle switches MS(1,1), MS(1,2), MS(1,5) and MS(1,6) through the links ML(1,1), ML(1,2), ML(1,3) and ML(1,4) respectively).

Each of the

$$2 \times \frac{N_1}{d}$$

middle switches MS(1,1)-MS(1,8) in the middle stage 130 are connected from exactly d input switches through d links (for example the links ML(1,1) and ML(1,9) are connected to the middle switch MS(1,1) from input switch IS1 and IS3 respectively) and also are connected to exactly d switches in middle stage 140 through d links (for example the links ML(2,1) and ML(2,2) are connected from middle switch MS(1,1) to middle switch MS(2,1) and MS(2,2) respectively).

Similarly each of the

$$2 \times \frac{N_1}{d}$$

middle switches MS(2,1)-MS(2,8) in the middle stage 140 are connected from exactly d switches in middle stage 130 through d links (for example the links ML(2,1) and ML(2,5) are connected to the middle switch MS(2,1) from middle switches MS(1,1) and MS(1,3) respectively) and also are connected to exactly d switches in middle stage 150 through d links (for example the links ML(3,1) and ML(3,2) are connected from middle switch MS(2,1) to middle switch MS(3,1) and MS(3,2) respectively).

Similarly each of the

$$2 \times \frac{N_1}{d}$$

middle switches MS(3,1)-MS(3,8) in the middle stage 150 are connected from exactly d switches in middle stage 140 through d links (for example the links ML(3,1) and ML(3,5) are connected to the middle switch MS(3,1) from middle switches MS(2,1) and MS(2,3) respectively) and also are connected to exactly

$$\frac{d + d_2}{2}$$

112

output switches in output stage 120 through

$$\frac{d + d_2}{2}$$

links (for example the links ML(4,1), ML(4,2), ML(4,3) and ML(4,4) are connected to output switches OS1, OS2, OS3, and OS4 respectively from middle switches MS(3,1)).

Each of the

$$\frac{N_1}{d}$$

output switches OS1-OS4 are connected from exactly $d+d_2$ switches in middle stage 150 through $d+d_2$ links (for example output switch OS1 is connected from middle switches MS(3,1), MS(3,2), MS(3,3), MS(3,4), MS(3,5), MS(3,6), MS(3,7), and MS(3,8) through the links ML(4,1), ML(4,5), ML(4,9), ML(4,13), ML(4,17), ML(4,21), ML(4,25) and ML(4,29) respectively).

Finally the connection topology of the network 400C1 shown in FIG. 4C1 is known to be back to back Omega connection topology.

Referring to FIG. 4C2, in another embodiment of network $V_{fold}(N_1, N_2, d, s)$, an exemplary asymmetrical folded multi-stage network 400C2 with five stages of thirty two switches for satisfying communication requests, such as setting up a telephone call or a data call, or a connection between configurable logic blocks, between an input stage 110 and output stage 120 via middle stages 130, 140, and 150 is shown where input stage 110 consists of four, two by four switches IS1-IS4 and output stage 120 consists of four, eight by six switches OS1-OS4. And all the middle stages namely middle stage 130 consists of eight, two by two switches MS(1,1)-MS(1,8), middle stage 140 consists of eight, two by two switches MS(2,1)-MS(2,8), and middle stage 150 consists of eight, two by four switches MS(3,1)-MS(3,8).

Such a network can be operated in strictly non-blocking manner for unicast connections, because the switches in the input stage 110 are of size two by four, the switches in output stage 120 are of size eight by six, and there are eight switches in each of middle stage 130, middle stage 140 and middle stage 150. Such a network can be operated in rearrangeably non-blocking manner for multicast connections, because the switches in the input stage 110 are of size two by four, the switches in output stage 120 are of size eight by six, and there are eight switches of size two by two in each of middle stage 130 and middle stage 140, and eight switches of size two by four in middle stage 150.

In one embodiment of this network each of the input switches IS1-IS4 and output switches OS1-OS4 are crossbar switches. The number of switches of input stage 110 and of output stage 120 can be denoted in general with the variable

$$\frac{N_1}{d}$$

where N_1 is the total number of inlet links or and N_2 is the total number of outlet links and $N_2 > N_1$ and $N_2 = p * N_1$ where $p > 1$. The number of middle switches in each middle stage is denoted by

$$2 \times \frac{N_1}{d}$$

The size of each input switch IS1-IS4 can be denoted in general with the notation $d * 2d$ and each output switch OS1-

113

OS4 can be denoted in general with the notation $(d+d_2)*d$, where

$$d_2 = N_2 \times \frac{d}{N_1} = p \times d.$$

The size of each switch in any of the middle stages excepting the last middle stage can be denoted as $d*d$. The size of each switch in the last middle stage can be denoted as

$$d * \frac{(d + d_2)}{2}.$$

A switch as used herein can be either a crossbar switch, or a network of switches each of which in turn may be a crossbar switch or a network of switches. The asymmetric folded multi-stage network of FIG. 4C2 is also the network of the type $V_{fold}(N_1, N_2, d, s)$, where N_1 represents the total number of inlet links of all input switches (for example the links IL1-IL8), N_2 represents the total number of outlet links of all output switches (for example the links OL1-OL24), d represents the inlet links of each input switch where $N_2 > N_1$, and s is the ratio of number of outgoing links from each input switch to the inlet links of each input switch.

Each of the

$$\frac{N_1}{d}$$

input switches IS1-IS4 are connected to exactly $2*d$ switches in middle stage 130 through $2*d$ links (for example input switch IS1 is connected to middle switches MS(1,1), MS(1,2), MS(1,5) and MS(1,6) through the links ML(1,1), ML(1,2), ML(1,3) and ML(1,4) respectively).

Each of the

$$2 \times \frac{N_1}{d}$$

middle switches MS(1,1)-MS(1,8) in the middle stage 130 are connected from exactly d input switches through d links (for example the links ML(1,1) and ML(1,14) are connected to the middle switch MS(1,1) from input switch IS1 and IS4 respectively) and also are connected to exactly d switches in middle stage 140 through d links (for example the links ML(2,1) and ML(2,2) are connected from middle switch MS(1,1) to middle switch MS(2,1) and MS(2,2) respectively).

Similarly each of the

$$2 \times \frac{N_1}{d}$$

middle switches MS(2,1)-MS(2,8) in the middle stage 140 are connected from exactly d switches in middle stage 130 through d links (for example the links ML(2,1) and ML(2,8) are connected to the middle switch MS(2,1) from middle switches MS(1,1) and MS(1,4) respectively) and also are connected to exactly d switches in middle stage 150 through d links (for example the links ML(3,1) and ML(3,2) are

114

connected from middle switch MS(2,1) to middle switch MS(3,1) and MS(3,2) respectively).

Similarly each of the

$$2 \times \frac{N_1}{d}$$

middle switches MS(3,1)-MS(3,8) in the middle stage 150 are connected from exactly d switches in middle stage 140 through d links (for example the links ML(3,1) and ML(3,8) are connected to the middle switch MS(3,1) from middle switches MS(2,1) and MS(2,4) respectively) and also are connected to exactly

$$\frac{d + d_2}{2}$$

output switches in output stage 120 through

$$\frac{d + d_2}{2}$$

links (for example the links ML(4,1), ML(4,2), ML(4,3) and ML(4,4) are connected to output switches OS1, OS2, OS3, and OS4 respectively from middle switches MS(3,1)).

Each of the

$$\frac{N_1}{d}$$

output switches OS1-OS4 are connected from exactly $d+d_2$ switches in middle stage 150 through $d+d_1$ links (for example output switch OS1 is connected from middle switches MS(3,1), MS(3,2), MS(3,3), MS(3,4), MS(3,5), MS(3,6), MS(3,7), and MS(3,8) through the links ML(4,1), ML(4,5), ML(4,9), ML(4,13), ML(4,17), ML(4,21), ML(4,25) and ML(4,29) respectively).

Finally the connection topology of the network 400C2 shown in FIG. 4C2 is hereinafter called nearest neighbor connection topology.

In the three embodiments of FIG. 4C, FIG. 4C1 and FIG. 4C2 the connection topology is different. That is the way the links ML(1,1)-ML(1,16), ML(2,1)-ML(2,16), ML(3,1)-ML(3,16), and ML(4,1)-ML(4,16) are connected between the respective stages is different. Even though only three embodiments are illustrated, in general, the network $V_{fold}(N_1, N_2, d, s)$ can comprise any arbitrary type of connection topology. For example the connection topology of the network $V_{fold}(N_1, N_2, d, s)$ may be back to back Benes networks, Delta Networks and many more combinations. The applicant notes that the fundamental property of a valid connection topology of the $V_{fold}(N_1, N_2, d, s)$ network is, when no connections are setup from any input link all the output links should be reachable. Based on this property numerous embodiments of the network $V_{fold}(N_1, N_2, d, s)$ can be built. The embodiments of FIG. 4C, FIG. 4C1, and FIG. 4C2 are only three examples of network $V_{fold}(N_1, N_2, d, s)$.

In the three embodiments of FIG. 4C, FIG. 4C1 and FIG. 4C2, each of the links ML(1,1)-ML(1,32), ML(2,1)-ML(2,16), ML(3,1)-ML(3,16) and ML(4,1)-ML(4,16) are either available for use by a new connection or not available if

115

currently used by an existing connection. The input switches IS1-IS4 are also referred to as the network input ports. The input stage 110 is often referred to as the first stage. The output switches OS1-OS4 are also referred to as the network output ports. The output stage 120 is often referred to as the last stage. The middle stage switches MS(1,1)-MS(1,8), MS(2,1)-MS(2,8), and MS(3,1)-MS(3,8) are referred to as middle switches or middle ports.

In the example illustrated in FIG. 4C (or in FIG. 1C1, or in FIG. 4C2), a fan-out of four is possible to satisfy a multicast connection request if input switch is IS2, but only two switches in middle stage 130 will be used. Similarly, although a fan-out of three is possible for a multicast connection request if the input switch is IS1, again only a fan-out of two is used. The specific middle switches that are chosen in middle stage 130 when selecting a fan-out of two is irrelevant so long as at most two middle switches are selected to ensure that the connection request is satisfied. In essence, limiting the fan-out from input switch to no more than two middle switches permits the network 400C (or 400C1, or 400C2), to be operated in rearrangeably nonblocking manner in accordance with the invention.

The connection request of the type described above can be unicast connection request, a multicast connection request or a broadcast connection request, depending on the example. In case of a unicast connection request, a fan-out of one is used, i.e. a single middle stage switch in middle stage 130 is used to satisfy the request. Moreover, although in the above-described embodiment a limit of two has been placed on the fan-out into the middle stage switches in middle stage 130, the limit can be greater depending on the number of middle stage switches in a network (while maintaining the rearrangeably nonblocking nature of operation of the network for multicast connections). However any arbitrary fan-out may be used within any of the middle stage switches and the output stage switches to satisfy the connection request.

Generalized Asymmetric Folded RNB ($N_2 > N_1$) Embodiments:

Network 400D of FIG. 4D is an example of general asymmetrical folded multi-stage network $V_{fold}(N_1, N_2, d, s)$ with $(2 \times \log_d N_1) - 1$ stages where $N_2 > N_1$ and $N_2 = p * N_1$ where $p > 1$. In network 400D of FIG. 4D, $N_1 = N$ and $N_2 = p * N$. The general asymmetrical folded multi-stage network $V_{fold}(N_1, N_2, d, s)$ can be operated in rearrangeably nonblocking manner for multicast when $s \geq 2$ according to the current invention. Also the general asymmetrical folded multi-stage network $V_{fold}(N_1, N_2, d, s)$ can be operated in strictly nonblocking manner for unicast if $s \geq 2$ according to the current invention. (And in the example of FIG. 4D, $s = 2$). The general asymmetrical folded multi-stage network $V_{fold}(N_1, N_2, d, s)$ with $(2 \times \log_d N_1) - 1$ stages has d inlet links for each of

$$\frac{N_1}{d}$$

input switches IS1-IS(N_1/d) (for example the links IL1-IL(d) to the input switch IS1) and $2 \times d$ outgoing links for each of

$$\frac{N_1}{d}$$

116

input switches IS1-IS(N_1/d) (for example the links ML(1,1)-ML(1,2d) to the input switch IS1). There are d_2 (where

$$\left(\text{where } d_2 = N_2 \times \frac{d}{N_1} = p \times d \right)$$

outlet links for each of

$$\frac{N_1}{d}$$

output switches OS1-OS(N_1/d) (for example the links OL1-OL($p * d$) to the output switch OS1) and $d + d_2$ ($= d + p \times d$) incoming links for each of

$$\frac{N_1}{d}$$

output switches OS1-OS(N_1/d) (for example ML($2 \times \log_d N_1 - 2, 1$)-ML($2 \times \log_d N_1 - 2, d + d_2$) to the output switch OS1).

Each of the

$$\frac{N_1}{d}$$

input switches IS1-IS(N_1/d) are connected to exactly $2 \times d$ switches in middle stage 130 through $2 \times d$ links (for example in one embodiment the input switch IS1 is connected to middle switches MS(1,1)-MS(1, d) through the links ML(1, 1)-ML(1, d) and to middle switches MS(1, $N_1/d + 1$)-MS(1, $\{N_1/d\} + d$) through the links ML(1, $d + 1$)-ML(1, $2d$) respectively.

Each of the

$$2 \times \frac{N_1}{d}$$

middle switches MS(1,1)-MS(1, $2N_1/d$) in the middle stage 130 are connected from exactly d input switches through d links and also are connected to exactly d switches in middle stage 140 through d links.

Similarly each of the

$$MS(\log_d N_1 - 1, 1) - MS(\log_d N_1 - 1, 2 \times \frac{N_1}{d})$$

middle switches

$$2 \times \frac{N_1}{d}$$

in the middle stage $130 + 10 * (\log_d N_1 - 2)$ are connected from exactly d switches in middle stage $130 + 10 * (\log_d N_1 - 3)$ through d links and also are connected to exactly d switches in middle stage $130 + 10 * (\log_d N_1 - 1)$ through d links.

Similarly each of the

$$2 \times \frac{N_1}{d}$$

middle switches

$$MS(2 \times \text{Log}_d N_1 - 3, 1) - MS\left(2 \times \text{Log}_d N_1 - 3, 2 \times \frac{N_1}{d}\right)$$

in the middle stage $130+10*(2*\text{Log}_d N_1-4)$ are connected from exactly d switches in middle stage $130+10*(2*\text{Log}_d N_1-5)$ through d links and also are connected to exactly d output switches in output stage **120** through d links.

Each of the

$$\frac{N_1}{d}$$

output switches $OS1-OS(N_1/d)$ are connected from exactly $d+d_2$ switches in middle stage $130+10*(2*\text{Log}_d N_1-4)$ through $d+d_1$ links.

As described before, again the connection topology of a general $V_{fold}(N_1, N_2, d, s)$ may be any one of the connection topologies. For example the connection topology of the network $V_{fold}(N_1, N_2, d, s)$ may be back to back inverse Benes networks, back to back Omega networks, back to back Benes networks, Delta Networks and many more combinations. The applicant notes that the fundamental property of a valid connection topology of the general $V_{fold}(N_1, N_2, d, s)$ network is, when no connections are setup from any input link if any output link should be reachable. Based on this property numerous embodiments of the network $V_{fold}(N_1, N_2, d, s)$ can be built. The embodiments of FIG. 4C, FIG. 4C1, and FIG. 4C2 are three examples of network $V_{fold}(N_1, N_2, d, s)$ for $s=2$ and $N_2 > N_1$.

The general symmetrical folded multi-stage network $V_{fold}(N_1, N_2, d, s)$ can be operated in rearrangeably nonblocking manner for multicast when $s \geq 2$ according to the current invention. Also the general symmetrical folded multi-stage network $V_{fold}(N_1, N_2, d, s)$ can be operated in strictly non-blocking manner for unicast if $s \geq 2$ according to the current invention.

For example, the network of FIG. 4C shows an exemplary five-stage network, namely $V_{fold}(8, 24, 2, 2)$, with the following multicast assignment $I_1 = \{2, 3\}$ and all other $I_j = \emptyset$ for $j = [2-8]$. It should be noted that the connection I_1 fans out in the first stage switch IS1 into middle switches MS(1,1) and MS(1,5) in middle stage **130**, and fans out in middle switches MS(1,1) and MS(1,5) only once into middle switches MS(2,1) and MS(2,5) respectively in middle stage **140**.

The connection I_1 also fans out in middle switches MS(2,1) and MS(2,5) only once into middle switches MS(3,1) and MS(3,7) respectively in middle stage **150**. The connection I_1 also fans out in middle switches MS(3,1) and MS(3,7) only once into output switches OS2 and OS3 in output stage **120**. Finally the connection I_1 fans out once in the output stage switch OS2 into outlet link OL7 and in the output stage switch OS3 twice into the outlet links OL13 and OL16. In accordance with the invention, each connection can fan out in the input stage switch into at most two middle stage switches in middle stage **130**.

Asymmetric Folded RNB ($N_1 > N_2$) Embodiments:

Referring to FIG. 4E, in one embodiment, an exemplary asymmetrical folded multi-stage network **400E** with five stages of thirty two switches for satisfying communication requests, such as setting up a telephone call or a data call, or a connection between configurable logic blocks, between an input stage **110** and output stage **120** via middle stages **130**, **140**, and **150** is shown where input stage **110** consists of four, six by eight switches IS1-IS4 and output stage **120** consists of four, four by two switches OS1-OS4. And all the middle stages namely middle stage **130** consists of eight, four by two switches MS(1,1)-MS(1,8), middle stage **140** consists of eight, two by two switches MS(2,1)-MS(2,8), and middle stage **150** consists of eight, two by two switches MS(3,1)-MS(3,8).

Such a network can be operated in strictly non-blocking manner for unicast connections, because the switches in the input stage **110** are of size six by eight, the switches in output stage **120** are of size four by two, and there are eight switches in each of middle stage **130**, middle stage **140** and middle stage **150**. Such a network can be operated in rearrangeably non-blocking manner for multicast connections, because the switches in the input stage **110** are of size six by eight, the switches in output stage **120** are of size four by two, and there are eight switches of size four by two in middle stage **130**, and eight switches of size two by two in middle stage **140** and middle stage **150**.

In one embodiment of this network each of the input switches IS1-IS4 and output switches OS1-OS4 are crossbar switches. The number of switches of input stage **110** and of output stage **120** can be denoted in general with the variable

$$\frac{N_2}{d}$$

where N_1 is the total number of inlet links or and N_2 is the total number of outlet links and $N_1 > N_2$ and $N_1 = p * N_2$ where $p > 1$. The number of middle switches in each middle stage is denoted by

$$2 \times \frac{N_2}{d}$$

The size of each input switch IS1-IS4 can be denoted in general with the notation $d*(d+d_1)$ and each output switch OS1-OS4 can be denoted in general with the notation $(2*d*d)$, where

$$d_1 = N_1 \times \frac{d}{N_2} = p \times d$$

The size of each switch in any of the middle stages excepting the first middle stage can be denoted as $d*d$. The size of each switch in the first middle stage can be denoted as

$$\frac{(d + d_1)}{2} * d$$

A switch as used herein can be either a crossbar switch, or a network of switches each of which in turn may be a crossbar switch or a network of switches. An asymmetric folded multi-

stage network can be represented with the notation $V_{fold}(N_1, N_2, d, s)$, where N_1 represents the total number of inlet links of all input switches (for example the links IL1-IL24), N_2 represents the total number of outlet links of all output switches (for example the links OL1-OL8), d represents the inlet links of each input switch where $N_1 > N_2$, and s is the ratio of number of incoming links to each output switch to the outlet links of each output switch.

Each of the

$$\frac{N_2}{d}$$

input switches IS1-IS4 are connected to exactly $d+d_1$ switches in middle stage 130 through $d+d_1$ links (for example input switch IS1 is connected to middle switches MS(1,1), MS(1,2), MS(1,3), MS(1,4), MS(1,5), MS(1,6), MS(1,7), and MS(1,8) through the links ML(1,1), ML(1,2), ML(1,3), ML(1,4), ML(1,5), ML(1,6), ML(1,7), and ML(1,8) respectively).

Each of the

$$2 \times \frac{N_2}{d}$$

middle switches MS(1,1)-MS(1,8) in the middle stage 130 are connected from exactly

$$\frac{(d + d_1)}{2}$$

input switches through

$$\frac{(d + d_1)}{2}$$

links (for example the links ML(1,1), ML(1,9), ML(1,17) and ML(1,25) are connected to the middle switch MS(1,1) from input switch IS1, IS2, IS3, and IS4 respectively) and also are connected to exactly d switches in middle stage 140 through d links (for example the links ML(2,1) and ML(2,2) are connected from middle switch MS(1,1) to middle switch MS(2,1) and MS(2,3) respectively).

Similarly each of the

$$2 \times \frac{N_2}{d}$$

middle switches MS(2,1)-MS(2,8) in the middle stage 140 are connected from exactly d switches in middle stage 130 through d links (for example the links ML(2,1) and ML(2,6) are connected to the middle switch MS(2,1) from middle switches MS(1,1) and MS(1,3) respectively) and also are connected to exactly d switches in middle stage 150 through d links (for example the links ML(3,1) and ML(3,2) are connected from middle switch MS(2,1) to middle switch MS(3,1) and MS(3,3) respectively).

Similarly each of the

$$2 \times \frac{N_2}{d}$$

middle switches MS(3,1)-MS(3,8) in the middle stage 150 are connected from exactly d switches in middle stage 140 through d links (for example the links ML(3,1) and ML(3,6) are connected to the middle switch MS(3,1) from middle switches MS(2,1) and MS(2,3) respectively) and also are connected to exactly d output switches in output stage 120 through d links (for example the links ML(4,1) and ML(4,2) are connected to output switches OS1 and OS2 respectively from middle switches MS(3,1)).

Each of the

$$\frac{N_2}{d}$$

output switches OS1-OS4 are connected from exactly $2 \times d$ switches in middle stage 150 through $2 \times d$ links (for example output switch OS1 is connected from middle switches MS(3,1), MS(3,2), MS(3,5), and MS(3,6) through the links ML(4,1), ML(4,3), ML(4,9), and ML(4,11) respectively).

Finally the connection topology of the network 400E shown in FIG. 4E is known to be back to back inverse Benes connection topology.

Referring to FIG. 4E1, in another embodiment of network $V_{fold}(N_1, N_2, d, s)$, an exemplary asymmetrical folded multi-stage network 400E1 with five stages of thirty two switches for satisfying communication requests, such as setting up a telephone call or a data call, or a connection between configurable logic blocks, between an input stage 110 and output stage 120 via middle stages 130, 140, and 150 is shown where input stage 110 consists of four, six by eight switches IS1-IS4 and output stage 120 consists of four, four by two switches OS1-OS4. And all the middle stages namely middle stage 130 consists of eight, four by two switches MS(1,1)-MS(1,8), middle stage 140 consists of eight, two by two switches MS(2,1)-MS(2,8), and middle stage 150 consists of eight, two by two switches MS(3,1)-MS(3,8).

Such a network can be operated in strictly non-blocking manner for unicast connections, because the switches in the input stage 110 are of size six by eight, the switches in output stage 120 are of size four by two, and there are eight switches in each of middle stage 130, middle stage 140 and middle stage 150. Such a network can be operated in rearrangeably non-blocking manner for multicast connections, because the switches in the input stage 110 are of size six by eight, the switches in output stage 120 are of size four by two, and there are eight switches of size four by two in middle stage 130, and eight switches of size two by two in middle stage 140 and middle stage 150.

In one embodiment of this network each of the input switches IS1-IS4 and output switches OS1-OS4 are crossbar switches. The number of switches of input stage 110 and of output stage 120 can be denoted in general with the variable

$$\frac{N_2}{d}$$

where N_1 is the total number of inlet links or and N_2 is the total number of outlet links and $N_1 > N_2$ and $N_1 = p * N_2$ where $p > 1$.

121

The number of middle switches in each middle stage is denoted by

$$2 \times \frac{N_2}{d}$$

The size of each input switch IS1-IS4 can be denoted in general with the notation $d \times (d+d_1)$ and each output switch OS1-OS4 can be denoted in general with the notation $(2 \times d \times d)$, where

$$d_1 = N_1 \times \frac{d}{N_2} = p \times d$$

The size of each switch in any of the middle stages excepting the first middle stage can be denoted as $d \times d$. The size of each switch in the first middle stage can be denoted as

$$\frac{(d + d_1)}{2} \times d$$

A switch as used herein can be either a crossbar switch, or a network of switches each of which in turn may be a crossbar switch or a network of switches. The asymmetric folded multi-stage network of FIG. 4E1 is also the network of the type $V_{fold}(N_1, N_2, d, s)$, where N_1 represents the total number of inlet links of all input switches (for example the links IL1-IL24), N_2 represents the total number of outlet links of all output switches (for example the links OL1-OL8), d represents the inlet links of each input switch where $N_1 > N_2$, and s is the ratio of number of incoming links to each output switch to the outlet links of each output switch.

Each of the

$$\frac{N_2}{d}$$

input switches IS1-IS4 are connected to exactly $d+d_1$ switches in middle stage 130 through $d+d_1$ links (for example input switch IS1 is connected to middle switches MS(1,1), MS(1,2), MS(1,3), MS(1,4), MS(1,5), MS(1,6), MS(1,7), and MS(1,8) through the links ML(1,1), ML(1,2), ML(1,3), ML(1,4), ML(1,5), ML(1,6), ML(1,7), and ML(1,8) respectively).

Each of the

$$2 \times \frac{N_2}{d}$$

middle switches MS(1,1)-MS(1,8) in the middle stage 130 are connected from exactly

$$\frac{(d + d_1)}{2}$$

122

input switches through

$$\frac{(d + d_1)}{2}$$

links (for example the links ML(1,1), ML(1,9), ML(1,17) and ML(1,25) are connected to the middle switch MS(1,1) from input switch IS1, IS2, IS3, and IS4 respectively) and also are connected to exactly d switches in middle stage 140 through d links (for example the links ML(2,1) and ML(2,2) are connected from middle switch MS(1,1) to middle switch MS(2,1) and MS(2,2) respectively).

Similarly each of the

$$2 \times \frac{N_2}{d}$$

middle switches MS(2,1)-MS(2,8) in the middle stage 140 are connected from exactly d switches in middle stage 130 through d links (for example the links ML(2,1) and ML(2,5) are connected to the middle switch MS(2,1) from middle switches MS(1,1) and MS(1,3) respectively) and also are connected to exactly d switches in middle stage 150 through d links (for example the links ML(3,1) and ML(3,2) are connected from middle switch MS(2,1) to middle switch MS(3,1) and MS(3,2) respectively).

Similarly each of the

$$2 \times \frac{N_2}{d}$$

middle switches MS(3,1)-MS(3,8) in the middle stage 150 are connected from exactly d switches in middle stage 140 through d links (for example the links ML(3,1) and ML(3,5) are connected to the middle switch MS(3,1) from middle switches MS(2,1) and MS(2,3) respectively) and also are connected to exactly d output switches in output stage 120 through d links (for example the links ML(4,1) and ML(4,2) are connected to output switches OS1 and OS2 respectively from middle switches MS(3,1)).

Each of the

$$\frac{N_2}{d}$$

output switches OS1-OS4 are connected from exactly $2 \times d$ switches in middle stage 150 through $2 \times d$ links (for example output switch OS1 is connected from middle switches MS(3,1), MS(3,3), MS(3,5), and MS(3,7) through the links ML(4,1), ML(4,5), ML(4,9), and ML(4,13) respectively).

Finally the connection topology of the network 400E1 shown in FIG. 4E1 is known to be back to back Omega connection topology.

Referring to FIG. 4E2, in another embodiment of network $V_{fold}(N_1, N_2, d, s)$, an exemplary asymmetrical folded multi-stage network 400E2 with five stages of thirty two switches for satisfying communication requests, such as setting up a telephone call or a data call, or a connection between configurable logic blocks, between an input stage 110 and output stage 120 via middle stages 130, 140, and 150 is shown where input stage 110 consists of four, six by eight switches IS1-IS4

123

and output stage **120** consists of four, four by two switches OS1-OS4. And all the middle stages namely middle stage **130** consists of eight, four by two switches MS(1,1)-MS(1,8), middle stage **140** consists of eight, two by two switches MS(2,1)-MS(2,8), and middle stage **150** consists of eight, two by two switches MS(3,1)-MS(3,8).

Such a network can be operated in strictly non-blocking manner for unicast connections, because the switches in the input stage **110** are of size six by eight, the switches in output stage **120** are of size four by two, and there are eight switches in each of middle stage **130**, middle stage **140** and middle stage **150**. Such a network can be operated in rearrangeably non-blocking manner for multicast connections, because the switches in the input stage **110** are of size six by eight, the switches in output stage **120** are of size four by two, and there are eight switches of size four by two in middle stage **130**, and eight switches of size two by two in middle stage **140** and middle stage **150**.

In one embodiment of this network each of the input switches IS1-IS4 and output switches OS1-OS4 are crossbar switches. The number of switches of input stage **110** and of output stage **120** can be denoted in general with the variable

$$\frac{N_2}{d},$$

where N_1 is the total number of inlet links or and N_2 is the total number of outlet links and $N_1 > N_2$ and $N_1 = p * N_2$ where $p > 1$. The number of middle switches in each middle stage is denoted by

$$2 \times \frac{N_2}{d}.$$

The size of each input switch IS1-IS4 can be denoted in general with the notation $d * (d + d_1)$ and each output switch OS1-OS4 can be denoted in general with the notation $(2 * d * d)$, where

$$d_1 = N_1 \times \frac{d}{N_2} = p \times d.$$

The size of each switch in any of the middle stages excepting the first middle stage can be denoted as $d * d$. The size of each switch in the first middle stage can be denoted as

$$\frac{(d + d_1)}{2} * d.$$

A switch as used herein can be either a crossbar switch, or a network of switches each of which in turn may be a crossbar switch or a network of switches. The asymmetric folded multi-stage network of FIG. 4E1 is also the network of the type $V_{fold}(N_1, N_2, d, s)$, where N_1 represents the total number of inlet links of all input switches (for example the links IL1-IL24), N_2 represents the total number of outlet links of all output switches (for example the links OL1-OL8), d represents the inlet links of each input switch where $N_1 > N_2$, and s is the ratio of number of incoming links to each output switch to the outlet links of each output switch.

124

Each of the

$$\frac{N_2}{d}$$

input switches IS1-IS4 are connected to exactly $d + d_1$ switches in middle stage **130** through $d + d_1$ links (for example input switch IS1 is connected to middle switches MS(1,1), MS(1,2), MS(1,3), MS(1,4), MS(1,5), MS(1,6), MS(1,7), and MS(1,8) through the links ML(1,1), ML(1,2), ML(1,3), ML(1,4), ML(1,5), ML(1,6), ML(1,7), and ML(1,8) respectively).

Each of the

$$2 \times \frac{N_2}{d}$$

middle switches MS(1,1)-MS(1,8) in the middle stage **130** are connected from exactly

$$\frac{(d + d_1)}{2}$$

input switches through

$$\frac{(d + d_1)}{2}$$

links (for example the links ML(1,1), ML(1,9), ML(1,17) and ML(1,25) are connected to the middle switch MS(1,1) from input switch IS1, IS2, IS3, and IS4 respectively) and also are connected to exactly d switches in middle stage **140** through d links (for example the links ML(2,1) and ML(2,2) are connected from middle switch MS(1,1) to middle switch MS(2,1) and MS(2,2) respectively).

Similarly each of the

$$2 \times \frac{N_2}{d}$$

middle switches MS(2,1)-MS(2,8) in the middle stage **140** are connected from exactly d switches in middle stage **130** through d links (for example the links ML(2,1) and ML(2,8) are connected to the middle switch MS(2,1) from middle switches MS(1,1) and MS(1,4) respectively) and also are connected to exactly d switches in middle stage **150** through d links (for example the links ML(3,1) and ML(3,2) are connected from middle switch MS(2,1) to middle switch MS(3,1) and MS(3,2) respectively).

Similarly each of the

$$2 \times \frac{N_2}{d}$$

middle switches MS(3,1)-MS(3,8) in the middle stage **150** are connected from exactly d switches in middle stage **140** through d links (for example the links ML(3,1) and ML(3,8) are connected to the middle switch MS(3,1) from middle switches MS(2,1) and MS(2,4) respectively) and also are

connected to exactly d output switches in output stage **120** through d links (for example the links $ML(4,1)$ and $ML(4,2)$ are connected to output switches $OS1$ and $OS2$ respectively from middle switches $MS(3,1)$).

Each of the

$$\frac{N_2}{d}$$

output switches $OS1-OS4$ are connected from exactly $2 \times d$ switches in middle stage **150** through $2 \times d$ links (for example output switch $OS1$ is connected from middle switches $MS(3,1)$, $MS(3,4)$, $MS(3,5)$, and $MS(3,8)$ through the links $ML(4,1)$, $ML(4,8)$, $ML(4,9)$, and $ML(4,16)$ respectively).

Finally the connection topology of the network **400E2** shown in FIG. **4E2** is hereinafter called nearest neighbor connection topology.

In the three embodiments of FIG. **4E**, FIG. **4E1** and FIG. **4E2** the connection topology is different. That is the way the links $ML(1,1)-ML(1,32)$, $ML(2,1)-ML(2,16)$, $ML(3,1)-ML(3,16)$, and $ML(4,1)-ML(4,16)$ are connected between the respective stages is different. Even though only three embodiments are illustrated, in general, the network $V_{fold}(N_1, N_2, d, s)$ can comprise any arbitrary type of connection topology. For example the connection topology of the network $V_{fold}(N_1, N_2, d, s)$ may be back to back Benes networks, Delta Networks and many more combinations. The applicant notes that the fundamental property of a valid connection topology of the $V_{fold}(N_1, N_2, d, s)$ network is, when no connections are setup from any input link all the output links should be reachable. Based on this property numerous embodiments of the network $V_{fold}(N_1, N_2, d, s)$ can be built. The embodiments of FIG. **4E**, FIG. **4E1**, and FIG. **4E2** are only three examples of network $V_{fold}(N_1, N_2, d, s)$.

In the three embodiments of FIG. **4E**, FIG. **4E1** and FIG. **4E2**, each of the links $ML(1,1)-ML(1,32)$, $ML(2,1)-ML(2,16)$, $ML(3,1)-ML(3,16)$ and $ML(4,1)-ML(4,16)$ are either available for use by a new connection or not available if currently used by an existing connection. The input switches $IS1-IS4$ are also referred to as the network input ports. The input stage **110** is often referred to as the first stage. The output switches $OS1-OS4$ are also referred to as the network output ports. The output stage **120** is often referred to as the last stage. The middle stage switches $MS(1,1)-MS(1,8)$, $MS(2,1)-MS(2,8)$, and $MS(3,1)-MS(3,8)$ are referred to as middle switches or middle ports.

In the example illustrated in FIG. **4E** (or in FIG. **1E1**, or in FIG. **4E2**), a fan-out of four is possible to satisfy a multicast connection request if input switch is $IS2$, but only two switches in middle stage **130** will be used. Similarly, although a fan-out of three is possible for a multicast connection request if the input switch is $IS1$, again only a fan-out of two is used. The specific middle switches that are chosen in middle stage **130** when selecting a fan-out of two is irrelevant so long as at most two middle switches are selected to ensure that the connection request is satisfied. In essence, limiting the fan-out from input switch to no more than two middle switches permits the network **400E** (or **400E1**, or **400E2**), to be operated in rearrangeably nonblocking manner in accordance with the invention.

The connection request of the type described above can be unicast connection request, a multicast connection request or a broadcast connection request, depending on the example. In case of a unicast connection request, a fan-out of one is used, i.e. a single middle stage switch in middle stage **130** is used to

satisfy the request. Moreover, although in the above-described embodiment a limit of two has been placed on the fan-out into the middle stage switches in middle stage **130**, the limit can be greater depending on the number of middle stage switches in a network (while maintaining the rearrangeably nonblocking nature of operation of the network for general connections). However any arbitrary fan-out may be used within any of the middle stage switches and the output stage switches to satisfy the connection request.

Generalized Asymmetric Folded RNB ($N_1 > N_2$) Embodiments:

Network **400F** of FIG. **4F** is an example of general asymmetrical folded multi-stage network $V_{fold}(N_1, N_2, d, s)$ with $(2 \times \log_d N_2) - 1$ stages where $N_1 > N_2$ and $N_1 = p * N_2$ where $p > 1$. In network **400D** of FIG. **4F**, $N_2 = N$ and $N_1 = p * N$. The general asymmetrical folded multi-stage network $V_{fold}(N_1, N_2, d, s)$ can be operated in rearrangeably nonblocking manner for multicast when $s \geq 2$ according to the current invention. Also the general asymmetrical folded multi-stage network $V_{fold}(N_1, N_2, d, s)$ can be operated in strictly nonblocking manner for unicast if $s \geq 2$ according to the current invention. (And in the example of FIG. **4F**, $s = 2$). The general asymmetrical folded multi-stage network $V_{fold}(N_1, N_2, d, s)$ with $(2 \times \log_d N_2) - 1$ stages has d_1 (where

$$d_1 = N_1 \times \frac{d}{N_2} = p \times d$$

inlet links for each of

$$\frac{N_2}{d}$$

input switches $IS1-IS(N_2/d)$ (for example the links $IL1-IL(p * d)$ to the input switch $IS1$) and $d + d_1 (= d + p * d)$ outgoing links for each of

$$\frac{N_2}{d}$$

input switches $IS1-IS(N_2/d)$ (for example the links $ML(1,1)-ML(1,(d + p * d))$ to the input switch $IS1$). There are d outlet links for each of

$$\frac{N_2}{d}$$

output switches $OS1-OS(N_2/d)$ (for example the links $OL1-OL(d)$ to the output switch $OS1$) and $2 \times d$ incoming links for each of

$$\frac{N_2}{d}$$

output switches $OS1-OS(N_2/d)$ (for example $ML(2 \times \log_d N_2 - 2, 1) - ML(2 \times \log_d N_2 - 2, 2 \times d)$ to the output switch $OS1$).

Each of the

$$\frac{N_2}{d}$$

input switches IS1-IS(N₂/d) are connected to exactly d+d₁ switches in middle stage **130** through d+d₁ links (for example in one embodiment the input switch IS1 is connected to middle switches MS(1,1)-MS(1, (d+d₁)/2) through the links ML(1,1)-ML(1,(d+d₁)/2) and to middle switches MS(1,N₁/d+1)-MS(1,{N₁/d}+(d+d₁)/2) through the links ML(1, ((d+d₁)/2)+1)-ML(1, (d+d₁)) respectively.

Each of the

$$2 \times \frac{N_2}{d}$$

middle switches MS(1,1)-MS(1,2*N₂/d) in the middle stage **130** are connected from exactly d input switches through d links and also are connected to exactly d switches in middle stage **140** through d links.

Similarly each of the

$$2 \times \frac{N_2}{d}$$

middle switches

$$MS(\text{Log}_d N_2 - 1, 1) - MS(\text{Log}_d N_2 - 1, 2 \times \frac{N_2}{d})$$

in the middle stage **130**+10*(Log_d N₂-2) are connected from exactly d switches in middle stage **130**+10*(Log_d N₂-3) through d links and also are connected to exactly d switches in middle stage **130**+10*(Log_d N₂-1) through d links.

Similarly each of the

$$2 \times \frac{N_2}{d}$$

middle switches

$$MS(2 \times \text{Log}_d N_2 - 3, 1) - MS(2 \times \text{Log}_d N_2 - 3, 2 \times \frac{N_2}{d})$$

in the middle stage **130**+10*(2*Log_d N₂-4) are connected from exactly d switches in middle stage **130**+10*(2*Log_d N₂-5) through d links and also are connected to exactly d output switches in output stage **120** through d links.

Each of the

$$\frac{N_2}{d}$$

output switches OS1-OS(N₂/d) are connected from exactly 2xd switches in middle stage **130**+10*(2*Log_d N₂-4) through 2xd links.

As described before, again the connection topology of a general V_{fold}(N₁, N₂, d, s) may be any one of the connection topologies. For example the connection topology of the network V_{fold}(N₁, N₂, d, s) may be back to back inverse Benes networks, back to back Omega networks, back to back Benes networks, Delta Networks and many more combinations. The applicant notes that the fundamental property of a valid connection topology of the general V_{fold}(N₁, N₂, d, s) network is, when no connections are setup from any input link if any output link should be reachable. Based on this property numerous embodiments of the network V_{fold}(N₁, N₂, d, s) can be built. The embodiments of FIG. 4E, FIG. 4E1, and FIG. 4E2 are three examples of network V_{fold}(N₁, N₂, d, s) for s=2 and N₁>N₂.

15 The general symmetrical folded multi-stage network V_{fold}(N₁, N₂, d, s) can be operated in rearrangeably nonblocking manner for multicast when s≧2 according to the current invention. Also the general symmetrical folded multi-stage network V_{fold}(N₁, N₂, d, s) can be operated in strictly non-blocking manner for unicast if S≧2 according to the current invention.

For example, the network of FIG. 4E shows an exemplary five-stage network, namely V_{fold}(24,8,2,2), with the following multicast assignment I₁={2,3} and all other I_j=∅ for j=[2-8]. It should be noted that the connection I₁ fans out in the first stage switch IS1 into middle switches MS(1,1) and MS(1,5) in middle stage **130**, and fans out in middle switches MS(1,1) and MS(1,5) only once into middle switches MS(2,1) and MS(2,5) respectively in middle stage **140**.

25 The connection I₁ also fans out in middle switches MS(2,1) and MS(2,5) only once into middle switches MS(3,1) and MS(3,7) respectively in middle stage **150**. The connection I₁ also fans out in middle switches MS(3,1) and MS(3,7) only once into output switches OS2 and OS3 in output stage **120**. Finally the connection I₁ fans out once in the output stage switch OS2 into outlet link OL3 and in the output stage switch OS3 twice into the outlet links OL5 and OL6. In accordance with the invention, each connection can fan out in the input stage switch into at most two middle stage switches in middle stage **130**.

SNB Embodiments:

The folded multi-stage network V_{fold}(N₁, N₂, d, s) disclosed, in the current invention, is topologically exactly the same as the multi-stage network V_{fold}(N₁, N₂, d, s), disclosed in U.S. Provisional Patent Application Ser. No. 60/940,391 that is incorporated by reference above, excepting that in the illustrations folded network V_{fold}(N₁, N₂, d, s) is shown as it is folded at middle stage **130**+10*(Log_d N₁-2).

The general symmetrical folded multi-stage network V_{fold}(N, d, s) can also be operated in strictly nonblocking manner for multicast when s≧3 according to the current invention. Similarly the general asymmetrical folded multi-stage network V_{fold}(N₁, N₂, d, s) can also be operated in strictly non-blocking manner for multicast when S≧3 according to the current invention.

Symmetric Folded RNB Unicast Embodiments:

Referring to FIG. 5A, an exemplary symmetrical folded multi-stage network **500A** respectively with five stages of twenty switches for satisfying communication requests, such as setting up a telephone call or a data call, or a connection between configurable logic blocks, between an input stage **110** and output stage **120** via middle stages **130**, **140**, and **150** is shown where input stage **110** consists of four, two by two switches IS1-IS4 and output stage **120** consists of four, two by two switches OS1-OS4. And all the middle stages namely middle stage **130** consists of four, two by two switches MS(1,1)-MS(1,4), middle stage **140** consists of four, two by two

switches MS(2,1)-MS(2,4), and middle stage 150 consists of four, two by two switches MS(3,1)-MS(3,4).

Such a network can be operated in rearrangeably non-blocking manner for unicast connections, because the switches in the input stage 110 are of size two by two, the switches in output stage 120 are of size two by two, and there are four switches in each of middle stage 130, middle stage 140 and middle stage 150.

The connection topology of the network 500A shown in FIG. 5A is known to be back to back inverse Benes connection topology. In other embodiments the connection topology is different. That is the way the links ML(1,1)-ML(1,8), ML(2,1)-ML(2,8), ML(3,1)-ML(3,8), and ML(4,1)-ML(4,8) are connected between the respective stages is different.

Even though only one embodiment is illustrated, in general, the network $V_{fold}(N, d, s)$ can comprise any arbitrary type of connection topology. For example the connection topology of the network $V_{fold}(N, d, s)$ may be back to back Benes networks, Delta Networks and many more combinations. The applicant notes that the fundamental property of a valid connection topology of the $V_{fold}(N, d, s)$ network is, when no connections are setup from any input link all the output links should be reachable. Based on this property numerous embodiments of the network $V_{fold}(N, d, s)$ can be built. The embodiment of FIG. 5A is only one example of network $V_{fold}(N, d, s)$.

The network 500A of FIG. 5A is also rearrangeably non-blocking for unicast according to the current invention. In one embodiment of these networks each of the input switches IS1-IS4 and output switches OS1-OS4 are crossbar switches. The number of switches of input stage 110 and of output stage 120 can be denoted in general with the variable N/d, where N is the total number of inlet links or outlet links. The number of middle switches in each middle stage is denoted by N/d. The size of each input switch IS1-IS4 can be denoted in general with the notation d^*d and each output switch OS1-OS4 can be denoted in general with the notation $d*d$. Likewise, the size of each switch in any of the middle stages can be denoted as $d*d$. A switch as used herein can be either a crossbar switch, or a network of switches each of which in turn may be a crossbar switch or a network of switches. A symmetric folded multi-stage network can be represented with the notation $V_{fold}(N, d, s)$, where N represents the total number of inlet links of all input switches (for example the links IL1-IL8), d represents the inlet links of each input switch or outlet links of each output switch, and s is the ratio of number of outgoing links from each input switch to the inlet links of each input switch. Although it is not necessary that there be the same number of inlet links IL1-IL8 as there are outlet links OL1-OL8, in a symmetrical network they are the same.

In network 500A of FIG. 5A, each of the N/d input switches IS1-IS4 are connected to exactly d switches in middle stage 130 through d links (for example input switch IS1 is connected to middle switches MS(1,1) and MS(1,2) through the links ML(1,1) and ML(1,2) respectively).

Each of the N/d middle switches MS(1,1)-MS(1,4) in the middle stage 130 are connected from exactly d input switches through d links (for example the links ML(1,1) and ML(1,4) are connected to the middle switch MS(1,1) from input switch IS1 and IS2 respectively) and also are connected to exactly d switches in middle stage 140 through d links (for example the links ML(2,1) and ML(2,2) are connected from middle switch MS(1,1) to middle switch MS(2,1) and MS(2,3) respectively).

Similarly each of the N/d middle switches MS(2,1)-MS(2,4) in the middle stage 140 are connected from exactly d switches in middle stage 130 through d links (for example the

links ML(2,1) and ML(2,6) are connected to the middle switch MS(2,1) from middle switches MS(1,1) and MS(1,3) respectively) and also are connected to exactly d switches in middle stage 150 through d links (for example the links ML(3,1) and ML(3,2) are connected from middle switch MS(2,1) to middle switch MS(3,1) and MS(3,3) respectively).

Similarly each of the N/d middle switches MS(3,1)-MS(3,4) in the middle stage 150 are connected from exactly d switches in middle stage 140 through d links (for example the links ML(3,1) and ML(3,6) are connected to the middle switch MS(3,1) from middle switches MS(2,1) and MS(2,3) respectively) and also are connected to exactly d output switches in output stage 120 through d links (for example the links ML(4,1) and ML(4,2) are connected to output switches OS1 and OS2 respectively from middle switch MS(3,1)).

Each of the N/d output switches OS1-OS4 are connected from exactly d switches in middle stage 150 through d links (for example output switch OS1 is connected from middle switches MS(3,1) and MS(3,2) through the links ML(4,1) and ML(4,4) respectively).

Generalized Symmetric Folded RNB Unicast Embodiments:

Network 500B of FIG. 5B is an example of general symmetrical folded multi-stage network $V_{fold}(N, d, s)$ with $(2 \times \log_d N) - 1$ stages. The general symmetrical folded multi-stage network $V_{fold}(N, d, s)$ can be operated in rearrangeably nonblocking manner for unicast when $s \geq 1$ according to the current invention (and in the example of FIG. 5B, $s=1$). The general symmetrical folded multi-stage network $V_{fold}(N, d, s)$ with $(2 \times \log_d N) - 1$ stages has d inlet links for each of N/d input switches IS1-IS(N/d) (for example the links IL1-IL(d) to the input switch IS1) and d outgoing links for each of N/d input switches IS1-IS(N/d) (for example the links ML(1,1)-ML(1, d) to the input switch IS1). There are d outlet links for each of N/d output switches OS1-OS(N/d) (for example OL1-OL(d) to the output switch OS1) and d incoming links for each of N/d output switches OS1-OS(N/d) (for example ML(2xLog_dN-2,1)-ML(2xLog_dN-2, d) to the output switch OS1).

Each of the N/d input switches IS1-IS(N/d) are connected to exactly d switches in middle stage 130 through d links.

Each of the N/d middle switches MS(1,1)-MS(1,N/d) in the middle stage 130 are connected from exactly d input switches through d links and also are connected to exactly d switches in middle stage 140 through d links.

Similarly each of the N/d middle switches

$$MS(\log_d N - 1, 1) - MS\left(\log_d N - 1, \frac{N}{d}\right)$$

in the middle stage $130 + 10^*(\log_d N - 2)$ are connected from exactly d switches in middle stage $130 + 10^*(\log_d N - 3)$ through d links and also are connected to exactly d switches in middle stage $130 + 10^*(\log_d N - 1)$ through d links.

Similarly each of the N/d middle switches

$$MS(2 \times \log_d N - 3, 1) - MS\left(2 \times \log_d N - 3, \frac{N}{d}\right)$$

in the middle stage $130 + 10^*(2 * \log_d N - 4)$ are connected from exactly d switches in middle stage $130 + 10^*(2 * \log_d N - 5)$ through d links and also are connected to exactly d output switches in output stage 120 through d links.

131

Each of the N/d output switches OS1-OS(N/d) are connected from exactly d switches in middle stage 130+10* (2*Log_dN-4) through d links.

The general symmetrical folded multi-stage network V_{fold}(N, d, s) can be operated in rearrangeably nonblocking manner for multicast when s=1 according to the current invention. Asymmetric Folded RNB (N₂>N₁) Unicast Embodiments:

Referring to FIG. 5C, an exemplary symmetrical folded multi-stage network 500C respectively with five stages of twenty switches for satisfying communication requests, such as setting up a telephone call or a data call, or a connection between configurable logic blocks, between an input stage 110 and output stage 120 via middle stages 130, 140, and 150 is shown where input stage 110 consists of four, two by two switches IS1-IS4 and output stage 120 consists of four, six by six switches OS1-OS4. And all the middle stages namely middle stage 130 consists of four, two by two switches MS(1,1)-MS(1,4), middle stage 140 consists of four, two by two switches MS(2,1)-MS(2,4), and middle stage 150 consists of four, two by six switches MS(3,1)-MS(3,4).

Such networks can be operated in rearrangeably nonblocking manner for unicast connections, because the switches in the input stage 110 are of size two by two, the switches in output stage 120 are of size six by six, and there are four switches in each of middle stage 130, middle stage 140 and middle stage 150.

The connection topology of the network 500C shown in FIG. 5C is known to be back to back inverse Benes connection topology. The connection topology of the networks 500C is different in the other embodiments. That is the way the links ML(1,1)-ML(1,8), ML(2,1)-ML(2,8), ML(3,1)-ML(3,8), and ML(4,1)-ML(4,8) are connected between the respective stages is different.

Even though only one embodiment is illustrated, in general, the network V_{fold}(N₁, N₂, d, s) can comprise any arbitrary type of connection topology. For example the connection topology of the network V_{fold}(N₁, N₂, d, s) may be back to back Benes networks, Delta Networks and many more combinations. The applicant notes that the fundamental property of a valid connection topology of the V_{fold}(N₁, N₂, d, s) network is, when no connections are setup from any input link all the output links should be reachable. Based on this property numerous embodiments of the network V_{fold}(N₁, N₂, d, s) can be built. The embodiment of FIG. 5C is only one example of network V_{fold}(N₁, N₂, d, s).

The networks 500C of FIG. 5C is also rearrangeably nonblocking for unicast according to the current invention. In one embodiment of these networks each of the input switches IS1-IS4 and output switches OS1-OS4 are crossbar switches. The number of switches of input stage 110 and of output stage 120 can be denoted in general with the variable

$$\frac{N_1}{d}$$

where N₁ is the total number of inlet links or and N₂ is the total number of outlet links and N₂>N₁ and N₂=p*N₁ where p>1. The number of middle switches in each middle stage is denoted by

$$\frac{N_1}{d}$$

132

The size of each input switch IS1-IS4 can be denoted in general with the notation d*d and each output switch OS1-OS4 can be denoted in general with the notation d₂*d₂, where

$$d_2 = N_2 \times \frac{d}{N_1} = p \times d.$$

The size of each switch in any of the middle stages excepting the last middle stage can be denoted as d*d. The size of each switch in the last middle stage can be denoted as d*d₂. A switch as used herein can be either a crossbar switch, or a network of switches each of which in turn may be a crossbar switch or a network of switches. An asymmetric folded multi-stage network can be represented with the notation V_{fold}(N₁, N₂, d, s), where N₁ represents the total number of inlet links of all input switches (for example the links IL1-IL8), N₂ represents the total number of outlet links of all output switches (for example the links OL1-OL24), d represents the inlet links of each input switch where N₂>N₁, and s is the ratio of number of outgoing links from each input switch to the inlet links of each input switch.

In network 500C of FIG. 5C, each of the

$$\frac{N_1}{d}$$

input switches IS1-IS4 are connected to exactly d switches in middle stage 130 through d links (for example input switch IS1 is connected to middle switches MS(1,1) and MS(1,2) through the links ML(1,1) and ML(1,2) respectively).

Each of the

$$\frac{N_1}{d}$$

middle switches MS(1,1)-MS(1,4) in the middle stage 130 are connected from exactly d input switches through d links (for example the links ML(1,1) and ML(1,4) are connected to the middle switch MS(1,1) from input switch IS1 and IS2 respectively) and also are connected to exactly d switches in middle stage 140 through d links (for example the links ML(2,1) and ML(2,2) are connected from middle switch MS(1,1) to middle switch MS(2,1) and MS(2,3) respectively).

Similarly each of the

$$\frac{N_1}{d}$$

middle switches MS(2,1)-MS(2,4) in the middle stage 140 are connected from exactly d switches in middle stage 130 through d links (for example the links ML(2,1) and ML(2,6) are connected to the middle switch MS(2,1) from middle switches MS(1,1) and MS(1,3) respectively) and also are connected to exactly d switches in middle stage 150 through d links (for example the links ML(3,1) and ML(3,2) are connected from middle switch MS(2,1) to middle switch MS(3,1) and MS(3,3) respectively).

133

Similarly each of the

$$\frac{N_1}{d}$$

middle switches MS(3,1)-MS(3,4) in the middle stage 150 are connected from exactly d switches in middle stage 140 through d links (for example the links ML(3,1) and ML(3,6) are connected to the middle switch MS(3,1) from middle switches MS(2,1) and MS(2,3) respectively) and also are connected to exactly d output switches in output stage 120 through d₂ links (for example the links ML(4,1) and ML(4,2) are connected to output switches OS1 from middle switch MS(3,1); the links ML(4,3) and ML(4,4) are connected to output switches OS2 from middle switch MS(3,1); the link ML(4,5) is connected to output switches OS3 from middle switch MS(3,1); and the link ML(4,6) is connected to output switches OS4 from middle switch MS(3,1)).

Each of the

$$\frac{N_1}{d}$$

output switches OS1-OS4 are connected from exactly d switches in middle stage 150 through d₂ links (for example output switch OS1 is connected from middle switch MS(3,1) through the links ML(4,1) and ML(4,2); output switch OS1 is connected from middle switch MS(3,2) through the links ML(4,7) and ML(4,8); output switch OS1 is connected from middle switch MS(3,3) through the link ML(4,13); and output switch OS1 is connected from middle switch MS(3,4) through the links ML(4,19)). Generalized Asymmetric Folded RNB (N₂>N₁) Unicast Embodiments:

Network 500D of FIG. 5D is an example of general asymmetrical folded multi-stage network V_{fold}(N₁, N₂, d, s) with (2×log_d N)-1 stages where N₂>N₁ and N₂=p*N₁ where p>1. In network 500D of FIG. 5D, N₁=N and N₂=p*N. The general symmetrical folded multi-stage network V_{fold}(N₁, N₂, d, s) can be operated in rearrangeably nonblocking manner for unicast when s≧1 according to the current invention (and in the example of FIG. 5D, s=1). The general asymmetrical folded multi-stage network V_{fold}(N₁, N₂, d, s) with (2×log_d N)-1 stages has d inlet links for each of

$$\frac{N_1}{d}$$

input switches IS1-IS(N₁/d) (for example the links IL1-IL(d) to the input switch IS1) and d outgoing links for each of

$$\frac{N_1}{d}$$

input switches IS1-IS(N₁/d) (for example the links ML(1,1)-ML(1, d) to the input switch IS1). There are d₂ (where

$$\left(\text{where } d_2 = N_2 \times \frac{d}{N_1} = p \times d \right)$$

134

outlet links for each of

$$\frac{N_1}{d}$$

output switches OS1-OS(N₁/d) (for example the links OL1-OL(p*d) to the output switch OS1) and d₂ (=p*d) incoming links for each of

$$\frac{N_1}{d}$$

output switches OS1-OS(N₁/d) (for example ML(2×Log_d N₁-2,1)-ML(2×Log_d N₁-2, d₂) to the output switch OS1). Each of the

$$\frac{N_1}{d}$$

input switches IS1-IS(N₁/d) are connected to exactly d switches in middle stage 130 through d links.

Each of the

$$\frac{N_1}{d}$$

middle switches MS(1,1)-MS(1,N₁/d) in the middle stage 130 are connected from exactly d input switches through d links and also are connected to exactly d switches in middle stage 140 through d links.

Similarly each of the

$$\frac{N_1}{d}$$

middle switches

$$MS(\text{Log}_d N_1 - 1, 1) - MS\left(\text{Log}_d N_1 - 1, \frac{N_1}{d}\right)$$

in the middle stage 130+10*(Log_d N₁-2) are connected from exactly d switches in middle stage 130+10*(Log_d N₁-3) through d links and also are connected to exactly d switches in middle stage 130+10*(Log_d N₁-1) through d links.

Similarly each of the

$$\frac{N_1}{d}$$

middle switches

$$MS(2 \times \text{Log}_d N_1 - 3, 1) - MS\left(2 \times \text{Log}_d N_1 - 3, \frac{N_1}{d}\right)$$

in the middle stage 130+10*(2*Log_d N₁-4) are connected from exactly d switches in middle stage 130+10*(2*Log_d

135

N_1-5) through d links and also are connected to exactly d output switches in output stage **120** through d_1 links.

Each of the

$$\frac{N_1}{d}$$

output switches $OS1-OS(N_1/d)$ are connected from exactly d switches in middle stage **130** through d_2 links.

The general symmetrical folded multi-stage network $V_{fold}(N_1, N_2, d, s)$ can be operated in rearrangeably nonblocking manner for multicast when $s \geq 1$ according to the current invention.

Asymmetric Folded RNB ($N_1 > N_2$) Unicast Embodiments:

Referring to FIG. **5E**, an exemplary symmetrical folded multi-stage network **500E** with five stages of twenty switches for satisfying communication requests, such as setting up a telephone call or a data call, or a connection between configurable logic blocks, between an input stage **110** and output stage **120** via middle stages **130**, **140**, and **150** is shown where input stage **110** consists of four, six by six switches **IS1-IS4** and output stage **120** consists of four, two by two switches **OS1-OS4**. And all the middle stages namely middle stage **130** consists of four, six by two switches **MS(1,1)-MS(1,4)**, middle stage **140** consists of four, two by two switches **MS(2,1)-MS(2,4)**, and middle stage **150** consists of four, two by two switches **MS(3,1)-MS(3,4)**.

Such a network can be operated in rearrangeably non-blocking manner for unicast connections, because the switches in the input stage **110** are of size six by six, the switches in output stage **120** are of size two by two, and there are four switches in each of middle stage **130**, middle stage **140** and middle stage **150**.

The connection topology of the network **500E** shown in FIG. **5E** is known to be back to back inverse Benes connection topology. The connection topology of the networks **500E** is different in the other embodiments. That is the way the links **ML(1,1)-ML(1,8)**, **ML(2,1)-ML(2,8)**, **ML(3,1)-ML(3,8)**, and **ML(4,1)-ML(4,8)** are connected between the respective stages is different.

Even though only one embodiment is illustrated, in general, the network $V_{fold}(N_1, N_2, d, s)$, comprise any arbitrary type of connection topology. For example the connection topology of the network $V_{fold}(N_1, N_2, d, s)$ may be back to back Benes networks, Delta Networks and many more combinations. The applicant notes that the fundamental property of a valid connection topology of the $V_{fold}(N_1, N_2, d, s)$ network is, when no connections are setup from any input link all the output links should be reachable. Based on this property numerous embodiments of the network $V_{fold}(N_1, N_2, d, s)$ can be built. The embodiment of FIG. **5E** is only one example of network $V_{fold}(N_1, N_2, d, s)$.

The network **500E** is rearrangeably nonblocking for unicast according to the current invention. In one embodiment of these networks each of the input switches **IS1-IS4** and output switches **OS1-OS4** are crossbar switches. The number of switches of input stage **110** and of output stage **120** can be denoted in general with the variable

$$\frac{N_2}{d}$$

136

where N_1 is the total number of inlet links or and N_2 is the total number of outlet links and $N_1 > N_2$ and $N_1 = p * N_2$ where $p > 1$. The number of middle switches in each middle stage is denoted by

$$\frac{N_2}{d}$$

The size of each input switch **IS1-IS4** can be denoted in general with the notation $d_1 * d_1$ and each output switch **OS1-OS4** can be denoted in general with the notation $(d * d)$, where

$$d_1 = N_1 \times \frac{d}{N_2} = p \times d.$$

The size of each switch in any of the middle stages excepting the first middle stage can be denoted as $d * d$. The size of each switch in the first middle stage can be denoted as $d_1 * d$. A switch as used herein can be either a crossbar switch, or a network of switches each of which in turn may be a crossbar switch or a network of switches. An asymmetric folded multi-stage network can be represented with the notation $V_{fold}(N_1, N_2, d, s)$, where N_1 represents the total number of inlet links of all input switches (for example the links **IL1-IL24**), N_2 represents the total number of outlet links of all output switches (for example the links **OL1-OL8**), d represents the inlet links of each output switch where $N_1 > N_2$, and s is the ratio of number of outgoing links from each input switch to the inlet links of each input switch.

In network **500E** of FIG. **5E**, each of the

$$\frac{N_2}{d}$$

input switches **IS1-IS4** are connected to exactly d switches in middle stage **130** through d_1 links (for example input switch **IS1** is connected to middle switch **MS(1,1)** through the links **ML(1,1)** and **ML(1,2)**; input switch **IS1** is connected to middle switch **MS(1,2)** through the links **ML(1,3)** and **ML(1,4)**; input switch **IS1** is connected to middle switch **MS(1,3)** through the link **ML(1,5)**; and input switch **IS1** is connected to middle switch **MS(1,4)** through the links **ML(1,6)**).

Each of the

$$\frac{N_2}{d}$$

middle switches **MS(1,1)-MS(1,4)** in the middle stage **130** are connected from exactly d , input switches through d links (for example the links **ML(1,1)** and **ML(1,2)** are connected to the middle switch **MS(1,1)** from input switch **IS1**; the links **ML(1,7)** and **ML(1,8)** are connected to the middle switch **MS(1,1)** from input switch **IS2**; the link **ML(1,13)** is connected to the middle switch **MS(1,1)** from input switch **IS3**; and the link **ML(1,19)** is connected to the middle switch **MS(1,1)** from input switch **IS4**), and also are connected to exactly d switches in middle stage **140** through d links (for example the links **ML(2,1)** and **ML(2,2)** are connected from middle switch **MS(1,1)** to middle switch **MS(2,1)** and **MS(2,3)** respectively).

137

Similarly each of the

$$\frac{N_1}{d}$$

middle switches MS(2,1)-MS(2,4) in the middle stage 140 are connected from exactly d switches in middle stage 130 through d links (for example the links ML(2,1) and ML(2,6) are connected to the middle switch MS(2,1) from middle switches MS(1,1) and MS(1,3) respectively) and also are connected to exactly d switches in middle stage 150 through d links (for example the links ML(3,1) and ML(3,2) are connected from middle switch MS(2,1) to middle switch MS(3,1) and MS(3,3) respectively).

Similarly each of the

$$\frac{N_1}{d}$$

middle switches MS(3,1)-MS(3,4) in the middle stage 150 are connected from exactly d switches in middle stage 140 through d links (for example the links ML(3,1) and ML(3,6) are connected to the middle switch MS(3,1) from middle switches MS(2,1) and MS(2,3) respectively) and also are connected to exactly d output switches in output stage 120 through d₁ links (for example the links ML(4,1) and ML(4,2) are connected to output switches OS1 and OS2 respectively from middle switch MS(3,1)).

Each of the

$$\frac{N_1}{d}$$

output switches OS1-OS4 are connected from exactly d switches in middle stage 150 through d₂ links (for example output switch OS1 is connected from middle switches MS(3,1) and MS(3,2) through the links ML(4,1) and ML(4,4) respectively).

Generalized Asymmetric Folded RNB (N₁>N₂) Unicast Embodiments:

Network 500F of FIG. 5F is an example of general asymmetrical folded multi-stage network V_{fold}(N₁, N₂, d, s) with (2×log_d N)-1 stages where N₁>N₂ and N₁=p*N₂ where p>1. In network 500F of FIG. 5F, N₂=N and N₁=p*N. The general symmetrical folded multi-stage network V_{fold}(N₁, N₂, d, s) can be operated in rearrangeably nonblocking manner for unicast when s=1 according to the current invention (and in the example of FIG. 5F, s=1). The general asymmetrical folded multi-stage network V_{fold}(N₁, N₂, d, s) with (2×log_d N)-1 stages has d₁ (where

$$d_1 = N_1 \times \frac{d}{N_2} = p \times d$$

inlet links for each of

$$\frac{N_2}{d}$$

138

input switches IS1-IS(N₂/d) (for example the links IL1-IL(p*d) to the input switch IS1) and d₁ (=p*d) outgoing links for each of

5

$$\frac{N_2}{d}$$

10 input switches IS1-IS(N₂/d) (for example the links ML(1,1)-ML(1,(d+p*d)) to the input switch IS1). There are d outlet links for each of

15

$$\frac{N_2}{d}$$

20 output switches OS1-OS(N₂/d) (for example the links OL1-OL(d) to the output switch OS1) and d incoming links for each of

25

$$\frac{N_2}{d}$$

output switches OS1-OS(N₂/d) (for example ML(2×Log_d N₂-2,1)-ML(2×Log_d N₂-2, d) to the output switch OS1).

30

Each of the

35

$$\frac{N_2}{d}$$

input switches IS1-IS(N₂/d) are connected to exactly d switches in middle stage 130 through d₁ links.

Each of the

40

$$\frac{N_2}{d}$$

45 middle switches MS(1,1)-MS(1,N₂/d) in the middle stage 130 are connected from exactly d input switches through d₁ links and also are connected to exactly d switches in middle stage 140 through d links.

50

Similarly each of the

55

$$\frac{N_2}{d}$$

middle switches

60

$$MS(\text{Log}_d N_2 - 1, 1) - MS\left(\text{Log}_d N_2 - 1, \frac{N_2}{d}\right)$$

65 in the middle stage 130+10*(Log_d N₂-2) are connected from exactly d switches in middle stage 130+10*(Log_d N₂-3) through d links and also are connected to exactly d switches in middle stage 130+10*(Log_d N₂-1) through d links.

Similarly each of the

$$\frac{N_2}{d}$$

middle switches

$$MS(2 \times \text{Log}_d N_2 - 3, 1) - MS(2 \times \text{Log}_d N_2 - 3, \frac{N_2}{d})$$

in the middle stage **130**+10*(2*Log_d N₂-4) are connected from exactly d switches in middle stage **130**+10*(2*Log_d N₂-5) through d links and also are connected to exactly d

Each of the

$$\frac{N_2}{d}$$

output switches OS1-OS(N₂/d) are connected from exactly d switches in middle stage **130**+10*(2*Log_d N₂-4) through d links.

The general symmetrical folded multi-stage network V_{fold}(N₁, N₂, d, s) can be operated in rearrangeably nonblocking manner for unicast when s ≥ 1 according to the current invention.

Symmetric RNB Unicast Embodiments:

Referring to FIG. 6A, FIG. 6B, FIG. 6C, FIG. 6D, FIG. 6E, FIG. 6F, FIG. 6G, FIG. 600H, FIG. 600I and FIG. 6J with exemplary symmetrical multi-stage networks **600A**, **600B**, **600C**, **600D**, **600E**, **600F**, **600G**, **600H**, **600I**, and **600J** respectively with five stages of twenty switches for satisfying communication requests, such as setting up a telephone call or a data call, or a connection between configurable logic blocks, between an input stage **110** and output stage **120** via middle stages **130**, **140**, and **150** is shown where input stage **110** consists of four, two by two switches IS1-IS4 and output stage **120** consists of four, two by two switches OS1-OS4. And all the middle stages namely middle stage **130** consists of four, two by two switches MS(1,1)-MS(1,4), middle stage **140** consists of four, two by two switches MS(2,1)-MS(2,4), and middle stage **150** consists of four, two by two switches MS(3,1)-MS(3,4).

Such networks can be operated in rearrangeably nonblocking manner for unicast connections, because the switches in the input stage **110** are of size two by two, the switches in output stage **120** are of size two by two, and there are four switches in each of middle stage **130**, middle stage **140** and middle stage **150**.

In all the ten embodiments of FIG. 6A to FIG. 6J the connection topology is different. That is the way the links ML(1,1)-ML(1,8), ML(2,1)-ML(2,8), ML(3,1)-ML(3,8), and ML(4,1)-ML(4,8) are connected between the respective stages is different. For example, the connection topology of the network **600A** shown in FIG. 6A is known to be back to back inverse Benes connection topology; the connection topology of the network **600B** shown in FIG. 6B is known to be back to back Omega connection topology; and the connection topology of the network **600C** shown in FIG. 6C is hereinafter called nearest neighbor connection topology.

Even though only ten embodiments are illustrated, in general, the network V(N, d, s) can comprise any arbitrary type of connection topology. For example the connection topology of

the network V(N, d, s) may be back to back Benes networks, Delta Networks and many more combinations. The applicant notes that the fundamental property of a valid connection topology of the V(N, d, s) network is, when no connections are setup from any input link all the output links should be reachable. Based on this property numerous embodiments of the network V(N, d, s) can be built. The ten embodiments of FIG. 6A to FIG. 6J are only three examples of network V(N, d, s).

The networks **600A**-**600J** of FIG. 6A-FIG. 6J are also rearrangeably nonblocking for unicast according to the current invention. In one embodiment of these networks each of the input switches IS1-IS4 and output switches OS1-OS4 are crossbar switches. The number of switches of input stage **110** and of output stage **120** can be denoted in general with the variable N/d, where N is the total number of inlet links or outlet links. The number of middle switches in each middle stage is denoted by N/d. The size of each input switch IS1-IS4 can be denoted in general with the notation d*d and each output switch OS1-OS4 can be denoted in general with the notation d*d. Likewise, the size of each switch in any of the middle stages can be denoted as d*d. A switch as used herein can be either a crossbar switch, or a network of switches each of which in turn may be a crossbar switch or a network of switches. A symmetric multi-stage network can be represented with the notation V(N, d, s), where N represents the total number of inlet links of all input switches (for example the links IL1-IL8), d represents the inlet links of each input switch or outlet links of each output switch, and s is the ratio of number of outgoing links from each input switch to the inlet links of each input switch. Although it is not necessary that there be the same number of inlet links IL1-IL8 as there are outlet links OL1-OL8, in a symmetrical network they are the same.

In network **600A** of FIG. 6A, each of the N/d input switches IS1-IS4 are connected to exactly d switches in middle stage **130** through d links (for example input switch IS1 is connected to middle switches MS(1,1) and MS(1,2) through the links ML(1,1) and ML(1,2) respectively).

Each of the N/d middle switches MS(1,1)-MS(1,4) in the middle stage **130** are connected from exactly d input switches through d links (for example the links ML(1,1) and ML(1,4) are connected to the middle switch MS(1,1) from input switch IS1 and IS2 respectively) and also are connected to exactly d switches in middle stage **140** through d links (for example the links ML(2,1) and ML(2,2) are connected from middle switch MS(1,1) to middle switch MS(2,1) and MS(2,3) respectively).

Similarly each of the N/d middle switches MS(2,1)-MS(2,4) in the middle stage **140** are connected from exactly d switches in middle stage **130** through d links (for example the links ML(2,1) and ML(2,6) are connected to the middle switch MS(2,1) from middle switches MS(1,1) and MS(1,3) respectively) and also are connected to exactly d switches in middle stage **150** through d links (for example the links ML(3,1) and ML(3,2) are connected from middle switch MS(2,1) to middle switch MS(3,1) and MS(3,3) respectively).

Similarly each of the N/d middle switches MS(3,1)-MS(3,4) in the middle stage **150** are connected from exactly d switches in middle stage **140** through d links (for example the links ML(3,1) and ML(3,6) are connected to the middle switch MS(3,1) from middle switches MS(2,1) and MS(2,3) respectively) and also are connected to exactly d output switches in output stage **120** through d links (for example the links ML(4,1) and ML(4,2) are connected to output switches OS1 and OS2 respectively from middle switch MS(3,1)).

141

Each of the N/d output switches OS1-OS4 are connected from exactly d switches in middle stage 150 through d links (for example output switch OS1 is connected from middle switches MS(3,1) and MS(3,2) through the links ML(4,1) and ML(4,4) respectively).

Generalized Symmetric RNB Unicast Embodiments:

Network 600K of FIG. 6K is an example of general symmetrical multi-stage network V(N, d, s) with (2*log_d N)-1 stages. The general symmetrical multi-stage network V(N, d, s) can be operated in rearrangeably nonblocking manner for unicast when s ≥ 1 according to the current invention (and in the example of FIG. 6K, s=1). The general symmetrical multi-stage network V(N, d, s) with (2*log_d N)-1 stages has d inlet links for each of N/d input switches IS1-IS(N/d) (for example the links IL1-IL(d) to the input switch IS1) and d outgoing links for each of N/d input switches IS1-IS(N/d) (for example the links ML(1,1)-ML(1, d) to the input switch IS1). There are d outlet links for each of N/d output switches OS1-OS(N/d) (for example OL1-OL(d) to the output switch OS1) and d incoming links for each of N/d output switches OS1-OS(N/d) (for example ML(2*Log_dN-2,1)-ML(2*Log_dN-2,d) to the output switch OS1).

Each of the N/d input switches IS1-IS(N/d) are connected to exactly d switches in middle stage 130 through d links.

Each of the N/d middle switches MS(1,1)-MS(1,N/d) in the middle stage 130 are connected from exactly d input switches through d links and also are connected to exactly d switches in middle stage 140 through d links.

Similarly each of the N/d middle switches

$$MS(\text{Log}_d N - 1, 1) - MS\left(\text{Log}_d N - 1, \frac{N}{d}\right)$$

in the middle stage 130+10*(Log_d N-2) are connected from exactly d switches in middle stage 130+10*(Log_d N-3) through d links and also are connected to exactly d switches in middle stage 130+10*(Log_d N-1) through d links.

Similarly each of the N/d middle switches

$$MS(2 \times \text{Log}_d N - 3, 1) - MS\left(2 \times \text{Log}_d N - 3, \frac{N}{d}\right)$$

in the middle stage 130+10*(2*Log_d N-4) are connected from exactly d switches in middle stage 130+10*(2*Log_d N-5) through d links and also are connected to exactly d output switches in output stage 120 through d links.

Each of the N/d output switches OS1-OS(N/d) are connected from exactly d switches in middle stage 130+10*(2*Log_d N-4) through d links.

The general symmetrical multi-stage network V(N, d, s) can be operated in rearrangeably nonblocking manner for unicast when s ≥ 1 according to the current invention.

Asymmetric RNB (N₂>N₁) Unicast Embodiments:

Referring to FIG. 6A1, FIG. 6B1, FIG. 6C1, FIG. 6D1, FIG. 6E1, FIG. 6F1, FIG. 6G1, FIG. 600H1, FIG. 600H1 and FIG. 6J1 with exemplary symmetrical multi-stage networks 600A1, 600B1, 600C1, 600D1, 600E1, 600F1, 600G1, 600H1, 600I1, and 600J1 respectively with five stages of twenty switches for satisfying communication requests, such as setting up a telephone call or a data call, or a connection between configurable logic blocks, between an input stage 110 and output stage 120 via middle stages 130, 140, and 150 is shown where input stage 110 consists of four, two by two switches IS1-IS4 and output stage 120 consists of four, six by

142

six switches OS1-OS4. And all the middle stages namely middle stage 130 consists of four, two by two switches MS(1, 1)-MS(1,4), middle stage 140 consists of four, two by two switches MS(2,1)-MS(2,4), and middle stage 150 consists of four, two by six switches MS(3,1)-MS(3,4).

Such networks can be operated in rearrangeably nonblocking manner for unicast connections, because the switches in the input stage 110 are of size two by two, the switches in output stage 120 are of size six by six, and there are four switches in each of middle stage 130, middle stage 140 and middle stage 150.

In all the ten embodiments of FIG. 6A1 to FIG. 6J1 the connection topology is different. That is the way the links ML(1,1)-ML(1,8), ML(2,1)-ML(2,8), ML(3,1)-ML(3,8), and ML(4,1)-ML(4,8) are connected between the respective stages is different. For example, the connection topology of the network 600A1 shown in FIG. 6A1 is known to be back to back inverse Benes connection topology; the connection topology of the network 600B1 shown in FIG. 6B1 is known to be back to back Omega connection topology; and the connection topology of the network 600C1 shown in FIG. 6C1 is hereinafter called nearest neighbor connection topology.

Even though only ten embodiments are illustrated, in general, the network V(N₁, N₂, d, s) can comprise any arbitrary type of connection topology. For example the connection topology of the network V(N₁, N₂, d, s) may be back to back Benes networks, Delta Networks and many more combinations. The applicant notes that the fundamental property of a valid connection topology of the V(N₁, N₂, d, s) network is, when no connections are setup from any input link all the output links should be reachable. Based on this property numerous embodiments of the network V(N₁, N₂, d, s) can be built. The ten embodiments of FIG. 6A1 to FIG. 6J1 are only three examples of network V(N₁, N₂, d, s).

The networks 600A1-600J1 of FIG. 6A1-FIG. 6J1 are also rearrangeably nonblocking for unicast according to the current invention. In one embodiment of these networks each of the input switches IS1-IS4 and output switches OS1-OS4 are crossbar switches. The number of switches of input stage 110 and of output stage 120 can be denoted in general with the variable

$$\frac{N_1}{d}$$

where N₁ is the total number of inlet links or and N₂ is the total number of outlet links and N₂>N₁ and N₂=p*N₁ where p>1. The number of middle switches in each middle stage is denoted by

$$\frac{N_1}{d}$$

The size of each input switch IS1-IS4 can be denoted in general with the notation d*d and each output switch OS1-OS4 can be denoted in general with the notation d₂*d₂, where

$$d_2 = N_2 \times \frac{d}{N_1} = p \times d.$$

The size of each switch in any of the middle stages excepting the last middle stage can be denoted as d*d. The size of each

143

switch in the last middle stage can be denoted as $d \cdot d_2$. A switch as used herein can be either a crossbar switch, or a network of switches each of which in turn may be a crossbar switch or a network of switches. An asymmetric multi-stage network can be represented with the notation $V(N_1, N_2, d, s)$, where N_1 represents the total number of inlet links of all input switches (for example the links IL1-IL8), N_2 represents the total number of outlet links of all output switches (for example the links OL1-OL24), d represents the inlet links of each input switch where $N_2 > N_1$, and s is the ratio of number of outgoing links from each input switch to the inlet links of each input switch.

In network 600A1 of FIG. 6A1, each of the

$$\frac{N_1}{d}$$

input switches IS1-IS4 are connected to exactly d switches in middle stage 130 through d links (for example input switch IS1 is connected to middle switches MS(1,1) and MS(1,2) through the links ML(1,1) and ML(1,2) respectively).

Each of the

$$\frac{N_1}{d}$$

middle switches MS(1,1)-MS(1,4) in the middle stage 130 are connected from exactly d input switches through d links (for example the links ML(1,1) and ML(1,4) are connected to the middle switch MS(1,1) from input switch IS1 and IS2 respectively) and also are connected to exactly d switches in middle stage 140 through d links (for example the links ML(2,1) and ML(2,2) are connected from middle switch MS(1,1) to middle switch MS(2,1) and MS(2,3) respectively).

Similarly each of the

$$\frac{N_1}{d}$$

middle switches MS(2,1)-MS(2,4) in the middle stage 140 are connected from exactly d switches in middle stage 130 through d links (for example the links ML(2,1) and ML(2,6) are connected to the middle switch MS(2,1) from middle switches MS(1,1) and MS(1,3) respectively) and also are connected to exactly d switches in middle stage 150 through d links (for example the links ML(3,1) and ML(3,2) are connected from middle switch MS(2,1) to middle switch MS(3,1) and MS(3,3) respectively).

Similarly each of the

$$\frac{N_1}{d}$$

middle switches MS(3,1)-MS(3,4) in the middle stage 150 are connected from exactly d switches in middle stage 140 through d links (for example the links ML(3,1) and ML(3,6) are connected to the middle switch MS(3,1) from middle switches MS(2,1) and MS(2,3) respectively) and also are connected to exactly d output switches in output stage 120 through d_2 links (for example the links ML(4,1) and ML(4,2) are connected to output switches OS1 from middle switch MS(3,1); the links ML(4,3) and ML(4,4) are connected to

144

output switches OS2 from middle switch MS(3,1); the link ML(4,5) is connected to output switches OS3 from middle switch MS(3,1); and the link ML(4,6) is connected to output switches OS4 from middle switch MS(3,1)).

Each of the

$$\frac{N_1}{d}$$

output switches OS1-OS4 are connected from exactly d switches in middle stage 150 through d_2 links (for example output switch OS1 is connected from middle switch MS(3,1) through the links ML(4,1) and ML(4,2); output switch OS1 is connected from middle switch MS(3,2) through the links ML(4,7) and ML(4,8); output switch OS1 is connected from middle switch MS(3,3) through the link ML(4,13); and output switch OS1 is connected from middle switch MS(3,4) through the links ML(4,19)).

Generalized Asymmetric RNB ($N_2 > N_1$) Unicast Embodiments:

Network 600K1 of FIG. 6K1 is an example of general asymmetrical multi-stage network $V(N_1, N_2, d, s)$ with $(2 \times \log_d N) - 1$ stages where $N_2 > N_1$ and $N_2 = p \cdot N_1$ where $p > 1$. In network 400K1 of FIG. 4K1, $N_1 = N$ and $N_2 = p \cdot N$. The general symmetrical multi-stage network $V(N_1, N_2, d, s)$ can be operated in rearrangeably nonblocking manner for unicast when $s \geq 1$ according to the current invention (and in the example of FIG. 6K1, $s = 1$). The general asymmetrical multi-stage network $V(N_1, N_2, d, s)$ with $(2 \times \log_d N) - 1$ stages has d inlet links for each of

$$\frac{N_1}{d}$$

input switches IS1-IS(N_1/d) (for example the links IL1-IL(d) to the input switch IS1) and d outgoing links for each of

$$\frac{N_1}{d}$$

input switches IS1-IS(N_1/d) (for example the links ML(1,1)-ML(1, d) to the input switch IS1). There are d_2 (where

$$\left(\text{where } d_2 = N_2 \times \frac{d}{N_1} = p \times d \right)$$

outlet links for each of

$$\frac{N_1}{d}$$

output switches OS1-OS(N_1/d) (for example the links OL1-OL($p \cdot d$) to the output switch OS1) and d_2 ($= p \times d$) incoming links for each of

$$\frac{N_1}{d}$$

145

output switches OS1-OS(N₁/d) (for example ML(2×Log_d N₁-2,1)-ML(2×Log_d N₁-2, d₂) to the output switch OS1).

Each of the

$$\frac{N_1}{d}$$

input switches IS1-IS(N₁/d) are connected to exactly d switches in middle stage 130 through d links.

Each of the

$$\frac{N_1}{d}$$

middle switches MS(1,1)-MS(1,N₁/d) in the middle stage 130 are connected from exactly d input switches through d links and also are connected to exactly d switches in middle stage 140 through d links.

Similarly each of the

$$\frac{N_1}{d}$$

middle switches

$$MS(\text{Log}_d N_1 - 1, 1) - MS(\text{Log}_d N_1 - 1, \frac{N_1}{d})$$

in the middle stage 130+10*(Log_d N₁-2) are connected from exactly d switches in middle stage 130+10*(Log_d N₁-3) through d links and also are connected to exactly d switches in middle stage 130+10*(Log_d N₁-1) through d links.

Similarly each of the

$$\frac{N_1}{d}$$

middle switches

$$MS(2 \times \text{Log}_d N_1 - 3, 1) - MS(2 \times \text{Log}_d N_1 - 3, \frac{N_1}{d})$$

in the middle stage 130+10*(2*Log_d N₁-4) are connected from exactly d switches in middle stage 130+10*(2*Log_d N₁-5) through d links and also are connected to exactly d output switches in output stage 120 through d₁ links.

Each of the

$$\frac{N_1}{d}$$

output switches OS1-OS(N₁/d) are connected from exactly d switches in middle stage 130+10*(2*Log_d N-4) through d₂ links.

The general symmetrical multi-stage network V(N₁, N₂, d, s) can be operated in rearrangeably nonblocking manner for multicast when s=1 according to the current invention.

146

Asymmetric RNB (N₁>N₂) Unicast Embodiments:

Referring to FIG. 6A2, FIG. 6B2, FIG. 6C2, FIG. 6D2, FIG. 6E2, FIG. 6F2, FIG. 6G2, FIG. 600H2, FIG. 600I2 and FIG. 6J2 with exemplary symmetrical multi-stage networks 600A2, 600B2, 600C2, 600D2, 600E2, 600F2, 600G2, 600H2, 600I2, and 600J2 respectively with five stages of twenty switches for satisfying communication requests, such as setting up a telephone call or a data call, or a connection between configurable logic blocks, between an input stage 110 and output stage 120 via middle stages 130, 140, and 150 is shown where input stage 110 consists of four, six by six switches IS1-IS4 and output stage 120 consists of four, two by two switches OS1-OS4. And all the middle stages namely middle stage 130 consists of four, six by two switches MS(1, 1)-MS(1,4), middle stage 140 consists of four, two by two switches MS(2,1)-MS(2,4), and middle stage 150 consists of four, two by two switches MS(3,1)-MS(3,4).

Such networks can be operated in rearrangeably nonblocking manner for unicast connections, because the switches in the input stage 110 are of size six by six, the switches in output stage 120 are of size two by two, and there are four switches in each of middle stage 130, middle stage 140 and middle stage 150.

In all the ten embodiments of FIG. 6A2 to FIG. 6J2 the connection topology is different. That is the way the links ML(1,1)-ML(1,8), ML(2,1)-ML(2,8), ML(3,1)-ML(3,8), and ML(4,1)-ML(4,8) are connected between the respective stages is different. For example, the connection topology of the network 600A2 shown in FIG. 6A2 is known to be back to back inverse Benes connection topology; the connection topology of the network 600B2 shown in FIG. 6B2 is known to be back to back Omega connection topology; and the connection topology of the network 600C2 shown in FIG. 6C2 is hereinafter called nearest neighbor connection topology.

Even though only ten embodiments are illustrated, in general, the network V(N₁, N₂, d, s) can comprise any arbitrary type of connection topology. For example the connection topology of the network V(N₁, N₂, d, s) may be back to back Benes networks, Delta Networks and many more combinations. The applicant notes that the fundamental property of a valid connection topology of the V(N₁, N₂, d, s) network is, when no connections are setup from any input link all the output links should be reachable. Based on this property numerous embodiments of the network V(N₁, N₂, d, s) can be built. The ten embodiments of FIG. 6A2 to FIG. 6J2 are only three examples of network V(N₁, N₂, d, s).

The networks 600A2-600J2 of FIG. 6A2-FIG. 6J2 are also rearrangeably nonblocking for unicast according to the current invention. In one embodiment of these networks each of the input switches IS1-IS4 and output switches OS1-OS4 are crossbar switches. The number of switches of input stage 110 and of output stage 120 can be denoted in general with the variable

$$\frac{N_2}{d}$$

where N₁ is the total number of inlet links or and N₂ is the total number of outlet links and N₁>N₂ and N₁=p*N₂ where p>1.

147

The number of middle switches in each middle stage is denoted by

$$\frac{N_2}{d}$$

The size of each input switch IS1-IS4 can be denoted in general with the notation $d_1 * d_1$ and each output switch OS1-OS4 can be denoted in general with the notation $(d * d)$, where

$$d_1 = N_1 \times \frac{d}{N_2} = p \times d.$$

The size of each switch in any of the middle stages excepting the first middle stage can be denoted as $d * d$. The size of each switch in the first middle stage can be denoted as $d_1 * d$. A switch as used herein can be either a crossbar switch, or a network of switches each of which in turn may be a crossbar switch or a network of switches. An asymmetric multi-stage network can be represented with the notation $V(N_1, N_2, d, s)$, where N_1 represents the total number of inlet links of all input switches (for example the links IL1-IL24), N_2 represents the total number of outlet links of all output switches (for example the links OL1-OL8), d represents the inlet links of each output switch where $N_1 > N_2$, and s is the ratio of number of outgoing links from each input switch to the inlet links of each input switch.

In network 600A2 of FIG. 6A2, each of the

$$\frac{N_2}{d}$$

input switches IS1-IS4 are connected to exactly d switches in middle stage 130 through d_1 links (for example input switch IS1 is connected to middle switch MS(1,1) through the links ML(1,1) and ML(1,2); input switch IS1 is connected to middle switch MS(1,2) through the links ML(1,3) and ML(1,4); input switch IS1 is connected to middle switch MS(1,3) through the link ML(1,5); and input switch IS1 is connected to middle switch MS(1,4) through the links ML(1,6)).

Each of the

$$\frac{N_2}{d}$$

middle switches MS(1,1)-MS(1,4) in the middle stage 130 are connected from exactly d input switches through d links (for example the links ML(1,1) and ML(1,2) are connected to the middle switch MS(1,1) from input switch IS1; the links ML(1,7) and ML(1,8) are connected to the middle switch MS(1,1) from input switch IS2; the link ML(1,13) is connected to the middle switch MS(1,1) from input switch IS3; and the link ML(1,19) is connected to the middle switch MS(1,1) from input switch IS4), and also are connected to exactly d switches in middle stage 140 through d links (for example the links ML(2,1) and ML(2,2) are connected from middle switch MS(1,1) to middle switch MS(2,1) and MS(2,3) respectively).

148

Similarly each of the

$$\frac{N_1}{d}$$

middle switches MS(2,1)-MS(2,4) in the middle stage 140 are connected from exactly d switches in middle stage 130 through d links (for example the links ML(2,1) and ML(2,6) are connected to the middle switch MS(2,1) from middle switches MS(1,1) and MS(1,3) respectively) and also are connected to exactly d switches in middle stage 150 through d links (for example the links ML(3,1) and ML(3,2) are connected from middle switch MS(2,1) to middle switch MS(3,1) and MS(3,3) respectively).

Similarly each of the

$$\frac{N_1}{d}$$

middle switches MS(3,1)-MS(3,4) in the middle stage 150 are connected from exactly d switches in middle stage 140 through d links (for example the links ML(3,1) and ML(3,6) are connected to the middle switch MS(3,1) from middle switches MS(2,1) and MS(2,3) respectively) and also are connected to exactly d output switches in output stage 120 through d_1 links (for example the links ML(4,1) and ML(4,2) are connected to output switches OS1 and OS2 respectively from middle switch MS(3,1)).

Each of the

$$\frac{N_1}{d}$$

output switches OS1-OS4 are connected from exactly d switches in middle stage 150 through d_2 links (for example output switch OS1 is connected from middle switches MS(3,1) and MS(3,2) through the links ML(4,1) and ML(4,4) respectively).

Generalized Asymmetric RNB ($N_1 > N_2$) Unicast Embodiments:

Network 600K2 of FIG. 6K2 is an example of general asymmetrical multi-stage network $V(N_1, N_2, d, s)$ with $(2 \times \log_d N) - 1$ stages where $N_1 > N_2$ and $N_1 = p * N_2$ where $p > 1$. In network 400K2 of FIG. 4K2, $N_2 = N$ and $N_1 = p * N$. The general symmetrical multi-stage network $V(N_1, N_2, d, s)$ can be operated in rearrangeably nonblocking manner for unicast when $s \geq 1$ according to the current invention (and in the example of FIG. 6K2, $s = 1$). The general asymmetrical multi-stage network $V(N_1, N_2, d, s)$ with $(2 \times \log_d N) - 1$ stages has d_1 (where

$$d_1 = N_1 \times \frac{d}{N_2} = p \times d$$

inlet links for each of

$$\frac{N_2}{d}$$

149

input switches IS1-IS(N₂/d) (for example the links IL1-IL(p*d) to the input switch IS1) and d, (=p*d) outgoing links for each of

$$\frac{N_2}{d}$$

input switches IS1-IS(N₂/d) (for example the links ML(1,1)-ML(1,(d+p*d)) to the input switch IS1). There are d outlet links for each of

$$\frac{N_2}{d}$$

output switches OS1-OS(N₂/d) (for example the links OL1-OL(d) to the output switch OS1) and d incoming links for each of

$$\frac{N_2}{d}$$

output switches OS1-OS(N₂/d) (for example ML(2*Log_dN₂-2,1)-ML(2*Log_dN₂-2, d) to the output switch OS1).

Each of the

$$\frac{N_2}{d}$$

input switches IS1-IS(N₂/d) are connected to exactly d switches in middle stage 130 through d₁ links.

Each of the

$$\frac{N_2}{d}$$

middle switches MS(1,1)-MS(1,N₂/d) in the middle stage 130 are connected from exactly d input switches through d₁ links and also are connected to exactly d switches in middle stage 140 through d links.

Similarly each of the

$$\frac{N_2}{d}$$

middle switches

$$MS(\text{Log}_d N_2 - 1, 1) - MS(\text{Log}_d N_2 - 1, \frac{N_2}{d})$$

in the middle stage 130+10*(Log_d N₁-2) are connected from exactly d switches in middle stage 130+10*(Log_d N₁-3) through d links and also are connected to exactly d switches in middle stage 130+10*(Log_d N₁-1) through d links.

150

Similarly each of the

$$\frac{N_2}{d}$$

middle switches

$$MS(2 \times \text{Log}_d N_2 - 3, 1) - MS(2 \times \text{Log}_d N_2 - 3, \frac{N_2}{d})$$

in the middle stage 130+10*(2*Log_d N₁-4) are connected from exactly d switches in middle stage 130+10*(2*Log_d N₁-5) through d links and also are connected to exactly d output switches in output stage 120 through d links.

Each of the

$$\frac{N_2}{d}$$

output switches OS1-OS(N₂/d) are connected from exactly d switches in middle stage 130+10*(2*Log_d N₁-4) through d links.

The general symmetrical multi-stage network V(N₁, N₂, d, s) can be operated in rearrangeably nonblocking manner for unicast when s ≥ 1 according to the current invention.

Scheduling Method Embodiments:

FIG. 7A shows a high-level flowchart of a scheduling method 1000, in one embodiment executed to setup multicast and unicast connections in network 100A of FIG. 1A (or any of the networks V_{mlink}(N₁, N₂, d, s) and the networks V(N₁, N₂, d, s) disclosed in this invention). According to this embodiment, a multicast connection request is received in act 1010. Then the control goes to act 1020.

In act 1020, based on the inlet link and input switch of the multicast connection received in act 1010, from each available outgoing middle link of the input switch of the multicast connection, by traveling forward from middle stage 130 to middle stage 130+10*(Log_d N-2), the lists of all reachable middle switches in each middle stage are derived recursively. That is, first, by following each available outgoing middle link of the input switch all the reachable middle switches in middle stage 130 are derived. Next, starting from the selected middle switches in middle stage 130 traveling through all of their available outgoing middle links to middle stage 140 all the available middle switches in middle stage 140 are derived. This process is repeated recursively until all the reachable middle switches, starting from the outgoing middle link of input switch, in middle stage 130+10*(Log_d N-2) are derived. This process is repeated for each available outgoing middle link from the input switch of the multicast connection and separate reachable lists are derived in each middle stage from middle stage 130 to middle stage 130+10*(Log_d N-2) for all the available outgoing middle links from the input switch. Then the control goes to act 1030.

In act 1030, based on the destinations of the multicast connection received in act 1010, from the output switch of each destination, by traveling backward from output stage 120 to middle stage 130+10*(Log_d N-2), the lists of all middle switches in each middle stage from which each destination output switch (and hence the destination outlet links) is reachable, are derived recursively. That is, first, by following each available incoming middle link of the output switch of each destination link of the multicast connection, all the

middle switches in middle stage $130+10*(2*\text{Log}_d N-4)$ from which the output switch is reachable, are derived. Next, starting from the selected middle switches in middle stage $130+10*(2*\text{Log}_d N-4)$ traveling backward through all of their available incoming middle links from middle stage $130+10*(2*\text{Log}_d N-5)$ all the available middle switches in middle stage $130+10*(2*\text{Log}_d N-5)$ from which the output switch is reachable, are derived. This process is repeated recursively until all the middle switches in middle stage $130+10*(\text{Log}_d N-2)$ from which the output switch is reachable, are derived. This process is repeated for each output switch of each destination link of the multicast connection and separate lists in each middle stage from middle stage $130+10*(2*\text{Log}_d N-4)$ to middle stage $130+10*(\text{Log}_d N-2)$ for all the output switches of each destination link of the connection are derived. Then the control goes to act 1040.

In act 1040, using the lists generated in acts 1020 and 1030, particularly list of middle switches derived in middle stage $130+10*(\text{Log}_d N-2)$ corresponding to each outgoing link of the input switch of the multicast connection, and the list of middle switches derived in middle stage $130+10*(\text{Log}_d N-2)$ corresponding to each output switch of the destination links, the list of all the reachable destination links from each outgoing link of the input switch are derived. Specifically if a middle switch in middle stage $130+10*(\text{Log}_d N-2)$ is reachable from an outgoing link of the input switch, say "x", and also from the same middle switch in middle stage $130+10*(\text{Log}_d N-2)$ if the output switch of a destination link, say "y", is reachable then using the outgoing link of the input switch x, destination link y is reachable. Accordingly, the list of all the reachable destination links from each outgoing link of the input switch is derived. The control then goes to act 1050.

In act 1050, among all the outgoing links of the input switch, it is checked if all the destinations are reachable using only one outgoing link of the input switch. If one outgoing link is available through which all the destinations of the multicast connection are reachable (i.e., act 1050 results in "yes"), the control goes to act 1070. And in act 1070, the multicast connection is setup by traversing from the selected only one outgoing middle link of the input switch in act 1050, to all the destinations. Then the control transfers to act 1090.

If act 1050 results "no", that is one outgoing link is not available through which all the destinations of the multicast connection are reachable, then the control goes to act 1060. In act 1060, it is checked if all destination links of the multicast connection are reachable using two outgoing middle links from the input switch. According to the current invention, it is always possible to find at most two outgoing middle links from the input switch through which all the destinations of a multicast connection are reachable. So act 1060 always results in "yes", and then the control transfers to act 1080. In act 1080, the multicast connection is setup by traversing from the selected only two outgoing middle links of the input switch in act 1060, to all the destinations. Then the control transfers to act 1090.

In act 1090, all the middle links between any two stages of the network used to setup the connection in either act 1070 or act 1080 are marked unavailable so that these middle links will be made unavailable to other multicast connections. The control then returns to act 1010, so that acts 1010, 1020, 1030, 1040, 1050, 1060, 1070, 1080, and 1090 are executed in a loop, for each connection request until the connections are set up.

In the example illustrated in FIG. 1A, four outgoing middle links are available to satisfy a multicast connection request if input switch is IS2, but only at most two outgoing middle links of the input switch will be used in accordance with this

method. Similarly, although three outgoing middle links is available for a multicast connection request if the input switch is IS1, again only at most two outgoing middle links is used. The specific outgoing middle links of the input switch that are chosen when selecting two outgoing middle links of the input switch is irrelevant to the method of FIG. 7A so long as at most two outgoing middle links of the input switch are selected to ensure that the connection request is satisfied, i.e. the destination switches identified by the connection request can be reached from the outgoing middle links of the input switch that are selected. In essence, limiting the outgoing middle links of the input switch to no more than two permits the network $V_{mmlink}(N_1, N_2, d, s)$ and the network $V(N_1, N_2, d, s)$ to be operated in nonblocking manner in accordance with the invention.

According to the current invention, using the method 1040 of FIG. 7A, the network $V_{mmlink}(N_1, N_2, d, s)$ and the networks $V(N_1, N_2, d, s)$ are operated in rearrangeably nonblocking for unicast connections when $s \geq 1$, are operated in strictly nonblocking for unicast connections when $s \geq 2$, and are operated in rearrangeably nonblocking for multicast connections when $s \geq 2$.

The connection request of the type described above in reference to method 1000 of FIG. 7A can be unicast connection request, a multicast connection request or a broadcast connection request, depending on the example. In case of a unicast connection request, only one outgoing middle link of the input switch is used to satisfy the request. Moreover, in method 1000 described above in reference to FIG. 7A any number of middle links may be used between any two stages excepting between the input stage and middle stage 130, and also any arbitrary fan-out may be used within each output stage switch, to satisfy the connection request.

As noted above method 1000 of FIG. 7A can be used to setup multicast connections, unicast connections, or broadcast connection of all the networks $V_{mmlink}(N, d, s)$, $V_{mmlink}(N_1, N_2, d, s)$, $V(N, d, s)$ and $V(N_1, N_2, d, s)$ disclosed in this invention.

Applications Embodiments:

All the embodiments disclosed in the current invention are useful in many varieties of applications. FIG. 8A1 illustrates the diagram of 800A1 which is a typical two by two switch with two inlet links namely IL1 and IL2, and two outlet links namely OL1 and OL2. The two by two switch also implements four crosspoints namely CP(1,1), CP(1,2), CP(2,1) and CP(2,2) as illustrated in FIG. 8A1. For example the diagram of 800A1 may be the implementation of middle switch MS(1,1) of the diagram 400A of FIG. 4A where inlet link IL1 of diagram 800A1 corresponds to middle link ML(1,1) of diagram 400A, inlet link IL2 of diagram 800A1 corresponds to middle link ML(1,5) of diagram 400A, outlet link OL1 of diagram 800A1 corresponds to middle link ML(2,1) of diagram 400A, outlet link OL2 of diagram 800A1 corresponds to middle link ML(2,2) of diagram 400A.

1) Programmable Integrated Circuit Embodiments:

All the embodiments disclosed in the current invention are useful in programmable integrated circuit applications. FIG. 8A2 illustrates the detailed diagram 800A2 for the implementation of the diagram 800A1 in programmable integrated circuit embodiments. Each crosspoint is implemented by a transistor coupled between the corresponding inlet link and outlet link, and a programmable cell in programmable integrated circuit embodiments. Specifically crosspoint CP(1,1) is implemented by transistor C(1,1) coupled between inlet link IL1 and outlet link OL1, and programmable cell P(1,1); crosspoint CP(1,2) is implemented by transistor C(1,2) coupled between inlet link IL1 and outlet link OL2, and

programmable cell P(1,2); crosspoint CP(2,1) is implemented by transistor C(2,1) coupled between inlet link IL2 and outlet link OL1, and programmable cell P(2,1); and crosspoint CP(2,2) is implemented by transistor C(2,2) coupled between inlet link IL2 and outlet link OL2, and programmable cell P(2,2).

If the programmable cell is programmed ON, the corresponding transistor couples the corresponding inlet link and outlet link. If the programmable cell is programmed OFF, the corresponding inlet link and outlet link are not connected. For example if the programmable cell P(1,1) is programmed ON, the corresponding transistor C(1,1) couples the corresponding inlet link IL1 and outlet link OL1. If the programmable cell P(1,1) is programmed OFF, the corresponding inlet link IL1 and outlet link OL1 are not connected. In volatile programmable integrated circuit embodiments the programmable cell may be an SRAM (Static Random Access Memory) cell. In non-volatile programmable integrated circuit embodiments the programmable cell may be a Flash memory cell. Also the programmable integrated circuit embodiments may implement field programmable logic arrays (FPGA) devices, or programmable Logic devices (PLD), or Application Specific Integrated Circuits (ASIC) embedded with programmable logic circuits or 3D-FPGAs.

2) One-time Programmable Integrated Circuit Embodiments: All the embodiments disclosed in the current invention are useful in one-time programmable integrated circuit applications. FIG. 8A3 illustrates the detailed diagram 800A3 for the implementation of the diagram 800A1 in one-time programmable integrated circuit embodiments. Each crosspoint is implemented by a via coupled between the corresponding inlet link and outlet link in one-time programmable integrated circuit embodiments. Specifically crosspoint CP(1,1) is implemented by via V(1,1) coupled between inlet link IL1 and outlet link OL1; crosspoint CP(1,2) is implemented by via V(1,2) coupled between inlet link IL1 and outlet link OL2; crosspoint CP(2,1) is implemented by via V(2,1) coupled between inlet link IL2 and outlet link OL1; and crosspoint CP(2,2) is implemented by via V(2,2) coupled between inlet link IL2 and outlet link OL2.

If the via is programmed ON, the corresponding inlet link and outlet link are permanently connected which is denoted by thick circle at the intersection of inlet link and outlet link. If the via is programmed OFF, the corresponding inlet link and outlet link are not connected which is denoted by the absence of thick circle at the intersection of inlet link and outlet link. For example in the diagram 800A3 the via V(1,1) is programmed ON, and the corresponding inlet link IL1 and outlet link OL1 are connected as denoted by thick circle at the intersection of inlet link IL1 and outlet link OL1; the via V(2,2) is programmed ON, and the corresponding inlet link IL2 and outlet link OL2 are connected as denoted by thick circle at the intersection of inlet link IL2 and outlet link OL2; the via V(1,2) is programmed OFF, and the corresponding inlet link IL1 and outlet link OL2 are not connected as denoted by the absence of thick circle at the intersection of inlet link IL1 and outlet link OL2; the via V(2,1) is programmed OFF, and the corresponding inlet link IL2 and outlet link OL1 are not connected as denoted by the absence of thick circle at the intersection of inlet link IL2 and outlet link OL1. One-time programmable integrated circuit embodiments may be anti-fuse based programmable integrated circuit devices or mask programmable structured ASIC devices.

3) Integrated Circuit Placement and Route Embodiments: All the embodiments disclosed in the current invention are useful in Integrated Circuit Placement and Route applications, for example in ASIC backend Placement and Route

tools. FIG. 8A4 illustrates the detailed diagram 800A4 for the implementation of the diagram 800A1 in Integrated Circuit Placement and Route embodiments. In an integrated circuit since the connections are known a-priori, the switch and crosspoints are actually virtual. However the concept of virtual switch and virtual crosspoint using the embodiments disclosed in the current invention reduces the number of required wires, wire length needed to connect the inputs and outputs of different netlists and the time required by the tool for placement and route of netlists in the integrated circuit.

Each virtual crosspoint is used to either to hardwire or provide no connectivity between the corresponding inlet link and outlet link. Specifically crosspoint CP(1,1) is implemented by direct connect point DCP(1,1) to hardwire (i.e., to permanently connect) inlet link IL1 and outlet link OL1 which is denoted by the thick circle at the intersection of inlet link IL1 and outlet link OL1; crosspoint CP(2,2) is implemented by direct connect point DCP(2,2) to hardwire inlet link IL2 and outlet link OL2 which is denoted by the thick circle at the intersection of inlet link IL2 and outlet link OL2. The diagram 800A4 does not show direct connect point DCP(1,2) and direct connect point DCP(1,3) since they are not needed and in the hardware implementation they are eliminated. Alternatively inlet link IL1 needs to be connected to outlet link OL1 and inlet link IL1 does not need to be connected to outlet link OL2. Also inlet link IL2 needs to be connected to outlet link OL2 and inlet link IL2 does not need to be connected to outlet link OL1. Furthermore in the example of the diagram 800A4, there is no need to drive the signal of inlet link IL1 horizontally beyond outlet link OL1 and hence the inlet link IL1 is not even extended horizontally until the outlet link OL2. Also the absence of direct connect point DCP(2,1) illustrates there is no need to connect inlet link IL2 and outlet link OL1.

In summary in integrated circuit placement and route tools, the concept of virtual switches and virtual cross points is used during the implementation of the placement & routing algorithmically in software, however during the hardware implementation cross points in the cross state are implemented as hardwired connections between the corresponding inlet link and outlet link, and in the bar state are implemented as no connection between inlet link and outlet link

3) More Application Embodiments:

All the embodiments disclosed in the current invention are also useful in the design of SoC interconnects, Field programmable interconnect chips, parallel computer systems and in time-space-time switches.

Numerous modifications and adaptations of the embodiments, implementations, and examples described herein will be apparent to the skilled artisan in view of the disclosure.

What is claimed is:

1. A network having a plurality of multicast connections, said network comprising:

N_1 inlet links and N_2 outlet links, where $N_1 > 1$, $N_2 > 1$ and when $N_2 > N_1$ and $N_2 = p * N_1$ where $p > 1$ then $N_1 = N$, $d_1 = d$, and

$$d_2 = N_2 \times \frac{d}{N_1} = p \times d;$$

where $N > 1$, $d_1 > 1$, $d_2 > 1$, $d > 1$ and

155

an input stage comprising

$$\frac{N_1}{d}$$

input switches, and said each input switch comprising d inlet links and each said input switch further comprising xxd outgoing links connecting to switches in a second stage where x>0; and

an output stage comprising

$$\frac{N_1}{d}$$

output switches, and said each output switch comprising d₂ outlet links and each said output switch further comprising

$$x \times \frac{(d + d_2)}{2}$$

incoming links connecting from switches in a penultimate stage; and

a plurality of y middle stages comprising N/d middle switches in each of said y middle stages wherein said second stage and said penultimate stage are one of said middle stages where y>3, and

said each middle switch in all said middle stages excepting said penultimate stage comprising xxd incoming links (hereinafter "incoming middle links") connecting from switches in its immediate preceding stage, and said each middle switch further comprising xxd outgoing links (hereinafter "outgoing middle links") connecting to switches in its immediate succeeding stage; and

said each middle switch in said penultimate stage comprising xxd incoming links connecting from switches in its said immediate preceding stage, and said each middle switch further comprising

$$x \times \frac{(d + d_2)}{2}$$

outgoing links connecting to switches in its said immediate succeeding stage i.e., said output stage; or when N₁>N₂ and N₁=p*N₂ where p>1 then N₂=N, d₂=d and

$$d_1 = N_1 \times \frac{d}{N_2} = p \times d$$

and
an input stage comprising

$$\frac{N_2}{d}$$

input switches, and said each input switch comprising d₁ inlet links and said each input switch further comprising

$$x \times \frac{(d + d_1)}{2}$$

outgoing links connecting to switches in a second stage where x>0; and

156

an output stage comprising

$$\frac{N_2}{d}$$

output switches, and said each output switch comprising d outlet links and said each output switch further comprising xxd incoming links connecting from switches in a penultimate stage; and

a plurality of y middle stages comprising N/d middle switches in each of said y middle stages wherein said second stage and said penultimate stage are one of said middle stages where y>3, and

said each middle switch in said second stage comprising

$$x \times \frac{(d + d_1)}{2}$$

incoming links connecting from switches in its immediate preceding stage i.e., said input stage, and said each middle switch further comprising xxd outgoing links connecting to switches in its immediate succeeding stage; and

said each middle switch in all said middle stages excepting said second stage comprising xxd incoming links (hereinafter "incoming middle links") connecting from switches in its immediate preceding stage, and said each middle switch further comprising xxd outgoing links (hereinafter "outgoing middle links") connecting to switches in its said immediate succeeding stage; and

wherein said each multicast connection from an inlet link passes through at most two outgoing links in said input switch, and said multicast connection further passes through a plurality of outgoing links in a plurality of switches in each said middle stage and in said output stage.

2. The network of claim 1, wherein all said incoming middle links and outgoing middle links are connected in any arbitrary topology such that when no connections are setup in said network, a connection from any said inlet link to any said outlet link can be setup.

3. The network of claim 2, wherein y≧(2×log_dN)-3 when N₂>N₁, and y≧(2×log_dN₂)-3 when N₁>N₂.

4. The network of claim 3, wherein x≧1, wherein said each multicast connection comprises only one destination link, and

said each multicast connection from an inlet link passes through only one outgoing link in input switch, and said multicast connection further passes through only one outgoing link in one of the switches in each said middle stage and in said output stage, and

further is always capable of setting up said multicast connection by changing the path, defined by passage of an existing multicast connection, thereby to change only one outgoing link of the input switch used by said existing multicast connection, and said network is hereinafter "rearrangeably nonblocking network for unicast".

5. The network of claim 3, wherein x≧2, wherein said each multicast connection comprises only one destination link, and

said each multicast connection from an inlet link passes through only one outgoing link in input switch, and said multicast connection further passes through only one

157

outgoing link in one of the switches in each said middle stage and in said output stage, and

further is always capable of setting up said multicast connection by never changing path of an existing multicast connection, wherein said each multicast connection comprises only one destination link and the network is hereinafter "strictly nonblocking network for unicast".

6. The network of claim 3, wherein $x \geq 2$, further is always capable of setting up said multicast connection by changing the path, defined by passage of an existing multicast connection, thereby to change one or two outgoing links of the input switch used by said existing multicast connection, and said network is hereinafter "rearrangeably nonblocking network".

7. The network of claim 3, wherein $x \geq 3$, further is always capable of setting up said multicast connection by never changing path of an existing multicast connection, and the network is hereinafter "strictly nonblocking network".

8. The network of claim 1, further comprising a controller coupled to each of said input, output and middle stages to set up said multicast connection.

9. The network of claim 1, wherein said N_1 inlet links and N_2 outlet links are the same number of links, i.e., $N_1 = N_2 = N$, and $d_1 = d_2 = d$.

10. The network of claim 1, wherein said each input switch, said each output switch and said each middle switch is either fully populated or partially populated.

11. The network of claim 1, wherein each of said input switches, or each of said output switches, or each of said middle switches further recursively comprise one or more networks.

12. A method for setting up one or more multicast connections in a network having N_1 inlet links and N_2 outlet links, where $N_1 > 1$, $N_2 > 1$ and when $N_2 > N_1$ and $N_2 = p * N_1$ where $p > 1$ then $N_1 = N$, $d_1 = d$, and

$$d_2 = N_2 \times \frac{d}{N_1} = p \times d;$$

where $N > 1$, $d_1 > 1$, $d_2 > 1$, $d > 1$ and having an input stage having

$$\frac{N_1}{d}$$

input switches, and said each input switch having d inlet links and said each input switch further having $x \times d$ outgoing links connected to switches in a second stage where $x > 0$; and an output stage having

$$\frac{N_1}{d}$$

output switches, and said each output switch having d_2 outlet links and said each output switch further having

$$x \times \frac{(d + d_2)}{2}$$

incoming links connected from switches in a penultimate stage; and

158

a plurality of y middle stages having N/d middle switches in each of said y middle stages wherein said second stage and said penultimate stage being one of said middle stages where $y > 3$, and

said each middle switch in all said middle stages excepting said penultimate stage having $x \times d$ incoming links connected from switches in its immediate preceding stage, and said each middle switch further having $x \times d$ outgoing links connected to switches in its immediate succeeding stage; and

said each middle switch in said penultimate stage having $x \times d$ incoming links connected from switches in its said immediate preceding stage, and said each middle switch further having

$$x \times \frac{(d + d_2)}{2}$$

outgoing links connected to switches in its said immediate succeeding stage; or when $N_1 > N_2$ and $N_1 = p * N_2$ where $p > 1$ then $N_2 = N$, $d_2 = d$ and

$$d_1 = N_1 \times \frac{d}{N_2} = p \times d;$$

and having an input stage having

$$\frac{N_2}{d}$$

input switches, and said each input switch having d_1 inlet links and said each input switch further having

$$x \times \frac{(d + d_1)}{2}$$

outgoing links connected to switches in a second stage where $x > 0$; and an output stage having output

$$\frac{N_2}{d}$$

switches, and said each output switch having d outlet links and said each output switch further having $x \times d$ incoming links connected from switches in a penultimate stage; and

a plurality of y middle stages having N/d middle switches in each of said y middle stages wherein said second stage and said penultimate stage being one of said middle stages where $y > 3$, and said each middle switch in said second stage having

$$x \times \frac{(d + d_1)}{2}$$

159

incoming links connected from switches in its immediate preceding stage, and said each middle switch further having $x \times d$ outgoing links connected to switches in its said immediate succeeding stage; and
 said each middle switch in all said middle stages excepting said second stage having $x \times d$ incoming links connected from switches in its immediate preceding stage, and said each middle switch further having $x \times d$ outgoing links connected to switches in its immediate succeeding stage; and said method comprising:
 receiving a multicast connection at said input stage;
 fanning out said multicast connection through at most two outgoing links in said input switch and a plurality of outgoing links in a plurality of middle switches in each said middle stage to set up said multicast connection to a plurality of output switches among said

$$\frac{N_2}{d}$$

output switches, wherein said plurality of output switches are specified as destinations of said multicast connection, wherein said at most two outgoing links in input switch and said plurality of outgoing links in said plurality of middle switches in each said middle stage are available.

13. A method of claim 12 wherein said act of fanning out is performed without changing any existing connection to pass through another set of plurality of middle switches in each said middle stage.

14. A method of claim 12 wherein said act of fanning out is performed recursively.

15. A method of claim 12 wherein a connection exists through said network and passes through a plurality of middle switches in each said middle stage and said method further comprises:

if necessary, changing said connection to pass through another set of plurality of middle switches in each said middle stage, act hereinafter "rearranging connection".

16. A method of claim 12 wherein said acts of fanning out and rearranging are performed recursively.

17. A method for setting up one or more multicast connections in a network having N_1 inlet links and N_2 outlet links, where $N_1 > 1$, $N_2 > 1$ and
 when $N_2 > N_1$ and $N_2 = p * N_1$ where $p > 1$ then $N_1 = N$, $d_1 = d$, and

$$d_2 = N_2 \times \frac{d}{N_1} = p \times d;$$

where $N > 1$, $d_1 > 1$, $d_2 > 1$, $d > 1$ and having an input stage having

$$\frac{N_1}{d}$$

input switches, and said each input switch having d inlet links and said each input switch further having $x \times d$ outgoing links connected to switches in a second stage where $x > 0$; and
 an output stage having

$$\frac{N_1}{d}$$

160

output switches, and said each output switch having d_2 outlet links and said each output switch further having

$$x \times \frac{(d + d_2)}{2}$$

incoming links connected from switches in a penultimate stage; and

a plurality of y middle stages having N/d middle switches in each of said y middle stages wherein said second stage and said penultimate stage being one of said middle stages where $y > 3$, and

said each middle switch in all said middle stages excepting said penultimate stage having $x \times d$ incoming links connected from switches in its immediate preceding stage, and said each middle switch further having $x \times d$ outgoing links connected to switches in its immediate succeeding stage; and

said each middle switch in said penultimate stage having $x \times d$ incoming links connected from switches in its said immediate preceding stage, and said each middle switch further having

$$x \times \frac{(d + d_2)}{2}$$

outgoing links connected to switches in its said immediate succeeding stage; or
 when $N_1 > N_2$ and $N_1 = p * N_2$ where $p > 1$ then $N_2 = N$, $d_2 = d$ and

$$d_1 = N_1 \times \frac{d}{N_2} = p \times d;$$

and having
 an input stage having

$$\frac{N_2}{d}$$

input switches, and said each input switch having d_1 inlet links and said each input switch further having

$$x \times \frac{(d + d_1)}{2}$$

outgoing links connected to switches in a second stage where $x > 0$; and
 an output stage having

$$\frac{N_2}{d}$$

output switches, and said each output switch having d outlet links and said each output switch further having $x \times d$ incoming links connected from switches in a penultimate stage; and

161

a plurality of y middle stages having N/d middle switches in each of said y middle stages wherein said second stage and said penultimate stage being one of said middle stages where y>3, and said each middle switch in said second stage having

$$x \times \frac{(d + d_1)}{2}$$

incoming links connected from switches in its immediate preceding stage, and said each middle switch further having xxd outgoing links connected to switches in its immediate succeeding stage; and said each middle switch in all said middle stages excepting said second stage having xxd incoming links connected from switches in its immediate preceding stage, and said each middle switch further having xxd outgoing links connected to switches in its immediate succeeding stage; and said method comprising: checking if a first outgoing link in input switch and a first plurality of outgoing links in plurality of middle switches in each said middle stage are available to at least a first subset of destination output switches of said multicast connection; and checking if a second outgoing link in input switch and second plurality of outgoing links in plurality of middle switches in each said middle stage are available to a second subset of destination output switches of said multicast connection, wherein each destination output switch of said multicast connection is one of said first subset of destination output switches and said second subset of destination output switches.

162

18. The method of claim 17 further comprising: prior to said checkings, checking if all the destination output switches of said multicast connection are available through said first outgoing link in input switch and said first plurality of outgoing links in plurality of middle switches in each said middle stage.
19. The method of claim 17 further comprising: repeating said checkings of available second outgoing link in input switch and second plurality of outgoing links in plurality of middle switches in each said middle stage to a second subset of destination output switches of said multicast connection to each outgoing link in input switch other than said first and said second outgoing links in input switch, wherein each destination output switch of said multicast connection is one of said first subset of destination output switches and said second subset of destination output switches.
20. The method of claim 17 further comprising: repeating said checkings of available first outgoing link in input switch and first plurality of outgoing links in plurality of middle switches in each said middle stage to a first subset of destination output switches of said multicast connection to each outgoing link in input switch other than said first outgoing link in input switch.
21. The method of claim 17 further comprising: setting up each of said multicast connection from its said input switch to its said output switches through not more than two outgoing links, selected by said checkings, by fanning out said multicast connection in its said input switch into not more than said two outgoing links.
22. The method of claim 17 wherein any of said acts of checking and setting up are performed recursively.

* * * * *