

[54] **FREQUENCY DIVISION MULTIPLEXED ACKNOWLEDGE BACK PAGING SYSTEM**

[75] **Inventors:** Kazimierz Siwiak, Coral Springs; Leon Jasinski, Fort Lauderdale; Francis R. Steel, Parkland, all of Fla.

[73] **Assignee:** Motorola, Inc., Schaumburg, Ill.

[21] **Appl. No.:** 141,654

[22] **Filed:** Jan. 7, 1988

[51] **Int. Cl.⁴** H04Q 9/00

[52] **U.S. Cl.** 340/825.44; 340/825.47; 379/57; 370/76

[58] **Field of Search** 340/825.44, 825.47, 340/825.48, 311.1; 370/92, 93, 94, 50, 69.1, 73, 76; 379/56, 57; 455/31, 89, 92

[56] **References Cited**

U.S. PATENT DOCUMENTS

3,573,379	4/1971	Schmitz	370/76
3,973,200	8/1976	Akerberg	340/825.44
4,194,153	3/1980	Masaki et al.	
4,208,630	6/1980	Martinez	455/31
4,352,955	10/1982	Kai et al.	379/57
4,392,242	7/1983	Kai	

4,466,001	8/1984	Moore et al.	340/825.47
4,590,473	5/1986	Burke et al.	340/825.44
4,604,583	8/1986	Aoyagi et al.	
4,636,741	1/1987	Mitzlaff	
4,646,082	2/1987	Engel et al.	340/825.44
4,654,882	3/1987	Ikeda	
4,713,808	12/1987	Gaskill et al.	270/93

Primary Examiner—Gerald Brigance
Attorney, Agent, or Firm—William E. Zitelli; Vincent B. Ingrassia

[57] **ABSTRACT**

An acknowledge back (ack-back) paging system is provided which includes a central station which transmits a group of message signals to a group of ack-back pagers which are addressed as a group. The users of the group of addressed ack-back pagers indicate a response to their respective pagers thus providing ack-back data. The pagers in the group of addressed ack-back pagers then simultaneously transmit back to the central station their ack-back data on different frequency sub-bands, a different frequency sub-band being allocated to each of the pagers in the group.

21 Claims, 9 Drawing Sheets

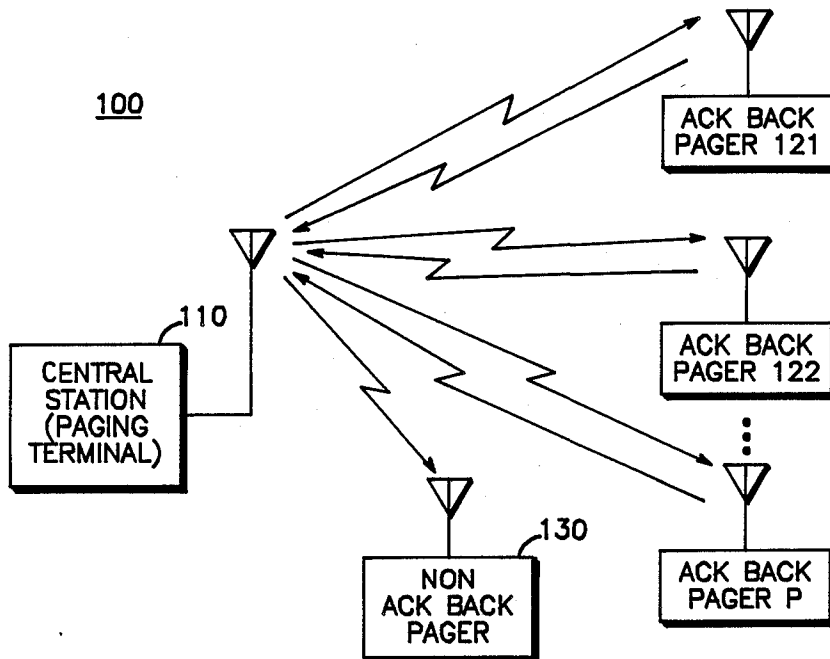
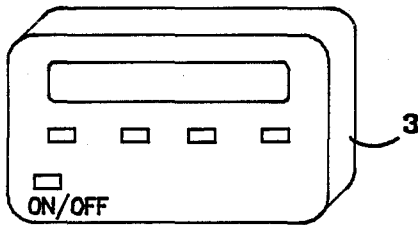
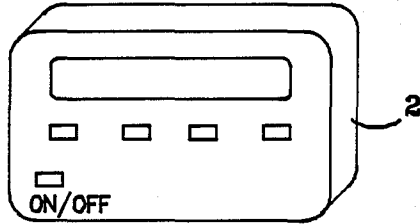
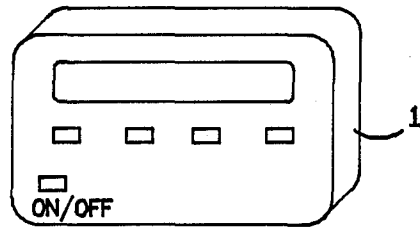

FIG. 1

10



⋮

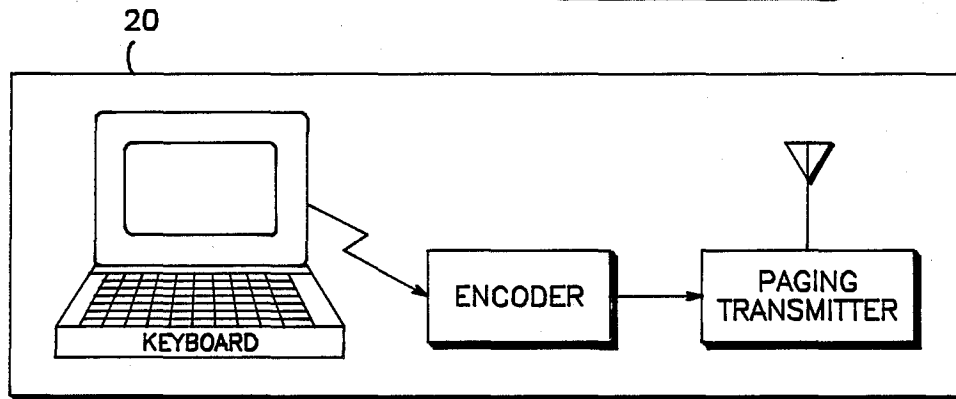
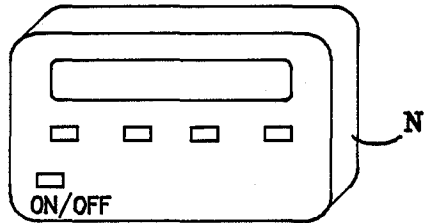

FIG. 2
100

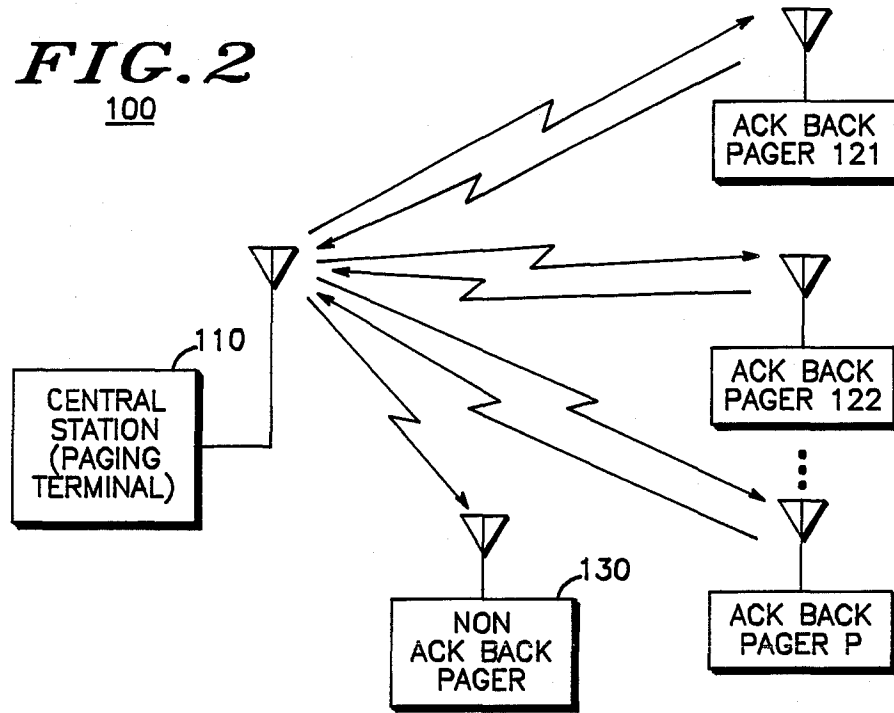
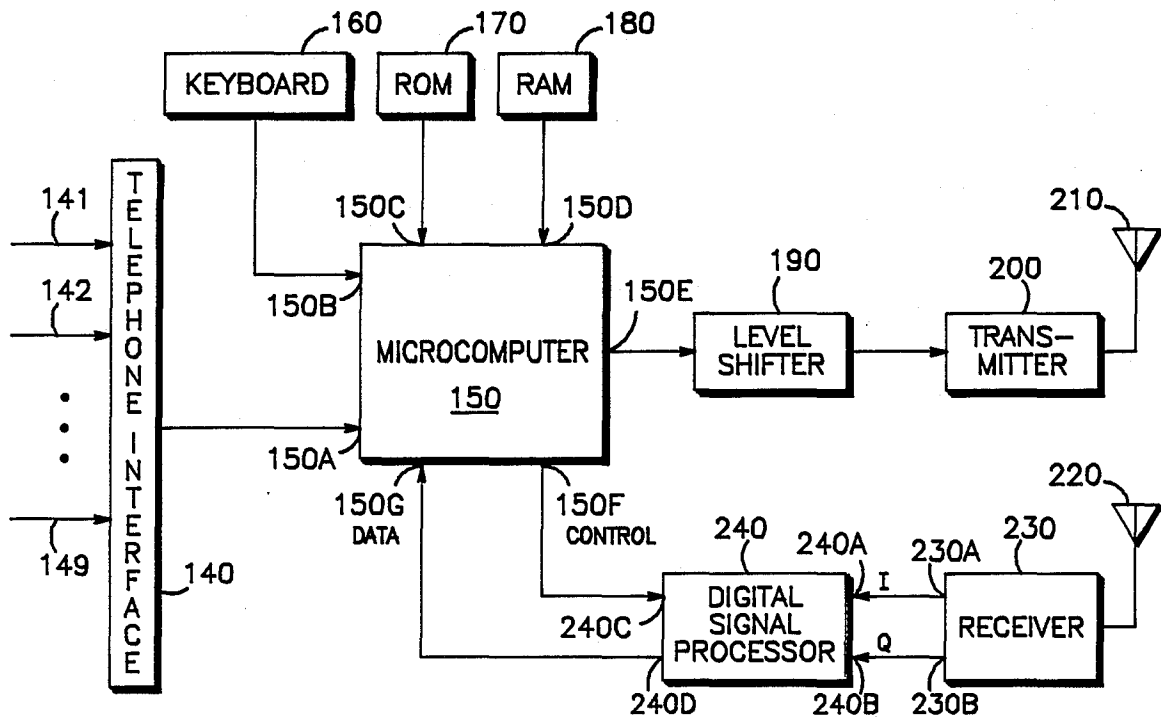

FIG. 3
110



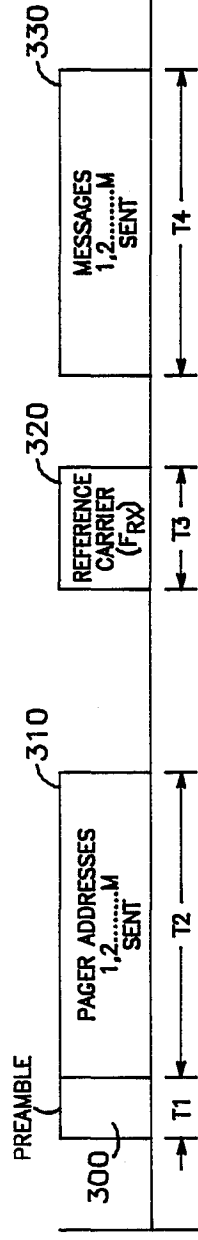

FIG. 4A

CENTRAL STATION TRANSMITTER

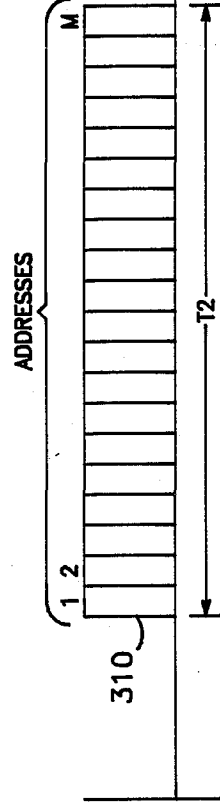

FIG. 4B

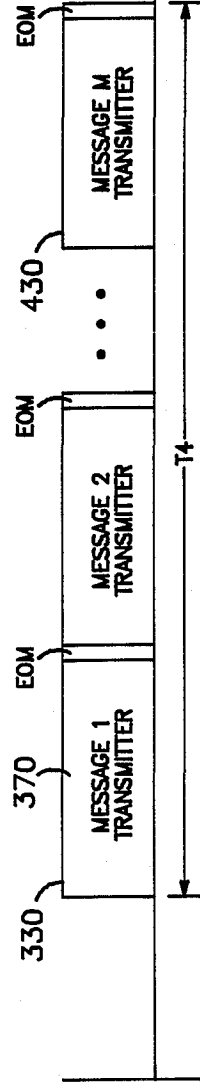

FIG. 4C

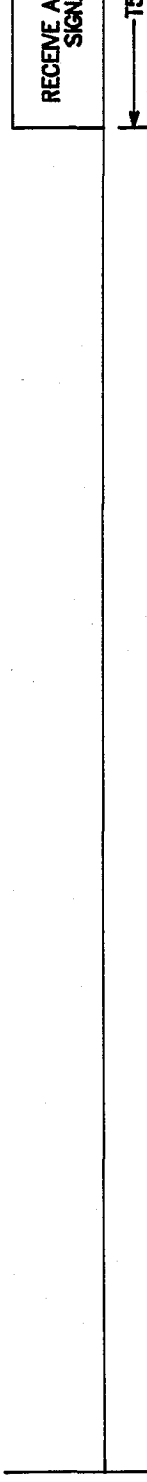

FIG. 4D

CENTRAL STATION RECEIVER

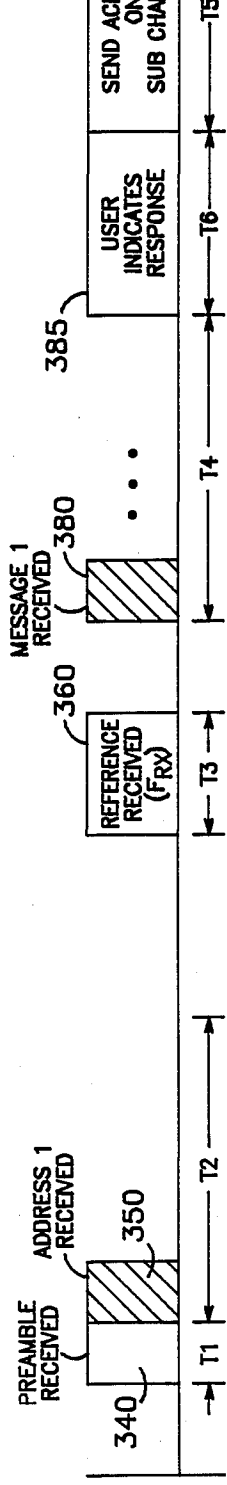

FIG. 4E

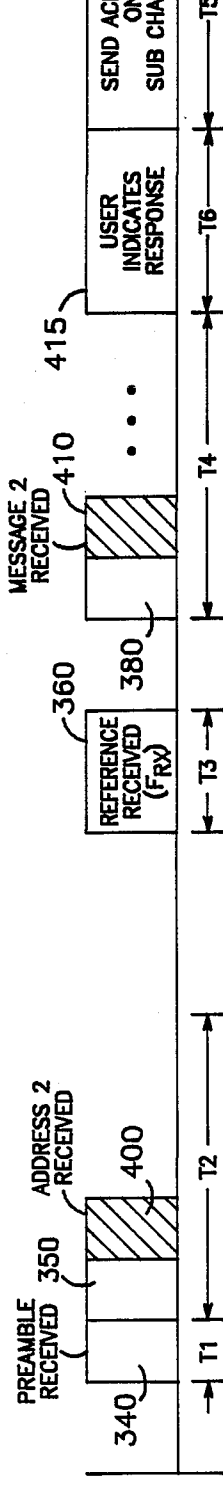

FIG. 4F

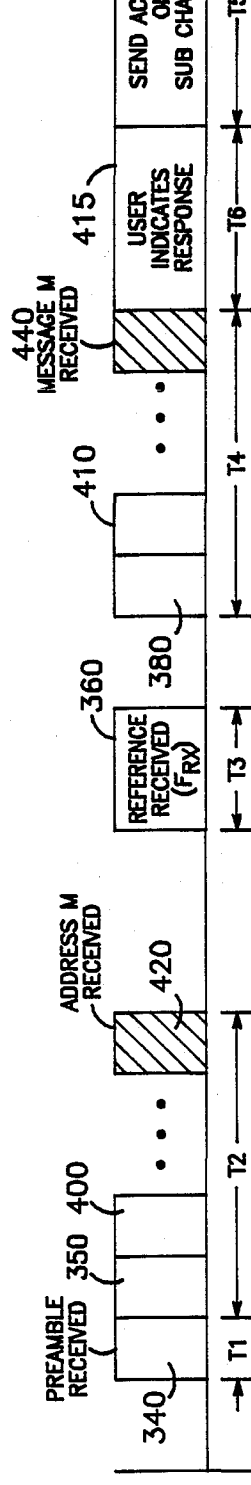

FIG. 4G

Explore Litigation Insights

Docket Alarm provides insights to develop a more informed litigation strategy and the peace of mind of knowing you're on top of things.

Real-Time Litigation Alerts



Keep your litigation team up-to-date with **real-time alerts** and advanced team management tools built for the enterprise, all while greatly reducing PACER spend.

Our comprehensive service means we can handle Federal, State, and Administrative courts across the country.

Advanced Docket Research



With over 230 million records, Docket Alarm's cloud-native docket research platform finds what other services can't. Coverage includes Federal, State, plus PTAB, TTAB, ITC and NLRB decisions, all in one place.

Identify arguments that have been successful in the past with full text, pinpoint searching. Link to case law cited within any court document via Fastcase.

Analytics At Your Fingertips



Learn what happened the last time a particular judge, opposing counsel or company faced cases similar to yours.

Advanced out-of-the-box PTAB and TTAB analytics are always at your fingertips.

API

Docket Alarm offers a powerful API (application programming interface) to developers that want to integrate case filings into their apps.

LAW FIRMS

Build custom dashboards for your attorneys and clients with live data direct from the court.

Automate many repetitive legal tasks like conflict checks, document management, and marketing.

FINANCIAL INSTITUTIONS

Litigation and bankruptcy checks for companies and debtors.

E-DISCOVERY AND LEGAL VENDORS

Sync your system to PACER to automate legal marketing.