

Throughput Density Constraints for Wireless LANs Based on DSSS

Ad Kamerman

Lucent Technologies - Bell Laboratories/WCND
Zadelstede 1- 10, 3431 JZ Nieuwegein, The Netherlands
Tel: +31 30 60 97 479, Fax: +31 30 60 97 498
E-mail: ak@blu.att.com

Abstract - The throughput performance of wireless LANs can be characterized in various ways. The installation of wireless LANs and the positioning of accesspoints will be based on requirements for throughput and coverage, while the cost of the accesspoint infrastructure is important. This paper considers the critical parameters for wireless LANs that operate conform to the IEEE 802.11 DSSS (direct sequence spread spectrum) standard with regard to medium reuse. The carrier sense threshold is one of the key parameters to provide a higher throughput density.

I. INTRODUCTION

At first we will look to the medium access behavior of the IEEE 802.11 LANs. Thereafter limitations for wireless systems and path loss characteristics are discussed shortly. Next the medium reuse conditions for wireless LANs are considered. Thereupon the robustness of DSSS transceiver with regard to cochannel interference is illustrated, which is fundamental for medium reuse. Subsequently the impact of the carrier sense threshold level and its relation to capture effect properties are discussed. Then there is looked to automatic rate control to keep the cochannel interference at a tolerable level. At last the throughput density results are described at two alternatives for selecting the carrier sense threshold.

II. IEEE 802.11

Currently the IEEE 802.11 standard for wireless LANs has been formulated [1]. IEEE 802.11 is a standard for systems that will operate in the 2.400 - 2.483 GHz ISM (industrial, scientific and medical) band. This ISM band is worldwide available and allows unlicensed operation for spread spectrum systems. IEEE 802.11 focuses on the MAC (medium access control) and PHY (physical layer) protocols for accesspoint based networks and ad-hoc networks. IEEE 802.11 supports DSSS (direct sequence spread spectrum) with

differential encoded BPSK and QPSK, FHSS (frequency hopping spread spectrum) with GFSK (Gaussian FSK), and infrared with PPM (pulse position modulation). The basic medium access behavior allows interoperability between compatible PHYs through the use of CSMA/CA (carrier sense multiple access with collision avoidance) and a random backoff time following a busy medium condition. In addition, all directed traffic uses immediate positive acknowledgment (ACK frame), where retransmission is scheduled by the sender if no ACK is received.

The CSMA/CA protocol is designed to reduce the collision probability between multiple stations accessing the medium, at the point where they would most likely occur. The highest probability of a collision would occur at the moment in time that is just after the medium becomes free, following a busy medium. This is because multiple stations would have been waiting for the medium to become available again. Therefore, a random backoff arrangement is used to resolve medium contention conflicts.

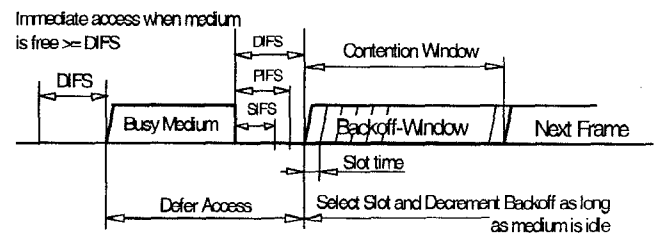

Fig. 1. Basic CSMA/CA behavior.

III. SYSTEM LIMITATIONS

The performance of transceiver systems is normally characterized by limitations in relation to noise and to different kinds of interference as intersymbol, adjacent-channel and cochannel interference. The noise limitation relates to the power budget parameters as transmitter output power, antenna gain, isotropic loss, path loss including multipath fading, man-made noise, receiver degradation (noise factor and implementation loss) and

Rembrandt Wireless

required SNR for the modulation in question. Intersymbol interference is caused by the impulse response of the air-channel and partially by imperfections in the transmitter and receiver circuitry (filtering). Adjacent-channel interference is related to filtering and channel shaping conditions as the spectrum of modulated signal. At non-constant envelope modulation there occurs sideband regeneration by non-linearity in the TX power amplifier. Cochannel interference relates to medium reuse conditions and the capture effect properties in relation to the desired and unwanted signal, are crucial for the medium reuse.

IV. PATH LOSS

An overview for indoor propagation can be found in [2]. Although more accurate modeling is possible by ray tracing as described in [3], we will use here expressions for path loss based distance because of simplicity. However, at cell planning and the installation of accesspoints the ray tracing approach would be very useful for the prediction of the path loss between accesspoints. The formula below (borrowed from [4]) illustrates the various path loss contribution. In addition there occurs large-scale variation and small-scale fluctuations in a multipath fading environment.

$$L = L_0 + 10 \cdot \gamma_0 \cdot \log\left(\frac{\lambda}{4\pi d_{ref}}\right) + 10 \cdot \gamma \cdot \log\left(\frac{d}{d_{ref}}\right) + \dots + \sum_{i=0}^I N_i^F L_i^F + \sum_{j=0}^J N_j^W L_j^W + g \cdot d$$

where

L_0 = antenna gain / loss (for dipole -2 dB)

λ = wavelength

d_{ref} = reference distance from transmitter

d = transmitter-receiver distance

γ_0 = decay exponent below d_{ref}

(up to 5 or 10 meter $\gamma_0 = 2$)

γ = decay exponent above d_{ref}

N_i^F = number of floors of the i 'th category

L_i^F = loss due i 'th floor category

N_j^W = number of walls of j 'th category

L_j^W = loss due j 'th wall category

g = (linear) decay rate

The second term of the above formula gives the isotropic loss with respect to the reference distance. At 2.4 GHz this loss with respect to 1 meter is 40 dB. The third term is the exponential path loss term; common decay exponents for indoor environments are 2 through 6,

meaning 6 dB through 18 dB loss per distance doubling; the value of the decay exponent is also dependent on taking into account other loss terms. The fourth term characterizes loss by walls, the fifth by floors. The sixth term gives a loss that is linear to distance; common values for this indoor loss are 0.2 - 0.6 dB/m in combination with the decay exponent equal to the one for free space propagation ($\gamma = 2$).

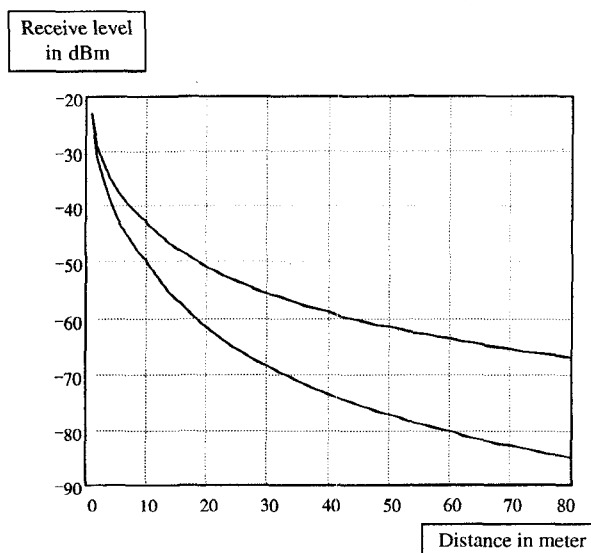

Fig. 2. Variation of RX levels vs. distance; characterized by exponential path loss for typical indoor environments (office, warehouse, supermarket), TX power level is 17 dBm.

V. MEDIUM REUSE

When neighbor cell systems use different channels, then a farther away network cell systems can reuse the same channel again. However, under the condition that the interference from the further away cell systems is limited. If reuse of the same channel is allowed within another cell having at a distance D and the cell has a radius R , then the cochannel reduction factor $a = (D/R)$ is used as a key parameter dealing with cochannel interference.

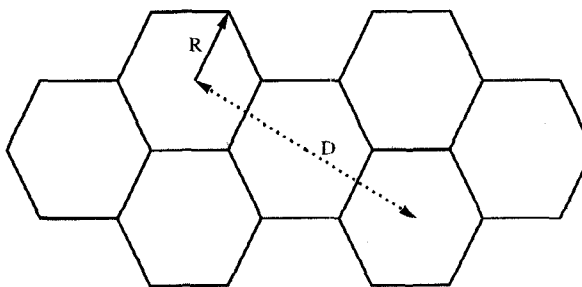

Fig. 3a. Illustration of medium reuse distance.

Rembrandt Wireless

cellular telephone systems are described in [5]. At cellular radio the cochannel interference contributions from neighbor cells are permanent present. Since there are separate channels for the uplink and the downlink, the cochannel interference contributions are all based on uplink or all based on downlink. For analog cellular FM systems there is mostly assumed that the combined cochannel interference from six neighbor cells may not exceed a CSIR (cochannel signal-to-interference ratio) of 18 dB. Furthermore, the assumption includes that the total of the six contributions corresponds to six times the average case contribution based on the cochannel reduction factor $a = D/R$. We can define the MRE (medium reuse efficiency) as cell area over area assigned for a single channel. This implies

$$MRE = \left(\frac{R}{D}\right)^2 \quad \text{where} \quad \frac{1}{6} \cdot \left(\frac{D}{R}\right)^\gamma \geq 10^{1.8}$$

(based on $CSIR = 18 \text{ dB}$)

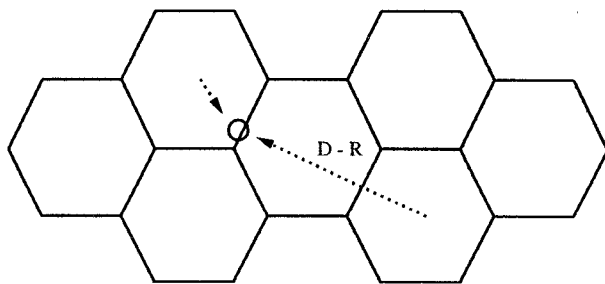

Fig. 3b. Worst case interference distance for cellular telephone systems (separate channels for uplink and downlink).

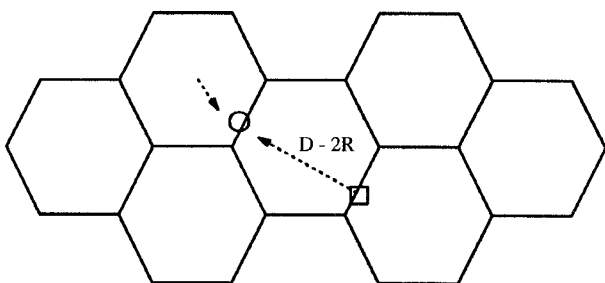

Fig. 3c. Worst case interference distance for wireless LANs (same channel for uplink and downlink).

There are a lot of differences between cellular telephone systems and indoor wireless LANs. In general LANs have to deal with requirements for throughput / delay characteristics, packet error rate and fairness. Furthermore, LANs are applied in an environment with bursty traffic where one station gets the whole "bandwidth".

For indoor wireless LANs the number of installed accesspoints has to be as low as possible to save cost for infrastructure, as long as the required throughput / delay performance at peak-load and fairness can be guaranteed. At a high density of accesspoints any performance would be possible. At indoor wireless LANs there is just one

transmissions. This single channel structure and the packet switching nature of this type of LANs, imply that the cochannel interference scenario is different from the one of cellular telephone systems.

In particular the difference between wireless LANs (based on IEEE 802.11 DS) and DS-CDMA (direct sequence code division multiple access) systems is fundamental. At DS-CDMA the different codes gives sufficient separation between individual links which share the same band, if the receive levels don't diverge too much.

At indoor wireless LANs the maximum level of interference as present during the transmission of a frame, will be dominated by the interference from one neighbor cell station. Such a neighbor cell interference could be present for a short period, like it can occur at the transmission of an ACK. The IEEE 802.11 CSMA/CA does not apply an individual carrier sensing before an ACK is transmitted. The worst case distance scenario at which one interferer that dominates, gives a CSIR requirement with

$$CSIR = \left(\frac{D-2R}{R}\right)^\gamma = (a-2)^\gamma$$

This leads to a MRE with

$$MRE = \left(\frac{1}{2+CSIR^{1/\gamma}}\right)^2$$

The duration of a worst interference presence is less relevant. Because when the received frame will be mutilated, the number of erroneous bits does not matter. For transmission of data packets the target FER (frame error rate) has to be better than 10^{-2} at transmission of 1 kbyte packets. This FER requirement is in contrast to the requirement for telephone systems at which the BER has to be better than 10^{-3} . For an IEEE 802.11 DS receiver we have to think on a detection margin with regard to noise that corresponds a BER better than 10^{-6} . However, the capture effect properties of an IEEE 802.11 DS receiver don't correspond to the detector margins with respect to for noise. We will look to the capture effect properties of such DS systems in the following sections.

VI. DSSS TRANSCIEVER

The IEEE 802.11 DS is based on the following 11-chips Barker sequence +1, -1, +1, +1, -1, +1, +1, +1, -1, -1, -1. This sequence is used as a PN code sequence and the symbol duration corresponds duration of the 11-chips. The 11-chips spreading makes the occupied bandwidth larger, this DS spreading increases the effective bandwidth from 1 MHz to 11 MHz. At the same time the 11-chips spreading gives that the impact of multipath fading is reduced. At an indoor channel with a delay spread of 100 nsec and selecting one out of two antennas the fading margin required for an outage of 1% is reduced to 4 dB, while it would be 9 dB for a 1 MHz system.

Rembrandt Wireless

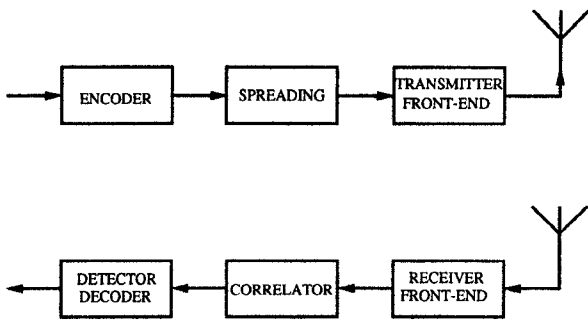

Fig. 4. Basic block diagram of DSSS transceiver.

Fig. 5a shows the RX correlator output spike-waveform for the ideal case (no degradation by filtering and air-channel). Fig. 5b demonstrates the presence of a cochannel interferer. The most likely case the spike-waveform contribution from the interferer falls in between the spike-waveform peaks of the desired signal. A clock drift of a X ppm (difference between clocks in the desired signal TX and the interferer TX) means for typical packet transmission time as 5 msec a shift-in-time of $5 X$ nsec. X will have a maximum of a few tens (ppm) for low cost clock circuitry. Therefore, it is unlikely that the interferer spike-waveform peak will shift during a packet transmission time to a position-in-time with overlapping spike-waveform peaks. Fig. 5c illustrates degradation due to the channel which introduces delay spread. The allowed margin with regard to the interferer level and clock drift will decrease at an increase of delay spread. More severe requirements for clock circuitry helps for the MRE, since the probability of non-overlap for the peaks during the full reception of a frame becomes more likely.

However, we have to keep in mind that the most threatening situation is introduced by the acknowledgment mechanism. The ACK has no individual carrier sensing, which means more risk on strong interference. The shift-in-time during the 250 μ sec period during which an ACK interferes is only $0.25 X$ nsec. This $0.25 X$ nsec shift-in-time is for typical values of X (a few tens ppm) very small compared to 1 μ sec between two successive symbol-peaks in the spike-waveform.

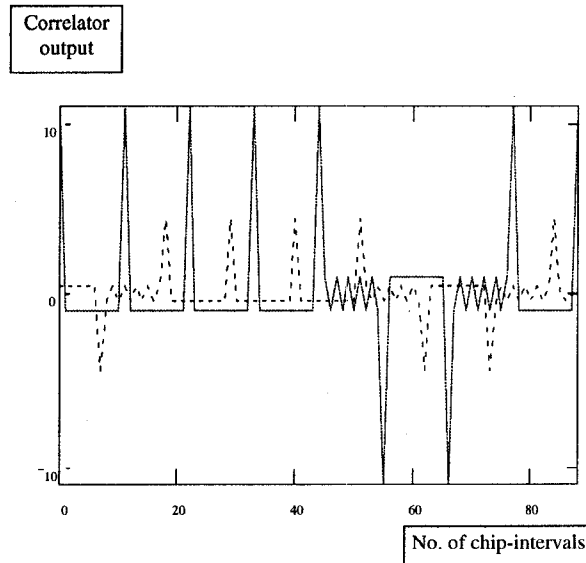

Fig. 5b. Correlator output with desired signal contribution (solid) and interferer signal contribution (dotted).

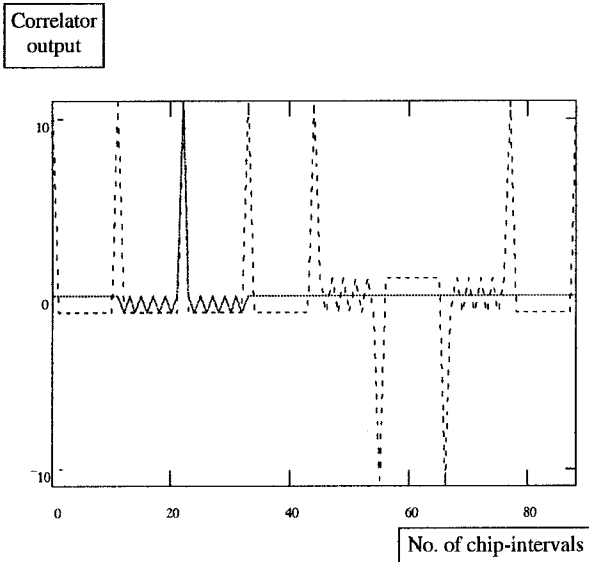

Fig. 5a. Correlator output at a single symbol (solid) and successive symbols (dotted).

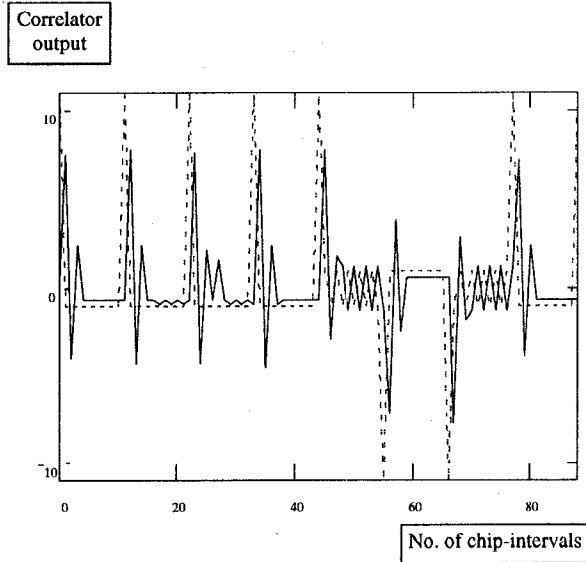

Fig. 5c. Correlator output at significant channel degradation (solid) and at an ideal channel (dotted).

IEEE 802.11 DS gives twelve channel frequencies in the 2.4 GHz band. However, there will be only a few non-overlapping channels that can operate simultaneously without interfering each other. The allowed CSIR and ASIR (adjacent channel signal-to-interference ratio) depend on the transceiver implementation. Further the CRS (carrier sense) function is important for the CSMA/CA behavior. The medium busy state occurs when the RX level is above the CRS threshold. IEEE 802.11 DS describes an upper limit for the CRS threshold which is dependent on the applied TX power: for a TX power 17 dBm (50 mW) or below this threshold is -70 dBm. For higher TX power there has to applied one of the lower (more sensitive) thresholds.

Figs. 6a and 6b depict RX levels for a scenario with exponential path loss of $\gamma = 3.5$ (10.5 dB/octave) for distances above 10 meter. At a CRS threshold at -75 dBm the transmissions from the accesspoints at 0 and 80 meter will be received well by the stations within 20 meter distance when the required CSIR is 10 dB or less. In Fig. 6a an ACK is returned from the station at 20 meter towards the accesspoint at 0, this ACK does not disturb an ongoing transmission by the accesspoint at 80 meter to the station at 60 meter (in the neighbor cell).

Likewise as in Fig. 6a more (less) sensitive CRS thresholds can be applied for larger (smaller) cell sizes with an adaptation according to the exponential path loss and resulting in a figure with the same form. In Fig. 6b there is between the two neighbor cells a 10 dB wall loss. Here the ACK from the station at 30 meter towards the accesspoint at 40 meter, can disturb the reception of the transmission from the accesspoint at 0 by the station at 20 meter.

The applied CRS threshold leads to the distinction between “sharing” and “reuse”. All stations (and accesspoints) around an actively transmitting station (or accesspoint) will measure the RX level of the DSSS signal. When the RX level is above the CRS threshold, then such a station cannot start a transmission, and it has to defer the packet transmission. Such deferrals are not coupled to the cell boundaries. If we look to Fig. 6a, then we see that transmissions around the accesspoints at 0 and 80 meter will start independently for a cell size radius of 20 meter and a CSIR around 8 dB. At a smaller distance between the accesspoints the medium will be shared frequently. In Fig. 6b we see the impact of disturbed symmetry, which gives some risk on errors for stations at one edge of the cell around the accesspoint at 0 meter.

The optimum CRS threshold is dependent on the target RX level at the edge of the cell, the required CSIR and also on path loss conditions (path loss coefficient γ , multipath fading and packet traffic (type of offered load, mixture of packet sizes), performance criteria (throughput, tolerable transmission delay).

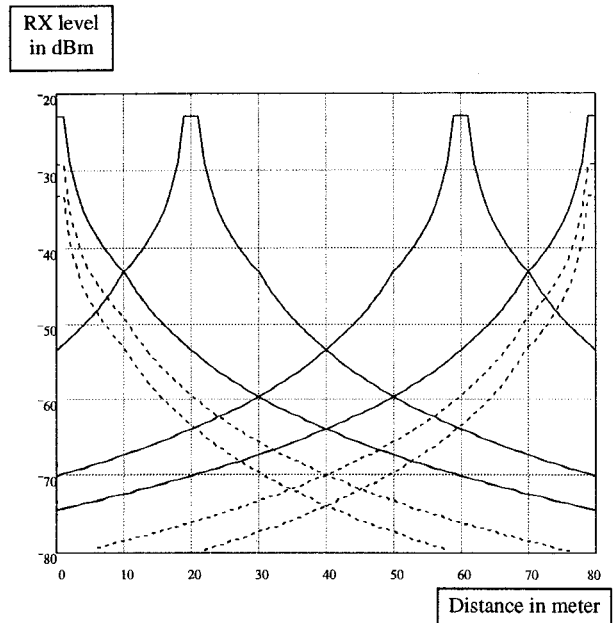

Fig. 6a. RX-levels around accesspoints at positions 0 and 80 meter and stations at 20 meter from the accesspoints (solid) and references for 6 and 10 dB margin with respect to the signal from the accesspoints (dotted).

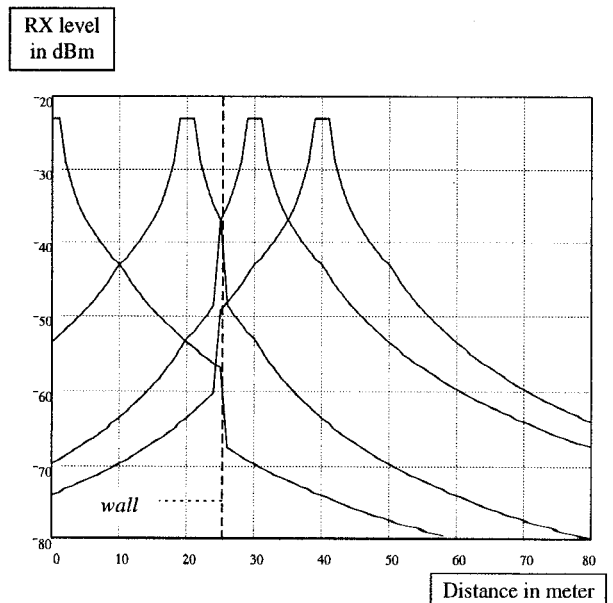

Fig. 6b. RX-levels around accesspoints at positions 0 and 40 meter and stations at respectively 20 meter and 10 meter from the accesspoints (solid) in presence of 10 dB wall loss.

Explore Litigation Insights

Docket Alarm provides insights to develop a more informed litigation strategy and the peace of mind of knowing you're on top of things.

Real-Time Litigation Alerts



Keep your litigation team up-to-date with **real-time alerts** and advanced team management tools built for the enterprise, all while greatly reducing PACER spend.

Our comprehensive service means we can handle Federal, State, and Administrative courts across the country.

Advanced Docket Research



With over 230 million records, Docket Alarm's cloud-native docket research platform finds what other services can't. Coverage includes Federal, State, plus PTAB, TTAB, ITC and NLRB decisions, all in one place.

Identify arguments that have been successful in the past with full text, pinpoint searching. Link to case law cited within any court document via Fastcase.

Analytics At Your Fingertips



Learn what happened the last time a particular judge, opposing counsel or company faced cases similar to yours.

Advanced out-of-the-box PTAB and TTAB analytics are always at your fingertips.

API

Docket Alarm offers a powerful API (application programming interface) to developers that want to integrate case filings into their apps.

LAW FIRMS

Build custom dashboards for your attorneys and clients with live data direct from the court.

Automate many repetitive legal tasks like conflict checks, document management, and marketing.

FINANCIAL INSTITUTIONS

Litigation and bankruptcy checks for companies and debtors.

E-DISCOVERY AND LEGAL VENDORS

Sync your system to PACER to automate legal marketing.