

(12) **UK Patent Application** (19) **GB** (11) **2 365 664** (13) **A**

(43) Date of A Publication **20.02.2002**

(21) Application No **0106915.2**
 (22) Date of Filing **20.03.2001**
 (30) Priority Data
 (31) **0006614** (32) **20.03.2000** (33) **GB**

(51) INT CL⁷
H04M 3/42
 (52) UK CL (Edition T)
H4K KF54
 (56) Documents Cited
EP 0719059 A2 EP 0531268 A2
EP 0520194 A2 EP 0152908 A2
WO 91/11874 A1 WO 91/07838 A1
US 5329578 A
 (58) Field of Search
 UK CL (Edition S) **H4K KF54**
 INT CL⁷ **H04M 1/57 3/42 , H04Q 3/00**
Online databases: WPI, EPODOC, PAJ

(71) Applicant(s)
Pressurecell Limited
(Incorporated in the United Kingdom)
Heron House, Albert Square, MANCHESTER,
M60 8GT, United Kingdom
 (72) Inventor(s)
Andrew David Kirkwood
 (74) Agent and/or Address for Service
Wilson Gunn M'Caw
41-51 Royal Exchange, Cross Street, MANCHESTER,
M2 7BD, United Kingdom

(54) Abstract Title
Improved communication system

(57) A communication system which enables users to communicate with each other includes a unique user identification code assigned to each user. The system also includes an information storage device which stores each unique user identifier and associated with each user identifier as a user profile which provides routing information for communication between respective users.

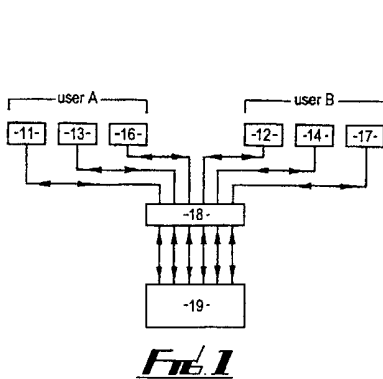

Fig 1

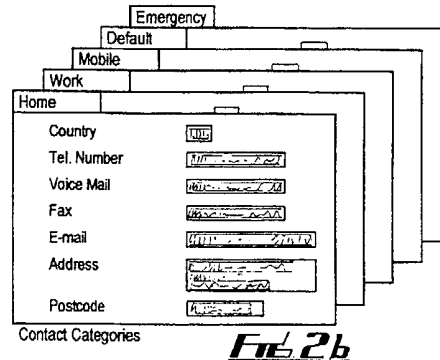

Fig 2b

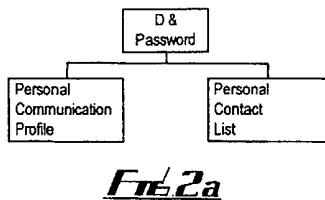

Fig 2a

Business Ass.	Friends	Family	More
Access	Work	Mon-Fri	8am-8pm Work
	Mobile	Mon-Fri	8pm-8am Mobile
	Emergency	Sat	Work - Voice mail
		Sun	Work - Voice mail

Access Profiles

Fig 2c

Name	String ID	VAN	Access Profile
Ian Jones	ijones21	✓	Friend
Gary Rodgers	garythefish	✓	Business Ass.
Tamara Maw	tamaram	✓	Family
Jane Fisher	janefisher2	✗	Barred

Personal Contact List

Fig 2d

GB 2 365 664

(12) **UK Patent Application** (19) **GB** (11) **2 365 664** (13) **A**

(43) Date of A Publication **20.02.2002**

(21) Application No **0106915.2**
 (22) Date of Filing **20.03.2001**
 (30) Priority Data
 (31) **0006614** (32) **20.03.2000** (33) **GB**

(51) INT CL⁷
H04M 3/42
 (52) UK CL (Edition T)
H4K KF54
 (56) Documents Cited
EP 0719059 A2 EP 0531268 A2
EP 0520194 A2 EP 0152908 A2
WO 91/11874 A1 WO 91/07838 A1
US 5329578 A
 (58) Field of Search
 UK CL (Edition S) **H4K KF54**
 INT CL⁷ **H04M 1/57 3/42 , H04Q 3/00**
Online databases: WPI, EPODOC, PAJ

(71) Applicant(s)
Pressurecell Limited
(Incorporated in the United Kingdom)
Heron House, Albert Square, MANCHESTER,
M60 8GT, United Kingdom
 (72) Inventor(s)
Andrew David Kirkwood
 (74) Agent and/or Address for Service
Wilson Gunn M'Caw
41-51 Royal Exchange, Cross Street, MANCHESTER,
M2 7BD, United Kingdom

(54) Abstract Title
Improved communication system

(57) A communication system which enables users to communicate with each other includes a unique user identification code assigned to each user. The system also includes an information storage device which stores each unique user identifier and associated with each user identifier as a user profile which provides routing information for communication between respective users.

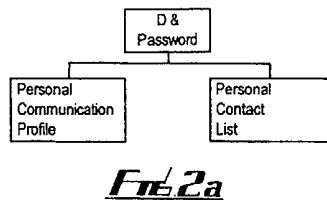
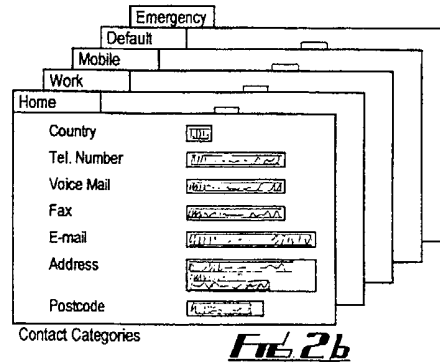
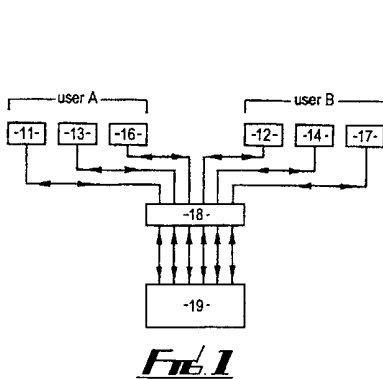

Business Ass.	Friends	Family	More
Access	Work	Mon-Fri	8am-8pm Work
	Mobile	Mon-Fri	8pm-8am Mobile
	Emergency	Sat	Work - Voice mail
		Sun	Work - Voice mail

Access Profiles

Fig. 2c

Name	String ID	VAN	Access Profile
Ian Jones	ijones21	✓	Friend
Gary Rodgers	garythefish	✓	Business Ass.
Tamara Maw	tamaram	✓	Family
Jane Fisher	janefisher2	✗	Barred

Personal Contact List

Fig. 2d

GB 2 365 664

1/2

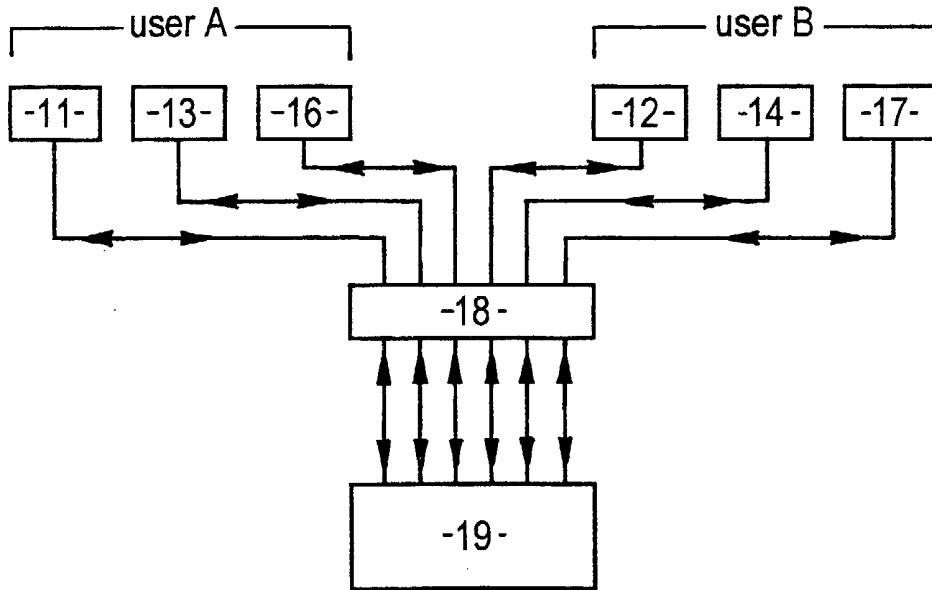

FIG. 1

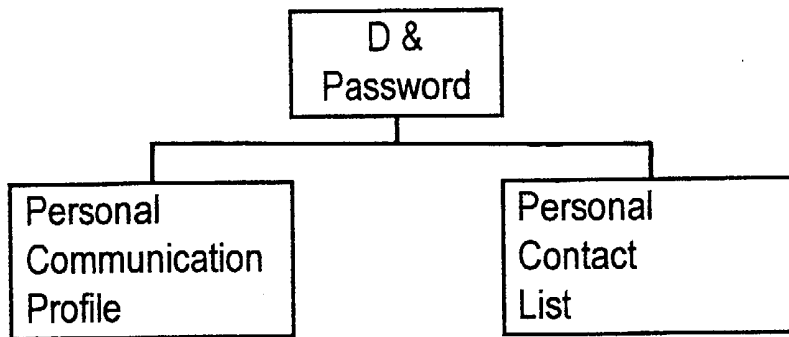

FIG. 2a



2/2

Emergency

Default

Mobile

Work

Home

Country

Tel. Number

Voice Mail

Fax

E-mail

Address

Postcode

Contact Categories

FIG 2b

Business Ass.	Friends	Family	More
Access	Work	Mon-Fri	8am-8pm Work
	Mobile	Mon-Fri	8pm-8am Mobile
	Emergency	Sat	Work - Voice mail
		Sun	Work - Voice mail

Access Profiles

FIG 2c

Name	String ID	VAN	Access Profile
Ian Jones	ijones21	✓	Friend
Gary Rodgers	garythefish	✓	Business Ass.
Tamara Maw	tamaram	✓	Family
Jane Fisher	janefisher2	✗	Barred

Personal Contact List

IMPROVED COMMUNICATION SYSTEM

The invention relates to an improved communication system particularly although not exclusively for use with a telecommunications network.

5 Communication over telecommunication networks is well known and such communication can be voice or data communication using various system devices for example, telephones (fixed line or mobile) and/or personal computers (PC's) linked to the network. Each system device linked to the network is required to be uniquely identified on the network. For
10 example, each telephone linked to the telecommunication network is identified by a unique multiple digit telephone number. Communication between telephones over the network is effected by identifying to the network, the unique identification of the telephone with whom contact is desired to be made. Similarly, for data communication using PC's over the
15 telecommunication network, each computer linked to the network is uniquely identified by an Internet protocol address and communication between computers over the network is effected by reference to that Internet protocol address. Further each user of each computer is uniquely identified by an e-mail address and communication between respective users
20 is effected by reference to that e-mail address.

A problem arises insofar as a single user of a telecommunication network may use a number of different system devices to communicate

Explore Litigation Insights

Docket Alarm provides insights to develop a more informed litigation strategy and the peace of mind of knowing you're on top of things.

Real-Time Litigation Alerts



Keep your litigation team up-to-date with **real-time alerts** and advanced team management tools built for the enterprise, all while greatly reducing PACER spend.

Our comprehensive service means we can handle Federal, State, and Administrative courts across the country.

Advanced Docket Research



With over 230 million records, Docket Alarm's cloud-native docket research platform finds what other services can't. Coverage includes Federal, State, plus PTAB, TTAB, ITC and NLRB decisions, all in one place.

Identify arguments that have been successful in the past with full text, pinpoint searching. Link to case law cited within any court document via Fastcase.

Analytics At Your Fingertips



Learn what happened the last time a particular judge, opposing counsel or company faced cases similar to yours.

Advanced out-of-the-box PTAB and TTAB analytics are always at your fingertips.

API

Docket Alarm offers a powerful API (application programming interface) to developers that want to integrate case filings into their apps.

LAW FIRMS

Build custom dashboards for your attorneys and clients with live data direct from the court.

Automate many repetitive legal tasks like conflict checks, document management, and marketing.

FINANCIAL INSTITUTIONS

Litigation and bankruptcy checks for companies and debtors.

E-DISCOVERY AND LEGAL VENDORS

Sync your system to PACER to automate legal marketing.