

(12) **United States Patent**
Zyren

(10) **Patent No.:** **US 6,377,608 B1**
(45) **Date of Patent:** **Apr. 23, 2002**

(54) **PULSED BEACON-BASED INTERFERENCE REDUCTION MECHANISM FOR WIRELESS COMMUNICATION NETWORKS**

6,028,853 A	*	2/2000	Haartsen	370/338
6,128,290 A	*	10/2000	Carvey	370/347
6,226,317 B1	*	5/2001	Bruckert et al.	375/146
6,246,884 B1	*	6/2001	Karmi et al.	455/521

(75) Inventor: **James G. Zyren**, Indialantic, FL (US)

* cited by examiner

(73) Assignee: **Intersil Americas Inc.**, Irvine, CA (US)

Primary Examiner—Chi Pham
Assistant Examiner—Emmanuel Bayard

(*) Notice: Subject to any disclaimer, the term of this patent is extended or adjusted under 35 U.S.C. 154(b) by 0 days.

(74) *Attorney, Agent, or Firm*—Gary R. Stanford

(57) **ABSTRACT**

(21) Appl. No.: **09/163,802**

A repetitively pulsed beacon based mechanism prevents interference between wireless communication devices of users of a band wireless local area network WLAN, and wireless communication devices of ad hoc networks using the same ISM band. A beacon generator is installed in the vicinity of an access point of the WLAN infrastructure, and generates a wireless beacon in a portion of the ISM band that does not overlap that portion used by the WLAN. A beacon responsive radio control mechanism, installed in each ad hoc radio, monitors the beacon channel for the presence of the wireless beacon. In response to detecting the beacon, the radio control mechanism adjusts the operation of its ad hoc radio, to avoid simultaneous use of the same portion of the ISM band as the WLAN. In one example, the ad hoc radio is adjusted so that it transmits within a selected portion of the ISM band other than that used by the WLAN.

(22) Filed: **Sep. 30, 1998**

(51) **Int. Cl.⁷** **H04K 1/00**

(52) **U.S. Cl.** **375/132**

(58) **Field of Search** 375/130, 132, 375/140, 141, 220; 370/320, 335, 342, 441, 479; 455/403, 418, 434, 440, 456, 462, 556, 515, 501, 524, 63, 67.3

(56) **References Cited**

U.S. PATENT DOCUMENTS

5,542,120 A	*	7/1996	Smith et al.	455/425
5,784,368 A	*	7/1998	Weigand et al.	370/350
5,809,421 A	*	9/1998	Manssen et al.	455/434
5,926,470 A	*	7/1999	Tiedmann, Jr.	370/334

44 Claims, 6 Drawing Sheets

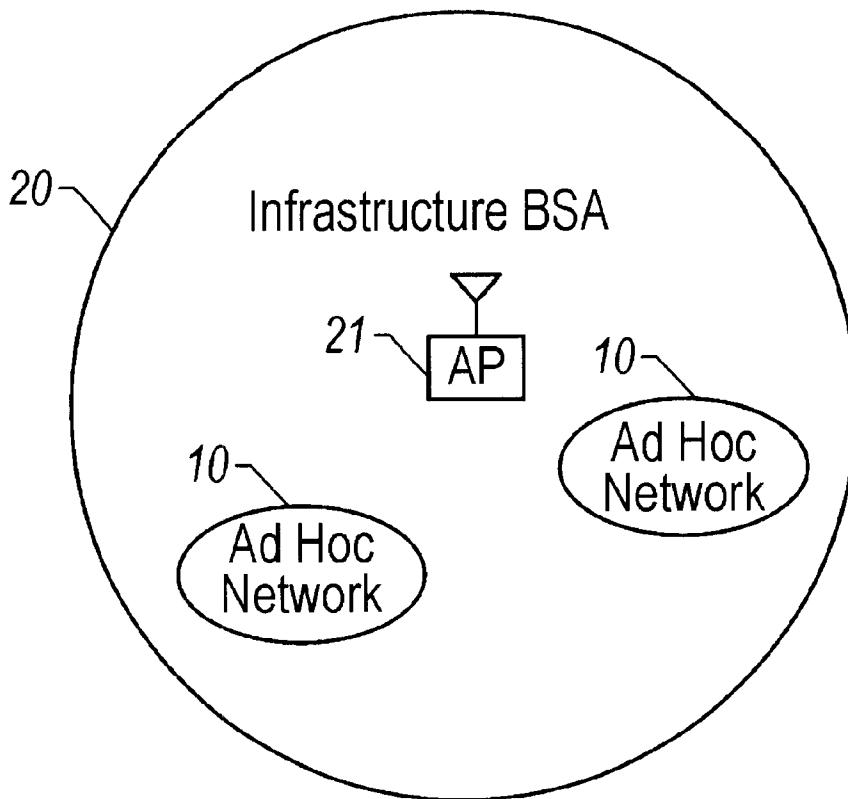

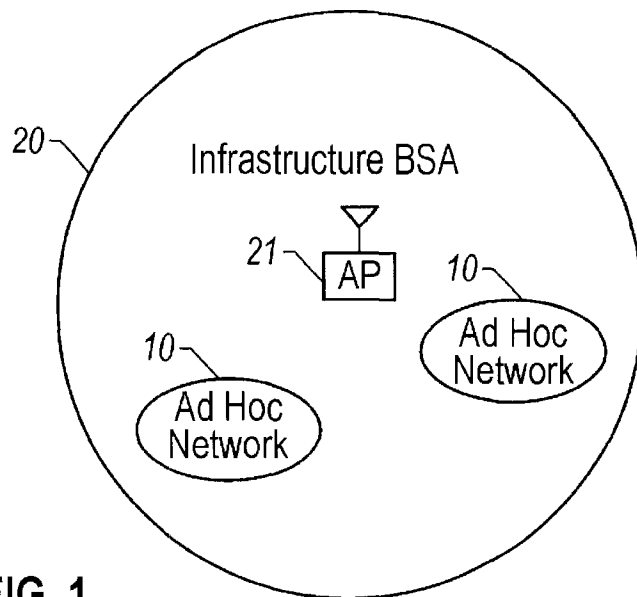

FIG. 1

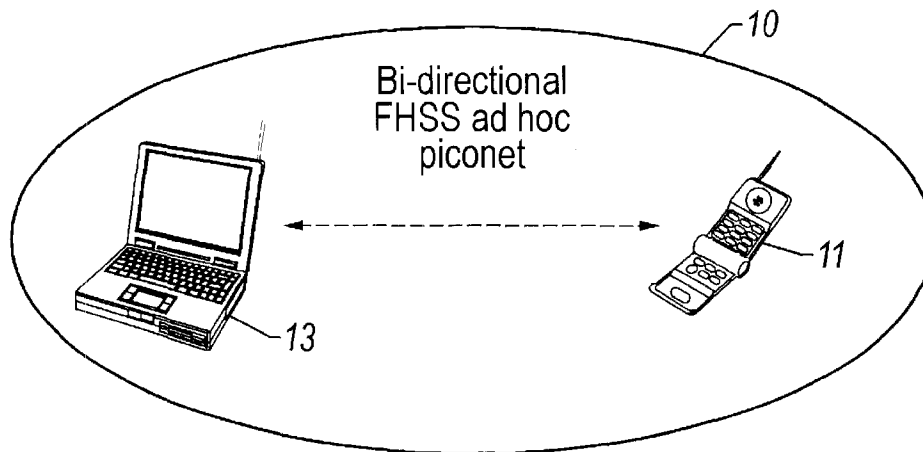

FIG. 2

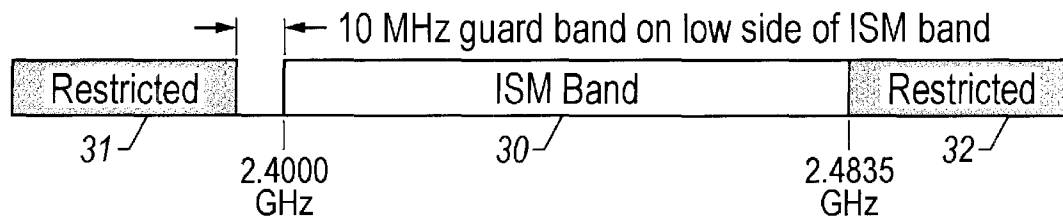

FIG. 3

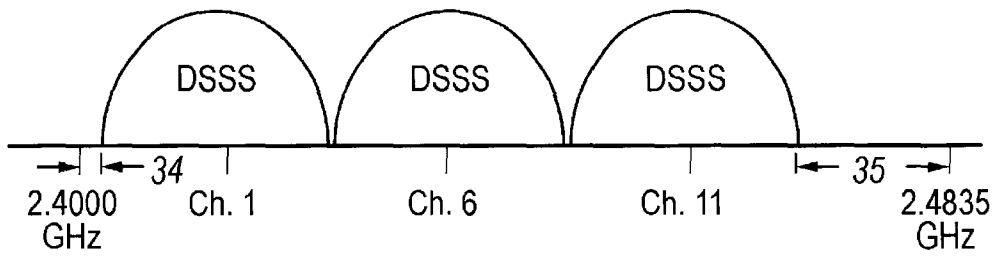

FIG. 4

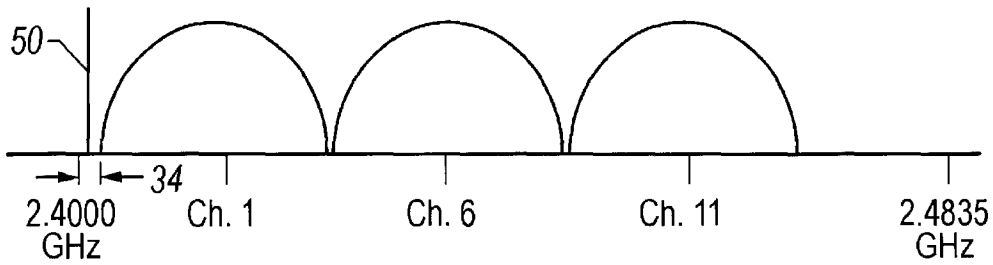

FIG. 5

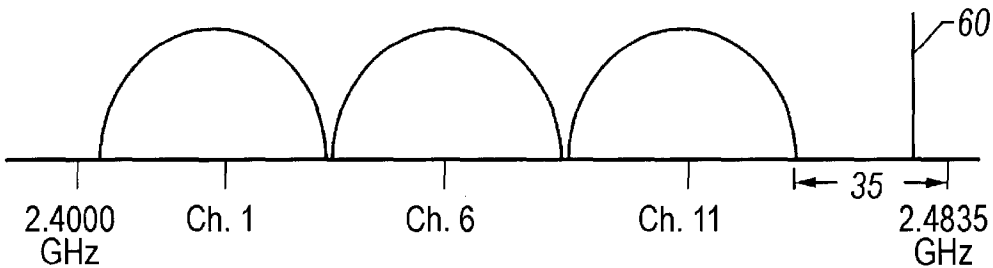

FIG. 6

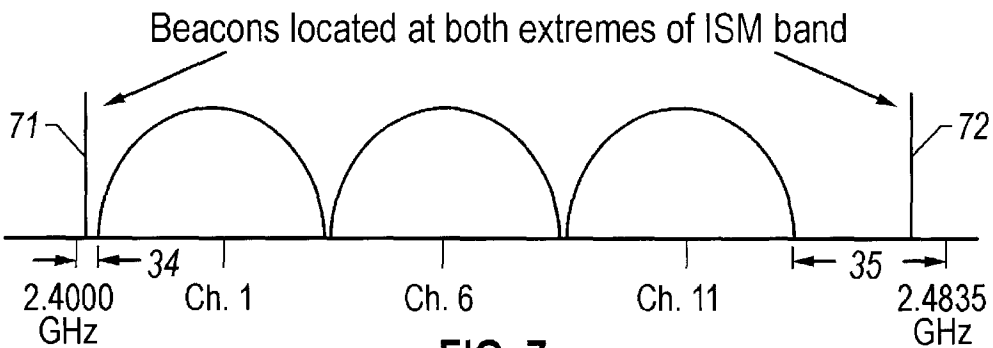

FIG. 7

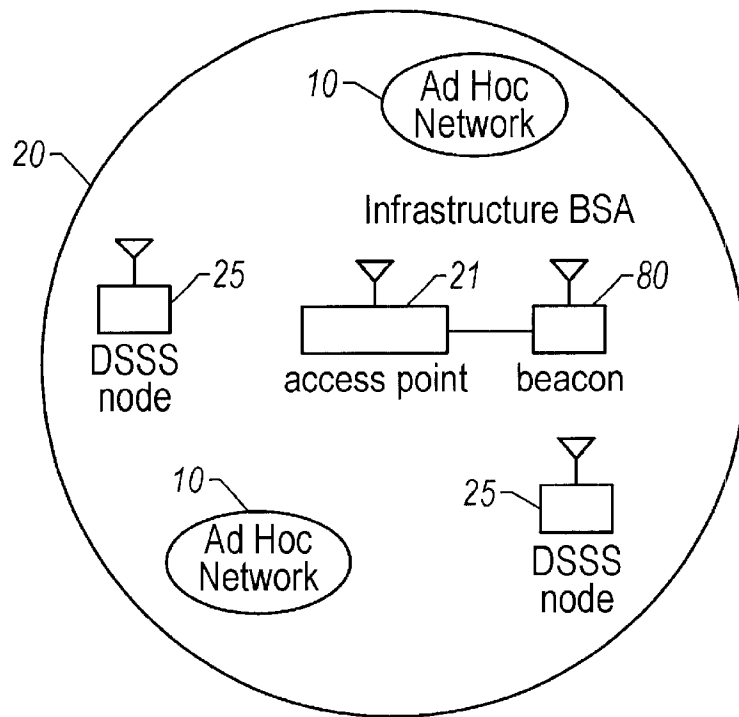

FIG. 8

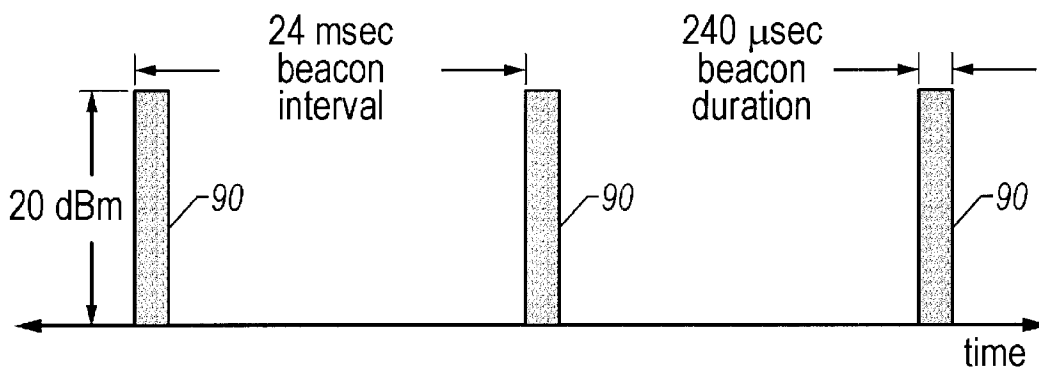

FIG. 9

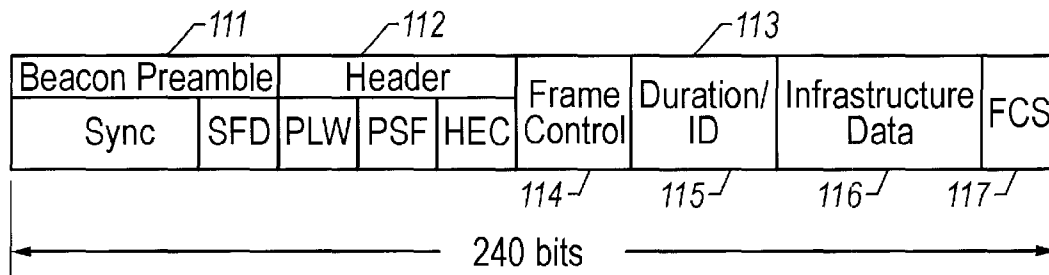

FIG. 10

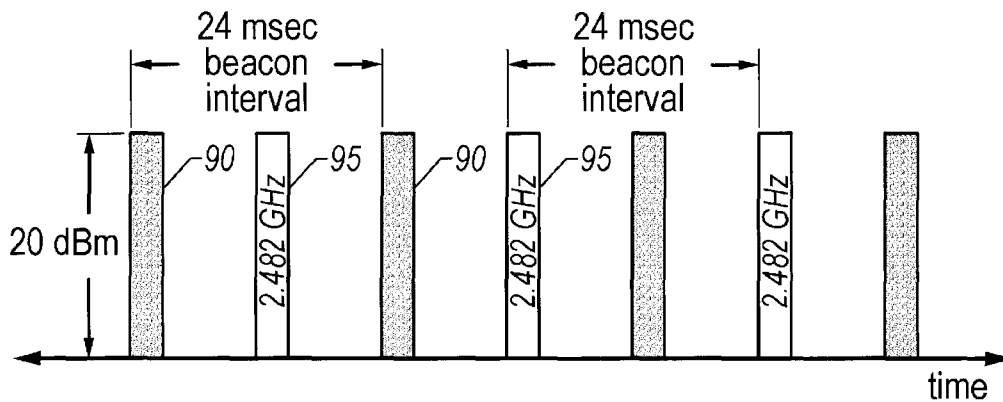

FIG. 11

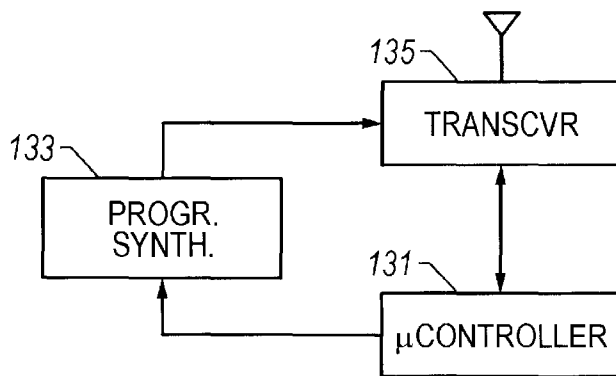

FIG. 12

Explore Litigation Insights

Docket Alarm provides insights to develop a more informed litigation strategy and the peace of mind of knowing you're on top of things.

Real-Time Litigation Alerts



Keep your litigation team up-to-date with **real-time alerts** and advanced team management tools built for the enterprise, all while greatly reducing PACER spend.

Our comprehensive service means we can handle Federal, State, and Administrative courts across the country.

Advanced Docket Research



With over 230 million records, Docket Alarm's cloud-native docket research platform finds what other services can't. Coverage includes Federal, State, plus PTAB, TTAB, ITC and NLRB decisions, all in one place.

Identify arguments that have been successful in the past with full text, pinpoint searching. Link to case law cited within any court document via Fastcase.

Analytics At Your Fingertips



Learn what happened the last time a particular judge, opposing counsel or company faced cases similar to yours.

Advanced out-of-the-box PTAB and TTAB analytics are always at your fingertips.

API

Docket Alarm offers a powerful API (application programming interface) to developers that want to integrate case filings into their apps.

LAW FIRMS

Build custom dashboards for your attorneys and clients with live data direct from the court.

Automate many repetitive legal tasks like conflict checks, document management, and marketing.

FINANCIAL INSTITUTIONS

Litigation and bankruptcy checks for companies and debtors.

E-DISCOVERY AND LEGAL VENDORS

Sync your system to PACER to automate legal marketing.