



Index of Claims 	Application/Control No. 10784781	Applicant(s)/Patent Under Reexamination KLASSEN ET AL.
	Examiner Heffington, John M	Art Unit 2179

✓	Rejected	-	Cancelled	N	Non-Elected	A	Appeal
=	Allowed	÷	Restricted	I	Interference	O	Objected

Claims renumbered in the same order as presented by applicant
 CPA
 T.D.
 R.1.47

CLAIM		DATE								
Final	Original	03/05/2007	12/07/2007	03/23/2008	10/17/2008	04/07/2009	09/23/2009	03/27/2010		
	1	✓	-	-	-	-	-	-		
	2	✓	-	-	-	-	-	-		
	3	✓	-	-	-	-	-	-		
	4	✓	-	-	-	-	-	-		
	5	✓	-	-	-	-	-	-		
	6	✓	-	-	-	-	-	-		
	7	✓	-	-	-	-	-	-		
	8	✓	-	-	-	-	-	-		
	9	✓	-	-	-	-	-	-		
	10	✓	-	-	-	-	-	-		
	11	✓	-	-	-	-	-	-		
	12	✓	-	-	-	-	-	-		
	13	✓	-	-	-	-	-	-		
	14	✓	-	-	-	-	-	-		
	15	✓	-	-	-	-	-	-		
	16	✓	-	-	-	-	-	-		
	17	✓	-	-	-	-	-	-		
	18	✓	-	-	-	-	-	-		
	19	✓	-	-	-	-	-	-		
	20	✓	-	-	-	-	-	-		
	21		✓	✓	✓	✓	✓	✓		
	22		✓	✓	✓	✓	✓	✓		
	23		✓	✓	✓	✓	✓	✓		
	24		✓	✓	✓	✓	✓	✓		
	25		✓	✓	✓	✓	✓	✓		
	26		✓	✓	✓	-	-	-		
	27		✓	✓	✓	✓	✓	-		
	28		✓	✓	✓	✓	✓	✓		
	29		✓	✓	✓	✓	✓	✓		
	30		✓	✓	✓	✓	✓	✓		
	31		✓	✓	✓	✓	✓	✓		
	32		✓	✓	✓	✓	✓	✓		
	33		✓	✓	✓	✓	✓	✓		
	34		✓	✓	✓	✓	✓	✓		
	35		✓	✓	✓	-	-	-		
	36		✓	✓	✓	✓	✓	-		

Index of Claims 	Application/Control No. 10784781	Applicant(s)/Patent Under Reexamination KLASSEN ET AL.
	Examiner Heffington, John M	Art Unit 2179

✓	Rejected	-	Cancelled	N	Non-Elected	A	Appeal
=	Allowed	÷	Restricted	I	Interference	O	Objected

Claims renumbered in the same order as presented by applicant
 CPA
 T.D.
 R.1.47

CLAIM		DATE								
Final	Original	03/05/2007	12/07/2007	03/23/2008	10/17/2008	04/07/2009	09/23/2009	03/27/2010		
	37		✓	✓	✓	✓	✓	✓		
	38		✓	✓	✓	✓	✓	✓		
	39		✓	✓	✓	✓	✓	✓		
	40		✓	✓	✓	✓	✓	✓		
	41		✓	✓	✓	✓	✓	✓		
	42						✓	✓		
	43						✓	✓		
	44						✓	✓		
	45						✓	✓		
	46						✓	✓		
	47						✓	✓		
	48						✓	✓		
	49						✓	✓		
	50						✓	✓		
	51						✓	✓		

Search Notes 	Application/Control No. 10784781	Applicant(s)/Patent Under Reexamination KLASSEN ET AL.
	Examiner Heffington, John M	Art Unit 2179

SEARCHED			
Class	Subclass	Date	Examiner
715	700	3/1/2007	JMH

SEARCH NOTES		
Search Notes	Date	Examiner
EAST Search	3/1/2007	JMH
EAST Search (update)	12/7/2007	JMH
EAST Search (update)	3/23/2008	JMH
NPL Search	3/23/2008	JMH
EAST Search	10/16/08	JMH
EAST Search	4/7/09	JMH
EAST Search	9/22/09	JMH
EAST Search	3/27/10	JMH

INTERFERENCE SEARCH			
Class	Subclass	Date	Examiner

--	--

EAST Search History

EAST Search History (Prior Art)

Ref #	Hits	Search Query	DBs	Default Operator	Plurals	Time Stamp
S1	8	("20020160817" "20050248437").PN. or ("20020035613" "20040155908").PN.	US-PGPUB; USPAT; FPRS; EPO; JPO; DERWENT; IBM_TDB	ADJ	ON	2010/03/27 17:51

EAST Search History (Interference)

<This search history is empty>

3/ 27/ 2010 7:48:45 PM

C:\ Documents and Settings\ jheffington\ My Documents\ OA Folders\ 10784781 \ SearchHistory8.wsp

RECEIVED
CENTRAL FAX CENTER

JUL 06 2010

IN THE UNITED STATES PATENT AND TRADEMARK OFFICE

Attorney Docket No. 05200204-272US

Group Art Unit:	2179)
Examiner:	John M. Heffington)
Serial No.:	10/784,781)
Filed:	February 24, 2004)
For:	Previewing a New Event on a Small Screen Device)

Agenda
for Examiner Interview

Examiner Heffington:

Thank you for agreeing to an in-person interview on 7 July 2010 at 1:00 p.m. to discuss the above-captioned application. Appearing at the interview for the patent owner will be Donna Flores, of Applicant RIM, and Applicant's representative Matthew J. Marquardt. During the interview, we would like to discuss your interpretation of the pending claims and the cited references, including Wagner (US 2004/0155908), Hirayama (US 2002/0035613), Hellebust (US 2005/0248437), and Salmimaa (US 2002/0160817). For brevity, we would like to focus on independent claim 21 and proposed new claims 52 - 56, 60 - 63, and 70 - 73, which further distinguish the cited references.

Respectfully,

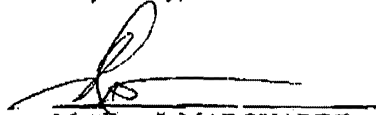

Matthew J. MARQUARDT
Reg. No. 40,997
Attorney for the Applicant

OGILVY RENAULT LLP
Royal Bank Plaza, South Tower
200 Bay Street, P.O. Box 84
Toronto, Ontario M5J 2Z4
CANADA

Tel. 416-216-4789
Fax 416-216-3930

RECEIVED
CENTRAL FAX CENTER
JUL 06 2010

PROPOSED CLAIMS
FOR DISCUSSION ONLY

Preview of incoming message in response to user selection of icon

21. (Currently Amended) A method for providing notifications of new events on a display of a wireless communication device ~~having a small display, the wireless communication device having a graphical user interface 'GUI' displayed on the display, the GUI having a main screen comprising an application portion for displaying icons for respective applications for execution on the wireless communication device,~~ the method comprising:

providing on the display a graphical user interface 'GUI' comprising the main screen and in the application portion a plurality of application icons, each icon representing an application at the wireless device and each being invocable to launch its respective a corresponding application; and

in response to a new event in respect of one of the applications, visually modifying the respective application icon ~~in the application portion of the main screen~~ to notify of the new event;

in response to a user selection of the respective application icon, displaying a first preview of a content of the new event in association with the selected application icon; ~~the first preview not being displayed prior to the user selection;~~

wherein the application icons are being maintained on the main screen continuously; and

wherein the first preview persists persisting on the main screen when a subsequent second preview is displayed, in response to a subsequent user selection, for a subsequent event.

Counter with number of correspondents (instead of raw number of messages)

52. (New) A method for providing notifications of new messages on a wireless communication device, comprising:

displaying a plurality of icons on a graphical user interface of the wireless communication device, the plurality of icons including an icon relating to electronic messaging;

receiving a plurality of electronic messages on the wireless communication device, the plurality of electronic messages including messages from a plurality of different messaging correspondents; and

in response to receiving the plurality of electronic messages, visually modifying the displayed icon relating to electronic messaging to include a count of the plurality of different messaging correspondents for which one or more of the electronic messages have been received but remain unread.

53. (New) The method of claim 52, further comprising:

in response to receiving the plurality of electronic messages, visually modifying one or more of the plurality of icons to include a count of the plurality of electronic messages, the count indicating a number of the plurality of electronic messages that have been received but remain unread.

54. (New) The method of claim 52, the plurality of icons including a plurality of application icons that are selectable to execute respective ones of a plurality of applications on the wireless communication device.

55. (New) The method of claim 54, the icon relating to electronic messaging being selectable to execute an electronic messaging application.

56. (New) A method for providing notifications of new messages on a wireless communication device, comprising:

displaying a graphical image on a graphical user interface of the wireless communication device, the graphical image relating to an electronic messaging application that is executable by the wireless communication device;

receiving a plurality of electronic messages on the wireless communication device, the plurality of electronic messages including messages from a plurality of different messaging correspondents; and

in response to receiving the plurality of electronic messages, visually modifying the displayed graphical image to include a count of the plurality of different messaging correspondents for which one or more of the electronic messages have been received but remain unread.

JUL 06 2010

Notification of correspondent state change

60. (New) A method for providing notifications on a wireless communication device, comprising:

displaying a plurality of icons on a graphical user interface of the wireless communication device, the plurality of icons including at least one icon relating to an electronic messaging application executable to enable messaging between the wireless communication device and at least one other device configured to execute the electronic messaging application;

receiving event information indicating a change in state of at least one user of the electronic messaging application executed by at least one other communication device; and

in response to receiving the event information indicating a change in state of the at least one user, visually modifying the displayed icon relating to electronic messaging to include a notification of the change in state.

RECEIVED
CENTRAL FAX CENTER

JUL 06 2010

Counter with number of unread messages

70. (New) A method for providing notifications of new messages on a wireless communication device, comprising:

displaying a plurality of icons on a graphical user interface of the wireless communication device, the plurality of icons including an icon relating to electronic messaging;

receiving a plurality of electronic messages on the wireless communication device; and

in response to receiving the plurality of electronic messages, visually modifying the displayed icon relating to electronic messaging to include a count of the electronic messages received.

71. (New) The method of claim 70, comprising visually modifying the displayed icon relating to electronic messaging to include an identifier of the correspondent from who at least one of the plurality of messages was received.

72. (New) The method of claim 70, comprising visually modifying the displayed icon relating to electronic message to include at least one preview of a content of at least one of the received electronic messages.

JUL-06-2010 TUE 11:01 AM

FAX NO.

P. 01

No.: 18481

Client No.: 05200204-272US

U.S. Patent Application No.
10/784781



Facsimile

RECEIVED
CENTRAL FAX CENTER

JUL 06 2010

Confidentiality Message

This communication sent by facsimile is confidential, may be privileged and is intended for the exclusive use of the addressee. Any other person is strictly prohibited from disclosing, distributing or reproducing it. If the addressee cannot be reached or is unknown to you, please destroy this message and all copies. Thank you.

Number of pages including this cover sheet: 7

Date: July 6, 2010

From: Matthew Marquardt

Telephone: 416.216.4789

Direct Fax: 416.216.3930

E-Mail: mmarquardt@ogilvyrenault.com

To	Company - City	Phone	Fax
Examiner John M. Heffington	USPTO - Group 2179		571-273-8300

Message

OGILVY RENAULT LLP / S.E.N.C.R.L., s.r.l.

Barristers & Solicitors,
Patent & Trade-mark Agents

Suite 2500
1 Place Ville Marie
Montreal, Quebec H3B 1R1
CANADA

T: 514.847.4747
F: 514.288.8389
montreal@ogilvyrenault.com

ogilvyrenault.com

PAGE 17 * RCVD AT 7/6/2010 11:01:59 AM [Eastern Daylight Time] * SVR:USPTO-EFXXF-5/25 * DNIS:2738300 * CSID: * DURATION (mm-ss):01-26ary . London

REQUEST FOR CONTINUED EXAMINATION(RCE)TRANSMITTAL (Submitted Only via EFS-Web)							
Application Number	10784781	Filing Date	2004-02-24	Docket Number (if applicable)	05200204-272US	Art Unit	2179
First Named Inventor	Gerhard D. KLASSEN			Examiner Name	HEFFINGTON, John M.		
<p>This is a Request for Continued Examination (RCE) under 37 CFR 1.114 of the above-identified application. Request for Continued Examination (RCE) practice under 37 CFR 1.114 does not apply to any utility or plant application filed prior to June 8, 1995, or to any design application. The Instruction Sheet for this form is located at WWW.USPTO.GOV</p>							
SUBMISSION REQUIRED UNDER 37 CFR 1.114							
<p>Note: If the RCE is proper, any previously filed unentered amendments and amendments enclosed with the RCE will be entered in the order in which they were filed unless applicant instructs otherwise. If applicant does not wish to have any previously filed unentered amendment(s) entered, applicant must request non-entry of such amendment(s).</p>							
<p><input type="checkbox"/> Previously submitted. If a final Office action is outstanding, any amendments filed after the final Office action may be considered as a submission even if this box is not checked.</p> <p style="margin-left: 40px;"><input type="checkbox"/> Consider the arguments in the Appeal Brief or Reply Brief previously filed on _____</p> <p style="margin-left: 40px;"><input type="checkbox"/> Other _____</p> <p><input checked="" type="checkbox"/> Enclosed</p> <p style="margin-left: 40px;"><input checked="" type="checkbox"/> Amendment/Reply</p> <p style="margin-left: 40px;"><input type="checkbox"/> Information Disclosure Statement (IDS)</p> <p style="margin-left: 40px;"><input type="checkbox"/> Affidavit(s)/ Declaration(s)</p> <p style="margin-left: 40px;"><input type="checkbox"/> Other _____</p>							
MISCELLANEOUS							
<p><input type="checkbox"/> Suspension of action on the above-identified application is requested under 37 CFR 1.103(c) for a period of months _____ (Period of suspension shall not exceed 3 months; Fee under 37 CFR 1.17(i) required)</p> <p><input type="checkbox"/> Other _____</p>							
FEES							
<p>The RCE fee under 37 CFR 1.17(e) is required by 37 CFR 1.114 when the RCE is filed.</p> <p><input checked="" type="checkbox"/> The Director is hereby authorized to charge any underpayment of fees, or credit any overpayments, to Deposit Account No <u>195113</u></p>							
SIGNATURE OF APPLICANT, ATTORNEY, OR AGENT REQUIRED							
<p><input checked="" type="checkbox"/> Patent Practitioner Signature</p> <p><input type="checkbox"/> Applicant Signature</p>							

Doc code: RCEX

Doc description: Request for Continued Examination (RCE)

PTO/SB/30EFS (07-09)

Approved for use through 07/31/2012. OMB 0651-0031
U.S. Patent and Trademark Office; U.S. DEPARTMENT OF COMMERCE

Under the Paperwork Reduction Act of 1995, no persons are required to respond to a collection of information unless it contains a valid OMB control number.

Signature of Registered U.S. Patent Practitioner			
Signature	/MJM/	Date (YYYY-MM-DD)	2010-07-28
Name	Matthew J. Marquardt	Registration Number	40997

This collection of information is required by 37 CFR 1.114. The information is required to obtain or retain a benefit by the public which is to file (and by the USPTO to process) an application. Confidentiality is governed by 35 U.S.C. 122 and 37 CFR 1.11 and 1.14. This collection is estimated to take 12 minutes to complete, including gathering, preparing, and submitting the completed application form to the USPTO. Time will vary depending upon the individual case. Any comments on the amount of time you require to complete this form and/or suggestions for reducing this burden, should be sent to the Chief Information Officer, U.S. Patent and Trademark Office, U.S. Department of Commerce, P.O. Box 1450, Alexandria, VA 22313-1450.

If you need assistance in completing the form, call 1-800-PTO-9199 and select option 2.

Privacy Act Statement

The Privacy Act of 1974 (P.L. 93-579) requires that you be given certain information in connection with your submission of the attached form related to a patent application or patent. Accordingly, pursuant to the requirements of the Act, please be advised that: (1) the general authority for the collection of this information is 35 U.S.C. 2(b)(2); (2) furnishing of the information solicited is voluntary; and (3) the principal purpose for which the information is used by the U.S. Patent and Trademark Office is to process and/or examine your submission related to a patent application or patent. If you do not furnish the requested information, the U.S. Patent and Trademark Office may not be able to process and/or examine your submission, which may result in termination of proceedings or abandonment of the application or expiration of the patent.

The information provided by you in this form will be subject to the following routine uses:

1. The information on this form will be treated confidentially to the extent allowed under the Freedom of Information Act (5 U.S.C. 552) and the Privacy Act (5 U.S.C. 552a). Records from this system of records may be disclosed to the Department of Justice to determine whether the Freedom of Information Act requires disclosure of these records.
2. A record from this system of records may be disclosed, as a routine use, in the course of presenting evidence to a court, magistrate, or administrative tribunal, including disclosures to opposing counsel in the course of settlement negotiations.
3. A record in this system of records may be disclosed, as a routine use, to a Member of Congress submitting a request involving an individual, to whom the record pertains, when the individual has requested assistance from the Member with respect to the subject matter of the record.
4. A record in this system of records may be disclosed, as a routine use, to a contractor of the Agency having need for the information in order to perform a contract. Recipients of information shall be required to comply with the requirements of the Privacy Act of 1974, as amended, pursuant to 5 U.S.C. 552a(m).
5. A record related to an International Application filed under the Patent Cooperation Treaty in this system of records may be disclosed, as a routine use, to the International Bureau of the World Intellectual Property Organization, pursuant to the Patent Cooperation Treaty.
6. A record in this system of records may be disclosed, as a routine use, to another federal agency for purposes of National Security review (35 U.S.C. 181) and for review pursuant to the Atomic Energy Act (42 U.S.C. 218(c)).
7. A record from this system of records may be disclosed, as a routine use, to the Administrator, General Services, or his/her designee, during an inspection of records conducted by GSA as part of that agency's responsibility to recommend improvements in records management practices and programs, under authority of 44 U.S.C. 2904 and 2906. Such disclosure shall be made in accordance with the GSA regulations governing inspection of records for this purpose, and any other relevant (i.e., GSA or Commerce) directive. Such disclosure shall not be used to make determinations about individuals.
8. A record from this system of records may be disclosed, as a routine use, to the public after either publication of the application pursuant to 35 U.S.C. 122(b) or issuance of a patent pursuant to 35 U.S.C. 151. Further, a record may be disclosed, subject to the limitations of 37 CFR 1.14, as a routine use, to the public if the record was filed in an application which became abandoned or in which the proceedings were terminated and which application is referenced by either a published application, an application open to public inspections or an issued patent.
9. A record from this system of records may be disclosed, as a routine use, to a Federal, State, or local law enforcement agency, if the USPTO becomes aware of a violation or potential violation of law or regulation.

IN THE UNITED STATES PATENT AND TRADEMARK OFFICE

Inventor(s) KLASSEN et al.
Serial No.: 10/784,781
Filed: 24 February 2004
Examiner: HEFFINGTON, John M.
Group Art Unit: 2179
Confirmation No.: 2200
Title: PREVIEWING A NEW EVENT ON A SMALL SCREEN
 DEVICE

VIA ELECTRONIC FILING

Commissioner for Patents
P.O. Box 1450
Alexandria, Virginia 22313-1450
U.S.A.

**RESPONSE TO OFFICE ACTION
AND SUMMARY OF INTERVIEW**

This paper (the Response) is filed in response to the Office Action mailed herein
31 March 2010.

Amendments to the Abstract are presented beginning at page 2.

Amendments to the Specification are presented beginning at page 3.

Amendments to the Claims are presented beginning at page 6.

Remarks, which include a Summary of Interview, are presented beginning at
page 22.

By separate paper submitted herewith Applicant has filed:

- (1) Petition for 1 month extension of time in which to file this Response.
- (2) Request for Continued Examination. This paper constitutes the submission
required under 37 CFR 1.114.

AMENDMENT

In the Abstract

Please delete the Abstract and replace it with the text shown below. A marked up version is provided below pursuant to 37 CFR 1.121. Pursuant to 37 CFR 1.72, a clean copy of the Abstract is provided on a separate sheet attached hereto.

Method and apparatus for previewing new ~~eve~~ events in a computing device having a plurality of applications for managing respective events are described. Individual applications are each represented by an application icon on a screen of a graphical user interface for the device. When a new event occurs, particularly when the new event relates to a specific one of a plurality of similar applications, the invention provides a convenient way to denote which application relates to the event. In response to a new event of a one of the applications, the application's icon is visually modified to notify of the new event. A visual modification may be determined in response to the new event, for example, to preview a content of the event. The visual modification may include a count of all new events that remain to be disposed. On a selection of the visually modified icon, additional previewing may be provided. Activation of the application having a visually modified application icon may be configured to automatically initiate the application at the new event.

In the Specification

Please delete paragraph [0002] and replace it with the following replacement paragraph. The replacement paragraph is provided in marked-up form pursuant to 37 CFR 1.121.

[0002] The present invention relates generally to wireless communication devices, and more particularly to [[a]] graphical user interfaces for controlling such devices.

Please delete paragraph [0036] and replace it with the following replacement paragraph. The replacement paragraph is provided in marked-up form pursuant to 37 CFR 1.121. Specific support for the amendment is provided at paragraph [0042] of the published application.

[0036] Microprocessor 238, in addition to its operating system functions, preferably enables execution of software applications on mobile station 202. A predetermined set of applications which control basic device operations, including at least data and voice communication applications, will normally be installed on mobile station 202 during its manufacture. A preferred application that may be loaded onto mobile station 202 may be a personal information manager for organizing and managing data items relating to the user such as, but not limited to, instant messaging (IM), e-mail, calendar events, voice mails, appointments, and task items. Naturally, one or more memory stores are available on mobile station 202 and SIM 262 to facilitate storage of PIM data items and other information.

Please delete paragraph [0043] and replace it with the following replacement paragraph. The replacement paragraph is provided in marked-up form pursuant to 37 CFR 1.121.

[0043] Referring now to FIG. 3, there is an illustration of an exemplary main screen 300, in accordance with an embodiment of the invention, for a display 112, 222 of mobile station 202 providing a graphical user interface for controlling mobile station 202. Main screen 300 is divided into two main portions, namely an application portion 301 for displaying and manipulating icons (e.g. 304-312) for various software applications and functions enabled by mobile station 202 and a mobile station status portion 302 for displaying status information such as time, date, battery and signal strength, etc. FIG. 3 illustrates three icons 304, 306 and 308 for respective IM applications IM 1, IM 2 and IM 3 and two icons 310, 312 for the two e-mail services Email 1 and Email 2. Associated with each icon is a name (e.g. IM 1) for the application for icon 304. The name may also be presented in a name region 314 of application portion 301.

Please delete paragraph [0049] and replace it with the following replacement paragraph. The replacement paragraph is provided in marked-up form pursuant to 37 CFR 1.121.

[0049] FIG. 5 ~~is an illustration of~~ shows an IM application icon 306 following a user action. When the user of mobile station 202 moves the focus of main screen from icon 304 through 306 and 308 to highlight phone icon 502, visual modification 400 persists at icon 306 to maintain the visual modification and remind the user of the unread message. Preferably, only once the user activates an application and reads the unread message is the visual modification changed, for example, to decrease the count and, if applicable, remove the modification if the count is zero.

Please delete paragraph [0053] and replace it with the following replacement paragraph. The replacement paragraph is provided in marked-up form pursuant to 37 CFR 1.121.

[0053] FIG. 8 is an illustration of another embodiment for previewing events on a main screen of a mobile station such as station 202. In this embodiment, two new events, one for each of IM application icons 304, 306 are indicated via respective visual modifications 802 and 804. Visual modification 802 comprises an event count, namely a count of unread messages and a message preview providing a sender identity and a portion of the unread message. Similarly though differently modification 804 comprises an event count and state preview indicating IM correspondent buddy Tom "Red98" has signed on. Persons of ordinary skill in the art will appreciate that different events may be visualized on the main screen in accordance with the invention and these events may depend upon the associated application.

In the Claims

Please rewrite the claims as follows. A complete listing of the claims is provided pursuant to 37 CFR 1.121.

1 – 51. (Cancelled)

52. (New) A method of providing notifications of unread messages on a wireless communication device, comprising:

displaying at least one icon relating to electronic messaging on a graphical user interface of the wireless communication device;

receiving a plurality of electronic messages on the wireless communication device, the plurality of electronic messages including messages from a plurality of different messaging correspondents; and

in response to receiving at least one of the plurality of electronic messages, visually modifying at least one displayed icon relating to electronic messaging to include a count of the plurality of different messaging correspondents for which one or more of the electronic messages have been received and remain unread.

53. (New) The method of claim 52, further comprising displaying a plurality of icons including one or more application icons that are selectable to invoke respective ones of a plurality of applications on the wireless communication device.

54. (New) The method of claim 53, further comprising visually modifying one or more of the plurality of icons to include a count of electronic messages that have been received and remain unread.

55. (New) The method of claim 52, the at least one icon relating to electronic messaging being selectable to invoke an electronic messaging application.

56. (New) The method of claim 52, comprising displaying on the graphical user interface an identifier of the correspondent from whom at least one of the plurality of messages was received.

57. (New) The method of claim 52, comprising displaying on the graphical user interface at least one preview of content associated with at least one of the received electronic messages.

58. (New) A medium or media comprising machine-readable instructions executable by a processor of a wireless communication device, the wireless communication device including a graphical user interface, the machine-readable instructions, when executed, causing the wireless communication device to:

display at least one icon relating to an electronic messaging application on the graphical user interface;

receive a plurality of electronic messages, the plurality of electronic messages including messages from a plurality of different messaging correspondents; and

in response to receiving at least one of the plurality of electronic messages, visually modify at least one displayed icon relating to the electronic messaging application to include a count of the plurality of different messaging correspondents for which one or more of the electronic messages have been received and remain unread.

59. (New) The medium or media of claim 58, further comprising machine-readable instructions which, when executed, cause the wireless communication device to display a plurality of icons including one or more application icons that are selectable to invoke respective ones of a plurality of applications on the wireless communication device.

60. (New) The medium or media of claim 59, further comprising machine-readable instructions which, when executed, cause the wireless communication device to visually modify one or more of the plurality of icons to include a count of electronic messages that have been received by the wireless communication device and remain unread.

61. (New) The medium or media of claim 58, the at least one icon relating to electronic messaging being selectable to invoke an electronic messaging application.

62. (New) The medium or media of claim 58, further comprising machine-readable instructions which, when executed, cause the wireless communication device to visually modify the graphical user interface to include an identifier of the correspondent from whom at least one of the plurality of messages was received.

63. (New) The medium or media of claim 58, further comprising machine-readable instructions which, when executed, cause the wireless communication device to visually modify the graphical user interface to include at least one preview of content associated with at least one of the received electronic messages.

64. (New) A computer-readable memory accessible by a processor of a wireless communication device, the memory comprising stored electronic data structures representing executable instructions which, when executed by the processor, cause the wireless communication device to:

display at least one icon relating to an electronic messaging application on the graphical user interface;

receive a plurality of electronic messages, the plurality of electronic messages including messages from a plurality of different messaging correspondents; and

in response to receiving at least one of the plurality of electronic messages, visually modify at least one displayed icon relating to the electronic messaging application to include a count of the plurality of different messaging correspondents for which one or more of the electronic messages have been received and remain unread.

65. (New) The computer-readable memory of claim 64, further comprising stored electronic data structures representing executable instructions which, when executed, cause the wireless communication device to display a plurality of icons including one or more application icons that are selectable to invoke respective ones of a plurality of applications on the wireless communication device.

66. (New) The computer-readable memory of claim 65, further comprising stored electronic data structures representing executable instructions which, when executed, cause the wireless communication device to visually modify one or more of the plurality of icons to include a count of electronic messages that have been received by the wireless communication device and remain unread.

67. (New) The computer-readable memory of claim 64, the at least one icon relating to electronic messaging being selectable to invoke an electronic messaging application.

68. (New) The computer-readable memory of claim 64, stored electronic data structures representing executable instructions which, when executed, cause the wireless communication device to visually modify the graphical user interface to include an identifier of the correspondent from whom at least one of the plurality of messages was received.

69. (New) The computer-readable memory of claim 64, further stored electronic data structures representing executable instructions which, when executed, cause the wireless communication device to visually modify the graphical user interface to include at least one preview of content associated with at least one of the received electronic messages.

70. (New) A wireless communication device comprising:

a processor;

a display electrically coupled to the processor, the display presenting a graphical user interface; and

a medium or media including machine-readable instructions executable by the processor to:

display at least one icon relating to electronic messaging on the graphical user interface;

receive a plurality of electronic messages, the plurality of electronic messages including messages from a plurality of different messaging correspondents; and

in response to receiving at least one of the plurality of electronic messages, visually modify the at least one displayed icon relating to electronic messaging to

include a count of the plurality of different messaging correspondents for which one or more of the electronic messages have been received and remain unread.

71. (New) The wireless communication device of claim 70, the medium or media further comprising machine-readable instructions which, when executed, cause the wireless communication device to display a plurality of icons including one or more application icons that are selectable to invoke respective ones of a plurality of applications on the wireless communication device.

72. (New) The wireless communication device of claim 71, the medium or media comprising machine-readable instructions which, when executed, cause the wireless communication device to visually modify one or more of the plurality of icons to include a count of electronic messages that have been received and remain unread.

73. (New) The wireless communication device of claim 70, the at least one icon relating to electronic messaging being selectable to invoke an electronic messaging application.

74. (New) The wireless communication device of claim 70, the medium or media further comprising machine-readable instructions which, when executed, cause the wireless communication device to visually modify the graphical user interface to include an identifier of the correspondent from whom at least one of the plurality of messages was received.

75. (New) The wireless communication device of claim 70, the medium or media further comprising machine-readable instructions which, when executed, cause the

wireless communication device to visually modify the graphical user interface to include at least one preview of content associated with at least one of the received electronic messages.

76. (New) A method of providing notifications of unread messages on a wireless communication device, comprising:

displaying at least one icon relating to an electronic messaging application on a graphical user interface of the wireless communication device;

receiving on the wireless communication device a plurality of electronic messages associated with the electronic messaging application; and

responsive to receiving at least one of the plurality of electronic messages:

visually modifying at least one icon relating to the electronic messaging application to include a count of the plurality of electronic messages which remain unread; and

displaying on the graphical user interface an identifier associated with a correspondent from whom the at least one of the plurality of electronic messages was received.

77. (New) The method of claim 76, the identifier associated with a correspondent from whom the at least one of the plurality of electronic messages was received comprising state information pertaining to the correspondent.

78. (New) The method of claim 76, further comprising displaying on the graphical user interface at least a preview of content associated with at least one of the received electronic messages.

79. (New) The method of claim 76, further comprising displaying on the graphical user interface for a predetermined period of time at least a preview of content associated with at least one of the received electronic messages.

80. (New) The method of claim 76, the at least one icon relating to electronic messaging being selectable to invoke an electronic messaging application.

81. (New) The method of claim 80, further comprising, responsive to invoking the electronic messaging application, navigating automatically to a graphical user interface comprising content associated with at least one of the received electronic messages.

82. (New) The method of claim 80, further comprising, responsive to invoking the electronic messaging application within a predetermined time following receipt of at least one of the received electronic messages, navigating automatically to a graphical user interface comprising content associated with the at least one of the received electronic messages.

83. (New) The method of claim 80, further comprising, responsive to invoking the electronic messaging application, visually modifying at least one icon relating to the electronic messaging application to include a decreased count of electronic messages which remain unread.

84. (New) The method of claim 80, further comprising, responsive to invoking the electronic messaging application, visually modifying at least one icon relating to the

electronic messaging application to remove the count of electronic messages which remain unread.

85. (New) A medium or media comprising machine-readable instructions executable by a processor of a wireless communication device, the wireless communication device including a graphical user interface, the machine-readable instructions, when executed, causing the wireless communication device to:

display at least one icon relating to an electronic messaging application on a graphical user interface of the wireless communication device;

receive on the wireless communication device a plurality of electronic messages associated with the electronic messaging application; and

responsive to receiving at least one of the plurality of electronic messages:

visually modify at least one icon relating to the electronic messaging application to include a count of the plurality of electronic messages which remain unread; and

display on the graphical user interface an identifier associated with a correspondent from whom the at least one of the plurality of electronic messages was received.

86. (New) The medium or media of claim 85, the identifier associated with a correspondent from whom the at least one of the plurality of electronic messages was received comprising state information pertaining to the correspondent.

87. (New) The medium or media of claim 85, further comprising machine-readable instructions which, when executed, cause the wireless communication device to display

on the graphical user interface at least a preview of content associated with at least one of the received electronic messages.

88. (New) The medium or media of claim 85, further comprising machine-readable instructions which, when executed, cause the wireless communication device to display on the graphical user interface for a predetermined period of time at least a preview of content associated with at least one of the received electronic messages.

89. (New) The medium or media of claim 85, the at least one icon relating to electronic messaging being selectable to invoke an electronic messaging application.

90. (New) The medium or media of claim 89, further comprising machine-readable instructions which, when executed, cause the wireless communication device to, responsive to invoking the electronic messaging application, navigate automatically to a graphical user interface comprising content associated with at least one of the received electronic messages.

91. (New) The medium or media of claim 89, further comprising machine-readable instructions which, when executed, cause the wireless communication device to, responsive to invoking the electronic messaging application within a predetermined time following receipt of at least one of the received electronic messages, navigate automatically to a graphical user interface comprising content associated with the at least one of the received electronic messages.

92. (New) The medium or media of claim 89, further comprising machine-readable instructions which, when executed, cause the wireless communication device to,

responsive to invoking the electronic messaging application, visually modify at least one icon relating to the electronic messaging application to include a decreased count of electronic messages which remain unread.

93. (New) The medium or media of claim 89, further comprising machine-readable instructions which, when executed, cause the wireless communication device to, responsive to invoking the electronic messaging application, visually modify at least one icon relating to the electronic messaging application to remove the count of electronic messages which remain unread.

94. (New) A computer-readable memory accessible by a processor of a wireless communication device, the memory comprising stored electronic data structures representing executable instructions which, when executed by the processor, cause the wireless communication device to:

display at least one icon relating to an electronic messaging application on a graphical user interface of the wireless communication device;

receive on the wireless communication device a plurality of electronic messages associated with the electronic messaging application; and

responsive to receiving at least one of the plurality of electronic messages:

visually modify at least one icon relating to the electronic messaging application to include a count of the plurality of electronic messages which remain unread; and

display on the graphical user interface an identifier associated with a correspondent from whom the at least one of the plurality of electronic messages was received.

95. (New) The computer-readable memory of claim 94, the identifier associated with a correspondent from whom the at least one of the plurality of electronic messages was received comprising state information pertaining to the correspondent.

96. (New) The computer-readable memory of claim 94, further stored electronic data structures representing executable instructions which, when executed, cause the wireless communication device to display on the graphical user interface at least a preview of content associated with at least one of the received electronic messages.

97. (New) The computer-readable memory of claim 94, further stored electronic data structures representing executable instructions which, when executed, cause the wireless communication device to display on the graphical user interface for a predetermined period of time at least a preview of content associated with at least one of the received electronic messages.

98. (New) The computer-readable memory of claim 94, the at least one icon relating to electronic messaging being selectable to invoke an electronic messaging application.

99. (New) The computer-readable memory of claim 98, further stored electronic data structures representing executable instructions which, when executed, cause the wireless communication device to, responsive to invoking the electronic messaging application, navigate automatically to a graphical user interface comprising content associated with at least one of the received electronic messages.

100. (New) The computer-readable memory of claim 98, further stored electronic data structures representing executable instructions which, when executed, cause the

wireless communication device to, responsive to invoking the electronic messaging application within a predetermined time following receipt of at least one of the received electronic messages, navigate automatically to a graphical user interface comprising content associated with the at least one of the received electronic messages.

101. (New) The computer-readable memory of claim 98, further stored electronic data structures representing executable instructions which, when executed, cause the wireless communication device to, responsive to invoking the electronic messaging application, visually modify at least one icon relating to the electronic messaging application to include a decreased count of electronic messages which remain unread.

102. (New) The computer-readable memory of claim 98, further stored electronic data structures representing executable instructions which, when executed, cause the wireless communication device to, responsive to invoking the electronic messaging application, visually modify at least one icon relating to the electronic messaging application to remove the count of electronic messages which remain unread.

103. (New) A wireless communication device comprising

a processor;

a display electrically coupled to the processor, the display presenting a graphical user interface; and

a medium or media including machine-readable instructions executable by the processor to:

display on the graphical user interface at least one icon relating to an electronic messaging application;

receive on the wireless communication device a plurality of electronic messages associated with the electronic messaging application; and

responsive to receiving at least one of the plurality of electronic messages:

visually modify at least one icon relating to the electronic messaging application to include a count of the plurality of electronic messages which remain unread; and

display on the graphical user interface an identifier associated with a correspondent from whom the at least one of the plurality of electronic messages was received.

104. (New) The wireless communication device of claim 103, the identifier associated with a correspondent from whom the at least one of the plurality of electronic messages was received comprising state information pertaining to the correspondent.

105. (New) The wireless communication device of claim 103, the medium or media further comprising machine-readable instructions which, when executed, cause the wireless communication device to display on the graphical user interface at least a preview of content associated with at least one of the received electronic messages.

106. (New) The wireless communication device of claim 103, the medium or media further comprising machine-readable instructions which, when executed, cause the wireless communication device to display on the graphical user interface for a predetermined period of time at least a preview of content associated with at least one of the received electronic messages.

107. (New) The wireless communication device of claim 103, the at least one icon relating to electronic messaging being selectable to invoke an electronic messaging application.

108. (New) The wireless communication device of claim 107, the medium or media further comprising machine-readable instructions which, when executed, cause the wireless communication device to, responsive to invoking the electronic messaging application, navigate automatically to a graphical user interface comprising content associated with at least one of the received electronic messages.

109. (New) The wireless communication device of claim 107, the medium or media further comprising machine-readable instructions which, when executed, cause the wireless communication device to, responsive to invoking the electronic messaging application within a predetermined time following receipt of at least one of the received electronic messages, navigate automatically to a graphical user interface comprising content associated with the at least one of the received electronic messages.

110. (New) The wireless communication device of claim 107, the medium or media further comprising machine-readable instructions which, when executed, cause the wireless communication device to, responsive to invoking the electronic messaging application, visually modify at least one icon relating to the electronic messaging application to include a decreased count of electronic messages which remain unread.

111. (New) The wireless communication device of claim 107, the medium or media further comprising machine-readable instructions which, when executed, cause the wireless communication device to, responsive to invoking the electronic messaging

application, visually modify at least one icon relating to the electronic messaging application to remove the count of electronic messages which remain unread.

REMARKS**Amendment**

Prior to the amendment presented herein, claims 21 – 25, 28 – 34, and 37 – 51 were pending in the application. Claims 1 – 20, 26, 27, 35, and 36 were previously cancelled without prejudice.

By this Response new claims 52 – 111 are added. The Abstract and paragraphs [0002], [0036], [0043], [0049], and [0053] are amended. Claims 21 – 25, 28 – 34, and 37 – 51 are cancelled. Like claims 1 – 20, 26, 27, 35, and 36, they are cancelled without prejudice. Support for the amendment may be found throughout the specification as originally filed, including the Figures and the claims; and in particular at paragraphs [0025], [0036], [0040], [0042], and [0043] – [0052], and in Figures 6 – 8.

No new matter is added by the amendment.

Summary of Interview

Applicant thanks the Examiner for his time and insight during the interview conducted with Applicant's representatives Donna Flores and Matthew Marquardt in the Examiner's offices on 7 July 2010. Claims 21 and 52, and the Wagner (US 2004/0155908), Salmimaa (US 2002/0160817), Hirayama (US 2002/0035613), and Hellebust (2005/0248437) references were discussed. While no agreement on claims was reached, the Examiner agreed that Claim 52 substantially as presented herein would appear to patentably distinguish the art of record.

Disclaimer of Prior Statements and Amendments

The claims as presented herein may be broader in some respects than claims previously presented. Applicant intends that the claims as now pending be interpreted under the ordinary interpretation understood in the art. Accordingly Applicant expressly rescinds, and no longer intends that the claims be limited by, any and all assertions, statements, arguments, amendments or other actions previously made in this patent

application, and/or any application whose file history is available for use in interpreting any patent issuing on this application, that might be taken to be a surrender or disclaimer of any subject matter from the scope of any claim. No such assertion, statement, argument, amendment or other action in this application or in any such available application should be taken as a surrender or disclaimer from, and may not be used to interpret, any claim of this patent, or any claim of any patent to which such applications' file histories may be pertinent.

Applicant intends, and expressly requests, that the Application be presented and examined *de novo*. Accordingly, Applicant urges the Examiner to make a thorough and diligent search of the prior art with respect to each and every claim presented herein. Applicant requests that the Examiner reconsider any previous surrender, disclaimer or characterization of claims, and that he reconsider any prior art that may have been avoided or intended to be avoided by such surrender, disclaimer or characterization. To facilitate this request, Applicant submits with this amendment a new Form 1449 with all references previously applied in this application and in corresponding applications. Applicant requests that the 1449 be initialled to confirm that the references have been newly considered. In addition, a new search is requested.

Rejection under 35 USC § 112

At paragraph 2 of the Detailed Action the Examiner has rejected claim 21 under 35 USC 112 as failing to comply with the written description requirement. Claim 21 has hereby been cancelled without prejudice, and the rejection thereby rendered moot. Applicant respectfully requests reconsideration and withdrawal of the rejection.

Rejections under 35 USC § 103

At paragraph 5 of the Detailed Action the Examiner has rejected claims 21 – 25, 38 – 34, and 37 – 51 under 35 USC 103 as obvious over Wagner (US 2004/0155908) in view Hirayama (US 2002/0035613). Each of claims 21 – 25, 38 – 34, and 37 – 51 has hereby been cancelled without prejudice, and the rejection thereby rendered moot. Applicant respectfully requests reconsideration and withdrawal of the rejection.

With respect to Wagner, Applicant notes that it qualifies as prior art against the application herein, if at all, solely under 35 USC 102(e). While Applicant submits the claims as presented distinguish Wagner on their merits, Applicant respectfully and expressly reserves all right to establish prior invention in order to establish that Wagner is not valid prior art against this application or the claims presented herein.

CONCLUSION

Applicant believes that it has responded to each ground of rejection raised by the Examiner, and that for at least the reasons cited above the claims, as presented, are in condition for immediate allowance. Applicant respectfully requests reconsideration and immediate allowance of the claims.

Applicant has submitted herewith extra claim fees in view of the amendment made herein. Applicant believes that no further fees are due in connection with the filing of this paper, beyond those paid herewith. In the event that the office determines that any further fee is due, Appellant requests that such fee be charged to its Deposit Account No. 195113.

Applicant is concerned to advance this application as quickly as is reasonably possible. Accordingly, Applicant respectfully requests that, in the event the Examiner has any further questions about this application, the Examiner call Applicant's attorney at the number provided below.

Respectfully submitted,

Dated: 28 Sept 2018

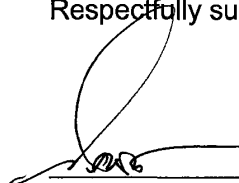

Matthew J. MARQUARDT
Reg. No. 40,997
Attorney for the Applicant
OGILVY RENAULT LLP

Royal Bank Plaza, South Tower
200 Bay Street, P.O. Box 84
Toronto, Ontario M5J 2Z4
CANADA
Tel. 416-216-4789
Fax 416-216-3930

Electronic Patent Application Fee Transmittal				
Application Number:	10784781			
Filing Date:	24-Feb-2004			
Title of Invention:	Previewing a new event on a small screen device			
First Named Inventor/Applicant Name:	Gerhard D. Klassen			
Filer:	Matthew J. Marquardt/Heidi Umstadt			
Attorney Docket Number:	05200204-272US			
Filed as Large Entity				
Utility under 35 USC 111(a) Filing Fees				
Description	Fee Code	Quantity	Amount	Sub-Total in USD(\$)
Basic Filing:				
Pages:				
Claims:				
Claims in excess of 20	1202	40	52	2080
Independent claims in excess of 3	1201	5	220	1100
Miscellaneous-Filing:				
Petition:				
Patent-Appeals-and-Interference:				
Post-Allowance-and-Post-Issuance:				

Description	Fee Code	Quantity	Amount	Sub-Total in USD(\$)
Extension-of-Time:				
Extension - 1 month with \$0 paid	1251	1	130	130
Miscellaneous:				
Request for continued examination	1801	1	810	810
Total in USD (\$)				4120

Electronic Acknowledgement Receipt	
EFS ID:	8106265
Application Number:	10784781
International Application Number:	
Confirmation Number:	2200
Title of Invention:	Previewing a new event on a small screen device
First Named Inventor/Applicant Name:	Gerhard D. Klassen
Customer Number:	20988
Filer:	Matthew J. Marquardt/Heidi Umstadt
Filer Authorized By:	Matthew J. Marquardt
Attorney Docket Number:	05200204-272US
Receipt Date:	28-JUL-2010
Filing Date:	24-FEB-2004
Time Stamp:	14:01:18
Application Type:	Utility under 35 USC 111(a)

Payment information:

Submitted with Payment	yes
Payment Type	Deposit Account
Payment was successfully received in RAM	\$4120
RAM confirmation Number	277
Deposit Account	195113
Authorized User	
The Director of the USPTO is hereby authorized to charge indicated fees and credit any overpayment as follows: Charge any Additional Fees required under 37 C.F.R. Section 1.17 (Patent application and reexamination processing fees)	

File Listing:					
Document Number	Document Description	File Name	File Size(Bytes)/ Message Digest	Multi Part /.zip	Pages (if appl.)
1	Abstract	Abstract.pdf	25420 22d92d3400b16db9a395cd807a1e2cd08354ff3	no	1
Warnings:					
Information:					
2	Extension of Time	sb0022.pdf	312350 50e85b2a009ef9220ac2050cb6562d3e92f0de96	no	2
Warnings:					
Information:					
3	Request for Continued Examination (RCE)	sb0030e_fill.pdf	797989 9be604c1b3d774e9c1c1ed9e076bdce9bbe046e2	no	3
Warnings:					
Information:					
4	Amendment After Final	Response.pdf	870455 e44ecc3ec75c847a3ebad95c75ada792b26362	no	24
Warnings:					
Information:					
5	Fee Worksheet (PTO-875)	fee-info.pdf	35001 6a2c007183b6288e10af5f8d20777b507578d973	no	2
Warnings:					
Information:					
Total Files Size (in bytes):			2041215		
<p>This Acknowledgement Receipt evidences receipt on the noted date by the USPTO of the indicated documents, characterized by the applicant, and including page counts, where applicable. It serves as evidence of receipt similar to a Post Card, as described in MPEP 503.</p> <p><u>New Applications Under 35 U.S.C. 111</u> If a new application is being filed and the application includes the necessary components for a filing date (see 37 CFR 1.53(b)-(d) and MPEP 506), a Filing Receipt (37 CFR 1.54) will be issued in due course and the date shown on this Acknowledgement Receipt will establish the filing date of the application.</p> <p><u>National Stage of an International Application under 35 U.S.C. 371</u> If a timely submission to enter the national stage of an international application is compliant with the conditions of 35 U.S.C. 371 and other applicable requirements a Form PCT/DO/EO/903 indicating acceptance of the application as a national stage submission under 35 U.S.C. 371 will be issued in addition to the Filing Receipt, in due course.</p> <p><u>New International Application Filed with the USPTO as a Receiving Office</u> If a new international application is being filed and the international application includes the necessary components for an international filing date (see PCT Article 11 and MPEP 1810), a Notification of the International Application Number and of the International Filing Date (Form PCT/RO/105) will be issued in due course, subject to prescriptions concerning national security, and the date shown on this Acknowledgement Receipt will establish the international filing date of the application.</p>					

ABSTRACT

Method and apparatus for previewing new events in a computing device having a plurality of applications for managing respective events are described. Individual applications are each represented by an application icon on a screen of a graphical user interface for the device. When a new event occurs, particularly when the new event relates to a specific one of a plurality of similar applications, the invention provides a convenient way to denote which application relates to the event. In response to a new event of a one of the applications, the application's icon is visually modified to notify of the new event. A visual modification may be determined in response to the new event, for example, to preview a content of the event. The visual modification may include a count of all new events that remain to be disposed. On a selection of the visually modified icon, additional previewing may be provided. Activation of the application having a visually modified application icon may be configured to automatically initiate the application at the new event.

Under the paperwork Reduction Act of 1995, no persons are required to respond to a collection of information unless it displays a valid OMB control number.

PETITION FOR EXTENSION OF TIME UNDER 37 CFR 1.136(a) FY 2009 <i>(Fees pursuant to the Consolidated Appropriations Act, 2005 (H.R. 4818).)</i>		Docket Number (Optional) 05200204-272US	
Application Number 10/784781		Filed 24 February 2004	
For PREVIEWING A NEW EVENT ON A SMALL SCREEN DEVICE			
Art Unit 2179		Examiner HEFFINGTON, John M.	
This is a request under the provisions of 37 CFR 1.136(a) to extend the period for filing a reply in the above identified application.			
The requested extension and fee are as follows (check time period desired and enter the appropriate fee below):			
		<u>Fee</u>	<u>Small Entity Fee</u>
<input checked="" type="checkbox"/>	One month (37 CFR 1.17(a)(1))	\$130	\$65 \$ <u>130.00</u>
<input type="checkbox"/>	Two months (37 CFR 1.17(a)(2))	\$490	\$245 \$ _____
<input type="checkbox"/>	Three months (37 CFR 1.17(a)(3))	\$1110	\$555 \$ _____
<input type="checkbox"/>	Four months (37 CFR 1.17(a)(4))	\$1730	\$865 \$ _____
<input type="checkbox"/>	Five months (37 CFR 1.17(a)(5))	\$2350	\$1175 \$ _____
<input type="checkbox"/>	Applicant claims small entity status. See 37 CFR 1.27.		
<input type="checkbox"/>	A check in the amount of the fee is enclosed.		
<input type="checkbox"/>	Payment by credit card. Form PTO-2038 is attached.		
<input checked="" type="checkbox"/>	The Director has already been authorized to charge fees in this application to a Deposit Account.		
<input type="checkbox"/>	The Director is hereby authorized to charge any fees which may be required, or credit any overpayment, to Deposit Account Number _____.		
WARNING: Information on this form may become public. Credit card information should not be included on this form. Provide credit card information and authorization on PTO-2038.			
I am the	<input type="checkbox"/>	applicant/inventor.	
	<input type="checkbox"/>	assignee of record of the entire interest. See 37 CFR 3.71. Statement under 37 CFR 3.73(b) is enclosed (Form PTO/SB/96).	
	<input type="checkbox"/>	attorney or agent of record. Registration Number _____	
	<input checked="" type="checkbox"/>	attorney or agent under 37 CFR 1.34. Registration number if acting under 37 CFR 1.34 <u>40997</u>	
<u>/MJM/</u>	_____	July 28, 2010	_____
	Signature		Date
<u>Matthew J. Marquardt</u>	_____	416-216-4789	_____
	Typed or printed name		Telephone Number
NOTE: Signatures of all the inventors or assignees of record of the entire interest or their representative(s) are required. Submit multiple forms if more than one signature is required, see below.			
<input checked="" type="checkbox"/>	Total of <u>1</u> forms are submitted.		

This collection of information is required by 37 CFR 1.136(a). The information is required to obtain or retain a benefit by the public which is to file (and by the USPTO to process) an application. Confidentiality is governed by 35 U.S.C. 122 and 37 CFR 1.11 and 1.14. This collection is estimated to take 6 minutes to complete, including gathering, preparing, and submitting the completed application form to the USPTO. Time will vary depending upon the individual case. Any comments on the amount of time you require to complete this form and/or suggestions for reducing this burden, should be sent to the Chief Information Officer, U.S. Patent and Trademark Office, U.S. Department of Commerce, P.O. Box 1450, Alexandria, VA 22313-1450. DO NOT SEND FEES OR COMPLETED FORMS TO THIS ADDRESS. **SEND TO: Commissioner for Patents, P.O. Box 1450, Alexandria, VA 22313-1450.**

If you need assistance in completing the form, call 1-800-PTO-9199 and select option 2.

Privacy Act Statement

The Privacy Act of 1974 (P.L. 93-579) requires that you be given certain information in connection with your submission of the attached form related to a patent application or patent. Accordingly, pursuant to the requirements of the Act, please be advised that: (1) the general authority for the collection of this information is 35 U.S.C. 2(b)(2); (2) furnishing of the information solicited is voluntary; and (3) the principal purpose for which the information is used by the U.S. Patent and Trademark Office is to process and/or examine your submission related to a patent application or patent. If you do not furnish the requested information, the U.S. Patent and Trademark Office may not be able to process and/or examine your submission, which may result in termination of proceedings or abandonment of the application or expiration of the patent.

The information provided by you in this form will be subject to the following routine uses:

1. The information on this form will be treated confidentially to the extent allowed under the Freedom of Information Act (5 U.S.C. 552) and the Privacy Act (5 U.S.C. 552a). Records from this system of records may be disclosed to the Department of Justice to determine whether disclosure of these records is required by the Freedom of Information Act.
2. A record from this system of records may be disclosed, as a routine use, in the course of presenting evidence to a court, magistrate, or administrative tribunal, including disclosures to opposing counsel in the course of settlement negotiations.
3. A record in this system of records may be disclosed, as a routine use, to a Member of Congress submitting a request involving an individual, to whom the record pertains, when the individual has requested assistance from the Member with respect to the subject matter of the record.
4. A record in this system of records may be disclosed, as a routine use, to a contractor of the Agency having need for the information in order to perform a contract. Recipients of information shall be required to comply with the requirements of the Privacy Act of 1974, as amended, pursuant to 5 U.S.C. 552a(m).
5. A record related to an International Application filed under the Patent Cooperation Treaty in this system of records may be disclosed, as a routine use, to the International Bureau of the World Intellectual Property Organization, pursuant to the Patent Cooperation Treaty.
6. A record in this system of records may be disclosed, as a routine use, to another federal agency for purposes of National Security review (35 U.S.C. 181) and for review pursuant to the Atomic Energy Act (42 U.S.C. 218(c)).
7. A record from this system of records may be disclosed, as a routine use, to the Administrator, General Services, or his/her designee, during an inspection of records conducted by GSA as part of that agency's responsibility to recommend improvements in records management practices and programs, under authority of 44 U.S.C. 2904 and 2906. Such disclosure shall be made in accordance with the GSA regulations governing inspection of records for this purpose, and any other relevant (i.e., GSA or Commerce) directive. Such disclosure shall not be used to make determinations about individuals.
8. A record from this system of records may be disclosed, as a routine use, to the public after either publication of the application pursuant to 35 U.S.C. 122(b) or issuance of a patent pursuant to 35 U.S.C. 151. Further, a record may be disclosed, subject to the limitations of 37 CFR 1.14, as a routine use, to the public if the record was filed in an application which became abandoned or in which the proceedings were terminated and which application is referenced by either a published application, an application open to public inspection or an issued patent.
9. A record from this system of records may be disclosed, as a routine use, to a Federal, State, or local law enforcement agency, if the USPTO becomes aware of a violation or potential violation of law or regulation.

Under the Paperwork Reduction Act of 1995, no persons are required to respond to a collection of information unless it displays a valid OMB control number.

PATENT APPLICATION FEE DETERMINATION RECORD Substitute for Form PTO-875				Application or Docket Number 10/784,781		Filing Date 02/24/2004		<input type="checkbox"/> To be Mailed							
APPLICATION AS FILED – PART I						OTHER THAN									
(Column 1)			(Column 2)			SMALL ENTITY <input type="checkbox"/>		OR		SMALL ENTITY					
FOR	NUMBER FILED	NUMBER EXTRA	RATE (\$)	FEE (\$)	OR	RATE (\$)	FEE (\$)								
<input type="checkbox"/> BASIC FEE <small>(37 CFR 1.16(a), (b), or (c))</small>	N/A	N/A	N/A			N/A									
<input type="checkbox"/> SEARCH FEE <small>(37 CFR 1.16(k), (l), or (m))</small>	N/A	N/A	N/A			N/A									
<input type="checkbox"/> EXAMINATION FEE <small>(37 CFR 1.16(o), (p), or (q))</small>	N/A	N/A	N/A			N/A									
TOTAL CLAIMS <small>(37 CFR 1.16(i))</small>	minus 20 =	*	X \$ =			X \$ =									
INDEPENDENT CLAIMS <small>(37 CFR 1.16(h))</small>	minus 3 =	*	X \$ =			X \$ =									
<input type="checkbox"/> APPLICATION SIZE FEE <small>(37 CFR 1.16(s))</small>	If the specification and drawings exceed 100 sheets of paper, the application size fee due is \$250 (\$125 for small entity) for each additional 50 sheets or fraction thereof. See 35 U.S.C. 41(a)(1)(G) and 37 CFR 1.16(s).														
<input type="checkbox"/> MULTIPLE DEPENDENT CLAIM PRESENT <small>(37 CFR 1.16(j))</small>															
* If the difference in column 1 is less than zero, enter "0" in column 2.															
APPLICATION AS AMENDED – PART II						OTHER THAN									
(Column 1)			(Column 2)			(Column 3)			SMALL ENTITY		OR		SMALL ENTITY		
AMENDMENT	07/28/2010	CLAIMS REMAINING AFTER AMENDMENT		HIGHEST NUMBER PREVIOUSLY PAID FOR	PRESENT EXTRA	RATE (\$)	ADDITIONAL FEE (\$)		RATE (\$)	ADDITIONAL FEE (\$)					
	Total <small>(37 CFR 1.16(i))</small>	* 60	Minus	** 29	= 31	X \$ =			OR	X \$52=	1612				
	Independent <small>(37 CFR 1.16(b))</small>	* 8	Minus	***3	= 5	X \$ =			OR	X \$220=	1100				
	<input type="checkbox"/> Application Size Fee <small>(37 CFR 1.16(s))</small>														
	<input type="checkbox"/> FIRST PRESENTATION OF MULTIPLE DEPENDENT CLAIM <small>(37 CFR 1.16(j))</small>														
						TOTAL ADD'L FEE			OR	TOTAL ADD'L FEE	2712				
AMENDMENT		CLAIMS REMAINING AFTER AMENDMENT		HIGHEST NUMBER PREVIOUSLY PAID FOR	PRESENT EXTRA	RATE (\$)	ADDITIONAL FEE (\$)		RATE (\$)	ADDITIONAL FEE (\$)					
	Total <small>(37 CFR 1.16(i))</small>	*	Minus	**	=	X \$ =			OR	X \$ =					
	Independent <small>(37 CFR 1.16(b))</small>	*	Minus	***	=	X \$ =			OR	X \$ =					
	<input type="checkbox"/> Application Size Fee <small>(37 CFR 1.16(s))</small>														
	<input type="checkbox"/> FIRST PRESENTATION OF MULTIPLE DEPENDENT CLAIM <small>(37 CFR 1.16(j))</small>														
						TOTAL ADD'L FEE			OR	TOTAL ADD'L FEE					
* If the entry in column 1 is less than the entry in column 2, write "0" in column 3.															
** If the "Highest Number Previously Paid For" IN THIS SPACE is less than 20, enter "20".															
*** If the "Highest Number Previously Paid For" IN THIS SPACE is less than 3, enter "3".															
The "Highest Number Previously Paid For" (Total or Independent) is the highest number found in the appropriate box in column 1.															

Legal Instrument Examiner:
/FREDERICK E. BRISCOE/

This collection of information is required by 37 CFR 1.16. The information is required to obtain or retain a benefit by the public which is to file (and by the USPTO to process) an application. Confidentiality is governed by 35 U.S.C. 122 and 37 CFR 1.14. This collection is estimated to take 12 minutes to complete, including gathering, preparing, and submitting the completed application form to the USPTO. Time will vary depending upon the individual case. Any comments on the amount of time you require to complete this form and/or suggestions for reducing this burden, should be sent to the Chief Information Officer, U.S. Patent and Trademark Office, U.S. Department of Commerce, P.O. Box 1450, Alexandria, VA 22313-1450. DO NOT SEND FEES OR COMPLETED FORMS TO THIS ADDRESS. **SEND TO: Commissioner for Patents, P.O. Box 1450, Alexandria, VA 22313-1450.**

If you need assistance in completing the form, call 1-800-PTO-9199 and select option 2.

INFORMATION DISCLOSURE STATEMENT BY APPLICANT (Not for submission under 37 CFR 1.99)	Application Number	10784781
	Filing Date	2004-02-24
	First Named Inventor	Gerhard D. Klassen
	Art Unit	2179
	Examiner Name	John M. Heffington
	Attorney Docket Number	05200204-272US

U.S.PATENTS							Remove
Examiner Initial*	Cite No	Patent Number	Kind Code ¹	Issue Date	Name of Patentee or Applicant of cited Document	Pages,Columns,Lines where Relevant Passages or Relevant Figures Appear	
	1	5617526	A	1997-04-01	ORAN, Daniel et al	column 5, paragraph 4, claims 1,2,6; figures 4,8,10	
	2	5333256	A	1994-07-26	GREEN, Emily et al	claim 1; figures 5, 6	
	3	6424354	B1	2002-07-23	WHITE, Christopher et al	claim 1, figure 12	
	4	6385459	B1	2002-05-07	LAWRENCE, Peter Robert et al	claim 9; figure 5	
	5	5634102	A	1997-05-27	CAPPS, Stephen P	claim 1, figure 4A	
	6	6628194	B1	2003-09-30	HELLEBUSTER et al		
If you wish to add additional U.S. Patent citation information please click the Add button.							Add
U.S.PATENT APPLICATION PUBLICATIONS							Remove
Examiner Initial*	Cite No	Publication Number	Kind Code ¹	Publication Date	Name of Patentee or Applicant of cited Document	Pages,Columns,Lines where Relevant Passages or Relevant Figures Appear	

INFORMATION DISCLOSURE STATEMENT BY APPLICANT (Not for submission under 37 CFR 1.99)	Application Number	10784781
	Filing Date	2004-02-24
	First Named Inventor	Gerhard D. Klassen
	Art Unit	2179
	Examiner Name	John M. Heffington
	Attorney Docket Number	05200204-272US

	1	20060020904		2006-01-26	AALTONEN, Antti et al	
	2	20050120306		2005-06-02	KLASSEN, GERHARD D. et al	
	3	20060030295		2005-02-02	ADAMS, Neil P. et al	
	4	20020160817	A1	2002-10-31	SALMIMAA et al	

If you wish to add additional U.S. Published Application citation information please click the Add button.

FOREIGN PATENT DOCUMENTS

Examiner Initial*	Cite No	Foreign Document Number ³	Country Code ² j	Kind Code ⁴	Publication Date	Name of Patentee or Applicant of cited Document	Pages, Columns, Lines where Relevant Passages or Relevant Figures Appear	T ⁵
	1	JP2003271277	JP		2003-09-26	AKITANE, Tsuchiya		<input type="checkbox"/>
	2	EP0943987	EP	A	1999-07-26	OCE TECH BV	claim 1, figure 3	<input type="checkbox"/>

If you wish to add additional Foreign Patent Document citation information please click the Add button.

NON-PATENT LITERATURE DOCUMENTS

Examiner Initials*	Cite No	Include name of the author (in CAPITAL LETTERS), title of the article (when appropriate), title of the item (book, magazine, journal, serial, symposium, catalog, etc), date, pages(s), volume-issue number(s), publisher, city and/or country where published.	T ⁵
	1	International Search Report and Written Opinion dated October 15, 2004, issued by the International Searching Authority for corresponding PCT Patent application no. PCT/CA2004/000263	<input type="checkbox"/>

INFORMATION DISCLOSURE STATEMENT BY APPLICANT (Not for submission under 37 CFR 1.99)	Application Number		10784781
	Filing Date		2004-02-24
	First Named Inventor	Gerhard D. Klassen	
	Art Unit		2179
	Examiner Name	John M. Heffington	
	Attorney Docket Number		05200204-272US

2	Notice Requesting Submission of Opinion / Results of Examination dated October 13, 2007, issued by the Korean Intellectual Property Office for corresponding Korean Patent Application No. 10-2006-7013025, along with Applicant's response to same.	<input type="checkbox"/>
3	Notice Requesting Submission of Opinion / Results of Examination dated April 10, 2008, issued by the Korean Intellectual Property Office, for corresponding Korean Patent Application No. 10-2006-7013025, along with Applicant's response to same.	<input type="checkbox"/>
4	Notice of Reasons for Rejection dated June 25, 2008, issued by the Japanese Patent Office for corresponding Japanese Patent Application No. 2006-541762, along with Applicant's response to same.	<input type="checkbox"/>
5	First Examination Report dated March 11, 2010, issued by the Government of Indian Patent Office for corresponding Indian Patent Application No. 3113/DELNP/2006.	<input type="checkbox"/>
6	First Office Action dated August 21, 2009, issued by the Chinese Patent Office for corresponding Chinese Patent Application No. 200810099973.X, , along with Applicant's response to same.	<input type="checkbox"/>
7	Second Office Action dated January 8, 2010, issued by the Chinese Patent Office for corresponding Chinese Patent Application No. 200810099973.X, along with Applicant's response to same.	<input type="checkbox"/>
8	First Office Action dated August 3, 2007, issued by the Chinese Patent Office for corresponding Chinese Patent Application No. 200480039930.2 , along with Applicant's response to same.	<input type="checkbox"/>
9	Examination Report dated July 27, 2009, issue by the Canadian Intellectual Property Office for corresponding Patent Application No. 2,548,598, along with Applicant's response to same.	<input type="checkbox"/>
10	Communication pursuant to Article 96(2) EPC dated October 12, 2006, issued by the European Patent Office for corresponding Patent Application No. 04713831.8, along with Applicant's response to same.	<input type="checkbox"/>
11	Communication pursuant to Article 94(3) EPC dated April 26, 2010, issued by the European Patent Office for corresponding Patent Application No. 08168419.3.	<input type="checkbox"/>
12	Extended European Search Report dated December 3, 2008, issued by the European Patent Office for corresponding Patent Application No. 08168419.3, along with Applicant's response to same.	<input type="checkbox"/>

INFORMATION DISCLOSURE STATEMENT BY APPLICANT (Not for submission under 37 CFR 1.99)	Application Number		10784781
	Filing Date		2004-02-24
	First Named Inventor	Gerhard D. Klassen	
	Art Unit		2179
	Examiner Name	John M. Heffington	
	Attorney Docket Number		05200204-272US

	13	Notice of Reasons for Rejection dated February 27, 2009, issued by the Japanese Patent Office for corresponding Japanese Patent Application No. 2006-541762, along with Applicant's response to same.	<input type="checkbox"/>
	14	Notice of Reasons for Rejection dated June 17, 2010, issued by the Japanese Patent Office for corresponding Japanese Patent Application No. 2006-541762.	<input type="checkbox"/>

If you wish to add additional non-patent literature document citation information please click the Add button

EXAMINER SIGNATURE

Examiner Signature	Date Considered
--------------------	-----------------

*EXAMINER: Initial if reference considered, whether or not citation is in conformance with MPEP 609. Draw line through a citation if not in conformance and not considered. Include copy of this form with next communication to applicant.

¹ See Kind Codes of USPTO Patent Documents at www.USPTO.GOV or MPEP 901.04. ² Enter office that issued the document, by the two-letter code (WIPO Standard ST.3). ³ For Japanese patent documents, the indication of the year of the reign of the Emperor must precede the serial number of the patent document. ⁴ Kind of document by the appropriate symbols as indicated on the document under WIPO Standard ST.16 if possible. ⁵ Applicant is to place a check mark here if English language translation is attached.

INFORMATION DISCLOSURE STATEMENT BY APPLICANT (Not for submission under 37 CFR 1.99)	Application Number	10784781
	Filing Date	2004-02-24
	First Named Inventor	Gerhard D. Klassen
	Art Unit	2179
	Examiner Name	John M. Heffington
	Attorney Docket Number	05200204-272US

CERTIFICATION STATEMENT

Please see 37 CFR 1.97 and 1.98 to make the appropriate selection(s):

That each item of information contained in the information disclosure statement was first cited in any communication from a foreign patent office in a counterpart foreign application not more than three months prior to the filing of the information disclosure statement. See 37 CFR 1.97(e)(1).

OR

That no item of information contained in the information disclosure statement was cited in a communication from a foreign patent office in a counterpart foreign application, and, to the knowledge of the person signing the certification after making reasonable inquiry, no item of information contained in the information disclosure statement was known to any individual designated in 37 CFR 1.56(c) more than three months prior to the filing of the information disclosure statement. See 37 CFR 1.97(e)(2).

See attached certification statement.

Fee set forth in 37 CFR 1.17 (p) has been submitted herewith.

None

SIGNATURE

A signature of the applicant or representative is required in accordance with CFR 1.33, 10.18. Please see CFR 1.4(d) for the form of the signature.

Signature	/Matthew MARQUARDT/	Date (YYYY-MM-DD)	2010-08-09
Name/Print	Matthew Marquardt	Registration Number	40997

This collection of information is required by 37 CFR 1.97 and 1.98. The information is required to obtain or retain a benefit by the public which is to file (and by the USPTO to process) an application. Confidentiality is governed by 35 U.S.C. 122 and 37 CFR 1.14. This collection is estimated to take 1 hour to complete, including gathering, preparing and submitting the completed application form to the USPTO. Time will vary depending upon the individual case. Any comments on the amount of time you require to complete this form and/or suggestions for reducing this burden, should be sent to the Chief Information Officer, U.S. Patent and Trademark Office, U.S. Department of Commerce, P.O. Box 1450, Alexandria, VA 22313-1450. **DO NOT SEND FEES OR COMPLETED FORMS TO THIS ADDRESS. SEND TO: Commissioner for Patents, P.O. Box 1450, Alexandria, VA 22313-1450.**

Privacy Act Statement

The Privacy Act of 1974 (P.L. 93-579) requires that you be given certain information in connection with your submission of the attached form related to a patent application or patent. Accordingly, pursuant to the requirements of the Act, please be advised that: (1) the general authority for the collection of this information is 35 U.S.C. 2(b)(2); (2) furnishing of the information solicited is voluntary; and (3) the principal purpose for which the information is used by the U.S. Patent and Trademark Office is to process and/or examine your submission related to a patent application or patent. If you do not furnish the requested information, the U.S. Patent and Trademark Office may not be able to process and/or examine your submission, which may result in termination of proceedings or abandonment of the application or expiration of the patent.

The information provided by you in this form will be subject to the following routine uses:

1. The information on this form will be treated confidentially to the extent allowed under the Freedom of Information Act (5 U.S.C. 552) and the Privacy Act (5 U.S.C. 552a). Records from this system of records may be disclosed to the Department of Justice to determine whether the Freedom of Information Act requires disclosure of these records.
2. A record from this system of records may be disclosed, as a routine use, in the course of presenting evidence to a court, magistrate, or administrative tribunal, including disclosures to opposing counsel in the course of settlement negotiations.
3. A record in this system of records may be disclosed, as a routine use, to a Member of Congress submitting a request involving an individual, to whom the record pertains, when the individual has requested assistance from the Member with respect to the subject matter of the record.
4. A record in this system of records may be disclosed, as a routine use, to a contractor of the Agency having need for the information in order to perform a contract. Recipients of information shall be required to comply with the requirements of the Privacy Act of 1974, as amended, pursuant to 5 U.S.C. 552a(m).
5. A record related to an International Application filed under the Patent Cooperation Treaty in this system of records may be disclosed, as a routine use, to the International Bureau of the World Intellectual Property Organization, pursuant to the Patent Cooperation Treaty.
6. A record in this system of records may be disclosed, as a routine use, to another federal agency for purposes of National Security review (35 U.S.C. 181) and for review pursuant to the Atomic Energy Act (42 U.S.C. 218(c)).
7. A record from this system of records may be disclosed, as a routine use, to the Administrator, General Services, or his/her designee, during an inspection of records conducted by GSA as part of that agency's responsibility to recommend improvements in records management practices and programs, under authority of 44 U.S.C. 2904 and 2906. Such disclosure shall be made in accordance with the GSA regulations governing inspection of records for this purpose, and any other relevant (i.e., GSA or Commerce) directive. Such disclosure shall not be used to make determinations about individuals.
8. A record from this system of records may be disclosed, as a routine use, to the public after either publication of the application pursuant to 35 U.S.C. 122(b) or issuance of a patent pursuant to 35 U.S.C. 151. Further, a record may be disclosed, subject to the limitations of 37 CFR 1.14, as a routine use, to the public if the record was filed in an application which became abandoned or in which the proceedings were terminated and which application is referenced by either a published application, an application open to public inspections or an issued patent.
9. A record from this system of records may be disclosed, as a routine use, to a Federal, State, or local law enforcement agency, if the USPTO becomes aware of a violation or potential violation of law or regulation.

IN THE UNITED STATES PATENT AND TRADEMARK OFFICE

Inventor(s) KLASSEN et al.
Serial No.: 10/784,781
Filed: 24 February 2004
Examiner: HEFFINGTON, John M.
Group Art Unit: 2179
Confirmation No.: 2200
Title: PREVIEWING A NEW EVENT ON A SMALL SCREEN DEVICE

VIA ELECTRONIC FILING

Commissioner for Patents
P.O. Box 1450
Alexandria, Virginia 22313-1450
U.S.A.

INFORMATION DISCLOSURE STATEMENT BY APPLICANT

The Applicant encloses the attached Information Disclosure Statement in connection with the above noted application.

In accordance with the Request for Continued Examination filed on July 28, 2010, no fee is enclosed with this submission.

Regards,

Respectfully submitted,

Dated: August 9, 2010

/Matthew MARQUARDT/
Matthew J. MARQUARDT
Reg. No. 40,997
Attorney for the Applicant

OGILVY RENAULT LLP
Royal Bank Plaza, South Tower
200 Bay Street, P.O. Box 84
Toronto, Ontario M5J 2Z4
CANADA
Tel. 416-216-4789
Fax 416-216-3930

Electronic Acknowledgement Receipt	
EFS ID:	8178748
Application Number:	10784781
International Application Number:	
Confirmation Number:	2200
Title of Invention:	Previewing a new event on a small screen device
First Named Inventor/Applicant Name:	Gerhard D. Klassen
Customer Number:	20988
Filer:	Matthew J. Marquardt/Nicole Farrugia
Filer Authorized By:	Matthew J. Marquardt
Attorney Docket Number:	05200204-272US
Receipt Date:	09-AUG-2010
Filing Date:	24-FEB-2004
Time Stamp:	14:19:01
Application Type:	Utility under 35 USC 111(a)

Payment information:

Submitted with Payment	no
------------------------	----

File Listing:

Document Number	Document Description	File Name	File Size(Bytes)/ Message Digest	Multi Part /.zip	Pages (if appl.)
1	Foreign Reference	JP_2003-271277.PDF	2162983 29206fd070de5741434396f117da8e91b7e108d8	no	38

Warnings:

Information:

2	Foreign Reference	EP0943987.PDF	710101	no	16
			21142ecaa8844fcc7e8e5f5960aa87bde53b3cff		
Warnings:					
Information:					
3	NPL Documents	KR_OA_and_response.pdf	1679889	no	46
			f2cc1872c5dae49330bce69a2ca824a04c9cd3a0		
Warnings:					
Information:					
4	NPL Documents	KR_secondOA_and_response.pdf	295228	no	10
			7aad65753bd3e3ba1e620401263b12c2e9c2		
Warnings:					
Information:					
5	NPL Documents	JP_OA_and_response.pdf	4030863	no	54
			ed9dde602352200bf33567ebb614ab4b11ee554b		
Warnings:					
Information:					
6	NPL Documents	JP_secondOA_and_response.pdf	608443	no	14
			0f9174a066d54a2f672bb76a75befd51a9b89103		
Warnings:					
Information:					
7	NPL Documents	JP_thirdOA_and_response.pdf	2842234	no	41
			a0be7481599ce508f3d4d2da4617770aa9502df6c		
Warnings:					
Information:					
8	NPL Documents	IN_OA_.PDF	174364	no	2
			c56da69e33aef16d78a2951b544093a91edf366		
Warnings:					
Information:					
9	NPL Documents	CN_OA_and_response.pdf	881352	no	17
			49a1d5840feeb7034eda55c73c506cfa061c851		
Warnings:					
Information:					
10	NPL Documents	CN1_OA_and_response.pdf	1048831	no	20
			1d2ff8624417a1f3a805f229f807a30adca48a3		
Warnings:					
Information:					

11	NPL Documents	CN1_secondOA_and_response.pdf	651020 a4c883c665fecc81587e9a5cd29098ee05260577	no	13
Warnings:					
Information:					
12	NPL Documents	CA_OA_and_response.pdf	667960 4481332c227014f798112b881d6b6159e4fea11	no	15
Warnings:					
Information:					
13	NPL Documents	EP_OA_and_response.pdf	610306 22a927026bcebb11b3ac4354ce254e7c99c88c8f	no	16
Warnings:					
Information:					
14	NPL Documents	EP1_OA_and_response.pdf	1120926 a892696b434201f295793fe0b8062c4c1eea6c8	no	24
Warnings:					
Information:					
15	NPL Documents	EP1_secondOA.pdf	462320 0204c7d3207fa7633d720831b62be9ec43f4b62	no	12
Warnings:					
Information:					
16	NPL Documents	PCT_ISR_WO.PDF	423992 b870a0d624969b61cd44ee3e8116046042123065	no	11
Warnings:					
Information:					
17	Information Disclosure Statement (IDS) Filed (SB/08)	IDS_Citation.PDF	613694 d0bd11539eea47d26be4cffe24bcd168e42bc89e	no	6
Warnings:					
Information:					
18	Transmittal Letter	IDS_Cover.pdf	58183 feee15e2db8d491ff041d0c824b4103e2b1c3831	no	1
Warnings:					
Information:					
Total Files Size (in bytes):			19042689		

This Acknowledgement Receipt evidences receipt on the noted date by the USPTO of the indicated documents, characterized by the applicant, and including page counts, where applicable. It serves as evidence of receipt similar to a Post Card, as described in MPEP 503.

New Applications Under 35 U.S.C. 111

If a new application is being filed and the application includes the necessary components for a filing date (see 37 CFR 1.53(b)-(d) and MPEP 506), a Filing Receipt (37 CFR 1.54) will be issued in due course and the date shown on this Acknowledgement Receipt will establish the filing date of the application.

National Stage of an International Application under 35 U.S.C. 371

If a timely submission to enter the national stage of an international application is compliant with the conditions of 35 U.S.C. 371 and other applicable requirements a Form PCT/DO/EO/903 indicating acceptance of the application as a national stage submission under 35 U.S.C. 371 will be issued in addition to the Filing Receipt, in due course.

New International Application Filed with the USPTO as a Receiving Office

If a new international application is being filed and the international application includes the necessary components for an international filing date (see PCT Article 11 and MPEP 1810), a Notification of the International Application Number and of the International Filing Date (Form PCT/RO/105) will be issued in due course, subject to prescriptions concerning national security, and the date shown on this Acknowledgement Receipt will establish the international filing date of the application.

(19) 日本国特許庁 (J P)

(12) 公開特許公報 (A)

(11) 特許出願公開番号
特開2003-271277
(P2003-271277A)

(43) 公開日 平成15年9月26日 (2003.9.26)

(51) Int.Cl. ⁷	識別記号	F I	テーマコード(参考)
G 0 6 F 3/00	6 5 4	G 0 6 F 3/00	6 5 4 A 5 E 5 0 1

審査請求 未請求 請求項の数18 O L (全 38 頁)

(21) 出願番号 特願2002-66974(P2002-66974)

(22) 出願日 平成14年3月12日 (2002.3.12)

(71) 出願人 000002185
ソニー株式会社
東京都品川区北品川6丁目7番35号

(72) 発明者 土屋 昇胤
東京都品川区北品川6丁目7番35号 ソニ
ー株式会社内

(74) 代理人 100110434
弁理士 佐藤 勝

Fターム(参考) 5E501 AA02 AB19 BA05 CA03 CB02
CB09 EA10 FA03 FA13 FA43

(54) 【発明の名称】 情報処理装置及び情報入力方法

(57) 【要約】

【課題】 情報の入力対象が複数設定されている場合に、円滑に連続して入力操作を行う。

【解決手段】 表示画面上に、テキスト入力領域1と、第1及び第2のチャット内容表示領域2、3と、これら第1及び第2のチャット内容表示領域2、3のいずれに対してテキストを入力するかを選択するための第1乃至第3の入力先選択ボタン4、5、6を表示する。テキスト入力領域1にテキストが入力された状態の下で各入力先選択ボタンが選択された場合には、選択された入力先選択ボタンに対応したチャット内容表示領域にテキストの入力(書き込む)を行う。テキスト入力領域1にテキストが入力されていない状態の下で各入力先選択ボタンが選択された場合には、当該入力先選択ボタンを選択継続状態とする。

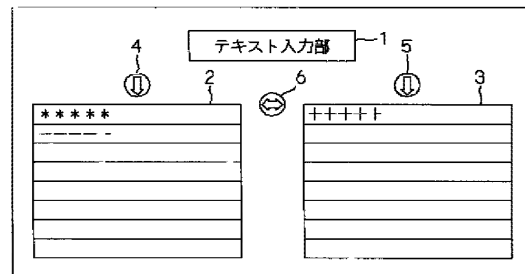

【特許請求の範囲】

【請求項1】 ユーザによりボタン選択操作及び情報入力操作が行われる操作手段と、

上記操作手段により入力された情報を一時記憶する一時記憶領域と、上記操作手段により入力された情報の格納対象となる複数の情報記憶領域とが設定された記憶手段と、

上記複数の情報記憶領域にそれぞれ対応した複数の入力先選択ボタンを表示装置の表示画面に表示する表示制御手段と、

上記一時記憶領域に対して情報が入力された状態の下で上記入力先選択ボタンが選択された場合に、当該入力先選択ボタンに対応した情報記憶領域に対して当該情報を格納した後に上記一時記憶領域の記憶内容を初期化するとともに、上記一時記憶領域に対して情報が入力されていない状態の下で上記入力先選択ボタンが選択された場合に、当該入力先選択ボタンを選択継続状態として、これ以降入力された情報を当該入力先選択ボタンに対応した情報記憶領域に対して格納する制御手段とを備えることを特徴とする情報処理装置。

【請求項2】 上記制御手段は、上記一時記憶領域に対して情報が入力されていない状態の下で、選択継続状態とされた入力先選択ボタンが選択された場合に、当該入力先選択ボタンの選択継続状態を解除することを特徴とする請求項1記載の情報処理装置。

【請求項3】 上記制御手段は、上記一時記憶領域に対して情報が入力されておらず、且つ選択継続状態とされた入力先選択ボタンが存在する状態の下で、他の入力先選択ボタンが選択された場合に、選択継続状態とされた入力先選択ボタンの選択継続状態を解除し、選択された入力先選択ボタンを選択継続状態とすることを特徴とする請求項1記載の情報処理装置。

【請求項4】 上記制御手段は、上記一時記憶領域に対して情報が入力されており、且つ選択継続状態とされた入力先選択ボタンが存在する状態の下で、他の入力先選択ボタンが選択された場合に、選択された入力先選択ボタンに対応した情報記憶領域に対して当該情報を格納した後に上記一時記憶領域の記憶内容を初期化し、元の入力先選択ボタンの選択継続状態を維持することを特徴とする請求項1記載の情報処理装置。

【請求項5】 上記制御手段は、上記一時記憶領域に対して情報が入力されており、且つ選択継続状態とされた入力先選択ボタンが存在する状態の下で、他の入力先選択ボタンが選択された場合に、選択された入力先選択ボタンに対応した情報記憶領域に対して当該情報を格納した後に上記一時記憶領域の記憶内容を初期化し、元の入力先選択ボタンの選択継続状態を解除して、選択された入力先選択ボタンを選択継続状態とすることを特徴とする請求項1記載の情報処理装置。

【請求項6】 上記表示制御手段は、上記一時記憶領域

に対して入力された情報の内容を表示する情報入力領域を表示装置の表示画面に表示することを特徴とする請求項1記載の情報処理装置。

【請求項7】 上記表示制御手段は、上記複数の情報記憶領域に格納された情報の内容をそれぞれ表示する複数の情報表示領域を表示装置の表示画面に表示することを特徴とする請求項1記載の情報処理装置。

【請求項8】 上記表示制御手段は、上記入力先選択ボタンと同等の機能を有し、上記複数の情報記憶領域のうちから選択された少なくとも2つの情報記憶領域に対して一度に情報を格納するための複数入力先選択ボタンを表示装置の表示画面に表示することを特徴とする請求項1記載の情報処理装置。

【請求項9】 情報処理装置を用いて情報を入力するに際して、

ユーザにより入力された情報を一時記憶する一時記憶領域と、ユーザにより入力された情報の格納対象となる複数の情報記憶領域とを設定する記憶領域設定ステップと、

上記複数の情報記憶領域にそれぞれ対応した複数の入力先選択ボタンを表示装置の表示画面に表示するボタン表示ステップと、

上記一時記憶領域に対して情報が入力された状態の下で上記入力先選択ボタンが選択された場合に、当該入力先選択ボタンに対応した情報記憶領域に対して当該情報を格納した後に上記一時記憶領域の記憶内容を初期化する第1の情報格納ステップと、

上記一時記憶領域に対して情報が入力されていない状態の下で上記入力先選択ボタンが選択された場合に、当該入力先選択ボタンを選択継続状態として、これ以降入力された情報を当該入力先選択ボタンに対応した情報記憶領域に対して格納する第2の情報格納ステップとを有することを特徴とする情報入力方法。

【請求項10】 上記一時記憶領域に対して情報が入力されていない状態の下で、選択継続状態とされた入力先選択ボタンが選択された場合に、当該入力先選択ボタンの選択継続状態を解除する選択状態解除ステップをさらに有することを特徴とする請求項9記載の情報入力方法。

【請求項11】 上記一時記憶領域に対して情報が入力されておらず、且つ選択継続状態とされた入力先選択ボタンが存在する状態の下で、他の入力先選択ボタンが選択された場合に、選択継続状態とされた入力先選択ボタンの選択継続状態を解除し、選択された入力先選択ボタンを選択継続状態とする選択ボタン切替ステップをさらに有することを特徴とする請求項9記載の情報入力方法。

【請求項12】 上記一時記憶領域に対して情報が入力されており、且つ選択継続状態とされた入力先選択ボタンが存在する状態の下で、他の入力先選択ボタンが選択

された場合に、選択された入力先選択ボタンに対応した情報記憶領域に対して当該情報を格納した後に上記一時記憶領域の記憶内容を初期化し、元の入力先選択ボタンの選択継続状態を維持する第3の情報格納ステップをさらに有することを特徴とする請求項9記載の情報入力方法。

【請求項13】 上記一時記憶領域に対して情報が入力されており、且つ選択継続状態とされた入力先選択ボタンが存在する状態の下で、他の入力先選択ボタンが選択された場合に、選択された入力先選択ボタンに対応した情報記憶領域に対して当該情報を格納した後に上記一時記憶領域の記憶内容を初期化し、元の入力先選択ボタンの選択継続状態を解除して、選択された入力先選択ボタンを選択継続状態とする第4の情報格納ステップをさらに有することを特徴とする請求項9記載の情報入力方法。

【請求項14】 上記一時記憶領域に対して入力された情報の内容を表示する情報入力領域を表示装置の表示画面に表示する入力領域表示ステップをさらに有することを特徴とする請求項9記載の情報入力方法。

【請求項15】 上記複数の情報記憶領域に格納された情報の内容をそれぞれ表示する複数の情報表示領域を表示装置の表示画面に表示する表示領域表示ステップをさらに有することを特徴とする請求項9記載の情報入力方法。

【請求項16】 上記ボタン表示ステップにおいては、上記入力先選択ボタンと同等の機能を有し、上記複数の情報記憶領域のうちから選択された少なくとも2つの情報記憶領域に対して一度に情報を格納するための複数入力先選択ボタンをさらに表示することを特徴とする請求項9記載の情報入力方法。

【請求項17】 情報処理装置を用いて情報を入力するための情報入力プログラムにおいて、上記情報処理装置に対して、ユーザにより入力された情報を一時記憶する一時記憶領域と、ユーザにより入力された情報の格納対象となる複数の情報記憶領域とを設定する記憶領域設定処理と、上記複数の情報記憶領域にそれぞれ対応した複数の入力先選択ボタンを表示装置の表示画面に表示するボタン表示処理と、

上記一時記憶領域に対して情報が入力された状態の下で上記入力先選択ボタンが選択された場合に、当該入力先選択ボタンに対応した情報記憶領域に対して当該情報を格納した後に上記一時記憶領域の記憶内容を初期化する第1の情報格納処理と、

上記一時記憶領域に対して情報が入力されていない状態の下で上記入力先選択ボタンが選択された場合に、当該入力先選択ボタンを選択継続状態として、これ以降入力された情報を当該入力先選択ボタンに対応した情報記憶領域に対して格納する第2の情報格納処理とをを実行さ

せることを特徴とする情報入力プログラム。

【請求項18】 情報処理装置を用いて情報を入力するための情報入力プログラムが記録された記録媒体において、

上記情報処理装置に対して、

ユーザにより入力された情報を一時記憶する一時記憶領域と、ユーザにより入力された情報の格納対象となる複数の情報記憶領域とを設定する記憶領域設定処理と、上記複数の情報記憶領域にそれぞれ対応した複数の入力先選択ボタンを表示装置の表示画面に表示するボタン表示処理と、

上記一時記憶領域に対して情報が入力された状態の下で上記入力先選択ボタンが選択された場合に、当該入力先選択ボタンに対応した情報記憶領域に対して当該情報を格納した後に上記一時記憶領域の記憶内容を初期化する第1の情報格納処理と、

上記一時記憶領域に対して情報が入力されていない状態の下で上記入力先選択ボタンが選択された場合に、当該入力先選択ボタンを選択継続状態として、これ以降入力された情報を当該入力先選択ボタンに対応した情報記憶領域に対して格納する第2の情報格納処理とをを実行させることを特徴とする情報入力プログラムが記録された記録媒体。

【発明の詳細な説明】

【0001】

【発明の属する技術分野】本発明は、情報の格納対象とされた複数の情報記憶領域に対して情報を円滑に入力するための情報処理装置、情報入力方法、情報入力プログラム、並びに情報入力プログラムが記録された記録媒体に関する。

【0002】

【従来の技術】従来から、例えばコンピュータ装置、PDA (Personal Digital Assistant) 機器、或いは携帯型電話機などの情報処理装置においては、様々な場面でテキスト（文字列）を入力する操作が要求されている。

【0003】また、近年では、多数の情報処理装置が接続されたコンピュータネットワークとして、いわゆるインターネット (The Internet) が広く普及しており、相互に接続された情報処理装置の間で様々な情報を自在に送受信する環境が整備されつつある。そして、このインターネットを利用してユーザ同士の間で意思や感情の伝達を行うシステムとして、いわゆる掲示板システムやチャットシステムなどが存在する。このような掲示板システムやチャットシステムを利用するに際しても、テキストの入力操作を行う機会が多い。

【0004】従来から、情報処理装置を用いてテキストの入力操作を行うに際しては、矩形の入力領域が表示画面に表示され、この入力領域を選択した状態で、例えばキーボードやスタイラスペン等を用いてテキストを入力した後に、例えばキーボードの確定キーを押下すること

によって入力したテキストの確定操作が行われる。また、例えば、入力領域に対応付けされた確定ボタンを表示画面に表示し、入力領域内にテキストが入力された状態で確定ボタンを選択することによって確定操作が行われる入力方式も広く採用されている。

【0005】

【発明が解決しようとする課題】ところで、従来から用いられているテキストの入力方式においては、複数の入力領域が存在する場合に、入力対象とする入力領域をテキストを入力する度に選択操作することが必要とされる。この選択操作としては、例えば、キーボードの矢印キーやタブ (TAB) キー等を用いて入力対象とする入力領域を順次ハイライト表示させたり、或いは、マウス装置を用いてマウスマウスカーソルを入力対象とする入力領域に移動させた後にクリック操作すること等によって行われる。したがって、複数の入力領域に対してテキストの入力操作を行うに際しては、甚だ煩雑な操作が要求されるという問題があった。

【0006】また、例えば、インターネットを利用した掲示板システムやチャットシステムにおいては、一般に、書き込み内容や発言内容となるテキストを入力するテキスト入力領域と、書き込み内容や発言内容が表示されるテキスト表示領域と、テキスト入力領域に入力されたテキストを確定して実際の書き込み内容や発言内容として反映させるための確定ボタン (送信ボタン) とがひと組に構成されている。

【0007】したがって、例えば書き込み対象 (或いは発言対象) としてのテキスト表示領域が複数設定されている場合には、各テキスト表示領域に対応して、それぞれテキスト入力領域と確定ボタンとを用意する必要があった。このため、同様な機能を有するテキスト入力領域や確定ボタンが画面上に複数表示されることとなり、表示画面の美観を損ねてユーザに煩雑な印象を与えてしまうといった問題が生じる。また、テキストを入力する毎に確定ボタンを選択する必要が生じ、例えばキーボードとマウス装置とを持ち替える頻度が高くなるなどして、操作性が悪い。

【0008】そこで、本発明は、上述した従来の実情に鑑みてなされたものであり、入力された情報の格納対象が複数設定されている場合であっても、自然な操作で円滑に且つ連続的に情報の入力操作を行なうことが可能な情報処理装置、情報入力方法、情報入力プログラム、並びに情報入力プログラムが記録された記録媒体を提供することを目的とする。

【0009】

【課題を解決するための手段】本発明の請求項1に係る情報処理装置は、ユーザによりボタン選択操作及び情報入力操作が行われる操作手段と、上記操作手段により入力された情報を一時記憶する一時記憶領域と、上記操作手段により入力された情報の格納対象となる複数の情報

記憶領域とが設定された記憶手段と、上記複数の情報記憶領域にそれぞれ対応した複数の入力先選択ボタンを表示装置の表示画面に表示する表示制御手段と、上記一時記憶領域に対して情報が入力された状態の下で上記入力先選択ボタンが選択された場合に、当該入力先選択ボタンに対応した情報記憶領域に対して当該情報を格納した後に上記一時記憶領域の記憶内容を初期化するとともに、上記一時記憶領域に対して情報が入力されていない状態の下で上記入力先選択ボタンが選択された場合に、当該入力先選択ボタンを選択継続状態として、これ以降入力された情報を当該入力先選択ボタンに対応した情報記憶領域に対して格納する制御手段とを備える。

【0010】また、本発明の請求項9に係る情報入力方法は、情報処理装置を用いて情報を入力するに際して、ユーザにより入力された情報を一時記憶する一時記憶領域と、ユーザにより入力された情報の格納対象となる複数の情報記憶領域とを設定する記憶領域設定ステップと、上記複数の情報記憶領域にそれぞれ対応した複数の入力先選択ボタンを表示装置の表示画面に表示するボタン表示ステップと、上記一時記憶領域に対して情報が入力された状態の下で上記入力先選択ボタンが選択された場合に、当該入力先選択ボタンに対応した情報記憶領域に対して当該情報を格納した後に上記一時記憶領域の記憶内容を初期化する第1の情報格納ステップと、上記一時記憶領域に対して情報が入力されていない状態の下で上記入力先選択ボタンが選択された場合に、当該入力先選択ボタンを選択継続状態として、これ以降入力された情報を当該入力先選択ボタンに対応した情報記憶領域に対して格納する第2の情報格納ステップとを有する。

【0011】さらに、本発明の請求項17に係る情報入力プログラムは、情報処理装置を用いて情報を入力するための情報入力プログラムにおいて、上記情報処理装置に対して、ユーザにより入力された情報を一時記憶する一時記憶領域と、ユーザにより入力された情報の格納対象となる複数の情報記憶領域とを設定する記憶領域設定処理と、上記複数の情報記憶領域にそれぞれ対応した複数の入力先選択ボタンを表示装置の表示画面に表示するボタン表示処理と、上記一時記憶領域に対して情報が入力された状態の下で上記入力先選択ボタンが選択された場合に、当該入力先選択ボタンに対応した情報記憶領域に対して当該情報を格納した後に上記一時記憶領域の記憶内容を初期化する第1の情報格納処理と、上記一時記憶領域に対して情報が入力されていない状態の下で上記入力先選択ボタンが選択された場合に、当該入力先選択ボタンを選択継続状態として、これ以降入力された情報を当該入力先選択ボタンに対応した情報記憶領域に対して格納する第2の情報格納処理とを有する。

【0012】さらにまた、本発明の請求項18に係る情報入力プログラムが記録された記録媒体は、情報処理装置を用いて情報を入力するための情報入力プログラムが

記録された記録媒体において、上記情報処理装置に対して、ユーザにより入力された情報を一時記憶する一時記憶領域と、ユーザにより入力された情報の格納対象となる複数の情報記憶領域とを設定する記憶領域設定処理と、上記複数の情報記憶領域にそれぞれ対応した複数の入力先選択ボタンを表示装置の表示画面に表示するボタン表示処理と、上記一時記憶領域に対して情報が入力された状態の下で上記入力先選択ボタンが選択された場合に、当該入力先選択ボタンに対応した情報記憶領域に対して当該情報を格納した後に上記一時記憶領域の記憶内容を初期化する第1の情報格納処理と、上記一時記憶領域に対して情報が入力されていない状態の下で上記入力先選択ボタンが選択された場合に、当該入力先選択ボタンを選択継続状態として、これ以降入力された情報を当該入力先選択ボタンに対応した情報記憶領域に対して格納する第2の情報格納処理とをを実行させることを特徴とする情報入力プログラムが記録されている。

【0013】以上のように構成された本発明によれば、一時記憶領域に対して情報が入力された下でいずれかの入力先選択ボタンを選択することによって、選択された入力先選択ボタンに対応した情報記憶領域に当該情報が格納される。また、一時記憶領域に対して情報が入力されていない状態の下で入力先選択ボタンが選択された場合には、この入力先選択ボタンが選択継続状態となり、これ以降入力された情報が当該入力先選択ボタンに対応した情報記憶領域に対して格納されることとなる。

【0014】このため、入力先選択ボタンを選択継続状態とすることによって、以降のボタン選択操作を行う必要なく、所定の一時記憶領域に対して連続して情報を入力することができる。また、一時記憶領域に対して情報を入力した状態の下では、入力先選択ボタンを選択するという極めて簡便な操作のみで、任意の情報記録領域に対して情報を格納することができる。

【0015】なお、選択継続状態を解除するに際しては、上記一時記憶領域に対して情報が入力されていない状態の下で、選択継続状態とされた入力先選択ボタンが選択された場合に行うとすればよい。これにより、入力先選択ボタンの選択継続状態のオン/オフ切替を、自然な操作感覚で実現することができる。

【0016】また、上記一時記憶領域に対して情報が入力されておらず、且つ選択継続状態とされた入力先選択ボタンが存在する状態の下で、他の入力先選択ボタンが選択された場合には、選択継続状態とされた入力先選択ボタンの選択継続状態を解除し、選択された入力先選択ボタンを選択継続状態とするとともに、選択された入力先選択ボタンに対応した情報記憶領域に対して当該情報を格納した後に上記一時記憶領域の記憶内容を初期化し、元の入力先選択ボタンの選択継続状態を維持するとともによい。すなわち、この場合には、選択された入力先選択ボタンに対応した情報記憶領域を情報の入力

対象として一時的に切り替えてもよいし、選択された入力先選択ボタンを選択継続状態として、当該入力先選択ボタンに対応した情報記憶領域を新たな入力対象として切り替えるとしてもよい。

【0017】さらに、上記一時記憶領域に対して入力された情報の内容を表示する情報入力領域を表示装置の表示画面に表示するとともによい。この場合であっても、情報を入力するという機能を有する情報入力領域を唯一用意することで複数の情報記録領域に対する入力操作を行うことができる。このため、入力領域と表示領域と確定ボタンとが一組とされた従来の入力方式を用いて複数の入力対象に対して情報の入力操作を行う場合と比較して、画面上の構成物を減らすことができる。したがって、表示画面の美観が向上し、ユーザに対して煩雑な印象を与えることがない。

【0018】また、上記複数の情報記憶領域に格納された情報の内容をそれぞれ表示する複数の情報表示領域を表示装置の表示画面に表示するとともによい。これにより、各情報記憶領域にどのような情報が入力されたかをユーザに対して明示的に逐次示すことができる。これにより、どの情報記憶領域に対して情報を入力するかというユーザの選択を促すことができる。

【0019】

【発明の実施の形態】以下、本発明の実施の形態について、図面を参照しながら詳細に説明する。

【0020】(1) 本発明の基本的な構成

まず、本発明の最も基本的な構成について、図1に示す画面例を参照しながら説明する。図1は、コンピュータネットワークを介して複数のコンピュータ装置が接続されたシステムにおいて、各コンピュータ装置のユーザ（利用者）間でテキスト（文字列）を授受することにより意思や感情の伝達（コミュニケーション）を行うチャットシステムに本発明を適用した場合に、各コンピュータ装置の表示画面上に表示される内容、すなわちグラフィカル・ユーザ・インターフェース（GUI: Graphical User Interface）の一例を示すものである。

【0021】図1に示す例においては、表示画面内の上部に矩形のテキスト入力領域1が設定され、このテキスト入力領域1の下部に第1のチャット内容表示領域2と第2のチャット内容表示領域3とが左右に並んで設定されている。また、第1のチャット内容表示領域2の上部に、この第1のチャット内容表示領域2に対してテキストを入力することを選択するための第1の入力先選択ボタン4が表示され、第2のチャット内容表示領域3の上部に、この第2のチャット内容表示領域3に対してテキストを入力することを選択するための第2の入力先選択ボタン5が表示されている。さらに、第1の入力先選択ボタン4と第2の入力先選択ボタン5との中間位置に、第1のチャット内容表示領域2及び第2のチャット内容表示領域3との双方にテキストを入力することを選択す

るための第3の入力先選択ボタン6が表示されている。

【0022】テキスト入力領域1は、コンピュータ装置に備えられたキーボード等の入力デバイスを用いて、ユーザにより入力されたテキストが表示される。ここで、ユーザにより入力されたテキストは、コンピュータ装置に備えられたRAM(Random Access Memory)等の記憶デバイスに一時記憶される。コンピュータ装置は、テキスト入力領域1に対して入力されたテキストを一時記憶する記憶領域(入力バッファ)が予め記憶デバイス内に確保されており、この入力バッファに蓄積された入力内容をテキスト入力領域1に表示する。すなわち、ユーザの観点では、キーボード等により入力したテキストがテキスト入力領域1に表示されることとなるが、実際には、入力されたテキストは入力バッファに一時記憶され、この入力バッファの記憶内容がテキスト入力領域1に表示されていることとなる。

【0023】本例においては、入力内容を確認しながらユーザがテキストの入力操作を行うことを可能とする目的でテキスト入力領域1を表示しているが、このテキスト入力領域1は非表示であってもよい。

【0024】第1のチャット内容表示領域2及び第2のチャット内容表示領域3は、チャットシステムに接続されたコンピュータ装置の間で送受信されたテキスト、すなわち各コンピュータ装置のユーザが入力したテキスト(チャット内容)が表示される領域である。ここで、各ユーザ間で送受信されるチャット内容は、コンピュータ装置に備えられたRAM(Random Access Memory)やハードディスク装置等の記憶デバイスに一時記憶される。コンピュータ装置は、第1のチャット内容表示領域2及び第2のチャット内容表示領域3のそれぞれに対応して、チャット内容を記憶するテキスト記憶領域が予め記憶デバイス内に所定のアドレス空間として或いはファイルとして確保されており、これらテキスト記憶領域に蓄積された内容をそれぞれ第1のチャット内容表示領域2及び第2のチャット内容表示領域3に表示する。

【0025】本例においては、チャット内容を確認しながらチャットに参加し、いずれのテキスト記憶領域に対してテキストを入力するかというユーザによる選択を容易とする目的で、これらテキスト記憶領域の内容をそれぞれ示す第1のチャット内容表示領域2及び第2のチャット内容表示領域3を表示しているが、これらは非表示とされていてもよい。

【0026】第1の入力先選択ボタン4及び第2の入力先選択ボタン5は、それぞれ、テキスト入力領域1に入力されたテキストを、第1のチャット内容表示領域2及び第2のチャット内容表示領域3に書き込む場合に選択されるボタンである。また、第3の入力先選択ボタン6は、テキスト入力領域1に入力されたテキストを、第1のチャット内容表示領域2及び第2のチャット内容表示領域3の双方に対して同時に書き込む場合に選択される

ボタンである。すなわち、第1乃至第3の入力先選択ボタン5は、テキスト入力領域1に入力されたテキストを、第1のチャット内容表示領域2と第2のチャット内容表示領域3とのいずれに入力する(書き込む)かを選択するボタン、入力対象を選択するためのボタンとして構成されている。

【0027】これら各入力先選択ボタンを選択するに際しては、例えば、ユーザがコンピュータ装置に接続されたマウス装置を操作することによって、画面上に表示されるマウスカーソルが各入力先選択ボタン上に移動操作され、マウス装置をクリック操作することなどによって行われる。

【0028】ここで、第1乃至第3の入力先選択ボタン4、5、6の各入力先選択ボタンは、図2に示すように、ユーザによる操作に応じてそれぞれ3つの状態を遷移する。すなわち各入力先選択ボタンは、ユーザによって選択操作されていない状態である未選択状態N1と、ユーザによって選択操作されたときの状態である選択状態N2と、選択が継続された状態である選択継続状態N3との3つの状態を遷移する。以下では、各入力先選択ボタンの状態遷移について説明する。

【0029】第1乃至第3の入力先選択ボタン4、5、6の各入力先選択ボタンは、それぞれ初期状態として未選択状態N1が設定されている。この未選択状態N1において、テキスト入力領域1内にテキストが入力されている場合、すなわち入力バッファにテキストが一時記憶されている場合に、ユーザによって選択操作されると、選択された入力先選択ボタンは図2中矢印A1で示すように状態が遷移して選択状態N2となる。

【0030】これにより、テキスト入力領域1に入力されたテキストが選択されたボタンに対応したチャット内容表示領域に対して書き込まれ、テキスト入力領域1が初期化されて内容が空となる。すなわち、このとき、入力バッファに蓄積されたテキストが入力対象として選択されたチャット内容表示領域に対応したテキスト記憶領域に転写されるとともに、入力バッファがクリアされる。

【0031】上述のようにして、テキスト入力領域1に入力されたテキストが所定のチャット内容表示領域に書き込まれた後に、選択状態N2とされた入力先選択ボタンは、図中矢印A2で示すように状態が遷移して未選択状態N1に戻る。

【0032】また、第1乃至第3の入力先選択ボタン4、5、6の各入力先選択ボタンは、未選択状態N1において、テキスト入力領域1内にテキストが入力されていない場合にユーザによって選択操作されると、選択された入力先選択ボタンは図中矢印A3で示すように状態が遷移して選択継続状態N3となる。第1乃至第3の入力先選択ボタン4、5、6のうちいずれかの入力先選択ボタンが選択継続状態N3に遷移すると、この選択継続

状態N3とされた入力先選択ボタンに対応したチャット内容表示領域が、入力対象として継続的に選択された状態となり、テキスト入力領域1に対して入力されたテキストが逐次、このチャット内容表示領域に対して書き込まれることとなる。これにより、入力先選択ボタンの選択操作を行うことなく、入力対象として選択されたチャット内容表示領域に対して連続してテキストを書き込むことが可能となる。

【0033】また、第1乃至第3の入力先選択ボタン4, 5, 6のうちいずれかの入力先選択ボタンが選択継続状態N3とされているときに、テキスト入力領域1内にテキストが入力されておらず、且つ他の入力先選択ボタンが選択された場合、又は、選択継続状態N3とされた入力先選択ボタンがユーザにより選択された場合には、当該入力先選択ボタンは図中矢印A4で示すように状態が遷移して未選択状態N1に戻る。

【0034】なお、第1乃至第3の入力先選択ボタン4, 5, 6は、上述のように遷移する3つの状態に応じて、各状態毎に特徴的な状態で表示されることが望ましい。具体的には例えば、各状態に応じて、色や絵柄を変化させたり、ハイライト表示したり、アニメーション表示の内容を変化させるなどすることが望ましい。これにより、ユーザに対して明示的に現在の状態を示すことができ、ユーザによる誤った操作を防止することができる。

【0035】つぎに、上述のようにして遷移する第1乃至第3の入力先選択ボタン4, 5, 6の状態に着目して、本例に係るチャットシステムでテキストを入力する場合のコンピュータ装置の動作を、図3及び図4に示すフローチャートを参照しながら説明する。

【0036】なお、第1乃至第3の入力先選択ボタン4, 5, 6は、いずれもテキストの入力先を選択するという同等の機能を有しており、いずれも同様にしてユーザによる選択操作に応じて状態が遷移することから、以下の説明においては、特定の入力先選択ボタンを想定せずに、単に「入力先選択ボタン」と称して説明することとする。本例に係るチャットシステムにおいては、第1乃至第3の入力先選択ボタン4, 5, 6のそれぞれに対して以下で説明する処理が行われる。

【0037】また、以下で説明する処理は、チャットシステムを構成するコンピュータ装置上で実行されるソフトウェア・プログラムに記述された処理内容に従って、コンピュータ装置を構成するCPU (Central Processing Unit) が、RAM、キーボード、或いはマウス装置に対する各種情報の入出力を行うことにより実現されるものとする。

【0038】入力先選択ボタンは、その初期状態として未選択状態N1とされている。また、初期状態において、入力バッファにはテキストが入力されていないものとする。このとき、コンピュータ装置は、例えば各部の

動作を制御する制御部として備えられたCPU等によって、入力先選択ボタンがユーザにより選択されたか否かを判定する(ステップB1)。この判定の結果、選択されていない場合には処理をステップB2に進め、選択されている場合には、選択された入力先選択ボタンを選択継続状態N3に遷移させて、処理をステップB6に進める。

【0039】ステップB2において、コンピュータ装置は、ユーザがキーボード等を操作することにより入力されたテキストを入力バッファに一時記憶するとともに、この入力バッファに記憶された内容をテキスト入力領域1に表示する。

【0040】次にステップB3において、コンピュータ装置は、ユーザによって例えばマウス装置を用いた選択操作等がなされ、入力先選択ボタンが選択されたか否かを判定する。この判定の結果、選択されている場合には処理をステップB4に進め、選択されていない場合には処理をステップB2に戻してテキストの入力処理を継続する。

【0041】ステップB4において、コンピュータ装置は、ユーザにより入力されたテキストが入力バッファ内に存在するか否かを判定する。この判定の結果、入力バッファが空である場合、すなわちユーザによってテキストが何も入力されていない場合には、選択された入力先選択ボタンを選択継続状態N3に遷移させて処理をステップB6に進め、入力バッファが空ではない場合には処理をステップB5に進める。

【0042】ステップB5において、コンピュータ装置は、入力バッファ内に記憶されたテキストを、選択された入力先選択ボタンに対応したチャット内容表示領域に対して書き込み、入力バッファを初期化して空にする。この後、処理をステップB1に戻して、上述した一連の処理を繰り返す。

【0043】一方、ステップB6においては、入力先選択ボタンが選択継続状態N3とされていることから、この入力先選択ボタンに対応したチャット内容表示領域に対して、テキストの書き込みを連続して行う処理が行われる。このステップB6が開始されると、図4に示すステップB10において、コンピュータ装置は、ユーザがキーボード等を操作することにより入力されたテキストを入力バッファに一時記憶するとともに、この入力バッファに記憶された内容をテキスト入力領域1に表示する。

【0044】次に、ステップB11において、コンピュータ装置は、ユーザにより例えばキーボードの「リターンキー」が入力されるなどして、入力内容の確定操作が行われたか否かを判定する。この判定の結果、確定操作が行われている場合には処理をステップB12に進め、確定操作が行われていない場合には処理をステップB10に戻してテキストの入力を継続する。

【0045】ステップB12において、コンピュータ装置は、入力バッファ内に記憶されたテキストを、選択継続状態N3とされた入力先選択ボタンに対応したチャット内容表示領域に対して書き込み、入力バッファを初期化して空にする。その後、処理をステップB10に戻して、上述した一連のステップB6における処理を繰り返す。

【0046】上述した一連のステップB6における処理は、当該入力先選択ボタンの選択継続状態N3が解除されて、未選択状態N1に戻るまで繰り返される。

【0047】本例に係るチャットシステムにおいては、テキスト入力領域1にテキストを入力した状態で第1乃至第3の入力選択ボタン4、5、6のいずれかを選択するという極めて簡便な操作により、複数設定されたチャット内容表示領域のうちから任意のチャット内容表示領域を入力対象として選択し、このチャット内容表示領域に対してテキストを入力することができる。したがって、チャット内容表示領域が複数設定されている場合であっても、ユーザによってテキストの入力操作が行われるテキスト入力領域1は1つだけで十分となり、入力領域と表示領域と確定ボタンとが一組とされた従来の入力方式を用いる場合と比較して、画面上の構成物を減らすことができる。したがって、表示画面の美観が向上し、ユーザに対して煩雑な印象を与えることがない。

【0048】また、テキスト入力領域1にテキストが入力されていない状態で第1乃至第3の入力選択ボタン4、5、6のいずれかが選択されると、選択された入力選択ボタンが選択継続状態となり、これ以降入力されたテキストが当該入力先選択ボタンに対応したチャット内容表示領域に対して入力されることとなる。したがって、特定のチャット内容表示領域に対して連続して入力（書き込み）を行う場合においても、入力を行う度に入力先選択ボタンを選択操作する必要がない。すなわち、特定のチャット内容表示領域に対する連続した入力操作を極めて円滑に行うことができる。

【0049】ところで、本例に係るチャットシステムにおいて、上述のようにして第1乃至第3の入力先選択ボタン4、5、6のうちのいずれかが選択継続状態N3とされている状態で、テキスト入力領域1にテキストが入力されていない場合に他の入力先選択ボタンが選択されたときには、選択された入力先選択ボタンを選択継続状態N3とし、それ以前に選択継続状態N3とされていた入力先選択ボタンの選択継続状態N3を解除して未選択状態N1とすることが望ましい。これにより、ユーザは、テキストを連続して入力する入力先（チャット内容表示領域）を1回のボタン選択操作で切り替えることができる。

【0050】また、第1乃至第3の入力先選択ボタン4、5、6のうちのいずれかが選択継続状態N3とされている状態で、テキスト入力領域1にテキストが入力さ

れている場合に他の入力先選択ボタンが選択されたときには、以下で説明する2つの動作のうちのいずれかを処理することが考えられる。

【0051】第1の動作としては、テキスト入力領域1に入力されているテキストを、選択操作された入力先選択ボタンに対応した入力先に入力した後に、テキスト入力領域1を初期化し、それ以前から選択継続状態N3とされている入力先選択ボタンの状態を、選択継続状態N3のまま維持するという動作である。この第1の動作が処理されることにより、ユーザは、特定の入力先に対して連続してテキストの入力を行っている途中に、1回だけ他の入力先に対してテキストの入力を行うという操作を、1回のボタン選択操作のみで実現することができる。

【0052】第2の動作としては、テキスト入力領域1に入力されているテキストを、選択操作された入力先選択ボタンに対応した入力先に入力した後に、テキスト入力領域1を初期化する。そして、それ以前から選択継続状態N3とされていた入力先選択ボタンの状態を未選択状態N1に遷移させるとともに、選択操作された入力先選択ボタンを選択継続状態N3に遷移させるという動作である。すなわち、この第2の動作が処理されることにより、現在テキスト入力領域1に入力されているテキストの選択操作された入力先選択ボタンに対応した入力先に入力するとともに、これ以降、新たに指定された入力先に対して連続してテキストの入力を行うことができるようになる。

【0053】上述した2つの動作は、特に一方が優れているというのではなく、チャットシステムの用途や利用形態に準じていずれかを選択的に採用すればよい。また、ユーザの操作に応じて上述した2つの動作が切り替え可能とされていてもよい。

【0054】なお、上述においては、本発明をチャットシステムに適用した場合について説明したが、本発明は、その趣旨を逸脱しない範囲で、情報処理装置を用いて各種の情報を入力する場合に広く適用することができる。具体的には、例えば、いわゆる掲示板システムにテキストを入力する場合に適用するとしてもよいし、住所録アプリケーションや表計算アプリケーションを用いて各種の情報を入力する場合に適用してもよい。

【0055】また、上述においては、ユーザにより入力されたテキストの入力対象となるチャット内容表示領域が2つ設定された場合を想定して説明したが、本発明は、テキストの入力対象を2つに限定されるものではなく、任意の数だけ情報の入力対象が設定された場合に適用することもできる。

【0056】(2)より具体的な実施の形態につき、上述した本発明の基本的な構成に基づく、より具体的な本発明の実施の形態について説明する。以下では、コンピュータネットワークに接続された複数の情報

処理装置の間で、画像データ、音声データ、文字データ、及び制御データのうち任意のデータを送受信することによって、各情報処理装置の利用者間で意思や感情の相互伝達（コミュニケーション）を行うコミュニケーションシステムに対して本発明を適用した場合について説明する。

【0057】（2-1）コミュニケーションシステムの基本構成

まず、このようなコミュニケーションを実現する基本的なシステムの構成について概略的に説明する。

【0058】なお、以下では、コンピュータネットワークとして、いわゆるTCP/IP（Transmission Control Protocol / Internet Protocol）プロトコル群を利用して複数の情報処理装置間で相互接続が可能とされたネットワーク形態を想定して説明する。ただし、本発明は、このようなネットワーク形態への適用に限定されるものではなく、複数の情報処理装置間で相互に各種情報の授受を行うコンピュータネットワークを利用する場合に広く適用することが可能である。

【0059】また、以下では、各種情報の授受を行う情報処理装置として、コンシューマ用途のパーソナル・コンピュータ装置（以下、単にコンピュータ装置と称する。）を用いた場合を想定して説明する。ただし、本発明は、このようなコンピュータ装置を用いた場合への適用に限定されるものではなく、例えば、各種のPDA（Personal Digital Assistants）機器、或いは通信機能が搭載された携帯電話などのように各種の情報処理装置を用いた場合に対して広く適用することができる。

【0060】本例で説明するコミュニケーションシステムは、例えば図5に示すように、複数のコンピュータ装置10がインターネット（The Internet）11を介して相互に各種情報の授受が可能で接続されてなる。

【0061】ここで、各コンピュータ装置10は、インターネット11に対して直接接続されていてもよいし、ISP（Internet Service Provider）などを利用して公衆回線網15を介してインターネット11に接続可能な環境とされていてもよい。公衆回線網15としては、例えば、電話回線網15a、ケーブルテレビ網15b又はADSL（Asymmetric Digital Subscriber Line）網15c等を挙げることができる。このとき、コンピュータ装置10は、インターネット11に接続可能な環境であれば、有線接続或いは無線接続の別を問わない。例えば、コンピュータ装置10は、いわゆる簡易型携帯電話（PHS：Personal Handyphone System）等を介して、インターネット11に接続する構成とされていてもよい。

【0062】各コンピュータ装置10は、各々がインターネット11に接続した状態で、TCP/IPプロトコル群を用いてインターネット11上に伝送路を確立し、互いに画像データ、音声データ、文字データ、及び制御

データ等の各種情報を相互に授受することが可能とされている。

【0063】（2-2）ユーザ端末の構成

つぎに以下では、上述したコミュニケーションシステムを構成するコンピュータ装置10の構成について説明する。

【0064】なお、以下では、説明の便宜上、コンピュータ装置10にデジタルビデオカメラが搭載されている場合について説明するものとする。ただし、コンピュータ装置10は、外部機器として構成されたデジタルビデオカメラが有線又は無線により接続されていてもよいし、例えばコンピュータ装置10が接続されたLAN（Local Area Network）等のコンピュータネットワークに対して直接接続可能とされたデジタルビデオカメラを用いて、このデジタルビデオカメラにより撮像或いは録音された画像データや音声データがコンピュータネットワークを介してコンピュータ装置10に取り込まれる構成とされていてもよい。

【0065】コンピュータ装置10は、図6に示すように、各種演算処理を実行するとともに各部を統括して制御するCPU（Central Processing Unit）20と、このCPU20のワークエリアとして機能するRAM（Random Access Memory）21と、CPU20によって実行される各種プログラムを含む情報を格納する読み取り専用のROM（Read Only Memory）22と、CPU20によって実行されるオペレーティング・システム（Operating System）やアプリケーション・プログラム等の各種プログラムが記録され、各種データ等の記録再生が行われるHDD（Hard Disk Drive）23と、各種情報を表示する表示部24と、この表示部24とCPU20との間でのデータの授受を行うための表示用インターフェース25と、ユーザによって各種情報や指示操作を入力するための操作部26と、この操作部26とCPU20との間でのデータの授受を行うための操作用インターフェース27と、上述した公衆回線網15を介してインターネット11に接続された外部装置との間でデータの授受を行うためのネットワークインターフェース28と、被写体を撮影して映像データや音声データを得るデジタルビデオカメラ29と、いわゆるMPEG2（Moving Picture Experts Group phase 2）方式に基づく圧縮符号化及び復号を行うMPEG2コーデック30とを備える。

【0066】コンピュータ装置10は、これらの各部のうち、CPU20、RAM21、ROM22、HDD23、表示用インターフェース25、操作用インターフェース27、ネットワークインターフェース28、デジタルビデオカメラ29、及びMPEG2コーデック30がバス31を介して接続されて構成される。

【0067】なお、コンピュータ装置10におけるデジタルビデオカメラ29は、コンピュータ装置10に搭載されずに、例えば外部機器接続用の所定のインターフェ

ースや、ネットワークインターフェース28などを介してバス31に接続されてもよい。また、コンピュータ装置10は、必要に応じて、例えば着脱自在とされる記録媒体に対する記録再生を行うリムーバブル型の記録再生装置などがHDD23の他に搭載又は接続され、この記録再生装置に対する各種データの記録再生が可能とされていてもよい。

【0068】CPU20は、バス31を介して、RAM21、ROM22、HDD23、表示用インターフェース25、操作用インターフェース27、ネットワークインターフェース28、デジタルビデオカメラ29、及びMPEG2コーデック30と接続されている。CPU20は、各部を統括的に制御するとともに、例えばHDD23等に記録されているオペレーティング・システムや各種アプリケーション・プログラムを実行処理する。特に、CPU20は、アプリケーション・プログラムのひとつとして構成されたコミュニケーションプログラムの実行を処理する。なお、このコミュニケーションプログラムについての詳細は後述する。

【0069】RAM21は、CPU20が各種プログラムを実行する際のワークエリアとして機能し、CPU20の制御のもとに、各種データを一時記憶する。

【0070】ROM22は、コンピュータ装置10の起動に必要な各種プログラムや設定情報などを格納している。このROM22に格納されている各種プログラムや設定情報は、コンピュータ装置10の起動時に読み出され、CPU20によって利用される。

【0071】HDD23は、オペレーティング・システムやアプリケーション・プログラム等が記録されるとともに、CPU20の制御のもとに各種プログラムやデータ等の記録再生を行う。

【0072】表示部24は、例えばLCD (Liquid Crystal Display) からなり、CPU20の制御のもとに、HDD23に記録されているデータ等の各種情報を表示画面に表示する。特に、表示部24は、CPU20の制御のもとに、後述するコミュニケーションプログラムを実行処理した結果を表示したり、このコミュニケーションプログラムに対して各種の指示操作を行うボタンを表示するためのウィンドウといった、所定のグラフィカル・ユーザ・インターフェースを表示画面に表示する。

【0073】表示用インターフェース25は、CPU20と表示部24との間でのデータの授受を行う。すなわち、表示用インターフェース25は、CPU20からバス31を介して供給された各種情報を表示部24に供給する。

【0074】操作部26は、例えば、キーボード、マウス等のポインティングデバイス、或いはいわゆるジョグダイヤル等回転操作式スイッチなどによるユーザ・インターフェースを用いたユーザによる操作を受け付け、操作内容を示す制御信号を操作用インターフェース27を

介してCPU20に供給する。

【0075】操作用インターフェース27は、CPU20と操作部26との間でのデータの授受を行う。すなわち、操作用インターフェース27は、操作部26から供給された制御信号をバス31を介してCPU20に供給する。

【0076】ネットワークインターフェース28は、CPU20の制御のもとに、外部との通信を行うインターフェースとして機能する。すなわち、ネットワークインターフェース28は、インターネット11に接続された他のコンピュータ装置10との間で各種情報の授受を行うために設けられるものである。

【0077】デジタルビデオカメラ29は、被写体を撮影するための所定の光学系や、CCD (Charge Coupled Devices) 等の光電変換用のデバイス等からなる。デジタルビデオカメラ29により得られた映像データや音声データは、CPU20の制御のもとに、バス31を介してMPEG2コーデック30に供給される。

【0078】MPEG2コーデック30は、バス31を介してデジタルビデオカメラ29から供給された映像データや音声データを、CPU20の制御のもとに、MPEG2方式に基づく圧縮符号化を行う。このとき、MPEG2コーデック30は、CPU20の制御のもとに、映像データや音声データをリアルタイムに圧縮符号化する。また、MPEG2コーデック30は、MPEG2方式に基づいて圧縮符号化されたデータを復号することもできる。

【0079】(2-3) コミュニケーションプログラムの概略

つぎに以下では、上述したコンピュータ装置10により実行されるコミュニケーションプログラムについて説明する。

【0080】コミュニケーションプログラムは、それぞれ個別の機能を実現する複数のモジュールを組み合わせて自在とされた一連のプログラム群によって構成されており、例えばコンピュータ装置10のHDD23に記録されている。コンピュータ装置10は、このコミュニケーションプログラムをCPU20によって実行することにより、他のコンピュータ装置との間で、画像データ、音声データ、或いは文字データ等の各種情報を授受することによって、各コンピュータ装置のユーザ間での意思や感情の相互伝達(コミュニケーション)を可能とする。なお、コミュニケーションプログラムは、例えばいわゆるコンパクトディスク (Compact Disc) 等の所定の記録媒体やインターネット11等の伝送媒体によっても提供され得るものである。

【0081】コンピュータ装置10で実行されるコミュニケーションプログラムは、他のコンピュータ装置で実行されるコミュニケーションプログラムとの間で、いわゆるサーバ・クライアント方式により通信を行う。すな

わち、相互接続状態が確立された複数のコミュニケーションプログラムにおいては、所定のコミュニケーションプログラムによりサーバとしての機能が実現され、他のコミュニケーションプログラムがクライアントとして動作する。ただし、コミュニケーションプログラムは、コンピュータ装置10において実行処理が開始され、他のコミュニケーションプログラムとの間で相互接続状態が確立されていない時点、すなわち初期起動状態において、いわば仮想セッションモードでの動作となり、サーバ又はクライアントの区別なく、自分自身でセッションの確立を行うことができる。

【0082】ここで、複数のコンピュータ装置10で実行される各々のコミュニケーションプログラム間でセッションの確立を行う場合には、これらコミュニケーションプログラム間で接続設定情報の授受が行われる。この接続設定情報は、例えば、コミュニケーションプログラムの起動時にコンピュータ装置10によって生成されるものであり、この接続設定情報の送出元となるコンピュータ装置10に設定されたIPアドレス、及び当該コミュニケーションプログラムで利用されるポート番号などが記述されたファイルにより構成されている。なお、接続設定情報についての詳細は後述する。

【0083】そして、コミュニケーションプログラムから、他のコミュニケーションプログラムに対して接続設定情報が送出されると、この接続設定情報を取得したコミュニケーションプログラムは、接続設定情報に記述されたIPアドレスやポート番号などに基づいて、送出元であるコンピュータ装置10（ひいては、このコンピュータ装置10で実行されるコミュニケーションプログラム）に対して、接続処理を行い、セッションが確立される。

【0084】このとき、接続設定情報を含むファイルは、例えば拡張子によってコミュニケーションプログラムとの関連付けがなされており、いわゆるダブルクリック操作を行うことなどによってコンピュータ装置上でこのファイルが選択されると、自動的にコミュニケーションプログラムが起動するよう構成されている。

【0085】コミュニケーションシステムにおいては、起動時に接続設定情報を生成し、この接続設定情報を他のコミュニケーションプログラムに対して送出した側のコミュニケーションプログラムがサーバとしての機能を果たし、取得した接続設定情報に基づいて起動された側のコミュニケーションプログラムがクライアントとして動作するものとする。

【0086】ここで、上述のようにしてコンピュータ装置間で接続設定情報を授受するに際しては、例えば、サーバとなるコンピュータ装置10からクライアントとなるコンピュータ装置に対して、接続開始を促すメッセージが記載された電子メールに接続設定情報を含むファイルを添付して送信することにより実現されている。

【0087】なお、本例で説明するコミュニケーションシステムにおいては、電子メールを利用して接続設定情報を送出するものとするが、例えば、いわゆるFTPソフトウェアなどのような、インターネット11に接続されたコンピュータ装置の間で各種のファイル交換を実現するアプリケーションプログラムを用いることによって、接続設定情報をデータ・ファイル或いはアプリケーション・プログラムの形で送出するとしてもよい。また、例えば、コンピュータ装置の利用者（ユーザ）に対して接続開始を通知することなく、接続設定情報を直接コンピュータ装置間で授受することによって、ユーザに接続の開始（セッションの確立）を意識させることなく自動的にクライアント側のコンピュータ装置上でコミュニケーションプログラムが起動するように構成してもよい。

【0088】（2-4）コミュニケーションプログラムのモジュール構造

ここで、コミュニケーションプログラムにおけるモジュール構造の一例について、図7を参照しながら説明する。コミュニケーションプログラムは、例えば図7に示すように、コンピュータ装置10におけるネットワークインターフェース28の動作を制御するインターフェースモジュール50と、他のコンピュータ装置で実行されるコミュニケーションプログラム間でのセッションの確立などを提供するコアモジュール51と、コミュニケーションプログラムにおける基本的な機能を提供する基本モジュール52と、各々個別の機能を提供する複数のアプリケーションモジュール53と、グラフィカル・ユーザ・インターフェース（以下、GUI：Graphical User Interfaceと称する。）を管理するGUIモジュール54とにより構成されている。

【0089】インターフェースモジュール50は、いわばAPI（Application Program Interface）として構成されており、インターネット11等のコンピュータネットワークを介して他のコンピュータ装置で実行されるプログラムとの間で画像データ、音声データ、或いは文字データ等の各種情報の伝送路を確立し、ネットワーク通信の詳細を簡便な命令体系によって容易に処理可能とするモジュールである。このインターフェースモジュール50としては、例えば、マイクロソフト株式会社の「Direct Play」などを用いることができる。

【0090】コアモジュール51は、他のコミュニケーションプログラムとの間でセッションの確立を行うとともに、確立されたセッションの管理を行うセッション管理機能を有している。具体的には例えば、接続設定情報を作成する接続設定情報作成機能、セッションを確立するセッション確立機能、コミュニケーションプログラム間でデータの送受信を行うデータ送受信機能、確立されたセッション内のプレーヤーを管理するセッション内プレーヤー管理機能などが、セッション管理機能としてコ

アモジュール51により提供される。

【0091】ここで、コミュニケーションシステムにおいては、サーバとなるコミュニケーションプログラムと、クライアントとなるコミュニケーションプログラムとが存在している。サーバ側のコミュニケーションプログラムは、クライアント側のコミュニケーションプログラムから送出されたデータを、このデータの宛先を参照して、宛先として指定された他のクライアント側のコミュニケーションプログラムに転送するなどの処理が行われる。このため、コミュニケーションシステムにおいては、画像データ、音声データ、或いは文字データなどの各種情報を授受するに際して、セッションを確立しておくことが必要となる。そこで、コミュニケーションプログラムにおいては、このようなセッションの確立や管理を行うためのインターフェースとしてセッション管理機能がコアモジュール51により提供されている。

【0092】コアモジュール51は、IPアドレス及びポート番号などを取得して接続設定情報が記述されたファイルを生成する。また、このファイルに対して暗号化や復号化などを行う。また、コアモジュール51は、クライアントとして動作する場合に、取得した接続設定情報に記述されたIPアドレス及びポート番号などに基づいて、サーバ側となるコンピュータ装置に対する接続を行う。これにより、セッションが確立される。

【0093】また、コアモジュール51は、セッション内に存在するコミュニケーションプログラム（プレイヤー）の管理を行う。具体的には例えば、プレイヤーのリストを生成或いは取得したり、プレイヤー毎に割り当てられた固有の識別情報（プレイヤーID）の取得或いは管理を行う。また、コアモジュール51は、新規なプレイヤーとの接続が確立されたり、所定のプレイヤーとの接続が切断されたり、プレイヤー毎の接続状態や接続名などの情報を含むプレイヤー情報が変更されるなどして、イベントが生じた場合に、このイベントを基本モジュール52及び各アプリケーションモジュール53に対して通知する。

【0094】また、コアモジュール51は、複数のアプリケーションモジュール53の各々に対する制御を行うアプリケーションモジュール管理機能を有している。具体的には例えば、各アプリケーションモジュール53の起動管理や、各アプリケーションモジュール53との間でデータの送受信などを行う。

【0095】コアモジュール51は、具体的には例えば、コミュニケーションプログラムに実装されているアプリケーションモジュール53に関するモジュール情報を、コンピュータ装置10の所定の記憶領域から取得して、実装済みのアプリケーションモジュール53をリスト化する。このモジュール情報は、例えば、アプリケーションモジュール毎に固有のモジュール識別情報、GUIに関する情報であるGUI情報、或いは、コミュニケ

ーションプログラムの起動と同時に動作を開始するか否かを示すフラグ情報などにより構成されている。そして、コアモジュール51は、このモジュール情報に基づいて、各アプリケーションモジュール53の起動状態を管理する。

【0096】また、コアモジュール51は、起動されていないアプリケーションモジュール53を起動したり、コンピュータ装置10の表示部24に対する表示/非表示の切り替え制御などを行う。

【0097】ここで、コアモジュール51の動作の一例として、クライアント側である一方のコミュニケーションプログラムから他方のコミュニケーションプログラムに対して、サーバ側のコミュニケーションプログラムを介してデータを送信する場合について、図8を参照しながら説明する。

【0098】この場合において、データ送信側で動作するコアモジュール51aは、基本モジュール52やアプリケーションモジュール53から送信されたデータを受信し、このデータに対して送信ヘッダーを付与して、サーバ側のコミュニケーションプログラムに対して送信する。このようにサーバ側に送信するに際しては、受信したデータの内容については関与しない。

【0099】一方、サーバ側で動作するコアモジュール51bは、データ送信側から取得したデータに含まれる送信ヘッダーを参照して、この送信ヘッダーに宛先として記述されたデータ受信側のコミュニケーションプログラムに対して、データ送信側から取得したデータを送信する。

【0100】また、データ受信側で動作するコアモジュール51cは、取得したデータに含まれる送信ヘッダーを参照して、このデータを所定のアプリケーションモジュール53に対して受け渡す。このとき、コアモジュール51cは、データ受信側におけるコミュニケーションプログラムでデータの受け渡し先として該当するアプリケーションモジュール53が起動していない場合に、このアプリケーションモジュール53を起動処理する。

【0101】また、コアモジュール51cは、データ受信側のコミュニケーションプログラムに該当するアプリケーションモジュール53が存在しない場合に、この旨を示すメッセージをデータ送信側のコミュニケーションプログラムに対して送信する。このとき、コアモジュール51cは、取得したデータを受け渡し対象となるアプリケーションモジュール53として、全てのアプリケーションモジュール53が指定されている場合には、起動中であるアプリケーションモジュールにのみ、このデータを受け渡す。

【0102】コアモジュール51は、上述のように動作することによって、クライアントとして動作するコミュニケーションプログラム間でデータの受け渡しを行う。

【0103】一方、基本モジュール52は、コミュニケ

ーションプログラムで用いる各種ウィンドウを用意する機能を有するモジュールである。また、基本モジュール52は、コミュニケーションプログラムの実行処理に必要なとなる各種の情報を設定する設定機能、及び、セッションを確立する際に接続設定情報を電子メールに添付してクライアント側に送信する電子メール送信機能などを有する。

【0104】また、アプリケーションモジュール53は、コミュニケーションプログラムに必要なに応じて複数実装され、それぞれ独自の機能を提供する機能を有している。本例におけるコミュニケーションプログラムにおいては、アプリケーションモジュール53として、個人情報管理モジュール、画像送信モジュール、音声データ送受信モジュール、Web機能モジュール、チャット内容転送モジュール、チャットログモジュール、感情表現モジュール、アクションモジュール、ライブ出演モジュール、及び意見収集モジュールなどが実装されているものとする。

【0105】個人情報管理モジュールは、セッション内に存在する各コミュニケーションプログラム、すなわち各ユーザ（プレイヤー）に対応した画像データや名前情報などの個人情報を管理するモジュールである。

【0106】このコミュニケーションプログラムにおいては、最初に起動された状態で、ユーザに対応した画像や名前などの入力及び設定をユーザに要求して取得する。このとき、コアモジュール51を介して個人情報管理モジュールに対して、表示要求が送信される。このようにして他のモジュールからの表示要求を受信すると、個人情報管理モジュールは、GUIモジュール54に対して所定の取得要求を送信して、該当する個人情報を取得し、コンピュータ装置10に表示されたウィンドウ内の所定の領域に所定の個人情報を表示する。

【0107】また、個人情報管理モジュールは、他のモジュールからのプレイヤー情報更新要求を受信した場合に、ネットワークを介して接続が確立された他のコミュニケーションプログラムにおける個人情報管理モジュールに対して、個人情報取得要求を送信する。このとき、個人情報取得要求を取得した側の個人情報管理モジュール53aは、自分自身の個人情報を取得して表示通知として返信する。

【0108】このようなプレイヤー情報更新要求は、例えば、コミュニケーションシステムに対して新たにユーザが参入した場合に、コアモジュール51によって個人情報管理モジュールに対して送信される。

【0109】画像送信モジュールは、画像データの追加処理、削除処理、或いは選択時の処理などを提供するモジュールである。また、画像送信モジュールは、コンピュータ装置10に搭載又は接続されたデジタルビデオカメラ29に対して、撮影状態のオン・オフの切り替え制御などの各種制御を行う。デジタルビデオカメラ29の

撮影状態がオンである場合には、インターネット11に対する通信状態の負荷を監視しながら、画像データの送信処理を行う。なお、画像送信モジュールにおいては、ユーザによる設定に応じて、他のコミュニケーションプログラムに対する送信を非保証通信で行うこともできる。この場合には、送信した画像データが伝送路の途中で失われた場合であっても再送信を行わない。

【0110】音声送受信モジュールは、画像送信モジュールに相当するものであり、音声データの追加処理、削除処理、或いは選択時の処理などを提供するモジュールである。また、音声送受信モジュールは、インターフェースモジュール50に実装された音声機能を利用して、コミュニケーションプログラム間で音声データの送受信を実現する機能を有している。なお、コミュニケーションシステムにおいては、サーバ側のコミュニケーションプログラムにおいて音声出力をオンしている場合のみ、クライアント側のコミュニケーションプログラムにおいても音声出力をオンとすることが可能とされている。また、クライアント側のコミュニケーションプログラムから送出された音声データは、サーバ側のコミュニケーションプログラムに実装された音声送受信モジュールによってミキシングされ、再度各クライアント側のコミュニケーションプログラムに対して送信される。

【0111】Web機能モジュールは、コミュニケーションプログラムが実行されるコンピュータ装置10、或いはインターネット11に接続された他のコンピュータ装置に保持されたハイパーテキストや画像データなどの各種情報を取得して、コミュニケーションプログラムのウィンドウ内における所定の表示領域に、取得した各種情報を表示するWeb情報表示機能を提供するモジュールである。また、Web機能モジュールは、他のコミュニケーションプログラムとの間で、インターネット11上に存在する各種情報（リソース）の所在地及び取得方法を示すURL（Uniform Resource Locator）を共有するURL共有機能を有する。

【0112】チャット内容転送モジュールは、文字データがGUIモジュール54に対して入力されたことを示すイベントが、このGUIモジュール54から通知された際に、このイベントに基づいて入力された文字データを取得し、取得した文字データを含むチャットメッセージ通知を、セッションが確立された他のコミュニケーションプログラムの全てに対して送信するモジュールである。また、チャット内容転送モジュールは、チャットメッセージ通知を受信すると、このチャットメッセージ通知に含まれる文字データを表示する要求をGUIモジュール54に対して行う。これにより、コミュニケーションプログラムのウィンドウ内の所定の位置に、いわゆる「吹き出し」状の文字表示領域が確保され、この領域内に文字データが表示される。

【0113】チャットログモジュールは、チャット内容

転送モジュールから送信されたチャットメッセージ通知などに基づいて、入力又は受信した文字データを記録してチャットログファイルを生成する。チャットログモジュールは、所定の記憶容量分の文字データを、コンピュータ装置10のRAM21内に記憶するとともに、必要に応じて、RAM21内に記憶された文字データをHDD23などに待避させてチャットログファイルを生成する。また、チャットログモジュールは、チャットログを表示する要求がなされた場合に、チャットログファイル内に記憶された文字データを取得して、コミュニケーションプログラムのウィンドウ内の所定の領域に表示する機能を有している。

【0114】感情表現モジュールは、感情表現に関するアニメーション効果の読み込みや表示などを行うモジュールである。また、感情表現モジュールは、感情を表現する際に選択されるボタンの表示などをGUIモジュール54に要求する。

【0115】また、感情表現モジュールは、GUIモジュール54により所定のボタンが選択された通知を受信すると、このボタンに対応した感情表現データ(アニメーションデータ)を、セッションが確立されている全てのコミュニケーションプログラムに対して送信する。一方、感情表現データを受信した際には、この感情表現データを表示する要求をGUIモジュール54に対して行う。なお、感情表現についての詳細は後述する。

【0116】アクションモジュールは、アクションデータの読み込みや表示などを行うモジュールである。また、アクションモジュールは、アクションを表示する際に選択されるボタンの表示などをGUIモジュール54に要求する。

【0117】また、アクションモジュールは、アクションを表示する際に選択されるボタンがユーザによって選択されると、選択されたボタンに対応したアクションデータ(アニメーションデータ)を、セッションが確立されている全てのコミュニケーションプログラムに対して送信する。一方、アクションデータを受信した際には、このアクションデータを表示する要求をGUIモジュール54に対して行う。

【0118】ライブ出演モジュールは、インターネット11を介して画像データや音声データのライブ配信を行うライブ配信プログラムと連携して動作するモジュールである。コミュニケーションプログラムは、ライブ出演モジュールが実装されていることにより、外部のライブ配信プログラムとの間で画像データや音声データ等の授受を行うことが可能とされている。

【0119】意見収集モジュールは、コミュニケーションプログラムが実行される複数のコンピュータ装置10のユーザ同士で意見や感情などを含む情報を収集するモジュールであり、先に図1及び図2を参照して説明した機能と同等の機能を含むモジュールである。

【0120】なお、コミュニケーションシステムにおいては、相互に接続された複数のコンピュータ装置のうち、所定のコンピュータ装置(例えば最初に意見収集モジュール53jが起動されたコンピュータ装置)が他のコンピュータ装置から情報を収集するサーバとしての動作し、他のコンピュータ装置で動作する意見収集モジュール53jはサーバ側の意見収集モジュール53jに対して情報を送出するクライアントとしての動作する。

【0121】このとき、サーバ側となる意見収集モジュール53jが動作するコンピュータ装置は、コミュニケーションシステムにおけるシステム全体のサーバとなるコミュニケーションプログラムが動作するコンピュータ装置と同一であってもよいし、異なってもよい。

【0122】アプリケーションモジュール53は、上述したような各種のモジュールにより構成されている。なお、コミュニケーションプログラムにおいては、実装されるアプリケーションモジュール53の数や機能に限定されるものではなく、上述した各種のモジュールの他にも、それぞれ独自の機能を提供するモジュールがアプリケーションモジュール53のひとつとして実装されている。また、コミュニケーションプログラムにおいては、必要に応じてアプリケーションモジュール53の追加又は削除を行うことが可能とされている。

【0123】GUIモジュール54は、コミュニケーションプログラムで発生するウィンドウ表示等の画面表示を提供するモジュールである。ただし、ダイアログボックスなどの各種ウィンドウの基本的な描画については、基本モジュール52により提供される。GUIモジュール54は、他のモジュールからなされた画面表示要求に応じて、ウィンドウ内の描画を行い、機能選択ボタンや画像データなどの表示を行う。

【0124】このGUIモジュール54は、機能選択ボタンの位置や並べ方、或いは画像データの表示位置や、ウィンドウ内における全体的な配列・構成に関する情報は有しているが、機能選択ボタンの数や内容に関しては、コアモジュール51或いは各アプリケーションモジュール53による要求に含まれるデータを参照することにより表示する。

【0125】なお、コミュニケーションプログラムに実装されるアプリケーションモジュール53は、GUIモジュール54に依らずに、独自に描画処理することが可能なアプリケーション表示領域を利用することが可能とされている。このようなアプリケーション表示領域を利用して画面表示を行う場合には、アプリケーションモジュール53からの要求に応じてGUIモジュールがアプリケーション表示領域を確保し、確保されたアプリケーション表示領域内に対する描画処理は、アプリケーションモジュール53側で行うことができる。

【0126】また、GUIモジュール54は、ウィンドウ内に表示された機能選択ボタン等がユーザによって選

択された場合に、この機能選択ボタンが選択されたことを示すイベントを、基本モジュール52やアプリケーションモジュール53に対して通知する機能を有している。

【0127】コミュニケーションプログラムは、上述したように、複数のモジュールによって構成されてなり、各モジュールが必要に応じて適宜連携して動作するように構成されている。

【0128】(2-5) 接続設定情報
つぎに、コミュニケーションシステムにおいて、コンピュータ装置間でセッションを確立する際に用いられる接続設定情報について説明する。接続設定情報は、サーバとなるコミュニケーションプログラムが実行されるコンピュータ装置において生成される情報である。

【0129】接続設定情報は、例えば図9に示すように、クライアントとなるコミュニケーションプログラムがサーバとなるコミュニケーションプログラムに対してセッションを確立する際に認証などを行うためのアクセスキー、コミュニケーションプログラムが利用するコンピュータ装置10のネットワークインターフェース28のポート番号、サーバとなるコミュニケーションプログラムが実行されるコンピュータ装置10に設定されたIPアドレスの数、及びサーバとなるコミュニケーションプログラムが実行されるコンピュータ装置10に設定された一連のIPアドレスなどによって構成される。

【0130】(2-6) コミュニケーションプログラムによる基本処理

以下では、上述したコミュニケーションプログラムがコンピュータ装置10において実行される場合における基本的な一連の処理について、図10及び図11に示すフローチャートを参照しながら順を追って説明する。

【0131】コミュニケーションプログラムは、実行処理が開始(起動)されると、図10に示すステップS10において、機能モジュールリストを参照することにより、起動フラグが立っているモジュールを起動する。機能モジュールリストは、例えば図12に示すようなデータ構造とされており、コミュニケーションプログラムを構成するモジュール毎に、モジュールに固有の識別情報(ID)と、モジュールに固有のモジュール名と、モジュールの実行形態や利用条件などを示すタイプと、起動時の条件に応じて起動されるか否かを示す起動フラグとにより構成されている。コミュニケーションプログラムは、機能モジュールリストを参照することによって、起動時の条件に応じて起動するモジュールを選択して起動することが可能とされている。

【0132】次に、コミュニケーションプログラムは、ステップS11において、他のコンピュータ装置により実行されるコミュニケーションプログラムから接続設定情報を受信しているか否かを判定する。この判定の結果、受信している場合にはステップS12に処理を進

め、受信していない場合にはステップS13に処理を進める。

【0133】ここで、コミュニケーションプログラムは、接続設定情報を受信している場合に、当該コミュニケーションプログラムがクライアントとして動作して、接続設定情報の送信元であるサーバ側のコミュニケーションプログラムとの間で各種情報の送受信を行うこととなる。一方、接続設定情報を受信していない場合には、当該コミュニケーションプログラムがサーバとして動作する。

【0134】ステップS12において、コミュニケーションプログラムは、受信した接続設定情報に基づいて、この接続設定情報の送信元であるサーバ側のコミュニケーションプログラムとの間でセッションを確立する処理を行う。

【0135】ステップS13において、コミュニケーションプログラムは、サーバとして動作することを要求されるか否かを判定する。この判定は、ステップS11における判定に対応しており、接続設定情報を他のコンピュータ装置で実行されるコミュニケーションプログラムから受信したか否かを判定することによって行われる。そして、この判定の結果、サーバモジュールを起動する場合にはステップS14に処理を進め、サーバモジュールを起動せずにクライアントとして動作する場合にはステップS17に処理を進める。

【0136】ステップS14において、コミュニケーションプログラムは、自身が起動したサーバモジュールに対してセッションが確立されて接続済みであるか否かを判定する。この判定の結果、未だ接続が行われていない場合にはステップS15に処理を進め、接続済みである場合にはステップS17に処理を進める。

【0137】ステップS15において、コミュニケーションプログラムは、サーバ機能を提供するサーバモジュールを起動する。次に、ステップS16において、コミュニケーションプログラムは、自身起動したサーバモジュールに対してセッションを確立して接続を行う。これにより、当該コミュニケーションプログラムにおいては、自身が起動したサーバモジュールによりサーバとしての機能が実現されるとともに、サーバモジュール以外の他のモジュールは、当該サーバモジュールに対して、いわばクライアントとして接続動作することが可能となる。

【0138】コミュニケーションプログラムにおいては、このようにサーバ機能がモジュールとして実現されていることから、サーバとして動作する場合であっても、クライアントとして動作する場合と同様な手続きにより、サーバモジュール以外の他のモジュールが、サーバに対してアクセスすることが可能となる。このため、これら他のモジュールにおける処理手続きを簡略化する

ことができる。なお、ステップS16において、サーバモジュールに対するセッションが確立された後に、コミュニケーションプログラムは、ステップS17に処理を進める。

【0139】ステップS17において、コミュニケーションプログラムは、コンピュータ装置10の画面上にウィンドウを表示し、このウィンドウ内に表示された入力領域や各種の機能選択ボタン等によって、ユーザによる各種指示操作が入力可能な状態となる。そして、ステップS17において、コミュニケーションプログラムは、上述した機能選択ボタンがユーザによって選択され、この機能選択ボタンに対応した機能モジュールを起動するか否かを判定する。この判定の結果、機能モジュールを起動する場合にはステップS18に処理を進め、起動しない場合にはステップS19に処理を進める。

【0140】ステップS18において、コミュニケーションプログラムは、ステップS17において選択された機能選択ボタンに対応した機能モジュールを起動する。そして、機能モジュールを起動した後に、コミュニケーションプログラムは、ステップS19に処理を進める。

【0141】ステップS19において、コミュニケーションプログラムは、メッセージ送信キューに送信すべきメッセージが存在するか否かを判定する。そして、メッセージ送信キューにメッセージが存在する場合にはステップS20に処理を進め、メッセージが存在しない場合には図11に示すステップS21に処理を進める。

【0142】ここで、コミュニケーションプログラムは、他のコミュニケーションプログラムとの間で画像データ、音声データ、或いは文字データなどの各種情報を授受するに際して、これら情報がメッセージと称される情報単位に分割される。そして、相手のコミュニケーションプログラムに対して送信すべきメッセージがメッセージ送信キューに、相手のコミュニケーションプログラムから受信したメッセージがメッセージ受信キューに、それぞれ一時的に蓄積される。なお、メッセージ送信キュー及びメッセージ受信キューは、例えば、コンピュータ装置10のRAM21における記憶領域内に、予め所定の容量だけ確保されている。

【0143】ステップS20において、コミュニケーションプログラムは、メッセージ送信キューに存在するメッセージをセッションが確立されているサーバに対して送信する。このステップS20における処理の後に、コミュニケーションプログラムは、処理を図11に示すステップS21に進める。

【0144】ステップS21において、コミュニケーションプログラムは、メッセージ受信キューにサーバから受信したメッセージが存在するか否かを判定する。そして、メッセージ受信キューにメッセージが存在する場合には処理をステップS22に進め、メッセージが存在しない場合には処理をステップS25に進める。

【0145】ステップS22において、コミュニケーションプログラムは、メッセージの送信先となる機能モジュール、すなわち、このメッセージを利用する機能モジュールが起動済みであるか否かを判定する。この判定の結果、送信先として該当する機能モジュールが未だ起動されていない場合にはステップS23に処理を進め、起動済みである場合にはステップS24に処理を進める。

【0146】ステップS23において、コミュニケーションプログラムは、メッセージの送信先となる起動モジュールを起動する。そして、送信先として該当する機能モジュールを起動した後に、コミュニケーションプログラムは、処理をステップS24に進める。

【0147】ステップS24において、コミュニケーションプログラムは、メッセージ送信キューに存在するメッセージの送信先として該当する機能モジュールに対して、当該メッセージを送信する。このステップS24における処理の後に、コミュニケーションプログラムは、処理をステップS25に進める。

【0148】ステップS25において、コミュニケーションプログラムは、ユーザから所定の指示操作が行われることにより、実行動作を終了することを要求されているか否かを判定する。この判定の結果、終了することを要求されている場合には、処理をステップS26に進め、終了することを要求されていない場合には、処理を図10に示すステップS13に進めて、上述したステップS13以降の一連の処理を繰り返す。

【0149】ステップS26において、コミュニケーションプログラムは、サーバ機能を実現するサーバモジュールを自身で起動したか否かを判定する。すなわち、当該コミュニケーションプログラムがサーバとして動作しているか否かを判定する。この判定の結果、自身でサーバモジュールを起動した場合には処理をステップS27に進め、自身でサーバモジュールを起動しておらず、クライアントとして動作している場合には、各種の終了処理を行って、一連の処理動作を停止する。

【0150】ステップS27において、コミュニケーションプログラムは、ステップS15において自身で起動したサーバモジュールに対して終了処理を行い、このサーバモジュールの動作を停止する。この後に、コミュニケーションプログラムは、各種の終了処理を行って、一連の処理動作を停止する。

【0151】つぎに、上述したステップS15において起動されるサーバモジュールにおける一連の処理について、図13及び図14に示すフローチャートを参照しながら順を追って説明する。

【0152】サーバモジュールは、実行処理が開始されると、図13に示すステップS50において、クライアントからの接続要求（セッション確立要求）を受信したか否かを判定する。このとき、クライアントとしては、当該サーバモジュールを起動したコミュニケーション

プログラムを構成する他の機能モジュールであってもよいし、他のコンピュータ装置で実行されるコミュニケーションプログラムを構成する機能モジュールであってもよい。そして、この判定の結果、接続要求を受信している場合にはステップS51に処理を進め、受信していない場合にはステップS55に処理を進める。

【0153】ステップS51において、サーバモジュールは、現在接続しているユーザの数が、予め設定された最大人数に達しているか否かを判定する。この判定の結果、最大人数に達していない場合にはステップS52に処理を進め、最大人数に達している場合にはステップS55に処理を進める。

【0154】ステップS52において、サーバモジュールは、新たに接続要求を行ったユーザに対して、ユーザ毎に固有の情報であるユーザIDを生成するとともに、このユーザ側で動作するコミュニケーションプログラムとの間でセッションを確立して接続を行う。これにより、接続要求を行ったユーザ側で動作するコミュニケーションプログラムがクライアントとして、当該サーバモジュールとの間で通信状態が確立され、画像データ、音声データ、或いは文字データなどの各種情報を授受を行うことが可能となる。

【0155】次に、ステップS53において、サーバモジュールは、新たに接続要求を行ったユーザ側でコミュニケーションプログラムを実行するコンピュータ装置のIPアドレスと、このユーザのユーザ名とを取得するとともに、これらIPアドレス及びユーザ名と、ステップS52において生成したユーザIDとをユーザリストに追加する。

【0156】ここで、ユーザリストは、例えば図15に示すようなデータ構造とされており、サーバモジュールに対してセッションの確立が行われたユーザのユーザIDと、このユーザのユーザ名と、このユーザ側でコミュニケーションプログラムを実行するコンピュータ装置のIPアドレスとにより構成されている。

【0157】次に、ステップS54において、サーバモジュールは、セッションが確立されている全てのクライアントに対して、ステップS53において追加したユーザのユーザIDなどを通知する。これにより、サーバモジュールに接続された全てのクライアントは、新たなユーザが接続されたことを知ることができる。このステップS54における処理の後に、サーバモジュールは、ステップS55に処理を進める。

【0158】ステップS55において、サーバモジュールは、セッションが確立されているクライアントとの間で接続状態が切断されたか否かを判定する。この判定の結果、接続状態が切断されている場合にはステップS56に処理を進め、接続状態が切断されていない場合には図14に示すステップS58に処理を進める。このとき、接続状態が切断される要因としては、例えば、サー

バモジュールとクライアントとの間の伝送路において生じた不具合、ユーザによるコミュニケーションモジュールの終了処理などを挙げることができる。

【0159】ステップS56において、サーバモジュールは、ステップS55において接続状態が切断されたと判定されたユーザに関する情報を、ユーザリストから削除する。次に、ステップS57において、サーバモジュールは、ステップS56でユーザリストから削除したユーザに関するユーザIDなどの情報を、セッションが確立されている全てのクライアントに対して通知する。これにより、サーバモジュールに接続された全てのクライアントは、当該ユーザの接続が切断されたことを知ることができる。このステップS57における処理の後に、サーバモジュールは、図14に示すステップS58に処理を進める。

【0160】ステップS58において、サーバモジュールは、接続されたクライアントからメッセージが送信されたか否かを判定する。この判定の結果、送信されている場合にはステップS59に処理を進め、送信されていない場合にはステップS61に処理を進める。

【0161】ステップS59において、サーバモジュールは、メッセージの宛先として指定されたユーザIDを参照し、ユーザリストに基づいて当該ユーザIDに対応したIPアドレスを取得する。次に、ステップS60において、サーバモジュールは、ステップS59において取得したIPアドレスが設定されたコンピュータ装置に対して、インターネット11等のコンピュータネットワークを介してメッセージを送信する。これにより、メッセージが送信先のコミュニケーションプログラムに届けられる。このステップS60における処理の後に、サーバモジュールはステップS61に処理を進める。

【0162】ステップS61において、サーバモジュールは、コミュニケーションプログラムからの終了要求を受信したか否かを判定する。そして、この判定の結果、終了要求を受信した場合には、各種の終了処理を行って、一連の処理動作を停止する。また、終了要求を受信していない場合には、処理を図13に示すステップS50に進めて、上述したステップS50以降の一連の処理を繰り返す。このサーバモジュールに対する終了要求は、図11に示したコミュニケーションプログラムの一連の処理におけるステップS27が処理された場合に相当するものである。

【0163】コミュニケーションプログラムは、以上で説明したようにして一連の処理を行うアプリケーション・プログラムである。上述した一連の処理の説明から明らかであるように、コミュニケーションプログラムは、必要に応じてサーバ或いはクライアントとして動作することが可能とされている。

【0164】(2-7) コミュニケーションプログラムによる画面表示

つぎに、上述したコミュニケーションプログラムがコンピュータ装置10において実行処理されることにより表示部24の画面上に表示されるアプリケーションウィンドウについて、図面を参照しながら順を追って説明する。

【0165】なお、コミュニケーションプログラムは、起動時の条件に応じた状態でウィンドウ表示されるように構成されているが、以下の説明においては、最も基本的な条件の下で実行処理される場合の一例について説明するものとする。

【0166】また、コミュニケーションシステムにおいては、各コンピュータ装置10にコミュニケーションプログラムが実行可能な状態で備えられ、各コンピュータ装置10上でコミュニケーションプログラムが動作して互いに各種情報を授受することにより構成されるが、以下の説明においては、特定のコンピュータ装置10上で動作するコミュニケーションプログラムが実行処理されたときのウィンドウ表示について説明することとする。

【0167】また、以下の説明においては、着目して説明するコミュニケーションプログラムの利用者を「ユーザ」と称し、当該コミュニケーションプログラムに接続されるコミュニケーションプログラムの利用者、すなわち、相手方の利用者を「クライアント」と称することとする。ただし、以下で着目して説明するコミュニケーションプログラムは、必ずしもサーバ機能を果たしている必要はなく、相手側の利用者（クライアント）側で動作するコミュニケーションプログラムによってサーバ機能が果たされていてもよい。

【0168】コミュニケーションプログラムの実行処理が開始されると、表示部24の画面上には、図16に示すようなユーザ情報設定ウィンドウ100が表示される。このユーザ情報設定ウィンドウ100は、コミュニケーションプログラムの起動に際して、ユーザ自身に対応した名前及び顔画像の選択を促すためのウィンドウであり、名前をテキスト入力するためのテキスト入力領域S100と、顔画像に対応した画像ファイルを選択するための顔画像選択領域S101とを有している。

【0169】テキスト入力領域S100は、例えばコンピュータ装置10に接続されたマウスなどにより選択することによって、テキスト入力可能な状態となり、この状態でキーボードなどにより入力したテキストが入力される領域である。このテキスト入力領域S100に入力されたテキストが、以後のコミュニケーションプログラムの処理において、ユーザの名前として設定される。

【0170】顔画像選択領域S101は、予め顔画像として登録されたコンピュータ装置10内に記憶されている画像データに対応したファイル名が一覧表示される領域である。この顔画像表示領域S101に一覧表示されたファイル名がユーザにより選択されることにより、選択されたファイル名に対応した画像データが以後のコミ

ュニケーションプログラムの処理において、ユーザの顔画像として設定される。

【0171】また、ユーザ情報設定ウィンドウ100には、ユーザが任意の画像データを顔画像として設定するに際して、この画像データに対応したファイルを参照するための参照ボタンS102を有している。参照ボタンS102が選択されると、コンピュータ装置10内に存在する画像データを選択するためのファイル選択ウィンドウが表示される。そして、このファイル選択ウィンドウ内でユーザがファイルを選択操作することにより、選択されたファイルに対応した画像データがユーザの顔画像として設定される。また、このようにして選択されたファイルのコンピュータ装置10における所在（パス）は、ユーザ情報設定ウィンドウ100のパス表示領域S103に表示される。なお、パス表示領域S103にパスを指定するテキストを直接入力することにより、任意の画像データ（ファイル）を顔画像として選択可能とされている。

【0172】また、ユーザ情報設定ウィンドウ100は、上述のようにしてユーザにより選択された画像データの内容をプレビュー表示するプレビュー表示領域S104を有している。これにより、コミュニケーションプログラムは、ユーザが所望とする顔画像を容易且つ確実に選択することが可能とされている。

【0173】なお、図16においては、予め選択された状態とされた、いわゆるデフォルトの顔画像がプレビュー表示領域S104に表示された場合の例について図示している。なお、以降の説明においては、このユーザ情報設定ウィンドウ100においてユーザによる顔画像の選択が特になされず、このデフォルトの顔画像が選択された場合を想定して説明する。

【0174】ユーザ情報設定ウィンドウ100は、次の起動時にも上述したようにして名前及び顔画像の選択を行うか否かを設定するためのチェックボックスS105と、名前及び顔画像の選択操作を終了するためのOKボタンS106と、名前及び顔画像の選択操作を中止して、コミュニケーションプログラムの起動を中止するためのキャンセルボタンS107とを有している。

【0175】コミュニケーションプログラムは、チェックボックスS105が「オン」に設定された場合には、次回に起動された際にもユーザ情報設定ウィンドウ100を表示する。一方、チェックボックスS105が「オフ」に設定された場合には、次の起動時にユーザ情報設定ウィンドウ100の表示を省略して、ユーザにより前回設定された名前及び顔画像を参照して用いる。

【0176】ここで、ユーザ情報設定ウィンドウ100におけるOKボタンS106がユーザにより選択されると、コミュニケーションプログラムは、基本表示モードに移行して、図17に示すような基本表示ウィンドウ110を表示する。なお、前回の起動時ユーザ情報設定ウ

ィンドウ100においてチェックボックスS17が「オフ」に設定されている場合には、コミュニケーションプログラムの起動時にユーザ情報設定ウィンドウ100の表示が省略され、起動直後から基本表示モードに移行して基本表示ウィンドウ110が表示される。

【0177】(2-7-1)基本表示モード
ここで、コミュニケーションプログラムが基本表示モードに移行した場合について、図17に示す基本表示ウィンドウ110を参照しながら説明する。

【0178】基本表示ウィンドウ110は、コミュニケーションプログラムが基本表示モードに移行した場合に表示されるウィンドウであり、図17に示すように、ユーザに対応した顔画像が表示されるユーザ顔画像フレームS110と、複数のクライアントに対応した顔画像がそれぞれ表示される複数のクライアント顔画像フレームS111と、各種機能の実行を選択操作するための複数の機能選択ボタンS112とを有している。

【0179】ユーザ顔画像フレームS110は、基本表示ウィンドウ110の中央部に配されており、ユーザにより選択された顔画像を表示する顔画像表示領域S110aと、この顔画像表示領域S110aの下部に位置して、ユーザにより設定された名前を表示する名前表示領域S110bとにより構成されている。

【0180】クライアント顔画像フレームS111は、ユーザ顔画像フレームS110を中心とする仮想円の円周上に所定の間隔で配されている。これらクライアント顔画像フレームS111は、ユーザ顔画像フレームS110に相当してクライアント側の情報を表示するためのフレームであり、それぞれ、各クライアントにより選択された顔画像を表示する顔画像表示領域S111aと、この顔画像表示領域S111aの下部に位置して、各クライアントにより設定された名前を表示する名前表示領域S111bとにより構成されている。

【0181】なお、図17においては、未だクライアントが接続されていない状態を图示している。この状態において、クライアント顔画像フレームS111には、クライアントが接続していないことを示す予め設定された所定の顔画像が表示された状態とされる。

【0182】また、クライアント顔画像フレームS111の各々は、それぞれ初期表示位置を中心とした所定の領域を、ゆるやかに移動しながら表示されている。これにより、基本表示ウィンドウ110においては、各クライアント顔画像フレームS111が、いわば浮遊感を伴って表示された状態とされている。

【0183】機能選択ボタンS112は、ユーザ顔画像フレームS110を中心とした仮想円上に所定の間隔で配されている。なお、機能選択ボタンS112が配される仮想円の半径は、クライアント顔画像フレームS111が配される仮想円の半径よりも小とされている。すなわち、機能選択ボタンS112は、クライアント顔画像

フレームS111よりも内側に位置して表示されている。

【0184】各機能選択ボタンS112には、それぞれ所定の機能が対応付けされている。コミュニケーションプログラムは、ユーザによって機能選択ボタンS112のいずれかが選択操作されると、選択された機能選択ボタンS112に対応した機能を実現する動作モードに移行する。

【0185】図17に示す例においては、機能選択ボタンS112として、「設定」ボタンS112a、「終了」ボタンS112b、「ヘルプ」ボタンS112c、「友達」ボタンS112d、及び「ツール」ボタンS112eが表示された状態を示している。

【0186】設定ボタンS112aは、コミュニケーションプログラムに必要となる各種設定を行うための機能選択ボタンである。コミュニケーションプログラムは、ユーザによって設定ボタンS112aが選択されることにより、例えば、ユーザによる各種操作が行われた際に効果音を鳴らすか否かといった設定項目を表示する設定ウィンドウ(図示を省略する。)を表示する。コミュニケーションプログラムにおいては、この設定ウィンドウにより設定された事項をコンピュータ装置10内の所定の記憶領域に保存し、コミュニケーションプログラム自身の動作に反映させる。

【0187】終了ボタンS112bは、コミュニケーションプログラムの実行処理を終了するための機能選択ボタンである。コミュニケーションプログラムは、ユーザによって終了ボタンS112bが選択されることにより、全体の実行処理を終了する。

【0188】ヘルプボタンS112cは、コミュニケーションプログラムの操作をユーザに説明するヘルプ情報を表示するための機能選択ボタンである。コミュニケーションプログラムは、ユーザによってヘルプボタンS112cが選択されることにより、操作の案内や問題の解決方法などが記述されたヘルプ情報をヘルプウィンドウ(図示を省略する。)に表示する。このようにヘルプ情報を表示することが可能とされていることにより、コミュニケーションプログラムにおいては、操作に不慣れなユーザに対して、自身の動作や機能を分かりやすく説明することができる。

【0189】友達ボタンS112dは、インターネット11に接続された他のユーザ(クライアント)に対して、コミュニケーションプログラムに接続してコミュニケーションに参加することを促すためのボタンである。コミュニケーションプログラムは、ユーザによって友達ボタンS112dが選択されることにより、クライアントに対して参加を促す一連の処理を行う。なお、この処理についての詳細は後述する。

【0190】ツールボタンS112eは、ユーザによる各種操作を実現するツールモードに移行するための機能

選択ボタンである。コミュニケーションプログラムは、ユーザによってツールボタンS112eが選択されると、ツールモードに移行する。なお、このツールモードについての詳細は後述する。

【0191】また、基本表示ウィンドウ110は、ウィンドウの最上部に位置して、基本表示ウィンドウ110の表示状態を操作するための複数の操作アイコンS113が隣接して配されているとともに、ウィンドウの最下部に位置して、必要に応じてコミュニケーションプログラムの動作状態（ステイタス）や各種のメッセージが表示されるステイタス表示領域S114が配されている。

【0192】ここで、図17に示す例においては、操作アイコンS113として、「終了」アイコンS113a、「最大化」アイコンS113b、「最小化」アイコンS113c、及び「表示サイズ変更」アイコンS113dが配された場合について図示している。

【0193】終了アイコンS113aは、コミュニケーションプログラムの実行処理を終了するための操作アイコンである。コミュニケーションプログラムは、ユーザによって終了アイコンS113aが選択されることによって、全体の実行処理を終了する。

【0194】最大化アイコンS113bは、基本表示ウィンドウ110をコンピュータ装置10の表示画面の全面に拡大して表示するための操作アイコンである。コミュニケーションプログラムは、ユーザによって最大化アイコンS113bが選択されると、基本表示ウィンドウ110をコンピュータ装置10の表示画面の全面に拡大して表示する処理を行う。

【0195】最小化アイコンS113cは、基本表示ウィンドウ110の表示を中止して、コンピュータ装置10の表示画面から消去するための操作アイコンである。コミュニケーションプログラムは、ユーザによって最小化アイコンS113cが選択されると、基本表示ウィンドウ110の表示を中止して、コンピュータ装置10の表示画面から消去する処理を行う。なお、このように、表示画面から基本表示ウィンドウ110が消去された状態においても、コミュニケーションプログラムの実行処理は継続される。

【0196】表示サイズ変更アイコンS113dは、基本表示ウィンドウ110を縮小表示する縮小表示モードに移行するための操作アイコンである。コミュニケーションプログラムは、ユーザによって表示サイズ変更アイコンS113dが選択されると、基本表示モードから縮小表示モードに移行する。これにより、基本表示ウィンドウ110の表示領域が縮小され、例えば、図18に示すような縮小表示ウィンドウ120となる。

【0197】(2-7-2) 縮小表示モード
ここで、コミュニケーションプログラムが縮小表示モードに移行した場合について、図18に示す縮小表示ウィンドウ120を参照しながら説明する。

【0198】縮小表示ウィンドウ120は、コミュニケーションプログラムが縮小表示モードに移行した場合に表示されるウィンドウであり、基本表示ウィンドウ110に対して表示領域が小とされ、コンピュータ装置10の画面上で横方向に長いウィンドウ形状とされている。

【0199】ここで、図18に示す縮小表示ウィンドウ120においては、図17に示した基本表示ウィンドウ110と同等な機能を有するフレーム、ボタン、及びアイコンについての説明を省略し、同一の符号を付すこととする。なお、以下の説明においても、図中において同一の符号を付したフレーム、ボタン、及びアイコンは、前出したそれぞれに相当するものであるとして説明する。

【0200】この縮小表示ウィンドウ120においては、中央部に配されたユーザ顔画像フレームS110の両側に複数のクライアント顔画像フレームS111が横方向に並んで配されており、これらユーザ顔画像フレームS110及びクライアント顔画像フレームS111の下部に、機能選択ボタンS112が横方向に並んで配されている。また、縮小表示ウィンドウ120の最上部には、複数の操作アイコンS113が配されている。

【0201】コミュニケーションプログラムは、この縮小表示ウィンドウ120において、ユーザにより表示サイズ変更アイコンS113dが選択されると、縮小表示モードから基本表示モードに移行する。これにより、縮小表示ウィンドウ120の表示領域が拡大され、図17に示した基本表示ウィンドウ110となる。

【0202】すなわち、コミュニケーションプログラムにおいては、ユーザによって表示サイズ変更アイコンS113dが選択されることによって、基本表示モードと縮小表示モードとの間で自在に動作モードを移行することが可能とされている。

【0203】(2-7-3) クライアントの参加
ここで、上述した友達ボタンS112dがユーザによって選択された場合について説明する。コミュニケーションプログラムは、ユーザによって友達ボタンS112dが選択されると、クライアントに対して参加を促す一連の処理を行う。

【0204】このとき、コミュニケーションプログラムは、ユーザが指定したクライアントに対して、接続設定情報を送信する。これにより、接続設定情報に含まれるIPアドレスに基づいてクライアント側からユーザ側に対するセッションの確立が行われて接続が完了することとなる。

【0205】このようにして接続設定情報をユーザからクライアントに対して送信する手法としては、例えば、電子メールに接続設定情報を含むファイルを添付する手法や、いわゆるFTPソフトウェアなどのような、インターネット11に接続されたコンピュータ装置の間で各種のファイル交換を実現するアプリケーションプログラ

ムを用いることによって、接続設定情報をデータ・ファイル或いはアプリケーション・プログラムの形で送出する手法を用いることができる。

【0206】また、クライアント側のコンピュータ装置においては、上述のようにして接続設定情報を受信した後に、例えば、このコンピュータ装置の利用者（ユーザ）による指示操作に応じてコミュニケーションプログラムを起動させるとしてもよいし、ユーザに対して接続開始を通知することなく、ユーザに接続の開始（セッションの確立）を意識させることなく自動的にコミュニケーションプログラムが起動するように構成してもよい。

【0207】（2-7-4）クライアントとの間でのコミュニケーション

ここで、上述のようにして接続設定情報がクライアント側に送信され、クライアントとの間でセッションが確立されると、例えば、図19に示すように、例えば、基本表示ウィンドウ110におけるクライアント顔画像フレームには、接続されたクライアントの顔画像及び名前が表示されることとなる。

【0208】なお、図19においては、女性の半身を模した画像が設定された第1のクライアントと、動物の顔を模した画像が設定された第2のクライアントとの2つのクライアントが接続され、それぞれ、第1のクライアント顔画像フレームS111aと第2のクライアント顔画像フレームS111bとに表示された状態における基本表示ウィンドウ110を図示している。なお、以後の説明においては、これら第1及び第2のクライアントが接続された状態とされていることを想定する。

【0209】ところで、コミュニケーションプログラムは、例えばマウス操作により画面上でカーソルがユーザ顔画像フレームS110に重なるなどして、ユーザによってユーザ顔画像フレームS110が選択されると、図20に示すように、ユーザ顔画像フレームS110を縮小して表示するとともに、縮小表示されたユーザ顔画像フレームS110の近傍位置に、ユーザによってテキスト（文字データ）の入力が可能とされたテキスト入力領域S115を表示する。

【0210】このテキスト入力領域S115は、縮小表示されたユーザ顔画像フレームS110に対して、一般の漫画におけるいわゆる「吹き出し」状の外形を有する領域とされている。そして、コミュニケーションプログラムは、このテキスト入力領域S115に対してユーザによりテキストが入力されると、入力されたテキスト（文字データ）を、現在接続されているクライアントの全てに対して送信する。

【0211】また、コミュニケーションプログラムは、同様にしてクライアントから送信されたテキスト（文字データ）を受信すると、図21に示すように、当該クライアントに対応したクライアント顔画像フレームS111を縮小して表示するとともに、縮小表示されたクライ

アント顔画像フレームS111の近傍位置に、クライアントから送信されたテキストが表示されるテキスト表示領域S116を表示する。このテキスト表示領域S116は、縮小表示されたクライアント顔画像フレームS111に対して、一般の漫画におけるいわゆる「吹き出し」状の外形を有する領域とされている。

【0212】なお、図21においては、第1のクライアントから「こんにちは！」なるテキストが送信され、第1のクライアント顔画像フレームS111aが縮小表示されるとともに、この第1のクライアント顔画像フレームS111aの近傍位置にテキスト表示領域S116が表示された場合について図示している。また、コミュニケーションプログラムにおいては、例えば、複数のクライアントから同時にテキストが送信された場合には、各クライアントに対応したテキスト表示領域S116がそれぞれ表示される。すなわち、4人のクライアントから同時にテキストが送信された場合には、各クライアントに対応したクライアント顔画像フレームS111が縮小表示され、それぞれに吹き出し状のテキスト表示領域S116が表示されることとなる。

【0213】以上のようにして、コミュニケーションプログラムは、ユーザとクライアントとの間で文字データを相互に授受することが可能とされているとともに、複数のクライアントとの間で、同時進行的にテキストの授受を行うことが可能とされている。

【0214】なお、コミュニケーションプログラムにおいて、上述したようなテキスト入力領域S115及びテキスト表示領域S116テキストを利用したテキストの授受は、基本表示モードにおける基本表示ウィンドウ110内のみならず、他の動作モードにおけるウィンドウ内においても可能とされている。

【0215】（2-7-5）ツールモード

ここで、コミュニケーションプログラムがツールモードに移行した場合について、図22に示すツール表示ウィンドウ150を参照しながら説明する。

【0216】ツール表示ウィンドウ150は、コミュニケーションプログラムがツールモードに移行した場合に表示されるウィンドウであり、図22に示すように、基本的には図17に示した基本表示ウィンドウ110と同様な構成とされている。このため、図22に示すツール表示ウィンドウ150においては、図17に示す基本表示ウィンドウ110と同一又は同等のフレーム、ボタン、及びアイコンについては、説明を省略し、同一の符号を付すこととする。

【0217】ツール表示ウィンドウ150は、基本表示ウィンドウ110との相違点として、図17に示した機能選択ボタンS112に代えて、複数の機能選択ボタンS150を有している。機能選択ボタンS150は、図17に示した機能選択ボタンS112と同様に、ユーザ顔画像フレームS110を中心とした仮想円上に所定の

間隔で配されている。なお、機能選択ボタンS150が配される仮想円の半径は、クライアント顔画像フレームS111が配される仮想円の半径よりも小とされている。すなわち、機能選択ボタンS150は、クライアント顔画像フレームS111よりも内側に位置して表示されている。

【0218】各機能選択ボタンS150には、それぞれ所定の機能が対応付けされている。コミュニケーションプログラムは、ユーザによって機能選択ボタンS150のいずれかが選択操作されると、選択された機能選択ボタンS150に対応した機能を実現する動作モードに移行し、この動作モードで必要となる機能モジュールを起動する。

【0219】図22に示す例においては、機能選択ボタンS150として、「感情」ボタンS150a、「アクション」ボタンS150b、「ヘルプ」ボタンS150c、「戻る」ボタンS150d、「画像・音声」ボタンS150e、「チャットログ」ボタンS150f、「Webブラウザ」ボタンS150g、及び「情報収集」ボタンS150hが表示された状態を示している。

【0220】感情ボタンS150aは、ユーザによる感情表現を実現する感情表現モードに移行するための機能選択ボタンである。コミュニケーションプログラムは、ユーザによって感情ボタンS150aが選択されると、感情表現モードに移行する。

【0221】アクションボタンS150bは、ユーザによる他のクライアントに対するアクション表現を実現するアクション表現モードに移行するための機能選択ボタンである。コミュニケーションプログラムは、ユーザによってアクションボタンS150bが選択されると、アクション表現モードに移行する。

【0222】ヘルプボタンS150cは、図17に示した基本表示ウィンドウ110におけるヘルプボタンS112cに相当し、コミュニケーションプログラムの操作をユーザに説明するヘルプ情報を表示するための機能選択ボタンである。コミュニケーションプログラムは、ユーザによってヘルプボタンS150cが選択されることにより、操作の案内や問題の既決方法などが記述されたヘルプ情報をヘルプウィンドウ（図示を省略する。）に表示する。

【0223】戻るボタンS150dは、ツールモードを終了して基本表示モードに移行するための機能選択ボタンである。コミュニケーションプログラムは、ユーザによって戻るボタンS150dが選択されると、ツールモードを終了して基本表示モードに移行する。

【0224】画像・音声ボタンS150eは、ユーザによる画像や音声に関する各種設定操作を実現する画像音声設定モードに移行するための機能選択ボタンである。コミュニケーションプログラムは、ユーザによって画像・音声ボタンS150eが選択されると、画像音声設定モ

ードに移行する。

【0225】チャットログボタンS150fは、チャットログを表示するチャットログ表示モードに移行するための機能選択ボタンである。コミュニケーションプログラムは、ユーザによってチャットログボタンS150fが選択されると、チャットログ表示モードに移行する。

【0226】WebブラウザボタンS150gは、Webブラウジングモードに移行するための機能選択ボタンである。コミュニケーションプログラムは、ユーザによってWebブラウザボタンS150gが選択されると、Webブラウジングモードに移行する。

【0227】情報収集ボタンS150hは、情報収集モードに移行するための機能選択ボタンである。コミュニケーションプログラムは、ユーザによって情報収集ボタンS150hが選択されると、情報収集モードに移行する。

【0228】また、コミュニケーションプログラムは、ツール表示ウィンドウ150が表示された状態において、表示サイズ変更アイコンS113dがユーザにより選択されると、図18に示した縮小表示ウィンドウ120となる。このとき、ツールモードの状態では縮小表示ウィンドウ120となった場合には、図18に示した縮小表示ウィンドウ120内には、各機能選択ボタンS112に代えて、上述した機能選択ボタンS150が表示されることとなる。また、図18に示した縮小表示ウィンドウ120の状態ではツールモードに移行した場合には、縮小表示ウィンドウ120の状態のままで、各機能選択ボタンS112に代えて、上述した機能選択ボタンS150が表示されることとなる。

【0229】すなわち、コミュニケーションプログラムにおいては、動作モードに依存せず、最大化アイコンS113bと最小化アイコンS113cとに対応して、ウィンドウが最大化された状態、又はウィンドウが最小化された状態となることが可能とされている。また、表示サイズ変更アイコンS113dがユーザによって選択される毎に、基本表示ウィンドウ110或いはツール表示ウィンドウ150に相当する標準サイズで表示された状態、又は縮小表示ウィンドウ120に相当する縮小サイズで表示された状態となることが可能とされている。

【0230】（2-7-6）情報収集モード
ここで、ユーザによって情報収集ボタンS150hが選択され、コミュニケーションプログラムが情報収集モードに移行した場合について、図23に示す情報収集ウィンドウ220を参照しながら説明する。なお、図23に示す情報収集ウィンドウ220は、互いにセッションが確立された複数のコミュニケーションプログラムのうち、最初に情報収集モードに移行したコミュニケーションプログラムについて図示するものであり、後述する一連の情報収集処理においてサーバ側となるコミュニケーションプログラムで情報収集モードに移行した直後の状

態を図示するものである。

【0231】情報収集ウィンドウ220は、コミュニケーションプログラムが情報収集モードに移行した場合に表示されるウィンドウであり、図23に示すように、図18に示した縮小表示ウィンドウ120の下部に、新たに情報収集領域S220が確保された構成とされている。

【0232】情報収集領域S220内の上部には、収集する情報に関する設問を文字入力するための設問入力領域S221と、この設問に対する回答を要求する制限時間を入力するための制限時間入力領域S222とを有している。また、情報収集領域S220内で設問入力領域S221の下方には、設問に対する一対の対極的な回答基準をそれぞれ入力するための第1の回答基準入力領域S223及び第2の回答基準入力領域S224を有している。

【0233】情報収集領域S220の下部には、コメント入力領域S225と、第1乃至第3の入力先選択ボタンS226、S227、S228と、第1及び第2のコメント表示領域S229、S230とを有している。

【0234】これらコメント入力領域S225、第1乃至第3の入力先選択ボタンS226、S227、S228、第1及び第2のコメント表示領域S229、S230は、それぞれ、先の説明で図1に図示したテキスト入力領域1、第1乃至第3の入力先選択ボタン4、5、6、第1及び第2のチャット内容表示領域2、3に相当するものであり、それぞれと同等の機能を有するものである。

【0235】また、情報収集領域S220の中央付近の領域は、図1で説明した回答領域1に相当する回答領域S231として設定されている。回答領域S231内には、セッションが確立されている各ユーザの顔画像フレームS110、S111a、S111bが表示されている。

【0236】これらの顔画像フレームS110、S111a、S111bは、図1で説明したアイコン3に相当する機能を果たす目的で回答領域S231内に表示されており、回答領域S231内でそれぞれ各ユーザの回答に対応した位置に移動され、表示されるものである。ここで、回答領域S231内に表示される顔画像フレームS110、S111a、S111bは、それぞれ、情報収集ウィンドウ220の上部に配された縮小表示ウィンドウ120内に表示された顔画像フレームS110、S111a、S111bに対応するものであり、各ユーザの回答結果に対応付けがなされている。

【0237】また、この回答領域S231には、情報収集を行う際に生じる意見の対立を調整する第三者としての人物を表現するアイコンS232が表示されている。コミュニケーションシステムにおいては、例えば後に示す図26及び図27に示すように、アイコンS232に

隣接した位置に、必要に応じて吹き出し形状の説明表示領域S233を表示し、この説明表示領域S233内にユーザの操作手順や、各ユーザの現在の回答状況などを説明するテキストが表示される。これにより、ユーザが行うべき操作や現在の回答状況などをユーザに対して示すことができ、操作の混乱を防止して情報の収集を円滑に行うことができる。

【0238】なお、コミュニケーションシステムにおいては、情報収集モードで動作する場合においても、図20及び図21を参照した先の説明と同様にして、縮小表示ウィンドウ120内でテキストの授受を行うことにより、複数のユーザ間でのコミュニケーションを図ることが可能とされている。

【0239】以上のように構成された情報収集ウィンドウ220が表示された状態で、情報収集処理におけるサーバ側となるユーザによって、設問入力領域S221、制限時間入力領域S222、第1及び第2の回答基準入力領域S223、S224に対してそれぞれ、設問内容を示すテキスト、制限時間を示す数値、第1の回答基準、及び第2の回答基準が入力されると、情報収集モジュールによって情報収集処理が開始される。

【0240】ここで、上述のようにしてサーバ側で設問などが入力・決定されるまでの間に、クライアント側に表示される情報収集ウィンドウ220の一例を、図24に示す。このとき、クライアント側の情報収集ウィンドウ220には、図24に示すように、設問入力領域S221、制限時間入力領域S222、第1及び第2の回答基準入力領域S223、S224は表示されない。これにより、設問等の設定がサーバ側のユーザのみに限定され、複数のユーザによって設問等が入力されることにより生じる混乱を防止することができる。

【0241】つぎに、サーバ側で設問等が入力・決定され、情報収集処理が開始された状態における情報収集ウィンドウ220の一例について、図25に示す。なお、この状態においては、情報収集処理におけるサーバ側とクライアント側との双方で、情報収集ウィンドウ220が図25に示すような表示内容とされる。また、以下では、サーバ側のユーザにより、「明日、どこへ行く？」という設問、「3」分という数値、「海」及び「ハイキング」という回答基準が設定された場合について例示している。これらの設問等は、それぞれ、設問入力領域S221、制限時間入力領域S222、第1及び第2の回答基準入力領域S223、S224の表示位置に対応した位置に表示される。また、回答領域S231内の右上部には、各ユーザが最終的な回答を行う意思が固まったときに選択される回答同意ボタンS234が配されている。

【0242】ここで、情報収集処理が開始されると、各ユーザは、この情報収集ウィンドウ220内に配された各部S225～S230を用いて、設問に対する回答を

行うに際しての討論を行うことが可能とされている。

【0243】具体的には、コメント入力領域S225に対してユーザにより入力されたテキストが、第1乃至第3の入力先選択ボタンS226～S228の選択状態に応じて、第1のテキスト表示領域S229又は第2のテキスト表示領域S230内に記入される。このとき第1又は第2のテキスト表示領域S229、S230に記入された内容は、他のコンピュータ装置上で動作するコミュニケーションプログラムに送信され、各コンピュータ装置の表示画面に表示された情報収集ウィンドウ220における第1及び第2のテキスト表示領域S229、S230にそれぞれ表示される。コミュニケーションシステムにおいては、このようにして複数のユーザの間でメッセージ（テキスト入力領域S225に入力されたテキスト）を交換することにより、設定された設問に関して討論を行うことが可能である。

【0244】また、各ユーザは、例えばコンピュータ装置10に接続されたマウスを用いて、画面上に表示されるマウスカーソルによりいわゆるドラッグ操作を行うことなどによって、自分の顔画像フレーム（本例においては顔画像フレームS110）を回答領域S231内の任意の位置に移動操作可能とされている。そして、各ユーザにより回答領域内に表示された顔画像フレームが移動されると、この顔画像フレームの座標がセッションが確立された全てのコンピュータ装置に送出され、各顔画像フレームの表示位置がそれぞれのコンピュータ装置の表示画面上における情報収集ウィンドウ220に反映される。

【0245】なお、本例においては、回答領域S231がX軸及びY軸により設定された2次元平面として構成されており、顔画像フレームは、この回答領域S231内で任意の位置に移動させることが可能である。ここで、回答領域S231のX軸は、後述するように、各ユーザの回答内容を示す目的で用いられる。なお、回答領域S231のY軸は、複数の顔画像フレームが重なってしまうことを防止する目的で設定されている。

【0246】また、十分な討論が行われるなどして、設定された設問に対する回答の意思が固まったユーザは、回答同意ボタンS234を選択する。そして、コミュニケーションシステムにおいては、全てのユーザがそれぞれ回答同意ボタンS234を選択された場合、又は予めサーバ側となるユーザにより設定された制限時間が経過した場合に、設問回答状態に移行する。

【0247】設問回答状態に移行すると、情報収集ウィンドウ220は、図26に示す表示内容となる。この設問回答状態においては、回答領域S231内に他のユーザの顔画像フレームS111a、S111bが表示されない。これにより、各ユーザは、他のユーザの回答内容に左右されずに回答することができる。

【0248】設問回答状態とされた情報収集ウィンドウ

220において、各ユーザは、回答領域S231内で自身の顔画像アイコンS110を移動操作する。このとき、顔画像アイコンS110を回答領域S231の中央位置から左に移動させるほど、第1の回答基準（本例では、「明日、どこへ行く？」という設問に対して「海」という回答）に意見が傾いていることを示し、顔画像アイコンS110を回答領域S231の中央位置から右に移動させるほど、第2の回答基準（本例では、「ハイキング」という回答）に意見が傾いていることを示している。また、顔画像アイコンS110を回答領域S231の中央付近に移動させた場合には、第1及び第2の回答基準に対して、中立的な意見（「どちらでもない」）であることを示している。

【0249】ここで、回答領域S231における中心のX座標が「0」であり、右方向に正の値が設定されているものとする。顔画像アイコンS110の表示位置のX座標が負である場合に、このユーザの意見（回答）が第1の回答基準に傾いていることを示し、顔画像アイコンS110のX座標が正である場合に、このユーザの意見が第2の回答基準に傾いていることを示す。また、このX座標の絶対値が大きい程それぞれの回答基準に近いことを示し、絶対値が小さい場合には中立的な意見であることを示すこととなる。

【0250】この設問回答状態においては、各ユーザにより、例えば自身の顔画像フレームに対してマウスカーソルによりいわゆるダブルクリック操作が行われることにより、最終的な回答が決定することとなる。

【0251】コミュニケーションシステムにおいては、各ユーザによる回答結果が、所定の回答データとしてサーバ側のコミュニケーションプログラムに送信され、このサーバ側のコミュニケーションプログラムによって集計処理又は分析処理される。

【0252】そして、サーバ側のコミュニケーションプログラムによって例えば各顔画像フレームのX座標の平均値を算出するなどして集計処理された結果を、サーバ側からクライアント側のコミュニケーションプログラムに送出することにより、情報収集ウィンドウ220は図27に示すような内容となる。なお、図27においては、自身の顔画像フレームS110の表示位置が、集計処理によって算出された座標に表示された状態を図示している。これにより、各ユーザは、他の全員の意見を集計した結果を知ることができる。

【0253】（2-7-7）情報収集モードにおける処理

つぎに、コミュニケーションプログラムが情報収集モードで動作する場合の一連の処理の流れについて、図28に示すフローチャートを参照しながら説明する。なお、以下では、複数のコンピュータ装置10上で各々動作する複数のコミュニケーションプログラムのうち、最初に情報収集モジュールが起動して情報収集モードに移行す

るコミュニケーションプログラムに注目して説明する。また、以下で説明する処理は、コミュニケーションプログラムを構成する各種のモジュール（例えば、コアモジュール51、基本モジュール52、或いは情報収集モジュール等のアプリケーションモジュール53）が連携して動作することによって実現されるものである。

【0254】コミュニケーションプログラムは、ユーザによって情報収集ボタンS150hが選択されることにより情報収集モードに移行すると、図28に示すステップS240において、図23に示した情報収集ウィンドウ220をコンピュータ装置10の表示画面上に表示する。これにより、コミュニケーションシステムにおいては、当該コミュニケーションプログラムが情報収集処理におけるサーバとして機能することとなる。また、これにより、サーバ側のコミュニケーションプログラムでは、設問入力領域S221、制限時間入力領域S222、第1及び第2の回答基準入力領域S223、S224などにより、設問等が入力可能な状態となる。

【0255】次にステップS241において、コミュニケーションプログラムは、セッションが確立されている他のコミュニケーションプログラムに対して、情報収集モジュールを起動する要求を送信する。これにより、ステップS242において、これら他のコミュニケーションプログラム（クライアント側のコミュニケーションプログラム）上でそれぞれ情報収集モジュールが起動する。この後、クライアント側のコミュニケーションプログラムは、サーバ側で設問等が設定されるまで待機状態となり、図24に示した情報収集ウィンドウ220を表示する。

【0256】次にステップS243において、サーバ側のコミュニケーションプログラムは、ユーザによって設問入力領域S221等に設問等が正しく入力され、設問や回答基準などが決定されたか否かを判定する。この判定の結果、設問等が全て入力され、決定されている場合には処理をステップS244に進め、設問等が未だ決定されていない場合には処理をステップS242に戻して、ステップS243における判定処理を繰り返す。

【0257】ステップS244において、コミュニケーションプログラムは、図29に示すテキストデータの共有処理を行う。このテキストデータの共有処理においては、サーバ側のコミュニケーションプログラムとクライアント側のコミュニケーションプログラムとの双方で、図29に示すようにテキストの送信処理とテキストの受信処理とが共に行われる。

【0258】ここで、テキストの送信処理としては、所定の時間だけ待ち状態とした後に（ステップA50）、コメント入力領域S225にユーザによってテキストが入力され、第1乃至第3の入力先選択ボタンS226～S228が適切に選択されることにより、入力されたテキストを第1のテキスト表示領域S229と第2のテキ

スト表示領域S230のうちの何れに記入するかが決定されているか否かを判定する（ステップA51）。そして、テキストが入力され、このテキストの記入対象が決定している場合には、入力されたテキスト、当該コミュニケーションプログラムを操作するユーザ毎に設定されたユーザID、及びテキストの記入対象を示す情報を含むコメントデータを、セッションが確立された全てのコミュニケーションプログラムに対して送信する（ステップA52）。また、テキストの入力や記入対象の決定が未だ行われていない場合には、処理をステップA50に戻す。

【0259】また、テキストの受信処理としては、所定の時間だけ待ち状態とした後に（ステップB50）、コメントデータを受信したか否かを判定する（ステップB51）。そして、受信している場合には、コメントデータに含まれる情報に基づいて、第1のテキスト表示領域S229と第2のテキスト入力領域S230とのうちの一方に、受信したテキストを記入して表示する（ステップB52）。このとき、ユーザIDを参照することにより、このテキストを入力したユーザに設定されたユーザ名を併せて記入・表示するとしてもよい。これにより、記入されるテキストがどのユーザにより入力されたものであるかを見分けることができる。また、ステップB51において、コメントデータが受信されていない場合には、処理をステップB50に戻す。

【0260】以上のようなステップS244におけるテキストデータの共有処理を行った後に、コミュニケーションプログラムは、ステップS245において図30に示す座標データの共有処理を行う。この座標データの共有処理においては、サーバ側のコミュニケーションプログラムとクライアント側のコミュニケーションプログラムとの双方で、図30に示すように座標データの送信処理と座標データの受信処理とが共に行われる。

【0261】ここで、座標データの送信処理としては、所定の時間だけ待ち状態とした後に（ステップA60）、当該コミュニケーションプログラムのユーザに対応した顔画像フレームS110が回答領域S231内で移動され、この顔画像フレームS110の座標が変更されたか否かを判定する（ステップA61）。そして、座標が変更されている場合には、顔画像フレームS110の座標を示す座標データと、当該ユーザに固有のユーザIDとを、セッションが確立された全てのコミュニケーションプログラムに対して送信する（ステップA62）。また、座標が変更されていない場合には、処理をステップA60に戻す。

【0262】また、座標データの受信処理としては、所定の時間だけ待ち状態とした後に（ステップB60）、座標データ及びユーザIDを受信したか否かを判定する（ステップB61）。そして、受信している場合には、ユーザIDを参照することにより送信元のユーザを特定

し、このユーザに対応した顔画像フレーム（例えば顔画像フレームS111a又は顔画像フレームS111bなど）を座標データが示す位置まで回答領域S231内で移動させて表示する。また、座標データ及びユーザIDを受信していない場合には、処理をステップB60に戻す。

【0263】以上のようなステップS245における座標データの共有処理を行った後に、コミュニケーションプログラムは、図28に示すステップS246において、サーバ側となるユーザによって設定された回答までの制限時間が経過したか、或いは全てのユーザが回答同意ボタンS234を選択したか否か（すなわち、最終的な回答を行う準備が整ったか否か）を判定する。この判定の結果、準備が整っている場合には処理をステップS247に進め、準備が整っていない場合には処理をステップS244に戻す。

【0264】ステップS247において、コミュニケーションプログラムは、情報収集ウィンドウ220の表示内容を図26の状態とし、当該コミュニケーションプログラムのユーザ以外のユーザに対応する顔画像フレーム（本例では顔画像フレームS111a及び顔画像フレームS111b）を非表示とする。

【0265】次にステップS248において、コミュニケーションプログラムは、当該コミュニケーションプログラムのユーザにより、顔画像フレームS110の回答領域S231内での座標が決定されると、この顔画像フレームS110の座標とユーザIDとを、例えば図3に示した座標データD1に相当する構造のデータとしてサーバ側のコミュニケーションプログラムに対して送信する。なお、サーバ側のコミュニケーションプログラムにおいては、自分自身に向けて送信することとなるが、コミュニケーションプログラムは実際にはモジュール単位で動作しているため、この場合にはモジュール間で送信が行われることとなる。

【0266】次にステップS249において、サーバ側のコミュニケーションプログラムは、各ユーザから送信された各々の座標データを受信して、全ての座標データに関して集計処理又は分析処理を行い、その結果をセッションが確立された全てのコミュニケーションプログラムに対して送信する。これにより、情報収集処理においてサーバ側及びクライアント側として動作する全てのコンピュータ装置10の表示画面上に、図27に示した状態の情報収集ウィンドウ220が表示される。

【0267】本例に係るコミュニケーションシステムにおいては、図1を参照して説明した場合と同様に、コメント入力領域S225にテキストを入力した状態で第1乃至第3の入力選択ボタンS226、S227、S228のいずれかを選択するという極めて簡便な操作により、第1のテキスト表示領域S229及び第2のテキスト表示領域S230のうちから任意のテキスト表示領域

を入力対象として選択し、このテキスト表示領域に対してテキストを入力することができる。したがって、テキスト表示領域が2つ設定されているのに対して、ユーザによってテキストの入力操作が行われるコメント入力領域S225は1つだけ用意するだけで十分となり、入力領域と表示領域と確定ボタンとが組とされた従来の入力方式を用いる場合と比較して、画面上の構成物を減らすことができる。したがって、表示画面の美観が向上し、ユーザに対して煩雑な印象を与えることがない。

【0268】また、コメント入力領域S225にテキストが入力されていない状態で第1乃至第3の入力選択ボタンS226、S227、S228のいずれかが選択されると、選択された入力選択ボタンが選択継続状態となり、これ以降入力されたテキストが当該入力先選択ボタンに対応したテキスト表示領域に対して入力されることとなる。したがって、特定のテキスト表示領域に対して連続して入力（書き込み）を行う場合においても、入力を行う度に入力先選択ボタンを選択操作する必要がない。すなわち、特定のテキスト表示領域に対する連続した入力操作を極めて円滑に行うことができる。

【0269】したがって、本例に係るコミュニケーションシステムを利用することにより、各ユーザ自身の意思や立場を明確に表現しながら、極めて良好な操作性を確保しながら柔軟に意思や感情をユーザ間で交換して会議や討論を行うことができる。

【0270】なお、上述の説明においては、設問に対して最終的な回答を行う際に他のユーザに対応した顔画像フレームが非表示となり、各ユーザが他のユーザの回答状況を個別に知ることができない場合について例示したが、例えば他のユーザの顔画像フレームを非表示とせず、他のユーザの回答状況を鑑みながら最終的な回答を行う構成としてもよい。

【0271】(3) 他の実施の形態

なお、上述においては、本発明の実施の形態として、コミュニケーションシステムを構成する各情報処理装置上で実行処理されるコミュニケーションプログラムに注目して説明したが、本発明は、このようなコミュニケーションプログラムが実行処理されることにより実現されるコミュニケーションシステム、上述したコミュニケーションプログラムにより実行される処理に相当する手続きが行われることにより実現されるコミュニケーション方法、或いは、上述したコミュニケーションプログラムにより実行される処理に相当する手続きが他のソフトウェア又はハードウェア的手法により実現される情報処理装置に対して、広く適用することができることは述べるまでもない。

【0272】また、上述したコミュニケーションプログラムにより実行される処理に相当する手続きを所望の電子機器で実行処理させるソフトウェアプログラムを各種の記録媒体に格納して提供するとしてもよい。

【0273】

【発明の効果】本発明によれば、一時記憶領域に対して情報が入力された下でいずれかの入力先選択ボタンを選択することによって、選択された入力先選択ボタンに対応した情報記憶領域に当該情報が格納される。また、一時記憶領域に対して情報が入力されていない状態の下で入力先選択ボタンが選択された場合には、この入力先選択ボタンが選択継続状態となり、これ以降入力された情報が当該入力先選択ボタンに対応した情報記憶領域に対して格納されることとなる。

【0274】したがって、入力された情報の格納対象が複数設定されている場合であっても、自然な操作で円滑に且つ連続的に情報の入力操作を行なうことができる。これにより、本発明を適用して、例えば掲示板システムやチャットシステムを構築した場合に、テーマや意見に応じて複数配設された掲示板或いはチャットルーム等に対して、簡便な操作で極めて柔軟に書き込み操作或いは発言操作を行うことができる。

【図面の簡単な説明】

【図1】本発明の最も基本的な構成とされた実施の形態として示すチャットシステムにおける画面例を示す模式図である。

【図2】同チャットシステムで用いられる入力先選択ボタンの状態が遷移する様子を示す状態遷移図である。

【図3】同チャットシステムで用いられる入力先選択ボタンの状態に応じて、テキストの入力先を選択する動作を示すフローチャートである。

【図4】同チャットシステムで用いられる入力先選択ボタンの状態に応じて、テキストの入力先を選択する動作を示すフローチャートである。

【図5】本発明の実施の形態として示すコミュニケーションシステムの全体的な基本構成を示す概略図である。

【図6】同コミュニケーションシステムに用いられるコンピュータ装置の構成を示す機能ブロック図である。

【図7】同コンピュータ装置上で実行処理されるコミュニケーションプログラムのモジュール構造を示す模式図である。

【図8】同コミュニケーションプログラムによりデータが送受信されることにより、当該コミュニケーションプログラムを構成するアプリケーションモジュールが起動される場合について説明する模式図である。

【図9】同コミュニケーションプログラムにおいて用いられる接続設定情報のデータ構造を示す模式図である。

【図10】同コミュニケーションプログラムが実行されることによる全体的な処理の流れについて示すフローチャートである。

【図11】同コミュニケーションプログラムが実行されることによる全体的な処理の流れについて示すフローチャートである。

【図12】同コミュニケーションプログラムで用いられ

る機能モジュールリストのデータ構造を示す模式図である。

【図13】同コミュニケーションプログラムにおいて起動されるサーバモジュールによる処理の流れについて示すフローチャートである。

【図14】同コミュニケーションプログラムにおいて起動されるサーバモジュールによる処理の流れについて示すフローチャートである。

【図15】同コミュニケーションプログラムにおいて起動されるサーバモジュールで用いられるユーザリストのデータ構造を示す模式図である。

【図16】同コミュニケーションプログラムが実行されることによりコンピュータ装置の画面上に表示されるユーザ情報設定ウィンドウの一例を示す模式図である。

【図17】同コミュニケーションプログラムが実行されることによりコンピュータ装置の画面上に表示される基本表示ウィンドウの一例を示す模式図である。

【図18】同コミュニケーションプログラムが実行されることによりコンピュータ装置の画面上に表示される縮小表示ウィンドウの一例を示す模式図である。

【図19】同コミュニケーションプログラムにクライアントが接続され、基本表示ウィンドウ内にクライアントに対応した画像が表示された状態の一例を示す模式図である。

【図20】同コミュニケーションプログラムにおいて、ユーザ側から文字データ（テキスト）を送信する場合における基本表示ウィンドウの一例を示す模式図である。

【図21】同コミュニケーションプログラムにおいて、クライアント側から送信された文字データ（テキスト）が表示された場合における基本表示ウィンドウの一例を示す模式図である。

【図22】同コミュニケーションプログラムが実行されることによりコンピュータ装置の画面上に表示されるツール表示ウィンドウの一例を示す模式図である。

【図23】同コミュニケーションプログラムが実行されることによりコンピュータ装置の画面上に表示される情報収集ウィンドウの一例を示す模式図である。

【図24】同コミュニケーションプログラムが実行されることによりコンピュータ装置の画面上に表示される情報収集ウィンドウの一例を示す模式図である。

【図25】同コミュニケーションプログラムが実行されることによりコンピュータ装置の画面上に表示される情報収集ウィンドウの一例を示す模式図である。

【図26】同コミュニケーションプログラムが実行されることによりコンピュータ装置の画面上に表示される情報収集ウィンドウの一例を示す模式図である。

【図27】同コミュニケーションプログラムが実行されることによりコンピュータ装置の画面上に表示される情報収集ウィンドウの一例を示す模式図である。

【図28】同コミュニケーションプログラムにおいて

報収集処理が行われる場合における処理の流れについて示すフローチャートである。

【図29】同情報収集処理において行われるテキストデータの共有処理についての流れを示すフローチャートである。

【図30】同情報収集処理において行われる座標データの共有処理についての流れを示すフローチャートである。

【符号の説明】

1 テキスト入力領域、2 第1のチャット内容表示領域、3 第2のチャット内容表示領域、4 第1の入力先選択ボタン、5 第2の入力先選択ボタン、6 第3の入力先選択ボタン、10 コンピュータ装置、11 インターネット、20 CPU、21 RAM、50 インターフェースモジュール、51 コアモジュール、

52 基本モジュール、53 アプリケーションモジュール、54 GUIモジュール、110 基本表示ウィンドウ、S110 ユーザ顔画像フレーム、S111 クライアント顔画像フレーム、S112 機能選択ボタン、S113 操作アイコン、S114 ステータス表示領域、S115 テキスト入力領域、S116 テキスト表示領域、120 縮小表示ウィンドウ、150 ツール表示ウィンドウ、S150 機能選択ボタン、220 情報収集ウィンドウ、S220 情報収集領域、S225 コメント入力領域、S226 第1の入力先選択ボタン、S227 第2の入力先選択ボタン、S228 第3の入力先選択ボタン、S229 第1のテキスト表示領域、S230 第2のテキスト表示領域、S231 回答領域

【図1】

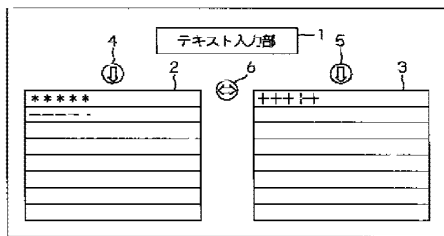

【図3】

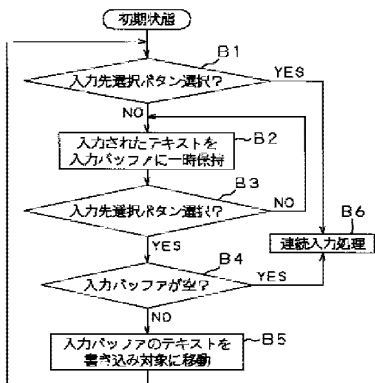

【図2】

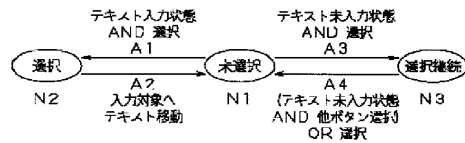

【図4】

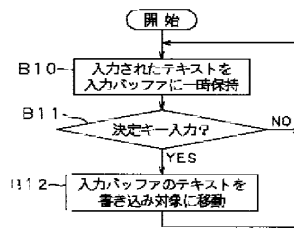

【図7】

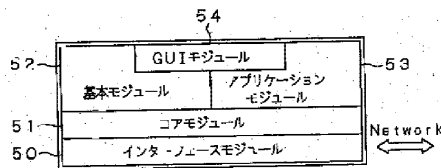

コミュニケーションプログラムのモジュール構造

【図5】

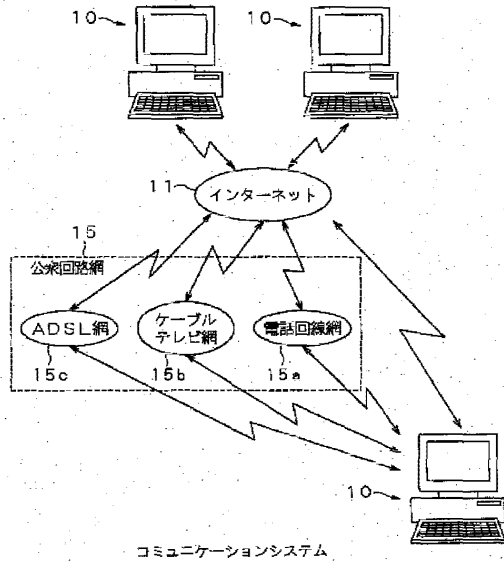

コミュニケーションシステム

【図9】

アクセスキー
 使用するポート番号
 サーバーに割り当てられているIPアドレス数
 サーバーのIPアドレス1
 サーバーのIPアドレス2
 ...

【図10】

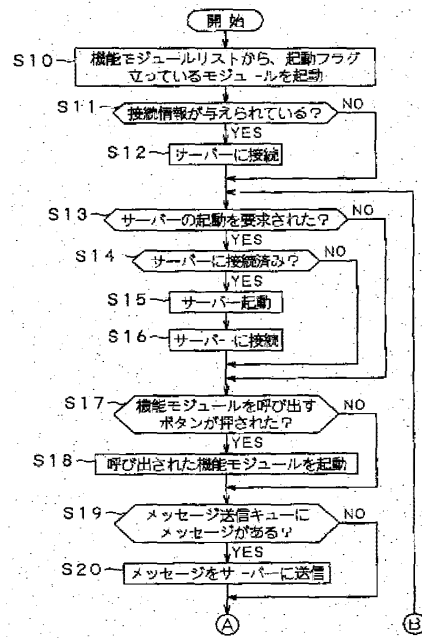

【図6】

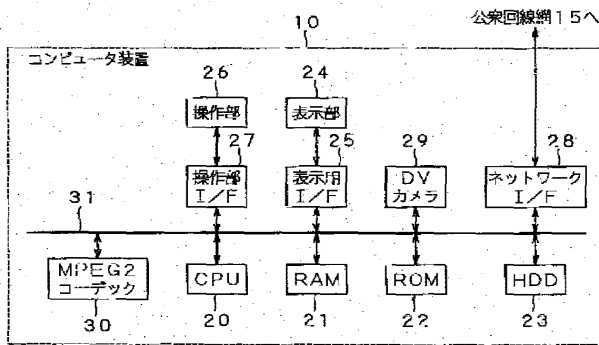

コンピュータ装置の構成

【図14】

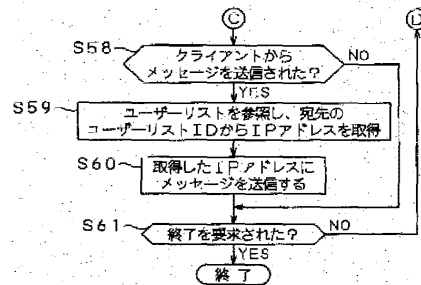

【図12】

ID	モジュール名	タイプ	起動フラグ
0x00001001	ChatMer	0x00000000	0x01
0x00001007	JoinLive	0x00000005	0x00
...

【図8】

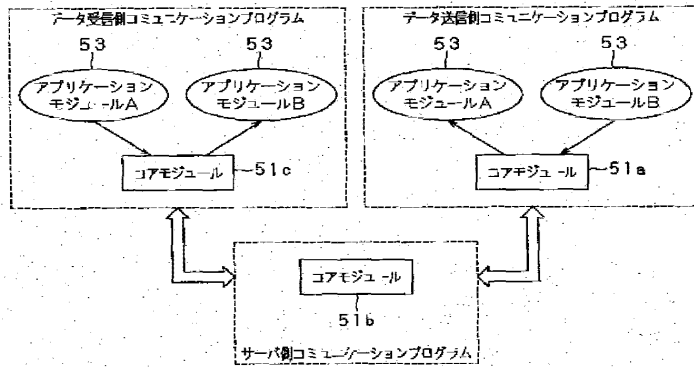

【図11】

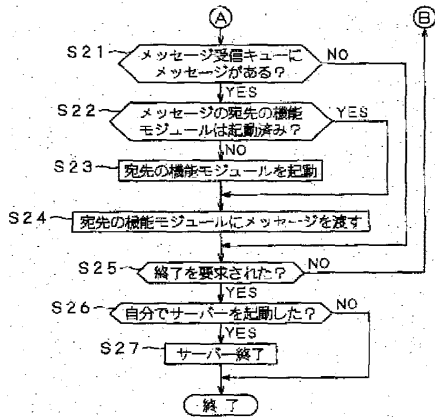

【図13】

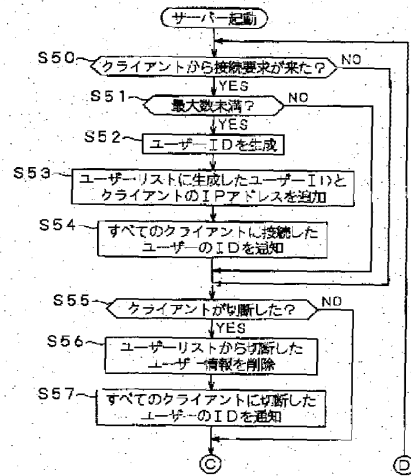

【図15】

ID	ユーザー名	IPアドレス
0x000098/6	Suzuki	201.123.45.6
0x00001234	Sato	192.168.1.2
...

ユーザーリスト

【図16】

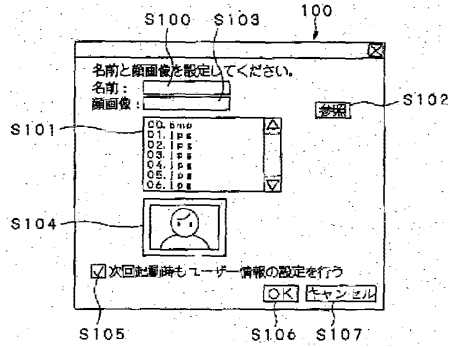

【図17】

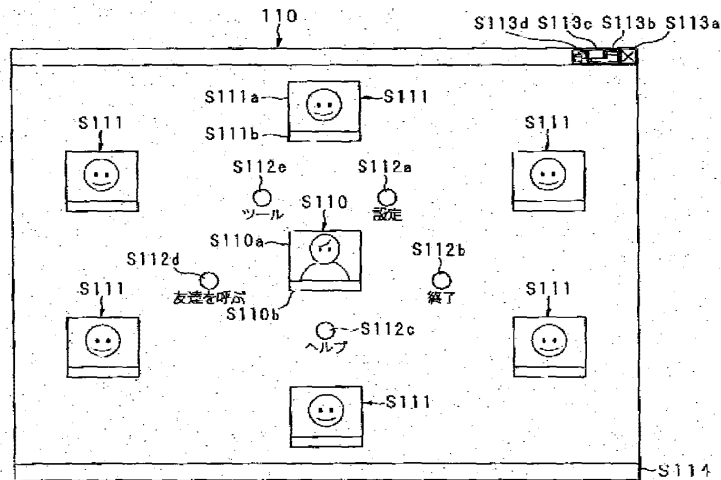

【図18】

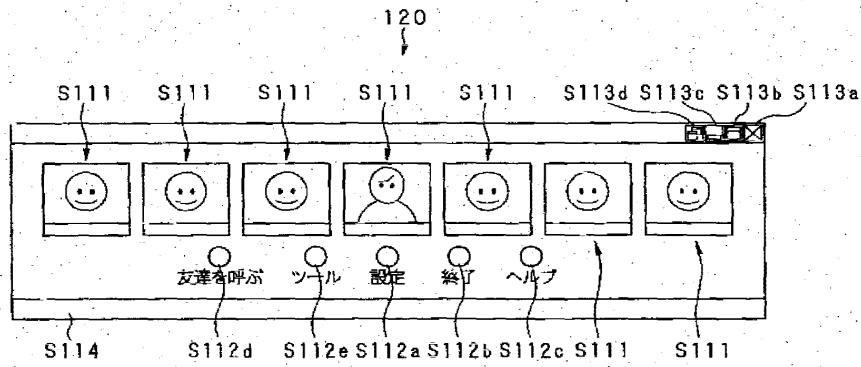

【図19】

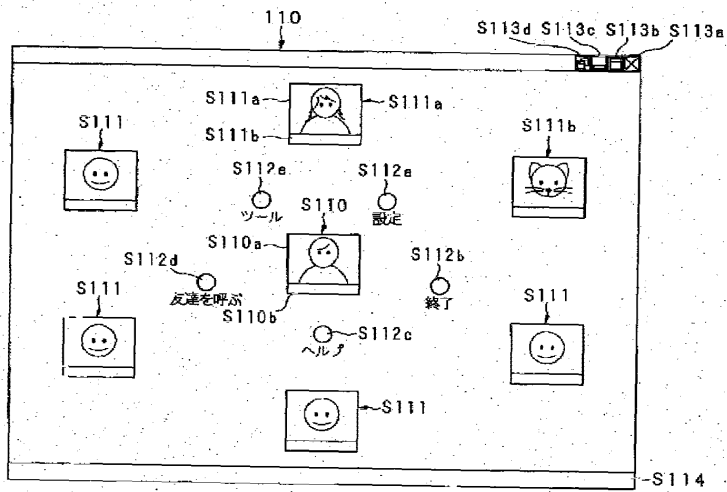

【図20】

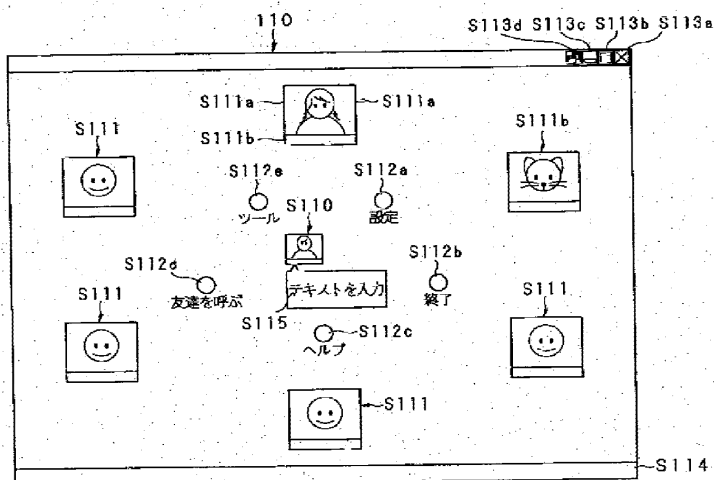

【図21】

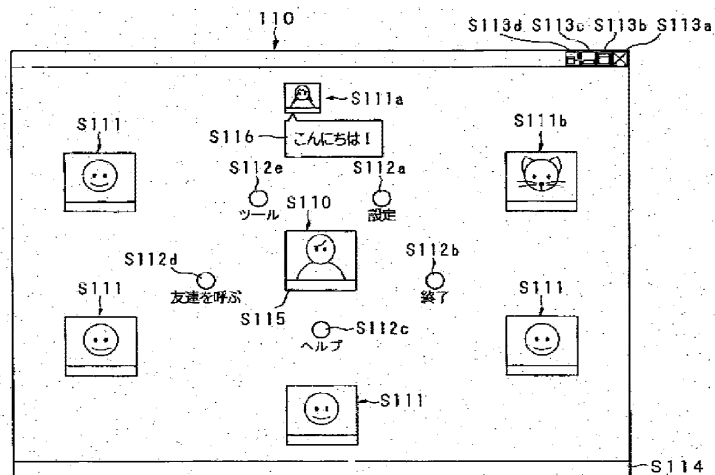

【図22】

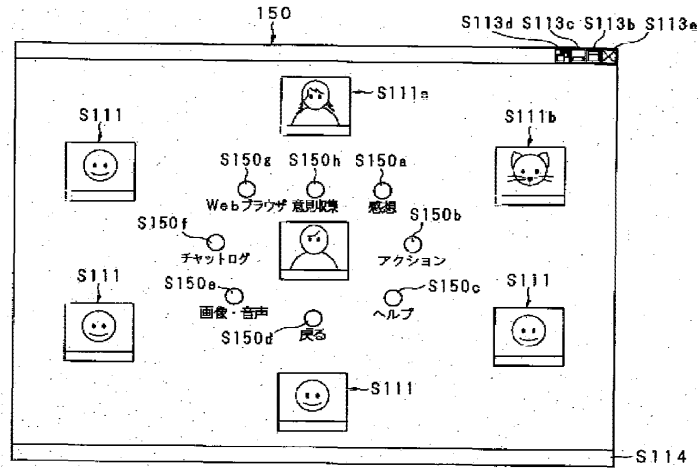

【図23】

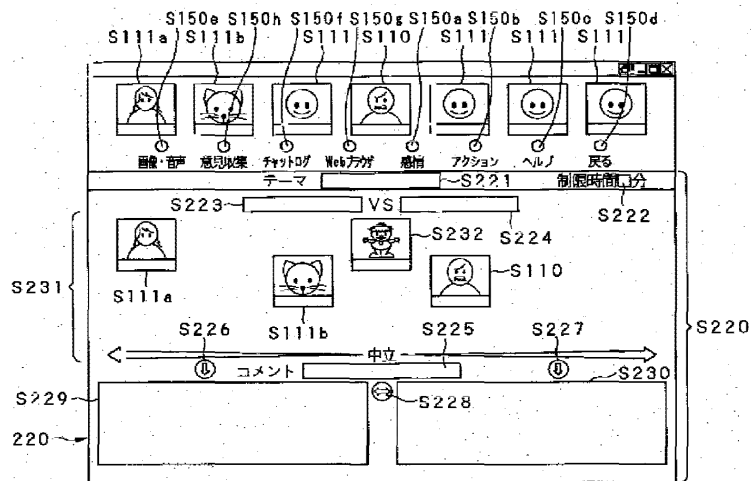

【図24】

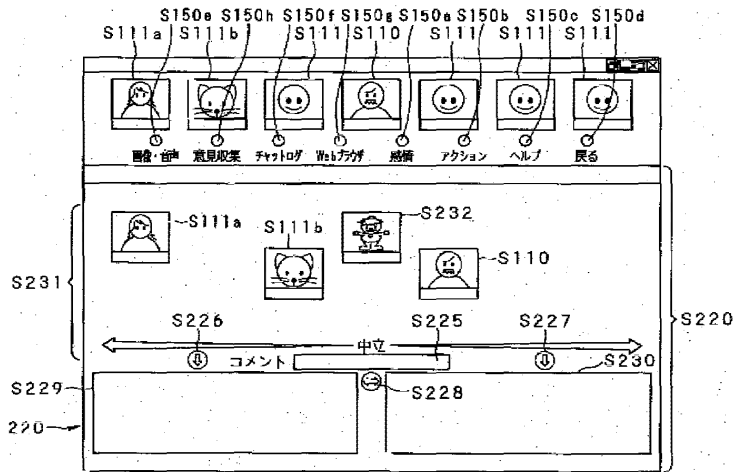

【図25】

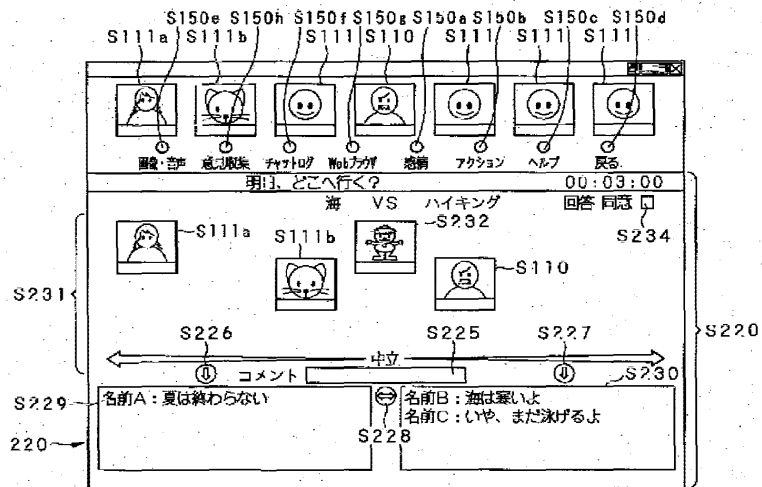

【図26】

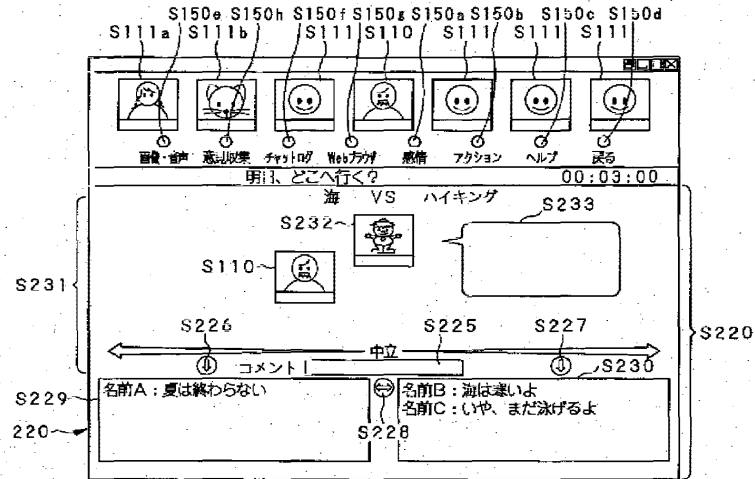

【図27】

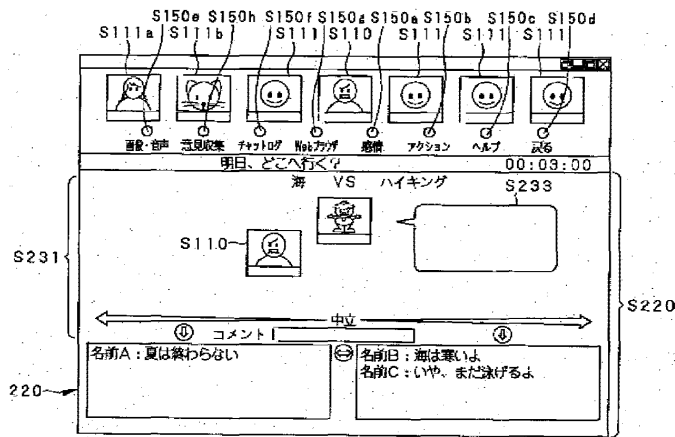

【図28】

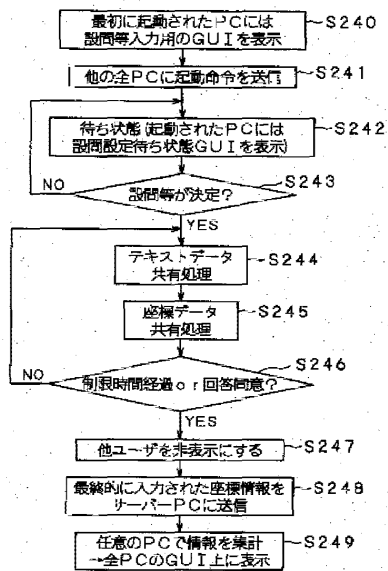

【図29】

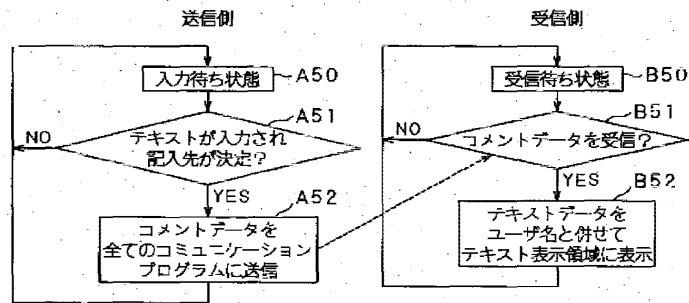

【図30】

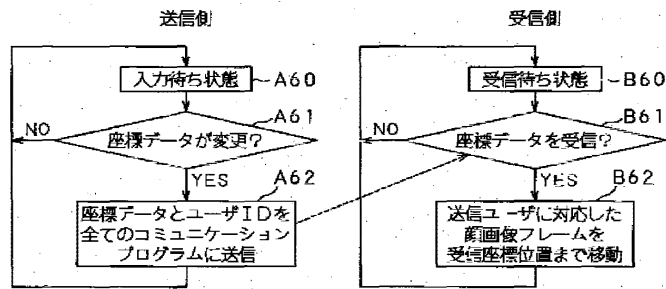



(12) **EUROPEAN PATENT APPLICATION**

(43) Date of publication:
22.09.1999 Bulletin 1999/38

(51) Int Cl.⁶: **G06F 3/12**

(21) Application number: **99200801.1**

(22) Date of filing: **16.03.1999**

(84) Designated Contracting States:
AT BE CH CY DE DK ES FI FR GB GR IE IT LI LU
MC NL PT SE
 Designated Extension States:
AL LT LV MK RO SI

- **Wilbers, Theodoor Johannes Marie**
5931 ST Tegelen (NL)
- **van Herwaarden, Janine Dorette**
2585 CS Den Haag (NL)
- **Geelen, Johannes Franciscus Maria Elisabeth**
5991 AV Baarlo (NL)
- **Collard, René François Albert**
6591 TT Gennep (NL)

(30) Priority: **20.03.1998 NL 1008659**

(71) Applicant: **Océ-Technologies B.V.**
5914 CC Venlo (NL)

(74) Representative: **Hanneman, Henri W., Dr. et al**
Océ-Technologies B.V.
Patents & Information
St. Urbanusweg 43
P.O. Box 101
5900 MA Venlo (NL)

(72) Inventors:
 • **Roosen, Monica Maria Wilhelmina Mathea**
5922 BL Venlo (NL)

(54) **Presentation of printer status in an information-processing system**

(57) In an information-processing system comprising workstations and at least one printer interconnected by a digital network, the current state of the printer or printers is presented on the screen of a workstation in the form of an icon.

The printers are of a type which can carry out printing processes in an autonomous mode, in which a print

job sent from a workstation is executed directly, and in a command-controlled mode in which a reproduction process, including a copying process, must be started from an operator control panel on the printer.

When the printer is "occupied" in the autonomous mode, a different icon is displayed from that displayed when the printer is "occupied" in the command-controlled mode.

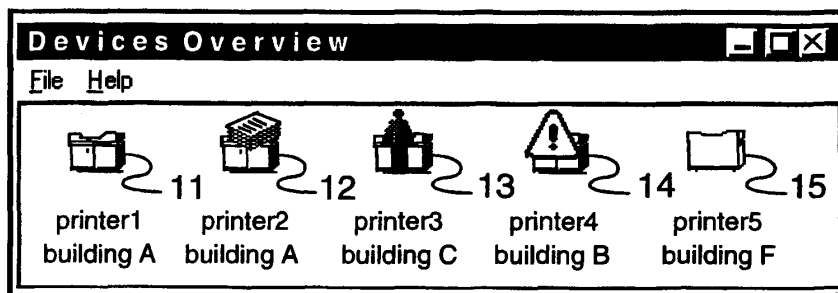

Fig. 3

10

EP 0 943 987 A1

Description

[0001] The invention relates to an information-processing system comprising:

at least one workstation provided with a processor unit, a screen and operator control means such as a keyboard and mouse,
 at least one printer provided with a control unit and an operator control panel, and
 a digital network to which the workstations and the printers are connected,
 wherein a workstation is provided with a program for communication with a printer for sending print jobs to said printer and calling up or receiving status information concerning said printer,
 which program comprises means for displaying on the workstation screen in the form of a symbolic illustration or icon current status information concerning the said printer.

[0002] A system of this kind is known from EP-A 0 398 648. In this known system the status of application programs, including a printer application, is displayed by means of icons on the screen at the workstations. When the status of an application changes, the icon of that application is dynamically adjusted in this system, by the addition of a different icon.

[0003] In Applicants' patent application EP-A 0 814 424, a digital copying machine is described comprising a scanner and a printer section, wherein the printer section can also be used as a network printer. This machine is adapted to receive and process two types of print jobs from a workstation coupled to the network, namely automatic print jobs which, after receipt, must be printed directly and without the intervention of a printer operator, and interactive print jobs (referred to as "deferred print jobs" in the said patent application), which are only received by the printer and stored in a memory, but are not printed, unless an operator selects on the printer operator control panel a print job of this kind and gives a print command. This machine thus operates in one of two modes, namely an autonomous mode in which at its own initiative it executes an (automatic) print job, and a command-controlled mode, in which it executes a reproduction job, a copying process or an interactive print process.

[0004] The use of digital copying machines as network printers gives a new dimension to procedure with these machines. On the one hand, a user who sends his print job to the machine for automatic printing thereby is interested in the question whether the machine is ready to process his print job immediately, and on the other hand the user can immediately see at his workplace (at his workstation) whether the machine is available for a command-controlled job (e.g. a copying job).

[0005] When a user intends to make a copy or an interactive print, it is not only desirable that he should see

on his workstation screen whether the machine of his choice is free or occupied in a copying or printing process, but also to differentiate in detail the information concerning the "occupied" state. An automatic print job can of course be interrupted without obstruction to someone else. The senders of such print jobs usually do not come to fetch their prints immediately, and if these prints are ready somewhat later, because another user has interrupted the printing process for some time, this will usually be readily accepted.

[0006] Conditions are different if the machine is occupied in the command-controlled mode, namely because an operator is busy at the machine. In that case it is much less acceptable to interrupt the current process because the said operator is waiting for the prints from that process.

[0007] The invention now meets the demand for extra information, by the fact that the printer control unit is adapted to execute print jobs in either an autonomous mode or a command-controlled mode, and the program displays different icons for those cases in which the printer is active in the said autonomous mode and those in which the printer is active in the said command-controlled mode.

[0008] A different icon for different "occupied" states is a new solution to a new problem, considered in the light of the prior art.

[0009] Preferably, an icon has a form which is self-evident, and hence according to one embodiment of the invention the icon for the command-controlled "occupied" mode is preferably in a form which contains a human figure.

[0010] The invention will now be explained by reference to the following exemplified embodiment and the accompanying drawings wherein:

[0011] Fig. 1 shows an information-processing system in which the invention is situated.

[0012] Fig. 2 is a diagrammatic overview of the software according to the invention.

[0013] Figs. 3 to 13 show information windows displayed by the software according to the invention on the workstation screen.

[0014] Fig. 1 shows a system of workstations WS and printers PR connected by a local network N. The workstations are, for example, PC's and are in each case equipped with a processing unit, a screen, a keyboard and a mouse. The printers are digital copying machines, each comprising a scanner, a printer, an operator control unit and a connection unit (Digital Access Controller or DAC) for connection to the network and processing print jobs sent from the workstations. In addition it is possible to use machines which only have a printer function but also have a control system adapted to the functionality described hereinafter. All these machines, copying machines and printers, are hereinafter referred to as "printer". Users wishing to have a specific data file printed from their workstation, can for the purpose choose from a number of, or even all, the printers of the system.

[0015] For the purpose of communication with the printers and the presentation of information relating thereto to the users, there is operative in each connected workstation a program which is hereinafter referred to as "desktop software". This program is personalised, i.e., it works on the instructions of just one user who on starting up has identified himself and input his authorisation code.

[0016] The desktop software, hereinafter also referred to as "desktop" for short, is built up from a number of sub-programs diagrammatically illustrated in block 100 in Fig. 2. The core of the desktop software is formed by a sub-program indicated by "virtual printer", which communicates with the connected printers and updates the properties and status of each of these insofar as this is of interest to the workstation user. As will be explained in the following description, a user can choose how much information he wants to have presented concerning the state of connected printers and the printing files to be processed thereon and at what time. The exchange of data concerning these matters between the desktop software and the printers is limited to what is essential for the user's requirements. This prevents the network from being loaded more than is necessary and in addition the processing capacity of the workstation is not loaded more than necessary, since only the relevant information is present in the workstation and has to be processed.

[0017] The "virtual printer" program is provided with an operator control program, hereinafter referred to as "user interface" (UI), which controls the communication between the user and the desktop software in a manner understandable to the user, in the form of key strokes on the keyboard and windows on the screen, in which windows information is presented and in which the user can select and control the operation of elements by means of mouse movements. The desktop software is also provided with a communication program COM for controlling data transport from and to the printers via the network.

[0018] Block 200 in Fig. 2 gives a diagrammatic illustration of the communication software in the DACs of the printers. This is formed particularly by an "information server" IS, which is intended to receive from and send to workstations digital information such as status information concerning the printer itself and the print jobs that the printer is processing. The information server updates data concerning the information required by each desktop and transmits only that information which is really required, and at the time at which it is required. The information server is also provided with a communication program COM for controlling data transport from and to the desktops via the network.

[0019] Files of digital data which are transmitted to a printer via the network for printing by the printer are either of a first or a second type. Files of the first type, hereinafter referred to as automatic print jobs, are required to be printed directly, i.e. without further action by

an operator at the printer, while files of the second type, hereinafter referred to as interactive print jobs, must only be stored in the printer memory and must not be printed until an operator at the printer explicitly so requests there by selection with the aid of the operator control means. An attribute added to the file shows the type of file involved.

[0020] Processing of a data file of the first type is referred to in this description as automatic printing (AP).

[0021] Processing of a data file of the second type is hereinafter referred to as interactive printing (IP). The procedure with this is as follows.

[0022] A data file for printing by interactive printing and transmitted by a workstation via the network is received by the DAC. This extracts from the file a number of predetermined identification data, such as the name of the owner and the name of the file itself. The file is then stored unchanged on a storage unit, e.g. a hard disk, in the printer, whereafter the machine passes to the stand-by state in respect of this job.

[0023] The DAC manages an administration system containing the identification data of all the data files for printing which are stored. If a new file is supplied via the network, the DAC adds the identification data thereof in the name of the owner/sender to the administration system.

[0024] The disk together with the said administration system of the DAC form, as it were, a set of "logic storage spaces" for data files, each logic storage space being allocated to one user. Thus in actual fact storage in a user's logic storage space means that the file is stored on the disk and registered in the administration system in the name of that user. A logic storage space can be protected by a code specific to the owner/user, i.e. in practice an operator can obtain information over the files stored in a specific logic storage space only after he has input this code via the operator control means of the printer.

[0025] If an operator now wishes to have a specific interactive print file printed, then he must select that file by means of the printer operator control panel and give a print command by actuating a start key. In response thereto the data file is brought up from the disk and converted to printable data, which are processed by the printer to form a print. An interactive print file can be protected by the sender by means of a code. This code is in the form of an attribute to the print file. If a user wishes to print this file interactively, he must key in the security code at the operator control panel before the file is printed.

[0026] When a data file has been interactively printed, it remains in principle stored on the disk and registered in the administration system until it is removed by the user himself or by the printer manager.

[0027] The printer manager can bring the machine into a mode in which automatic print jobs are not accepted. In that case, incoming automatic print jobs are converted by the printer into interactive print jobs and stored

on the disk.

[0028] As already stated, at least a number of the printers in this system are in fact digital copying machines, which can also make a copy of an original document by scanning it and printing the digital image data generated thereby.

[0029] There are therefore jobs which are started by a user at the machine itself (copy jobs and interactive print jobs) and jobs which are fed from a distance, e.g. from a workstation (PC) (an automatic print job). In the former case, the printer operates in a command-controlled mode in which the machine starts a reproduction process in response to a start command from the operator control panel, while in the latter case it operates in an autonomous mode in which the machine starts a reproduction process on its own initiative.

[0030] A user who has gone to the machine in order to start a job there by means of the keys finds it very frustrating if a remote-started automatic print job begins just before he wants to start his job. He then has to wait until the remote-started job is finished, or he must at least interrupt that job by means of an "interrupt" mechanism, before he can make his copy. This frequently occurs in practice, particularly at a machine which is frequently used, and results in annoyance and delay.

[0031] In order to protect the position of the user at the machine as much as possible, the machine passes into the command-controlled mode in response to a physical interaction by an operator at the machine, and/or remains there for a predetermined first waiting period. During this waiting period, the machine cannot pass into the autonomous mode. This offers the user at the machine the opportunity of creating, by any interaction, e.g. by actuating a key or placing one or more documents in the machine feed tray, time for himself in order to start his job unhurriedly.

[0032] In addition, on completion of the execution of a job in the command-controlled mode, the machine remains in the command-controlled mode for a predetermined second waiting time.

[0033] Thus if the user wishes to process further copying or interactive print jobs, he will not be overtaken by an automatic print job. Also during the said second waiting period, the machine cannot pass to the autonomous mode. The second waiting period can be equal to the first. A practical value for waiting periods is, for example, 30 seconds to 2 minutes.

[0034] The above-mentioned desktop software will now be described further.

[0035] The desktop software comprises the following modules:

- An overview of all available connected printers with an indication of their status (hereinafter referred to as: Devices Overview)
- An overview of current print jobs with the possibility of intervening in the settings for each job (hereinafter referred to as: Job Control)

- Information provision concerning the progress of current print jobs (hereinafter referred to as: Job Monitoring).

[0036] The mode information presented by the three modules of the desktop software is dynamic, i.e. it is adapted directly as soon as there is any change in the presented mode.

[0037] It should again be noted that the desktop software is personalised and that the information provision and control possibilities are therefore directed towards the wishes of one specific user.

[0038] The three program modules referred to can be started from a general start menu which appears when the desktop software is selected on the workstation screen, and will now be described in sequence.

[0039] Fig. 3 shows a window 10 which is displayed on the workstation screen after the user has selected the option "Devices Overview" in the desktop software.

This window displays for each printer a symbol indicating the status of that printer. Examples of this are shown in Fig. 3. In addition, each symbol has a short description of the printer so that it is clear which printer is involved.

[0040] A first symbol 11 is a stylised illustration of the printer. This symbol indicates that the printer in question is available for print jobs and is at the moment idle. A second symbol 12 shows the printer with a stack of papers over it and indicates that this machine is occupied with an automatic print job in the autonomous mode.

Symbol 13 shows the printer with a person in front of it, to indicate that the machine is in the command-controlled mode and hence either occupied with a copy job or an interactive print job or is in the above-described first or second waiting period, in which no automatic print jobs can start. Symbol 14 is an illustration of the printer with, superimposed thereon, a notice board indicating that this printer is in a malfunction state. Symbol 15 is an undetailed illustration of the printer to indicate that this printer is connected but at the present time is not available for copy jobs or print jobs.

[0041] From these symbols a user can determine which printer he should send his print job to, and also, when he wishes to carry out a copying or interactive print job, whether the chosen machine is free. Particularly convenient is the differentiated indication of the occupied state, i.e. occupation in the autonomous mode and occupation in the command-controlled mode, because an automatic print job can without difficulty be stopped during operation by a user at the machine, in order to carry out a copy job or interactive print job in an "interrupt" mode, but passing another user at the machine will always require more convincing reasons.

[0042] The user can select one of the symbols, and hence one of the printers, and then call up one of the following functions either with a menu in the top bar of the window or with a pop-up menu or the right-hand mouse button:

50

55

- Displaying the waiting print jobs for the printer concerned; in this function automatic and interactive print jobs are displayed separately and they can also be manipulated. This function forms part of the "Job Control" program module and will be described in detail there. This function can also be called up with a double mouse click on the printer symbol.
- Displaying the properties and status of the printer concerned.
- Calling up a monitor function which during the work gives information on the display screen concerning the status of the printer concerned.
- Defining the printer concerned as the default printer.

[0043] In the above-mentioned function in which the properties and status of the printer are displayed, a window with this information appears on the screen, the information being distributed over three tab cards which can be made visible by selection of their tab, as shown in Figs. 4A, B and C. The stock of printing paper in the printer trays is displayed on a first tab card, the current state of operation of the printer is described on the second tab card and information as to the installed functionality is shown on the third tab card.

[0044] In response to selection of the above-mentioned monitor function, the workstation screen shows a window in which the user can set his preferences for the form of presentation of the printer status data (see Fig. 5). There are two main forms of presentation, namely with a permanent icon on the screen ("by icon") and with messages which appear on the screen at the time that a change of printer status occurs ("by alerts").

[0045] When monitoring with icons is set, the icon displays a symbolic illustration of the status just as shown in Fig. 3. An example of such an icon is given in Fig. 6A. A user can also simultaneously have the status of different printers maintained. In that case, the screen shows an icon for each monitored printer as shown in Fig. 6B. By a double click of the mouse on an icon the function of displaying the waiting print jobs for the printer concerned is called up. In this connection we would again refer to the description of the "Job Control" program module.

[0046] When monitoring is by means of messages, the user can indicate the changes of state for which he wants to receive a message, in order thus to avoid unnecessary reports. An example of a message of this kind is displayed in Fig. 7.

[0047] Fig. 8 shows the relevant layout of the workstation screen after the user has selected the "Job Control" option in the desktop software to maintain an overview of current print jobs.

[0048] Here a number of windows 20A, B and C are displayed, each applicable to a printer at which a print job of the user is present at that time. Thus there are as many windows displayed as there are printers at which the user's print jobs are present at that time. If this function was called up from the "Device Overview" module,

then only the window for the printer selected there would be displayed.

[0049] A window 20 contains a space 21 for automatic print jobs, a space 22 for interactive print jobs of the user, and a space 23 for specifying the active print job. There are also a number of "keys" which can be operated by means of the mouse.

[0050] Space 21 contains the queue of automatic print jobs of the user, with their status (number in the queue), name, and other data to be selected by the user during set-up. By clicking on a switchbox on the left beneath the space 21 the user can also have displayed all the waiting automatic print jobs, i.e. including those of other users. In that case his own jobs are reproduced in a manner which is distinguishable from the others, for example in colour. If the Job Control module is called up from the "Devices Overview" module, for a specific printer, the presentation of all the waiting automatic print jobs, i.e. including those of other users, is the default setting.

[0051] Space 22 contains an overview of waiting interactive print jobs of the user, here reproduced with icons with a name, which corresponds to the character of the jobs, which are not in a queue but do not become operative until the user starts them on the operator control panel. To obtain more information concerning these jobs, the user can also have them presented in a detailed list.

[0052] Space 23 displays the data of the print job which is active at that time, or, if there is no job active, the state of the printer ("idle", "error"). The space contains the following data: type of job (copying job, automatic print job, interactive print job), number of prints, name of the owner of the job, and the name of the job. Next to the space 23 is a key 24, by means of which the active job can be discontinued ("abort").

[0053] By means of the key 25, an interactive print job selected in the space 22 can be converted to an automatic print job and be added to the queue in space 21, while the key 26 can convert an automatic print job selected in space 21 into an interactive job and move it to space 22.

[0054] By means of key 27, the print settings can be displayed for a print job selected in either of the spaces 21 or 22. The same effect is achieved by double clicking of the mouse on the job name. In response to this, a window is opened on the screen of the workstation, displaying all the settings. The settings can also be changed in this window.

[0055] Finally, a print job selected in either of the spaces 21 or 22 can be removed by means of key 28.

[0056] The above functions can also be called up by selecting a job and choosing from the "document" menu in the menu bar above the window 20 or by selecting in a pop-menu which appears when the right-hand mouse button is clicked on a job name.

[0057] The functions explained with reference to the keys 24 - 28 can be used by the user only for his own

print jobs.

[0058] The "View" menu in the menu bar above the window 20 offers the following options:

- Selection of the form of presentation of automatic print jobs (choice of which information is displayed)
- Selection of the form of presentation of interactive print jobs (as icons or in a list and, if a list is chosen, what information is displayed)
- Display of all print jobs of the user (over all the printers), with the printer on which the job is present, plus this information concerning the print jobs that have already been finished.

[0059] This latter function will now be explained with reference to Fig. 9.

[0060] When this function is selected, the screen at the workstation displays the window 30. This window 30 contains a space 31 in which there is displayed a list of all the print jobs which have not yet been finished for the user concerned, on all the printers, with their status (waiting, busy, error) and the printer at which they are present. This list shows both automatic and interactive print jobs and their type. Double clicking of the mouse on the name of a print job in space 31 opens the Job Control window (Fig. 8) of the printer where the job is present, so that the user can see the status of the job in the queue (if it is an automatic print job), can manipulate the job, and can inspect and/or change the print settings.

[0061] The window 30 also contains a space 32 displaying a list of all the finished print jobs of the user concerned, on all the printers, with the printer which processed them. A key 33 is provided beneath the space 32 to enable the user to remove from the list a print job after he has selected this by clicking with the mouse.

[0062] If a list is too long in space 31 or 32 to fit in that space, a scroll bar appears by means of which the jobs not fitting in the window can still be reached.

[0063] The list of finished print jobs in space 32 can also give a status indication although this is not shown here. In the case of a printer with more than one delivery tray, the printer machine control system knows the delivery tray in which the prints have been deposited and this information can be displayed in the list. The printer can also be provided with sensors to determine whether there are prints in the delivery trays. In that case, the machine control system can also note that a delivered stack of prints is taken from the tray. This information can also be displayed in the list in space 32. The status information can have the form of: "present in delivery tray X", or "removed".

[0064] By means of this function a user can always find out where his print jobs are in the queue or where his prints are situated, this being extremely convenient particularly in an environment in which a number of printers are used.

[0065] The monitor function can also operate for just a specified sub-set of all the printers in the system. This

can be set when the system is configured, or by means of a set-up function of the program.

[0066] The "monitor" menu in the menu bar above the Job Control window 20 offers the opportunity of activating a monitor function for the print jobs of the user concerned on the printer concerned. This function can also be called up from the start menu of the desktop software and will be described hereinafter.

[0067] The monitor function is intended to keep the user informed as to the status of his automatic print jobs. It can be operative for all the current jobs or for some of the jobs, as selected by the user.

[0068] The monitor function has three modes:

- A first mode ("active"): there is still at least one job of the set which has not been completed; also included is the number of jobs that have not yet been finished.
- A second mode ("passive"): all the jobs of the set have been finished or the set is empty.
- A third mode ("error"): one of the jobs has caused an error.

[0069] In response to the selection of the monitor function in the start menu of the desktop software, the workstation display screen displays a window in which the user can select one, more, or all the printers for the monitor function. This is shown in Fig. 10. After the user has clicked the "OK" key with the mouse, the workstation display screen displays a window in which the user can set his preferences for the form of presentation of the status of his personal print jobs (see Fig. 11). There are two main forms of the presentation, namely by means of a permanent icon on the screen ("by icon") or by means of messages which appear on the screen when there is any change in that status ("by alerts"). In the latter case the user can indicate the changes of status for which he wants to receive a message in order thus to avoid unnecessary reports.

[0070] The user inputs his preferences and presses the "OK" key, whereafter the function is activated. An icon now appears on the screen if the icon mode was selected.

[0071] When Job Monitoring is activated from Job Control, the selection window of Fig. 10 is skipped (the printer of the Job Control window is automatically selected), but the window of Fig. 11 is immediately displayed.

[0072] Fig. 12 shows monitor icons. In addition to the name of the printer for which it is active, an icon contains a symbol showing the status of a set of print jobs of the user on that printer. In this example, the following symbols are displayed for the above-mentioned three states:

For the first state ("active"): an illustration of a document with a pen;

For the second state ("passive"): an illustration of a

document;
For the third state ("error"): a notice board in front of a document.

[0073] The said set of print jobs monitored by the monitor function can be the complete set of jobs on the printer concerned, but it can alternatively be a sub-set. This sub-set can only be selected in the Job Control window 20, space 21, by clicking the required print jobs with the mouse, followed by clicking the monitor menu in the menu bar. When Job Monitoring is called up from the start menu of the desktop software, the set always contains all the jobs. The monitor function is dynamic: print jobs can be added to a monitored set.

[0074] In response to a double click of the mouse on a monitoring icon, the Job Control window of the printer concerned is opened, so that the user can inspect the complete status of his jobs.

[0075] A plurality of icons can also be displayed simultaneously on the screen, so that the user can inspect the status of different sets or printers simultaneously.

[0076] If the "by alerts" mode is selected, message windows appear only if there is a user-selected change of status of a print job from the set. An example of such a window is shown in Fig. 13.

[0077] Although the invention has been described with reference to the above exemplified embodiment, it will be clear to the skilled man that other embodiments are possible within the text of the claims. They are considered to come within the scope of protection of this patent.

Claims

1. An information-processing system comprising

at least one workstation provided with a processor unit, a screen and operator control means such as a keyboard and mouse,
at least one printer provided with a control unit and an operator control panel, and
a digital network to which the workstations and the printers are connected,
wherein a workstation is provided with a program for communication with a printer for sending print jobs to said printer and calling up or receiving status information concerning said printer,
which program comprises means for displaying on the workstation screen in the form of a symbolic illustration or icon current status information concerning the said printer,

characterised in that

the control unit of the printer is adapted to execute print jobs in either an autonomous mode

or a command-controlled mode,
the control unit in the autonomous mode starting the execution of a print order on its own initiative while in the command-controlled mode it starts the execution of a reproduction process, including a print order, in response to a start command from the operator control panel of the printer,
and in that the program displays different icons for the cases in which the printer is active in the said autonomous mode and in which the printer is active in the said command-controlled mode.

2. A system according to claim 1, wherein a reproduction process in the command-controlled mode is formed by a copying process, in which an original document is scanned by a scanner present in the printer and digital image data are generated, and a print is made using the said digital image data.

3. A system according to claim 1 or 2, wherein a reproduction process in the command-controlled mode is formed by an interactive printing process, in which a print file which has been sent via the network and stored in a storage unit in the printer is selected by an operator using the operator control panel and is printed in response to a print command following upon the selection.

4. A system according to claim 1, wherein the icon for the command-controlled mode contains a human figure.

5

10

15

20

25

30

35

40

45

50

55

7

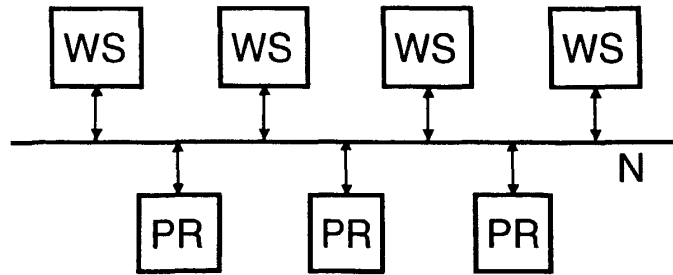

FIG. 1

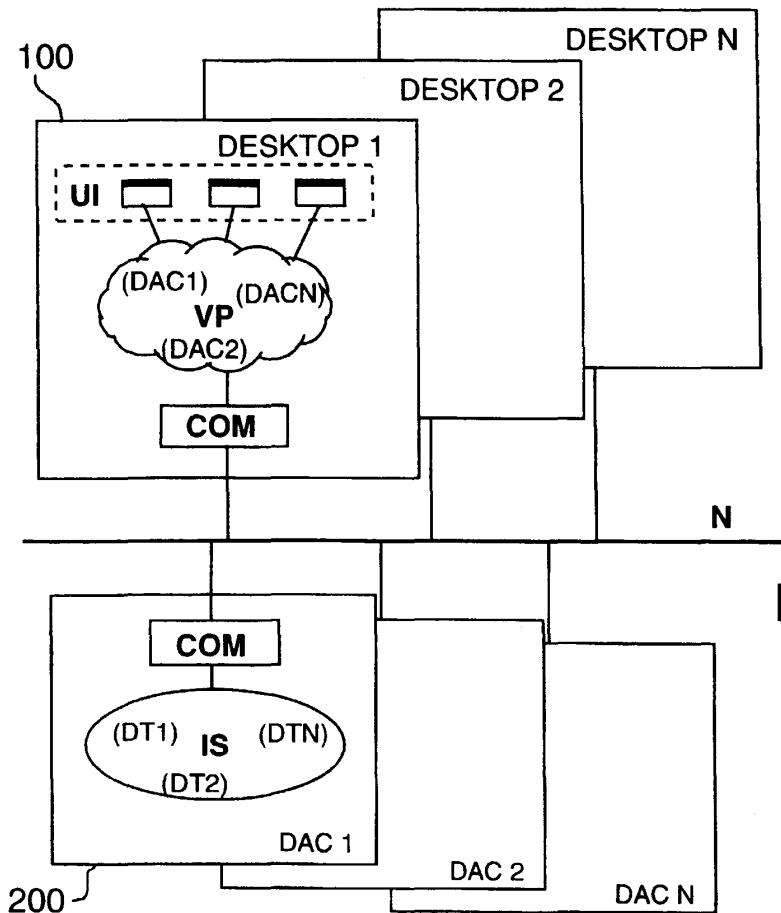

FIG. 2

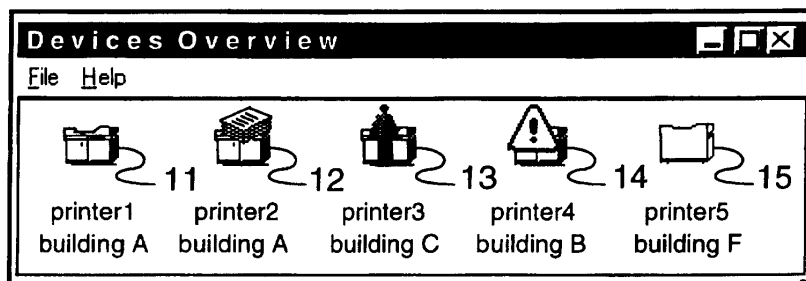

Fig. 3

10

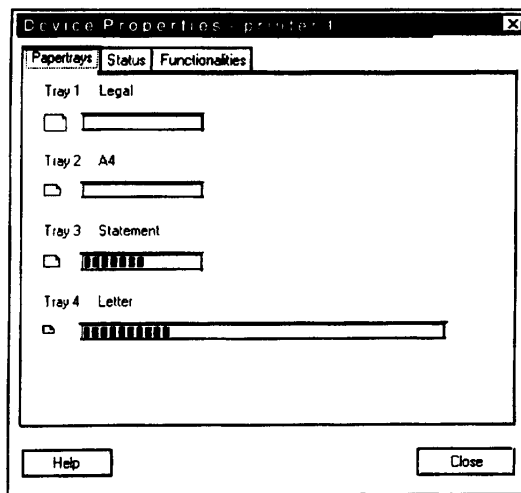
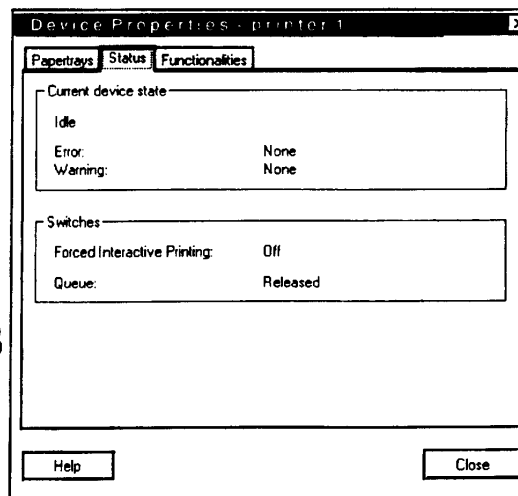

FIG. 4A

FIG. 4B



EP 0 943 987 A1

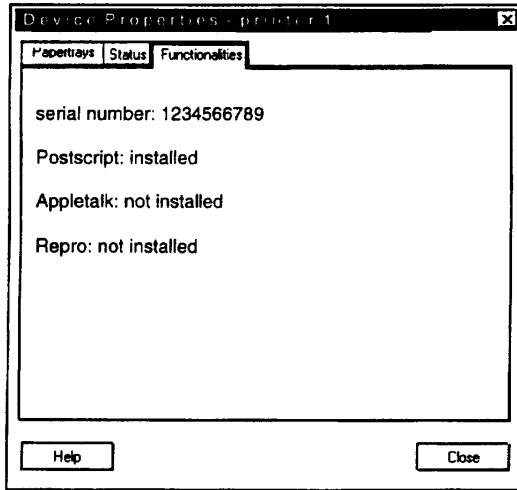

Fig. 4C



Fig. 6A

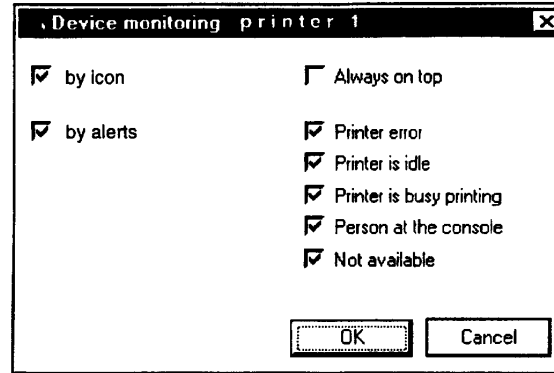

Fig. 5

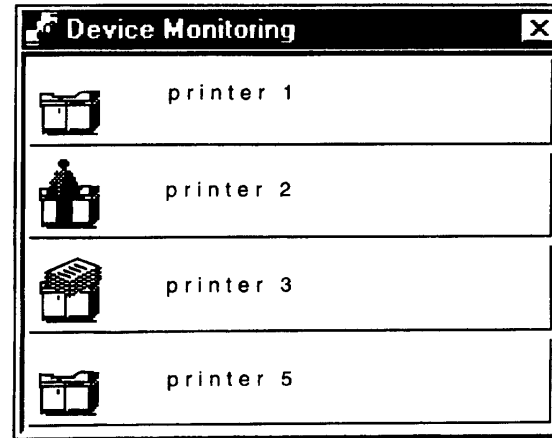

Fig. 6B

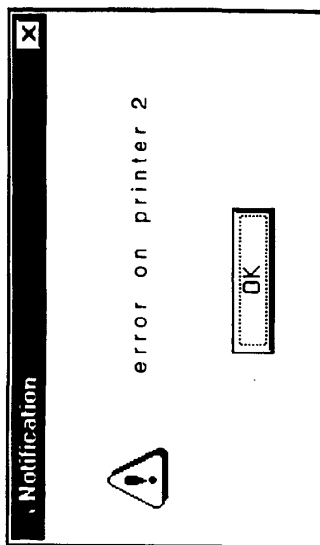
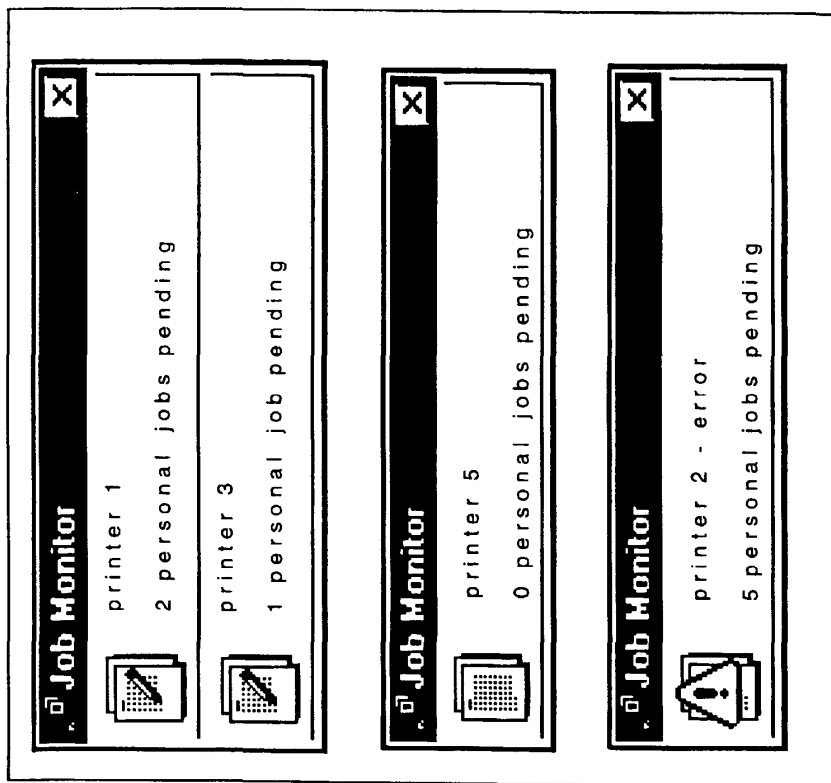

Fig. 7

Fig. 12

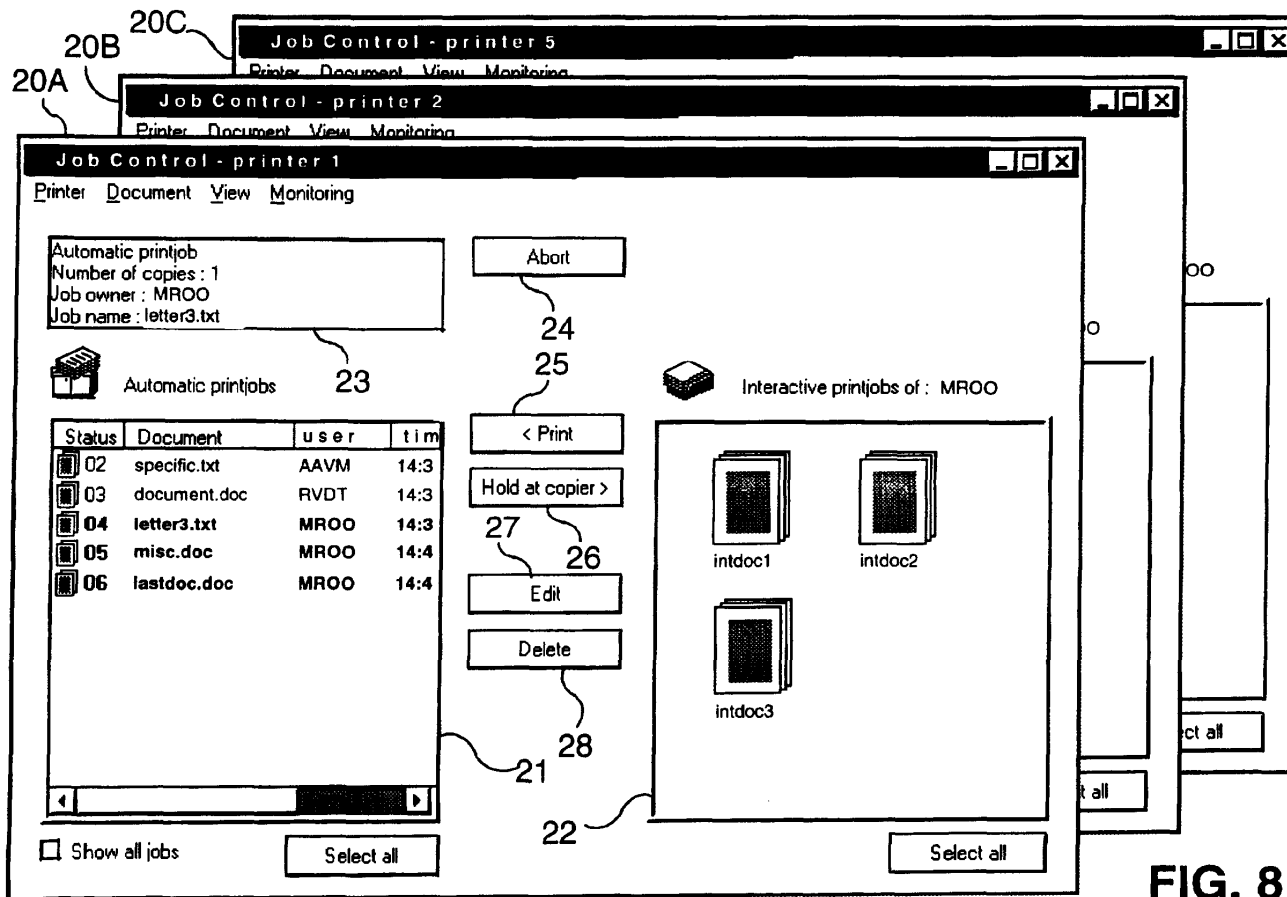

FIG. 8

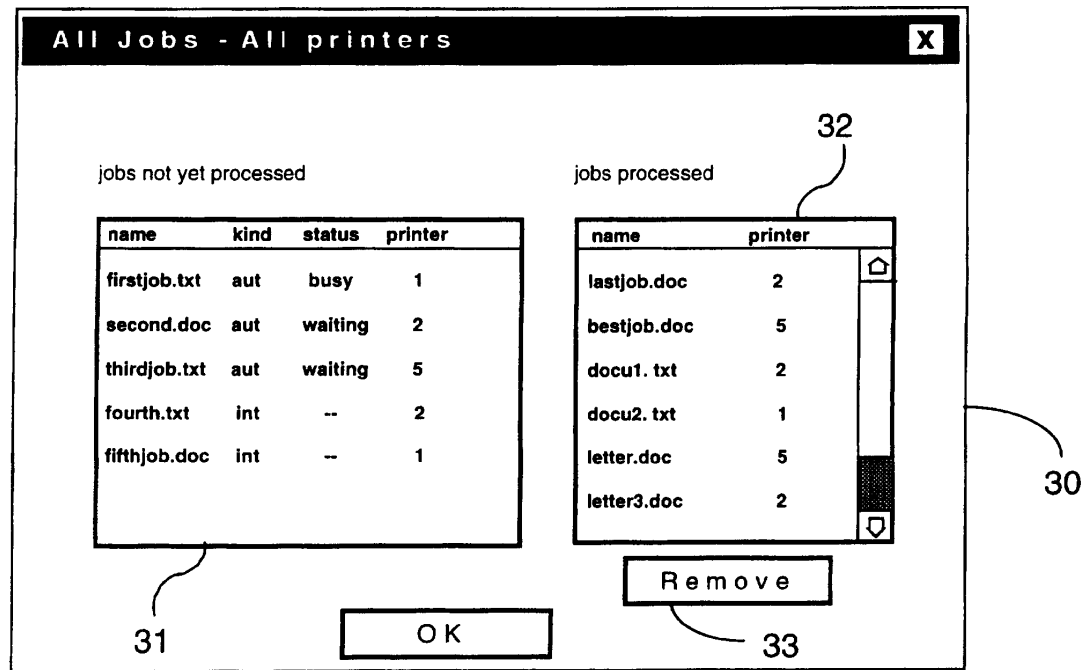

Fig. 9

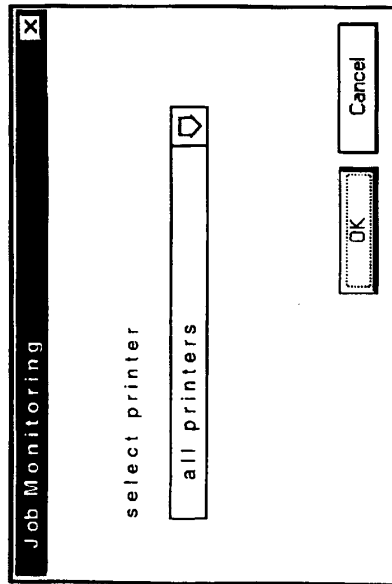

Fig. 10

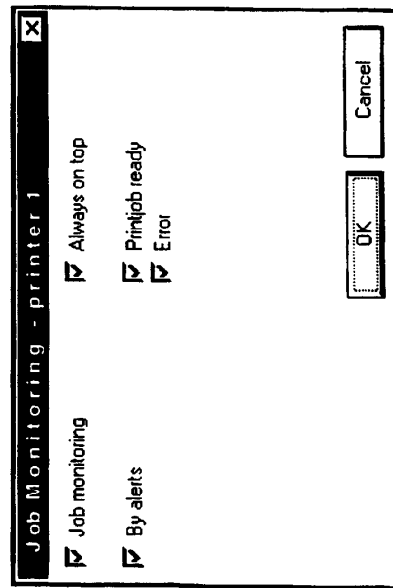

Fig. 11

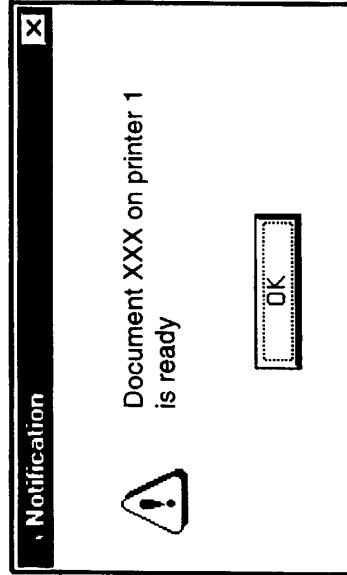

Fig. 13



European Patent Office

EUROPEAN SEARCH REPORT

Application Number
EP 99 20 0801

DOCUMENTS CONSIDERED TO BE RELEVANT			
Category	Citation of document with indication, where appropriate, of relevant passages	Relevant to claim	CLASSIFICATION OF THE APPLICATION (Int.Cl.6)
X	US 5 727 135 A (WELLMAN JOHN NEIL ET AL) 10 March 1998 * figures 1,2,8,9 * * column 5, line 47 - column 10, line 54 * * column 22, line 52 - column 23, line 67 * * ---	1,3	G06F3/12
A	EP 0 750 251 A (CANON KK) 27 December 1996 * figures 1,2 * * column 5, line 55 - column 8, line 7 * ---	1,3	
A	EP 0 562 995 A (IBM) 29 September 1993 * figures 1-4 * * column 6, line 40 - column 7, line 14 * -----	1,4	
The present search report has been drawn up for all claims			TECHNICAL FIELDS SEARCHED (Int.Cl.6)
			G06F
Place of search	Date of completion of the search	Examiner	
THE HAGUE	5 July 1999	Weiss, P	
CATEGORY OF CITED DOCUMENTS		T : theory or principle underlying the invention E : earlier patent document, but published on, or after the filing date D : document cited in the application L : document cited for other reasons & : member of the same patent family, corresponding document	
X : particularly relevant if taken alone Y : particularly relevant if combined with another document of the same category A : technological background O : non-written disclosure P : intermediate document			

EPO FORM 1503 (03/02) (P/EC/C)

**ANNEX TO THE EUROPEAN SEARCH REPORT
ON EUROPEAN PATENT APPLICATION NO.**

EP 99 20 0801

This annex lists the patent family members relating to the patent documents cited in the above-mentioned European search report. The members are as contained in the European Patent Office EDP file on The European Patent Office is in no way liable for these particulars which are merely given for the purpose of information.

05-07-1999

Patent document cited in search report	Publication date	Patent family member(s)	Publication date
US 5727135 A	10-03-1998	NONE	
EP 0750251 A	27-12-1996	JP 9006550 A JP 9006555 A CN 1147177 A	10-01-1997 10-01-1997 09-04-1997
EP 0562995 A	29-09-1993	US 5727174 A JP 2539152 B JP 6168093 A	10-03-1998 02-10-1996 14-06-1994

EPO FORM P0699

For more details about this annex . see Official Journal of the European Patent Office, No. 12/82

0526204-272 PCT
R

PATENT COOPERATION TREATY

From the INTERNATIONAL SEARCHING AUTHORITY

PCT

To:
 OGILVY RENAULT
 Suite 1600
 1981 McGill College Avenue
 Montreal, Quebec H3A 2G6
 CANADA

RECEIVED
 OCT 21 2004
 SWABEY OGILVY RENAULT-TORONTO

NOTIFICATION OF TRANSMITTAL OF
 THE INTERNATIONAL SEARCH REPORT AND
 THE WRITTEN OPINION OF THE INTERNATIONAL
 SEARCHING AUTHORITY, OR THE DECLARATION

AMENDMENT ART. 19 DUE ON DEC 15 2004 *h*

(PCT Rule 44.1)

Date of mailing (day/month/year)	15/10/2004
Applicant's or agent's file reference 16813-1PCT <i>JAMES LONGWELL</i>	FOR FURTHER ACTION See paragraphs 1 and 4 below
International application No. PCT/CA2004/000263	International filing date (day/month/year) 24/02/2004
Applicant KLASSEN, Gerhard D.	

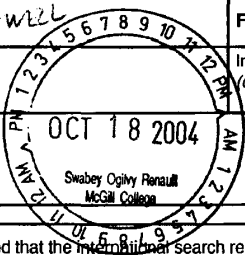

1. The applicant is hereby notified that the international search report and the written opinion of the International Searching Authority have been established and are transmitted herewith.

Filing of amendments and statement under Article 19:
 The applicant is entitled, if he so wishes, to amend the claims of the International Application (see Rule 46):

When? The time limit for filing such amendments is normally 2 months from the date of transmittal of the International Search Report; however, for more details, see the notes on the accompanying sheet.

Where? Directly to the International Bureau of WIPO, 34 chemin des Colombettes
 1211 Geneva 20, Switzerland, Facsimile No.: (41-22) 740.14.35

For more detailed instructions, see the notes on the accompanying sheet.

2. The applicant is hereby notified that no international search report will be established and that the declaration under Article 17(2)(a) to that effect and the written opinion of the International Searching Authority are transmitted herewith.

3. **With regard to the protest** against payment of (an) additional fee(s) under Rule 40.2, the applicant is notified that:

the protest together with the decision thereon has been transmitted to the International Bureau together with the applicant's request to forward the texts of both the protest and the decision thereon to the designated Offices.

no decision has been made yet on the protest; the applicant will be notified as soon as a decision is made.

4. **Reminders**

Shortly after the expiration of **18 months** from the priority date, the international application will be published by the International Bureau. If the applicant wishes to avoid or postpone publication, a notice of withdrawal of the international application, or of the priority claim, must reach the International Bureau as provided in Rules 90bis.1 and 90bis.3, respectively, before the completion of the technical preparations for international publication.

The applicant may submit comments on an informal basis on the written opinion of the International Searching Authority to the International Bureau. The International Bureau will send a copy of such comments to all designated Offices unless an international preliminary examination report has been or is to be established. These comments would also be made available to the public but not before the expiration of 30 months from the priority date.

Within **19 months** from the priority date, but only in respect of some designated Offices, a demand for international preliminary examination must be filed if the applicant wishes to postpone the entry into the national phase until **30 months** from the priority date (in some Offices even later); otherwise, the applicant must, **within 20 months** from the priority date, perform the prescribed acts for entry into the national phase before those designated Offices.

In respect of other designated Offices, the time limit of **30 months** (or later) will apply even if no demand is filed within 19 months.

See the Annex to Form PCT/IB/301 and, for details about the applicable time limits, Office by Office, see the *PCT Applicant's Guide*, Volume II, National Chapters and the WIPO Internet site.

Name and mailing address of the International Searching Authority  European Patent Office, P.B. 5818 Patentlaan 2 NL-2280 HV Rijswijk Tel. (+31-70) 340-2040, Tx. 31 651 epo nl, Fax: (+31-70) 340-3016	Authorized officer Doreen Golze
---	--

Form PCT/ISA/220 (January 2004)

(See notes on accompanying sheet)

NOTES TO FORM PCT/ISA/220

These Notes are intended to give the basic instructions concerning the filing of amendments under article 19. The Notes are based on the requirements of the Patent Cooperation Treaty, the Regulations and the Administrative Instructions under that Treaty. In case of discrepancy between these Notes and those requirements, the latter are applicable. For more detailed information, see also the PCT Applicant's Guide, a publication of WIPO.

In these Notes, "Article", "Rule", and "Section" refer to the provisions of the PCT, the PCT Regulations and the PCT Administrative Instructions respectively.

INSTRUCTIONS CONCERNING AMENDMENTS UNDER ARTICLE 19

The applicant has, after having received the international search report, one opportunity to amend the claims of the international application. It should however be emphasized that, since all parts of the international application (claims, description and drawings) may be amended during the international preliminary examination procedure, there is usually no need to file amendments of the claims under Article 19 except where, e.g. the applicant wants the latter to be published for the purposes of provisional protection or has another reason for amending the claims before international publication. Furthermore, it should be emphasized that provisional protection is available in some States only.

What parts of the international application may be amended?

Under Article 19, only the claims may be amended.

During the international phase, the claims may also be amended (or further amended) under Article 34 before the International Preliminary Examining Authority. The description and drawings may only be amended under Article 34 before the International Examining Authority.

Upon entry into the national phase, all parts of the international application may be amended under Article 28 or, where applicable, Article 41.

When?

Within 2 months from the date of transmittal of the international search report or 16 months from the priority date, whichever time limit expires later. It should be noted, however, that the amendments will be considered as having been received on time if they are received by the International Bureau after the expiration of the applicable time limit but before the completion of the technical preparations for international publication (Rule 46.1).

Where not to file the amendments?

The amendments may only be filed with the International Bureau and not with the receiving Office or the International Searching Authority (Rule 46.2).

Where a demand for international preliminary examination has been/is filed, see below.

How?

Either by cancelling one or more entire claims, by adding one or more new claims or by amending the text of one or more of the claims as filed.

A replacement sheet must be submitted for each sheet of the claims which, on account of an amendment or amendments, differs from the sheet originally filed.

All the claims appearing on a replacement sheet must be numbered in Arabic numerals. Where a claim is cancelled, no renumbering of the other claims is required. In all cases where claims are renumbered, they must be renumbered consecutively (Administrative Instructions, Section 205(b)).

The amendments must be made in the language in which the international application is to be published.

What documents must/may accompany the amendments?

Letter (Section 205(b)):

The amendments must be submitted with a letter.

The letter will not be published with the international application and the amended claims. It should not be confused with the "Statement under Article 19(1)" (see below, under "Statement under Article 19(1)").

The letter must be in English or French, at the choice of the applicant. However, if the language of the international application is English, the letter must be in English; if the language of the international application is French, the letter must be in French.

Notes to Form PCT/ISA/220 (first sheet) (January 1994)

BNSDOCID: <XS_____ISA220NOENP4_I_>

Facebook's Exhibit No. 1013
0511

Snap Inc. Ex. 1013 Page 0511

NOTES TO FORM PCT/ISA/220 (continued)

The letter must indicate the differences between the claims as filed and the claims as amended. It must, in particular, indicate, in connection with each claim appearing in the international application (it being understood that identical indications concerning several claims may be grouped), whether

- (i) the claim is unchanged;
- (ii) the claim is cancelled;
- (iii) the claim is new;
- (iv) the claim replaces one or more claims as filed;
- (v) the claim is the result of the division of a claim as filed.

The following examples illustrate the manner in which amendments must be explained in the accompanying letter:

1. [Where originally there were 48 claims and after amendment of some claims there are 51]:
"Claims 1 to 29, 31, 32, 34, 35, 37 to 48 replaced by amended claims bearing the same numbers; claims 30, 33 and 36 unchanged; new claims 49 to 51 added."
2. [Where originally there were 15 claims and after amendment of all claims there are 11]:
"Claims 1 to 15 replaced by amended claims 1 to 11."
3. [Where originally there were 14 claims and the amendments consist in cancelling some claims and in adding new claims]:
"Claims 1 to 6 and 14 unchanged; claims 7 to 13 cancelled; new claims 15, 16 and 17 added." or
"Claims 7 to 13 cancelled; new claims 15, 16 and 17 added; all other claims unchanged."
4. [Where various kinds of amendments are made]:
"Claims 1-10 unchanged; claims 11 to 13, 18 and 19 cancelled; claims 14, 15 and 16 replaced by amended claim 14; claim 17 subdivided into amended claims 15, 16 and 17; new claims 20 and 21 added."

"Statement under article 19(1)" (Rule 46.4)

The amendments may be accompanied by a statement explaining the amendments and indicating any impact that such amendments might have on the description and the drawings (which cannot be amended under Article 19(1)).

The statement will be published with the international application and the amended claims.

It must be in the language in which the international application is to be published.

It must be brief, not exceeding 500 words if in English or if translated into English.

It should not be confused with and does not replace the letter indicating the differences between the claims as filed and as amended. It must be filed on a separate sheet and must be identified as such by a heading, preferably by using the words "Statement under Article 19(1)."

It may not contain any disparaging comments on the international search report or the relevance of citations contained in that report. Reference to citations, relevant to a given claim, contained in the international search report may be made only in connection with an amendment of that claim.

Consequence if a demand for international preliminary examination has already been filed

If, at the time of filing any amendments under Article 19, a demand for international preliminary examination has already been submitted, the applicant must preferably, at the same time of filing the amendments with the International Bureau, also file a copy of such amendments with the International Preliminary Examining Authority (see Rule 62.2(a), first sentence).

Consequence with regard to translation of the international application for entry into the national phase

The applicant's attention is drawn to the fact that, where upon entry into the national phase, a translation of the claims as amended under Article 19 may have to be furnished to the designated/elected Offices, instead of, or in addition to, the translation of the claims as filed.

For further details on the requirements of each designated/elected Office, see Volume II of the PCT Applicant's Guide.

PATENT COOPERATION TREATY

PCT

INTERNATIONAL SEARCH REPORT

(PCT Article 18 and Rules 43 and 44)

Applicant's or agent's file reference 16813-1PCT	FOR FURTHER ACTION		see Form PCT/ISA/220 as well as, where applicable, item 5 below.
International application No. PCT/CA2004/000263	International filing date (day/month/year) 24/02/2004	(Earliest) Priority Date (day/month/year) 01/12/2003	
Applicant KLASSEN, Gerhard D.			

This International Search Report has been prepared by this International Searching Authority and is transmitted to the applicant according to Article 18. A copy is being transmitted to the International Bureau.

This International Search Report consists of a total of 4 sheets.

It is also accompanied by a copy of each prior art document cited in this report.

1. **Basis of the report**

a. With regard to the **language**, the international search was carried out on the basis of the international application in the language in which it was filed, unless otherwise indicated under this item.

The international search was carried out on the basis of a translation of the international application furnished to this Authority (Rule 23.1(b)).

b. With regard to any **nucleotide and/or amino acid sequence** disclosed in the international application, see Box No. I.

2. **Certain claims were found unsearchable** (See Box II).

3. **Unity of invention is lacking** (see Box III).

4. With regard to the **title**,

the text is approved as submitted by the applicant.

the text has been established by this Authority to read as follows:

5. With regard to the **abstract**,

the text is approved as submitted by the applicant.

the text has been established, according to Rule 38.2(b), by this Authority as it appears in Box No. IV. The applicant may, within one month from the date of mailing of this international search report, submit comments to this Authority.

6. With regards to the **drawings**,

a. the figure of the **drawings** to be published with the abstract is Figure No. 6

as suggested by the applicant.

as selected by this Authority, because the applicant failed to suggest a figure.

as selected by this Authority, because this figure better characterizes the invention.

b. none of the figures is to be published with the abstract.

Form PCT/ISA/210 (first sheet) (January 2004)

INTERNATIONAL SEARCH REPORT

International Application No
PCT/CA2004/000263

A. CLASSIFICATION OF SUBJECT MATTER IPC 7 G06F3/033 G06F3/023		
According to International Patent Classification (IPC) or to both national classification and IPC		
B. FIELDS SEARCHED		
Minimum documentation searched (classification system followed by classification symbols) IPC 7 G06F		
Documentation searched other than minimum documentation to the extent that such documents are included in the fields searched		
Electronic data base consulted during the international search (name of data base and, where practical, search terms used)		
C. DOCUMENTS CONSIDERED TO BE RELEVANT		
Category *	Citation of document, with indication, where appropriate, of the relevant passages	Relevant to claim No.
X	US 5 617 526 A (ORAN DANIEL P ET AL) 1 April 1997 (1997-04-01) column 5, paragraph 4; claims 1,2,6; figures 4,8,10	1-20
A	US 5 333 256 A (GREEN EMILY A ET AL) 26 July 1994 (1994-07-26) claim 1; figures 5,6	1-20
A	EP 0 943 987 A (OCE TECH BV) 22 September 1999 (1999-09-22) claim 1; figure 3	1-20
A	US 6 424 354 B1 (WHITE CHRISTOPHER ET AL) 23 July 2002 (2002-07-23) claim 1; figure 12	1-20
	-/--	
<input checked="" type="checkbox"/> Further documents are listed in the continuation of box C. <input checked="" type="checkbox"/> Patent family members are listed in annex.		
* Special categories of cited documents : *A* document defining the general state of the art which is not considered to be of particular relevance *E* earlier document but published on or after the international filing date *L* document which may throw doubts on priority claim(s) or which is cited to establish the publication date of another citation or other special reason (as specified) *O* document referring to an oral disclosure, use, exhibition or other means *P* document published prior to the international filing date but later than the priority date claimed *T* later document published after the international filing date or priority date and not in conflict with the application but cited to understand the principle or theory underlying the invention *X* document of particular relevance; the claimed invention cannot be considered novel or cannot be considered to involve an inventive step when the document is taken alone *Y* document of particular relevance; the claimed invention cannot be considered to involve an inventive step when the document is combined with one or more other such documents, such combination being obvious to a person skilled in the art. *8* document member of the same patent family		
Date of the actual completion of the international search 6 October 2004		Date of mailing of the international search report 15/10/2004
Name and mailing address of the ISA European Patent Office, P.B. 5818 Patentlaan 2 NL - 2280 HV Rijswijk Tel. (+31-70) 340-2040, Tx. 31 651 epo nl, Fax: (+31-70) 340-3016		Authorized officer Kirsten, K

Form PCT/ISA/210 (second sheet) (January 2004)

INTERNATIONAL SEARCH REPORT

International Application No
PCT/CA2004/000263

C.(Continuation) DOCUMENTS CONSIDERED TO BE RELEVANT		
Category °	Citation of document, with indication, where appropriate, of the relevant passages	Relevant to claim No.
A	US 6 385 459 B1 (LAWRENCE PETER ROBERT ET AL) 7 May 2002 (2002-05-07) claim 9; figure 5	1-20
A	US 5 634 102 A (CAPPS STEPHEN P) 27 May 1997 (1997-05-27) claim 1; figure 4A	1-20

1

Form PCT/ISA/210 (continuation of second sheet) (January 2004)

page 2 of 2

Facebook's Exhibit No. 1013
0515

Snap Inc. Ex. 1013 Page 0515

INTERNATIONAL SEARCH REPORT

Information on patent family members

International Application No

PCT/CA2004/000263

Patent document cited in search report		Publication date	Patent family member(s)	Publication date
US 5617526	A	01-04-1997	NONE	
US 5333256	A	26-07-1994	BR 9002272 A CA 2016397 A1 EP 0398648 A2 JP 3006631 A KR 9305803 B1	06-08-1991 15-11-1990 22-11-1990 14-01-1991 25-06-1993
EP 0943987	A	22-09-1999	NL 1008659 C2 DE 69914007 D1 EP 0943987 A1 JP 11327818 A US 6618163 B1	21-09-1999 12-02-2004 22-09-1999 30-11-1999 09-09-2003
US 6424354	B1	23-07-2002	US 6259446 B1 CA 2145676 A1 DE 69303289 D1 DE 69303289 T2 EP 0664021 A1 JP 8505719 T WO 9415273 A1	10-07-2001 07-07-1994 25-07-1996 20-02-1997 26-07-1995 18-06-1996 07-07-1994
US 6385459	B1	07-05-2002	NONE	
US 5634102	A	27-05-1997	NONE	

Form PCT/ISA/210 (patent family annex) (January 2004)

PATENT COOPERATION TREATY

From the
INTERNATIONAL SEARCHING AUTHORITY

To:

see form PCT/ISA/220

PCT
REPLY TO:
WRITTEN OPINION OF THE
INTERNATIONAL SEARCHING AUTHORITY
(PCT Rule 43bis.1)

DUE ON OCT 11 2005
Date of mailing
(day/month/year) see form PCT/ISA/210 (second sheet)

Applicant's or agent's file reference see form PCT/ISA/220		FOR FURTHER ACTION See paragraph 2 below	
International application No. PCT/CA2004/000263	International filing date (day/month/year) 24.02.2004	Priority date (day/month/year) 01.12.2003	
International Patent Classification (IPC) or both national classification and IPC G06F3/033, G06F3/023			
Applicant KLASSEN, Gerhard D.			

1. This opinion contains indications relating to the following items:

- Box No. I Basis of the opinion
- Box No. II Priority
- Box No. III Non-establishment of opinion with regard to novelty, inventive step and industrial applicability
- Box No. IV Lack of unity of invention
- Box No. V Reasoned statement under Rule 43bis.1(a)(i) with regard to novelty, inventive step or industrial applicability; citations and explanations supporting such statement
- Box No. VI Certain documents cited
- Box No. VII Certain defects in the international application
- Box No. VIII Certain observations on the international application

2. **FURTHER ACTION**



If a demand for international preliminary examination is made, this opinion will usually be considered to be a written opinion of the International Preliminary Examining Authority ("IPEA"). However, this does not apply where the applicant chooses an Authority other than this one to be the IPEA and the chosen IPEA has notified the International Bureau under Rule 66.1bis(b) that written opinions of this International Searching Authority will not be so considered.

If this opinion is, as provided above, considered to be a written opinion of the IPEA, the applicant is invited to submit to the IPEA a written reply together, where appropriate, with amendments, before the expiration of three months from the date of mailing of Form PCT/ISA/220 or before the expiration of 22 months from the priority date, whichever expires later.

For further options, see Form PCT/ISA/220.

3. For further details, see notes to Form PCT/ISA/220.

OCT. 11/05
JAN 1/05

<p>Name and mailing address of the ISA:</p>  <p>European Patent Office - Gitschiner Str. 103 D-10958 Berlin Tel. +49 30 25901 - 0 Fax: +49 30 25901 - 840</p>	<p>Authorized Officer</p> <p>Kirsten, K Telephone No. +49 30 25901-424</p> 
--	--

Form PCT/ISA/237 (Cover Sheet) (January 2004)

Facebook's Exhibit No. 1013
0517

Box No. I Basis of the opinion

1. With regard to the **language**, this opinion has been established on the basis of the international application in the language in which it was filed, unless otherwise indicated under this item.
 - This opinion has been established on the basis of a translation from the original language into the following language , which is the language of a translation furnished for the purposes of international search (under Rules 12.3 and 23.1(b)).
2. With regard to any **nucleotide and/or amino acid sequence** disclosed in the international application and necessary to the claimed invention, this opinion has been established on the basis of:
 - a. type of material:
 - a sequence listing
 - table(s) related to the sequence listing
 - b. format of material:
 - in written format
 - in computer readable form
 - c. time of filing/furnishing:
 - contained in the international application as filed.
 - filed together with the international application in computer readable form.
 - furnished subsequently to this Authority for the purposes of search.
3. In addition, in the case that more than one version or copy of a sequence listing and/or table relating thereto has been filed or furnished, the required statements that the information in the subsequent or additional copies is identical to that in the application as filed or does not go beyond the application as filed, as appropriate, were furnished.
4. Additional comments:

**WRITTEN OPINION OF THE
INTERNATIONAL SEARCHING AUTHORITY**

International application No.
PCT/CA2004/000263

Box No. II Priority

1. The following document has not been furnished:
- copy of the earlier application whose priority has been claimed (Rule 43*bis*.1 and 66.7(a)).
 - translation of the earlier application whose priority has been claimed (Rule 43*bis*.1 and 66.7(b)).
- Consequently it has not been possible to consider the validity of the priority claim. This opinion has nevertheless been established on the assumption that the relevant date is the claimed priority date.
2. This opinion has been established as if no priority had been claimed due to the fact that the priority claim has been found invalid (Rules 43*bis*.1 and 64.1). Thus for the purposes of this opinion, the international filing date indicated above is considered to be the relevant date.
3. Additional observations, if necessary:

Box No. V Reasoned statement under Rule 43*bis*.1(a)(i) with regard to novelty, inventive step or industrial applicability; citations and explanations supporting such statement

1. Statement

Novelty (N)	Yes: Claims	5,11,20
	No: Claims	1-4,6-10,12-19
Inventive step (IS)	Yes: Claims	
	No: Claims	5,11,20
Industrial applicability (IA)	Yes: Claims	1-20
	No: Claims	

2. Citations and explanations

see separate sheet

Re Item V.

1. The following document is referred to in this communication:
D1 : US 5 617 526 A (ORAN DANIEL P ET AL) 1 April 1997 (1997-04-01)
2. The present application does not meet the criteria of Article 33(1) PCT, because the subject-matter of claims 1,12,13,14 is not new in the sense of Article 33(2) PCT.
 - 2.1 Document D1 discloses all the features of modifying the look of icons in response to events and previewing them that are described in these claims. See e.g. column 5, paragraph 4; claims 1,2,6; figures 4,8,10.
3. The dependent claims do not contain any features which, in combination with the features of any claim to which they refer, meet the requirements of the PCT in respect of novelty and/or inventive step for the following reasons:
 - 3.1 The features described in the dependent claims 2-4,6-10,15-19 are disclosed in D1. (Article 33(2) PCT).
 - 3.2 The features described in the dependent claims 5,11,20 are commonly known in the field, and it would not involve an inventive activity to include them into the system described in D1. (Article 33(3) PCT).

INFORMATION DISCLOSURE STATEMENT BY APPLICANT (Not for submission under 37 CFR 1.99)	Application Number	10784781
	Filing Date	2004-02-24
	First Named Inventor	Gerhard D. Klassen
	Art Unit	2179
	Examiner Name	John M. Heffington
	Attorney Docket Number	0520024-272US

U.S.PATENTS							Remove	
Examiner Initial*	Cite No	Patent Number	Kind Code ¹	Issue Date	Name of Patentee or Applicant of cited Document	Pages,Columns,Lines where Relevant Passages or Relevant Figures Appear		
	1							
If you wish to add additional U.S. Patent citation information please click the Add button.							Add	
U.S.PATENT APPLICATION PUBLICATIONS							Remove	
Examiner Initial*	Cite No	Publication Number	Kind Code ¹	Publication Date	Name of Patentee or Applicant of cited Document	Pages,Columns,Lines where Relevant Passages or Relevant Figures Appear		
	1							
If you wish to add additional U.S. Published Application citation information please click the Add button.							Add	
FOREIGN PATENT DOCUMENTS							Remove	
Examiner Initial*	Cite No	Foreign Document Number ³	Country Code ² j	Kind Code ⁴	Publication Date	Name of Patentee or Applicant of cited Document	Pages,Columns,Lines where Relevant Passages or Relevant Figures Appear	T ⁵
	1							<input type="checkbox"/>
If you wish to add additional Foreign Patent Document citation information please click the Add button							Add	
NON-PATENT LITERATURE DOCUMENTS							Remove	
Examiner Initials*	Cite No	Include name of the author (in CAPITAL LETTERS), title of the article (when appropriate), title of the item (book, magazine, journal, serial, symposium, catalog, etc), date, pages(s), volume-issue number(s), publisher, city and/or country where published.					T ⁵	

INFORMATION DISCLOSURE STATEMENT BY APPLICANT (Not for submission under 37 CFR 1.99)	Application Number		10784781
	Filing Date		2004-02-24
	First Named Inventor	Gerhard D. Klassen	
	Art Unit	2179	
	Examiner Name	John M. Heffington	
	Attorney Docket Number	0520024-272US	

1	Letters Patent issued by the Korean Intellectual Property Office dated November 25, 2008, for corresponding Korean Patent No. 0871404.	<input type="checkbox"/>
2	Notification of Grant of Rights for Invention Patent dated May 26, 2010, issued by the State Intellectual Property Office the P.R. Of China for corresponding Chinese Patent Application No. 200810099973.X.	<input type="checkbox"/>
3	Patent Certificate for Invention dated July 23, 2008, issued by the State Intellectual Property Office the P.R. Of China, for corresponding Chinese Patent No. 413649.	<input type="checkbox"/>
4	Summons to attend Oral Proceedings pursuant to Rule 71(1) EPC, dated September 19, 2007, issued by the European Patent Office for corresponding Patent Application No. 04713831.8.	<input type="checkbox"/>
5	Observations pursuant to Rule 71(a) EPC, dated December 31, 2007, issued by the European Patent Office for corresponding Patent Application No. 04713831.8.	<input type="checkbox"/>
6	Brief Communication dated January 29, 2008, issued by the European Patent Office for corresponding Patent Application No. 04713831.8.	<input type="checkbox"/>
7	Decision to Refuse a European Patent Application, dated September 9, 2008, issued by the European Patent Office for corresponding Patent Application No. 04713831.8.	<input type="checkbox"/>
8	Request for Appeal to the European Patent Office dated November 3, 2008, for corresponding Patent Application No. 04713831.8.	<input type="checkbox"/>

If you wish to add additional non-patent literature document citation information please click the Add button

EXAMINER SIGNATURE

Examiner Signature		Date Considered	
--------------------	--	-----------------	--

*EXAMINER: Initial if reference considered, whether or not citation is in conformance with MPEP 609. Draw line through a citation if not in conformance and not considered. Include copy of this form with next communication to applicant.

¹ See Kind Codes of USPTO Patent Documents at www.USPTO.GOV or MPEP 901.04. ² Enter office that issued the document, by the two-letter code (WIPO Standard ST.3). ³ For Japanese patent documents, the indication of the year of the reign of the Emperor must precede the serial number of the patent document. ⁴ Kind of document by the appropriate symbols as indicated on the document under WIPO Standard ST.16 if possible. ⁵ Applicant is to place a check mark here if English language translation is attached.

INFORMATION DISCLOSURE STATEMENT BY APPLICANT (Not for submission under 37 CFR 1.99)	Application Number	10784781
	Filing Date	2004-02-24
	First Named Inventor	Gerhard D. Klassen
	Art Unit	2179
	Examiner Name	John M. Heffington
	Attorney Docket Number	0520024-272US

CERTIFICATION STATEMENT

Please see 37 CFR 1.97 and 1.98 to make the appropriate selection(s):

That each item of information contained in the information disclosure statement was first cited in any communication from a foreign patent office in a counterpart foreign application not more than three months prior to the filing of the information disclosure statement. See 37 CFR 1.97(e)(1).

OR

That no item of information contained in the information disclosure statement was cited in a communication from a foreign patent office in a counterpart foreign application, and, to the knowledge of the person signing the certification after making reasonable inquiry, no item of information contained in the information disclosure statement was known to any individual designated in 37 CFR 1.56(c) more than three months prior to the filing of the information disclosure statement. See 37 CFR 1.97(e)(2).

See attached certification statement.

Fee set forth in 37 CFR 1.17 (p) has been submitted herewith.

None

SIGNATURE

A signature of the applicant or representative is required in accordance with CFR 1.33, 10.18. Please see CFR 1.4(d) for the form of the signature.

Signature	/Matthew MARQUARDT/	Date (YYYY-MM-DD)	2010-08-20
Name/Print	Matthew Marquardt	Registration Number	40997

This collection of information is required by 37 CFR 1.97 and 1.98. The information is required to obtain or retain a benefit by the public which is to file (and by the USPTO to process) an application. Confidentiality is governed by 35 U.S.C. 122 and 37 CFR 1.14. This collection is estimated to take 1 hour to complete, including gathering, preparing and submitting the completed application form to the USPTO. Time will vary depending upon the individual case. Any comments on the amount of time you require to complete this form and/or suggestions for reducing this burden, should be sent to the Chief Information Officer, U.S. Patent and Trademark Office, U.S. Department of Commerce, P.O. Box 1450, Alexandria, VA 22313-1450. **DO NOT SEND FEES OR COMPLETED FORMS TO THIS ADDRESS. SEND TO: Commissioner for Patents, P.O. Box 1450, Alexandria, VA 22313-1450.**

Privacy Act Statement

The Privacy Act of 1974 (P.L. 93-579) requires that you be given certain information in connection with your submission of the attached form related to a patent application or patent. Accordingly, pursuant to the requirements of the Act, please be advised that: (1) the general authority for the collection of this information is 35 U.S.C. 2(b)(2); (2) furnishing of the information solicited is voluntary; and (3) the principal purpose for which the information is used by the U.S. Patent and Trademark Office is to process and/or examine your submission related to a patent application or patent. If you do not furnish the requested information, the U.S. Patent and Trademark Office may not be able to process and/or examine your submission, which may result in termination of proceedings or abandonment of the application or expiration of the patent.

The information provided by you in this form will be subject to the following routine uses:

1. The information on this form will be treated confidentially to the extent allowed under the Freedom of Information Act (5 U.S.C. 552) and the Privacy Act (5 U.S.C. 552a). Records from this system of records may be disclosed to the Department of Justice to determine whether the Freedom of Information Act requires disclosure of these records.
2. A record from this system of records may be disclosed, as a routine use, in the course of presenting evidence to a court, magistrate, or administrative tribunal, including disclosures to opposing counsel in the course of settlement negotiations.
3. A record in this system of records may be disclosed, as a routine use, to a Member of Congress submitting a request involving an individual, to whom the record pertains, when the individual has requested assistance from the Member with respect to the subject matter of the record.
4. A record in this system of records may be disclosed, as a routine use, to a contractor of the Agency having need for the information in order to perform a contract. Recipients of information shall be required to comply with the requirements of the Privacy Act of 1974, as amended, pursuant to 5 U.S.C. 552a(m).
5. A record related to an International Application filed under the Patent Cooperation Treaty in this system of records may be disclosed, as a routine use, to the International Bureau of the World Intellectual Property Organization, pursuant to the Patent Cooperation Treaty.
6. A record in this system of records may be disclosed, as a routine use, to another federal agency for purposes of National Security review (35 U.S.C. 181) and for review pursuant to the Atomic Energy Act (42 U.S.C. 218(c)).
7. A record from this system of records may be disclosed, as a routine use, to the Administrator, General Services, or his/her designee, during an inspection of records conducted by GSA as part of that agency's responsibility to recommend improvements in records management practices and programs, under authority of 44 U.S.C. 2904 and 2906. Such disclosure shall be made in accordance with the GSA regulations governing inspection of records for this purpose, and any other relevant (i.e., GSA or Commerce) directive. Such disclosure shall not be used to make determinations about individuals.
8. A record from this system of records may be disclosed, as a routine use, to the public after either publication of the application pursuant to 35 U.S.C. 122(b) or issuance of a patent pursuant to 35 U.S.C. 151. Further, a record may be disclosed, subject to the limitations of 37 CFR 1.14, as a routine use, to the public if the record was filed in an application which became abandoned or in which the proceedings were terminated and which application is referenced by either a published application, an application open to public inspections or an issued patent.
9. A record from this system of records may be disclosed, as a routine use, to a Federal, State, or local law enforcement agency, if the USPTO becomes aware of a violation or potential violation of law or regulation.

Electronic Acknowledgement Receipt	
EFS ID:	8258511
Application Number:	10784781
International Application Number:	
Confirmation Number:	2200
Title of Invention:	Previewing a new event on a small screen device
First Named Inventor/Applicant Name:	Gerhard D. Klassen
Customer Number:	20988
Filer:	Matthew J. Marquardt/Nicole Farrugia
Filer Authorized By:	Matthew J. Marquardt
Attorney Docket Number:	05200204-272US
Receipt Date:	20-AUG-2010
Filing Date:	24-FEB-2004
Time Stamp:	14:23:26
Application Type:	Utility under 35 USC 111(a)

Payment information:

Submitted with Payment	no
------------------------	----

File Listing:

Document Number	Document Description	File Name	File Size(Bytes)/ Message Digest	Multi Part /.zip	Pages (if appl.)
1	Information Disclosure Statement (IDS) Filed (SB/08)	Supp_IDS.pdf	621460 <small>f69dd04e951f47b9ca9512280084adc277b a07a2</small>	no	4

Warnings:

Information:

A U.S. Patent Number Citation or a U.S. Publication Number Citation is required in the Information Disclosure Statement (IDS) form for autoloading of data into USPTO systems. You may remove the form to add the required data in order to correct the Informational Message if you are citing U.S. References. If you chose not to include U.S. References, the image of the form will be processed and be made available within the Image File Wrapper (IFW) system. However, no data will be extracted from this form. Any additional data such as Foreign Patent Documents or Non Patent Literature will be manually reviewed and keyed into USPTO systems.

2	NPL Documents	Certificate_of_Patent_CN.PDF	121999 f61196786404824408bf3834898449721fc28b85	no	3
Warnings:					
Information:					
3	NPL Documents	EP_oralproceedings_communication.PDF	499868 336804bc7dab085eb964aca99524aeb7f0dffa1	no	11
Warnings:					
Information:					
4	NPL Documents	Fax_EPO_requesting_appeal.PDF	35062 491f464b3017d1b647465eb7f19aeebd02d0e7ff	no	1
Warnings:					
Information:					
5	NPL Documents	Issue_NotificationKR.PDF	112626 408db6629fc4fd678660fcc86a276344cba96b18	no	4
Warnings:					
Information:					
6	NPL Documents	Notification_Grant_CN1.PDF	219870 a4f6e74cde7b6450371e6c6a52847de95313d08f	no	4
Warnings:					
Information:					
7	NPL Documents	observations_pursuant_to_rule71.PDF	1844554 d3bdf59687ef36ff8ad72deec251a85765fe856	no	41
Warnings:					
Information:					
8	NPL Documents	Summons_to_attend_oral_proceedings.PDF	317554 b1df70d7f1ce86a69997229210538f8bde554f3d	no	8
Warnings:					
Information:					
9	NPL Documents	EP_Decison_to_refuse.PDF	628396 cee836dff19f38f667d89cb05e05ae084f9627d6	no	17
Warnings:					
Information:					
Total Files Size (in bytes):			4401389		

This Acknowledgement Receipt evidences receipt on the noted date by the USPTO of the indicated documents, characterized by the applicant, and including page counts, where applicable. It serves as evidence of receipt similar to a Post Card, as described in MPEP 503.

New Applications Under 35 U.S.C. 111

If a new application is being filed and the application includes the necessary components for a filing date (see 37 CFR 1.53(b)-(d) and MPEP 506), a Filing Receipt (37 CFR 1.54) will be issued in due course and the date shown on this Acknowledgement Receipt will establish the filing date of the application.

National Stage of an International Application under 35 U.S.C. 371

If a timely submission to enter the national stage of an international application is compliant with the conditions of 35 U.S.C. 371 and other applicable requirements a Form PCT/DO/EO/903 indicating acceptance of the application as a national stage submission under 35 U.S.C. 371 will be issued in addition to the Filing Receipt, in due course.

New International Application Filed with the USPTO as a Receiving Office

If a new international application is being filed and the international application includes the necessary components for an international filing date (see PCT Article 11 and MPEP 1810), a Notification of the International Application Number and of the International Filing Date (Form PCT/RO/105) will be issued in due course, subject to prescriptions concerning national security, and the date shown on this Acknowledgement Receipt will establish the international filing date of the application.



UNITED STATES PATENT AND TRADEMARK OFFICE

UNITED STATES DEPARTMENT OF COMMERCE
United States Patent and Trademark Office
Address: COMMISSIONER FOR PATENTS
P.O. Box 1450
Alexandria, Virginia 22313-1450
www.uspto.gov

APPLICATION NO.	FILING DATE	FIRST NAMED INVENTOR	ATTORNEY DOCKET NO.	CONFIRMATION NO.
10/784,781	02/24/2004	Gerhard D. Klassen	05200204-272US	2200
20988	7590	08/26/2010	EXAMINER	
OGILVY RENAULT LLP 1, Place Ville Marie SUITE 2500 MONTREAL, QC H3B 1R1 CANADA			HEFFINGTON, JOHN M	
			ART UNIT	PAPER NUMBER
			2179	
			MAIL DATE	DELIVERY MODE
			08/26/2010	PAPER

Please find below and/or attached an Office communication concerning this application or proceeding.

The time period for reply, if any, is set in the attached communication.

Interview Summary	Application No. 10/784,781	Applicant(s) KLASSEN ET AL.	
	Examiner JOHN HEFFINGTON	Art Unit 2179	

All participants (applicant, applicant's representative, PTO personnel):

(1) JOHN HEFFINGTON. (3)_____.

(2) Matt Marquadt. (4)_____.

Date of Interview: 25 August 2010.

Type: a) Telephonic b) Video Conference
c) Personal [copy given to: 1) applicant 2) applicant's representative]

Exhibit shown or demonstration conducted: d) Yes e) No.
If Yes, brief description: _____.

Claim(s) discussed: 52 and 76.

Identification of prior art discussed: Neilsen et al. US 20060084450 A1.

Agreement with respect to the claims f) was reached. g) was not reached. h) N/A.

Substance of Interview including description of the general nature of what was agreed to if an agreement was reached, or any other comments: The examiner presented Neilsen to the applicant, stating the examiner believed that Neilsen read on the discussed independent claims. The examiner suggested that the applicant review the specification of the instant application to determine if there is support for the limitation that count of correspondents who have sent messages that remain unread persists after the previews of the messages have been viewed..

(A fuller description, if necessary, and a copy of the amendments which the examiner agreed would render the claims allowable, if available, must be attached. Also, where no copy of the amendments that would render the claims allowable is available, a summary thereof must be attached.)

THE FORMAL WRITTEN REPLY TO THE LAST OFFICE ACTION MUST INCLUDE THE SUBSTANCE OF THE INTERVIEW. (See MPEP Section 713.04). If a reply to the last Office action has already been filed, APPLICANT IS GIVEN A NON-EXTENDABLE PERIOD OF THE LONGER OF ONE MONTH OR THIRTY DAYS FROM THIS INTERVIEW DATE, OR THE MAILING DATE OF THIS INTERVIEW SUMMARY FORM, WHICHEVER IS LATER, TO FILE A STATEMENT OF THE SUBSTANCE OF THE INTERVIEW. See Summary of Record of Interview requirements on reverse side or on attached sheet.

	/Boris Pesin/ Supervisory Patent Examiner, Art Unit 2174
--	---

Summary of Record of Interview Requirements

Manual of Patent Examining Procedure (MPEP), Section 713.04, Substance of Interview Must be Made of Record

A complete written statement as to the substance of any face-to-face, video conference, or telephone interview with regard to an application must be made of record in the application whether or not an agreement with the examiner was reached at the interview.

Title 37 Code of Federal Regulations (CFR) § 1.133 Interviews Paragraph (b)

In every instance where reconsideration is requested in view of an interview with an examiner, a complete written statement of the reasons presented at the interview as warranting favorable action must be filed by the applicant. An interview does not remove the necessity for reply to Office action as specified in §§ 1.111, 1.135. (35 U.S.C. 132)

37 CFR §1.2 Business to be transacted in writing.

All business with the Patent or Trademark Office should be transacted in writing. The personal attendance of applicants or their attorneys or agents at the Patent and Trademark Office is unnecessary. The action of the Patent and Trademark Office will be based exclusively on the written record in the Office. No attention will be paid to any alleged oral promise, stipulation, or understanding in relation to which there is disagreement or doubt.

The action of the Patent and Trademark Office cannot be based exclusively on the written record in the Office if that record is itself incomplete through the failure to record the substance of interviews.

It is the responsibility of the applicant or the attorney or agent to make the substance of an interview of record in the application file, unless the examiner indicates he or she will do so. It is the examiner's responsibility to see that such a record is made and to correct material inaccuracies which bear directly on the question of patentability.

Examiners must complete an Interview Summary Form for each interview held where a matter of substance has been discussed during the interview by checking the appropriate boxes and filling in the blanks. Discussions regarding only procedural matters, directed solely to restriction requirements for which interview recordation is otherwise provided for in Section 812.01 of the Manual of Patent Examining Procedure, or pointing out typographical errors or unreadable script in Office actions or the like, are excluded from the interview recordation procedures below. Where the substance of an interview is completely recorded in an Examiners Amendment, no separate Interview Summary Record is required.

The Interview Summary Form shall be given an appropriate Paper No., placed in the right hand portion of the file, and listed on the "Contents" section of the file wrapper. In a personal interview, a duplicate of the Form is given to the applicant (or attorney or agent) at the conclusion of the interview. In the case of a telephone or video-conference interview, the copy is mailed to the applicant's correspondence address either with or prior to the next official communication. If additional correspondence from the examiner is not likely before an allowance or if other circumstances dictate, the Form should be mailed promptly after the interview rather than with the next official communication.

The Form provides for recordation of the following information:

- Application Number (Series Code and Serial Number)
- Name of applicant
- Name of examiner
- Date of interview
- Type of interview (telephonic, video-conference, or personal)
- Name of participant(s) (applicant, attorney or agent, examiner, other PTO personnel, etc.)
- An indication whether or not an exhibit was shown or a demonstration conducted
- An identification of the specific prior art discussed
- An indication whether an agreement was reached and if so, a description of the general nature of the agreement (may be by attachment of a copy of amendments or claims agreed as being allowable). Note: Agreement as to allowability is tentative and does not restrict further action by the examiner to the contrary.
- The signature of the examiner who conducted the interview (if Form is not an attachment to a signed Office action)

It is desirable that the examiner orally remind the applicant of his or her obligation to record the substance of the interview of each case. It should be noted, however, that the Interview Summary Form will not normally be considered a complete and proper recordation of the interview unless it includes, or is supplemented by the applicant or the examiner to include, all of the applicable items required below concerning the substance of the interview.

A complete and proper recordation of the substance of any interview should include at least the following applicable items:

- 1) A brief description of the nature of any exhibit shown or any demonstration conducted,
- 2) an identification of the claims discussed,
- 3) an identification of the specific prior art discussed,
- 4) an identification of the principal proposed amendments of a substantive nature discussed, unless these are already described on the Interview Summary Form completed by the Examiner,
- 5) a brief identification of the general thrust of the principal arguments presented to the examiner,
(The identification of arguments need not be lengthy or elaborate. A verbatim or highly detailed description of the arguments is not required. The identification of the arguments is sufficient if the general nature or thrust of the principal arguments made to the examiner can be understood in the context of the application file. Of course, the applicant may desire to emphasize and fully describe those arguments which he or she feels were or might be persuasive to the examiner.)
- 6) a general indication of any other pertinent matters discussed, and
- 7) if appropriate, the general results or outcome of the interview unless already described in the Interview Summary Form completed by the examiner.

Examiners are expected to carefully review the applicant's record of the substance of an interview. If the record is not complete and accurate, the examiner will give the applicant an extendable one month time period to correct the record.

Examiner to Check for Accuracy

If the claims are allowable for other reasons of record, the examiner should send a letter setting forth the examiner's version of the statement attributed to him or her. If the record is complete and accurate, the examiner should place the indication, "Interview Record OK" on the paper recording the substance of the interview along with the date and the examiner's initials.



UNITED STATES PATENT AND TRADEMARK OFFICE

UNITED STATES DEPARTMENT OF COMMERCE
United States Patent and Trademark Office
Address: COMMISSIONER FOR PATENTS
P.O. Box 1450
Alexandria, Virginia 22313-1450
www.uspto.gov

APPLICATION NO.	FILING DATE	FIRST NAMED INVENTOR	ATTORNEY DOCKET NO.	CONFIRMATION NO.
10/784,781	02/24/2004	Gerhard D. Klassen	05200204-272US	2200
20988	7590	11/02/2010	EXAMINER	
OGILVY RENAULT LLP 1, Place Ville Marie SUITE 2500 MONTREAL, QC H3B 1R1 CANADA			HEFFINGTON, JOHN M	
			ART UNIT	PAPER NUMBER
			2172	
			MAIL DATE	DELIVERY MODE
			11/02/2010	PAPER

Please find below and/or attached an Office communication concerning this application or proceeding.

The time period for reply, if any, is set in the attached communication.

Interview Summary	Application No. 10/784,781	Applicant(s) KLASSEN ET AL.	
	Examiner JOHN HEFFINGTON	Art Unit 2172	

All participants (applicant, applicant's representative, PTO personnel):

(1) JOHN HEFFINGTON. (3) Matthew Marquadt.

(2) Boris Pesin. (4) _____.

Date of Interview: 22 October 2010.

Type: a) Telephonic b) Video Conference
c) Personal [copy given to: 1) applicant 2) applicant's representative]

Exhibit shown or demonstration conducted: d) Yes e) No.
If Yes, brief description: _____.

Claim(s) discussed: 52,58,64,70,76,85,94 and 103.

Identification of prior art discussed: Wagner, Hirayama, Nielson (US 2007/0060206 A1).

Agreement with respect to the claims f) was reached. g) was not reached. h) N/A.

Substance of Interview including description of the general nature of what was agreed to if an agreement was reached, or any other comments: See Continuation Sheet.

(A fuller description, if necessary, and a copy of the amendments which the examiner agreed would render the claims allowable, if available, must be attached. Also, where no copy of the amendments that would render the claims allowable is available, a summary thereof must be attached.)

THE FORMAL WRITTEN REPLY TO THE LAST OFFICE ACTION MUST INCLUDE THE SUBSTANCE OF THE INTERVIEW. (See MPEP Section 713.04). If a reply to the last Office action has already been filed, APPLICANT IS GIVEN A NON-EXTENDABLE PERIOD OF THE LONGER OF ONE MONTH OR THIRTY DAYS FROM THIS INTERVIEW DATE, OR THE MAILING DATE OF THIS INTERVIEW SUMMARY FORM, WHICHEVER IS LATER, TO FILE A STATEMENT OF THE SUBSTANCE OF THE INTERVIEW. See Summary of Record of Interview requirements on reverse side or on attached sheet.

	/Boris Pesin/ Supervisory Patent Examiner, Art Unit 2172
--	---

Summary of Record of Interview Requirements

Manual of Patent Examining Procedure (MPEP), Section 713.04, Substance of Interview Must be Made of Record

A complete written statement as to the substance of any face-to-face, video conference, or telephone interview with regard to an application must be made of record in the application whether or not an agreement with the examiner was reached at the interview.

Title 37 Code of Federal Regulations (CFR) § 1.133 Interviews Paragraph (b)

In every instance where reconsideration is requested in view of an interview with an examiner, a complete written statement of the reasons presented at the interview as warranting favorable action must be filed by the applicant. An interview does not remove the necessity for reply to Office action as specified in §§ 1.111, 1.135. (35 U.S.C. 132)

37 CFR §1.2 Business to be transacted in writing.

All business with the Patent or Trademark Office should be transacted in writing. The personal attendance of applicants or their attorneys or agents at the Patent and Trademark Office is unnecessary. The action of the Patent and Trademark Office will be based exclusively on the written record in the Office. No attention will be paid to any alleged oral promise, stipulation, or understanding in relation to which there is disagreement or doubt.

The action of the Patent and Trademark Office cannot be based exclusively on the written record in the Office if that record is itself incomplete through the failure to record the substance of interviews.

It is the responsibility of the applicant or the attorney or agent to make the substance of an interview of record in the application file, unless the examiner indicates he or she will do so. It is the examiner's responsibility to see that such a record is made and to correct material inaccuracies which bear directly on the question of patentability.

Examiners must complete an Interview Summary Form for each interview held where a matter of substance has been discussed during the interview by checking the appropriate boxes and filling in the blanks. Discussions regarding only procedural matters, directed solely to restriction requirements for which interview recordation is otherwise provided for in Section 812.01 of the Manual of Patent Examining Procedure, or pointing out typographical errors or unreadable script in Office actions or the like, are excluded from the interview recordation procedures below. Where the substance of an interview is completely recorded in an Examiners Amendment, no separate Interview Summary Record is required.

The Interview Summary Form shall be given an appropriate Paper No., placed in the right hand portion of the file, and listed on the "Contents" section of the file wrapper. In a personal interview, a duplicate of the Form is given to the applicant (or attorney or agent) at the conclusion of the interview. In the case of a telephone or video-conference interview, the copy is mailed to the applicant's correspondence address either with or prior to the next official communication. If additional correspondence from the examiner is not likely before an allowance or if other circumstances dictate, the Form should be mailed promptly after the interview rather than with the next official communication.

The Form provides for recordation of the following information:

- Application Number (Series Code and Serial Number)
- Name of applicant
- Name of examiner
- Date of interview
- Type of interview (telephonic, video-conference, or personal)
- Name of participant(s) (applicant, attorney or agent, examiner, other PTO personnel, etc.)
- An indication whether or not an exhibit was shown or a demonstration conducted
- An identification of the specific prior art discussed
- An indication whether an agreement was reached and if so, a description of the general nature of the agreement (may be by attachment of a copy of amendments or claims agreed as being allowable). Note: Agreement as to allowability is tentative and does not restrict further action by the examiner to the contrary.
- The signature of the examiner who conducted the interview (if Form is not an attachment to a signed Office action)

It is desirable that the examiner orally remind the applicant of his or her obligation to record the substance of the interview of each case. It should be noted, however, that the Interview Summary Form will not normally be considered a complete and proper recordation of the interview unless it includes, or is supplemented by the applicant or the examiner to include, all of the applicable items required below concerning the substance of the interview.

A complete and proper recordation of the substance of any interview should include at least the following applicable items:

- 1) A brief description of the nature of any exhibit shown or any demonstration conducted,
- 2) an identification of the claims discussed,
- 3) an identification of the specific prior art discussed,
- 4) an identification of the principal proposed amendments of a substantive nature discussed, unless these are already described on the Interview Summary Form completed by the Examiner,
- 5) a brief identification of the general thrust of the principal arguments presented to the examiner,
(The identification of arguments need not be lengthy or elaborate. A verbatim or highly detailed description of the arguments is not required. The identification of the arguments is sufficient if the general nature or thrust of the principal arguments made to the examiner can be understood in the context of the application file. Of course, the applicant may desire to emphasize and fully describe those arguments which he or she feels were or might be persuasive to the examiner.)
- 6) a general indication of any other pertinent matters discussed, and
- 7) if appropriate, the general results or outcome of the interview unless already described in the Interview Summary Form completed by the examiner.

Examiners are expected to carefully review the applicant's record of the substance of an interview. If the record is not complete and accurate, the examiner will give the applicant an extendable one month time period to correct the record.

Examiner to Check for Accuracy

If the claims are allowable for other reasons of record, the examiner should send a letter setting forth the examiner's version of the statement attributed to him or her. If the record is complete and accurate, the examiner should place the indication, "Interview Record OK" on the paper recording the substance of the interview along with the date and the examiner's initials.

Continuation of Substance of Interview including description of the general nature of what was agreed to if an agreement was reached, or any other comments: The applicant suggested amending the claims to include a limitation claiming that the number representing a count be further limited to include that the number is represented by a numeric digit. The applicant further suggested amending the claims to include the limitation claiming that the identifier associated with the correspondent be further limited to include a text identifier. The examiner suggested that the claims could be amended to include a limitation that the meaning of the displayed count could be user configurable. The examiner agreed to a future interview to discuss amendments that may overcome the prior art of record and other discussed prior art..

IN THE UNITED STATES PATENT AND TRADEMARK OFFICE

Inventor(s) KLASSEN et al.
Serial No.: 10/784,781
Filed: 24 February 2004
Examiner: HEFFINGTON, John M.
Group Art Unit: 2179
Confirmation No.: 2200
Title: PREVIEWING A NEW EVENT ON A SMALL SCREEN
 DEVICE

VIA ELECTRONIC FILING

Commissioner for Patents
P.O. Box 1450
Alexandria, Virginia 22313-1450
U.S.A.

**SUPPLEMENTAL AMENDMENT
AND SUMMARY OF INTERVIEW**

This paper (the Response) is filed further to the Request for Continued Examination filed herein 28 July 2010.

Amendments to the Claims are presented beginning at page 2.

Remarks, which include a Summary of Interview, are presented beginning at page 18.

AMENDMENT

In the Claims

Please rewrite the claims as follows. A complete listing of the claims is provided pursuant to 37 CFR 1.121.

1 – 51. (Cancelled)

52. (Currently amended) A method of providing notifications of unread messages on a wireless communication device, comprising:

displaying at least one icon relating to electronic messaging on a graphical user interface of the wireless communication device;

receiving a plurality of electronic messages on the wireless communication device, the plurality of electronic messages including messages from a plurality of different messaging correspondents; and

in response to receiving at least one of the plurality of electronic messages, visually modifying at least one displayed icon relating to electronic messaging to include a number representing a count of the plurality of different messaging correspondents for which one or more of the electronic messages have been received and remain unread.

53. (Previously presented) The method of claim 52, further comprising displaying a plurality of icons including one or more application icons that are selectable to invoke respective ones of a plurality of applications on the wireless communication device.

54. (Previously presented) The method of claim 53, further comprising visually modifying one or more of the plurality of icons to include a count of electronic messages that have been received and remain unread.

55. (Previously presented) The method of claim 52, the at least one icon relating to electronic messaging being selectable to invoke an electronic messaging application.

56. (Previously presented) The method of claim 52, comprising displaying on the graphical user interface an identifier of the correspondent from whom at least one of the plurality of messages was received.

57. (Previously presented) The method of claim 52, comprising displaying on the graphical user interface at least one preview of content associated with at least one of the received electronic messages.

58. (Currently amended) A medium or media comprising machine-readable instructions executable by a processor of a wireless communication device, the wireless communication device including a graphical user interface, the machine-readable instructions, when executed, causing the wireless communication device to:

display at least one icon relating to an electronic messaging application on the graphical user interface;

receive a plurality of electronic messages, the plurality of electronic messages including messages from a plurality of different messaging correspondents; and

in response to receiving at least one of the plurality of electronic messages, visually modify at least one displayed icon relating to the electronic messaging application to include a number representing a count of the plurality of different

messaging correspondents for which one or more of the electronic messages have been received and remain unread.

59. (Previously presented) The medium or media of claim 58, further comprising machine-readable instructions which, when executed, cause the wireless communication device to display a plurality of icons including one or more application icons that are selectable to invoke respective ones of a plurality of applications on the wireless communication device.

60. (Previously presented) The medium or media of claim 59, further comprising machine-readable instructions which, when executed, cause the wireless communication device to visually modify one or more of the plurality of icons to include a count of electronic messages that have been received by the wireless communication device and remain unread.

61. (Previously presented) The medium or media of claim 58, the at least one icon relating to electronic messaging being selectable to invoke an electronic messaging application.

62. (Previously presented) The medium or media of claim 58, further comprising machine-readable instructions which, when executed, cause the wireless communication device to visually modify the graphical user interface to include an identifier of the correspondent from whom at least one of the plurality of messages was received.

63. (Previously presented) The medium or media of claim 58, further comprising machine-readable instructions which, when executed, cause the wireless communication device to visually modify the graphical user interface to include at least one preview of content associated with at least one of the received electronic messages.

64. (Currently amended) A computer-readable memory accessible by a processor of a wireless communication device, the memory comprising stored electronic data structures representing executable instructions which, when executed by the processor, cause the wireless communication device to:

display at least one icon relating to an electronic messaging application on the graphical user interface;

receive a plurality of electronic messages, the plurality of electronic messages including messages from a plurality of different messaging correspondents; and

in response to receiving at least one of the plurality of electronic messages, visually modify at least one displayed icon relating to the electronic messaging application to include a number representing a count of the plurality of different messaging correspondents for which one or more of the electronic messages have been received and remain unread.

65. (Previously presented) The computer-readable memory of claim 64, further comprising stored electronic data structures representing executable instructions which, when executed, cause the wireless communication device to display a plurality of icons including one or more application icons that are selectable to invoke respective ones of a plurality of applications on the wireless communication device.

66. (Previously presented) The computer-readable memory of claim 65, further comprising stored electronic data structures representing executable instructions which, when executed, cause the wireless communication device to visually modify one or more of the plurality of icons to include a count of electronic messages that have been received by the wireless communication device and remain unread.

67. (Previously presented) The computer-readable memory of claim 64, the at least one icon relating to electronic messaging being selectable to invoke an electronic messaging application.

68. (Previously presented) The computer-readable memory of claim 64, stored electronic data structures representing executable instructions which, when executed, cause the wireless communication device to visually modify the graphical user interface to include an identifier of the correspondent from whom at least one of the plurality of messages was received.

69. (Previously presented) The computer-readable memory of claim 64, further stored electronic data structures representing executable instructions which, when executed, cause the wireless communication device to visually modify the graphical user interface to include at least one preview of content associated with at least one of the received electronic messages.

70. (Currently amended) A wireless communication device comprising:

a processor;

a display electrically coupled to the processor, the display presenting a graphical user interface; and

a medium or media including machine-readable instructions executable by the processor to:

display at least one icon relating to electronic messaging on the graphical user interface;

receive a plurality of electronic messages, the plurality of electronic messages including messages from a plurality of different messaging correspondents; and

in response to receiving at least one of the plurality of electronic messages, visually modify the at least one displayed icon relating to electronic messaging to include a number representing a count of the plurality of different messaging correspondents for which one or more of the electronic messages have been received and remain unread.

71. (Previously presented) The wireless communication device of claim 70, the medium or media further comprising machine-readable instructions which, when executed, cause the wireless communication device to display a plurality of icons including one or more application icons that are selectable to invoke respective ones of a plurality of applications on the wireless communication device.

72. (Previously presented) The wireless communication device of claim 71, the medium or media comprising machine-readable instructions which, when executed, cause the wireless communication device to visually modify one or more of the plurality of icons to include a count of electronic messages that have been received and remain unread.

73. (Previously presented) The wireless communication device of claim 70, the at least one icon relating to electronic messaging being selectable to invoke an electronic messaging application.

74. (Previously presented) The wireless communication device of claim 70, the medium or media further comprising machine-readable instructions which, when executed, cause the wireless communication device to visually modify the graphical user interface to include an identifier of the correspondent from whom at least one of the plurality of messages was received.

75. (Previously presented) The wireless communication device of claim 70, the medium or media further comprising machine-readable instructions which, when executed, cause the wireless communication device to visually modify the graphical user interface to include at least one preview of content associated with at least one of the received electronic messages.

76. (Currently amended) A method of providing notifications of unread messages on a wireless communication device, comprising:

displaying at least one icon relating to an electronic messaging application on a graphical user interface of the wireless communication device;

receiving on the wireless communication device a plurality of electronic messages associated with the electronic messaging application; and

responsive to receiving at least one of the plurality of electronic messages:

visually modifying at least one icon relating to the electronic messaging application to include a count of the plurality of electronic messages which remain unread; and

displaying on the graphical user interface an a text identifier associated with a correspondent from whom the at least one of the plurality of electronic messages was received.

77. (Previously presented) The method of claim 76, the identifier associated with a correspondent from whom the at least one of the plurality of electronic messages was received comprising state information pertaining to the correspondent.

78. (Previously presented) The method of claim 76, further comprising displaying on the graphical user interface at least a preview of content associated with at least one of the received electronic messages.

79. (Previously presented) The method of claim 76, further comprising displaying on the graphical user interface for a predetermined period of time at least a preview of content associated with at least one of the received electronic messages.

80. (Previously presented) The method of claim 76, the at least one icon relating to electronic messaging being selectable to invoke an electronic messaging application.

81. (Previously presented) The method of claim 80, further comprising, responsive to invoking the electronic messaging application, navigating automatically to a graphical user interface comprising content associated with at least one of the received electronic messages.

82. (Previously presented) The method of claim 80, further comprising, responsive to invoking the electronic messaging application within a predetermined time following receipt of at least one of the received electronic messages, navigating automatically to a graphical user interface comprising content associated with the at least one of the received electronic messages.

83. (Previously presented) The method of claim 80, further comprising, responsive to invoking the electronic messaging application, visually modifying at least one icon relating to the electronic messaging application to include a decreased count of electronic messages which remain unread.

84. (Previously presented) The method of claim 80, further comprising, responsive to invoking the electronic messaging application, visually modifying at least one icon relating to the electronic messaging application to remove the count of electronic messages which remain unread.

85. (Currently amended) A medium or media comprising machine-readable instructions executable by a processor of a wireless communication device, the wireless communication device including a graphical user interface, the machine-readable instructions, when executed, causing the wireless communication device to:

display at least one icon relating to an electronic messaging application on a graphical user interface of the wireless communication device;

receive on the wireless communication device a plurality of electronic messages associated with the electronic messaging application; and

responsive to receiving at least one of the plurality of electronic messages:

visually modify at least one icon relating to the electronic messaging application to include a count of the plurality of electronic messages which remain unread; and

display on the graphical user interface an a text identifier associated with a correspondent from whom the at least one of the plurality of electronic messages was received.

86. (Previously presented) The medium or media of claim 85, the identifier associated with a correspondent from whom the at least one of the plurality of electronic messages was received comprising state information pertaining to the correspondent.

87. (Previously presented) The medium or media of claim 85, further comprising machine-readable instructions which, when executed, cause the wireless communication device to display on the graphical user interface at least a preview of content associated with at least one of the received electronic messages.

88. (Previously presented) The medium or media of claim 85, further comprising machine-readable instructions which, when executed, cause the wireless communication device to display on the graphical user interface for a predetermined period of time at least a preview of content associated with at least one of the received electronic messages.

89. (Previously presented) The medium or media of claim 85, the at least one icon relating to electronic messaging being selectable to invoke an electronic messaging application.

90. (Previously presented) The medium or media of claim 89, further comprising machine-readable instructions which, when executed, cause the wireless communication device to, responsive to invoking the electronic messaging application, navigate automatically to a graphical user interface comprising content associated with at least one of the received electronic messages.

91. (Previously presented) The medium or media of claim 89, further comprising machine-readable instructions which, when executed, cause the wireless communication device to, responsive to invoking the electronic messaging application within a predetermined time following receipt of at least one of the received electronic messages, navigate automatically to a graphical user interface comprising content associated with the at least one of the received electronic messages.

92. (Previously presented) The medium or media of claim 89, further comprising machine-readable instructions which, when executed, cause the wireless communication device to, responsive to invoking the electronic messaging application, visually modify at least one icon relating to the electronic messaging application to include a decreased count of electronic messages which remain unread.

93. (Previously presented) The medium or media of claim 89, further comprising machine-readable instructions which, when executed, cause the wireless communication device to, responsive to invoking the electronic messaging application, visually modify at least one icon relating to the electronic messaging application to remove the count of electronic messages which remain unread.

94. (Currently amended) A computer-readable memory accessible by a processor of a wireless communication device, the memory comprising stored electronic data structures representing executable instructions which, when executed by the processor, cause the wireless communication device to:

display at least one icon relating to an electronic messaging application on a graphical user interface of the wireless communication device;

receive on the wireless communication device a plurality of electronic messages associated with the electronic messaging application; and

responsive to receiving at least one of the plurality of electronic messages:

visually modify at least one icon relating to the electronic messaging application to include a count of the plurality of electronic messages which remain unread; and

display on the graphical user interface an a text identifier associated with a correspondent from whom the at least one of the plurality of electronic messages was received.

95. (Previously presented) The computer-readable memory of claim 94, the identifier associated with a correspondent from whom the at least one of the plurality of electronic messages was received comprising state information pertaining to the correspondent.

96. (Previously presented) The computer-readable memory of claim 94, further stored electronic data structures representing executable instructions which, when executed, cause the wireless communication device to display on the graphical user interface at least a preview of content associated with at least one of the received electronic messages.

97. (Previously presented) The computer-readable memory of claim 94, further stored electronic data structures representing executable instructions which, when executed, cause the wireless communication device to display on the graphical user interface for a predetermined period of time at least a preview of content associated with at least one of the received electronic messages.

98. (Previously presented) The computer-readable memory of claim 94, the at least one icon relating to electronic messaging being selectable to invoke an electronic messaging application.

99. (Previously presented) The computer-readable memory of claim 98, further stored electronic data structures representing executable instructions which, when executed, cause the wireless communication device to, responsive to invoking the electronic messaging application, navigate automatically to a graphical user interface comprising content associated with at least one of the received electronic messages.

100. (Previously presented) The computer-readable memory of claim 98, further stored electronic data structures representing executable instructions which, when executed, cause the wireless communication device to, responsive to invoking the electronic messaging application within a predetermined time following receipt of at least one of the received electronic messages, navigate automatically to a graphical user interface comprising content associated with the at least one of the received electronic messages.

101. (Previously presented) The computer-readable memory of claim 98, further stored electronic data structures representing executable instructions which, when executed, cause the wireless communication device to, responsive to invoking the electronic messaging application, visually modify at least one icon relating to the electronic messaging application to include a decreased count of electronic messages which remain unread.

102. (Previously presented) The computer-readable memory of claim 98, further stored electronic data structures representing executable instructions which, when

executed, cause the wireless communication device to, responsive to invoking the electronic messaging application, visually modify at least one icon relating to the electronic messaging application to remove the count of electronic messages which remain unread.

103. (Currently amended) A wireless communication device comprising

a processor;

a display electrically coupled to the processor, the display presenting a graphical user interface; and

a medium or media including machine-readable instructions executable by the processor to:

display on the graphical user interface at least one icon relating to an electronic messaging application;

receive on the wireless communication device a plurality of electronic messages associated with the electronic messaging application; and

responsive to receiving at least one of the plurality of electronic messages:

visually modify at least one icon relating to the electronic messaging application to include a count of the plurality of electronic messages which remain unread; and

display on the graphical user interface ~~an~~ a text identifier associated with a correspondent from whom the at least one of the plurality of electronic messages was received.

104. (Previously presented) The wireless communication device of claim 103, the identifier associated with a correspondent from whom the at least one of the plurality of

electronic messages was received comprising state information pertaining to the correspondent.

105. (Previously presented) The wireless communication device of claim 103, the medium or media further comprising machine-readable instructions which, when executed, cause the wireless communication device to display on the graphical user interface at least a preview of content associated with at least one of the received electronic messages.

106. (Previously presented) The wireless communication device of claim 103, the medium or media further comprising machine-readable instructions which, when executed, cause the wireless communication device to display on the graphical user interface for a predetermined period of time at least a preview of content associated with at least one of the received electronic messages.

107. (Previously presented) The wireless communication device of claim 103, the at least one icon relating to electronic messaging being selectable to invoke an electronic messaging application.

108. (Previously presented) The wireless communication device of claim 107, the medium or media further comprising machine-readable instructions which, when executed, cause the wireless communication device to, responsive to invoking the electronic messaging application, navigate automatically to a graphical user interface comprising content associated with at least one of the received electronic messages.

109. (Previously presented) The wireless communication device of claim 107, the medium or media further comprising machine-readable instructions which, when executed, cause the wireless communication device to, responsive to invoking the electronic messaging application within a predetermined time following receipt of at least one of the received electronic messages, navigate automatically to a graphical user interface comprising content associated with the at least one of the received electronic messages.

110. (Previously presented) The wireless communication device of claim 107, the medium or media further comprising machine-readable instructions which, when executed, cause the wireless communication device to, responsive to invoking the electronic messaging application, visually modify at least one icon relating to the electronic messaging application to include a decreased count of electronic messages which remain unread.

111. (Previously presented) The wireless communication device of claim 107, the medium or media further comprising machine-readable instructions which, when executed, cause the wireless communication device to, responsive to invoking the electronic messaging application, visually modify at least one icon relating to the electronic messaging application to remove the count of electronic messages which remain unread.

REMARKS**Amendment**

Claims 52 – 111 are currently pending in the application. Claims 1 – 51 were previously cancelled, without prejudice. By this amendment claims 52, 58, 64, 70, 76, 85, 94, and 103 are amended. Support for the amendment may be found throughout the specification as originally filed, including the Figures and the claims; and in particular at paragraphs [0047], [0057], and [0058], and in Figures 4 – 8.

No new matter is added by the amendment.

Summary of Interview

Applicant thanks the Examiner for his time and insight during the telephone interview conducted with Applicant's representative Matthew Marquardt on 15 September 2010; and the interview conducted at the Examiner's office on 22 October 2010. Claims 52 and 76, and the Wagner (US 2004/0155908) and Dam Nielsen (2006/0084450) references, were discussed. No agreement on claims was reached.

Disclaimer of Prior Statements and Amendments

The claims as presented herein may be broader in some respects than claims previously presented. Applicant intends that the claims as now pending be interpreted under the ordinary interpretation understood in the art. Accordingly Applicant expressly rescinds, and no longer intends that the claims be limited by, any and all assertions, statements, arguments, amendments or other actions previously made in this patent application, and/or any application whose file history is available for use in interpreting any patent issuing on this application, that might be taken to be a surrender or disclaimer of any subject matter from the scope of any claim. No such assertion, statement, argument, amendment or other action in this application or in any such available application should be taken as a surrender or disclaimer from, and may not be used to interpret, any claim of this patent, or any claim of any patent to which such applications' file histories may be pertinent.

Applicant intends, and expressly requests, that the Application be presented and examined *de novo*. Accordingly, Applicant urges the Examiner to make a thorough and diligent search of the prior art with respect to each and every claim presented herein. Applicant requests that the Examiner reconsider any previous surrender, disclaimer or characterization of claims, and that

he reconsider any prior art that may have been avoided or intended to be avoided by such surrender, disclaimer or characterization. To facilitate this request, Applicant submits with this amendment a new Form 1449 with all references previously applied in this application and in corresponding applications. Applicant requests that the 1449 be initialled to confirm that the references have been newly considered. In addition, a new search is requested.

CONCLUSION

Applicant believes that it has presented each of the pending claims in immediately-allowable form. Applicant respectfully requests reconsideration and immediate allowance of the claims.

Applicant believes that no fees are due in connection with the filing of this paper, beyond those paid herewith. In the event that the office determines that any further fee is due, Appellant requests that such fee be charged to its Deposit Account No. 195113.

Applicant is concerned to advance this application as quickly as is reasonably possible. Accordingly, Applicant respectfully requests that, in the event the Examiner has any further questions about this application, the Examiner call Applicant's attorney at the number provided below.

Respectfully submitted,

Dated:

1 Dec 2010

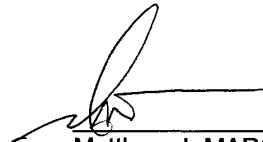

Matthew J. MARQUARDT
Reg. No. 40,997
Attorney for the Applicant

OGILVY RENAULT LLP
Royal Bank Plaza, South Tower
200 Bay Street, P.O. Box 84
Toronto, Ontario M5J 2Z4
CANADA
Tel. 416-216-4789
Fax 416-216-3930

Electronic Acknowledgement Receipt	
EFS ID:	8942755
Application Number:	10784781
International Application Number:	
Confirmation Number:	2200
Title of Invention:	Previewing a new event on a small screen device
First Named Inventor/Applicant Name:	Gerhard D. Klassen
Customer Number:	20988
Filer:	Matthew J. Marquardt
Filer Authorized By:	
Attorney Docket Number:	05200204-272US
Receipt Date:	01-DEC-2010
Filing Date:	24-FEB-2004
Time Stamp:	14:01:56
Application Type:	Utility under 35 USC 111(a)

Payment information:

Submitted with Payment	no
------------------------	----

File Listing:

Document Number	Document Description	File Name	File Size(Bytes)/ Message Digest	Multi Part /.zip	Pages (if appl.)
1	Supplemental Response or Supplemental Amendment	10784781SupplAmend.pdf	708315 c80ffd6ab738aa84967324b07c71f698f13981	no	19

Warnings:

Information:

This Acknowledgement Receipt evidences receipt on the noted date by the USPTO of the indicated documents, characterized by the applicant, and including page counts, where applicable. It serves as evidence of receipt similar to a Post Card, as described in MPEP 503.

New Applications Under 35 U.S.C. 111

If a new application is being filed and the application includes the necessary components for a filing date (see 37 CFR 1.53(b)-(d) and MPEP 506), a Filing Receipt (37 CFR 1.54) will be issued in due course and the date shown on this Acknowledgement Receipt will establish the filing date of the application.

National Stage of an International Application under 35 U.S.C. 371

If a timely submission to enter the national stage of an international application is compliant with the conditions of 35 U.S.C. 371 and other applicable requirements a Form PCT/DO/EO/903 indicating acceptance of the application as a national stage submission under 35 U.S.C. 371 will be issued in addition to the Filing Receipt, in due course.

New International Application Filed with the USPTO as a Receiving Office

If a new international application is being filed and the international application includes the necessary components for an international filing date (see PCT Article 11 and MPEP 1810), a Notification of the International Application Number and of the International Filing Date (Form PCT/RO/105) will be issued in due course, subject to prescriptions concerning national security, and the date shown on this Acknowledgement Receipt will establish the international filing date of the application.

Under the Paperwork Reduction Act of 1995, no persons are required to respond to a collection of information unless it displays a valid OMB control number.

PATENT APPLICATION FEE DETERMINATION RECORD Substitute for Form PTO-875				Application or Docket Number 10/784,781		Filing Date 02/24/2004		<input type="checkbox"/> To be Mailed				
APPLICATION AS FILED – PART I						OTHER THAN						
(Column 1)		(Column 2)		SMALL ENTITY <input type="checkbox"/>		OR		SMALL ENTITY				
FOR	NUMBER FILED	NUMBER EXTRA	RATE (\$)	FEE (\$)	OR	RATE (\$)	FEE (\$)					
<input type="checkbox"/> BASIC FEE <small>(37 CFR 1.16(a), (b), or (c))</small>	N/A	N/A	N/A			N/A						
<input type="checkbox"/> SEARCH FEE <small>(37 CFR 1.16(k), (l), or (m))</small>	N/A	N/A	N/A			N/A						
<input type="checkbox"/> EXAMINATION FEE <small>(37 CFR 1.16(o), (p), or (q))</small>	N/A	N/A	N/A			N/A						
TOTAL CLAIMS <small>(37 CFR 1.16(i))</small>	minus 20 =	*	X \$ =			X \$ =						
INDEPENDENT CLAIMS <small>(37 CFR 1.16(h))</small>	minus 3 =	*	X \$ =			X \$ =						
<input type="checkbox"/> APPLICATION SIZE FEE <small>(37 CFR 1.16(s))</small>	If the specification and drawings exceed 100 sheets of paper, the application size fee due is \$250 (\$125 for small entity) for each additional 50 sheets or fraction thereof. See 35 U.S.C. 41(a)(1)(G) and 37 CFR 1.16(s).											
<input type="checkbox"/> MULTIPLE DEPENDENT CLAIM PRESENT <small>(37 CFR 1.16(j))</small>												
* If the difference in column 1 is less than zero, enter "0" in column 2.			TOTAL			TOTAL						
APPLICATION AS AMENDED – PART II						OTHER THAN						
(Column 1)		(Column 2)		(Column 3)		SMALL ENTITY		OR		SMALL ENTITY		
AMENDMENT	12/01/2010	CLAIMS REMAINING AFTER AMENDMENT	HIGHEST NUMBER PREVIOUSLY PAID FOR	PRESENT EXTRA	RATE (\$)	ADDITIONAL FEE (\$)	OR	RATE (\$)	ADDITIONAL FEE (\$)			
	Total <small>(37 CFR 1.16(i))</small>	* 60	Minus	** 60	= 0	X \$ =		OR	X \$52=	0		
	Independent <small>(37 CFR 1.16(h))</small>	* 8	Minus	***8	= 0	X \$ =		OR	X \$220=	0		
	<input type="checkbox"/> Application Size Fee <small>(37 CFR 1.16(s))</small>								OR			
	<input type="checkbox"/> FIRST PRESENTATION OF MULTIPLE DEPENDENT CLAIM <small>(37 CFR 1.16(j))</small>								OR			
			TOTAL ADD'L FEE			OR	TOTAL ADD'L FEE	0				
AMENDMENT	(Column 1)	(Column 2)	(Column 3)	HIGHEST NUMBER PREVIOUSLY PAID FOR	PRESENT EXTRA	RATE (\$)	ADDITIONAL FEE (\$)	OR	RATE (\$)	ADDITIONAL FEE (\$)		
	Total <small>(37 CFR 1.16(i))</small>	*	Minus	**	=	X \$ =		OR	X \$ =			
	Independent <small>(37 CFR 1.16(h))</small>	*	Minus	***	=	X \$ =		OR	X \$ =			
	<input type="checkbox"/> Application Size Fee <small>(37 CFR 1.16(s))</small>								OR			
	<input type="checkbox"/> FIRST PRESENTATION OF MULTIPLE DEPENDENT CLAIM <small>(37 CFR 1.16(j))</small>								OR			
			TOTAL ADD'L FEE			OR	TOTAL ADD'L FEE					
* If the entry in column 1 is less than the entry in column 2, write "0" in column 3.												
** If the "Highest Number Previously Paid For" IN THIS SPACE is less than 20, enter "20".												
*** If the "Highest Number Previously Paid For" IN THIS SPACE is less than 3, enter "3".												
The "Highest Number Previously Paid For" (Total or Independent) is the highest number found in the appropriate box in column 1.												

Legal Instrument Examiner:
/LINDA W. BADIE/

This collection of information is required by 37 CFR 1.16. The information is required to obtain or retain a benefit by the public which is to file (and by the USPTO to process) an application. Confidentiality is governed by 35 U.S.C. 122 and 37 CFR 1.14. This collection is estimated to take 12 minutes to complete, including gathering, preparing, and submitting the completed application form to the USPTO. Time will vary depending upon the individual case. Any comments on the amount of time you require to complete this form and/or suggestions for reducing this burden, should be sent to the Chief Information Officer, U.S. Patent and Trademark Office, U.S. Department of Commerce, P.O. Box 1450, Alexandria, VA 22313-1450. DO NOT SEND FEES OR COMPLETED FORMS TO THIS ADDRESS. **SEND TO: Commissioner for Patents, P.O. Box 1450, Alexandria, VA 22313-1450.**

If you need assistance in completing the form, call 1-800-PTO-9199 and select option 2.

INFORMATION DISCLOSURE STATEMENT BY APPLICANT (Not for submission under 37 CFR 1.99)	Application Number	10784781
	Filing Date	2004-02-24
	First Named Inventor	Gerhard D. Klassen
	Art Unit	2172
	Examiner Name	John M. Heffington
	Attorney Docket Number	05200204-272US

U.S. PATENTS							Remove	
Examiner Initial*	Cite No	Patent Number	Kind Code ¹	Issue Date	Name of Patentee or Applicant of cited Document	Pages, Columns, Lines where Relevant Passages or Relevant Figures Appear		
	1							
If you wish to add additional U.S. Patent citation information please click the Add button.							Add	
U.S. PATENT APPLICATION PUBLICATIONS							Remove	
Examiner Initial*	Cite No	Publication Number	Kind Code ¹	Publication Date	Name of Patentee or Applicant of cited Document	Pages, Columns, Lines where Relevant Passages or Relevant Figures Appear		
	1							
If you wish to add additional U.S. Published Application citation information please click the Add button.							Add	
FOREIGN PATENT DOCUMENTS							Remove	
Examiner Initial*	Cite No	Foreign Document Number ³	Country Code ² j	Kind Code ⁴	Publication Date	Name of Patentee or Applicant of cited Document	Pages, Columns, Lines where Relevant Passages or Relevant Figures Appear	T ⁵
	1							<input type="checkbox"/>
If you wish to add additional Foreign Patent Document citation information please click the Add button							Add	
NON-PATENT LITERATURE DOCUMENTS							Remove	
Examiner Initials*	Cite No	Include name of the author (in CAPITAL LETTERS), title of the article (when appropriate), title of the item (book, magazine, journal, serial, symposium, catalog, etc), date, pages(s), volume-issue number(s), publisher, city and/or country where published.					T ⁵	

INFORMATION DISCLOSURE STATEMENT BY APPLICANT (Not for submission under 37 CFR 1.99)	Application Number		10784781
	Filing Date		2004-02-24
	First Named Inventor	Gerhard D. Klassen	
	Art Unit		2172
	Examiner Name	John M. Heffington	
	Attorney Docket Number		05200204-272US

1	Applicant's response to the Official Action dated June 17, 2010, issued by the Japanese Patent Office for corresponding Japanese Patent Application No. 2006-541762.	<input type="checkbox"/>
2	Extended European Search Report dated October 13, 2010, issued by the European Patent Office for corresponding European Patent Application No. 10177959.3.	<input type="checkbox"/>
3	Extended European Search Report dated October 13, 2010, issued by the European Patent Office for corresponding European Patent Application No. 10177958.5.	<input type="checkbox"/>

If you wish to add additional non-patent literature document citation information please click the Add button

EXAMINER SIGNATURE

Examiner Signature		Date Considered	
--------------------	--	-----------------	--

*EXAMINER: Initial if reference considered, whether or not citation is in conformance with MPEP 609. Draw line through a citation if not in conformance and not considered. Include copy of this form with next communication to applicant.

¹ See Kind Codes of USPTO Patent Documents at www.USPTO.GOV or MPEP 901.04. ² Enter office that issued the document, by the two-letter code (WIPO Standard ST.3). ³ For Japanese patent documents, the indication of the year of the reign of the Emperor must precede the serial number of the patent document. ⁴ Kind of document by the appropriate symbols as indicated on the document under WIPO Standard ST.16 if possible. ⁵ Applicant is to place a check mark here if English language translation is attached.

INFORMATION DISCLOSURE STATEMENT BY APPLICANT (Not for submission under 37 CFR 1.99)	Application Number	10784781
	Filing Date	2004-02-24
	First Named Inventor	Gerhard D. Klassen
	Art Unit	2172
	Examiner Name	John M. Heffington
	Attorney Docket Number	05200204-272US

CERTIFICATION STATEMENT

Please see 37 CFR 1.97 and 1.98 to make the appropriate selection(s):

That each item of information contained in the information disclosure statement was first cited in any communication from a foreign patent office in a counterpart foreign application not more than three months prior to the filing of the information disclosure statement. See 37 CFR 1.97(e)(1).

OR

That no item of information contained in the information disclosure statement was cited in a communication from a foreign patent office in a counterpart foreign application, and, to the knowledge of the person signing the certification after making reasonable inquiry, no item of information contained in the information disclosure statement was known to any individual designated in 37 CFR 1.56(c) more than three months prior to the filing of the information disclosure statement. See 37 CFR 1.97(e)(2).

- See attached certification statement.
- The fee set forth in 37 CFR 1.17 (p) has been submitted herewith.
- A certification statement is not submitted herewith.

SIGNATURE

A signature of the applicant or representative is required in accordance with CFR 1.33, 10.18. Please see CFR 1.4(d) for the form of the signature.

Signature	/Matthew MARQUARDT/	Date (YYYY-MM-DD)	2010-12-07
Name/Print	Matthew Marquardt	Registration Number	40997

This collection of information is required by 37 CFR 1.97 and 1.98. The information is required to obtain or retain a benefit by the public which is to file (and by the USPTO to process) an application. Confidentiality is governed by 35 U.S.C. 122 and 37 CFR 1.14. This collection is estimated to take 1 hour to complete, including gathering, preparing and submitting the completed application form to the USPTO. Time will vary depending upon the individual case. Any comments on the amount of time you require to complete this form and/or suggestions for reducing this burden, should be sent to the Chief Information Officer, U.S. Patent and Trademark Office, U.S. Department of Commerce, P.O. Box 1450, Alexandria, VA 22313-1450. **DO NOT SEND FEES OR COMPLETED FORMS TO THIS ADDRESS. SEND TO: Commissioner for Patents, P.O. Box 1450, Alexandria, VA 22313-1450.**

Privacy Act Statement

The Privacy Act of 1974 (P.L. 93-579) requires that you be given certain information in connection with your submission of the attached form related to a patent application or patent. Accordingly, pursuant to the requirements of the Act, please be advised that: (1) the general authority for the collection of this information is 35 U.S.C. 2(b)(2); (2) furnishing of the information solicited is voluntary; and (3) the principal purpose for which the information is used by the U.S. Patent and Trademark Office is to process and/or examine your submission related to a patent application or patent. If you do not furnish the requested information, the U.S. Patent and Trademark Office may not be able to process and/or examine your submission, which may result in termination of proceedings or abandonment of the application or expiration of the patent.

The information provided by you in this form will be subject to the following routine uses:

1. The information on this form will be treated confidentially to the extent allowed under the Freedom of Information Act (5 U.S.C. 552) and the Privacy Act (5 U.S.C. 552a). Records from this system of records may be disclosed to the Department of Justice to determine whether the Freedom of Information Act requires disclosure of these records.
2. A record from this system of records may be disclosed, as a routine use, in the course of presenting evidence to a court, magistrate, or administrative tribunal, including disclosures to opposing counsel in the course of settlement negotiations.
3. A record in this system of records may be disclosed, as a routine use, to a Member of Congress submitting a request involving an individual, to whom the record pertains, when the individual has requested assistance from the Member with respect to the subject matter of the record.
4. A record in this system of records may be disclosed, as a routine use, to a contractor of the Agency having need for the information in order to perform a contract. Recipients of information shall be required to comply with the requirements of the Privacy Act of 1974, as amended, pursuant to 5 U.S.C. 552a(m).
5. A record related to an International Application filed under the Patent Cooperation Treaty in this system of records may be disclosed, as a routine use, to the International Bureau of the World Intellectual Property Organization, pursuant to the Patent Cooperation Treaty.
6. A record in this system of records may be disclosed, as a routine use, to another federal agency for purposes of National Security review (35 U.S.C. 181) and for review pursuant to the Atomic Energy Act (42 U.S.C. 218(c)).
7. A record from this system of records may be disclosed, as a routine use, to the Administrator, General Services, or his/her designee, during an inspection of records conducted by GSA as part of that agency's responsibility to recommend improvements in records management practices and programs, under authority of 44 U.S.C. 2904 and 2906. Such disclosure shall be made in accordance with the GSA regulations governing inspection of records for this purpose, and any other relevant (i.e., GSA or Commerce) directive. Such disclosure shall not be used to make determinations about individuals.
8. A record from this system of records may be disclosed, as a routine use, to the public after either publication of the application pursuant to 35 U.S.C. 122(b) or issuance of a patent pursuant to 35 U.S.C. 151. Further, a record may be disclosed, subject to the limitations of 37 CFR 1.14, as a routine use, to the public if the record was filed in an application which became abandoned or in which the proceedings were terminated and which application is referenced by either a published application, an application open to public inspections or an issued patent.
9. A record from this system of records may be disclosed, as a routine use, to a Federal, State, or local law enforcement agency, if the USPTO becomes aware of a violation or potential violation of law or regulation.

Electronic Acknowledgement Receipt	
EFS ID:	8979379
Application Number:	10784781
International Application Number:	
Confirmation Number:	2200
Title of Invention:	Previewing a new event on a small screen device
First Named Inventor/Applicant Name:	Gerhard D. Klassen
Customer Number:	20988
Filer:	Matthew J. Marquardt/Nicole Farrugia
Filer Authorized By:	Matthew J. Marquardt
Attorney Docket Number:	05200204-272US
Receipt Date:	07-DEC-2010
Filing Date:	24-FEB-2004
Time Stamp:	11:17:35
Application Type:	Utility under 35 USC 111(a)

Payment information:

Submitted with Payment	no
------------------------	----

File Listing:

Document Number	Document Description	File Name	File Size(Bytes)/ Message Digest	Multi Part /.zip	Pages (if appl.)
1	Information Disclosure Statement (IDS) Filed (SB/08)	IDS_Citation.PDF	612404 <small>78d39bbc93da0a95fd2373b7e3118c2e7d00ba7c</small>	no	4

Warnings:

Information:

A U.S. Patent Number Citation or a U.S. Publication Number Citation is required in the Information Disclosure Statement (IDS) form for autoloading of data into USPTO systems. You may remove the form to add the required data in order to correct the Informational Message if you are citing U.S. References. If you chose not to include U.S. References, the image of the form will be processed and be made available within the Image File Wrapper (IFW) system. However, no data will be extracted from this form. Any additional data such as Foreign Patent Documents or Non Patent Literature will be manually reviewed and keyed into USPTO systems.

2	NPL Documents	272EP-2_EESR.PDF	460651	no	11
			096a376ed3c7f4afb7b4b53c4910bcd103d b0caf		
Warnings:					
Information:					
3	NPL Documents	EESR_272-EP-3.PDF	474512	no	11
			c16afa57fa525d4e7ef44bec0ace7d62e54e a13e		
Warnings:					
Information:					
4	NPL Documents	Response_JP_OA.PDF	2330996	no	30
			0e9b905c2bd52effc8b43e927c78679d390 714e		
Warnings:					
Information:					
Total Files Size (in bytes):			3878563		

This Acknowledgement Receipt evidences receipt on the noted date by the USPTO of the indicated documents, characterized by the applicant, and including page counts, where applicable. It serves as evidence of receipt similar to a Post Card, as described in MPEP 503.

New Applications Under 35 U.S.C. 111

If a new application is being filed and the application includes the necessary components for a filing date (see 37 CFR 1.53(b)-(d) and MPEP 506), a Filing Receipt (37 CFR 1.54) will be issued in due course and the date shown on this Acknowledgement Receipt will establish the filing date of the application.

National Stage of an International Application under 35 U.S.C. 371

If a timely submission to enter the national stage of an international application is compliant with the conditions of 35 U.S.C. 371 and other applicable requirements a Form PCT/DO/EO/903 indicating acceptance of the application as a national stage submission under 35 U.S.C. 371 will be issued in addition to the Filing Receipt, in due course.

New International Application Filed with the USPTO as a Receiving Office

If a new international application is being filed and the international application includes the necessary components for an international filing date (see PCT Article 11 and MPEP 1810), a Notification of the International Application Number and of the International Filing Date (Form PCT/RO/105) will be issued in due course, subject to prescriptions concerning national security, and the date shown on this Acknowledgement Receipt will establish the international filing date of the application.

IN THE UNITED STATES PATENT AND TRADEMARK OFFICE

Inventor(s) KLASSEN et al.
Serial No.: 10/784,781
Filed: 24 February 2004
Examiner: HEFFINGTON, John M.
Group Art Unit: 2172
Confirmation No.: 2200
Title: PREVIEWING A NEW EVENT ON A SMALL SCREEN
 DEVICE

VIA ELECTRONIC FILING

Commissioner for Patents
P.O. Box 1450
Alexandria, Virginia 22313-1450
U.S.A.

INFORMATION DISCLOSURE STATEMENT

Applicant encloses a further Information Disclosure Statement (IDS) citation list for consideration in the above-noted application.

Cited in herein is a Notice of Allowance issued by the Japanese Patent Office in corresponding Japanese patent application no. 2006-541762, with an English translation thereof. Applicant respectfully notes for the convenience of the Examiner that all of claims 1-80 presented as of 17 November in such Japanese application were allowed. These include claims 21 – 80, which correspond to claims 52 - 111 currently presented in the application herein.

An English translation of the allowed claims in the corresponding Japanese application was provided for review by the Office in an information disclosure statement filed herein 7 December 2010.

Each item of information contained in this information disclosure statement was first cited in a communication from a foreign patent office in a counterpart foreign application not more than three months prior to the filing of this information disclosure statement. Thus, pursuant to 37 CFR 1.97(c)(1), no fee is believed to be due in connection with the filing of this paper.

In the event that the Office determines that any further fee is due, Appellant requests that such fee be charged to its Deposit Account No. 195113.

Applicant is concerned to advance this application as rapidly as possible. In the event the Examiner has any questions or concerns, Applicant requests a telephone call to Applicant's representative at the telephone number below to discuss.

Respectfully submitted,

Dated: January 5, 2011



Matthew J. MARQUARDT
Reg. No. 40,997
Attorney for the Applicant

OGILVY RENAULT LLP
Royal Bank Plaza, South Tower
200 Bay Street, P.O. Box 84
Toronto, Ontario M5J 2Z4
CANADA
Tel. 416-216-4789
Fax 416-216-3930

Doc code: IDS

Doc description: Information Disclosure Statement (IDS) Filed

PTO/SB/08a (01-10)

Approved for use through 07/31/2012. OMB 0651-0031

U.S. Patent and Trademark Office; U.S. DEPARTMENT OF COMMERCE

Under the Paperwork Reduction Act of 1995, no persons are required to respond to a collection of information unless it contains a valid OMB control number.

INFORMATION DISCLOSURE STATEMENT BY APPLICANT (Not for submission under 37 CFR 1.99)	Application Number		10784781	
	Filing Date		2004-02-24	
	First Named Inventor		Gerhard D. Klassen	
	Art Unit		2172	
	Examiner Name		John M. Heffington	
	Attorney Docket Number		05200204-272US	

U.S.PATENTS						
Examiner Initial*	Cite No	Patent Number	Kind Code ¹	Issue Date	Name of Patentee or Applicant of cited Document	Pages, Columns, Lines where Relevant Passages or Relevant Figures Appear
	1					

If you wish to add additional U.S. Patent citation information please click the Add button.

U.S.PATENT APPLICATION PUBLICATIONS						
Examiner Initial*	Cite No	Publication Number	Kind Code ¹	Publication Date	Name of Patentee or Applicant of cited Document	Pages, Columns, Lines where Relevant Passages or Relevant Figures Appear
	1					

If you wish to add additional U.S. Published Application citation information please click the Add button.

FOREIGN PATENT DOCUMENTS								
Examiner Initial*	Cite No	Foreign Document Number ³	Country Code ²ⁱ	Kind Code ⁴	Publication Date	Name of Patentee or Applicant of cited Document	Pages, Columns, Lines where Relevant Passages or Relevant Figures Appear	T ⁵
	1							<input type="checkbox"/>

If you wish to add additional Foreign Patent Document citation information please click the Add button

NON-PATENT LITERATURE DOCUMENTS			
Examiner Initials*	Cite No	Include name of the author (in CAPITAL LETTERS), title of the article (when appropriate), title of the item (book, magazine, journal, serial, symposium, catalog, etc), date, pages(s), volume-issue number(s), publisher, city and/or country where published.	T ⁵

INFORMATION DISCLOSURE STATEMENT BY APPLICANT (Not for submission under 37 CFR 1.99)	Application Number		10784781
	Filing Date		2004-02-24
	First Named Inventor	Gerhard D. Klassen	
	Art Unit	2172	
	Examiner Name	John M. Heffington	
	Attorney Docket Number	05200204-272US	

1	Notice of Allowance along with English translation of same, issued by the Japanese Patent Office in connection with corresponding Japanese Patent Application No. 2006-541762 dated December 3, 2010.	<input type="checkbox"/>
If you wish to add additional non-patent literature document citation information please click the Add button		
EXAMINER SIGNATURE		
Examiner Signature		Date Considered
*EXAMINER: Initial if reference considered, whether or not citation is in conformance with MPEP 609. Draw line through a citation if not in conformance and not considered. Include copy of this form with next communication to applicant.		
<small>¹ See Kind Codes of USPTO Patent Documents at www.USPTO.GOV or MPEP 901.04. ² Enter office that issued the document, by the two-letter code (WIPO Standard ST.3). ³ For Japanese patent documents, the indication of the year of the reign of the Emperor must precede the serial number of the patent document. ⁴ Kind of document by the appropriate symbols as indicated on the document under WIPO Standard ST.16 if possible. ⁵ Applicant is to place a check mark here if English language translation is attached.</small>		

INFORMATION DISCLOSURE STATEMENT BY APPLICANT (Not for submission under 37 CFR 1.99)	Application Number	10784781
	Filing Date	2004-02-24
	First Named Inventor	Gerhard D. Klassen
	Art Unit	2172
	Examiner Name	John M. Heffington
	Attorney Docket Number	05200204-272US

CERTIFICATION STATEMENT

Please see 37 CFR 1.97 and 1.98 to make the appropriate selection(s):

That each item of information contained in the information disclosure statement was first cited in any communication from a foreign patent office in a counterpart foreign application not more than three months prior to the filing of the information disclosure statement. See 37 CFR 1.97(e)(1).

OR

That no item of information contained in the information disclosure statement was cited in a communication from a foreign patent office in a counterpart foreign application, and, to the knowledge of the person signing the certification after making reasonable inquiry, no item of information contained in the information disclosure statement was known to any individual designated in 37 CFR 1.56(c) more than three months prior to the filing of the information disclosure statement. See 37 CFR 1.97(e)(2).

- See attached certification statement.
- The fee set forth in 37 CFR 1.17 (p) has been submitted herewith.
- A certification statement is not submitted herewith.

SIGNATURE

A signature of the applicant or representative is required in accordance with CFR 1.33, 10.18. Please see CFR 1.4(d) for the form of the signature.

Signature	/Matthew MARQUARDT/	Date (YYYY-MM-DD)	2011-01-06
Name/Print	Matthew Marquardt	Registration Number	40997

This collection of information is required by 37 CFR 1.97 and 1.98. The information is required to obtain or retain a benefit by the public which is to file (and by the USPTO to process) an application. Confidentiality is governed by 35 U.S.C. 122 and 37 CFR 1.14. This collection is estimated to take 1 hour to complete, including gathering, preparing and submitting the completed application form to the USPTO. Time will vary depending upon the individual case. Any comments on the amount of time you require to complete this form and/or suggestions for reducing this burden, should be sent to the Chief Information Officer, U.S. Patent and Trademark Office, U.S. Department of Commerce, P.O. Box 1450, Alexandria, VA 22313-1450. **DO NOT SEND FEES OR COMPLETED FORMS TO THIS ADDRESS. SEND TO: Commissioner for Patents, P.O. Box 1450, Alexandria, VA 22313-1450.**

Electronic Acknowledgement Receipt

EFS ID:	9172214
Application Number:	10784781
International Application Number:	
Confirmation Number:	2200
Title of Invention:	Previewing a new event on a small screen device
First Named Inventor/Applicant Name:	Gerhard D. Klassen
Customer Number:	20988
Filer:	Matthew J. Marquardt
Filer Authorized By:	
Attorney Docket Number:	05200204-272US
Receipt Date:	05-JAN-2011
Filing Date:	24-FEB-2004
Time Stamp:	17:30:42
Application Type:	Utility under 35 USC 111(a)

Payment information:

Submitted with Payment	no
------------------------	----

File Listing:

Document Number	Document Description	File Name	File Size(Bytes)/ Message Digest	Multi Part /.zip	Pages (if appl.)
1	Information Disclosure Statement (IDS) Filed (SB/08)	IDS_and_citation_list.pdf	174401 <small>3f62d07147ae87c3f0ad95bc7891a4fa638e6c99</small>	no	5

Warnings:

Information:

This is not an USPTO supplied IDS fillable form

2	NPL Documents	JPO_NOA.pdf	101180	no	5
			beb2ff477bc6d99d3401231eb16b265f3978214c		

Warnings:

Information:

Total Files Size (in bytes): 275581

This Acknowledgement Receipt evidences receipt on the noted date by the USPTO of the indicated documents, characterized by the applicant, and including page counts, where applicable. It serves as evidence of receipt similar to a Post Card, as described in MPEP 503.

New Applications Under 35 U.S.C. 111

If a new application is being filed and the application includes the necessary components for a filing date (see 37 CFR 1.53(b)-(d) and MPEP 506), a Filing Receipt (37 CFR 1.54) will be issued in due course and the date shown on this Acknowledgement Receipt will establish the filing date of the application.

National Stage of an International Application under 35 U.S.C. 371

If a timely submission to enter the national stage of an international application is compliant with the conditions of 35 U.S.C. 371 and other applicable requirements a Form PCT/DO/EO/903 indicating acceptance of the application as a national stage submission under 35 U.S.C. 371 will be issued in addition to the Filing Receipt, in due course.

New International Application Filed with the USPTO as a Receiving Office

If a new international application is being filed and the international application includes the necessary components for an international filing date (see PCT Article 11 and MPEP 1810), a Notification of the International Application Number and of the International Filing Date (Form PCT/RO/105) will be issued in due course, subject to prescriptions concerning national security, and the date shown on this Acknowledgement Receipt will establish the international filing date of the application.



UNITED STATES PATENT AND TRADEMARK OFFICE

UNITED STATES DEPARTMENT OF COMMERCE
United States Patent and Trademark Office
Address: COMMISSIONER FOR PATENTS
P.O. Box 1450
Alexandria, Virginia 22313-1450
www.uspto.gov

APPLICATION NO.	FILING DATE	FIRST NAMED INVENTOR	ATTORNEY DOCKET NO.	CONFIRMATION NO.
10/784,781	02/24/2004	Gerhard D. Klassen	05200204-272US	2200
20988	7590	03/02/2011	EXAMINER	
OGILVY RENAULT LLP 1, Place Ville Marie SUITE 2500 MONTREAL, QC H3B 1R1 CANADA			HEFFINGTON, JOHN M	
			ART UNIT	PAPER NUMBER
			2172	
			MAIL DATE	DELIVERY MODE
			03/02/2011	PAPER

Please find below and/or attached an Office communication concerning this application or proceeding.

The time period for reply, if any, is set in the attached communication.

Interview Summary	Application No. 10/784,781	Applicant(s) KLASSEN ET AL.	
	Examiner JOHN HEFFINGTON	Art Unit 2172	

All participants (applicant, applicant's representative, PTO personnel):

(1) JOHN HEFFINGTON. (3)_____.

(2) Mark Marquardt. (4)_____.

Date of Interview: 23 February 2011.

Type: a) Telephonic b) Video Conference
c) Personal [copy given to: 1) applicant 2) applicant's representative]

Exhibit shown or demonstration conducted: d) Yes e) No.
If Yes, brief description: _____.

Claim(s) discussed: 52.

Identification of prior art discussed: Nielsen.

Agreement with respect to the claims f) was reached. g) was not reached. h) N/A.

Substance of Interview including description of the general nature of what was agreed to if an agreement was reached, or any other comments: The examiner cited the difference between displaying an icon for each unique sender in Nielsen and displaying a numeric digit representing the number of senders in the instant invention. The examiner suggested clarifying the claim language to explicitly claim a numeric digit rather than the broader language of a "number." The examiner also suggested claiming that the meaning of the number is user configurable.

(A fuller description, if necessary, and a copy of the amendments which the examiner agreed would render the claims allowable, if available, must be attached. Also, where no copy of the amendments that would render the claims allowable is available, a summary thereof must be attached.)

THE FORMAL WRITTEN REPLY TO THE LAST OFFICE ACTION MUST INCLUDE THE SUBSTANCE OF THE INTERVIEW. (See MPEP Section 713.04). If a reply to the last Office action has already been filed, APPLICANT IS GIVEN A NON-EXTENDABLE PERIOD OF THE LONGER OF ONE MONTH OR THIRTY DAYS FROM THIS INTERVIEW DATE, OR THE MAILING DATE OF THIS INTERVIEW SUMMARY FORM, WHICHEVER IS LATER, TO FILE A STATEMENT OF THE SUBSTANCE OF THE INTERVIEW. See Summary of Record of Interview requirements on reverse side or on attached sheet.

	/Boris Pesin/ Supervisory Patent Examiner, Art Unit 2172
--	---

Summary of Record of Interview Requirements

Manual of Patent Examining Procedure (MPEP), Section 713.04, Substance of Interview Must be Made of Record

A complete written statement as to the substance of any face-to-face, video conference, or telephone interview with regard to an application must be made of record in the application whether or not an agreement with the examiner was reached at the interview.

Title 37 Code of Federal Regulations (CFR) § 1.133 Interviews Paragraph (b)

In every instance where reconsideration is requested in view of an interview with an examiner, a complete written statement of the reasons presented at the interview as warranting favorable action must be filed by the applicant. An interview does not remove the necessity for reply to Office action as specified in §§ 1.111, 1.135. (35 U.S.C. 132)

37 CFR §1.2 Business to be transacted in writing.

All business with the Patent or Trademark Office should be transacted in writing. The personal attendance of applicants or their attorneys or agents at the Patent and Trademark Office is unnecessary. The action of the Patent and Trademark Office will be based exclusively on the written record in the Office. No attention will be paid to any alleged oral promise, stipulation, or understanding in relation to which there is disagreement or doubt.

The action of the Patent and Trademark Office cannot be based exclusively on the written record in the Office if that record is itself incomplete through the failure to record the substance of interviews.

It is the responsibility of the applicant or the attorney or agent to make the substance of an interview of record in the application file, unless the examiner indicates he or she will do so. It is the examiner's responsibility to see that such a record is made and to correct material inaccuracies which bear directly on the question of patentability.

Examiners must complete an Interview Summary Form for each interview held where a matter of substance has been discussed during the interview by checking the appropriate boxes and filling in the blanks. Discussions regarding only procedural matters, directed solely to restriction requirements for which interview recordation is otherwise provided for in Section 812.01 of the Manual of Patent Examining Procedure, or pointing out typographical errors or unreadable script in Office actions or the like, are excluded from the interview recordation procedures below. Where the substance of an interview is completely recorded in an Examiners Amendment, no separate Interview Summary Record is required.

The Interview Summary Form shall be given an appropriate Paper No., placed in the right hand portion of the file, and listed on the "Contents" section of the file wrapper. In a personal interview, a duplicate of the Form is given to the applicant (or attorney or agent) at the conclusion of the interview. In the case of a telephone or video-conference interview, the copy is mailed to the applicant's correspondence address either with or prior to the next official communication. If additional correspondence from the examiner is not likely before an allowance or if other circumstances dictate, the Form should be mailed promptly after the interview rather than with the next official communication.

The Form provides for recordation of the following information:

- Application Number (Series Code and Serial Number)
- Name of applicant
- Name of examiner
- Date of interview
- Type of interview (telephonic, video-conference, or personal)
- Name of participant(s) (applicant, attorney or agent, examiner, other PTO personnel, etc.)
- An indication whether or not an exhibit was shown or a demonstration conducted
- An identification of the specific prior art discussed
- An indication whether an agreement was reached and if so, a description of the general nature of the agreement (may be by attachment of a copy of amendments or claims agreed as being allowable). Note: Agreement as to allowability is tentative and does not restrict further action by the examiner to the contrary.
- The signature of the examiner who conducted the interview (if Form is not an attachment to a signed Office action)

It is desirable that the examiner orally remind the applicant of his or her obligation to record the substance of the interview of each case. It should be noted, however, that the Interview Summary Form will not normally be considered a complete and proper recordation of the interview unless it includes, or is supplemented by the applicant or the examiner to include, all of the applicable items required below concerning the substance of the interview.

A complete and proper recordation of the substance of any interview should include at least the following applicable items:

- 1) A brief description of the nature of any exhibit shown or any demonstration conducted,
- 2) an identification of the claims discussed,
- 3) an identification of the specific prior art discussed,
- 4) an identification of the principal proposed amendments of a substantive nature discussed, unless these are already described on the Interview Summary Form completed by the Examiner,
- 5) a brief identification of the general thrust of the principal arguments presented to the examiner,
(The identification of arguments need not be lengthy or elaborate. A verbatim or highly detailed description of the arguments is not required. The identification of the arguments is sufficient if the general nature or thrust of the principal arguments made to the examiner can be understood in the context of the application file. Of course, the applicant may desire to emphasize and fully describe those arguments which he or she feels were or might be persuasive to the examiner.)
- 6) a general indication of any other pertinent matters discussed, and
- 7) if appropriate, the general results or outcome of the interview unless already described in the Interview Summary Form completed by the examiner.

Examiners are expected to carefully review the applicant's record of the substance of an interview. If the record is not complete and accurate, the examiner will give the applicant an extendable one month time period to correct the record.

Examiner to Check for Accuracy

If the claims are allowable for other reasons of record, the examiner should send a letter setting forth the examiner's version of the statement attributed to him or her. If the record is complete and accurate, the examiner should place the indication, "Interview Record OK" on the paper recording the substance of the interview along with the date and the examiner's initials.

IN THE UNITED STATES PATENT AND TRADEMARK OFFICE

Inventor(s) KLASSEN et al.
Serial No.: 10/784,781
Filed: 24 February 2004
Examiner: HEFFINGTON, John M.
Group Art Unit: 2179
Confirmation No.: 2200
Title: PREVIEWING A NEW EVENT ON A SMALL SCREEN
 DEVICE

VIA ELECTRONIC FILING

Commissioner for Patents
P.O. Box 1450
Alexandria, Virginia 22313-1450
U.S.A.

**SUPPLEMENTAL AMENDMENT
AND SUMMARY OF INTERVIEWS**

This paper (the Response) is filed in response to telephone interviews conducted 23 February and 3 March 2011.

Amendments to the Claims are presented beginning at page 2.

Remarks, which include a Summary of Interviews, are presented beginning at page 18.

AMENDMENT

In the Claims

Please rewrite the claims as follows. A complete listing of the claims is provided pursuant to 37 CFR 1.121.

1 – 51. (Cancelled)

52. (currently amended) A method of providing notifications of unread messages on a wireless communication device, comprising:

displaying at least one icon relating to electronic messaging on a graphical user interface of the wireless communication device;

receiving a plurality of electronic messages on the wireless communication device, the plurality of electronic messages including messages from a plurality of different messaging correspondents; and

in response to receiving at least one of the plurality of electronic messages, visually modifying at least one displayed icon relating to electronic messaging to include a ~~number~~ numeric character representing a count of the plurality of different messaging correspondents for which one or more of the electronic messages have been received and remain unread.

53. (previously presented) The method of claim 52, further comprising displaying a plurality of icons including one or more application icons that are selectable to invoke respective ones of a plurality of applications on the wireless communication device.

54. (previously presented) The method of claim 53, further comprising visually modifying one or more of the plurality of icons to include a count of electronic messages that have been received and remain unread.

55. (previously presented) The method of claim 52, the at least one icon relating to electronic messaging being selectable to invoke an electronic messaging application.

56. (previously presented) The method of claim 52, comprising displaying on the graphical user interface an identifier of the correspondent from whom at least one of the plurality of messages was received.

57. (previously presented) The method of claim 52, comprising displaying on the graphical user interface at least one preview of content associated with at least one of the received electronic messages.

58. (currently amended) A medium or media comprising machine-readable instructions executable by a processor of a wireless communication device, the wireless communication device including a graphical user interface, the machine-readable instructions, when executed, causing the wireless communication device to:

display at least one icon relating to an electronic messaging application on the graphical user interface;

receive a plurality of electronic messages, the plurality of electronic messages including messages from a plurality of different messaging correspondents; and

in response to receiving at least one of the plurality of electronic messages, visually modify at least one displayed icon relating to the electronic messaging application to include a ~~number~~ numeric character representing a count of the plurality of different messaging correspondents for which one or more of the electronic messages have been received and remain unread.

59. (previously presented) The medium or media of claim 58, further comprising machine-readable instructions which, when executed, cause the wireless communication device to display a plurality of icons including one or more application icons that are selectable to invoke respective ones of a plurality of applications on the wireless communication device.

60. (previously presented) The medium or media of claim 59, further comprising machine-readable instructions which, when executed, cause the wireless communication device to visually modify one or more of the plurality of icons to include a count of electronic messages that have been received by the wireless communication device and remain unread.

61. (previously presented) The medium or media of claim 58, the at least one icon relating to electronic messaging being selectable to invoke an electronic messaging application.

62. (previously presented) The medium or media of claim 58, further comprising machine-readable instructions which, when executed, cause the wireless communication device to visually modify the graphical user interface to include an identifier of the correspondent from whom at least one of the plurality of messages was received.

63. (previously presented) The medium or media of claim 58, further comprising machine-readable instructions which, when executed, cause the wireless communication device to visually modify the graphical user interface to include at least

one preview of content associated with at least one of the received electronic messages.

64. (currently amended) A computer-readable memory accessible by a processor of a wireless communication device, the memory comprising stored electronic data structures representing executable instructions which, when executed by the processor, cause the wireless communication device to:

display at least one icon relating to an electronic messaging application on the graphical user interface;

receive a plurality of electronic messages, the plurality of electronic messages including messages from a plurality of different messaging correspondents; and

in response to receiving at least one of the plurality of electronic messages, visually modify at least one displayed icon relating to the electronic messaging application to include a ~~number~~ numeric character representing a count of the plurality of different messaging correspondents for which one or more of the electronic messages have been received and remain unread.

65. (previously presented) The computer-readable memory of claim 64, further comprising stored electronic data structures representing executable instructions which, when executed, cause the wireless communication device to display a plurality of icons including one or more application icons that are selectable to invoke respective ones of a plurality of applications on the wireless communication device.

66. (previously presented) The computer-readable memory of claim 65, further comprising stored electronic data structures representing executable instructions which, when executed, cause the wireless communication device to visually modify one or

more of the plurality of icons to include a count of electronic messages that have been received by the wireless communication device and remain unread.

67. (previously presented) The computer-readable memory of claim 64, the at least one icon relating to electronic messaging being selectable to invoke an electronic messaging application.

68. (previously presented) The computer-readable memory of claim 64, stored electronic data structures representing executable instructions which, when executed, cause the wireless communication device to visually modify the graphical user interface to include an identifier of the correspondent from whom at least one of the plurality of messages was received.

69. (previously presented) The computer-readable memory of claim 64, further stored electronic data structures representing executable instructions which, when executed, cause the wireless communication device to visually modify the graphical user interface to include at least one preview of content associated with at least one of the received electronic messages.

70. (currently amended) A wireless communication device comprising:

a processor;

a display electrically coupled to the processor, the display presenting a graphical user interface; and

a medium or media including machine-readable instructions executable by the processor to:

display at least one icon relating to electronic messaging on the graphical user interface;

receive a plurality of electronic messages, the plurality of electronic messages including messages from a plurality of different messaging correspondents; and

in response to receiving at least one of the plurality of electronic messages, visually modify the at least one displayed icon relating to electronic messaging to include a ~~number~~ numeric character representing a count of the plurality of different messaging correspondents for which one or more of the electronic messages have been received and remain unread.

71. (previously presented) The wireless communication device of claim 70, the medium or media further comprising machine-readable instructions which, when executed, cause the wireless communication device to display a plurality of icons including one or more application icons that are selectable to invoke respective ones of a plurality of applications on the wireless communication device.

72. (previously presented) The wireless communication device of claim 71, the medium or media comprising machine-readable instructions which, when executed, cause the wireless communication device to visually modify one or more of the plurality of icons to include a count of electronic messages that have been received and remain unread.

73. (previously presented) The wireless communication device of claim 70, the at least one icon relating to electronic messaging being selectable to invoke an electronic messaging application.

74. (previously presented) The wireless communication device of claim 70, the medium or media further comprising machine-readable instructions which, when executed, cause the wireless communication device to visually modify the graphical user interface to include an identifier of the correspondent from whom at least one of the plurality of messages was received.

75. (previously presented) The wireless communication device of claim 70, the medium or media further comprising machine-readable instructions which, when executed, cause the wireless communication device to visually modify the graphical user interface to include at least one preview of content associated with at least one of the received electronic messages.

76. (previously presented) A method of providing notifications of unread messages on a wireless communication device, comprising:

displaying at least one icon relating to an electronic messaging application on a graphical user interface of the wireless communication device;

receiving on the wireless communication device a plurality of electronic messages associated with the electronic messaging application; and

responsive to receiving at least one of the plurality of electronic messages:

visually modifying at least one icon relating to the electronic messaging application to include a count of the plurality of electronic messages which remain unread; and

displaying on the graphical user interface a text identifier associated with a correspondent from whom the at least one of the plurality of electronic messages was received.

77. (previously presented) The method of claim 76, the identifier associated with a correspondent from whom the at least one of the plurality of electronic messages was received comprising state information pertaining to the correspondent.

78. (previously presented) The method of claim 76, further comprising displaying on the graphical user interface at least a preview of content associated with at least one of the received electronic messages.

79. (previously presented) The method of claim 76, further comprising displaying on the graphical user interface for a predetermined period of time at least a preview of content associated with at least one of the received electronic messages.

80. (previously presented) The method of claim 76, the at least one icon relating to electronic messaging being selectable to invoke an electronic messaging application.

81. (previously presented) The method of claim 80, further comprising, responsive to invoking the electronic messaging application, navigating automatically to a graphical user interface comprising content associated with at least one of the received electronic messages.

82. (previously presented) The method of claim 80, further comprising, responsive to invoking the electronic messaging application within a predetermined time following receipt of at least one of the received electronic messages, navigating automatically to a graphical user interface comprising content associated with the at least one of the received electronic messages.

83. (previously presented) The method of claim 80, further comprising, responsive to invoking the electronic messaging application, visually modifying at least one icon relating to the electronic messaging application to include a decreased count of electronic messages which remain unread.

84. (previously presented) The method of claim 80, further comprising, responsive to invoking the electronic messaging application, visually modifying at least one icon relating to the electronic messaging application to remove the count of electronic messages which remain unread.

85. (previously presented) A medium or media comprising machine-readable instructions executable by a processor of a wireless communication device, the wireless communication device including a graphical user interface, the machine-readable instructions, when executed, causing the wireless communication device to:

display at least one icon relating to an electronic messaging application on a graphical user interface of the wireless communication device;

receive on the wireless communication device a plurality of electronic messages associated with the electronic messaging application; and

responsive to receiving at least one of the plurality of electronic messages:

visually modify at least one icon relating to the electronic messaging application to include a count of the plurality of electronic messages which remain unread; and

display on the graphical user interface a text identifier associated with a correspondent from whom the at least one of the plurality of electronic messages was received.

86. (previously presented) The medium or media of claim 85, the identifier associated with a correspondent from whom the at least one of the plurality of electronic messages was received comprising state information pertaining to the correspondent.

87. (previously presented) The medium or media of claim 85, further comprising machine-readable instructions which, when executed, cause the wireless communication device to display on the graphical user interface at least a preview of content associated with at least one of the received electronic messages.

88. (previously presented) The medium or media of claim 85, further comprising machine-readable instructions which, when executed, cause the wireless communication device to display on the graphical user interface for a predetermined period of time at least a preview of content associated with at least one of the received electronic messages.

89. (previously presented) The medium or media of claim 85, the at least one icon relating to electronic messaging being selectable to invoke an electronic messaging application.

90. (previously presented) The medium or media of claim 89, further comprising machine-readable instructions which, when executed, cause the wireless communication device to, responsive to invoking the electronic messaging application, navigate automatically to a graphical user interface comprising content associated with at least one of the received electronic messages.

91. (previously presented) The medium or media of claim 89, further comprising machine-readable instructions which, when executed, cause the wireless communication device to, responsive to invoking the electronic messaging application within a predetermined time following receipt of at least one of the received electronic messages, navigate automatically to a graphical user interface comprising content associated with the at least one of the received electronic messages.

92. (previously presented) The medium or media of claim 89, further comprising machine-readable instructions which, when executed, cause the wireless communication device to, responsive to invoking the electronic messaging application, visually modify at least one icon relating to the electronic messaging application to include a decreased count of electronic messages which remain unread.

93. (previously presented) The medium or media of claim 89, further comprising machine-readable instructions which, when executed, cause the wireless communication device to, responsive to invoking the electronic messaging application, visually modify at least one icon relating to the electronic messaging application to remove the count of electronic messages which remain unread.

94. (previously presented) A computer-readable memory accessible by a processor of a wireless communication device, the memory comprising stored electronic data structures representing executable instructions which, when executed by the processor, cause the wireless communication device to:

display at least one icon relating to an electronic messaging application on a graphical user interface of the wireless communication device;

receive on the wireless communication device a plurality of electronic messages associated with the electronic messaging application; and

responsive to receiving at least one of the plurality of electronic messages:

visually modify at least one icon relating to the electronic messaging application to include a count of the plurality of electronic messages which remain unread; and

display on the graphical user interface a text identifier associated with a correspondent from whom the at least one of the plurality of electronic messages was received.

95. (previously presented) The computer-readable memory of claim 94, the identifier associated with a correspondent from whom the at least one of the plurality of electronic messages was received comprising state information pertaining to the correspondent.

96. (previously presented) The computer-readable memory of claim 94, further stored electronic data structures representing executable instructions which, when executed, cause the wireless communication device to display on the graphical user interface at least a preview of content associated with at least one of the received electronic messages.

97. (previously presented) The computer-readable memory of claim 94, further stored electronic data structures representing executable instructions which, when executed, cause the wireless communication device to display on the graphical user interface for a predetermined period of time at least a preview of content associated with at least one of the received electronic messages.

98. (previously presented) The computer-readable memory of claim 94, the at least one icon relating to electronic messaging being selectable to invoke an electronic messaging application.

99. (previously presented) The computer-readable memory of claim 98, further stored electronic data structures representing executable instructions which, when executed, cause the wireless communication device to, responsive to invoking the electronic messaging application, navigate automatically to a graphical user interface comprising content associated with at least one of the received electronic messages.

100. (previously presented) The computer-readable memory of claim 98, further stored electronic data structures representing executable instructions which, when executed, cause the wireless communication device to, responsive to invoking the electronic messaging application within a predetermined time following receipt of at least one of the received electronic messages, navigate automatically to a graphical user interface comprising content associated with the at least one of the received electronic messages.

101. (previously presented) The computer-readable memory of claim 98, further stored electronic data structures representing executable instructions which, when executed, cause the wireless communication device to, responsive to invoking the electronic messaging application, visually modify at least one icon relating to the electronic messaging application to include a decreased count of electronic messages which remain unread.

102. (previously presented) The computer-readable memory of claim 98, further stored electronic data structures representing executable instructions which, when

executed, cause the wireless communication device to, responsive to invoking the electronic messaging application, visually modify at least one icon relating to the electronic messaging application to remove the count of electronic messages which remain unread.

103. (previously presented) A wireless communication device comprising

a processor;

a display electrically coupled to the processor, the display presenting a graphical user interface; and

a medium or media including machine-readable instructions executable by the processor to:

display on the graphical user interface at least one icon relating to an electronic messaging application;

receive on the wireless communication device a plurality of electronic messages associated with the electronic messaging application; and

responsive to receiving at least one of the plurality of electronic messages:

visually modify at least one icon relating to the electronic messaging application to include a count of the plurality of electronic messages which remain unread; and

display on the graphical user interface a text identifier associated with a correspondent from whom the at least one of the plurality of electronic messages was received.

104. (previously presented) The wireless communication device of claim 103, the identifier associated with a correspondent from whom the at least one of the plurality of

electronic messages was received comprising state information pertaining to the correspondent.

105. (previously presented) The wireless communication device of claim 103, the medium or media further comprising machine-readable instructions which, when executed, cause the wireless communication device to display on the graphical user interface at least a preview of content associated with at least one of the received electronic messages.

106. (previously presented) The wireless communication device of claim 103, the medium or media further comprising machine-readable instructions which, when executed, cause the wireless communication device to display on the graphical user interface for a predetermined period of time at least a preview of content associated with at least one of the received electronic messages.

107. (previously presented) The wireless communication device of claim 103, the at least one icon relating to electronic messaging being selectable to invoke an electronic messaging application.

108. (previously presented) The wireless communication device of claim 107, the medium or media further comprising machine-readable instructions which, when executed, cause the wireless communication device to, responsive to invoking the electronic messaging application, navigate automatically to a graphical user interface comprising content associated with at least one of the received electronic messages.

109. (previously presented) The wireless communication device of claim 107, the medium or media further comprising machine-readable instructions which, when executed, cause the wireless communication device to, responsive to invoking the electronic messaging application within a predetermined time following receipt of at least one of the received electronic messages, navigate automatically to a graphical user interface comprising content associated with the at least one of the received electronic messages.

110. (previously presented) The wireless communication device of claim 107, the medium or media further comprising machine-readable instructions which, when executed, cause the wireless communication device to, responsive to invoking the electronic messaging application, visually modify at least one icon relating to the electronic messaging application to include a decreased count of electronic messages which remain unread.

111. (previously presented) The wireless communication device of claim 107, the medium or media further comprising machine-readable instructions which, when executed, cause the wireless communication device to, responsive to invoking the electronic messaging application, visually modify at least one icon relating to the electronic messaging application to remove the count of electronic messages which remain unread.

REMARKS**Status of Related Applications**

The following US, foreign, and international patent applications are or may be considered to be related to the application herein. Relevant documents pertaining to such cases are being provided or have been provided in one or more separately-filed Information Disclosure Statements. The status of such applications, as currently understood by Applicant, is summarized in order to ensure that the Office is fully apprised of the current state thereof. In the event the Office has any questions about the identified cases, the Examiner is requested to call Applicant's representative at the number below.

<u>Serial No.</u>	<u>Country</u>	<u>Status</u>
2006-541762	Japan	Granted
0871404	Rep of Korea	Granted
200480039930.2	China	Registered
200810099973.X	China	Registered
3113/DELP/2006	India	Pending – in examination
04713831.8	EPO	Oral Proceedings
08168419.3	EPO	Pending – in examination
10177958.5	EPO	Pending - search report received
10177959.3	EPO	Pending - search report received
07100038.7	Hong Kong	Pending – awaiting allowance in EPO
200603555-4	Singapore	Pending – awaiting allowance in US or EPO
200603555-4	Singapore	Pending – examination requested
2,548,598	Canada	Pending – in examination
2,727,763	Canada	Pending (divisional of 2,548,598) – not yet examined
TBA	Canada	Pending (divisional of 2,548,598) – not yet examined
CA2004/000263	PCT	Expired (NPE entered as above)

Summary of Interviews

Applicant thanks the Examiner for his time and insight during the interviews conducted with Applicant's representative Matthew Marquardt by telephone on 23 February 2011 and 3 March 2011. All of the claims were discussed in view of Dam Nielsen (US 2006-0084450). It was agreed that the claims as presented distinguish Dam Nielsen.

Amendment

Claims 52, 58, 64, and 70 are amended by this response. Support for the amendment may be found throughout the specification as originally filed, including the Figures and the claims; and in particular at paragraphs [0025], [0036], [0040], [0042], and [0043] – [0052], and in Figures 6 – 8.

No new matter is added by the amendment.

Remarks

Applicant notes that substantially identical claims are granted in Japan. A copy of the claims allowed in Japan has previously been submitted by IDS.

The claims as presented distinguish the prior art of record, and particularly the Dam Nielsen reference (US 2006-0084450), at least through recitation of numeric character identifiers in the case of claims 52 – 75, and text identifiers in claims 76 – 111. Dam Nielsen teaches the use of images ("icons" 716, 717, etc.):

a personalized icon [e.g., 716, 717], which the user has previously associated with a particular sender, will be displayed and indicate to the user who the sender is.

(See for example Dam Nielsen paragraph [0013], and figures 3 - 7.)

By contrast, Applicant's claims recite numeric characters and text identifiers such as those shown at 400, 604, 802, 804 in Applicant's figures 4 – 8, which, as will be understood by those skilled in the relevant arts:

- consume significantly less device memory and local storage space on a communications device than graphical or other image icons such as those taught by Dam Nielsen;
- consume significantly less processing resources, including time and power, than graphical or other image icons such as those taught by Dam Nielsen;
- can communicate significantly more information in significantly less display space than is possible using the solution taught by Dam Nielsen. This can be particularly important for small-screen devices such as wireless handheld devices, in which screen space is notoriously precious.
- can in at least some cases be either read directly or derived from data received by the mobile device or other communication system 102, 202, and therefore need not be “previously associated with a particular sender” by the user, and stored on the user’s device, as required by Dam Nielsen (paragraph [0013]); and
- therefore can require significantly less (or no) user interaction, with associated loss of time and convenience, than required by Dam Nielsen, as manual association of images with correspondents can be eliminated.

Applicant respectfully submits that the claims, as presented are neither anticipated nor rendered obvious by the cited references.

Disclaimer of Prior Statements and Amendments

Applicant intends that the claims as presented herein be interpreted under the ordinary interpretation understood in the art. Accordingly Applicant expressly rescinds, and no longer intends that the claims be limited by, any assertions, statements, arguments, amendments or other actions previously made in this patent application, and/or any application whose file history is available for use in interpreting any patent issuing on this application, that might be taken to be a surrender or disclaimer of any subject matter from the scope of any claim. No such assertion, statement, argument, amendment or other action in this application or in any such available application should be taken as a surrender or disclaimer from, and may not be used to interpret, any claim of this patent, or any claim of any patent to which such applications' file histories may be pertinent.

Applicant intends, and expressly requests, that the Application be presented and examined *de novo*. Accordingly, Applicant urges the Examiner to make a thorough and diligent search of the prior art with respect to each and every claim presented herein. Applicant requests that the Examiner reconsider any previous surrender, disclaimer or characterization of claims, and that he reconsider any prior art that may have been avoided or intended to be avoided by such surrender, disclaimer or characterization.

CONCLUSION

Applicant believes that the claims, as presented, are in condition for immediate allowance. Applicant respectfully requests reconsideration and immediate allowance of the claims.

Applicant believes that no fees are due in connection with the filing of this paper. In the event that the office determines that any further fee is due, Appellant requests that such fee be charged to its Deposit Account No. 195113.

Applicant is concerned to advance this application as quickly as is reasonably possible. Accordingly, Applicant respectfully requests that, in the event the Examiner has any further questions about this application, the Examiner call Applicant's attorney at the number provided below.

Dated: 4 March 201

Respectfully submitted,



Matthew J. MARQUARDT
Reg. No. 40,997
Attorney for the Applicant
OGILVY RENAULT LLP

Royal Bank Plaza, South Tower
200 Bay Street, P.O. Box 84
Toronto, Ontario M5J 2Z4
CANADA
Tel. 416-216-4789
Fax 416-216-3930

Electronic Acknowledgement Receipt

EFS ID:	9591576
Application Number:	10784781
International Application Number:	
Confirmation Number:	2200
Title of Invention:	Previewing a new event on a small screen device
First Named Inventor/Applicant Name:	Gerhard D. Klassen
Customer Number:	20988
Filer:	Matthew J. Marquardt
Filer Authorized By:	
Attorney Docket Number:	05200204-272US
Receipt Date:	04-MAR-2011
Filing Date:	24-FEB-2004
Time Stamp:	17:06:13
Application Type:	Utility under 35 USC 111(a)

Payment information:

Submitted with Payment	no
------------------------	----

File Listing:

Document Number	Document Description	File Name	File Size(Bytes)/ Message Digest	Multi Part /.zip	Pages (if appl.)
1	Supplemental Response or Supplemental Amendment	Amendment.pdf	783948 <small>56af4126a405114ba010c8108695a996cea d5196</small>	no	21

Warnings:

Information:

This Acknowledgement Receipt evidences receipt on the noted date by the USPTO of the indicated documents, characterized by the applicant, and including page counts, where applicable. It serves as evidence of receipt similar to a Post Card, as described in MPEP 503.

New Applications Under 35 U.S.C. 111

If a new application is being filed and the application includes the necessary components for a filing date (see 37 CFR 1.53(b)-(d) and MPEP 506), a Filing Receipt (37 CFR 1.54) will be issued in due course and the date shown on this Acknowledgement Receipt will establish the filing date of the application.

National Stage of an International Application under 35 U.S.C. 371

If a timely submission to enter the national stage of an international application is compliant with the conditions of 35 U.S.C. 371 and other applicable requirements a Form PCT/DO/EO/903 indicating acceptance of the application as a national stage submission under 35 U.S.C. 371 will be issued in addition to the Filing Receipt, in due course.

New International Application Filed with the USPTO as a Receiving Office

If a new international application is being filed and the international application includes the necessary components for an international filing date (see PCT Article 11 and MPEP 1810), a Notification of the International Application Number and of the International Filing Date (Form PCT/RO/105) will be issued in due course, subject to prescriptions concerning national security, and the date shown on this Acknowledgement Receipt will establish the international filing date of the application.

INFORMATION DISCLOSURE STATEMENT BY APPLICANT (Not for submission under 37 CFR 1.99)	Application Number	10784781
	Filing Date	2004-02-24
	First Named Inventor	Gerhard D. Klassen
	Art Unit	2172
	Examiner Name	John M. Heffington
	Attorney Docket Number	05200204-272US

U.S. PATENTS							Remove	
Examiner Initial*	Cite No	Patent Number	Kind Code ¹	Issue Date	Name of Patentee or Applicant of cited Document	Pages, Columns, Lines where Relevant Passages or Relevant Figures Appear		
	1							
If you wish to add additional U.S. Patent citation information please click the Add button.							Add	
U.S. PATENT APPLICATION PUBLICATIONS							Remove	
Examiner Initial*	Cite No	Publication Number	Kind Code ¹	Publication Date	Name of Patentee or Applicant of cited Document	Pages, Columns, Lines where Relevant Passages or Relevant Figures Appear		
	1	20030167310	A1	2003-09-04	Moody et al.			
If you wish to add additional U.S. Published Application citation information please click the Add button.							Add	
FOREIGN PATENT DOCUMENTS							Remove	
Examiner Initial*	Cite No	Foreign Document Number ³	Country Code ² j	Kind Code ⁴	Publication Date	Name of Patentee or Applicant of cited Document	Pages, Columns, Lines where Relevant Passages or Relevant Figures Appear	T ⁵
	1							<input type="checkbox"/>
If you wish to add additional Foreign Patent Document citation information please click the Add button.							Add	
NON-PATENT LITERATURE DOCUMENTS							Remove	
Examiner Initials*	Cite No	Include name of the author (in CAPITAL LETTERS), title of the article (when appropriate), title of the item (book, magazine, journal, serial, symposium, catalog, etc), date, pages(s), volume-issue number(s), publisher, city and/or country where published.					T ⁵	

INFORMATION DISCLOSURE STATEMENT BY APPLICANT (Not for submission under 37 CFR 1.99)	Application Number		10784781
	Filing Date		2004-02-24
	First Named Inventor	Gerhard D. Klassen	
	Art Unit		2172
	Examiner Name	John M. Heffington	
	Attorney Docket Number		05200204-272US

1	Official Action dated February 21, 2011, issued by the Canadian Intellectual Property Office for corresponding Canadian Patent Application No. 2,548,589.	<input type="checkbox"/>
2	Certificate of Patent dated December 24, 2010, issued by the Japanese Patent Office for corresponding Japanese Patent No. 4651623.	<input type="checkbox"/>
3	Summons to Attend Oral Proceedings dated February 17, 2011, issued by the European Patent Office for corresponding European Divisional Patent Application No. 08168419.3	<input type="checkbox"/>
4	Article entitled "10 Minute Guide to Pocket PC 2002," dated September 2002, issued by Que.	<input type="checkbox"/>
5	Applicant's response to the Official Action dated March 11, 2010, issued by the Indian Patent Office for corresponding Indian Patent Application No. 3113/DELNP/2006.	<input type="checkbox"/>
6	Official Action dated February 22, 2011, issued by the Indian Patent Office for corresponding Indian Patent Application No. 3113/DELNP/2006.	<input type="checkbox"/>

If you wish to add additional non-patent literature document citation information please click the Add button

EXAMINER SIGNATURE

Examiner Signature	Date Considered
--------------------	-----------------

*EXAMINER: Initial if reference considered, whether or not citation is in conformance with MPEP 609. Draw line through a citation if not in conformance and not considered. Include copy of this form with next communication to applicant.

¹ See Kind Codes of USPTO Patent Documents at www.USPTO.GOV or MPEP 901.04. ² Enter office that issued the document, by the two-letter code (WIPO Standard ST.3). ³ For Japanese patent documents, the indication of the year of the reign of the Emperor must precede the serial number of the patent document. ⁴ Kind of document by the appropriate symbols as indicated on the document under WIPO Standard ST.16 if possible. ⁵ Applicant is to place a check mark here if English language translation is attached.

INFORMATION DISCLOSURE STATEMENT BY APPLICANT (Not for submission under 37 CFR 1.99)	Application Number	10784781
	Filing Date	2004-02-24
	First Named Inventor	Gerhard D. Klassen
	Art Unit	2172
	Examiner Name	John M. Heffington
	Attorney Docket Number	05200204-272US

CERTIFICATION STATEMENT

Please see 37 CFR 1.97 and 1.98 to make the appropriate selection(s):

That each item of information contained in the information disclosure statement was first cited in any communication from a foreign patent office in a counterpart foreign application not more than three months prior to the filing of the information disclosure statement. See 37 CFR 1.97(e)(1).

OR

That no item of information contained in the information disclosure statement was cited in a communication from a foreign patent office in a counterpart foreign application, and, to the knowledge of the person signing the certification after making reasonable inquiry, no item of information contained in the information disclosure statement was known to any individual designated in 37 CFR 1.56(c) more than three months prior to the filing of the information disclosure statement. See 37 CFR 1.97(e)(2).

- See attached certification statement.
- The fee set forth in 37 CFR 1.17 (p) has been submitted herewith.
- A certification statement is not submitted herewith.

SIGNATURE

A signature of the applicant or representative is required in accordance with CFR 1.33, 10.18. Please see CFR 1.4(d) for the form of the signature.

Signature	/Matthew MARQUARDT/	Date (YYYY-MM-DD)	2011-03-07
Name/Print	Matthew Marquardt	Registration Number	40997

This collection of information is required by 37 CFR 1.97 and 1.98. The information is required to obtain or retain a benefit by the public which is to file (and by the USPTO to process) an application. Confidentiality is governed by 35 U.S.C. 122 and 37 CFR 1.14. This collection is estimated to take 1 hour to complete, including gathering, preparing and submitting the completed application form to the USPTO. Time will vary depending upon the individual case. Any comments on the amount of time you require to complete this form and/or suggestions for reducing this burden, should be sent to the Chief Information Officer, U.S. Patent and Trademark Office, U.S. Department of Commerce, P.O. Box 1450, Alexandria, VA 22313-1450. **DO NOT SEND FEES OR COMPLETED FORMS TO THIS ADDRESS. SEND TO: Commissioner for Patents, P.O. Box 1450, Alexandria, VA 22313-1450.**

Privacy Act Statement

The Privacy Act of 1974 (P.L. 93-579) requires that you be given certain information in connection with your submission of the attached form related to a patent application or patent. Accordingly, pursuant to the requirements of the Act, please be advised that: (1) the general authority for the collection of this information is 35 U.S.C. 2(b)(2); (2) furnishing of the information solicited is voluntary; and (3) the principal purpose for which the information is used by the U.S. Patent and Trademark Office is to process and/or examine your submission related to a patent application or patent. If you do not furnish the requested information, the U.S. Patent and Trademark Office may not be able to process and/or examine your submission, which may result in termination of proceedings or abandonment of the application or expiration of the patent.

The information provided by you in this form will be subject to the following routine uses:

1. The information on this form will be treated confidentially to the extent allowed under the Freedom of Information Act (5 U.S.C. 552) and the Privacy Act (5 U.S.C. 552a). Records from this system of records may be disclosed to the Department of Justice to determine whether the Freedom of Information Act requires disclosure of these records.
2. A record from this system of records may be disclosed, as a routine use, in the course of presenting evidence to a court, magistrate, or administrative tribunal, including disclosures to opposing counsel in the course of settlement negotiations.
3. A record in this system of records may be disclosed, as a routine use, to a Member of Congress submitting a request involving an individual, to whom the record pertains, when the individual has requested assistance from the Member with respect to the subject matter of the record.
4. A record in this system of records may be disclosed, as a routine use, to a contractor of the Agency having need for the information in order to perform a contract. Recipients of information shall be required to comply with the requirements of the Privacy Act of 1974, as amended, pursuant to 5 U.S.C. 552a(m).
5. A record related to an International Application filed under the Patent Cooperation Treaty in this system of records may be disclosed, as a routine use, to the International Bureau of the World Intellectual Property Organization, pursuant to the Patent Cooperation Treaty.
6. A record in this system of records may be disclosed, as a routine use, to another federal agency for purposes of National Security review (35 U.S.C. 181) and for review pursuant to the Atomic Energy Act (42 U.S.C. 218(c)).
7. A record from this system of records may be disclosed, as a routine use, to the Administrator, General Services, or his/her designee, during an inspection of records conducted by GSA as part of that agency's responsibility to recommend improvements in records management practices and programs, under authority of 44 U.S.C. 2904 and 2906. Such disclosure shall be made in accordance with the GSA regulations governing inspection of records for this purpose, and any other relevant (i.e., GSA or Commerce) directive. Such disclosure shall not be used to make determinations about individuals.
8. A record from this system of records may be disclosed, as a routine use, to the public after either publication of the application pursuant to 35 U.S.C. 122(b) or issuance of a patent pursuant to 35 U.S.C. 151. Further, a record may be disclosed, subject to the limitations of 37 CFR 1.14, as a routine use, to the public if the record was filed in an application which became abandoned or in which the proceedings were terminated and which application is referenced by either a published application, an application open to public inspections or an issued patent.
9. A record from this system of records may be disclosed, as a routine use, to a Federal, State, or local law enforcement agency, if the USPTO becomes aware of a violation or potential violation of law or regulation.

Electronic Acknowledgement Receipt	
EFS ID:	9598610
Application Number:	10784781
International Application Number:	
Confirmation Number:	2200
Title of Invention:	Previewing a new event on a small screen device
First Named Inventor/Applicant Name:	Gerhard D. Klassen
Customer Number:	20988
Filer:	Matthew J. Marquardt/Nicole Farrugia
Filer Authorized By:	Matthew J. Marquardt
Attorney Docket Number:	05200204-272US
Receipt Date:	07-MAR-2011
Filing Date:	24-FEB-2004
Time Stamp:	14:19:13
Application Type:	Utility under 35 USC 111(a)

Payment information:

Submitted with Payment	no
------------------------	----

File Listing:

Document Number	Document Description	File Name	File Size(Bytes)/ Message Digest	Multi Part /.zip	Pages (if appl.)
1	Information Disclosure Statement (IDS) Filed (SB/08)	CitationPage.pdf	612663 <small>6227c20e1f29bdfb2c846cd1454325fbec927e9</small>	no	4

Warnings:

Information:

2	NPL Documents	CA_OA.PDF	162539 bbf832f59656b257d5779c46b39ef0396df4e14	no	3
Warnings:					
Information:					
3	NPL Documents	JP_Grant.PDF	201507 ae78a52ad4d040f5e19ffb67535d6ee0c9aec274	no	2
Warnings:					
Information:					
4	NPL Documents	EP_OralProceedings.PDF	385420 71387b3cba6471368253fb59371c278db609fce3	no	9
Warnings:					
Information:					
5	NPL Documents	10_GuidetoPC.PDF	590680 f02ee9e3b22ee2a4a0bbb19bcbef50ae63d0b37d	no	8
Warnings:					
Information:					
6	NPL Documents	IN_OA_Response.PDF	873980 51bda3f10a3611b99766364bf01622e4d96fc2f3	no	21
Warnings:					
Information:					
7	NPL Documents	IN_OA.PDF	42467 b32067a4b3cb2e57adfb2ef37e4b065921fc91f8e	no	1
Warnings:					
Information:					
Total Files Size (in bytes):				2869256	

This Acknowledgement Receipt evidences receipt on the noted date by the USPTO of the indicated documents, characterized by the applicant, and including page counts, where applicable. It serves as evidence of receipt similar to a Post Card, as described in MPEP 503.

New Applications Under 35 U.S.C. 111

If a new application is being filed and the application includes the necessary components for a filing date (see 37 CFR 1.53(b)-(d) and MPEP 506), a Filing Receipt (37 CFR 1.54) will be issued in due course and the date shown on this Acknowledgement Receipt will establish the filing date of the application.

National Stage of an International Application under 35 U.S.C. 371

If a timely submission to enter the national stage of an international application is compliant with the conditions of 35 U.S.C. 371 and other applicable requirements a Form PCT/DO/EO/903 indicating acceptance of the application as a national stage submission under 35 U.S.C. 371 will be issued in addition to the Filing Receipt, in due course.

New International Application Filed with the USPTO as a Receiving Office

If a new international application is being filed and the international application includes the necessary components for an international filing date (see PCT Article 11 and MPEP 1810), a Notification of the International Application Number and of the International Filing Date (Form PCT/RO/105) will be issued in due course, subject to prescriptions concerning national security, and the date shown on this Acknowledgement Receipt will establish the international filing date of the application.

Under the Paperwork Reduction Act of 1995, no persons are required to respond to a collection of information unless it displays a valid OMB control number.

PATENT APPLICATION FEE DETERMINATION RECORD Substitute for Form PTO-875				Application or Docket Number 10/784,781		Filing Date 02/24/2004		<input type="checkbox"/> To be Mailed											
APPLICATION AS FILED – PART I						OTHER THAN													
(Column 1)			(Column 2)			SMALL ENTITY <input type="checkbox"/>		OR		SMALL ENTITY									
FOR		NUMBER FILED		NUMBER EXTRA		RATE (\$)		FEE (\$)		RATE (\$)		FEE (\$)							
<input type="checkbox"/> BASIC FEE <small>(37 CFR 1.16(a), (b), or (c))</small>		N/A		N/A		N/A				N/A									
<input type="checkbox"/> SEARCH FEE <small>(37 CFR 1.16(k), (l), or (m))</small>		N/A		N/A		N/A				N/A									
<input type="checkbox"/> EXAMINATION FEE <small>(37 CFR 1.16(o), (p), or (q))</small>		N/A		N/A		N/A				N/A									
TOTAL CLAIMS <small>(37 CFR 1.16(i))</small>		minus 20 =		*		X \$ =		OR		X \$ =									
INDEPENDENT CLAIMS <small>(37 CFR 1.16(h))</small>		minus 3 =		*		X \$ =		OR		X \$ =									
<input type="checkbox"/> APPLICATION SIZE FEE <small>(37 CFR 1.16(s))</small>		If the specification and drawings exceed 100 sheets of paper, the application size fee due is \$250 (\$125 for small entity) for each additional 50 sheets or fraction thereof. See 35 U.S.C. 41(a)(1)(G) and 37 CFR 1.16(s).																	
<input type="checkbox"/> MULTIPLE DEPENDENT CLAIM PRESENT <small>(37 CFR 1.16(j))</small>																			
* If the difference in column 1 is less than zero, enter "0" in column 2.																			
APPLICATION AS AMENDED – PART II						OTHER THAN													
(Column 1)			(Column 2)			(Column 3)			SMALL ENTITY		OR		SMALL ENTITY						
AMENDMENT	03/07/2011		CLAIMS REMAINING AFTER AMENDMENT				HIGHEST NUMBER PREVIOUSLY PAID FOR		PRESENT EXTRA		RATE (\$)		ADDITIONAL FEE (\$)		RATE (\$)		ADDITIONAL FEE (\$)		
	Total <small>(37 CFR 1.16(i))</small>		* 60		Minus		** 60		= 0		X \$ =		OR		X \$52=		0		
	Independent <small>(37 CFR 1.16(b))</small>		* 8		Minus		***8		= 0		X \$ =		OR		X \$220=		0		
	<input type="checkbox"/> Application Size Fee <small>(37 CFR 1.16(s))</small>																		
	<input type="checkbox"/> FIRST PRESENTATION OF MULTIPLE DEPENDENT CLAIM <small>(37 CFR 1.16(j))</small>																		
												TOTAL ADD'L FEE		OR		TOTAL ADD'L FEE		0	
AMENDMENT			CLAIMS REMAINING AFTER AMENDMENT				HIGHEST NUMBER PREVIOUSLY PAID FOR		PRESENT EXTRA		RATE (\$)		ADDITIONAL FEE (\$)		RATE (\$)		ADDITIONAL FEE (\$)		
	Total <small>(37 CFR 1.16(i))</small>		*		Minus		**		=		X \$ =		OR		X \$ =				
	Independent <small>(37 CFR 1.16(b))</small>		*		Minus		***		=		X \$ =		OR		X \$ =				
	<input type="checkbox"/> Application Size Fee <small>(37 CFR 1.16(s))</small>																		
	<input type="checkbox"/> FIRST PRESENTATION OF MULTIPLE DEPENDENT CLAIM <small>(37 CFR 1.16(j))</small>																		
												TOTAL ADD'L FEE		OR		TOTAL ADD'L FEE			
* If the entry in column 1 is less than the entry in column 2, write "0" in column 3.																			
** If the "Highest Number Previously Paid For" IN THIS SPACE is less than 20, enter "20".																			
*** If the "Highest Number Previously Paid For" IN THIS SPACE is less than 3, enter "3".																			
The "Highest Number Previously Paid For" (Total or Independent) is the highest number found in the appropriate box in column 1.																			
Legal Instrument Examiner: /PATRICIA F. LEWIS/																			

This collection of information is required by 37 CFR 1.16. The information is required to obtain or retain a benefit by the public which is to file (and by the USPTO to process) an application. Confidentiality is governed by 35 U.S.C. 122 and 37 CFR 1.14. This collection is estimated to take 12 minutes to complete, including gathering, preparing, and submitting the completed application form to the USPTO. Time will vary depending upon the individual case. Any comments on the amount of time you require to complete this form and/or suggestions for reducing this burden, should be sent to the Chief Information Officer, U.S. Patent and Trademark Office, U.S. Department of Commerce, P.O. Box 1450, Alexandria, VA 22313-1450. DO NOT SEND FEES OR COMPLETED FORMS TO THIS ADDRESS. **SEND TO: Commissioner for Patents, P.O. Box 1450, Alexandria, VA 22313-1450.**

If you need assistance in completing the form, call 1-800-PTO-9199 and select option 2.



UNITED STATES PATENT AND TRADEMARK OFFICE

UNITED STATES DEPARTMENT OF COMMERCE
United States Patent and Trademark Office
Address: COMMISSIONER FOR PATENTS
P.O. Box 1450
Alexandria, Virginia 22313-1450
www.uspto.gov

APPLICATION NO.	FILING DATE	FIRST NAMED INVENTOR	ATTORNEY DOCKET NO.	CONFIRMATION NO.
10/784,781	02/24/2004	Gerhard D. Klassen	05200204-272US	2200
20988	7590	03/14/2011	EXAMINER	
OGILVY RENAULT LLP 1, Place Ville Marie SUITE 2500 MONTREAL, QC H3B 1R1 CANADA			HEFFINGTON, JOHN M	
			ART UNIT	PAPER NUMBER
			2172	
			MAIL DATE	DELIVERY MODE
			03/14/2011	PAPER

Please find below and/or attached an Office communication concerning this application or proceeding.

The time period for reply, if any, is set in the attached communication.

Interview Summary	Application No. 10/784,781	Applicant(s) KLASSEN ET AL.	
	Examiner JOHN HEFFINGTON	Art Unit 2172	

All participants (applicant, applicant's representative, PTO personnel):

(1) JOHN HEFFINGTON. (3)_____.

(2) Matt Marquardt. (4)_____.

Date of Interview: 03 March 2011.

Type: a) Telephonic b) Video Conference
c) Personal [copy given to: 1) applicant 2) applicant's representative]

Exhibit shown or demonstration conducted: d) Yes e) No.
If Yes, brief description: _____.

Claim(s) discussed: 52.

Identification of prior art discussed: Nielson.

Agreement with respect to the claims f) was reached. g) was not reached. h) N/A.

Substance of Interview including description of the general nature of what was agreed to if an agreement was reached, or any other comments: The applicant proposed an amendment to overcome Nielson. The amendment specifies a numeric character representing a count rather than a number representing a count. The applicant presented arguments that the instant invention has advantages over Nielson in that Nielson displays icons which require more memory and screen space than the instant invention which merely displays a numeric character..

(A fuller description, if necessary, and a copy of the amendments which the examiner agreed would render the claims allowable, if available, must be attached. Also, where no copy of the amendments that would render the claims allowable is available, a summary thereof must be attached.)

THE FORMAL WRITTEN REPLY TO THE LAST OFFICE ACTION MUST INCLUDE THE SUBSTANCE OF THE INTERVIEW. (See MPEP Section 713.04). If a reply to the last Office action has already been filed, APPLICANT IS GIVEN A NON-EXTENDABLE PERIOD OF THE LONGER OF ONE MONTH OR THIRTY DAYS FROM THIS INTERVIEW DATE, OR THE MAILING DATE OF THIS INTERVIEW SUMMARY FORM, WHICHEVER IS LATER, TO FILE A STATEMENT OF THE SUBSTANCE OF THE INTERVIEW. See Summary of Record of Interview requirements on reverse side or on attached sheet.

	/Boris Pesin/ Supervisory Patent Examiner, Art Unit 2172
--	---

Summary of Record of Interview Requirements

Manual of Patent Examining Procedure (MPEP), Section 713.04, Substance of Interview Must be Made of Record

A complete written statement as to the substance of any face-to-face, video conference, or telephone interview with regard to an application must be made of record in the application whether or not an agreement with the examiner was reached at the interview.

Title 37 Code of Federal Regulations (CFR) § 1.133 Interviews Paragraph (b)

In every instance where reconsideration is requested in view of an interview with an examiner, a complete written statement of the reasons presented at the interview as warranting favorable action must be filed by the applicant. An interview does not remove the necessity for reply to Office action as specified in §§ 1.111, 1.135. (35 U.S.C. 132)

37 CFR §1.2 Business to be transacted in writing.

All business with the Patent or Trademark Office should be transacted in writing. The personal attendance of applicants or their attorneys or agents at the Patent and Trademark Office is unnecessary. The action of the Patent and Trademark Office will be based exclusively on the written record in the Office. No attention will be paid to any alleged oral promise, stipulation, or understanding in relation to which there is disagreement or doubt.

The action of the Patent and Trademark Office cannot be based exclusively on the written record in the Office if that record is itself incomplete through the failure to record the substance of interviews.

It is the responsibility of the applicant or the attorney or agent to make the substance of an interview of record in the application file, unless the examiner indicates he or she will do so. It is the examiner's responsibility to see that such a record is made and to correct material inaccuracies which bear directly on the question of patentability.

Examiners must complete an Interview Summary Form for each interview held where a matter of substance has been discussed during the interview by checking the appropriate boxes and filling in the blanks. Discussions regarding only procedural matters, directed solely to restriction requirements for which interview recordation is otherwise provided for in Section 812.01 of the Manual of Patent Examining Procedure, or pointing out typographical errors or unreadable script in Office actions or the like, are excluded from the interview recordation procedures below. Where the substance of an interview is completely recorded in an Examiners Amendment, no separate Interview Summary Record is required.

The Interview Summary Form shall be given an appropriate Paper No., placed in the right hand portion of the file, and listed on the "Contents" section of the file wrapper. In a personal interview, a duplicate of the Form is given to the applicant (or attorney or agent) at the conclusion of the interview. In the case of a telephone or video-conference interview, the copy is mailed to the applicant's correspondence address either with or prior to the next official communication. If additional correspondence from the examiner is not likely before an allowance or if other circumstances dictate, the Form should be mailed promptly after the interview rather than with the next official communication.

The Form provides for recordation of the following information:

- Application Number (Series Code and Serial Number)
- Name of applicant
- Name of examiner
- Date of interview
- Type of interview (telephonic, video-conference, or personal)
- Name of participant(s) (applicant, attorney or agent, examiner, other PTO personnel, etc.)
- An indication whether or not an exhibit was shown or a demonstration conducted
- An identification of the specific prior art discussed
- An indication whether an agreement was reached and if so, a description of the general nature of the agreement (may be by attachment of a copy of amendments or claims agreed as being allowable). Note: Agreement as to allowability is tentative and does not restrict further action by the examiner to the contrary.
- The signature of the examiner who conducted the interview (if Form is not an attachment to a signed Office action)

It is desirable that the examiner orally remind the applicant of his or her obligation to record the substance of the interview of each case. It should be noted, however, that the Interview Summary Form will not normally be considered a complete and proper recordation of the interview unless it includes, or is supplemented by the applicant or the examiner to include, all of the applicable items required below concerning the substance of the interview.

A complete and proper recordation of the substance of any interview should include at least the following applicable items:

- 1) A brief description of the nature of any exhibit shown or any demonstration conducted,
- 2) an identification of the claims discussed,
- 3) an identification of the specific prior art discussed,
- 4) an identification of the principal proposed amendments of a substantive nature discussed, unless these are already described on the Interview Summary Form completed by the Examiner,
- 5) a brief identification of the general thrust of the principal arguments presented to the examiner,
(The identification of arguments need not be lengthy or elaborate. A verbatim or highly detailed description of the arguments is not required. The identification of the arguments is sufficient if the general nature or thrust of the principal arguments made to the examiner can be understood in the context of the application file. Of course, the applicant may desire to emphasize and fully describe those arguments which he or she feels were or might be persuasive to the examiner.)
- 6) a general indication of any other pertinent matters discussed, and
- 7) if appropriate, the general results or outcome of the interview unless already described in the Interview Summary Form completed by the examiner.

Examiners are expected to carefully review the applicant's record of the substance of an interview. If the record is not complete and accurate, the examiner will give the applicant an extendable one month time period to correct the record.

Examiner to Check for Accuracy

If the claims are allowable for other reasons of record, the examiner should send a letter setting forth the examiner's version of the statement attributed to him or her. If the record is complete and accurate, the examiner should place the indication, "Interview Record OK" on the paper recording the substance of the interview along with the date and the examiner's initials.



UNITED STATES PATENT AND TRADEMARK OFFICE

UNITED STATES DEPARTMENT OF COMMERCE
United States Patent and Trademark Office
Address: COMMISSIONER FOR PATENTS
P.O. Box 1450
Alexandria, Virginia 22313-1450
www.uspto.gov

APPLICATION NO.	FILING DATE	FIRST NAMED INVENTOR	ATTORNEY DOCKET NO.	CONFIRMATION NO.
10/784,781	02/24/2004	Gerhard D. Klassen	05200204-272US	2200
20988	7590	05/19/2011	EXAMINER	
OGILVY RENAULT LLP 1, Place Ville Marie SUITE 2500 MONTREAL, QC H3B 1R1 CANADA			HEFFINGTON, JOHN M	
			ART UNIT	PAPER NUMBER
			2172	
			MAIL DATE	DELIVERY MODE
			05/19/2011	PAPER

Please find below and/or attached an Office communication concerning this application or proceeding.

The time period for reply, if any, is set in the attached communication.

Office Action Summary	Application No.	Applicant(s)	
	10/784,781	KLASSEN ET AL.	
	Examiner	Art Unit	
	JOHN HEFFINGTON	2172	

-- The MAILING DATE of this communication appears on the cover sheet with the correspondence address --
Period for Reply

A SHORTENED STATUTORY PERIOD FOR REPLY IS SET TO EXPIRE 3 MONTH(S) OR THIRTY (30) DAYS, WHICHEVER IS LONGER, FROM THE MAILING DATE OF THIS COMMUNICATION.

- Extensions of time may be available under the provisions of 37 CFR 1.136(a). In no event, however, may a reply be timely filed after SIX (6) MONTHS from the mailing date of this communication.
- If NO period for reply is specified above, the maximum statutory period will apply and will expire SIX (6) MONTHS from the mailing date of this communication.
- Failure to reply within the set or extended period for reply will, by statute, cause the application to become ABANDONED (35 U.S.C. § 133). Any reply received by the Office later than three months after the mailing date of this communication, even if timely filed, may reduce any earned patent term adjustment. See 37 CFR 1.704(b).

Status

- 1) Responsive to communication(s) filed on 04 March 2011.
- 2a) This action is **FINAL**.
- 2b) This action is non-final.
- 3) Since this application is in condition for allowance except for formal matters, prosecution as to the merits is closed in accordance with the practice under *Ex parte Quayle*, 1935 C.D. 11, 453 O.G. 213.

Disposition of Claims

- 4) Claim(s) 52-111 is/are pending in the application.
- 4a) Of the above claim(s) _____ is/are withdrawn from consideration.
- 5) Claim(s) _____ is/are allowed.
- 6) Claim(s) 52-111 is/are rejected.
- 7) Claim(s) _____ is/are objected to.
- 8) Claim(s) _____ are subject to restriction and/or election requirement.

Application Papers

- 9) The specification is objected to by the Examiner.
- 10) The drawing(s) filed on _____ is/are: a) accepted or b) objected to by the Examiner.
Applicant may not request that any objection to the drawing(s) be held in abeyance. See 37 CFR 1.85(a).
Replacement drawing sheet(s) including the correction is required if the drawing(s) is objected to. See 37 CFR 1.121(d).
- 11) The oath or declaration is objected to by the Examiner. Note the attached Office Action or form PTO-152.

Priority under 35 U.S.C. § 119

- 12) Acknowledgment is made of a claim for foreign priority under 35 U.S.C. § 119(a)-(d) or (f).
- a) All b) Some * c) None of:
- 1. Certified copies of the priority documents have been received.
- 2. Certified copies of the priority documents have been received in Application No. _____.
- 3. Copies of the certified copies of the priority documents have been received in this National Stage application from the International Bureau (PCT Rule 17.2(a)).

* See the attached detailed Office action for a list of the certified copies not received.

Attachment(s)

- 1) Notice of References Cited (PTO-892)
- 2) Notice of Draftsperson's Patent Drawing Review (PTO-948)
- 3) Information Disclosure Statement(s) (PTO/SB/08)
Paper No(s)/Mail Date 8/9/10, 8/20/10, 12/7/10, 1/5/11, 3/7/11.
- 4) Interview Summary (PTO-413)
Paper No(s)/Mail Date _____.
- 5) Notice of Informal Patent Application
- 6) Other: _____.

DETAILED ACTION

This action is in response to the request for continued examination dated 4 March 2011. Claims 1-51 have been canceled. Claims 52-111 are new. Claims 52-111 are pending and have been considered below.

Response to Arguments

1. Applicant's arguments with respect to independent claims 52, 58, 64, 70, 76, 85, 94, 103 have been considered but are moot in view of the new ground(s) of rejection.

Specification

2. The specification is objected to as failing to provide proper antecedent basis for the claimed subject matter. See 37 CFR 1.75(d)(1) and MPEP § 608.01(o). Correction of the following is required: Claims 58-63, 70-75, 85-93 and 103-111 cite a medium or media. The specification does not disclose a medium or media.

Claim Rejections - 35 USC § 101

3. 35 U.S.C. 101 reads as follows:

Whoever invents or discovers any new and useful process, machine, manufacture, or composition of matter, or any new and useful improvement thereof, may obtain a patent therefor, subject to the conditions and requirements of this title.

Claims 58-63, 70-75, 85-93 and 103-111 are rejected under 35 U.S.C. 101 because the claimed invention is directed to non-statutory subject matter. The claims cite a medium or media comprising machine-readable instructions. The specification of the instant invention does not cite or reference a medium or media comprising machine-readable

instructions. A medium or media could be a transmission signal or wave. A transmission signal or wave is none of process, machine, manufacture or composition of matter and, therefore is not a statutory category of invention.

Claim Rejections - 35 USC § 103

4. The following is a quotation of 35 U.S.C. 103(a) which forms the basis for all obviousness rejections set forth in this Office action:

(a) A patent may not be obtained though the invention is not identically disclosed or described as set forth in section 102 of this title, if the differences between the subject matter sought to be patented and the prior art are such that the subject matter as a whole would have been obvious at the time the invention was made to a person having ordinary skill in the art to which said subject matter pertains. Patentability shall not be negated by the manner in which the invention was made.

5. This application currently names joint inventors. In considering patentability of the claims under 35 U.S.C. 103(a), the examiner presumes that the subject matter of the various claims was commonly owned at the time any inventions covered therein were made absent any evidence to the contrary. Applicant is advised of the obligation under 37 CFR 1.56 to point out the inventor and invention dates of each claim that was not commonly owned at the time a later invention was made in order for the examiner to consider the applicability of 35 U.S.C. 103(c) and potential 35 U.S.C. 102(e), (f) or (g) prior art under 35 U.S.C. 103(a).

6. Claims 52-75, 83, 84, 92, 93, 101, 102, 110, 111 are rejected under 35 U.S.C. 103(a) as being unpatentable over Wagner (US 2004/0155908 A1) in view of Canfield et al. (US 2004/0056893 A1).

1 - 51. (Cancelled)

Claim 52. Wagner discloses a method of providing notifications of unread messages on a wireless communication device (paragraph 0003 [This invention relates generally to mobile devices, and more particularly to software and systems for user interfaces on mobile devices.]), comprising: displaying at least one icon relating to electronic messaging on a graphical user interface of the wireless communication device; receiving a plurality of electronic messages on the wireless communication device, the plurality of electronic messages including messages from a plurality of different messaging correspondents (paragraph 0064 [For example in FIG. 5A, the mobile device displays a ski service 502, a news service 504, a buddies service 506, a messaging service 508, ...], paragraph 0060 [As another example, a mail icon may display a counter that changes to indicate the number of unread messages a user has.], figure 3).

Wagner does not disclose in response to receiving at least one of the plurality of electronic messages, visually modifying at least one displayed icon relating to electronic messaging to include a numeric character representing a count of the plurality of different messaging correspondents for which one or more of the electronic messages have been received and remain unread, as disclosed in the claims. However, in the

same field of invention, Canfield discloses “ ... in another implementation, such devices [as a mobile telephone 192, a PDA 193] may themselves include the functionality of the general-purpose computer 170 and operate as the client device 120.” (paragraph 0026) and “Once the new message is viewed or acknowledged, the indicator changes and the conversation counter 650 is updated to reflect one fewer message waiting to be viewed. ... Although not shown in FIG. 6, either the conversation counter 650, the indicator, or both, may distinguish between a new message received from an ongoing IM session and new message received as part of the initiation of a new IM session.” (paragraph 0054). Therefore, considering the teachings of Wagner and Canfield, it would have been obvious to one having ordinary skill in the art at the time of the invention to add in response to receiving at least one of the plurality of electronic messages, visually modifying at least one displayed icon relating to electronic messaging to include a numeric character representing a count of the plurality of different messaging correspondents for which one or more of the electronic messages have been received and remain unread to the teachings of Wagner. One would have been motivated to add in response to receiving at least one of the plurality of electronic messages, visually modifying at least one displayed icon relating to electronic messaging to include a numeric character representing a count of the plurality of different messaging correspondents for which one or more of the electronic messages have been received and remain unread to the

teachings of Wagner in order to provide the user with comprehensive statistics regarding concurrent messaging sessions (Canfield: paragraph 0052).

Claim 53: Wagner and Canfield disclose the method of claim 52, and Wagner further discloses displaying a plurality of icons including one or more application icons that are selectable to invoke respective ones of a plurality of applications on the wireless communication device (paragraph 0056 [The context-based display 300 presents services and applications to users utilizing icons. In the example of FIG. 3, the icons are displayed in various locations on the context-based display 300 dependent on predicted usage.], figure 3).

Claim 54. Wagner and Canfield disclose the method of claim 53, and Canfield further discloses visually modifying one or more of the plurality of icons to include a count of electronic messages that have been received and remain unread, as disclosed in the claims (paragraph 0026 [... in another implementation, such devices [as a mobile telephone 192, a PDA 193] may themselves include the functionality of the general-purpose computer 170 and operate as the client device 120.]). Therefore, considering the teachings of Wagner and Canfield, it would have been obvious to one having ordinary skill in the art at the time of the invention to add visually modifying one or more of the plurality of icons to include a count of electronic messages that have been received and remain unread to the

teachings of Wagner and Canfield. One would have been motivated to add visually modifying one or more of the plurality of icons to include a count of electronic messages that have been received and remain unread to the teachings of Wagner and Canfield in order to provide the user with comprehensive statistics regarding concurrent messaging sessions (Canfield: paragraph 0052).

Claim 55. Wagner and Canfield disclose the method of claim 52, and Wagner further discloses the at least one icon relating to electronic messaging being selectable to invoke an electronic messaging application (paragraphs 0060, [To further assist the user in service and application selection, embodiments of the present invention animate particular icons to indicate additional information regarding the particular service or application that the icon represents.], 0065, [In the example of FIG. 5A the user decides to view the news by selecting the news data service 504.]).

Claim 56. Wagner and Canfield disclose the method of claim 52 and Wagner further discloses displaying on the graphical user interface an identifier of the correspondent from whom at least one of the plurality of messages was received (paragraph 0080 [Then, for example, Bob may call the user and leave a voice mail for the user. In this example, the user action proxy 612 will notice that Bob is a common theme within the services and

applications, and as such, may send the user an alert indicating something important may be occurring regarding Bob.]).

Claim 57. Wagner and Canfield disclose the method of claim 52, and Wagner further discloses displaying on the graphical user interface at least one preview of content associated with at least one of the received electronic messages (paragraph 0060 [Then, to indicate new news has arrived, the news icon may animate to display an "unrolled" newspaper.], figure 3).

Claims 58-63 disclose a medium or media comprising machine-readable instructions executable by a processor of a wireless communication device similar to the method of claims 52-57 and are rejected with the same rationale.

Claim 64-69 disclose a computer-readable memory accessible by a processor of a wireless communication device, the memory comprising stored electronic data structures representing executable instructions similar to the method of claims 52-57 and are rejected with the same rationale.

Claims 70-75 disclose a wireless communication device comprising: a processor; a display electrically coupled to the processor, the display presenting a graphical user interface; and a medium or media including machine-readable instructions executable

by the processor similar to the method claims 52-57 and are rejected with the same rational.

Claim 83. Wagner discloses the method of claim 80, but Wagner does not disclose responsive to invoking the electronic messaging application, visually modifying at least one icon relating to the electronic messaging application to include a decreased count of electronic messages which remain unread, as disclosed in the claims. However, in the same field of invention, Canfield discloses "Once the new message is viewed or acknowledged, the indicator changes and the conversation counter 650 is updated to reflect one fewer message waiting to be viewed." (paragraph 0054), and "Conversation counter 650 may be updated to show that are no new IM messages waiting to be viewed." (paragraph 0059). Therefore, considering the teachings of Wagner and Canfield, it would have been obvious to one having ordinary skill in the art at the time of the invention to add responsive to invoking the electronic messaging application, visually modifying at least one icon relating to the electronic messaging application to include a decreased count of electronic messages which remain unread to the teachings of Wagner. One would have been motivated to add responsive to invoking the electronic messaging application, visually modifying at least one icon relating to the electronic messaging application to include a decreased count of electronic messages which remain unread to the teachings of Wagner in order to keep an accurate count of

unread messages so the user is not misled about the number of unread messages after one or more messages have been read.

Claim 84. Wagner discloses the method of claim 80, but Wagner does not disclose responsive to invoking the electronic messaging application, visually modifying at least one icon relating to the electronic messaging application to remove the count of electronic messages which remain unread, as disclosed in the claims. However, in the same field of invention, Canfield discloses "Once the new message is viewed or acknowledged, the indicator changes and the conversation counter 650 is updated to reflect one fewer message waiting to be viewed." (paragraph 0054), and "Conversation counter 650 may be updated to show that are no new IM messages waiting to be viewed." (paragraph 0059). Therefore, considering the teachings of Wagner and Canfield, it would have been obvious to one having ordinary skill in the art at the time of the invention to add responsive to invoking the electronic messaging application, visually modifying at least one icon relating to the electronic messaging application to remove the count of electronic messages which remain unread to the teachings of Wagner. One would have been motivated to add responsive to invoking the electronic messaging application, visually modifying at least one icon relating to the electronic messaging application to remove the count of electronic messages which remain unread to the teachings of Wagner in order to keep an accurate count of unread messages so the

user is not misled about the number of unread messages after one or more messages have been read.

Claims 92-93 disclose a medium or media comprising machine-readable instructions executable by a processor similar to the method of claims 83-84 and are rejected with the same rationale.

Claims 101-102 disclose a computer-readable memory accessible by a processor of a wireless communication device, the memory comprising stored electronic data structures representing executable instructions which similar to the method of claims 83-84 and are rejected with the same rationale.

Claims 110-111 disclose a wireless communication device comprising: a processor; a display electrically coupled to the processor, the display presenting a graphical user interface; and a medium or media including machine-readable instructions executable by the processor similar to the method claims 83-84 and are rejected with the same rationale.

Claim Rejections - 35 USC § 102

7. The following is a quotation of the appropriate paragraphs of 35 U.S.C. 102 that form the basis for the rejections under this section made in this Office action:

A person shall be entitled to a patent unless –

Art Unit: 2172

(e) the invention was described in (1) an application for patent, published under section 122(b), by another filed in the United States before the invention by the applicant for patent or (2) a patent granted on an application for patent by another filed in the United States before the invention by the applicant for patent, except that an international application filed under the treaty defined in section 351(a) shall have the effects for purposes of this subsection of an application filed in the United States only if the international application designated the United States and was published under Article 21(2) of such treaty in the English language.

8. Claims 76-82, 85-91, 94-100, 103-109 are rejected under 35 U.S.C. 102(e) as being anticipated by Wagner (US 2004/0155908 A1).

Claim 76. Wagner discloses a method of providing notifications of unread messages on a wireless communication device (paragraph 0003 [This invention relates generally to mobile devices, and more particularly to software and systems for user interfaces on mobile devices.]), comprising:

- a. displaying at least one icon relating to an electronic messaging application on a graphical user interface of the wireless communication device; receiving on the wireless communication device a plurality of electronic messages associated with the electronic messaging application; and responsive to receiving at least one of the plurality of electronic messages: visually modifying at least one icon relating to the electronic messaging application to include a count of the plurality of electronic messages which remain unread (paragraph 0064 [For example in FIG. 5A, the mobile device displays a ski service 502, a news service 504, a buddies service 506, a messaging service 508, ...], paragraph 0060 [As another example, a mail icon may display a counter that changes to indicate the number of unread messages a user has.], figure 3); and

- b. displaying on the graphical user interface a text identifier associated with a correspondent from whom the at least one of the plurality of electronic messages was received (paragraph 0059 [Further, the text comprising each informational icon label 310 can be automatically updated as the state of that particular service changes as it applies to the particular user.], paragraph 0080 [Then, for example, Bob may call the user and leave a voice mail for the user. In this example, the user action proxy 612 will notice that Bob is a common theme within the services and applications, and as such, may send the user an alert indicating something important may be occurring regarding Bob.]).

Claim 77. Wagner discloses the method of claim 76, and Wagner further discloses the identifier associated with a correspondent from whom the at least one of the plurality of electronic messages was received comprising state information pertaining to the correspondent (paragraph 0059 [Further, the text comprising each informational icon label 310 can be automatically updated as the state of that particular service changes as it applies to the particular user.]).

Claim 78. Wagner discloses the method of claim 76, and Wagner further discloses displaying on the graphical user interface at least a preview of content associated with at least one of the received electronic messages (paragraph 0060 [Then, to indicate new news has arrived, the news icon may animate to display an "unrolled" newspaper.], figure 3).

Claim 79. Wagner discloses the method of claim 76, and Wagner further discloses displaying on the graphical user interface for a predetermined period of time at least a preview of content associated with at least one of the received electronic messages (paragraph 0060 [Then, to indicate new news has arrived, the news icon may animate to display an "unrolled" newspaper.], figure 3).

Claim 80. Wagner discloses the method of claim 76, and Wagner further discloses the at least one icon relating to electronic messaging being selectable to invoke an electronic messaging application (paragraphs 0060, [To further assist the user in service and application selection, embodiments of the present invention animate particular icons to indicate additional information regarding the particular service or application that the icon represents.], 0065, [In the example of FIG. 5A the user decides to view the news by selecting the news data service 504.]).

Claim 81. Wagner discloses the method of claim 80, and Wagner further discloses, responsive to invoking the electronic messaging application, navigating automatically to a graphical user interface comprising content associated with at least one of the received electronic messages (paragraphs 0060, [To further assist the user in service and application selection, embodiments of the present invention animate particular icons to indicate additional information regarding the particular service or application that the icon represents.], 0065, [In the example of FIG. 5A the user decides to view the news by selecting the news data service 504.]).

Claim 82. Wagner discloses the method of claim 80, and Wagner further discloses responsive to invoking the electronic messaging application within a predetermined time following receipt of at least one of the received electronic messages, navigating automatically to a graphical user interface comprising content associated with the at least one of the received electronic messages (paragraphs 0060, [To further assist the user in service and application selection, embodiments of the present invention animate particular icons to indicate additional information regarding the particular service or application that the icon represents.], 0065, [In the example of FIG. 5A the user decides to view the news by selecting the news data service 504.])..

Claims 85-91 disclose a medium or media comprising machine-readable instructions executable by a processor similar to the method of claims 76-82 and are rejected with the same rational.

Claims 94-100 disclose a computer-readable memory accessible by a processor of a wireless communication device, the memory comprising stored electronic data structures representing executable instructions which similar to the method of claims 76- 82 and are rejected with the same rational.

Claims 103-109 disclose a wireless communication device comprising: a processor; a display electrically coupled to the processor, the display presenting a graphical user interface; and a medium or media including machine-readable instructions executable by the processor similar to the method claims 76-82 and are rejected with the same rational.

Conclusion

Any inquiry concerning this communication or earlier communications from the examiner should be directed to JOHN HEFFINGTON whose telephone number is (571)270-1696. The examiner can normally be reached on 8:30 am to 5:30 pm.

If attempts to reach the examiner by telephone are unsuccessful, the examiner's supervisor, Boris M. Pesin can be reached on 571-272-4070. The fax phone number for the organization where this application or proceeding is assigned is 571-273-8300.

Information regarding the status of an application may be obtained from the Patent Application Information Retrieval (PAIR) system. Status information for published applications may be obtained from either Private PAIR or Public PAIR. Status information for unpublished applications is available through Private PAIR only. For more information about the PAIR system, see <http://pair-direct.uspto.gov>. Should you have questions on access to the Private PAIR system, contact the Electronic Business Center (EBC) at 866-217-9197 (toll-free). If you would like assistance from a USPTO Customer Service Representative or access to the automated information system, call 800-786-9199 (IN USA OR CANADA) or 571-272-1000.

/Boris Pesin/
Supervisory Patent Examiner, Art
Unit 2172

JMH
5/8/11

Notice of References Cited	Application/Control No. 10/784,781	Applicant(s)/Patent Under Reexamination KLASSEN ET AL.	
	Examiner JOHN HEFFINGTON	Art Unit 2172	Page 1 of 1

U.S. PATENT DOCUMENTS

*	Document Number Country Code-Number-Kind Code	Date MM-YYYY	Name	Classification	
*	A	US-6,169,911 B1	01-2001	Wagner et al.	455/566
*	B	US-6,519,629 B2	02-2003	Harvey et al.	709/204
*	C	US-6,691,159 B1	02-2004	Grewal et al.	709/219
*	D	US-2004/0056893 A1	03-2004	Canfield et al.	345/753
*	E	US-2004/0155908 A1	08-2004	Wagner, Annette M.	345/854
*	F	US-2004/0172456 A1	09-2004	Green et al.	709/207
*	G	US-2004/0172455 A1	09-2004	Green et al.	709/207
*	H	US-2004/0225901 A1	11-2004	Bear et al.	713/300
*	I	US-2005/0117733 A1	06-2005	Widger et al.	379/221.05
*	J	US-2005/0165880 A1	07-2005	Moody et al.	709/200
*	K	US-7,127,685 B2	10-2006	Canfield et al.	715/842
	L	US-			
	M	US-			

FOREIGN PATENT DOCUMENTS

*	Document Number Country Code-Number-Kind Code	Date MM-YYYY	Country	Name	Classification
	N				
	O				
	P				
	Q				
	R				
	S				
	T				

NON-PATENT DOCUMENTS

*	Document Number Country Code-Number-Kind Code	Date MM-YYYY	Country	Name	Classification
	Include as applicable: Author, Title Date, Publisher, Edition or Volume, Pertinent Pages)				
	U				
	V				
	W				
	X				

*A copy of this reference is not being furnished with this Office action. (See MPEP § 707.05(a).)
Dates in MM-YYYY format are publication dates. Classifications may be US or foreign.

EAST Search History

EAST Search History (Prior Art)

Ref #	Hits	Search Query	DBs	Default Operator	Plurals	Time Stamp
L1	25	("20020160817" "20050120306" "20060020904" "20060030295" "5333256" "5617526" "5634102" "6385459" "6424354" "662819").PN. or ("20030167310").PN.	US-PGPUB; USPAT; FPRS; EPO; JPO; DERWENT; IBM_TDB	ADJ	ON	2011/05/08 20:39
L2	198	715/842.ccls. or 715/851.ccls.	US-PGPUB; USPAT; FPRS; EPO; JPO; DERWENT; IBM_TDB	ADJ	ON	2011/05/08 20:52
S1	8	("20020160817" "20050248437").PN. or ("20020035613" "20040155908").PN.	US-PGPUB; USPAT; FPRS; EPO; JPO; DERWENT; IBM_TDB	ADJ	ON	2010/03/27 17:51
S2	8	("20020160817" "20050248437").PN. or ("20020035613" "20040155908").PN.	US-PGPUB; USPAT; FPRS; EPO; JPO; DERWENT; IBM_TDB	ADJ	ON	2010/08/25 09:57
S3	1	10/784781.app.	US-PGPUB; USPAT; FPRS; EPO; JPO; DERWENT; IBM_TDB	ADJ	ON	2010/08/25 10:09
S4	2353	((unread or (un read) or ("not" viewed) or unopened or (un opened)) near2 (message or text or im or email or (e mail) or chat))	US-PGPUB; USPAT; FPRS; EPO; JPO; DERWENT; IBM_TDB	ADJ	ON	2010/08/25 10:22
S5	1491	((unread or (un read) or ("not" viewed) or unopened or (un opened)) near2 (message or text or im or email or (e mail) or chat)) same (((number or count) near2 users) or users)	US-PGPUB; USPAT; FPRS; EPO; JPO; DERWENT; IBM_TDB	ADJ	ON	2010/08/25 10:23

S6	305	((unread or (un read) or ("not" viewed) or unopened or (un opened)) near2 (message or text or im or email or (e mail) or chat) same (((number or count) near2 users) or users) with (icon or symbol or graphic\$2 or widget or image or token or picture or thumbnail))	US-PGPUB; USPAT; FPRS; EPO; JPO; DERWENT; IBM_TDB	ADJ	ON	2010/08/25 10:28
S7	260	((unread or (un read) or ("not" viewed) or unopened or (un opened)) near2 (message or text or im or email or (e mail) or chat) same (((number or count) near2 users) or users) with (icon or symbol or graphic\$2 or widget or image or token or picture or thumbnail))) and wireless	US-PGPUB; USPAT; FPRS; EPO; JPO; DERWENT; IBM_TDB	ADJ	ON	2010/08/25 10:30
S8	252	((unread or (un read) or ("not" viewed) or unopened or (un opened)) near2 (message or text or im or email or (e mail) or chat) same (((number or count) near2 users) or users) with (icon or symbol or graphic\$2 or widget or image or token or picture or thumbnail))) and wireless not (research near2 "in" near2 motion).as.	US-PGPUB; USPAT; FPRS; EPO; JPO; DERWENT; IBM_TDB	ADJ	ON	2010/08/25 10:37
S9	3	((unread or (un read) or ("not" viewed) or unopened or (un opened)) near2 (message or text or im or email or (e mail) or chat) same (((number or count) near2 users) with (icon or symbol or graphic \$2 or widget or image or token or picture or thumbnail))) and wireless not (research near2 "in" near2 motion).as.	US-PGPUB; USPAT; FPRS; EPO; JPO; DERWENT; IBM_TDB	ADJ	ON	2010/08/25 10:49

S10	252	((unread or (un read) or ("not" viewed) or unopened or (un opened)) near2 (message or text or im or email or (e mail) or chat) same (((number or count) near2 (users near2 (sent or received))) or users) with (icon or symbol or graphic\$2 or widget or image or token or picture or thumbnail)) and wireless not (research near2 "in" near2 motion). as.	US-PGPUB; USPAT; FPRS; EPO; JPO; DERWENT; IBM_TDB	ADJ	ON	2010/08/25 10:56
S11	8	((unread or (un read) or ("not" viewed) or unopened or (un opened)) near2 (message or text or im or email or (e mail) or chat) same (((number or count) near2 (users near2 (sent or received))) or (users near2 (sent or received))) with (icon or symbol or graphic\$2 or widget or image or token or picture or thumbnail)) and wireless not (research near2 "in" near2 motion). as.	US-PGPUB; USPAT; FPRS; EPO; JPO; DERWENT; IBM_TDB	ADJ	ON	2010/08/25 10:57
S12	111	(US-20100211917-\$ or US-20100207871-\$ or US-20100203872-\$ or US-20100192081-\$ or US-20100185980-\$ or US-20100184453-\$ or US-20100179991-\$ or US-20100171712-\$ or US-20100156816-\$ or US-20100131191-\$ or US-20100125811-\$ or US-20100125785-\$ or US-20100123724-\$ or US-20100115559-\$ or US-20100100964-\$ or US-20100082759-\$ or US-20100079405-\$ or US-20100064016-\$ or US-20100057743-\$ or US-20100041331-\$ or US-20100030860-\$ or US-20100030549-\$ or US-20100011304-\$ or US-20100004028-\$ or US-20090327976-\$ or US-20090327168-\$).did. or	US-PGPUB	ADJ	ON	2010/08/25 11:04

(US-20090322688-\$ or US-
20090307322-\$ or US-
20090305732-\$ or US-
20090303231-\$ or US-
20090235184-\$ or US-
20090235175-\$ or US-
20090228825-\$ or US-
20090228807-\$ or US-
20090228792-\$ or US-
20090216634-\$ or US-
20090191926-\$ or US-
20090191848-\$ or US-
20090178008-\$ or US-
20090178007-\$ or US-
20090177981-\$ or US-
20090174680-\$ or US-
20090164923-\$ or US-
20090163190-\$ or US-
20090138828-\$ or US-
20090138823-\$ or US-
20090119678-\$ or US-
20090106036-\$ or US-
20090100027-\$ or US-
20090094518-\$ or US-
20090093273-\$ or US-
20090082043-\$ or US-
20090077488-\$).did. or
(US-20090073194-\$ or US-
20090070705-\$ or US-
20090070704-\$ or US-
20090066728-\$ or US-
20090061827-\$ or US-
20090058830-\$ or US-
20090044200-\$ or US-
20090030998-\$ or US-
20090017806-\$ or US-
20090013275-\$ or US-
20090007017-\$ or US-
20090006644-\$ or US-
20090006570-\$ or US-
20090005011-\$ or US-
20080320419-\$ or US-
20080320391-\$ or US-
20080307220-\$ or US-
20080295017-\$ or US-
20080293385-\$ or US-
20080222545-\$ or US-
20080220752-\$ or US-
20080218535-\$ or US-
20080216022-\$ or US-
20080215687-\$ or US-
20080211778-\$ or US-
20080208992-\$ or US-
20080201650-\$).did. or
(US-20080180408-\$ or US-
20080174570-\$ or US-
20080172357-\$ or US-
20080168405-\$ or US-

		20080168404-\$ or US-20080168396-\$ or US-20080168395-\$ or US-20080168379-\$ or US-20080168365-\$ or US-20080168361-\$ or US-20080168353-\$ or US-20080168349-\$ or US-20080167078-\$ or US-20080165160-\$ or US-20080165153-\$ or US-20080165152-\$ or US-20080165151-\$ or US-20080165149-\$ or US-20080165148-\$ or US-20080165147-\$ or US-20080165146-\$ or US-20080165145-\$ or US-20080165144-\$ or US-20080165143-\$ or US-20080165142-\$ or US-20080165136-\$ or US-20080165022-\$).did. or (US-20080162651-\$ or US-20080129816-\$ or US-20080122796-\$ or US-20080119274-\$).did.				
S13	191	(((unread or (un read) or ("not" viewed) or unopened or (un opened)) near2 (message or text or im or email or (e mail) or chat)) with (((number or count) near2 (users)) or users) with (icon or symbol or graphic\$2 or widget or image or token or picture or thumbnail))) and wireless not (research near2 "in" near2 motion). as.	US-PGPUB; USPAT; FPRS; EPO; JPO; DERWENT; IBM_TDB	ADJ	ON	2010/08/25 11:05
S14	105	(((unread or (un read) or ("not" viewed) or unopened or (un opened)) near2 (message or text or im or email or (e mail) or chat)) with (((number or count) near2 (users)) or users) with (icon or symbol or graphic\$2 or widget or image or token or picture or thumbnail))) and wireless not (research near2 "in" near2 motion). as. not S12	US-PGPUB; USPAT; FPRS; EPO; JPO; DERWENT; IBM_TDB	ADJ	ON	2010/08/25 11:05

S15	0	(11/599507).APP.	USPAT; USOCR	ADJ	ON	2010/08/25 11:16
S16	8	("20010055038" "20020091774" "20020094806" "20020126146" "20030032414" "5533110" "5579472" "5742779" "5907604" "6020828" "6333973" "6430405" "6771974"). PN.	USPAT; USOCR	ADJ	ON	2010/08/25 11:17
S17	416	(hover\$3 or over or select \$3) near2 (message (icon or symbol or graphic\$2 or widget or image or token or picture or thumbnail))	US-PGPUB; USPAT; FPRS; EPO; JPO; DERWENT; IBM_TDB	ADJ	ON	2010/08/25 14:54
S18	2	((hover\$3 or over or select \$3) near2 (message (icon or symbol or graphic\$2 or widget or image or token or picture or thumbnail))) with (preview or snapshot or (snap shot) or summar \$3)	US-PGPUB; USPAT; FPRS; EPO; JPO; DERWENT; IBM_TDB	ADJ	ON	2010/08/25 14:55
S19	20	((hover\$3 or over or select \$3) with (message (icon or symbol or graphic\$2 or widget or image or token or picture or thumbnail))) with (preview or snapshot or (snap shot) or summar \$3)	US-PGPUB; USPAT; FPRS; EPO; JPO; DERWENT; IBM_TDB	ADJ	ON	2010/08/25 14:56
S20	16	("20020094806" "20020126146" "20030032414" "5907604").PN. or ("20020094806" "20020126146" "20030032414" "5907604").PN. or ("20020094806" "20020126146" "5907604" "6430405"). PN. or ("20020091774" "20020094806" "20020126146" "5907604" "6333973" "6771974").PN.	US-PGPUB; USPAT; FPRS; EPO; JPO; DERWENT; IBM_TDB	ADJ	ON	2010/10/22 09:50
S21	0	(10/533245).APP.	USPAT; USOCR	ADJ	ON	2010/11/12 12:09
S22	1	("2006/0084450").URPN.	USPAT	ADJ	ON	2010/11/12 12:09

S23	4	("5533110" "5579472" "5742779" "6020828").PN. or ("5579472").PN. or ("20010055038").PN.	USPAT	ADJ	ON	2010/11/12 12:11
S24	8384	((number or digit or character or (alpha numeric)) near2 (sender or buddy or friend or contact)) same (message or email or text or im (instant message) or (voice (message or mail)))	US-PGPUB; USPAT; FPRS; EPO; JPO; DERWENT; IBM_TDB	ADJ	ON	2011/04/26 11:35
S25	306	((number or digit or character or (alpha numeric)) near2 ((sender or buddy or friend or contact)) near2 (unique or individual or different or separate or distinct)) same (message or email or text or im (instant message) or (voice (message or mail)))	US-PGPUB; USPAT; FPRS; EPO; JPO; DERWENT; IBM_TDB	ADJ	ON	2011/04/26 11:39
S26	6	("2005/0120306").URPN.	USPAT	ADJ	ON	2011/04/26 14:07
S27	85	(tear off) element	US-PGPUB; USPAT; FPRS; EPO; JPO; DERWENT; IBM_TDB	ADJ	ON	2011/04/26 14:20
S28	10	("2004/0056893").URPN.	USPAT	ADJ	ON	2011/04/26 14:49
S29	45	("6377944" "5416895" "6002398" "6057844" "6078935" "6144375" "6233726" "5721852" "20030164862" "6281879" "6407757" "6434599" "5546528" "5877765" "5937417" "6304879" "6781608" "20030052915" "20030142141" "5546528" "5929851" "5884306" "5974413" "5990905" "6018571" "6092068" "6275790" "6981223" "6384849" "5877758" "6091409" "6237135" "6173316" "6369837" "4995101" "6246411" "20020073207" "20020130904" "6381735" "6229539" "5754176" "6147685"	USPAT	ADJ	ON	2011/04/26 14:58

		"6691159" "20020097277" "6784901" "20020101446" "6002400" "6346952" "6252594" "6362842" "6519629" "20030210265" "6907447" "5617526"). PN.				
S30	0	"20050165880".pn.	USPAT	ADJ	ON	2011/04/27 10:05
S31	0	"2005/0165880".pn.	USPAT	ADJ	ON	2011/04/27 10:05
S32	2	"20050165880".pn.	US-PGPUB; USPAT; FPRS; EPO; JPO; DERWENT; IBM_TDB	ADJ	ON	2011/04/27 10:06
S33	1	(10/284429).APP.	USPAT; USOCR	ADJ	ON	2011/04/27 10:07
S34	2	"20040056893".pn.	US-PGPUB; USPAT; FPRS; EPO; JPO; DERWENT; IBM_TDB	ADJ	ON	2011/04/28 11:00
S35	1	"20040056893".pn. and (messag\$3 with receiv\$3)	US-PGPUB; USPAT; FPRS; EPO; JPO; DERWENT; IBM_TDB	ADJ	ON	2011/04/28 11:00
S36	1	(10/284429).APP.	USPAT; USOCR	ADJ	ON	2011/04/28 16:04
S37	744716	((mobile or portable or cell or smart) (device or phone or telephone))	US-PGPUB; USPAT; FPRS; EPO; JPO; DERWENT; IBM_TDB	ADJ	ON	2011/04/29 15:43
S38	167950	((mobile or portable or cell or smart) (device or phone or telephone)) same (display or screen)	US-PGPUB; USPAT; FPRS; EPO; JPO; DERWENT; IBM_TDB	ADJ	ON	2011/04/29 15:43
S39	548	((mobile or portable or cell or smart) (device or phone or telephone)) same (display or screen) same ((icon or symbol) near2 (application or program or function))	US-PGPUB; USPAT; FPRS; EPO; JPO; DERWENT; IBM_TDB	ADJ	ON	2011/04/29 16:03

S40	365	((mobile or portable or cell or smart) (device or phone or telephone)) same ((display or screen) with ((icon or symbol) near2 (application or program or function)))	US-PGPUB; USPAT; FPRS; EPO; JPO; DERWENT; IBM_TDB	ADJ	ON	2011/04/29 16:04
S41	1	((mobile or portable or cell or smart) (device or phone or telephone)) same ((display or screen) with ((icon or symbol) near2 (application or program or function))) same count	US-PGPUB; USPAT; FPRS; EPO; JPO; DERWENT; IBM_TDB	ADJ	ON	2011/04/29 16:05
S42	14	((mobile or portable or cell or smart) (device or phone or telephone)) same ((display or screen) with ((icon or symbol) near2 (application or program or function)))) and ((count or number) near2 new near2 (message or email or (e mail) or (electronic mail)))	US-PGPUB; USPAT; FPRS; EPO; JPO; DERWENT; IBM_TDB	ADJ	ON	2011/04/29 16:07
S43	1	((mobile or portable or cell or smart) (device or phone or telephone)) same (((icon or symbol) near2 (application or program or function)))) and ((count or number) near2 new near2 (message or email or (e mail) or (electronic mail))) not S42	US-PGPUB; USPAT; FPRS; EPO; JPO; DERWENT; IBM_TDB	ADJ	ON	2011/04/29 16:18
S44	535	((mobile or portable or cell or smart) (device or phone or telephone))) and ((count or number) near2 new near2 (message or email or (e mail) or (electronic mail))) not S42	US-PGPUB; USPAT; FPRS; EPO; JPO; DERWENT; IBM_TDB	ADJ	ON	2011/04/29 16:19
S45	23	((mobile or portable or cell or smart) (device or phone or telephone)) and ((display or screen) with ((icon or symbol) near2 (application or program or function)))) and ((count or number) near2 new near2 (message or email or (e mail) or (electronic mail))) not S42	US-PGPUB; USPAT; FPRS; EPO; JPO; DERWENT; IBM_TDB	ADJ	ON	2011/04/29 16:20

S46	23	((mobile or portable or cell or smart or wireless) (device or phone or telephone)) and ((display or screen) with ((icon or symbol) near2 (application or program or function)))) and ((count or number) near2 new near2 (message or email or (e mail) or (electronic mail))) not S42	US-PGPUB; USPAT; FPRS; EPO; JPO; DERWENT; IBM_TDB	ADJ	ON	2011/04/29 16:22
S51	14	((mobile or portable or cell or smart) (device or phone or telephone)) same ((display or screen) with ((icon or symbol) near2 (application or program or function)))) and ((count or number) near2 new near2 (message or email or (e mail) or (electronic mail)))	US-PGPUB; USPAT; FPRS; EPO; JPO; DERWENT; IBM_TDB	ADJ	ON	2011/05/03 14:07
S52	23	((mobile or portable or cell or smart or wireless) (device or phone or telephone)) and ((display or screen) with ((icon or symbol) near2 (application or program or function)))) and ((count or number) near2 new near2 (message or email or (e mail) or (electronic mail))) not S51	US-PGPUB; USPAT; FPRS; EPO; JPO; DERWENT; IBM_TDB	ADJ	ON	2011/05/03 14:07
S53	276	((mobile or portable or cell or smart or wireless) (device or phone or telephone)) and ((display or screen) with ((icon or symbol) with (application or program or function)))) and ((count or number) with new with (message or email or (e mail) or (electronic mail))) not S51 not S52	US-PGPUB; USPAT; FPRS; EPO; JPO; DERWENT; IBM_TDB	ADJ	ON	2011/05/03 14:07
S54	6	("2005/0120306").URPN.	USPAT	ADJ	ON	2011/05/03 15:47
S55	0	(10/911225).APP.	USPAT; USOCR	ADJ	ON	2011/05/03 15:54
S56	0	"20050117733".pn.	USPAT; USOCR	ADJ	ON	2011/05/03 16:14
S57	1	"20050117733".pn. and (application with icon)	US-PGPUB; USPAT; USOCR; EPO; JPO; DERWENT; IBM_TDB	ADJ	ON	2011/05/03 16:14

S58	1	"20050117733".pn. and (application with gui)	US-PGPUB; USPAT; USOCR; EPO; JPO; DERWENT; IBM_TDB	ADJ	ON	2011/05/03 16:15
S59	1	"20050117733".pn. and (icon)	US-PGPUB; USPAT; USOCR; EPO; JPO; DERWENT; IBM_TDB	ADJ	ON	2011/05/03 16:16
S60	2	"20050117733".pn. and (application)	US-PGPUB; USPAT; USOCR; EPO; JPO; DERWENT; IBM_TDB	ADJ	ON	2011/05/03 16:19
S61	28	("5610970" "5668862" "5673299" "5742905" "5742905" "5752191" "5812653" "5812653" "5841837" "5999611" "5999611" "6185565" "6185565" "6425005" "6425005" "6456619" "6456619" "6463146" "6463146" "6529502" "6529502" "6570969" "6570969" "6678265" "6678265").PN.	US-PGPUB; USPAT; FPRS; EPO; JPO; DERWENT; IBM_TDB	ADJ	ON	2011/05/03 17:07
S62	2	"20050117733".pn. and (contact with receiv\$3)	US-PGPUB; USPAT; FPRS; EPO; JPO; DERWENT; IBM_TDB	ADJ	ON	2011/05/04 11:05
S63	1	"20050117733".pn. and (contact with (sent or send \$3))	US-PGPUB; USPAT; FPRS; EPO; JPO; DERWENT; IBM_TDB	ADJ	ON	2011/05/04 11:07
S64	1	"20050117733".pn. and (contact with messag\$3)	US-PGPUB; USPAT; FPRS; EPO; JPO; DERWENT; IBM_TDB	ADJ	ON	2011/05/04 11:07
S65	0	(10/911225).APP.	USPAT; USOCR	ADJ	ON	2011/05/04 11:09
S66	303	display\$3 message received	USPAT; USOCR	ADJ	ON	2011/05/04 16:54
S67	3	(display\$3 message received) near3 (sender or buddy or contact)	USPAT; USOCR	ADJ	ON	2011/05/04 16:55
S68	0	(display\$3 message received) near3 (name)	USPAT; USOCR	ADJ	ON	2011/05/04 16:55

S69	768	(message received) near3 (sender or buddy or contact)	USPAT; USOCR	ADJ	ON	2011/05/04 16:57
S70	7	(message received) near3 (name near2 (sender or buddy or contact))	USPAT; USOCR	ADJ	ON	2011/05/04 16:58
S71	476	(message) near3 (name near2 (sender or buddy or contact))	USPAT; USOCR	ADJ	ON	2011/05/04 16:59
S72	5	((message) near3 (name near2 (sender or buddy or contact))) near2 icon	USPAT; USOCR	ADJ	ON	2011/05/04 16:59
S73	0	((mobile or portable or cell) (device or terminal or phone or telephone)) and (((email or (e mail) or (electronic mail)) near2 icon) with ((preview or snapshot or (snap shot)) near2 content)) and (((message or im) near2 icon) with ((preview or snapshot or (snap shot)) near2 content))	US-PGPUB; USPAT; FPRS; EPO; JPO; DERWENT; IBM_TDB	ADJ	ON	2011/05/06 11:18
S74	1	((mobile or portable or cell) (device or terminal or phone or telephone)) and (((email or (e mail) or (electronic mail)) near2 icon) with ((preview or snapshot or (snap shot)) near2 content)) or (((message or im) near2 icon) with ((preview or snapshot or (snap shot)) near2 content))	US-PGPUB; USPAT; FPRS; EPO; JPO; DERWENT; IBM_TDB	ADJ	ON	2011/05/06 11:19
S75	1	(((email or (e mail) or (electronic mail)) near2 icon) with ((preview or snapshot or (snap shot)) near2 content)) or (((message or im) near2 icon) with ((preview or snapshot or (snap shot)) near2 content))	US-PGPUB; USPAT; FPRS; EPO; JPO; DERWENT; IBM_TDB	ADJ	ON	2011/05/06 11:21
S76	11	((email or (e mail) or (electronic mail)) near2 icon) and (((email or (e mail) or (electronic mail))) with ((preview or snapshot or (snap shot)) near2 content)) or (((message or im)) with ((preview or snapshot or (snap shot)) near2 content))	US-PGPUB; USPAT; FPRS; EPO; JPO; DERWENT; IBM_TDB	ADJ	ON	2011/05/06 11:27

S77	112	((email or (e mail) or (electronic mail)) near2 icon) and (((email or (e mail) or (electronic mail))) with ((preview or snapshot or (snap shot)))) or (((message or im)) with ((preview or snapshot or (snap shot))))))	US-PGPUB; USPAT; FPRS; EPO; JPO; DERWENT; IBM_TDB	ADJ	ON	2011/05/06 11:30
S78	3909	(((email or (e mail) or (electronic mail))) with ((preview or snapshot or (snap shot)))) or (((message or im)) with ((preview or snapshot or (snap shot)))))) not S77	US-PGPUB; USPAT; FPRS; EPO; JPO; DERWENT; IBM_TDB	ADJ	ON	2011/05/06 11:45
S79	462	(((email or (e mail) or (electronic mail))) with ((preview or snapshot or (snap shot)))) and (((message or im)) with ((preview or snapshot or (snap shot)))))) not S77	US-PGPUB; USPAT; FPRS; EPO; JPO; DERWENT; IBM_TDB	ADJ	ON	2011/05/06 11:47
S80	153	(((email or (e mail) or (electronic mail))) with ((preview or snapshot or (snap shot)))) and (((message or im)) with ((preview or snapshot or (snap shot)))))) not S77 and ((mobile or portable or cell) (device or terminal or phone or telephone))	US-PGPUB; USPAT; FPRS; EPO; JPO; DERWENT; IBM_TDB	ADJ	ON	2011/05/06 11:48
S81	153	(((email or (e mail) or (electronic mail))) with ((preview or snapshot or (snap shot)))) and (((message or im)) with ((preview or snapshot or (snap shot)))))) not S77 and ((mobile or portable or cell) (device or terminal or phone or telephone))	US-PGPUB; USPAT; FPRS; EPO; JPO; DERWENT; IBM_TDB	ADJ	ON	2011/05/06 11:54
S82	153	(((email or (e mail) or (electronic mail))) with ((preview or snapshot or (snap shot)))) and (((message or im)) with ((preview or snapshot or (snap shot)))))) and ((mobile or portable or cell) (device or terminal or phone or telephone)) not S77	US-PGPUB; USPAT; FPRS; EPO; JPO; DERWENT; IBM_TDB	ADJ	ON	2011/05/06 11:56

S83	112	((email or (e mail) or (electronic mail)) near2 icon) and (((email or (e mail) or (electronic mail))) with ((preview or snapshot or (snap shot)))) or (((message or im)) with ((preview or snapshot or (snap shot))))	US-PGPUB; USPAT; FPRS; EPO; JPO; DERWENT; IBM_TDB	ADJ	ON	2011/05/06 13:21
S84	153	(((email or (e mail) or (electronic mail))) with ((preview or snapshot or (snap shot))) and (((message or im)) with ((preview or snapshot or (snap shot)))) and ((mobile or portable or cell) (device or terminal or phone or telephone)) not S83	US-PGPUB; USPAT; FPRS; EPO; JPO; DERWENT; IBM_TDB	ADJ	ON	2011/05/06 13:21
S85	224	((email or (e mail) or (electronic mail)) with (preview or snapshot or (snap shot)) and ((mobile or portable or cell) (device or terminal or phone or telephone)) not S83 not S84	US-PGPUB; USPAT; FPRS; EPO; JPO; DERWENT; IBM_TDB	ADJ	ON	2011/05/06 13:21
S86	3	((email or (e mail) or (electronic mail)) with (preview or snapshot or (snap shot)) with icon) and ((mobile or portable or cell) (device or terminal or phone or telephone)) not S83 not S84	US-PGPUB; USPAT; FPRS; EPO; JPO; DERWENT; IBM_TDB	ADJ	ON	2011/05/06 13:22
S87	76	((email or (e mail) or (electronic mail)) with (preview or snapshot or (snap shot)) with icon)	US-PGPUB; USPAT; FPRS; EPO; JPO; DERWENT; IBM_TDB	ADJ	ON	2011/05/06 13:24
S88	27	receiv\$3 near2 message near2 display\$3 (preview or snapshot or (snap shot))	US-PGPUB; USPAT; FPRS; EPO; JPO; DERWENT; IBM_TDB	ADJ	ON	2011/05/06 13:32
S89	4534	message near2 icon	US-PGPUB; USPAT; FPRS; EPO; JPO; DERWENT; IBM_TDB	ADJ	ON	2011/05/06 13:34

S90	6	(message near2 icon) near2 preview	US-PGPUB; USPAT; FPRS; EPO; JPO; DERWENT; IBM_TDB	ADJ	ON	2011/05/06 13:34
S91	6	(message near2 icon) near2 (preview or snapshot or (snap shot))	US-PGPUB; USPAT; FPRS; EPO; JPO; DERWENT; IBM_TDB	ADJ	ON	2011/05/06 13:35
S92	4	("20020035613" "20040155908").PN.	US-PGPUB; USPAT; FPRS; EPO; JPO; DERWENT; IBM_TDB	ADJ	ON	2011/05/06 13:55
S93	306	receiv\$3 near2 message near2 ((name or id or identifier) near2 (buddy or sender or friend))	US-PGPUB; USPAT; FPRS; EPO; JPO; DERWENT; IBM_TDB	ADJ	ON	2011/05/06 14:23
S94	430	receiv\$3 near2 (message or email or (e mail) or (electronic mail) or im or chat) near2 ((name or id or identifier) near2 (buddy or sender or friend))	US-PGPUB; USPAT; FPRS; EPO; JPO; DERWENT; IBM_TDB	ADJ	ON	2011/05/06 14:24
S95	163	(receiv\$3 near2 (message or email or (e mail) or (electronic mail) or im or chat) near2 ((name or id or identifier) near2 (buddy or sender or friend))) and ((portable or mobile or cell) (phone or telephone or device or terminal or apparatus))	US-PGPUB; USPAT; FPRS; EPO; JPO; DERWENT; IBM_TDB	ADJ	ON	2011/05/06 14:26
S96	512	((receiv\$3 near2 (message or email or (e mail) or (electronic mail) or im or chat)) with (((name or id or identifier) near2 (buddy or sender or friend)))) and ((portable or mobile or cell) (phone or telephone or device or terminal or apparatus))	US-PGPUB; USPAT; FPRS; EPO; JPO; DERWENT; IBM_TDB	ADJ	ON	2011/05/07 16:14

S97	163	((receiv\$3 near2 (message or email or (e mail) or (electronic mail) or im or chat) near2 ((name or id or identifier) near2 (buddy or sender or friend))) and ((portable or mobile or cell) (phone or telephone or device or terminal or apparatus))	US-PGPUB; USPAT; FPRS; EPO; JPO; DERWENT; IBM_TDB	ADJ	ON	2011/05/07 16:14
S98	349	((receiv\$3 near2 (message or email or (e mail) or (electronic mail) or im or chat) with (((name or id or identifier) near2 (buddy or sender or friend)))) and ((portable or mobile or cell) (phone or telephone or device or terminal or apparatus)) not S97	US-PGPUB; USPAT; FPRS; EPO; JPO; DERWENT; IBM_TDB	ADJ	ON	2011/05/07 16:14
S99	328	((receiv\$3 near2 (message or email or (e mail) or (electronic mail) or im or chat) with (((name or id or identifier) near2 (buddy or sender or friend)))) and ((portable or mobile or cell) (phone or telephone or device or terminal or apparatus)) and (count or number) not S97	US-PGPUB; USPAT; FPRS; EPO; JPO; DERWENT; IBM_TDB	ADJ	ON	2011/05/07 16:16
S100	215	((receiv\$3 near2 (message or email or (e mail) or (electronic mail) or im or chat) with (((name or id or identifier) near2 (buddy or sender or friend)))) and ((portable or mobile or cell) (phone or telephone or device or terminal or apparatus)) and ((count or number) near2 (message or email or (e mail) or (electronic mail) or im or chat)) not S97	US-PGPUB; USPAT; FPRS; EPO; JPO; DERWENT; IBM_TDB	ADJ	ON	2011/05/07 16:17
S101	1	10/715205.app.	US-PGPUB; USPAT; FPRS; EPO; JPO; DERWENT; IBM_TDB	ADJ	ON	2011/05/07 16:57
S102	1	10/784781.app.	US-PGPUB; USPAT; FPRS; EPO; JPO; DERWENT; IBM_TDB	ADJ	ON	2011/05/08 19:20

EAST Search History (Interference)

<This search history is empty>

5/ 8/ 2011 8:52:57 PM

**C:\ Documents and Settings\ jheffington\ My Documents\ OA Folders\ 10784781
\ 10784781 SearchHistory10.wsp**

Doc code: IDS

Doc description: Information Disclosure Statement (IDS) Filed

PTO/SB/08a (01-10)

Approved for use through 07/31/2012. OMB 0651-0031

U.S. Patent and Trademark Office; U.S. DEPARTMENT OF COMMERCE

Under the Paperwork Reduction Act of 1995, no persons are required to respond to a collection of information unless it contains a valid OMB control number.

INFORMATION DISCLOSURE STATEMENT BY APPLICANT (Not for submission under 37 CFR 1.99)	Application Number		10784781	
	Filing Date		2004-02-24	
	First Named Inventor	Gerhard D. Klassen		
	Art Unit	2172		
	Examiner Name	John M. Heffington		
	Attorney Docket Number	05200204-272US		

U.S.PATENTS						
Examiner Initial*	Cite No	Patent Number	Kind Code ¹	Issue Date	Name of Patentee or Applicant of cited Document	Pages, Columns, Lines where Relevant Passages or Relevant Figures Appear
	1					

If you wish to add additional U.S. Patent citation information please click the Add button.

U.S.PATENT APPLICATION PUBLICATIONS						
Examiner Initial*	Cite No	Publication Number	Kind Code ¹	Publication Date	Name of Patentee or Applicant of cited Document	Pages, Columns, Lines where Relevant Passages or Relevant Figures Appear
	1					

If you wish to add additional U.S. Published Application citation information please click the Add button.

FOREIGN PATENT DOCUMENTS								
Examiner Initial*	Cite No	Foreign Document Number ³	Country Code ²ⁱ	Kind Code ⁴	Publication Date	Name of Patentee or Applicant of cited Document	Pages, Columns, Lines where Relevant Passages or Relevant Figures Appear	T ⁵
	1							<input type="checkbox"/>

If you wish to add additional Foreign Patent Document citation information please click the Add button

NON-PATENT LITERATURE DOCUMENTS			
Examiner Initials*	Cite No	Include name of the author (in CAPITAL LETTERS), title of the article (when appropriate), title of the item (book, magazine, journal, serial, symposium, catalog, etc), date, pages(s), volume-issue number(s), publisher, city and/or country where published.	T ⁵

EFS Web 2.1.17

ALL REFERENCES CONSIDERED EXCEPT WHERE LINED THROUGH. /J.H./

Facebook's Exhibit No. 1013

0643

Snap Inc. Ex. 1013 Page 0643

INFORMATION DISCLOSURE STATEMENT BY APPLICANT (Not for submission under 37 CFR 1.99)	Application Number	10784781
	Filing Date	2004-02-24
	First Named Inventor	Gerhard D. Klassen
	Art Unit	2172
	Examiner Name	John M. Heffington
	Attorney Docket Number	05200204-272US

1	Notice of Allowance along with English translation of same, issued by the Japanese Patent Office in connection with corresponding Japanese Patent Application No. 2006-541762 dated December 3, 2010.	<input type="checkbox"/>
---	---	--------------------------

If you wish to add additional non-patent literature document citation information please click the Add button

EXAMINER SIGNATURE

Examiner Signature	/John Heffington/	Date Considered	05/08/2011
--------------------	-------------------	-----------------	------------

*EXAMINER: Initial if reference considered, whether or not citation is in conformance with MPEP 609. Draw line through a citation if not in conformance and not considered. Include copy of this form with next communication to applicant.

¹ See Kind Codes of USPTO Patent Documents at www.USPTO.GOV or MPEP 901.04. ² Enter office that issued the document, by the two-letter code (WIPO Standard ST.3). ³ For Japanese patent documents, the indication of the year of the reign of the Emperor must precede the serial number of the patent document. ⁴ Kind of document by the appropriate symbols as indicated on the document under WIPO Standard ST.16 if possible. ⁵ Applicant is to place a check mark here if English language translation is attached.

INFORMATION DISCLOSURE STATEMENT BY APPLICANT (Not for submission under 37 CFR 1.99)	Application Number	10784781
	Filing Date	2004-02-24
	First Named Inventor	Gerhard D. Klassen
	Art Unit	2172
	Examiner Name	John M. Heffington
	Attorney Docket Number	05200204-272US

U.S.PATENTS							Remove
Examiner Initial*	Cite No	Patent Number	Kind Code ¹	Issue Date	Name of Patentee or Applicant of cited Document	Pages,Columns,Lines where Relevant Passages or Relevant Figures Appear	
	1						

If you wish to add additional U.S. Patent citation information please click the Add button.

Add

U.S.PATENT APPLICATION PUBLICATIONS							Remove
Examiner Initial*	Cite No	Publication Number	Kind Code ¹	Publication Date	Name of Patentee or Applicant of cited Document	Pages,Columns,Lines where Relevant Passages or Relevant Figures Appear	
	1	20030167310	A1	2003-09-04	Moody et al.		

If you wish to add additional U.S. Published Application citation information please click the Add button.

Add

FOREIGN PATENT DOCUMENTS								Remove
Examiner Initial*	Cite No	Foreign Document Number ³	Country Code ² j	Kind Code ⁴	Publication Date	Name of Patentee or Applicant of cited Document	Pages,Columns,Lines where Relevant Passages or Relevant Figures Appear	T ⁵
	1							<input type="checkbox"/>

If you wish to add additional Foreign Patent Document citation information please click the Add button.

Add

NON-PATENT LITERATURE DOCUMENTS			Remove
Examiner Initials*	Cite No	Include name of the author (in CAPITAL LETTERS), title of the article (when appropriate), title of the item (book, magazine, journal, serial, symposium, catalog, etc), date, pages(s), volume-issue number(s), publisher, city and/or country where published.	T ⁵

**INFORMATION DISCLOSURE
STATEMENT BY APPLICANT**
(Not for submission under 37 CFR 1.99)

Application Number	10784781
Filing Date	2004-02-24
First Named Inventor	Gerhard D. Klassen
Art Unit	2172
Examiner Name	John M. Heffington
Attorney Docket Number	05200204-272US

1	Official Action dated February 21, 2011, issued by the Canadian Intellectual Property Office for corresponding Canadian Patent Application No. 2,540,580.	<input type="checkbox"/>
2	Certificate of Patent dated December 24, 2010, issued by the Japanese Patent Office for corresponding Japanese Patent No. 4031023.	<input type="checkbox"/>
3	Summons to Attend Oral Proceedings dated February 17, 2011, issued by the European Patent Office for corresponding European Divisional Patent Application No. 08168419.3	<input type="checkbox"/>
4	Article entitled "10 Minute Guide to Pocket PC 2002," dated September 2002, issued by Que.	<input type="checkbox"/>
5	Applicant's response to the Official Action dated March 11, 2010, issued by the Indian Patent Office for corresponding Indian Patent Application No. 3113/DELNP/2006.	<input type="checkbox"/>
6	Official Action dated February 22, 2011, issued by the Indian Patent Office for corresponding Indian Patent Application No. 3113/DELNP/2006.	<input type="checkbox"/>

If you wish to add additional non-patent literature document citation information please click the Add button

EXAMINER SIGNATURE

Examiner Signature	/John Heffington/	Date Considered	05/08/2011
--------------------	-------------------	-----------------	------------

*EXAMINER: Initial if reference considered, whether or not citation is in conformance with MPEP 609. Draw line through a citation if not in conformance and not considered. Include copy of this form with next communication to applicant.

¹ See Kind Codes of USPTO Patent Documents at www.USPTO.GOV or MPEP 901.04. ² Enter office that issued the document, by the two-letter code (WIPO Standard ST.3). ³ For Japanese patent documents, the indication of the year of the reign of the Emperor must precede the serial number of the patent document. ⁴ Kind of document by the appropriate symbols as indicated on the document under WIPO Standard ST.16 if possible. ⁵ Applicant is to place a check mark here if English language translation is attached.

INFORMATION DISCLOSURE STATEMENT BY APPLICANT (Not for submission under 37 CFR 1.99)	Application Number	10784781
	Filing Date	2004-02-24
	First Named Inventor	Gerhard D. Klassen
	Art Unit	2179
	Examiner Name	John M. Heffington
	Attorney Docket Number	05200204-272US

U.S.PATENTS							Remove
Examiner Initial*	Cite No	Patent Number	Kind Code ¹	Issue Date	Name of Patentee or Applicant of cited Document	Pages,Columns,Lines where Relevant Passages or Relevant Figures Appear	
	1	5617526	A	1997-04-01	ORAN, Daniel et al	column 5, paragraph 4, claims 1,2,6; figures 4,8,10	
	2	5333256	A	1994-07-26	GREEN, Emily et al	claim 1; figures 5, 6	
	3	6424354	B1	2002-07-23	WHITE, Christopher et al	claim 1, figure 12	
	4	6385459	B1	2002-05-07	LAWRENCE, Peter Robert et al	claim 9; figure 5	
	5	5634102	A	1997-05-27	CAPPS, Stephen P	claim 1, figure 4A	
	6	6628194	B1	2003-09-30	HELLEBUSTER et al		
If you wish to add additional U.S. Patent citation information please click the Add button.							Add
U.S.PATENT APPLICATION PUBLICATIONS							Remove
Examiner Initial*	Cite No	Publication Number	Kind Code ¹	Publication Date	Name of Patentee or Applicant of cited Document	Pages,Columns,Lines where Relevant Passages or Relevant Figures Appear	

INFORMATION DISCLOSURE STATEMENT BY APPLICANT (Not for submission under 37 CFR 1.99)	Application Number	10784781	10784781 - GAU: 2172
	Filing Date	2004-02-24	
	First Named Inventor	Gerhard D. Klassen	
	Art Unit	2179	
	Examiner Name	John M. Heffington	
	Attorney Docket Number	05200204-272US	

	1	20060020904		2006-01-26	AALTONEN, Antti et al	
	2	20050120306		2005-06-02	KLASSEN, GERHARD D. et al	
	3	20060030295		2005-02-02	ADAMS, Neil P. et al	
	4	20020160817	A1	2002-10-31	SALMIMAA et al	

If you wish to add additional U.S. Published Application citation information please click the Add button.

FOREIGN PATENT DOCUMENTS

Examiner Initial*	Cite No	Foreign Document Number ³	Country Code ² j	Kind Code ⁴	Publication Date	Name of Patentee or Applicant of cited Document	Pages, Columns, Lines where Relevant Passages or Relevant Figures Appear	T ⁵
	1	JP2003271277	JP		2003-09-26	AKITANE, Tsuchiya		<input type="checkbox"/>
	2	EP0943987	EP	A	1999-07-26	OCE TECH BV	claim 1, figure 3	<input type="checkbox"/>

If you wish to add additional Foreign Patent Document citation information please click the Add button.

NON-PATENT LITERATURE DOCUMENTS

Examiner Initials*	Cite No	Include name of the author (in CAPITAL LETTERS), title of the article (when appropriate), title of the item (book, magazine, journal, serial, symposium, catalog, etc), date, pages(s), volume-issue number(s), publisher, city and/or country where published.	T ⁵
	1	International Search Report and Written Opinion dated October 15, 2004, issued by the International Searching Authority for corresponding PCT Patent application no. PCT/CA2004/000263	<input type="checkbox"/>

**INFORMATION DISCLOSURE
STATEMENT BY APPLICANT**
(Not for submission under 37 CFR 1.99)

Application Number	10784781	10784781 - GAU: 2172
Filing Date	2004-02-24	
First Named Inventor	Gerhard D. Klassen	
Art Unit	2179	
Examiner Name	John M. Heffington	
Attorney Docket Number	05200204-272US	

2	Notice Requesting Submission of Opinion / Results of Examination dated October 13, 2007, issued by the Korean Intellectual Property Office for corresponding Korean Patent Application No. 10-2006-7013025, along with Applicant's response to same.	<input type="checkbox"/>
3	Notice Requesting Submission of Opinion / Results of Examination dated April 10, 2008, issued by the Korean Intellectual Property Office for corresponding Korean Patent Application No. 10-2006-7013025, along with Applicant's response to same.	<input type="checkbox"/>
4	Notice of Reasons for Rejection dated June 25, 2008, issued by the Japanese Patent Office for corresponding Japanese Patent Application No. 2006-541762, along with Applicant's response to same.	<input type="checkbox"/>
5	First Examination Report dated March 11, 2010, issued by the Government of Indian Patent Office for corresponding Indian Patent Application No. 3113/DELNP/2006.	<input type="checkbox"/>
6	First Office Action dated August 21, 2009, issued by the Chinese Patent Office for corresponding Chinese Patent Application No. 200810099973.X, , along with Applicant's response to same.	<input type="checkbox"/>
7	Second Office Action dated January 8, 2010, issued by the Chinese Patent Office for corresponding Chinese Patent Application No. 200810099973.X, along with Applicant's response to same.	<input type="checkbox"/>
8	First Office Action dated August 3, 2007, issued by the Chinese Patent Office for corresponding Chinese Patent Application No. 200480039930.2 , along with Applicant's response to same.	<input type="checkbox"/>
9	Examination Report dated July 27, 2009, issue by the Canadian Intellectual Property Office for corresponding Patent Application No. 2,548,598, along with Applicant's response to same.	<input type="checkbox"/>
10	Communication pursuant to Article 96(2) EPC dated October 12, 2006, issued by the European Patent Office for corresponding Patent Application No. 04743834.0, along with Applicant's response to same.	<input type="checkbox"/>
11	Communication pursuant to Article 94(3) EPC dated April 26, 2010, issued by the European Patent Office for corresponding Patent Application No. 08168419.3.	<input type="checkbox"/>
12	Extended European Search Report dated December 3, 2008, issued by the European Patent Office for corresponding Patent Application No. 08168419.3, along with Applicant's response to same.	<input type="checkbox"/>

INFORMATION DISCLOSURE STATEMENT BY APPLICANT (Not for submission under 37 CFR 1.99)	Application Number	10784781	10784781 - GAU: 2172
	Filing Date	2004-02-24	
	First Named Inventor	Gerhard D. Klassen	
	Art Unit	2179	
	Examiner Name	John M. Heffington	
	Attorney Docket Number	05200204-272US	

	13	Notice of Reasons for Rejection dated February 27, 2009, issued by the Japanese Patent Office for corresponding Japanese Patent Application No. 2006-541762, along with Applicant's response to same.	<input type="checkbox"/>
	14	Notice of Reasons for Rejection dated June 17, 2010, issued by the Japanese Patent Office for corresponding Japanese Patent Application No. 2006-541762.	<input type="checkbox"/>

If you wish to add additional non-patent literature document citation information please click the Add button

EXAMINER SIGNATURE

Examiner Signature	/John Heffington/	Date Considered	05/08/2011
--------------------	-------------------	-----------------	------------

*EXAMINER: Initial if reference considered, whether or not citation is in conformance with MPEP 609. Draw line through a citation if not in conformance and not considered. Include copy of this form with next communication to applicant.

¹ See Kind Codes of USPTO Patent Documents at www.USPTO.GOV or MPEP 901.04. ² Enter office that issued the document, by the two-letter code (WIPO Standard ST.3). ³ For Japanese patent documents, the indication of the year of the reign of the Emperor must precede the serial number of the patent document. ⁴ Kind of document by the appropriate symbols as indicated on the document under WIPO Standard ST.16 if possible. ⁵ Applicant is to place a check mark here if English language translation is attached.

INFORMATION DISCLOSURE STATEMENT BY APPLICANT (Not for submission under 37 CFR 1.99)	Application Number	10784781
	Filing Date	2004-02-24
	First Named Inventor	Gerhard D. Klassen
	Art Unit	2179
	Examiner Name	John M. Heffington
	Attorney Docket Number	0520024-272US

U.S. PATENTS							Remove	
Examiner Initial*	Cite No	Patent Number	Kind Code ¹	Issue Date	Name of Patentee or Applicant of cited Document	Pages, Columns, Lines where Relevant Passages or Relevant Figures Appear		
	1							
If you wish to add additional U.S. Patent citation information please click the Add button.							Add	
U.S. PATENT APPLICATION PUBLICATIONS							Remove	
Examiner Initial*	Cite No	Publication Number	Kind Code ¹	Publication Date	Name of Patentee or Applicant of cited Document	Pages, Columns, Lines where Relevant Passages or Relevant Figures Appear		
	1							
If you wish to add additional U.S. Published Application citation information please click the Add button.							Add	
FOREIGN PATENT DOCUMENTS							Remove	
Examiner Initial*	Cite No	Foreign Document Number ³	Country Code ²	Kind Code ⁴	Publication Date	Name of Patentee or Applicant of cited Document	Pages, Columns, Lines where Relevant Passages or Relevant Figures Appear	T ⁵
	1							<input type="checkbox"/>
If you wish to add additional Foreign Patent Document citation information please click the Add button.							Add	
NON-PATENT LITERATURE DOCUMENTS							Remove	
Examiner Initials*	Cite No	Include name of the author (in CAPITAL LETTERS), title of the article (when appropriate), title of the item (book, magazine, journal, serial, symposium, catalog, etc), date, pages(s), volume-issue number(s), publisher, city and/or country where published.					T ⁵	

**INFORMATION DISCLOSURE
STATEMENT BY APPLICANT**
(Not for submission under 37 CFR 1.99)

Application Number	10784781	10784781 - GAU: 2172
Filing Date	2004-02-24	
First Named Inventor	Gerhard D. Klassen	
Art Unit	2179	
Examiner Name	John M. Heffington	
Attorney Docket Number	0520024-272US	

1	Letters Patent issued by the Korean Intellectual Property Office dated November 25, 2008, for corresponding Korean Patent No. 0871404	<input type="checkbox"/>
2	Notification of Grant of Rights for Invention Patent dated May 26, 2010, issued by the State Intellectual Property Office the P.R. Of China for corresponding Chinese Patent Application No. 200810099973.X.	<input type="checkbox"/>
3	Patent Certificate for Invention dated July 23, 2008, issued by the State Intellectual Property Office the P.R. Of China, for corresponding Chinese Patent No. 413649.	<input type="checkbox"/>
4	Summons to attend Oral Proceedings pursuant to Rule 71(1) EPC, dated September 19, 2007, issued by the European Patent Office for corresponding Patent Application No. 04713831.8.	<input type="checkbox"/>
5	Observations pursuant to Rule 71(a) EPC, dated December 31, 2007, issued by the European Patent Office for corresponding Patent Application No. 04713831.8.	<input type="checkbox"/>
6	Brief Communication dated January 29, 2008, issued by the European Patent Office for corresponding Patent Application No. 04713831.8.	<input type="checkbox"/>
7	Decision to Refuse a European Patent Application, dated September 9, 2008, issued by the European Patent Office for corresponding Patent Application No. 04713831.8.	<input type="checkbox"/>
8	Request for Appeal to the European Patent Office dated November 9, 2008, for corresponding Patent Application No. 04713831.8.	<input type="checkbox"/>

If you wish to add additional non-patent literature document citation information please click the Add button

EXAMINER SIGNATURE

Examiner Signature	/John Heffington/	Date Considered	05/08/2011
--------------------	-------------------	-----------------	------------

*EXAMINER: Initial if reference considered, whether or not citation is in conformance with MPEP 609. Draw line through a citation if not in conformance and not considered. Include copy of this form with next communication to applicant.

¹ See Kind Codes of USPTO Patent Documents at www.USPTO.GOV or MPEP 901.04. ² Enter office that issued the document, by the two-letter code (WIPO Standard ST.3). ³ For Japanese patent documents, the indication of the year of the reign of the Emperor must precede the serial number of the patent document. ⁴ Kind of document by the appropriate symbols as indicated on the document under WIPO Standard ST.16 if possible. ⁵ Applicant is to place a check mark here if English language translation is attached.

INFORMATION DISCLOSURE STATEMENT BY APPLICANT (Not for submission under 37 CFR 1.99)	Application Number	10784781
	Filing Date	2004-02-24
	First Named Inventor	Gerhard D. Klassen
	Art Unit	2172
	Examiner Name	John M. Heffington
	Attorney Docket Number	05200204-272US

U.S. PATENTS							Remove	
Examiner Initial*	Cite No	Patent Number	Kind Code ¹	Issue Date	Name of Patentee or Applicant of cited Document	Pages, Columns, Lines where Relevant Passages or Relevant Figures Appear		
	1							
If you wish to add additional U.S. Patent citation information please click the Add button.							Add	
U.S. PATENT APPLICATION PUBLICATIONS							Remove	
Examiner Initial*	Cite No	Publication Number	Kind Code ¹	Publication Date	Name of Patentee or Applicant of cited Document	Pages, Columns, Lines where Relevant Passages or Relevant Figures Appear		
	1							
If you wish to add additional U.S. Published Application citation information please click the Add button.							Add	
FOREIGN PATENT DOCUMENTS							Remove	
Examiner Initial*	Cite No	Foreign Document Number ³	Country Code ² j	Kind Code ⁴	Publication Date	Name of Patentee or Applicant of cited Document	Pages, Columns, Lines where Relevant Passages or Relevant Figures Appear	T ⁵
	1							<input type="checkbox"/>
If you wish to add additional Foreign Patent Document citation information please click the Add button.							Add	
NON-PATENT LITERATURE DOCUMENTS							Remove	
Examiner Initials*	Cite No	Include name of the author (in CAPITAL LETTERS), title of the article (when appropriate), title of the item (book, magazine, journal, serial, symposium, catalog, etc), date, pages(s), volume-issue number(s), publisher, city and/or country where published.					T ⁵	

INFORMATION DISCLOSURE STATEMENT BY APPLICANT (Not for submission under 37 CFR 1.99)	Application Number		10784781
	Filing Date		2004-02-24
	First Named Inventor	Gerhard D. Klassen	
	Art Unit	2172	
	Examiner Name	John M. Heffington	
	Attorney Docket Number	05200204-272US	

1	Applicant's response to the Official Action dated June 17, 2010, issued by the Japanese Patent Office for corresponding Japanese Patent Application No. 2006-541762	<input type="checkbox"/>
2	Extended European Search Report dated October 13, 2010, issued by the European Patent Office for corresponding European Patent Application No. 10177959.5.	<input type="checkbox"/>
3	Extended European Search Report dated October 13, 2010, issued by the European Patent Office for corresponding European Patent Application No. 10177958.5.	<input type="checkbox"/>

If you wish to add additional non-patent literature document citation information please click the Add button

EXAMINER SIGNATURE

Examiner Signature	/John Heffington/	Date Considered	05/08/2011
--------------------	-------------------	-----------------	------------

*EXAMINER: Initial if reference considered, whether or not citation is in conformance with MPEP 609. Draw line through a citation if not in conformance and not considered. Include copy of this form with next communication to applicant.

¹ See Kind Codes of USPTO Patent Documents at www.USPTO.GOV or MPEP 901.04. ² Enter office that issued the document, by the two-letter code (WIPO Standard ST.3). ³ For Japanese patent documents, the indication of the year of the reign of the Emperor must precede the serial number of the patent document. ⁴ Kind of document by the appropriate symbols as indicated on the document under WIPO Standard ST.16 if possible. ⁵ Applicant is to place a check mark here if English language translation is attached.

Index of Claims 	Application/Control No. 10784781	Applicant(s)/Patent Under Reexamination KLASSEN ET AL.
	Examiner Heffington, John M	Art Unit 2179

✓	Rejected	-	Cancelled	N	Non-Elected	A	Appeal
=	Allowed	÷	Restricted	I	Interference	O	Objected

Claims renumbered in the same order as presented by applicant
 CPA
 T.D.
 R.1.47

CLAIM		DATE								
Final	Original	03/05/2007	12/07/2007	03/23/2008	10/17/2008	04/07/2009	09/23/2009	03/27/2010	05/08/2011	
	1	✓	-	-	-	-	-	-	-	
	2	✓	-	-	-	-	-	-	-	
	3	✓	-	-	-	-	-	-	-	
	4	✓	-	-	-	-	-	-	-	
	5	✓	-	-	-	-	-	-	-	
	6	✓	-	-	-	-	-	-	-	
	7	✓	-	-	-	-	-	-	-	
	8	✓	-	-	-	-	-	-	-	
	9	✓	-	-	-	-	-	-	-	
	10	✓	-	-	-	-	-	-	-	
	11	✓	-	-	-	-	-	-	-	
	12	✓	-	-	-	-	-	-	-	
	13	✓	-	-	-	-	-	-	-	
	14	✓	-	-	-	-	-	-	-	
	15	✓	-	-	-	-	-	-	-	
	16	✓	-	-	-	-	-	-	-	
	17	✓	-	-	-	-	-	-	-	
	18	✓	-	-	-	-	-	-	-	
	19	✓	-	-	-	-	-	-	-	
	20	✓	-	-	-	-	-	-	-	
	21		✓	✓	✓	✓	✓	✓	-	
	22		✓	✓	✓	✓	✓	✓	-	
	23		✓	✓	✓	✓	✓	✓	-	
	24		✓	✓	✓	✓	✓	✓	-	
	25		✓	✓	✓	✓	✓	✓	-	
	26		✓	✓	✓	-	-	-	-	
	27		✓	✓	✓	✓	✓	-	-	
	28		✓	✓	✓	✓	✓	✓	-	
	29		✓	✓	✓	✓	✓	✓	-	
	30		✓	✓	✓	✓	✓	✓	-	
	31		✓	✓	✓	✓	✓	✓	-	
	32		✓	✓	✓	✓	✓	✓	-	
	33		✓	✓	✓	✓	✓	✓	-	
	34		✓	✓	✓	✓	✓	✓	-	
	35		✓	✓	✓	-	-	-	-	
	36		✓	✓	✓	✓	✓	-	-	

Index of Claims 	Application/Control No. 10784781	Applicant(s)/Patent Under Reexamination KLASSEN ET AL.
	Examiner Heffington, John M	Art Unit 2179

✓	Rejected	-	Cancelled	N	Non-Elected	A	Appeal
=	Allowed	÷	Restricted	I	Interference	O	Objected

Claims renumbered in the same order as presented by applicant
 CPA
 T.D.
 R.1.47

CLAIM		DATE								
Final	Original	03/05/2007	12/07/2007	03/23/2008	10/17/2008	04/07/2009	09/23/2009	03/27/2010	05/08/2011	
	37		✓	✓	✓	✓	✓	✓	-	
	38		✓	✓	✓	✓	✓	✓	-	
	39		✓	✓	✓	✓	✓	✓	-	
	40		✓	✓	✓	✓	✓	✓	-	
	41		✓	✓	✓	✓	✓	✓	-	
	42						✓	✓	-	
	43						✓	✓	-	
	44						✓	✓	-	
	45						✓	✓	-	
	46						✓	✓	-	
	47						✓	✓	-	
	48						✓	✓	-	
	49						✓	✓	-	
	50						✓	✓	-	
	51						✓	✓	-	
	52								✓	
	53								✓	
	54								✓	
	55								✓	
	56								✓	
	57								✓	
	58								✓	
	59								✓	
	60								✓	
	61								✓	
	62								✓	
	63								✓	
	64								✓	
	65								✓	
	66								✓	
	67								✓	
	68								✓	
	69								✓	
	70								✓	
	71								✓	
	72								✓	

Index of Claims 	Application/Control No. 10784781	Applicant(s)/Patent Under Reexamination KLASSEN ET AL.
	Examiner Heffington, John M	Art Unit 2179

✓	Rejected	-	Cancelled	N	Non-Elected	A	Appeal
=	Allowed	÷	Restricted	I	Interference	O	Objected

Claims renumbered in the same order as presented by applicant
 CPA
 T.D.
 R.1.47

CLAIM		DATE								
Final	Original	03/05/2007	12/07/2007	03/23/2008	10/17/2008	04/07/2009	09/23/2009	03/27/2010	05/08/2011	
	73								✓	
	74								✓	
	75								✓	
	76								✓	
	77								✓	
	78								✓	
	79								✓	
	80								✓	
	81								✓	
	82								✓	
	83								✓	
	84								✓	
	85								✓	
	86								✓	
	87								✓	
	88								✓	
	89								✓	
	90								✓	
	91								✓	
	92								✓	
	93								✓	
	94								✓	
	95								✓	
	96								✓	
	97								✓	
	98								✓	
	99								✓	
	100								✓	
	101								✓	
	102								✓	
	103								✓	
	104								✓	
	105								✓	
	106								✓	
	107								✓	
	108								✓	

Index of Claims 	Application/Control No. 10784781	Applicant(s)/Patent Under Reexamination KLASSEN ET AL.
	Examiner Heffington, John M	Art Unit 2179

✓	Rejected	-	Cancelled	N	Non-Elected	A	Appeal
=	Allowed	÷	Restricted	I	Interference	O	Objected

Claims renumbered in the same order as presented by applicant
 CPA
 T.D.
 R.1.47

CLAIM		DATE								
Final	Original	03/05/2007	12/07/2007	03/23/2008	10/17/2008	04/07/2009	09/23/2009	03/27/2010	05/08/2011	
	109								✓	
	110								✓	
	111								✓	

Search Notes 	Application/Control No. 10784781	Applicant(s)/Patent Under Reexamination KLASSEN ET AL.
	Examiner Heffington, John M	Art Unit 2179

SEARCHED			
Class	Subclass	Date	Examiner
715	700	3/1/2007	JMH
715	842, 851	5/8/11	JMH

SEARCH NOTES		
Search Notes	Date	Examiner
EAST Search	3/1/2007	JMH
EAST Search (update)	12/7/2007	JMH
EAST Search (update)	3/23/2008	JMH
NPL Search	3/23/2008	JMH
EAST Search	10/16/08	JMH
EAST Search	4/7/09	JMH
EAST Search	9/22/09	JMH
EAST Search	3/27/10	JMH
EAST Search	4/26/11-5/8/11	JMH

INTERFERENCE SEARCH			
Class	Subclass	Date	Examiner

--	--

IN THE UNITED STATES PATENT AND TRADEMARK OFFICE

Inventor(s) KLASSEN et al.
Serial No.: 10/784,781
Filed: 24 February 2004
Examiner: HEFFINGTON, John M.
Group Art Unit: 2179
Confirmation No.: 2200
Title: PREVIEWING A NEW EVENT ON A SMALL SCREEN
 DEVICE

VIA ELECTRONIC FILING

Commissioner for Patents
P.O. Box 1450
Alexandria, Virginia 22313-1450
U.S.A.

RESPONSE TO OFFICE ACTION

This paper (the Response) is filed in response to the Office Action mailed herein
19 May 2011.

- Amendments to the Claims are presented beginning at page 2.
- Remarks are presented beginning at page 12.
- Filed herewith is a Petition for a one (1) month extension of time in which to make this response.

AMENDMENT

In the Claims

Please rewrite the claims as follows. A complete listing of the claims is provided pursuant to 37 CFR 1.121.

1 – 51. (Cancelled)

52. (previously presented) A method of providing notifications of unread messages on a wireless communication device, comprising:

displaying at least one icon relating to electronic messaging on a graphical user interface of the wireless communication device;

receiving a plurality of electronic messages on the wireless communication device, the plurality of electronic messages including messages from a plurality of different messaging correspondents; and

in response to receiving at least one of the plurality of electronic messages, visually modifying at least one displayed icon relating to electronic messaging to include a numeric character representing a count of the plurality of different messaging correspondents for which one or more of the electronic messages have been received and remain unread.

53. (previously presented) The method of claim 52, further comprising displaying a plurality of icons including one or more application icons that are selectable to invoke respective ones of a plurality of applications on the wireless communication device.

54. (previously presented) The method of claim 53, further comprising visually modifying one or more of the plurality of icons to include a count of electronic messages that have been received and remain unread.

55. (previously presented) The method of claim 52, the at least one icon relating to electronic messaging being selectable to invoke an electronic messaging application.

56. (previously presented) The method of claim 52, comprising displaying on the graphical user interface an identifier of the correspondent from whom at least one of the plurality of messages was received.

57. (previously presented) The method of claim 52, comprising displaying on the graphical user interface at least one preview of content associated with at least one of the received electronic messages.

58 - 63. (cancelled)

64. (previously presented) A computer-readable memory accessible by a processor of a wireless communication device, the memory comprising stored electronic data structures representing executable instructions which, when executed by the processor, cause the wireless communication device to:

display at least one icon relating to an electronic messaging application on the graphical user interface;

receive a plurality of electronic messages, the plurality of electronic messages including messages from a plurality of different messaging correspondents; and

in response to receiving at least one of the plurality of electronic messages, visually modify at least one displayed icon relating to the electronic messaging application to include a numeric character representing a count of the plurality of different messaging correspondents for which one or more of the electronic messages have been received and remain unread.

65. (previously presented) The computer-readable memory of claim 64, further comprising stored electronic data structures representing executable instructions which, when executed, cause the wireless communication device to display a plurality of icons including one or more application icons that are selectable to invoke respective ones of a plurality of applications on the wireless communication device.

66. (previously presented) The computer-readable memory of claim 65, further comprising stored electronic data structures representing executable instructions which, when executed, cause the wireless communication device to visually modify one or more of the plurality of icons to include a count of electronic messages that have been received by the wireless communication device and remain unread.

67. (previously presented) The computer-readable memory of claim 64, the at least one icon relating to electronic messaging being selectable to invoke an electronic messaging application.

68. (previously presented) The computer-readable memory of claim 64, stored electronic data structures representing executable instructions which, when executed, cause the wireless communication device to visually modify the graphical user interface to include an identifier of the correspondent from whom at least one of the plurality of messages was received.

69. (previously presented) The computer-readable memory of claim 64, further stored electronic data structures representing executable instructions which, when executed, cause the wireless communication device to visually modify the graphical user interface to include at least one preview of content associated with at least one of the received electronic messages.

70. (currently amended) A wireless communication device comprising:

a processor;

a display electrically coupled to the processor, the display presenting a graphical user interface; and

~~a medium or media including~~ memory storing machine-readable instructions executable by the processor to:

display at least one icon relating to electronic messaging on the graphical user interface;

receive a plurality of electronic messages, the plurality of electronic messages including messages from a plurality of different messaging correspondents; and

in response to receiving at least one of the plurality of electronic messages, visually modify the at least one displayed icon relating to electronic messaging to include a numeric character representing a count of the plurality of different messaging correspondents for which one or more of the electronic messages have been received and remain unread.

71. (currently amended) The wireless communication device of claim 70, the ~~medium or media~~ memory further comprising machine-readable instructions which, when executed, cause the wireless communication device to display a plurality of icons including one or more application icons that are selectable to invoke respective ones of a plurality of applications on the wireless communication device.

72. (currently amended) The wireless communication device of claim 71, the ~~medium or media~~ memory comprising machine-readable instructions which, when executed, cause the wireless communication device to visually modify one or more of the plurality of icons to include a count of electronic messages that have been received and remain unread.

73. (previously presented) The wireless communication device of claim 70, the at least one icon relating to electronic messaging being selectable to invoke an electronic messaging application.

74. (currently amended) The wireless communication device of claim 70, the ~~medium or media~~ memory further comprising machine-readable instructions which, when executed, cause the wireless communication device to visually modify the graphical user interface to include an identifier of the correspondent from whom at least one of the plurality of messages was received.

75. (currently amended) The wireless communication device of claim 70, the ~~medium or media~~ memory further comprising machine-readable instructions which, when executed, cause the wireless communication device to visually modify the graphical

user interface to include at least one preview of content associated with at least one of the received electronic messages.

76. (currently amended) A method of providing notifications of unread messages on a wireless communication device, comprising:

displaying at least one icon relating to an electronic messaging application on a graphical user interface of the wireless communication device;

receiving on the wireless communication device a plurality of electronic messages associated with the electronic messaging application; and

responsive to receiving at least one of the plurality of electronic messages:

visually modifying at least one icon relating to the electronic messaging application to include a count of the plurality of electronic messages which remain unread; and

displaying on the graphical user interface concurrently with the visually-modified icon a text identifier associated with a correspondent from whom the at least one of the plurality of electronic messages was received.

77. (previously presented) The method of claim 76, the identifier associated with a correspondent from whom the at least one of the plurality of electronic messages was received comprising state information pertaining to the correspondent.

78. (previously presented) The method of claim 76, further comprising displaying on the graphical user interface at least a preview of content associated with at least one of the received electronic messages.

79. (previously presented) The method of claim 76, further comprising displaying on the graphical user interface for a predetermined period of time at least a preview of content associated with at least one of the received electronic messages.

80. (previously presented) The method of claim 76, the at least one icon relating to electronic messaging being selectable to invoke an electronic messaging application.

81. (previously presented) The method of claim 80, further comprising, responsive to invoking the electronic messaging application, navigating automatically to a graphical user interface comprising content associated with at least one of the received electronic messages.

82. (previously presented) The method of claim 80, further comprising, responsive to invoking the electronic messaging application within a predetermined time following receipt of at least one of the received electronic messages, navigating automatically to a graphical user interface comprising content associated with the at least one of the received electronic messages.

83. (previously presented) The method of claim 80, further comprising, responsive to invoking the electronic messaging application, visually modifying at least one icon relating to the electronic messaging application to include a decreased count of electronic messages which remain unread.

84. (previously presented) The method of claim 80, further comprising, responsive to invoking the electronic messaging application, visually modifying at least one icon relating to the electronic messaging application to remove the count of electronic messages which remain unread.

85. – 93. (cancelled)

94. (currently amended) A computer-readable memory accessible by a processor of a wireless communication device, the memory comprising stored electronic data structures representing executable instructions which, when executed by the processor, cause the wireless communication device to:

display at least one icon relating to an electronic messaging application on a graphical user interface of the wireless communication device;

receive on the wireless communication device a plurality of electronic messages associated with the electronic messaging application; and

responsive to receiving at least one of the plurality of electronic messages:

visually modify at least one icon relating to the electronic messaging application to include a count of the plurality of electronic messages which remain unread; and

display on the graphical user interface concurrently with the visually-modified icon a text identifier associated with a correspondent from whom the at least one of the plurality of electronic messages was received.

95. (previously presented) The computer-readable memory of claim 94, the identifier associated with a correspondent from whom the at least one of the plurality of electronic messages was received comprising state information pertaining to the correspondent.

96. (previously presented) The computer-readable memory of claim 94, further stored electronic data structures representing executable instructions which, when executed, cause the wireless communication device to display on the graphical user interface at least a preview of content associated with at least one of the received electronic messages.

97. (previously presented) The computer-readable memory of claim 94, further stored electronic data structures representing executable instructions which, when executed, cause the wireless communication device to display on the graphical user interface for a predetermined period of time at least a preview of content associated with at least one of the received electronic messages.

98. (previously presented) The computer-readable memory of claim 94, the at least one icon relating to electronic messaging being selectable to invoke an electronic messaging application.

99. (previously presented) The computer-readable memory of claim 98, further stored electronic data structures representing executable instructions which, when executed, cause the wireless communication device to, responsive to invoking the electronic messaging application, navigate automatically to a graphical user interface comprising content associated with at least one of the received electronic messages.

100. (previously presented) The computer-readable memory of claim 98, further stored electronic data structures representing executable instructions which, when executed, cause the wireless communication device to, responsive to invoking the electronic messaging application within a predetermined time following receipt of at least one of the received electronic messages, navigate automatically to a graphical user interface comprising content associated with the at least one of the received electronic messages.

101. (previously presented) The computer-readable memory of claim 98, further stored electronic data structures representing executable instructions which, when executed, cause the wireless communication device to, responsive to invoking the electronic messaging application, visually modify at least one icon relating to the electronic messaging application to include a decreased count of electronic messages which remain unread.

102. (previously presented) The computer-readable memory of claim 98, further stored electronic data structures representing executable instructions which, when executed, cause the wireless communication device to, responsive to invoking the electronic messaging application, visually modify at least one icon relating to the electronic messaging application to remove the count of electronic messages which remain unread.

103. (currently amended) A wireless communication device comprising

a processor;

a display electrically coupled to the processor, the display presenting a graphical user interface; and

~~a medium or media including~~ memory storing machine-readable instructions executable by the processor to:

display on the graphical user interface at least one icon relating to an electronic messaging application;

receive on the wireless communication device a plurality of electronic messages associated with the electronic messaging application; and

responsive to receiving at least one of the plurality of electronic messages:

visually modify at least one icon relating to the electronic messaging application to include a count of the plurality of electronic messages which remain unread; and

display on the graphical user interface concurrently with the visually-modified icon a text identifier associated with a correspondent from whom the at least one of the plurality of electronic messages was received.

104. (previously presented) The wireless communication device of claim 103, the identifier associated with a correspondent from whom the at least one of the plurality of electronic messages was received comprising state information pertaining to the correspondent.

105. (currently amended) The wireless communication device of claim 103, the ~~medium or media further comprising~~ memory storing machine-readable instructions which, when executed, cause the wireless communication device to display on the graphical user interface at least a preview of content associated with at least one of the received electronic messages.

106. (currently amended) The wireless communication device of claim 103, the ~~medium or media further comprising~~ memory storing machine-readable instructions which, when executed, cause the wireless communication device to display on the graphical user interface for a predetermined period of time at least a preview of content associated with at least one of the received electronic messages.

107. (previously presented) The wireless communication device of claim 103, the at least one icon relating to electronic messaging being selectable to invoke an electronic messaging application.

108. (currently amended) The wireless communication device of claim 107, the ~~medium or media further comprising~~ memory storing machine-readable instructions which, when executed, cause the wireless communication device to, responsive to invoking the electronic messaging application, navigate automatically to a graphical user interface comprising content associated with at least one of the received electronic messages.

109. (currently amended) The wireless communication device of claim 103, the ~~medium or media further comprising~~ memory storing machine-readable instructions which, when executed, cause the wireless communication device to, responsive to invoking the electronic messaging application within a predetermined time following receipt of at least one of the received electronic messages, navigate automatically to a graphical user interface comprising content associated with the at least one of the received electronic messages.

110. (currently amended) The wireless communication device of claim 103, the ~~medium or media further comprising~~ memory storing machine-readable instructions which, when executed, cause the wireless communication device to, responsive to invoking the electronic messaging application, visually modify at least one icon relating to the electronic messaging application to include a decreased count of electronic messages which remain unread.

111. (currently amended) The wireless communication device of claim 103, the ~~medium or media further comprising~~ memory storing machine-readable instructions which, when executed, cause the wireless communication device to, responsive to invoking the electronic messaging application, visually modify at least one icon relating to the electronic messaging application to remove the count of electronic messages which remain unread.

REMARKS**Status of Claims; Amendment**

Prior to the amendment herein, claims 52 – 111 were pending in the application. Claims 70 – 72, 74 – 76, 94, 103, 105, 106, and 108 – 111 are hereby amended; and claims 58 – 63 and 85 - 93 are hereby cancelled, without prejudice and without disclaimer of subject matter.

Support for the amendment may be found throughout the specification as originally filed, including the Figures and the claims; and in particular at paragraphs [0049] – [0060], and in Figures 6 - 9.

No new matter is added by the amendment.

Applicant notes, for the Examiner's information, that the claims presented herein correspond to claims allowed in a corresponding Japanese application (serial number provided in table below).

Disclaimer of Prior Statements and Amendments

The claims, as presented herein, may be broader in some respects than claims previously presented. Applicant intends that the claims now pending be interpreted under the ordinary interpretation understood in the art. Accordingly Applicant expressly rescinds, and no longer intends that the claims be limited by, any and all assertions, statements, arguments, amendments or other actions previously made in this application, and/or any application whose file history is appropriate for use in interpreting any patent issuing on this application, that might be taken to be a surrender or disclaimer of any subject matter from the scope of any claim. No such assertion, statement, argument, amendment, or other action should be taken as a surrender or disclaimer from, and may not be used to interpret, any claim of this application, or any claim of any patent to which such applications' file histories may be pertinent.

Applicant intends, and expressly requests, that the Application be presented and examined *de novo*. Accordingly, Applicant urges the Examiner to make a thorough and

diligent search of the prior art with respect to each and every claim presented herein. Applicant requests that the Examiner reconsider any previous surrender, disclaimer or characterization of claims, and that he reconsider any prior art that may have been avoided or intended to be avoided by such surrender, disclaimer or characterization.

Objection to Specification; Rejections under 35 USC § 101

At paragraphs 2 and 3 of the Detailed Action the Examiner has objected to the specification as failing to provide proper antecedent basis for claims 58-63, 70-75, 85-93, and 103-111, and in the alternative has rejected those claims as directed to non-statutory subject matter under 35 USC 101.

Applicant respectfully traverses both the rejection and the objection: the subject matter of the claims is disclosed in such manner that any person of ordinary skill in the art would understand that proper antecedent basis is provided within the specification. Moreover, the affected claims clearly recite patentable devices, memories, and non-transient computer-readable media.

However, in the interest of advancing the application as rapidly as possible, Applicant has hereby cancelled claims 58 – 63 and 85-93, and amended claims 70-75 and 103-111. Both the cancellation and the amendment are made without prejudice, for the sole purpose of advancing examination at this time.

Applicant believes that such cancellation and amendment moots both the objection and the rejection, and requests reconsideration and allowance of the amended claims.

Claims 52-75: rejections under 35 USC § 103

At pages 3 – 11 of the Detailed Action the Examiner has rejected claims 52-75 as obvious over Wagner (US 2004/0155908) in view of Canfield (US 2004/0056893).

Applicant respectfully traverses. The cited references fail to teach or suggest each element of the claims, whether considered alone or in combination; and they teach away from each other and Applicant's claimed invention. Specifically:

- As acknowledged by the Examiner, the cited portions of Wagner and Canfield fail, whether considered alone or in combination, to teach or suggest at least the claimed limitation of visually modifying a displayed icon to include a character representing a count of a plurality of different messaging correspondents from whom messages have been received. The cited references are concerned primarily with a number of new messages, without regard to the correspondents from whom the messages have been received, or the number of such correspondents from whom messages have been received and remain unread. To track messages by correspondent in the manner claimed, rather than simple numbers of messages received, is novel, is significantly different from what was done before, and in the context of wireless devices and the cited art is counterintuitive.
- Canfield does not teach or suggest methods, devices, or other solutions suitable for implementation on wireless communications devices, such as mobile PDAs. Canfield is concerned solely with desktop-type large screen devices having access to virtually unlimited screen space and processing power. As such, Canfield teaches away from Applicant's invention.

Applicant notes that both Wagner and Canfield qualify as prior art against the application herein, if at all, solely under 35 USC 102(e). While Applicant submits that the claims as presented distinguish Wagner and Canfield on their merits, Applicant respectfully and expressly reserves all right to establish prior invention in order to establish that neither Wagner nor Canfield is valid prior art against this application or the claims presented herein.

Legal Standard

In order to establish a case of obviousness, "the scope and content of the prior art are to be determined; differences between the prior art and the claims at issue are to be determined; and the level of ordinary skill in the art resolved. Against this background the obviousness or non-obviousness of the subject matter is determined. Such secondary factors as commercial success, long felt but unrecognized needs, failures of others, etc., might be utilized to give light to the circumstances surrounding to origin of

the subject matter sought to be patented.” *KSR Int’l Co. v. Teleflex Inc.*, 127 S.Ct. 1727 (2007), citing *Graham v. John Deere Co.*, 383 U.S. 1 (1966).

In order to reject a claim based on a combination of references, it is explained at MPEP 2143 (citing the Supreme Court in *KSR v. Teleflex*), that “Office personnel must resolve the *Graham* factual inquiries...

Then, Office personnel must articulate the following:

(1) a finding that the prior art included each element claimed, although not necessarily in a single prior art reference, with the only difference between the claimed invention and the prior art being the lack of actual combination of the elements in a single prior art reference;

(2) a finding that one of ordinary skill in the art could have combined the elements as claimed by known methods, and that in combination, each element merely performs the same function as it does separately;

(3) a finding that one of ordinary skill in the art would have recognized that the results of the combination were predictable; and

(4) whatever additional findings based on the *Graham* factual inquiries may be necessary, in view of the facts of the case under consideration, to explain a conclusion of obviousness.

KSR, 82 USPQ2d at 1395; *Sakraida v. AG Pro, Inc.*, 425 U.S. 273, 282, 189 USPQ 449, 453 (1976); *Anderson's-Black Rock, Inc. v. Pavement Salvage Co.*, 396 U.S. 57, 62-63, 163 USPQ 673, 675 (1969); *Great Atlantic & P. Tea Co. v. Supermarket Equipment Corp.*, 340 U.S. 147, 152, 87 USPQ 303, 306 (1950).

"[I]t can be important to identify a reason that would have prompted a person of ordinary skill in the relevant field to combine the elements in the way the claimed new invention does." *KSR*, 82 USPQ2d at 1396.

MPEP 2143 further notes that if “any of these findings cannot be made, then this rationale cannot be used to support a conclusion that the claim would have been obvious to one of ordinary skill in the art.”

KSR further explains that even where (as is not the case here) all of the claimed elements may be found in the prior art, the teaching-suggestion-motivation test provides useful insights in making obviousness determinations: a patent composed of several

elements is not proved obvious merely by demonstrating that each element was, independently, known in the prior art. It can be important to identify a reason that would have prompted a person of ordinary skill in the art to combine the elements as the new invention does. Inventions usually rely on building blocks long since uncovered, and claimed discoveries almost necessarily will be combinations of what was, in some sense, already known. The determination whether there was an apparent reason to combine the known elements in the fashion claimed by the patent at issue should be made explicit.

Applicant respectfully reminds the Examiner also that determinations of obviousness are not to be based on hindsight combination of components selectively culled from the prior art to fit the parameters of the patented invention, as noted in, for example, *ATD Corp. v. Lydall, Inc.*, 48 USPQ2d 1321, 1329 (Fed. Cir. 1998).

Analysis

For purposes of this rejection, Claim 52 is representative. Claim 52 recites a method of providing notifications of unread messages on a wireless communication device. The method comprises displaying at least one icon relating to electronic messaging on a graphical user interface of the wireless communication device and, in response to receiving messages from a plurality of different messaging correspondents, visually modifying at least one displayed icon include a count of different messaging correspondents from whom one or more of the electronic messages have been received and remain unread.

Claims 53-57 depend from claim 52. Claims 64-69 recite corresponding computer-readable memories. Claims 70-75 recite corresponding wireless communication devices.

At page 4 of the Detailed Action, the Examiner has acknowledged that Wagner does not disclose "in response to receiving at least one of the plurality of electronic messages, visually modifying at least one displayed icon relating to electronic messaging to include a numeric character representing a count of the plurality of different messaging

correspondents for which one or more of the electronic messages have been received and remain unread,' as claimed by Applicant.

However, the Examiner notes, "in the same field of invention" Canfield discloses tracking a number of new, unread messages. In doing so, the Examiner cites to paragraph [0054] of Canfield.

With respect, (a) Canfield is not in the same field of invention as Applicant's claims; and (b) as Applicant and the Examiner have previously agreed with respect to Wagner, counting a number of new, unread messages is not the same as, or for present purposes analogous to, counting a number of correspondents from whom messages which remain unread have been received. To the extent that Canfield and Wagner teach counting of messages, they teach away from Applicant's claims.

Counting unread messages is not the same as counting correspondents

As is well understood by those skilled in the relevant arts, and was particularly understood by such persons as of the effective filing date of the application herein, counting a number of messages received by a device which have not yet been read is very different from tracking a plurality of different correspondents from whom messages have been received, and presenting for a user's reference a number of such correspondents from whom messages have been received and remain unread. Both the mechanics of making such a determination and the use that may be made of such information are very different; and they both respond to and enable different patterns of communication, particularly by users of wireless devices.

In order to maintain such counts communications applications must track, count, and otherwise process different types of information. Merely counting a number of unread messages, regardless of source, is typically a simple matter of incrementing a counter variable each time a new message is received.

Counting a number of different correspondents from whom messages have been received, and remain unread, on the other hand, is significantly more involved: using, for example, contemporary techniques, each incoming message must be parsed for a correspondent's identity; parsed identities must be compared to a list of correspondents

from whom messages have previously been received; redundant entries must be ignored (at least for present purposes); a count of distinct correspondents must be maintained; and, as messages are accessed and read, the corresponding correspondent must be identified and the list of correspondents associated with unread messages must be adjusted as appropriate. If no further messages from that correspondent remain unread, then the correspondent must be removed from the count; if further messages remain, then the correspondent must continue to be counted.

Where such counts are maintained for multiple messaging applications, the problem can be geometrically compounded.

As is further understood by those skilled in the relevant arts, tracking and presentation of such information can be of immense value to users of wireless communications devices, particularly where (as here) correspondent information can be tracked and displayed separately for each of a plurality of messaging applications. For example, for users of IM, SMS, and other types of messaging applications, it is often more important to track a number of distinct correspondents from whom messages have been received, rather than the number of individual communications that have been received.

For example, it is well known that many users of IM, SMS, and other messaging applications send multiple individual messages to each other; sometimes the messages are related to a common topic, and sometimes not. For example, an IM or SMS user might inquire about a single subject multiple times; and the same user might ask a number of unrelated questions. In some cases, those from to whom such a proliferation of messages are addressed need not be concerned to read each message as it is received. However, it may be critical to look for even a single message received from another correspondent, such as a child travelling between school and home. By displaying the number of distinct correspondents from whom messages have been received, Applicant's claimed invention opens new possibilities for users of such communications.

Moreover, as those skilled in the arts understand, in the context of wireless communications devices it is counterintuitive to place any further burden on an operating system which is typically subject to significant restraints in power supply (e.g.,

battery life), processing power, memory, communications bandwidth, and display space. Thus a designer of such devices would not have been motivated to put them to the extra work of identifying and tracking numbers of distinct correspondents, and maintaining lists of such correspondents dynamically.

However, as the inventors herein realized, by expending such resources and modifying an icon associated with a corresponding communications application, as claimed, they could allow a user to very efficiently track sometimes crucial information while making very efficient use of display resources, and significantly reducing input, output, display, and other processing tasks that previously were required for the users to obtain and track such information.

As noted above, the Examiner has acknowledged that the cited portions of Wagner and Canfield fail, whether considered alone or in combination, to teach or suggest at least this feature of Applicant's claims. The cited references are concerned primarily with a number of new messages, without regard to the correspondents from whom the messages have been received, or the number of such correspondents from whom messages have been received and remain unread.

Applicant notes, for the sake of completeness and in the interest of advancing the application without delay, that at paragraph [0052] Canfield describes a conversation counter 650 displayed on IM interface 525 for the purpose of providing information relating to the concurrent IM sessions, such as the total number of concurrent or new IM sessions. Applicant further notes that for present purposes the counting of distinct IM sessions is closely analogous to counting numbers of distinct messages: the processes are involved are much simpler than tracking and displaying information relating to distinct correspondents, and none of the advantages described above relating to tracking of distinct correspondents is retained: again, for example, the advantage of being able to know that a new correspondent has attempted to communicate can be of great importance, and it is lost if simple numbers of current or new IM sessions is tracked. Applicant notes, for example, that a single correspondent can initiate an unlimited number of new IM sessions, just as he/she can send any number of e-mails or

other types of messages. Applicant's claimed solution of tracking distinct correspondents provides unique and unobvious advantages.

Far from being obvious, Applicant's claimed solutions are deceptively elegant and powerful, particularly when viewed in the context of device designs and methodology at the time the application herein was filed.

Canfield is not in the same field of invention, and teaches away from Applicant's claims

Not only does Canfield fail to teach or suggest the limitations of Applicant's claims; to the extent that it teaches, it teaches away from Applicant's invention, in a different field of communications: Canfield is concerned with processing and displaying information solely on desktop-type large-screen devices having relatively unlimited screen space and supported by relatively unlimited processing power. Canfield does not teach or suggest methods, devices, or other solutions suitable applicable to the problems faced by Applicant, or suitable for implementation on wireless communications devices, such as mobile PDAs.

In stating that Canfield discloses, "in the same field of invention," the limitations of Applicant's claims, at page 5 of the Detailed Action the Examiner points to Canfield's paragraph [0026]. At that location, the Examiner notes, Canfield states that "in another implementation, such devices [as a mobile telephone 192, a PDA 193] may themselves include the functionality of the general purpose computer 170 and operate as the client device 120."

This reference, however, is merely empty boilerplate patentese. Canfield provides no guidance whatever, and certainly no enabling disclosure, as to how one skilled in the relevant arts might implement the processes it teaches on a small screen device such as a wireless communication device. Through 18 columns of text and 17 sheets of drawings, Canfield describes user interface screens that could only meaningfully be implemented on large screen devices such as those depicted in Canfield's drawings. Nowhere does Canfield acknowledge, much less address, special problems associated with communicating information on wireless devices, and particularly small-screen wireless devices.

As is well understood by those skilled in the relevant arts, desktop and other fixed computer systems such as those addressed by Canfield are typically not subject to processing, communications, power, memory, or display limitations such as those faced in wireless (and particularly-small screen) systems. With relatively unlimited display space, power supply, memory, and processing power, information can be processed in ways that are much less efficient than those typically required for wireless devices.

By teaching solutions such as those shown on the large-screen displays depicted in each of its relevant figures, Canfield teaches away from Applicant's claimed invention.

Claims 76-111: rejections under 35 USC §§ 102 and 103

At pages 11 - 16 of the Detailed Action the Examiner has rejected claims 76-111 as anticipated by Wagner, or obvious over Wagner (US 2004/0155908) in view of Canfield (US 2004/0056893).

Applicant respectfully traverses. Neither Wagner nor Canfield teaches or suggests each element claimed; and each of them teaches away both from the invention claimed and from each other. Specifically:

- Neither Wagner nor Canfield, alone or in combination, teaches or suggests at least the claimed limitation of visually modifying a displayed icon to include a count of unread electronic messages concurrently with a text identifier associated with a correspondent from whom the at least one of the plurality of electronic messages was received.
- As noted above, Canfield does not teach or suggest methods, devices, or other solutions suitable for implementation on wireless communications devices, such as mobile PDAs. Canfield is concerned solely with desktop-type large screen devices having unlimited screen space and processing power.

Applicant reiterates that both Wagner and Canfield qualify as prior art against the application herein, if at all, solely under 35 USC 102(e). While Applicant submits that the claims as presented distinguish Wagner and Canfield on their merits, Applicant

respectfully and expressly reserves all right to establish prior invention in order to establish that neither Wagner nor Canfield is valid prior art against this application or the claims presented herein.

Legal Standard

Anticipation

A claim is anticipated if, and only if, each and every element set forth in the claim is either expressly or inherently described in a single prior art reference. *Verdegaal Bros. v. Union Oil Co. of California*, 814 F.2d 628, 631, 2 USPQ2d 1051, 1053 (Fed. Cir. 1987). All elements of the claim must be shown in the single reference, *Richardson v. Suzuki Motor Co.*, 868 F.2d 1226, 1236, 9 USPQ2d 1913, 1920 (Fed. Cir. 1989). Moreover, a patent claim "cannot be anticipated by a prior art reference if the allegedly anticipatory disclosures cited as prior art are not enabled." *Elan Pharm., Inc. v. Mayo Found. for Med. Educ. & Research*, 346 F.3d 1051, 1054 (Fed. Cir. 2003); *Rasmusson and Reynolds v. SmithKline Beecham Corp.*, case 04-1191, -1192 (Fed. Cir. 2005).

As noted in *Richardson v. Suzuki*, 15 USPQ.2d 1913 (cited at MPEP 2131.01), "The identical invention must be shown in as complete detail as is contained in the claim."

Obviousness

The legal standard for obviousness is set forth above.

Analysis

For purposes of this response, Claim 76 is representative. Claim 76, as rewritten for clarity, recites a method of providing notifications of unread messages on a wireless communication device. The method comprises visually modifying at least one displayed electronic messaging icon to include a count of a plurality of unread electronic messages which remain unread; and displaying concurrently with the visually-modified icon a text identifier associated with a correspondent from whom the at least one of the plurality of electronic messages was received.

Claims 77-84 depend from claim 76. Claims 85-102 recite corresponding computer-readable memories. Claims 103-111 recite corresponding wireless communication devices.

The claims have been rewritten to clarify that the visually-modified icon is displayed concurrently with the text identifier as shown, for example, in Figures 6, 7, and 8. No such methods or devices are disclosed or suggested by the cited references.

For clarity, Applicant notes that to say that the visually-modified icon and text identifier are shown concurrently means that at some point in time both items are displayed on the same interface screen, as shown for example in Figures 6, 7, and 8.

The passages of Wagner cited by the Examiner suggest the display of various items, but are silent as to the possibility of any of them being concurrently displayed. Moreover, it is not at all clear that Wagner is suggesting the display of an identifier of a correspondent from whom a message has been received in conjunction with an application icon; and no such thing is taught in an enabling way. Rather, the passage relied upon by the Examiner for establishing this proposition (paragraph [0080]) appears to suggest that some vague (and certainly undisclosed) information pertaining to a correspondent might be displayed in some vague (and undisclosed) manner:

[0080] In addition, the user action proxy 612 can interpret a combination of service activities to mean a particular event. That is, the user action proxy 612 monitors the services of each user and notices particular patterns that may occur within the services. When such patterns are detected, the user action proxy 612 can notify the user that the user should potentially take action regarding the pattern. For example, a user may have a note in their "to-do" list on their calendaring application that says "Call Bob." In addition, the user may have an appointment with Bob at 3:00 p.m. stored in the user's calendar. Then, for example, Bob may call the user and leave a voice mail for the user. In this example, the user action proxy 612 will notice that Bob is a common theme within the services and applications, and as such, may send the user an alert indicating something important may be occurring regarding Bob.

A suggestion in this context that "the user proxy 612 will notice that Bob is a common theme within the services and applications, and as such, may send the user an alert indicating something important may be occurring regarding Bob" does not amount to an enabling disclosure that an identifier associated with a sender of unread messages may

be displayed together with an icon, in the manner claimed by Applicant. There is no suggestion that it might be advantageous to provide such information in conjunction with an icon showing a number of unread messages, and no teaching of any manner of doing so.

Thus Wagner anticipates none of claims 76 – 111.

To the extent that it teaches communications processes, Canfield teaches away from both Applicant's claimed innovation and from Wagner.

Wagner is concerned with providing modified navigation techniques for a variety of mobile applications, including news services, etc. It appears to suggest a number of distinct, independent means of imparting different forms of information. It does not teach or suggest Applicant's elegant, claimed solutions regarding communications notifications.

Canfield, as noted above, is concerned with displays suitable for use with desktop-type large screens having relatively unlimited screen space and supported by relatively unlimited processing power. Canfield does not teach or suggest methods, devices, or other solutions suitable applicable to the problems faced by Applicant, or suitable for implementation on wireless communications devices, such as mobile PDAs, and particularly those incorporating small-screen displays.

By teaching solutions such as those shown on the large-screen displays depicted in each of its relevant figures, Canfield teaches away from Applicant's claimed invention.

Dependent Claims

Claims 53-57, 59-63, 65-69, 71-75, 77-84, 86-93, 95-102, and 104-111 depend from claims 52, 58, 64, 70, 76, 85, 94, and 103 respectively, and are allowable for at least the reasons outlined above.

Applicant disagrees strongly with the characterization of the cited references relative to many of the dependent claims provided by the Examiner at pages 3 – 16 of the Detailed Action. However, in view of the clear patentability of each of the independent claims for

the reasons cited above, and in the interest of advancing the application without delay and in the clearest possible matter, Applicant defers at the present time from providing detailed arguments.

Applicant hereby expressly reserves all right to provide separate reasons for patentability of any or all of the dependent claims presented herein, if and as necessary or desirable in future.

Status of Related Applications

The following US, foreign, and international patent applications are or may be considered to be related to the application herein. Relevant documents pertaining to such cases are being provided or have been provided in one or more separately-filed Information Disclosure Statements. The status of such applications, as currently understood by Applicant, is summarized in order to ensure that the Office is fully apprised of the current state thereof. In the event the Office has any questions about the identified cases, the Examiner is requested to call Applicant's representative at the number below.

Applicant respectfully reminds the Examiner that the claims herein correspond to claims allowed in the Japanese application. Relevant documents have previously been provided via Information Disclosure Statement.

Serial No.	Country	Status
2006-541762	Japan	Granted
0871404	Rep of Korea	Granted
200480039930.2	China	Registered
200810099973.X	China	Registered
3113/DELP/2006	India	Pending – in examination
04713831.8	EPO	Closed - divisionals filed
08168419.3	EPO	Pending – oral proceedings
10177958.5	EPO	Pending - search report received
10177959.3	EPO	Pending - search report received
07100038.7	Hong Kong	Pending – awaiting allowance in EPO
200603555-4	Singapore	Pending – awaiting allowance in US or EPO
200804162.6	Singapore	Pending – In examination

Attorney Docket No. 05200204-272US

PATENT
Serial No. 10/784,781

2,548,598	Canada	Pending – in examination
2,732,050	Canada	Pending - in examination
2,727,763	Canada	Pending - in examination
CA2004/000263	PCT	Expired (NPE entered as above)

CONCLUSION

Applicant believes that it has responded to each ground of rejection raised by the Examiner, and that for at least the reasons cited above the claims, as presented, are in condition for immediate allowance. Applicant respectfully requests reconsideration and immediate allowance of the claims.

Applicant believes that no fees other than a one-month extension of time are due in connection with the filing of this paper. In the event that the office determines that any further fee is due, Appellant requests that such fee be charged to its Deposit Account No. 195113.

Applicant is concerned to advance this application as quickly as is reasonably possible. Accordingly, Applicant respectfully reiterates its request that, in the event the Examiner has any further questions about this application, the Examiner call Applicant's attorney at the number provided below.

Respectfully submitted,

Dated: _____September 8, 2011_____

_____/matthew j. marquardt/_____

Matthew J. MARQUARDT
Reg. No. 40,997
Attorney for the Applicant
NORTON ROSE OR LLP
Royal Bank Plaza, South Tower
200 Bay Street, P.O. Box 84
Toronto, Ontario M5J 2Z4
CANADA
Tel. 416-216-4789
Fax 416-216-3930

Under the paperwork Reduction Act of 1995, no persons are required to respond to a collection of information unless it displays a valid OMB control number.

PETITION FOR EXTENSION OF TIME UNDER 37 CFR 1.136(a)		Docket Number (Optional)
FY 2009 <i>(Fees pursuant to the Consolidated Appropriations Act, 2005 (H.R. 4818).)</i>		05200204-272US
Application Number 10784781		Filed February 24, 2004
For PREVIEWING A NEW EVENT ON A SMALL SCREEN DEVICE		
Art Unit 2179		Examiner HEFFINGTON, John M.
This is a request under the provisions of 37 CFR 1.136(a) to extend the period for filing a reply in the above identified application.		
The requested extension and fee are as follows (check time period desired and enter the appropriate fee below):		
	<u>Fee</u>	<u>Small Entity Fee</u>
<input checked="" type="checkbox"/> One month (37 CFR 1.17(a)(1))	\$130	\$65 \$ <u>130.00</u>
<input type="checkbox"/> Two months (37 CFR 1.17(a)(2))	\$490	\$245 \$ _____
<input type="checkbox"/> Three months (37 CFR 1.17(a)(3))	\$1110	\$555 \$ _____
<input type="checkbox"/> Four months (37 CFR 1.17(a)(4))	\$1730	\$865 \$ _____
<input type="checkbox"/> Five months (37 CFR 1.17(a)(5))	\$2350	\$1175 \$ _____
<input type="checkbox"/> Applicant claims small entity status. See 37 CFR 1.27.		
<input type="checkbox"/> A check in the amount of the fee is enclosed.		
<input type="checkbox"/> Payment by credit card. Form PTO-2038 is attached.		
<input checked="" type="checkbox"/> The Director has already been authorized to charge fees in this application to a Deposit Account.		
<input type="checkbox"/> The Director is hereby authorized to charge any fees which may be required, or credit any overpayment, to Deposit Account Number _____.		
WARNING: Information on this form may become public. Credit card information should not be included on this form. Provide credit card information and authorization on PTO-2038.		
I am the <input type="checkbox"/> applicant/inventor.		
<input type="checkbox"/> assignee of record of the entire interest. See 37 CFR 3.71. Statement under 37 CFR 3.73(b) is enclosed (Form PTO/SB/96).		
<input checked="" type="checkbox"/> attorney or agent of record. Registration Number <u>40997</u>		
<input type="checkbox"/> attorney or agent under 37 CFR 1.34. Registration number if acting under 37 CFR 1.34 _____		
<u>/matthew j. marquardt/</u>		<u>September 8, 2011</u>
Signature		Date
<u>MATTHEW J. MARQUARDT</u>		<u>416.216.4789</u>
Typed or printed name		Telephone Number
NOTE: Signatures of all the inventors or assignees of record of the entire interest or their representative(s) are required. Submit multiple forms if more than one signature is required, see below.		
<input checked="" type="checkbox"/> Total of <u>1</u> forms are submitted.		

This collection of information is required by 37 CFR 1.136(a). The information is required to obtain or retain a benefit by the public which is to file (and by the USPTO to process) an application. Confidentiality is governed by 35 U.S.C. 122 and 37 CFR 1.11 and 1.14. This collection is estimated to take 6 minutes to complete, including gathering, preparing, and submitting the completed application form to the USPTO. Time will vary depending upon the individual case. Any comments on the amount of time you require to complete this form and/or suggestions for reducing this burden, should be sent to the Chief Information Officer, U.S. Patent and Trademark Office, U.S. Department of Commerce, P.O. Box 1450, Alexandria, VA 22313-1450. DO NOT SEND FEES OR COMPLETED FORMS TO THIS ADDRESS. **SEND TO: Commissioner for Patents, P.O. Box 1450, Alexandria, VA 22313-1450.**

If you need assistance in completing the form, call 1-800-PTO-9199 and select option 2.

Privacy Act Statement

The Privacy Act of 1974 (P.L. 93-579) requires that you be given certain information in connection with your submission of the attached form related to a patent application or patent. Accordingly, pursuant to the requirements of the Act, please be advised that: (1) the general authority for the collection of this information is 35 U.S.C. 2(b)(2); (2) furnishing of the information solicited is voluntary; and (3) the principal purpose for which the information is used by the U.S. Patent and Trademark Office is to process and/or examine your submission related to a patent application or patent. If you do not furnish the requested information, the U.S. Patent and Trademark Office may not be able to process and/or examine your submission, which may result in termination of proceedings or abandonment of the application or expiration of the patent.

The information provided by you in this form will be subject to the following routine uses:

1. The information on this form will be treated confidentially to the extent allowed under the Freedom of Information Act (5 U.S.C. 552) and the Privacy Act (5 U.S.C. 552a). Records from this system of records may be disclosed to the Department of Justice to determine whether disclosure of these records is required by the Freedom of Information Act.
2. A record from this system of records may be disclosed, as a routine use, in the course of presenting evidence to a court, magistrate, or administrative tribunal, including disclosures to opposing counsel in the course of settlement negotiations.
3. A record in this system of records may be disclosed, as a routine use, to a Member of Congress submitting a request involving an individual, to whom the record pertains, when the individual has requested assistance from the Member with respect to the subject matter of the record.
4. A record in this system of records may be disclosed, as a routine use, to a contractor of the Agency having need for the information in order to perform a contract. Recipients of information shall be required to comply with the requirements of the Privacy Act of 1974, as amended, pursuant to 5 U.S.C. 552a(m).
5. A record related to an International Application filed under the Patent Cooperation Treaty in this system of records may be disclosed, as a routine use, to the International Bureau of the World Intellectual Property Organization, pursuant to the Patent Cooperation Treaty.
6. A record in this system of records may be disclosed, as a routine use, to another federal agency for purposes of National Security review (35 U.S.C. 181) and for review pursuant to the Atomic Energy Act (42 U.S.C. 218(c)).
7. A record from this system of records may be disclosed, as a routine use, to the Administrator, General Services, or his/her designee, during an inspection of records conducted by GSA as part of that agency's responsibility to recommend improvements in records management practices and programs, under authority of 44 U.S.C. 2904 and 2906. Such disclosure shall be made in accordance with the GSA regulations governing inspection of records for this purpose, and any other relevant (i.e., GSA or Commerce) directive. Such disclosure shall not be used to make determinations about individuals.
8. A record from this system of records may be disclosed, as a routine use, to the public after either publication of the application pursuant to 35 U.S.C. 122(b) or issuance of a patent pursuant to 35 U.S.C. 151. Further, a record may be disclosed, subject to the limitations of 37 CFR 1.14, as a routine use, to the public if the record was filed in an application which became abandoned or in which the proceedings were terminated and which application is referenced by either a published application, an application open to public inspection or an issued patent.
9. A record from this system of records may be disclosed, as a routine use, to a Federal, State, or local law enforcement agency, if the USPTO becomes aware of a violation or potential violation of law or regulation.

INFORMATION DISCLOSURE STATEMENT BY APPLICANT (Not for submission under 37 CFR 1.99)	Application Number	10784781
	Filing Date	2004-02-24
	First Named Inventor	Gerhard D. KLASSEN
	Art Unit	2172
	Examiner Name	HEFFINGTON, John M.
	Attorney Docket Number	05200204-272US

U.S.PATENTS							Remove	
Examiner Initial*	Cite No	Patent Number	Kind Code ¹	Issue Date	Name of Patentee or Applicant of cited Document	Pages,Columns,Lines where Relevant Passages or Relevant Figures Appear		
	1							
If you wish to add additional U.S. Patent citation information please click the Add button.							Add	
U.S.PATENT APPLICATION PUBLICATIONS							Remove	
Examiner Initial*	Cite No	Publication Number	Kind Code ¹	Publication Date	Name of Patentee or Applicant of cited Document	Pages,Columns,Lines where Relevant Passages or Relevant Figures Appear		
	1	20030013483		2003-01-16	Ausems et al			
If you wish to add additional U.S. Published Application citation information please click the Add button.							Add	
FOREIGN PATENT DOCUMENTS							Remove	
Examiner Initial*	Cite No	Foreign Document Number ³	Country Code ² j	Kind Code ⁴	Publication Date	Name of Patentee or Applicant of cited Document	Pages,Columns,Lines where Relevant Passages or Relevant Figures Appear	T ⁵
	1							<input type="checkbox"/>
If you wish to add additional Foreign Patent Document citation information please click the Add button							Add	
NON-PATENT LITERATURE DOCUMENTS							Remove	
Examiner Initials*	Cite No	Include name of the author (in CAPITAL LETTERS), title of the article (when appropriate), title of the item (book, magazine, journal, serial, symposium, catalog, etc), date, pages(s), volume-issue number(s), publisher, city and/or country where published.						T ⁵

INFORMATION DISCLOSURE STATEMENT BY APPLICANT (Not for submission under 37 CFR 1.99)	Application Number		10784781
	Filing Date		2004-02-24
	First Named Inventor	Gerhard D. KLASSEN	
	Art Unit		2172
	Examiner Name	HEFFINGTON, John M.	
	Attorney Docket Number		05200204-272US

1	Response to Examination Report issued by the Canadian Intellectual Property Office against corresponding Canadian Application No. 2,548,598 dated May 20, 2011	<input type="checkbox"/>
2	Examiner's Requisition issued by the Canadian Intellectual Property Office against corresponding Canadian Application No. 2,727,763 dated March 21, 2011 along with Applicant's response dated June 21, 2011;	<input type="checkbox"/>
3	Examiner's Requisition issued by the Canadian Intellectual Property Office against corresponding Canadian Application No. 2,732,050 dated April 14, 2011 along with Applicant's response dated July 13, 2011;	<input type="checkbox"/>
4	Examiner's Search Report and Written Opinion issued by the Intellectual Property Office of Singapore against corresponding Singapore Patent Application No. 200804162-6 dated April 12, 2011	<input type="checkbox"/>
5	Summons to attend oral proceedings pursuant to Rule 115(1) EPC in corresponding European Patent Application No. 08168419.3 dated February 2, 2011	<input type="checkbox"/>
6	Response from Barker Brettell to European Patent Office dated May 12, 2011 to summons to attend oral proceedings in corresponding European Patent Application No. 08168419.3	<input type="checkbox"/>
7	First, Second and Third Auxiliary Requests dated June 14, 2011	<input type="checkbox"/>
8	"10 Minute Guide to Pocket PC 2002"; Copyright 2003 by Que; XP007916815; ISBN 0-7897-2797-8; Library of Congress Catalog Card No. 2002103976; U.S.A.; September, 2002; Wiegand, G. et al	<input type="checkbox"/>
9	Response from Barker Brettell to European Patent Office dated June 1, 2011 to Extended European Search Report in corresponding European Patent Application No. 10177958.5	<input type="checkbox"/>
10	EPO to Barker Brettell dated August 22, 2011; Provision of a copy of the minutes of the oral proceedings dated June 14, 2011, in accordance with Rule 124(4)EPC in corresponding European Patent Application No. 08168419.3	<input type="checkbox"/>
11	EPO to Barker Brettell dated August 22, 2011; Decision to refuse a European Patent application at the oral proceedings dated June 14, 2011 in corresponding European Patent Application No. 08168419.3	<input type="checkbox"/>

INFORMATION DISCLOSURE STATEMENT BY APPLICANT (Not for submission under 37 CFR 1.99)	Application Number	10784781
	Filing Date	2004-02-24
	First Named Inventor	Gerhard D. KLASSEN
	Art Unit	2172
	Examiner Name	HEFFINGTON, John M.
	Attorney Docket Number	05200204-272US

If you wish to add additional non-patent literature document citation information please click the Add button Add			
EXAMINER SIGNATURE			
Examiner Signature		Date Considered	
<p>*EXAMINER: Initial if reference considered, whether or not citation is in conformance with MPEP 609. Draw line through a citation if not in conformance and not considered. Include copy of this form with next communication to applicant.</p>			
<p><small>¹ See Kind Codes of USPTO Patent Documents at www.USPTO.GOV or MPEP 901.04. ² Enter office that issued the document, by the two-letter code (WIPO Standard ST.3). ³ For Japanese patent documents, the indication of the year of the reign of the Emperor must precede the serial number of the patent document. ⁴ Kind of document by the appropriate symbols as indicated on the document under WIPO Standard ST.16 if possible. ⁵ Applicant is to place a check mark here if English language translation is attached.</small></p>			

INFORMATION DISCLOSURE STATEMENT BY APPLICANT (Not for submission under 37 CFR 1.99)	Application Number	10784781
	Filing Date	2004-02-24
	First Named Inventor	Gerhard D. KLASSEN
	Art Unit	2172
	Examiner Name	HEFFINGTON, John M.
	Attorney Docket Number	05200204-272US

CERTIFICATION STATEMENT

Please see 37 CFR 1.97 and 1.98 to make the appropriate selection(s):

That each item of information contained in the information disclosure statement was first cited in any communication from a foreign patent office in a counterpart foreign application not more than three months prior to the filing of the information disclosure statement. See 37 CFR 1.97(e)(1).

OR

That no item of information contained in the information disclosure statement was cited in a communication from a foreign patent office in a counterpart foreign application, and, to the knowledge of the person signing the certification after making reasonable inquiry, no item of information contained in the information disclosure statement was known to any individual designated in 37 CFR 1.56(c) more than three months prior to the filing of the information disclosure statement. See 37 CFR 1.97(e)(2).

See attached certification statement.

The fee set forth in 37 CFR 1.17 (p) has been submitted herewith.

A certification statement is not submitted herewith.

SIGNATURE

A signature of the applicant or representative is required in accordance with CFR 1.33, 10.18. Please see CFR 1.4(d) for the form of the signature.

Signature	/matthew j. marquardt/	Date (YYYY-MM-DD)	2011-09-08
Name/Print	MATTHEW J. MARQUARDT	Registration Number	40997

This collection of information is required by 37 CFR 1.97 and 1.98. The information is required to obtain or retain a benefit by the public which is to file (and by the USPTO to process) an application. Confidentiality is governed by 35 U.S.C. 122 and 37 CFR 1.14. This collection is estimated to take 1 hour to complete, including gathering, preparing and submitting the completed application form to the USPTO. Time will vary depending upon the individual case. Any comments on the amount of time you require to complete this form and/or suggestions for reducing this burden, should be sent to the Chief Information Officer, U.S. Patent and Trademark Office, U.S. Department of Commerce, P.O. Box 1450, Alexandria, VA 22313-1450. **DO NOT SEND FEES OR COMPLETED FORMS TO THIS ADDRESS. SEND TO: Commissioner for Patents, P.O. Box 1450, Alexandria, VA 22313-1450.**

Privacy Act Statement

The Privacy Act of 1974 (P.L. 93-579) requires that you be given certain information in connection with your submission of the attached form related to a patent application or patent. Accordingly, pursuant to the requirements of the Act, please be advised that: (1) the general authority for the collection of this information is 35 U.S.C. 2(b)(2); (2) furnishing of the information solicited is voluntary; and (3) the principal purpose for which the information is used by the U.S. Patent and Trademark Office is to process and/or examine your submission related to a patent application or patent. If you do not furnish the requested information, the U.S. Patent and Trademark Office may not be able to process and/or examine your submission, which may result in termination of proceedings or abandonment of the application or expiration of the patent.

The information provided by you in this form will be subject to the following routine uses:

1. The information on this form will be treated confidentially to the extent allowed under the Freedom of Information Act (5 U.S.C. 552) and the Privacy Act (5 U.S.C. 552a). Records from this system of records may be disclosed to the Department of Justice to determine whether the Freedom of Information Act requires disclosure of these records.
2. A record from this system of records may be disclosed, as a routine use, in the course of presenting evidence to a court, magistrate, or administrative tribunal, including disclosures to opposing counsel in the course of settlement negotiations.
3. A record in this system of records may be disclosed, as a routine use, to a Member of Congress submitting a request involving an individual, to whom the record pertains, when the individual has requested assistance from the Member with respect to the subject matter of the record.
4. A record in this system of records may be disclosed, as a routine use, to a contractor of the Agency having need for the information in order to perform a contract. Recipients of information shall be required to comply with the requirements of the Privacy Act of 1974, as amended, pursuant to 5 U.S.C. 552a(m).
5. A record related to an International Application filed under the Patent Cooperation Treaty in this system of records may be disclosed, as a routine use, to the International Bureau of the World Intellectual Property Organization, pursuant to the Patent Cooperation Treaty.
6. A record in this system of records may be disclosed, as a routine use, to another federal agency for purposes of National Security review (35 U.S.C. 181) and for review pursuant to the Atomic Energy Act (42 U.S.C. 218(c)).
7. A record from this system of records may be disclosed, as a routine use, to the Administrator, General Services, or his/her designee, during an inspection of records conducted by GSA as part of that agency's responsibility to recommend improvements in records management practices and programs, under authority of 44 U.S.C. 2904 and 2906. Such disclosure shall be made in accordance with the GSA regulations governing inspection of records for this purpose, and any other relevant (i.e., GSA or Commerce) directive. Such disclosure shall not be used to make determinations about individuals.
8. A record from this system of records may be disclosed, as a routine use, to the public after either publication of the application pursuant to 35 U.S.C. 122(b) or issuance of a patent pursuant to 35 U.S.C. 151. Further, a record may be disclosed, subject to the limitations of 37 CFR 1.14, as a routine use, to the public if the record was filed in an application which became abandoned or in which the proceedings were terminated and which application is referenced by either a published application, an application open to public inspections or an issued patent.
9. A record from this system of records may be disclosed, as a routine use, to a Federal, State, or local law enforcement agency, if the USPTO becomes aware of a violation or potential violation of law or regulation.

Electronic Patent Application Fee Transmittal				
Application Number:	10784781			
Filing Date:	24-Feb-2004			
Title of Invention:	Previewing a new event on a small screen device			
First Named Inventor/Applicant Name:	Gerhard D. Klassen			
Filer:	Matthew J. Marquardt/Heidi Umstadt			
Attorney Docket Number:	05200204-272US			
Filed as Large Entity				
Utility under 35 USC 111(a) Filing Fees				
Description	Fee Code	Quantity	Amount	Sub-Total in USD(\$)
Basic Filing:				
Pages:				
Claims:				
Miscellaneous-Filing:				
Petition:				
Patent-Appeals-and-Interference:				
Post-Allowance-and-Post-Issuance:				
Extension-of-Time:				
Extension - 1 month with \$0 paid	1251	1	130	130

Description	Fee Code	Quantity	Amount	Sub-Total in USD(\$)
Miscellaneous:				
Submission- Information Disclosure Stmt	1806	1	180	180
Total in USD (\$)				310

Electronic Acknowledgement Receipt	
EFS ID:	10901995
Application Number:	10784781
International Application Number:	
Confirmation Number:	2200
Title of Invention:	Previewing a new event on a small screen device
First Named Inventor/Applicant Name:	Gerhard D. Klassen
Customer Number:	20988
Filer:	Matthew J. Marquardt/Heidi Umstadt
Filer Authorized By:	Matthew J. Marquardt
Attorney Docket Number:	05200204-272US
Receipt Date:	08-SEP-2011
Filing Date:	24-FEB-2004
Time Stamp:	12:37:47
Application Type:	Utility under 35 USC 111(a)

Payment information:

Submitted with Payment	yes
Payment Type	Deposit Account
Payment was successfully received in RAM	\$ 310
RAM confirmation Number	12601
Deposit Account	195113
Authorized User	
The Director of the USPTO is hereby authorized to charge indicated fees and credit any overpayment as follows: Charge any Additional Fees required under 37 C.F.R. Section 1.21 (Miscellaneous fees and charges)	

File Listing:					
Document Number	Document Description	File Name	File Size(Bytes)/ Message Digest	Multi Part /.zip	Pages (if appl.)
1	Amendment Copy Claims/Response to Suggested Claims	Response.pdf	1215768 8963a26bc660f8e612896994bc43f6ea33ba25c	no	27
Warnings:					
Information:					
2	Extension of Time	sb0022.pdf	312361 32e53f840fedea0adf17e5785561d3721b7ba90d	no	2
Warnings:					
Information:					
3	Information Disclosure Statement (IDS) Form (SB08)	updated_IDS.pdf	613151 e71bdbb85dd8cb75551e918a380503674383e373	no	5
Warnings:					
Information:					
4	Non Patent Literature	NPL1.pdf	858093 f6e9e8be8f0180a6097786b8f98b9c1c6c58c6ff	no	16
Warnings:					
Information:					
5	Non Patent Literature	NPL2.pdf	99844 b082c79b4a864d3ac0e534122f27f7529c10f842	no	2
Warnings:					
Information:					
6	Non Patent Literature	NPL3.pdf	1419673 0e238dadfb2bfe96509786e79e08c0823a4d03a6b	no	28
Warnings:					
Information:					
7	Non Patent Literature	NPL4.pdf	195131 9b4682816f932fb2064f5eea1fd1664266c26fa3	no	4
Warnings:					
Information:					
8	Non Patent Literature	NPL5.pdf	240893 bfca34f543a66318270472197589e11e2eea5e93	no	7
Warnings:					
Information:					

9	Non Patent Literature	NPL6.pdf	477009	no	14
			8835fda9703d20838e6397fd5fd1ca3bcdb0333		
Warnings:					
Information:					
10	Non Patent Literature	NPL7.pdf	391386	no	9
			a8fcf7420a1b925ac0e4c68a8bb9363e3f513a97		
Warnings:					
Information:					
11	Non Patent Literature	NPL8.pdf	602665	no	8
			c3829ec31c47b26de172b2754ba9e0f8d602082e		
Warnings:					
Information:					
12	Non Patent Literature	NPL9.pdf	191029	no	4
			7edd27718e5673ae47adcc0c3db103be2ee05913		
Warnings:					
Information:					
13	Non Patent Literature	NPL10.pdf	321753	no	9
			e324cf0ff4676f0435adacc22daf240279225ec		
Warnings:					
Information:					
14	Non Patent Literature	NPL11.pdf	438408	no	8
			e640d46705f7106ab373b8fd4091be58c2d23897		
Warnings:					
Information:					
15	Non Patent Literature	NPL12.pdf	632872	no	16
			62b1f0e7249beb0782285091d6b4131a4d3da60c		
Warnings:					
Information:					
16	Non Patent Literature	NPL13.pdf	1154390	no	27
			5ed6681962c21c2b5d1108dac5d5434c035aac2c		
Warnings:					
Information:					
17	Fee Worksheet (SB06)	fee-info.pdf	31816	no	2
			c31f5bfa25c7da64ca1806c6b0e35414a1d38be		
Warnings:					
Information:					

This Acknowledgement Receipt evidences receipt on the noted date by the USPTO of the indicated documents, characterized by the applicant, and including page counts, where applicable. It serves as evidence of receipt similar to a Post Card, as described in MPEP 503.

New Applications Under 35 U.S.C. 111

If a new application is being filed and the application includes the necessary components for a filing date (see 37 CFR 1.53(b)-(d) and MPEP 506), a Filing Receipt (37 CFR 1.54) will be issued in due course and the date shown on this Acknowledgement Receipt will establish the filing date of the application.

National Stage of an International Application under 35 U.S.C. 371

If a timely submission to enter the national stage of an international application is compliant with the conditions of 35 U.S.C. 371 and other applicable requirements a Form PCT/DO/EO/903 indicating acceptance of the application as a national stage submission under 35 U.S.C. 371 will be issued in addition to the Filing Receipt, in due course.

New International Application Filed with the USPTO as a Receiving Office

If a new international application is being filed and the international application includes the necessary components for an international filing date (see PCT Article 11 and MPEP 1810), a Notification of the International Application Number and of the International Filing Date (Form PCT/RO/105) will be issued in due course, subject to prescriptions concerning national security, and the date shown on this Acknowledgement Receipt will establish the international filing date of the application.

Under the Paperwork Reduction Act of 1995, no persons are required to respond to a collection of information unless it displays a valid OMB control number.

PATENT APPLICATION FEE DETERMINATION RECORD Substitute for Form PTO-875				Application or Docket Number 10/784,781		Filing Date 02/24/2004		<input type="checkbox"/> To be Mailed			
APPLICATION AS FILED – PART I						OTHER THAN					
(Column 1)		(Column 2)		SMALL ENTITY <input type="checkbox"/>		OR		SMALL ENTITY			
FOR		NUMBER FILED		NUMBER EXTRA		RATE (\$)		FEE (\$)			
<input type="checkbox"/> BASIC FEE <small>(37 CFR 1.16(a), (b), or (c))</small>		N/A		N/A		N/A		N/A			
<input type="checkbox"/> SEARCH FEE <small>(37 CFR 1.16(k), (l), or (m))</small>		N/A		N/A		N/A		N/A			
<input type="checkbox"/> EXAMINATION FEE <small>(37 CFR 1.16(o), (p), or (q))</small>		N/A		N/A		N/A		N/A			
TOTAL CLAIMS <small>(37 CFR 1.16(i))</small>		minus 20 =		*		X \$ =		OR X \$ =			
INDEPENDENT CLAIMS <small>(37 CFR 1.16(h))</small>		minus 3 =		*		X \$ =		OR X \$ =			
<input type="checkbox"/> APPLICATION SIZE FEE <small>(37 CFR 1.16(s))</small>		If the specification and drawings exceed 100 sheets of paper, the application size fee due is \$250 (\$125 for small entity) for each additional 50 sheets or fraction thereof. See 35 U.S.C. 41(a)(1)(G) and 37 CFR 1.16(s).									
<input type="checkbox"/> MULTIPLE DEPENDENT CLAIM PRESENT <small>(37 CFR 1.16(j))</small>											
* If the difference in column 1 is less than zero, enter "0" in column 2.											
APPLICATION AS AMENDED – PART II						OTHER THAN					
(Column 1)		(Column 2)		(Column 3)		SMALL ENTITY		OR		SMALL ENTITY	
AMENDMENT	09/08/2011	CLAIMS REMAINING AFTER AMENDMENT		HIGHEST NUMBER PREVIOUSLY PAID FOR	PRESENT EXTRA	RATE (\$)	ADDITIONAL FEE (\$)		RATE (\$)	ADDITIONAL FEE (\$)	
	Total <small>(37 CFR 1.16(i))</small>	* 45	Minus	** 60	=	X \$ =		OR	X \$ =		
	Independent <small>(37 CFR 1.16(b))</small>	* 6	Minus	***8	=	X \$ =		OR	X \$ =		
	<input type="checkbox"/> Application Size Fee <small>(37 CFR 1.16(s))</small>										
	<input type="checkbox"/> FIRST PRESENTATION OF MULTIPLE DEPENDENT CLAIM <small>(37 CFR 1.16(j))</small>										
(Column 1)		(Column 2)		(Column 3)		TOTAL ADD'L FEE		OR		TOTAL ADD'L FEE	
AMENDMENT		CLAIMS REMAINING AFTER AMENDMENT		HIGHEST NUMBER PREVIOUSLY PAID FOR	PRESENT EXTRA	RATE (\$)	ADDITIONAL FEE (\$)		RATE (\$)	ADDITIONAL FEE (\$)	
	Total <small>(37 CFR 1.16(i))</small>	*	Minus	**	=	X \$ =		OR	X \$ =		
	Independent <small>(37 CFR 1.16(b))</small>	*	Minus	***	=	X \$ =		OR	X \$ =		
	<input type="checkbox"/> Application Size Fee <small>(37 CFR 1.16(s))</small>										
	<input type="checkbox"/> FIRST PRESENTATION OF MULTIPLE DEPENDENT CLAIM <small>(37 CFR 1.16(j))</small>										
(Column 1)		(Column 2)		(Column 3)		TOTAL ADD'L FEE		OR		TOTAL ADD'L FEE	
* If the entry in column 1 is less than the entry in column 2, write "0" in column 3.											
** If the "Highest Number Previously Paid For" IN THIS SPACE is less than 20, enter "20".											
*** If the "Highest Number Previously Paid For" IN THIS SPACE is less than 3, enter "3".											
The "Highest Number Previously Paid For" (Total or Independent) is the highest number found in the appropriate box in column 1.											
Legal Instrument Examiner: /TERRANCE LAWRENCE/											

This collection of information is required by 37 CFR 1.16. The information is required to obtain or retain a benefit by the public which is to file (and by the USPTO to process) an application. Confidentiality is governed by 35 U.S.C. 122 and 37 CFR 1.14. This collection is estimated to take 12 minutes to complete, including gathering, preparing, and submitting the completed application form to the USPTO. Time will vary depending upon the individual case. Any comments on the amount of time you require to complete this form and/or suggestions for reducing this burden, should be sent to the Chief Information Officer, U.S. Patent and Trademark Office, U.S. Department of Commerce, P.O. Box 1450, Alexandria, VA 22313-1450. DO NOT SEND FEES OR COMPLETED FORMS TO THIS ADDRESS. **SEND TO: Commissioner for Patents, P.O. Box 1450, Alexandria, VA 22313-1450.**

If you need assistance in completing the form, call 1-800-PTO-9199 and select option 2.

INFORMATION DISCLOSURE STATEMENT BY APPLICANT (Not for submission under 37 CFR 1.99)	Application Number	10784781
	Filing Date	2004-02-24
	First Named Inventor	Gerhard D. KLASSEN
	Art Unit	2179
	Examiner Name	HEFFINGTON, John M.
	Attorney Docket Number	05200204-272US

U.S.PATENTS							Remove	
Examiner Initial*	Cite No	Patent Number	Kind Code ¹	Issue Date	Name of Patentee or Applicant of cited Document	Pages,Columns,Lines where Relevant Passages or Relevant Figures Appear		
	1							
If you wish to add additional U.S. Patent citation information please click the Add button.							Add	
U.S.PATENT APPLICATION PUBLICATIONS							Remove	
Examiner Initial*	Cite No	Publication Number	Kind Code ¹	Publication Date	Name of Patentee or Applicant of cited Document	Pages,Columns,Lines where Relevant Passages or Relevant Figures Appear		
	1							
If you wish to add additional U.S. Published Application citation information please click the Add button.							Add	
FOREIGN PATENT DOCUMENTS							Remove	
Examiner Initial*	Cite No	Foreign Document Number ³	Country Code ² j	Kind Code ⁴	Publication Date	Name of Patentee or Applicant of cited Document	Pages,Columns,Lines where Relevant Passages or Relevant Figures Appear	T ⁵
	1							<input type="checkbox"/>
If you wish to add additional Foreign Patent Document citation information please click the Add button							Add	
NON-PATENT LITERATURE DOCUMENTS							Remove	
Examiner Initials*	Cite No	Include name of the author (in CAPITAL LETTERS), title of the article (when appropriate), title of the item (book, magazine, journal, serial, symposium, catalog, etc), date, pages(s), volume-issue number(s), publisher, city and/or country where published.						T ⁵

INFORMATION DISCLOSURE STATEMENT BY APPLICANT (Not for submission under 37 CFR 1.99)	Application Number		10784781
	Filing Date		2004-02-24
	First Named Inventor	Gerhard D. KLASSEN	
	Art Unit	2179	
	Examiner Name	HEFFINGTON, John M.	
	Attorney Docket Number	05200204-272US	

1	Allen & Gledhill to Registrar of Patents, Singapore; Response to Written Opinion in divisional Singapore patent application no. 200804162-6 dated September 12, 2011	<input type="checkbox"/>
---	--	--------------------------

If you wish to add additional non-patent literature document citation information please click the Add button **Add**

EXAMINER SIGNATURE

Examiner Signature		Date Considered	
--------------------	--	-----------------	--

*EXAMINER: Initial if reference considered, whether or not citation is in conformance with MPEP 609. Draw line through a citation if not in conformance and not considered. Include copy of this form with next communication to applicant.

¹ See Kind Codes of USPTO Patent Documents at www.USPTO.GOV or MPEP 901.04. ² Enter office that issued the document, by the two-letter code (WIPO Standard ST.3). ³ For Japanese patent documents, the indication of the year of the reign of the Emperor must precede the serial number of the patent document. ⁴ Kind of document by the appropriate symbols as indicated on the document under WIPO Standard ST.16 if possible. ⁵ Applicant is to place a check mark here if English language translation is attached.

INFORMATION DISCLOSURE STATEMENT BY APPLICANT (Not for submission under 37 CFR 1.99)	Application Number	10784781
	Filing Date	2004-02-24
	First Named Inventor	Gerhard D. KLASSEN
	Art Unit	2179
	Examiner Name	HEFFINGTON, John M.
	Attorney Docket Number	05200204-272US

CERTIFICATION STATEMENT

Please see 37 CFR 1.97 and 1.98 to make the appropriate selection(s):

That each item of information contained in the information disclosure statement was first cited in any communication from a foreign patent office in a counterpart foreign application not more than three months prior to the filing of the information disclosure statement. See 37 CFR 1.97(e)(1).

OR

That no item of information contained in the information disclosure statement was cited in a communication from a foreign patent office in a counterpart foreign application, and, to the knowledge of the person signing the certification after making reasonable inquiry, no item of information contained in the information disclosure statement was known to any individual designated in 37 CFR 1.56(c) more than three months prior to the filing of the information disclosure statement. See 37 CFR 1.97(e)(2).

See attached certification statement.

The fee set forth in 37 CFR 1.17 (p) has been submitted herewith.

A certification statement is not submitted herewith.

SIGNATURE

A signature of the applicant or representative is required in accordance with CFR 1.33, 10.18. Please see CFR 1.4(d) for the form of the signature.

Signature	/matthew j. marquardt/	Date (YYYY-MM-DD)	2011-09-16
Name/Print	MATTHEW J. MARQUARDT	Registration Number	40997

This collection of information is required by 37 CFR 1.97 and 1.98. The information is required to obtain or retain a benefit by the public which is to file (and by the USPTO to process) an application. Confidentiality is governed by 35 U.S.C. 122 and 37 CFR 1.14. This collection is estimated to take 1 hour to complete, including gathering, preparing and submitting the completed application form to the USPTO. Time will vary depending upon the individual case. Any comments on the amount of time you require to complete this form and/or suggestions for reducing this burden, should be sent to the Chief Information Officer, U.S. Patent and Trademark Office, U.S. Department of Commerce, P.O. Box 1450, Alexandria, VA 22313-1450. **DO NOT SEND FEES OR COMPLETED FORMS TO THIS ADDRESS. SEND TO: Commissioner for Patents, P.O. Box 1450, Alexandria, VA 22313-1450.**

Privacy Act Statement

The Privacy Act of 1974 (P.L. 93-579) requires that you be given certain information in connection with your submission of the attached form related to a patent application or patent. Accordingly, pursuant to the requirements of the Act, please be advised that: (1) the general authority for the collection of this information is 35 U.S.C. 2(b)(2); (2) furnishing of the information solicited is voluntary; and (3) the principal purpose for which the information is used by the U.S. Patent and Trademark Office is to process and/or examine your submission related to a patent application or patent. If you do not furnish the requested information, the U.S. Patent and Trademark Office may not be able to process and/or examine your submission, which may result in termination of proceedings or abandonment of the application or expiration of the patent.

The information provided by you in this form will be subject to the following routine uses:

1. The information on this form will be treated confidentially to the extent allowed under the Freedom of Information Act (5 U.S.C. 552) and the Privacy Act (5 U.S.C. 552a). Records from this system of records may be disclosed to the Department of Justice to determine whether the Freedom of Information Act requires disclosure of these records.
2. A record from this system of records may be disclosed, as a routine use, in the course of presenting evidence to a court, magistrate, or administrative tribunal, including disclosures to opposing counsel in the course of settlement negotiations.
3. A record in this system of records may be disclosed, as a routine use, to a Member of Congress submitting a request involving an individual, to whom the record pertains, when the individual has requested assistance from the Member with respect to the subject matter of the record.
4. A record in this system of records may be disclosed, as a routine use, to a contractor of the Agency having need for the information in order to perform a contract. Recipients of information shall be required to comply with the requirements of the Privacy Act of 1974, as amended, pursuant to 5 U.S.C. 552a(m).
5. A record related to an International Application filed under the Patent Cooperation Treaty in this system of records may be disclosed, as a routine use, to the International Bureau of the World Intellectual Property Organization, pursuant to the Patent Cooperation Treaty.
6. A record in this system of records may be disclosed, as a routine use, to another federal agency for purposes of National Security review (35 U.S.C. 181) and for review pursuant to the Atomic Energy Act (42 U.S.C. 218(c)).
7. A record from this system of records may be disclosed, as a routine use, to the Administrator, General Services, or his/her designee, during an inspection of records conducted by GSA as part of that agency's responsibility to recommend improvements in records management practices and programs, under authority of 44 U.S.C. 2904 and 2906. Such disclosure shall be made in accordance with the GSA regulations governing inspection of records for this purpose, and any other relevant (i.e., GSA or Commerce) directive. Such disclosure shall not be used to make determinations about individuals.
8. A record from this system of records may be disclosed, as a routine use, to the public after either publication of the application pursuant to 35 U.S.C. 122(b) or issuance of a patent pursuant to 35 U.S.C. 151. Further, a record may be disclosed, subject to the limitations of 37 CFR 1.14, as a routine use, to the public if the record was filed in an application which became abandoned or in which the proceedings were terminated and which application is referenced by either a published application, an application open to public inspections or an issued patent.
9. A record from this system of records may be disclosed, as a routine use, to a Federal, State, or local law enforcement agency, if the USPTO becomes aware of a violation or potential violation of law or regulation.

Electronic Acknowledgement Receipt	
EFS ID:	10964149
Application Number:	10784781
International Application Number:	
Confirmation Number:	2200
Title of Invention:	Previewing a new event on a small screen device
First Named Inventor/Applicant Name:	Gerhard D. Klassen
Customer Number:	20988
Filer:	Matthew J. Marquardt/Heidi Umstadt
Filer Authorized By:	Matthew J. Marquardt
Attorney Docket Number:	05200204-272US
Receipt Date:	16-SEP-2011
Filing Date:	24-FEB-2004
Time Stamp:	11:40:22
Application Type:	Utility under 35 USC 111(a)

Payment information:

Submitted with Payment	no
------------------------	----

File Listing:

Document Number	Document Description	File Name	File Size(Bytes)/ Message Digest	Multi Part /.zip	Pages (if appl.)
1	Information Disclosure Statement (IDS) Form (SB08)	updated_IDS.pdf	612330 <small>dbba6397a5fa7d60c3f1be2eb1591f126b10c538</small>	no	4

Warnings:

Information:

A U.S. Patent Number Citation or a U.S. Publication Number Citation is required in the Information Disclosure Statement (IDS) form for autoloading of data into USPTO systems. You may remove the form to add the required data in order to correct the Informational Message if you are citing U.S. References. If you chose not to include U.S. References, the image of the form will be processed and be made available within the Image File Wrapper (IFW) system. However, no data will be extracted from this form. Any additional data such as Foreign Patent Documents or Non Patent Literature will be manually reviewed and keyed into USPTO systems.

2	Non Patent Literature	Response.pdf	1646017	no	47
			71f9206b3c96276c2c54be3c4c24c894c5a66fb5		

Warnings:

Information:

Total Files Size (in bytes):	2258347
-------------------------------------	---------

This Acknowledgement Receipt evidences receipt on the noted date by the USPTO of the indicated documents, characterized by the applicant, and including page counts, where applicable. It serves as evidence of receipt similar to a Post Card, as described in MPEP 503.

New Applications Under 35 U.S.C. 111

If a new application is being filed and the application includes the necessary components for a filing date (see 37 CFR 1.53(b)-(d) and MPEP 506), a Filing Receipt (37 CFR 1.54) will be issued in due course and the date shown on this Acknowledgement Receipt will establish the filing date of the application.

National Stage of an International Application under 35 U.S.C. 371

If a timely submission to enter the national stage of an international application is compliant with the conditions of 35 U.S.C. 371 and other applicable requirements a Form PCT/DO/EO/903 indicating acceptance of the application as a national stage submission under 35 U.S.C. 371 will be issued in addition to the Filing Receipt, in due course.

New International Application Filed with the USPTO as a Receiving Office

If a new international application is being filed and the international application includes the necessary components for an international filing date (see PCT Article 11 and MPEP 1810), a Notification of the International Application Number and of the International Filing Date (Form PCT/RO/105) will be issued in due course, subject to prescriptions concerning national security, and the date shown on this Acknowledgement Receipt will establish the international filing date of the application.



UNITED STATES PATENT AND TRADEMARK OFFICE

UNITED STATES DEPARTMENT OF COMMERCE
United States Patent and Trademark Office
Address: COMMISSIONER FOR PATENTS
P.O. Box 1450
Alexandria, Virginia 22313-1450
www.uspto.gov

APPLICATION NO.	FILING DATE	FIRST NAMED INVENTOR	ATTORNEY DOCKET NO.	CONFIRMATION NO.
10/784,781	02/24/2004	Gerhard D. Klassen	05200204-272US	2200
20988	7590	10/26/2011	EXAMINER	
NORTON ROSE OR LLP 1, Place Ville Marie SUITE 2500 MONTREAL, QC H3B 1R1 CANADA			HEFFINGTON, JOHN M	
			ART UNIT	PAPER NUMBER
			2172	
			MAIL DATE	DELIVERY MODE
			10/26/2011	PAPER

Please find below and/or attached an Office communication concerning this application or proceeding.

The time period for reply, if any, is set in the attached communication.

Office Action Summary	Application No. 10/784,781	Applicant(s) KLASSEN ET AL.	
	Examiner JOHN HEFFINGTON	Art Unit 2172	

-- The MAILING DATE of this communication appears on the cover sheet with the correspondence address --
Period for Reply

A SHORTENED STATUTORY PERIOD FOR REPLY IS SET TO EXPIRE 3 MONTH(S) OR THIRTY (30) DAYS, WHICHEVER IS LONGER, FROM THE MAILING DATE OF THIS COMMUNICATION.

- Extensions of time may be available under the provisions of 37 CFR 1.136(a). In no event, however, may a reply be timely filed after SIX (6) MONTHS from the mailing date of this communication.
- If NO period for reply is specified above, the maximum statutory period will apply and will expire SIX (6) MONTHS from the mailing date of this communication.
- Failure to reply within the set or extended period for reply will, by statute, cause the application to become ABANDONED (35 U.S.C. § 133). Any reply received by the Office later than three months after the mailing date of this communication, even if timely filed, may reduce any earned patent term adjustment. See 37 CFR 1.704(b).

Status

- 1) Responsive to communication(s) filed on 08 September 2011.
- 2a) This action is **FINAL**. 2b) This action is non-final.
- 3) An election was made by the applicant in response to a restriction requirement set forth during the interview on ____; the restriction requirement and election have been incorporated into this action.
- 4) Since this application is in condition for allowance except for formal matters, prosecution as to the merits is closed in accordance with the practice under *Ex parte Quayle*, 1935 C.D. 11, 453 O.G. 213.

Disposition of Claims

- 5) Claim(s) 52-57,64-84 and 94-111 is/are pending in the application.
5a) Of the above claim(s) ____ is/are withdrawn from consideration.
- 6) Claim(s) ____ is/are allowed.
- 7) Claim(s) 52-57,64-84 and 94-111 is/are rejected.
- 8) Claim(s) ____ is/are objected to.
- 9) Claim(s) ____ are subject to restriction and/or election requirement.

Application Papers

- 10) The specification is objected to by the Examiner.
- 11) The drawing(s) filed on ____ is/are: a) accepted or b) objected to by the Examiner.
Applicant may not request that any objection to the drawing(s) be held in abeyance. See 37 CFR 1.85(a).
Replacement drawing sheet(s) including the correction is required if the drawing(s) is objected to. See 37 CFR 1.121(d).
- 12) The oath or declaration is objected to by the Examiner. Note the attached Office Action or form PTO-152.

Priority under 35 U.S.C. § 119

- 13) Acknowledgment is made of a claim for foreign priority under 35 U.S.C. § 119(a)-(d) or (f).
a) All b) Some * c) None of:
1. Certified copies of the priority documents have been received.
2. Certified copies of the priority documents have been received in Application No. ____.
3. Copies of the certified copies of the priority documents have been received in this National Stage application from the International Bureau (PCT Rule 17.2(a)).
* See the attached detailed Office action for a list of the certified copies not received.

Attachment(s)

- 1) Notice of References Cited (PTO-892)
- 2) Notice of Draftsperson's Patent Drawing Review (PTO-948)
- 3) Information Disclosure Statement(s) (PTO/SB/08)
Paper No(s)/Mail Date 9/8/11, 9/16/11.
- 4) Interview Summary (PTO-413)
Paper No(s)/Mail Date. ____.
- 5) Notice of Informal Patent Application
- 6) Other: ____.

DETAILED ACTION

This action is in response to the amendment dated 8 September 2011. Claims 70-76, 94, 103, 105, 106 and 108-111 have been amended. Claims 1-51 have been previously canceled and claims 58-63 and 85-93 have been canceled. Claims 52-57, 64-84 and 94-111 are pending and have been considered below.

Response to Arguments

1. Applicant's arguments filed 8 September 2011 have been fully considered but they are not persuasive.

The applicant argues that "As acknowledged by the Examiner, the cited portions of Wagner and Canfield fail, whether considered alone or in combination, to teach or suggest at least the claimed limitation of visually modifying a displayed icon to include a character representing a count of a plurality of different messaging correspondents from whom messages have been received. The cited references are concerned primarily with a number of new messages, without regard to the correspondents from whom the messages have been received, or the number of such correspondents from whom messages have been received and remain unread. The examiner respectfully disagrees. The cited passage of Canfield states "Once the new message is viewed or acknowledged, the indicator changes and the conversation counter 650 is updated to reflect one fewer message

Art Unit: 2172

waiting to be viewed. ... Although not shown in FIG. 6, either the conversation counter 650, the indicator, or both, may distinguish between a new message received from an ongoing IM session and new message received as part of the initiation of a new IM session.” (paragraph 0054). The "conversation counter" of Canfield clearly distinguishes new messages as part of an ongoing IM session from a new message received as part of the initiation of a new IM session, i.e. a message from a new correspondent. Canfield states that this feature is not shown in figure 6. In figure 6, the "conversation counter" shows only new messages. However, paragraph 0054 makes it clear that the "conversation counter" can show two different new message counts, new messages from an ongoing IM session, and a new messages from the initiation of new IM session. Since the new message is not from the correspondent involved in an ongoing IM session, the new message from a new IM session must be from a new different correspondent.

The applicant argues that "Canfield does not teach or suggest methods, devices, or other solutions suitable for implementation on wireless communications devices, such as mobile PDAs." The examiner respectfully disagrees. Canfield discloses " ... in another implementation, such devices [as a mobile telephone 192, a PDA 193] may themselves include the functionality of the general-purpose computer 170 and operate as the client device

120.” (paragraph 0026). Canfield identifies mobile telephones and PDA as operating as the client devices in Canfield.

The applicant argues “With respect, (a) Canfield is not in the same field of invention as Applicant's claims; and (b) as Applicant and the Examiner have previously agreed with respect to Wagner, counting a number of new, unread messages is not the same as, or for present purposes analogous to, counting a number of correspondents from whom messages which remain unread have been received. To the extent that Canfield and Wagner teach counting of messages, they teach away from Applicant's claims.” As shown above, Canfield discloses that mobile telephones and PDAs may function as client devices in Canfield. With respect Wagner and Canfield teaching away from each other, Wagner discloses “As such, the informational icon label 310 for the news service displays the business headline “Tech Markets Boom.” Further, the text comprising each informational icon label 310 can be automatically updated as the state of that particular service changes as it applies to the particular user.” (paragraph 0059). As shown, Wagner discloses an informational icon label that automatically updates as the state of the particular service changes. This is analogous to Canfield providing “an identifier, such as the screen name of the IM buddy, to identify the particular IM session to which it is assigned.” (paragraph 0054).

The applicant argues that “The passages of Wagner cited by the Examiner suggest the display of various items, but are silent as to the possibility of any of them being concurrently displayed.” The examiner respectfully disagrees. As shown in figure 6 of Canfield, the "conversation counter" is displayed concurrently with the number representing the number of IMs. Canfield also discloses "... either the conversation counter 650, the indicator, or both, may distinguish between a new message received from an ongoing IM session and new message received as part of the initiation of a new IM session.” (paragraph 0054). The fact that the "conversation counter" or the indicator, each singularly, may distinguish a new message as part of an ongoing IM session from a new message received as part of the initiation of a new IM session clearly suggests that the indications of the new message as part of an ongoing IM session is displayed concurrently with indication of the new message received as part of the initiation of a new IM session.

The applicant argues that “Moreover, it is not at all clear that Wagner is suggesting the display of an identifier of a correspondent from whom a message has been received in conjunction with an application icon; and no such thing is taught in an enabling way.” The examiner respectfully disagrees. Since the "conversation counter" show the counts of IM messages, the "conversation counter" must be shown in conjunction with an IM application.

Claim Rejections - 35 USC § 103

2. The following is a quotation of 35 U.S.C. 103(a) which forms the basis for all obviousness rejections set forth in this Office action:

(a) A patent may not be obtained though the invention is not identically disclosed or described as set forth in section 102 of this title, if the differences between the subject matter sought to be patented and the prior art are such that the subject matter as a whole would have been obvious at the time the invention was made to a person having ordinary skill in the art to which said subject matter pertains. Patentability shall not be negated by the manner in which the invention was made.

3. This application currently names joint inventors. In considering patentability of the claims under 35 U.S.C. 103(a), the examiner presumes that the subject matter of the various claims was commonly owned at the time any inventions covered therein were made absent any evidence to the contrary. Applicant is advised of the obligation under 37 CFR 1.56 to point out the inventor and invention dates of each claim that was not commonly owned at the time a later invention was made in order for the examiner to consider the applicability of 35 U.S.C. 103(c) and potential 35 U.S.C. 102(e), (f) or (g) prior art under 35 U.S.C. 103(a).

4. Claims 52-75, 83, 84, 92, 93, 101, 102, 110, 111 are rejected under 35 U.S.C. 103(a) as being unpatentable over Wagner (US 2004/0155908 A1) in view of Canfield et al. (US 2004/0056893 A1).

1 - 51. (Cancelled)

Claim 52. Wagner discloses a method of providing notifications of unread messages on a wireless communication device (paragraph 0003 [This invention relates

generally to mobile devices, and more particularly to software and systems for user interfaces on mobile devices.]), comprising: displaying at least one icon relating to electronic messaging on a graphical user interface of the wireless communication device; receiving a plurality of electronic messages on the wireless communication device, the plurality of electronic messages including messages from a plurality of different messaging correspondents (paragraph 0064 [For example in FIG. 5A, the mobile device displays a ski service 502, a news service 504, a buddies service 506, a messaging service 508, ...], paragraph 0060 [As another example, a mail icon may display a counter that changes to indicate the number of unread messages a user has.], figure 3).

Wagner does not disclose in response to receiving at least one of the plurality of electronic messages, visually modifying at least one displayed icon relating to electronic messaging to include a numeric character representing a count of the plurality of different messaging correspondents for which one or more of the electronic messages have been received and remain unread, as disclosed in the claims. However, in the same field of invention, Canfield discloses “ ... in another implementation, such devices [as a mobile telephone 192, a PDA 193] may themselves include the functionality of the general-purpose computer 170 and operate as the client device 120.” (paragraph 0026) and “Once the new message is viewed or acknowledged, the indicator

Art Unit: 2172

changes and the conversation counter 650 is updated to reflect one fewer message waiting to be viewed. ... Although not shown in FIG. 6, either the conversation counter 650, the indicator, or both, may distinguish between a new message received from an ongoing IM session and new message received as part of the initiation of a new IM session.” (paragraph 0054). Therefore, considering the teachings of Wagner and Canfield, it would have been obvious to one having ordinary skill in the art at the time of the invention to add in response to receiving at least one of the plurality of electronic messages, visually modifying at least one displayed icon relating to electronic messaging to include a numeric character representing a count of the plurality of different messaging correspondents for which one or more of the electronic messages have been received and remain unread to the teachings of Wagner. One would have been motivated to add in response to receiving at least one of the plurality of electronic messages, visually modifying at least one displayed icon relating to electronic messaging to include a numeric character representing a count of the plurality of different messaging correspondents for which one or more of the electronic messages have been received and remain unread to the teachings of Wagner in order to provide the user with comprehensive statistics regarding concurrent messaging sessions (Canfield: paragraph 0052).

Claim 53: Wagner and Canfield disclose the method of claim 52, and Wagner further discloses displaying a plurality of icons including one or more application icons that are

selectable to invoke respective ones of a plurality of applications on the wireless communication device (paragraph 0056 [The context-based display 300 presents services and applications to users utilizing icons. In the example of FIG. 3, the icons are displayed in various locations on the context-based display 300 dependent on predicted usage.], figure 3).

Claim 54. Wagner and Canfield disclose the method of claim 53, and Canfield further discloses visually modifying one or more of the plurality of icons to include a count of electronic messages that have been received and remain unread, as disclosed in the claims (paragraph 0026 [... in another implementation, such devices [as a mobile telephone 192, a PDA 193] may themselves include the functionality of the general-purpose computer 170 and operate as the client device 120."]). Therefore, considering the teachings of Wagner and Canfield, it would have been obvious to one having ordinary skill in the art at the time of the invention to add visually modifying one or more of the plurality of icons to include a count of electronic messages that have been received and remain unread to the teachings of Wagner and Canfield. One would have been motivated to add visually modifying one or more of the plurality of icons to include a count of electronic messages that have been received and remain unread to the teachings of Wagner and Canfield in order to provide the user with comprehensive statistics regarding concurrent messaging sessions (Canfield: paragraph 0052).

Claim 55. Wagner and Canfield disclose the method of claim 52, and Wagner further discloses the at least one icon relating to electronic messaging being selectable to invoke an electronic messaging application (paragraphs 0060, [To further assist the user in service and application selection, embodiments of the present invention animate particular icons to indicate additional information regarding the particular service or application that the icon represents.], 0065, [In the example of FIG. 5A the user decides to view the news by selecting the news data service 504.]).

Claim 56. Wagner and Canfield disclose the method of claim 52 and Wagner further discloses displaying on the graphical user interface an identifier of the correspondent from whom at least one of the plurality of messages was received (paragraph 0080 [Then, for example, Bob may call the user and leave a voice mail for the user. In this example, the user action proxy 612 will notice that Bob is a common theme within the services and applications, and as such, may send the user an alert indicating something important may be occurring regarding Bob.]).

Claim 57. Wagner and Canfield disclose the method of claim 52, and Wagner further discloses displaying on the graphical user interface at least one preview of content

associated with at least one of the received electronic messages (paragraph 0060 [Then, to indicate new news has arrived, the news icon may animate to display an "unrolled" newspaper.], figure 3).

Claims 58-63 Canceled.

Claim 64-69 disclose a computer-readable memory accessible by a processor of a wireless communication device, the memory comprising stored electronic data structures representing executable instructions similar to the method of claims 52-57 and are rejected with the same rational.

Claims 70-75 disclose a wireless communication device comprising: a processor; a display electrically coupled to the processor, the display presenting a graphical user interface; and a memory storing machine-readable instructions executable by the processor similar to the method claims 52-57 and are rejected with the same rational.

Claim 76. Wagner discloses a method of providing notifications of unread messages on a wireless communication device (paragraph 0003 [This invention relates generally to mobile devices, and more particularly to software and systems for user interfaces on mobile devices.]), comprising:

- a. displaying at least one icon relating to an electronic messaging application on a graphical user interface of the wireless communication device; receiving on the

wireless communication device a plurality of electronic messages associated with the electronic messaging application; and responsive to receiving at least one of the plurality of electronic messages: visually modifying at least one icon relating to the electronic messaging application to include a count of the plurality of electronic messages which remain unread (paragraph 0064 [For example in FIG. 5A, the mobile device displays a ski service 502, a news service 504, a buddies service 506, a messaging service 508, ...], paragraph 0060 [As another example, a mail icon may display a counter that changes to indicate the number of unread messages a user has.], figure 3); and

- b. displaying on the graphical user interface a text identifier associated with a correspondent from whom the at least one of the plurality of electronic messages was received (paragraph 0059 [Further, the text comprising each informational icon label 310 can be automatically updated as the state of that particular service changes as it applies to the particular user.], paragraph 0080 [Then, for example, Bob may call the user and leave a voice mail for the user. In this example, the user action proxy 612 will notice that Bob is a common theme within the services and applications, and as such, may send the user an alert indicating something important may be occurring regarding Bob.]).

Wagner does not disclose displaying on the graphical user interface concurrently with the visually-modified icon a text identifier, as disclosed in the claims. However, in the same field of invention, Canfield discloses “The tear-off elements 522 and 622 include a status indicator (e.g., 622a2, 622b2, 622d2, 622h2) to indicate whether a new IM message within the IM session corresponding to an interface tear-off element remains pending for review. In general, the indicator provides a perceivable status indication to the user that a new message is pending in at least one concurrent instant messaging session. Once the new message is viewed or acknowledged, the indicator changes and the conversation counter 650 is updated to reflect one fewer message waiting to be viewed. The tear-off elements 522 and 622 also may include an identifier, such as the screen name of the IM buddy, to identify the particular IM session to which it is assigned.” (paragraph 0054). Therefore, considering the teachings of Wagner and Canfield, it would have been obvious to one having ordinary skill in the art at the time of the invention to add displaying on the graphical user interface concurrently with the visually-modified icon a text identifier to the teachings of Wagner. One would have been motivated to add displaying on the graphical user interface concurrently with the visually-modified icon a text identifier to the teachings of Wagner in order to assist the user in service and application selection (Wagner: paragraph 0059 [In addition to

using positional data to assist the user in service and application selection, the service management system also provides informational icon labels 310.]).

Claim 77. Wagner and Canfield disclose the method of claim 76, and Wagner further discloses the identifier associated with a correspondent from whom the at least one of the plurality of electronic messages was received comprising state information pertaining to the correspondent (paragraph 0059 [Further, the text comprising each informational icon label 310 can be automatically updated as the state of that particular service changes as it applies to the particular user.]).

Claim 78. Wagner and Canfield disclose the method of claim 76, and Wagner further discloses displaying on the graphical user interface at least a preview of content associated with at least one of the received electronic messages (paragraph 0060 [Then, to indicate new news has arrived, the news icon may animate to display an "unrolled" newspaper.], figure 3).

Claim 79. Wagner and Canfield disclose the method of claim 76, and Wagner further discloses displaying on the graphical user interface for a predetermined period of time at least a preview of content associated with at least one of the received electronic messages (paragraph 0060 [Then, to indicate new news has arrived, the

news icon may animate to display an "unrolled" newspaper.], figure 3).

Claim 80. Wagner and Canfield disclose the method of claim 76, and Wagner further discloses the at least one icon relating to electronic messaging being selectable to invoke an electronic messaging application (paragraphs 0060, [To further assist the user in service and application selection, embodiments of the present invention animate particular icons to indicate additional information regarding the particular service or application that the icon represents.], 0065, [In the example of FIG. 5A the user decides to view the news by selecting the news data service 504.]).

Claim 81. Wagner and Canfield disclose the method of claim 80, and Wagner further discloses, responsive to invoking the electronic messaging application, navigating automatically to a graphical user interface comprising content associated with at least one of the received electronic messages (paragraphs 0060, [To further assist the user in service and application selection, embodiments of the present invention animate particular icons to indicate additional information regarding the particular service or application that the icon represents.], 0065, [In the example of FIG. 5A the user decides to view the news by selecting the news

data service 504.]).

Claim 82. Wagner and Canfield disclose the method of claim 80, and Wagner further discloses responsive to invoking the electronic messaging application within a predetermined time following receipt of at least one of the received electronic messages, navigating automatically to a graphical user interface comprising content associated with the at least one of the received electronic messages (paragraphs 0060, [To further assist the user in service and application selection, embodiments of the present invention animate particular icons to indicate additional information regarding the particular service or application that the icon represents.], 0065, [In the example of FIG. 5A the user decides to view the news by selecting the news data service 504.]).

Claim 83. Wagner and Canfield disclose the method of claim 80, but Wagner does not disclose responsive to invoking the electronic messaging application, visually modifying at least one icon relating to the electronic messaging application to include a decreased count of electronic messages which remain unread, as disclosed in the claims.

However, in the same field of invention, Canfield discloses "Once the new message is viewed or acknowledged, the indicator changes and the conversation counter 650 is updated to reflect one fewer message waiting to be viewed." (paragraph 0054), and "Conversation counter 650

may be updated to show that are no new IM messages waiting to be viewed.” (paragraph 0059). Therefore, considering the teachings of Wagner and Canfield, it would have been obvious to one having ordinary skill in the art at the time of the invention to add responsive to invoking the electronic messaging application, visually modifying at least one icon relating to the electronic messaging application to include a decreased count of electronic messages which remain unread to the teachings of Wagner and Canfield. One would have been motivated to add responsive to invoking the electronic messaging application, visually modifying at least one icon relating to the electronic messaging application to include a decreased count of electronic messages which remain unread to the teachings of Wagner and Canfield in order to keep an accurate count of unread messages so the user is not misled about the number of unread messages after one or more messages have been read.

Claim 84. Wagner and Canfield disclose the method of claim 80, but Wagner does not disclose responsive to invoking the electronic messaging application, visually modifying at least one icon relating to the electronic messaging application to remove the count of electronic messages which remain unread, as disclosed in the claims. However, in the same field of invention, Canfield discloses “Once the new message is viewed or acknowledged, the indicator changes and the conversation counter 650 is updated to reflect one fewer message waiting to be viewed.” (paragraph 0054), and “Conversation counter 650 may be updated to show that are no new IM messages waiting to be viewed.”

(paragraph 0059). Therefore, considering the teachings of Wagner and Canfield, it would have been obvious to one having ordinary skill in the art at the time of the invention to add responsive to invoking the electronic messaging application, visually modifying at least one icon relating to the electronic messaging application to remove the count of electronic messages which remain unread to the teachings of Wagner and Canfield. One would have been motivated to add responsive to invoking the electronic messaging application, visually modifying at least one icon relating to the electronic messaging application to remove the count of electronic messages which remain unread to the teachings of Wagner and Canfield in order to keep an accurate count of unread messages so the user is not misled about the number of unread messages after one or more messages have been read.

Claims 85-93 Canceled.

Claims 94-100 disclose a computer-readable memory accessible by a processor of a wireless communication device, the memory comprising stored electronic data structures representing executable instructions which similar to the method of claims 76- 82 and are rejected with the same rational.

Claims 101-102 disclose a computer-readable memory accessible by a processor of a wireless communication device, the memory comprising stored electronic data

structures representing executable instructions which similar to the method of claims 83-84 and are rejected with the same rational.

Claims 103-109 disclose a wireless communication device comprising: a processor; a display electrically coupled to the processor, the display presenting a graphical user interface; and a medium or media including machine-readable instructions executable by the processor similar to the method claims 76-82 and are rejected with the same rational.

Claims 110-111 disclose a wireless communication device comprising: a processor; a display electrically coupled to the processor, the display presenting a graphical user interface; and a medium or media including machine-readable instructions executable by the processor similar to the method claims 83-84 and are rejected with the same rational.

Conclusion

1. Applicant's amendment necessitated the new ground(s) of rejection presented in this Office action. Accordingly, **THIS ACTION IS MADE FINAL**. See MPEP § 706.07(a). Applicant is reminded of the extension of time policy as set forth in 37 CFR 1.136(a).

A shortened statutory period for reply to this final action is set to expire THREE MONTHS from the mailing date of this action. In the event a first reply is filed within TWO MONTHS of the mailing date of this final action and the advisory action is not mailed until after the end of the THREE-MONTH shortened statutory period, then the shortened statutory period will expire on the date the advisory action is mailed, and any extension fee pursuant to 37 CFR 1.136(a) will be calculated from the mailing date of the advisory action. In no event, however, will the statutory period for reply expire later than SIX MONTHS from the date of this final action.

Any inquiry concerning this communication or earlier communications from the examiner should be directed to JOHN HEFFINGTON whose telephone number is (571)270-1696. The examiner can normally be reached on 8:30 am to 5:30 pm.

If attempts to reach the examiner by telephone are unsuccessful, the examiner's supervisor, Boris M. Pesin can be reached on 571-272-4070. The fax phone number for the organization where this application or proceeding is assigned is 571-273-8300.

Information regarding the status of an application may be obtained from the Patent Application Information Retrieval (PAIR) system. Status information for published applications may be obtained from either Private PAIR or Public PAIR. Status information for unpublished applications is available through Private PAIR only. For more information about the PAIR system, see <http://pair-direct.uspto.gov>. Should you have questions on access to the Private PAIR system, contact the Electronic Business Center (EBC) at 866-217-9197 (toll-free). If you would like assistance from a USPTO Customer Service Representative or access to the automated information system, call 800-786-9199 (IN USA OR CANADA) or 571-272-1000.

JMH

10/19/11

/Boris Pesin/

Supervisory Patent Examiner, Art Unit 2172

Notice of References Cited	Application/Control No. 10/784,781	Applicant(s)/Patent Under Reexamination KLASSEN ET AL.	
	Examiner JOHN HEFFINGTON	Art Unit 2172	Page 1 of 1

U.S. PATENT DOCUMENTS

*	Document Number Country Code-Number-Kind Code	Date MM-YYYY	Name	Classification	
*	A	US-6,842,795 B2	01-2005	Keller, Jay	710/15
*	B	US-2005/0114777 A1	05-2005	Szeto, Christopher	715/710
*	C	US-2008/0282162 A1	11-2008	Lincke et al.	715/710
*	D	US-2009/0006959 A1	01-2009	Kalenius et al.	715/710
*	E	US-2009/0006958 A1	01-2009	Pohjola et al.	715/710
*	F	US-7,596,540 B2	09-2009	Tzruya et al.	706/47
*	G	US-7,606,866 B2	10-2009	Mora, Gary E.	709/207
*	H	US-2009/0288004 A1	11-2009	Strandell et al.	715/710
*	I	US-7,743,340 B2	06-2010	Horvitz et al.	715/808
*	J	US-2010/0192064 A1	07-2010	Beppu et al.	715/710
*	K	US-7,802,187 B2	09-2010	Yoshida, Hiroyoshi	715/710
*	L	US-7,882,434 B2	02-2011	Slotznick et al.	715/710
*	M	US-7,921,368 B2	04-2011	Moody et al.	715/751

FOREIGN PATENT DOCUMENTS

*	Document Number Country Code-Number-Kind Code	Date MM-YYYY	Country	Name	Classification
	N				
	O				
	P				
	Q				
	R				
	S				
	T				

NON-PATENT DOCUMENTS

*	Document Number Country Code-Number-Kind Code	Date MM-YYYY	Country	Name	Classification
	Include as applicable: Author, Title Date, Publisher, Edition or Volume, Pertinent Pages)				
	U				
	V				
	W				
	X				

*A copy of this reference is not being furnished with this Office action. (See MPEP § 707.05(a).)
Dates in MM-YYYY format are publication dates. Classifications may be US or foreign.

EAST Search History

EAST Search History (Prior Art)

Ref #	Hits	Search Query	DBs	Default Operator	Plurals	Time Stamp
L1	99	715/710.ccls.	US-PGPUB; USPAT; FPRS; EPO; JPO; DERWENT; IBM_TDB	ADJ	OFF	2011/10/19 16:31
L2	19	715/710.ccls. and (email or (e\$1mail) or (e mail) or (electronic mail) or im or (instant messag\$3) or texting or (text messag\$3)) and (((mobile or portable or cell or smart) (phone or telephone)) or pda)	US-PGPUB; USPAT; FPRS; EPO; JPO; DERWENT; IBM_TDB	ADJ	OFF	2011/10/19 16:33
S1	8	("20020160817" "20050248437").PN. or ("20020035613" "20040155908").PN.	US-PGPUB; USPAT; FPRS; EPO; JPO; DERWENT; IBM_TDB	ADJ	ON	2010/03/27 17:51
S2	8	("20020160817" "20050248437").PN. or ("20020035613" "20040155908").PN.	US-PGPUB; USPAT; FPRS; EPO; JPO; DERWENT; IBM_TDB	ADJ	ON	2010/08/25 09:57
S3	1	10/784781.app.	US-PGPUB; USPAT; FPRS; EPO; JPO; DERWENT; IBM_TDB	ADJ	ON	2010/08/25 10:09
S4	2353	((unread or (un read) or ("not" viewed) or unopened or (un opened)) near2 (message or text or im or email or (e mail) or chat))	US-PGPUB; USPAT; FPRS; EPO; JPO; DERWENT; IBM_TDB	ADJ	ON	2010/08/25 10:22
S5	1491	((unread or (un read) or ("not" viewed) or unopened or (un opened)) near2 (message or text or im or email or (e mail) or chat)) same (((number or count) near2 users) or users)	US-PGPUB; USPAT; FPRS; EPO; JPO; DERWENT; IBM_TDB	ADJ	ON	2010/08/25 10:23
S6	305	((unread or (un read) or ("not" viewed) or unopened or (un opened)) near2 (message or text or im or email or (e mail) or chat)) same (((number or count) near2 users) or users) with (icon or symbol or graphic\$2 or widget or image or token or picture or thumbnail))	US-PGPUB; USPAT; FPRS; EPO; JPO; DERWENT; IBM_TDB	ADJ	ON	2010/08/25 10:28

S7	260	((unread or (un read) or ("not" viewed) or unopened or (un opened)) near2 (message or text or im or email or (e mail) or chat)) same (((number or count) near2 users) or users) with (icon or symbol or graphic\$2 or widget or image or token or picture or thumbnail))) and wireless	US-PGPUB; USPAT; FPRS; EPO; JPO; DERWENT; IBM_TDB	ADJ	ON	2010/08/25 10:30
S8	252	((unread or (un read) or ("not" viewed) or unopened or (un opened)) near2 (message or text or im or email or (e mail) or chat)) same (((number or count) near2 users) or users) with (icon or symbol or graphic\$2 or widget or image or token or picture or thumbnail))) and wireless not (research near2 "in" near2 motion).as.	US-PGPUB; USPAT; FPRS; EPO; JPO; DERWENT; IBM_TDB	ADJ	ON	2010/08/25 10:37
S9	3	((unread or (un read) or ("not" viewed) or unopened or (un opened)) near2 (message or text or im or email or (e mail) or chat)) same (((number or count) near2 users)) with (icon or symbol or graphic\$2 or widget or image or token or picture or thumbnail))) and wireless not (research near2 "in" near2 motion).as.	US-PGPUB; USPAT; FPRS; EPO; JPO; DERWENT; IBM_TDB	ADJ	ON	2010/08/25 10:49
S10	252	((unread or (un read) or ("not" viewed) or unopened or (un opened)) near2 (message or text or im or email or (e mail) or chat)) same (((number or count) near2 (users near2 (sent or received))) or users) with (icon or symbol or graphic\$2 or widget or image or token or picture or thumbnail))) and wireless not (research near2 "in" near2 motion).as.	US-PGPUB; USPAT; FPRS; EPO; JPO; DERWENT; IBM_TDB	ADJ	ON	2010/08/25 10:56
S11	8	((unread or (un read) or ("not" viewed) or unopened or (un opened)) near2 (message or text or im or email or (e mail) or chat)) same (((number or count) near2 (users near2 (sent or received))) or (users near2 (sent or received))) with (icon or symbol or graphic\$2 or widget or image or token or picture or thumbnail))) and wireless not (research near2 "in" near2 motion).as.	US-PGPUB; USPAT; FPRS; EPO; JPO; DERWENT; IBM_TDB	ADJ	ON	2010/08/25 10:57
S12	111	(US-20100211917-\$ or US-20100207871-\$ or US-20100203872-\$ or US-20100192081-\$ or US-20100185980-\$ or US-20100184453-\$ or US-20100179991-\$ or US-20100171712-\$ or US-20100156816-\$ or US-20100131191-\$ or US-20100125811-\$ or US-20100125785-\$ or US-20100123724-\$ or US-20100115559-\$ or US-20100100964-\$ or US-20100082759-\$ or US-20100079405-\$ or US-20100064016-\$ or US-20100057743-\$ or US-20100041331-\$ or US-20100030860-\$ or US-20100030549-\$ or US-	US-PGPUB	ADJ	ON	2010/08/25 11:04

		20100011304-\$ or US-20100004028-\$ or US-20090327976-\$ or US-20090327168-\$).did. or (US-20090322688-\$ or US-20090307322-\$ or US-20090305732-\$ or US-20090303231-\$ or US-20090235184-\$ or US-20090235175-\$ or US-20090228825-\$ or US-20090228807-\$ or US-20090228792-\$ or US-20090216634-\$ or US-20090191926-\$ or US-20090191848-\$ or US-20090178008-\$ or US-20090178007-\$ or US-20090177981-\$ or US-20090174680-\$ or US-20090164923-\$ or US-20090163190-\$ or US-20090138828-\$ or US-20090138823-\$ or US-20090119678-\$ or US-20090106036-\$ or US-20090100027-\$ or US-20090094518-\$ or US-20090093273-\$ or US-20090082043-\$ or US-20090077488-\$).did. or (US-20090073194-\$ or US-20090070705-\$ or US-20090070704-\$ or US-20090066728-\$ or US-20090061827-\$ or US-20090058830-\$ or US-20090044200-\$ or US-20090030998-\$ or US-20090017806-\$ or US-20090013275-\$ or US-20090007017-\$ or US-20090006644-\$ or US-20090006570-\$ or US-20090005011-\$ or US-20080320419-\$ or US-20080320391-\$ or US-20080307220-\$ or US-20080295017-\$ or US-20080293385-\$ or US-20080222545-\$ or US-20080220752-\$ or US-20080218535-\$ or US-20080216022-\$ or US-20080215687-\$ or US-20080211778-\$ or US-20080208992-\$ or US-20080201650-\$).did. or (US-20080180408-\$ or US-20080174570-\$ or US-20080172357-\$ or US-20080168405-\$ or US-20080168404-\$ or US-20080168396-\$ or US-20080168395-\$ or US-20080168379-\$ or US-20080168365-\$ or US-20080168361-\$ or US-20080168353-\$ or US-20080168349-\$ or US-20080167078-\$ or US-20080165160-\$ or US-20080165153-\$ or US-20080165152-\$ or US-20080165151-\$ or US-20080165149-\$ or US-20080165148-\$ or US-20080165147-\$ or US-20080165146-\$ or US-20080165145-\$ or US-20080165144-\$ or US-20080165143-\$ or US-20080165142-\$ or US-20080165136-\$ or US-20080165022-\$).did. or (US-20080162651-\$ or US-20080129816-\$ or US-20080122796-\$ or US-20080119274-\$).did.			
S13	191	((unread or (un read) or ("not viewed) or unopened or (un opened)) near2 (message or text or im or email or (e mail) or chat)) with (((number or	US-PGPUB; ADJ USPAT; FPRS; EPO; JPO;	ON	2010/08/25 11:05

		count) near2 (users) or users) with (icon or symbol or graphic\$2 or widget or image or token or picture or thumbnail))) and wireless not (research near2 "in" near2 motion).as.	DERWENT; IBM_TDB			
S14	105	((unread or (un read) or ("not" viewed) or unopened or (un opened)) near2 (message or text or im or email or (e mail) or chat)) with (((number or count) near2 (users) or users) with (icon or symbol or graphic\$2 or widget or image or token or picture or thumbnail))) and wireless not (research near2 "in" near2 motion).as. not S12	US-PGPUB; USPAT; FPRS; EPO; JPO; DERWENT; IBM_TDB	ADJ	ON	2010/08/25 11:05
S15	0	(11/599507).APP.	USPAT; USOCR	ADJ	ON	2010/08/25 11:16
S16	8	("20010055038" "20020091774" "20020094806" "20020126146" "20030032414" "5533110" "5579472" "5742779" "5907604" "6020828" "6333973" "6430405" "6771974").PN.	USPAT; USOCR	ADJ	ON	2010/08/25 11:17
S17	416	(hover\$3 or over or select\$3) near2 (message (icon or symbol or graphic\$2 or widget or image or token or picture or thumbnail))	US-PGPUB; USPAT; FPRS; EPO; JPO; DERWENT; IBM_TDB	ADJ	ON	2010/08/25 14:54
S18	2	((hover\$3 or over or select\$3) near2 (message (icon or symbol or graphic\$2 or widget or image or token or picture or thumbnail))) with (preview or snapshot or (snap shot) or summar\$3)	US-PGPUB; USPAT; FPRS; EPO; JPO; DERWENT; IBM_TDB	ADJ	ON	2010/08/25 14:55
S19	20	((hover\$3 or over or select\$3) with (message (icon or symbol or graphic\$2 or widget or image or token or picture or thumbnail))) with (preview or snapshot or (snap shot) or summar\$3)	US-PGPUB; USPAT; FPRS; EPO; JPO; DERWENT; IBM_TDB	ADJ	ON	2010/08/25 14:56
S20	16	("20020094806" "20020126146" "20030032414" "5907604").PN. or ("20020094806" "20020126146" "20030032414" "5907604").PN. or ("20020094806" "20020126146" "5907604" "6430405").PN. or ("20020091774" "20020094806" "20020126146" "5907604" "6333973" "6771974").PN.	US-PGPUB; USPAT; FPRS; EPO; JPO; DERWENT; IBM_TDB	ADJ	ON	2010/10/22 09:50
S21	0	(10/533245).APP.	USPAT; USOCR	ADJ	ON	2010/11/12 12:09
S22	1	("2006/0084450").URPN.	USPAT	ADJ	ON	2010/11/12 12:09
S23	4	("5533110" "5579472" "5742779" "6020828").PN. or ("5579472").PN. or ("20010055038").PN.	USPAT	ADJ	ON	2010/11/12 12:11
S24	8384	((number or digit or character or (alpha numeric) near2 (sender or buddy or friend or contact)) same (message or email or text or im (instant message) or	US-PGPUB; USPAT; FPRS; EPO; JPO;	ADJ	ON	2011/04/26 11:35

		(voice (message or mail)))	DERWENT; IBM_TDB			
S25	306	((number or digit or character or (alpha numeric)) near2 ((sender or buddy or friend or contact)) near2 (unique or individual or different or separate or distinct)) same (message or email or text or im (instant message) or (voice (message or mail)))	US-PGPUB; USPAT; FPRS; EPO; JPO; DERWENT; IBM_TDB	ADJ	ON	2011/04/26 11:39
S26	6	("2005/0120306").URPN.	USPAT	ADJ	ON	2011/04/26 14:07
S27	85	(tear off) element	US-PGPUB; USPAT; FPRS; EPO; JPO; DERWENT; IBM_TDB	ADJ	ON	2011/04/26 14:20
S28	10	("2004/0056893").URPN.	USPAT	ADJ	ON	2011/04/26 14:49
S29	45	("6377944" "5416895" "6002398" "6057844" "6078935" "6144375" "6233726" "5721852" "20030164862" "6281879" "6407757" "6434599" "5546528" "5877765" "5937417" "6304879" "6781608" "20030052915" "20030142141" "5546528" "5929851" "5884306" "5974413" "5990905" "6018571" "6092068" "6275790" "6981223" "6384849" "5877758" "6091409" "6237135" "6173316" "6369837" "4995101" "6246411" "20020073207" "20020130904" "6381735" "6229539" "5754176" "6147685" "6691159" "20020097277" "6784901" "20020101446" "6002400" "6346952" "6252594" "6362842" "6519629" "20030210265" "6907447" "5617526").PN.	USPAT	ADJ	ON	2011/04/26 14:58
S30	0	"20050165880".pn.	USPAT	ADJ	ON	2011/04/27 10:05
S31	0	"2005/0165880".pn.	USPAT	ADJ	ON	2011/04/27 10:05
S32	2	"20050165880".pn.	US-PGPUB; USPAT; FPRS; EPO; JPO; DERWENT; IBM_TDB	ADJ	ON	2011/04/27 10:06
S33	1	(10/284429).APP.	USPAT; USOCR	ADJ	ON	2011/04/27 10:07
S34	2	"20040056893".pn.	US-PGPUB; USPAT; FPRS; EPO; JPO; DERWENT; IBM_TDB	ADJ	ON	2011/04/28 11:00
S35	1	"20040056893".pn. and (messag\$3	US-PGPUB;	ADJ	ON	2011/04/28

		with receiv\$3)	USPAT; FPRS; EPO; JPO; DERWENT; IBM_TDB			11:00
S36	1	(10/284429).APP.	USPAT; USOCR	ADJ	ON	2011/04/28 16:04
S37	744716	((mobile or portable or cell or smart (device or phone or telephone))	US-PGPUB; USPAT; FPRS; EPO; JPO; DERWENT; IBM_TDB	ADJ	ON	2011/04/29 15:43
S38	167950	((mobile or portable or cell or smart (device or phone or telephone)) same (display or screen)	US-PGPUB; USPAT; FPRS; EPO; JPO; DERWENT; IBM_TDB	ADJ	ON	2011/04/29 15:43
S39	548	((mobile or portable or cell or smart (device or phone or telephone)) same (display or screen) same ((icon or symbol) near2 (application or program or function))	US-PGPUB; USPAT; FPRS; EPO; JPO; DERWENT; IBM_TDB	ADJ	ON	2011/04/29 16:03
S40	365	((mobile or portable or cell or smart (device or phone or telephone)) same ((display or screen) with ((icon or symbol) near2 (application or program or function)))	US-PGPUB; USPAT; FPRS; EPO; JPO; DERWENT; IBM_TDB	ADJ	ON	2011/04/29 16:04
S41	1	((mobile or portable or cell or smart (device or phone or telephone)) same ((display or screen) with ((icon or symbol) near2 (application or program or function))) same count	US-PGPUB; USPAT; FPRS; EPO; JPO; DERWENT; IBM_TDB	ADJ	ON	2011/04/29 16:05
S42	14	((mobile or portable or cell or smart (device or phone or telephone)) same ((display or screen) with ((icon or symbol) near2 (application or program or function)))) and ((count or number) near2 new near2 (message or email or (e mail) or (electronic mail)))	US-PGPUB; USPAT; FPRS; EPO; JPO; DERWENT; IBM_TDB	ADJ	ON	2011/04/29 16:07
S43	1	((mobile or portable or cell or smart (device or phone or telephone)) same (((icon or symbol) near2 (application or program or function)))) and ((count or number) near2 new near2 (message or email or (e mail) or (electronic mail))) not S42	US-PGPUB; USPAT; FPRS; EPO; JPO; DERWENT; IBM_TDB	ADJ	ON	2011/04/29 16:18
S44	535	((mobile or portable or cell or smart (device or phone or telephone))) and ((count or number) near2 new near2 (message or email or (e mail) or (electronic mail))) not S42	US-PGPUB; USPAT; FPRS; EPO; JPO; DERWENT; IBM_TDB	ADJ	ON	2011/04/29 16:19
S45	23	((mobile or portable or cell or smart (device or phone or telephone)) and ((display or screen) with ((icon or	US-PGPUB; USPAT; FPRS;	ADJ	ON	2011/04/29 16:20

		symbol) near2 (application or program or function)))) and ((count or number) near2 new near2 (message or email or (e mail) or (electronic mail))) not S42	EPO; JPO; DERWENT; IBM_TDB			
S46	23	((mobile or portable or cell or smart or wireless) (device or phone or telephone)) and ((display or screen) with ((icon or symbol) near2 (application or program or function)))) and ((count or number) near2 new near2 (message or email or (e mail) or (electronic mail))) not S42	US-PGPUB; USPAT; FPRS; EPO; JPO; DERWENT; IBM_TDB	ADJ	ON	2011/04/29 16:22
S51	14	((mobile or portable or cell or smart) (device or phone or telephone)) same ((display or screen) with ((icon or symbol) near2 (application or program or function)))) and ((count or number) near2 new near2 (message or email or (e mail) or (electronic mail)))	US-PGPUB; USPAT; FPRS; EPO; JPO; DERWENT; IBM_TDB	ADJ	ON	2011/05/03 14:07
S52	23	((mobile or portable or cell or smart or wireless) (device or phone or telephone)) and ((display or screen) with ((icon or symbol) near2 (application or program or function)))) and ((count or number) near2 new near2 (message or email or (e mail) or (electronic mail))) not S51	US-PGPUB; USPAT; FPRS; EPO; JPO; DERWENT; IBM_TDB	ADJ	ON	2011/05/03 14:07
S53	276	((mobile or portable or cell or smart or wireless) (device or phone or telephone)) and ((display or screen) with ((icon or symbol) with (application or program or function)))) and ((count or number) with new with (message or email or (e mail) or (electronic mail))) not S51 not S52	US-PGPUB; USPAT; FPRS; EPO; JPO; DERWENT; IBM_TDB	ADJ	ON	2011/05/03 14:07
S54	6	"2005/0120306".URPN.	USPAT	ADJ	ON	2011/05/03 15:47
S55	0	(10/911225).APP.	USPAT; USOCR	ADJ	ON	2011/05/03 15:54
S56	0	"20050117733".pn.	USPAT; USOCR	ADJ	ON	2011/05/03 16:14
S57	1	"20050117733".pn. and (application with icon)	US-PGPUB; USPAT; USOCR; EPO; JPO; DERWENT; IBM_TDB	ADJ	ON	2011/05/03 16:14
S58	1	"20050117733".pn. and (application with gui)	US-PGPUB; USPAT; USOCR; EPO; JPO; DERWENT; IBM_TDB	ADJ	ON	2011/05/03 16:15
S59	1	"20050117733".pn. and (icon)	US-PGPUB; USPAT; USOCR; EPO; JPO; DERWENT; IBM_TDB	ADJ	ON	2011/05/03 16:16
S60	2	"20050117733".pn. and (application)	US-PGPUB;	ADJ	ON	2011/05/03

			USPAT; USOCR; EPO; JPO; DERWENT; IBM_TDB			16:19
S61	28	("5610970" "5668862" "5673299" "5742905" "5742905" "5752191" "5812653" "5812653" "5841837" "5999611" "5999611" "6185565" "6185565" "6425005" "6425005" "6456619" "6456619" "6463146" "6463146" "6529502" "6529502" "6570969" "6570969" "6678265" "6678265").PN.	US-PGPUB; USPAT; FPRS; EPO; JPO; DERWENT; IBM_TDB	ADJ	ON	2011/05/03 17:07
S62	2	"20050117733".pn. and (contact with receiv\$3)	US-PGPUB; USPAT; FPRS; EPO; JPO; DERWENT; IBM_TDB	ADJ	ON	2011/05/04 11:05
S63	1	"20050117733".pn. and (contact with (sent or send\$3))	US-PGPUB; USPAT; FPRS; EPO; JPO; DERWENT; IBM_TDB	ADJ	ON	2011/05/04 11:07
S64	1	"20050117733".pn. and (contact with messag\$3)	US-PGPUB; USPAT; FPRS; EPO; JPO; DERWENT; IBM_TDB	ADJ	ON	2011/05/04 11:07
S65	0	(10/911225).APP.	USPAT; USOCR	ADJ	ON	2011/05/04 11:09
S66	303	display\$3 message received	USPAT; USOCR	ADJ	ON	2011/05/04 16:54
S67	3	(display\$3 message received) near3 (sender or buddy or contact)	USPAT; USOCR	ADJ	ON	2011/05/04 16:55
S68	0	(display\$3 message received) near3 (name)	USPAT; USOCR	ADJ	ON	2011/05/04 16:55
S69	768	(message received) near3 (sender or buddy or contact)	USPAT; USOCR	ADJ	ON	2011/05/04 16:57
S70	7	(message received) near3 (name near2 (sender or buddy or contact))	USPAT; USOCR	ADJ	ON	2011/05/04 16:58
S71	476	(message) near3 (name near2 (sender or buddy or contact))	USPAT; USOCR	ADJ	ON	2011/05/04 16:59
S72	5	((message) near3 (name near2 (sender or buddy or contact))) near2 icon	USPAT; USOCR	ADJ	ON	2011/05/04 16:59
S73	0	((mobile or portable or cell) (device or terminal or phone or telephone)) and (((email or (e mail) or (electronic mail)) near2 icon) with ((preview or snapshot or (snap shot)) near2 content)) and (((message or im) near2 icon) with ((preview or snapshot or (snap shot)) near2 content))	US-PGPUB; USPAT; FPRS; EPO; JPO; DERWENT; IBM_TDB	ADJ	ON	2011/05/06 11:18
S74	1	((mobile or portable or cell) (device or terminal or phone or telephone)) and (((email or (e mail) or (electronic	US-PGPUB; USPAT; FPRS;	ADJ	ON	2011/05/06 11:19

		mail)) near2 icon) with ((preview or snapshot or (snap shot)) near2 content)) or (((message or im) near2 icon) with ((preview or snapshot or (snap shot)) near2 content)))	EPO; JPO; DERWENT; IBM_TDB			
S75	1	(((email or (e mail) or (electronic mail)) near2 icon) with ((preview or snapshot or (snap shot)) near2 content)) or (((message or im) near2 icon) with ((preview or snapshot or (snap shot)) near2 content)))	US-PGPUB; USPAT; FPRS; EPO; JPO; DERWENT; IBM_TDB	ADJ	ON	2011/05/06 11:21
S76	11	((email or (e mail) or (electronic mail)) near2 icon) and (((email or (e mail) or (electronic mail))) with ((preview or snapshot or (snap shot)) near2 content)) or (((message or im) with ((preview or snapshot or (snap shot)) near2 content)))	US-PGPUB; USPAT; FPRS; EPO; JPO; DERWENT; IBM_TDB	ADJ	ON	2011/05/06 11:27
S77	112	((email or (e mail) or (electronic mail)) near2 icon) and (((email or (e mail) or (electronic mail))) with ((preview or snapshot or (snap shot)))) or (((message or im) with ((preview or snapshot or (snap shot))))))	US-PGPUB; USPAT; FPRS; EPO; JPO; DERWENT; IBM_TDB	ADJ	ON	2011/05/06 11:30
S78	3909	(((email or (e mail) or (electronic mail))) with ((preview or snapshot or (snap shot)))) or (((message or im) with ((preview or snapshot or (snap shot)))))) not S77	US-PGPUB; USPAT; FPRS; EPO; JPO; DERWENT; IBM_TDB	ADJ	ON	2011/05/06 11:45
S79	462	(((email or (e mail) or (electronic mail))) with ((preview or snapshot or (snap shot)))) and (((message or im) with ((preview or snapshot or (snap shot)))))) not S77	US-PGPUB; USPAT; FPRS; EPO; JPO; DERWENT; IBM_TDB	ADJ	ON	2011/05/06 11:47
S80	153	(((email or (e mail) or (electronic mail))) with ((preview or snapshot or (snap shot)))) and (((message or im) with ((preview or snapshot or (snap shot)))))) not S77 and ((mobile or portable or cell) (device or terminal or phone or telephone))	US-PGPUB; USPAT; FPRS; EPO; JPO; DERWENT; IBM_TDB	ADJ	ON	2011/05/06 11:48
S81	153	(((email or (e mail) or (electronic mail))) with ((preview or snapshot or (snap shot)))) and (((message or im) with ((preview or snapshot or (snap shot)))))) not S77 and ((mobile or portable or cell) (device or terminal or phone or telephone))	US-PGPUB; USPAT; FPRS; EPO; JPO; DERWENT; IBM_TDB	ADJ	ON	2011/05/06 11:54
S82	153	(((email or (e mail) or (electronic mail))) with ((preview or snapshot or (snap shot)))) and (((message or im) with ((preview or snapshot or (snap shot)))))) and ((mobile or portable or cell) (device or terminal or phone or telephone)) not S77	US-PGPUB; USPAT; FPRS; EPO; JPO; DERWENT; IBM_TDB	ADJ	ON	2011/05/06 11:56
S83	112	((email or (e mail) or (electronic mail)) near2 icon) and (((email or (e mail) or (electronic mail))) with ((preview or snapshot or (snap shot)))) or	US-PGPUB; USPAT; FPRS; EPO; JPO;	ADJ	ON	2011/05/06 13:21

		((message or im)) with ((preview or snapshot or (snap shot))))	DERWENT; IBM_TDB			
S84	153	((email or (e mail) or (electronic mail))) with ((preview or snapshot or (snap shot))) and ((message or im)) with ((preview or snapshot or (snap shot))) and ((mobile or portable or cell) (device or terminal or phone or telephone)) not S83	US-PGPUB; USPAT; FPRS; EPO; JPO; DERWENT; IBM_TDB	ADJ	ON	2011/05/06 13:21
S85	224	((email or (e mail) or (electronic mail)) with (preview or snapshot or (snap shot)) and ((mobile or portable or cell) (device or terminal or phone or telephone)) not S83 not S84	US-PGPUB; USPAT; FPRS; EPO; JPO; DERWENT; IBM_TDB	ADJ	ON	2011/05/06 13:21
S86	3	((email or (e mail) or (electronic mail)) with (preview or snapshot or (snap shot)) with icon) and ((mobile or portable or cell) (device or terminal or phone or telephone)) not S83 not S84	US-PGPUB; USPAT; FPRS; EPO; JPO; DERWENT; IBM_TDB	ADJ	ON	2011/05/06 13:22
S87	76	((email or (e mail) or (electronic mail)) with (preview or snapshot or (snap shot)) with icon)	US-PGPUB; USPAT; FPRS; EPO; JPO; DERWENT; IBM_TDB	ADJ	ON	2011/05/06 13:24
S88	27	receiv\$3 near2 message near2 display\$3 (preview or snapshot or (snap shot))	US-PGPUB; USPAT; FPRS; EPO; JPO; DERWENT; IBM_TDB	ADJ	ON	2011/05/06 13:32
S89	4534	message near2 icon	US-PGPUB; USPAT; FPRS; EPO; JPO; DERWENT; IBM_TDB	ADJ	ON	2011/05/06 13:34
S90	6	(message near2 icon) near2 preview	US-PGPUB; USPAT; FPRS; EPO; JPO; DERWENT; IBM_TDB	ADJ	ON	2011/05/06 13:34
S91	6	(message near2 icon) near2 (preview or snapshot or (snap shot))	US-PGPUB; USPAT; FPRS; EPO; JPO; DERWENT; IBM_TDB	ADJ	ON	2011/05/06 13:35
S92	4	("20020035613" "20040155908").PN.	US-PGPUB; USPAT; FPRS; EPO; JPO; DERWENT; IBM_TDB	ADJ	ON	2011/05/06 13:55
S93	306	receiv\$3 near2 message near2 ((name or id or identifier) near2 (buddy or sender or friend))	US-PGPUB; USPAT; FPRS;	ADJ	ON	2011/05/06 14:23

			EPO; JPO; DERWENT; IBM_TDB			
S94	430	receiv\$3 near2 (message or email or (e mail) or (electronic mail) or im or chat) near2 ((name or id or identifier) near2 (buddy or sender or friend))	US-PGPUB; USPAT; FPRS; EPO; JPO; DERWENT; IBM_TDB	ADJ	ON	2011/05/06 14:24
S95	163	((receiv\$3 near2 (message or email or (e mail) or (electronic mail) or im or chat) near2 ((name or id or identifier) near2 (buddy or sender or friend))) and ((portable or mobile or cell) (phone or telephone or device or terminal or apparatus))	US-PGPUB; USPAT; FPRS; EPO; JPO; DERWENT; IBM_TDB	ADJ	ON	2011/05/06 14:26
S96	512	((receiv\$3 near2 (message or email or (e mail) or (electronic mail) or im or chat)) with (((name or id or identifier) near2 (buddy or sender or friend)))) and ((portable or mobile or cell) (phone or telephone or device or terminal or apparatus))	US-PGPUB; USPAT; FPRS; EPO; JPO; DERWENT; IBM_TDB	ADJ	ON	2011/05/07 16:14
S97	163	((receiv\$3 near2 (message or email or (e mail) or (electronic mail) or im or chat) near2 ((name or id or identifier) near2 (buddy or sender or friend))) and ((portable or mobile or cell) (phone or telephone or device or terminal or apparatus))	US-PGPUB; USPAT; FPRS; EPO; JPO; DERWENT; IBM_TDB	ADJ	ON	2011/05/07 16:14
S98	349	((receiv\$3 near2 (message or email or (e mail) or (electronic mail) or im or chat)) with (((name or id or identifier) near2 (buddy or sender or friend)))) and ((portable or mobile or cell) (phone or telephone or device or terminal or apparatus)) not S97	US-PGPUB; USPAT; FPRS; EPO; JPO; DERWENT; IBM_TDB	ADJ	ON	2011/05/07 16:14
S99	328	((receiv\$3 near2 (message or email or (e mail) or (electronic mail) or im or chat)) with (((name or id or identifier) near2 (buddy or sender or friend)))) and ((portable or mobile or cell) (phone or telephone or device or terminal or apparatus)) and (count or number) not S97	US-PGPUB; USPAT; FPRS; EPO; JPO; DERWENT; IBM_TDB	ADJ	ON	2011/05/07 16:16
S100	215	((receiv\$3 near2 (message or email or (e mail) or (electronic mail) or im or chat)) with (((name or id or identifier) near2 (buddy or sender or friend)))) and ((portable or mobile or cell) (phone or telephone or device or terminal or apparatus)) and ((count or number) near2 (message or email or (e mail) or (electronic mail) or im or chat)) not S97	US-PGPUB; USPAT; FPRS; EPO; JPO; DERWENT; IBM_TDB	ADJ	ON	2011/05/07 16:17
S101	1	10/715205.app.	US-PGPUB; USPAT; FPRS; EPO; JPO; DERWENT; IBM_TDB	ADJ	ON	2011/05/07 16:57

S102	1	10/784781.app.	US-PGPUB; USPAT; FPRS; EPO; JPO; DERWENT; IBM_TDB	ADJ	ON	2011/05/08 19:20
S103	25	("20020160817" "20050120306" "20060020904" "20060030295" "5333256" "5617526" "5634102" "6385459" "6424354" "662819").PN. or ("20030167310").PN.	US-PGPUB; USPAT; FPRS; EPO; JPO; DERWENT; IBM_TDB	ADJ	ON	2011/05/08 20:39
S104	198	715/842.ccls. or 715/851.ccls.	US-PGPUB; USPAT; FPRS; EPO; JPO; DERWENT; IBM_TDB	ADJ	ON	2011/05/08 20:52
S105	1	(10/284429).APP.	USPAT; USOCR	ADJ	OFF	2011/10/17 20:25
S106	93	("20020073207" "20020097277" "20020101446" "20020130904" "20030052915" "20030142141" "20030164862" "20030210265" "5283560" "5287514" "5416895" "5544352" "5546528" "5581670" "5588107" "5617114" "5617526" "5627960" "5644737" "5664133" "5692142" "5712995" "5721852" "5742813" "5754176" "5760768" "5798752" "5801703" "5832494" "5838315" "5877758" "5877765" "5884306" "5929851" "5937417" "5974413" "5990905" "5995101" "6002398" "6002400" "6018571" "6057844" "6078935" "6091409" "6092068" "6097389" "6118427" "6144375" "6147685" "6173316" "6188403" "6229539" "6233571" "6233726" "6237135" "6246411" "6248946" "6252594" "6260148" "6275790" "6281879" "6301609" "6304879" "6317128" "6346952" "6362842" "6369837" "6377944" "6381735" "6384849" "6407757" "6434599" "6519629" "6539421" "6691159" "6781608" "6784901" "6907447" "6981223").PN. OR ("7127685").URPN.	US-PGPUB; USPAT; USOCR	ADJ	OFF	2011/10/17 20:25
S107	1	(10/762698).APP.	USPAT; USOCR	ADJ	OFF	2011/10/18 14:53
S108	17	("20010025280" "20040172455" "20040183829" "20040203766" "20050055405" "20050120306" "20050138564" "20050181878" "5793365" "5960173" "5990887" "6349327" "6631412" "6697840" "7127685" "7148814" "7185290").PN. OR ("7921368").URPN.	US-PGPUB; USPAT; USOCR	ADJ	OFF	2011/10/18 14:53
S109	0	(10/533245).APP.	USPAT; USOCR	ADJ	OFF	2011/10/18 15:58

S110	0	(11/599507).APP.	USPAT; USOCR	ADJ	OFF	2011/10/18 15:58
S111	8	"20020085027" "6430405" "20020098874" "5533110" "5923327" "20020032641" "7548875" "20030153337" "7548875" "20010055038" "20020094806" "20020126146" "5907604" "6771974" "5742779" "20040203824" "7266186").PN.	USPAT; USOCR	ADJ	OFF	2011/10/18 16:00
S112	8	"20020085027" "6430405" "20020098874" "5533110" "5923327" "20020032641" "7548875" "20030153337" "7548875" "20010055038" "20020094806" "20020126146" "5907604" "6771974" "5742779" "20040203824" "7266186").PN. or ("6333973" "6020828" "6430405" "20020032641" "20020085027" "5579472" "20020098874" "5533110" "20020091774" "7266186" "6771974" "5923327" "20030153337" "20020094806" "20020126146" "5907604" "20010055038" "20040203824" "5742779" "20030032414" "7548875").PN"	USPAT; USOCR	ADJ	OFF	2011/10/18 16:01
S113	8	"20020085027" "6430405" "20020098874" "5533110" "5923327" "20020032641" "7548875" "20030153337" "7548875" "20010055038" "20020094806" "20020126146" "5907604" "6771974" "5742779" "20040203824" "7266186").PN.	USPAT; USOCR	ADJ	OFF	2011/10/18 16:02
S114	0	("6333973" "6020828" "6430405" "20020032641" "20020085027" "5579472" "20020098874" "5533110" "20020091774" "7266186" "6771974" "5923327" "20030153337" "20020094806" "20020126146" "5907604" "20010055038" "20040203824" "5742779" "20030032414" "7548875").PN"	USPAT; USOCR	ADJ	OFF	2011/10/18 16:03
S115	0	("6333973" "6020828" "6430405" "20020032641" "20020085027" "5579472" "20020098874" "5533110" "20020091774" "7266186" "6771974" "5923327" "20030153337" "20020094806" "20020126146" "5907604" "20010055038" "20040203824" "5742779" "20030032414" "7548875").PN"	US-PGPUB; USPAT; USOCR; EPO; JPO; DERWENT; IBM_TDB	ADJ	OFF	2011/10/18 16:03
S116	32	"20020085027" "6430405" "20020098874" "5533110" "5923327" "20020032641" "7548875" "20030153337" "7548875" "20010055038" "20020094806" "20020126146"	US-PGPUB; USPAT; USOCR; EPO; JPO; DERWENT; IBM_TDB	ADJ	OFF	2011/10/18 16:04

EAST Search History

		"5907604" "6771974" "5742779" "20040203824" "7266186").PN.				
S117	42	("6333973" "6020828" "6430405" "20020032641" "20020085027" "5579472" "20020098874" "5533110" "20020091774" "7266186" "6771974" "5923327" "20030153337" "20020094806" "20020126146" "5907604" "20010055038" "20040203824" "5742779" "20030032414" "7548875").PN.	US-PGPUB; USPAT; USOCR; EPO; JPO; DERWENT; IBM_TDB	ADJ	OFF	2011/10/18; 16:06
S118	42	S116 or S117	US-PGPUB; USPAT; USOCR; EPO; JPO; DERWENT; IBM_TDB	ADJ	OFF	2011/10/18; 16:06
S119	42	("6333973" "6020828" "6430405" "20020032641" "20020085027" "5579472" "20020098874" "5533110" "20020091774" "7266186" "6771974" "5923327" "20030153337" "20020094806" "20020126146" "5907604" "20010055038" "20040203824" "5742779" "20030032414" "7548875").PN. or ("20020085027" "6430405" "20020098874" "5533110" "5923327" "20020032641" "7548875" "20030153337" "7548875" "20010055038" "20020094806" "20020126146" "5907604" "6771974" "5742779" "20040203824" "7266186").PN.	US-PGPUB; USPAT; USOCR; EPO; JPO; DERWENT; IBM_TDB	ADJ	OFF	2011/10/18; 16:07

EAST Search History (Interference)

< This search history is empty >

10/ 19/ 2011 4:37:28 PM

C:\ Users\ jheffington\ Documents\ OA Folders\ 10784781\ 10784781-SearchHistory11-10-17-2011.wsp

INFORMATION DISCLOSURE STATEMENT BY APPLICANT (Not for submission under 37 CFR 1.99)	Application Number	10784781
	Filing Date	2004-02-24
	First Named Inventor	Gerhard D. KLASSEN
	Art Unit	2172
	Examiner Name	HEFFINGTON, John M.
	Attorney Docket Number	05200204-272US

U.S.PATENTS						Remove
Examiner Initial*	Cite No	Patent Number	Kind Code ¹	Issue Date	Name of Patentee or Applicant of cited Document	Pages,Columns,Lines where Relevant Passages or Relevant Figures Appear
	1					

If you wish to add additional U.S. Patent citation information please click the Add button.

Add

U.S.PATENT APPLICATION PUBLICATIONS						Remove
Examiner Initial*	Cite No	Publication Number	Kind Code ¹	Publication Date	Name of Patentee or Applicant of cited Document	Pages,Columns,Lines where Relevant Passages or Relevant Figures Appear
	1	20030013483		2003-01-16	Ausems et al	

If you wish to add additional U.S. Published Application citation information please click the Add button.

Add

FOREIGN PATENT DOCUMENTS								Remove
Examiner Initial*	Cite No	Foreign Document Number ³	Country Code ² j	Kind Code ⁴	Publication Date	Name of Patentee or Applicant of cited Document	Pages,Columns,Lines where Relevant Passages or Relevant Figures Appear	T ⁵
	1							<input type="checkbox"/>

If you wish to add additional Foreign Patent Document citation information please click the Add button

Add

NON-PATENT LITERATURE DOCUMENTS			Remove
Examiner Initials*	Cite No	Include name of the author (in CAPITAL LETTERS), title of the article (when appropriate), title of the item (book, magazine, journal, serial, symposium, catalog, etc), date, pages(s), volume-issue number(s), publisher, city and/or country where published.	T ⁵

INFORMATION DISCLOSURE STATEMENT BY APPLICANT (Not for submission under 37 CFR 1.99)	Application Number		10784781
	Filing Date		2004-02-24
	First Named Inventor	Gerhard D. KLASSEN	
	Art Unit		2172
	Examiner Name	HEFFINGTON, John M.	
	Attorney Docket Number		05200204-272US

1	Response to Examination Report issued by the Canadian Intellectual Property Office against corresponding Canadian Application No. 2,548,598 dated May 20, 2011	<input type="checkbox"/>
2	Examiner's Requisition issued by the Canadian Intellectual Property Office against corresponding Canadian Application No. 2,727,763 dated March 21, 2011 along with Applicant's response dated June 21, 2011;	<input type="checkbox"/>
3	Examiner's Requisition issued by the Canadian Intellectual Property Office against corresponding Canadian Application No. 2,732,050 dated April 14, 2011 along with Applicant's response dated July 13, 2011;	<input type="checkbox"/>
4	Examiner's Search Report and Written Opinion issued by the Intellectual Property Office of Singapore against corresponding Singapore Patent Application No. 200804162-6 dated April 12, 2011	<input type="checkbox"/>
5	Summons to attend oral proceedings pursuant to Rule 115(1) EPC in corresponding European Patent Application No. 08168419.3 dated February 2, 2011	<input type="checkbox"/>
6	Response from Barker Brettell to European Patent Office dated May 12, 2011 to summons to attend oral proceedings in corresponding European Patent Application No. 08168419.3	<input type="checkbox"/>
7	First, Second and Third Auxiliary Requests dated June 14, 2011	<input type="checkbox"/>
8	"10 Minute Guide to Pocket PC 2002"; Copyright 2003 by Que; XP007916815; ISBN 0-7897-2797-8; Library of Congress Catalog Card No. 2002103976; U.S.A.; September, 2002; Wiegand, G. et al	<input type="checkbox"/>
9	Response from Barker Brettell to European Patent Office dated June 1, 2011 to Extended European Search Report in corresponding European Patent Application No. 10177958.5	<input type="checkbox"/>
10	EPO to Barker Brettell dated August 22, 2011; Provision of a copy of the minutes of the oral proceedings dated June 14, 2011, in accordance with Rule 124(4)EPC in corresponding European Patent Application No. 08168419.3	<input type="checkbox"/>
11	EPO to Barker Brettell dated August 22, 2011; Decision to refuse a European Patent application at the oral proceedings dated June 14, 2011 in corresponding European Patent Application No. 08168419.3	<input type="checkbox"/>

INFORMATION DISCLOSURE STATEMENT BY APPLICANT (Not for submission under 37 CFR 1.99)	Application Number	10784781
	Filing Date	2004-02-24
	First Named Inventor	Gerhard D. KLASSEN
	Art Unit	2172
	Examiner Name	HEFFINGTON, John M.
	Attorney Docket Number	05200204-272US

If you wish to add additional non-patent literature document citation information please click the Add button **Add**

EXAMINER SIGNATURE			
Examiner Signature	/John Heffington/	Date Considered	10/20/2011

*EXAMINER: Initial if reference considered, whether or not citation is in conformance with MPEP 609. Draw line through a citation if not in conformance and not considered. Include copy of this form with next communication to applicant.

¹ See Kind Codes of USPTO Patent Documents at www.USPTO.GOV or MPEP 901.04. ² Enter office that issued the document, by the two-letter code (WIPO Standard ST.3). ³ For Japanese patent documents, the indication of the year of the reign of the Emperor must precede the serial number of the patent document. ⁴ Kind of document by the appropriate symbols as indicated on the document under WIPO Standard ST.16 if possible. ⁵ Applicant is to place a check mark here if English language translation is attached.

INFORMATION DISCLOSURE STATEMENT BY APPLICANT (Not for submission under 37 CFR 1.99)	Application Number	10784781
	Filing Date	2004-02-24
	First Named Inventor	Gerhard D. KLASSEN
	Art Unit	2172
	Examiner Name	HEFFINGTON, John M.
	Attorney Docket Number	05200204-272US

CERTIFICATION STATEMENT

Please see 37 CFR 1.97 and 1.98 to make the appropriate selection(s):

That each item of information contained in the information disclosure statement was first cited in any communication from a foreign patent office in a counterpart foreign application not more than three months prior to the filing of the information disclosure statement. See 37 CFR 1.97(e)(1).

OR

That no item of information contained in the information disclosure statement was cited in a communication from a foreign patent office in a counterpart foreign application, and, to the knowledge of the person signing the certification after making reasonable inquiry, no item of information contained in the information disclosure statement was known to any individual designated in 37 CFR 1.56(c) more than three months prior to the filing of the information disclosure statement. See 37 CFR 1.97(e)(2).

See attached certification statement.

The fee set forth in 37 CFR 1.17 (p) has been submitted herewith.

A certification statement is not submitted herewith.

SIGNATURE

A signature of the applicant or representative is required in accordance with CFR 1.33, 10.18. Please see CFR 1.4(d) for the form of the signature.

Signature	/matthew j. marquardt/	Date (YYYY-MM-DD)	2011-09-08
Name/Print	MATTHEW J. MARQUARDT	Registration Number	40997

This collection of information is required by 37 CFR 1.97 and 1.98. The information is required to obtain or retain a benefit by the public which is to file (and by the USPTO to process) an application. Confidentiality is governed by 35 U.S.C. 122 and 37 CFR 1.14. This collection is estimated to take 1 hour to complete, including gathering, preparing and submitting the completed application form to the USPTO. Time will vary depending upon the individual case. Any comments on the amount of time you require to complete this form and/or suggestions for reducing this burden, should be sent to the Chief Information Officer, U.S. Patent and Trademark Office, U.S. Department of Commerce, P.O. Box 1450, Alexandria, VA 22313-1450. **DO NOT SEND FEES OR COMPLETED FORMS TO THIS ADDRESS. SEND TO: Commissioner for Patents, P.O. Box 1450, Alexandria, VA 22313-1450.**

Privacy Act Statement

The Privacy Act of 1974 (P.L. 93-579) requires that you be given certain information in connection with your submission of the attached form related to a patent application or patent. Accordingly, pursuant to the requirements of the Act, please be advised that: (1) the general authority for the collection of this information is 35 U.S.C. 2(b)(2); (2) furnishing of the information solicited is voluntary; and (3) the principal purpose for which the information is used by the U.S. Patent and Trademark Office is to process and/or examine your submission related to a patent application or patent. If you do not furnish the requested information, the U.S. Patent and Trademark Office may not be able to process and/or examine your submission, which may result in termination of proceedings or abandonment of the application or expiration of the patent.

The information provided by you in this form will be subject to the following routine uses:

1. The information on this form will be treated confidentially to the extent allowed under the Freedom of Information Act (5 U.S.C. 552) and the Privacy Act (5 U.S.C. 552a). Records from this system of records may be disclosed to the Department of Justice to determine whether the Freedom of Information Act requires disclosure of these records.
2. A record from this system of records may be disclosed, as a routine use, in the course of presenting evidence to a court, magistrate, or administrative tribunal, including disclosures to opposing counsel in the course of settlement negotiations.
3. A record in this system of records may be disclosed, as a routine use, to a Member of Congress submitting a request involving an individual, to whom the record pertains, when the individual has requested assistance from the Member with respect to the subject matter of the record.
4. A record in this system of records may be disclosed, as a routine use, to a contractor of the Agency having need for the information in order to perform a contract. Recipients of information shall be required to comply with the requirements of the Privacy Act of 1974, as amended, pursuant to 5 U.S.C. 552a(m).
5. A record related to an International Application filed under the Patent Cooperation Treaty in this system of records may be disclosed, as a routine use, to the International Bureau of the World Intellectual Property Organization, pursuant to the Patent Cooperation Treaty.
6. A record in this system of records may be disclosed, as a routine use, to another federal agency for purposes of National Security review (35 U.S.C. 181) and for review pursuant to the Atomic Energy Act (42 U.S.C. 218(c)).
7. A record from this system of records may be disclosed, as a routine use, to the Administrator, General Services, or his/her designee, during an inspection of records conducted by GSA as part of that agency's responsibility to recommend improvements in records management practices and programs, under authority of 44 U.S.C. 2904 and 2906. Such disclosure shall be made in accordance with the GSA regulations governing inspection of records for this purpose, and any other relevant (i.e., GSA or Commerce) directive. Such disclosure shall not be used to make determinations about individuals.
8. A record from this system of records may be disclosed, as a routine use, to the public after either publication of the application pursuant to 35 U.S.C. 122(b) or issuance of a patent pursuant to 35 U.S.C. 151. Further, a record may be disclosed, subject to the limitations of 37 CFR 1.14, as a routine use, to the public if the record was filed in an application which became abandoned or in which the proceedings were terminated and which application is referenced by either a published application, an application open to public inspections or an issued patent.
9. A record from this system of records may be disclosed, as a routine use, to a Federal, State, or local law enforcement agency, if the USPTO becomes aware of a violation or potential violation of law or regulation.

ALL REFERENCES CONSIDERED EXCEPT WHERE LINED THROUGH. /J.H./

INFORMATION DISCLOSURE STATEMENT BY APPLICANT (Not for submission under 37 CFR 1.99)	Application Number	10784781
	Filing Date	2004-02-24
	First Named Inventor	Gerhard D. KLASSEN
	Art Unit	2179
	Examiner Name	HEFFINGTON, John M.
	Attorney Docket Number	05200204-272US

U.S.PATENTS						Remove
Examiner Initial*	Cite No	Patent Number	Kind Code ¹	Issue Date	Name of Patentee or Applicant of cited Document	Pages,Columns,Lines where Relevant Passages or Relevant Figures Appear
	1					

If you wish to add additional U.S. Patent citation information please click the Add button. **Add**

U.S.PATENT APPLICATION PUBLICATIONS						Remove
Examiner Initial*	Cite No	Publication Number	Kind Code ¹	Publication Date	Name of Patentee or Applicant of cited Document	Pages,Columns,Lines where Relevant Passages or Relevant Figures Appear
	1					

If you wish to add additional U.S. Published Application citation information please click the Add button. **Add**

FOREIGN PATENT DOCUMENTS								Remove
Examiner Initial*	Cite No	Foreign Document Number ³	Country Code ²	Kind Code ⁴	Publication Date	Name of Patentee or Applicant of cited Document	Pages,Columns,Lines where Relevant Passages or Relevant Figures Appear	T ⁵
	1							<input type="checkbox"/>

If you wish to add additional Foreign Patent Document citation information please click the Add button. **Add**

NON-PATENT LITERATURE DOCUMENTS			Remove
Examiner Initials*	Cite No	Include name of the author (in CAPITAL LETTERS), title of the article (when appropriate), title of the item (book, magazine, journal, serial, symposium, catalog, etc), date, pages(s), volume-issue number(s), publisher, city and/or country where published.	T ⁵

EFS Web 2.1.17 ALL REFERENCES CONSIDERED EXCEPT WHERE LINED THROUGH. /J.H./

INFORMATION DISCLOSURE STATEMENT BY APPLICANT (Not for submission under 37 CFR 1.99)	Application Number	10784781	10784781 - GAU: 2172
	Filing Date	2004-02-24	
	First Named Inventor	Gerhard D. KLASSEN	
	Art Unit	21-79	
	Examiner Name	HEFFINGTON, John M.	
	Attorney Docket Number	05200204-272US	

1	Allen & Gledhill to Registrar of Patents, Singapore; Response to Written Opinion in divisional Singapore patent application no. 200804162-6 dated September 12, 2011	<input type="checkbox"/>
If you wish to add additional non-patent literature document citation information please click the Add button Add		
EXAMINER SIGNATURE		
Examiner Signature	/John Heffington/	Date Considered 10/20/2011
*EXAMINER: Initial if reference considered, whether or not citation is in conformance with MPEP 609. Draw line through a citation if not in conformance and not considered. Include copy of this form with next communication to applicant.		
<small> ¹ See Kind Codes of USPTO Patent Documents at www.USPTO.GOV or MPEP 901.04. ² Enter office that issued the document, by the two-letter code (WIPO Standard ST.3). ³ For Japanese patent documents, the indication of the year of the reign of the Emperor must precede the serial number of the patent document. ⁴ Kind of document by the appropriate symbols as indicated on the document under WIPO Standard ST.16 if possible. ⁵ Applicant is to place a check mark here if English language translation is attached. </small>		

INFORMATION DISCLOSURE STATEMENT BY APPLICANT (Not for submission under 37 CFR 1.99)	Application Number	10784781	10784781 - GAU: 2172
	Filing Date	2004-02-24	
	First Named Inventor	Gerhard D. KLASSEN	
	Art Unit	2179	
	Examiner Name	HEFFINGTON, John M.	
	Attorney Docket Number	05200204-272US	

CERTIFICATION STATEMENT

Please see 37 CFR 1.97 and 1.98 to make the appropriate selection(s):

That each item of information contained in the information disclosure statement was first cited in any communication from a foreign patent office in a counterpart foreign application not more than three months prior to the filing of the information disclosure statement. See 37 CFR 1.97(e)(1).

OR

That no item of information contained in the information disclosure statement was cited in a communication from a foreign patent office in a counterpart foreign application, and, to the knowledge of the person signing the certification after making reasonable inquiry, no item of information contained in the information disclosure statement was known to any individual designated in 37 CFR 1.56(c) more than three months prior to the filing of the information disclosure statement. See 37 CFR 1.97(e)(2).

See attached certification statement.

The fee set forth in 37 CFR 1.17 (p) has been submitted herewith.

A certification statement is not submitted herewith.

SIGNATURE

A signature of the applicant or representative is required in accordance with CFR 1.33, 10.18. Please see CFR 1.4(d) for the form of the signature.

Signature	/matthew j. marquardt/	Date (YYYY-MM-DD)	2011-09-16
Name/Print	MATTHEW J. MARQUARDT	Registration Number	40997

This collection of information is required by 37 CFR 1.97 and 1.98. The information is required to obtain or retain a benefit by the public which is to file (and by the USPTO to process) an application. Confidentiality is governed by 35 U.S.C. 122 and 37 CFR 1.14. This collection is estimated to take 1 hour to complete, including gathering, preparing and submitting the completed application form to the USPTO. Time will vary depending upon the individual case. Any comments on the amount of time you require to complete this form and/or suggestions for reducing this burden, should be sent to the Chief Information Officer, U.S. Patent and Trademark Office, U.S. Department of Commerce, P.O. Box 1450, Alexandria, VA 22313-1450. **DO NOT SEND FEES OR COMPLETED FORMS TO THIS ADDRESS. SEND TO: Commissioner for Patents, P.O. Box 1450, Alexandria, VA 22313-1450.**

Privacy Act Statement

The Privacy Act of 1974 (P.L. 93-579) requires that you be given certain information in connection with your submission of the attached form related to a patent application or patent. Accordingly, pursuant to the requirements of the Act, please be advised that: (1) the general authority for the collection of this information is 35 U.S.C. 2(b)(2); (2) furnishing of the information solicited is voluntary; and (3) the principal purpose for which the information is used by the U.S. Patent and Trademark Office is to process and/or examine your submission related to a patent application or patent. If you do not furnish the requested information, the U.S. Patent and Trademark Office may not be able to process and/or examine your submission, which may result in termination of proceedings or abandonment of the application or expiration of the patent.

The information provided by you in this form will be subject to the following routine uses:

1. The information on this form will be treated confidentially to the extent allowed under the Freedom of Information Act (5 U.S.C. 552) and the Privacy Act (5 U.S.C. 552a). Records from this system of records may be disclosed to the Department of Justice to determine whether the Freedom of Information Act requires disclosure of these records.
2. A record from this system of records may be disclosed, as a routine use, in the course of presenting evidence to a court, magistrate, or administrative tribunal, including disclosures to opposing counsel in the course of settlement negotiations.
3. A record in this system of records may be disclosed, as a routine use, to a Member of Congress submitting a request involving an individual, to whom the record pertains, when the individual has requested assistance from the Member with respect to the subject matter of the record.
4. A record in this system of records may be disclosed, as a routine use, to a contractor of the Agency having need for the information in order to perform a contract. Recipients of information shall be required to comply with the requirements of the Privacy Act of 1974, as amended, pursuant to 5 U.S.C. 552a(m).
5. A record related to an International Application filed under the Patent Cooperation Treaty in this system of records may be disclosed, as a routine use, to the International Bureau of the World Intellectual Property Organization, pursuant to the Patent Cooperation Treaty.
6. A record in this system of records may be disclosed, as a routine use, to another federal agency for purposes of National Security review (35 U.S.C. 181) and for review pursuant to the Atomic Energy Act (42 U.S.C. 218(c)).
7. A record from this system of records may be disclosed, as a routine use, to the Administrator, General Services, or his/her designee, during an inspection of records conducted by GSA as part of that agency's responsibility to recommend improvements in records management practices and programs, under authority of 44 U.S.C. 2904 and 2906. Such disclosure shall be made in accordance with the GSA regulations governing inspection of records for this purpose, and any other relevant (i.e., GSA or Commerce) directive. Such disclosure shall not be used to make determinations about individuals.
8. A record from this system of records may be disclosed, as a routine use, to the public after either publication of the application pursuant to 35 U.S.C. 122(b) or issuance of a patent pursuant to 35 U.S.C. 151. Further, a record may be disclosed, subject to the limitations of 37 CFR 1.14, as a routine use, to the public if the record was filed in an application which became abandoned or in which the proceedings were terminated and which application is referenced by either a published application, an application open to public inspections or an issued patent.
9. A record from this system of records may be disclosed, as a routine use, to a Federal, State, or local law enforcement agency, if the USPTO becomes aware of a violation or potential violation of law or regulation.

ALL REFERENCES CONSIDERED EXCEPT WHERE LINED THROUGH. /J.H./

Search Notes 	Application/Control No. 10784781	Applicant(s)/Patent Under Reexamination KLASSEN ET AL.
	Examiner Heffington, John M	Art Unit 2179

SEARCHED			
Class	Subclass	Date	Examiner
715	700	3/1/2007	JMH
715	842, 851	5/8/11	JMH
715	710	10/19/11	JMH

SEARCH NOTES		
Search Notes	Date	Examiner
EAST Search	3/1/2007	JMH
EAST Search (update)	12/7/2007	JMH
EAST Search (update)	3/23/2008	JMH
NPL Search	3/23/2008	JMH
EAST Search	10/16/08	JMH
EAST Search	4/7/09	JMH
EAST Search	9/22/09	JMH
EAST Search	3/27/10	JMH
EAST Search	4/26/11-5/8/11	JMH
EAST Search	10/17/11 - 10/19/11	JMH
Text Search 715/710	10/17/11	JMH

INTERFERENCE SEARCH			
Class	Subclass	Date	Examiner

--	--

Index of Claims 	Application/Control No. 10784781	Applicant(s)/Patent Under Reexamination KLASSEN ET AL.
	Examiner Heffington, John M	Art Unit 2179

✓	Rejected	-	Cancelled	N	Non-Elected	A	Appeal
=	Allowed	÷	Restricted	I	Interference	O	Objected

Claims renumbered in the same order as presented by applicant
 CPA
 T.D.
 R.1.47

CLAIM		DATE								
Final	Original	03/05/2007	12/07/2007	03/23/2008	10/17/2008	04/07/2009	09/23/2009	03/27/2010	05/08/2011	10/20/2011
	1	✓	-	-	-	-	-	-	-	-
	2	✓	-	-	-	-	-	-	-	-
	3	✓	-	-	-	-	-	-	-	-
	4	✓	-	-	-	-	-	-	-	-
	5	✓	-	-	-	-	-	-	-	-
	6	✓	-	-	-	-	-	-	-	-
	7	✓	-	-	-	-	-	-	-	-
	8	✓	-	-	-	-	-	-	-	-
	9	✓	-	-	-	-	-	-	-	-
	10	✓	-	-	-	-	-	-	-	-
	11	✓	-	-	-	-	-	-	-	-
	12	✓	-	-	-	-	-	-	-	-
	13	✓	-	-	-	-	-	-	-	-
	14	✓	-	-	-	-	-	-	-	-
	15	✓	-	-	-	-	-	-	-	-
	16	✓	-	-	-	-	-	-	-	-
	17	✓	-	-	-	-	-	-	-	-
	18	✓	-	-	-	-	-	-	-	-
	19	✓	-	-	-	-	-	-	-	-
	20	✓	-	-	-	-	-	-	-	-
	21		✓	✓	✓	✓	✓	✓	-	-
	22		✓	✓	✓	✓	✓	✓	-	-
	23		✓	✓	✓	✓	✓	✓	-	-
	24		✓	✓	✓	✓	✓	✓	-	-
	25		✓	✓	✓	✓	✓	✓	-	-
	26		✓	✓	✓	-	-	-	-	-
	27		✓	✓	✓	✓	✓	-	-	-
	28		✓	✓	✓	✓	✓	✓	-	-
	29		✓	✓	✓	✓	✓	✓	-	-
	30		✓	✓	✓	✓	✓	✓	-	-
	31		✓	✓	✓	✓	✓	✓	-	-
	32		✓	✓	✓	✓	✓	✓	-	-
	33		✓	✓	✓	✓	✓	✓	-	-
	34		✓	✓	✓	✓	✓	✓	-	-
	35		✓	✓	✓	-	-	-	-	-
	36		✓	✓	✓	✓	✓	-	-	-

Index of Claims 	Application/Control No. 10784781	Applicant(s)/Patent Under Reexamination KLASSEN ET AL.
	Examiner Heffington, John M	Art Unit 2179

✓	Rejected	-	Cancelled	N	Non-Elected	A	Appeal
=	Allowed	÷	Restricted	I	Interference	O	Objected

Claims renumbered in the same order as presented by applicant
 CPA
 T.D.
 R.1.47

CLAIM		DATE								
Final	Original	03/05/2007	12/07/2007	03/23/2008	10/17/2008	04/07/2009	09/23/2009	03/27/2010	05/08/2011	10/20/2011
	37		✓	✓	✓	✓	✓	✓	-	-
	38		✓	✓	✓	✓	✓	✓	-	-
	39		✓	✓	✓	✓	✓	✓	-	-
	40		✓	✓	✓	✓	✓	✓	-	-
	41		✓	✓	✓	✓	✓	✓	-	-
	42						✓	✓	-	-
	43						✓	✓	-	-
	44						✓	✓	-	-
	45						✓	✓	-	-
	46						✓	✓	-	-
	47						✓	✓	-	-
	48						✓	✓	-	-
	49						✓	✓	-	-
	50						✓	✓	-	-
	51						✓	✓	-	-
	52								✓	✓
	53								✓	✓
	54								✓	✓
	55								✓	✓
	56								✓	✓
	57								✓	✓
	58								✓	-
	59								✓	-
	60								✓	-
	61								✓	-
	62								✓	-
	63								✓	-
	64								✓	✓
	65								✓	✓
	66								✓	✓
	67								✓	✓
	68								✓	✓
	69								✓	✓
	70								✓	✓
	71								✓	✓
	72								✓	✓

Index of Claims 	Application/Control No. 10784781	Applicant(s)/Patent Under Reexamination KLASSEN ET AL.
	Examiner Heffington, John M	Art Unit 2179

✓	Rejected	-	Cancelled	N	Non-Elected	A	Appeal
=	Allowed	÷	Restricted	I	Interference	O	Objected

Claims renumbered in the same order as presented by applicant
 CPA
 T.D.
 R.1.47

CLAIM		DATE								
Final	Original	03/05/2007	12/07/2007	03/23/2008	10/17/2008	04/07/2009	09/23/2009	03/27/2010	05/08/2011	10/20/2011
	73								✓	✓
	74								✓	✓
	75								✓	✓
	76								✓	✓
	77								✓	✓
	78								✓	✓
	79								✓	✓
	80								✓	✓
	81								✓	✓
	82								✓	✓
	83								✓	✓
	84								✓	✓
	85								✓	-
	86								✓	-
	87								✓	-
	88								✓	-
	89								✓	-
	90								✓	-
	91								✓	-
	92								✓	-
	93								✓	-
	94								✓	✓
	95								✓	✓
	96								✓	✓
	97								✓	✓
	98								✓	✓
	99								✓	✓
	100								✓	✓
	101								✓	✓
	102								✓	✓
	103								✓	✓
	104								✓	✓
	105								✓	✓
	106								✓	✓
	107								✓	✓
	108								✓	✓

Index of Claims 	Application/Control No. 10784781	Applicant(s)/Patent Under Reexamination KLASSEN ET AL.
	Examiner Heffington, John M	Art Unit 2179

✓	Rejected	-	Cancelled	N	Non-Elected	A	Appeal
=	Allowed	÷	Restricted	I	Interference	O	Objected

Claims renumbered in the same order as presented by applicant
 CPA
 T.D.
 R.1.47

CLAIM		DATE								
Final	Original	03/05/2007	12/07/2007	03/23/2008	10/17/2008	04/07/2009	09/23/2009	03/27/2010	05/08/2011	10/20/2011
	109								✓	✓
	110								✓	✓
	111								✓	✓



UNITED STATES PATENT AND TRADEMARK OFFICE

UNITED STATES DEPARTMENT OF COMMERCE
United States Patent and Trademark Office
Address: COMMISSIONER FOR PATENTS
P.O. Box 1450
Alexandria, Virginia 22313-1450
www.uspto.gov

APPLICATION NO.	FILING DATE	FIRST NAMED INVENTOR	ATTORNEY DOCKET NO.	CONFIRMATION NO.
10/784,781	02/24/2004	Gerhard D. Klassen	05200204-272US	2200
20988	7590	03/12/2012	EXAMINER	
NORTON ROSE CANADA LLP			HEFFINGTON, JOHN M	
1, Place Ville Marie			ART UNIT	PAPER NUMBER
SUITE 2500			2172	
MONTREAL, QC H3B 1R1			MAIL DATE	DELIVERY MODE
CANADA			03/12/2012	PAPER

Please find below and/or attached an Office communication concerning this application or proceeding.

The time period for reply, if any, is set in the attached communication.

Applicant-Initiated Interview Summary	Application No. 10/784,781	Applicant(s) KLASSEN ET AL.	
	Examiner JOHN HEFFINGTON	Art Unit 2172	

All participants (applicant, applicant's representative, PTO personnel):

(1) JOHN HEFFINGTON. (3) Donna Flores.
(2) Matt Marquardt. (4) Gary Klassen.

Date of Interview: 06 March 2012.

Type: Telephonic Video Conference
 Personal [copy given to: applicant applicant's representative]

Exhibit shown or demonstration conducted: Yes No.
If Yes, brief description: _____.

Issues Discussed 101 112 102 103 Others
(For each of the checked box(es) above, please describe below the issue and detailed description of the discussion)

Claim(s) discussed: 52.

Identification of prior art discussed: Wagner, Canfield.

Substance of Interview
(For each issue discussed, provide a detailed description and indicate if agreement was reached. Some topics may include: identification or clarification of a reference or a portion thereof, claim interpretation, proposed amendments, arguments of any applied references etc...)

The applicants argued that the prior art of record, when interpreted correctly, does not read on the independent claim. The examiner stated that, upon the applicant filing an after final amendment, the examiner would consider the applicant's arguments. If the arguments overcome the rejections, the examiner agreed to reopen prosecution.

Applicant recordation instructions: The formal written reply to the last Office action must include the substance of the interview. (See MPEP section 713.04). If a reply to the last Office action has already been filed, applicant is given a non-extendable period of the longer of one month or thirty days from this interview date, or the mailing date of this interview summary form, whichever is later, to file a statement of the substance of the interview

Examiner recordation instructions: Examiners must summarize the substance of any interview of record. A complete and proper recordation of the substance of an interview should include the items listed in MPEP 713.04 for complete and proper recordation including the identification of the general thrust of each argument or issue discussed, a general indication of any other pertinent matters discussed regarding patentability and the general results or outcome of the interview, to include an indication as to whether or not agreement was reached on the issues raised.

Attachment

/Boris Pesin/
Supervisory Patent Examiner, Art Unit 2172

Summary of Record of Interview Requirements

Manual of Patent Examining Procedure (MPEP), Section 713.04, Substance of Interview Must be Made of Record

A complete written statement as to the substance of any face-to-face, video conference, or telephone interview with regard to an application must be made of record in the application whether or not an agreement with the examiner was reached at the interview.

Title 37 Code of Federal Regulations (CFR) § 1.133 Interviews

Paragraph (b)

In every instance where reconsideration is requested in view of an interview with an examiner, a complete written statement of the reasons presented at the interview as warranting favorable action must be filed by the applicant. An interview does not remove the necessity for reply to Office action as specified in §§ 1.111, 1.135. (35 U.S.C. 132)

37 CFR §1.2 Business to be transacted in writing.

All business with the Patent or Trademark Office should be transacted in writing. The personal attendance of applicants or their attorneys or agents at the Patent and Trademark Office is unnecessary. The action of the Patent and Trademark Office will be based exclusively on the written record in the Office. No attention will be paid to any alleged oral promise, stipulation, or understanding in relation to which there is disagreement or doubt.

The action of the Patent and Trademark Office cannot be based exclusively on the written record in the Office if that record is itself incomplete through the failure to record the substance of interviews.

It is the responsibility of the applicant or the attorney or agent to make the substance of an interview of record in the application file, unless the examiner indicates he or she will do so. It is the examiner's responsibility to see that such a record is made and to correct material inaccuracies which bear directly on the question of patentability.

Examiners must complete an Interview Summary Form for each interview held where a matter of substance has been discussed during the interview by checking the appropriate boxes and filling in the blanks. Discussions regarding only procedural matters, directed solely to restriction requirements for which interview recordation is otherwise provided for in Section 812.01 of the Manual of Patent Examining Procedure, or pointing out typographical errors or unreadable script in Office actions or the like, are excluded from the interview recordation procedures below. Where the substance of an interview is completely recorded in an Examiners Amendment, no separate Interview Summary Record is required.

The Interview Summary Form shall be given an appropriate Paper No., placed in the right hand portion of the file, and listed on the "Contents" section of the file wrapper. In a personal interview, a duplicate of the Form is given to the applicant (or attorney or agent) at the conclusion of the interview. In the case of a telephone or video-conference interview, the copy is mailed to the applicant's correspondence address either with or prior to the next official communication. If additional correspondence from the examiner is not likely before an allowance or if other circumstances dictate, the Form should be mailed promptly after the interview rather than with the next official communication.

The Form provides for recordation of the following information:

- Application Number (Series Code and Serial Number)
- Name of applicant
- Name of examiner
- Date of interview
- Type of interview (telephonic, video-conference, or personal)
- Name of participant(s) (applicant, attorney or agent, examiner, other PTO personnel, etc.)
- An indication whether or not an exhibit was shown or a demonstration conducted
- An identification of the specific prior art discussed
- An indication whether an agreement was reached and if so, a description of the general nature of the agreement (may be by attachment of a copy of amendments or claims agreed as being allowable). Note: Agreement as to allowability is tentative and does not restrict further action by the examiner to the contrary.
- The signature of the examiner who conducted the interview (if Form is not an attachment to a signed Office action)

It is desirable that the examiner orally remind the applicant of his or her obligation to record the substance of the interview of each case. It should be noted, however, that the Interview Summary Form will not normally be considered a complete and proper recordation of the interview unless it includes, or is supplemented by the applicant or the examiner to include, all of the applicable items required below concerning the substance of the interview.

A complete and proper recordation of the substance of any interview should include at least the following applicable items:

- 1) A brief description of the nature of any exhibit shown or any demonstration conducted,
- 2) an identification of the claims discussed,
- 3) an identification of the specific prior art discussed,
- 4) an identification of the principal proposed amendments of a substantive nature discussed, unless these are already described on the Interview Summary Form completed by the Examiner,
- 5) a brief identification of the general thrust of the principal arguments presented to the examiner,
(The identification of arguments need not be lengthy or elaborate. A verbatim or highly detailed description of the arguments is not required. The identification of the arguments is sufficient if the general nature or thrust of the principal arguments made to the examiner can be understood in the context of the application file. Of course, the applicant may desire to emphasize and fully describe those arguments which he or she feels were or might be persuasive to the examiner.)
- 6) a general indication of any other pertinent matters discussed, and
- 7) if appropriate, the general results or outcome of the interview unless already described in the Interview Summary Form completed by the examiner.

Examiners are expected to carefully review the applicant's record of the substance of an interview. If the record is not complete and accurate, the examiner will give the applicant an extendable one month time period to correct the record.

Examiner to Check for Accuracy

If the claims are allowable for other reasons of record, the examiner should send a letter setting forth the examiner's version of the statement attributed to him or her. If the record is complete and accurate, the examiner should place the indication, "Interview Record OK" on the paper recording the substance of the interview along with the date and the examiner's initials.

INFORMATION DISCLOSURE STATEMENT BY APPLICANT (Not for submission under 37 CFR 1.99)	Application Number	10784781
	Filing Date	2004-02-24
	First Named Inventor	Gerhard D. Klassen
	Art Unit	2172
	Examiner Name	Heffington, John M.
	Attorney Docket Number	05200204-272US

U.S.PATENTS						
Examiner Initial*	Cite No	Patent Number	Kind Code ¹	Issue Date	Name of Patentee or Applicant of cited Document	Pages, Columns, Lines where Relevant Passages or Relevant Figures Appear
	1					

If you wish to add additional U.S. Patent citation information please click the Add button.

U.S.PATENT APPLICATION PUBLICATIONS						
Examiner Initial*	Cite No	Publication Number	Kind Code ¹	Publication Date	Name of Patentee or Applicant of cited Document	Pages, Columns, Lines where Relevant Passages or Relevant Figures Appear
	1					

If you wish to add additional U.S. Published Application citation information please click the Add button.

FOREIGN PATENT DOCUMENTS								
Examiner Initial*	Cite No	Foreign Document Number ³	Country Code ²	Kind Code ⁴	Publication Date	Name of Patentee or Applicant of cited Document	Pages, Columns, Lines where Relevant Passages or Relevant Figures Appear	T ⁵
	1	WO2003014905	WO	A2	2003-02-20	Danger Research, Inc.		<input type="checkbox"/>

If you wish to add additional Foreign Patent Document citation information please click the Add button

NON-PATENT LITERATURE DOCUMENTS			
Examiner Initials*	Cite No	Include name of the author (in CAPITAL LETTERS), title of the article (when appropriate), title of the item (book, magazine, journal, serial, symposium, catalog, etc), date, pages(s), volume-issue number(s), publisher, city and/or country where published.	T ⁵

INFORMATION DISCLOSURE STATEMENT BY APPLICANT (Not for submission under 37 CFR 1.99)	Application Number	10784781
	Filing Date	2004-02-24
	First Named Inventor	Gerhard D. Klassen
	Art Unit	2172
	Examiner Name	Heffington, John M.
	Attorney Docket Number	05200204-272US

	1		<input type="checkbox"/>
If you wish to add additional non-patent literature document citation information please click the Add button			
EXAMINER SIGNATURE			
Examiner Signature		Date Considered	
<p>*EXAMINER: Initial if reference considered, whether or not citation is in conformance with MPEP 609. Draw line through a citation if not in conformance and not considered. Include copy of this form with next communication to applicant.</p>			
<p>¹ See Kind Codes of USPTO Patent Documents at www.USPTO.GOV or MPEP 901.04. ² Enter office that issued the document, by the two-letter code (WIPO Standard ST.3). ³ For Japanese patent documents, the indication of the year of the reign of the Emperor must precede the serial number of the patent document. ⁴ Kind of document by the appropriate symbols as indicated on the document under WIPO Standard ST.16 if possible. ⁵ Applicant is to place a check mark here if English language translation is attached.</p>			

INFORMATION DISCLOSURE STATEMENT BY APPLICANT (Not for submission under 37 CFR 1.99)	Application Number	10784781
	Filing Date	2004-02-24
	First Named Inventor	Gerhard D. Klassen
	Art Unit	2172
	Examiner Name	Heffington, John M.
	Attorney Docket Number	05200204-272US

CERTIFICATION STATEMENT

Please see 37 CFR 1.97 and 1.98 to make the appropriate selection(s):

That each item of information contained in the information disclosure statement was first cited in any communication from a foreign patent office in a counterpart foreign application not more than three months prior to the filing of the information disclosure statement. See 37 CFR 1.97(e)(1).

OR

That no item of information contained in the information disclosure statement was cited in a communication from a foreign patent office in a counterpart foreign application, and, to the knowledge of the person signing the certification after making reasonable inquiry, no item of information contained in the information disclosure statement was known to any individual designated in 37 CFR 1.56(c) more than three months prior to the filing of the information disclosure statement. See 37 CFR 1.97(e)(2).

See attached certification statement.

The fee set forth in 37 CFR 1.17 (p) has been submitted herewith.

A certification statement is not submitted herewith.

SIGNATURE

A signature of the applicant or representative is required in accordance with CFR 1.33, 10.18. Please see CFR 1.4(d) for the form of the signature.

Signature	/Matthew J. Marquardt/	Date (YYYY-MM-DD)	2012-03-12
Name/Print	Matthew J. Marquardt	Registration Number	40997

This collection of information is required by 37 CFR 1.97 and 1.98. The information is required to obtain or retain a benefit by the public which is to file (and by the USPTO to process) an application. Confidentiality is governed by 35 U.S.C. 122 and 37 CFR 1.14. This collection is estimated to take 1 hour to complete, including gathering, preparing and submitting the completed application form to the USPTO. Time will vary depending upon the individual case. Any comments on the amount of time you require to complete this form and/or suggestions for reducing this burden, should be sent to the Chief Information Officer, U.S. Patent and Trademark Office, U.S. Department of Commerce, P.O. Box 1450, Alexandria, VA 22313-1450. **DO NOT SEND FEES OR COMPLETED FORMS TO THIS ADDRESS. SEND TO: Commissioner for Patents, P.O. Box 1450, Alexandria, VA 22313-1450.**

Privacy Act Statement

The Privacy Act of 1974 (P.L. 93-579) requires that you be given certain information in connection with your submission of the attached form related to a patent application or patent. Accordingly, pursuant to the requirements of the Act, please be advised that: (1) the general authority for the collection of this information is 35 U.S.C. 2(b)(2); (2) furnishing of the information solicited is voluntary; and (3) the principal purpose for which the information is used by the U.S. Patent and Trademark Office is to process and/or examine your submission related to a patent application or patent. If you do not furnish the requested information, the U.S. Patent and Trademark Office may not be able to process and/or examine your submission, which may result in termination of proceedings or abandonment of the application or expiration of the patent.

The information provided by you in this form will be subject to the following routine uses:

1. The information on this form will be treated confidentially to the extent allowed under the Freedom of Information Act (5 U.S.C. 552) and the Privacy Act (5 U.S.C. 552a). Records from this system of records may be disclosed to the Department of Justice to determine whether the Freedom of Information Act requires disclosure of these records.
2. A record from this system of records may be disclosed, as a routine use, in the course of presenting evidence to a court, magistrate, or administrative tribunal, including disclosures to opposing counsel in the course of settlement negotiations.
3. A record in this system of records may be disclosed, as a routine use, to a Member of Congress submitting a request involving an individual, to whom the record pertains, when the individual has requested assistance from the Member with respect to the subject matter of the record.
4. A record in this system of records may be disclosed, as a routine use, to a contractor of the Agency having need for the information in order to perform a contract. Recipients of information shall be required to comply with the requirements of the Privacy Act of 1974, as amended, pursuant to 5 U.S.C. 552a(m).
5. A record related to an International Application filed under the Patent Cooperation Treaty in this system of records may be disclosed, as a routine use, to the International Bureau of the World Intellectual Property Organization, pursuant to the Patent Cooperation Treaty.
6. A record in this system of records may be disclosed, as a routine use, to another federal agency for purposes of National Security review (35 U.S.C. 181) and for review pursuant to the Atomic Energy Act (42 U.S.C. 218(c)).
7. A record from this system of records may be disclosed, as a routine use, to the Administrator, General Services, or his/her designee, during an inspection of records conducted by GSA as part of that agency's responsibility to recommend improvements in records management practices and programs, under authority of 44 U.S.C. 2904 and 2906. Such disclosure shall be made in accordance with the GSA regulations governing inspection of records for this purpose, and any other relevant (i.e., GSA or Commerce) directive. Such disclosure shall not be used to make determinations about individuals.
8. A record from this system of records may be disclosed, as a routine use, to the public after either publication of the application pursuant to 35 U.S.C. 122(b) or issuance of a patent pursuant to 35 U.S.C. 151. Further, a record may be disclosed, subject to the limitations of 37 CFR 1.14, as a routine use, to the public if the record was filed in an application which became abandoned or in which the proceedings were terminated and which application is referenced by either a published application, an application open to public inspections or an issued patent.
9. A record from this system of records may be disclosed, as a routine use, to a Federal, State, or local law enforcement agency, if the USPTO becomes aware of a violation or potential violation of law or regulation.

(12) INTERNATIONAL APPLICATION PUBLISHED UNDER THE PATENT COOPERATION TREATY (PCT)

(19) World Intellectual Property Organization
International Bureau



(43) International Publication Date
20 February 2003 (20.02.2003)

(10) International Publication Number
PCT
WO 03/014905 A2

- (51) International Patent Classification⁷: G06F 3/00
- (21) International Application Number: PCT/US02/24710
- (22) International Filing Date: 5 August 2002 (05.08.2002)
- (25) Filing Language: English
- (26) Publication Language: English
- (30) Priority Data:
09/927,947 10 August 2001 (10.08.2001) US
- (71) Applicant: DANGER RESEARCH, INC. [US/US]; 165 University Avenue, Palo Alto, CA 94301 (US).
- (72) Inventors: DUARTE, Matias, G.; 1299 California Street, No. 20, San Francisco, CA 94109 (US). DESALVO, Christopher, J.; 148 Central Avenue, Apartment 1, San Francisco, CA 94117 (US).
- (74) Agents: MALLIE, Michael, J. et al.; Blakely, Sokoloff, Taylor & Zafman, 12400 Wilshire Boulevard, 7th Floor, Los Angeles, CA 90025 (US).
- (81) Designated States (*national*): AE, AG, AL, AM, AT, AU, AZ, BA, BB, BG, BR, BY, BZ, CA, CH, CN, CO, CR, CU, CZ, DE, DK, DM, DZ, EC, EE, ES, FI, GB, GD, GE, GH, GM, HR, HU, ID, IL, IN, IS, JP, KE, KG, KP, KR, KZ, LC, LK, LR, LS, LT, LU, LV, MA, MD, MG, MK, MN, MW, MX, MZ, NO, NZ, OM, PH, PL, PT, RO, RU, SD, SE, SG, SI, SK, SL, TJ, TM, TN, TR, TT, TZ, UA, UG, UZ, VN, YU, ZA, ZM, ZW.
- (84) Designated States (*regional*): ARIPO patent (GH, GM, KE, LS, MW, MZ, SD, SL, SZ, TZ, UG, ZM, ZW), Eurasian patent (AM, AZ, BY, KG, KZ, MD, RU, TJ, TM), European patent (AT, BE, BG, CH, CY, CZ, DE, DK, EE, ES, FI, FR, GB, GR, IE, IT, LU, MC, NL, PT, SE, SK, TR), OAPI patent (BF, BJ, CF, CG, CI, CM, GA, GN, GQ, GW, ML, MR, NE, SN, TD, TG).
- Published:
— without international search report and to be republished upon receipt of that report
- For two-letter codes and other abbreviations, refer to the "Guidance Notes on Codes and Abbreviations" appearing at the beginning of each regular issue of the PCT Gazette.



WO 03/014905 A2

(54) Title: A SYSTEM AND METHOD OF DISPLAYING MULTIPLE PENDING NOTIFICATION IN A SINGLE WINDOW

(57) Abstract: A system and method of displaying multiple, concurrent instant messaging (IM) sessions is described. The system and method includes providing multiple IM sessions, displaying a first one of the IM sessions in an IM session window. Representing each one of the IM sessions as a corresponding one of a number of indicators in the IM session window.

**A SYSTEM AND METHOD OF DISPLAYING MULTIPLE PENDING
NOTIFICATIONS IN A SINGLE WINDOW**

FIELD OF THE INVENTION

[0001] The present invention is related to computer displays and more specifically to the user interface of a computer display.

BACKGROUND OF THE INVENTION

[0002] One common user interface is a window such as a pop up window. A very common pop-up window is a message window such as is used in an instant messaging (IM) system such as America On-line's (AOL's) Instant Messenger, Yahoo's Yahoo Messenger, ICQ, Inc's ICQ messaging system, and other similar messaging systems.

[0003] Figs. 1-1A illustrate typical IM windows. Fig. 1 shows a IM user menu 102 that includes tool bars 104 for providing the maintenance functions of the IM system such as logging in (LOGIN), MESSAGE to initiate an IM session, and other functions. The user menu also identifies the user 106 and all of the user's friends 108, i.e. the list of other users that the user 106 has set up to converse with via the IM system. Each of the friends 108 typically also has a corresponding indicator 110, 112. The indicators 110, 112 provide an indication that the corresponding user is available to participate in an IM session. For example, the indicators 110 are not highlighted i.e. in an outline mode and therefore indicate friends Jim, Jane, and Jack are not available to participate in an IM session. Conversely, indicator 112 is highlighted i.e. filled in with a bright color to indicate that friend Xavier is available for an IM session.

[0004] Fig. 1A shows an IM session window 122. The IM session window includes a tool bar 124, a user ID field 126 to identify the current user, an addressee field 128 that identifies the other user that is participating in the IM session. A conversation window 130 shows the last few lines of the IM session and which user had entered each line. As the lines of the IM session exceed the number of lines that can be shown in the conversation window 130, then a scroll bar 132 is provided to scroll up and down through the lines of the IM session. The conversation window 130 is typically visible to both the user 126 and the addressee 128. A composition field 134 is provided for the user to compose his IM session lines i.e. a comment or reply that will be posted to the conversation window 130 when the user selects the send button 136. A close button 138 is also provided for the user 126 to end the IM session.

[0005] Fig. 2 shows the process of an IM session. At block 202, the user selects a first friend (i.e. a first addressee) from the IM friend list to initiate an IM session. Next, in block 204, a first IM session window is displayed. The user then composes a line to the first addressee in block 206. The user then posts the line and the line appears in the conversation window in blocks 208, 210. Both the user and the addressee can view the conversation window. The first addressee posts a reply to the line from the user in the conversation window in block 212. When the first addressee posts a reply, an indication such as the border 140 or the IM banner 142, from Fig. 1A, “flashes” or alternates changes in color or in a similar manner draws the user’s attention to the first IM session window 122 because a new comment has been posted by the other participant, i.e. the first addressee, has posted a new comment or reply to the IM conversation window 130. If the user is finished with the IM session in block 214, then the user selects the close button to end the IM session. If the user does not want to end the IM session in block 214, then the process repeats beginning at block 206.

[0006] If the user desires to have more than one IM session concurrently. i.e. simultaneously, so that the user can have two or more separate IM conversations with a different addressee in each IM session, then the user simply performs the process of Fig 2 multiple times, in parallel. The user can thereby have multiple concurrent IM session windows.

[0007] A user may often desire to have multiple IM sessions concurrently. When the user is using a PC or other computing device with a large display, each one of the IM session windows can be displayed in whole or tiled i.e. partially covered by one or more other windows. In this way, as a reply is received in each of the IM sessions, at least a portion of the IM session window that received the reply is visible so that the user can see a portion of the flashing IM session window.

[0008] Compact computing devices such as computer with a compact display i.e. a personal digital assistant (PDA), a palm-top computer, a two way pager, an IM session enabled telephone, or other compact computing devices with compact displays are becoming very popular devices for IM. However, because a compact computing device has a compact display, it is often difficult for a user to simultaneously view multiple IM session windows and to easily switch between the multiple IM session windows.

SUMMARY OF THE INVENTION

[0009] A system and method of displaying multiple, concurrent instant messaging (IM) sessions is described. The system and method includes providing multiple IM sessions, displaying a first one of the IM sessions in an IM session window. Representing each one of the IM sessions as a corresponding one of a number of indicators in the IM session window.

BRIEF DESCRIPTION OF THE DRAWINGS

[0010] The present invention is illustrated by way of example and not limitation in the figures of the accompanying drawings in which like references indicate similar elements.

[0011] Fig. 1 shows a IM user menu.

[0012] Fig. 1A shows an IM session window.

[0013] Fig. 2 shows the process of an IM session.

[0014] Fig. 3 illustrates one embodiment of an IM session window.

[0015] Fig. 4 illustrates a process flow chart of one embodiment of managing multiple, concurrent IM sessions.

[0016] Fig. 5 illustrates one embodiment of a client-server architecture.

[0017] Fig. 6 illustrates one embodiment of a mobile user terminal.

DETAILED DESCRIPTION

[0018] A system and method of conducting an instant messaging (IM) session is described. As will be described in more detail below, one embodiment provides an improved method of managing multiple concurrent IM sessions. The described systems and methods of managing multiple concurrent IM sessions are especially useful when participating in multiple, concurrent IM sessions from a compact computing device that has a limited display capability.

[0019] Fig. 3 illustrates one embodiment of an IM session window 300. The IM session window includes a conversation window. The conversation window 302 shows the messages that have been sent and received by the user, in the order that they were sent or received by the user. The IM session window 300 also includes multiple indicators 310, 312, 314, 316. Each of the indicators 310, 312, 314, 316 corresponds to a different IM session. As shown in Fig. 3, the user is involved in four, concurrent IM sessions. One of the concurrent IM sessions, i.e. IM session 3, is shown in the conversation window 302. IM session 3 also

corresponds with indicator 316 and field 332 shows the IM session 3 is between the user and a second IM session participant "Ficus^7".

[0020] In one embodiment, each of the indicators 310, 312, 314, 316 also include IM session data regarding the corresponding IM session. For example, indicator 310 identifies the corresponding IM session as IM session number 4 and the three periods "..." indicates that three messages have been received since the user last viewed IM session number 4. Similarly, indicator 314 identifies the corresponding IM session as IM session number 2. The exclamation mark has been included in indicator 314 to indicate that there have been more than a predetermined number of messages received in IM session number 2 since the user last viewed IM session number 2. The predetermined number can be user selected or automatically selected based on the space available to display the indications, i.e. the periods. For example, the indicators 310, 312, 314, 316 are relatively small so as to not consume unnecessarily large amounts of space on the IM session window 300.

[0021] Similar to indicator 314, indicator 312 identifies the corresponding IM session as IM session number 1. Since no additional symbols such as a period or an exclamation mark has been included in indicator 312, then there have been no additional messages received in IM session number 1 since the user last viewed IM session number 1. Similarly, IM session number 3 is identified by indicator 316. Indicator 316 also includes three periods "...". The three periods indicate that three messages, i.e. messages 334, 336, 337 as shown, have been received since the user last viewed IM session number 3.

[0022] In an alternative embodiment, when an IM session has no pending i.e. no unread messages received since the user last viewed the IM session, such as IM session 1 represented by indicator 312 above, then the IM session is not represented by a corresponding indicator in the IM session window.

[0023] As described above the periods and exclamation marks as used above are only examples of possible symbols and are not intended to limit the scope of the embodiment. Other symbols could be used to indicate the data points described above and additional data points for each corresponding IM session such as an indication of the originator of the message such as a color or symbol. The urgency and/or size of a message could also be indicated. A file attachment and/or file attachment type could also be indicated. For example, if a pending message included a file attachment of a graphic format such as a JPEG file, then a specific symbol corresponding to the JPEG is included in the indicator corresponding to the IM session that received the file attachment.

[0024] In another embodiment, the indicators 310, 312, 314, 316 can also be presented in a prioritized order. For example, as shown, indicator 310 is presented on top of the list of indicators 310, 312, 314, 316 and that could be used to indicate that the last message received in the corresponding IM session 4 was received more recently than any other messages in any of the other IM sessions. In this way the user can very quickly see the status of each of the multiple concurrent IM sessions. In one embodiment, as shown in Fig. 3, the currently viewed IM session, IM session 3, has the lowest priority. Alternatively, the currently viewed IM session could have the highest priority. Alternatively, the multiple IM sessions could also be prioritized in order of other activities in addition to receiving messages such as sending a message, displaying the IM session or other activities in the IM sessions such as a number of messages so that the IM session which the user has not participated in the longest is at the top. In another alternative, the priority of represented IM session can be determined by the status of a participant in the represented IM session. For example, if the other participant sets his status as "out to lunch" or "be right back" or "away from my desk", then the priority of the represented IM session is automatically reduced.

[0025] In one embodiment, a user can switch between IM sessions quickly and easily by selecting a hotkey. In one embodiment the hotkey is simply the number of the IM session, i.e. to switch from IM session 3 shown in Fig. 3, to IM session 4, the user need only select a hotkey and the number “3” key. In an alternative embodiment a single hotkey can automatically switch from the currently displayed IM session to the IM session having the highest priority. In yet another embodiment, the hotkey can allow the user to “page through” each of the multiple concurrent IM sessions. For example, IM session 3 is currently displayed in the conversation window 302. Pressing the hotkey once could cause IM session 4 to be displayed in the conversation window 302. Similarly, pressing the hotkey a second time could cause IM session 1 to be displayed and so forth to IM sessions 2, 3, 4, 1, etc.

[0026] In another embodiment, the hotkey can page through each of the multiple concurrent IM sessions in order of the displayed priority i.e. IM session 4, then IM session 1, then IM session 2 and finally IM session 3 again. In one embodiment, the hotkey is a specially designated key. Alternatively, the hotkey can be a user assigned key through the software of the system displaying the IM session.

[0027] In yet another embodiment, the user can select another IM session to display by selecting the corresponding indicator 310, 312, 314, 316 with a pointing device such as a mouse or similar pointing devices that are well known in the art. Similarly, if the conversation window is presented on a touch sensitive display, then a user could select the new IM session to display by touching the screen over the corresponding indicator 310, 312, 314, 316.

[0028] In one embodiment, the number of IM sessions that can be represented as one of the corresponding indicators 310, 312, 314, 316 is limited to a

predetermined number such as a number that can be easily managed on the given display or IM session window 300 size. Alternatively, no limits may be placed on the number of IM sessions that can be represented as one of the corresponding indicators 310, 312, 314, 316, however, the number of indicators 310, 312, 314, 316 that may be displayed in the IM session window 300 may be limited. In such an embodiment the user may be able to scroll through the list of indicators 310, 312, 314, 316. In one embodiment, the scrolling list of indicators is endless, i.e. when the user scrolls “downward” to the “last” indicator in the list, scrolling further returns to the first indicator so that the user scrolls in repeating order, indicators 310, 312, 314, 316 and again to indicator 310, 312, 314, 316 and so forth. Alternatively, the highest priority IM sessions could be automatically moved to the top of the displayed list, in order of priority so that the highest priority IM sessions are displayed in the IM session window 300.

[0029] In one embodiment, the conversation window 302 includes a variety of symbols 320, 322, 323, 324, 326, 327 as part of the respective messages 330, 332, 333, 334, 336, 337. Each of the symbols 320, 322, 323, 324, 326, 327 indicates information about the corresponding message 330, 332, 333, 334, 336, 337. For example, symbols 320, 326, 327 are arrows pointing toward the conversation window 302 and thereby indicate that the corresponding messages 330, 336, 337 were received in the conversation window 302. Conversely, symbols 322, 323 are arrows pointing out of the conversation window 302, and thereby indicate that the corresponding messages 332, 333 were sent by the user to the other participants in the IM session.

[0030] Symbol 324 indicates a first line of messages received since the user last viewed the IM session 3. Symbol 324 allows a user to quickly identify where he left the conversation and what to read and/or respond to. Messages 334, 336, 337 are shown in bold typeface to indicate that the messages 334, 336, 337 were received by the other participants of the IM sessions.

[0031] As described above the symbols 320, 322, 323, 324, 326, 327 as used above are only examples of possible symbols and are not intended to limit the scope of the embodiment. Other symbols could be used to indicate the data points described above and additional data points for each corresponding message such as symbols that indicate current state of a user, i.e. emotional indicators that indicate: happy, sad, etc or a proximity indicator that indicates the other user in the IM session is in the same locale i.e. city, state, country or in a mobile environment in the same cellular telephone cell, etc. In yet another embodiment, information about the location of one or all users in IM session. User identity information can also be included. For example if a user is an individual or the representative of a company or an automated reply system, etc.

[0032] In various alternative embodiments, the IM session window can also include a user ID field 332 that identifies the user's identification. The IM session can also include a date and/or time field 334. The IM session can also include a message entry field 336.

[0033] Fig. 4 illustrates a process flow chart of one embodiment. First, multiple concurrent IM sessions are provided in block 402. A first IM session is displayed in block 404. All or at least a portion of the IM sessions are represented in the IM session window as corresponding indicators in block 406. When a message is received in one of the non-displayed IM sessions, the corresponding indicator for the non-displayed IM session indicates that the message was received in blocks 408, 410. An non-displayed IM session can also be selected to be displayed in block 412.

[0034] It will be further appreciated that the instructions represented by the blocks in Fig. 4 are not required to be performed in the order illustrated, and that

all the processing represented by the blocks may not be necessary to practice the invention.

[0035] Elements of the present invention may be included within a client-server based architecture 500 such as that illustrated in Fig. 5. According to the embodiment depicted in Fig. 5, a portal server 510 communicates with clients 540 i.e. user terminals, and other network servers 530 over a network 520 (e.g., the Internet). The network 520 over which the clients 540 and servers 510, 530 transmit and receive data may be comprised of any combination of private (e.g., leased) and/or public communication channels. These may include, for example, Digital Signal ("DS") channels (e.g., DS-3/T-3, DS-1/T1), Synchronous Optical Network ("SONET") channels (e.g., OC-3/STS-3), Integrated Services Digital Network ("ISDN") channels, Digital Subscriber Line ("DSL") channels, cable modem channels and a variety of wireless communication channels including satellite broadcast and cellular channels.

[0036] In addition, various networking protocols may be used to support communication across the network 520 including, for example, the Asynchronous Transfer Mode ("ATM"), Ethernet, and Token Ring (at the data-link level); as well as Transmission Control Protocol/Internet Protocol ("TCP/IP"), Internetwork Packet Exchange ("IPX"), AppleTalk and DECnet (at the network/transport level). It should be noted, however, that the principles of the invention are not limited to any particular communication channel or protocol.

[0037] The portal server 510 in one embodiment includes a user database for storing various types of user configuration and account data. Users may register and login to the portal server 510 from a client 540 by specifying a user ID and/or password. According to one embodiment, a user connects to the servers 510, 530 via a browser application such as Netscape Navigator™ or Microsoft

Internet Explorer™ which communicates via the Hypertext Transfer Protocol (hereinafter “HTTP”).

[0038] In one embodiment, users may configure the portal server 510 to retrieve and manage specific types of information. For example, a user may configure the portal server 510 to retrieve up-to-date stock quotes for a specified set of stocks (e.g., reflecting the user’s portfolio), to collect the weather forecast for the user’s hometown, and/or to retrieve recent articles relating to a particular sports franchise. The portal server will then retrieve the specified information from other servers (e.g., server 530) on behalf of the user.

[0039] In addition to information retrieval and management, in one embodiment the portal server 510 also provides application services such as email, online scheduling (e.g., appointments, to-do lists, etc), instant messaging, contact management, word processing and a variety of other online services. Users may access these services by logging in to the portal server 510 with a valid user ID and password. In one embodiment, the portal server 510 generates a unique, personalized Web page for each user containing links to all, or a subset of, the information and/or services subscribed to by the user.

[0040] As illustrated in **Fig. 6**, one embodiment of the mobile user terminal 650 is comprised generally of a microcontroller 605, an external memory 665, a display controller 675, a display 680, one or more input/output devices 685, and a battery 660. The external memory 650 may be used to store programs and/or portal data 665 transmitted to the user terminal 650 from the portal server 610 (e.g., via client 540). In one embodiment, the external memory 665 is non-volatile memory (e.g., an electrically erasable programmable read only memory (“EEPROM”); a programmable read only memory (“PROM”), etc). Alternatively, the memory 665 may be a volatile memory (e.g., random access memory or “RAM”) but the data stored therein may be continually maintained

via the battery 660. The battery 660 in one embodiment is a coin cell battery (e.g., of the same type used in portable electronic devices such as calculators and watches). In one embodiment, when the battery power decreases below a threshold level, the user terminal 650 will notify the user and/or the portal server 510. The portal server 510 in one embodiment will then automatically send the user a new battery.

[0041] The microcontroller 605 of one embodiment is comprised of a central processing unit (“CPU”) 610, a read only memory (“ROM”) 670, and a scratchpad RAM 640. The ROM 670 is further comprised of an interpreter module 620 and a toolbox module 630.

[0042] The toolbox module 630 of the ROM 670 contains a set of toolbox routines for processing data, text and graphics on the user terminal 650. These routines include drawing text and graphics on the user terminal’s display 630, decompressing data transmitted from the portal server 610, reproducing audio on the user terminal 650, and performing various input/output and communication functions (e.g., transmitting/receiving data over the client link 560). A variety of additional user terminal functions may be included within the toolbox 630 while still complying with the underlying principles of the invention.

[0043] In one embodiment, microprograms and portal data 660 are transmitted from the portal server 510 to the external memory 665 of the user terminal via a communication interface 680 under control of the CPU 610. Various communication interfaces 680 may be employed without departing from the underlying principles of the invention including, for example, a Universal Serial Bus (“USB”) interface or a serial communication (“serial”) interface. The microprograms in one embodiment are comprised of compact, interpreted instructions known as “bytecodes,” which are converted into native code by the interpreter module 620 before being executed by the CPU 610. One of the

benefits of this configuration is that when the microcontroller/CPU portion of the user terminal 650 is upgraded (e.g., to a faster and/or less expensive model), only the interpreter module 620 and toolbox 630 of the ROM needs to be rewritten to interpret the currently existing bytecodes for the new microcontroller/CPU. In addition, this configuration allows user terminals 650 with different CPUs to coexist and execute the same microprograms. Moreover, programming frequently-used routines in the ROM toolbox module 630 reduces the size of microprograms stored in the external memory 665, thereby conserving memory and bandwidth over the client link 560. In one embodiment, new interpreter modules 620 and/or toolbox routines 630 may be developed to execute the same microprograms on cellular phones, personal information managers ("PIMs"), or any other device with a CPU and memory.

[0044] One embodiment of the ROM 670 may be comprised of interpreted code as well as native code written specifically for the microcontroller CPU 605. More particularly, some toolbox routines may be written as interpreted code (as indicated by the arrow between the toolbox 630 and the interpreter module 620) to conserve memory and bandwidth for the same reasons described above with respect to microprograms. Moreover, in one embodiment, data and microprograms stored in external memory 665 may be configured to override older versions of data/microprograms stored in the ROM 670 (e.g., in the ROM toolbox 630).

[0045] As mentioned above, the user terminal 650 may communicate with the portal server 510 using various RF communication techniques. For example, in one particular embodiment, the user terminal 650 transmits and receives data to/from a cellular network via the cellular digital packet data ("CDPD") standard. As it is known in the art, the CDPD standard is a digital wireless standard that is deployed as an enhancement to the existing analog cellular network. It provides a packet overlay onto the AMPS network and moves data at 19.2 Kbps over

continuously-changing unused intervals in standard voice channels.

Accordingly, this embodiment of the user terminal is capable of exploiting normally unused bandwidth on a nation-wide, analog cellular network.

Embodiments of the user terminal may also be configured to transmit/receive data using a variety of other communication standards including 2-way paging standards and third generation ("3G") wireless standards (e.g., UTMS, CDMA 2000, NTT DoCoMo, . . . etc).

[0046] The display 680 is included so that a user may view the information processed in the user terminal 650. the input/output devices 685 provide, among other functions, the ability for a user to input and interact with the data. The input output devices 685 includes such items as a mouse, keyboard, touch-sensitive display, and other similar input output devices as are well known in the art.

[0047] As indicated in Fig. 6, one embodiment of the user terminal, the CPU 605 employs a 32-bit RISC-based microprocessor such as an ARM processor. As is known in the art, ARM processors are widely used in PDAs, cell phones and a variety of other wireless devices. It should be noted, however, that various other hardware and software (and/or firmware) architectures may be used for the user terminal 650 while still complying with the underlying principles of the invention.

[0048] One skilled in the art will immediately appreciate that the invention can be practiced with other computer system configurations, including multiprocessor systems, minicomputers, mainframe computers, and the like. The invention can also be practiced in distributed computing environments where tasks are performed by remote processing devices that are linked through a communications network.

[0049] Embodiments of the invention may include various steps as set forth above. The steps may be embodied in machine-executable instructions. The instructions can be used to cause a general-purpose or special-purpose processor to perform certain steps. Alternatively, these steps may be performed by specific hardware components that contain hardwired logic for performing the steps, or by any combination of programmed computer components and custom hardware components.

[0050] Elements of the present invention may also be provided as a machine-readable medium for storing the machine-executable instructions. The machine-readable medium may include, but is not limited to, floppy diskettes, optical disks, CD-ROMs, and magneto-optical disks, ROMs, RAMs, EPROMs, EEPROMs, magnetic or optical cards, propagation media or other type of media/machine-readable medium suitable for storing electronic instructions. For example, the present invention may be downloaded as a computer program which may be transferred from a remote computer (e.g., a server) to a requesting computer (e.g., a client) by way of data signals embodied in a carrier wave or other propagation medium via a communication link (e.g., a modem or network connection).

[0051] Throughout the foregoing description, for the purposes of explanation, numerous specific details were set forth in order to provide a thorough understanding of the invention. It will be apparent, however, to one skilled in the art that the invention may be practiced without some of these specific details. For example, while the system described above employs a single portal server 510, alternative embodiments of the invention may include numerous different servers (e.g., database servers, web servers, etc), and/or mirrored servers distributed across a network. Moreover, while the embodiments described above focus on a user terminal which executes interpreted code (e.g., Java bytecodes), the principles of the invention may also be implemented on devices which

execute non-interpreted code. Accordingly, the scope and spirit of the invention should be judged in terms of the claims which follow.

[0052] In the foregoing specification, the invention has been described with reference to specific exemplary embodiments thereof. It will be evident that various modifications may be made thereto without departing from the broader spirit and scope of the invention as set forth in the following claims. The specification and drawings are, accordingly, to be regarded in an illustrative sense rather than a restrictive sense.

CLAIMS

What is claimed is:

1. A method of displaying a plurality of concurrent IM sessions:
providing a plurality of IM sessions;
displaying a first one of the plurality of IM sessions in an IM session window; and
representing each one of the plurality of IM sessions as a corresponding one of a plurality indicators in the IM session window.
2. The method of claim 1, wherein providing a plurality of IM sessions includes initiating a plurality of IM sessions.
3. The method of claim 1, wherein representing each one of the plurality of IM sessions as a corresponding one of the plurality indicators in the IM session window includes representing each one the non-displayed ones of the plurality of IM sessions as a corresponding one of the plurality indicators in the IM session window.
4. The method of claim 1, further comprising:
providing a second symbol indicating a beginning of a received message that is displayed in the IM session window.
5. The method of claim 1, further comprising:
providing a third symbol indicating a beginning of a sent message that is displayed in the IM session window.
6. The method of claim 1 further comprising:

receiving a first message in a selected one of the plurality of IM sessions;
and
indicating the first message is received in the indicator that corresponds
to the selected session.

7. The method of claim 6, further comprising:
providing a first symbol indicating a beginning of the first message.
8. The method of claim 6, further comprising:
receiving a second message in the selected session; and
indicating the second message is received in the indicator that
corresponds to the selected session.
9. The method of claim 1, further comprising:
displaying a second one of the plurality of IM sessions, wherein the
second session is one of the plurality of IM sessions that was not displayed.
10. The method of claim 9, further comprising representing the first one of
the plurality of IM sessions only as a corresponding one of the plurality
indicators in the IM session window.
11. The method of claim 9, further comprising representing the first one of
the plurality of IM sessions as a corresponding one of the plurality indicators in
the IM session window.
12. The method of claim 9, wherein displaying a second one of the plurality
of IM sessions includes:
selecting a hot key.

13. The method of claim 12, wherein selecting a hot key includes:
selecting a numbered key that corresponds to a number assigned to the
corresponding one of the plurality indicators in the IM session window.

14. The method of claim 9, wherein displaying a second one of the plurality
of IM sessions includes:
selecting the indicator that corresponds to the second one of the plurality
of IM sessions.

15. The method of claim 1, further comprising prioritizing each one of the
plurality of indicators.

16. The method of claim 15, wherein the prioritizing each one of the plurality
of indicators includes:
prioritizing each one of the plurality of indicators in order of activity of
the IM session that corresponds to each one of the plurality of indicators.

17. The method of claim 16, wherein the activity of the IM session includes
at least one of a group consisting of:
receiving a message in the IM session;
sending a message in the IM session;
displaying the IM session.

18. The method of claim 15, wherein the prioritizing each one of the plurality
of indicators includes:
assigning the displayed IM session a lowest priority.

19. The method of claim 15, wherein the prioritizing each one of the plurality of indicators includes:
assigning the displayed IM session a highest priority.
20. The method of claim 1 further comprising:
receiving a plurality of messages in a selected one of the plurality of IM sessions; and
indicating the plurality of messages are received in the indicator that corresponds to the selected session.
21. The method of claim 20, wherein if the number of the plurality of messages exceeds a pre-selected number then:
indicating the plurality of messages are received in the indicator that corresponds to the selected session includes:
displaying a fourth symbol in the indicator that corresponds to the selected session.
22. An instant messaging session window comprising:
a conversation window;
an indicator, wherein the indicator represents a number equal to a number of comments received in the conversation window.
23. An instant messaging session window comprising:
a conversation window;
a plurality indicators wherein each one of the plurality indicators represent a corresponding one of a plurality of IM sessions.
24. A system for instant messaging comprising:
a processor;

a display coupled to the processor;
a network coupled to the processor;
a memory coupled to the processor, wherein the memory includes
instruction that when executed by the processor cause the processor to:
 provide a plurality of IM sessions;
 display a first one of the plurality of IM sessions in an IM session
window; and
 represent each one of the plurality of IM sessions as a
corresponding one of a plurality indicators in the IM session window.

25. The system of claim 24, wherein the processor is coupled to the network
via a wireless network.

26. The system of claim 24 further comprising a mobile user terminal,
wherein the processor and the display are included in the mobile user terminal.

27. A mobile user terminal comprising:
a processor;
a display coupled to the processor;
a wireless network coupled to the processor;
a memory coupled to the processor, wherein the memory includes
instruction that when executed by the processor cause the processor to:
 provide a plurality of IM sessions;
 display a first one of the plurality of IM sessions in an IM session
window;
 represent each one of the plurality of IM sessions as a
corresponding one of a plurality indicators in the IM session window;
 receive a first message in a selected one of the plurality of IM
sessions;

indicate the first message is received in the indicator that
corresponds to the selected session; and
prioritize each one of the plurality of indicators.

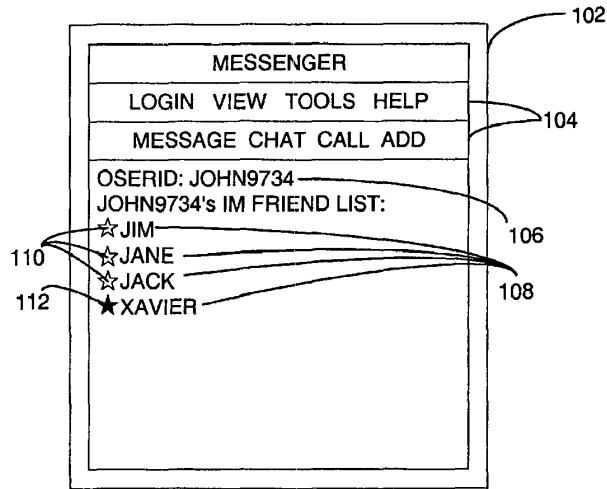

FIG. 1

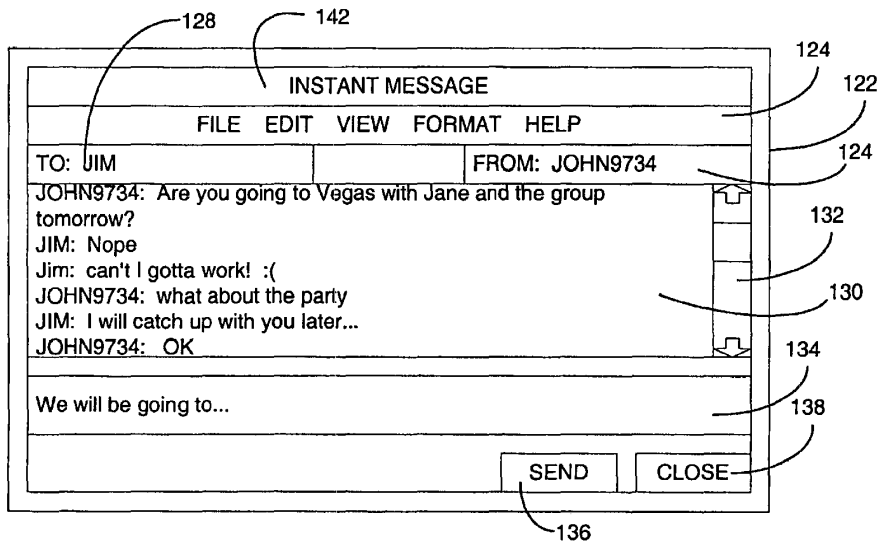

FIG. 1A

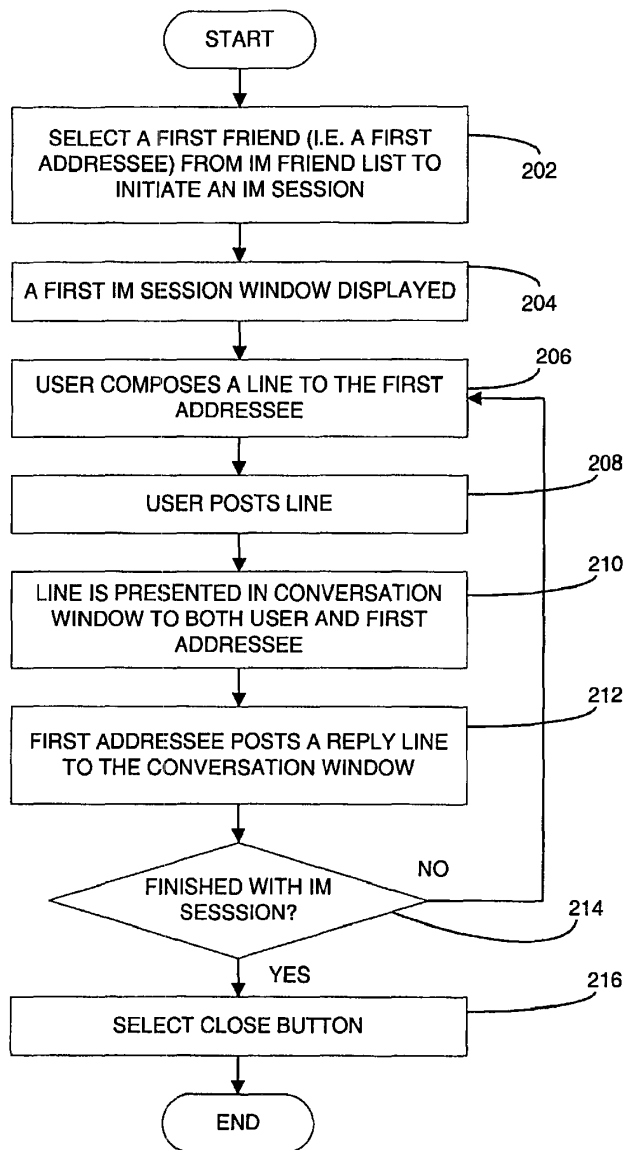

FIG. 2

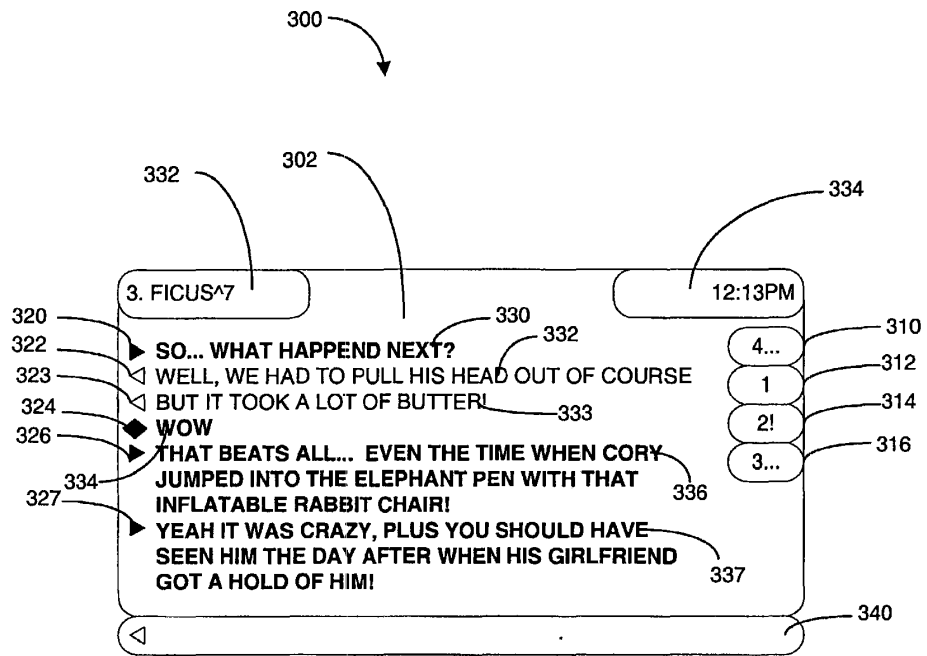

FIG. 3

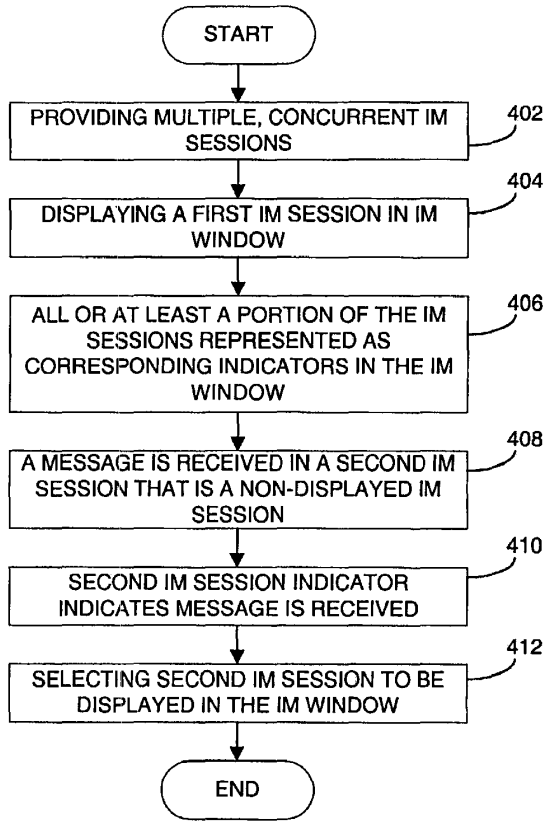

FIG. 4

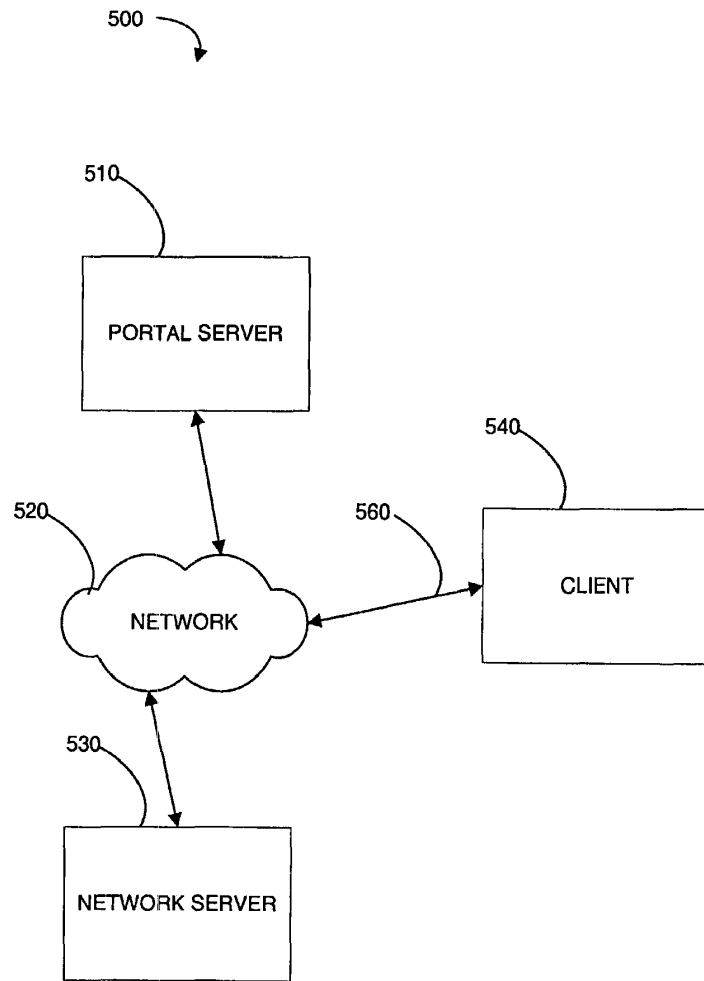

FIG. 5

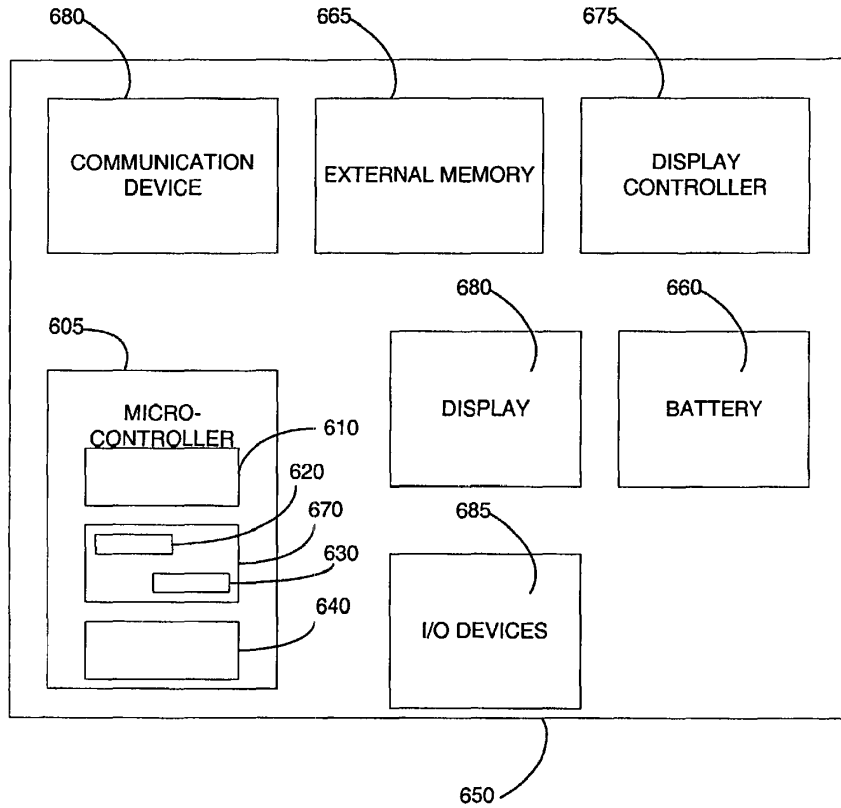

FIG. 6

Electronic Patent Application Fee Transmittal				
Application Number:	10784781			
Filing Date:	24-Feb-2004			
Title of Invention:	Previewing a new event on a small screen device			
First Named Inventor/Applicant Name:	Gerhard D. Klassen			
Filer:	Matthew J. Marquardt/Judy Ramalho			
Attorney Docket Number:	05200204-272US			
Filed as Large Entity				
Utility under 35 USC 111(a) Filing Fees				
Description	Fee Code	Quantity	Amount	Sub-Total in USD(\$)
Basic Filing:				
Pages:				
Claims:				
Miscellaneous-Filing:				
Petition:				
Patent-Appeals-and-Interference:				
Post-Allowance-and-Post-Issuance:				
Extension-of-Time:				
Extension - 2 months with \$0 paid	1252	1	560	560

Description	Fee Code	Quantity	Amount	Sub-Total in USD(\$)
Miscellaneous:				
Submission- Information Disclosure Stmt	1806	1	180	180
Total in USD (\$)				740

Electronic Acknowledgement Receipt	
EFS ID:	12280509
Application Number:	10784781
International Application Number:	
Confirmation Number:	2200
Title of Invention:	Previewing a new event on a small screen device
First Named Inventor/Applicant Name:	Gerhard D. Klassen
Customer Number:	20988
Filer:	Matthew J. Marquardt
Filer Authorized By:	
Attorney Docket Number:	05200204-272US
Receipt Date:	12-MAR-2012
Filing Date:	24-FEB-2004
Time Stamp:	16:44:44
Application Type:	Utility under 35 USC 111(a)

Payment information:

Submitted with Payment	yes
Payment Type	Deposit Account
Payment was successfully received in RAM	\$ 740
RAM confirmation Number	4018
Deposit Account	195113
Authorized User	
<p>The Director of the USPTO is hereby authorized to charge indicated fees and credit any overpayment as follows:</p> <p style="padding-left: 40px;">Charge any Additional Fees required under 37 C.F.R. Section 1.16 (National application filing, search, and examination fees)</p> <p style="padding-left: 40px;">Charge any Additional Fees required under 37 C.F.R. Section 1.17 (Patent application and reexamination processing fees)</p>	

Charge any Additional Fees required under 37 C.F.R. Section 1.20 (Post Issuance fees)

Charge any Additional Fees required under 37 C.F.R. Section 1.21 (Miscellaneous fees and charges)

File Listing:

Document Number	Document Description	File Name	File Size(Bytes)/ Message Digest	Multi Part /.zip	Pages (if appl.)
1		Response.pdf	695444 a0947bc64a601ee776e3d15b49306d907a a626a	yes	19
Multipart Description/PDF files in .zip description					
Document Description		Start	End		
Amendment After Final		1	1		
Claims		2	13		
Applicant Arguments/Remarks Made in an Amendment		14	19		
Warnings:					
Information:					
2	Extension of Time	Petition_for_Extension_of_Tim e.pdf	128121 756153026eb63e11b87cfc681de02758be5 d0750	no	2
Warnings:					
Information:					
3	Information Disclosure Statement (IDS) Form (SB08)	IDS_.pdf	198080 c955272db2e780ce961cac9c778e0af6e838 815c	no	4
Warnings:					
Information:					
This is not an USPTO supplied IDS fillable form					
4	Foreign Reference	WO20030014905.pdf	878592 e143965609ecaba05a611425bac5c427d58 f75b8	no	29
Warnings:					
Information:					
5	Fee Worksheet (SB06)	fee-info.pdf	31886 f8da812441c1b96502f0d3b5ca7022d5b2e 04336	no	2
Warnings:					
Information:					
Total Files Size (in bytes):			1932123		

This Acknowledgement Receipt evidences receipt on the noted date by the USPTO of the indicated documents, characterized by the applicant, and including page counts, where applicable. It serves as evidence of receipt similar to a Post Card, as described in MPEP 503.

New Applications Under 35 U.S.C. 111

If a new application is being filed and the application includes the necessary components for a filing date (see 37 CFR 1.53(b)-(d) and MPEP 506), a Filing Receipt (37 CFR 1.54) will be issued in due course and the date shown on this Acknowledgement Receipt will establish the filing date of the application.

National Stage of an International Application under 35 U.S.C. 371

If a timely submission to enter the national stage of an international application is compliant with the conditions of 35 U.S.C. 371 and other applicable requirements a Form PCT/DO/EO/903 indicating acceptance of the application as a national stage submission under 35 U.S.C. 371 will be issued in addition to the Filing Receipt, in due course.

New International Application Filed with the USPTO as a Receiving Office

If a new international application is being filed and the international application includes the necessary components for an international filing date (see PCT Article 11 and MPEP 1810), a Notification of the International Application Number and of the International Filing Date (Form PCT/RO/105) will be issued in due course, subject to prescriptions concerning national security, and the date shown on this Acknowledgement Receipt will establish the international filing date of the application.

IN THE UNITED STATES PATENT AND TRADEMARK OFFICE

Inventor(s) KLASSEN et al.
Serial No.: 10/784,781
Filed: 24 February 2004
Examiner: HEFFINGTON, John M.
Group Art Unit: 2179
Confirmation No.: 2200
Title: PREVIEWING A NEW EVENT ON A SMALL SCREEN
 DEVICE

VIA ELECTRONIC FILING

Commissioner for Patents
P.O. Box 1450
Alexandria, Virginia 22313-1450
U.S.A.

**AFTER-FINAL AMENDMENT
AND SUMMARY OF INTERVIEW**

This paper (the Response) is filed in response to the Office Action mailed herein
26 October 2011.

- A listing of the Claims is presented beginning at page 2.
- A Summary of Interview and Remarks are presented beginning at page 14.
- Filed herewith is a petition for a two (2) month extension of time in which to make this response.

LISTING OF CLAIMS

A complete listing of the claims is provided for the convenience of the Examiner.

What is claimed is:

1 – 51. (Cancelled)

52. (previously presented) A method of providing notifications of unread messages on a wireless communication device, comprising:

displaying at least one icon relating to electronic messaging on a graphical user interface of the wireless communication device;

receiving a plurality of electronic messages on the wireless communication device, the plurality of electronic messages including messages from a plurality of different messaging correspondents; and

in response to receiving at least one of the plurality of electronic messages, visually modifying at least one displayed icon relating to electronic messaging to include a numeric character representing a count of the plurality of different messaging correspondents for which one or more of the electronic messages have been received and remain unread.

53. (previously presented) The method of claim 52, further comprising displaying a plurality of icons including one or more application icons that are selectable to invoke respective ones of a plurality of applications on the wireless communication device.

54. (previously presented) The method of claim 53, further comprising visually modifying one or more of the plurality of icons to include a count of electronic messages that have been received and remain unread.

55. (previously presented) The method of claim 52, the at least one icon relating to electronic messaging being selectable to invoke an electronic messaging application.

56. (previously presented) The method of claim 52, comprising displaying on the graphical user interface an identifier of the correspondent from whom at least one of the plurality of messages was received.

57. (previously presented) The method of claim 52, comprising displaying on the graphical user interface at least one preview of content associated with at least one of the received electronic messages.

58 - 63. (cancelled)

64. (previously presented) A computer-readable memory accessible by a processor of a wireless communication device, the memory comprising stored electronic data structures representing executable instructions which, when executed by the processor, cause the wireless communication device to:

display at least one icon relating to an electronic messaging application on the graphical user interface;

receive a plurality of electronic messages, the plurality of electronic messages including messages from a plurality of different messaging correspondents; and

in response to receiving at least one of the plurality of electronic messages, visually modify at least one displayed icon relating to the electronic messaging application to include a numeric character representing a count of the plurality of different messaging correspondents for which one or more of the electronic messages have been received and remain unread.

65. (previously presented) The computer-readable memory of claim 64, further comprising stored electronic data structures representing executable instructions which, when executed, cause the wireless communication device to display a plurality of icons including one or more application icons that are selectable to invoke respective ones of a plurality of applications on the wireless communication device.

66. (previously presented) The computer-readable memory of claim 65, further comprising stored electronic data structures representing executable instructions which, when executed, cause the wireless communication device to visually modify one or more of the plurality of icons to include a count of electronic messages that have been received by the wireless communication device and remain unread.

67. (previously presented) The computer-readable memory of claim 64, the at least one icon relating to electronic messaging being selectable to invoke an electronic messaging application.

68. (previously presented) The computer-readable memory of claim 64, stored electronic data structures representing executable instructions which, when executed, cause the wireless communication device to visually modify the graphical user interface to include an identifier of the correspondent from whom at least one of the plurality of messages was received.

69. (previously presented) The computer-readable memory of claim 64, further stored electronic data structures representing executable instructions which, when executed, cause the wireless communication device to visually modify the graphical user interface to include at least one preview of content associated with at least one of the received electronic messages.

70. (previously presented) A wireless communication device comprising:

a processor;

a display electrically coupled to the processor, the display presenting a graphical user interface; and

memory storing machine-readable instructions executable by the processor to:

display at least one icon relating to electronic messaging on the graphical user interface;

receive a plurality of electronic messages, the plurality of electronic messages including messages from a plurality of different messaging correspondents; and

in response to receiving at least one of the plurality of electronic messages, visually modify the at least one displayed icon relating to electronic messaging to include a numeric character representing a count of the plurality of different messaging correspondents for which one or more of the electronic messages have been received and remain unread.

71. (previously presented) The wireless communication device of claim 70, the memory further comprising machine-readable instructions which, when executed, cause the wireless communication device to display a plurality of icons including one or more

application icons that are selectable to invoke respective ones of a plurality of applications on the wireless communication device.

72. (previously presented) The wireless communication device of claim 71, the memory comprising machine-readable instructions which, when executed, cause the wireless communication device to visually modify one or more of the plurality of icons to include a count of electronic messages that have been received and remain unread.

73. (previously presented) The wireless communication device of claim 70, the at least one icon relating to electronic messaging being selectable to invoke an electronic messaging application.

74. (previously presented) The wireless communication device of claim 70, the memory further comprising machine-readable instructions which, when executed, cause the wireless communication device to visually modify the graphical user interface to include an identifier of the correspondent from whom at least one of the plurality of messages was received.

75. (previously presented) The wireless communication device of claim 70, the memory further comprising machine-readable instructions which, when executed, cause the wireless communication device to visually modify the graphical user interface to include at least one preview of content associated with at least one of the received electronic messages.

76. (withdrawn) A method of providing notifications of unread messages on a wireless communication device, comprising:

displaying at least one icon relating to an electronic messaging application on a graphical user interface of the wireless communication device;

receiving on the wireless communication device a plurality of electronic messages associated with the electronic messaging application; and

responsive to receiving at least one of the plurality of electronic messages:

visually modifying at least one icon relating to the electronic messaging application to include a count of the plurality of electronic messages which remain unread; and

displaying on the graphical user interface concurrently with the visually-modified icon a text identifier associated with a correspondent from whom the at least one of the plurality of electronic messages was received.

77. (withdrawn) The method of claim 76, the identifier associated with a correspondent from whom the at least one of the plurality of electronic messages was received comprising state information pertaining to the correspondent.

78. (withdrawn) The method of claim 76, further comprising displaying on the graphical user interface at least a preview of content associated with at least one of the received electronic messages.

79. (withdrawn) The method of claim 76, further comprising displaying on the graphical user interface for a predetermined period of time at least a preview of content associated with at least one of the received electronic messages.

80. (withdrawn) The method of claim 76, the at least one icon relating to electronic messaging being selectable to invoke an electronic messaging application.

81. (withdrawn) The method of claim 80, further comprising, responsive to invoking the electronic messaging application, navigating automatically to a graphical user interface comprising content associated with at least one of the received electronic messages.

82. (withdrawn) The method of claim 80, further comprising, responsive to invoking the electronic messaging application within a predetermined time following receipt of at least one of the received electronic messages, navigating automatically to a graphical user interface comprising content associated with the at least one of the received electronic messages.

83. (withdrawn) The method of claim 80, further comprising, responsive to invoking the electronic messaging application, visually modifying at least one icon relating to the electronic messaging application to include a decreased count of electronic messages which remain unread.

84. (withdrawn) The method of claim 80, further comprising, responsive to invoking the electronic messaging application, visually modifying at least one icon relating to the electronic messaging application to remove the count of electronic messages which remain unread.

85. – 93. (cancelled)

94. (withdrawn) A computer-readable memory accessible by a processor of a wireless communication device, the memory comprising stored electronic data structures representing executable instructions which, when executed by the processor, cause the wireless communication device to:

display at least one icon relating to an electronic messaging application on a graphical user interface of the wireless communication device;

receive on the wireless communication device a plurality of electronic messages associated with the electronic messaging application; and

responsive to receiving at least one of the plurality of electronic messages:

visually modify at least one icon relating to the electronic messaging application to include a count of the plurality of electronic messages which remain unread; and

display on the graphical user interface concurrently with the visually-modified icon a text identifier associated with a correspondent from whom the at least one of the plurality of electronic messages was received.

95. (withdrawn) The computer-readable memory of claim 94, the identifier associated with a correspondent from whom the at least one of the plurality of electronic messages was received comprising state information pertaining to the correspondent.

96. (withdrawn) The computer-readable memory of claim 94, further stored electronic data structures representing executable instructions which, when executed, cause the wireless communication device to display on the graphical user interface at least a preview of content associated with at least one of the received electronic messages.

97. (withdrawn) The computer-readable memory of claim 94, further stored electronic data structures representing executable instructions which, when executed, cause the wireless communication device to display on the graphical user interface for a predetermined period of time at least a preview of content associated with at least one of the received electronic messages.

98. (withdrawn) The computer-readable memory of claim 94, the at least one icon relating to electronic messaging being selectable to invoke an electronic messaging application.

99. (withdrawn) The computer-readable memory of claim 98, further stored electronic data structures representing executable instructions which, when executed, cause the wireless communication device to, responsive to invoking the electronic messaging application, navigate automatically to a graphical user interface comprising content associated with at least one of the received electronic messages.

100. (withdrawn) The computer-readable memory of claim 98, further stored electronic data structures representing executable instructions which, when executed, cause the wireless communication device to, responsive to invoking the electronic messaging application within a predetermined time following receipt of at least one of the received electronic messages, navigate automatically to a graphical user interface comprising content associated with the at least one of the received electronic messages.

101. (withdrawn) The computer-readable memory of claim 98, further stored electronic data structures representing executable instructions which, when executed, cause the wireless communication device to, responsive to invoking the electronic

messaging application, visually modify at least one icon relating to the electronic messaging application to include a decreased count of electronic messages which remain unread.

102. (withdrawn) The computer-readable memory of claim 98, further stored electronic data structures representing executable instructions which, when executed, cause the wireless communication device to, responsive to invoking the electronic messaging application, visually modify at least one icon relating to the electronic messaging application to remove the count of electronic messages which remain unread.

103. (withdrawn) A wireless communication device comprising

a processor;

a display electrically coupled to the processor, the display presenting a graphical user interface; and

memory storing machine-readable instructions executable by the processor to:

display on the graphical user interface at least one icon relating to an electronic messaging application;

receive on the wireless communication device a plurality of electronic messages associated with the electronic messaging application; and

responsive to receiving at least one of the plurality of electronic messages:

visually modify at least one icon relating to the electronic messaging application to include a count of the plurality of electronic messages which remain unread; and

display on the graphical user interface concurrently with the visually-modified icon a text identifier associated with a correspondent from whom the at least one of the plurality of electronic messages was received.

104. (withdrawn) The wireless communication device of claim 103, the identifier associated with a correspondent from whom the at least one of the plurality of electronic messages was received comprising state information pertaining to the correspondent.

105. (withdrawn) The wireless communication device of claim 103, the memory storing machine-readable instructions which, when executed, cause the wireless communication device to display on the graphical user interface at least a preview of content associated with at least one of the received electronic messages.

106. (withdrawn) The wireless communication device of claim 103, the memory storing machine-readable instructions which, when executed, cause the wireless communication device to display on the graphical user interface for a predetermined period of time at least a preview of content associated with at least one of the received electronic messages.

107. (withdrawn) The wireless communication device of claim 103, the at least one icon relating to electronic messaging being selectable to invoke an electronic messaging application.

108. (withdrawn) The wireless communication device of claim 107, the memory storing machine-readable instructions which, when executed, cause the wireless communication device to, responsive to invoking the electronic messaging application,

navigate automatically to a graphical user interface comprising content associated with at least one of the received electronic messages.

109. (withdrawn) The wireless communication device of claim 103, the memory storing machine-readable instructions which, when executed, cause the wireless communication device to, responsive to invoking the electronic messaging application within a predetermined time following receipt of at least one of the received electronic messages, navigate automatically to a graphical user interface comprising content associated with the at least one of the received electronic messages.

110. (withdrawn) The wireless communication device of claim 103, the memory storing machine-readable instructions which, when executed, cause the wireless communication device to, responsive to invoking the electronic messaging application, visually modify at least one icon relating to the electronic messaging application to include a decreased count of electronic messages which remain unread.

111. (withdrawn) The wireless communication device of claim 103, the memory storing machine-readable instructions which, when executed, cause the wireless communication device to, responsive to invoking the electronic messaging application, visually modify at least one icon relating to the electronic messaging application to remove the count of electronic messages which remain unread.

REMARKS

Summary of Interview

Applicant thanks Examiners Heffington and Pesin for the time and insights they provided in an interview conducted at the Examiners' office on 6 March 2012. In addition to Mr. Heffington and Mr. Pesin, the interview was attended by inventor G. Klassen, Applicant's internal patent counsel D. Flores, and Applicant's undersigned attorney.

Claim 52 was discussed. It was agreed, subject to confirmatory review of the cited references and any further searching the Examiner might deem appropriate, that claim 52 as presented is patentably distinct from the cited art.

Final Action

As noted in the Examiner's summary of interview, the Examiner suggested filing of this after-final amendment to make Applicant's arguments of record. Applicant thanks the Examiner for the recommendation.

Status of Claims; Withdrawal of Claims 76 – 84 and 94 -111

Claims 52 – 57, 64 – 84, and 94 - 111 are pending in the application. Claims 58 – 63 and 85 - 93 were previously cancelled, without prejudice and without disclaimer of subject matter.

In view of the understanding reached during the interview of 6 March, and in the interest of advancing allowance of claims 52 – 57 and 64 - 75, Applicant hereby withdraws claims 76 – 84 and 94 -111 from examination. Applicant withdraws such claims without prejudice, and expressly reserves an intention of pursuing such claims in another application, or at a later point in prosecution of this application.

Applicant notes, for the Examiner's information, that the claims presented herein correspond to claims allowed in a corresponding Japanese application (serial number provided in table below).

Disclaimer of Prior Statements and Amendments

The claims, as presented herein, may be broader in some respects than claims previously presented. Applicant intends that the claims now pending be interpreted under the ordinary interpretation understood in the art. Accordingly Applicant expressly rescinds, and no longer intends that the claims be limited by, any and all assertions, statements, arguments, amendments or other actions previously made in this application, and/or any application whose file history is appropriate for use in interpreting any patent issuing on this application, that might be taken to be a surrender or disclaimer of any subject matter from the scope of any claim. No such assertion, statement, argument, amendment, or other action should be taken as a surrender or disclaimer from, and may not be used to interpret, any claim of this application, or any claim of any patent to which such applications' file histories may be pertinent.

Applicant intends, and expressly requests, that the Application be presented and examined *de novo*. Accordingly, Applicant urges the Examiner to make a thorough and diligent search of the prior art with respect to each and every claim presented herein. Applicant requests that the Examiner reconsider any previous surrender, disclaimer or characterization of claims, and that he reconsider any prior art that may have been avoided or intended to be avoided by such surrender, disclaimer or characterization.

Rejections under 35 USC § 103

At pages 6 – 11 of the Detailed Action the Examiner has rejected claims 52-75 as obvious over Wagner (US 2004/0155908) in view of Canfield (US 2004/0056893).

Applicant respectfully traverses. As agreed during the interview of 6 March 2011, subject to further search by the Examiner and confirmation of his understanding of the cited references, the prior art fails to teach or suggest at least the feature, recited by each of those claims, of visually modifying a displayed icon to include a character

representing a count of a plurality of different messaging correspondents from whom messages have been received.

The cited references are concerned with either

- a raw count of new messages, without regard to the number or identity(ies) of correspondents from whom the messages have been received, and optionally remain unread; or
- a number of concurrent, ongoing, or new instant message sessions, or conversations.

As discussed during the 6 March interview, counting either a total number of unread messages or a number of conversations does not, for example, enable a user to track the number of correspondents from whom the user has received unread messages. By tracking a number of correspondents, rather than a number of messages or conversations, a device presents different information to a user. For example, a single correspondent might either (a) send a plurality of messages to the user, or (b) start and stop a number of conversations, without affecting the number of distinct correspondents from whom the user has received unread messages. The following example illustrates one such difference:

Conversation (i.e., session)	Correspondent	Total Messages	Read Messages	Unread Messages	Conversation Status
1	A	4	4	0	Old (contains only read messages)
2	B	4	2	2	Old (contains read and unread messages)
3	C	4	3	1	Old (contains read and unread messages)
4	D	1	0	1	New (contains only unread messages)

5	E	2	0	2	New (contains only unread messages)
---	---	---	---	---	-------------------------------------

Number of new / unread messages (as taught by Wagner): 6
 Number of concurrent conversations/sessions (as taught by Canfield): 5
 Number of new conversations/sessions (as taught by Canfield): 2
 Number of correspondents w/ unread messages (as claimed by Applicant): 4

As explained during the 6 March interview, a user of a communications device can make significantly different, and in many circumstances more efficient, use of a communications application by tracking a number of correspondents from whom the user has received new messages than by counting all new messages or numbers of conversations.

Applicant's claimed methods, devices, and programming media provide elegantly inventive improvements for users of communications devices, particularly in the handheld or other mobile context.

Applicant notes that both Wagner and Canfield qualify as prior art against the application herein, if at all, solely under 35 USC 102(e). While Applicant submits that the claims as presented distinguish Wagner and Canfield on their merits, Applicant respectfully and expressly reserves all right to establish prior invention in order to establish that neither Wagner nor Canfield is valid prior art against this application or the claims presented herein.

Applicant respectfully requests reconsideration and allowance of the claims.

Claims 76-111: rejections under 35 USC §§ 102 and 103

At pages 11 - 19 of the Detailed Action the Examiner has rejected claims 76-111 as anticipated by Wagner, or obvious over Wagner (US 2004/0155908) in view of Canfield (US 2004/0056893).

Applicant respectfully submits that withdrawal of the claims moots the rejection and requests reconsideration and allowance of the claims presented.

Status of Related Applications

The following US, foreign, and international patent applications are or may be considered to be related to the application herein. Relevant documents pertaining to such cases are being provided or have been provided in one or more separately-filed Information Disclosure Statements. The status of such applications, as currently understood by Applicant, is summarized in order to ensure that the Office is fully apprised of the current state thereof. In the event the Office has any questions about the identified cases, the Examiner is requested to call Applicant's representative at the number below.

Applicant respectfully reminds the Examiner that the claims herein correspond to claims allowed in the Japanese application. Relevant documents have previously been provided via Information Disclosure Statement.

<u>Serial No.</u>	<u>Country</u>	<u>Status</u>
13/358,737	U.S.	Pending (PPH based on allowed CA 2732050)
2006-541762	Japan	Granted (Patent No. 4651623)
0871404	Rep of Korea	Granted
200480039930.2	China	Registered
200810099973.X	China	Registered
3113/DELP/2006	India	Pending – in examination
04713831.8	EPO	Closed - divisionals filed
08168419.3	EPO	Pending – oral proceedings
10177958.5	EPO	Pending - search report received
10177959.3	EPO	Pending - search report received
07100038.7	Hong Kong	Pending – awaiting allowance in EPO
200603555-4	Singapore	Pending – awaiting allowance in US or EPO
200804162.6	Singapore	Pending – In examination
2,548,598	Canada	Pending – in examination
2,732,050	Canada	Allowed
2,727,763	Canada	Pending - in examination
CA2004/000263	PCT	Expired (NPE entered as above)

CONCLUSION

Applicant believes that it has responded to each ground of rejection raised by the Examiner, and that for at least the reasons cited above the claims, as presented, are in condition for immediate allowance. Applicant respectfully requests reconsideration and immediate allowance of the claims.

Applicant believes that no fees other than a two-month extension of time are due in connection with the filing of this paper. In the event that the office determines that any further fee is due, Appellant requests that such fee be charged to its Deposit Account No. 195113.

Applicant is concerned to advance this application as quickly as is reasonably possible. Accordingly, Applicant respectfully reiterates its request that, in the event the Examiner has any further questions about this application, the Examiner call Applicant's attorney at the number provided below.

Respectfully submitted,



Matthew J. MARQUARDT
Reg. No. 40,997
Attorney for the Applicant

NORTON ROSE OR LLP
Royal Bank Plaza, South Tower
200 Bay Street, P.O. Box 84
Toronto, Ontario M5J 2Z4
CANADA
Tel. 416-216-4789
Fax 416-216-3930

Dated: March 12, 2012

Under the paperwork Reduction Act of 1995, no persons are required to respond to a collection of information unless it displays a valid OMB control number.

PETITION FOR EXTENSION OF TIME UNDER 37 CFR 1.136(a)		Docket Number (Optional) 05200204-272US	
Application Number 10/784,781		Filed 24 February 2004	
For PREVIEWING A NEW EVENT ON A SMALL SCREEN DEVICE			
Art Unit 2179		Examiner John M. Heffington	
This is a request under the provisions of 37 CFR 1.136(a) to extend the period for filing a reply in the above identified application.			
The requested extension and fee are as follows (check time period desired and enter the appropriate fee below):			
		<u>Fee</u>	<u>Small Entity Fee</u>
<input type="checkbox"/>	One month (37 CFR 1.17(a)(1))	\$150	\$75 \$ _____
<input checked="" type="checkbox"/>	Two months (37 CFR 1.17(a)(2))	\$560	\$280 \$ <u>560</u>
<input type="checkbox"/>	Three months (37 CFR 1.17(a)(3))	\$1270	\$635 \$ _____
<input type="checkbox"/>	Four months (37 CFR 1.17(a)(4))	\$1980	\$990 \$ _____
<input type="checkbox"/>	Five months (37 CFR 1.17(a)(5))	\$2690	\$1345 \$ _____
<input type="checkbox"/> Applicant claims small entity status. See 37 CFR 1.27.			
<input type="checkbox"/> A check in the amount of the fee is enclosed.			
<input type="checkbox"/> Payment by credit card. Form PTO-2038 is attached.			
<input type="checkbox"/> The Director has already been authorized to charge fees in this application to a Deposit Account.			
<input checked="" type="checkbox"/> The Director is hereby authorized to charge any fees which may be required, or credit any overpayment, to Deposit Account Number <u>195113</u> .			
WARNING: Information on this form may become public. Credit card information should not be included on this form. Provide credit card information and authorization on PTO-2038.			
I am the <input type="checkbox"/> applicant/inventor.			
<input type="checkbox"/> assignee of record of the entire interest. See 37 CFR 3.71. Statement under 37 CFR 3.73(b) is enclosed (Form PTO/SB/96).			
<input checked="" type="checkbox"/> attorney or agent of record. Registration Number <u>40,997</u>			
<input type="checkbox"/> attorney or agent under 37 CFR 1.34. Registration number if acting under 37 CFR 1.34 _____			
<u>/Matthew J. Marquardt</u>		<u>March 12, 2012</u>	
Signature		Date	
<u>Matthew J. Marquardt</u>		<u>1-416-216-4789</u>	
Typed or printed name		Telephone Number	
NOTE: Signatures of all the inventors or assignees of record of the entire interest or their representative(s) are required. Submit multiple forms if more than one signature is required, see below.			
<input checked="" type="checkbox"/> Total of <u>1</u> forms are submitted.			

This collection of information is required by 37 CFR 1.136(a). The information is required to obtain or retain a benefit by the public which is to file (and by the USPTO to process) an application. Confidentiality is governed by 35 U.S.C. 122 and 37 CFR 1.11 and 1.14. This collection is estimated to take 6 minutes to complete, including gathering, preparing, and submitting the completed application form to the USPTO. Time will vary depending upon the individual case. Any comments on the amount of time you require to complete this form and/or suggestions for reducing this burden, should be sent to the Chief Information Officer, U.S. Patent and Trademark Office, U.S. Department of Commerce, P.O. Box 1450, Alexandria, VA 22313-1450. DO NOT SEND FEES OR COMPLETED FORMS TO THIS ADDRESS. **SEND TO: Commissioner for Patents, P.O. Box 1450, Alexandria, VA 22313-1450.**

If you need assistance in completing the form, call 1-800-PTO-9199 and select option 2.

Privacy Act Statement

The Privacy Act of 1974 (P.L. 93-579) requires that you be given certain information in connection with your submission of the attached form related to a patent application or patent. Accordingly, pursuant to the requirements of the Act, please be advised that: (1) the general authority for the collection of this information is 35 U.S.C. 2(b)(2); (2) furnishing of the information solicited is voluntary; and (3) the principal purpose for which the information is used by the U.S. Patent and Trademark Office is to process and/or examine your submission related to a patent application or patent. If you do not furnish the requested information, the U.S. Patent and Trademark Office may not be able to process and/or examine your submission, which may result in termination of proceedings or abandonment of the application or expiration of the patent.

The information provided by you in this form will be subject to the following routine uses:

1. The information on this form will be treated confidentially to the extent allowed under the Freedom of Information Act (5 U.S.C. 552) and the Privacy Act (5 U.S.C. 552a). Records from this system of records may be disclosed to the Department of Justice to determine whether disclosure of these records is required by the Freedom of Information Act.
2. A record from this system of records may be disclosed, as a routine use, in the course of presenting evidence to a court, magistrate, or administrative tribunal, including disclosures to opposing counsel in the course of settlement negotiations.
3. A record in this system of records may be disclosed, as a routine use, to a Member of Congress submitting a request involving an individual, to whom the record pertains, when the individual has requested assistance from the Member with respect to the subject matter of the record.
4. A record in this system of records may be disclosed, as a routine use, to a contractor of the Agency having need for the information in order to perform a contract. Recipients of information shall be required to comply with the requirements of the Privacy Act of 1974, as amended, pursuant to 5 U.S.C. 552a(m).
5. A record related to an International Application filed under the Patent Cooperation Treaty in this system of records may be disclosed, as a routine use, to the International Bureau of the World Intellectual Property Organization, pursuant to the Patent Cooperation Treaty.
6. A record in this system of records may be disclosed, as a routine use, to another federal agency for purposes of National Security review (35 U.S.C. 181) and for review pursuant to the Atomic Energy Act (42 U.S.C. 218(c)).
7. A record from this system of records may be disclosed, as a routine use, to the Administrator, General Services, or his/her designee, during an inspection of records conducted by GSA as part of that agency's responsibility to recommend improvements in records management practices and programs, under authority of 44 U.S.C. 2904 and 2906. Such disclosure shall be made in accordance with the GSA regulations governing inspection of records for this purpose, and any other relevant (i.e., GSA or Commerce) directive. Such disclosure shall not be used to make determinations about individuals.
8. A record from this system of records may be disclosed, as a routine use, to the public after either publication of the application pursuant to 35 U.S.C. 122(b) or issuance of a patent pursuant to 35 U.S.C. 151. Further, a record may be disclosed, subject to the limitations of 37 CFR 1.14, as a routine use, to the public if the record was filed in an application which became abandoned or in which the proceedings were terminated and which application is referenced by either a published application, an application open to public inspection or an issued patent.
9. A record from this system of records may be disclosed, as a routine use, to a Federal, State, or local law enforcement agency, if the USPTO becomes aware of a violation or potential violation of law or regulation.

Under the Paperwork Reduction Act of 1995, no persons are required to respond to a collection of information unless it displays a valid OMB control number.

PATENT APPLICATION FEE DETERMINATION RECORD Substitute for Form PTO-875				Application or Docket Number 10/784,781		Filing Date 02/24/2004		<input type="checkbox"/> To be Mailed			
APPLICATION AS FILED – PART I						OTHER THAN					
(Column 1)		(Column 2)		SMALL ENTITY <input type="checkbox"/>		OR		SMALL ENTITY			
FOR	NUMBER FILED	NUMBER EXTRA	RATE (\$)	FEE (\$)	OR	RATE (\$)	FEE (\$)				
<input type="checkbox"/> BASIC FEE <small>(37 CFR 1.16(a), (b), or (c))</small>	N/A	N/A	N/A			N/A					
<input type="checkbox"/> SEARCH FEE <small>(37 CFR 1.16(k), (l), or (m))</small>	N/A	N/A	N/A			N/A					
<input type="checkbox"/> EXAMINATION FEE <small>(37 CFR 1.16(o), (p), or (q))</small>	N/A	N/A	N/A			N/A					
TOTAL CLAIMS <small>(37 CFR 1.16(i))</small>	minus 20 =	*	X \$ =			X \$ =					
INDEPENDENT CLAIMS <small>(37 CFR 1.16(h))</small>	minus 3 =	*	X \$ =			X \$ =					
<input type="checkbox"/> APPLICATION SIZE FEE <small>(37 CFR 1.16(s))</small>	If the specification and drawings exceed 100 sheets of paper, the application size fee due is \$250 (\$125 for small entity) for each additional 50 sheets or fraction thereof. See 35 U.S.C. 41(a)(1)(G) and 37 CFR 1.16(s).										
<input type="checkbox"/> MULTIPLE DEPENDENT CLAIM PRESENT <small>(37 CFR 1.16(j))</small>											
* If the difference in column 1 is less than zero, enter "0" in column 2.			TOTAL			TOTAL					
APPLICATION AS AMENDED – PART II						OTHER THAN					
(Column 1)		(Column 2)		(Column 3)		SMALL ENTITY		OR		SMALL ENTITY	
AMENDMENT	03/12/2012	CLAIMS REMAINING AFTER AMENDMENT		HIGHEST NUMBER PREVIOUSLY PAID FOR	PRESENT EXTRA	RATE (\$)	ADDITIONAL FEE (\$)	OR	RATE (\$)	ADDITIONAL FEE (\$)	
	Total <small>(37 CFR 1.16(j))</small>	* 45	Minus	** 60	=	X \$ =			X \$ =		
	Independent <small>(37 CFR 1.16(h))</small>	* 6	Minus	*** 8	=	X \$ =			X \$ =		
	<input type="checkbox"/> Application Size Fee <small>(37 CFR 1.16(s))</small>										
	<input type="checkbox"/> FIRST PRESENTATION OF MULTIPLE DEPENDENT CLAIM <small>(37 CFR 1.16(j))</small>										
(Column 1)		(Column 2)		(Column 3)		TOTAL ADD'L FEE			TOTAL ADD'L FEE		
AMENDMENT		CLAIMS REMAINING AFTER AMENDMENT		HIGHEST NUMBER PREVIOUSLY PAID FOR	PRESENT EXTRA	RATE (\$)	ADDITIONAL FEE (\$)	OR	RATE (\$)	ADDITIONAL FEE (\$)	
	Total <small>(37 CFR 1.16(j))</small>	*	Minus	**	=	X \$ =			X \$ =		
	Independent <small>(37 CFR 1.16(h))</small>	*	Minus	***	=	X \$ =			X \$ =		
	<input type="checkbox"/> Application Size Fee <small>(37 CFR 1.16(s))</small>										
	<input type="checkbox"/> FIRST PRESENTATION OF MULTIPLE DEPENDENT CLAIM <small>(37 CFR 1.16(j))</small>										
(Column 1)		(Column 2)		(Column 3)		TOTAL ADD'L FEE			TOTAL ADD'L FEE		
* If the entry in column 1 is less than the entry in column 2, write "0" in column 3.			** If the "Highest Number Previously Paid For" IN THIS SPACE is less than 20, enter "20".			Legal Instrument Examiner:					
*** If the "Highest Number Previously Paid For" IN THIS SPACE is less than 3, enter "3".			The "Highest Number Previously Paid For" (Total or Independent) is the highest number found in the appropriate box in column 1.			/ELMIRA HALL/					

This collection of information is required by 37 CFR 1.16. The information is required to obtain or retain a benefit by the public which is to file (and by the USPTO to process) an application. Confidentiality is governed by 35 U.S.C. 122 and 37 CFR 1.14. This collection is estimated to take 12 minutes to complete, including gathering, preparing, and submitting the completed application form to the USPTO. Time will vary depending upon the individual case. Any comments on the amount of time you require to complete this form and/or suggestions for reducing this burden, should be sent to the Chief Information Officer, U.S. Patent and Trademark Office, U.S. Department of Commerce, P.O. Box 1450, Alexandria, VA 22313-1450. DO NOT SEND FEES OR COMPLETED FORMS TO THIS ADDRESS. **SEND TO: Commissioner for Patents, P.O. Box 1450, Alexandria, VA 22313-1450.**

If you need assistance in completing the form, call 1-800-PTO-9199 and select option 2.



UNITED STATES PATENT AND TRADEMARK OFFICE

UNITED STATES DEPARTMENT OF COMMERCE
United States Patent and Trademark Office
Address: COMMISSIONER FOR PATENTS
P.O. Box 1450
Alexandria, Virginia 22313-1450
www.uspto.gov

NOTICE OF ALLOWANCE AND FEE(S) DUE

20988 7590 03/30/2012
NORTON ROSE CANADA LLP
1, Place Ville Marie
SUITE 2500
MONTREAL, QC H3B 1R1
CANADA

EXAMINER

HEFFINGTON, JOHN M

ART UNIT PAPER NUMBER

2172

DATE MAILED: 03/30/2012

Table with 5 columns: APPLICATION NO., FILING DATE, FIRST NAMED INVENTOR, ATTORNEY DOCKET NO., CONFIRMATION NO.
10/784,781 02/24/2004 Gerhard D. Klassen 05200204-272US 2200

TITLE OF INVENTION: PREVIEWING A NEW EVENT ON A SMALL SCREEN DEVICE

Table with 7 columns: APPLN. TYPE, SMALL ENTITY, ISSUE FEE DUE, PUBLICATION FEE DUE, PREV. PAID ISSUE FEE, TOTAL FEE(S) DUE, DATE DUE
nonprovisional NO \$1740 \$300 \$0 \$2040 07/02/2012

THE APPLICATION IDENTIFIED ABOVE HAS BEEN EXAMINED AND IS ALLOWED FOR ISSUANCE AS A PATENT. PROSECUTION ON THE MERITS IS CLOSED. THIS NOTICE OF ALLOWANCE IS NOT A GRANT OF PATENT RIGHTS. THIS APPLICATION IS SUBJECT TO WITHDRAWAL FROM ISSUE AT THE INITIATIVE OF THE OFFICE OR UPON PETITION BY THE APPLICANT. SEE 37 CFR 1.313 AND MPEP 1308.

THE ISSUE FEE AND PUBLICATION FEE (IF REQUIRED) MUST BE PAID WITHIN THREE MONTHS FROM THE MAILING DATE OF THIS NOTICE OR THIS APPLICATION SHALL BE REGARDED AS ABANDONED. THIS STATUTORY PERIOD CANNOT BE EXTENDED. SEE 35 U.S.C. 151. THE ISSUE FEE DUE INDICATED ABOVE DOES NOT REFLECT A CREDIT FOR ANY PREVIOUSLY PAID ISSUE FEE IN THIS APPLICATION. IF AN ISSUE FEE HAS PREVIOUSLY BEEN PAID IN THIS APPLICATION (AS SHOWN ABOVE), THE RETURN OF PART B OF THIS FORM WILL BE CONSIDERED A REQUEST TO REAPPLY THE PREVIOUSLY PAID ISSUE FEE TOWARD THE ISSUE FEE NOW DUE.

HOW TO REPLY TO THIS NOTICE:

I. Review the SMALL ENTITY status shown above.

If the SMALL ENTITY is shown as YES, verify your current SMALL ENTITY status:

A. If the status is the same, pay the TOTAL FEE(S) DUE shown above.

B. If the status above is to be removed, check box 5b on Part B - Fee(s) Transmittal and pay the PUBLICATION FEE (if required) and twice the amount of the ISSUE FEE shown above, or

If the SMALL ENTITY is shown as NO:

A. Pay TOTAL FEE(S) DUE shown above, or

B. If applicant claimed SMALL ENTITY status before, or is now claiming SMALL ENTITY status, check box 5a on Part B - Fee(s) Transmittal and pay the PUBLICATION FEE (if required) and 1/2 the ISSUE FEE shown above.

II. PART B - FEE(S) TRANSMITTAL, or its equivalent, must be completed and returned to the United States Patent and Trademark Office (USPTO) with your ISSUE FEE and PUBLICATION FEE (if required). If you are charging the fee(s) to your deposit account, section "4b" of Part B - Fee(s) Transmittal should be completed and an extra copy of the form should be submitted. If an equivalent of Part B is filed, a request to reapply a previously paid issue fee must be clearly made, and delays in processing may occur due to the difficulty in recognizing the paper as an equivalent of Part B.

III. All communications regarding this application must give the application number. Please direct all communications prior to issuance to Mail Stop ISSUE FEE unless advised to the contrary.

IMPORTANT REMINDER: Utility patents issuing on applications filed on or after Dec. 12, 1980 may require payment of maintenance fees. It is patentee's responsibility to ensure timely payment of maintenance fees when due.

PART B - FEE(S) TRANSMITTAL

**Complete and send this form, together with applicable fee(s), to: Mail Mail Stop ISSUE FEE
 Commissioner for Patents
 P.O. Box 1450
 Alexandria, Virginia 22313-1450
 or Fax (571)-273-2885**

INSTRUCTIONS: This form should be used for transmitting the ISSUE FEE and PUBLICATION FEE (if required). Blocks 1 through 5 should be completed where appropriate. All further correspondence including the Patent, advance orders and notification of maintenance fees will be mailed to the current correspondence address as indicated unless corrected below or directed otherwise in Block 1, by (a) specifying a new correspondence address; and/or (b) indicating a separate "FEE ADDRESS" for maintenance fee notifications.

CURRENT CORRESPONDENCE ADDRESS (Note: Use Block 1 for any change of address)

20988 7590 03/30/2012
NORTON ROSE CANADA LLP
 1, Place Ville Marie
 SUITE 2500
 MONTREAL, QC H3B 1R1
 CANADA

Note: A certificate of mailing can only be used for domestic mailings of the Fee(s) Transmittal. This certificate cannot be used for any other accompanying papers. Each additional paper, such as an assignment or formal drawing, must have its own certificate of mailing or transmission.

Certificate of Mailing or Transmission

I hereby certify that this Fee(s) Transmittal is being deposited with the United States Postal Service with sufficient postage for first class mail in an envelope addressed to the Mail Stop ISSUE FEE address above, or being facsimile transmitted to the USPTO (571) 273-2885, on the date indicated below.

_____ (Depositor's name)
_____ (Signature)
_____ (Date)

APPLICATION NO.	FILING DATE	FIRST NAMED INVENTOR	ATTORNEY DOCKET NO.	CONFIRMATION NO.
10/784,781	02/24/2004	Gerhard D. Klassen	05200204-272US	2200

TITLE OF INVENTION: PREVIEWING A NEW EVENT ON A SMALL SCREEN DEVICE

APPLN. TYPE	SMALL ENTITY	ISSUE FEE DUE	PUBLICATION FEE DUE	PREV. PAID ISSUE FEE	TOTAL FEE(S) DUE	DATE DUE
nonprovisional	NO	\$1740	\$300	\$0	\$2040	07/02/2012

EXAMINER	ART UNIT	CLASS-SUBCLASS
HEFFINGTON, JOHN M	2172	715-700000

1. Change of correspondence address or indication of "Fee Address" (37 CFR 1.363). <input type="checkbox"/> Change of correspondence address (or Change of Correspondence Address form PTO/SB/122) attached. <input type="checkbox"/> "Fee Address" indication (or "Fee Address" Indication form PTO/SB/47; Rev 03-02 or more recent) attached. Use of a Customer Number is required.	2. For printing on the patent front page, list (1) the names of up to 3 registered patent attorneys or agents OR, alternatively, _____ 1 (2) the name of a single firm (having as a member a registered attorney or agent) and the names of up to 2 registered patent attorneys or agents. If no name is listed, no name will be printed. _____ 2 _____ 3
--	--

3. ASSIGNEE NAME AND RESIDENCE DATA TO BE PRINTED ON THE PATENT (print or type)
 PLEASE NOTE: Unless an assignee is identified below, no assignee data will appear on the patent. If an assignee is identified below, the document has been filed for recordation as set forth in 37 CFR 3.11. Completion of this form is NOT a substitute for filing an assignment.

(A) NAME OF ASSIGNEE _____ (B) RESIDENCE: (CITY and STATE OR COUNTRY) _____

Please check the appropriate assignee category or categories (will not be printed on the patent): Individual Corporation or other private group entity Government

4a. The following fee(s) are submitted: <input type="checkbox"/> Issue Fee <input type="checkbox"/> Publication Fee (No small entity discount permitted) <input type="checkbox"/> Advance Order - # of Copies _____	4b. Payment of Fee(s): (Please first reapply any previously paid issue fee shown above) <input type="checkbox"/> A check is enclosed. <input type="checkbox"/> Payment by credit card. Form PTO-2038 is attached. <input type="checkbox"/> The Director is hereby authorized to charge the required fee(s), any deficiency, or credit any overpayment, to Deposit Account Number _____ (enclose an extra copy of this form).
--	---

5. **Change in Entity Status** (from status indicated above)
 a. Applicant claims SMALL ENTITY status. See 37 CFR 1.27. b. Applicant is no longer claiming SMALL ENTITY status. See 37 CFR 1.27(g)(2).

NOTE: The Issue Fee and Publication Fee (if required) will not be accepted from anyone other than the applicant; a registered attorney or agent; or the assignee or other party in interest as shown by the records of the United States Patent and Trademark Office.

Authorized Signature _____ Date _____
 Typed or printed name _____ Registration No. _____

This collection of information is required by 37 CFR 1.311. The information is required to obtain or retain a benefit by the public which is to file (and by the USPTO to process) an application. Confidentiality is governed by 35 U.S.C. 122 and 37 CFR 1.14. This collection is estimated to take 12 minutes to complete, including gathering, preparing, and submitting the completed application form to the USPTO. Time will vary depending upon the individual case. Any comments on the amount of time you require to complete this form and/or suggestions for reducing this burden, should be sent to the Chief Information Officer, U.S. Patent and Trademark Office, U.S. Department of Commerce, P.O. Box 1450, Alexandria, Virginia 22313-1450. DO NOT SEND FEES OR COMPLETED FORMS TO THIS ADDRESS. SEND TO: Commissioner for Patents, P.O. Box 1450, Alexandria, Virginia 22313-1450.

Under the Paperwork Reduction Act of 1995, no persons are required to respond to a collection of information unless it displays a valid OMB control number.



UNITED STATES PATENT AND TRADEMARK OFFICE

UNITED STATES DEPARTMENT OF COMMERCE
United States Patent and Trademark Office
Address: COMMISSIONER FOR PATENTS
P.O. Box 1450
Alexandria, Virginia 22313-1450
www.uspto.gov

Table with 5 columns: APPLICATION NO., FILING DATE, FIRST NAMED INVENTOR, ATTORNEY DOCKET NO., CONFIRMATION NO.
Row 1: 10/784,781, 02/24/2004, Gerhard D. Klassen, 05200204-272US, 2200
Row 2: 20988, 7590, 03/30/2012, [EXAMINER], [PAPER NUMBER]
Row 3: [NORTON ROSE CANADA LLP], [HEFFINGTON, JOHN M], [ART UNIT], [PAPER NUMBER]
Row 4: [1, Place Ville Marie], [MONTREAL, QC H3B 1R1], [2172], [DATE MAILED: 03/30/2012]

Determination of Patent Term Adjustment under 35 U.S.C. 154 (b)
(application filed on or after May 29, 2000)

The Patent Term Adjustment to date is 675 day(s). If the issue fee is paid on the date that is three months after the mailing date of this notice and the patent issues on the Tuesday before the date that is 28 weeks (six and a half months) after the mailing date of this notice, the Patent Term Adjustment will be 675 day(s).

If a Continued Prosecution Application (CPA) was filed in the above-identified application, the filing date that determines Patent Term Adjustment is the filing date of the most recent CPA.

Applicant will be able to obtain more detailed information by accessing the Patent Application Information Retrieval (PAIR) WEB site (http://pair.uspto.gov).

Any questions regarding the Patent Term Extension or Adjustment determination should be directed to the Office of Patent Legal Administration at (571)-272-7702. Questions relating to issue and publication fee payments should be directed to the Customer Service Center of the Office of Patent Publication at 1-(888)-786-0101 or (571)-272-4200.

Privacy Act Statement

The Privacy Act of 1974 (P.L. 93-579) requires that you be given certain information in connection with your submission of the attached form related to a patent application or patent. Accordingly, pursuant to the requirements of the Act, please be advised that: (1) the general authority for the collection of this information is 35 U.S.C. 2(b)(2); (2) furnishing of the information solicited is voluntary; and (3) the principal purpose for which the information is used by the U.S. Patent and Trademark Office is to process and/or examine your submission related to a patent application or patent. If you do not furnish the requested information, the U.S. Patent and Trademark Office may not be able to process and/or examine your submission, which may result in termination of proceedings or abandonment of the application or expiration of the patent.

The information provided by you in this form will be subject to the following routine uses:

1. The information on this form will be treated confidentially to the extent allowed under the Freedom of Information Act (5 U.S.C. 552) and the Privacy Act (5 U.S.C. 552a). Records from this system of records may be disclosed to the Department of Justice to determine whether disclosure of these records is required by the Freedom of Information Act.
2. A record from this system of records may be disclosed, as a routine use, in the course of presenting evidence to a court, magistrate, or administrative tribunal, including disclosures to opposing counsel in the course of settlement negotiations.
3. A record in this system of records may be disclosed, as a routine use, to a Member of Congress submitting a request involving an individual, to whom the record pertains, when the individual has requested assistance from the Member with respect to the subject matter of the record.
4. A record in this system of records may be disclosed, as a routine use, to a contractor of the Agency having need for the information in order to perform a contract. Recipients of information shall be required to comply with the requirements of the Privacy Act of 1974, as amended, pursuant to 5 U.S.C. 552a(m).
5. A record related to an International Application filed under the Patent Cooperation Treaty in this system of records may be disclosed, as a routine use, to the International Bureau of the World Intellectual Property Organization, pursuant to the Patent Cooperation Treaty.
6. A record in this system of records may be disclosed, as a routine use, to another federal agency for purposes of National Security review (35 U.S.C. 181) and for review pursuant to the Atomic Energy Act (42 U.S.C. 218(c)).
7. A record from this system of records may be disclosed, as a routine use, to the Administrator, General Services, or his/her designee, during an inspection of records conducted by GSA as part of that agency's responsibility to recommend improvements in records management practices and programs, under authority of 44 U.S.C. 2904 and 2906. Such disclosure shall be made in accordance with the GSA regulations governing inspection of records for this purpose, and any other relevant (i.e., GSA or Commerce) directive. Such disclosure shall not be used to make determinations about individuals.
8. A record from this system of records may be disclosed, as a routine use, to the public after either publication of the application pursuant to 35 U.S.C. 122(b) or issuance of a patent pursuant to 35 U.S.C. 151. Further, a record may be disclosed, subject to the limitations of 37 CFR 1.14, as a routine use, to the public if the record was filed in an application which became abandoned or in which the proceedings were terminated and which application is referenced by either a published application, an application open to public inspection or an issued patent.
9. A record from this system of records may be disclosed, as a routine use, to a Federal, State, or local law enforcement agency, if the USPTO becomes aware of a violation or potential violation of law or regulation.

Notice of Allowability	Application No. 10/784,781	Applicant(s) KLASSEN ET AL.	
	Examiner JOHN HEFFINGTON	Art Unit 2172	

-- The MAILING DATE of this communication appears on the cover sheet with the correspondence address--

All claims being allowable, PROSECUTION ON THE MERITS IS (OR REMAINS) CLOSED in this application. If not included herewith (or previously mailed), a Notice of Allowance (PTOL-85) or other appropriate communication will be mailed in due course. **THIS NOTICE OF ALLOWABILITY IS NOT A GRANT OF PATENT RIGHTS.** This application is subject to withdrawal from issue at the initiative of the Office or upon petition by the applicant. See 37 CFR 1.313 and MPEP 1308.

1. This communication is responsive to Amendment After Final dated 12 March 2012.
2. An election was made by the applicant in response to a restriction requirement set forth during the interview on ____; the restriction requirement and election have been incorporated into this action.
3. The allowed claim(s) is/are 52-57 and 64-75.
4. Acknowledgment is made of a claim for foreign priority under 35 U.S.C. § 119(a)-(d) or (f).
 - a) All b) Some* c) None of the:
 1. Certified copies of the priority documents have been received.
 2. Certified copies of the priority documents have been received in Application No. ____ .
 3. Copies of the certified copies of the priority documents have been received in this national stage application from the International Bureau (PCT Rule 17.2(a)).

* Certified copies not received: ____.

Applicant has THREE MONTHS FROM THE "MAILING DATE" of this communication to file a reply complying with the requirements noted below. Failure to timely comply will result in ABANDONMENT of this application.
THIS THREE-MONTH PERIOD IS NOT EXTENDABLE.

5. A SUBSTITUTE OATH OR DECLARATION must be submitted. Note the attached EXAMINER'S AMENDMENT or NOTICE OF INFORMAL PATENT APPLICATION (PTO-152) which gives reason(s) why the oath or declaration is deficient.
6. CORRECTED DRAWINGS (as "replacement sheets") must be submitted.
 - (a) including changes required by the Notice of Draftsperson's Patent Drawing Review (PTO-948) attached
 - 1) hereto or 2) to Paper No./Mail Date ____.
 - (b) including changes required by the attached Examiner's Amendment / Comment or in the Office action of Paper No./Mail Date ____.

Identifying indicia such as the application number (see 37 CFR 1.84(c)) should be written on the drawings in the front (not the back) of each sheet. Replacement sheet(s) should be labeled as such in the header according to 37 CFR 1.121(d).
7. DEPOSIT OF and/or INFORMATION about the deposit of BIOLOGICAL MATERIAL must be submitted. Note the attached Examiner's comment regarding REQUIREMENT FOR THE DEPOSIT OF BIOLOGICAL MATERIAL.

Attachment(s)

- | | |
|--|---|
| <ol style="list-style-type: none"> 1. <input checked="" type="checkbox"/> Notice of References Cited (PTO-892) 2. <input type="checkbox"/> Notice of Draftsperson's Patent Drawing Review (PTO-948) 3. <input checked="" type="checkbox"/> Information Disclosure Statements (PTO/SB/08), Paper No./Mail Date <u>3/12/12</u> 4. <input type="checkbox"/> Examiner's Comment Regarding Requirement for Deposit of Biological Material | <ol style="list-style-type: none"> 5. <input type="checkbox"/> Notice of Informal Patent Application 6. <input type="checkbox"/> Interview Summary (PTO-413), Paper No./Mail Date ____ . 7. <input type="checkbox"/> Examiner's Amendment/Comment 8. <input checked="" type="checkbox"/> Examiner's Statement of Reasons for Allowance 9. <input type="checkbox"/> Other ____. |
|--|---|

--	--

REASONS FOR ALLOWANCE

1. The following is an examiner's statement of reasons for allowance.

Independent claims 52, 64, 70 are allowable over the prior art of record, specifically:

The prior art of record fails to disclose a numeric character that represents a count of the plurality of different messaging correspondents for which one or more of the electronic messages have been received and remain unread.

The respective dependent claims add further limitations to the allowable subject matter of the independent claims and are, therefore, allowable over the prior art of record. Specifically, the prior art fails to clearly teach or fairly suggest the combination of elements as recited in the claims.

Any comments considered necessary by applicant must be submitted no later than the payment of the issue fee and, to avoid processing delays, should preferably accompany the issue fee. Such submissions should be clearly labeled "Comments on Statement of Reasons for Allowance."

Summary of the Prior Art of Record

Dam Nielson et al. (US 2006/0084450 A1) – Dam Nielson discloses displaying icons representing correspondents that have sent messages to a device including an

envelope icon indicating new messages received and a count of new messages received.

Canfield et al. (US 2004/0056893 A1) – Canfield discloses tear-off elements that include a status indicator to indicate whether a new IM message within the IM session corresponding to an interface tear-off element remains pending for review. In general, the indicator provides a perceivable status indication to the user that a new message is pending in at least one concurrent instant messaging session. Once the new message is viewed or acknowledged, the indicator changes and the conversation counter is updated to reflect one fewer message waiting to be viewed. The tear-off elements also may include an identifier, such as the screen name of the IM buddy, to identify the particular IM session to which it is assigned. The conversation counter, the indicator, or both, may distinguish between a new message received from an ongoing IM session and new message received as part of the initiation of a new IM session.

Wagner et al. (US 2004/0155908 A1) – Wagner discloses displaying icons for different types of messages and services received, including news and email. The icons can include indicia that indicate an update to the information provided by a service, such as news, or indicate different types of messages received, including total messages and number of urgent messages.

Conclusion

Any inquiry concerning this communication or earlier communications from the examiner should be directed to JOHN HEFFINGTON whose telephone number is (571)270-1696. The examiner can normally be reached on 8:30 am to 5:30 pm.

If attempts to reach the examiner by telephone are unsuccessful, the examiner's supervisor, Boris M. Pesin can be reached on 571-272-4070. The fax phone number for the organization where this application or proceeding is assigned is 571-273-8300.

Information regarding the status of an application may be obtained from the Patent Application Information Retrieval (PAIR) system. Status information for published applications may be obtained from either Private PAIR or Public PAIR. Status information for unpublished applications is available through Private PAIR only. For more information about the PAIR system, see <http://pair-direct.uspto.gov>. Should you have questions on access to the Private PAIR system, contact the Electronic Business Center (EBC) at 866-217-9197 (toll-free). If you would like assistance from a USPTO Customer Service Representative or access to the automated information system, call 800-786-9199 (IN USA OR CANADA) or 571-272-1000.

JMH
3/18/12

/Boris Pesin/
Supervisory Patent Examiner, Art Unit 2172

Notice of References Cited	Application/Control No. 10/784,781	Applicant(s)/Patent Under Reexamination KLASSEN ET AL.	
	Examiner JOHN HEFFINGTON	Art Unit 2172	Page 1 of 6

U.S. PATENT DOCUMENTS

*	Document Number Country Code-Number-Kind Code	Date MM-YYYY	Name	Classification	
*	A	US-5,793,365 A	08-1998	Tang et al.	715/758
*	B	US-5,872,521 A	02-1999	Lopatukin et al.	340/7.52
*	C	US-5,960,173 A	09-1999	Tang et al.	709/201
*	D	US-5,990,887 A	11-1999	Redpath et al.	715/758
*	E	US-6,131,046 A	10-2000	Sano et al.	455/566
*	F	US-6,169,911 B1	01-2001	Wagner et al.	455/566
*	G	US-6,346,952 B1	02-2002	Shtivelman, Yuri	715/758
*	H	US-2002/0035613 A1	03-2002	Hirayama, Naofumi	709/218
*	I	US-6,393,307 B1	05-2002	Kim, Hoo-Ja	455/566
*	J	US-6,434,599 B1	08-2002	Porter, Swain W.	709/204
*	K	US-6,430,405 B1	08-2002	Jambhekar et al.	455/403
*	L	US-2002/0138584 A1	09-2002	Fujimoto et al.	709/206
*	M	US-2002/0130904 A1	09-2002	Becker et al.	345/753

FOREIGN PATENT DOCUMENTS

*	Document Number Country Code-Number-Kind Code	Date MM-YYYY	Country	Name	Classification
	N				
	O				
	P				
	Q				
	R				
	S				
	T				

NON-PATENT DOCUMENTS

*	Include as applicable: Author, Title Date, Publisher, Edition or Volume, Pertinent Pages)
U	Nokia 9210i Communicator, 2002, Nokia
V	Duarte et al., WO 03/014905 A2, 20 February 2003
W	Ask Search, http://www.ask.com/web?qsrc=1&o=0&l=dir&q=wireless+correspondents+new+messages
X	Ask Search, http://www.ask.com/web?qsrc=1&o=0&l=dir&q=telephone+%28correspondents+or+cont...

*A copy of this reference is not being furnished with this Office action. (See MPEP § 707.05(a).)
Dates in MM-YYYY format are publication dates. Classifications may be US or foreign.

Notice of References Cited	Application/Control No. 10/784,781	Applicant(s)/Patent Under Reexamination KLASSEN ET AL.	
	Examiner JOHN HEFFINGTON	Art Unit 2172	Page 2 of 6

U.S. PATENT DOCUMENTS

*	Document Number Country Code-Number-Kind Code	Date MM-YYYY	Name	Classification	
*	A	US-2002/0160817 A1	10-2002	Salmimaa et al.	455/566
*	B	US-6,493,547 B1	12-2002	Raith, Alex Krister	455/405
*	C	US-2002/0194379 A1	12-2002	Bennett et al.	709/246
*	D	US-6,519,629 B2	02-2003	Harvey et al.	709/204
*	E	US-2003/0052915 A1	03-2003	Brown et al.	345/752
*	F	US-6,539,421 B1	03-2003	Appelman et al.	709/206
*	G	US-2003/0131023 A1	07-2003	Bassett et al.	707/200
*	H	US-2003/0210265 A1	11-2003	Haimberg, Nadav Y.	345/758
*	I	US-6,691,159 B1	02-2004	Grewal et al.	709/219
*	J	US-6,697,840 B1	02-2004	Godefroid et al.	709/205
*	K	US-2004/0056893 A1	03-2004	Canfield et al.	345/753
*	L	US-6,725,228 B1	04-2004	Clark et al.	1/1
*	M	US-2004/0090469 A1	05-2004	Moon et al.	345/846

FOREIGN PATENT DOCUMENTS

*	Document Number Country Code-Number-Kind Code	Date MM-YYYY	Country	Name	Classification
	N				
	O				
	P				
	Q				
	R				
	S				
	T				

NON-PATENT DOCUMENTS

*	Document Number Country Code-Number-Kind Code	Date MM-YYYY	Country	Name	Classification
	Include as applicable: Author, Title Date, Publisher, Edition or Volume, Pertinent Pages)				
	U	Ask Search, http://www.ask.com/web?qsrc=1&o=0&l=dir&q=+wireless+%28correspondents+or+conta...			
	V	Ask Search, http://www.ask.com/web?qsrc=1&o=0&l=dir&q=+phone+%28correspondents+or+contact...			
	W	Ask Search, http://www.ask.com/web?q=correspondents+new+messages&search=&qsrc=364&o=0&l=...			
	X				

*A copy of this reference is not being furnished with this Office action. (See MPEP § 707.05(a).)
Dates in MM-YYYY format are publication dates. Classifications may be US or foreign.

Notice of References Cited	Application/Control No. 10/784,781	Applicant(s)/Patent Under Reexamination KLASSEN ET AL.	
	Examiner JOHN HEFFINGTON	Art Unit 2172	Page 3 of 6

U.S. PATENT DOCUMENTS

*	Document Number Country Code-Number-Kind Code	Date MM-YYYY	Name	Classification	
*	A	US-2004/0155908 A1	08-2004	Wagner, Annette M.	345/854
*	B	US-2004/0172455 A1	09-2004	Green et al.	709/207
*	C	US-6,788,949 B1	09-2004	Bansal, Pradeep K	455/519
*	D	US-2004/0172456 A1	09-2004	Green et al.	709/207
*	E	US-2004/0225901 A1	11-2004	Bear et al.	713/300
*	F	US-2004/0229200 A1	11-2004	McKeon et al.	434/350
*	G	US-2005/0071736 A1	03-2005	Schneider et al.	715/500
*	H	US-2005/0047563 A1	03-2005	Fellenstein et al.	379/088.22
*	I	US-2005/0055405 A1	03-2005	Kaminsky et al.	709/206
*	J	US-2005/0091609 A1	04-2005	Matthews et al.	715/804
*	K	US-2005/0114777 A1	05-2005	Szeto, Christopher	715/710
*	L	US-6,907,447 B1	06-2005	Cooperman et al.	709/203
*	M	US-2005/0138183 A1	06-2005	O'Rourke et al.	709/228

FOREIGN PATENT DOCUMENTS

*	Document Number Country Code-Number-Kind Code	Date MM-YYYY	Country	Name	Classification
	N				
	O				
	P				
	Q				
	R				
	S				
	T				

NON-PATENT DOCUMENTS

*	Document Number Country Code-Number-Kind Code	Date MM-YYYY	Country	Name	Classification
	Include as applicable: Author, Title Date, Publisher, Edition or Volume, Pertinent Pages)				
	U				
	V				
	W				
	X				

*A copy of this reference is not being furnished with this Office action. (See MPEP § 707.05(a).)
Dates in MM-YYYY format are publication dates. Classifications may be US or foreign.

Notice of References Cited	Application/Control No. 10/784,781	Applicant(s)/Patent Under Reexamination KLASSEN ET AL.	
	Examiner JOHN HEFFINGTON	Art Unit 2172	Page 4 of 6

U.S. PATENT DOCUMENTS

*	Document Number Country Code-Number-Kind Code	Date MM-YYYY	Name	Classification	
*	A	US-2005/0117733 A1	06-2005	Widger et al.	379/221.05
*	B	US-6,970,906 B1	11-2005	Parsons et al.	709/204
*	C	US-2005/0248437 A1	11-2005	Hellebust et al.	340/007.51
*	D	US-6,981,223 B2	12-2005	Becker et al.	715/753
*	E	US-2006/0007051 A1	01-2006	Bear et al.	345/001.1
*	F	US-6,993,574 B2	01-2006	Hall, Robert	709/219
*	G	US-7,003,279 B2	02-2006	Nickum, Larry A.	455/405
*	H	US-2006/0084450 A1	04-2006	Dam Nielsen et al.	455/466
*	I	US-7,127,685 B2	10-2006	Canfield et al.	715/842
*	J	US-2006/0256130 A1	11-2006	Gonzalez, Ruben	345/619
*	K	US-2006/0284787 A1	12-2006	Bear et al.	345/001.1
*	L	US-2007/0038718 A1	02-2007	Khoo et al.	709/206
*	M	US-2007/0060206 A1	03-2007	Dam Nielsen et al.	455/566

FOREIGN PATENT DOCUMENTS

*	Document Number Country Code-Number-Kind Code	Date MM-YYYY	Country	Name	Classification
	N				
	O				
	P				
	Q				
	R				
	S				
	T				

NON-PATENT DOCUMENTS

*	Document Number Country Code-Number-Kind Code	Date MM-YYYY	Country	Name	Classification
	U	Include as applicable: Author, Title Date, Publisher, Edition or Volume, Pertinent Pages)			
	V				
	W				
	X				

*A copy of this reference is not being furnished with this Office action. (See MPEP § 707.05(a).)
Dates in MM-YYYY format are publication dates. Classifications may be US or foreign.

Notice of References Cited	Application/Control No. 10/784,781	Applicant(s)/Patent Under Reexamination KLASSEN ET AL.	
	Examiner JOHN HEFFINGTON	Art Unit 2172	Page 5 of 6

U.S. PATENT DOCUMENTS

*	Document Number Country Code-Number-Kind Code	Date MM-YYYY	Name	Classification	
*	A	US-2007/0129068 A1	06-2007	Ishigaki, Junji	455/414.1
*	B	US-2007/0195007 A1	08-2007	Bear et al.	345/001.1
*	C	US-2007/0213099 A1	09-2007	Bast, Christopher De	455/566
*	D	US-7,275,215 B2	09-2007	Werndorfer et al.	715/752
*	E	US-7,284,207 B2	10-2007	Canfield et al.	715/842
*	F	US-7,379,066 B1	05-2008	Ostermann et al.	345/473
*	G	US-7,386,535 B1	06-2008	Kalucha et al.	1/1
*	H	US-2008/0200215 A1	08-2008	DE BAST, CHRISTOPHER	455/566
*	I	US-2008/0220751 A1	09-2008	DE BAST, CHRISTOPHER	455/414.2
*	J	US-2008/0282162 A1	11-2008	Lincke et al.	715/710
*	K	US-2009/0006959 A1	01-2009	Kalenius et al.	715/710
*	L	US-7,493,573 B2	02-2009	Wagner, Annette M.	715/864
*	M	US-7,606,866 B2	10-2009	Mora, Gary E.	709/207

FOREIGN PATENT DOCUMENTS

*	Document Number Country Code-Number-Kind Code	Date MM-YYYY	Country	Name	Classification
	N				
	O				
	P				
	Q				
	R				
	S				
	T				

NON-PATENT DOCUMENTS

*	Document Number Country Code-Number-Kind Code	Date MM-YYYY	Country	Name	Classification
	Include as applicable: Author, Title Date, Publisher, Edition or Volume, Pertinent Pages)				
	U				
	V				
	W				
	X				

*A copy of this reference is not being furnished with this Office action. (See MPEP § 707.05(a).)
Dates in MM-YYYY format are publication dates. Classifications may be US or foreign.

Notice of References Cited	Application/Control No. 10/784,781	Applicant(s)/Patent Under Reexamination KLASSEN ET AL.	
	Examiner JOHN HEFFINGTON	Art Unit 2172	Page 6 of 6

U.S. PATENT DOCUMENTS

*	Document Number Country Code-Number-Kind Code	Date MM-YYYY	Name	Classification
*	A US-7,631,266 B2	12-2009	Werndorfer et al.	715/752
*	B US-7,743,340 B2	06-2010	Horvitz et al.	715/808
*	C US-7,813,488 B2	10-2010	Kozdon et al.	379/201.04
*	D US-7,900,148 B1	03-2011	Canfield et al.	715/752
*	E US-7,921,368 B2	04-2011	Moody et al.	715/751
	F US-			
	G US-			
	H US-			
	I US-			
	J US-			
	K US-			
	L US-			
	M US-			

FOREIGN PATENT DOCUMENTS

*	Document Number Country Code-Number-Kind Code	Date MM-YYYY	Country	Name	Classification
	N				
	O				
	P				
	Q				
	R				
	S				
	T				

NON-PATENT DOCUMENTS

*	Document Number Country Code-Number-Kind Code	Date MM-YYYY	Country	Name	Classification
	Include as applicable: Author, Title Date, Publisher, Edition or Volume, Pertinent Pages)				
	U				
	V				
	W				
	X				

*A copy of this reference is not being furnished with this Office action. (See MPEP § 707.05(a).)
Dates in MM-YYYY format are publication dates. Classifications may be US or foreign.

EAST Search History

EAST Search History (Prior Art)

Ref #	Hits	Search Query	DBs	Default Operator	Plurals	Time Stamp
L1	871	715/736.ccls.	US-PGPUB; USPAT; FPRS; EPO; JPO; DERWENT; IBM_TDB	ADJ	ON	2012/03/18 16:24
S1	8	("20020160817" "20050248437").PN. or ("20020035613" "20040155908").PN.	US-PGPUB; USPAT; FPRS; EPO; JPO; DERWENT; IBM_TDB	ADJ	ON	2010/03/27 17:51
S2	8	("20020160817" "20050248437").PN. or ("20020035613" "20040155908").PN.	US-PGPUB; USPAT; FPRS; EPO; JPO; DERWENT; IBM_TDB	ADJ	ON	2010/08/25 09:57
S3	1	10/784781.app.	US-PGPUB; USPAT; FPRS; EPO; JPO; DERWENT; IBM_TDB	ADJ	ON	2010/08/25 10:09
S4	2353	((unread or (un read) or ("not" viewed) or unopened or (un opened)) near2 (message or text or im or email or (e mail) or chat))	US-PGPUB; USPAT; FPRS; EPO; JPO; DERWENT; IBM_TDB	ADJ	ON	2010/08/25 10:22
S5	1491	((unread or (un read) or ("not" viewed) or unopened or (un opened)) near2 (message or text or im or email or (e mail) or chat)) same (((number or count) near2 users) or users)	US-PGPUB; USPAT; FPRS; EPO; JPO; DERWENT; IBM_TDB	ADJ	ON	2010/08/25 10:23
S6	305	((unread or (un read) or ("not" viewed) or unopened or (un opened)) near2 (message or text or im or email or (e mail) or chat)) same (((number or count) near2 users) or users) with (icon or symbol or graphic\$2 or widget or image or token or picture or thumbnail))	US-PGPUB; USPAT; FPRS; EPO; JPO; DERWENT; IBM_TDB	ADJ	ON	2010/08/25 10:28
S7	260	((unread or (un read) or ("not" viewed) or unopened or (un opened)) near2 (message or text or im or email or (e mail) or chat)) same (((number or count) near2 users) or users) with (icon or symbol or graphic\$2 or widget	US-PGPUB; USPAT; FPRS; EPO; JPO; DERWENT; IBM_TDB	ADJ	ON	2010/08/25 10:30

		or image or token or picture or thumbnail))) and wireless				
S8	252	(((unread or (un read) or ("not" viewed) or unopened or (un opened)) near2 (message or text or im or email or (e mail) or chat)) same (((number or count) near2 users) or users) with (icon or symbol or graphic\$2 or widget or image or token or picture or thumbnail))) and wireless not (research near2 "in" near2 motion).as.	US-PGPUB; USPAT; FPRS; EPO; JPO; DERWENT; IBM_TDB	ADJ	ON	2010/08/25 10:37
S9	3	(((unread or (un read) or ("not" viewed) or unopened or (un opened)) near2 (message or text or im or email or (e mail) or chat)) same (((number or count) near2 users)) with (icon or symbol or graphic\$2 or widget or image or token or picture or thumbnail))) and wireless not (research near2 "in" near2 motion).as.	US-PGPUB; USPAT; FPRS; EPO; JPO; DERWENT; IBM_TDB	ADJ	ON	2010/08/25 10:49
S10	252	(((unread or (un read) or ("not" viewed) or unopened or (un opened)) near2 (message or text or im or email or (e mail) or chat)) same (((number or count) near2 (users near2 (sent or received))) or users) with (icon or symbol or graphic\$2 or widget or image or token or picture or thumbnail))) and wireless not (research near2 "in" near2 motion).as.	US-PGPUB; USPAT; FPRS; EPO; JPO; DERWENT; IBM_TDB	ADJ	ON	2010/08/25 10:56
S11	8	(((unread or (un read) or ("not" viewed) or unopened or (un opened)) near2 (message or text or im or email or (e mail) or chat)) same (((number or count) near2 (users near2 (sent or received))) or (users near2 (sent or received))) with (icon or symbol or graphic\$2 or widget or image or token or picture or thumbnail))) and wireless not (research near2 "in" near2 motion).as.	US-PGPUB; USPAT; FPRS; EPO; JPO; DERWENT; IBM_TDB	ADJ	ON	2010/08/25 10:57
S12	111	(US-20100211917-\$ or US-20100207871-\$ or US-20100203872-\$ or US-20100192081-\$ or US-20100185980-\$ or US-20100184453-\$ or US-20100179991-\$ or US-20100171712-\$ or US-20100156816-\$ or US-20100131191-\$ or US-20100125811-\$ or US-20100125785-\$ or US-20100123724-\$ or US-20100115559-\$ or US-20100100964-\$ or US-20100082759-\$ or US-20100079405-\$ or US-20100064016-\$ or US-20100057743-\$ or US-20100041331-\$ or US-20100030860-\$ or US-20100030549-\$ or US-20100011304-\$ or US-20100004028-\$ or US-20090327976-\$ or US-20090327168-\$).did. or (US-20090322688-\$ or US-20090307322-\$ or US-20090305732-\$ or US-20090303231-\$ or US-20090235184-\$	US-PGPUB	ADJ	ON	2010/08/25 11:04

		or US-20090235175-\$ or US-20090228825-\$ or US-20090228807-\$ or US-20090228792-\$ or US-20090216634-\$ or US-20090191926-\$ or US-20090191848-\$ or US-20090178008-\$ or US-20090178007-\$ or US-20090177981-\$ or US-20090174680-\$ or US-20090164923-\$ or US-20090163190-\$ or US-20090138828-\$ or US-20090138823-\$ or US-20090119678-\$ or US-20090106036-\$ or US-20090100027-\$ or US-20090094518-\$ or US-20090093273-\$ or US-20090082043-\$ or US-20090077488-\$).did. or (US-20090073194-\$ or US-20090070705-\$ or US-20090070704-\$ or US-20090066728-\$ or US-20090061827-\$ or US-20090058830-\$ or US-20090044200-\$ or US-20090030998-\$ or US-20090017806-\$ or US-20090013275-\$ or US-20090007017-\$ or US-20090006644-\$ or US-20090006570-\$ or US-20090005011-\$ or US-20080320419-\$ or US-20080320391-\$ or US-20080307220-\$ or US-20080295017-\$ or US-20080293385-\$ or US-20080222545-\$ or US-20080220752-\$ or US-20080218535-\$ or US-20080216022-\$ or US-20080215687-\$ or US-20080211778-\$ or US-20080208992-\$ or US-20080201650-\$).did. or (US-20080180408-\$ or US-20080174570-\$ or US-20080172357-\$ or US-20080168405-\$ or US-20080168404-\$ or US-20080168396-\$ or US-20080168395-\$ or US-20080168379-\$ or US-20080168365-\$ or US-20080168361-\$ or US-20080168353-\$ or US-20080168349-\$ or US-20080167078-\$ or US-20080165160-\$ or US-20080165153-\$ or US-20080165152-\$ or US-20080165151-\$ or US-20080165149-\$ or US-20080165148-\$ or US-20080165147-\$ or US-20080165146-\$ or US-20080165145-\$ or US-20080165144-\$ or US-20080165143-\$ or US-20080165142-\$ or US-20080165136-\$ or US-20080165022-\$).did. or (US-20080162651-\$ or US-20080129816-\$ or US-20080122796-\$ or US-20080119274-\$).did.				
S13	191	(((unread or (un read) or ("not" viewed) or unopened or (un opened)) near2 (message or text or im or email or (e mail) or chat)) with (((number or count) near2 (users) or users) with (icon or symbol or graphic\$2 or widget or image or token or picture or thumbnail))) and wireless not (research near2 "in" near2 motion).as.	US-PGPUB; ADJ USPAT; FPRS; EPO; JPO; DERWENT; IBM_TDB	ADJ	ON	2010/08/25 11:05
S14	105	(((unread or (un read) or ("not"	US-PGPUB;	ADJ	ON	2010/08/25

		viewed) or unopened or (un opened)) near2 (message or text or im or email or (e mail) or chat)) with (((number or count) near2 (users) or users) with (icon or symbol or graphic\$2 or widget or image or token or picture or thumbnail))) and wireless not (research near2 "in" near2 motion).as. not S12	USPAT; FPRS; EPO; JPO; DERWENT; IBM_TDB			11:05
S15	0	(11/599507).APP.	USPAT; USOCR	ADJ	ON	2010/08/25 11:16
S16	8	("20010055038" "20020091774" "20020094806" "20020126146" "20030032414" "5533110" "5579472" "5742779" "5907604" "6020828" "6333973" "6430405" "6771974").PN.	USPAT; USOCR	ADJ	ON	2010/08/25 11:17
S17	416	(hover\$3 or over or select\$3) near2 (message (icon or symbol or graphic\$2 or widget or image or token or picture or thumbnail))	US-PGPUB; USPAT; FPRS; EPO; JPO; DERWENT; IBM_TDB	ADJ	ON	2010/08/25 14:54
S18	2	((hover\$3 or over or select\$3) near2 (message (icon or symbol or graphic\$2 or widget or image or token or picture or thumbnail))) with (preview or snapshot or (snap shot) or summar\$3)	US-PGPUB; USPAT; FPRS; EPO; JPO; DERWENT; IBM_TDB	ADJ	ON	2010/08/25 14:55
S19	20	((hover\$3 or over or select\$3) with (message (icon or symbol or graphic\$2 or widget or image or token or picture or thumbnail))) with (preview or snapshot or (snap shot) or summar\$3)	US-PGPUB; USPAT; FPRS; EPO; JPO; DERWENT; IBM_TDB	ADJ	ON	2010/08/25 14:56
S20	16	("20020094806" "20020126146" "20030032414" "5907604").PN. or ("20020094806" "20020126146" "20030032414" "5907604").PN. or ("20020094806" "20020126146" "5907604" "6430405").PN. or ("20020091774" "20020094806" "20020126146" "5907604" "6333973" "6771974").PN.	US-PGPUB; USPAT; FPRS; EPO; JPO; DERWENT; IBM_TDB	ADJ	ON	2010/10/22 09:50
S21	0	(10/533245).APP.	USPAT; USOCR	ADJ	ON	2010/11/12 12:09
S22	1	("2006/0084450").URPN.	USPAT	ADJ	ON	2010/11/12 12:09
S23	4	("5533110" "5579472" "5742779" "6020828").PN. or ("5579472").PN. or ("20010055038").PN.	USPAT	ADJ	ON	2010/11/12 12:11
S24	8384	((number or digit or character or (alpha numeric)) near2 (sender or buddy or friend or contact)) same (message or email or text or im (instant message) or (voice (message or mail)))	US-PGPUB; USPAT; FPRS; EPO; JPO; DERWENT; IBM_TDB	ADJ	ON	2011/04/26 11:35
S25	306	((number or digit or character or (alpha numeric)) near2 ((sender or buddy or friend or contact)) near2 (unique or individual or different or separate or	US-PGPUB; USPAT; FPRS; EPO; JPO;	ADJ	ON	2011/04/26 11:39

		distinct)) same (message or email or text or im (instant message) or (voice (message or mail)))	DERWENT; IBM_TDB			
S26	6	("2005/0120306").URPN.	USPAT	ADJ	ON	2011/04/26 14:07
S27	85	(tear off) element	US-PGPUB; USPAT; FPRS; EPO; JPO; DERWENT; IBM_TDB	ADJ	ON	2011/04/26 14:20
S28	10	("2004/0056893").URPN.	USPAT	ADJ	ON	2011/04/26 14:49
S29	45	("6377944" "5416895" "6002398" "6057844" "6078935" "6144375" "6233726" "5721852" "20030164862" "6281879" "6407757" "6434599" "5546528" "5877765" "5937417" "6304879" "6781608" "20030052915" "20030142141" "5546528" "5929851" "5884306" "5974413" "5990905" "6018571" "6092068" "6275790" "6981223" "6384849" "5877758" "6091409" "6237135" "6173316" "6369837" "4995101" "6246411" "20020073207" "20020130904" "6381735" "6229539" "5754176" "6147685" "6691159" "20020097277" "6784901" "20020101446" "6002400" "6346952" "6252594" "6362842" "6519629" "20030210265" "6907447" "5617526").PN.	USPAT	ADJ	ON	2011/04/26 14:58
S30	0	"20050165880".pn.	USPAT	ADJ	ON	2011/04/27 10:05
S31	0	"2005/0165880".pn.	USPAT	ADJ	ON	2011/04/27 10:05
S32	2	"20050165880".pn.	US-PGPUB; USPAT; FPRS; EPO; JPO; DERWENT; IBM_TDB	ADJ	ON	2011/04/27 10:06
S33	1	(10/284429).APP.	USPAT; USOCR	ADJ	ON	2011/04/27 10:07
S34	2	"20040056893".pn.	US-PGPUB; USPAT; FPRS; EPO; JPO; DERWENT; IBM_TDB	ADJ	ON	2011/04/28 11:00
S35	1	"20040056893".pn. and (messag\$3 with receiv\$3)	US-PGPUB; USPAT; FPRS; EPO; JPO; DERWENT; IBM_TDB	ADJ	ON	2011/04/28 11:00
S36	1	(10/284429).APP.	USPAT;	ADJ	ON	2011/04/28

			USOCR			16:04
S37	744716	((mobile or portable or cell or smart) (device or phone or telephone))	US-PGPUB; USPAT; FPRS; EPO; JPO; DERWENT; IBM_TDB	ADJ	ON	2011/04/29 15:43
S38	167950	((mobile or portable or cell or smart) (device or phone or telephone)) same (display or screen)	US-PGPUB; USPAT; FPRS; EPO; JPO; DERWENT; IBM_TDB	ADJ	ON	2011/04/29 15:43
S39	548	((mobile or portable or cell or smart) (device or phone or telephone)) same (display or screen) same ((icon or symbol) near2 (application or program or function))	US-PGPUB; USPAT; FPRS; EPO; JPO; DERWENT; IBM_TDB	ADJ	ON	2011/04/29 16:03
S40	365	((mobile or portable or cell or smart) (device or phone or telephone)) same ((display or screen) with ((icon or symbol) near2 (application or program or function)))	US-PGPUB; USPAT; FPRS; EPO; JPO; DERWENT; IBM_TDB	ADJ	ON	2011/04/29 16:04
S41	1	((mobile or portable or cell or smart) (device or phone or telephone)) same ((display or screen) with ((icon or symbol) near2 (application or program or function))) same count	US-PGPUB; USPAT; FPRS; EPO; JPO; DERWENT; IBM_TDB	ADJ	ON	2011/04/29 16:05
S42	14	((mobile or portable or cell or smart) (device or phone or telephone)) same ((display or screen) with ((icon or symbol) near2 (application or program or function)))) and ((count or number) near2 new near2 (message or email or (e mail) or (electronic mail)))	US-PGPUB; USPAT; FPRS; EPO; JPO; DERWENT; IBM_TDB	ADJ	ON	2011/04/29 16:07
S43	1	((mobile or portable or cell or smart) (device or phone or telephone)) same (((icon or symbol) near2 (application or program or function)))) and ((count or number) near2 new near2 (message or email or (e mail) or (electronic mail))) not S42	US-PGPUB; USPAT; FPRS; EPO; JPO; DERWENT; IBM_TDB	ADJ	ON	2011/04/29 16:18
S44	535	((mobile or portable or cell or smart) (device or phone or telephone)) and ((count or number) near2 new near2 (message or email or (e mail) or (electronic mail))) not S42	US-PGPUB; USPAT; FPRS; EPO; JPO; DERWENT; IBM_TDB	ADJ	ON	2011/04/29 16:19
S45	23	((mobile or portable or cell or smart) (device or phone or telephone)) and ((display or screen) with ((icon or symbol) near2 (application or program or function)))) and ((count or number) near2 new near2 (message or email or (e mail) or (electronic mail))) not S42	US-PGPUB; USPAT; FPRS; EPO; JPO; DERWENT; IBM_TDB	ADJ	ON	2011/04/29 16:20
S46	23	((mobile or portable or cell or smart or wireless) (device or phone or	US-PGPUB; USPAT;	ADJ	ON	2011/04/29 16:22

		telephone)) and ((display or screen) with ((icon or symbol) near2 (application or program or function)))) and ((count or number) near2 new near2 (message or email or (e mail) or (electronic mail))) not S42	FPRS; EPO; JPO; DERWENT; IBM_TDB			
S51	14	((mobile or portable or cell or smart) (device or phone or telephone)) same ((display or screen) with ((icon or symbol) near2 (application or program or function)))) and ((count or number) near2 new near2 (message or email or (e mail) or (electronic mail)))	US-PGPUB; USPAT; FPRS; EPO; JPO; DERWENT; IBM_TDB	ADJ	ON	2011/05/03 14:07
S52	23	((mobile or portable or cell or smart or wireless) (device or phone or telephone)) and ((display or screen) with ((icon or symbol) near2 (application or program or function)))) and ((count or number) near2 new near2 (message or email or (e mail) or (electronic mail))) not S51	US-PGPUB; USPAT; FPRS; EPO; JPO; DERWENT; IBM_TDB	ADJ	ON	2011/05/03 14:07
S53	276	((mobile or portable or cell or smart or wireless) (device or phone or telephone)) and ((display or screen) with ((icon or symbol) with (application or program or function)))) and ((count or number) with new with (message or email or (e mail) or (electronic mail))) not S51 not S52	US-PGPUB; USPAT; FPRS; EPO; JPO; DERWENT; IBM_TDB	ADJ	ON	2011/05/03 14:07
S54	6	("2005/0120306").URPN.	USPAT	ADJ	ON	2011/05/03 15:47
S55	0	(10/911225).APP.	USPAT; USOCR	ADJ	ON	2011/05/03 15:54
S56	0	"20050117733".pn.	USPAT; USOCR	ADJ	ON	2011/05/03 16:14
S57	1	"20050117733".pn. and (application with icon)	US-PGPUB; USPAT; USOCR; EPO; JPO; DERWENT; IBM_TDB	ADJ	ON	2011/05/03 16:14
S58	1	"20050117733".pn. and (application with gui)	US-PGPUB; USPAT; USOCR; EPO; JPO; DERWENT; IBM_TDB	ADJ	ON	2011/05/03 16:15
S59	1	"20050117733".pn. and (icon)	US-PGPUB; USPAT; USOCR; EPO; JPO; DERWENT; IBM_TDB	ADJ	ON	2011/05/03 16:16
S60	2	"20050117733".pn. and (application)	US-PGPUB; USPAT; USOCR; EPO; JPO; DERWENT; IBM_TDB	ADJ	ON	2011/05/03 16:19
S61	28	("5610970" "5668862" "5673299"	US-PGPUB;	ADJ	ON	2011/05/03

		"5742905" "5742905" "5752191" "5812653" "5812653" "5841837" "5999611" "5999611" "6185565" "6185565" "6425005" "6425005" "6456619" "6456619" "6463146" "6463146" "6529502" "6529502" "6570969" "6570969" "6678265" "6678265").PN.	USPAT; FPRS; EPO; JPO; DERWENT; IBM_TDB			17:07
S62	2	"20050117733".pn. and (contact with receiv\$3)	US-PGPUB; USPAT; FPRS; EPO; JPO; DERWENT; IBM_TDB	ADJ	ON	2011/05/04 11:05
S63	1	"20050117733".pn. and (contact with (sent or send\$3))	US-PGPUB; USPAT; FPRS; EPO; JPO; DERWENT; IBM_TDB	ADJ	ON	2011/05/04 11:07
S64	1	"20050117733".pn. and (contact with messag\$3)	US-PGPUB; USPAT; FPRS; EPO; JPO; DERWENT; IBM_TDB	ADJ	ON	2011/05/04 11:07
S65	0	(/10/911225).APP.	USPAT; USOCR	ADJ	ON	2011/05/04 11:09
S66	303	display\$3 message received	USPAT; USOCR	ADJ	ON	2011/05/04 16:54
S67	3	(display\$3 message received) near3 (sender or buddy or contact)	USPAT; USOCR	ADJ	ON	2011/05/04 16:55
S68	0	(display\$3 message received) near3 (name)	USPAT; USOCR	ADJ	ON	2011/05/04 16:55
S69	768	(message received) near3 (sender or buddy or contact)	USPAT; USOCR	ADJ	ON	2011/05/04 16:57
S70	7	(message received) near3 (name near2 (sender or buddy or contact))	USPAT; USOCR	ADJ	ON	2011/05/04 16:58
S71	476	(message) near3 (name near2 (sender or buddy or contact))	USPAT; USOCR	ADJ	ON	2011/05/04 16:59
S72	5	((message) near3 (name near2 (sender or buddy or contact))) near2 icon	USPAT; USOCR	ADJ	ON	2011/05/04 16:59
S73	0	((mobile or portable or cell) (device or terminal or phone or telephone)) and (((email or (e mail) or (electronic mail)) near2 icon) with ((preview or snapshot or (snap shot)) near2 content)) and (((message or im) near2 icon) with (((preview or snapshot or (snap shot)) near2 content))	US-PGPUB; USPAT; FPRS; EPO; JPO; DERWENT; IBM_TDB	ADJ	ON	2011/05/06 11:18
S74	1	((mobile or portable or cell) (device or terminal or phone or telephone)) and (((email or (e mail) or (electronic mail)) near2 icon) with ((preview or snapshot or (snap shot)) near2 content)) or (((message or im) near2 icon) with ((preview or snapshot or (snap shot)) near2 content))	US-PGPUB; USPAT; FPRS; EPO; JPO; DERWENT; IBM_TDB	ADJ	ON	2011/05/06 11:19
S75	1	(((email or (e mail) or (electronic	US-PGPUB;	ADJ	ON	2011/05/06

		mail)) near2 icon) with ((preview or snapshot or (snap shot)) near2 content)) or (((message or im) near2 icon) with ((preview or snapshot or (snap shot)) near2 content)))	USPAT; FPRS; EPO; JPO; DERWENT; IBM_TDB			11:21
S76	11	((email or (e mail) or (electronic mail)) near2 icon) and (((email or (e mail) or (electronic mail))) with ((preview or snapshot or (snap shot)) near2 content)) or (((message or im) with ((preview or snapshot or (snap shot)) near2 content)))	US-PGPUB; USPAT; FPRS; EPO; JPO; DERWENT; IBM_TDB	ADJ	ON	2011/05/06 11:27
S77	112	((email or (e mail) or (electronic mail)) near2 icon) and (((email or (e mail) or (electronic mail))) with ((preview or snapshot or (snap shot)))) or (((message or im) with ((preview or snapshot or (snap shot))))))	US-PGPUB; USPAT; FPRS; EPO; JPO; DERWENT; IBM_TDB	ADJ	ON	2011/05/06 11:30
S78	3909	(((email or (e mail) or (electronic mail))) with ((preview or snapshot or (snap shot)))) or (((message or im) with ((preview or snapshot or (snap shot)))))) not S77	US-PGPUB; USPAT; FPRS; EPO; JPO; DERWENT; IBM_TDB	ADJ	ON	2011/05/06 11:45
S79	462	(((email or (e mail) or (electronic mail))) with ((preview or snapshot or (snap shot)))) and (((message or im) with ((preview or snapshot or (snap shot)))))) not S77	US-PGPUB; USPAT; FPRS; EPO; JPO; DERWENT; IBM_TDB	ADJ	ON	2011/05/06 11:47
S80	153	(((email or (e mail) or (electronic mail))) with ((preview or snapshot or (snap shot)))) and (((message or im) with ((preview or snapshot or (snap shot)))))) not S77 and ((mobile or portable or cell) (device or terminal or phone or telephone))	US-PGPUB; USPAT; FPRS; EPO; JPO; DERWENT; IBM_TDB	ADJ	ON	2011/05/06 11:48
S81	153	(((email or (e mail) or (electronic mail))) with ((preview or snapshot or (snap shot)))) and (((message or im) with ((preview or snapshot or (snap shot)))))) not S77 and ((mobile or portable or cell) (device or terminal or phone or telephone))	US-PGPUB; USPAT; FPRS; EPO; JPO; DERWENT; IBM_TDB	ADJ	ON	2011/05/06 11:54
S82	153	(((email or (e mail) or (electronic mail))) with ((preview or snapshot or (snap shot)))) and (((message or im) with ((preview or snapshot or (snap shot)))))) and ((mobile or portable or cell) (device or terminal or phone or telephone)) not S77	US-PGPUB; USPAT; FPRS; EPO; JPO; DERWENT; IBM_TDB	ADJ	ON	2011/05/06 11:56
S83	112	((email or (e mail) or (electronic mail)) near2 icon) and (((email or (e mail) or (electronic mail))) with ((preview or snapshot or (snap shot)))) or (((message or im) with ((preview or snapshot or (snap shot))))))	US-PGPUB; USPAT; FPRS; EPO; JPO; DERWENT; IBM_TDB	ADJ	ON	2011/05/06 13:21
S84	153	(((email or (e mail) or (electronic mail))) with ((preview or snapshot or (snap shot)))) and (((message or im) with ((preview or snapshot or (snap	US-PGPUB; USPAT; FPRS; EPO; JPO;	ADJ	ON	2011/05/06 13:21

		shot)))) and ((mobile or portable or cell) (device or terminal or phone or telephone)) not S83	DERWENT; IBM_TDB			
S85	224	((email or (e mail) or (electronic mail)) with (preview or snapshot or (snap shot))) and ((mobile or portable or cell) (device or terminal or phone or telephone)) not S83 not S84	US-PGPUB; USPAT; FPRS; EPO; JPO; DERWENT; IBM_TDB	ADJ	ON	2011/05/06 13:21
S86	3	((email or (e mail) or (electronic mail)) with (preview or snapshot or (snap shot)) with icon) and ((mobile or portable or cell) (device or terminal or phone or telephone)) not S83 not S84	US-PGPUB; USPAT; FPRS; EPO; JPO; DERWENT; IBM_TDB	ADJ	ON	2011/05/06 13:22
S87	76	((email or (e mail) or (electronic mail)) with (preview or snapshot or (snap shot)) with icon)	US-PGPUB; USPAT; FPRS; EPO; JPO; DERWENT; IBM_TDB	ADJ	ON	2011/05/06 13:24
S88	27	receiv\$3 near2 message near2 display\$3 (preview or snapshot or (snap shot))	US-PGPUB; USPAT; FPRS; EPO; JPO; DERWENT; IBM_TDB	ADJ	ON	2011/05/06 13:32
S89	4534	message near2 icon	US-PGPUB; USPAT; FPRS; EPO; JPO; DERWENT; IBM_TDB	ADJ	ON	2011/05/06 13:34
S90	6	(message near2 icon) near2 preview	US-PGPUB; USPAT; FPRS; EPO; JPO; DERWENT; IBM_TDB	ADJ	ON	2011/05/06 13:34
S91	6	(message near2 icon) near2 (preview or snapshot or (snap shot))	US-PGPUB; USPAT; FPRS; EPO; JPO; DERWENT; IBM_TDB	ADJ	ON	2011/05/06 13:35
S92	4	("20020035613" "20040155908").PN.	US-PGPUB; USPAT; FPRS; EPO; JPO; DERWENT; IBM_TDB	ADJ	ON	2011/05/06 13:55
S93	306	receiv\$3 near2 message near2 ((name or id or identifier) near2 (buddy or sender or friend))	US-PGPUB; USPAT; FPRS; EPO; JPO; DERWENT; IBM_TDB	ADJ	ON	2011/05/06 14:23
S94	430	receiv\$3 near2 (message or email or (e mail) or (electronic mail) or im or chat) near2 ((name or id or identifier) near2	US-PGPUB; USPAT; FPRS;	ADJ	ON	2011/05/06 14:24

		(buddy or sender or friend))	EPO; JPO; DERWENT; IBM_TDB			
S95	163	((receiv\$3 near2 (message or email or (e mail) or (electronic mail) or im or chat) near2 ((name or id or identifier) near2 (buddy or sender or friend))) and ((portable or mobile or cell) (phone or telephone or device or terminal or apparatus))	US-PGPUB; USPAT; FPRS; EPO; JPO; DERWENT; IBM_TDB	ADJ	ON	2011/05/06 14:26
S96	512	((receiv\$3 near2 (message or email or (e mail) or (electronic mail) or im or chat)) with (((name or id or identifier) near2 (buddy or sender or friend)))) and ((portable or mobile or cell) (phone or telephone or device or terminal or apparatus))	US-PGPUB; USPAT; FPRS; EPO; JPO; DERWENT; IBM_TDB	ADJ	ON	2011/05/07 16:14
S97	163	((receiv\$3 near2 (message or email or (e mail) or (electronic mail) or im or chat) near2 ((name or id or identifier) near2 (buddy or sender or friend))) and ((portable or mobile or cell) (phone or telephone or device or terminal or apparatus))	US-PGPUB; USPAT; FPRS; EPO; JPO; DERWENT; IBM_TDB	ADJ	ON	2011/05/07 16:14
S98	349	((receiv\$3 near2 (message or email or (e mail) or (electronic mail) or im or chat)) with (((name or id or identifier) near2 (buddy or sender or friend)))) and ((portable or mobile or cell) (phone or telephone or device or terminal or apparatus)) not S97	US-PGPUB; USPAT; FPRS; EPO; JPO; DERWENT; IBM_TDB	ADJ	ON	2011/05/07 16:14
S99	328	((receiv\$3 near2 (message or email or (e mail) or (electronic mail) or im or chat)) with (((name or id or identifier) near2 (buddy or sender or friend)))) and ((portable or mobile or cell) (phone or telephone or device or terminal or apparatus)) and (count or number) not S97	US-PGPUB; USPAT; FPRS; EPO; JPO; DERWENT; IBM_TDB	ADJ	ON	2011/05/07 16:16
S100	215	((receiv\$3 near2 (message or email or (e mail) or (electronic mail) or im or chat)) with (((name or id or identifier) near2 (buddy or sender or friend)))) and ((portable or mobile or cell) (phone or telephone or device or terminal or apparatus)) and ((count or number) near2 (message or email or (e mail) or (electronic mail) or im or chat)) not S97	US-PGPUB; USPAT; FPRS; EPO; JPO; DERWENT; IBM_TDB	ADJ	ON	2011/05/07 16:17
S101	1	10/715205.app.	US-PGPUB; USPAT; FPRS; EPO; JPO; DERWENT; IBM_TDB	ADJ	ON	2011/05/07 16:57
S102	1	10/784781.app.	US-PGPUB; USPAT; FPRS; EPO; JPO; DERWENT; IBM_TDB	ADJ	ON	2011/05/08 19:20

EAST Search History

S103	25	("20020160817" "20050120306" "20060020904" "20060030295" "5333256" "5617526" "5634102" "6385459" "6424354" "662819").PN. or ("20030167310").PN.	US-PGPUB; USPAT; FPRS; EPO; JPO; DERWENT; IBM_TDB	ADJ	ON	2011/05/08 20:39
S104	198	715/842.ccls. or 715/851.ccls.	US-PGPUB; USPAT; FPRS; EPO; JPO; DERWENT; IBM_TDB	ADJ	ON	2011/05/08 20:52
S105	1	(10/284429).APP.	USPAT; USOCR	ADJ	OFF	2011/10/17 20:25
S106	93	("20020073207" "20020097277" "20020101446" "20020130904" "20030052915" "20030142141" "20030164862" "20030210265" "5283560" "5287514" "5416895" "5544352" "5546528" "5581670" "5588107" "5617114" "5617526" "5627960" "5644737" "5664133" "5692142" "5712995" "5721852" "5742813" "5754176" "5760768" "5798752" "5801703" "5832494" "5838315" "5877758" "5877765" "5884306" "5929851" "5937417" "5974413" "5990905" "5995101" "6002398" "6002400" "6018571" "6057844" "6078935" "6091409" "6092068" "6097389" "6118427" "6144375" "6147685" "6173316" "6188403" "6229539" "6233571" "6233726" "6237135" "6246411" "6248946" "6252594" "6260148" "6275790" "6281879" "6301609" "6304879" "6317128" "6346952" "6362842" "6369837" "6377944" "6381735" "6384849" "6407757" "6434599" "6519629" "6539421" "6691159" "6781608" "6784901" "6907447" "6981223").PN. OR ("7127685").URPN.	US-PGPUB; USPAT; USOCR	ADJ	OFF	2011/10/17 20:25
S107	1	(10/762698).APP.	USPAT; USOCR	ADJ	OFF	2011/10/18 14:53
S108	17	("20010025280" "20040172455" "20040183829" "20040203766" "20050055405" "20050120306" "20050138564" "20050181878" "5793365" "5960173" "5990887" "6349327" "6631412" "6697840" "7127685" "7148814" "7185290").PN. OR ("7921368").URPN.	US-PGPUB; USPAT; USOCR	ADJ	OFF	2011/10/18 14:53
S109	0	(10/533245).APP.	USPAT; USOCR	ADJ	OFF	2011/10/18 15:58
S110	0	(11/599507).APP.	USPAT; USOCR	ADJ	OFF	2011/10/18 15:58
S111	8	("20020085027" "6430405" "20020098874" "5533110" "5923327" "20020032641" "7548875" "20030153337"	USPAT; USOCR	ADJ	OFF	2011/10/18 16:00

		"7548875" "20010055038" "20020094806" "20020126146" "5907604" "6771974" "5742779" "20040203824" "7266186").PN.				
S112	8	("20020085027" "6430405" "20020098874" "5533110" "5923327" "20020032641" "7548875" "20030153337" "7548875" "20010055038" "20020094806" "20020126146" "5907604" "6771974" "5742779" "20040203824" "7266186").PN. or ("6333973" "6020828" "6430405" "20020032641" "20020085027" "5579472" "20020098874" "5533110" "20020091774" "7266186" "6771974" "5923327" "20030153337" "20020094806" "20020126146" "5907604" "20010055038" "20040203824" "5742779" "20030032414" "7548875").PN"	USPAT; USOCR	ADJ	OFF	2011/10/18 16:01
S113	8	("20020085027" "6430405" "20020098874" "5533110" "5923327" "20020032641" "7548875" "20030153337" "7548875" "20010055038" "20020094806" "20020126146" "5907604" "6771974" "5742779" "20040203824" "7266186").PN.	USPAT; USOCR	ADJ	OFF	2011/10/18 16:02
S114	0	("6333973" "6020828" "6430405" "20020032641" "20020085027" "5579472" "20020098874" "5533110" "20020091774" "7266186" "6771974" "5923327" "20030153337" "20020094806" "20020126146" "5907604" "20010055038" "20040203824" "5742779" "20030032414" "7548875").PN"	USPAT; USOCR	ADJ	OFF	2011/10/18 16:03
S115	0	("6333973" "6020828" "6430405" "20020032641" "20020085027" "5579472" "20020098874" "5533110" "20020091774" "7266186" "6771974" "5923327" "20030153337" "20020094806" "20020126146" "5907604" "20010055038" "20040203824" "5742779" "20030032414" "7548875").PN"	US-PGPUB; USPAT; USOCR; EPO; JPO; DERWENT; IBM_TDB	ADJ	OFF	2011/10/18 16:03
S116	32	("20020085027" "6430405" "20020098874" "5533110" "5923327" "20020032641" "7548875" "20030153337" "7548875" "20010055038" "20020094806" "20020126146" "5907604" "6771974" "5742779" "20040203824" "7266186").PN.	US-PGPUB; USPAT; USOCR; EPO; JPO; DERWENT; IBM_TDB	ADJ	OFF	2011/10/18 16:04
S117	42	("6333973" "6020828" "6430405" "20020032641" "20020085027" "5579472" "20020098874" "5533110" "20020091774"	US-PGPUB; USPAT; USOCR; EPO; JPO;	ADJ	OFF	2011/10/18 16:06

		"7266186" "6771974" "5923327" "20030153337" "20020094806" "20020126146" "5907604" "20010055038" "20040203824" "5742779" "20030032414" "7548875").PN.	DERWENT; IBM_TDB			
S118	42	S116 or S117	US-PGPUB; USPAT; USOCR; EPO; JPO; DERWENT; IBM_TDB	ADJ	OFF	2011/10/18: 16:06
S119	42	("6333973" "6020828" "6430405" "20020032641" "20020085027" "5579472" "20020098874" "5533110" "20020091774" "7266186" "6771974" "5923327" "20030153337" "20020094806" "20020126146" "5907604" "20010055038" "20040203824" "5742779" "20030032414" "7548875").PN. or ("20020085027" "6430405" "20020098874" "5533110" "5923327" "20020032641" "7548875" "20030153337" "7548875" "20010055038" "20020094806" "20020126146" "5907604" "6771974" "5742779" "20040203824" "7266186").PN.	US-PGPUB; USPAT; USOCR; EPO; JPO; DERWENT; IBM_TDB	ADJ	OFF	2011/10/18: 16:07
S120	99	715/710.ccls.	US-PGPUB; USPAT; FPRS; EPO; JPO; DERWENT; IBM_TDB	ADJ	OFF	2011/10/19: 16:31
S121	19	715/710.ccls. and (email or (e\$1mail) or (e mail) or (electronic mail) or im or (instant messag\$3) or texting or (text messag\$3)) and (((mobile or portable or cell or smart) (phone or telephone) or pda)	US-PGPUB; USPAT; FPRS; EPO; JPO; DERWENT; IBM_TDB	ADJ	OFF	2011/10/19: 16:33
S122	8537	(indicat\$3 with (number or count) with (correspondents or buddy or contact))	US-PGPUB; USPAT; FPRS; EPO; JPO; DERWENT; IBM_TDB	ADJ	ON	2012/03/17: 17:27
S123	2394	(indicat\$3 with (number or count) with (correspondents or buddy or contact)) and ((mobile or portable or cell or smart) (device or phone or telephone or terminal))	US-PGPUB; USPAT; FPRS; EPO; JPO; DERWENT; IBM_TDB	ADJ	ON	2012/03/17: 17:57
S124	0	((alpha\$1numeric or (alpha numeric) or numeric) indicat\$3 with (number or count) with (correspondents or buddy or contact)) and ((mobile or portable or cell or smart) (device or phone or telephone or terminal))	US-PGPUB; USPAT; FPRS; EPO; JPO; DERWENT; IBM_TDB	ADJ	ON	2012/03/17: 18:00
S125	5	((alpha\$1numeric or (alpha numeric) or	US-PGPUB;	ADJ	ON	2012/03/17:

		numeric) indicat\$3 with (number or count) with (correspondents or buddy or contact)) and ((mobile or portable or cell or smart) (device or phone or telephone or terminal))	USPAT; FPRS; EPO; JPO; DERWENT; IBM_TDB			18:01
S126	142	((number) indicat\$3 with (number or count) with (correspondents or buddy or contact)) and ((mobile or portable or cell or smart) (device or phone or telephone or terminal))	US-PGPUB; USPAT; FPRS; EPO; JPO; DERWENT; IBM_TDB	ADJ	ON	2012/03/17 18:01
S127	142	((number or numerically) indicat\$3 with (number or count) with (correspondents or buddy or contact)) and ((mobile or portable or cell or smart) (device or phone or telephone or terminal))	US-PGPUB; USPAT; FPRS; EPO; JPO; DERWENT; IBM_TDB	ADJ	ON	2012/03/17 18:02
S128	209	(indicat\$3 with (number or count) with (correspondents or buddy or contact) with new)	US-PGPUB; USPAT; FPRS; EPO; JPO; DERWENT; IBM_TDB	ADJ	ON	2012/03/17 18:14
S129	204	S128 not S127	US-PGPUB; USPAT; FPRS; EPO; JPO; DERWENT; IBM_TDB	ADJ	ON	2012/03/17 18:15
S130	2	03/014905	US-PGPUB; USPAT; FPRS; EPO; JPO; DERWENT; IBM_TDB	ADJ	ON	2012/03/17 18:34
S131	0	(10/551979).APP.	USPAT; USOCR	ADJ	ON	2012/03/17 19:44
S132	0	(12/711718).APP.	USPAT; USOCR	ADJ	ON	2012/03/17 19:45
S133	2	("2006/0200778").URPN.	USPAT	ADJ	ON	2012/03/17 19:45
S134	1828	(message with new with (sender or contact or correspondent or buddy))	USPAT	ADJ	ON	2012/03/17 19:48
S135	761	(message with new with (sender or contact or correspondent or buddy)) and ((mobile or portable or cell or smart) (device or phone or telephone or device or terminal))	USPAT	ADJ	ON	2012/03/17 19:49
S136	335	((message near3 new) with (sender or contact or correspondent or buddy)) and ((mobile or portable or cell or smart) (device or phone or telephone or device or terminal))	USPAT	ADJ	ON	2012/03/17 19:51
S137	22	((message near3 new) with ((number or numeric or alpha\$1numeric or (alpha numeric) or count or sum or total or amount or tally) near2 (sender or contact or correspondent or buddy))) and ((mobile or portable or cell or smart) (device or phone or telephone	USPAT	ADJ	ON	2012/03/17 19:57

		(or device or terminal))				
S138	1	(10/284429).APP.	USPAT; USOCR	ADJ	ON	2012/03/18 10:33
S139	14	("7127685").URPN.	USPAT	ADJ	ON	2012/03/18 10:33
S140	79	("20020073207" "20020097277" "20020101446" "20020130904" "20030052915" "20030142141" "20030164862" "20030210265" "5283560" "5287514" "5416895" "5544352" "5546528" "5581670" "5588107" "5617114" "5617526" "5627960" "5644737" "5664133" "5692142" "5712995" "5721852" "5742813" "5754176" "5760768" "5798752" "5801703" "5832494" "5838315" "5877758" "5877765" "5884306" "5929851" "5937417" "5974413" "5990905" "5995101" "6002398" "6002400" "6018571" "6057844" "6078935" "6091409" "6092068" "6097389" "6118427" "6144375" "6147685" "6173316" "6188403" "6229539" "6233571" "6233726" "6237135" "6246411" "6248946" "6252594" "6260148" "6275790" "6281879" "6301609" "6304879" "6317128" "6346952" "6362842" "6369837" "6377944" "6381735" "6384849" "6407757" "6434599" "6519629" "6539421" "6691159" "6781608" "6784901" "6907447" "6981223").PN.	US-PGPUB; USPAT; USOCR	ADJ	ON	2012/03/18 10:40
S141	23	("4992972" "5179695" "5239617" "5361361" "5388251" "5477447" "5644735" "5715415" "5754176" "5823781" "5877757" "5933140" "6098061" "6177932" "6208338" "6230287" "6236989" "6297822" "6300950" "6471521" "6477531" "6493000" "6535492").PN.	US-PGPUB; USPAT; USOCR	ADJ	ON	2012/03/18 10:46
S142	1	(10/762698).APP.	USPAT; USOCR	ADJ	ON	2012/03/18 10:47
S143	17	("20010025280" "20040172455" "20040183829" "20040203766" "20050055405" "20050120306" "20050138564" "20050181878" "5793365" "5960173" "5990887" "6349327" "6631412" "6697840" "7127685" "7148814" "7185290").PN.	US-PGPUB; USPAT; USOCR	ADJ	ON	2012/03/18 10:47
S144	79	("20020073207" "20020097277" "20020101446" "20020130904" "20030052915" "20030142141" "20030164862" "20030210265" "5283560" "5287514" "5416895" "5544352" "5546528" "5581670" "5588107" "5617114" "5617526" "5627960" "5644737" "5664133" "5692142" "5712995" "5721852" "5742813" "5754176" "5760768" "5798752" "5801703" "5832494"	US-PGPUB; USPAT; USOCR	ADJ	ON	2012/03/18 10:51

		"5838315" "5877758" "5877765" "5884306" "5929851" "5937417" "5974413" "5990905" "5995101" "6002398" "6002400" "6018571" "6057844" "6078935" "6091409" "6092068" "6097389" "6118427" "6144375" "6147685" "6173316" "6188403" "6229539" "6233571" "6233726" "6237135" "6246411" "6248946" "6252594" "6260148" "6275790" "6281879" "6301609" "6304879" "6317128" "6346952" "6362842" "6369837" "6377944" "6381735" "6384849" "6407757" "6434599" "6519629" "6539421" "6691159" "6781608" "6784901" "6907447" "6981223").PN.				
S145	0	(10/911225).APP.	USPAT; USOCR	ADJ	ON	2012/03/18 10:52
S146	23	("4908848" "5146612" "5457108" "5568540" "5579489" "5584054" "5590178" "5603090" "5615248" "5657049" "5722088" "5758295" "5797089" "5797098" "5852783" "5857157" "5875403" "5884193" "5963875" "5966652" "5995592" "6029072" "6047196").PN.	US-PGPUB; USPAT; USOCR	ADJ	ON	2012/03/18 10:52
S147	1	(10/429930).APP.	USPAT; USOCR	ADJ	ON	2012/03/18 10:53
S148	23	("20020087225" "4860342" "5487181" "5546538" "5675810" "5768164" "5802305" "6006285" "6101610" "6240168" "6266714" "6279056" "6362440" "6513128" "6518957" "6603855" "6628267" "6691233" "6806867" "6819961" "6882326" "6897851" "6938174").PN.	US-PGPUB; USPAT; USOCR	ADJ	ON	2012/03/18 10:53
S149	0	(10/715207).APP.	USPAT; USOCR	ADJ	ON	2012/03/18 10:54
S150	0	(10/715205).APP.	USPAT; USOCR	ADJ	ON	2012/03/18 10:54
S151	1	(10/600185).APP.	USPAT; USOCR	ADJ	ON	2012/03/18 10:54
S152	0	(11/599507).APP.	USPAT; USOCR	ADJ	ON	2012/03/18 10:55
S153	0	(10/533245).APP.	USPAT; USOCR	ADJ	ON	2012/03/18 10:55
S154	17	("20010025280" "20040172455" "20040183829" "20040203766" "20050055405" "20050120306" "20050138564" "20050181878" "5793365" "5960173" "5990887" "6349327" "6631412" "6697840" "7127685" "7148814" "7185290").PN.	US-PGPUB; USPAT; USOCR	ADJ	ON	2012/03/18 10:56
S155	0	(12/218634).APP.	USPAT; USOCR	ADJ	ON	2012/03/18 10:57
S156	1	(12/142358).APP.	USPAT; USOCR	ADJ	ON	2012/03/18 10:57

EAST Search History

S157	5	("20040090469" "6131046" "6393307" "6493547" "7003279").PN.	US-PGPUB; USPAT; USOCR	ADJ	ON	2012/03/18 10:57
S158	0	(10/913696).APP.	USPAT; USOCR	ADJ	ON	2012/03/18 10:58
S159	7	("7743340").URPN.	USPAT	ADJ	ON	2012/03/18 10:58
S160	6	("20020022923" "20030131023" "6697840" "6763226" "6788949" "7127685").PN.	US-PGPUB; USPAT; USOCR	ADJ	ON	2012/03/18 10:59
S161	3764	(715/739 or 715/752 or 715/753 or 715/758 or 715/759 or 715/837 or 715/859 or 715/861 or 715/864).ccls.	US-PGPUB; USPAT; FPRS; EPO; JPO; DERWENT; IBM_TDB	ADJ	ON	2012/03/18 11:21
S162	1	10/784781.app.	US-PGPUB; USPAT; FPRS; EPO; JPO; DERWENT; IBM_TDB	ADJ	ON	2012/03/18 11:56

EAST Search History (Interference)

Ref #	Hits	Search Query	DBs	Default Operator	Plurals	Time Stamp
S163	1	(unread or un\$1read) and (plurality near2 messag\$3) and correspondent and (number or numeric) and (receiv\$3 near2 message) and wireless	USPAT; UPAD	ADJ	ON	2012/03/18 11:05
S164	4	(unread or un\$1read) and (plurality near2 messag\$3) and correspondent and (number or numeric) and (receiv\$3 near2 message)	USPAT; UPAD	ADJ	ON	2012/03/18 11:10

3/ 18/ 2012 4:50:40 PM

C:\Users\jheffington\Documents\OA Folders\10784781\10784781-SearchHistory11-10-17-2011.wsp

Issue Classification 	Application/Control No. 10784781	Applicant(s)/Patent Under Reexamination KLASSEN ET AL.
	Examiner JOHN HEFFINGTON	Art Unit 2172

ORIGINAL						INTERNATIONAL CLASSIFICATION											
CLASS			SUBCLASS			CLAIMED				NON-CLAIMED							
715			859			G	0	6	F	3 / 048 (2006.0)							
CROSS REFERENCE(S)																	
CLASS	SUBCLASS (ONE SUBCLASS PER BLOCK)																
715	736	739	752	753	758												
715	759	837	861	864													
715	710	842	851														

<input type="checkbox"/> Claims renumbered in the same order as presented by applicant <input type="checkbox"/> CPA <input type="checkbox"/> T.D. <input type="checkbox"/> R.1.47															
Final	Original	Final	Original	Final	Original	Final	Original	Final	Original	Final	Original	Final	Original	Final	Original
	1		17		33		49		8		65				
	2		18		34		50		9		66				
	3		19		35		51		10		67				
	4		20		36	1	52		11		68				
	5		21		37	2	53		12		69				
	6		22		38	3	54		13		70				
	7		23		39	4	55		14		71				
	8		24		40	5	56		15		72				
	9		25		41	6	57		16		73				
	10		26		42		58		17		74				
	11		27		43		59		18		75				
	12		28		44		60								
	13		29		45		61								
	14		30		46		62								
	15		31		47		63								
	16		32		48	7	64								

/JOHN HEFFINGTON/ Examiner.Art Unit 2172 (Assistant Examiner)	3/18/2012 (Date)	Total Claims Allowed: 18	
/BORIS PESIN/ Supervisory Patent Examiner.Art Unit 2172 (Primary Examiner)	03/25/2012 (Date)	O.G. Print Claim(s) 52	O.G. Print Figure 7

Search Notes 	Application/Control No. 10784781	Applicant(s)/Patent Under Reexamination KLASSEN ET AL.
	Examiner Heffington, John M	Art Unit 2179

SEARCHED			
Class	Subclass	Date	Examiner
715	700	3/1/2007	JMH
715	842, 851	5/8/11	JMH
715	710	10/19/11	JMH
715	736,739, 752, 753, 758, 759, 837, 859, 861, 864	3/18/12	JMH

SEARCH NOTES		
Search Notes	Date	Examiner
EAST Search	3/1/2007	JMH
EAST Search (update)	12/7/2007	JMH
EAST Search (update)	3/23/2008	JMH
NPL Search	3/23/2008	JMH
EAST Search	10/16/08	JMH
EAST Search	4/7/09	JMH
EAST Search	9/22/09	JMH
EAST Search	3/27/10	JMH
EAST Search	4/26/11-5/8/11	JMH
EAST Search	10/17/11 - 10/19/11	JMH
Text Search 715/710	10/17/11	JMH
EAST Search	3/17/12 - 3/18/12	JMH
NPL Search	3/18/12	JMH

INTERFERENCE SEARCH			
Class	Subclass	Date	Examiner
	PG-PUB and Patent text search, see interference search printout.	3/18/12	JMH

--	--

INFORMATION DISCLOSURE STATEMENT BY APPLICANT (Not for submission under 37 CFR 1.99)	Application Number		10784781	
	Filing Date		2004-02-24	
	First Named Inventor	Gerhard D. Klassen		
	Art Unit	2172		
	Examiner Name	John M. Heffington		
	Attorney Docket Number	05200204-272US		

U.S.PATENTS						
Examiner Initial*	Cite No	Patent Number	Kind Code ¹	Issue Date	Name of Patentee or Applicant of cited Document	Pages, Columns, Lines where Relevant Passages or Relevant Figures Appear
	1					

If you wish to add additional U.S. Patent citation information please click the Add button.

U.S.PATENT APPLICATION PUBLICATIONS						
Examiner Initial*	Cite No	Publication Number	Kind Code ¹	Publication Date	Name of Patentee or Applicant of cited Document	Pages, Columns, Lines where Relevant Passages or Relevant Figures Appear
	1					

If you wish to add additional U.S. Published Application citation information please click the Add button.

FOREIGN PATENT DOCUMENTS								
Examiner Initial*	Cite No	Foreign Document Number ³	Country Code ²ⁱ	Kind Code ⁴	Publication Date	Name of Patentee or Applicant of cited Document	Pages, Columns, Lines where Relevant Passages or Relevant Figures Appear	T ⁵
	1							<input type="checkbox"/>

If you wish to add additional Foreign Patent Document citation information please click the Add button

NON-PATENT LITERATURE DOCUMENTS			
Examiner Initials*	Cite No	Include name of the author (in CAPITAL LETTERS), title of the article (when appropriate), title of the item (book, magazine, journal, serial, symposium, catalog, etc), date, pages(s), volume-issue number(s), publisher, city and/or country where published.	T ⁵

INFORMATION DISCLOSURE STATEMENT BY APPLICANT (Not for submission under 37 CFR 1.99)	Application Number		10784781
	Filing Date		2004-02-24
	First Named Inventor	Gerhard D. Klassen	
	Art Unit	2172	
	Examiner Name	John M. Heffington	
	Attorney Docket Number	05200204-272US	

1	Notice of Allowance along with English translation of same, issued by the Japanese Patent Office in connection with corresponding Japanese Patent Application No. 2006-541762 dated December 3, 2010.	<input type="checkbox"/>
---	---	--------------------------

If you wish to add additional non-patent literature document citation information please click the Add button

EXAMINER SIGNATURE

Examiner Signature	/John Heffington/	Date Considered	03/18/2012
--------------------	-------------------	-----------------	------------

*EXAMINER: Initial if reference considered, whether or not citation is in conformance with MPEP 609. Draw line through a citation if not in conformance and not considered. Include copy of this form with next communication to applicant.

¹ See Kind Codes of USPTO Patent Documents at www.USPTO.GOV or MPEP 901.04. ² Enter office that issued the document, by the two-letter code (WIPO Standard ST.3). ³ For Japanese patent documents, the indication of the year of the reign of the Emperor must precede the serial number of the patent document. ⁴ Kind of document by the appropriate symbols as indicated on the document under WIPO Standard ST.16 if possible. ⁵ Applicant is to place a check mark here if English language translation is attached.

INFORMATION DISCLOSURE STATEMENT BY APPLICANT (Not for submission under 37 CFR 1.99)	Application Number	10784781
	Filing Date	2004-02-24
	First Named Inventor	Gerhard D. Klassen
	Art Unit	2172
	Examiner Name	Heffington, John M.
	Attorney Docket Number	05200204-272US

U.S.PATENTS						
Examiner Initial*	Cite No	Patent Number	Kind Code ¹	Issue Date	Name of Patentee or Applicant of cited Document	Pages, Columns, Lines where Relevant Passages or Relevant Figures Appear
	1					

If you wish to add additional U.S. Patent citation information please click the Add button.

U.S.PATENT APPLICATION PUBLICATIONS						
Examiner Initial*	Cite No	Publication Number	Kind Code ¹	Publication Date	Name of Patentee or Applicant of cited Document	Pages, Columns, Lines where Relevant Passages or Relevant Figures Appear
	1					

If you wish to add additional U.S. Published Application citation information please click the Add button.

FOREIGN PATENT DOCUMENTS								
Examiner Initial*	Cite No	Foreign Document Number ³	Country Code ²	Kind Code ⁴	Publication Date	Name of Patentee or Applicant of cited Document	Pages, Columns, Lines where Relevant Passages or Relevant Figures Appear	T ⁵
	1	WO2003014905	WO	A2	2003-02-20	Danger Research, Inc.		<input type="checkbox"/>

If you wish to add additional Foreign Patent Document citation information please click the Add button

NON-PATENT LITERATURE DOCUMENTS			
Examiner Initials*	Cite No	Include name of the author (in CAPITAL LETTERS), title of the article (when appropriate), title of the item (book, magazine, journal, serial, symposium, catalog, etc), date, pages(s), volume-issue number(s), publisher, city and/or country where published.	T ⁵

INFORMATION DISCLOSURE STATEMENT BY APPLICANT (Not for submission under 37 CFR 1.99)	Application Number	10784781
	Filing Date	2004-02-24
	First Named Inventor	Gerhard D. Klassen
	Art Unit	2172
	Examiner Name	Heffington, John M.
	Attorney Docket Number	05200204-272US

	1		<input type="checkbox"/>
If you wish to add additional non-patent literature document citation information please click the Add button			
EXAMINER SIGNATURE			
Examiner Signature	/John Heffington/		Date Considered
			03/18/2012
<p>*EXAMINER: Initial if reference considered, whether or not citation is in conformance with MPEP 609. Draw line through a citation if not in conformance and not considered. Include copy of this form with next communication to applicant.</p>			
<p><small>¹ See Kind Codes of USPTO Patent Documents at www.USPTO.GOV or MPEP 901.04. ² Enter office that issued the document, by the two-letter code (WIPO Standard ST.3). ³ For Japanese patent documents, the indication of the year of the reign of the Emperor must precede the serial number of the patent document. ⁴ Kind of document by the appropriate symbols as indicated on the document under WIPO Standard ST.16 if possible. ⁵ Applicant is to place a check mark here if English language translation is attached.</small></p>			

INFORMATION DISCLOSURE STATEMENT BY APPLICANT (Not for submission under 37 CFR 1.99)	Application Number	10784781
	Filing Date	2004-02-24
	First Named Inventor	Gerhard D. Klassen
	Art Unit	2172
	Examiner Name	Heffington, John M.
	Attorney Docket Number	05200204-272US

CERTIFICATION STATEMENT

Please see 37 CFR 1.97 and 1.98 to make the appropriate selection(s):

That each item of information contained in the information disclosure statement was first cited in any communication from a foreign patent office in a counterpart foreign application not more than three months prior to the filing of the information disclosure statement. See 37 CFR 1.97(e)(1).

OR

That no item of information contained in the information disclosure statement was cited in a communication from a foreign patent office in a counterpart foreign application, and, to the knowledge of the person signing the certification after making reasonable inquiry, no item of information contained in the information disclosure statement was known to any individual designated in 37 CFR 1.56(c) more than three months prior to the filing of the information disclosure statement. See 37 CFR 1.97(e)(2).

See attached certification statement.

The fee set forth in 37 CFR 1.17 (p) has been submitted herewith.

A certification statement is not submitted herewith.

SIGNATURE

A signature of the applicant or representative is required in accordance with CFR 1.33, 10.18. Please see CFR 1.4(d) for the form of the signature.

Signature	/Matthew J. Marquardt/	Date (YYYY-MM-DD)	2012-03-12
Name/Print	Matthew J. Marquardt	Registration Number	40997

This collection of information is required by 37 CFR 1.97 and 1.98. The information is required to obtain or retain a benefit by the public which is to file (and by the USPTO to process) an application. Confidentiality is governed by 35 U.S.C. 122 and 37 CFR 1.14. This collection is estimated to take 1 hour to complete, including gathering, preparing and submitting the completed application form to the USPTO. Time will vary depending upon the individual case. Any comments on the amount of time you require to complete this form and/or suggestions for reducing this burden, should be sent to the Chief Information Officer, U.S. Patent and Trademark Office, U.S. Department of Commerce, P.O. Box 1450, Alexandria, VA 22313-1450. DO NOT SEND FEES OR COMPLETED FORMS TO THIS ADDRESS. **SEND TO: Commissioner for Patents, P.O. Box 1450, Alexandria, VA 22313-1450.**

Privacy Act Statement

The Privacy Act of 1974 (P.L. 93-579) requires that you be given certain information in connection with your submission of the attached form related to a patent application or patent. Accordingly, pursuant to the requirements of the Act, please be advised that: (1) the general authority for the collection of this information is 35 U.S.C. 2(b)(2); (2) furnishing of the information solicited is voluntary; and (3) the principal purpose for which the information is used by the U.S. Patent and Trademark Office is to process and/or examine your submission related to a patent application or patent. If you do not furnish the requested information, the U.S. Patent and Trademark Office may not be able to process and/or examine your submission, which may result in termination of proceedings or abandonment of the application or expiration of the patent.

The information provided by you in this form will be subject to the following routine uses:

1. The information on this form will be treated confidentially to the extent allowed under the Freedom of Information Act (5 U.S.C. 552) and the Privacy Act (5 U.S.C. 552a). Records from this system of records may be disclosed to the Department of Justice to determine whether the Freedom of Information Act requires disclosure of these records.
2. A record from this system of records may be disclosed, as a routine use, in the course of presenting evidence to a court, magistrate, or administrative tribunal, including disclosures to opposing counsel in the course of settlement negotiations.
3. A record in this system of records may be disclosed, as a routine use, to a Member of Congress submitting a request involving an individual, to whom the record pertains, when the individual has requested assistance from the Member with respect to the subject matter of the record.
4. A record in this system of records may be disclosed, as a routine use, to a contractor of the Agency having need for the information in order to perform a contract. Recipients of information shall be required to comply with the requirements of the Privacy Act of 1974, as amended, pursuant to 5 U.S.C. 552a(m).
5. A record related to an International Application filed under the Patent Cooperation Treaty in this system of records may be disclosed, as a routine use, to the International Bureau of the World Intellectual Property Organization, pursuant to the Patent Cooperation Treaty.
6. A record in this system of records may be disclosed, as a routine use, to another federal agency for purposes of National Security review (35 U.S.C. 181) and for review pursuant to the Atomic Energy Act (42 U.S.C. 218(c)).
7. A record from this system of records may be disclosed, as a routine use, to the Administrator, General Services, or his/her designee, during an inspection of records conducted by GSA as part of that agency's responsibility to recommend improvements in records management practices and programs, under authority of 44 U.S.C. 2904 and 2906. Such disclosure shall be made in accordance with the GSA regulations governing inspection of records for this purpose, and any other relevant (i.e., GSA or Commerce) directive. Such disclosure shall not be used to make determinations about individuals.
8. A record from this system of records may be disclosed, as a routine use, to the public after either publication of the application pursuant to 35 U.S.C. 122(b) or issuance of a patent pursuant to 35 U.S.C. 151. Further, a record may be disclosed, subject to the limitations of 37 CFR 1.14, as a routine use, to the public if the record was filed in an application which became abandoned or in which the proceedings were terminated and which application is referenced by either a published application, an application open to public inspections or an issued patent.
9. A record from this system of records may be disclosed, as a routine use, to a Federal, State, or local law enforcement agency, if the USPTO becomes aware of a violation or potential violation of law or regulation.

PART B - FEE(S) TRANSMITTAL

**Complete and send this form, together with applicable fee(s), to: Mail Mail Stop ISSUE FEE
 Commissioner for Patents
 P.O. Box 1450
 Alexandria, Virginia 22313-1450
 or Fax (571)-273-2885**

INSTRUCTIONS: This form should be used for transmitting the ISSUE FEE and PUBLICATION FEE (if required). Blocks 1 through 5 should be completed where appropriate. All further correspondence including the Patent, advance orders and notification of maintenance fees will be mailed to the current correspondence address as indicated unless corrected below or directed otherwise in Block 1, by (a) specifying a new correspondence address; and/or (b) indicating a separate "FEE ADDRESS" for maintenance fee notifications.

CURRENT CORRESPONDENCE ADDRESS (Note: Use Block 1 for any change of address)

20988 7590 03/30/2012
 NORTON ROSE CANADA LLP
 1, Place Ville Marie
 SUITE 2500
 MONTREAL, QC H3B 1R1
 CANADA

Note: A certificate of mailing can only be used for domestic mailings of the Fee(s) Transmittal. This certificate cannot be used for any other accompanying papers. Each additional paper, such as an assignment or formal drawing, must have its own certificate of mailing or transmission.

Certificate of Mailing or Transmission

I hereby certify that this Fee(s) Transmittal is being deposited with the United States Postal Service with sufficient postage for first class mail in an envelope addressed to the Mail Stop ISSUE FEE address above, or being facsimile transmitted to the USPTO (571) 273-2885, on the date indicated below.

	(Depositor's name)
	(Signature)
	(Date)

APPLICATION NO.	FILING DATE	FIRST NAMED INVENTOR	ATTORNEY DOCKET NO.	CONFIRMATION NO.
10/784,781	02/24/2004	Gerhard D. Klassen	05200204-272US	2200

TITLE OF INVENTION: PREVIEWING A NEW EVENT ON A SMALL SCREEN DEVICE

APPLN. TYPE	SMALL ENTITY	ISSUE FEE DUE	PUBLICATION FEE DUE	PREV. PAID ISSUE FEE	TOTAL FEE(S) DUE	DATE DUE
nonprovisional	NO	\$1740	\$300	\$0	\$2040	07/02/2012

EXAMINER	ART UNIT	CLASS-SUBCLASS
HEFFINGTON, JOHN M	2172	715-700000

1. Change of correspondence address or indication of "Fee Address" (37 CFR 1.363).

- Change of correspondence address (or Change of Correspondence Address form PTO/SB/122) attached.
 "Fee Address" indication (or "Fee Address" Indication form PTO/SB/47; Rev 03-02 or more recent) attached. **Use of a Customer Number is required.**

2. For printing on the patent front page, list

- (1) the names of up to 3 registered patent attorneys or agents OR, alternatively,
 (2) the name of a single firm (having as a member a registered attorney or agent) and the names of up to 2 registered patent attorneys or agents. If no name is listed, no name will be printed.

1. **NORTON ROSE CANADA LLP**
 2. _____
 3. _____

3. ASSIGNEE NAME AND RESIDENCE DATA TO BE PRINTED ON THE PATENT (print or type)

PLEASE NOTE: Unless an assignee is identified below, no assignee data will appear on the patent. If an assignee is identified below, the document has been filed for recordation as set forth in 37 CFR 3.11. Completion of this form is NOT a substitute for filing an assignment.

(A) NAME OF ASSIGNEE

(B) RESIDENCE: (CITY and STATE OR COUNTRY)

RESEARCH IN MOTION LIMITED WATERLOO, CANADA

Please check the appropriate assignee category or categories (will not be printed on the patent): Individual Corporation or other private group entity Government

4a. The following fee(s) are submitted:

- Issue Fee
 Publication Fee (No small entity discount permitted)
 Advance Order - # of Copies _____

4b. Payment of Fee(s): (Please first reapply any previously paid issue fee shown above)

- A check is enclosed.
 Payment by credit card. Form PTO-2038 is attached.
 The Director is hereby authorized to charge the required fee(s), any deficiency, or credit any overpayment, to Deposit Account Number **195713** (enclose an extra copy of this form).

5. Change in Entity Status (from status indicated above)

- a. Applicant claims SMALL ENTITY status. See 37 CFR 1.27. b. Applicant is no longer claiming SMALL ENTITY status. See 37 CFR 1.27(g)(2).

NOTE: The Issue Fee and Publication Fee (if required) will not be accepted from anyone other than the applicant; a registered attorney or agent; or the assignee or other party in interest as shown by the records of the United States Patent and Trademark Office.

Authorized Signature

MATTHEW MARQUARDT

Date

25 MAY, 2012

Typed or printed name

Registration No.

40997

This collection of information is required by 37 CFR 1.311. The information is required to obtain or retain a benefit by the public which is to file (and by the USPTO to process) an application. Confidentiality is governed by 35 U.S.C. 122 and 37 CFR 1.14. This collection is estimated to take 12 minutes to complete, including gathering, preparing, and submitting the completed application form to the USPTO. Time will vary depending upon the individual case. Any comments on the amount of time you require to complete this form and/or suggestions for reducing this burden, should be sent to the Chief Information Officer, U.S. Patent and Trademark Office, U.S. Department of Commerce, P.O. Box 1450, Alexandria, Virginia 22313-1450. DO NOT SEND FEES OR COMPLETED FORMS TO THIS ADDRESS. SEND TO: Commissioner for Patents, P.O. Box 1450, Alexandria, Virginia 22313-1450.

Under the Paperwork Reduction Act of 1995, no persons are required to respond to a collection of information unless it displays a valid OMB control number.

Electronic Patent Application Fee Transmittal				
Application Number:	10784781			
Filing Date:	24-Feb-2004			
Title of Invention:	PREVIEWING A NEW EVENT ON A SMALL SCREEN DEVICE			
First Named Inventor/Applicant Name:	Gerhard D. Klassen			
Filer:	Matthew J. Marquardt/Judy Ramalho			
Attorney Docket Number:	05200204-272US			
Filed as Large Entity				
Utility under 35 USC 111(a) Filing Fees				
Description	Fee Code	Quantity	Amount	Sub-Total in USD(\$)
Basic Filing:				
Pages:				
Claims:				
Miscellaneous-Filing:				
Petition:				
Patent-Appeals-and-Interference:				
Post-Allowance-and-Post-Issuance:				
Utility Appl issue fee	1501	1	1740	1740
Publ. Fee- early, voluntary, or normal	1504	1	300	300

Description	Fee Code	Quantity	Amount	Sub-Total in USD(\$)
Extension-of-Time:				
Miscellaneous:				
Total in USD (\$)				2040

Electronic Acknowledgement Receipt	
EFS ID:	12870026
Application Number:	10784781
International Application Number:	
Confirmation Number:	2200
Title of Invention:	PREVIEWING A NEW EVENT ON A SMALL SCREEN DEVICE
First Named Inventor/Applicant Name:	Gerhard D. Klassen
Customer Number:	20988
Filer:	Matthew J. Marquardt/Judy Ramalho
Filer Authorized By:	Matthew J. Marquardt
Attorney Docket Number:	05200204-272US
Receipt Date:	25-MAY-2012
Filing Date:	24-FEB-2004
Time Stamp:	15:55:00
Application Type:	Utility under 35 USC 111(a)

Payment information:

Submitted with Payment	yes
Payment Type	Deposit Account
Payment was successfully received in RAM	\$ 2040
RAM confirmation Number	2488
Deposit Account	195113
Authorized User	
<p>The Director of the USPTO is hereby authorized to charge indicated fees and credit any overpayment as follows:</p> <p style="padding-left: 40px;">Charge any Additional Fees required under 37 C.F.R. Section 1.16 (National application filing, search, and examination fees)</p> <p style="padding-left: 40px;">Charge any Additional Fees required under 37 C.F.R. Section 1.17 (Patent application and reexamination processing fees)</p>	

Charge any Additional Fees required under 37 C.F.R. Section 1.19 (Document supply fees)
 Charge any Additional Fees required under 37 C.F.R. Section 1.20 (Post Issuance fees)
 Charge any Additional Fees required under 37 C.F.R. Section 1.21 (Miscellaneous fees and charges)

File Listing:

Document Number	Document Description	File Name	File Size(Bytes)/ Message Digest	Multi Part /.zip	Pages (if appl.)
1	Issue Fee Payment (PTO-85B)	Issue_Fee.pdf	95890 c721ceab739e6789a4a170126f8d829c0db26882	no	1

Warnings:

Information:

2	Fee Worksheet (SB06)	fee-info.pdf	32042 547cd834cd14f0ad61699164cc39eed1ea9bff9	no	2
---	----------------------	--------------	--	----	---

Warnings:

Information:

Total Files Size (in bytes):	127932
-------------------------------------	--------

This Acknowledgement Receipt evidences receipt on the noted date by the USPTO of the indicated documents, characterized by the applicant, and including page counts, where applicable. It serves as evidence of receipt similar to a Post Card, as described in MPEP 503.

New Applications Under 35 U.S.C. 111

If a new application is being filed and the application includes the necessary components for a filing date (see 37 CFR 1.53(b)-(d) and MPEP 506), a Filing Receipt (37 CFR 1.54) will be issued in due course and the date shown on this Acknowledgement Receipt will establish the filing date of the application.

National Stage of an International Application under 35 U.S.C. 371

If a timely submission to enter the national stage of an international application is compliant with the conditions of 35 U.S.C. 371 and other applicable requirements a Form PCT/DO/EO/903 indicating acceptance of the application as a national stage submission under 35 U.S.C. 371 will be issued in addition to the Filing Receipt, in due course.

New International Application Filed with the USPTO as a Receiving Office

If a new international application is being filed and the international application includes the necessary components for an international filing date (see PCT Article 11 and MPEP 1810), a Notification of the International Application Number and of the International Filing Date (Form PCT/RO/105) will be issued in due course, subject to prescriptions concerning national security, and the date shown on this Acknowledgement Receipt will establish the international filing date of the application.



UNITED STATES PATENT AND TRADEMARK OFFICE

UNITED STATES DEPARTMENT OF COMMERCE
United States Patent and Trademark Office
Address: COMMISSIONER FOR PATENTS
P. O. Box 1450
Alexandria, Virginia 22313-1450
www.uspto.gov

APPLICATION NO.	ISSUE DATE	PATENT NO.	ATTORNEY DOCKET NO.	CONFIRMATION NO.
10/784,781	06/26/2012	8209634	05200204-272US	2200

20988 7590 06/06/2012
NORTON ROSE CANADA LLP
1, Place Ville Marie
SUITE 2500
MONTREAL, QC H3B 1R1
CANADA

ISSUE NOTIFICATION

The projected patent number and issue date are specified above.

Determination of Patent Term Adjustment under 35 U.S.C. 154 (b)
(application filed on or after May 29, 2000)

The Patent Term Adjustment is 987 day(s). Any patent to issue from the above-identified application will include an indication of the adjustment on the front page.

If a Continued Prosecution Application (CPA) was filed in the above-identified application, the filing date that determines Patent Term Adjustment is the filing date of the most recent CPA.

Applicant will be able to obtain more detailed information by accessing the Patent Application Information Retrieval (PAIR) WEB site (<http://pair.uspto.gov>).

Any questions regarding the Patent Term Extension or Adjustment determination should be directed to the Office of Patent Legal Administration at (571)-272-7702. Questions relating to issue and publication fee payments should be directed to the Application Assistance Unit (AAU) of the Office of Data Management (ODM) at (571)-272-4200.

APPLICANT(s) (Please see PAIR WEB site <http://pair.uspto.gov> for additional applicants):

Gerhard D. Klassen, Waterloo, CANADA;
Craig A. Dunk, Guelph, CANADA;
Christopher R. Wormald, Kitchener, CANADA;

Under the Paperwork Reduction Act of 1995 no persons are required to respond to a collection of information unless it displays a valid OMB control number

PATENT - POWER OF ATTORNEY OR REVOCATION OF POWER OF ATTORNEY WITH A NEW POWER OF ATTORNEY AND CHANGE OF CORRESPONDENCE ADDRESS	Patent Number	8,209,634
	Issue Date	06-26-2012
	First Named Inventor	Gerhard D. Klassen
	Title	PREVIEWING A NEW EVENT ON A SMALL SCREEN DEVICE
	Attorney Docket No.	05200204-272US

I hereby revoke all previous powers of attorney given in the above-identified patent.

A Power of Attorney is submitted herewith.

OR

I hereby appoint Practitioner(s) associated with the Customer Number identified in the box at right as my/our attorney(s) or agent(s) with respect to the patent identified above, and to transact all business in the United States Patent and Trademark Office connected therewith: 54120

OR

I hereby appoint Practitioner(s) named below as my/our attorney(s) or agent(s) with respect to the patent identified above, and to transact all business in the United States Patent and Trademark Office connected therewith:

Practitioner(s) Name	Registration Number

Please recognize or change the correspondence address for the above-identified patent to:

The address associated with the above-identified Customer Number.

OR

The address associated with the Customer Number identified in the box at right:

OR

Firm or Individual Name

Address

City	State	Zip
Country	Telephone	Email

I am the:

Applicant.

OR

Patent owner.

Statement under 37 CFR 3.73(c) (Form PTO/AIA/96) submitted herewith or filed on _____

SIGNATURE of Applicant or Patent Owner

Signature	Date
Name	Telephone
Title and Company	

NOTE: Signatures of all the applicants or patent owners of the entire interest or their representative(s) are required. If more than one signature is required, submit multiple forms, check the box below, and identify the total number of forms submitted in the blank below.

A total of _____ forms are submitted.

This collection of information is required by 37 CFR 1.31, 1.32, and 1.33. The information is required to obtain or retain a benefit by the public, which is to update (and by the USPTO to process) the file of a patent or reexamination proceeding. Confidentiality is governed by 35 U.S.C. 122 and 37 CFR 1.14. This collection is estimated to take 3 minutes to complete, including gathering, preparing, and submitting the completed application form to the USPTO. Time will vary depending upon the individual case. Any comments on the amount of time you require to complete this form and/or suggestions for reducing this burden, should be sent to the Chief Information Officer, U.S. Patent and Trademark Office, U.S. Department of Commerce, P.O. Box 1450, Alexandria, VA 22313-1450. DO NOT SEND FEES OR COMPLETED FORMS TO THIS ADDRESS. SEND TO: Commissioner for Patents, P.O. Box 1450, Alexandria, VA 22313-1450.

If you need assistance in completing the form, call 1-800-PTO-9199 and select option 2.

Legal OK

Under the Paperwork Reduction Act of 1995, no persons are required to respond to a collection of information unless it displays a valid OMB control number.

STATEMENT UNDER 37 CFR 3.73(c)

Applicant/Patent Owner: BlackBerry Limited
 Application No./Patent No.: 8,209,634 Filed/Issue Date: 06-26-2012
 Titled: PREVIEWING A NEW EVENT ON A SMALL SCREEN DEVICE
BlackBerry Limited, a corporation
 (Name of Assignee) (Type of Assignee, e.g., corporation, partnership, university, government agency, etc.)

states that, for the patent application/patent identified above, it is (choose **one** of options 1, 2, 3 or 4 below):

1. The assignee of the entire right, title, and interest.
2. An assignee of less than the entire right, title, and interest (check applicable box):
 The extent (by percentage) of its ownership interest is _____%. Additional Statement(s) by the owners holding the balance of the interest must be submitted to account for 100% of the ownership interest.
 There are unspecified percentages of ownership. The other parties, including inventors, who together own the entire right, title and interest are:

Additional Statement(s) by the owner(s) holding the balance of the interest must be submitted to account for the entire right, title, and interest.

3. The assignee of an undivided interest in the entirety (a complete assignment from one of the joint inventors was made). The other parties, including inventors, who together own the entire right, title, and interest are:

Additional Statement(s) by the owner(s) holding the balance of the interest must be submitted to account for the entire right, title, and interest.

4. The recipient, via a court proceeding or the like (e.g., bankruptcy, probate), of an undivided interest in the entirety (a complete transfer of ownership interest was made). The certified document(s) showing the transfer is attached.

The interest identified in option 1, 2 or 3 above (not option 4) is evidenced by either (choose **one** of options A or B below):

- A. An assignment from the inventor(s) of the patent application/patent identified above. The assignment was recorded in the United States Patent and Trademark Office at Reel _____, Frame _____, or for which a copy thereof is attached.
- B. A chain of title from the inventor(s), of the patent application/patent identified above, to the current assignee as follows:

1. From: Inventors To: Research In Motion Limited
 The document was recorded in the United States Patent and Trademark Office at
 Reel 015021, Frame 0429, or for which a copy thereof is attached.
2. From: Research In Motion Limited To: BlackBerry Limited
 The document was recorded in the United States Patent and Trademark Office at
 Reel 034045, Frame 0741, or for which a copy thereof is attached.

[Page 1 of 2]

This collection of information is required by 37 CFR 3.73(b). The information is required to obtain or retain a benefit by the public which is to file (and by the USPTO to process) an application. Confidentiality is governed by 35 U.S.C. 122 and 37 CFR 1.11 and 1.14. This collection is estimated to take 12 minutes to complete, including gathering, preparing, and submitting the completed application form to the USPTO. Time will vary depending upon the individual case. Any comments on the amount of time you require to complete this form and/or suggestions for reducing this burden, should be sent to the Chief Information Officer, U.S. Patent and Trademark Office, U.S. Department of Commerce, P.O. Box 1450, Alexandria, VA 22313-1450. DO NOT SEND FEES OR COMPLETED FORMS TO THIS ADDRESS. SEND TO: Commissioner for Patents, P.O. Box 1450, Alexandria, VA 22313-1450.

If you need assistance in completing the form, call 1-800-PTO-9199 and select option 2.

Under the Paperwork Reduction Act of 1995, no persons are required to respond to a collection of information unless it displays a valid OMB control number.

STATEMENT UNDER 37 CFR 3.73(c)

3. From: To:

The document was recorded in the United States Patent and Trademark Office at
Reel _____, Frame _____, or for which a copy thereof is attached.

4. From: To:

The document was recorded in the United States Patent and Trademark Office at
Reel _____, Frame _____, or for which a copy thereof is attached.

5. From: To:

The document was recorded in the United States Patent and Trademark Office at
Reel _____, Frame _____, or for which a copy thereof is attached.

6. From: To:

The document was recorded in the United States Patent and Trademark Office at
Reel _____, Frame _____, or for which a copy thereof is attached.

Additional documents in the chain of title are listed on a supplemental sheet(s).

As required by 37 CFR 3.73(c)(1)(i), the documentary evidence of the chain of title from the original owner to the assignee was, or concurrently is being, submitted for recordation pursuant to 37 CFR 3.11.

[NOTE: A separate copy (i.e., a true copy of the original assignment document(s)) must be submitted to Assignment Division in accordance with 37 CFR Part 3, to record the assignment in the records of the USPTO. See MPEP 302.08]

The undersigned (whose title is supplied below) is authorized to act on behalf of the assignee.

/David S. Furbeck/

March 8, 2018

Signature

Date

David S. Furbeck

72,197

Printed or Typed Name

Title or Registration Number

Privacy Act Statement

The **Privacy Act of 1974 (P.L. 93-579)** requires that you be given certain information in connection with your submission of the attached form related to a patent application or patent. Accordingly, pursuant to the requirements of the Act, please be advised that: (1) the general authority for the collection of this information is 35 U.S.C. 2(b)(2); (2) furnishing of the information solicited is voluntary; and (3) the principal purpose for which the information is used by the U.S. Patent and Trademark Office is to process and/or examine your submission related to a patent application or patent. If you do not furnish the requested information, the U.S. Patent and Trademark Office may not be able to process and/or examine your submission, which may result in termination of proceedings or abandonment of the application or expiration of the patent.

The information provided by you in this form will be subject to the following routine uses:

1. The information on this form will be treated confidentially to the extent allowed under the Freedom of Information Act (5 U.S.C. 552) and the Privacy Act (5 U.S.C. 552a). Records from this system of records may be disclosed to the Department of Justice to determine whether disclosure of these records is required by the Freedom of Information Act.
2. A record from this system of records may be disclosed, as a routine use, in the course of presenting evidence to a court, magistrate, or administrative tribunal, including disclosures to opposing counsel in the course of settlement negotiations.
3. A record in this system of records may be disclosed, as a routine use, to a Member of Congress submitting a request involving an individual, to whom the record pertains, when the individual has requested assistance from the Member with respect to the subject matter of the record.
4. A record in this system of records may be disclosed, as a routine use, to a contractor of the Agency having need for the information in order to perform a contract. Recipients of information shall be required to comply with the requirements of the Privacy Act of 1974, as amended, pursuant to 5 U.S.C. 552a(m).
5. A record related to an International Application filed under the Patent Cooperation Treaty in this system of records may be disclosed, as a routine use, to the International Bureau of the World Intellectual Property Organization, pursuant to the Patent Cooperation Treaty.
6. A record in this system of records may be disclosed, as a routine use, to another federal agency for purposes of National Security review (35 U.S.C. 181) and for review pursuant to the Atomic Energy Act (42 U.S.C. 218(c)).
7. A record from this system of records may be disclosed, as a routine use, to the Administrator, General Services, or his/her designee, during an inspection of records conducted by GSA as part of that agency's responsibility to recommend improvements in records management practices and programs, under authority of 44 U.S.C. 2904 and 2906. Such disclosure shall be made in accordance with the GSA regulations governing inspection of records for this purpose, and any other relevant (*i.e.*, GSA or Commerce) directive. Such disclosure shall not be used to make determinations about individuals.
8. A record from this system of records may be disclosed, as a routine use, to the public after either publication of the application pursuant to 35 U.S.C. 122(b) or issuance of a patent pursuant to 35 U.S.C. 151. Further, a record may be disclosed, subject to the limitations of 37 CFR 1.14, as a routine use, to the public if the record was filed in an application which became abandoned or in which the proceedings were terminated and which application is referenced by either a published application, an application open to public inspection or an issued patent.
9. A record from this system of records may be disclosed, as a routine use, to a Federal, State, or local law enforcement agency, if the USPTO becomes aware of a violation or potential violation of law or regulation.

Electronic Acknowledgement Receipt	
EFS ID:	31997804
Application Number:	10784781
International Application Number:	
Confirmation Number:	2200
Title of Invention:	PREVIEWING A NEW EVENT ON A SMALL SCREEN DEVICE
First Named Inventor/Applicant Name:	Gerhard D. Klassen
Customer Number:	20988
Filer:	David S. Furbeck
Filer Authorized By:	
Attorney Docket Number:	05200204-272US
Receipt Date:	08-MAR-2018
Filing Date:	24-FEB-2004
Time Stamp:	15:12:44
Application Type:	Utility under 35 USC 111(a)

Payment information:

Submitted with Payment	no
------------------------	----

File Listing:

Document Number	Document Description	File Name	File Size(Bytes)/ Message Digest	Multi Part /.zip	Pages (if appl.)
1	Power of Attorney	11246-US-PAT_POA_executed.pdf	92687 <small>7a47b0aa921a55f0a0342019b3d635a8b14519205</small>	no	1

Warnings:

Information:					
2	Assignee showing of ownership per 37 CFR 3.73	11246-US-PAT_37CFR_executed.pdf	1637427	no	3
			67da8e656dc1304c70b72ac86aed6eb96ef102d		
Warnings:					
Information:					
Total Files Size (in bytes):				1730114	
<p>This Acknowledgement Receipt evidences receipt on the noted date by the USPTO of the indicated documents, characterized by the applicant, and including page counts, where applicable. It serves as evidence of receipt similar to a Post Card, as described in MPEP 503.</p> <p><u>New Applications Under 35 U.S.C. 111</u> If a new application is being filed and the application includes the necessary components for a filing date (see 37 CFR 1.53(b)-(d) and MPEP 506), a Filing Receipt (37 CFR 1.54) will be issued in due course and the date shown on this Acknowledgement Receipt will establish the filing date of the application.</p> <p><u>National Stage of an International Application under 35 U.S.C. 371</u> If a timely submission to enter the national stage of an international application is compliant with the conditions of 35 U.S.C. 371 and other applicable requirements a Form PCT/DO/EO/903 indicating acceptance of the application as a national stage submission under 35 U.S.C. 371 will be issued in addition to the Filing Receipt, in due course.</p> <p><u>New International Application Filed with the USPTO as a Receiving Office</u> If a new international application is being filed and the international application includes the necessary components for an international filing date (see PCT Article 11 and MPEP 1810), a Notification of the International Application Number and of the International Filing Date (Form PCT/RO/105) will be issued in due course, subject to prescriptions concerning national security, and the date shown on this Acknowledgement Receipt will establish the international filing date of the application.</p>					



UNITED STATES PATENT AND TRADEMARK OFFICE

UNITED STATES DEPARTMENT OF COMMERCE
United States Patent and Trademark Office
Address: COMMISSIONER FOR PATENTS
P.O. Box 1450
Alexandria, Virginia 22313-1450
www.uspto.gov

APPLICATION NUMBER	FILING OR 371(C) DATE	FIRST NAMED APPLICANT	ATTY. DOCKET NO./TITLE
10/784,781	02/24/2004	Gerhard D. Klassen	05200204-272US

CONFIRMATION NO. 2200

POA ACCEPTANCE LETTER



54120
BlackBerry Limited - Direct Practice - (US Team)
ATTN: PATENT TEAM
2200 University Avenue E.
Waterloo, ON N2K 0A7
CANADA

Date Mailed: 03/12/2018

NOTICE OF ACCEPTANCE OF POWER OF ATTORNEY

This is in response to the Power of Attorney filed 03/08/2018.

The Power of Attorney in this application is accepted. Correspondence in this application will be mailed to the above address as provided by 37 CFR 1.33.

Questions about the contents of this notice and the requirements it sets forth should be directed to the Office of Data Management, Application Assistance Unit, at (571) 272-4000 or (571) 272-4200 or 1-888-786-0101.

/tmwilliams/



UNITED STATES PATENT AND TRADEMARK OFFICE

UNITED STATES DEPARTMENT OF COMMERCE
United States Patent and Trademark Office
Address: COMMISSIONER FOR PATENTS
P.O. Box 1450
Alexandria, Virginia 22313-1450
www.uspto.gov

APPLICATION NUMBER	FILING OR 371(C) DATE	FIRST NAMED APPLICANT	ATTY. DOCKET NO./TITLE
10/784,781	02/24/2004	Gerhard D. Klassen	05200204-272US

CONFIRMATION NO. 2200

POWER OF ATTORNEY NOTICE



20988
NORTON ROSE FULBRIGHT CANADA LLP
1, Place Ville Marie
SUITE 2500
MONTREAL, QC H3B 1R1
CANADA

Date Mailed: 03/12/2018

NOTICE REGARDING CHANGE OF POWER OF ATTORNEY

This is in response to the Power of Attorney filed 03/08/2018.

- The Power of Attorney to you in this application has been revoked by the assignee who has intervened as provided by 37 CFR 3.71. Future correspondence will be mailed to the new address of record(37 CFR 1.33).

Questions about the contents of this notice and the requirements it sets forth should be directed to the Office of Data Management, Application Assistance Unit, at (571) 272-4000 or (571) 272-4200 or 1-888-786-0101.

/tmwilliams/