



User's Guide · ユーザーズガイド · Manuel de l'utilisateur · Benutzerhandbuch  
Manual del usuario · Manuale Utente · Guia do Usuário · Gebruikershandleiding · Handbook  
Brukerhåndbok · Brugerhåndbog · Käskirja · 使用手冊 · 사용 안내서

Once you've set up your iMac and followed the onscreen guide to connect to the Internet, what's next? Read on to find out how to get the most out of your iMac:

|    |   |
|----|---|
| 2  | Your iMac at a glance                         |
| 4  | Mac OS X basics                               |
| 8  | What you can do with your iMac                |
| 10 | Listen to music on your computer or on the go |
| 12 | Make your own movie or watch a movie on DVD   |
| 14 | Make your own Hollywood-style DVDs            |
| 16 | Search the Internet                           |
| 18 | Get more out of the Internet                  |
| 20 | Send and receive email                        |
| 22 | Organize, plan, and create                    |
| 24 | Keep your iMac's software up-to-date          |
| 26 | Learn more and solve problems                 |
| 32 | Install memory and an AirPort Card            |
| 34 | Work more comfortably                         |
| 36 | Safety, cleaning, and power management        |



# Your iMac at a glance

Your computer has these built-in features:



**Built-in microphone**  
Record sound or control your computer with spoken commands.

**Optical disc drive**  
Install software, use applications, and create your own music CDs. If you have the Combo drive, watch DVD videos. If you have the SuperDrive, you can make them, too.

**Apple Pro Speakers**  
Included with some models. Available separately at [www.apple.com/store](http://www.apple.com/store)

**USB port**  
Connect a USB device.

**Power indicator light**  
Pulsing light indicates that the computer is sleeping.

**Volume controls**  
Use the keyboard to adjust sound volume.

**Media Eject key**  
Use to open the drive tray or eject a CD or DVD.

**Apple Pro Mouse**  
A precision optical mouse you can use on almost any surface, no mouse pad required.

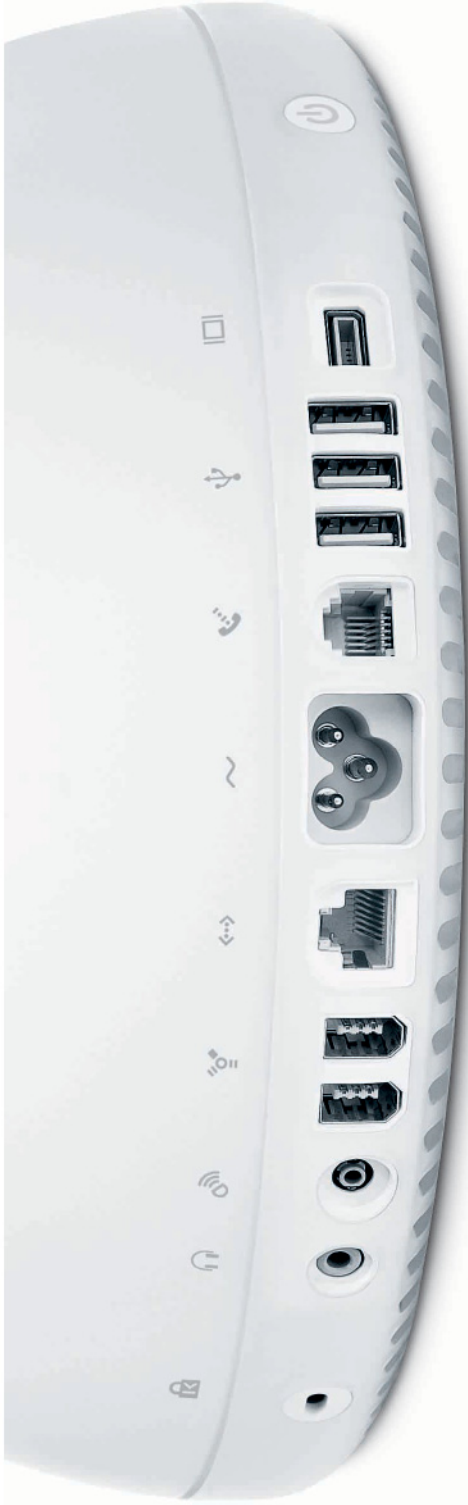

**Kensington Security Lock**  
Attach a lock and cable to prevent theft.

**Headphones port**  
Connect headphones or analog speakers.

**Apple Pro Speaker mini-jack**  
Connect Apple Pro Speakers.

**FireWire**  
Transfer video from a DV camera. Connect an Apple iPod, external hard disk, or other FireWire device.

**Ethernet**  
Share files with another computer. Connect a DSL or cable modem to access the Internet.

**Power Port**  
Connect to a standard electrical outlet.

**Modem**  
Connect to the Internet, browse the World Wide Web, and send email.

**USB**  
Connect printers, Zip and other disk drives, digital cameras, joysticks, and more.

**VGA output**  
Connect an external monitor for video mirroring using the Apple VGA adapter (available separately).

**Power button**  
Turn your computer on or put it to sleep.

**To learn more about your iMac's features:**

- Choose Mac Help from the Help menu, then click Go under "Discover my iMac."

# Mac OS X basics

The Macintosh desktop is your starting place.

The screenshot shows the Mac OS X desktop with a blue background. A Finder window titled 'tclark3' is open, displaying a sidebar with 'Computer' (Home, Favorites, Applications) and 'View' (Desktop, Documents, Music, Sites, Library, Pictures). The Dock at the bottom contains icons for Finder, Safari, Mail, iChat, iTunes, iPhoto, iMovie, iDVD, and the Trash. The menu bar at the top includes Apple menu, Finder, File, Edit, View, Go, Window, and Help. The status bar at the bottom right shows the time as 11:23 AM and the name 'Macintosh HD'.

**Apple menu**  
Use to change system settings, open recent items, and restart or shut down your computer. To see the menu, click the apple menu, (⌘) in the menu bar.

**Window buttons**  
Click the red button to close the window, the yellow one to minimize it into the Dock, and the green one to resize it.

**View buttons**  
Click to see your files as icons, in lists, or in columns.

**Finder icon**  
Click to open a Finder window so you can see the files and applications on your computer.

**Modem status**  
Use this menu to connect to and disconnect from the Internet using a dialup modem.

**Toolbar button**  
Click to show or hide the toolbar.

**Toolbar icons**  
Click to navigate quickly to different folders. Your home folder contains your personal documents.

**Trash**  
Drag an item here to delete it. Items remain here until you choose Empty Trash from the Finder menu.

**To learn more about Mac OS X:**

- See the Welcome to Mac OS X document in the Documents folder on your hard disk.

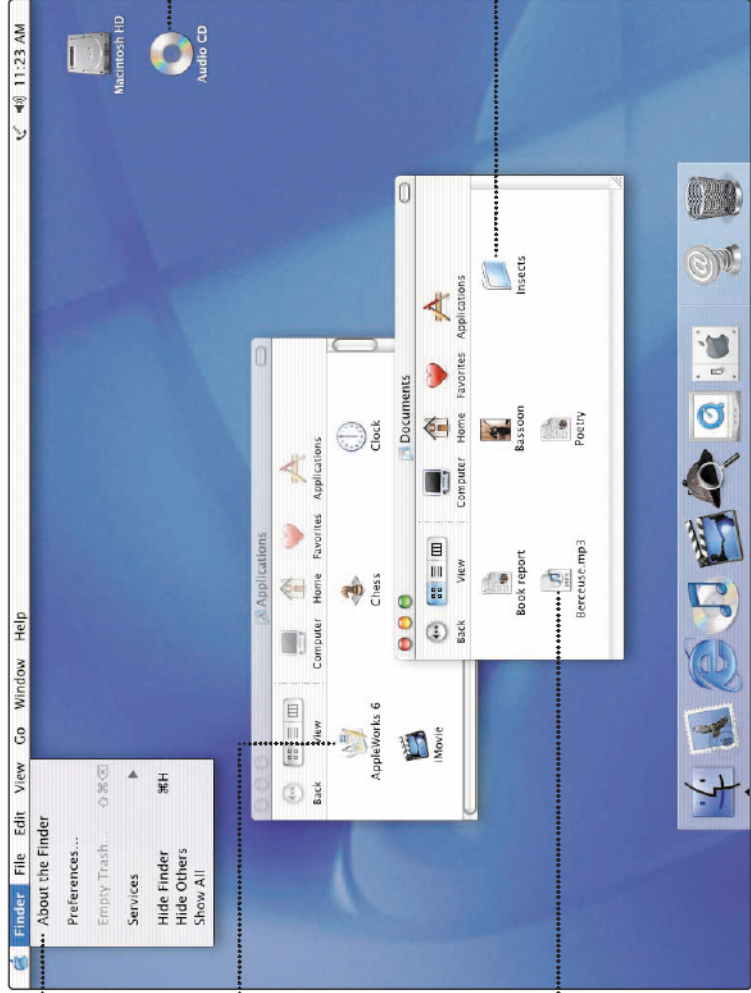

**Application menu**  
Shows the name of the application you're using. Use to set preferences or quit applications (other than the Finder).

**Application**  
Applications are software programs (such as a game or word processor) that you use with your computer. Double-click an application's icon to open the application.

**Document**  
Documents are files that you create with an application (such as a letter you create with your word processor). Double-click the icon to open the file in the application used to create it.

**Disc**  
This appears when a CD or DVD is in the disc drive. Double-click the icon to see what's on the disc. To eject a disc, press and hold the Media Eject (⏏) key on the keyboard.

**Folder**  
Folders help organize your files and applications. Double-click a folder to see what's inside.

**Dock**  
Click icons in the Dock to open applications, documents, folders, or minimized windows.

# Change the Mac OS to suit your preferences.

There are lots of ways to customize Mac OS X.

To change Finder settings, choose Preferences from the Finder menu.

Choose System Preferences from the Apple menu to change your computer's settings.

To select a desktop background picture, open System Preferences and click Desktop.



To change the size of the Dock or move it to a different place, open System Preferences and click Dock.

To change icon sizes or the background of a Finder window, choose Show View Options from the View menu.

Click the icons in the Dock or toolbar to find and open files and applications.

► Drag applications, files, and folders into the Dock for one-click access.



To set up the toolbar the way you want it, choose Customize Toolbar from the Finder's View menu, then drag items to the toolbar.

Press a folder icon to see its contents and open items in it.

This side of the Dock shows application icons.

The triangle indicates the application is open.

Drag this bar up or down to resize the Dock.

This side of the Dock shows files, windows, and folders.



## What you can do with your iMac

Not sure how to get the most out of your new iMac? Read on for a few ideas.

**Make your own CDs.** Use  to transfer and organize music from your CD collection, then burn your own custom music CDs. Transfer music to an iPod or other MP3 player to listen on the go. **Make a movie.** Shoot video on a DV camcorder and import it into iMovie . Then rearrange, edit, polish, and add titles and soundtracks. **Make a DVD.** If your iMac has a SuperDrive, use iDVD  to burn DVDs for viewing in almost any home DVD player. Connect to the Internet to **send email** and **browse the Web**, or use iTools  to **post digital photos** to the Web for everyone to see.

Browse through the next few pages to find out more.

# The iMac is your digital hub.



Send digital photos to friends and family.



Import and edit home movies.



Send email and surf the 'Net.



Put up to 1,000 songs in your pocket.



Watch a DVD movie or burn your own DVD.



Listen to music and burn your own CDs.



# Listen to music on your computer or on the go. Use iTunes to create a library of music and make your own CDs.

**Library**  
Your collection of songs, imported from your own audio CDs or downloaded from the Internet. Easily browse or search for music.

**Radio Tuner**  
Choose from hundreds of Internet radio stations – jazz, rock, talk, and more.

**Audio CDs**  
Play an audio CD on your computer. Import songs to your Library to play them without the CD.



**Burn CDs**  
Make your own audio CDs that play in standard CD players.

**Playlists**  
Make personalized playlists using songs from your Library. Arrange your music by mood, artist, genre, or however you like.

**Equalizer**  
Adjust the sound to your tastes using the 10-band EQ with 22 presets.

- To learn more about iTunes:**
- See iTunes Help, available in the Help menu.
  - Go to [www.apple.com/itunes](http://www.apple.com/itunes)

If you have an iPod, you can transfer up to 1,000 songs for listening on the go.



1. Connect iPod using the FireWire cable included with iPod. iTunes automatically transfers your music Library to iPod.
2. Unplug iPod.
3. Browse for a song on iPod and press the Play button.

**To learn more about iPod:**

- See iTunes and choose iPod Help from the Help menu
- Go to [www.apple.com/ipod](http://www.apple.com/ipod)

# Make your own movie or watch a movie on DVD.

Use iMovie to edit video from a digital video camera.

▶ Shoot video with a digital video camera. Then connect the camera using a 6-pin to 4-pin FireWire cable and import your clips.

**iMovie monitor**  
Preview your movie or view video from a connected DV camera.

**Viewers**  
Click the clip viewer (eye tab) to edit and place clips. Click the timeline viewer (clock tab) to edit sound.

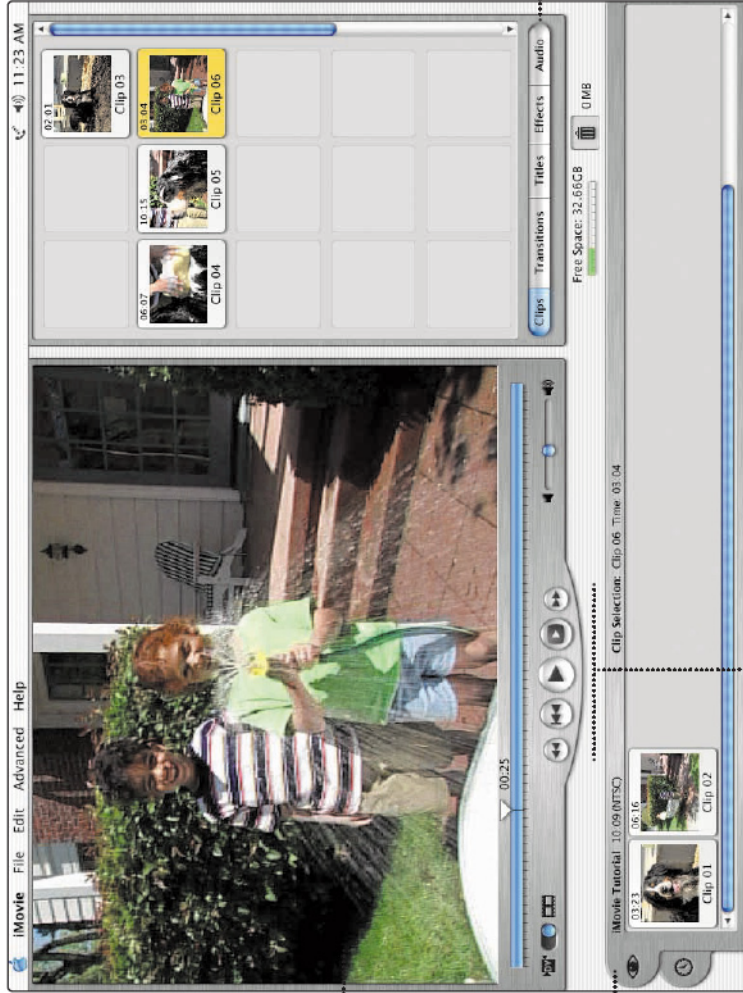

▶ You can export your finished movie to a tape in your DV camera or to a QuickTime file.

**Shelf**  
Clips appear here when you import them. Move clips to the viewer to make them part of your movie.

**Editing buttons**  
Click to open panels for adjusting and selecting sounds, video effects, titles, and transitions.

**To learn more about iMovie:**

- ▶ Open iMovie and choose iMovie Help from the Help menu.
- ▶ Go to [www.apple.com/store](http://www.apple.com/store) to find compatible DV cameras or to purchase a FireWire cable.

**Playback controls**  
Use these to play the movie in the iMovie monitor. Click the Play Full Screen button to use the entire screen.

If your computer has a Combo drive or SuperDrive, you can watch DVD movies.



▶ To use the whole screen to watch the movie, choose Enter Full Screen from the Video menu.

To learn more about DVD Player:  
■ Choose DVD Player Help from the Help menu.

1. Insert a DVD video disc. DVD Player opens automatically.
2. Use the controller to play the movie or see the DVD's special features.



With iDVD you can make your DVD look exactly the way you want.

#### Themes

Choose a background for your DVD from the included themes, or make your own theme.

#### Multiple menus

Click the Folder button to add multiple DVD menus.

#### Slideshow

Click Slideshow and drag still pictures to iDVD. Your DVD can hold thousands of pictures.



#### Burn

Insert a blank DVD-R disc and click Burn. You can work on your computer while the DVD is being created in the background.

#### Movies

To add a movie, simply drag it to iDVD. You can use movies you created in iMovie.

#### Preview

Click Preview to see what your DVD will look like.

#### To learn more about iDVD:

- Open iDVD and choose iDVD Tutorial from the Help menu.
- See iDVD Help, available in the Help menu.
- Go to [www.apple.com/iDVD](http://www.apple.com/iDVD) to purchase DVD-R discs.



# Search the Internet.

If you know the Internet address, you can go there directly.

▶ If you have a dialup connection, you can use the modem status icon (📠) to connect to and disconnect from the Internet.

## To learn more about Internet Explorer:

- Open Internet Explorer and choose Internet Explorer Help from the Help menu.



1. Click the icon in the Dock to open Internet Explorer.
2. Type the Internet address and press Return on your keyboard.

Or you can search the Internet with Sherlock.

- ▶ Click the other buttons to find people, read the news, shop, and more.
- ▶ Click the hard disk icon to search the files on your computer.



1. Click the icon in the Dock to open Sherlock.
2. Click the Internet icon and type a question in the search field.
3. Click the Search button (Q). Then double-click an item in the list of sites.

# Get more out of the Internet with iTools.

iTools is a suite of Internet services integrated into Mac OS X.



## iDisk

Your own storage space on Apple's Internet server. Share photos, movies, and other files over the Internet. Access your files from another Macintosh or PC.



## HomePage

Build a personal Web site in three easy steps. Create a photo album, publish an iMovie, post your résumé, and more. Anyone can view your site on the World Wide Web.



## iCards

Send an elegant iCard, just right for any occasion. Choose a ready-made photo, or create a personalized iCard using a photo on your iDisk.



## Email

Get your own Mac.com email address. It's easy and works with your favorite email application.

## To learn more about iTools:

- Go to [www.apple.com/itools](http://www.apple.com/itools) and click Help on the iTools menu bar.



- ▶ If you signed up for iTools when you first turned on your computer, you already have an account. Go to [www.apple.com/itools](http://www.apple.com/itools) to get started.

- ▶ To sign up for a new iTools account, open System Preferences and click Internet. Then click Sign Up.

Store pictures, movies, documents, and other files remotely.



- ▶ To access your files from another computer, log into your iTools account at [www.apple.com/itools](http://www.apple.com/itools)
- ▶ Anyone can access the files in your Public folder.
- ▶ To find out how to use pictures and other files from your iDisk to create a personal Web site, go to [www.apple.com/itools](http://www.apple.com/itools) and click the HomePage icon.

1. Choose iDisk from the Go menu.
2. Drag files to a folder on your iDisk to copy them.



- To learn more about Mail:**
- Open Mail, then choose Mail Help from the Help menu.
  - Go to [www.apple.com/macosx/applications/mail.html](http://www.apple.com/macosx/applications/mail.html)

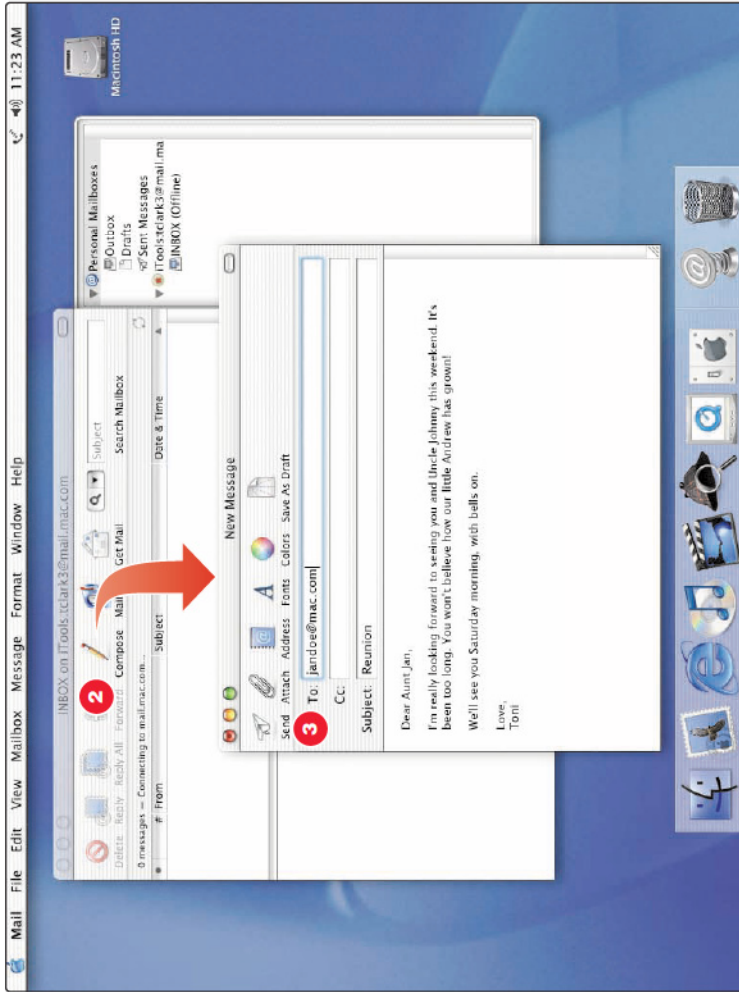

2. To create a new email message, click Compose.
3. Type the email address and a subject. Then type your message and click Send.

# Organize, plan, and create using AppleWorks.

Use AppleWorks for writing, drawing, making presentations, and more.

**Layout capabilities**  
Add photos, tables, charts, and sidebars. Link text frames, layer graphics, and wrap text.

**Word processing**  
Write letters, create brochures, make greeting cards and party invitations.

**Presentation tool**  
Create an onscreen slide presentation. Add movies, art, graphs, and charts.

**Database**  
Keep records, save addresses, make inventories. Merge mailing information with the word processor to send form letters.

**Gourmet News**  
Quarterly Newsletter for Food Lovers  
Winter 2000

**Make Cooking Fun, Fresh, and Fast**  
Duis autem vel eum irure dolor in hendit in vulpate velit esse molestie consequat, vel illum dolore eu feugiat nulla facilisis vero accumsan et justo odio dignissim.

**Cooking tips**

- Chop the onions
- Slice the tomatoes
- Mix with peppers
- Add 1 cup of olive oil
- Saute for 30 seconds
- Serve hot

**Making a Perfect Brew**  
Ut velis enim ad metum veniam, quis nonid evertis tation ullamcorper suscipit loonem praesentis et est. Ut velis enim ad metum veniam, quis nonid evertis tation ullamcorper suscipit loonem praesentis et est.

**Dinner for Six**  
Ut velis enim ad metum veniam, quis nonid evertis tation ullamcorper suscipit loonem praesentis et est. Ut velis enim ad metum veniam, quis nonid evertis tation ullamcorper suscipit loonem praesentis et est.

**Nutritional Tips**

| Food group  | Group       | Examples                    | Macros   | Dat  | Web link           |
|-------------|-------------|-----------------------------|----------|------|--------------------|
| Protein     | Meat        | Beef, Pork, Chicken, Turkey | Protein  | 0.1% | www.fda.gov        |
| Dairy       | Dairy       | Milk, Cheese, Yogurt        | Calcium  | 17%  | www.dailymail.com  |
| Fruit & Veg | Fruit & Veg | Apple, Banana, Carrot       | Vitamins | 23%  | www.healthline.com |
| Grains      | Grains      | Bread, Pasta                | Fiber    | 41%  | www.fda.gov        |

**Customizable templates**  
Choose from a wide range of pre-designed documents and modify them as needed.

**Spreadsheet**  
Compute data easily using over 100 built-in functions, then use formatting options to make it stand out.

**Painting**  
Create art from scratch or apply effects to existing pictures or scanned photos.

**Extensive clip art libraries**  
Choose from over 25,000 high-quality clip art images.



To get started using AppleWorks:



▶ Click the Web tab to download more templates from the Internet.

**To learn more about AppleWorks:**  
See AppleWorks Help, available in the Help menu.  
Go to the AppleWorks Web site at [www.apple.com/appleworks](http://www.apple.com/appleworks)

1. Click the icon in the Dock to open AppleWorks.
2. Click the type of document you want to create, or click the Templates tab to modify a ready-made document.



# Keep your iMac's software up-to-date.

Use Software Update to get the latest updates and drivers.

► To use Software Update, you must have an Internet connection.



1. Click the icon in the Dock to open System Preferences.
2. Click Software Update.



- ▶ Click the name of a software item to learn more about it.
- ▶ You can schedule your computer to check automatically for software updates.

3. Then click Update Now.
4. Select the software you want to update and then click Install.

Learn more about using your computer. Look in Mac Help for more information on using your computer.

- ▶ To browse the features of your computer, click Go under "At a glance."
- ▶ Click Quick Clicks topics for answers to frequently asked questions.
- ▶ To look at Help for other applications, click the ? button.

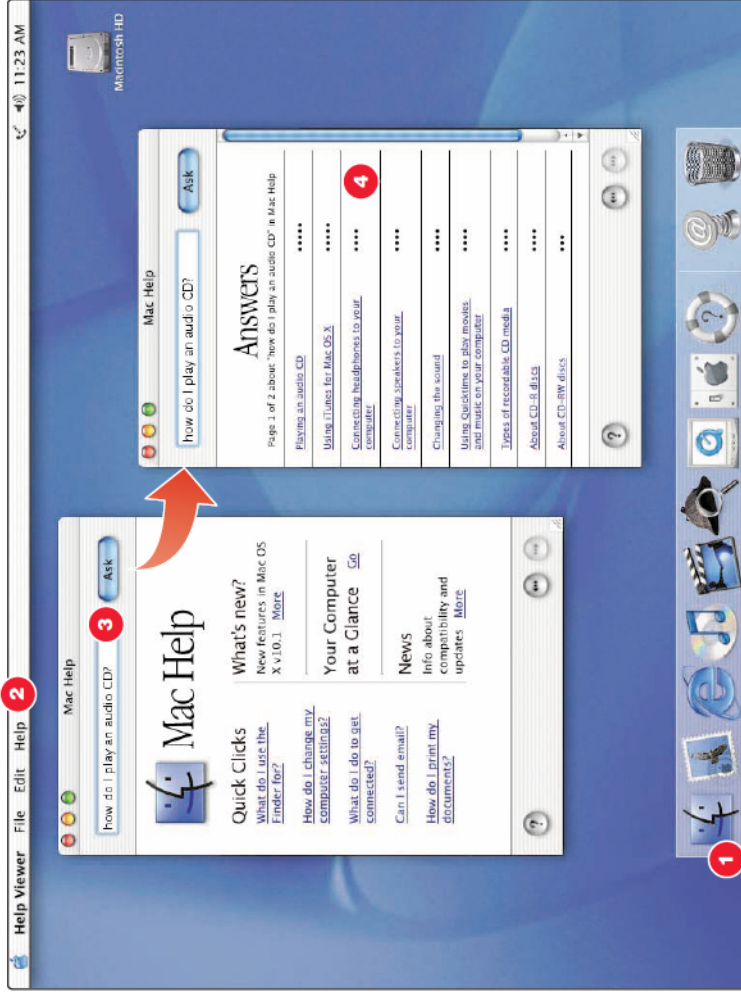

1. Click the Finder icon in the Dock.
2. Then choose Mac Help from the Help menu.
3. Type a question and click Ask.
4. Click an item in the list of Help topics.

These Apple Web sites will help you get the most out of your computer.



**Macintosh Products Guide**

[www.apple.com/guide](http://www.apple.com/guide)

For great hardware and software products for your Mac, check the Web site or look for the Mac symbol. Also get contact and support information for third-party software manufacturers.



**Apple Store**

[www.apple.com/store](http://www.apple.com/store)

Purchase the latest Apple and third-party hardware, software, and accessories.



**Apple Service and Support**

[www.apple.com/support](http://www.apple.com/support)

Product support, software updates, and technical information.

▶ From these Web sites you can quickly link to other Apple Web sites around the world.

# Advice and troubleshooting

If you don't find the answer to your problem on the following pages:

**Look in Mac Help.**

- In Mac Help (see page 26), you can find a great deal of troubleshooting advice, including information to help you solve problems with
  - Connecting to the Internet
  - Using software installation and restore discs
  - Changing your computer's settings
  - Printing
  - And more
- Click the Finder icon in the Dock, then choose Mac Help from the Help menu. Type a question in the search window (for example, type "How do I eject a disc?") and click Ask.

If your Apple Pro Speakers aren't working correctly:

**Make sure they are connected securely.**

- Unplug and then plug in the connector and make sure it is secure. You should feel two clicks.

## Switching between Mac OS X and Mac OS 9

Your iMac is set to use Mac OS X. Most applications made for Mac OS 9 will work in the Mac OS X Classic environment. Just open the application as you normally would. You can also start up your computer using Mac OS 9.

**To set your computer to use Mac OS 9:**

- Choose System Preferences from the Apple () menu in Mac OS X.
- Click the Startup Disk icon to open the Startup Disk pane.
- Select the Mac OS 9 folder as your startup disk. If the icons are dimmed, click the padlock icon and enter the password you chose when you first set up Mac OS X.
- Click Restart.

**To set your computer to use Mac OS X again:**

- Choose Control Panels from the Apple () menu.
- Open the Startup Disk control panel.
- Click the triangle next to the hard disk that contains your operating system folders.
- Select the Mac OS X System as your startup disk.
- Click Restart.

## If the computer won't respond:

### **First, make sure the mouse and keyboard are connected.**

- Unplug and then plug in the connectors and make sure they are secure.

### **Then try to cancel what the computer is doing.**

- Try to force problem applications to quit. Hold down the Option and Command (⌘) keys, then press the Esc key. Select the application and click Force Quit.

### **If the computer still doesn't respond, restart it.**

- Hold the Power button (⏻) on the computer for five seconds. When the computer turns off, press the Power button again to restart it.
- If that doesn't work, unplug the power cord from the computer. Then plug the power cord back in and press the Power button on the computer to turn it on.

## Then do this:

### **If the problem occurs frequently when you use a particular application:**

- Check with the application's manufacturer to see if it is compatible with your computer.
- For support and contact information about the software that came with your computer. Go to [www.apple.com/guide](http://www.apple.com/guide)

### **If the problem occurs frequently:**

- You may need to reinstall your system software. Choose Mac Help from the Help menu and type "install system software" for more information.

## If you see a flashing question mark during startup:

### **If the computer doesn't start up after a delay, hold down the Option key and restart your computer.**

- When your computer starts up, click the hard disk icon, then click the arrow.

## Then do this:

### **After the computer starts up:**

- Open System Preferences and click Startup Disk. Select a local Mac OS X System folder.

### **If the problem occurs frequently:**

- You may need to reinstall your system software. Choose Mac Help from the Help menu and type "install system software" for more information.

## If the computer won't turn on or start up:

### **First, make sure the power cord is connected.**

- Make sure both ends of the power cord are plugged in securely. Make sure the power cord is plugged into a powered electrical outlet.
- If your computer is plugged into a power strip, make sure the power strip is turned on.
- See the service and support information that came with your iMac for information on having your computer serviced.

## If you can't log into your computer:

### **Make sure you are typing your user name and password correctly.**

- Make sure you are using the same capitalization and punctuation that you used originally. Check to see if the Caps Lock key has been pressed.

### **If that doesn't work, reset your password.**

- Insert the Mac OS X software install CD that came with your computer. Restart your computer while holding down the C key. When the Installer appears, choose Reset Password from the Installer menu and follow the onscreen instructions.

## If your printer won't respond or work correctly:

### **Check all cables and connections.**

- Make sure the printer is plugged into the computer and an electrical outlet. Make sure the printer is turned on.

### **Make sure your computer is set up to use your printer.**

- Install the software that came with your printer. See the documentation that came with the printer for instructions.
- Open the Print Center application in the Utilities folder. Then select your printer.

## If you can't eject a CD or DVD, or open the drive tray:

### **Make sure the disc is not in use.**

- Quit all applications that are using files on the disc.
- Then press the Media Eject key (⏏) at the top-right corner of the keyboard.
- If that doesn't work, drag the disc's icon to the Trash.
- If that doesn't work, restart the computer, then hold down the mouse button. To restart, choose Restart from the Apple menu.

## If you have a problem with a third-party software program:

**Make sure the software is compatible with your version of system software.**

- See the documentation that came with the software. You can check the version of system software you have by choosing About This Mac from the Apple () menu.

**To resolve other problems with software, contact the software manufacturer.**

- For support and contact information about the software that came with your computer, go to [www.apple.com/guide](http://www.apple.com/guide)

## If you have a problem with your Internet connection:

**First, make sure the telephone line or Ethernet cable is properly connected to your computer.**

- Wait a while, then try connecting again.

**If that doesn't work, make sure your Internet settings are configured correctly.**

- Open the Internet Connect application in the Applications folder to check your dialup or AirPort settings. Open System Preferences and click Network to check your Internet settings.
- If you're not sure of the correct information for your Internet settings, contact your Internet service provider.

## If the Apple Pro Mouse isn't responding properly:

**First, make sure the mouse and keyboard are connected.**

- Unplug and then plug in the connectors and make sure they are secure.

**If that doesn't work, try using the mouse on another surface, like a mouse pad or a notebook.**

- Non-reflective, opaque surfaces without repetitive patterns work best.

**If you run out of room and want to keep the mouse clicked while you lift it:**

- Click the mouse, then squeeze the sides with your thumb and fingers and lift the mouse.

**If the mouse clicks too easily or not easily enough:**

- Turn the ring on the bottom of the mouse to adjust the tension of the click.

For the latest troubleshooting information, go to the Apple Support Web site at [www.apple.com/support](http://www.apple.com/support)



# Install memory and an AirPort Card.

For detailed instructions, refer to Mac Help (see page 26).

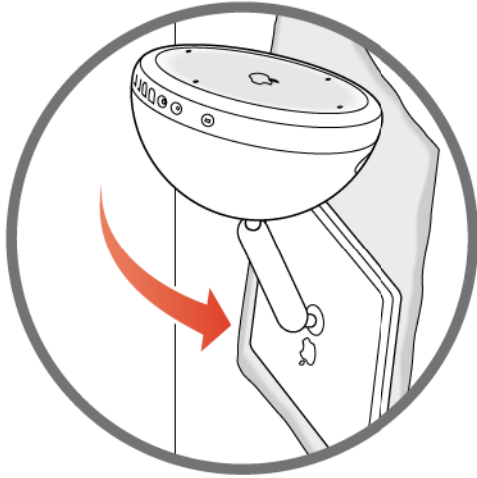

**1.** Lay the computer down sideways on a soft cloth. Be careful not to let the base roll.

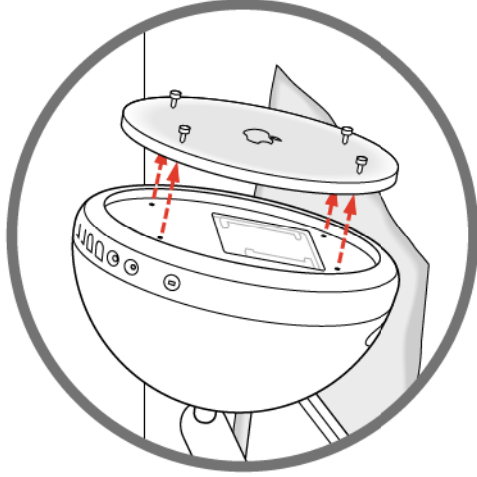

**2.** Loosen the four captive screws at the base of the computer and gently remove the access panel.

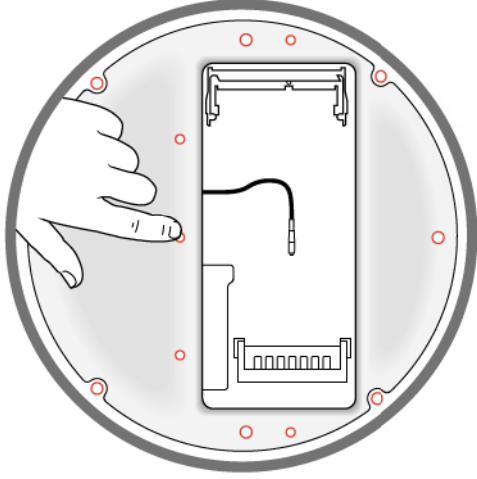

**3.** Touch a metal point inside the computer. Then unplug the power cord.

## Before installing:

- Get a Phillips screwdriver
- Shut down the computer
- Unplug all cables, except the power cord

► For instructions on using the AirPort software, choose Mac Help from the Help menu. Then click the question mark and click AirPort Help.

► Touch this metal before you touch any other parts inside the computer. Don't walk around the room until you've finished installing memory or an AirPort Card.

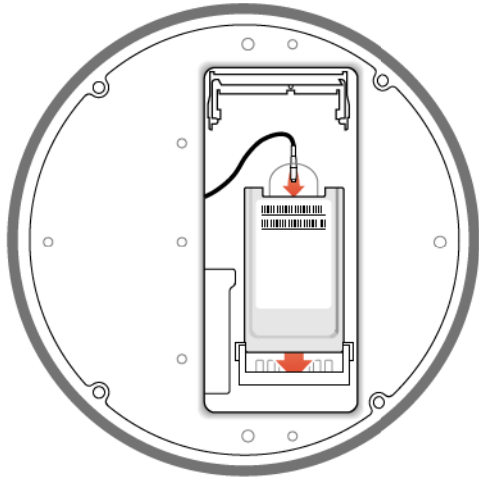

**4.** To install an AirPort Card, connect the antenna firmly to the card and insert the card into the AirPort Card slot.

▶ If the AirPort Card is connected to an adapter, remove the metal clip and pull the card from the adapter. You don't need the adapter.

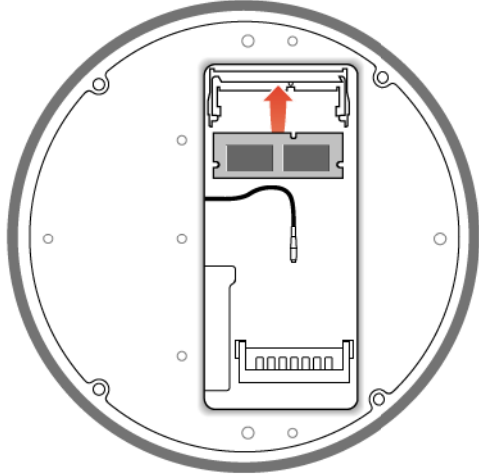

**5.** To install memory, insert a memory module into the memory slot at an angle. Press down to lock it in place.

▶ For more information on the type of memory to use with your computer, choose Mac Help from the Help menu. Then type "memory" and click Ask.

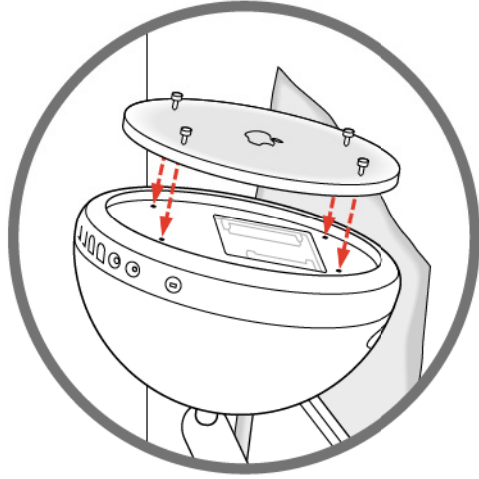

**6.** Replace the access panel and tighten the four screws.

▶ Never turn your computer on unless all of its internal and external parts are in place.

# Work more comfortably

The guidelines in this section can help you work more comfortably with your computer. For detailed information about ergonomics, see the Apple Environmental Health and Safety Web site at [www.apple.com/about/ergonomics](http://www.apple.com/about/ergonomics)

## Keyboard

- When you use the computer keyboard, your shoulders should be relaxed. Your upper arm and forearm should form an approximate right angle, with your wrist and hand in roughly a straight line.
- You may have to raise your chair so your forearms and hands are at the proper angle to the keyboard. If this makes it impossible to rest your feet flat on the floor, you can use a footrest with adjustable height and tilt to make up for any gap between the floor and your feet. Or you may lower the desktop to eliminate the need for a footrest. Another option is to use a desk with a keyboard tray that is lower than the regular work surface.
- Use a light touch when typing and keep your hands and fingers relaxed. Avoid rolling your thumbs under your palms.

## Mouse

- Position the mouse at the same height as your keyboard. Allow adequate space to use the mouse comfortably.

## Chair

- An adjustable chair that provides firm, comfortable support is best. Adjust the height of the chair so your thighs are horizontal and your feet flat on the floor.
- The back of the chair should support your lower back (lumbar region). Follow the manufacturer's instructions for adjusting the backrest to fit your body properly.

## Computer

- Adjust the angle of the screen so the top of the screen is slightly below your eye level when you're sitting at the keyboard. The best distance from your eyes to the screen is up to you, although most people seem to prefer 18 to 28 inches (45 to 70 cm).
- Position the computer to minimize glare and reflections on the screen from overhead lights and windows.

**Important** Don't lift the computer using the display. You could damage it. To move your computer, grab the display extension with one hand; with your other hand, hold the bottom of the computer.

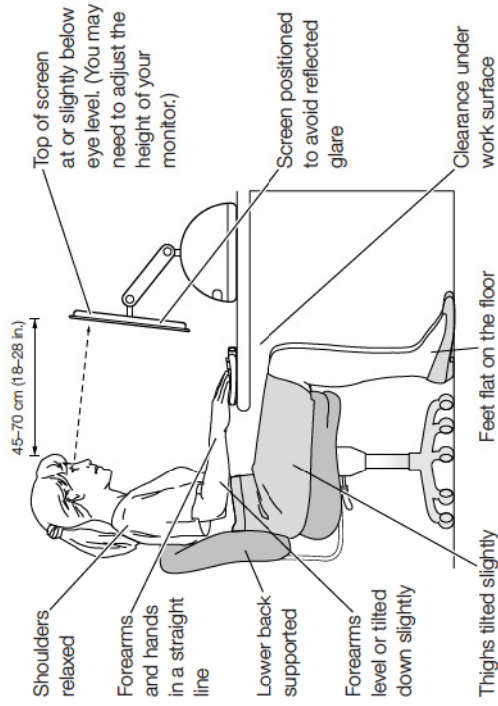

## Avoiding fatigue

- Change your seated position, stand up, or stretch whenever you start to feel tired. Frequent short breaks are helpful in reducing fatigue.
- Use a light touch when typing or using a mouse and keep your hands and fingers relaxed.
- Some computer users may develop discomfort in their hands, wrists, or arms after periods of intensive work without breaks. If you begin to develop chronic pain or discomfort in your hands, wrists, or arms, consult a qualified health specialist immediately.
- Allow adequate workspace so that you can use your keyboard and mouse comfortably. Place papers or other items so you can view them easily while using your computer. A document stand may make reading papers more comfortable.
- Eye muscles must work harder to focus on nearby objects. Occasionally focus your eyes on a distant object, and blink often while you work.
- Clean your screen regularly. Keeping the screen clean helps reduce unwanted reflections.

# Safety, cleaning, and power management

## Safety

Make sure that you

- keep these instructions handy for reference by you and others who may use your computer
- follow all instructions and warnings regarding your system

When setting up and using your computer, remember the following:

- Place your computer on a steady, flat surface in a location with adequate ventilation. Never block the vents on the computer.
- Your computer has a three-wire grounding plug that will only fit a grounded AC outlet. If you are unable to insert the plug into the outlet, contact a licensed electrician to replace the outlet with a properly grounded outlet.
- Make sure you only connect the modem to an analog phone line, the type commonly used in residences. Do not connect a digital telephone line to the modem, because it could damage the modem.
- Never turn on your computer unless all of its internal and external parts are in place. Operating the computer when it is open or missing parts can be dangerous and damage your computer.

**Important** The only way to disconnect power completely is to unplug the power cord. Make sure at least one end of the power cord is within easy reach so that you can unplug the computer when you need to.

**Warning** Electrical equipment may be hazardous if misused. Operation of this product must always be supervised by an adult. Do not allow children access to the interior of this product and do not permit them to handle any cables.

For your own safety and that of your equipment, always disconnect the power plug (by pulling the plug, not the cord) if any of the following conditions exists:

- you want to remove any parts (leave the cord disconnected as long as the computer is open)
- the power cord or plug becomes frayed or otherwise damaged
- you spill something into the case
- your computer is exposed to rain or any other excess moisture
- your computer has been dropped or the case has been otherwise damaged
- you suspect that your computer needs service or repair
- you want to clean the case (use only the recommended procedure discussed in Mac Help)

Be sure that you always do the following:

- Keep your computer away from sources of liquids, such as drinks, washbasins, bathtubs, shower stalls, and so on.
- Protect your computer from dampness or wet weather, such as rain, snow, and so on.

## Cleaning your computer equipment

To clean your computer equipment, use only the recommended procedures discussed in Mac Help. Make sure your computer is unplugged before cleaning.

**Warning** Do not clean the screen with a cleaner that contains alcohol or acetone. Use a cleaner intended for use with an LCD (liquid crystal display). Never spray cleaner directly onto the screen. Liquid could drip inside the computer and cause an electrical shock.

## Power supply

The power supply in your computer is a high-voltage component and not user-serviceable. If you suspect the power supply needs service, contact your Apple-authorized dealer or service provider.

**Warning** Do not attempt to access the high-voltage area or power supply. If you suspect the power supply needs service, contact your Apple-authorized dealer or service provider.

## Power-saving and environmental features

Your computer is equipped with energy-saving features that allow it to conserve energy when not in use. For instructions on adjusting the system and display sleep settings and additional energy-conservation information, see Mac Help.

## TCO

This product has been certified by TCO (the Swedish Confederation of Professional Employees) to meet the standards for ergonomics, energy efficiency, emissions, and ecology of the TCO 95 program. For more information, see the TCO document in the Documents folder on your computer's hard disk.

## ENERGY STAR®

As an ENERGY STAR® partner, Apple has determined that this product meets the ENERGY STAR® guidelines for energy efficiency. The ENERGY STAR® program is a partnership with office product equipment manufacturers to promote energy efficiency. Reducing energy consumption of office products saves money and reduces pollution by eliminating wasted energy.

# Where's the fine print?

## Communications, telephone, and modem regulation information

For information on FCC regulations, radio and television interference, and telephone and modem information related to this product, see the files in the Documents folder on your hard disk.

## Laser information

**Warning** Making adjustments or performing procedures other than those specified in your equipment's manual may result in hazardous radiation exposure.

Do not attempt to disassemble the cabinet containing the laser. The laser beam used in this product is harmful to the eyes. The use of optical instruments, such as magnifying lenses, with this product increases the potential hazard to your eyes. For your safety, have this equipment serviced only by an Apple-authorized service provider.

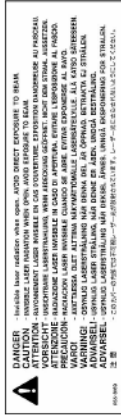

## Service warning label

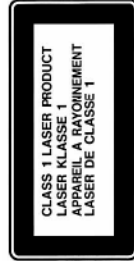

## High-risk activities warning

This computer system is not intended for use in the operation of nuclear facilities, aircraft navigation or communications systems, or air traffic control machines, or for any other uses where the failure of the computer system could lead to death, personal injury, or severe environmental damage.

## iPod information

The Apple iPod pictured on page 11 of this manual is not included with this product. For more information on iPod, go to [www.apple.com/ipod](http://www.apple.com/ipod)

## Mouse information

This product complies with the requirements of European Directives 72/23/EEC and 89/336/EEC. Complies with the Canadian ICES-003 Class B specification. This mouse is a Class 1 LED product. (IEC 60825-1:1993 + A1:1997 + A2:2001)

**Caution** Use of controls or adjustment or performance of procedures other than those specified herein may result in hazardous radiation exposure.

*Every effort has been made to ensure that the information in this manual is accurate. Apple is not responsible for printing or clerical errors.*

