

TRANSMITTAL FOR POWER OF ATTORNEY TO ONE OR MORE REGISTERED PRACTITIONERS

NOTE: This form is to be submitted with the Power of Attorney by Applicant form (PTO/AIA/82B or equivalent) to identify the application to which the Power of Attorney is directed, in accordance with 37 CFR 1.5. If the Power of Attorney by Applicant form is not accompanied by this transmittal form or an equivalent, the Power of Attorney will not be recognized in the application.

Application Number	
Filing Date	
First Named Inventor	Mohammed N. ISLAM
Title	SHORT-WAVE INFRARED SUPER-CONTINUUM LASERS FOR DETECTING COUNTERFEIT OR ILLICIT DRUGS AND PHARMACEUTICAL PROCESS CONTROL
Art Unit	
Examiner Name	
Attorney Docket Number	OMNI 0105 PUSP1

SIGNATURE of Applicant or Patent Practitioner

Signature	/David S. Bir/	Date (Optional)	2015-10-01
Name	David S. Bir	Registration Number	38,383
Title (if Applicant is a juristic entity)			
Applicant Name (if Applicant is a juristic entity)			

NOTE: This form must be signed in accordance with 37 CFR 1.33. See 37 CFR 1.4(d) for signature requirements and certifications. If more than one applicant, use multiple forms.

* Total of 1 forms are submitted.

This collection of information is required by 37 CFR 1.131, 1.32, and 1.33. The information is required to obtain or retain a benefit by the public which is to file (and by the USPTO to process) an application. Confidentiality is governed by 35 U.S.C. 122 and 37 CFR 1.11 and 1.14. This collection is estimated to take 3 minutes to complete, including gathering, preparing, and submitting the completed application form to the USPTO. Time will vary depending upon the individual case. Any comments on the amount of time you require to complete this form and/or suggestions for reducing this burden, should be sent to the Chief Information Officer, U.S. Patent and Trademark Office, U.S. Department of Commerce, P.O. Box 1450, Alexandria, VA 22313-1450. DO NOT SEND FEES OR COMPLETED FORMS TO THIS ADDRESS. **SEND TO: Commissioner for Patents, P.O. Box 1450, Alexandria, VA 22313-1450.**

If you need assistance in completing the form, call 1-800-PTO-9199 and select option 2.

Under the Paperwork Reduction Act of 1995, no persons are required to respond to a collection of information unless it displays a valid OMB control number.

POWER OF ATTORNEY BY APPLICANT

I hereby revoke all previous powers of attorney given in the application identified in the attached transmittal letter.

I hereby appoint Practitioner(s) associated with the following Customer Number as my/our attorney(s) or agent(s), and to transact all business in the United States Patent and Trademark Office connected therewith for the application referenced in the attached transmittal letter (form PTO/AIA/82A or equivalent):

109543

OR

I hereby appoint Practitioner(s) named below as my/our attorney(s) or agent(s), and to transact all business in the United States Patent and Trademark Office connected therewith for the application referenced in the attached transmittal letter (form PTO/AIA/82A or equivalent):

Name	Registration Number	Name	Registration Number

Please recognize or change the correspondence address for the application identified in the attached transmittal letter to:

The address associated with the above-mentioned Customer Number.

OR

The address associated with Customer Number:

OR

Firm or Individual Name

Address

City

State

Zip

Country

Telephone

Email

I am the Applicant:

Inventor or Joint Inventor

Legal Representative of a Deceased or Legally Incapacitated Inventor

Assignee or Person to Whom the Inventor is Under an Obligation to Assign

Person Who Otherwise Shows Sufficient Proprietary Interest (e.g., a petition under 37 CFR 1.48(b)(2) was granted in the application or is concurrently being filed with this document)

SIGNATURE of Applicant for Patent

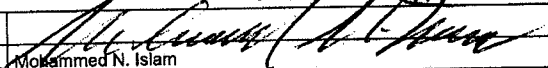
Signature		Date	October 10, 2012
Name	Mohammed N. Islam	Telephone	734-647-8941
Title and Company	President - OMNI MEDSCI, INC.		

NOTE: Signature - This form must be signed by the applicant in accordance with 37 CFR 1.33. See 37 CFR 1.4 for signature requirements and certifications. Submit multiple forms for more than one signature, see below *.

*Total of _____ forms are submitted.

This collection of information is required by 37 CFR 1.31, 1.32 and 1.33. The information is required to obtain or retain a benefit by the public which is to file (and by the USPTO to process) an application. Confidentiality is governed by 35 U.S.C. 122 and 37 CFR 1.11 and 1.14. This collection is estimated to take 3 minutes to complete, including gathering, preparing, and submitting the completed application form to the USPTO. Time will vary depending upon the individual case. Any comments on the amount of time you require to complete this form and/or suggestions for reducing this burden, should be sent to the Chief Information Officer, U.S. Patent and Trademark Office, U.S. Department of Commerce, P.O. Box 1450, Alexandria, VA 22313-1450. DO NOT SEND FEES OR COMPLETED FORMS TO THIS ADDRESS. SEND TO: Commissioner for Patents, P.O. Box 1450, Alexandria, VA 22313-1450.

If you need assistance in completing the form, call 1-800-PTO-9199 and select option 2.

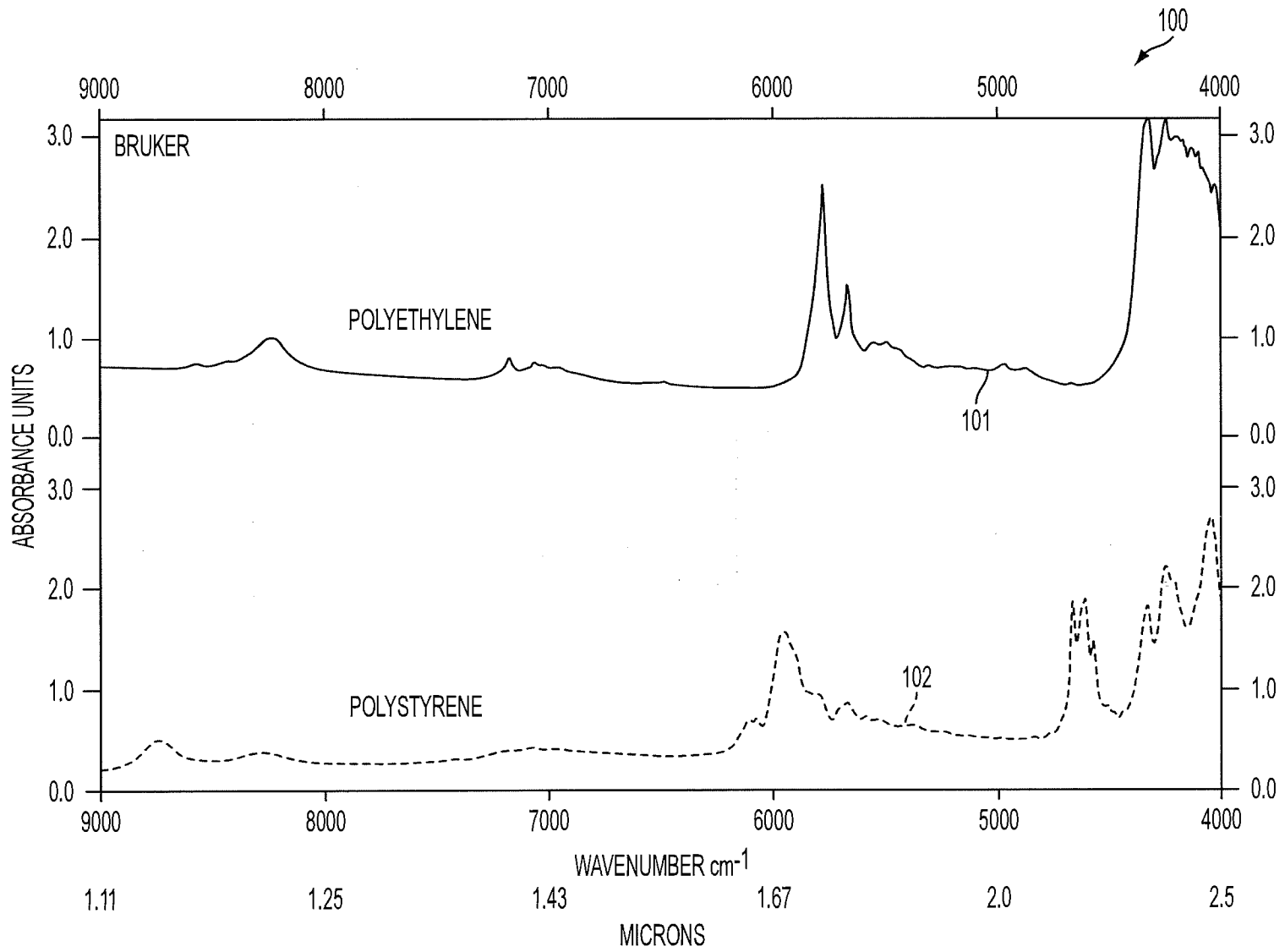

FIG. 1

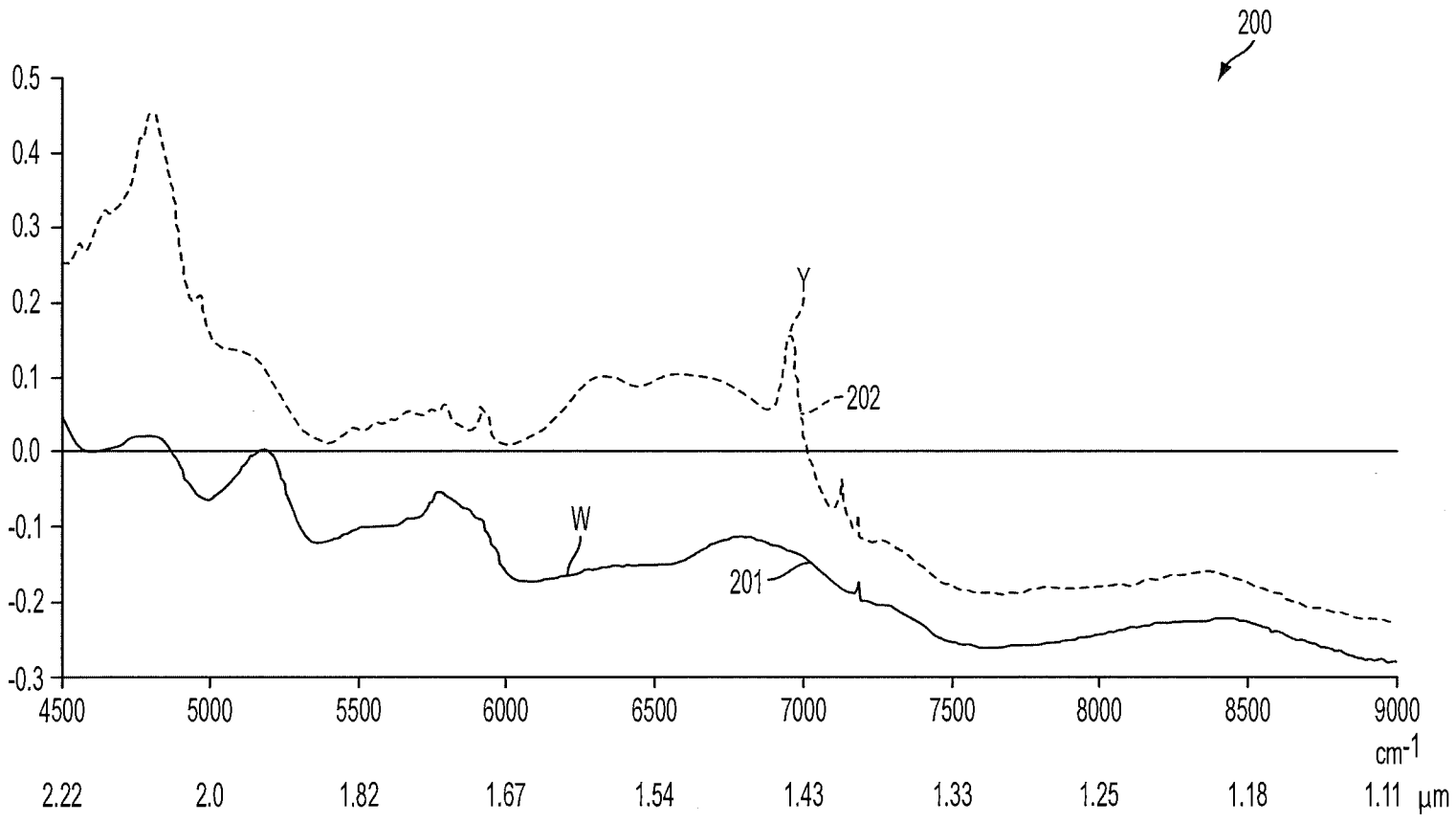

FIG. 2

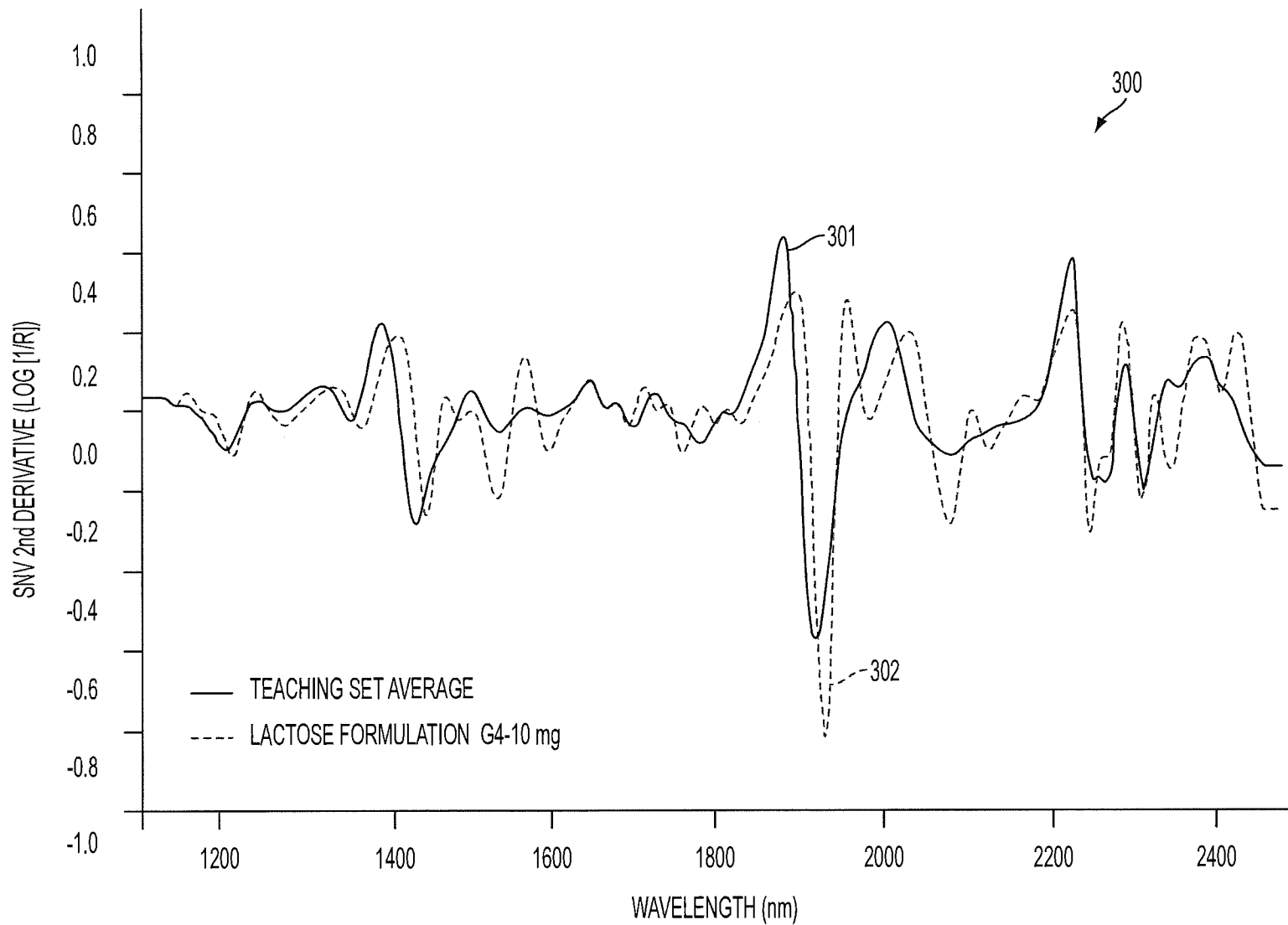

FIG. 3

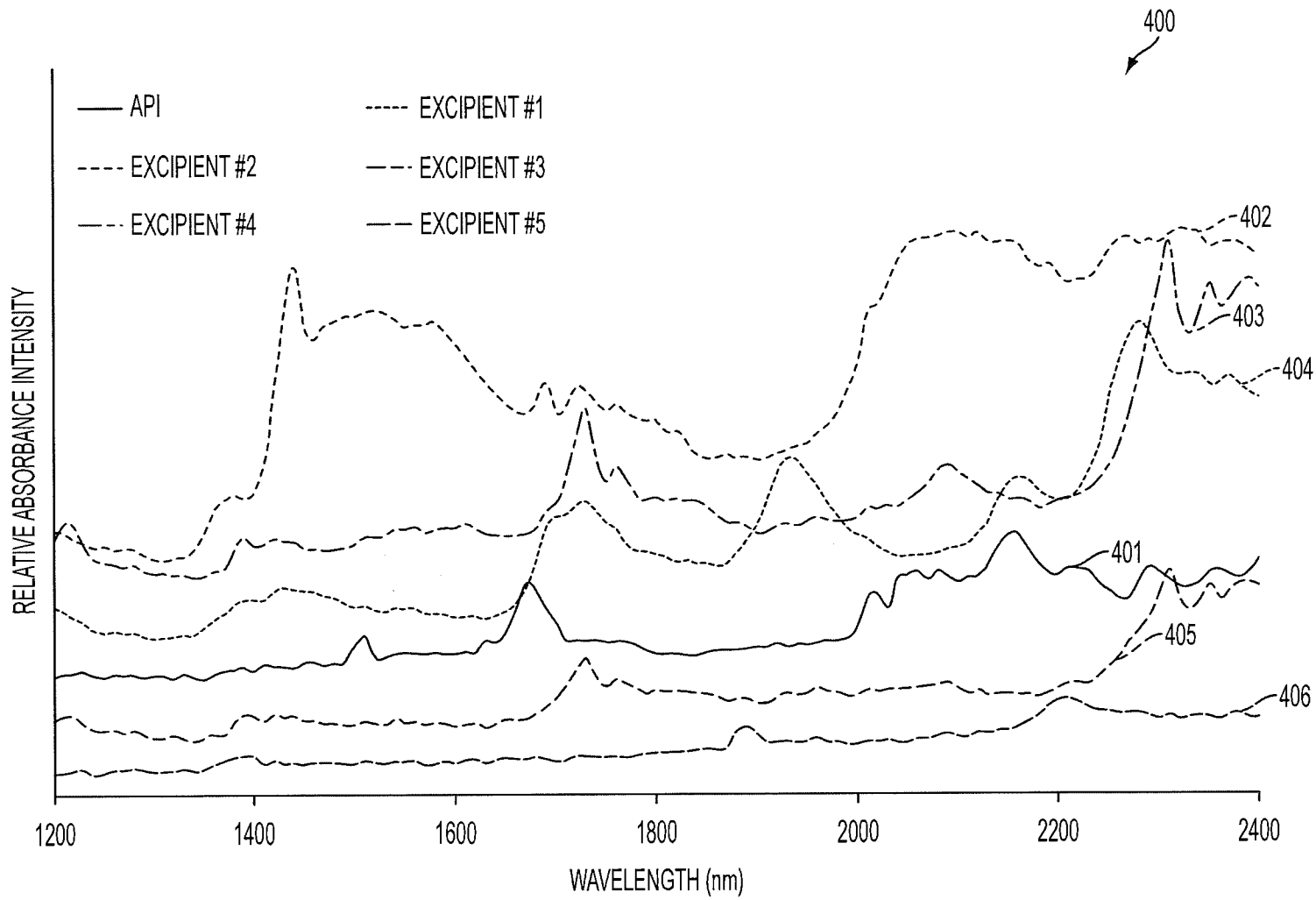

FIG. 4

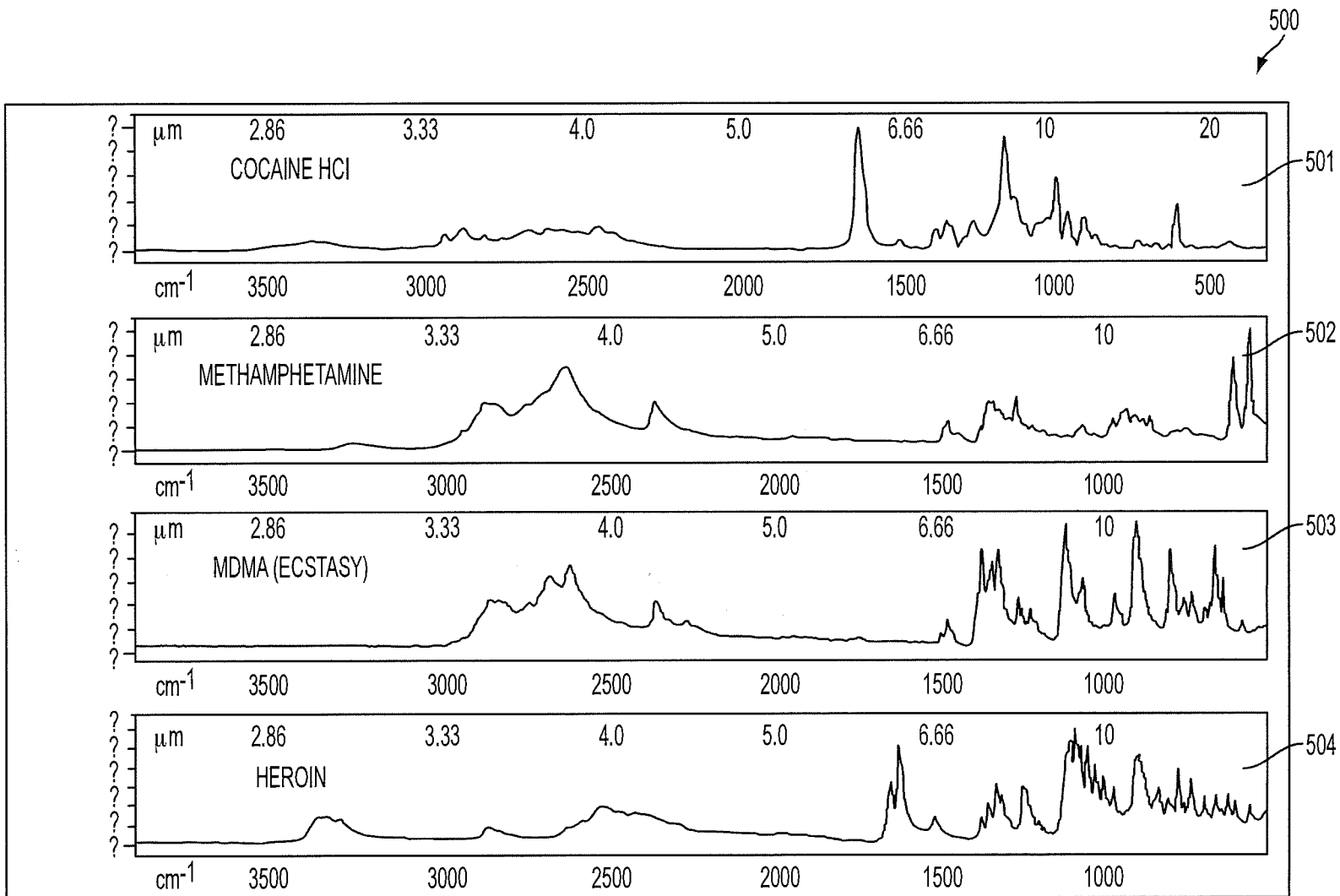

FIG. 5

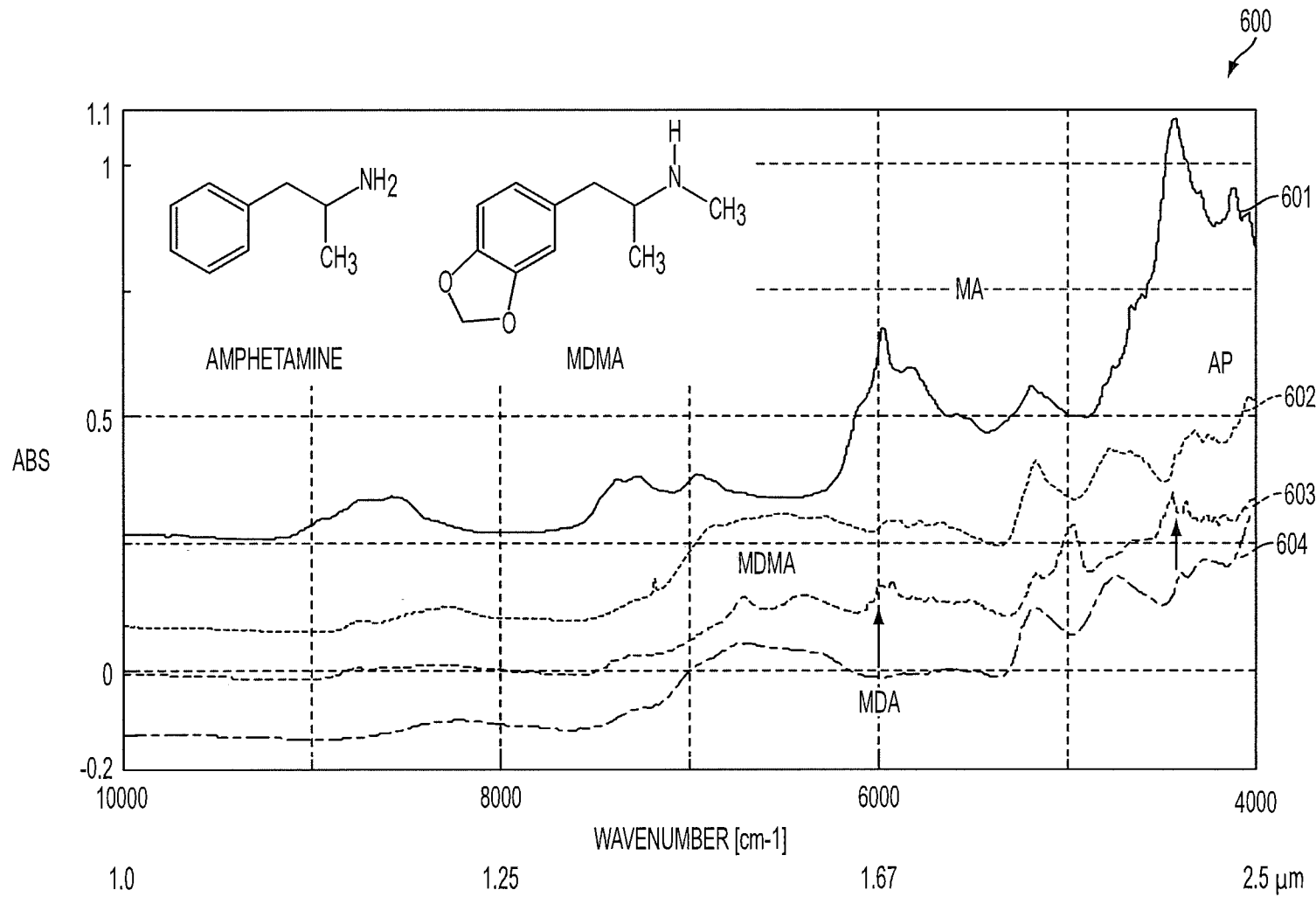

FIG. 6

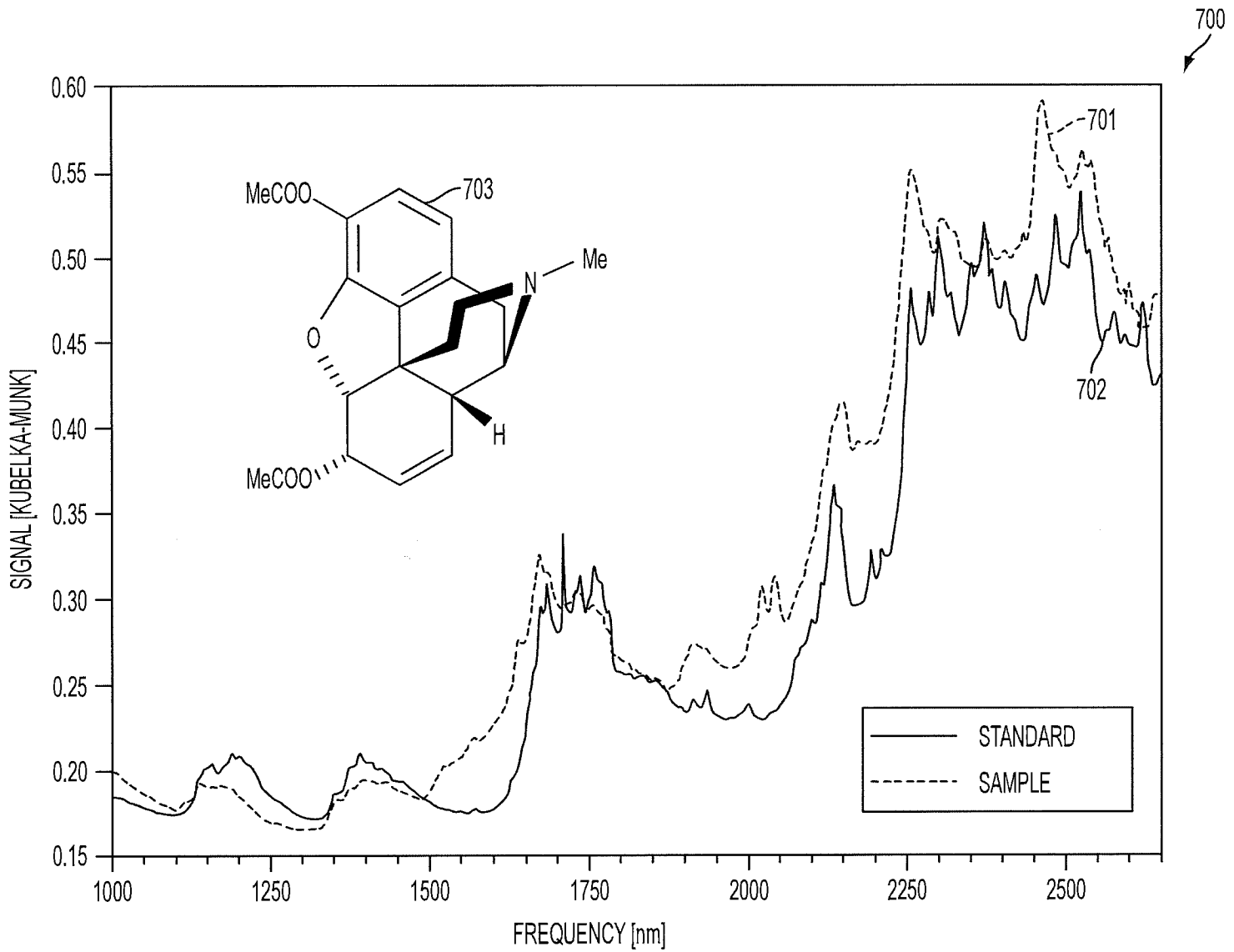

FIG. 7

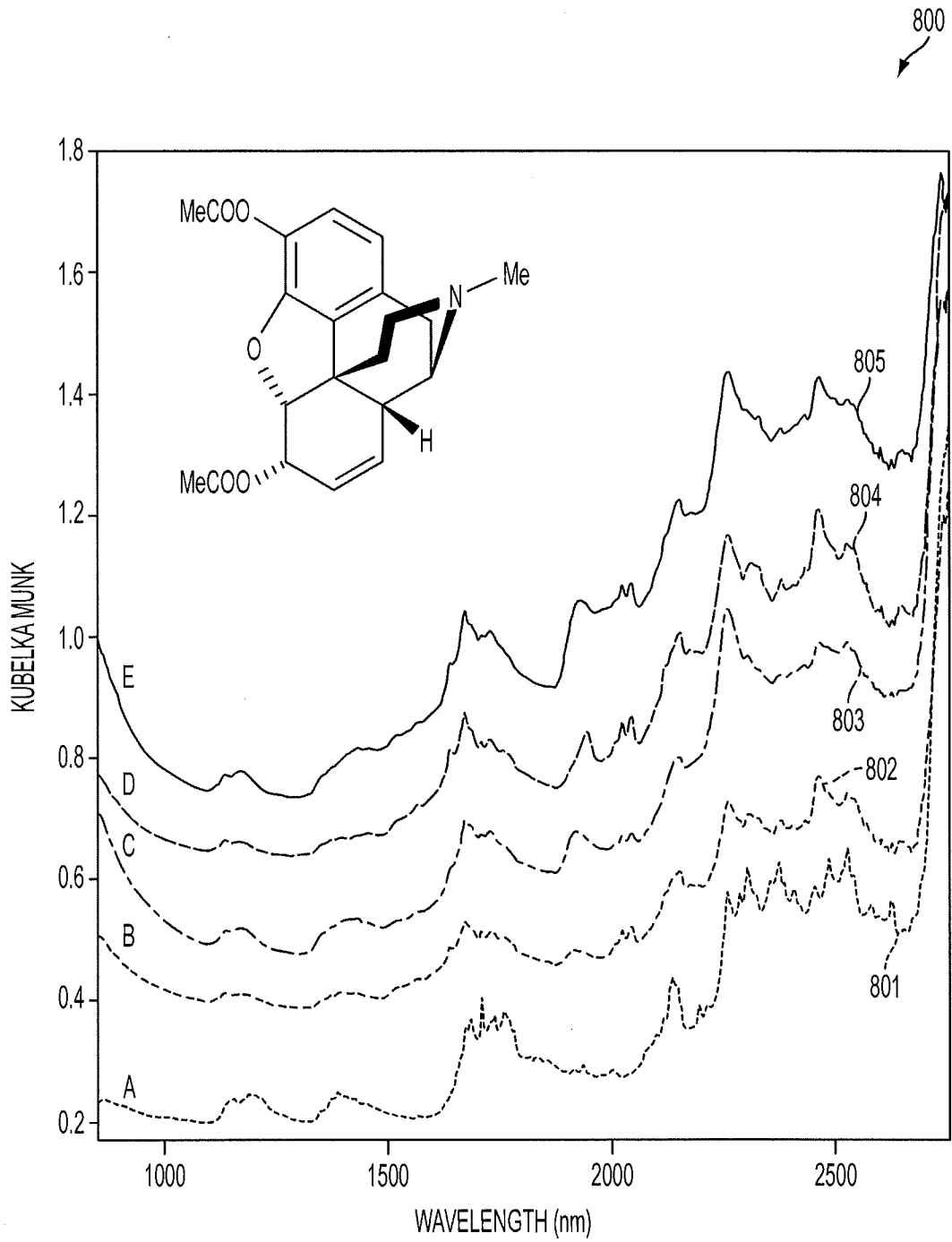

FIG. 8

TENTATIVE FREQUENCIES OF HEROIN BANDS (nm)	ACTUALLY MEASURED PEAK FREQUENCIES (nm)	FORMS OF MODES OF VIBRATION ASSIGNMENT
1160	1157	C—O STRETCH FOURTH OVERTONE
1195	1190	C—H SECOND OVERTONE
1360	1200	C—H SECOND OVERTONE
1395	1357	C—H COMBINATION
1420	1391	C—H COMBINATION
1570	1425	O—H FIRST OVERTONE
1685	1570	N—H STRETCH FIRST OVERTONE
1705	1684	C—H STRETCH FIRST OVERTONE
1725	1709	C—H STRETCH FIRST OVERTONE
1765	1727	C—H STRETCH FIRST OVERTONE
1780	1767	C—H STRETCH FIRST OVERTONE
1920	1780	C—H STRETCH FIRST OVERTONE
1950	1914	C—O STRETCH SECOND OVERTONE
1990	1936	C—O STRETCH SECOND OVERTONE
2070	2000	N—H STRETCH/N—H BEND COMBINATION
2090	2074	N—H DEFORMATION OVERTONE
2140	2100	C—H COMBINATION
	2135	C—H STRETCH/C—O STRETCH COMBINATION OR SYM C—H DEFORMATION
	2144	C—H STRETCH/C—O STRETCH COMBINATION OR SYM C—H DEFORMATION

900
↙↓
TO FIG. 9B

FIG. 9A

FROM FIG. 9A

2170	2172	ASYMMETRIC C—H STRETCH/C—H DEFORMATION COMBINATION
2180	2178	N—H BEND SECOND OVERTONE OR C—H STRETCH/C—O STRETCH COMBINATION, OR C—O STRETCH C—N STRETCH; N—H IN-PLANE BEND.
2200	2194	CH STRETCH/C—O STRETCH COMBINATION
2280	2284	C—H STRETCH/CH ₂ DEFORMATION
2300	2300	C—H BEND SECOND OVERTONE
2325	2320	CH STRETCH/CH ₂ DEFORMATION COMBINATION
2352	2352	CH ₂ BEND SECOND OVERTONE
2380	2384	C—H STRETCH/C—C STRETCH COMBINATION
2470	2454	C—H COMBINATION OR SYM C—N—C STRETCH OVERTONE
2488	2485	C—H STRETCH/C—C STRETCH COMBINATION
2530	2524	ASYMMETRIC C—N—C STRETCH FIRST OVERTONE
2530	2537	ASYMMETRIC C—N—C STRETCH FIRST OVERTONE

FIG. 9B

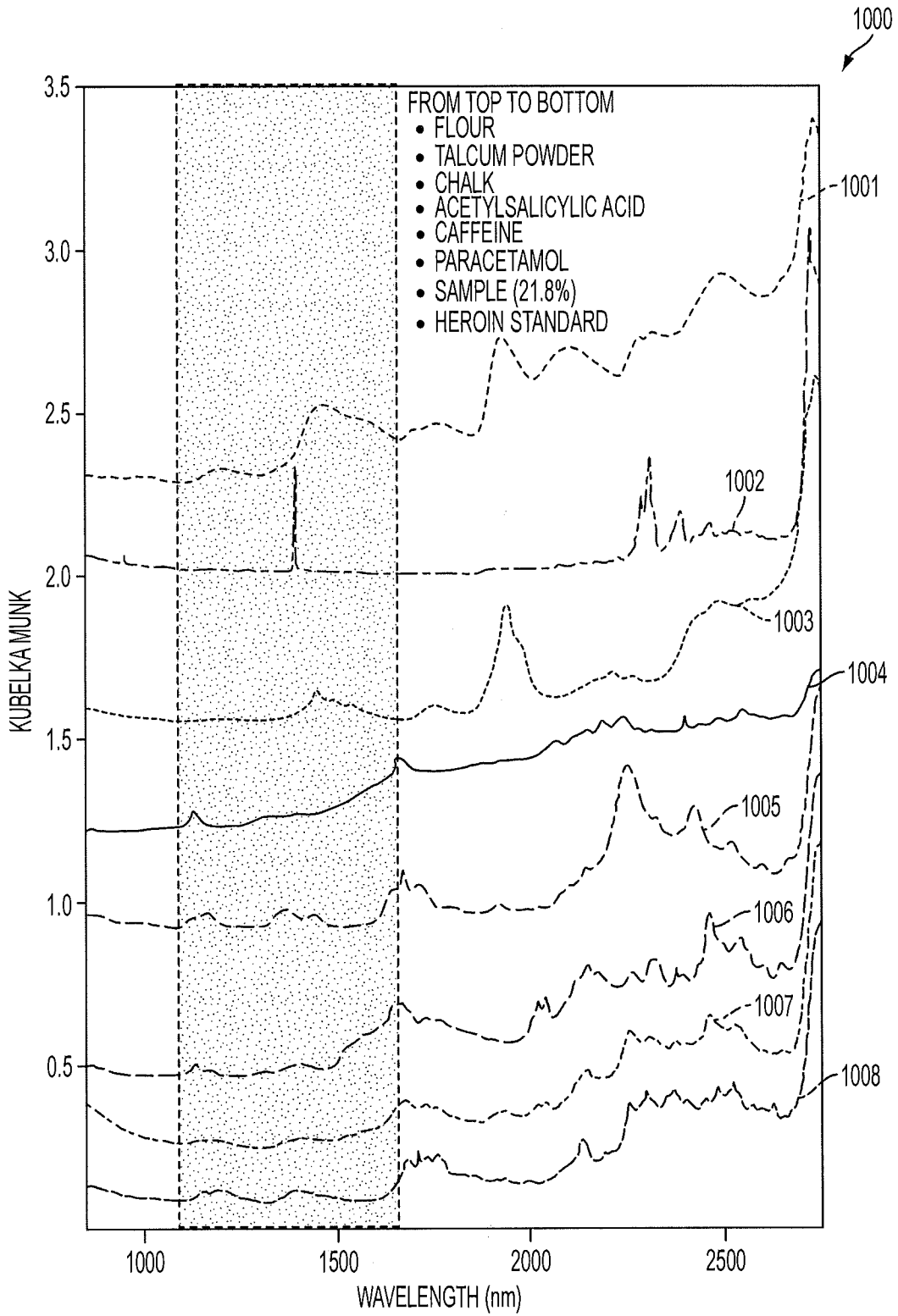

FIG. 10

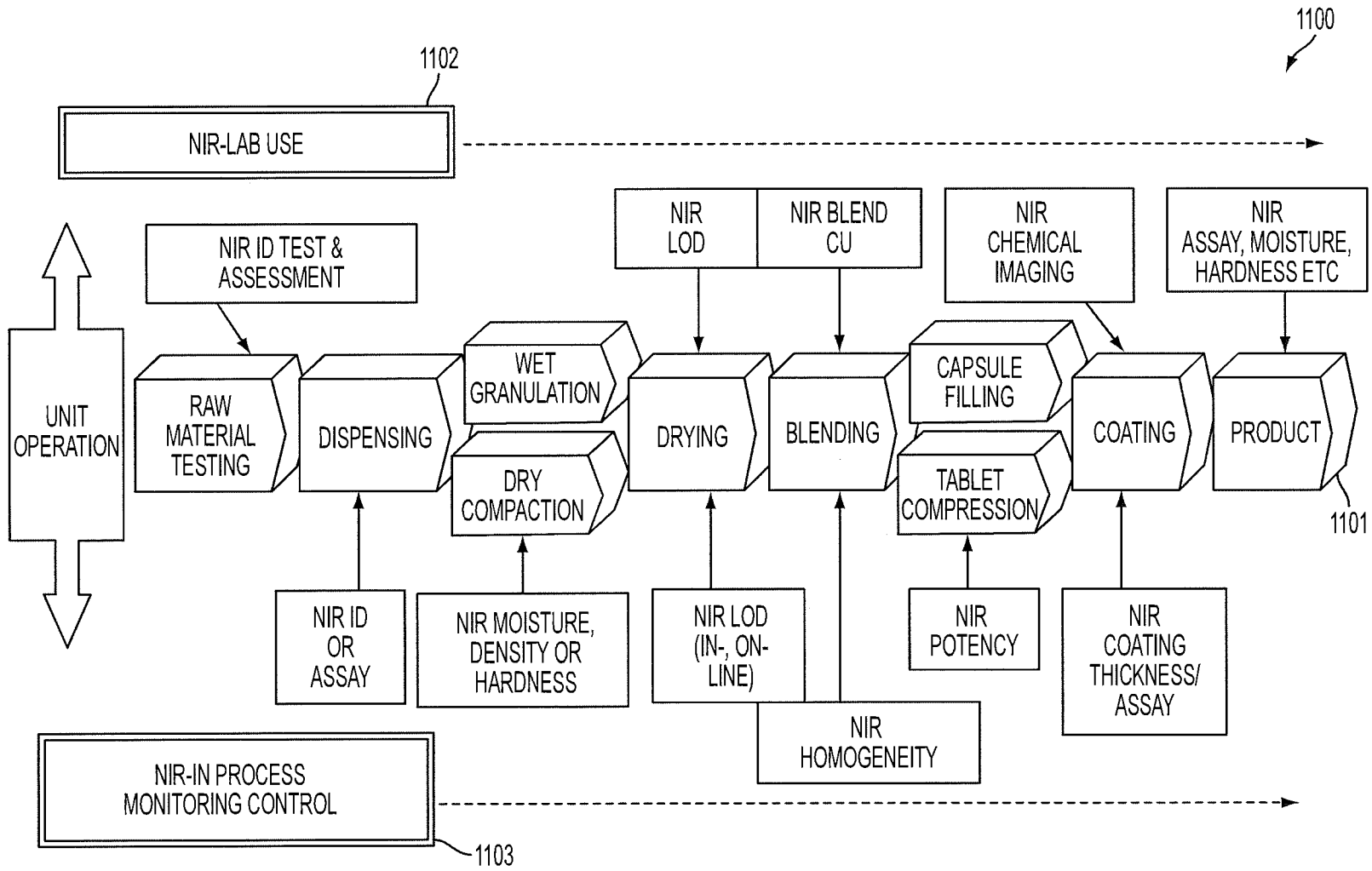

FIG. 11

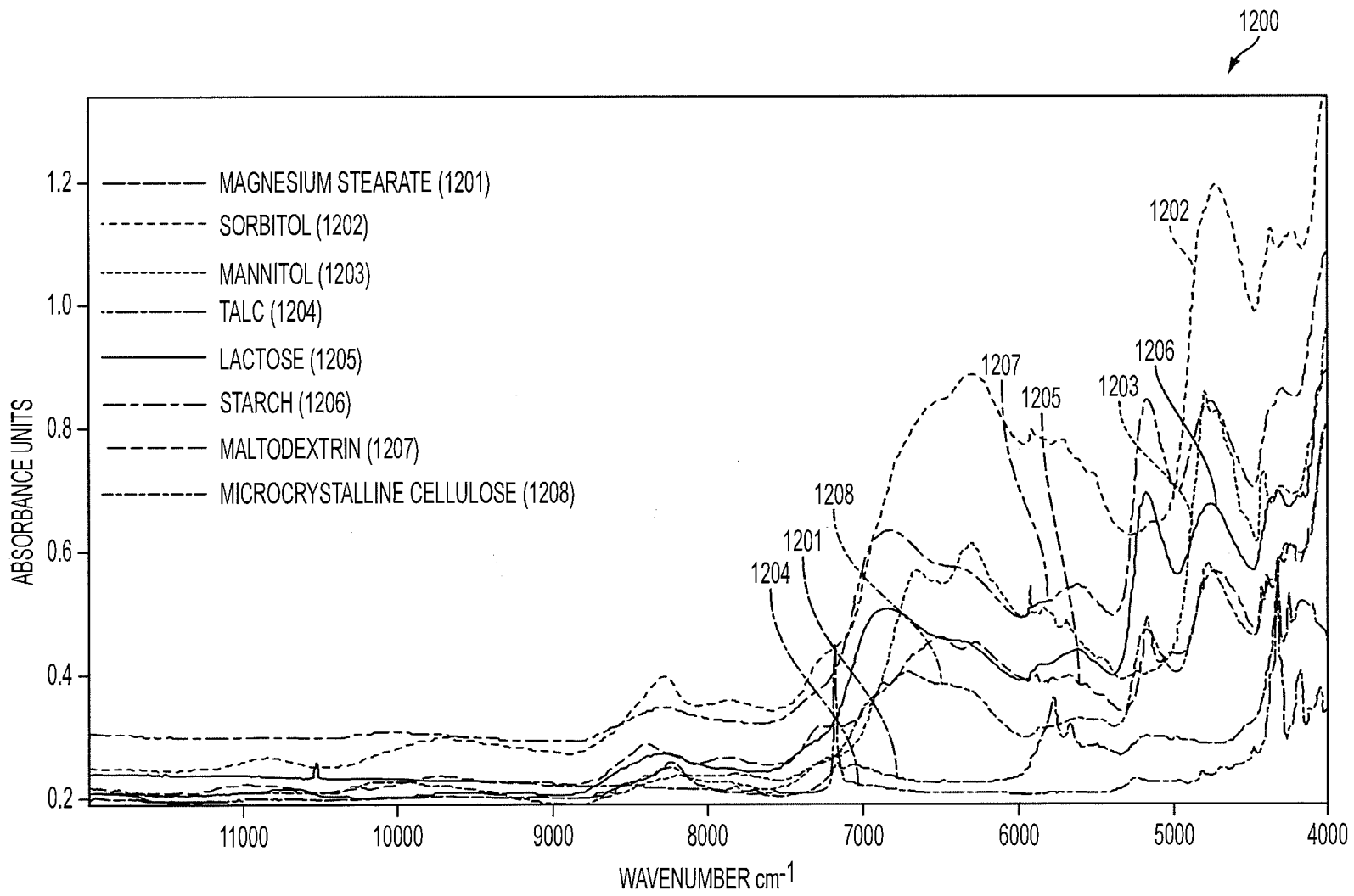

FIG. 12

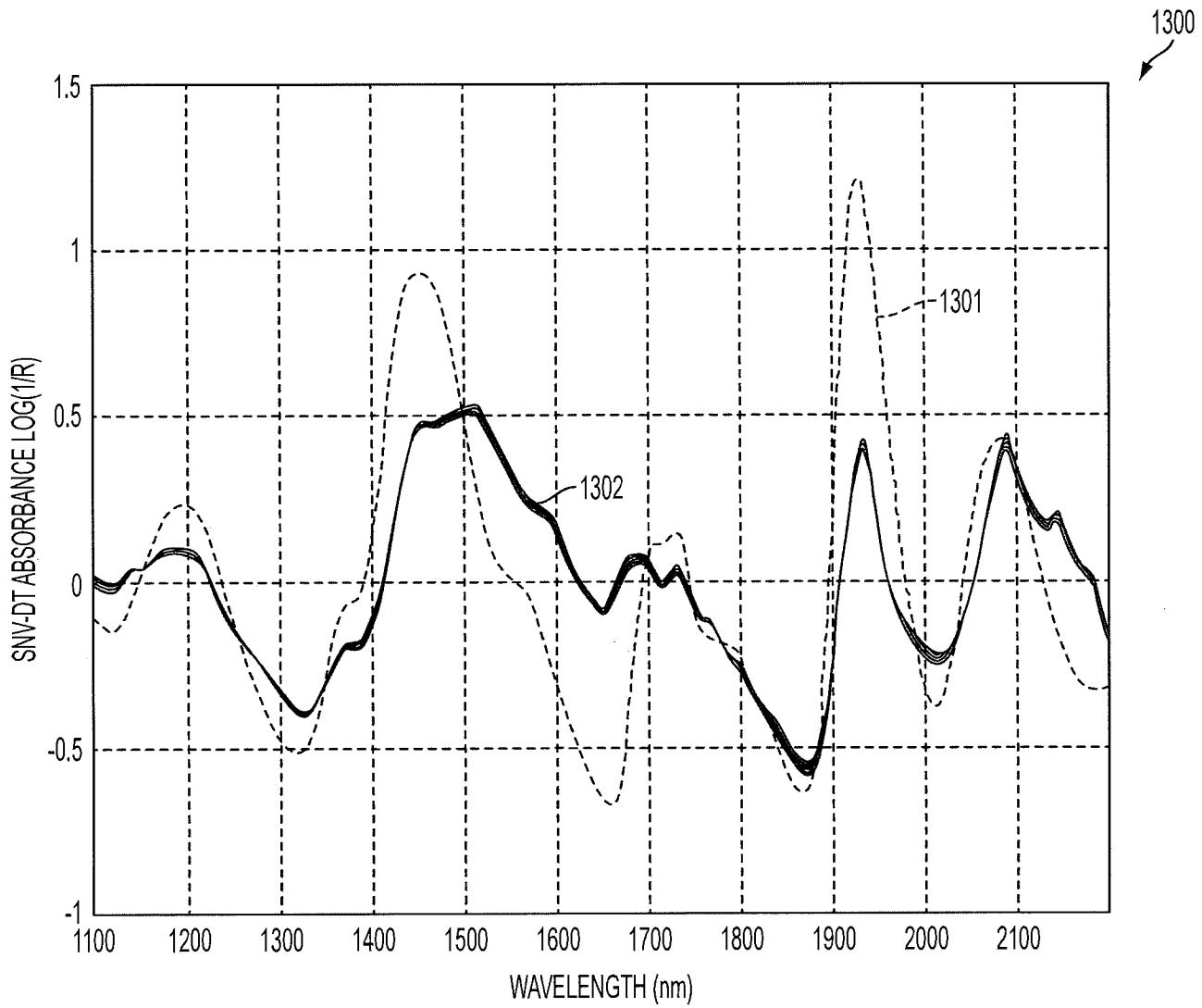

FIG. 13

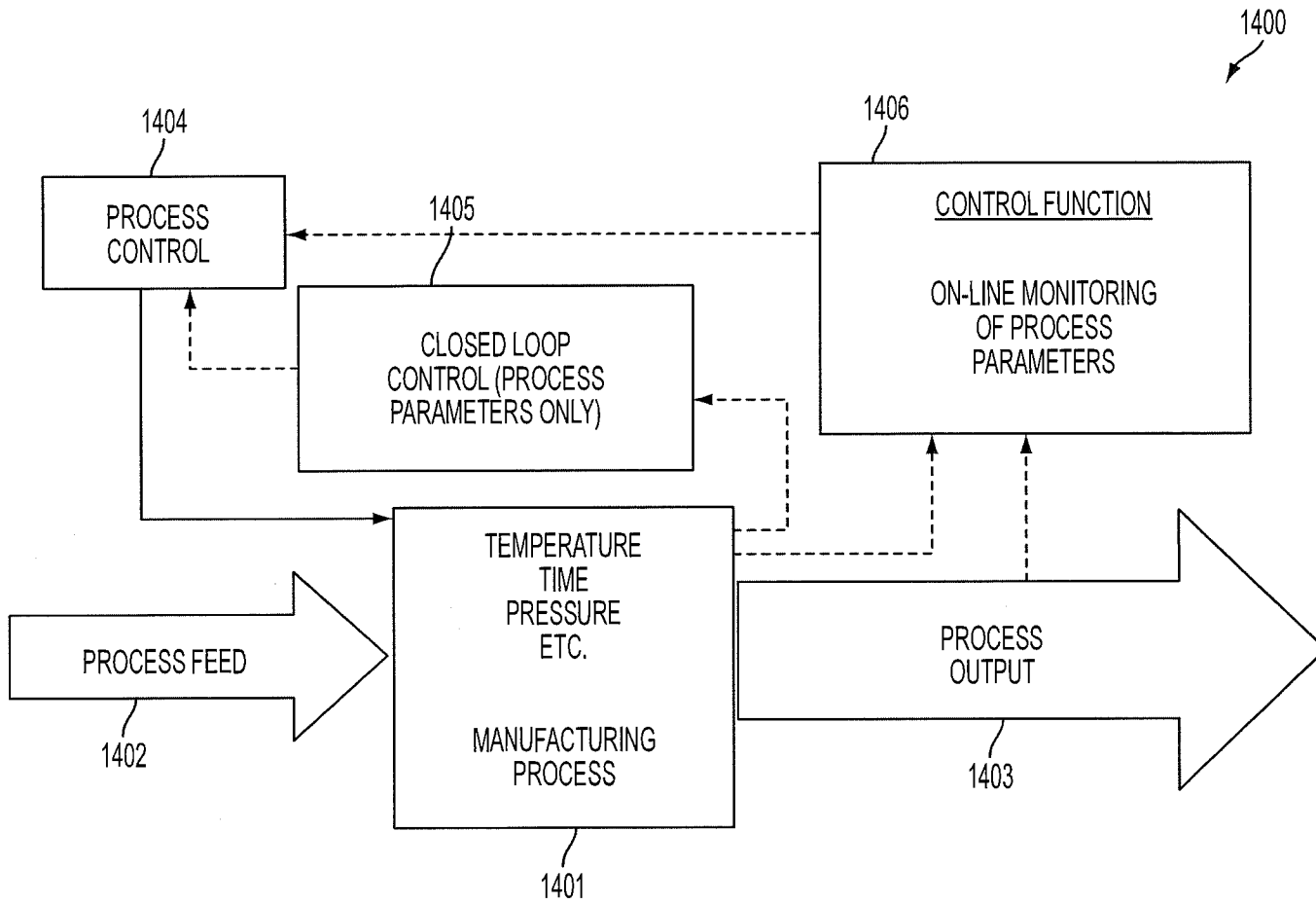

FIG. 14

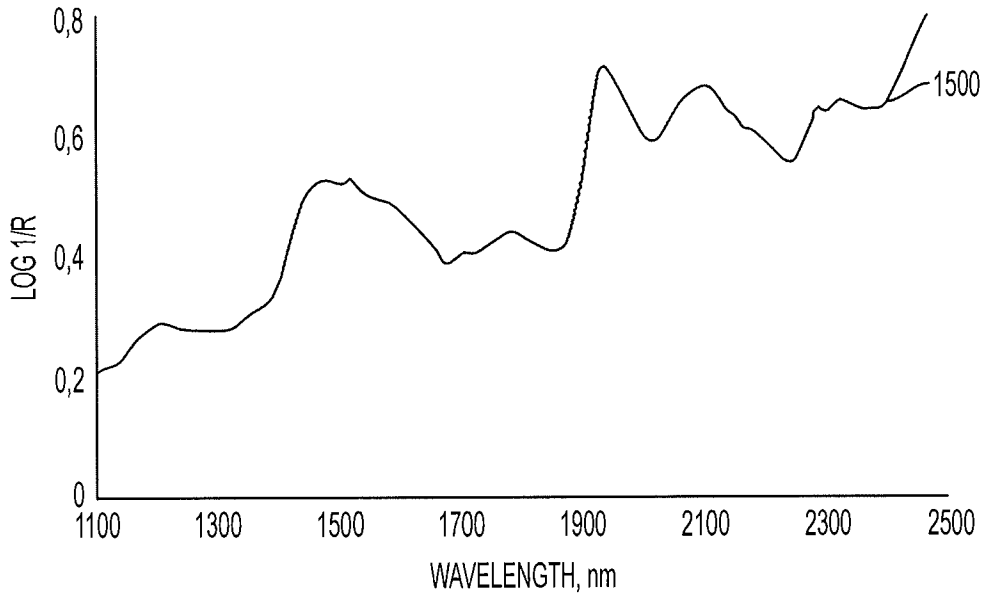

FIG. 15A

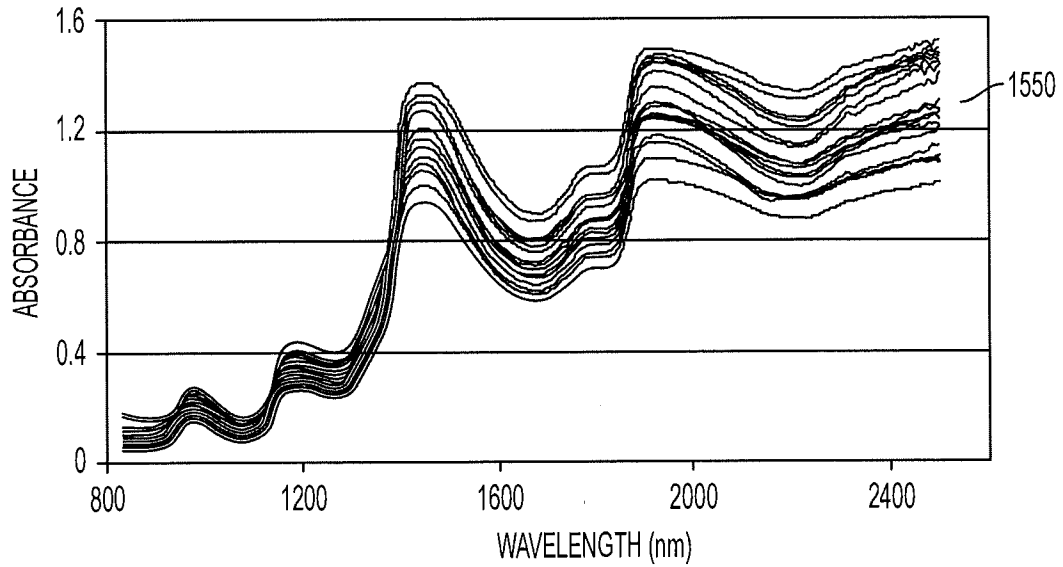

FIG. 15B

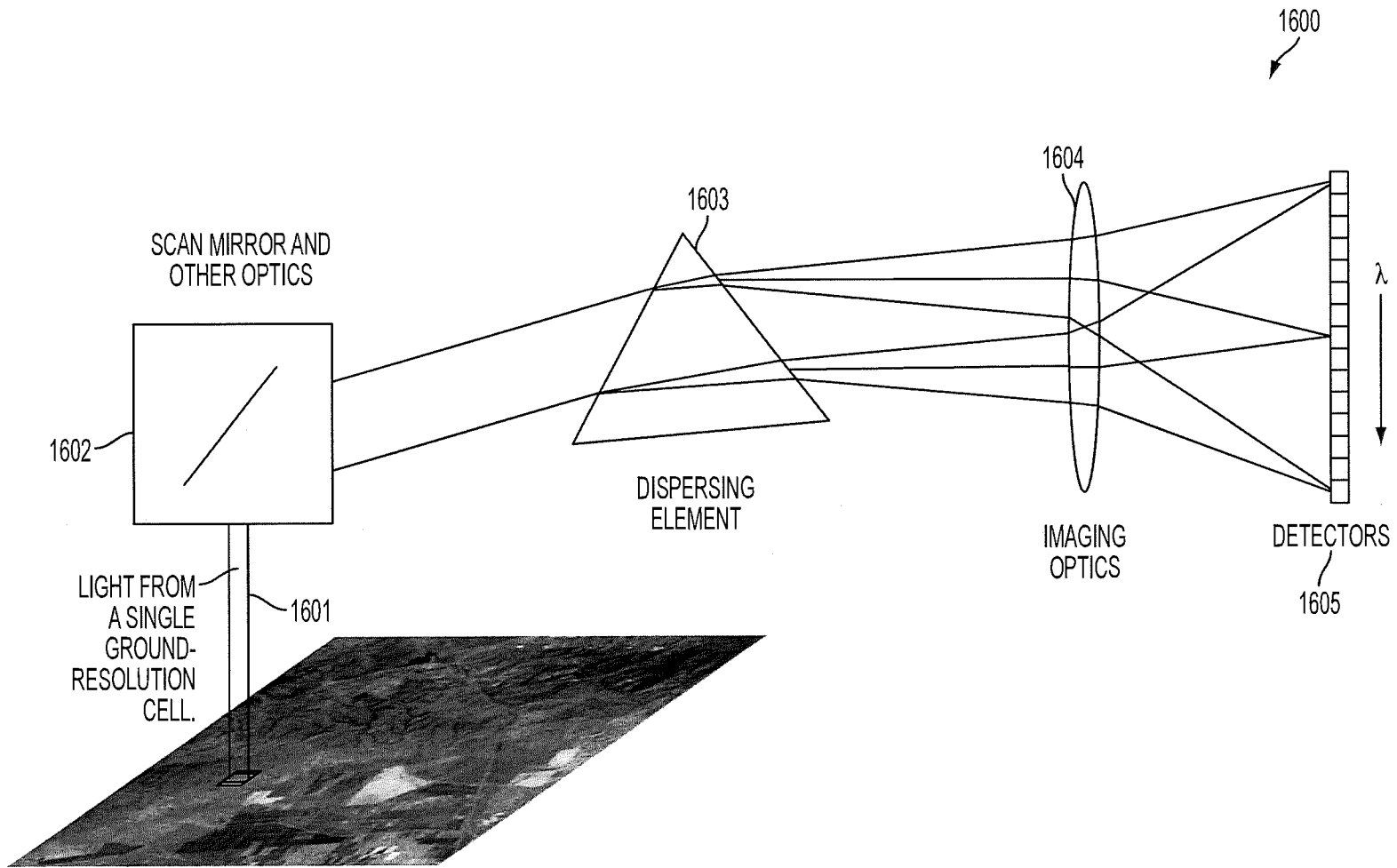

FIG. 16A

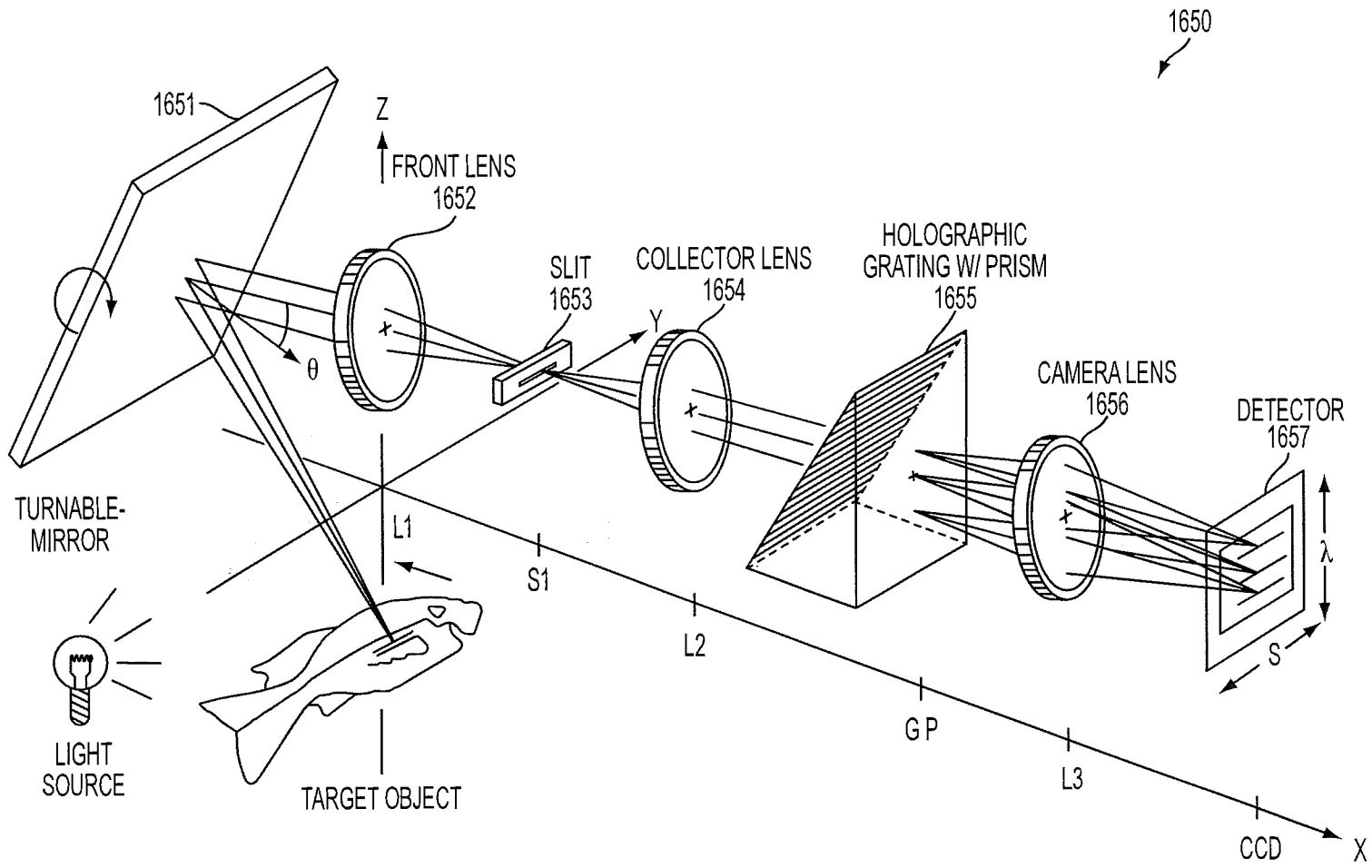

FIG. 16B

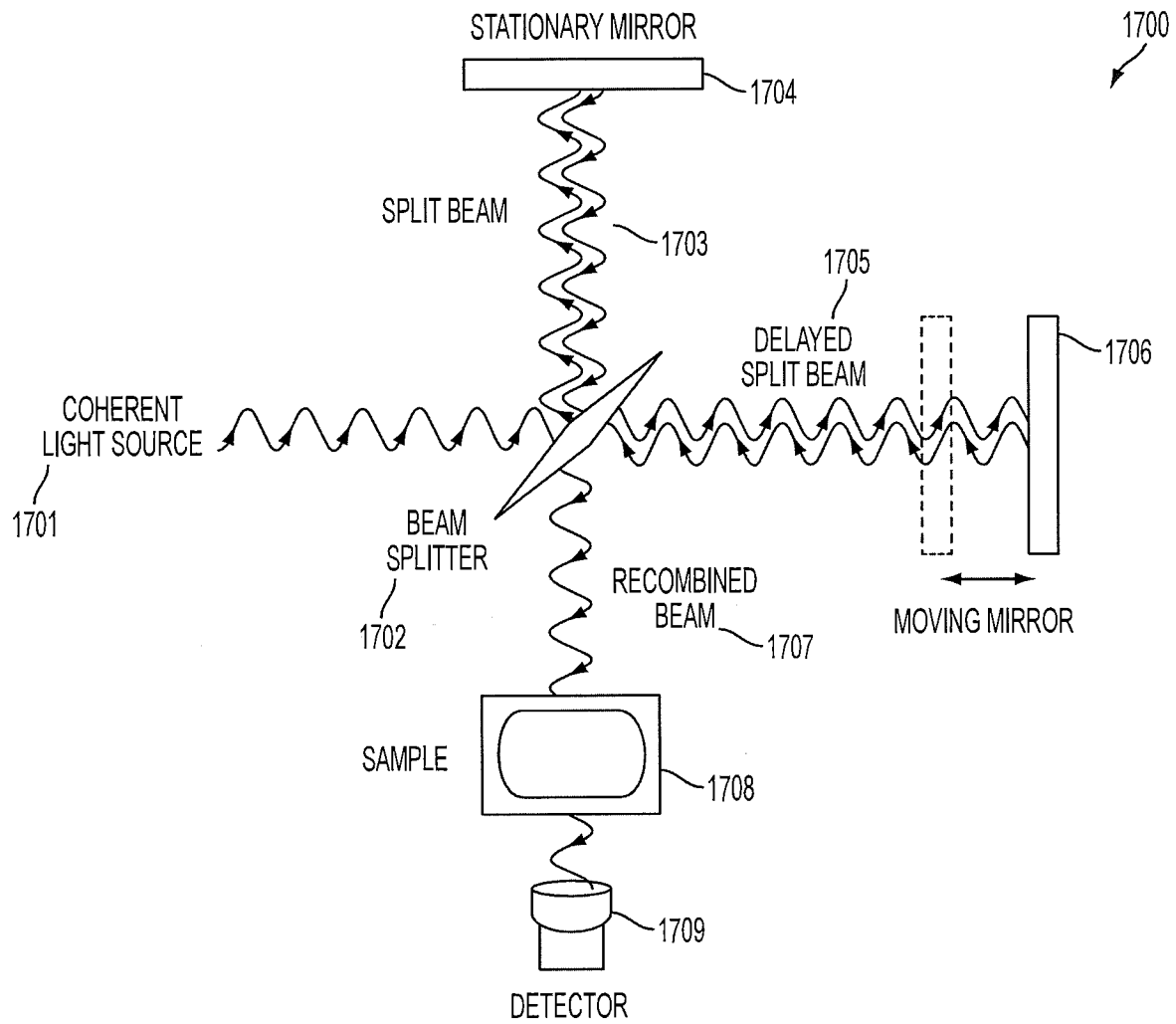

FIG. 17

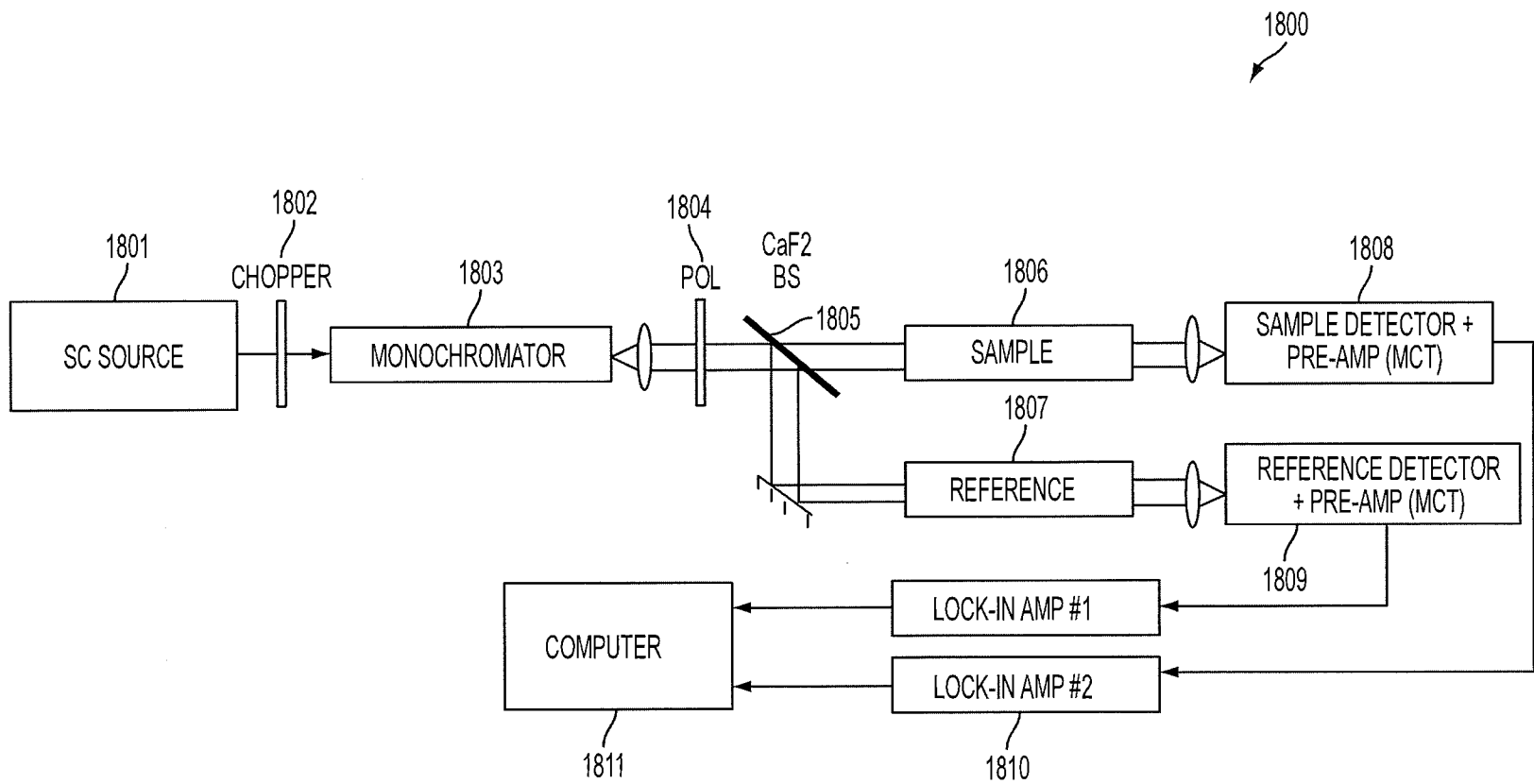

FIG. 18

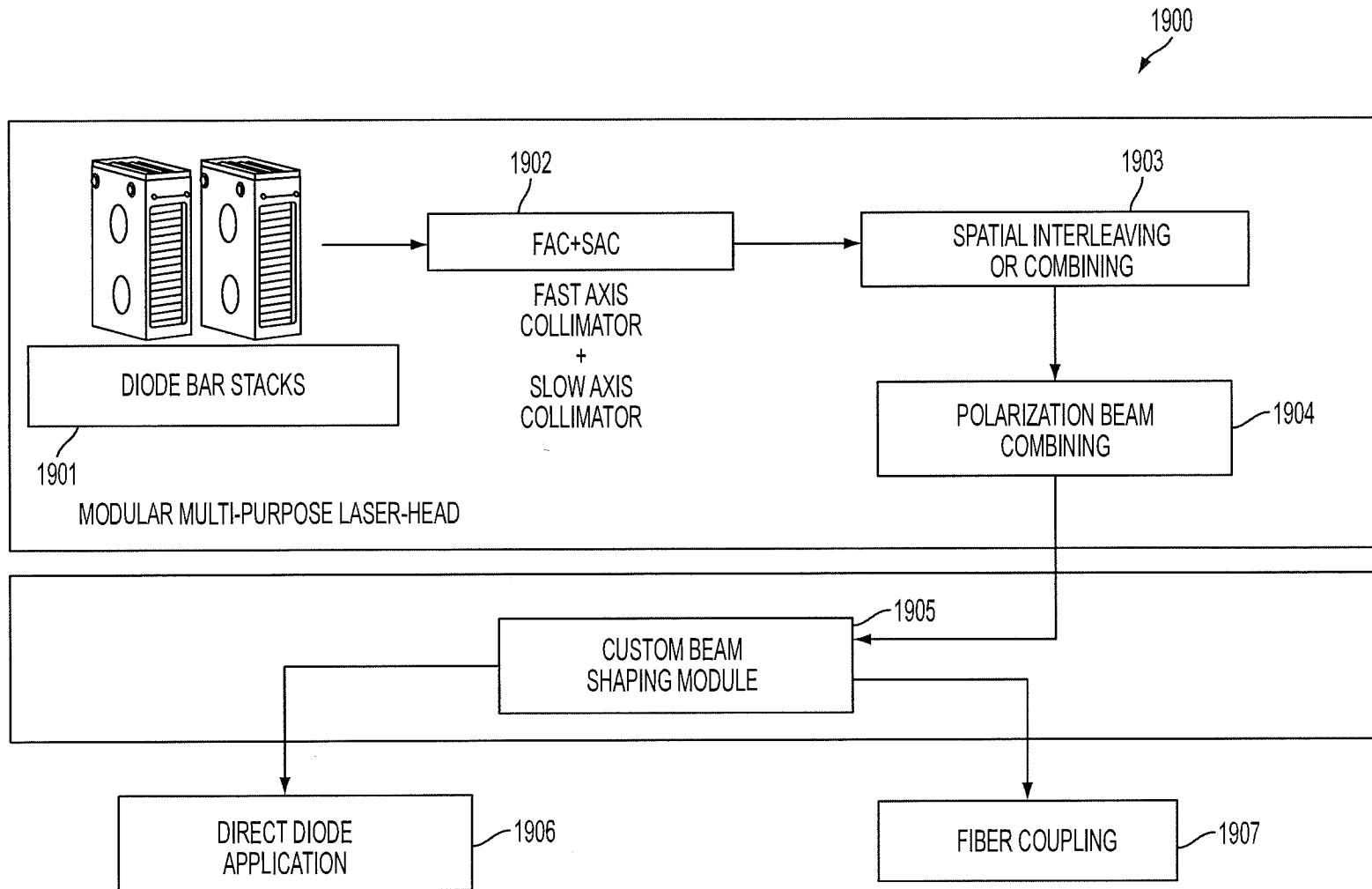

FIG. 19

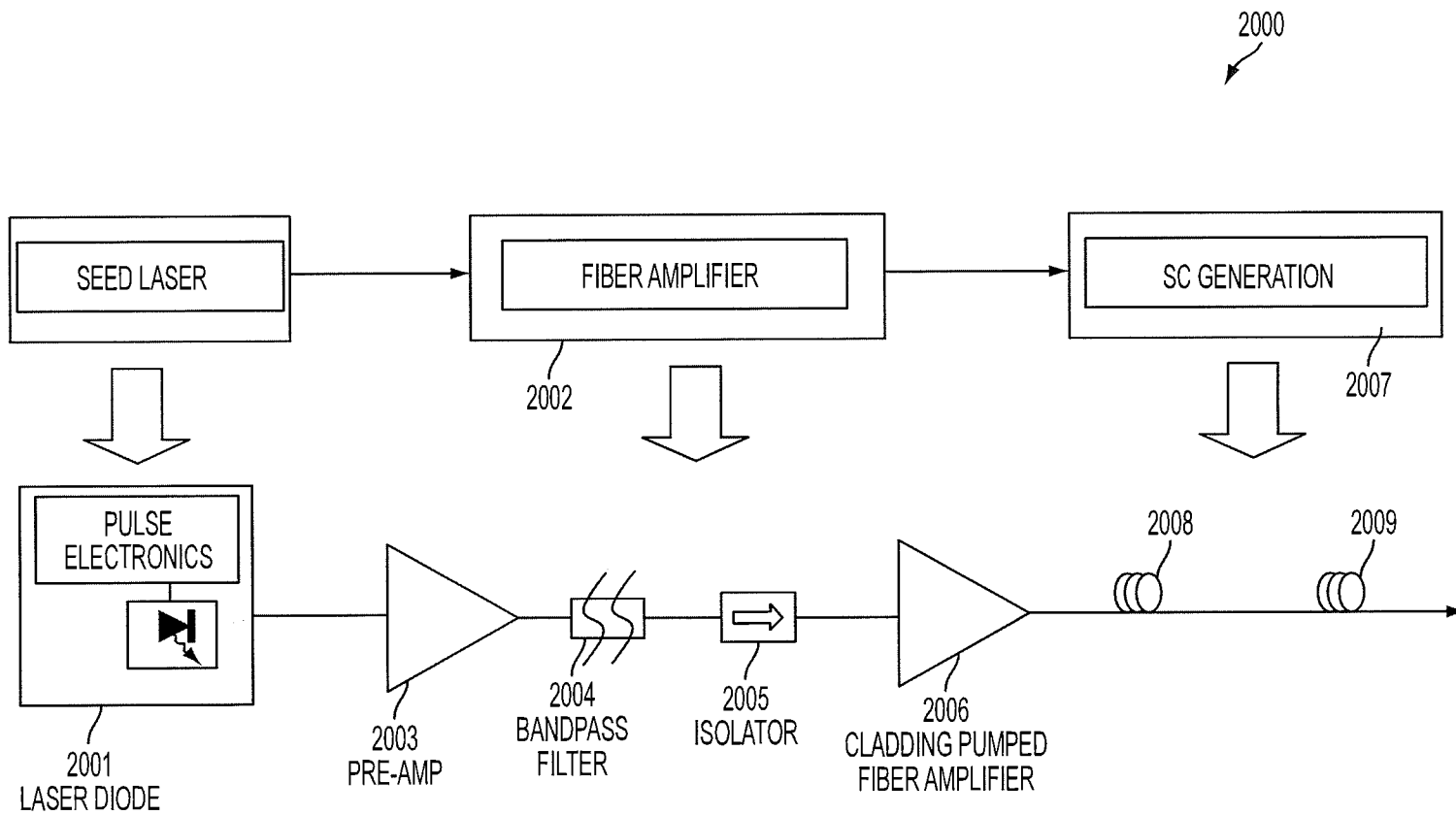

FIG. 20

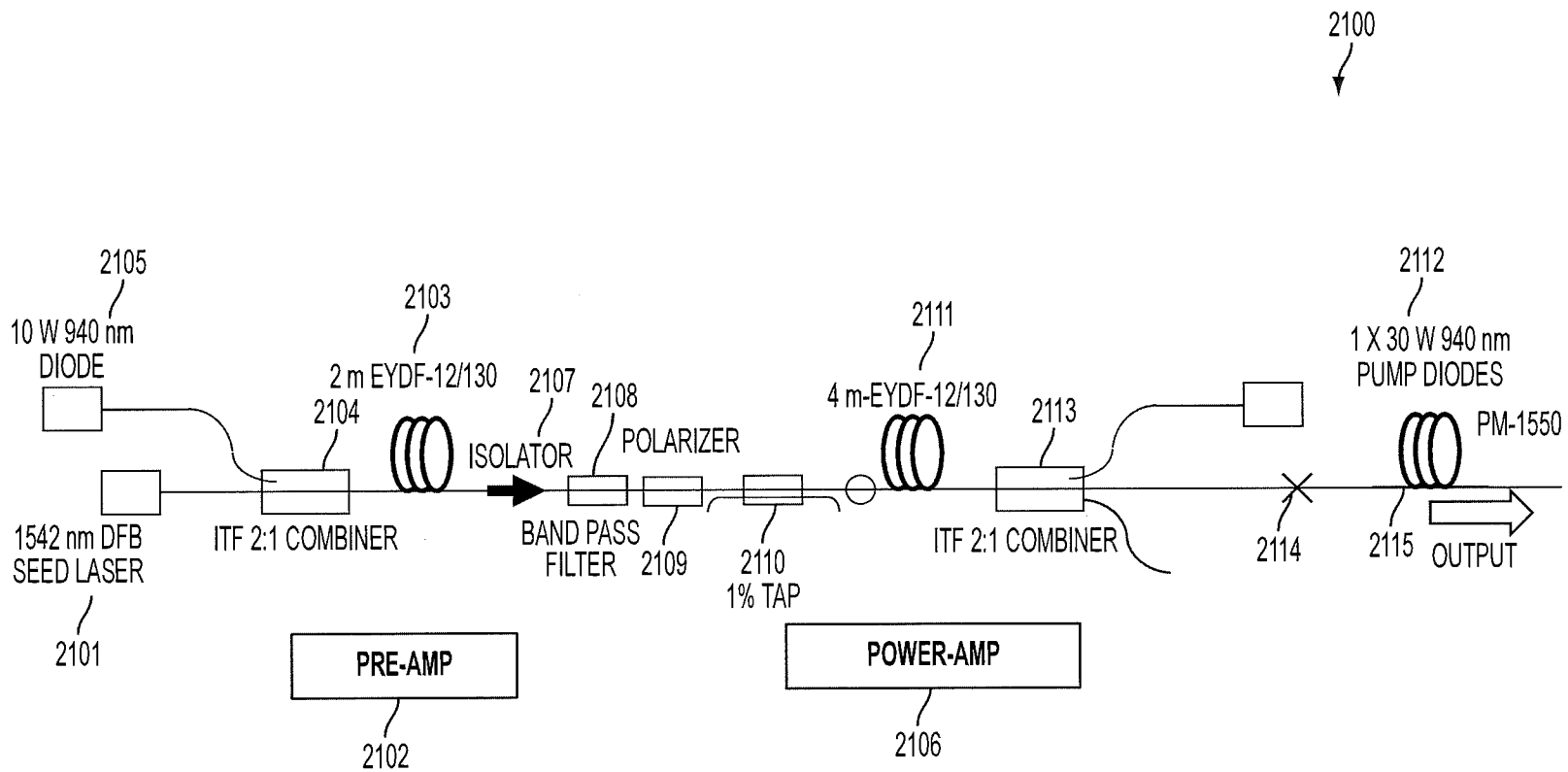

FIG. 21

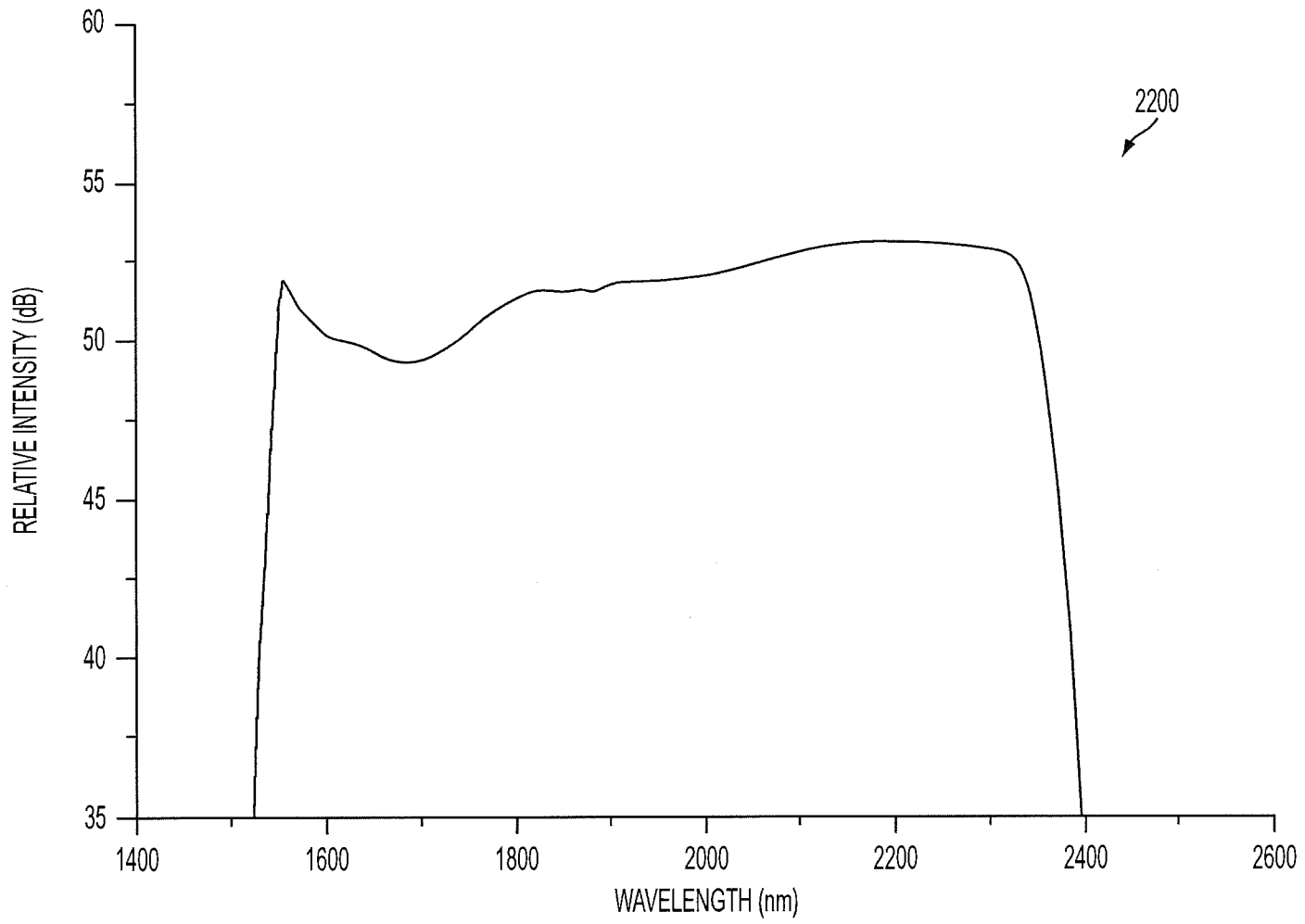

FIG. 22

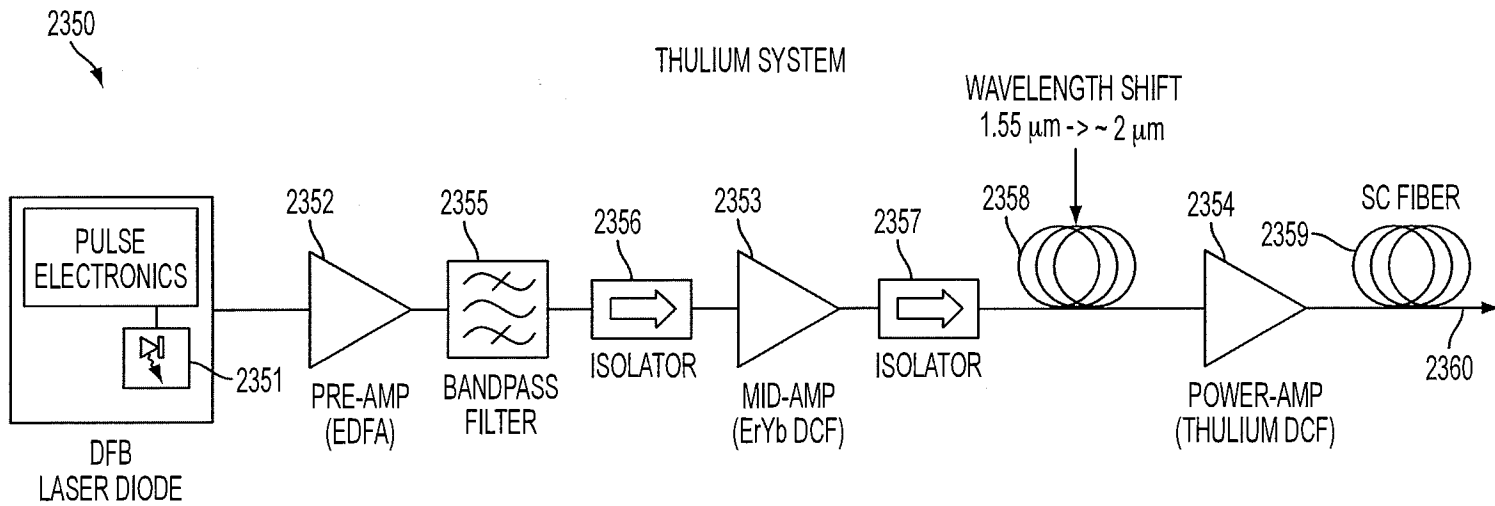
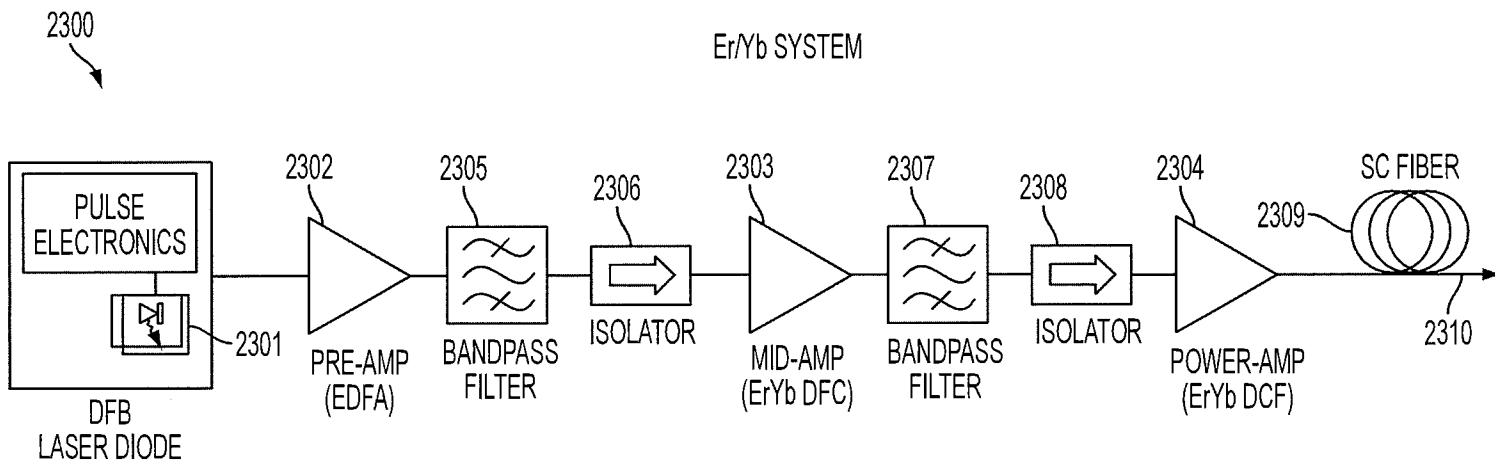

FIG. 23

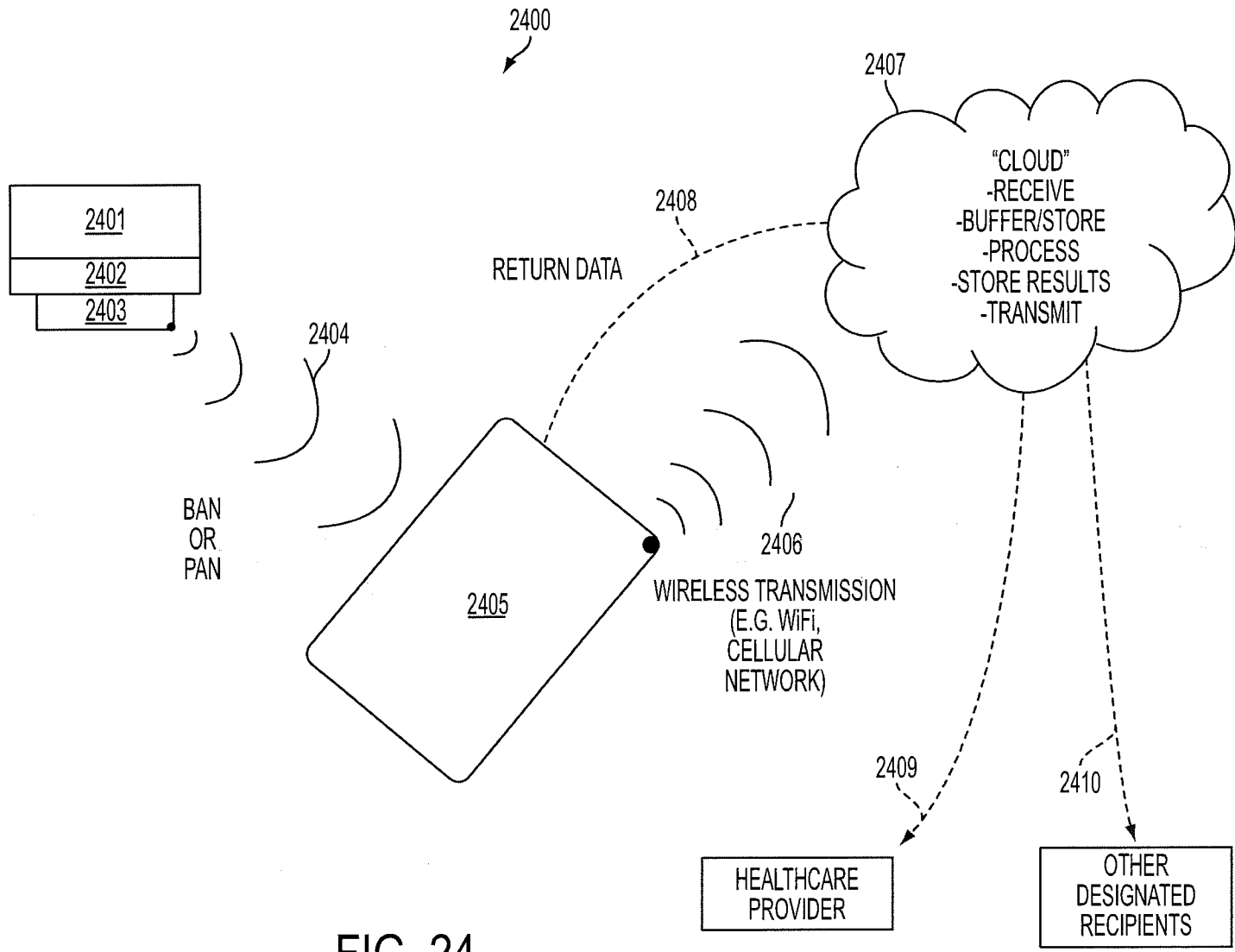

FIG. 24

IN THE UNITED STATES PATENT AND TRADEMARK OFFICE

In re application of:

Mohammed N. ISLAM

Serial No.:

Filed:

For: SHORT-WAVE INFRARED SUPER-CONTINUUM LASERS
 FOR DETECTING COUNTERFEIT OR ILLICIT DRUGS AND
 PHARMACEUTICAL PROCESS CONTROL

Group Art Unit:

Examiner:

Attorney Docket No.: OMNI 0105 PUSP1

INFORMATION DISCLOSURE STATEMENT
UNDER 37 C.F.R. § 1.97(b)(1)

Commissioner for Patents
P.O. Box 1450
Alexandria, VA 22313-1450

Commissioner:

In compliance with the duty of disclosure under 37 C.F.R. § 1.56 and §§ 1.97-1.98, the references listed and identified on the attached Form PTO/SB/08a are being submitted herewith for consideration by the Examiner. This Statement is being filed in accordance with 37 C.F.R. § 1.97(b)(1).

While this Statement is being filed in compliance with the duty of disclosure, citation of the listed references is not to be construed as an admission that any of the references are "material" as defined under 37 C.F.R. § 1.56(b).

In accordance with 37 C.F.R. § 1.98(d), copies of the listed references are not being provided since the references were previously cited by or submitted to the Patent and Trademark

Office in prior application Serial No. 14/108,986, filed December 17, 2013 (pending), of which the present application is a continuation.

Please charge any fees or credit any overpayments as a result of the filing of this paper to our Deposit Account No. 02-3978.

Respectfully submitted,

Mohammed N. ISLAM

By: /David S. Bir/
David S. Bir
Reg. No. 38,383
Attorney/Agent for Applicant

Date: October 1, 2015

BROOKS KUSHMAN P.C.
1000 Town Center, 22nd Floor
Southfield, MI 48075-1238
Phone: 248-358-4400
Fax: 248-358-3351

INFORMATION DISCLOSURE STATEMENT BY APPLICANT (Not for submission under 37 CFR 1.99)	Application Number		
	Filing Date		
	First Named Inventor	Mohammed N. ISLAM	
	Art Unit		
	Examiner Name		
	Attorney Docket Number	OMNI 0105 PUSP1	

U.S.PATENTS						Remove
Examiner Initial*	Cite No	Patent Number	Kind Code ¹	Issue Date	Name of Patentee or Applicant of cited Document	Pages,Columns,Lines where Relevant Passages or Relevant Figures Appear
	1	4063106		1977-12-13	Ashkin, et al.	
	2	4158750		1979-06-19	Sakoe, et al.	
	3	4221997		1980-09-09	Flemming	
	4	4275266		1981-06-23	Lasar	
	5	4374618		1983-02-22	Howard	
	6	4403605		1983-09-13	Tanikawa	
	7	4462080		1984-07-24	Johnstone, et al.	
	8	4516207		1985-05-07	Moriyama, et al.	

**INFORMATION DISCLOSURE
STATEMENT BY APPLICANT**
(Not for submission under 37 CFR 1.99)

Application Number		
Filing Date		
First Named Inventor	Mohammed N. ISLAM	
Art Unit		
Examiner Name		
Attorney Docket Number	OMNI 0105 PUSP1	

9	4523884		1985-06-18	Clement, et al.	
10	4605080		1986-08-12	Lemelson	
11	4641292		1987-02-03	Tunnell, et al.	
12	4704696		1987-11-03	Reimer, et al.	
13	4728974		1988-03-01	Nio, et al.	
14	4762455		1988-08-09	Coughlan, et al.	
15	4776016		1988-10-04	Hansen	
16	4958910		1990-09-25	Taylor, et al.	
17	4989253		1991-01-29	Liang, et al.	
18	5078140		1992-01-07	Kwoh	
19	5084880		1992-01-28	Esterowitz, et al.	

**INFORMATION DISCLOSURE
STATEMENT BY APPLICANT**
(Not for submission under 37 CFR 1.99)

Application Number		
Filing Date		
First Named Inventor	Mohammed N. ISLAM	
Art Unit		
Examiner Name		
Attorney Docket Number	OMNI 0105 PUSP1	

	20	5086401		1992-02-04	Glassman, et al.	
	21	5134620		1992-07-28	Huber	
	22	5142930		1992-09-01	Allen, et al.	
	23	5180378		1993-01-19	Kung, et al.	
	24	5191628		1993-03-02	Byron	
	25	5218655		1993-06-08	Mizrahi	
	26	5230023		1993-07-20	Nakano	
	27	5267256		1993-11-30	Saruwatari, et al.	
	28	5267323		1993-11-30	Kimura	
	29	5300097		1994-04-05	Lerner, et al.	
	30	5303148		1994-04-12	Mattson, et al.	

**INFORMATION DISCLOSURE
STATEMENT BY APPLICANT**
(Not for submission under 37 CFR 1.99)

Application Number		
Filing Date		
First Named Inventor	Mohammed N. ISLAM	
Art Unit		
Examiner Name		
Attorney Docket Number	OMNI 0105 PUSP1	

	31	5305427		1994-04-19	Nagata	
	32	5313306		1994-05-17	Kuban, et al.	
	33	5323404		1994-06-21	Grubb	
	34	5345538		1994-09-06	Narayannan, et al.	
	35	5408409		1995-04-18	Glassman, et al.	
	36	5544654		1996-08-13	Murphy, et al.	
	37	5572999		1996-11-12	Funda, et al.	
	38	5695493		1997-12-09	Nakajima, et al.	
	39	5696778		1997-12-09	MacPherson	
	40	5792204		1998-08-11	Snell	
	41	5812978		1998-09-22	Nolan	

**INFORMATION DISCLOSURE
STATEMENT BY APPLICANT**
(Not for submission under 37 CFR 1.99)

Application Number		
Filing Date		
First Named Inventor	Mohammed N. ISLAM	
Art Unit		
Examiner Name		
Attorney Docket Number	OMNI 0105 PUSP1	

	42	5950629		1999-09-14	Taylor, et al.	
	43	5970457		1999-10-19	Brant, et al.	
	44	6014249		2000-01-11	Fermann, et al.	
	45	6185535		2001-02-06	Hedin, et al.	
	46	6200309		2001-03-13	Rice, et al.	
	47	6224542		2001-05-01	Chang, et al.	
	48	6246707		2001-06-12	Yin, et al.	
	49	6273858		2001-08-14	Fox, et al.	
	50	6278975		2001-08-21	Brant, et al.	
	51	6301273		2001-10-09	Sanders, et al.	
	52	6337462		2002-01-08	Smart	

**INFORMATION DISCLOSURE
STATEMENT BY APPLICANT**
(Not for submission under 37 CFR 1.99)

Application Number		
Filing Date		
First Named Inventor	Mohammed N. ISLAM	
Art Unit		
Examiner Name		
Attorney Docket Number	OMNI 0105 PUSP1	

	53	6340806		2002-01-22	Smart, et al.	
	54	6350261		2002-02-26	Domankevitz, et al.	
	55	6374006		2002-04-16	Islam, et al.	
	56	6407853		2002-06-18	Samson, et al.	
	57	6436107		2002-08-20	Wang, et al.	
	58	6442430		2002-08-27	Ferek-Petric	
	59	6450172		2002-09-17	Hartlaub, et al.	
	60	6453201		2002-09-17	Daum, et al.	
	61	6458120		2002-10-01	Shen, et al.	
	62	6462500		2002-10-08	L'Hegarat, et al.	
	63	6463361		2002-10-08	Wang, et al.	

**INFORMATION DISCLOSURE
STATEMENT BY APPLICANT**
(Not for submission under 37 CFR 1.99)

Application Number		
Filing Date		
First Named Inventor	Mohammed N. ISLAM	
Art Unit		
Examiner Name		
Attorney Docket Number	OMNI 0105 PUSP1	

	64	6567431		2003-05-20	Tabirian, et al.	
	65	6605080		2003-08-12	Altshuler, et al.	
	66	6625180		2003-09-23	Bufetov, et al.	
	67	6631025		2003-10-07	Islam, et al.	
	68	6659999		2003-12-09	Anderson, et al.	
	69	6760148		2004-07-06	Islam	
	70	6885498		2005-04-26	Islam	
	71	6885683		2005-04-26	Fermann, et al.	
	72	6943936		2005-09-13	Islam, et al.	
	73	7027467		2006-04-11	Baev, et al.	
	74	7060061		2006-06-13	Altshuler, et al.	

INFORMATION DISCLOSURE STATEMENT BY APPLICANT (Not for submission under 37 CFR 1.99)	Application Number		
	Filing Date		
	First Named Inventor	Mohammed N. ISLAM	
	Art Unit		
	Examiner Name		
	Attorney Docket Number	OMNI 0105 PUSP1	

	75	7167300		2007-01-23	Fermann, et al.	
	76	7259906		2007-08-21	Islam	
	77	7433116		2008-10-07	Islam	

If you wish to add additional U.S. Patent citation information please click the Add button. [Add](#)

U.S.PATENT APPLICATION PUBLICATIONS

[Remove](#)

Examiner Initial*	Cite No	Publication Number	Kind Code ¹	Publication Date	Name of Patentee or Applicant of cited Document	Pages,Columns,Lines where Relevant Passages or Relevant Figures Appear
	1	20020032468		2002-03-14	Hill, Michael R.S. ; et al.	
	2	20020082612		2002-06-27	Moll, Frederic H. ; et al.	
	3	20020128846		2002-09-12	Miller, Steven C.	
	4	20020178003		2002-11-28	Gehrke, James K. ; et al.	
	5	20040174914		2004-09-09	Fukatsu, Susumu	

If you wish to add additional U.S. Published Application citation information please click the Add button. [Add](#)

FOREIGN PATENT DOCUMENTS

[Remove](#)

INFORMATION DISCLOSURE STATEMENT BY APPLICANT (Not for submission under 37 CFR 1.99)	Application Number		
	Filing Date		
	First Named Inventor	Mohammed N. ISLAM	
	Art Unit		
	Examiner Name		
	Attorney Docket Number	OMNI 0105 PUSP1	

Examiner Initial*	Cite No	Foreign Document Number ³	Country Code ² i	Kind Code ⁴	Publication Date	Name of Patentee or Applicant of cited Document	Pages, Columns, Lines where Relevant Passages or Relevant Figures Appear	T ⁵
	1	EP1148666	EP		2001-10-24	Grant Andrew R et al.		<input type="checkbox"/>
	2	WO01150959	WO		2001-07-19	SUHM		<input type="checkbox"/>
	3	WO09715240	WO		1997-05-01	BRANT		<input type="checkbox"/>
	4	WO97049340	WO		1997-12-31	WANG		<input type="checkbox"/>

If you wish to add additional Foreign Patent Document citation information please click the Add button **Add**

NON-PATENT LITERATURE DOCUMENTS

Remove

Examiner Initials*	Cite No	Include name of the author (in CAPITAL LETTERS), title of the article (when appropriate), title of the item (book, magazine, journal, serial, symposium, catalog, etc), date, pages(s), volume-issue number(s), publisher, city and/or country where published.	T ⁵
	1		<input type="checkbox"/>

If you wish to add additional non-patent literature document citation information please click the Add button **Add**

EXAMINER SIGNATURE

Examiner Signature		Date Considered	
--------------------	--	-----------------	--

*EXAMINER: Initial if reference considered, whether or not citation is in conformance with MPEP 609. Draw line through a citation if not in conformance and not considered. Include copy of this form with next communication to applicant.

¹ See Kind Codes of USPTO Patent Documents at www.USPTO.GOV or MPEP 901.04. ² Enter office that issued the document, by the two-letter code (WIPO Standard ST.3). ³ For Japanese patent documents, the indication of the year of the reign of the Emperor must precede the serial number of the patent document. ⁴ Kind of document by the appropriate symbols as indicated on the document under WIPO Standard ST.16 if possible. ⁵ Applicant is to place a check mark here if English language translation is attached.

INFORMATION DISCLOSURE STATEMENT BY APPLICANT (Not for submission under 37 CFR 1.99)	Application Number		
	Filing Date		
	First Named Inventor	Mohammed N. ISLAM	
	Art Unit		
	Examiner Name		
	Attorney Docket Number	OMNI 0105 PUSP1	

CERTIFICATION STATEMENT

Please see 37 CFR 1.97 and 1.98 to make the appropriate selection(s):

That each item of information contained in the information disclosure statement was first cited in any communication from a foreign patent office in a counterpart foreign application not more than three months prior to the filing of the information disclosure statement. See 37 CFR 1.97(e)(1).

OR

That no item of information contained in the information disclosure statement was cited in a communication from a foreign patent office in a counterpart foreign application, and, to the knowledge of the person signing the certification after making reasonable inquiry, no item of information contained in the information disclosure statement was known to any individual designated in 37 CFR 1.56(c) more than three months prior to the filing of the information disclosure statement. See 37 CFR 1.97(e)(2).

See attached certification statement.

Fee set forth in 37 CFR 1.17 (p) has been submitted herewith.

None

SIGNATURE

A signature of the applicant or representative is required in accordance with CFR 1.33, 10.18. Please see CFR 1.4(d) for the form of the signature.

Signature	/David S. Bir/	Date (YYYY-MM-DD)	2015-10-01
Name/Print	David S. Bir	Registration Number	38383

This collection of information is required by 37 CFR 1.97 and 1.98. The information is required to obtain or retain a benefit by the public which is to file (and by the USPTO to process) an application. Confidentiality is governed by 35 U.S.C. 122 and 37 CFR 1.14. This collection is estimated to take 1 hour to complete, including gathering, preparing and submitting the completed application form to the USPTO. Time will vary depending upon the individual case. Any comments on the amount of time you require to complete this form and/or suggestions for reducing this burden, should be sent to the Chief Information Officer, U.S. Patent and Trademark Office, U.S. Department of Commerce, P.O. Box 1450, Alexandria, VA 22313-1450. **DO NOT SEND FEES OR COMPLETED FORMS TO THIS ADDRESS. SEND TO: Commissioner for Patents, P.O. Box 1450, Alexandria, VA 22313-1450.**

Privacy Act Statement

The Privacy Act of 1974 (P.L. 93-579) requires that you be given certain information in connection with your submission of the attached form related to a patent application or patent. Accordingly, pursuant to the requirements of the Act, please be advised that: (1) the general authority for the collection of this information is 35 U.S.C. 2(b)(2); (2) furnishing of the information solicited is voluntary; and (3) the principal purpose for which the information is used by the U.S. Patent and Trademark Office is to process and/or examine your submission related to a patent application or patent. If you do not furnish the requested information, the U.S. Patent and Trademark Office may not be able to process and/or examine your submission, which may result in termination of proceedings or abandonment of the application or expiration of the patent.

The information provided by you in this form will be subject to the following routine uses:

1. The information on this form will be treated confidentially to the extent allowed under the Freedom of Information Act (5 U.S.C. 552) and the Privacy Act (5 U.S.C. 552a). Records from this system of records may be disclosed to the Department of Justice to determine whether the Freedom of Information Act requires disclosure of these records.
2. A record from this system of records may be disclosed, as a routine use, in the course of presenting evidence to a court, magistrate, or administrative tribunal, including disclosures to opposing counsel in the course of settlement negotiations.
3. A record in this system of records may be disclosed, as a routine use, to a Member of Congress submitting a request involving an individual, to whom the record pertains, when the individual has requested assistance from the Member with respect to the subject matter of the record.
4. A record in this system of records may be disclosed, as a routine use, to a contractor of the Agency having need for the information in order to perform a contract. Recipients of information shall be required to comply with the requirements of the Privacy Act of 1974, as amended, pursuant to 5 U.S.C. 552a(m).
5. A record related to an International Application filed under the Patent Cooperation Treaty in this system of records may be disclosed, as a routine use, to the International Bureau of the World Intellectual Property Organization, pursuant to the Patent Cooperation Treaty.
6. A record in this system of records may be disclosed, as a routine use, to another federal agency for purposes of National Security review (35 U.S.C. 181) and for review pursuant to the Atomic Energy Act (42 U.S.C. 218(c)).
7. A record from this system of records may be disclosed, as a routine use, to the Administrator, General Services, or his/her designee, during an inspection of records conducted by GSA as part of that agency's responsibility to recommend improvements in records management practices and programs, under authority of 44 U.S.C. 2904 and 2906. Such disclosure shall be made in accordance with the GSA regulations governing inspection of records for this purpose, and any other relevant (i.e., GSA or Commerce) directive. Such disclosure shall not be used to make determinations about individuals.
8. A record from this system of records may be disclosed, as a routine use, to the public after either publication of the application pursuant to 35 U.S.C. 122(b) or issuance of a patent pursuant to 35 U.S.C. 151. Further, a record may be disclosed, subject to the limitations of 37 CFR 1.14, as a routine use, to the public if the record was filed in an application which became abandoned or in which the proceedings were terminated and which application is referenced by either a published application, an application open to public inspections or an issued patent.
9. A record from this system of records may be disclosed, as a routine use, to a Federal, State, or local law enforcement agency, if the USPTO becomes aware of a violation or potential violation of law or regulation.

INFORMATION DISCLOSURE STATEMENT BY APPLICANT (Not for submission under 37 CFR 1.99)	Application Number		
	Filing Date		
	First Named Inventor	Mohammed N. ISLAM	
	Art Unit		
	Examiner Name		
	Attorney Docket Number	OMNI 0105 PUSP1	

U.S.PATENTS						Remove
Examiner Initial*	Cite No	Patent Number	Kind Code ¹	Issue Date	Name of Patentee or Applicant of cited Document	Pages,Columns,Lines where Relevant Passages or Relevant Figures Appear
	1	5084880		1992-01-28	Esterowitz, et al.	
	2	5180378		1993-01-19	Kung, et al.	
	3	5400165		1995-03-21	Gnauck, et al.	
	4	5458122		1995-10-17	Hethuin	
	5	5617871		1997-04-08	Burrows	
	6	5631758		1997-05-20	Knox, et al.	
	7	5687734		1997-11-18	Dempsey, et al.	
	8	5696778		1997-12-09	MacPherson	

**INFORMATION DISCLOSURE
STATEMENT BY APPLICANT**
(Not for submission under 37 CFR 1.99)

Application Number		
Filing Date		
First Named Inventor	Mohammed N. ISLAM	
Art Unit		
Examiner Name		
Attorney Docket Number	OMNI 0105 PUSP1	

9	5704351		1998-01-06	Mortara, et al.	
10	5718234		1998-02-17	Warden, et al.	
11	5748103		1998-05-05	Flach, et al.	
12	5855550		1999-01-05	Lai, et al.	
13	5862803		1999-01-26	Besson, et al.	
14	5867305		1999-02-02	Waarts, et al.	
15	5912749		1999-06-15	Harstead, et al.	
16	5944659		1999-08-31	Flach, et al.	
17	5957854		1999-09-28	Besson, et al.	
18	6014249		2000-01-11	Fermann, et al.	
19	6043927		2000-03-28	Islam	

**INFORMATION DISCLOSURE
STATEMENT BY APPLICANT**
(Not for submission under 37 CFR 1.99)

Application Number		
Filing Date		
First Named Inventor	Mohammed N. ISLAM	
Art Unit		
Examiner Name		
Attorney Docket Number	OMNI 0105 PUSP1	

	20	6289238		2001-09-11	Besson, et al.	
	21	6333803		2001-12-25	Kurotori, et al.	
	22	6364834		2002-04-02	Reuss, et al.	
	23	6381391		2002-04-30	Islam, et al.	
	24	6402691		2002-06-11	Peddicord, et al.	
	25	6407853		2002-06-18	Samson, et al.	
	26	6441747		2002-08-27	Khair, et al.	
	27	6443890		2002-09-03	Schulze, et al.	
	28	6454705		2002-09-24	Cosentino, et al.	
	29	6480656		2002-11-12	Islam, et al.	
	30	6549702		2003-04-15	Islam, et al.	

**INFORMATION DISCLOSURE
STATEMENT BY APPLICANT**
(Not for submission under 37 CFR 1.99)

Application Number		
Filing Date		
First Named Inventor	Mohammed N. ISLAM	
Art Unit		
Examiner Name		
Attorney Docket Number	OMNI 0105 PUSP1	

31	6603910		2003-08-05	Islam, et al.	
32	6659947		2003-12-09	Carter, et al.	
33	6802811		2004-10-12	Slepian	
34	7167300		2007-01-23	Fermann, et al.	
35	7209657		2007-04-24	Islam	
36	7263288		2007-08-28	Islam	
37	7519253		2009-04-14	Islam	

If you wish to add additional U.S. Patent citation information please click the Add button.

[Add](#)

U.S.PATENT APPLICATION PUBLICATIONS

[Remove](#)

Examiner Initial*	Cite No	Publication Number	Kind Code ¹	Publication Date	Name of Patentee or Applicant of cited Document	Pages,Columns,Lines where Relevant Passages or Relevant Figures Appear
	1	20020013518		2002-01-31	West, Kenneth G. ; et al.	
	2	20020019584		2002-02-14	Schulze, Arthur E. ; et al.	

**INFORMATION DISCLOSURE
STATEMENT BY APPLICANT**
(Not for submission under 37 CFR 1.99)

Application Number		
Filing Date		
First Named Inventor	Mohammed N. ISLAM	
Art Unit		
Examiner Name		
Attorney Docket Number	OMNI 0105 PUSP1	

3	20020032468		2002-03-14	Hill, Michael R.S. ; et al.	
4	20020082612		2002-06-27	Moll, Frederic H. ; et al.	
5	20020109621		2002-08-15	Khair, Mohammad ; et al.	
6	20020115914		2002-08-22	Russ, Tomas	
7	20020178003		2002-11-28	Gehrke, James K. ; et al.	
8	20040174914		2004-09-09	Fukatsu, Susumu	
9	20040240037		2004-12-02	Harter, Donald J.	
10	20050111500		2005-05-26	Harter, Donald J. ; et al.	
11	20060245461		2006-11-02	Islam; Mohammed N.	
12	20060268393		2006-11-30	Islam; Mohammed N.	
13	20070078348		2007-04-05	Holman; Hoi-Ying N.	

INFORMATION DISCLOSURE STATEMENT BY APPLICANT (Not for submission under 37 CFR 1.99)	Application Number		
	Filing Date		
	First Named Inventor	Mohammed N. ISLAM	
	Art Unit		
	Examiner Name		
	Attorney Docket Number	OMNI 0105 PUSP1	

14	20090028193		2009-01-29	Islam; Mohammed N.	
15	20090204110		2009-08-13	Islam; Mohammed N.	

If you wish to add additional U.S. Published Application citation information please click the Add button. **Add**

FOREIGN PATENT DOCUMENTS

Remove

Examiner Initial*	Cite No	Foreign Document Number ³	Country Code ² j	Kind Code ⁴	Publication Date	Name of Patentee or Applicant of cited Document	Pages, Columns, Lines where Relevant Passages or Relevant Figures Appear	T ⁵
	1	200189362	WO		2001-11-29	West Kenneth G et al.		<input type="checkbox"/>
	2	200227640	WO		2002-04-04	Whittington Charles Lynn et al.		<input type="checkbox"/>
	3	200228123	WO		2002-04-04	Whittington Charles Lynn		<input type="checkbox"/>

If you wish to add additional Foreign Patent Document citation information please click the Add button **Add**

NON-PATENT LITERATURE DOCUMENTS

Remove

Examiner Initials*	Cite No	Include name of the author (in CAPITAL LETTERS), title of the article (when appropriate), title of the item (book, magazine, journal, serial, symposium, catalog, etc), date, pages(s), volume-issue number(s), publisher, city and/or country where published.	T ⁵
	1		<input type="checkbox"/>

If you wish to add additional non-patent literature document citation information please click the Add button **Add**

EXAMINER SIGNATURE

Examiner Signature		Date Considered	
--------------------	--	-----------------	--

*EXAMINER: Initial if reference considered, whether or not citation is in conformance with MPEP 609. Draw line through a citation if not in conformance and not considered. Include copy of this form with next communication to applicant.

**INFORMATION DISCLOSURE
STATEMENT BY APPLICANT**
(Not for submission under 37 CFR 1.99)

Application Number		
Filing Date		
First Named Inventor	Mohammed N. ISLAM	
Art Unit		
Examiner Name		
Attorney Docket Number	OMNI 0105 PUSP1	

¹ See Kind Codes of USPTO Patent Documents at www.USPTO.GOV or MPEP 901.04. ² Enter office that issued the document, by the two-letter code (WIPO Standard ST.3). ³ For Japanese patent documents, the indication of the year of the reign of the Emperor must precede the serial number of the patent document. ⁴ Kind of document by the appropriate symbols as indicated on the document under WIPO Standard ST.16 if possible. ⁵ Applicant is to place a check mark here if English language translation is attached.

**INFORMATION DISCLOSURE
STATEMENT BY APPLICANT**
(Not for submission under 37 CFR 1.99)

Application Number		
Filing Date		
First Named Inventor	Mohammed N. ISLAM	
Art Unit		
Examiner Name		
Attorney Docket Number	OMNI 0105 PUSP1	

CERTIFICATION STATEMENT

Please see 37 CFR 1.97 and 1.98 to make the appropriate selection(s):

That each item of information contained in the information disclosure statement was first cited in any communication from a foreign patent office in a counterpart foreign application not more than three months prior to the filing of the information disclosure statement. See 37 CFR 1.97(e)(1).

OR

That no item of information contained in the information disclosure statement was cited in a communication from a foreign patent office in a counterpart foreign application, and, to the knowledge of the person signing the certification after making reasonable inquiry, no item of information contained in the information disclosure statement was known to any individual designated in 37 CFR 1.56(c) more than three months prior to the filing of the information disclosure statement. See 37 CFR 1.97(e)(2).

See attached certification statement.

Fee set forth in 37 CFR 1.17 (p) has been submitted herewith.

None

SIGNATURE

A signature of the applicant or representative is required in accordance with CFR 1.33, 10.18. Please see CFR 1.4(d) for the form of the signature.

Signature	/David S. Bir/	Date (YYYY-MM-DD)	2015-10-01
Name/Print	David S. Bir	Registration Number	38383

This collection of information is required by 37 CFR 1.97 and 1.98. The information is required to obtain or retain a benefit by the public which is to file (and by the USPTO to process) an application. Confidentiality is governed by 35 U.S.C. 122 and 37 CFR 1.14. This collection is estimated to take 1 hour to complete, including gathering, preparing and submitting the completed application form to the USPTO. Time will vary depending upon the individual case. Any comments on the amount of time you require to complete this form and/or suggestions for reducing this burden, should be sent to the Chief Information Officer, U.S. Patent and Trademark Office, U.S. Department of Commerce, P.O. Box 1450, Alexandria, VA 22313-1450. **DO NOT SEND FEES OR COMPLETED FORMS TO THIS ADDRESS. SEND TO: Commissioner for Patents, P.O. Box 1450, Alexandria, VA 22313-1450.**

Privacy Act Statement

The Privacy Act of 1974 (P.L. 93-579) requires that you be given certain information in connection with your submission of the attached form related to a patent application or patent. Accordingly, pursuant to the requirements of the Act, please be advised that: (1) the general authority for the collection of this information is 35 U.S.C. 2(b)(2); (2) furnishing of the information solicited is voluntary; and (3) the principal purpose for which the information is used by the U.S. Patent and Trademark Office is to process and/or examine your submission related to a patent application or patent. If you do not furnish the requested information, the U.S. Patent and Trademark Office may not be able to process and/or examine your submission, which may result in termination of proceedings or abandonment of the application or expiration of the patent.

The information provided by you in this form will be subject to the following routine uses:

1. The information on this form will be treated confidentially to the extent allowed under the Freedom of Information Act (5 U.S.C. 552) and the Privacy Act (5 U.S.C. 552a). Records from this system of records may be disclosed to the Department of Justice to determine whether the Freedom of Information Act requires disclosure of these records.
2. A record from this system of records may be disclosed, as a routine use, in the course of presenting evidence to a court, magistrate, or administrative tribunal, including disclosures to opposing counsel in the course of settlement negotiations.
3. A record in this system of records may be disclosed, as a routine use, to a Member of Congress submitting a request involving an individual, to whom the record pertains, when the individual has requested assistance from the Member with respect to the subject matter of the record.
4. A record in this system of records may be disclosed, as a routine use, to a contractor of the Agency having need for the information in order to perform a contract. Recipients of information shall be required to comply with the requirements of the Privacy Act of 1974, as amended, pursuant to 5 U.S.C. 552a(m).
5. A record related to an International Application filed under the Patent Cooperation Treaty in this system of records may be disclosed, as a routine use, to the International Bureau of the World Intellectual Property Organization, pursuant to the Patent Cooperation Treaty.
6. A record in this system of records may be disclosed, as a routine use, to another federal agency for purposes of National Security review (35 U.S.C. 181) and for review pursuant to the Atomic Energy Act (42 U.S.C. 218(c)).
7. A record from this system of records may be disclosed, as a routine use, to the Administrator, General Services, or his/her designee, during an inspection of records conducted by GSA as part of that agency's responsibility to recommend improvements in records management practices and programs, under authority of 44 U.S.C. 2904 and 2906. Such disclosure shall be made in accordance with the GSA regulations governing inspection of records for this purpose, and any other relevant (i.e., GSA or Commerce) directive. Such disclosure shall not be used to make determinations about individuals.
8. A record from this system of records may be disclosed, as a routine use, to the public after either publication of the application pursuant to 35 U.S.C. 122(b) or issuance of a patent pursuant to 35 U.S.C. 151. Further, a record may be disclosed, subject to the limitations of 37 CFR 1.14, as a routine use, to the public if the record was filed in an application which became abandoned or in which the proceedings were terminated and which application is referenced by either a published application, an application open to public inspections or an issued patent.
9. A record from this system of records may be disclosed, as a routine use, to a Federal, State, or local law enforcement agency, if the USPTO becomes aware of a violation or potential violation of law or regulation.

INFORMATION DISCLOSURE STATEMENT BY APPLICANT (Not for submission under 37 CFR 1.99)	Application Number			
	Filing Date			
	First Named Inventor	Mohammed N. ISLAM		
	Art Unit			
	Examiner Name			
	Attorney Docket Number		OMNI 0105 PUSP1	

U.S.PATENTS						Remove
Examiner Initial*	Cite No	Patent Number	Kind Code ¹	Issue Date	Name of Patentee or Applicant of cited Document	Pages,Columns,Lines where Relevant Passages or Relevant Figures Appear
	1	6246896	B1	2001-06-12	DUMOULIN	
	2	6285897	B1	2001-09-04	KILCOYNE	
	3	6847336	B1	2005-01-25	LEMELSON	

If you wish to add additional U.S. Patent citation information please click the Add button. Add

U.S.PATENT APPLICATION PUBLICATIONS						Remove
Examiner Initial*	Cite No	Publication Number	Kind Code ¹	Publication Date	Name of Patentee or Applicant of cited Document	Pages,Columns,Lines where Relevant Passages or Relevant Figures Appear
	1					

If you wish to add additional U.S. Published Application citation information please click the Add button. Add

FOREIGN PATENT DOCUMENTS								Remove
Examiner Initial*	Cite No	Foreign Document Number ³	Country Code ² j	Kind Code ⁴	Publication Date	Name of Patentee or Applicant of cited Document	Pages,Columns,Lines where Relevant Passages or Relevant Figures Appear	T ⁵
	1							<input type="checkbox"/>

INFORMATION DISCLOSURE STATEMENT BY APPLICANT (Not for submission under 37 CFR 1.99)	Application Number		
	Filing Date		
	First Named Inventor	Mohammed N. ISLAM	
	Art Unit		
	Examiner Name		
	Attorney Docket Number	OMNI 0105 PUSP1	

If you wish to add additional Foreign Patent Document citation information please click the Add button **Add**

NON-PATENT LITERATURE DOCUMENTS Remove

Examiner Initials*	Cite No	Include name of the author (in CAPITAL LETTERS), title of the article (when appropriate), title of the item (book, magazine, journal, serial, symposium, catalog, etc), date, pages(s), volume-issue number(s), publisher, city and/or country where published.	T ⁵
	1		<input type="checkbox"/>

If you wish to add additional non-patent literature document citation information please click the Add button **Add**

EXAMINER SIGNATURE

Examiner Signature		Date Considered	
--------------------	--	-----------------	--

*EXAMINER: Initial if reference considered, whether or not citation is in conformance with MPEP 609. Draw line through a citation if not in conformance and not considered. Include copy of this form with next communication to applicant.

¹ See Kind Codes of USPTO Patent Documents at www.USPTO.GOV or MPEP 901.04. ² Enter office that issued the document, by the two-letter code (WIPO Standard ST.3). ³ For Japanese patent documents, the indication of the year of the reign of the Emperor must precede the serial number of the patent document. ⁴ Kind of document by the appropriate symbols as indicated on the document under WIPO Standard ST.16 if possible. ⁵ Applicant is to place a check mark here if English language translation is attached.

INFORMATION DISCLOSURE STATEMENT BY APPLICANT (Not for submission under 37 CFR 1.99)	Application Number		
	Filing Date		
	First Named Inventor	Mohammed N. ISLAM	
	Art Unit		
	Examiner Name		
	Attorney Docket Number	OMNI 0105 PUSP1	

CERTIFICATION STATEMENT

Please see 37 CFR 1.97 and 1.98 to make the appropriate selection(s):

That each item of information contained in the information disclosure statement was first cited in any communication from a foreign patent office in a counterpart foreign application not more than three months prior to the filing of the information disclosure statement. See 37 CFR 1.97(e)(1).

OR

That no item of information contained in the information disclosure statement was cited in a communication from a foreign patent office in a counterpart foreign application, and, to the knowledge of the person signing the certification after making reasonable inquiry, no item of information contained in the information disclosure statement was known to any individual designated in 37 CFR 1.56(c) more than three months prior to the filing of the information disclosure statement. See 37 CFR 1.97(e)(2).

- See attached certification statement.
- The fee set forth in 37 CFR 1.17 (p) has been submitted herewith.
- A certification statement is not submitted herewith.

SIGNATURE

A signature of the applicant or representative is required in accordance with CFR 1.33, 10.18. Please see CFR 1.4(d) for the form of the signature.

Signature	/David S. Bir/	Date (YYYY-MM-DD)	2015-10-01
Name/Print	David S. Bir	Registration Number	38383

This collection of information is required by 37 CFR 1.97 and 1.98. The information is required to obtain or retain a benefit by the public which is to file (and by the USPTO to process) an application. Confidentiality is governed by 35 U.S.C. 122 and 37 CFR 1.14. This collection is estimated to take 1 hour to complete, including gathering, preparing and submitting the completed application form to the USPTO. Time will vary depending upon the individual case. Any comments on the amount of time you require to complete this form and/or suggestions for reducing this burden, should be sent to the Chief Information Officer, U.S. Patent and Trademark Office, U.S. Department of Commerce, P.O. Box 1450, Alexandria, VA 22313-1450. **DO NOT SEND FEES OR COMPLETED FORMS TO THIS ADDRESS. SEND TO: Commissioner for Patents, P.O. Box 1450, Alexandria, VA 22313-1450.**

Privacy Act Statement

The Privacy Act of 1974 (P.L. 93-579) requires that you be given certain information in connection with your submission of the attached form related to a patent application or patent. Accordingly, pursuant to the requirements of the Act, please be advised that: (1) the general authority for the collection of this information is 35 U.S.C. 2(b)(2); (2) furnishing of the information solicited is voluntary; and (3) the principal purpose for which the information is used by the U.S. Patent and Trademark Office is to process and/or examine your submission related to a patent application or patent. If you do not furnish the requested information, the U.S. Patent and Trademark Office may not be able to process and/or examine your submission, which may result in termination of proceedings or abandonment of the application or expiration of the patent.

The information provided by you in this form will be subject to the following routine uses:

1. The information on this form will be treated confidentially to the extent allowed under the Freedom of Information Act (5 U.S.C. 552) and the Privacy Act (5 U.S.C. 552a). Records from this system of records may be disclosed to the Department of Justice to determine whether the Freedom of Information Act requires disclosure of these records.
2. A record from this system of records may be disclosed, as a routine use, in the course of presenting evidence to a court, magistrate, or administrative tribunal, including disclosures to opposing counsel in the course of settlement negotiations.
3. A record in this system of records may be disclosed, as a routine use, to a Member of Congress submitting a request involving an individual, to whom the record pertains, when the individual has requested assistance from the Member with respect to the subject matter of the record.
4. A record in this system of records may be disclosed, as a routine use, to a contractor of the Agency having need for the information in order to perform a contract. Recipients of information shall be required to comply with the requirements of the Privacy Act of 1974, as amended, pursuant to 5 U.S.C. 552a(m).
5. A record related to an International Application filed under the Patent Cooperation Treaty in this system of records may be disclosed, as a routine use, to the International Bureau of the World Intellectual Property Organization, pursuant to the Patent Cooperation Treaty.
6. A record in this system of records may be disclosed, as a routine use, to another federal agency for purposes of National Security review (35 U.S.C. 181) and for review pursuant to the Atomic Energy Act (42 U.S.C. 218(c)).
7. A record from this system of records may be disclosed, as a routine use, to the Administrator, General Services, or his/her designee, during an inspection of records conducted by GSA as part of that agency's responsibility to recommend improvements in records management practices and programs, under authority of 44 U.S.C. 2904 and 2906. Such disclosure shall be made in accordance with the GSA regulations governing inspection of records for this purpose, and any other relevant (i.e., GSA or Commerce) directive. Such disclosure shall not be used to make determinations about individuals.
8. A record from this system of records may be disclosed, as a routine use, to the public after either publication of the application pursuant to 35 U.S.C. 122(b) or issuance of a patent pursuant to 35 U.S.C. 151. Further, a record may be disclosed, subject to the limitations of 37 CFR 1.14, as a routine use, to the public if the record was filed in an application which became abandoned or in which the proceedings were terminated and which application is referenced by either a published application, an application open to public inspections or an issued patent.
9. A record from this system of records may be disclosed, as a routine use, to a Federal, State, or local law enforcement agency, if the USPTO becomes aware of a violation or potential violation of law or regulation.

INFORMATION DISCLOSURE STATEMENT BY APPLICANT (Not for submission under 37 CFR 1.99)	Application Number		
	Filing Date		
	First Named Inventor	Mohammed N. ISLAM	
	Art Unit		
	Examiner Name		
	Attorney Docket Number	OMNI 0105 PUSP1	

U.S.PATENTS						Remove
Examiner Initial*	Cite No	Patent Number	Kind Code ¹	Issue Date	Name of Patentee or Applicant of cited Document	Pages,Columns,Lines where Relevant Passages or Relevant Figures Appear
	1					

If you wish to add additional U.S. Patent citation information please click the Add button. Add

U.S.PATENT APPLICATION PUBLICATIONS						Remove
Examiner Initial*	Cite No	Publication Number	Kind Code ¹	Publication Date	Name of Patentee or Applicant of cited Document	Pages,Columns,Lines where Relevant Passages or Relevant Figures Appear
	1					

If you wish to add additional U.S. Published Application citation information please click the Add button. Add

FOREIGN PATENT DOCUMENTS								Remove
Examiner Initial*	Cite No	Foreign Document Number ³	Country Code ² j	Kind Code ⁴	Publication Date	Name of Patentee or Applicant of cited Document	Pages,Columns,Lines where Relevant Passages or Relevant Figures Appear	T ⁵
	1							<input type="checkbox"/>

If you wish to add additional Foreign Patent Document citation information please click the Add button Add

NON-PATENT LITERATURE DOCUMENTS				Remove
Examiner Initials*	Cite No	Include name of the author (in CAPITAL LETTERS), title of the article (when appropriate), title of the item (book, magazine, journal, serial, symposium, catalog, etc), date, pages(s), volume-issue number(s), publisher, city and/or country where published.		T ⁵

**INFORMATION DISCLOSURE
STATEMENT BY APPLICANT**
(Not for submission under 37 CFR 1.99)

Application Number		
Filing Date		
First Named Inventor	Mohammed N. ISLAM	
Art Unit		
Examiner Name		
Attorney Docket Number	OMNI 0105 PUSP1	

1	Pan, Yingtian, et al., "Hand-held arthroscopic optical coherence tomography for in vivo high-resolution imaging of articular cartilage", Journal of Biomedical Optics 8(4), October 2003, pages 648-654.	<input type="checkbox"/>
2	Xie, Tuqiang, et al., "Endoscopic optical coherence tomography with a modified microelectromechanical systems mirror for detection of bladder cancers", APPLIED OPTICS, Vol. 42, No. 31, November 1, 2003, pages 6422-6426.	<input type="checkbox"/>
3	Dubois, A., et al., "Three-dimensional cellular-level imaging using full-field optical coherence tomography", Physics in Medicine and Biology, Phys. Med. Biol. 49, 2004, pages 1227-1234.	<input type="checkbox"/>
4	Park, Jesung, et al., "Analysis of birefringent image in the retinal nerve fiber layer by polarization sensitive optical coherence tomography", Ophthalmic Technologies XIV, Proceedings of SPIE, Vol. 5314, 2004, pages 188-194.	<input type="checkbox"/>
5	Unterhuber, A., et al., "Advances in broad bandwidth light sources for ultrahigh resolution optical coherence tomography", Physics in Medicine and Biology, Phys. Med. Biol. 49, 2004, pages 1235-1246.	<input type="checkbox"/>
6	Drexler, Wolfgang, "Ultrahigh-resolution optical coherence tomography", Journal of Biomedical Optics, Vol. 9, No. 1, January/February 2004, pages 47-74.	<input type="checkbox"/>
7	Schmitt, Joseph, et al., "Intravascular Optical Coherence Tomography Opens a Window Onto Coronary Artery Disease", Optics & Photonics News, February 2004, pages 20-25.	<input type="checkbox"/>
8	Nassif, N.A., et al., "In vivo high-resolution video-rate spectral-domain optical coherence tomography of the human retina and optic nerve", OPTICS EXPRESS, Vol. 12, No. 3, February 9, 2004, pages 367-376.	<input type="checkbox"/>
9	Choi, Seung-Ho, et al., "Observation of Optical Precursors in Water", Physical Review Letters, Volume 92, Number 19, May 14, 2004, pages 193903-1-193903-3.	<input type="checkbox"/>
10	Pierce, Mark C., et al., "Advances in Optical Coherence Tomography imaging for Dermatology", Optical Coherence Tomography Advances, The Journal of Investigative Dermatology, September 3, 2004, pages 458-463.	<input type="checkbox"/>
11	"State-Specific Trends in Chronic Kidney Failure - United States, 1990-2001", Morbidity and Mortality Weekly Report, Department of Health and Human Services Centers for Disease Control and Prevention, Vol. 53, No. 39, copied from internet: file://C:\Documents and Settings\eturl\\Desktop\State-Specific Trends in Chronic Kidney ... 2/12/10, October 8, 2004, pages 918-920.	<input type="checkbox"/>

**INFORMATION DISCLOSURE
STATEMENT BY APPLICANT**
(Not for submission under 37 CFR 1.99)

Application Number		
Filing Date		
First Named Inventor	Mohammed N. ISLAM	
Art Unit		
Examiner Name		
Attorney Docket Number	OMNI 0105 PUSP1	

12	I.B. Ads, A.A.E. Wagie, N.B. Mariun, A.B.E. Jammal, "An Internet-based blood pressure monitoring system for patients," Journal of Telemedicine and Telecare, 2001, pp. 51-53	<input type="checkbox"/>
13	R.H. Istepanian, B. Woodward, P.A. Bales, S. Chen, B. Luk, "The comparative performance of mobile telemedical systems based on the IS-54 and GSM cellular telephone standards," Journal of Telemedicine and Telecare, 1999, pp. 97-104	<input type="checkbox"/>
14	Shaw, et al, IR Supercontinuum Generation in As-Se Photonic Crystal Fiber, Optical Society of America, Copyright 2005, 3 pages	<input type="checkbox"/>
15	PCT/US06/44451, Notification of Transmittal of the International Search Report and the Written Opinion of the International Searching Authority, or the Declaration, November 29, 2007, 12 pages	<input type="checkbox"/>
16	G.S. Edwards et al., "Free-electron-laser-based biophysical and biomedical instrumentation," American Institute of Physics, Vol. 74, No. 7, July 2003, pp. 3207-3245	<input type="checkbox"/>
17	Computer Motion, Inc., "501(k) Summary -ZEUS® MicroWrist™ Surgical System and Accessories," September 24, 2002, 6 pages	<input type="checkbox"/>
18	Computer Motion, Inc. "HERMES™ O.R. Control Center - 510(k) Summary of Safety and Effectiveness," October 11, 2002, 5 pages	<input type="checkbox"/>
19	K.M. Joos, et al. "Optic Nerve Sheath Fenestration with a Novel Wavelength Produced by the Free Electron Laser (FEL)," Lasers in Surgery and Medicine, 27: 2000,191-205	<input type="checkbox"/>
20	J. Sanghera, I. Aggarwal, "IR Fiber Optics at NRL," undated, 10 pages	<input type="checkbox"/>
21	J. Sanghera, L.B. Shaw, I.D. Aggarwal, "Applications of chalcogenide glass optical fibers," Academic of Science, 2003, pp. 1-11	<input type="checkbox"/>
22	B. Rigas, P.T.T. Wong, "Human Colon Adenocarcinoma Cell Lines Display Infrared Spectroscopic Features," Cancer Research, January 1, 1992, pp. 84-88	<input type="checkbox"/>

**INFORMATION DISCLOSURE
STATEMENT BY APPLICANT**
(Not for submission under 37 CFR 1.99)

Application Number		
Filing Date		
First Named Inventor	Mohammed N. ISLAM	
Art Unit		
Examiner Name		
Attorney Docket Number	OMNI 0105 PUSP1	

23	G. Edwards, et al., "Comparison of OPA and Mark-III FEL for Tissue Ablation at 6.45 Microns," Department of Physics and Free Electron Laser Laboratory, Duke University, 2002, 7 pages	<input type="checkbox"/>
24	Glenn Edwards, "Biomedical and potential clinical applications for pulsed lasers operating near 6.45 um," Society of Photo-Optical Instrumentation Engineers, 1995, 2 pages	<input type="checkbox"/>
25	PASSAT, "Solid-State Lasers and Optical Components," July 14, 2003, 5 pages	<input type="checkbox"/>
26	P.A. Thielen and L.B. Shaw, et al., "Small-core As-Se fiber for Raman amplification," OPTICS LETI-ERS, Vol. 28, No. 16, August 15, 2003, 3 pages	<input type="checkbox"/>
27	R.Rox Anderson, et al., "Selective Photothermolysis: Precise Microsurgery by Selective Absorption of Pulsed Radiation," Department of Dermatology, Harvard Medical School, Science, Vol. 220, April 29, 1983, 4 pages	<input type="checkbox"/>
28	U.S. Appln. Serial No. 10/652,276, "System and Method for Voice Control of Medical devices," by Mohammed N. Islam, abandoned (074036.0129) Date filed: August 29, 2003	<input type="checkbox"/>
29	U.S. Appln. Serial No. 10/757,341, "System and Method for Voice Control of Medical devices," by Mohammed N. Islam, issued (074036.0132) Date filed: January 13, 2004	<input type="checkbox"/>
30	U.S. Appln. Serial No. 12/206432, "System and Method for Voice Control of Medical Devices," by Mohammed N. Islam, pending (074036.0154) Date filed: September 8, 2008	<input type="checkbox"/>
31	U.S. Patent and Trademark Office, Office Action for USSN 12/206,432, filed 09/08/2008, Mohammed N, Islam, Attorney Docket No. 074036.0154, Date filed: March 12, 2009	<input type="checkbox"/>
32	U.S. Patent and Trademark Office, Notice of Allowance and Fee(s) Due for USSN 12/206,432, filed 09/08/2008, Mohammed N. Islam, Attorney Docket No. 074036.0154, Date filed: August 28, 2009	<input type="checkbox"/>

If you wish to add additional non-patent literature document citation information please click the Add button [Add](#)

INFORMATION DISCLOSURE STATEMENT BY APPLICANT (Not for submission under 37 CFR 1.99)	Application Number		
	Filing Date		
	First Named Inventor	Mohammed N. ISLAM	
	Art Unit		
	Examiner Name		
	Attorney Docket Number	OMNI 0105 PUSP1	

EXAMINER SIGNATURE

Examiner Signature		Date Considered	
--------------------	--	-----------------	--

***EXAMINER:** Initial if reference considered, whether or not citation is in conformance with MPEP 609. Draw line through a citation if not in conformance and not considered. Include copy of this form with next communication to applicant.

¹ See Kind Codes of USPTO Patent Documents at www.USPTO.GOV or MPEP 901.04. ² Enter office that issued the document, by the two-letter code (WIPO Standard ST.3). ³ For Japanese patent documents, the indication of the year of the reign of the Emperor must precede the serial number of the patent document. ⁴ Kind of document by the appropriate symbols as indicated on the document under WIPO Standard ST.16 if possible. ⁵ Applicant is to place a check mark here if English language translation is attached.

**INFORMATION DISCLOSURE
STATEMENT BY APPLICANT**
(Not for submission under 37 CFR 1.99)

Application Number		
Filing Date		
First Named Inventor	Mohammed N. ISLAM	
Art Unit		
Examiner Name		
Attorney Docket Number	OMNI 0105 PUSP1	

CERTIFICATION STATEMENT

Please see 37 CFR 1.97 and 1.98 to make the appropriate selection(s):

That each item of information contained in the information disclosure statement was first cited in any communication from a foreign patent office in a counterpart foreign application not more than three months prior to the filing of the information disclosure statement. See 37 CFR 1.97(e)(1).

OR

That no item of information contained in the information disclosure statement was cited in a communication from a foreign patent office in a counterpart foreign application, and, to the knowledge of the person signing the certification after making reasonable inquiry, no item of information contained in the information disclosure statement was known to any individual designated in 37 CFR 1.56(c) more than three months prior to the filing of the information disclosure statement. See 37 CFR 1.97(e)(2).

- See attached certification statement.
- The fee set forth in 37 CFR 1.17 (p) has been submitted herewith.
- A certification statement is not submitted herewith.

SIGNATURE

A signature of the applicant or representative is required in accordance with CFR 1.33, 10.18. Please see CFR 1.4(d) for the form of the signature.

Signature	/David S. Bir/	Date (YYYY-MM-DD)	2015-10-01
Name/Print	David S. Bir	Registration Number	38383

This collection of information is required by 37 CFR 1.97 and 1.98. The information is required to obtain or retain a benefit by the public which is to file (and by the USPTO to process) an application. Confidentiality is governed by 35 U.S.C. 122 and 37 CFR 1.14. This collection is estimated to take 1 hour to complete, including gathering, preparing and submitting the completed application form to the USPTO. Time will vary depending upon the individual case. Any comments on the amount of time you require to complete this form and/or suggestions for reducing this burden, should be sent to the Chief Information Officer, U.S. Patent and Trademark Office, U.S. Department of Commerce, P.O. Box 1450, Alexandria, VA 22313-1450. **DO NOT SEND FEES OR COMPLETED FORMS TO THIS ADDRESS. SEND TO: Commissioner for Patents, P.O. Box 1450, Alexandria, VA 22313-1450.**

Privacy Act Statement

The Privacy Act of 1974 (P.L. 93-579) requires that you be given certain information in connection with your submission of the attached form related to a patent application or patent. Accordingly, pursuant to the requirements of the Act, please be advised that: (1) the general authority for the collection of this information is 35 U.S.C. 2(b)(2); (2) furnishing of the information solicited is voluntary; and (3) the principal purpose for which the information is used by the U.S. Patent and Trademark Office is to process and/or examine your submission related to a patent application or patent. If you do not furnish the requested information, the U.S. Patent and Trademark Office may not be able to process and/or examine your submission, which may result in termination of proceedings or abandonment of the application or expiration of the patent.

The information provided by you in this form will be subject to the following routine uses:

1. The information on this form will be treated confidentially to the extent allowed under the Freedom of Information Act (5 U.S.C. 552) and the Privacy Act (5 U.S.C. 552a). Records from this system of records may be disclosed to the Department of Justice to determine whether the Freedom of Information Act requires disclosure of these records.
2. A record from this system of records may be disclosed, as a routine use, in the course of presenting evidence to a court, magistrate, or administrative tribunal, including disclosures to opposing counsel in the course of settlement negotiations.
3. A record in this system of records may be disclosed, as a routine use, to a Member of Congress submitting a request involving an individual, to whom the record pertains, when the individual has requested assistance from the Member with respect to the subject matter of the record.
4. A record in this system of records may be disclosed, as a routine use, to a contractor of the Agency having need for the information in order to perform a contract. Recipients of information shall be required to comply with the requirements of the Privacy Act of 1974, as amended, pursuant to 5 U.S.C. 552a(m).
5. A record related to an International Application filed under the Patent Cooperation Treaty in this system of records may be disclosed, as a routine use, to the International Bureau of the World Intellectual Property Organization, pursuant to the Patent Cooperation Treaty.
6. A record in this system of records may be disclosed, as a routine use, to another federal agency for purposes of National Security review (35 U.S.C. 181) and for review pursuant to the Atomic Energy Act (42 U.S.C. 218(c)).
7. A record from this system of records may be disclosed, as a routine use, to the Administrator, General Services, or his/her designee, during an inspection of records conducted by GSA as part of that agency's responsibility to recommend improvements in records management practices and programs, under authority of 44 U.S.C. 2904 and 2906. Such disclosure shall be made in accordance with the GSA regulations governing inspection of records for this purpose, and any other relevant (i.e., GSA or Commerce) directive. Such disclosure shall not be used to make determinations about individuals.
8. A record from this system of records may be disclosed, as a routine use, to the public after either publication of the application pursuant to 35 U.S.C. 122(b) or issuance of a patent pursuant to 35 U.S.C. 151. Further, a record may be disclosed, subject to the limitations of 37 CFR 1.14, as a routine use, to the public if the record was filed in an application which became abandoned or in which the proceedings were terminated and which application is referenced by either a published application, an application open to public inspections or an issued patent.
9. A record from this system of records may be disclosed, as a routine use, to a Federal, State, or local law enforcement agency, if the USPTO becomes aware of a violation or potential violation of law or regulation.

INFORMATION DISCLOSURE STATEMENT BY APPLICANT (Not for submission under 37 CFR 1.99)	Application Number		
	Filing Date		
	First Named Inventor	Mohammed N. ISLAM	
	Art Unit		
	Examiner Name		
	Attorney Docket Number	OMNI 0105 PUSP1	

U.S.PATENTS						Remove
Examiner Initial*	Cite No	Patent Number	Kind Code ¹	Issue Date	Name of Patentee or Applicant of cited Document	Pages,Columns,Lines where Relevant Passages or Relevant Figures Appear
	1	6181414		2001-01-30	Raz et al.	
	2	7105823		2006-09-12	Abrahamsson et al.	
	3	8472108		2013-06-25	Islam	

If you wish to add additional U.S. Patent citation information please click the Add button.

Add

U.S.PATENT APPLICATION PUBLICATIONS						Remove
Examiner Initial*	Cite No	Publication Number	Kind Code ¹	Publication Date	Name of Patentee or Applicant of cited Document	Pages,Columns,Lines where Relevant Passages or Relevant Figures Appear
	1	20060283931		2006-12-21	Polli et al.	
	2	20120239013		2012-09-20	Islam	
	3	20130274569		2013-10-17	Islam	

INFORMATION DISCLOSURE STATEMENT BY APPLICANT (Not for submission under 37 CFR 1.99)	Application Number		
	Filing Date		
	First Named Inventor	Mohammed N. ISLAM	
	Art Unit		
	Examiner Name		
	Attorney Docket Number	OMNI 0105 PUSP1	

4	20140236021		2014-08-21	Islam	
---	-------------	--	------------	-------	--

If you wish to add additional U.S. Published Application citation information please click the Add button. [Add](#)

FOREIGN PATENT DOCUMENTS								Remove
Examiner Initial*	Cite No	Foreign Document Number ³	Country Code ² i	Kind Code ⁴	Publication Date	Name of Patentee or Applicant of cited Document	Pages, Columns, Lines where Relevant Passages or Relevant Figures Appear	T ⁵
	1							<input type="checkbox"/>

If you wish to add additional Foreign Patent Document citation information please click the Add button. [Add](#)

NON-PATENT LITERATURE DOCUMENTS			Remove
Examiner Initials*	Cite No	Include name of the author (in CAPITAL LETTERS), title of the article (when appropriate), title of the item (book, magazine, journal, serial, symposium, catalog, etc), date, pages(s), volume-issue number(s), publisher, city and/or country where published.	T ⁵
	1	"Application Brief AB-070: The role of infrared microprobe analysis in forensic drug analysis," www.smithsdetection.com, June 27, 2005.	<input type="checkbox"/>
	2	Jasco Application Note No. 200DR0188-E, "Rapid Identification of illegal drug using NIR (identification of MDMA tablet)", September 4, 2008.	<input type="checkbox"/>
	3	PALOU, A. J. CRUZ, M. BLANCO, J. TOMAS, J. DE LOS RIOS, M. ALCALA, "Determination of drug, excipients and coating distribution in pharmaceutical tablets using NIR-CI," Journal of Pharmaceutical Analysis, Vol. 2, no. 2, pp. 90-97 (2012).	<input type="checkbox"/>
	4	ARNOLD, T., M. De BIASIO, R. LEITNER, "Near-Infrared Imaging Spectroscopy for Counterfeit Drug Detection," Next Generation Spectroscopic Technologies IV, edited by M. A. Druy, R.A. Crocombe, Proceedings of SPIE, Vol. 8032, 80320Y-1 to 7, (2011).	<input type="checkbox"/>
	5	WEDDING, B.B., C. WRIGHT, S. GRAUF, R.D. WHITE, "The application of near infrared spectroscopy for the assessment of avocado quality attributes," Infrared Spectroscopy -- Life and Biomedical Sciences, pp. 211-230 (2011).	<input type="checkbox"/>

**INFORMATION DISCLOSURE
STATEMENT BY APPLICANT**
(Not for submission under 37 CFR 1.99)

Application Number		
Filing Date		
First Named Inventor	Mohammed N. ISLAM	
Art Unit		
Examiner Name		
Attorney Docket Number	OMNI 0105 PUSP1	

6	MICHAELS, C.A., T. MASIELLO, P.M. CHU, "Fourier transform spectrometry with a near infrared supercontinuum source," Optical Society of America, CLEO/IQEC Conference, paper CMDD6 (2009).	<input type="checkbox"/>
7	MICHAELS, C.A., T. MASIELLO, P.M. CHU, "Fourier transform spectrometry with a near-infrared supercontinuum source," Applied Spectroscopy, Vol. 63, no. 5, pp. 538-543 (2009).	<input type="checkbox"/>
8	MOROS, J., J. KULIGOWSKI, G. QUINTAS, S. GARRIGUES, M. DeLa GUARDIA, "New cut-off criterion for uninformative variable elimination in multivariate calibration of near-infrared spectra for the determination of heroin in illicit street drugs," Analytica Chimica Acta, Vol. 630, pp. 150-160 (2008).	<input type="checkbox"/>
9	MOROS, J. N. GALLPIENSO, R. VILCHES, S. GARRIGUES, M. DeLa GUARDIA, "Nondestructive direct determination of heroin in seized illicit street drugs by diffuse reflectance near-infrared spectroscopy," Analytical Chemistry, Vol. 80, no. 19, pp. 7257-7265 (October 1, 2008).	<input type="checkbox"/>
10	ROGGO, Y. P. CHALUS, L. MAURER, C. LEMA-MARTINEZ, A. EDMOND, N. JENT, "A review of near infrared spectroscopy and chemometrics in pharmaceutical technologies," Journal of Pharmaceutical and Biomedical Analysis, Vol. 44, pp. 683-700 (2007).	<input type="checkbox"/>
11	POJIC, M. J. MASTILOVIC, N. MAJCEN, "The application of near infrared spectroscopy in wheat quality control," Infrared Spectroscopy - Life and Biomedical Sciences, pp. 167-184 (2012).	<input type="checkbox"/>
12	REICH, G. "Near-infrared spectroscopy and imaging: basic principles and pharmaceutical applications," Advanced Drug Delivery Reviews, vol. 57, pp. 1109-1143 (2005).	<input type="checkbox"/>
13	RODIONOVA, O.Y., L.P. HOUMOLLER, A.L. POMERANTSEV, P. GELADI, J. BURGER, V.L. DOROFEYEV, A.P. ARZAMASTSEV, "NIR spectrometry for counterfeit drug detection: a feasibility study," Analytica Chimica Acta, vol. 549, pp. 151-158 (2005).	<input type="checkbox"/>
14	SCHNEIDER, R.C., K.A. KOVAR, "Analysis of ecstasy tablets: comparison of reflectance and transmittance near infrared spectroscopy," Forensic Science International, vol. 134, pp. 187-195 (2003).	<input type="checkbox"/>
15	OLSEN, B.A., M.W. BORER, F.M. PERRY, R.A. FORBES, "Screening for counterfeit drugs using near-infrared spectroscopy," Pharmaceutical Technology, pp. 62-71 (June 2002).	<input type="checkbox"/>
16	SCAFI, S.H.F., C. PASQUINI, "Identification of counterfeit drugs using near-infrared spectroscopy," Analyst, vol. 126, pp. 2218-2224 (2001).	<input type="checkbox"/>

INFORMATION DISCLOSURE STATEMENT BY APPLICANT (Not for submission under 37 CFR 1.99)	Application Number		
	Filing Date		
	First Named Inventor	Mohammed N. ISLAM	
	Art Unit		
	Examiner Name		
	Attorney Docket Number	OMNI 0105 PUSP1	

17	SONDERMANN, N., K.A. KOVAR, "Identification of ecstasy in complex matrices using near-infrared spectroscopy," Forensic Science International, vol. 102, pp. 133-147 (1999).	<input type="checkbox"/>
18	RAMBLA, F.J., S. GARRIGUES, M. DeLa GUARDIA, "PLS-NIR determination of total sugar, glucose, fructose and sucrose in aqueous solutions of fruit juices," Analytica Chimica Acta, vol. 344, pp. 41-53 (1997).	<input type="checkbox"/>

If you wish to add additional non-patent literature document citation information please click the Add button **Add**

EXAMINER SIGNATURE

Examiner Signature		Date Considered	
--------------------	--	-----------------	--

*EXAMINER: Initial if reference considered, whether or not citation is in conformance with MPEP 609. Draw line through a citation if not in conformance and not considered. Include copy of this form with next communication to applicant.

¹ See Kind Codes of USPTO Patent Documents at www.USPTO.GOV or MPEP 901.04. ² Enter office that issued the document, by the two-letter code (WIPO Standard ST.3). ³ For Japanese patent documents, the indication of the year of the reign of the Emperor must precede the serial number of the patent document. ⁴ Kind of document by the appropriate symbols as indicated on the document under WIPO Standard ST.16 if possible. ⁵ Applicant is to place a check mark here if English language translation is attached.

**INFORMATION DISCLOSURE
STATEMENT BY APPLICANT**
(Not for submission under 37 CFR 1.99)

Application Number		
Filing Date		
First Named Inventor	Mohammed N. ISLAM	
Art Unit		
Examiner Name		
Attorney Docket Number	OMNI 0105 PUSP1	

CERTIFICATION STATEMENT

Please see 37 CFR 1.97 and 1.98 to make the appropriate selection(s):

That each item of information contained in the information disclosure statement was first cited in any communication from a foreign patent office in a counterpart foreign application not more than three months prior to the filing of the information disclosure statement. See 37 CFR 1.97(e)(1).

OR

That no item of information contained in the information disclosure statement was cited in a communication from a foreign patent office in a counterpart foreign application, and, to the knowledge of the person signing the certification after making reasonable inquiry, no item of information contained in the information disclosure statement was known to any individual designated in 37 CFR 1.56(c) more than three months prior to the filing of the information disclosure statement. See 37 CFR 1.97(e)(2).

See attached certification statement.

The fee set forth in 37 CFR 1.17 (p) has been submitted herewith.

A certification statement is not submitted herewith.

SIGNATURE

A signature of the applicant or representative is required in accordance with CFR 1.33, 10.18. Please see CFR 1.4(d) for the form of the signature.

Signature	/David S. Bir/	Date (YYYY-MM-DD)	2015-10-01
Name/Print	David S. Bir	Registration Number	38383

This collection of information is required by 37 CFR 1.97 and 1.98. The information is required to obtain or retain a benefit by the public which is to file (and by the USPTO to process) an application. Confidentiality is governed by 35 U.S.C. 122 and 37 CFR 1.14. This collection is estimated to take 1 hour to complete, including gathering, preparing and submitting the completed application form to the USPTO. Time will vary depending upon the individual case. Any comments on the amount of time you require to complete this form and/or suggestions for reducing this burden, should be sent to the Chief Information Officer, U.S. Patent and Trademark Office, U.S. Department of Commerce, P.O. Box 1450, Alexandria, VA 22313-1450. **DO NOT SEND FEES OR COMPLETED FORMS TO THIS ADDRESS. SEND TO: Commissioner for Patents, P.O. Box 1450, Alexandria, VA 22313-1450.**

Privacy Act Statement

The Privacy Act of 1974 (P.L. 93-579) requires that you be given certain information in connection with your submission of the attached form related to a patent application or patent. Accordingly, pursuant to the requirements of the Act, please be advised that: (1) the general authority for the collection of this information is 35 U.S.C. 2(b)(2); (2) furnishing of the information solicited is voluntary; and (3) the principal purpose for which the information is used by the U.S. Patent and Trademark Office is to process and/or examine your submission related to a patent application or patent. If you do not furnish the requested information, the U.S. Patent and Trademark Office may not be able to process and/or examine your submission, which may result in termination of proceedings or abandonment of the application or expiration of the patent.

The information provided by you in this form will be subject to the following routine uses:

1. The information on this form will be treated confidentially to the extent allowed under the Freedom of Information Act (5 U.S.C. 552) and the Privacy Act (5 U.S.C. 552a). Records from this system of records may be disclosed to the Department of Justice to determine whether the Freedom of Information Act requires disclosure of these records.
2. A record from this system of records may be disclosed, as a routine use, in the course of presenting evidence to a court, magistrate, or administrative tribunal, including disclosures to opposing counsel in the course of settlement negotiations.
3. A record in this system of records may be disclosed, as a routine use, to a Member of Congress submitting a request involving an individual, to whom the record pertains, when the individual has requested assistance from the Member with respect to the subject matter of the record.
4. A record in this system of records may be disclosed, as a routine use, to a contractor of the Agency having need for the information in order to perform a contract. Recipients of information shall be required to comply with the requirements of the Privacy Act of 1974, as amended, pursuant to 5 U.S.C. 552a(m).
5. A record related to an International Application filed under the Patent Cooperation Treaty in this system of records may be disclosed, as a routine use, to the International Bureau of the World Intellectual Property Organization, pursuant to the Patent Cooperation Treaty.
6. A record in this system of records may be disclosed, as a routine use, to another federal agency for purposes of National Security review (35 U.S.C. 181) and for review pursuant to the Atomic Energy Act (42 U.S.C. 218(c)).
7. A record from this system of records may be disclosed, as a routine use, to the Administrator, General Services, or his/her designee, during an inspection of records conducted by GSA as part of that agency's responsibility to recommend improvements in records management practices and programs, under authority of 44 U.S.C. 2904 and 2906. Such disclosure shall be made in accordance with the GSA regulations governing inspection of records for this purpose, and any other relevant (i.e., GSA or Commerce) directive. Such disclosure shall not be used to make determinations about individuals.
8. A record from this system of records may be disclosed, as a routine use, to the public after either publication of the application pursuant to 35 U.S.C. 122(b) or issuance of a patent pursuant to 35 U.S.C. 151. Further, a record may be disclosed, subject to the limitations of 37 CFR 1.14, as a routine use, to the public if the record was filed in an application which became abandoned or in which the proceedings were terminated and which application is referenced by either a published application, an application open to public inspections or an issued patent.
9. A record from this system of records may be disclosed, as a routine use, to a Federal, State, or local law enforcement agency, if the USPTO becomes aware of a violation or potential violation of law or regulation.

INFORMATION DISCLOSURE STATEMENT BY APPLICANT (Not for submission under 37 CFR 1.99)	Application Number		
	Filing Date		
	First Named Inventor	Mohammed N. ISLAM	
	Art Unit		
	Examiner Name		
	Attorney Docket Number	POWM 0105 PUSP1	

U.S.PATENTS						Remove
Examiner Initial*	Cite No	Patent Number	Kind Code ¹	Issue Date	Name of Patentee or Applicant of cited Document	Pages,Columns,Lines where Relevant Passages or Relevant Figures Appear
	1	8157730	B2	2012-04-17	LeBoeuf, et al.	
	2	8430310	B1	2013-04-30	Ho, et al.	
	3	8509882	B2	2013-08-13	Albert, et al.	
	4	8788002	B2	2014-07-22	LeBoeuf, et al.	
	5	8948832	B2	2015-02-03	Hong, et al.	

If you wish to add additional U.S. Patent citation information please click the Add button. Add

U.S.PATENT APPLICATION PUBLICATIONS						Remove
Examiner Initial*	Cite No	Publication Number	Kind Code ¹	Publication Date	Name of Patentee or Applicant of cited Document	Pages,Columns,Lines where Relevant Passages or Relevant Figures Appear
	1	20080086318	A1	2008-04-10	Gilley, et al.	

**INFORMATION DISCLOSURE
STATEMENT BY APPLICANT**
(Not for submission under 37 CFR 1.99)

Application Number		
Filing Date		
First Named Inventor	Mohammed N. ISLAM	
Art Unit		
Examiner Name		
Attorney Docket Number	POWM 0105 PUSP1	

2	20090287067	A1	2009-11-19	Dorogusker, et al.	
3	20130281795	A1	2013-10-24	Varadan	
4	20140081100	A1	2014-03-20	Muhsin, et al.	
5	20150011851	A1	2015-01-08	Mehta, et al.	

If you wish to add additional U.S. Published Application citation information please click the Add button. **Add**

FOREIGN PATENT DOCUMENTS

Remove

Examiner Initial*	Cite No	Foreign Document Number ³	Country Code ² j	Kind Code ⁴	Publication Date	Name of Patentee or Applicant of cited Document	Pages, Columns, Lines where Relevant Passages or Relevant Figures Appear	T ⁵
	1	WO2013012938		A1	2013-01-24	Raskin, et al.		<input type="checkbox"/>
	2	WO2015084376		A1	2015-06-11	Han, et al.		<input type="checkbox"/>

If you wish to add additional Foreign Patent Document citation information please click the Add button **Add**

NON-PATENT LITERATURE DOCUMENTS

Remove

Examiner Initials*	Cite No	Include name of the author (in CAPITAL LETTERS), title of the article (when appropriate), title of the item (book, magazine, journal, serial, symposium, catalog, etc), date, pages(s), volume-issue number(s), publisher, city and/or country where published.	T ⁵
	1		<input type="checkbox"/>

If you wish to add additional non-patent literature document citation information please click the Add button **Add**

INFORMATION DISCLOSURE STATEMENT BY APPLICANT (Not for submission under 37 CFR 1.99)	Application Number		
	Filing Date		
	First Named Inventor	Mohammed N. ISLAM	
	Art Unit		
	Examiner Name		
	Attorney Docket Number	POWM 0105 PUSP1	

EXAMINER SIGNATURE

Examiner Signature		Date Considered	
--------------------	--	-----------------	--

*EXAMINER: Initial if reference considered, whether or not citation is in conformance with MPEP 609. Draw line through a citation if not in conformance and not considered. Include copy of this form with next communication to applicant.

¹ See Kind Codes of USPTO Patent Documents at www.USPTO.GOV or MPEP 901.04. ² Enter office that issued the document, by the two-letter code (WIPO Standard ST.3). ³ For Japanese patent documents, the indication of the year of the reign of the Emperor must precede the serial number of the patent document. ⁴ Kind of document by the appropriate symbols as indicated on the document under WIPO Standard ST.16 if possible. ⁵ Applicant is to place a check mark here if English language translation is attached.

**INFORMATION DISCLOSURE
STATEMENT BY APPLICANT**
(Not for submission under 37 CFR 1.99)

Application Number		
Filing Date		
First Named Inventor	Mohammed N. ISLAM	
Art Unit		
Examiner Name		
Attorney Docket Number	POWM 0105 PUSP1	

CERTIFICATION STATEMENT

Please see 37 CFR 1.97 and 1.98 to make the appropriate selection(s):

That each item of information contained in the information disclosure statement was first cited in any communication from a foreign patent office in a counterpart foreign application not more than three months prior to the filing of the information disclosure statement. See 37 CFR 1.97(e)(1).

OR

That no item of information contained in the information disclosure statement was cited in a communication from a foreign patent office in a counterpart foreign application, and, to the knowledge of the person signing the certification after making reasonable inquiry, no item of information contained in the information disclosure statement was known to any individual designated in 37 CFR 1.56(c) more than three months prior to the filing of the information disclosure statement. See 37 CFR 1.97(e)(2).

See attached certification statement.

The fee set forth in 37 CFR 1.17 (p) has been submitted herewith.

A certification statement is not submitted herewith.

SIGNATURE

A signature of the applicant or representative is required in accordance with CFR 1.33, 10.18. Please see CFR 1.4(d) for the form of the signature.

Signature	/David S. Bir/	Date (YYYY-MM-DD)	2015-10-01
Name/Print	David S. Bir	Registration Number	38383

This collection of information is required by 37 CFR 1.97 and 1.98. The information is required to obtain or retain a benefit by the public which is to file (and by the USPTO to process) an application. Confidentiality is governed by 35 U.S.C. 122 and 37 CFR 1.14. This collection is estimated to take 1 hour to complete, including gathering, preparing and submitting the completed application form to the USPTO. Time will vary depending upon the individual case. Any comments on the amount of time you require to complete this form and/or suggestions for reducing this burden, should be sent to the Chief Information Officer, U.S. Patent and Trademark Office, U.S. Department of Commerce, P.O. Box 1450, Alexandria, VA 22313-1450. **DO NOT SEND FEES OR COMPLETED FORMS TO THIS ADDRESS. SEND TO: Commissioner for Patents, P.O. Box 1450, Alexandria, VA 22313-1450.**

Privacy Act Statement

The Privacy Act of 1974 (P.L. 93-579) requires that you be given certain information in connection with your submission of the attached form related to a patent application or patent. Accordingly, pursuant to the requirements of the Act, please be advised that: (1) the general authority for the collection of this information is 35 U.S.C. 2(b)(2); (2) furnishing of the information solicited is voluntary; and (3) the principal purpose for which the information is used by the U.S. Patent and Trademark Office is to process and/or examine your submission related to a patent application or patent. If you do not furnish the requested information, the U.S. Patent and Trademark Office may not be able to process and/or examine your submission, which may result in termination of proceedings or abandonment of the application or expiration of the patent.

The information provided by you in this form will be subject to the following routine uses:

1. The information on this form will be treated confidentially to the extent allowed under the Freedom of Information Act (5 U.S.C. 552) and the Privacy Act (5 U.S.C. 552a). Records from this system of records may be disclosed to the Department of Justice to determine whether the Freedom of Information Act requires disclosure of these records.
2. A record from this system of records may be disclosed, as a routine use, in the course of presenting evidence to a court, magistrate, or administrative tribunal, including disclosures to opposing counsel in the course of settlement negotiations.
3. A record in this system of records may be disclosed, as a routine use, to a Member of Congress submitting a request involving an individual, to whom the record pertains, when the individual has requested assistance from the Member with respect to the subject matter of the record.
4. A record in this system of records may be disclosed, as a routine use, to a contractor of the Agency having need for the information in order to perform a contract. Recipients of information shall be required to comply with the requirements of the Privacy Act of 1974, as amended, pursuant to 5 U.S.C. 552a(m).
5. A record related to an International Application filed under the Patent Cooperation Treaty in this system of records may be disclosed, as a routine use, to the International Bureau of the World Intellectual Property Organization, pursuant to the Patent Cooperation Treaty.
6. A record in this system of records may be disclosed, as a routine use, to another federal agency for purposes of National Security review (35 U.S.C. 181) and for review pursuant to the Atomic Energy Act (42 U.S.C. 218(c)).
7. A record from this system of records may be disclosed, as a routine use, to the Administrator, General Services, or his/her designee, during an inspection of records conducted by GSA as part of that agency's responsibility to recommend improvements in records management practices and programs, under authority of 44 U.S.C. 2904 and 2906. Such disclosure shall be made in accordance with the GSA regulations governing inspection of records for this purpose, and any other relevant (i.e., GSA or Commerce) directive. Such disclosure shall not be used to make determinations about individuals.
8. A record from this system of records may be disclosed, as a routine use, to the public after either publication of the application pursuant to 35 U.S.C. 122(b) or issuance of a patent pursuant to 35 U.S.C. 151. Further, a record may be disclosed, subject to the limitations of 37 CFR 1.14, as a routine use, to the public if the record was filed in an application which became abandoned or in which the proceedings were terminated and which application is referenced by either a published application, an application open to public inspections or an issued patent.
9. A record from this system of records may be disclosed, as a routine use, to a Federal, State, or local law enforcement agency, if the USPTO becomes aware of a violation or potential violation of law or regulation.

SHORT-WAVE INFRARED SUPER-CONTINUUM LASERS FOR DETECTING
COUNTERFEIT OR ILLICIT DRUGS AND PHARMACEUTICAL PROCESS CONTROL

CROSS-REFERENCE TO RELATED APPLICATIONS

[0001] This application is a continuation of U.S. application Serial No. 14/108,986 filed December 17, 2013, which claims the benefit of U.S. provisional application Serial No. 61/747,487 filed December 31, 2012, the disclosures of which are hereby incorporated in their entirety by reference herein.

[0002] This application is related to U.S. provisional applications Serial Nos. 61/747,477 filed December 31, 2012; Serial No. 61/747,481 filed December 31, 2012; Serial No. 61/747,485 filed December 31, 2012; Serial No. 61/747,472 filed December 31, 2012; Serial No. 61/747,492 filed December 31, 2012; Serial No. 61/747,553 filed December 31, 2012; and Serial No. 61/754,698 filed January 21, 2013, the disclosures of which are hereby incorporated in their entirety by reference herein.

[0003] This application is also related to International Application No. PCT/US2013/075700 (Publication No. WO/2014/105520) entitled Near-Infrared Lasers For Non-Invasive Monitoring Of Glucose, Ketones, HBA1C, And Other Blood Constituents; International Application PCT/US2013/075736 (Publication No. WO/2014/105521) entitled Short-Wave Infrared Super-Continuum Lasers For Early Detection Of Dental Caries; U.S. Application 14/108,995 (Publication No. 2014/0188092) entitled Focused Near-Infrared Lasers For Non-Invasive Vasectomy And Other Thermal Coagulation Or Occlusion Procedures; International Application PCT/US2013/075767 (Publication No. WO/2014/143276) entitled Short-Wave Infrared Super-Continuum Lasers For Natural Gas Leak Detection, Exploration, And Other Active Remote Sensing Applications; U.S. Application 14/108,974 (Publication No. 2014/0188094) entitled Non-Invasive Treatment Of Varicose Veins; and U.S. Application 14/109,007 (Publication No. 2014/0236021) entitled Near-Infrared Super-Continuum Lasers For Early Detection Of Breast And Other Cancers, the disclosures of which are hereby incorporated in their entirety by reference herein.

BACKGROUND AND SUMMARY

[0004] Counterfeiting of pharmaceuticals is a significant issue in the healthcare community as well as for the pharmaceutical industry worldwide. For example, according to the World Health Organization, in 2006 the market for counterfeit drugs worldwide was estimated at around \$43 Billion. Moreover, the use of counterfeit medicines may result in treatment failure or even death. For instance, in 1995 dozens of children in Haiti and Nigeria died after taking counterfeit medicinal syrups that contained diethylene glycol, an industrial solvent. As another example, in Asia one report estimated that 90% of Viagra sold in Shanghai, China, was counterfeit. With more pharmaceuticals being purchased through the internet, the problem of counterfeit drugs coming from across the borders into the United States has been growing rapidly.

[0005] A rapid, non-destructive, non-contact optical method for screening or identification of counterfeit pharmaceuticals is needed. Spectroscopy using near-infrared or short-wave infrared (SWIR) light may provide such a method, because most pharmaceuticals comprise organic compounds that have overtone or combination absorption bands in this wavelength range (e.g., between approximately 1-2.5 microns). Moreover, most drug packaging materials are at least partially transparent in the near-infrared or SWIR, so that drug compositions may be detected and identified through the packaging non-destructively. Also, using a near-infrared or SWIR light source with a spatially coherent beam permits screening at stand-off or remote distances. Beyond identifying counterfeit drugs, the near-infrared or SWIR spectroscopy may have many other beneficial applications. For example, spectroscopy may be used for rapid screening of illicit drugs or to implement process analytical technology in pharmaceutical manufacturing. There are also a wide array of applications in assessment of quality in the food industry, including screening of fruit, vegetables, grains and meats.

[0006] In one embodiment, a near-infrared or SWIR super-continuum (SC) source may be used as the light source for spectroscopy, active remote sensing, or hyper-spectral imaging. One embodiment of the SWIR light source may be an all-fiber integrated SWIR SC source, which leverages the mature technologies from the telecommunications and fiber optics industry. Exemplary fiber-based super-continuum sources may emit light in the near-infrared or SWIR

between approximately 1.4-1.8 microns, 2-2.5 microns, 1.4-2.4 microns, 1-1.8 microns, or any number of other bands. In particular embodiments, the detection system may be a dispersive spectrometer, a Fourier transform infrared spectrometer, or a hyper-spectral imaging detector or camera. In addition, reflection or diffuse reflection light spectroscopy may be implemented using the SWIR light source, where the spectral reflectance can be the ratio of reflected energy to incident energy as a function of wavelength.

[0007] In one embodiment, a measurement system includes a light source configured to generate an output optical beam comprising one or more semiconductor sources configured to generate an input beam, one or more optical amplifiers configured to receive at least a portion of the input beam and to deliver an intermediate beam to an output end of the one or more optical amplifiers, and one or more optical fibers configured to receive at least a portion of the intermediate beam and to deliver at least the portion of the intermediate beam to a distal end of the one or more optical fibers to form a first optical beam. A nonlinear element is configured to receive at least a portion of the first optical beam and to broaden a spectrum associated with the at least a portion of the first optical beam to at least 10nm through a nonlinear effect in the nonlinear element to form the output optical beam with an output beam broadened spectrum, wherein at least a portion of the output beam broadened spectrum comprises a short-wave infrared wavelength between approximately 1400 nanometers and approximately 2500 nanometers, and wherein at least a portion of the one or more fibers is a fused silica fiber with a core diameter less than approximately 400 microns. A measurement apparatus is configured to receive a received portion of the output optical beam and to deliver a delivered portion of the output optical beam to a sample for a non-destructive and non-contact measurement, wherein the delivered portion of the output optical beam is configured to generate a spectroscopy output beam from the sample. A receiver is configured to receive at least a portion of the spectroscopy output beam having a bandwidth of at least 10 nanometers and to process the portion of the spectroscopy output beam to generate an output signal, and wherein at least a part of the delivered portion of the output optical beam is at least partially transmitting through a packaging material covering at least a part of the sample, and wherein the output signal is based on a chemical composition of the sample.

[0008] In another embodiment, a measurement system includes a light source configured to generate an output optical beam comprising a plurality of semiconductor sources configured to generate an input optical beam, a multiplexer configured to receive at least a portion of the input optical beam and to form an intermediate optical beam, and one or more fibers configured to receive at least a portion of the intermediate optical beam and to form the output optical beam, wherein the output optical beam comprises one or more optical wavelengths. A measurement apparatus is configured to receive a received portion of the output optical beam and to deliver a delivered portion of the output optical beam to a sample, wherein the delivered portion of the output optical beam is configured to generate a spectroscopy output beam from the sample. A receiver is configured to receive at least a portion of the spectroscopy output beam and to process the portion of the spectroscopy output beam to generate an output signal, wherein the receiver comprises a Fourier transform infrared (FTIR) spectrometer or a dispersive spectrometer, and wherein at least a part of the delivered portion of the output optical beam is at least partially transmitting through a packaging material covering at least a part of the sample.

[0009] In yet another embodiment, a method of measuring includes generating an output optical beam comprising generating an input optical beam from a plurality of semiconductor sources, multiplexing at least a portion of the input optical beam and forming an intermediate optical beam, and guiding at least a portion of the intermediate optical beam and forming the output optical beam, wherein the output optical beam comprises one or more optical wavelengths. The method may also include receiving a received portion of the output optical beam and delivering a delivered portion of the output optical beam to a sample, wherein the sample comprises an organic compound with an overtone or combinational absorption band in the wavelength range between approximately 1 micron and approximately 2.5 microns. The method may further include generating a spectroscopy output beam having a bandwidth of at least 10 nanometers from the sample using a Fourier transform infrared (FTIR) spectrometer or a dispersive spectrometer, receiving at least a portion of the spectroscopy output beam, and processing the portion of the spectroscopy output beam and generating an output signal.

[0010] With the growing obesity epidemic, the number of individuals with diabetes is increasing dramatically. For example, there are over 200 million people who have diabetes.

Diabetes control requires monitoring of the glucose level, and most glucose measuring systems available commercially require drawing of blood. Depending on the severity of the diabetes, a patient may have to draw blood and measure glucose four to six times a day. This may be extremely painful and inconvenient for many people. In addition, for some groups, such as soldiers in the battlefield, it may be dangerous to have to measure periodically their glucose level with finger pricks.

[0011] Thus, there is an unmet need for non-invasive glucose monitoring (e.g., monitoring glucose without drawing blood). The challenge has been that a non-invasive system requires adequate sensitivity and selectivity, along with repeatability of the results. Yet, this is a very large market, with an estimated annual market of over \$10B in 2011 for self-monitoring of glucose levels.

[0012] One approach to non-invasive monitoring of blood constituents or blood analytes is to use near-infrared spectroscopy, such as absorption spectroscopy or near-infrared diffuse reflection or transmission spectroscopy. Some attempts have been made to use broadband light sources, such as tungsten lamps, to perform the spectroscopy. However, several challenges have arisen in these efforts. First, many other constituents in the blood also have signatures in the near-infrared, so spectroscopy and pattern matching, often called spectral fingerprinting, is required to distinguish the glucose with sufficient confidence. Second, the non-invasive procedures have often transmitted or reflected light through the skin, but skin has many spectral artifacts in the near-infrared that may mask the glucose signatures. Moreover, the skin may have significant water and blood content. These difficulties become particularly complicated when a weak light source is used, such as a lamp. More light intensity can help to increase the signal levels, and, hence, the signal-to-noise ratio.

[0013] As described in this disclosure, by using brighter light sources, such as fiber-based supercontinuum lasers, super-luminescent laser diodes, light-emitting diodes or a number of laser diodes, the near-infrared signal level from blood constituents may be increased. By shining light through the teeth, which have fewer spectral artifacts than skin in the near-infrared, the blood constituents may be measured with less interfering artifacts. Also, by using pattern matching in spectral fingerprinting and various software techniques, the signatures from different constituents in the blood may be identified. Moreover, value-add services may be provided by wirelessly

communicating the monitored data to a handheld device such as a smart phone, and then wirelessly communicating the processed data to the cloud for storing, processing, and transmitting to several locations.

[0014] In various embodiments, a measurement system includes a light source configured to generate an output optical beam that includes one or more semiconductor sources configured to generate an input beam, one or more optical amplifiers configured to receive at least a portion of the input beam and to output an intermediate beam from at least one of the one or more optical amplifiers; and one or more optical fibers configured to receive at least a portion of the intermediate beam and to communicate at least part of the portion of the intermediate beam to a distal end of the one or more optical fibers to form a first optical beam. The light source may also include a nonlinear element configured to receive at least a portion of the first optical beam and to broaden a spectrum associated with the at least a portion of the first optical beam to at least 10nm through a nonlinear effect in the nonlinear element to form the output optical beam with an output beam broadened spectrum. The at least a portion of the output beam broadened spectrum comprises a near-infrared wavelength between approximately 700nm and approximately 2500nm, and at least a portion of the one or more fibers is a fused silica fiber with a core diameter less than approximately 400 microns. The system may also include a measurement apparatus configured to receive a received portion of the output optical beam and to deliver to a sample an analysis output beam, which is a delivered portion of the output optical beam and wherein the delivered portion of the output optical beam is a spatially coherent beam, and a receiver configured to receive and process at least a portion of the analysis output beam reflected or transmitted from the sample having a bandwidth of at least 10 nanometers and to generate an output signal. In addition, a personal device comprising a wireless receiver, a wireless transmitter, a display, a microphone, a speaker, one or more buttons or knobs, a microprocessor and a touch screen may be configured to receive and process at least a portion of the output signal, wherein the personal device is configured to store and display the processed output signal, wherein at least a portion of the processed output signal is configured to be transmitted over a wireless transmission link.

[0015] In another embodiment, a measurement system includes a light source comprising a plurality of semiconductor sources configured to generate an output optical beam with one or more

optical wavelengths, wherein at least a portion of the one or more optical wavelengths is a near-infrared wavelength between 700 nanometers and 2500 nanometers. A measurement apparatus is configured to receive a received portion of the output optical beam and to deliver to a sample an analysis output beam, which is a delivered portion of the output optical beam; and a receiver is configured to receive and process at least a portion of the analysis output beam reflected or transmitted from the sample and to generate an output signal. The system includes a personal device comprising a wireless receiver, a wireless transmitter, a display, a microphone, a speaker, one or more buttons or knobs, a microprocessor and a touch screen, the personal device configured to receive and process at least a portion of the output signal, wherein the personal device is configured to store and display the processed output signal, and wherein at least a portion of the processed output signal is configured to be transmitted over a wireless transmission link, and a remote device configured to receive over the wireless transmission link a received output status comprising the at least a portion of the processed output signal, to buffer the received output status, to process the received output status to generate processed data and to store the processed data.

[0016] Other embodiments may include a measurement system comprising a wearable measurement device for measuring one or more physiological parameters, including a light source comprising a plurality of semiconductor sources configured to generate an output optical beam with one or more optical wavelengths, wherein at least a portion of the one or more optical wavelengths is a near-infrared wavelength between 700 nanometers and 2500 nanometers. The wearable measurement device is configured to receive a received portion of the output optical beam and to deliver to a sample an analysis output beam, which is a delivered portion of the output optical beam. The wearable measurement device further comprises a receiver configured to receive and process at least a portion of the analysis output beam reflected or transmitted from the sample and to generate an output signal. The system also includes a personal device comprising a wireless receiver, a wireless transmitter, a display, a microphone, a speaker, one or more buttons or knobs, a microprocessor and a touch screen, the personal device configured to receive and process at least a portion of the output signal, wherein the personal device is configured to store and display the processed output signal, and wherein at least a portion of the processed output signal is configured to be transmitted over a wireless transmission link and a remote device configured to receive over the

wireless transmission link a received output status comprising the at least a portion of the processed output signal, to buffer the received output status, to process the received output status to generate processed data and to store the processed data, and wherein the remote device is capable of storing a history of at least a portion of the received output status over a specified period of time.

BRIEF DESCRIPTION OF THE DRAWINGS

[0017] For a more complete understanding of the present disclosure, and for further features and advantages thereof, reference is now made to the following description taken in conjunction with the accompanying drawings, in which:

[0018] FIGURE 1 shows the absorbance for two common plastics, polyethylene and polystyrene.

[0019] FIGURE 2 illustrates one example of the difference in near-infrared spectrum between an authentic tablet and a counterfeit tablet.

[0020] FIGURE 3 shows the second derivative of the spectral comparison of Prozac and a similarly formulated generic.

[0021] FIGURE 4 illustrates an example of the near infrared spectra for different pure components of a studied drug.

[0022] FIGURE 5 shows the mid-wave infrared and long-wave infrared absorption spectra for various illicit drugs.

[0023] FIGURE 6 shows the absorbance versus wavelength in the near-infrared region for four classes of illegal drugs.

[0024] FIGURE 7 illustrates the diffuse reflectance near-infrared spectrum of heroin samples.

[0025] FIGURE 8 illustrates the diffuse reflectance near-infrared spectra of different seized illicit drugs containing heroin of different concentrations, along with the spectrum for pure heroin.

- [0026] FIGURE 9 lists possible band assignments for the various spectral features in pure heroin.
- [0027] FIGURE 10 shows the diffuse reflectance near-infrared spectra of different compounds that may be frequently employed as cutting agents.
- [0028] FIGURE 11 provides one example of a flow-chart in the process analytical technology for the pharmaceutical industry.
- [0029] FIGURE 12 illustrates the typical near-infrared spectra of a variety of excipients.
- [0030] FIGURE 13 exemplifies the absorbance from the blending process of a pharmaceutical compound.
- [0031] FIGURE 14 shows what might be an eventual flow-chart of a smart manufacturing process.
- [0032] FIGURE 15A illustrates the near-infrared reflectance spectrum of wheat flour.
- [0033] FIGURE 15B shows the near-infrared absorbance spectra obtained in diffusion reflectance mode for a series of whole 'Hass' avocado fruit.
- [0034] FIGURE 16A is a schematic diagram of the basic elements of an imaging spectrometer.
- [0035] FIGURE 16B illustrates one example of a typical imaging spectrometer used in hyper-spectral imaging systems.
- [0036] FIGURE 17 shows one example of the Fourier transform infrared spectrometer.
- [0037] FIGURE 18 exemplifies a dual-beam experimental set-up that may be used to subtract out (or at least minimize the adverse effects of) light source fluctuations.
- [0038] FIGURE 19 illustrates a block diagram or building blocks for constructing high power laser diode assemblies.

[0039] FIGURE 20 shows a platform architecture for different wavelength ranges for an all-fiber-integrated, high powered, super-continuum light source.

[0040] FIGURE 21 illustrates one embodiment for a short-wave infrared super-continuum light source.

[0041] FIGURE 22 shows the output spectrum from the SWIR SC laser of FIGURE 21 when about a 10m length of fiber for SC generation is used. This fiber is a single-mode, non-dispersion shifted fiber that is optimized for operation near 1550nm.

[0042] FIGURE 23 illustrates high power SWIR-SC lasers that may generate light between approximately 1.4-1.8 microns (top) or approximately 2-2.5 microns (bottom).

[0043] FIGURE 24 schematically shows a medical measurement device as part of a personal or body area network that communicates with another device (e.g., smart phone or tablet) that communicates with the cloud. The cloud may in turn communicate information with the user, healthcare providers, or other designated recipients.

DETAILED DESCRIPTION

[0044] As required, detailed embodiments of the present disclosure are described herein; however, it is to be understood that the disclosed embodiments are merely exemplary of the disclosure that may be embodied in various and alternative forms. The figures are not necessarily to scale; some features may be exaggerated or minimized to show details of particular components. Therefore, specific structural and functional details disclosed herein are not to be interpreted as limiting, but merely as a representative basis for teaching one skilled in the art to variously employ the present disclosure.

[0045] One advantage of optical systems is that they can perform non-contact, stand-off or remote sensing distance spectroscopy of various materials. As an example, optical systems can be used for identification of counterfeit drugs, detection of illicit drugs, or process control in the pharmaceutical industry, especially when the sensing is to be done at remote or stand-off distances in

a non-contact, rapid manner. In general, the near-infrared region of the electromagnetic spectrum covers between approximately 0.7 microns (700nm) to about 2.5 microns (2500nm). However, it may also be advantageous to use just the short-wave infrared (SWIR) between approximately 1.4 microns (1400nm) and about 2.5 microns (2500nm). One reason for preferring the SWIR over the entire NIR may be to operate in the so-called “eye safe” window, which corresponds to wavelengths longer than about 1400nm. Therefore, for the remainder of the disclosure the SWIR will be used for illustrative purposes. However, it should be clear that the discussion that follows could also apply to using the near infrared – NIR -- wavelength range, or other wavelength bands.

[0046] In particular, wavelengths in the eye safe window may not transmit down to the retina of the eye, and therefore, these wavelengths may be less likely to create permanent eye damage from inadvertent exposure. The near-infrared wavelengths have the potential to be dangerous, because the eye cannot see the wavelengths (as it can in the visible), yet they can penetrate and cause damage to the eye. Even if a practitioner is not looking directly at the laser beam, the practitioner’s eyes may receive stray light from a reflection or scattering some surface. Hence, it can always be a good practice to use eye protection when working around lasers. Since wavelengths longer than about 1400nm are substantially not transmitted to the retina or substantially absorbed in the retina, this wavelength range is known as the eye safe window. For wavelengths longer than 1400nm, in general only the cornea of the eye may receive or absorb the light radiation.

[0047] The SWIR wavelength range may be particularly valuable for identifying materials based on their chemical composition because the wavelength range comprises overtones and combination bands for numerous chemical bonds. For example, in the SWIR numerous hydrocarbon chemical compounds have overtone and combinational bands, along with oxygen-hydrogen and carbon-oxygen compounds. Thus, gases, liquids and solids that comprise these chemical compounds may exhibit spectral features in the SWIR wavelength range. In a particular embodiment, the spectra of organic compounds may be dominated by the C-H stretch. The C-H stretch fundamental occurs near 3.4 microns, the first overtone is near 1.7 microns, and a combination band occurs near 2.3 microns.

[0048] One embodiment of remote sensing that is used to identify and classify various materials is so-called “hyper-spectral imaging.” Hyper-spectral sensors may collect information as a set of images, where each image represents a range of wavelengths over a spectral band. Hyper-spectral imaging may deal with imaging narrow spectral bands over an approximately continuous spectral range. As an example, in hyper-spectral imaging a lamp may be used as the light source. However, the incoherent light from a lamp may spatially diffract rapidly, thereby making it difficult to perform spectroscopy at stand-off distances or remote distances. Therefore, it would be advantageous to have a broadband light source covering the SWIR that may be used in place of a lamp to identify or classify materials in remote sensing or stand-off detection applications.

[0049] As used throughout this document, the term “couple” and or “coupled” refers to any direct or indirect communication between two or more elements, whether or not those elements are physically connected to one another. As used throughout this disclosure, the term “spectroscopy” means that a tissue or sample is inspected by comparing different features, such as wavelength (or frequency), spatial location, transmission, absorption, reflectivity, scattering, fluorescence, refractive index, or opacity. In one embodiment, “spectroscopy” may mean that the wavelength of the light source is varied, and the transmission, absorption, fluorescence, or reflectivity of the tissue or sample is measured as a function of wavelength. In another embodiment, “spectroscopy” may mean that the wavelength dependence of the transmission, absorption, fluorescence or reflectivity is compared between different spatial locations on a tissue or sample. As an illustration, the “spectroscopy” may be performed by varying the wavelength of the light source, or by using a broadband light source and analyzing the signal using a spectrometer, wavemeter, or optical spectrum analyzer.

[0050] As used throughout this document, the term “fiber laser” refers to a laser or oscillator that has as an output light or an optical beam, wherein at least a part of the laser comprises an optical fiber. For instance, the fiber in the “fiber laser” may comprise one of or a combination of a single mode fiber, a multi-mode fiber, a mid-infrared fiber, a photonic crystal fiber, a doped fiber, a gain fiber, or, more generally, an approximately cylindrically shaped waveguide or light-pipe. In one embodiment, the gain fiber may be doped with rare earth material, such as ytterbium, erbium, and/or thulium. In another embodiment, the mid-infrared fiber may comprise one or a combination of fluoride fiber, ZBLAN fiber, chalcogenide fiber, tellurite fiber, or germanium doped fiber. In yet

another embodiment, the single mode fiber may include standard single-mode fiber, dispersion shifted fiber, non-zero dispersion shifted fiber, high-nonlinearity fiber, and small core size fibers.

[0051] As used throughout this disclosure, the term “pump laser” refers to a laser or oscillator that has as an output light or an optical beam, wherein the output light or optical beam is coupled to a gain medium to excite the gain medium, which in turn may amplify another input optical signal or beam. In one particular example, the gain medium may be a doped fiber, such as a fiber doped with ytterbium, erbium and/or thulium. In one embodiment, the “pump laser” may be a fiber laser, a solid state laser, a laser involving a nonlinear crystal, an optical parametric oscillator, a semiconductor laser, or a plurality of semiconductor lasers that may be multiplexed together. In another embodiment, the “pump laser” may be coupled to the gain medium by using a fiber coupler, a dichroic mirror, a multiplexer, a wavelength division multiplexer, a grating, or a fused fiber coupler.

[0052] As used throughout this document, the term “super-continuum” and or “supercontinuum” and or “SC” refers to a broadband light beam or output that comprises a plurality of wavelengths. In a particular example, the plurality of wavelengths may be adjacent to one-another, so that the spectrum of the light beam or output appears as a continuous band when measured with a spectrometer. In one embodiment, the broadband light beam may have a bandwidth of at least 10nm. In another embodiment, the “super-continuum” may be generated through nonlinear optical interactions in a medium, such as an optical fiber or nonlinear crystal. For example, the “super-continuum” may be generated through one or a combination of nonlinear activities such as four-wave mixing, parametric amplification, the Raman effect, modulational instability, and self-phase modulation.

[0053] As used throughout this disclosure, the terms “optical light” and or “optical beam” and or “light beam” refer to photons or light transmitted to a particular location in space. The “optical light” and or “optical beam” and or “light beam” may be modulated or unmodulated, which also means that they may or may not contain information. In one embodiment, the “optical light” and or “optical beam” and or “light beam” may originate from a fiber, a fiber laser, a laser, a light emitting diode, a lamp, a pump laser, or a light source.

[0054] As used throughout this disclosure, the term “remote sensing” may include the measuring of properties of an object from a distance, without physically sampling the object, for example by detection of the interactions of the object with an electromagnetic field. In one embodiment, the electromagnetic field may be in the optical wavelength range, including the infrared or SWIR. One particular form of remote sensing may be stand-off detection, which may range exemplary from non-contact up to hundreds of meters away.

IDENTIFICATION OF COUNTERFEIT DRUGS

[0055] Pharmaceutical counterfeiting is a growing and significant issue for the healthcare community as well as the pharmaceutical industry worldwide. As a result of counterfeiting, users may be threatened by substandard drug quality or harmful ingredients, and legitimate companies may lose significant revenues. The definition for “counterfeit drug” by the World Health Organization was as follows: “A counterfeit medicine is one which is deliberately and fraudulently mislabeled with respect to identity and/or source. Counterfeiting can apply to both branded and generic products and counterfeit products may include products with the correct ingredients or with the wrong ingredients, without active ingredients, with insufficient active ingredient or with fake packaging.” Later this definition was slightly modified, “Counterfeiting in relation to medicinal products means the deliberate and fraudulent mislabeling with respect to the identity, composition and/or source of a finished medicinal product, or ingredient for the preparation of a medicinal product.”

[0056] A rapid screening technique such as near-infrared or SWIR spectroscopy could aid in the search for and identification of counterfeit drugs. In particular, using a non-lamp based light source could lead to contact-free control and analysis of drugs. In a particular embodiment, remote sensing, stand-off detection, or hyper-spectral imaging may be used for process control or counterfeit drug identification in a factory or manufacturing setting, or in a retail, wholesale, or warehouse setting. In one embodiment, the light source for remote sensing may direct the light beam toward the region of interest (e.g., conveyor belt, stocking shelves, boxes or cartons, etc), and the diffuse reflected light may then be measured using a detection system. Various kinds of SWIR light sources will be discussed later in this disclosure. The detection system may comprise, in one embodiment, a spectrometer followed by one or more detectors. In another embodiment, the

detection system may be a dispersive element (examples include prisms, gratings, or other wavelength separators) followed by one or more detectors or detector arrays. In yet another embodiment, the detection system may comprise a Fourier transform infrared spectrometer. These are merely specific examples of the detection system, but combinations of these or other detection systems may also be used and are contemplated within the scope of this disclosure.

[0057] For monitoring drugs, the SWIR light source and the detection system could be used in transmission, reflection, fluorescence, or diffuse reflection. Also, different system configurations may also be used and are included in the scope of this disclosure. For example, the light source and detection system may be placed in a fixed location, and for reflection the light source and detectors may be close to one another, while for transmission the light source and detectors may be at different locations. The region of interest may be surveyed, and the light beam may also be scanned to cover an area larger than the light source beam. In yet another embodiment, the system could be placed on a vehicle such as an automobile or a truck, or the light source could be placed on one vehicle, while the detection system is on another vehicle. If the light source and detection system are compact and lightweight, they might even be carried by a person in the field, either in their hands or in a backpack.

[0058] Another advantage of using the near-infrared or SWIR is that most drug packaging materials are at least partially transparent in this wavelength range, so that drug compositions may be detected and identified through the packaging non-destructively. As an example, SWIR light could be used to see through plastics, since the signature for plastics can be subtracted off and there are large wavelength windows where the plastics are transparent. FIGURE 1 illustrates the absorbance 100 for two common plastics: polyethylene 101 and polystyrene 102. Because of the hydro-carbon bonds, there are absorption features near 1.7 microns and 2.2-2.5 microns. In general, the absorption bands in the near infrared are due to overtones and combination bands for various functional group vibrations, including signals from C-H, O-H, C=O, N-H, -COOH, and aromatic C-H groups. It may be difficult to assign an absorption band to a specific functional group due to overlapping of several combinations and overtones. However, with advancements in computational power and chemometrics or multivariate analysis methods, complex systems may be better analyzed. In one embodiment, using software analysis tools the absorption spectrum may be converted to its second

derivative equivalent. The spectral differences may permit a fast, accurate, non-destructive and reliable identification of materials. Although particular derivatives are discussed, other mathematical manipulations may be used in the analysis, and these other techniques are also intended to be covered by this disclosure.

[0059] Spectroscopy in the near-infrared or SWIR may be sensitive to both the chemical and physical nature of the sample composition and may be performed rapidly with minimal sample preparation. For example, near-infrared or SWIR spectroscopy may be used to study the homogeneity of powder samples, particle size determinations, product composition, the determination of the concentrations and distribution of components in solid tablets and content uniformity, among other applications. In yet other embodiments, applications include tablet identification, determination of moisture, residual solvents, active ingredient potency, the study of blending operations, and the detection of capsule tampering.

[0060] FIGURE 2 illustrates one example of the difference in near-infrared spectrum 200 between an authentic tablet and a counterfeit tablet. Two grades of film coated tablets comprising drugs were investigated: curve 201 is the genuine drug, while 202 is a counterfeit drug. These two grades of capsules have noticeably different contents, and the differences are apparent in the near-infrared or SWIR spectra. In some cases the differences may not be as distinct. For these cases, more signal processing may be necessary to distinguish between samples.

[0061] In another embodiment, it may be advantageous to take a first, second or higher order derivative to elucidate the difference between real and counterfeit drugs. For example, FIGURE 3 shows the second derivative 300 of the spectral comparison of Prozac 301 and a similarly formulated generic 302, which had a fluoxetine hydrochloride (10mg). Although the reflectance curves from the two samples are close and, therefore, difficult to distinguish, the second derivative of the data helps to bring out the differences more clearly. Although a second derivative is used in this example, any number of signal processing algorithms and methods may be used, and these are also intended to be covered by this disclosure. For example, partial least square algorithms, multivariate data analysis, principal component analysis, or chemometric software may be implemented without departing from the scope of this disclosure.

[0062] In yet another embodiment, near-infrared or SWIR spectroscopy may be used to measure and calibrate various pharmaceutical formulations based on the active pharmaceutical ingredients and excipients. An excipient may be a pharmacologically inactive substance used as a carrier for the active ingredients of a medication. In some cases, the active substance may not be easily administered and/or absorbed by the human body; in such cases the active ingredient may be dissolved into or mixed with an excipient. Also, excipients are also sometimes used to bulk up formulations that contain very potent active ingredients, to allow for convenient and accurate dosage. In addition to their use in the single-dosage quantity, excipients can be used in the manufacturing process to aid in the handling of the active substance concerned.

[0063] FIGURE 4 shows an example of the near-infrared spectra 400 for different pure components of a studied drug. The spectrum for the active pharmaceutical ingredient (API) 401 is plotted, along with the spectra for five different excipients 402, 403, 404, 405 and 406. Each spectrum has been baseline shifted to avoid overlapping. The near-infrared spectra have been obtained by averaging the spectra of each pixel of an area of a hyper-spectral image. As FIGURE 4 shows, each of the chemical compositions have a distinct spectrum, and the composition of a drug may be decomposed into its constitutive ingredients. These are just some examples of how near-infrared or SWIR spectroscopy may be applied to counterfeit drug detection, but other methods and analysis techniques may also be used without departing from the scope of this disclosure. As one other example, once the active pharmaceutical ingredient and the excipients spectral distribution of a drug formulation are understood, feedback may be provided of this information to the drug development stages.

RAPID SCREENING FOR ILLICIT DRUGS

[0064] Thus, FIGURES 2-4 show that near-infrared or SWIR spectroscopy may be used to identify counterfeit drugs. More generally, various materials including illicit drugs, explosives, fertilizers, vegetation, and paints have features in the near-infrared and SWIR that can be used to identify the various samples, and these applications are also intended to be within the scope of this disclosure. Although stronger features may be found in the mid-infrared, the near-infrared may be easier to measure due to higher quality detection systems, more mature fiber optics and light sources,

and transmission through atmospheric transmission windows. Because of these distinct spectral signatures, these materials could also be detected using active remote sensing, hyper-spectral imaging, or near-infrared or SWIR spectroscopy. As just another example, illicit drugs may be detectable using remote sensing, hyper-spectral imaging, or near-infrared spectroscopy. FIGURE 5 shows the mid-wave infrared and long-wave infrared absorption spectra 500 for various illicit drugs. The absorbance for cocaine 501, methamphetamine 502, MDMA (ecstasy) 503, and heroin 504 are plotted versus wavelength from approximately 2.5-20 microns. Although the fundamental resonances for these drugs may lie in the longer wavelength regions, there are corresponding overtones and combination bands in the SWIR and near-infrared wavelength range. Therefore, the active remote sensing, hyper-spectral imaging, or near-infrared or SWIR spectroscopy techniques described herein may also be applicable to detecting illicit drugs from aircraft, vehicles, or hand held devices.

[0065] The diffuse reflectance technique may be useful with near-infrared or SWIR spectroscopy for rapid identification of illegal drugs due to simple handling and simple use of a search data library created using near-infrared diffuse reflectance. For instance, FIGURE 6 illustrates the absorbance 600 versus wavelength in the near-infrared region for four classes of illegal drugs. In particular, the spectra are shown for methamphetamine (MA) 601, amphetamine (AP) 602, MDMA (street name: ecstasy) 603, and MDA (street name: the love drug) 604. Each of the illegal drugs have unique spectral features in the near-infrared and SWIR. Also, comparing the mid-infrared spectrum for MDMA (503 in FIGURE 5) with the near-infrared spectrum for MDMA (603 in FIGURE 6), it seems clear that the near-infrared region shows overtones and combination bands that should be discernible. Referring to FIGURE 6, sample identification may be accomplished by using the region (indicated by the arrows) where the spectral absorptions may provide specific peaks depending on the drug component.

[0066] In another embodiment, FIGURE 7 shows the diffuse reflectance near-infrared spectrum 700 of heroin samples. Heroin, the 3,6-diacetyl derivative of morphine (hence diacetylmorphine) is an opiate drug synthesized from morphine, which is usually a naturally occurring substance extracted from the seedpod of certain varieties of poppy plants. In particular, 701 is the near-infrared spectrum for an illicit street drug sample, while 702 is the spectra for a pure heroin

standard. The difference between the spectra may arise at least in part from cutting agents. The inset 703 shows the molecular structure for heroin. As in the other examples, the absorption in the near-infrared range is caused by overtone and combination vibrations of O-H, C-H, N-H and C=O groups, which exhibit their fundamental molecular stretching and bending absorption in the mid-infrared range (c.f., the mid-infrared spectrum for heroin is shown 504 in FIGURE 5). These overtone and combination bands do not behave in a simple way, making the near-infrared spectra complex and harder to directly interpret. Also, although the near-infrared signatures may be weaker in magnitude, they are probably easier to detect in the near-infrared, and the sample preparation may also be much simpler in the near-infrared. Moreover, for remote sensing, the near-infrared may be preferable because of atmospheric transmission windows between approximately 1.4-1.8 microns and 2-2.5 microns.

[0067] Pure heroin may be a white powder with a bitter taste that is rarely sold on the streets, while illicit heroin may be a powder varying in color from white to dark brown due to impurities left from the manufacturing process or the presence of additives. The purity of street heroin may also vary widely, as the drug can be mixed with other white powders. The impurity of the drug may often make it difficult to gauge the strength of the dosage, which runs the risk of overdose. One nice feature of near-infrared or SWIR spectroscopy is that the technique may be used in a non-destructive, non-contact manner to determine rapidly the concentration of compounds present in complex samples at percentage levels with very little sample preparation. In a particular embodiment, FIGURE 8 illustrates the diffuse reflectance near-infrared spectra 800 of different seized illicit drugs containing heroin (between 10.7 and 21.8%) compared with the spectrum of pure heroin 801. Curve 802 is for 21.8% by weight, curve 803 is 13.2% by weight, curve 804 is 17% by weight, and curve 805 is 10.7% by weight of heroin. The spectra have been shifted along the vertical axis to better illustrate the differences.

[0068] Although quite complex in the near-infrared, it may be possible to identify from the pure heroin near-infrared spectrum (801 in FIGURE 8 or 702 in FIGURE 7) the main wavelengths related to the most common functional groups in heroin. For example, FIGURE 9 lists possible band assignments 900 for the various spectral features in pure heroin. As can be seen from FIGURE 9,

the absorption in the near-infrared may be mainly due to overtone and combination bands associated with O-H, C-H, N-H and C=O groups.

[0069] As can be appreciated from FIGURE 8, there may be significant differences between the spectrum of pure heroin and sample spectra. These differences may be due to the presence of different compounds used as cutting agents, which can affect the shape and intensity of the near-infrared signals. FIGURE 10 illustrates the diffuse reflectance near-infrared spectra 1000 of different compounds that may be frequently employed as cutting agents. In the bottom of FIGURE 10 are shown the spectra 1008 for pure heroin and the spectra 1007 for a seized illicit street drug sample comprising 21.8% of heroin. The spectra for various cutting agents include: 1001 for flour, 1002 for talcum powder, 1003 for chalk, 1004 for acetylsalicylic acid, 1005 for caffeine, and 1006 for paracetamol. Thus, near-infrared or SWIR spectroscopy may be used to work back to the composition of an unknown drug. Although particular examples of counterfeit and illicit drugs have been described, the near-infrared or SWIR spectroscopy (including diffuse reflectance, reflectance, fluorescence or transmission) may also be applied to the identification of other drugs and substances without departing from the scope of this disclosure. This spectroscopy may be used non-destructively and non-contact over stand-off distances or in remote sensing distances, whether from an airborne, vehicle, hand-held, or stationary platform.

PROCESS ANALYTICAL TECHNOLOGY (PAT)

[0070] One definition of process analytical technology, PAT, is “a system for designing, analyzing and controlling manufacturing through timely evaluations (i.e., during processing) of significant quality and performance attributes of raw and in-process materials and processes, with the goal of ensuring final product quality.” Near-infrared or SWIR spectroscopy may have applications in the PAT of the pharmaceutical industry by providing, for example, quantitative analysis of multiple components in a sample and in pack quantification of drugs in formulation, as well as quality of a drug and quality control of complex excipients used in formulation. The PAT process may benefit from near-infrared or SWIR spectroscopy for some steps, such as: raw material identification, active pharmaceutical ingredient applications, drying, granulation, blend uniformity and content uniformity. Some of the strengths of near-infrared or SWIR spectroscopy include:

radiation has good penetration properties, and, thus, minimal sample preparation may be required; measurement results may be obtained rapidly, and simultaneous measurements may be obtained for several parameters; non-destructive methods with little or no chemical waste; and organic chemicals that comprise most pharmaceutical products have unique spectra in the near-infrared and SWIR ranges, for example.

[0071] FIGURE 11 shows one example of a flow-chart 1100 in the PAT for the pharmaceutical industry. While the center shows the steps of the manufacturing process 1101, the top and bottom sides show where near-infrared spectroscopy could be applicable for lab use 1102 (top) or in process monitoring control 1103 (bottom). Indeed, near-infrared or SWIR spectroscopy has the potential to benefit almost every step in the manufacturing process. Just to provide a few examples of using near-infrared or SWIR spectroscopy in the PAT process, the raw material testing and blending process will be examined briefly.

[0072] At the commencement of manufacture of a drug product, it may be required to identify the correct material and grade of the pharmaceutical excipients to be used in the formulation. FIGURE 12 illustrates the typical near-infrared spectra 1200 for a variety of excipients. Included in the graph 1200 are spectra for: magnesium stearate 1201, sorbitol 1202, mannitol 1203, talc 1204, lactose 1205, starch 1206, maltodextrin 1207, and microcrystalline cellulose 1208. A suitable spectral database may be used to rapidly identify and qualify excipients. One nice aspect of the spectroscopy is that the near-infrared and SWIR are sensitive to both the physical and chemical characteristics of the samples.

[0073] One of the next steps in the manufacture of a dosage form is the blending together of the active component with the excipients to produce a homogeneous blend. In one embodiment, the near-infrared or SWIR spectroscopy apparatus may comprise a fiber-optic probe, which may, for example, interface with the blending vessel. For such a fiber-optic probe, near infrared or SWIR spectra may be collected in real-time from a blending process. FIGURE 13 exemplifies the absorbance 1300 from the blending process. Although the initial spectra 1301 shows differences from the eventual spectra, as the process continues the blend converges to the final spectra 1302 and continues to overlap that spectra. Similar converging or overlapping spectra may also be used to

check the product uniformity at the end of the process. The near-infrared spectra may be acquired in real-time; and, using appropriate data pre-processing and chemometric analysis, blend homogeneity plots may be derived, such as 1300.

[0074] One goal of the manufacturing process and PAT may be the concept of a “smart” manufacturing process, which may be a system or manufacturing operation responding to analytical data generated in real-time. Such a system may also have an in-built “artificial intelligence” as decisions may be made whether to continue a manufacturing operation. For example, with respect to the raw materials, integration of the quality measurement into smart manufacturing processes could be used to improve manufacturing operations by ensuring that the correct materials of the appropriate quality are used in the manufacture. Similarly, a smart blender would be under software control and would respond to the real-time spectral data collected.

[0075] FIGURE 14 illustrates what might be an eventual flow-chart 1400 of a smart manufacturing process. The manufacturing process 1401 may have as input the process feed 1402 and result in a process output 1403. A process controller 1404 may at least partially control the manufacturing process 1401, and the controller 1404 may receive inputs from the closed loop control (process parameters) 1405 as well as the on-line monitoring of process parameters 1406. The feedback loops in the process could refine the manufacturing process 1401 and improve the quality of the process output 1403. These are particular embodiments of the use of near-infrared or SWIR spectroscopy in the PAT of the pharmaceutical industry, but other variations, combinations, and methods may also be used and are intended to be covered by this disclosure.

[0076] The discussion thus far has centered on use of near-infrared or SWIR spectroscopy in applications such as identification of counterfeit drugs, detection of illicit drugs, and pharmaceutical process control. Although drugs and pharmaceuticals are one example, many other fields and applications may also benefit from the use of near infrared or SWIR spectroscopy, and these may also be implemented without departing from the scope of this disclosure. As just another example, near-infrared or SWIR spectroscopy may also be used as an analytic tool for food quality and safety control. Applications in food safety and quality assessment include contaminant detection, defect identification, constituent analysis, and quality evaluation. The techniques described in this

disclosure are particularly valuable when non-destructive testing is desired at stand-off or remote distances.

[0077] In one example, near-infrared or SWIR spectroscopy may be used in cereal breeding. The breeding purposes may require knowledge on both composition and functional properties of grain, while the functionality of wheat grain is an issue for wheat breeders. Most of the wheat functionality parameters depend on the protein-proteinase complex of wheat grain, as well as the condition of the carbohydrate complex. FIGURE 15A illustrates the near-infrared reflectance spectrum 1500 of wheat flour. Since these samples are complex in composition, several organic bonds involving hydrogen vibrate to produce overlapped spectral bands. Thus, the resulting spectrum 1500 appears like a wavy line without clearly defined features. Analytical methods based on this type of spectroscopy may have the potential to improve the quality of final cereal products by testing the products through the entire production process in the processing industry.

[0078] In yet another embodiment, near-infrared or SWIR spectroscopy may be used for the assessment of fruit and vegetable quality. Most commercial quality classification systems for fruit and vegetables are based on external features of the product, such as shape, color, size, weight and blemishes. However, the external appearance of most fruit is generally not an accurate guide to the internal eating quality of the fruit. As an example, for avocado fruit the external color is not a maturity characteristic, and its smell is too weak and appears later in its maturity stage. Analysis of the near-infrared or SWIR absorption spectra may provide qualitative and quantitative determination of many constituents and properties of horticulture produce, including oil, water, protein, pH, acidity, firmness, and soluble solids content or total soluble solids of fresh fruits. FIGURE 15B shows the near-infrared absorbance spectra 1550 obtained in diffusion reflectance mode for a series of whole 'Hass' avocado fruit. Four oil absorption bands are near 2200-2400nm (CH_2 stretch bend and combinations), with weaker absorption around 750nm, 1200nm, and 900-930nm ranges. On the other hand, near 1300-1750nm range may be useful for determining the protein and oil content. The 900-920nm absorbance band may be useful for sugar determination. Although described in the context of grains, fruits, and vegetables, the near-infrared or SWIR spectroscopy may also be valuable for other food quality control and assessment, such as measuring the properties of meats. These and other applications also fall within the scope of this disclosure.

DETECTION SYSTEMS

[0079] The near-infrared or SWIR spectroscopy system, remote sensing system or hyper-spectral imaging system may be on an airborne platform, mounted on a vehicle, a stationary transmission or reflection set-up, or even held by a human for a compact system. For such a system, there are fundamentally two hardware parts: the transmitter or light source and the detection system. Between the two, perhaps in a transmission or reflection setting, may be the sample being tested or measured. Moreover, the output from the detection system may go to a computational system, comprising computers or other processing equipment. The output from the computational system may be displayed graphically as well as with numerical tables and perhaps an identification of the material composition. These are just some of the parts of the systems, but other elements may be added or be eliminated, and these modified configurations are also intended to be covered by this disclosure.

[0080] By use of an active illuminator, a number of advantages may be achieved. First, stand-off or remote distances may be achieved if a non-lamp system is used – i.e., if the beam does not rapidly diffract. Also, higher signal-to-noise ratios may be achieved. For example, one way to improve the signal-to-noise ratio would be to use modulation and lock-in techniques. In one embodiment, the light source may be modulated, and then the detection system would be synchronized with the light source. In a particular embodiment, the techniques from lock-in detection may be used, where narrow band filtering around the modulation frequency may be used to reject noise outside the modulation frequency. In another embodiment, change detection schemes may be used, where the detection system captures the signal with the light source on and with the light source off. Again, for this system the light source may be modulated. Then, the signal with and without the light source is differenced. Change detection may help to identify objects that change in the field of view. In the following some exemplary detection systems are described.

[0081] In one embodiment, a SWIR camera or infrared camera system may be used to capture the images. The camera may include one or more lenses on the input, which may be adjustable. The focal plane assemblies may be made from mercury cadmium telluride material (HgCdTe), and the detectors may also include thermo-electric coolers. Alternately, the image sensors may be made from indium gallium arsenide (InGaAs), and CMOS transistors may be

connected to each pixel of the InGaAs photodiode array. The camera may interface wirelessly or with a cable (e.g., USB, Ethernet cable, or fiber optics cable) to a computer or tablet or smart phone, where the images may be captured and processed. These are a few examples of infrared cameras, but other SWIR or infrared cameras may be used and are intended to be covered by this disclosure.

[0082] In another embodiment, an imaging spectrometer may be used to detect the light received from the sample. For example, FIGURE 16A shows a schematic diagram 1600 of the basic elements of an imaging spectrometer. The input light 1601 from the sample may first be directed by a scanning mirror and/or other optics 1602. An optical dispersing element 1603, such as a grating or prism, in the spectrometer may split the light into many narrow, adjacent wavelength bands, which may then be passed through imaging optics 1604 onto one or more detectors or detector arrays 1605. Some sensors may use multiple detector arrays to measure hundreds of narrow wavelength bands.

[0083] An example of a typical imaging spectrometer 1650 used in hyper-spectral imaging systems is illustrated in FIGURE 16B. In this particular embodiment, the input light may be directed first by a tunable mirror 1651. A front lens 1652 may be placed before the entrance slit 1653 and the collector lens 1654. In this embodiment, the dispersing element is a holographic grating with a prism 1655, which separates the different wavelength bands. Then, a camera lens 1656 may be used to image the wavelengths onto a detector or camera 1657.

[0084] FIGURES 16 provide particular examples, but some of the elements may not be used, or other elements may be added, and these are also intended to be covered by this disclosure. For instance, a scanning spectrometer may be used before the detector, where a grating or dispersive element is scanned to vary the wavelength being measured by the detector. In yet another embodiment, filters may be used before one or more detectors to select the wavelengths or wavelength bands to be measured. This may be particularly useful if only a few bands or wavelengths are to be measured. The filters may be dielectric filters, Fabry-Perot filters, absorption or reflection filters, fiber gratings, or any other wavelength selective filter. In one embodiment, a wavelength division multiplexer, WDM, may be used followed by one or more detectors or detector arrays. One example of a planar wavelength division multiplexer may be a waveguide grating router or an arrayed waveguide grating. The WDM may be fiber coupled, and detectors may be placed

directly at the output or the detectors may be coupled through fibers to the WDM. Some of these components may also be combined with the configurations in FIGURE 16.

[0085] While the above detection systems could be categorized as single path detection systems, it may be advantageous in some cases to use multi-path detection systems. In one embodiment, a detection system from a Fourier transform infrared spectrometer, FTIR, may be used. The received light may be incident on a particular configuration of mirrors, called a Michelson interferometer, that allows some wavelengths to pass through but blocks others due to wave interference. The beam may be modified for each new data point by moving one of the mirrors, which changes the set of wavelengths that pass through. This collected data is called an interferogram. The interferogram is then processed, typically on a computing system, using an algorithm called the Fourier transform. One advantageous feature of FTIR is that it may simultaneously collect spectral data in a wide spectral range.

[0086] FIGURE 17 illustrates one example of the FTIR spectrometer 1700. Light from the near-infrared or SWIR light source 1701 may be collimated and directed to a beam splitter 1702. In one embodiment, the beam splitter 1702 may be a 50:50 beam splitter. One portion of the beam 1703 may be reflected toward a stationary mirror 1704, while the other portion of the beam 1705 may be transmitted towards a moving mirror 1706. Light may be reflected from the two mirrors 1704, 1706 back to the beam splitter 1702, and then a portion of the recombined beam 1707 may be directed toward the sample 1708. The recombined beam 1707 may be focused onto the sample 1708, in one embodiment. On leaving the sample 1708, the light may be refocused or at least collected at a detector 1709. A background interferogram may be obtained by using the set-up 1700 without a sample in the chamber 1708. When a sample is inserted into 1708, the background interferogram may be modulated by the presence of absorption bands in the sample. The FTIR spectrometer may have several advantages compared to a scanning (dispersive) spectrometer. Since all the wavelengths may be collected simultaneously, the FTIR may result in a higher signal-to-noise ratio for a given scan time or a shorter scan time for a given resolution. Moreover, unlike a spectrometer where a slit may limit the amount of the beam detected, the FTIR may accommodate the entire diameter of the beam coming from the light source 1701. The configuration 1700 is one

example of an FTIR, but other configurations may also be used, and these are also intended to be covered by this disclosure.

[0087] In yet another example of multi-beam detection systems, a dual-beam set-up 1800 such as in FIGURE 18 may be used to subtract out (or at least minimize the adverse effects of) light source fluctuations. In one embodiment, the output from an SC source 1801 may be collimated using a CaF₂ lens 1802 and then focused into the entrance slit of the monochromator 1803. At the exit slit, light at the selected wavelength is collimated again and may be passed through a polarizer 1804 before being incident on a calcium fluoride beam splitter 1805. After passing through the beam splitter 1805, the light is split into a sample 1806 and reference 1807 arm to enable ratiometric detection that may cancel out effects of intensity fluctuations in the SC source 1801. The light in the sample arm 1806 passes through the sample of interest and is then focused onto a HgCdTe detector 1808 connected to a pre-amp. A chopper 1802 and lock-in amplifier 1810 setup enable low noise detection of the sample arm signal. The light in the reference arm 1807 passes through an empty container (cuvette, gas cell etc.) of the same kind as used in the sample arm. A substantially identical detector 1809, pre-amp and lock-in amplifier 1810 is used for detection of the reference arm signal. The signal may then be analyzed using a computer system 1811. This is one particular example of a method to remove fluctuations from the light source, but other components may be added and other configurations may be used, and these are also intended to be covered by this disclosure.

[0088] Although particular examples of detection systems have been described, combinations of these systems or other systems may also be used, and these are also within the scope of this disclosure. As one example, environmental fluctuations (such as turbulence or winds) may lead to fluctuations in the beam for active remote sensing or hyper-spectral imaging. A configuration such as FIGURE 18 may be able to remove the effect of environmental fluctuations. Yet another technique may be to “wobble” the light beam after the light source using a vibrating mirror. The motion may lead to the beam moving enough to wash out spatial fluctuations within the beam waist at the sample or detection system. If the vibrating mirror is scanned faster than the integration time of the detectors, then the spatial fluctuations in the beam may be integrated out. Alternately, some sort of synchronous detection system may be used, where the detection is synchronized to the vibrating frequency.

LIGHT SOURCES FOR SWIR AND NEAR INFRARED

[0089] There are a number of light sources that may be used in the near infrared. To be more specific, the discussion below will consider light sources operating in the short wave infrared (SWIR), which may cover the wavelength range of approximately 1400nm to 2500nm. Other wavelength ranges may also be used for the applications described in this disclosure, so the discussion below is merely provided for exemplary types of light sources. The SWIR wavelength range may be valuable for a number of reasons. The SWIR corresponds to a transmission window through water and the atmosphere. Also, the so-called “eye-safe” wavelengths are wavelengths longer than approximately 1400nm as previously described.

[0090] Different light sources may be selected for the SWIR based on the needs of the application. Some of the features for selecting a particular light source include power or intensity, wavelength range or bandwidth, spatial or temporal coherence, spatial beam quality for focusing or transmission over long distance, and pulse width or pulse repetition rate. Depending on the application, lamps, light emitting diodes (LEDs), laser diodes (LD’s), tunable LD’s, super-luminescent laser diodes (SLDs), fiber lasers or super-continuum sources (SC) may be advantageously used. Also, different fibers may be used for transporting the light, such as fused silica fibers, plastic fibers, mid-infrared fibers (e.g., tellurite, chalcogenides, fluorides, ZBLAN, etc), or a hybrid of these fibers.

[0091] Lamps may be used if low power or intensity of light is required in the SWIR, and if an incoherent beam is suitable. In one embodiment, in the SWIR an incandescent lamp that can be used is based on tungsten and halogen, which have an emission wavelength between approximately 500nm to 2500nm. For low intensity applications, it may also be possible to use thermal sources, where the SWIR radiation is based on the black body radiation from the hot object. Although the thermal and lamp based sources are broadband and have low intensity fluctuations, it may be difficult to achieve a high signal-to-noise ratio due to the low power levels. Also, the lamp based sources tend to be energy inefficient.

[0092] In another embodiment, LED's can be used that have a higher power level in the SWIR wavelength range. LED's also produce an incoherent beam, but the power level can be higher than a lamp and with higher energy efficiency. Also, the LED output may more easily be modulated, and the LED provides the option of continuous wave or pulsed mode of operation. LED's are solid state components that emit a wavelength band that is of moderate width, typically between about 20nm to 40nm. There are also so-called super-luminescent LEDs that may even emit over a much wider wavelength range. In another embodiment, a wide band light source may be constructed by combining different LEDs that emit in different wavelength bands, some of which could preferably overlap in spectrum. One advantage of LEDs as well as other solid state components is the compact size that they may be packaged into.

[0093] In yet another embodiment, various types of laser diodes may be used in the SWIR wavelength range. Just as LEDs may be higher in power but narrower in wavelength emission than lamps and thermal sources, the LDs may be yet higher in power but yet narrower in wavelength emission than LEDs. Different kinds of LDs may be used, including Fabry-Perot LDs, distributed feedback (DFB) LDs, distributed Bragg reflector (DBR) LDs. Since the LDs have relatively narrow wavelength range (typically under 10nm), in one embodiment a plurality of LDs may be used that are at different wavelengths in the SWIR. The various LDs may be spatially multiplexed, polarization multiplexed, wavelength multiplexed, or a combination of these multiplexing methods. Also, the LDs may be fiber pig-tailed or have one or more lenses on the output to collimate or focus the light. Another advantage of LDs is that they may be packaged compactly and may have a spatially coherent beam output. Moreover, tunable LDs that can tune over a range of wavelengths are also available. The tuning may be done by varying the temperature, or electrical current may be used in particular structures such as distributed Bragg reflector LDs. In another embodiment, external cavity LDs may be used that have a tuning element, such as a fiber grating or a bulk grating, in the external cavity.

[0094] In another embodiment, super-luminescent laser diodes may provide higher power as well as broad bandwidth. An SLD is typically an edge emitting semiconductor light source based on super-luminescence (e.g., this could be amplified spontaneous emission). SLDs combine the higher power and brightness of LDs with the low coherence of conventional LEDs, and the emission band

for SLD's may be 5nm to 100nm wide, preferably in the 60nm to 100nm range. Although currently SLDs are commercially available in the wavelength range of approximately 400nm to 1700nm, SLDs could and may in the future be made that cover a broader region of the SWIR.

[0095] In yet another embodiment, high power LDs for either direct excitation or to pump fiber lasers and SC light sources may be constructed using one or more laser diode bar stacks. FIGURE 19 shows an example block diagram 1900 with building blocks for constructing the high power LDs. In this embodiment, one or more diode bar stacks 1901 may be used, where the diode bar stack may be an array of several single emitter LDs. Since the fast axis (e.g., vertical direction) may be nearly diffraction limited while the slow-axis (e.g., horizontal axis) may be far from diffraction limited, different collimators 1902 may be used for the two axes.

[0096] The brightness may be increased by spatially combining the beams from multiple stacks 1903. The combiner may include spatial interleaving, wavelength multiplexing, or a combination of the two. Different spatial interleaving schemes may be used, such as using an array of prisms or mirrors with spacers to bend one array of beams into the beam path of the other. In another embodiment, segmented mirrors with alternate high-reflection and anti-reflection coatings may be used. Moreover, the brightness may be increased by polarization beam combining 1904 the two orthogonal polarizations, such as by using a polarization beam splitter. In a particular embodiment, the output may then be focused or coupled into a large diameter core fiber. As an example, typical dimensions for the large diameter core fiber range from diameters of approximately 100 microns to 400 microns or more. Alternatively or in addition, a custom beam shaping module 1905 may be used, depending on the particular application. For example, the output of the high power LD may be used directly 1906, or it may be fiber coupled 1907 to combine, integrate, or transport the high power LD energy. These high power LDs may grow in importance because the LD powers can rapidly scale up. For example, instead of the power being limited by the power available from a single emitter, the power may increase in multiples depending on the number of diodes multiplexed and the size of the large diameter fiber. Although FIGURE 19 is shown as one embodiment, some or all of the elements may be used in a high power LD, or additional elements may also be used.

SWIR SUPER-CONTINUUM LASERS

[0097] Each of the light sources described above have particular strengths, but they also may have limitations. For example, there is typically a trade-off between wavelength range and power output. Also, sources such as lamps, thermal sources, and LEDs produce incoherent beams that may be difficult to focus to a small area and may have difficulty propagating for long distances. An alternative source that may overcome some of these limitations is an SC light source. Some of the advantages of the SC source may include high power and intensity, wide bandwidth, spatially coherent beam that can propagate nearly transform limited over long distances, and easy compatibility with fiber delivery.

[0098] Supercontinuum lasers may combine the broadband attributes of lamps with the spatial coherence and high brightness of lasers. By exploiting a modulational instability initiated supercontinuum (SC) mechanism, an all-fiber-integrated SC laser with no moving parts may be built using commercial-off-the-shelf (COTS) components. Moreover, the fiber laser architecture may be a platform where SC in the visible, near-infrared/SWIR, or mid-IR can be generated by appropriate selection of the amplifier technology and the SC generation fiber. But until recently, SC lasers were used primarily in laboratory settings since typically large, table-top, mode-locked lasers were used to pump nonlinear media such as optical fibers to generate SC light. However, those large pump lasers may now be replaced with diode lasers and fiber amplifiers that gained maturity in the telecommunications industry.

[0099] In one embodiment, an all-fiber-integrated, high-powered SC light source 2000 may be elegant for its simplicity (FIGURE 20). The light may be first generated from a seed laser diode 2001. For example, the seed LD 2001 may be a distributed feedback (DFB) laser diode with a wavelength near 1542nm or 1550 nm, with approximately 0.5–2.0ns pulsed output, and with a pulse repetition rate between one kilohertz to about 100MHz or more. The output from the seed laser diode may then be amplified in a multiple-stage fiber amplifier 2002 comprising one or more gain fiber segments. In a particular embodiment, the first stage pre-amplifier 2003 may be designed for optimal noise performance. For example, the pre-amplifier 2003 may be a standard erbium-doped fiber amplifier or an erbium/ytterbium doped cladding pumped fiber amplifier. Between amplifier

stages 2003 and 2006, it may be advantageous to use band-pass filters 2004 to block amplified spontaneous emission and isolators 2005 to prevent spurious reflections. Then, the power amplifier stage 2006 may use a cladding-pumped fiber amplifier that may be optimized to minimize nonlinear distortion. The power amplifier fiber 2006 may also be an erbium-doped fiber amplifier, if only low or moderate power levels are to be generated.

[0100] The SC generation 2007 may occur in the relatively short lengths of fiber that follow the pump laser. Exemplary SC fiber lengths may range from a few millimeters to 100m or more. In one embodiment, the SC generation may occur in a first fiber 2008 where the modulational-instability initiated pulse break-up occurs primarily, followed by a second fiber 2009 where the SC generation and spectral broadening occurs primarily.

[0101] In one embodiment, one or two meters of standard single-mode fiber (SMF) after the power amplifier stage may be followed by several meters of SC generation fiber. For this example, in the SMF the peak power may be several kilowatts and the pump light may fall in the anomalous group-velocity dispersion regime—often called the soliton regime. For high peak powers in the anomalous dispersion regime, the nanosecond pulses may be unstable due to a phenomenon known as modulational instability, which is basically parametric amplification in which the fiber nonlinearity helps to phase match the pulses. As a consequence, the nanosecond pump pulses may be broken into many shorter pulses as the modulational instability tries to form soliton pulses from the quasi-continuous-wave background. Although the laser diode and amplification process starts with approximately nanosecond-long pulses, modulational instability in the short length of SMF fiber may form approximately 0.5ps to several-picosecond-long pulses with high intensity. Thus, the few meters of SMF fiber may result in an output similar to that produced by mode-locked lasers, except in a much simpler and cost-effective manner.

[0102] The short pulses created through modulational instability may then be coupled into a nonlinear fiber for SC generation. The nonlinear mechanisms leading to broadband SC may include four-wave mixing or self-phase modulation along with the optical Raman effect. Since the Raman effect is self-phase-matched and shifts light to longer wavelengths by emission of optical photons, the SC may spread to longer wavelengths very efficiently. The short-wavelength edge may arise

from four-wave mixing, and often times the short wavelength edge may be limited by increasing group-velocity dispersion in the fiber. In many instances, if the particular fiber used has sufficient peak power and SC fiber length, the SC generation process may fill the long-wavelength edge up to the transmission window.

[0103] Mature fiber amplifiers for the power amplifier stage 2006 include ytterbium-doped fibers (near 1060 nm), erbium-doped fibers (near 1550nm), erbium/ytterbium-doped fibers (near 1550nm), or thulium-doped fibers (near 2000nm). In various embodiments, candidates for SC fiber 2009 include fused silica fibers (for generating SC between 0.8–2.7 μ m), mid-IR fibers such as fluorides, chalcogenides, or tellurites (for generating SC out to 4.5 μ m or longer), photonic crystal fibers (for generating SC between 0.4-1.7 μ m), or combinations of these fibers. Therefore, by selecting the appropriate fiber-amplifier doping for 2006 and nonlinear fiber 2009, SC may be generated in the visible, near-IR/SWIR, or mid-IR wavelength region.

[0104] The configuration 2000 of FIGURE 20 is just one particular example, and other configurations can be used and are intended to be covered by this disclosure. For example, further gain stages may be used, and different types of lossy elements or fiber taps may be used between the amplifier stages. In another embodiment, the SC generation may occur partially in the amplifier fiber and in the pig-tails from the pump combiner or other elements. In yet another embodiment, polarization maintaining fibers may be used, and a polarizer may also be used to enhance the polarization contrast between amplifier stages. Also, not discussed in detail are many accessories that may accompany this set-up, such as driver electronics, pump laser diodes, safety shut-offs, and thermal management and packaging.

[0105] In one embodiment, one example of the SC laser that operates in the SWIR is illustrated in FIGURE 21. This SWIR SC source 2100 produces an output of up to approximately 5W over a spectral range of about 1.5-2.4 microns, and this particular laser is made out of polarization maintaining components. The seed laser 2101 is a distributed feedback (DFB) laser operating near 1542nm producing approximately 0.5nsec pulses at an about 8MHz repetition rate. The pre-amplifier 2102 is forward pumped and uses about 2m length of erbium/ytterbium cladding pumped fiber 2103 (often also called dual-core fiber) with an inner core diameter of 12 microns and

outer core diameter of 130 microns. The pre-amplifier gain fiber 2103 is pumped using a 10W laser diode near 940nm 2105 that is coupled in using a fiber combiner 2104.

[0106] In this particular 5W unit, the mid-stage between amplifier stages 2102 and 2106 comprises an isolator 2107, a band-pass filter 2108, a polarizer 2109 and a fiber tap 2110. The power amplifier 2106 uses an approximately 4m length of the 12/130 micron erbium/ytterbium doped fiber 2111 that is counter-propagating pumped using one or more 30W laser diodes near 940nm 2112 coupled in through a combiner 2113. An approximately 1-2m length of the combiner pig-tail helps to initiate the SC process, and then a length of PM-1550 fiber 2115 (polarization maintaining, single-mode, fused silica fiber optimized for 1550nm) is spliced 2114 to the combiner output.

[0107] If an output fiber of about 10m in length is used, then the resulting output spectrum 2200 is shown in FIGURE 22. The details of the output spectrum 2200 depend on the peak power into the fiber, the fiber length, and properties of the fiber such as length and core size, as well as the zero dispersion wavelength and the dispersion properties. For example, if a shorter length of fiber is used, then the spectrum actually reaches to longer wavelengths (e.g., a 2m length of SC fiber broadens the spectrum to about 2500nm). Also, if extra-dry fibers are used with less O-H content, then the wavelength edge may also reach to a longer wavelength. To generate more spectrum toward the shorter wavelengths, the pump wavelength (in this case around 1542nm) should be close to the zero dispersion wavelength in the fiber. For example, by using a dispersion shifted fiber or so-called non-zero dispersion shifted fiber, the short wavelength edge may shift to shorter wavelengths.

[0108] Although one particular example of a 5W SWIR-SC has been described, different components, different fibers, and different configurations may also be used consistent with this disclosure. For instance, another embodiment of the similar configuration 2100 in FIGURE 21 may be used to generate high powered SC between approximately 1060nm and 1800nm. For this embodiment, the seed laser 2101 may be a distributed feedback laser diode around 1064nm, the pre-amplifier gain fiber 2103 may be a ytterbium-doped fiber amplifier with 10/125 microns dimensions, and the pump laser 2105 may be a 10W laser diode near 915nm. A mode field adapter may be included in the mid-stage, in addition to the isolator 2107, band pass filter 2108, polarizer 2109 and

tap 2110. The gain fiber 2111 in the power amplifier may be an about 20m length of ytterbium-doped fiber with 25/400 microns dimension. The pump 2112 for the power amplifier may be up to six pump diodes providing 30W each near 915nm. For this much pump power, the output power in the SC may be as high as 50W or more.

[0109] In one embodiment, it may be desirous to generate high power SWIR SC over 1.4-1.8 microns and separately 2-2.5 microns (the window between 1.8 and 2 microns may be less important due to the strong water and atmospheric absorption). For example, the top SC source of FIGURE 23 can lead to bandwidths ranging from about 1400nm to 1800nm or broader, while the lower SC source of FIGURE 23 can lead to bandwidths ranging from about 1900nm to 2500nm or broader. Since these wavelength ranges are shorter than about 2500nm, the SC fiber can be based on fused silica fiber. Exemplary SC fibers include standard single-mode fiber SMF, high-nonlinearity fiber, high-NA fiber, dispersion shifted fiber, dispersion compensating fiber, and photonic crystal fibers. Non-fused-silica fibers can also be used for SC generation, including chalcogenides, fluorides, ZBLAN, tellurites, and germanium oxide fibers.

[0110] In one embodiment, the top of FIGURE 23 illustrates an exemplary block diagram for an SC source 2300 capable of generating light between approximately 1400nm and 1800nm or broader. As an example, a pump fiber laser similar to FIGURE 21 can be used as the input to a SC fiber 2309. The seed laser diode 2301 can comprise a DFB laser that generates, for example, several milliwatts of power around 1542nm or 1553nm. The fiber pre-amplifier 2302 can comprise an erbium-doped fiber amplifier or an erbium/ytterbium doped double clad fiber. In this example a mid-stage amplifier 2303 can be used, which can comprise an erbium/ytterbium doped double-clad fiber. A bandpass filter 2305 and isolator 2306 may be used between the pre-amplifier 2302 and mid-stage amplifier 2303. The power amplifier stage 2304 can comprise a larger core size erbium/ytterbium doped double-clad fiber, and another bandpass filter 2307 and isolator 2308 can be used before the power amplifier 2304. The output of the power amplifier can be coupled to the SC fiber 2309 to generate the SC output 2310. This is just one exemplary configuration for an SC source, and other configurations or elements may be used consistent with this disclosure.

[0111] In yet another embodiment, the bottom of FIGURE 23 illustrates a block diagram for an exemplary SC source 2350 capable of generating light between approximately 1900nm and 2500nm or broader. As an example, the seed laser diode 2351 can comprise a DFB or DBR laser that generates, for example, several milliwatts of power around 1542nm or 1553nm. The fiber pre-amplifier 2352 can comprise an erbium-doped fiber amplifier or an erbium/ytterbium doped double-clad fiber. In this example a mid-stage amplifier 2353 can be used, which can comprise an erbium/ytterbium doped double-clad fiber. A bandpass filter 2355 and isolator 2356 may be used between the pre-amplifier 2352 and mid-stage amplifier 2353. The power amplifier stage 2354 can comprise a thulium doped double-clad fiber, and another isolator 2357 can be used before the power amplifier 2354. Note that the output of the mid-stage amplifier 2353 can be approximately near 1542nm, while the thulium-doped fiber amplifier 2354 can amplify wavelengths longer than approximately 1900nm and out to about 2100nm. Therefore, for this configuration wavelength shifting may be required between 2353 and 2354. In one embodiment, the wavelength shifting can be accomplished using a length of standard single-mode fiber 2358, which can have a length between approximately 5m and 50m, for example. The output of the power amplifier 2354 can be coupled to the SC fiber 2359 to generate the SC output 2360. This is just one exemplary configuration for an SC source, and other configurations or elements can be used consistent with this disclosure. For example, the various amplifier stages can comprise different amplifier types, such as erbium doped fibers, ytterbium doped fibers, erbium/ytterbium co-doped fibers and thulium doped fibers. One advantage of the SC lasers illustrated in FIGURES 20, 21, and 23 are that they may use all-fiber components, so that the SC laser can be all-fiber, monolithically integrated with no moving parts. The all-integrated configuration can consequently be robust and reliable.

[0112] FIGURES 20, 21 and 23 are examples of SC light sources that may advantageously be used for near-infrared or SWIR light generation in various spectroscopy, active remote sensing and hyper-spectral imaging applications. However, many other versions of the SC light sources may also be made that are intended to also be covered by this disclosure. For example, the SC generation fiber could be pumped by a mode-locked laser, a gain-switched semiconductor laser, an optically pumped semiconductor laser, a solid state laser, other fiber lasers, or a combination of these types of

lasers. Also, rather than using a fiber for SC generation, either a liquid or a gas cell might be used as the nonlinear medium in which the spectrum is to be broadened.

[0113] Even within the all-fiber versions illustrated such as in FIGURE 21, different configurations could be used consistent with the disclosure. In one embodiment, it may be desirable to have a lower cost version of the SWIR SC laser of FIGURE 21. One way to lower the cost could be to use a single stage of optical amplification, rather than two stages, which may be feasible if lower output power is required or the gain fiber is optimized. For example, the pre-amplifier stage 2102 might be removed, along with at least some of the mid-stage elements. In yet another embodiment, the gain fiber could be double passed to emulate a two stage amplifier. In this example, the pre-amplifier stage 2102 might be removed, and perhaps also some of the mid-stage elements. A mirror or fiber grating reflector could be placed after the power amplifier stage 2106 that may preferentially reflect light near the wavelength of the seed laser 2101. If the mirror or fiber grating reflector can transmit the pump light near 940nm, then this could also be used instead of the pump combiner 2113 to bring in the pump light 2112. The SC fiber 2115 could be placed between the seed laser 2101 and the power amplifier stage 2106 (SC is only generated after the second pass through the amplifier, since the power level may be sufficiently high at that time). In addition, an output coupler may be placed between the seed laser diode 2101 and the SC fiber, which now may be in front of the power amplifier 2106. In a particular embodiment, the output coupler could be a power coupler or divider, a dichroic coupler (e.g., passing seed laser wavelength but outputting the SC wavelengths), or a wavelength division multiplexer coupler. This is just one further example, but a myriad of other combinations of components and architectures could also be used for SC light sources to generate near-infrared or SWIR light that are intended to be covered by this disclosure.

[0114] Described herein are just some examples of the beneficial use of near-infrared or SWIR lasers for spectroscopy, active remote sensing or hyper-spectral imaging. However, many other spectroscopy and identification procedures can use the near-infrared or SWIR light consistent with this disclosure and are intended to be covered by the disclosure. As one example, the fiber-based super-continuum lasers may have a pulsed output with pulse durations of approximately 0.5-2nsec and pulse repetition rates of several Megahertz. Therefore, the near-infrared or SWIR spectroscopy, active remote sensing or hyper-spectral imaging applications may also be combined

with LIDAR-type applications. Namely, the distance or time axis can be added to the information based on time-of-flight measurements. For this type of information to be used, the detection system would also have to be time-gated to be able to measure the time difference between the pulses sent and the pulses received. By calculating the round-trip time for the signal, the distance of the object may be judged. In another embodiment, GPS (global positioning system) information may be added, so the near-infrared or SWIR spectroscopy, active remote sensing or hyper-spectral imagery would also have a location tag on the data. Moreover, the near-infrared or SWIR spectroscopy, active remote sensing or hyper-spectral imaging information could also be combined with two-dimensional or three-dimensional images to provide a physical picture as well as a chemical composition identification of the materials. These are just some modifications of the near-infrared or SWIR spectroscopy, active remote sensing or hyper-spectral imaging system described in this disclosure, but other techniques may also be added or combinations of these techniques may be added, and these are also intended to be covered by this disclosure.

WIRELESS LINK TO THE CLOUD

[0115] The non-invasive blood constituent or analytes measurement device may also benefit from communicating the data output to the “cloud” (e.g., data servers and processors in the web remotely connected) via wired and/or wireless communication strategies. The non-invasive devices may be part of a series of biosensors applied to the patient, and collectively these devices form what might be called a body area network or a personal area network. The biosensors and non-invasive devices may communicate to a smart phone, tablet, personal data assistant, computer, and/or other microprocessor-based device, which may in turn wirelessly or over wire and/or fiber optically transmit some or all of the signal or processed data to the internet or cloud. The cloud or internet may in turn send the data to doctors or health care providers as well as the patients themselves. Thus, it may be possible to have a panoramic, high-definition, relatively comprehensive view of a patient that doctors can use to assess and manage disease, and that patients can use to help maintain their health and direct their own care.

[0116] In a particular embodiment 2400 illustrated in Figure 24, the physiological measurement device or non-invasive blood constituent measurement device 2401 may comprise a

transmitter 2403 to communicate over a first communication link 2404 in the body area network or personal area network to a receiver in a smart phone, tablet cell phone, PDA, or computer 2405. For the measurement device 2401, it may also be advantageous to have a processor 2402 to process some of the physiological data, since with processing the amount of data to transmit may be less (hence, more energy efficient). The first communication link 2404 may operate through the use of one of many wireless technologies such as Bluetooth, Zigbee, WiFi, IrDA (infrared data association), wireless USB, or Z-wave, to name a few. Alternatively, the communication link 2404 may occur in the wireless medical band between 2360 and 2390MHz, which the FCC allocated for medical body area network devices, or in other designated medical device or WMTS bands. These are examples of devices that can be used in the body area network and surroundings, but other devices could also be used and are included in the scope of this disclosure.

[0117] The personal device 2405 may store, process, display, and transmit some of the data from the measurement device 2401. The device 2405 may comprise a receiver, transmitter, display, voice control and speakers, and one or more control buttons or knobs and a touch screen. Examples of the device 2405 include smart phones such as the Apple iPhones® or phones operating on the Android or Microsoft systems. In one embodiment, the device 2405 may have an application, software program, or firmware to receive and process the data from the measurement device 2401. The device 2405 may then transmit some or all of the data or the processed data over a second communication link 2406 to the internet or “cloud” 2407. The second communication link 2406 may advantageously comprise at least one segment of a wireless transmission link, which may operate using WiFi or the cellular network. The second communication link 2406 may additionally comprise lengths of fiber optic and/or communication over copper wires or cables.

[0118] The internet or cloud 2407 may add value to the measurement device 2401 by providing services that augment the physiological data collected. In a particular embodiment, some of the functions performed by the cloud include: (a) receive at least a fraction of the data from the device 2405; (b) buffer or store the data received; (c) process the data using software stored on the cloud; (d) store the resulting processed data; and (e) transmit some or all of the data either upon request or based on an alarm. As an example, the data or processed data may be transmitted 2408

back to the originator (e.g., patient or user), it may be transmitted 2409 to a health care provider or doctor, or it may be transmitted 2410 to other designated recipients.

[0119] The cloud 2407 may provide a number of value-add services. For example, the cloud application may store and process the physiological data for future reference or during a visit with the healthcare provider. If a patient has some sort of medical mishap or emergency, the physician can obtain the history of the physiological parameters over a specified period of time. In another embodiment, if the physiological parameters fall out of acceptable range, alarms may be delivered to the user 2408, the healthcare provider 2409, or other designated recipients 2410. These are just some of the features that may be offered, but many others may be possible and are intended to be covered by this disclosure. As an example, the device 2405 may also have a GPS sensor, so the cloud 2407 may be able to provide time, data and position along with the physiological parameters. Thus, if there is a medical emergency, the cloud 2407 could provide the location of the patient to the healthcare provider 2409 or other designated recipients 2410. Moreover, the digitized data in the cloud 2407 may help to move toward what is often called “personalized medicine.” Based on the physiological parameter data history, medication or medical therapies may be prescribed that are customized to the particular patient.

[0120] Beyond the above benefits, the cloud application 2407 and application on the device 2405 may also have financial value for companies developing measurement devices 2401 such as a non-invasive blood constituent monitor. In the case of glucose monitors, the companies make the majority of their revenue on the measurement strips. However, with a non-invasive monitor, there is no need for strips, so there is less of an opportunity for recurring costs (e.g., the razor/razor blade model does not work for non-invasive devices). On the other hand, people may be willing to pay a periodic fee for the value-add services provided on the cloud 2407. Diabetic patients, for example, would probably be willing to pay a periodic fee for monitoring their glucose levels, storing the history of the glucose levels, and having alarm warnings when the glucose level falls out of range. Similarly, patients taking ketone bodies supplement for treatment of disorders characterized by impaired glucose metabolism (e.g., Alzheimer’s, Parkinson’s, Huntington’s or ALS) may need to monitor their ketone bodies level. These patients would also probably be willing to pay a periodic fee for the value-add services provided on the cloud 2407. Thus, by leveraging the advances in

wireless connectivity and the widespread use of handheld devices such as smart phones that can wirelessly connect to the cloud, businesses can build a recurring cost business model even using non-invasive measurement devices.

[0121] Described herein are just some examples of the beneficial use of near-infrared or SWIR lasers for non-invasive monitoring of glucose, ketones, HbA1c and other blood constituents. However, many other medical procedures can use the near-infrared or SWIR light consistent with this disclosure and are intended to be covered by the disclosure.

[0122] Although the present disclosure has been described in several embodiments, a myriad of changes, variations, alterations, transformations, and modifications may be suggested to one skilled in the art, and it is intended that the present disclosure encompass such changes, variations, alterations, transformations, and modifications as falling within the spirit and scope of the appended claims.

[0123] While exemplary embodiments are described above, it is not intended that these embodiments describe all possible forms of the disclosure. Rather, the words used in the specification are words of description rather than limitation, and it is understood that various changes may be made without departing from the spirit and scope of the disclosure. Additionally, the features of various implementing embodiments may be combined to form further embodiments of the disclosure. While various embodiments may have been described as providing advantages or being preferred over other embodiments with respect to one or more desired characteristics, as one skilled in the art is aware, one or more characteristics may be compromised to achieve desired system attributes, which depend on the specific application and implementation. These attributes include, but are not limited to: cost, strength, durability, life cycle cost, marketability, appearance, packaging, size, serviceability, weight, manufacturability, ease of assembly, etc. The embodiments described herein that are described as less desirable than other embodiments or prior art implementations with respect to one or more characteristics are not outside the scope of the disclosure and may be desirable for particular applications.

WHAT IS CLAIMED IS:

1. A measurement system comprising:
 - a light source configured to generate an output optical beam, comprising:
 - one or more semiconductor sources configured to generate an input beam;
 - one or more optical amplifiers configured to receive at least a portion of the input beam and to output an intermediate beam from at least one of the one or more optical amplifiers; and
 - one or more optical fibers configured to receive at least a portion of the intermediate beam and to communicate at least part of the portion of the intermediate beam to a distal end of the one or more optical fibers to form a first optical beam;
 - a nonlinear element configured to receive at least a portion of the first optical beam and to broaden a spectrum associated with the at least a portion of the first optical beam to at least 10nm through a nonlinear effect in the nonlinear element to form the output optical beam with an output beam broadened spectrum; and
 - wherein at least a portion of the output beam broadened spectrum comprises a near-infrared wavelength between approximately 700nm and approximately 2500nm, and wherein at least a portion of the one or more fibers is a fused silica fiber with a core diameter less than approximately 400 microns;
 - a measurement apparatus configured to receive a received portion of the output optical beam and to deliver to a sample an analysis output beam, which is a delivered portion of the output optical beam and wherein the delivered portion of the output optical beam is a spatially coherent beam;
 - a receiver configured to receive and process at least a portion of the analysis output beam reflected or transmitted from the sample having a bandwidth of at least 10 nanometers and to generate an output signal; and
 - a personal device comprising a wireless receiver, a wireless transmitter, a display, a microphone, a speaker, one or more buttons or knobs, a microprocessor and a touch screen, the

personal device configured to receive and process at least a portion of the output signal, wherein the personal device is configured to store and display the processed output signal, and wherein at least a portion of the processed output signal is configured to be transmitted over a wireless transmission link.

2. The system of Claim 1, wherein the personal device is selected from the group consisting of a smart phone, a tablet, a personal data assistant, a computer, and a microprocessor-based device.

3. The system of Claim 1, wherein the output signal comprises one or more physiological parameters.

4. The system of Claim 1, further comprising a remote device configured to receive over the wireless transmission link a received output status comprising the at least a portion of the processed output signal, to buffer the received output status, to process the received output status to generate processed data and to store the processed data.

5. A measurement system comprising:

a light source comprising a plurality of semiconductor sources configured to generate an output optical beam with one or more optical wavelengths, wherein at least a portion of the one or more optical wavelengths is a near-infrared wavelength between 700 nanometers and 2500 nanometers;

a measurement apparatus configured to receive a received portion of the output optical beam and to deliver to a sample an analysis output beam, which is a delivered portion of the output optical beam; and

a receiver configured to receive and process at least a portion of the analysis output beam reflected or transmitted from the sample and to generate an output signal;

a personal device comprising a wireless receiver, a wireless transmitter, a display, a microphone, a speaker, one or more buttons or knobs, a microprocessor and a touch screen, the personal device configured to receive and process at least a portion of the output signal, wherein the personal device is configured to store and display the processed output signal, and wherein at least a

portion of the processed output signal is configured to be transmitted over a wireless transmission link;

a remote device configured to receive over the wireless transmission link a received output status comprising the at least a portion of the processed output signal, to buffer the received output status, to process the received output status to generate processed data and to store the processed data.

6. The system of Claim 5, wherein the semiconductor sources are light emitting diodes operating in pulsed mode.

7. The system of Claim 5, wherein the wireless transmission link is configured to operate at least in part on Bluetooth or WiFi.

8. The system of Claim 5, wherein the remote device is further configured to transmit at least a portion of the processed data to one or more other locations, wherein the one or more other locations is selected from the group consisting of the personal device, a doctor, a healthcare provider, a cloud-based server and one or more designated recipients, and wherein the remote device is capable of transmitting information related to a time and a position associated with the at least a portion of the processed data.

9. The system of Claim 5, wherein the personal device is a separate device from the measurement apparatus and the light source.

10. The system of Claim 5, wherein the output signal comprises one or more physiological parameters, and the remote device is capable of storing a history of at least a portion of the one or more physiological parameters over a specified period of time.

11. The system of Claim 10, wherein the remote device is capable of generating an alarm when at least one of the one or more physiological parameters falls out of an acceptable range.

12. The system of Claim 5, wherein the personal device is selected from the group consisting of a smart phone, a tablet, a personal data assistant, a computer, and a microprocessor-based device.

13. The system of Claim 5, wherein the measurement system is capable of performing a non-invasive blood measurement.

14. A measurement system comprising:

a wearable measurement device for measuring one or more physiological parameters, including a light source comprising a plurality of semiconductor sources configured to generate an output optical beam with one or more optical wavelengths, wherein at least a portion of the one or more optical wavelengths is a near-infrared wavelength between 700 nanometers and 2500 nanometers;

the wearable measurement device configured to receive a received portion of the output optical beam and to deliver to a sample an analysis output beam, which is a delivered portion of the output optical beam;

the wearable measurement device further comprising a receiver configured to receive and process at least a portion of the analysis output beam reflected or transmitted from the sample and to generate an output signal;

a personal device comprising a wireless receiver, a wireless transmitter, a display, a microphone, a speaker, one or more buttons or knobs, a microprocessor and a touch screen, the personal device configured to receive and process at least a portion of the output signal, wherein the personal device is configured to store and display the processed output signal, and wherein at least a portion of the processed output signal is configured to be transmitted over a wireless transmission link;

a remote device configured to receive over the wireless transmission link a received output status comprising the at least a portion of the processed output signal, to buffer the received output status, to process the received output status to generate processed data and to store the processed data, and wherein the remote device is capable of storing a history of at least a portion of the received output status over a specified period of time.

15. The system of Claim 14, wherein the semiconductor sources are light emitting diodes operating in pulsed mode.

16. The system of Claim 14, wherein the personal device is a separate device from the wearable measurement device.

17. The system of Claim 14, wherein the remote device is further configured to transmit at least a portion of the processed data to one or more other locations, wherein the one or more other locations is selected from the group consisting of the personal device, a doctor, a healthcare provider, a cloud-based server and one or more designated recipients, and wherein the remote device is capable of transmitting information related to a time and a position associated with the at least a portion of the processed data.

18. The system of Claim 14, wherein the remote device is capable of generating an alarm when at least one of the one or more physiological parameters falls out of an acceptable range.

19. The system of Claim 14, wherein the measurement system is capable of performing a non-invasive blood measurement.

20. The system of Claim 14, wherein the personal device is selected from the group consisting of a smart phone, a tablet, a personal data assistant, a computer, and a microprocessor-based device.

ABSTRACT

A measurement system includes a light source generating an output optical beam using semiconductor sources generating an input beam, optical amplifiers outputting an intermediate beam, and optical fibers receiving the intermediate beam and forming a first optical beam. A nonlinear element broadens the output beam spectrum to at least 10nm, the spectrum comprising a near-infrared wavelength of 700-2500nm. A measurement apparatus receives the output optical beam and delivers to a sample an analysis output beam. A receiver receives and processes the analysis output beam reflected or transmitted from the sample.

Electronic Patent Application Fee Transmittal

Application Number:				
Filing Date:				
Title of Invention:	SHORT-WAVE INFRARED SUPER-CONTINUUM LASERS FOR DETECTING COUNTERFEIT OR ILLICIT DRUGS AND PHARMACEUTICAL PROCESS CONTROL			
First Named Inventor/Applicant Name:	Mohammed N. ISLAM			
Filer:	David S. Bir/Pamela Demos			
Attorney Docket Number:	OMNI 0105 PUSP1			
Filed as Small Entity				
Filing Fees for Utility under 35 USC 111(a)				
Description	Fee Code	Quantity	Amount	Sub-Total in USD(\$)
Basic Filing:				
Utility filing Fee (Electronic filing)	4011	1	70	70
Utility Search Fee	2111	1	300	300
Utility Examination Fee	2311	1	360	360
Pages:				
Claims:				
Miscellaneous-Filing:				
Petition:				
Patent-Appeals-and-Interference:				

Description	Fee Code	Quantity	Amount	Sub-Total in USD(\$)
Post-Allowance-and-Post-Issuance:				
Extension-of-Time:				
Miscellaneous:				
Total in USD (\$)				730

Electronic Acknowledgement Receipt

EFS ID:	23633944
Application Number:	14875709
International Application Number:	
Confirmation Number:	7496
Title of Invention:	SHORT-WAVE INFRARED SUPER-CONTINUUM LASERS FOR DETECTING COUNTERFEIT OR ILLICIT DRUGS AND PHARMACEUTICAL PROCESS CONTROL
First Named Inventor/Applicant Name:	Mohammed N. ISLAM
Customer Number:	109543
Filer:	David S. Bir
Filer Authorized By:	
Attorney Docket Number:	OMNI 0105 PUSP1
Receipt Date:	06-OCT-2015
Filing Date:	
Time Stamp:	03:25:11
Application Type:	Utility under 35 USC 111(a)

Payment information:

Submitted with Payment	yes
Payment Type	Deposit Account
Payment was successfully received in RAM	\$730
RAM confirmation Number	8288
Deposit Account	023978
Authorized User	BIR, DAVID S.

The Director of the USPTO is hereby authorized to charge indicated fees and credit any overpayment as follows:

Charge any Additional Fees required under 37 C.F.R. Section 1.16 (National application filing, search, and examination fees)

Charge any Additional Fees required under 37 C.F.R. Section 1.17 (Patent application and reexamination processing fees)

File Listing:					
Document Number	Document Description	File Name	File Size(Bytes)/ Message Digest	Multi Part /.zip	Pages (if appl.)
1	Oath or Declaration filed	AssignmentDeclaration.pdf	90610	no	1
			f1093ab5bdca4392cc78c17c168d7534ae720ff5		
Warnings:					
Information:					
2	Foreign Reference	WO2013012938A1.pdf	1524053	no	35
			33f291e44365e56db1cfbb9ce04e57dee0e0fdfb		
Warnings:					
Information:					
3	Foreign Reference	WO2015084376A1.pdf	1500669	no	35
			4cd6ddf8cdf5ead44488e07b7b0ed3fd38b311c		
Warnings:					
Information:					
4	Application Data Sheet	ADS.pdf	1505257	no	6
			c6b04c62215e3d0067fd06c1ec7d08449d7d6da8		
Warnings:					
Information:					
5	Power of Attorney	POA.pdf	211428	no	2
			300c99d100eb68df2bc1da87a77b5a33c5c264af		
Warnings:					
Information:					
6	Drawings-only black and white line drawings	Formal_Figures.pdf	1242001	no	26
			2a4feb6b36e5c7f4af2d09b7c3c919a0e3120c7e		
Warnings:					
Information:					
7	Transmittal Letter	IDS_Transmittal.pdf	19796	no	2
			3a9437b0d23325141071f9d3b8cd36d9e474f7c6		
Warnings:					
Information:					

8	Information Disclosure Statement (IDS) Form (SB08)	IDS_1.pdf	612484	no	4
			0977c49c31729a74f102ea6e0c5f457f9c1b0cd		
Warnings:					
Information:					
9	Information Disclosure Statement (IDS) Form (SB08)	IDS_2.pdf	613345	no	9
			62f5bf9ea292cbf855f118f29775d998bbffd3d0		
Warnings:					
Information:					
10	Information Disclosure Statement (IDS) Form (SB08)	IDS_3.pdf	613988	no	11
			22c50b88c6e9edca6a8ab3fbfa65d0ef91b9b489		
Warnings:					
Information:					
11	Information Disclosure Statement (IDS) Form (SB08)	IDS_4.pdf	612929	no	5
			82f1a52541504d309f4cef6475cfe172e24b07f		
Warnings:					
Information:					
12	Information Disclosure Statement (IDS) Form (SB08)	IDS_5.pdf	612179	no	4
			a843f6052c22fe86f276be07f120bd36972681f2		
Warnings:					
Information:					
13	Information Disclosure Statement (IDS) Form (SB08)	IDS_6.pdf	616652	no	8
			5e047884d6a48e2b1925607e6e71786493bf226d		
Warnings:					
Information:					
A U.S. Patent Number Citation or a U.S. Publication Number Citation is required in the Information Disclosure Statement (IDS) form for autoloading of data into USPTO systems. You may remove the form to add the required data in order to correct the Informational Message if you are citing U.S. References. If you chose not to include U.S. References, the image of the form will be processed and be made available within the Image File Wrapper (IFW) system. However, no data will be extracted from this form. Any additional data such as Foreign Patent Documents or Non Patent Literature will be manually reviewed and keyed into USPTO systems.					
14	Information Disclosure Statement (IDS) Form (SB08)	IDS_7.pdf	616509	no	8
			62021442f8b28881784ae846f712bf1332647b3c		
Warnings:					
Information:					
A U.S. Patent Number Citation or a U.S. Publication Number Citation is required in the Information Disclosure Statement (IDS) form for autoloading of data into USPTO systems. You may remove the form to add the required data in order to correct the Informational Message if you are citing U.S. References. If you chose not to include U.S. References, the image of the form will be processed and be made available within the Image File Wrapper (IFW) system. However, no data will be extracted from this form. Any additional data such as Foreign Patent Documents or Non Patent Literature will be manually reviewed and keyed into USPTO systems.					

15	Information Disclosure Statement (IDS) Form (SB08)	IDS_8.pdf	615057 e23e096bec68af6d54a4365b1a04b090f48e01c76	no	7
Warnings:					
Information:					
A U.S. Patent Number Citation or a U.S. Publication Number Citation is required in the Information Disclosure Statement (IDS) form for autoloading of data into USPTO systems. You may remove the form to add the required data in order to correct the Informational Message if you are citing U.S. References. If you chose not to include U.S. References, the image of the form will be processed and be made available within the Image File Wrapper (IFW) system. However, no data will be extracted from this form. Any additional data such as Foreign Patent Documents or Non Patent Literature will be manually reviewed and keyed into USPTO systems.					
16	Information Disclosure Statement (IDS) Form (SB08)	IDS_9.pdf	615841 7642e7f63f99c8324ae67ebce2879b45305b11fe	no	9
Warnings:					
Information:					
17	Information Disclosure Statement (IDS) Form (SB08)	IDS_10.pdf	614179 94743582ff4e5ea1627016ba1c10bbf3436a1468	no	6
Warnings:					
Information:					
18	Information Disclosure Statement (IDS) Form (SB08)	IDS_11.pdf	612487 9ee97c265a7bd47651f200ce3a4c56f95352bb60	no	5
Warnings:					
Information:					
19		Continuation_Application.pdf	254705 b71b510fb1b0e62e7d2cf112701c53bfd1717dc	yes	47
	Multipart Description/PDF files in .zip description				
	Document Description		Start	End	
	Specification		1	41	
	Claims		42	46	
	Abstract		47	47	
Warnings:					
Information:					
20	Fee Worksheet (SB06)	fee-info.pdf	35134 40dde186d425736aab9e672a45f0ae139e1deb9d	no	2
Warnings:					
Information:					
Total Files Size (in bytes):			13139303		

This Acknowledgement Receipt evidences receipt on the noted date by the USPTO of the indicated documents, characterized by the applicant, and including page counts, where applicable. It serves as evidence of receipt similar to a Post Card, as described in MPEP 503.

New Applications Under 35 U.S.C. 111

If a new application is being filed and the application includes the necessary components for a filing date (see 37 CFR 1.53(b)-(d) and MPEP 506), a Filing Receipt (37 CFR 1.54) will be issued in due course and the date shown on this Acknowledgement Receipt will establish the filing date of the application.

National Stage of an International Application under 35 U.S.C. 371

If a timely submission to enter the national stage of an international application is compliant with the conditions of 35 U.S.C. 371 and other applicable requirements a Form PCT/DO/EO/903 indicating acceptance of the application as a national stage submission under 35 U.S.C. 371 will be issued in addition to the Filing Receipt, in due course.

New International Application Filed with the USPTO as a Receiving Office

If a new international application is being filed and the international application includes the necessary components for an international filing date (see PCT Article 11 and MPEP 1810), a Notification of the International Application Number and of the International Filing Date (Form PCT/RO/105) will be issued in due course, subject to prescriptions concerning national security, and the date shown on this Acknowledgement Receipt will establish the international filing date of the application.

ASSIGNMENT AND DECLARATION (37 C.F.R. 1.63) FOR UTILITY OR DESIGN APPLICATION USING AN APPLICATION DATA SHEET (37 C.F.R. 1.76)

Title of Invention	SHORT-WAVE INFRARED SUPER-CONTINUUM LASERS FOR DETECTING COUNTERFEIT OR ILLICIT DRUGS AND PHARMACEUTICAL PROCESS CONTROL
---------------------------	---

As a below named inventor, I hereby declare that:

This declaration is directed to:

- The attached application, or
- United States application or PCT international application number _____ filed on _____. (I hereby authorize the insertion of the application filing date and number when they become known.)

The above-identified application was made or authorized to be made by me.

I believe that I am the original inventor or an original joint inventor of a claimed invention in the application.

I hereby state that I have reviewed and understand the contents of the above-identified specification, including the claims.

I am aware of the duty to disclose to the U.S. Patent and Trademark Office all information known to me to be material to patentability as defined in 37 C.F.R. § 1.56.

NOW, THEREFORE, for good and valuable consideration, receipt of which is hereby acknowledged, I do hereby assign, sell and set over to Omni MedSci, Inc., a corporation organized and existing under the laws of the state of Michigan, and having a place of business at 1718 Newport Creek Drive, Ann Arbor, Michigan 48103, hereinafter referred to as the ASSIGNEE, its successors, assigns or other legal representatives, my entire right, title and interest, domestic and foreign, in and to the inventions and discoveries in the above-identified application including the right of said ASSIGNEE, its successors, assigns or other legal representatives to make applications and to receive Letters Patent for said inventions and discoveries in any and all foreign countries in its or their own name or names, or in my name, at its or their election, and I hereby assign, sell and set over to said ASSIGNEE, its successors, assigns or other legal representatives, all rights of priority, including any provisional applications, in and to said inventions and discoveries in all countries, including all applications claiming benefit of the filing date hereof, continuations, continuations-in-part, divisionals, reexaminations and reissue applications.

And I hereby agree for myself, my heirs, successors, assigns or other legal representatives to execute any and all papers, including applications for Letters Patent of any and all kinds and in any and all countries and to perform any and all acts which said ASSIGNEE, its successors, assigns or other legal representatives may deem necessary to secure thereto the rights herein assigned, sold and set over.

And I hereby represent and warrant that I have not granted any rights inconsistent with the rights granted herein.

I hereby acknowledge that any willful false statement made in this declaration is punishable under 18 U.S.C. 1001 by fine or imprisonment of not more than five (5) years or both.

LEGAL NAME OF INVENTOR

Inventor: MOHAMMED N. ISLAM Date: 12/17/2023

Signature: 

Page 1 (Supplemental Sheet with Additional Joint Inventors is attached if necessary)

Note: An Application Data Sheet (PTO/SB/14 or equivalent), including naming the entire inventive entity, must accompany this form.



- (51) International Patent Classification:
A61B 5/04 (2006.01)
- (21) International Application Number:
PCT/US2012/047229
- (22) International Filing Date:
18 July 2012 (18.07.2012)
- (25) Filing Language: English
- (26) Publication Language: English
- (30) Priority Data:
61/509,075 18 July 2011 (18.07.2011) US
61/527,730 26 August 2011 (26.08.2011) US
61/531,858 7 September 2011 (07.09.2011) US
- (71) Applicant (for all designated States except US):
MASSIVE HEALTH, INC. [US/US]; 330 Townsend,
Suite 207, San Francisco, CA 94107 (US).
- (72) Inventors; and
- (75) Inventors/Applicants (for US only): RASKIN, Aza
[US/US]; 49 Shipley, #8, San Francisco, CA 94107 (US).
KAMALANATHAN, Suthagar [CA/US]; 451 Kansas St,
Unit 390, San Francisco, CA 94107 (US).

- (74) Agent: SCHOX, Jeffrey; 500 3rd Street, Ste. 515, San Francisco, CA 94107 (US).
- (81) Designated States (unless otherwise indicated, for every kind of national protection available): AE, AG, AL, AM, AO, AT, AU, AZ, BA, BB, BG, BH, BR, BW, BY, BZ, CA, CH, CL, CN, CO, CR, CU, CZ, DE, DK, DM, DO, DZ, EC, EE, EG, ES, FI, GB, GD, GE, GH, GM, GT, HN, HR, HU, ID, IL, IN, IS, JP, KE, KG, KM, KN, KP, KR, KZ, LA, LC, LK, LR, LS, LT, LU, LY, MA, MD, ME, MG, MK, MN, MW, MX, MY, MZ, NA, NG, NI, NO, NZ, OM, PE, PG, PH, PL, PT, QA, RO, RS, RU, RW, SC, SD, SE, SG, SK, SL, SM, ST, SV, SY, TH, TJ, TM, TN, TR, TT, TZ, UA, UG, US, UZ, VC, VN, ZA, ZM, ZW.
- (84) Designated States (unless otherwise indicated, for every kind of regional protection available): ARIPO (BW, GH, GM, KE, LR, LS, MW, MZ, NA, RW, SD, SL, SZ, TZ, UG, ZM, ZW), Eurasian (AM, AZ, BY, KG, KZ, RU, TJ, TM), European (AL, AT, BE, BG, CH, CY, CZ, DE, DK, EE, ES, FI, FR, GB, GR, HR, HU, IE, IS, IT, LT, LU, LV, MC, MK, MT, NL, NO, PL, PT, RO, RS, SE, SI, SK, SM, TR), OAPI (BF, BJ, CF, CG, CI, CM, GA, GN, GQ, GW, ML, MR, NE, SN, TD, TG).

[Continued on next page]

(54) Title: HEALTH METER

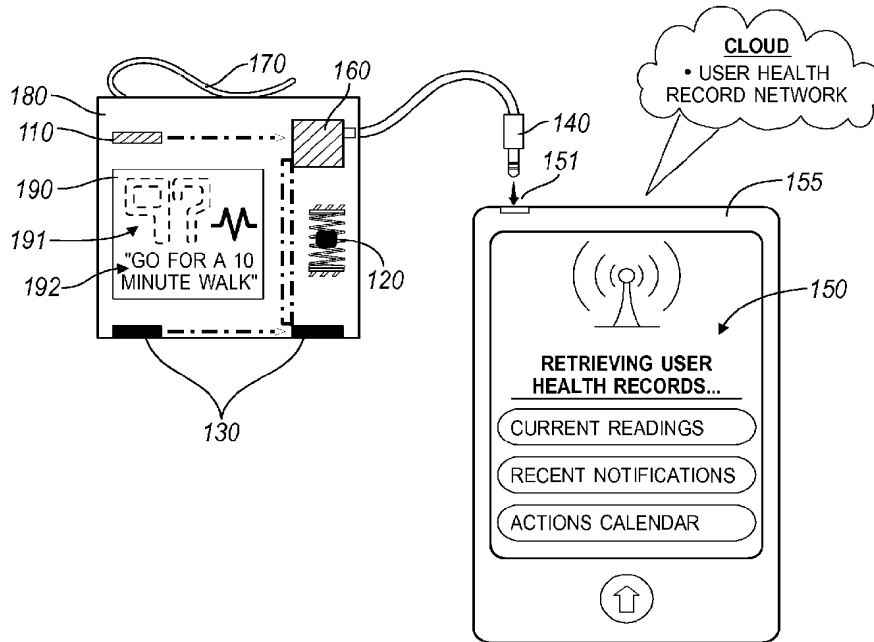

FIG. 1

(57) Abstract: One variation of a preferred health meter includes: a housing configured to be worn by a user; a glucose meter coupled to the housing; a pedometer coupled to the housing; a processor arranged within the housing and configured to generate a directive for a user action in response to a measured glucose level and an output of the pedometer; and a display arranged within the housing and configured to display the directive for the user.

WO 2013/012938 A1



Published:

— with international search report (Art. 21(3))

— before the expiration of the time limit for amending the claims and to be republished in the event of receipt of amendments (Rule 48.2(h))

HEALTH METER

CROSS-REFERENCE TO RELATED APPLICATIONS

[0001] This application claims the benefit of U.S. Provisional Application No. 61/509,075, filed 18 JUL 2011, U.S. Provisional Application No. 61/527,730, filed 26 AUG 2011, and U.S. Provisional Application No. 61/531,858, filed 07 SEP 2011, all of which are incorporated in their entirety by this reference.

TECHNICAL FIELD

[0002] This invention relates generally to the health care field, and more specifically to a new and useful health meter in the health care field.

BACKGROUND

[0003] Blood glucose meters are commonly used, particularly by individuals diagnosed with diabetes, to monitor glucose levels in the blood stream. Conventional blood glucose meters typically measure blood glucose levels in users and provide analyses of blood samples to users, but conventionally blood glucose meters fail to convey such information in valuable ways that are tailored to the needs of each user and that promote health improvements rather than just health maintenance. Thus, there is a need in the health care field for a new and useful health meter for testing the blood glucose level of a user.

BRIEF DESCRIPTION OF THE FIGURES

[0004] FIGURE 1 is a schematic representation of a health meter of a preferred embodiment;

[0005] FIGURE 2 is a schematic representation of a variation of the preferred health meter;

[0006] FIGURE 3 is a flowchart representation of one variation in accordance with the preferred health meter;

[0007] FIGURE 4 is a flowchart representation of one variation in accordance with the preferred health meter; and

[0008] FIGURE 5 is a schematic representation of a variation of the preferred health meter.

DESCRIPTION OF THE PREFERRED EMBODIMENTS

[0009] The following description of the preferred embodiments of the invention is not intended to limit the invention to these preferred embodiments, but rather to enable any person skilled in the art to make and use this invention.

1. Health Meter

[0010] As shown in FIGURES 1 and 2, the health meter 100 of the preferred embodiment for providing a health-related notification to a user includes: a blood glucose meter 110 that generates an output based upon the level of glucose in the blood of the user; a pedometer 120 that detects a footstep taken by the user and generates an output based upon the detected footstep; a heart rate monitor 130 that detects the heart rate of the user and generates an output based upon the heart rate of the user; a data link 140 that conveys the output of at least one of the blood glucose meter 110, pedometer 120, and heart rate monitor 130 to a digital multimedia device 155; a software module 150 that evaluates the output of at least one of the blood glucose meter 110, pedometer 120, and heart rate monitor 130 and generates a health report of the user based upon the evaluation; and a processor 160 that accesses the health report and controls the conveyance of the health-related notification 192, based upon the health report, to the user. The preferred health meter 100 may further include a clip 170 and a housing 180. The preferred health meter 100 may also include a display 190 that renders a form of the health-related notification 192. Finally, the preferred health meter 100 may further include a data storage device that stores the health report such that the processor 160 may access the health report and convey the health-related notification 192 to the user when the data link 140 is not in communication with the digital multimedia device 155.

[0011] The preferred health meter 100 preferably captures current biological and/or physiological metrics of the user to enable generation of directives for the user to improve the current and/or long-term health of the user. The preferred health meter 100 preferably interfaces with a digital multimedia device 155, via the data link 140, to analyze user physiological data, to display the directive, and/or to track and maintain user physiological data over time. The digital multimedia device 155 is preferably a cellular phone, a smartphone, a tablet, a desktop computer, or a laptop computer, though the digital multimedia device 155 may be any other suitable external electronic device. The preferred health meter 100 may additionally or alternatively communicate with a remote server, such as through the digital multimedia device 155 connected via the data link 140, to enable these or any additional functions.

[0012] The blood glucose meter 110 of the preferred health meter 100 functions to analyze the blood of the user and to generate an output based upon the analysis of the blood. In a first example implementation, the blood glucose meter 110 includes a glucose test strip slot configured to receive a test strip, as shown in FIGURE 1. In this example implementation, the user may dispense a blood sample onto the glucose test strip, such as by pricking a finger to induce the finger to bleed, then swiping blood from the finger onto the glucose test strip. The user may then insert the glucose test strip into the glucose test strip slot of the blood glucose meter 110, at which point the blood glucose meter 110 analyzes the blood sample, determines the glucose level in the blood sample, and then generates the output. In another example implementation, as shown in FIGURE 2, the blood glucose meter includes a recess configured to receive a finger of the user and a spike configured to prick the finger. In this example implementation, the user may insert a finger into the recess, wherein the spike pierces the skin of the finger to obtain a blood sample. The blood glucose meter 110 may then analyze the blood sample. In this example implementation, the user may activate the spike, such as by engaging a button, switch, or lever. Alternatively, the processor 160 may activate the spike, such as by triggering a linear actuator or solenoid.

[0013] In another example implementation shown in FIGURE 2, the blood glucose meter 110 is a bloodless glucose meter. For example, the blood glucose meter

110 may be an infrared glucose meter including an optical emitter and an optical receiver and implementing near-infrared spectroscopy to estimate the level of glucose in the blood of the user, such as disclosed in U.S. Patent No. 7,310,542, issued 18 DEC 2007 and which is incorporated herein in its entirety by this reference. Alternatively, the blood glucose meter 110 may use acoustic waves to analyze the glucose level in the blood under the skin. In this example implementation, the blood glucose meter 110 preferably analyzes intracorporeal blood under the skin of the finger, though the blood glucose meter 100 may additionally or alternatively analyze intracorporeal or intravascular blood under the skin of the palm, forearm, neck, or any other part of the body of the user. In this example implementation, the blood glucose meter 100 preferably measures the glucose level of the user whenever the user contacts the blood glucose meter for any suitable period of time, such as when the user attaches the housing to an article of clothing. In a further example implementation, the blood glucose meter 110 includes a first element that is a glucose sensor placed substantially beneath the skin of the user and in communication with a second element that analyzes the blood sensed by the first element. The communication link between the first and second elements of this fourth example may be a wired connection or a wireless connection, such as a Bluetooth connection. In this fourth example implementation, the blood glucose meter 110 may be a continuous blood glucose meter that measures the glucose level in the blood of the user at specified intervals (i.e. every five minutes). However, the blood glucose meter 110 may access a blood sample by any other method and estimate the glucose level in the blood of the user in any other way.

[0014] The blood glucose meter 110 may be activated directly by any number of inputs or actions. For example, insertion of a glucose test strip into a test strip slot of the blood glucose meter 110 may initiate the process of analyzing the blood sample and generating the output based upon the glucose in the blood sample. In this example, the insertion of the blood glucose test strip (or any other step of acquiring a blood sample, such as the first and second examples above) may activate the blood glucose meter 110 and may further activate one or more other elements of the health meter, such as the data link 140 to transmit and/or receive data, the software module 150 to analyze the

output of the blood glucose meter 110, or the processor 160 to convey a message to the user. Alternatively, the blood glucose meter 110 may be a passive element or indirectly activated such that the function of the blood glucose meter 110 is initiated by another element of the preferred health meter 100, such as by the processor 160 when the processor 160 receives a notification from an digital multimedia device 155 (e.g., a computer executing a native health maintenance application) indicating that the user should take test blood glucose. In this example, the processor 160 may control the blood glucose meter 110 such that the processor 160 sends commands to the blood glucose meter 110 and receives data from the blood glucose meter 110 based upon those commands. The processor 160 may further analyze the data to generate the directive that is based upon the blood glucose level. The processor 160 may further transmit the directive to a digital multimedia device 155 when connected via the data link 140. The directive is preferably related to the glucose level in the blood of the user but may also be related to additional information such as white blood cell count or cholesterol level of the user, any of which may be input by the user, received from the digital multimedia device 155, or measured by an additional biological or physiological sensor. The blood glucose meter 110, however, may function in any other way and may be activated by any other device or element to measure glucose level in the blood of the user.

[0015] The pedometer 120 of the preferred health meter 100 preferably detects a footstep taken by the user and generates an output based upon the detected footsteps. In a first example implementation, the pedometer 120 includes an accelerometer, such as a mass-spring accelerometer, a piezoelectric accelerometer, a null-balance accelerometer, a shear mode accelerometer, or any other type of accelerometer, wherein the pedometer associates an output of the accelerometer with a footstep taken by the user. In a second example implementation, the pedometer includes a Global Positioning System (GPS) sensor, a near-field communication (NFC) tag, or any other type of sensor and/or communication device that communicates with an external electronic device or transmitter to detect user motion or change of user location. For example, the pedometer 120 may sense NFC tags arranged along a walkway and estimate, based upon the distance between a NFC tags, the number of step taken by the user as the user

traverses the walkway. Furthermore, the time taken by the user to pass from a first to a second NFC tag may be used to determine if the user is walking, jogging, or running. A demographic of the user (i.e. age, height, race, gender, etc., a combination thereof) may suggest an average step length of the user in this example implementation. In another example implementation, the pedometer 120 may interface with the digital multimedia device 155 to retrieve a signal from the digital multimedia device 155 and to determine a footstep taken by the user based upon the signal. The signal could include a location measurement, an accelerometer measurement, a distance calculation, or any other suitable measurement or calculation. The pedometer 120 preferably actively monitors for footsteps and may add the detected footstep to a log of footsteps taken by the user. Alternatively, the processor 160 and/or software module 150 may log or track user footsteps. Furthermore, the processor 160 and/or software module 150 may activate the pedometer 120 by indicating when the pedometer 120 should and should not monitor for footsteps. However, the pedometer 120 may function in any other way and include any other type of sensor.

[0016] The heart rate monitor 130 of the preferred health meter 100 functions to detect the heart rate of the user. The heart rate monitor 130 preferably includes two conductive pads (or electrodes) that contact the skin of the patient and sense electrical signals within the body that control heart function, as shown in FIGURES 1, 2, and 5. The electrodes of the heart rate monitor 130 are preferably integrated into opposing legs of the clip 170, but may alternatively be located on the housing 180. In one example implementation, a first conductive pad is arranged on a surface of the clip 170 and a second conductive pad is arranged on the housing 180 such that the heart rate monitor 130 measures the heart rate of a user when the user contacts the first and second conductive pads to arrange the clip 140 on an article of clothing or to remove the clip 140 from the article of clothing. In another example implementation, a first conductive pad is arranged on a first section of the clip 140 and a second conductive pad is arranged on a second section of the clip 140, wherein the data link 140 that extends from an end of the first section and the second section encases the data link 140 when the first and second sections are assembled. In this example implementation, the heart rate monitor

preferably measures the heart rate of a user when the user engages the clip to separate the first and second sections to access the data link 140. The heart rate monitor 130 may alternatively include an infrared or RF transmitter and receiver that implement infrared or acoustic energy to detect blood flow through blood vessels in a particular region of the body of the user. In another example implementation, the heart rate monitor 130 includes a microphone that detects the sound of a mechanical disturbance in the body of the user consistent with a heartbeat. The heart rate monitor 130 may be active and consistently monitoring for heart beats of the user, such as whenever the user touches the heart rate monitor 130. The heart rate monitor may alternatively be passive and attempt to measure user heart rate only when instructed by the processor 160 or initiated by the user.

[0017] The heart rate monitor preferably incorporates a timer such that the heart rate monitor 130 may determine the heart rate of the user based upon the elapsed time between two or more heartbeats or based upon the number of heartbeats in a given period of time. However, the heart rate monitor 130 may rather interface with another element of the health monitor that does include a timer, such as the processor 160, in order to calculate the user heart rate. The heart rate monitor 130, however, may function in any other way and may be activated by any other device or element.

[0018] The data link 140 of the preferred health meter 100 functions to transmit the output of at least one of the blood glucose meter 110, the pedometer 120, and the heart rate monitor 130 to the digital multimedia device 155, as shown in FIGURES 3 and 4. The data link 140 is preferably a wired connection, as shown in FIGURES 1 and 2, wherein the data link includes a wired jack connector (e.g., a 1/8" headphone jack) such that the preferred health meter 100 may communicate with the digital multimedia device 155 through an audio jack of the digital multimedia device 155. In one example implementation of the data link 140 that is a wired jack, the data link 140 is configured only to transmit data (or outputs) from the blood glucose meter 110, the pedometer 120, the heart rate monitor 130, the processor 160, etc. In another example implementation, the data link 140 is configured to transmit data to and from at least one element of the preferred health meter 100 and the digital multimedia device 155. In this example

implementation, the data link 140 may transmit data into the digital multimedia device 155 through the microphone input of the audio jack of the digital multimedia device 151 and may retrieve data from the audio output of the audio jack of the digital multimedia device 151. In this example implementation, the data link 140 may communicate with the digital multimedia device 155 via inter-integrated circuit communication (I2C), one-wire, master-slave, or any other suitable communication protocol. However, the data link 140 may transmit data in any other way and may include any other type of wired connection (such as a USB wired connection) that supports data transfer between the preferred health meter 100 and the digital multimedia device 155.

[0019] Alternatively, the data link 140 may be a wireless connection. For example, the data link 140 may include a Bluetooth module that interfaces with a second Bluetooth module included in the digital multimedia device, wherein data (e.g., sensor outputs) are transmitted from the preferred health meter 100 to the digital multimedia device over Bluetooth communications. The data link 140 may implement other types of wireless communications, such as 3G, 4G, radio, or Wi-Fi communication. In this example implementation, data is preferably encrypted before being transmitted by the data link 140. For example, cryptographic protocols such as Diffie–Hellman key exchange, Wireless Transport Layer Security (WTLS), or any other suitable type of protocol may be used. The data encryption may also comply with standards such as the Data Encryption Standard (DES), Triple Data Encryption Standard (3-DES), or Advanced Encryption Standard (AES).

[0020] The data link 140 that is a wired connection may further serve as a power and/or charging connector for the preferred health meter 100. The data link 140 may transmit the outputs of the blood glucose meter 110, the pedometer 120, and the heart rate monitor 130 directly from these components to the digital multimedia device, as shown in FIGURE 4. Alternatively and as shown in FIGURE 3, the outputs of the blood glucose meter 110, the pedometer 120, and the heart rate monitor 130 may first pass to the processor 160 (and be subsequently modified) and/or pass to the data storage module 200 before transmission by the data link 140. However, the data link 140 may

include any other type of connector or connection, function via any other method, and/or complete any other function.

[0021] The software module 150 of the preferred health meter 100 functions to evaluate the output of at least one of the blood glucose meter 110, the pedometer 120, and the heart rate monitor 130 and to generate a health report of the user based upon the evaluation. Preferably, the software module 150 evaluates at least one of the blood glucose level, motion or activity, and heart rate of the user in order to determine the current health risk of the user. For example, the software module 150 may determine that the blood sugar of the user is too low or less than ideal (hypoglycemia), which increases short-term risk of diabetic crash. The software module 150 may additionally or alternatively determine that the blood sugar level of the user is within a proper range but recent activity (e.g., running) and a high heart rate indicate that the blood sugar level of the user will drop within a predicted period of time, which also increases risk of diabetic crash. The software module 150 may additionally or alternatively determine that the blood sugar level of the user is too high (hyperglycemia) and is not associated with an appropriate level of user activity, which increases long-term risk of worsening diabetic condition. The software module 150 preferably incorporates at least one of user goals, user health condition, user demographic, previous user activity, and previous user compliance in evaluating health risk and generating the health report for the user. For example, if the user, such as in consultation with a doctor, sets a specific acceptable blood glucose level range which is entered into the software module 150, the software module 150 may not only include short-term risks like diabetic crash or long-term risks like worsening diabetic condition in the health report, but may also include risk of moving outside of the acceptable glucose level range defined by the user as a user goal. In another example, the software module 150 may determine the user to be in poor health, such as suffering from a second disease, and therefore increase the evaluated health risk of certain measured biosignals. For example, the software module 150 may note that the user has cancer or bronchitis and therefore associate a greater health risk for the user with a heart rate outside a narrower range of acceptable heart rates. Furthermore, the software module may notify a physician, hospital, paramedic, etc. if

the health risk of the user is substantially high or above a preset threshold. For example, the software module 150 may contact a 9-1-1 service, send an email to a physician, or alert a family member of the user via a SMS message. The software module 150 may additionally or alternatively generate a health report that includes any other health- and/or user-related information that may be useful in treating, maintaining, improving, or generating a diagnosis of the user.

[0022] As shown in FIGURE 1, the software module 150 is preferably an application (or 'app') that executes on the digital multimedia device 155. As described above, the digital multimedia device is preferably a smartphone but may also be a tablet, laptop computer, desktop computer, PDA, e-book reader, or any other digital multimedia device. The software module 150 preferably includes an interface that accepts inputs from the user, such as user goals, user health condition, user demographic, etc., and uses these inputs to evaluate the health risk of the user. The software module 150 also or alternatively accesses a remote network (or database) that contains health information (health records) of the user. The remote network may be a server associated with a hospital or a network of hospitals (such as where a primary care physician of the user is employed), a server associated with a health insurance agency or network of health insurance agencies (such as a health insurance company that insures the user), a server associated with a third party that manages health records, or any other user- or health-related server or entity. Physicians and/or staff associated with the health care of the user may add to, update, or otherwise modify the user health record on the remote network such that the software module 150 may access current user health information and evaluate appropriate risk levels based upon the user health information, biosignals, and/or physiological data. The software module 150 may further add the health report generated by the software module 150 to the user health records on the remote network. In the variation of the preferred health meter 100 in which the software module 150 retrieves and/or transmits user health data from and/or to the remote network, the data is preferably encrypted with cryptographic protocols such as those described above. Alternatively, the user, physician, and/or staff may add, update, or otherwise modify user health information from directly within the software

module 150, such as by entering information into a user interface displayed on a screen of the digital multimedia device 155 that couples to the preferred health meter 100 via the data link 140.

[0023] The software module 150 may also execute fully or in part on a remote server. For example, the software module 150 may be a cloud-computing-based application that performs data analysis, calculations, and other actions remotely from the digital multimedia device 155. In this example, the digital multimedia device 155 may receive an output of the preferred health meter 100 via the data link 140 and then transfer the output to the remote server upon which the software module 150 executes. The data are preferably transferred via a wireless connection, such as a 3G or 4G cellular connection or via a Wi-Fi internet connection. In this variation, the digital multimedia device 155 performs the primary function of transmitting data to and/or receiving data from the software module 150. The software module 155 may include a first software component that executes on the digital multimedia device 155, such as an app that manages the collection, transmission, retrieval, and/or display of data. The software module 150 may thus further include a second software component that executes on the remote server to retrieve the data, analyze the data, generate the health report, and/or manage the transmission of the health report back to the digital multimedia device 155, wherein the first software component manages retrieval of data sent from the second software component, transmits a form of the health report back to the preferred health meter 100 through the data link 140, and/or renders of a form of the health report on the display of the digital multimedia device 155 and or display 190 of the health meter 100. However, the software module 150 may include any number of software components that execute on any digital multimedia device 155, health meter, or server and that perform any other function or combination of functions.

[0024] The processor 160 of the preferred health meter 100 functions to access the health report and to control conveyance of the health-related notification 192 (e.g., directive) to the user. The health-related notification 192 is preferably based upon the health report generated by the software module 150. In one example implementation, the processor 160 receives the health report and generates the health-related

notification 192 based upon the health report. In this example implementation, a form of the health report is preferably transmitted from the digital multimedia device 155 to the processor 160 via the data link 140, wherein the digital multimedia device 155 accesses the health report either from the software module 150 executing on the digital multimedia device 155 or from the software module 150 executing on a remote server and in communication with the digital multimedia device 155. In another example implementation, the software module 150 generates both the health report and the health-related notification 192 based upon the health report. In this example implementation, the health-related notification 192 is preferably transmitted to the processor 160 via the data link 140. The processor 160 preferably controls conveyance of the health-related notification 192 to the user, such as by triggering the display 190 to depict the directive or notification, by triggering a display of the digital multimedia device 155 to display the directive or notification, or by generating and/or transmitting an email, SMS, voicemail, Facebook or Twitter message, or any other message accessible by the user and which contains the health-related notification 192. The processor 160 may also convey the health-related notification 192 by altering the state (i.e. ON or OFF) of one or more lamps (e.g. LEDs) that comprise the display 190. For example, each of a series of lamps may be labeled one of 'Eat', 'Walk', 'Run', 'Rest', 'Test', 'Medicate', etc., wherein the processor 160 toggles the state of each lamp to indicate which action the user should take to minimize health risk associated with at least one of the blood glucose level, heart rate, and activity of the user. However, the processor 160 may manage the conveyance of any other information and function in any other way.

[0025] The health-related notification 192 preferably contains information relevant to the health of the user and specifically to minimizing the health risk of the user based upon at least a portion of the health report, such as the blood glucose level, the heart rate, and/or the activity level of the user. The health-related notification 192 preferably includes an explicit directive for the user to perform a certain action, such as to eat, rest, or exercise. Therefore, the health-related notification 192 preferably systematically and repeatably analyzes a health condition of the user and provides medical consultation to manage and/or improve user health (or substantially minimize

user health risk) substantially in real time. For example, the health-related notification 192 may indicate that the user should eat, walk, run, rest, test, or medicate. The notification may further include information related to what or how much to eat, how much protein or carbohydrate to consume, where and how long to run, level of exertion, how to rest and for how long, when to test blood glucose level or heart rate, when to schedule a future test, what and how much medication to consume or inject, and/or any other relevant information. The health-related notification 192 is preferably displayed to the user through the preferred health meter 100, such as with a series of labeled idiot lights or on the display 190. Alternatively, the health-related notification may be provided to the user through an email, voicemail, SMS, calendar, Facebook, or Twitter message, or any other message. Furthermore, the health-related notification provided through the digital multimedia device 155 or any other external electronic device, such as a phone, smartphone, tablet, PDA, e-book, MP3 player, laptop computer, or desktop computer. In one example, the processor 160 generates the health-related notification 192 and the display 190 renders the health-related notification 192. The data link 140 then manages an SMS message (or other type of message) that is sent to a cellular phone number associated with the user. The data link 140 may additionally or alternatively add to or modify a calendar of the user to include the directive of the health-related notification 192, such as by adding an exercise event to an opening in the user's schedule.

[0026] The preferred health meter 100 may further include an alarm or buzzer that alerts the user when a new health-related notification 192 is available. Alternatively, the preferred health meter 100 may communicate with the digital multimedia device that includes an alarm or buzzer to notify the user that a new health-related notification 192 is available. However, the health-related notification 192 may include any other information and/or directive and may be conveyed to the user in any other way or combination of ways.

[0027] As shown in FIGURES 1 and 2, the preferred health meter 100 may further include a display 190 that functions to depict the health-related notification 192. The display is preferably an e-ink display that requires power substantially only when

changing rendered content. However, the display 190 may include any other type of digital display, such as an LCD display with a LED, PDP, OLED, or SED backlight, a segment display, or any other type of display. The display may render content, such as the health-related notification 192, the number of steps taken by the user, or the heart rate of the user in black and white, in color, or in any other form, and the display may update at specific time intervals (such as every minute or every hour) or in conjunction with certain events. Such events may include a user request for updated information, a new blood glucose test, a certain heart rate of the user, a sufficient period of user inactivity, completion of the health-related notification 192 and/or health report, or immediacy of a health-related event scheduled in the user's calendar of the user. The processor 160 preferably controls the display 190, though the display 190 may be controlled by any other component of the preferred health meter 100 and in any other way.

[0028] One variation of the preferred health meter 100 further includes a data storage module 200 that retains health-related data such as the health report, the health-related notification, results of one or more blood glucose tests, one or more heart rates of the user, footsteps taken by the user, and/or any other output of any other physiological and/or biological sensor incorporated into the preferred health meter 100. The data storage module 200 is preferably arranged within the housing 180 and is preferably coupled to processor such that data stored on the data storage module 200 remains accessible to the processor 160. Alternatively, the data storage module 200 may be integral with the digital multimedia device 155 or otherwise substantially remote from the processor 160, such as connected to the remote server or a remote network. Data generated by the blood glucose meter 110, the pedometer 120, the heart rate monitor 130, or any other element connected to the data storage module 200, are preferably stored on the data storage module 200 when the data link 140 is not in communication with the digital multimedia device 155. Furthermore, data are preferably transmitted to the digital multimedia device 155 when a communication link is established via the data link 140. However the data storage module 200 may store these or any other data.

[0029] Another variation of the preferred health meter 100 further includes a housing 180 that substantially encases at least one of the blood glucose meter 110, the pedometer 120, the heart rate monitor 130, the data link 140, the processor 150, the display 190, and the data storage module 200. Generally, the housing 180 is preferably of a clamshell configuration, including a front element and a back element that fasten together to form a vessel that contains one or more components of the preferred health meter 100. The housing 180 preferably manufactured from medical-grade materials such as antimicrobial plastics, 316L stainless steel, or medical-grade silicone rubbers. Alternatively, the housing 180 may be manufactured of non-medical-grade materials but include a medical-grade coating, such as overmolded medical-grade silicone rubber. The housing 180 is also preferably waterproof and dustproof, such as with an Ingress Protection rating of 25 or greater. Implementation of medical-grade materials, a dustproof housing, and/or a waterproof housing may promote longevity of the preferred health meter 100 by reducing susceptibility to damage by cleaning agents, bodily fluids, misuse, etc. However, the housing 180 may be of any other form and may encase any other element.

[0030] Yet another variation of the preferred health meter 100 further includes a clip 170 that couples the housing to an article of clothing worn by the user, such as a belt, belt loop, purse, pocket, armband, or any other article of clothing, accessory, or wearable article worn by the user. Furthermore, the clip 170 may couple the preferred health meter 100 to other features or items proximal the user, such as to a seat belt of a car driven by the user or to the digital multimedia device 155 that is a cellular phone carried by the user. However, the clip 170 may couple the preferred health meter 100 to any other suitable object. In the variation of the preferred health meter 100 in which the data link 140 includes a wired connection, the clip 170 is preferably physically coextensive with the data link 140, as shown in FIGURES 2 and 5. In one example implementation, the data link 140 includes a wired jack that is separable from (i.e. transiently or removably coupled to) the clip 170 such that the wired jack may be inserted into the digital multimedia device 155 to enable communication therebetween. In another example implementation shown in FIGURE 2 and 5, clip includes a first

section 170a and a second section 170b, wherein the data link 140 extends from the second section 170b and the first section 170a transiently couples to the second section 170b to encase the wired jack and is separable from the second section 170b to enable access to the data link 140. In the foregoing example implementation, the first section 170a of the clip 170 is preferably sprung (i.e. coupled to a spring) and the second section of the clip 170 that includes the data link 140 is preferably not sprung to permit substantially free manipulation of the data link 140, such as when the user plugs the data link 140 into a port of the digital multimedia device 155. Generally, the data link 140 preferably slides out of the first section 170a of the clip 170, thus freeing the second section to pivot and to enable access to the wired jack of the data link 140.

[0031] As shown in FIGURES 2 and 5, the clip 170 preferably defines a circular cross-section swept along a U-shaped profile. Alternatively, the clip 170 may be an alligator-, carabineer-, snap-, French barrette-, plunger-type, or any other type of clip. The clip 170 is preferably arranged on the housing 180, such as glued, bonded, or fastened with one or more screws. However, a portion of the clip 170 may also be physically coextensive with the housing 180. For example, the housing 180 may include features that include one side or section of the clip 170. The clip 170 is preferably sprung against the housing 180 such that the clip 170 retains the housing 180 on an article of clothing by pinching (e.g., biasing against) a portion of the article of clothing between the housing 180 and a portion of the clip 170. At least one side or section of the clip 170 may therefore be coupled to a return spring that provides a clamping force between (at least one section of) the clip 170 and the housing 180. However, the clip 170 and data link 140 may be of any other physically coextensive or distinct configuration, and the clip 170 may be arranged within or on the preferred health meter 100 in any other way.

[0032] One variation of the preferred health meter 100 shown in FIGURE 1 includes: a housing 180 configured to be worn by a user; a glucose meter 110 coupled to the housing 180; a pedometer 120 coupled to the housing 180; a processor 160 arranged within the housing 180 and configured to generate a directive for a user action in response to a measured glucose level and an output of the pedometer 120; and a display 190 arranged within the housing 180 and configured to display the directive for the user.

[0033] As shown in FIGURE 5, another variation of the preferred health meter 100 configured to be worn by a user includes: a physiological sensor 109; a clip 170 coupled to the physiological sensor and including a sprung loop configured bias against (or pinch) an article of clothing worn by the user to couple the physiological sensor to the article of clothing; and a data link 140 comprising a wired jack physically coextensive with the clip 170 and configured to transmit a form of an output of the physiological sensor. In this variation, the wired jack of the data link 140 preferably includes a stereo jack that communicates data to and from an external electronic device via inter-integrated circuit communication protocol. The physiological sensor 109 is preferably a blood glucose meter 110 that analyzes intracorporeal blood of the user (i.e. a bloodless blood glucose meter). However, the physiological sensor 109 may be a pedometer 120, a heart rate monitor 130, or any other type of biological sensor. The physiological sensor 109 preferably measures a biological status of the user at a specified interval and the data link 140 preferably transmits a form of a plurality of outputs of the physiological sensor 109 when coupled to an external electronic device. As shown in FIGURE 5, the clip 170 may further include a first section 170a and a second section 170b, wherein the first section 170a transiently couples to the second section 170b to encase the wired jack that extends from the second section 170b. For example, the second section 170b of the clip 170 may translate linearly relative the first section 170a such that the wired jack may be exposed. Furthermore, the first section 170a may be sprung against the housing 180 while the second section 170b is not sprung but rather pivotable relative the first section 170a when the datalink 140 is exposed.

[0034] As shown in FIGURE 5, a further variation of the preferred health meter 100 includes: a housing 180; a clip 170 arranged on the housing 180 and including a sprung loop configured to bias against a portion of a wearable article to couple the housing 180 to the wearable article; and a heart rate monitor 130 comprising a first conductive pad 121 and a second conductive pad 122 configured to engage an extremity of a user, wherein the first conductive pad 121 is arranged on a surface of the clip 170. In this variation, the wearable article is preferably a shirt, a pair of pants, a belt, a jacket, a vest, a coat, a glove, a shoe, a hat, an armband, or any other suitable article of clothing

or accessory. However, the wearable article may be any other suitable item, article, or object, such as a seatbelt or medical diagnostic equipment or instrumentation. The second conductive pad 122 may be arranged on the housing 180 such that the heart rate monitor 120 measures the heart rate of a user when the user contacts the first and second conductive pads 121, 122 while arranging the clip 170 on an article of clothing. As shown in FIGURE 5, the clip 170 may define a circular cross-section swept along a U-shaped profile, though the clip 170 may be of any other cross section or profile. Furthermore, the clip 170 may include a first section 170a and a second section 170b separable from the first section 170a, wherein the first section is preferably sprung against the housing, as shown in FIGURE 5. The first conductive pad 121 is preferably arranged on the first section 170a and the second conductive pad 122 is preferably arranged on the second section 170b of the clip 170. The preferred health meter 100 may further include a data link 140 including a wired jack extending from the second section 170b, wherein the data link 140 transmits a form of an output of the heart rate monitor 120. The first section 170a of the clip 170 may also be removably coupled to the second section 170b to encase the data link 140, as described above. This variation of the preferred health meter 100 may further include a switch that triggers the heart rate monitor to measure the heart rate of a user when the user moves the second section 170b of the clip 170 relative to the first section 170a, such as to clip the preferred health meter 100 to the wearable article or to remove the preferred health meter 100 from the wearable article. In this and the foregoing variations in which the physiological sensor 109 and/or heart rate monitor 120 includes one or more conductive pads arranged on the clip 170, the clip is preferably electrically non-conductive such that the first and second conductive pads 121, 122 are electrically isolated via the clip 170. For example, the clip 170 may be nylon, polyethylene, ABS, or any other suitable type or polymer or plastic. However, the preferred health meter 100 can be of any other form or configuration and can function in any other way.

2. Example Implementations

[0035] In a first example implementation of the preferred health meter 100, the preferred health meter 100 includes a housing 180 that substantially encapsulates the blood glucose meter 110, the pedometer 120, and the processor 160; the clip 170, the heart rate monitor 130, and the display 190 are arranged on the housing 180. The blood glucose meter 110 includes a test strip slot into which the user inserts a blood sample on a glucose test strip. The pedometer 120 is a two-axis accelerometer and the heart rate monitor 130 includes two conductive pads, each arranged on separate sections of the clip 170. The data link 140 is a wired connection comprising 1/8" headphone jack connector and is physically coextensive with the clip 170 such that the data link 140 may separate from a portion of the clip 170 to enable insertion into a portion of the digital multimedia device 155. The digital multimedia device 155 is a smartphone with a 1/8" headphone jack 151 and the software module 150 is an application configured to execute on the smartphone. The software module 150: receives data from the blood glucose meter 110, the pedometer 120 and heart rate monitor 130 through the data link 140; assesses the data in conjunction with user goals, user health condition, user demographic, previous user activity, and previous user compliance to generate the health report; dispatches the health report to a remote network configured to store the health record of the patient and wherein the health record of the patient is available to a primary-care physician of the user; transmits the health report to the processor 160 via the data link 140; and/or modifies a calendar of the user on the smartphone to reflect explicit directives relevant to the health of the user (such as scheduling a walk). The processor 160 accesses the health report; generates the health-related notification 152 or directive, and renders the health-related notification 152 on the display 190.

[0036] In a second example implementation of the preferred health meter 100, the housing 180 encapsulates the blood glucose meter 110 and the data link 140 and is implanted into the body of the user such that the data link transmits the glucose level of the blood, as measured by the implanted blood glucose meter 110, to the digital multimedia device. The data link 140 includes a low-power, short-range wireless communication module that transmits and receives data to and from the digital multimedia device 155 that is a smartphone. The heart rate monitor 130 is a microphone

arranged on the smartphone and senses the heart rate of the user when the user places a finger over the microphone. The pedometer 120 is an accelerometer arranged within the smartphone and detects motion of the smartphone carried by the user. The software module 150 is a cloud-based application operating on a remote server that: receives data from the blood glucose meter 110, the pedometer 120 and heart rate monitor 130 through a wireless connection established with server by the smartphone; assesses the data in conjunction with user goals, user health condition, user demographic, previous user activity, and previous user compliance to generate the health report; stores the health report on a remote network configured to store the health record of the patient and wherein the health record of the patient is available to a primary-care physician of the user; and dispatches the health report to the smartphone via the wireless connection with the smartphone. The processor 160 is arranged within the smartphone and receives the health report from the software module 150 and renders a form of the health report (such as compliance with set user goals) on the display 190 integral with the smartphone. The processor 160 further suggests specific directives to the user, such as to go for a run with a second user substantially proximal the user and who has substantially similar health-related goals and has a substantially similar recent health report as the user.

[0037] In a third example implementation, the preferred health meter 100 functions much as the first example implementation above, but in place of (or in addition to) a blood glucose meter 110, the preferred health meter 100 includes elements of a polysomnography test kit, such as an lung airflow sensor, an eye movement sensor, and a chest wall movement meter, wherein the polysomnography sensors detect sleep patterns of the user. Data collected by the polysomnography sensors are preferably transmitted to the digital multimedia device 155 via the data link 140 and then accessed by the software module 150. The software module 150 uses the data to detect sleep apnea in the patient and to generate a health report incorporating a diagnosis thereof. The health report is then used to provide directives to the user for improving sleep, and the processor 160 manages generation and distribution of the directives to alter and improve the user sleep, such as to change the position of an

adjustable bed in which the user sleeps, to increase the level of white noise proximal to the user at night, or to increase oxygen flow through a face mask worn by the user.

[0038] In a fourth example implementation, the preferred health meter 100 functions much as the second example implementation above, aside from the housing 180 that encapsulates the blood glucose meter 110 and data link 140, wherein the data link 140 is a proprietary connector configured to plug into a data port of a digital multimedia device 155 that is a smartphone, and wherein the blood glucose meter 110 is a bloodless glucose meter.

[0039] As a person skilled in the art will recognize from the previous detailed description and from the figures and claims, modifications and changes can be made to the preferred embodiments of the invention without departing from the scope of this invention as defined in the following claims.

CLAIMS

We Claim:

1. A health meter comprising:
 - a housing configured to be worn by a user;
 - a glucose meter coupled to the housing;
 - a pedometer coupled to the housing;
 - a processor arranged within the housing and configured to generate a directive for a user action in response to a measured glucose level and an output of the pedometer; and
 - a display arranged within the housing and configured to display the directive for the user.
2. The health meter of Claim 1, wherein the processor is further configured to estimate an activity of the user based upon footsteps taken by the user and detected by the pedometer.
3. The health meter of Claim 1, further comprising a heart rate monitor, wherein the processor generates the directive in further response to a measured heart rate of the user.
4. The health meter of Claim 1, wherein the glucose meter comprises an optical emitter and an optical detector configured to detect a glucose level in intracorporeal blood of the user.
5. The health meter of Claim 1, wherein the display comprises a set of indicator lamps, wherein each lamp is assigned a distinct directive for a user action, and wherein the processor sets a state of each indicator lamp according to the generated directive for the user action.

6. The health meter of Claim 1, wherein the processor generates the directive for a user action that is one of to eat, to rest, and to exercise.
7. A health meter configured to be worn by a user, the health meter comprising:
 - a physiological sensor;
 - a clip coupled to the physiological sensor and comprising a sprung loop configured to bias against an article of clothing worn by the user to couple the physiological sensor to the article of clothing; and
 - a data link comprising a wired jack physically coextensive with the clip and configured to transmit a form of an output of the physiological sensor.
8. The health meter of Claim 7, wherein the wired jack of the data link comprises a stereo jack configured to communicate data between an external electronic device via inter-integrated circuit communication protocol.
9. The health meter of Claim 7, wherein the clip further comprises a first section and a second section, wherein the first section transiently couples to the second section to encase the wired jack that extends from the second section.
10. The health meter of Claim 9, wherein the first section of the clip is sprung against the housing, and wherein the second section is pivotable relative the first section.
11. The health meter of Claim 9, wherein the second section of the clip is configured to translate linearly relative the first section to expose the wired jack.
12. The health meter of Claim 7, wherein the physiological sensor measures a biological status of the user at a specified interval, and wherein the data link transmits a form of a plurality of outputs of the physiological sensor when coupled to an external electronic device.

13. The health meter of Claim 12, wherein the physiological sensor comprises a blood glucose meter configured analyze intracorporeal blood of the user.
14. A health meter comprising:
 - a housing;
 - a clip arranged on the housing and comprising a sprung loop configured to bias against a portion of a wearable object to couple the housing to the wearable object; and
 - a heart rate monitor comprising a first conductive pad and a second conductive pad configured to engage an extremity of a user, wherein the first conductive pad is arranged on a surface of the clip.
15. The health meter of Claim 14, wherein the second conductive pad is arranged on the housing, and wherein the heart rate monitor measures the heart rate of a user when the user contacts the first and second conductive pads.
16. The health meter of Claim 14, wherein the clip defines a circular cross-section swept along a U-shaped profile.
17. The health meter of Claim 14, wherein the clip further comprises a first section and a second section separable from the first section, wherein the first section is sprung against the housing and wherein the first conductive pad is arranged on the first section.
18. The health meter of Claim 17, further comprising a data link comprising a wired jack extending from the second section and configured to transmit a form of an output of the heart rate monitor, wherein the first section is removably coupled to the second section to encase the data link.

19. The health meter of Claim 17, further comprising a switch, wherein the second conductive pad is arranged on the second section, and wherein the switch is configured to trigger the heart rate monitor to measures the heart rate of a user when the user moves the second section relative to the first section.

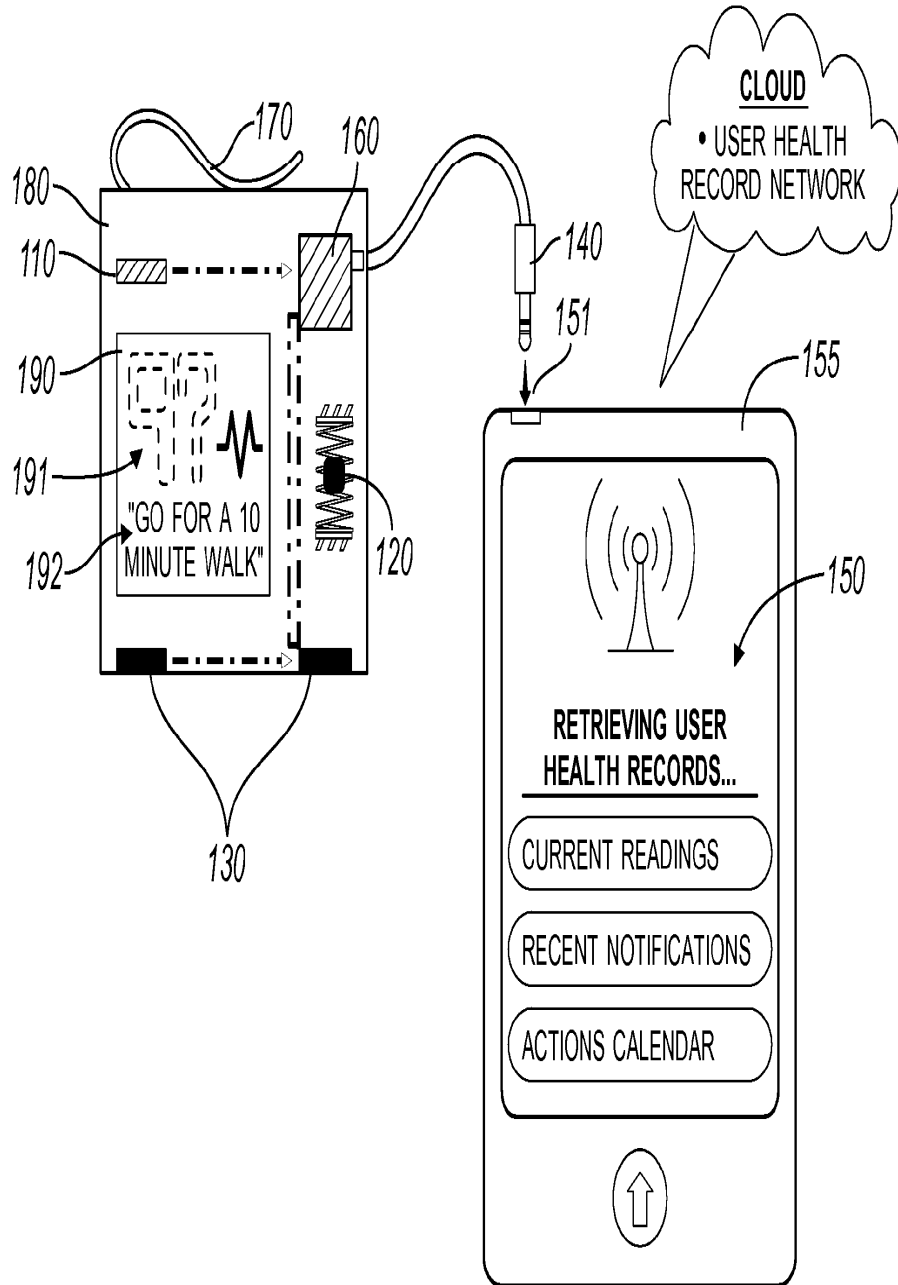

FIG. 1

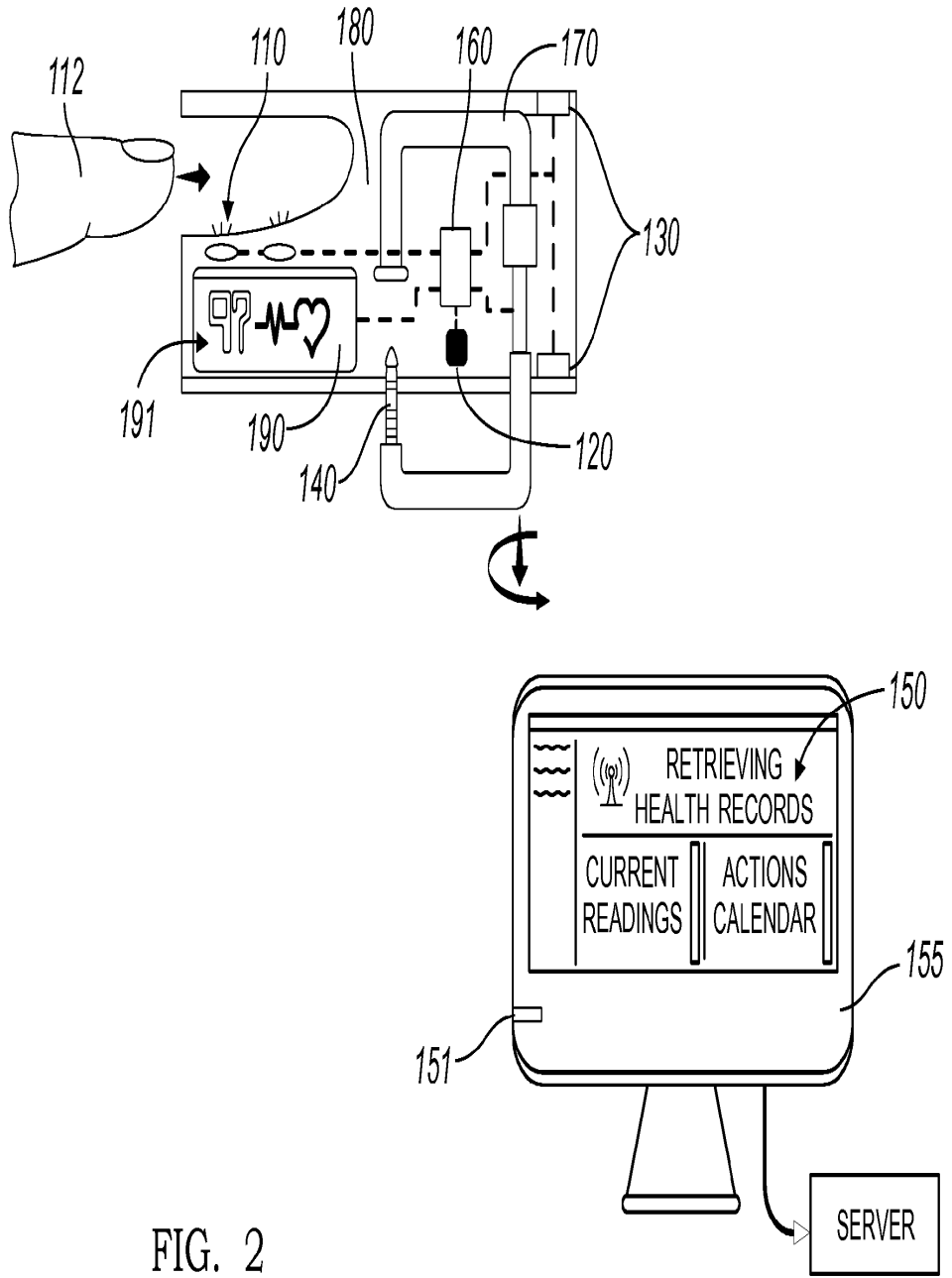

FIG. 2

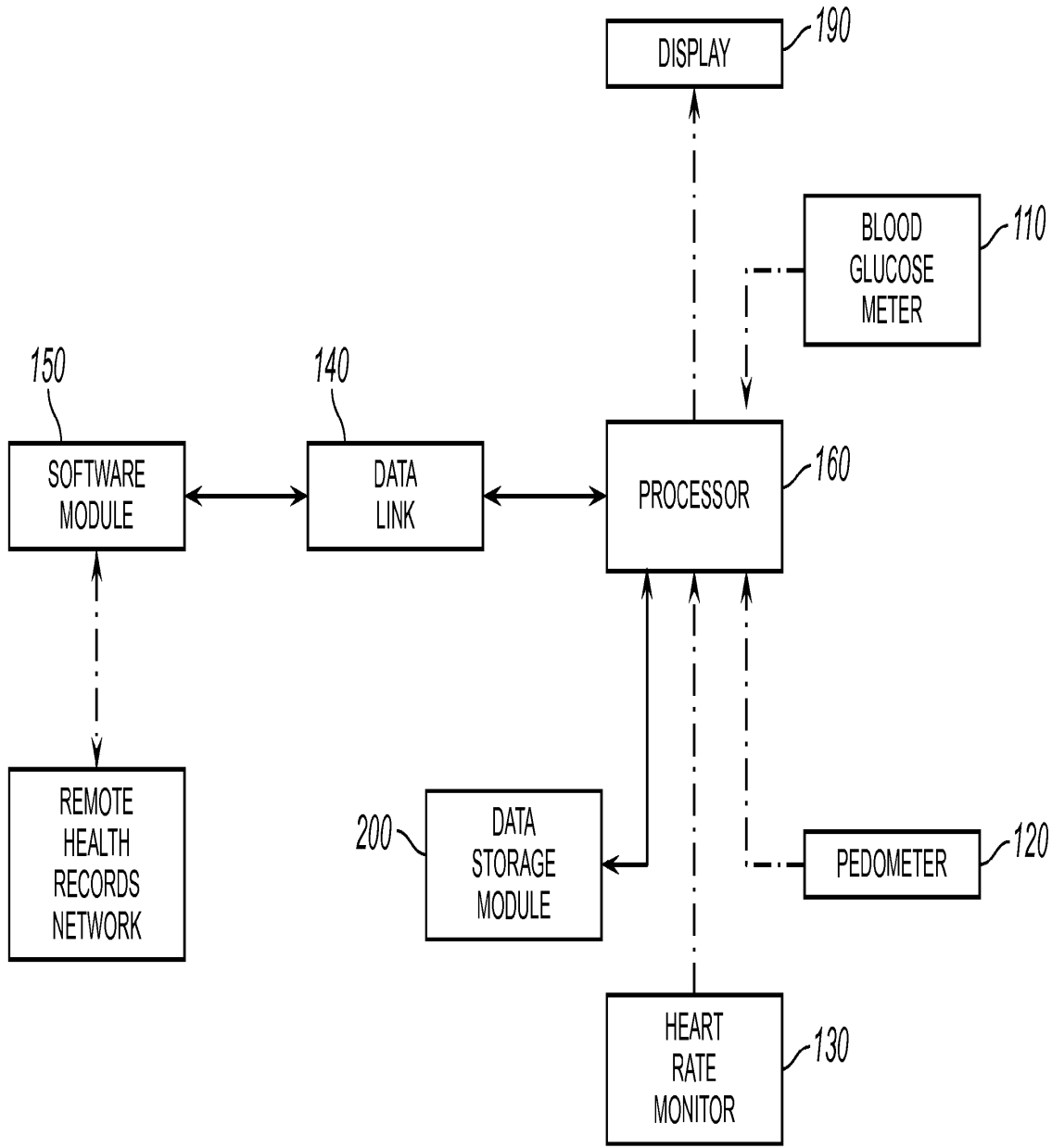
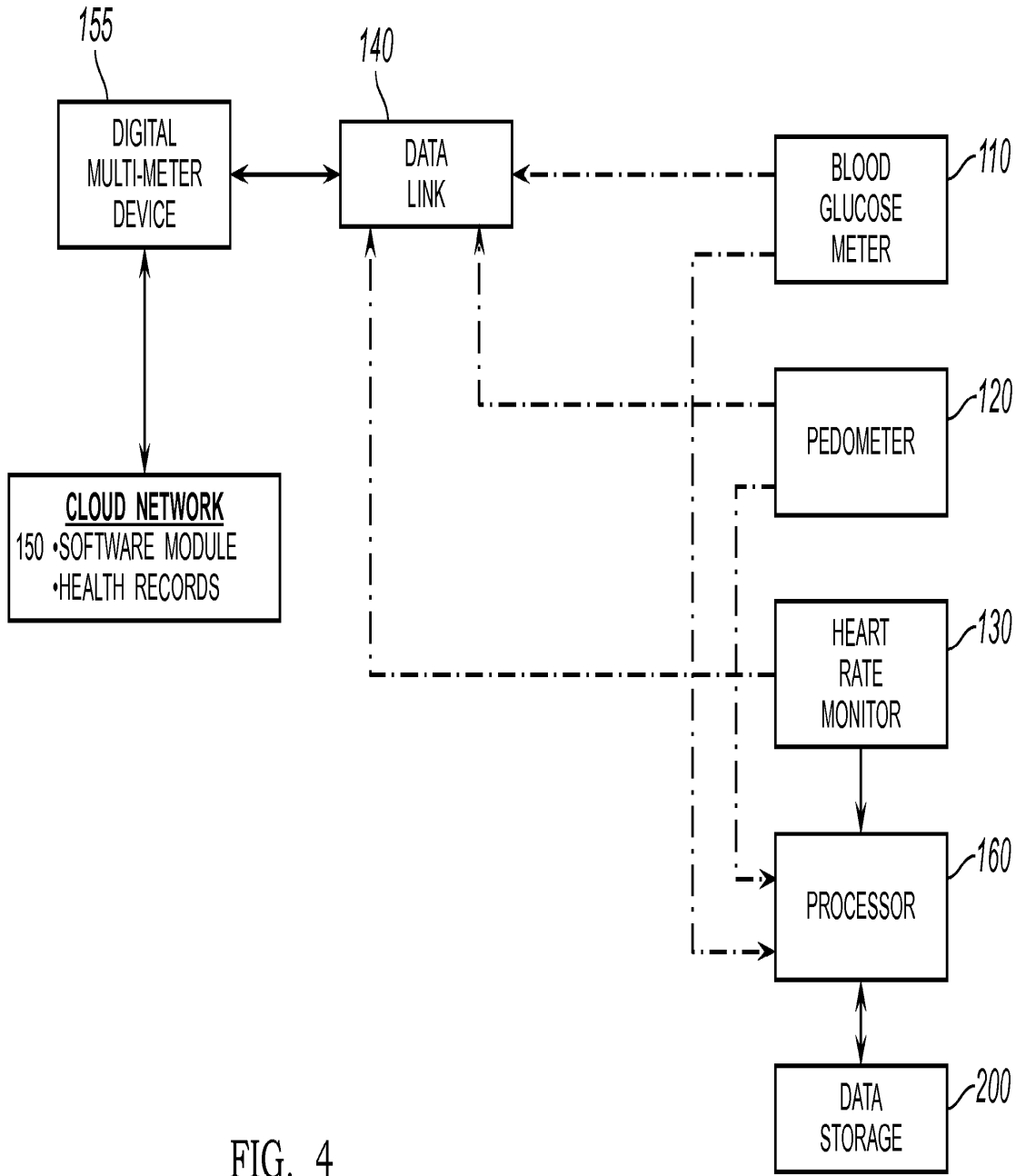

FIG. 3

3/5



4/5

FIG. 4

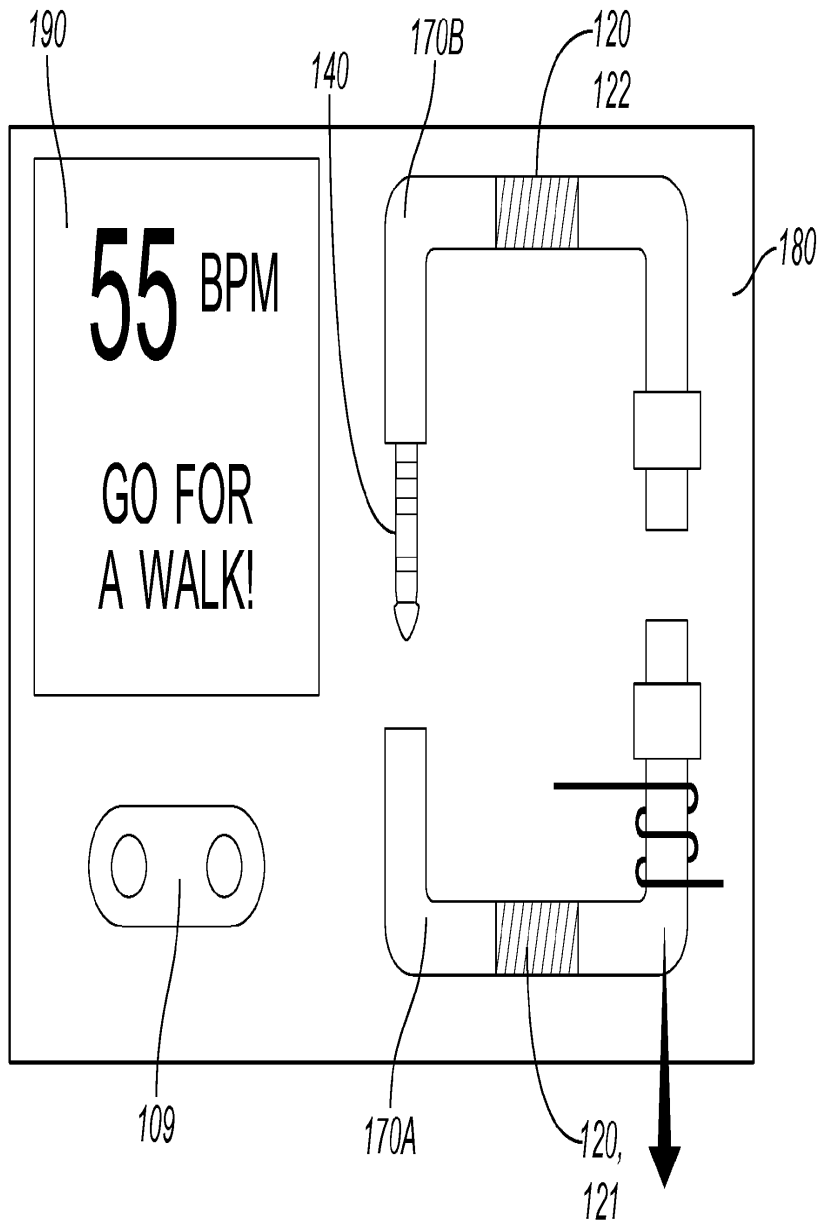

FIG. 5

INTERNATIONAL SEARCH REPORT

International application No.

PCT/US 12/47229

<p>A. CLASSIFICATION OF SUBJECT MATTER IPC(8) - A61B 5/04 (2012.01) USPC - 600/365, 587; 702/160 According to International Patent Classification (IPC) or to both national classification and IPC</p>																										
<p>B. FIELDS SEARCHED</p> <p>Minimum documentation searched (classification system followed by classification symbols) IPC(8) - A61B 5/04 (2012.01) USPC - 600/365, 587; 702/160</p> <p>Documentation searched other than minimum documentation to the extent that such documents are included in the fields searched 600/301, 347, 520 (Search term limited; see below)</p> <p>Electronic data base consulted during the international search (name of data base and, where practicable, search terms used) PubWest (PGPB, USPT, EPAB, JPAB); Google Search Terms: Glucose meter, sensor, measure, insulin pump, diabetes, health monitor, health meter, pedometer, exercise meter, exercise monitor, activity monitor, activity meter</p>																										
<p>C. DOCUMENTS CONSIDERED TO BE RELEVANT</p> <table border="1"> <thead> <tr> <th>Category*</th> <th>Citation of document, with indication, where appropriate, of the relevant passages</th> <th>Relevant to claim No.</th> </tr> </thead> <tbody> <tr> <td>X</td> <td>US 2010/0191075 A1 (ANGELIDES) 29 July 2010 (29.07.2010) Entire document, especially Abstract, para[0019]- para[0021], para[0024]- para[0031], para[0035], Claims 2-4 and FIG. 1.</td> <td>1-3</td> </tr> <tr> <td>X</td> <td>US 2003/0208113 A1 (MAULT et al.) 06 November 2003 (06.11.2003) Entire document, especially Abstract, para[0062], para[0069]- para[0075], para[0105], para[0132], para[0137], para[0148]- para[0149] and FIGS. 1, 16.</td> <td>1-2, 4-6</td> </tr> <tr> <td>X</td> <td>US 2009/0264337 A1 (ANGELIDES) 22 October 2009 (22.10.2009) Entire document, especially Abstract, para[0007]-[0009].</td> <td>1-2</td> </tr> <tr> <td>X</td> <td>US 2009/0240128 A1 (MENSINGER et al.) 24 September 2009 (24.09.2009) Entire document, especially Abstract, para[0097], Claims 11, 18, 19.</td> <td>1-2</td> </tr> <tr> <td>X</td> <td>US 2008/0139910 A1 (MASTRÓTOTARO et al.) 12 June 2008 (12.06.2008) Entire document, especially Abstract, para[0033].</td> <td>1-2</td> </tr> <tr> <td>A</td> <td>US 2011/0124996 A1 (REINKE et al.) 26 May 2011 (26.05.2011) Entire document.</td> <td>1-6</td> </tr> <tr> <td>A</td> <td>US 2009/0240193 A1 (MENSINGER et al.) 24 September 2009 (24.09.2009) Entire document.</td> <td>1-6</td> </tr> </tbody> </table>			Category*	Citation of document, with indication, where appropriate, of the relevant passages	Relevant to claim No.	X	US 2010/0191075 A1 (ANGELIDES) 29 July 2010 (29.07.2010) Entire document, especially Abstract, para[0019]- para[0021], para[0024]- para[0031], para[0035], Claims 2-4 and FIG. 1.	1-3	X	US 2003/0208113 A1 (MAULT et al.) 06 November 2003 (06.11.2003) Entire document, especially Abstract, para[0062], para[0069]- para[0075], para[0105], para[0132], para[0137], para[0148]- para[0149] and FIGS. 1, 16.	1-2, 4-6	X	US 2009/0264337 A1 (ANGELIDES) 22 October 2009 (22.10.2009) Entire document, especially Abstract, para[0007]-[0009].	1-2	X	US 2009/0240128 A1 (MENSINGER et al.) 24 September 2009 (24.09.2009) Entire document, especially Abstract, para[0097], Claims 11, 18, 19.	1-2	X	US 2008/0139910 A1 (MASTRÓTOTARO et al.) 12 June 2008 (12.06.2008) Entire document, especially Abstract, para[0033].	1-2	A	US 2011/0124996 A1 (REINKE et al.) 26 May 2011 (26.05.2011) Entire document.	1-6	A	US 2009/0240193 A1 (MENSINGER et al.) 24 September 2009 (24.09.2009) Entire document.	1-6
Category*	Citation of document, with indication, where appropriate, of the relevant passages	Relevant to claim No.																								
X	US 2010/0191075 A1 (ANGELIDES) 29 July 2010 (29.07.2010) Entire document, especially Abstract, para[0019]- para[0021], para[0024]- para[0031], para[0035], Claims 2-4 and FIG. 1.	1-3																								
X	US 2003/0208113 A1 (MAULT et al.) 06 November 2003 (06.11.2003) Entire document, especially Abstract, para[0062], para[0069]- para[0075], para[0105], para[0132], para[0137], para[0148]- para[0149] and FIGS. 1, 16.	1-2, 4-6																								
X	US 2009/0264337 A1 (ANGELIDES) 22 October 2009 (22.10.2009) Entire document, especially Abstract, para[0007]-[0009].	1-2																								
X	US 2009/0240128 A1 (MENSINGER et al.) 24 September 2009 (24.09.2009) Entire document, especially Abstract, para[0097], Claims 11, 18, 19.	1-2																								
X	US 2008/0139910 A1 (MASTRÓTOTARO et al.) 12 June 2008 (12.06.2008) Entire document, especially Abstract, para[0033].	1-2																								
A	US 2011/0124996 A1 (REINKE et al.) 26 May 2011 (26.05.2011) Entire document.	1-6																								
A	US 2009/0240193 A1 (MENSINGER et al.) 24 September 2009 (24.09.2009) Entire document.	1-6																								
<p><input type="checkbox"/> Further documents are listed in the continuation of Box C. <input type="checkbox"/></p>																										
<p>* Special categories of cited documents:</p> <table border="0"> <tr> <td> <p>"A" document defining the general state of the art which is not considered to be of particular relevance</p> <p>"E" earlier application or patent but published on or after the international filing date</p> <p>"L" document which may throw doubts on priority claim(s) or which is cited to establish the publication date of another citation or other special reason (as specified)</p> <p>"O" document referring to an oral disclosure, use, exhibition or other means</p> <p>"P" document published prior to the international filing date but later than the priority date claimed</p> </td> <td> <p>"T" later document published after the international filing date or priority date and not in conflict with the application but cited to understand the principle or theory underlying the invention</p> <p>"X" document of particular relevance; the claimed invention cannot be considered novel or cannot be considered to involve an inventive step when the document is taken alone</p> <p>"Y" document of particular relevance; the claimed invention cannot be considered to involve an inventive step when the document is combined with one or more other such documents, such combination being obvious to a person skilled in the art</p> <p>"&" document member of the same patent family</p> </td> </tr> </table>			<p>"A" document defining the general state of the art which is not considered to be of particular relevance</p> <p>"E" earlier application or patent but published on or after the international filing date</p> <p>"L" document which may throw doubts on priority claim(s) or which is cited to establish the publication date of another citation or other special reason (as specified)</p> <p>"O" document referring to an oral disclosure, use, exhibition or other means</p> <p>"P" document published prior to the international filing date but later than the priority date claimed</p>	<p>"T" later document published after the international filing date or priority date and not in conflict with the application but cited to understand the principle or theory underlying the invention</p> <p>"X" document of particular relevance; the claimed invention cannot be considered novel or cannot be considered to involve an inventive step when the document is taken alone</p> <p>"Y" document of particular relevance; the claimed invention cannot be considered to involve an inventive step when the document is combined with one or more other such documents, such combination being obvious to a person skilled in the art</p> <p>"&" document member of the same patent family</p>																						
<p>"A" document defining the general state of the art which is not considered to be of particular relevance</p> <p>"E" earlier application or patent but published on or after the international filing date</p> <p>"L" document which may throw doubts on priority claim(s) or which is cited to establish the publication date of another citation or other special reason (as specified)</p> <p>"O" document referring to an oral disclosure, use, exhibition or other means</p> <p>"P" document published prior to the international filing date but later than the priority date claimed</p>	<p>"T" later document published after the international filing date or priority date and not in conflict with the application but cited to understand the principle or theory underlying the invention</p> <p>"X" document of particular relevance; the claimed invention cannot be considered novel or cannot be considered to involve an inventive step when the document is taken alone</p> <p>"Y" document of particular relevance; the claimed invention cannot be considered to involve an inventive step when the document is combined with one or more other such documents, such combination being obvious to a person skilled in the art</p> <p>"&" document member of the same patent family</p>																									
<p>Date of the actual completion of the international search</p> <p>28 November 2012 (28.11.2012)</p>		<p>Date of mailing of the international search report</p> <p>04 DEC 2012</p>																								
<p>Name and mailing address of the ISA/US</p> <p>Mail Stop PCT, Attn: ISA/US, Commissioner for Patents P.O. Box 1450, Alexandria, Virginia 22313-1450 Facsimile No. 571-273-3201</p>		<p>Authorized officer:</p> <p>Lee W. Young</p> <p>PCT Helpdesk: 571-272-4300 PCT OSP: 571-272-7774</p>																								

INTERNATIONAL SEARCH REPORT

International application No.
PCT/US 12/47229

Box No. II Observations where certain claims were found unsearchable (Continuation of item 2 of first sheet)

This international search report has not been established in respect of certain claims under Article 17(2)(a) for the following reasons:

- 1. Claims Nos.:
because they relate to subject matter not required to be searched by this Authority, namely:

- 2. Claims Nos.:
because they relate to parts of the international application that do not comply with the prescribed requirements to such an extent that no meaningful international search can be carried out, specifically:

- 3. Claims Nos.:
because they are dependent claims and are not drafted in accordance with the second and third sentences of Rule 6.4(a).

Box No. III Observations where unity of invention is lacking (Continuation of item 3 of first sheet)

This International Searching Authority found multiple inventions in this international application, as follows:
-- see extra sheet --

- 1. As all required additional search fees were timely paid by the applicant, this international search report covers all searchable claims.
- 2. As all searchable claims could be searched without effort justifying additional fees, this Authority did not invite payment of additional fees.
- 3. As only some of the required additional search fees were timely paid by the applicant, this international search report covers only those claims for which fees were paid, specifically claims Nos.:
- 4. No required additional search fees were timely paid by the applicant. Consequently, this international search report is restricted to the invention first mentioned in the claims; it is covered by claims Nos.:
1-6

Remark on Protest

- The additional search fees were accompanied by the applicant's protest and, where applicable, the payment of a protest fee.
- The additional search fees were accompanied by the applicant's protest but the applicable protest fee was not paid within the time limit specified in the invitation.
- No protest accompanied the payment of additional search fees.

INTERNATIONAL SEARCH REPORT

International application No.

PCT/US 12/47229

Continuation of Box III: Observations where unity of invention is lacking (Continuation of item 3 of first sheet)

This application contains the following inventions or groups of inventions which are not so linked as to form a single general inventive concept under PCT Rule 13.1. In order for all inventions to be examined, the appropriate additional examination fees must be paid.

Group I: claims 1-6 describing a combination pedometer and glucose meter health monitor to generate a directive for a user action in response to a measured glucose level and an output of the pedometer

Group II: claims 7-19 describing a health monitor comprising a clip to bias a physiological sensor against clotting, a data link and a heart rate monitor or glucose sensor

The inventions listed as Groups I - IV do not relate to a single general inventive concept under PCT Rule 13.1 because, under PCT Rule 13.2, they lack the same or corresponding special technical features for the following reasons:

The commonality between the groups comprises a health monitor which comprises a generic glucose sensor, however, glucose sensors in general are well known in the art to monitor health (see US 2007/0276294 A1 to Gupta et al., who describes health monitors that monitor both glucose and heart rate (Abstract, para[0007]), therefore such monitors in general do not constitute an advancement over existing art.

Thus the remaining features are, group I: directive generation device for monitoring health in response to glucose and a pedometer, and group II: a clipping arrangement for physiological sensors (in general) and a data link for use therewith. None of the groups share a technical feature with another group. Thus, unity is lacking.



- (51) **International Patent Classification:**
A61B 5/024 (2006.01) A61B 5/00 (2006.01)
- (21) **International Application Number:**
PCT/US2013/073405
- (22) **International Filing Date:**
5 December 2013 (05.12.2013)
- (25) **Filing Language:** English
- (26) **Publication Language:** English
- (71) **Applicant:** APPLE INC. [US/US]; 1 Infinite Loop, Cupertino, California 95014 (US).
- (72) **Inventors:** HAN, Chin San; c/o Apple Inc., 1 Infinite Loop, MS 83-T, Cupertino, California 95014 (US). WANG, Albert; c/o Apple Inc., 1 Infinite Loop, MS 83-D, Cupertino, California 95014 (US).
- (74) **Agents:** JONES, Stephen, C. et al.; Morrison & Foerster LLP, 707 Wilshire Boulevard, Los Angeles, CA 90017 (US).
- (81) **Designated States** (unless otherwise indicated, for every kind of national protection available): AF, AG, AL, AM,

AO, AT, AU, AZ, BA, BB, BG, BH, BN, BR, BW, BY, BZ, CA, CH, CL, CN, CO, CR, CU, CZ, DE, DK, DM, DO, DZ, EC, EE, EG, ES, FI, GB, GD, GE, GH, GM, GT, HN, HR, HU, ID, IL, IN, IR, IS, JP, KE, KG, KN, KP, KR, KZ, LA, LC, LK, LR, LS, LT, LU, LY, MA, MD, ME, MG, MK, MN, MW, MX, MY, MZ, NA, NG, NI, NO, NZ, OM, PA, PE, PG, PH, PL, PT, QA, RO, RS, RU, RW, SA, SC, SD, SE, SG, SK, SL, SM, ST, SV, SY, TH, TJ, TM, TN, TR, TT, TZ, UA, UG, US, UZ, VC, VN, ZA, ZM, ZW.

- (84) **Designated States** (unless otherwise indicated, for every kind of regional protection available): ARIPO (BW, GH, GM, KE, LR, LS, MW, MZ, NA, RW, SD, SL, SZ, TZ, UG, ZM, ZW), Eurasian (AM, AZ, BY, KG, KZ, RU, TJ, TM), European (AL, AT, BE, BG, CH, CY, CZ, DE, DK, EE, ES, FI, FR, GB, GR, HR, HU, IE, IS, IT, LT, LU, LV, MC, MK, MT, NL, NO, PL, PT, RO, RS, SE, SI, SK, SM, TR), OAPI (BF, BJ, CF, CG, CI, CM, GA, GN, GQ, GW, KM, ML, MR, NE, SN, TD, TG).

Published:
— with international search report (Art. 21(3))



(54) **Title:** WEARABLE MULTI-MODAL PHYSIOLOGICAL SENSING SYSTEM

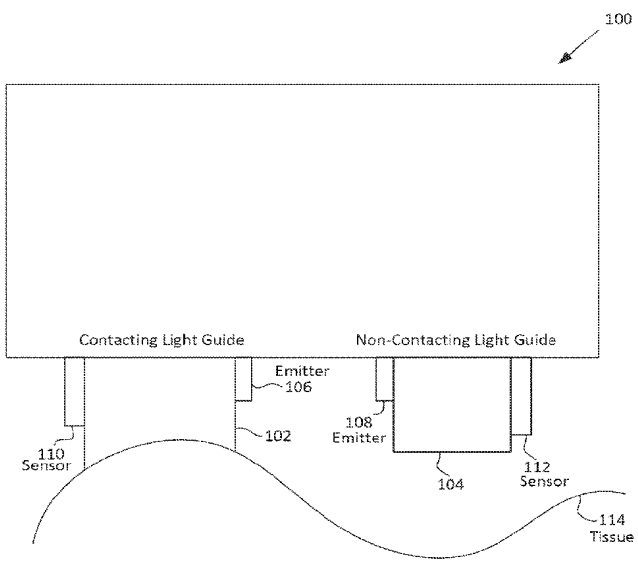

FIG. 1

(57) **Abstract:** A PPG signal may be obtained from a pulse oximeter, which employs a light emitter and a light sensor to measure the perfusion of blood to the skin of a user. However, the signal may be compromised by noise due to motion artifacts. To address the presence of motion artifacts, examples of the present disclosure can receive light information from each of two light guides, one in contact with the tissue of the user and one not in contact with the tissue of the user. First light information can be obtained from the first light guide, and second light information can be obtained from the second light guide. A heart rate signal can then be computed from the first and second light information, for example, by using blind source separation and/or cross-correlation.

WO 2015/084376 A1

WEARABLE MULTI-MODAL PHYSIOLOGICAL SENSING SYSTEM

Field of the Disclosure

[0001] This relates generally to reducing motion artifacts from a physiological signal.

Background of the Disclosure

[0002] A photoplethysmogram (PPG) signal may be obtained from a pulse oximeter, which employs a light emitter and a light sensor to measure the perfusion of blood to the skin of a user. However, the signal may be compromised by noise due to motion artifacts. That is, movement of the body of a user may cause the skin and vasculature to expand and contract, introducing noise to the signal. Further, the device itself may move with respect to the body of the user, introducing further noise. To address the presence of motion artifacts, examples of the present disclosure can receive light information from each of two light guides, one in contact with the tissue of the user and one not in contact with the tissue of the user. First light information can be obtained from the first light guide, and second light information can be obtained from the second light guide. A heart rate signal can then be computed from the first and second light information, for example, by using blind source separation and/or cross-correlation.

Summary of the Disclosure

[0003] A photoplethysmogram (PPG) signal may be obtained from a pulse oximeter, which employs a light emitter and a light sensor to measure the perfusion of blood to the skin of a user. However, the signal may be compromised by noise due to motion artifacts. That is, movement of the body of a user may cause the skin and vasculature to expand and contract, introducing noise to the signal. Further, the device itself may move with respect to the body of the user, introducing further noise. To address the presence of motion artifacts, examples of the present disclosure can receive light information from each of two light guides, one in contact with the tissue of the user

and one not in contact with the tissue of the user. First light information can be obtained from the first light guide, and second light information can be obtained from the second light guide. A heart rate signal can then be computed from the first and second light information, for example, by using blind source separation and/or cross-correlation.

Brief Description of the Drawings

[0004] FIG. 1 illustrates an electronic device having light sensors for determining a heart rate signal according to examples of the disclosure.

[0005] FIG. 2 illustrates a method of computing a heart rate signal according to examples of the disclosure.

[0006] FIG. 3 illustrates a method of computing a heart rate signal according to examples of the disclosure.

[0007] FIG. 4 is a block diagram illustrating an exemplary API architecture, which may be used in some examples of the disclosure.

[0008] FIG. 5 illustrates an exemplary software stack of an API according to examples of the disclosure.

[0009] FIG. 6 is a block diagram illustrating exemplary interactions between the touch screen and other components of the device according to examples of the disclosure.

[0010] FIG. 7 is a block diagram illustrating an example of a system architecture that may be embodied within any portable or non-portable device according to examples of the disclosure.

Detailed Description

[0011] In the following description of examples, reference is made to the accompanying drawings which form a part hereof, and in which it is shown by way of illustration specific examples that can be practiced. It is to be understood that other examples can be used and structural changes can be made without departing from the scope of the disclosed examples.

[0012] A photoplethysmogram (PPG) signal may be obtained from a pulse oximeter, which employs a light emitter and a light sensor to measure the perfusion of

blood to the skin of a user. However, the signal may be compromised by noise due to motion artifacts. That is, movement of the body of a user may cause the skin and vasculature to expand and contract, introducing noise to the signal. Further, the device itself may move with respect to the body of the user, introducing further noise. To address the presence of motion artifacts, examples of the present disclosure can receive light information from each of two light guides, one in contact with the tissue of the user and one not in contact with the tissue of the user. First light information can be obtained from the first light guide, and second light information can be obtained from the second light guide. A heart rate signal can then be computed from the first and second light information, for example, by using blind source separation and/or cross-correlation.

[0013] Although examples disclosed herein may be described and illustrated herein primarily in terms of two sensors, emitters, and light guides, it should be understood that the examples are not so limited, but are additionally applicable to devices including any number and configuration of sensors, emitters, and light guides.

[0014] Examples of the disclosure are directed to a system for sensing and measurement of physiological signals that enables a signal decomposition approach to physiological measurements. That is, multiple signals may be obtained, and each signal may contain a physiological signal of interest (e.g., a heart rate signal)—each signal may also contain different noise components, and thus signal decomposition methods may be used to filter the noise and compute the signal of interest. Multiple sensing modalities optimized for the signal decomposition approach may provide robustness against non-signal artifacts commonly induced in wearable sensors, such as motion- or biologically-induced artifacts. Sensing modalities may include detection of physiological signals from optical sensors, force and pressure sensors, temperature sensors, accelerometers, proximity detectors, and/or impedance sensors, among other possibilities. In some examples, sensing modalities may include optical sensors including light guides in contact and not in contact with tissue of a user. Because the signal of interest may be compromised by noise due to motion of the device with respect to the tissue and also by noise due to motion of the tissue itself (e.g., the expansion and contraction of tissue and vasculature), different noise may be captured by sensors corresponding to each of contacting and non-contacting light guides, and signal decomposition methods (e.g., blind source separation) may be employed to separate the signal of interest from the noise.

[0015] FIG. 1 illustrates an electronic device 100 having light sensors for determining a heart rate signal according to examples of the disclosure. A first light sensor 110 may be co-located with a contacting light guide 102 and a first light emitter 106. The contacting light guide 102 may be configured so as to be in contact with tissue 114 of a user, such as skin. For example, the contacting light guide 102 may be curved such that the surface is configured to contact tissue 114 of the user. In some examples, the contacting light guide 102 may jut out from the body of the electronic device 100 such that it is configured to contact tissue 114 of the user. A second light sensor 112 may be co-located with a non-contacting light guide 104 and a second light emitter 108. The non-contacting light guide 104 may be configured so as to not be in contact with tissue 114 of the user. In some examples, the non-contacting light guide 104 may be recessed with respect to the body of the electronic device 100 such that it is configured not to contact tissue 114 of the user.

[0016] The electronic device 100 may be situated such that the sensors 110 and 112, the emitters 106 and 108, and the light guides 102 and 104 are proximate the tissue 114 of the user, so that light from a light emitter may be directed through a light guide and be incident on the tissue. For example, the electronic device 100 may be held in a user's hand or strapped to a user's wrist, among other possibilities. A portion of the light from a light emitter may be absorbed by the skin, vasculature, and/or blood, among other possibilities, and a portion may be reflected back to a light sensor co-located with the light emitter. In some examples, light guides may direct light to tissue and/or back to a light sensor, and some emitters and sensors may direct light to and from tissue without a light guide.

[0017] FIG. 2 illustrates a method of computing a heart rate signal. Light may be emitted from a first light emitter through a contacting light guide (200). First light information may be received at a first light sensor through the contacting light guide (202). Similarly, light may be emitted from a second light emitter through a non-contacting light guide (204), and second light information may be received at a second light sensor through the non-contacting light guide (206). In some examples, a light emitter may emit light, the light may travel to the tissue of a user, and a portion of the light may reflect to a co-located light sensor, and some or all of the travel of the light may be directed by a light guide. Accordingly, the first light information may indicate an

amount of light from a first light emitter that has been reflected by the skin, blood, and/or vasculature of the user, among other possibilities. In some examples, the first light information may indicate an amount of light from the first light emitter that has been absorbed by the skin, blood, and/or vasculature of the user.

[0018] The light emitters may produce light in ranges corresponding to infrared (IR), green, amber, blue, and/or red light, among other possibilities. Additionally, the light sensors may be configured to sense light having certain wavelengths more easily than light having other wavelengths. For example, if the first light emitter emits light having a wavelength in the IR range, then the first light sensor may be configured to sense light in the IR range more powerfully than light in the green range. That is, the incidence of light in the IR range may produce a stronger response in the first light sensor than the incidence of light in the green range. In this way, the first light sensor can be configured so as to sense the light produced by the first light emitter more powerfully than the light produced by the second light emitter, for example. In some examples, each light emitter may produce light in the same wavelength.

[0019] In some examples, a light emitter may be a light emitting diode (LED) and a light sensor may be a photodiode. The light information may include information produced by the photodiode. For example, the light information may include a voltage reading that corresponds to light absorbed by the photodiode. In some examples, the light information may include some transformation of raw signal produced by the photodiode, such as through filtering, scaling, or other signal processing.

[0020] Based on the first and second light information, a heart rate signal may be computed (206). For example, the first and second light information may be processed through blind source separation and/or cross-correlation methods. For example, the first and second light information may be processed with principal component analysis (one example method of blind source separation), to separate out a plurality of linearly uncorrelated component signals. Those components may then be further processed with a cross-correlation method, serving as a second filter, to compute a heart rate signal. In some examples, the first light information may include light information of red, green, and blue wavelengths, and the second light information may also include light information of red, green, and blue wavelengths, although any number and combination of wavelengths is possible. In some examples, the computed heart rate signal may

include one or more additional signals, such as residual noise and/or a signal corresponding to a respiratory rate of a user, among other possibilities.

[0021] FIG. 3 illustrates a method of computing a heart rate signal based on multiple wavelengths of contacting and non-contacting light information. Red, green, and blue contacting light information (300) may be processed with blind source separation (e.g., principal component analysis, among other possibilities) (304). Further, red, green, and blue non-contacting light information (302) may be processed with blind source separation (306). The results of the contacting and non-contacting blind source separation processes may be cross-correlated (308), and the result may be a heart rate signal with reduced noise (310).

[0022] The examples discussed above can be implemented in one or more Application Programming Interfaces (APIs). An API is an interface implemented by a program code component or hardware component (hereinafter “API-implementing component”) that allows a different program code component or hardware component (hereinafter “API-calling component”) to access and use one or more functions, methods, procedures, data structures, classes, and/or other services provided by the API-implementing component. An API can define one or more parameters that are passed between the API-calling component and the API-implementing component.

[0023] The above-described features can be implemented as part of an application program interface (API) that can allow it to be incorporated into different applications (e.g., spreadsheet apps) utilizing touch input as an input mechanism. An API can allow a developer of an API-calling component (which may be a third party developer) to leverage specified features, such as those described above, provided by an API-implementing component. There may be one API-calling component or there may be more than one such component. An API can be a source code interface that a computer system or program library provides in order to support requests for services from an application. An operating system (OS) can have multiple APIs to allow applications running on the OS to call one or more of those APIs, and a service (such as a program library) can have multiple APIs to allow an application that uses the service to call one or more of those APIs. An API can be specified in terms of a programming language that can be interpreted or compiled when an application is built.

[0024] In some examples, the API-implementing component may provide more than one API, each providing a different view of the functionality implemented by the API-implementing component, or with different aspects that access different aspects of the functionality implemented by the API-implementing component. For example, one API of an API-implementing component can provide a first set of functions and can be exposed to third party developers, and another API of the API-implementing component can be hidden (not exposed) and provide a subset of the first set of functions and also provide another set of functions, such as testing or debugging functions which are not in the first set of functions. In other examples the API-implementing component may itself call one or more other components via an underlying API and thus be both an API-calling component and an API-implementing component.

[0025] An API defines the language and parameters that API-calling components use when accessing and using specified features of the API-implementing component. For example, an API-calling component accesses the specified features of the API-implementing component through one or more API calls or invocations (embodied for example by function or method calls) exposed by the API and passes data and control information using parameters via the API calls or invocations. The API-implementing component may return a value through the API in response to an API call from an API-calling component. While the API defines the syntax and result of an API call (e.g., how to invoke the API call and what the API call does), the API may not reveal how the API call accomplishes the function specified by the API call. Various API calls are transferred via the one or more application programming interfaces between the calling (API-calling component) and an API-implementing component. Transferring the API calls may include issuing, initiating, invoking, calling, receiving, returning, or responding to the function calls or messages; in other words, transferring can describe actions by either of the API-calling component or the API-implementing component. The function calls or other invocations of the API may send or receive one or more parameters through a parameter list or other structure. A parameter can be a constant, key, data structure, object, object class, variable, data type, pointer, array, list or a pointer to a function or method or another way to reference a data or other item to be passed via the API.

[0026] Furthermore, data types or classes may be provided by the API and implemented by the API-implementing component. Thus, the API-calling component

may declare variables, use pointers to, use or instantiate constant values of such types or classes by using definitions provided in the API.

[0027] Generally, an API can be used to access a service or data provided by the API-implementing component or to initiate performance of an operation or computation provided by the API-implementing component. By way of example, the API-implementing component and the API-calling component may each be any one of an operating system, a library, a device driver, an API, an application program, or other module (it should be understood that the API-implementing component and the API-calling component may be the same or different type of module from each other). API-implementing components may in some cases be embodied at least in part in firmware, microcode, or other hardware logic. In some examples, an API may allow a client program to use the services provided by a Software Development Kit (SDK) library. In other examples an application or other client program may use an API provided by an Application Framework. In these examples the application or client program may incorporate calls to functions or methods provided by the SDK and provided by the API or use data types or objects defined in the SDK and provided by the API. An Application Framework may in these examples provide a main event loop for a program that responds to various events defined by the Framework. The API allows the application to specify the events and the responses to the events using the Application Framework. In some implementations, an API call can report to an application the capabilities or state of a hardware device, including those related to aspects such as input capabilities and state, output capabilities and state, processing capability, power state, storage capacity and state, communications capability, etc., and the API may be implemented in part by firmware, microcode, or other low level logic that executes in part on the hardware component.

[0028] The API-calling component may be a local component (i.e., on the same data processing system as the API-implementing component) or a remote component (i.e., on a different data processing system from the API-implementing component) that communicates with the API-implementing component through the API over a network. It should be understood that an API-implementing component may also act as an API-calling component (i.e., it may make API calls to an API exposed by a different API-implementing component) and an API-calling component may also act as an API-

implementing component by implementing an API that is exposed to a different API-calling component.

[0029] The API may allow multiple API-calling components written in different programming languages to communicate with the API-implementing component (thus the API may include features for translating calls and returns between the API-implementing component and the API-calling component); however the API may be implemented in terms of a specific programming language. An API-calling component can, in one example, call APIs from different providers such as a set of APIs from an OS provider and another set of APIs from a plug-in provider and another set of APIs from another provider (e.g. the provider of a software library) or creator of the another set of APIs.

[0030] FIG. 4 is a block diagram illustrating an exemplary API architecture, which may be used in some examples of the disclosure. As shown in FIG. 4, the API architecture 600 includes the API-implementing component 610 (e.g., an operating system, a library, a device driver, an API, an application program, software or other module) that implements the API 620. The API 620 specifies one or more functions, methods, classes, objects, protocols, data structures, formats and/or other features of the API-implementing component that may be used by the API-calling component 630. The API 620 can specify at least one calling convention that specifies how a function in the API-implementing component receives parameters from the API-calling component and how the function returns a result to the API-calling component. The API-calling component 630 (e.g., an operating system, a library, a device driver, an API, an application program, software or other module), makes API calls through the API 620 to access and use the features of the API-implementing component 610 that are specified by the API 620. The API-implementing component 610 may return a value through the API 620 to the API-calling component 630 in response to an API call.

[0031] It will be appreciated that the API-implementing component 610 may include additional functions, methods, classes, data structures, and/or other features that are not specified through the API 620 and are not available to the API-calling component 630. It should be understood that the API-calling component 630 may be on the same system as the API-implementing component 610 or may be located remotely and accesses the API-implementing component 610 using the API 620 over a network. While FIG. 4 illustrates a single API-calling component 630 interacting with the API 620, it should be

understood that other API-calling components, which may be written in different languages (or the same language) than the API-calling component 630, may use the API 620.

[0032] The API-implementing component 610, the API 620, and the API-calling component 630 may be stored in a non-transitory machine-readable storage medium, which includes any mechanism for storing information in a form readable by a machine (e.g., a computer or other data processing system). For example, a machine-readable medium includes magnetic disks, optical disks, random access memory; read only memory, flash memory devices, etc.

[0033] In the exemplary software stack shown in FIG. 5, applications can make calls to Services A or B using several Service APIs and to Operating System (OS) using several OS APIs. Services A and B can make calls to OS using several OS APIs.

[0034] Note that the Service 2 has two APIs, one of which (Service 2 API 1) receives calls from and returns values to Application 1 and the other (Service 2 API 2) receives calls from and returns values to Application 2. Service 1 (which can be, for example, a software library) makes calls to and receives returned values from OS API 1, and Service 2 (which can be, for example, a software library) makes calls to and receives returned values from both OS API 1 and OS API 2. Application 2 makes calls to and receives returned values from OS API 2.

[0035] FIG. 6 is a block diagram illustrating exemplary interactions between the touch screen and the other components of the device. Described examples may include touch I/O device 1001 that can receive touch input for interacting with computing system 1003 via wired or wireless communication channel 1002. Touch I/O device 1001 may be used to provide user input to computing system 1003 in lieu of or in combination with other input devices such as a keyboard, mouse, etc. One or more touch I/O devices 1001 may be used for providing user input to computing system 1003. Touch I/O device 1001 may be an integral part of computing system 1003 (e.g., touch screen on a smartphone or a tablet PC) or may be separate from computing system 1003.

[0036] Touch I/O device 1001 may include a touch sensing panel which is wholly or partially transparent, semitransparent, non-transparent, opaque or any combination thereof. Touch I/O device 1001 may be embodied as a touch screen, touch pad, a touch

screen functioning as a touch pad (e.g., a touch screen replacing the touchpad of a laptop), a touch screen or touchpad combined or incorporated with any other input device (e.g., a touch screen or touchpad disposed on a keyboard) or any multi-dimensional object having a touch sensing surface for receiving touch input.

[0037] In one example, touch I/O device 1001 embodied as a touch screen may include a transparent and/or semitransparent touch sensing panel partially or wholly positioned over at least a portion of a display. According to this example, touch I/O device 1001 functions to display graphical data transmitted from computing system 1003 (and/or another source) and also functions to receive user input. In other examples, touch I/O device 1001 may be embodied as an integrated touch screen where touch sensing components/devices are integral with display components/devices. In still other examples a touch screen may be used as a supplemental or additional display screen for displaying supplemental or the same graphical data as a primary display and to receive touch input.

[0038] Touch I/O device 1001 may be configured to detect the location of one or more touches or near touches on device 1001 based on capacitive, resistive, optical, acoustic, inductive, mechanical, chemical measurements, or any phenomena that can be measured with respect to the occurrences of the one or more touches or near touches in proximity to device 1001. Software, hardware, firmware or any combination thereof may be used to process the measurements of the detected touches to identify and track one or more gestures. A gesture may correspond to stationary or non-stationary, single or multiple, touches or near touches on touch I/O device 1001. A gesture may be performed by moving one or more fingers or other objects in a particular manner on touch I/O device 1001 such as tapping, pressing, rocking, scrubbing, twisting, changing orientation, pressing with varying pressure and the like at essentially the same time, contiguously, or consecutively. A gesture may be characterized by, but is not limited to a pinching, sliding, swiping, rotating, flexing, dragging, or tapping motion between or with any other finger or fingers. A single gesture may be performed with one or more hands, by one or more users, or any combination thereof.

[0039] Computing system 1003 may drive a display with graphical data to display a graphical user interface (GUI). The GUI may be configured to receive touch input via touch I/O device 1001. Embodied as a touch screen, touch I/O device 1001 may display the GUI. Alternatively, the GUI may be displayed on a display separate from touch I/O

device 1001. The GUI may include graphical elements displayed at particular locations within the interface. Graphical elements may include but are not limited to a variety of displayed virtual input devices including virtual scroll wheels, a virtual keyboard, virtual knobs, virtual buttons, any virtual UI, and the like. A user may perform gestures at one or more particular locations on touch I/O device 1001 which may be associated with the graphical elements of the GUI. In other examples, the user may perform gestures at one or more locations that are independent of the locations of graphical elements of the GUI. Gestures performed on touch I/O device 1001 may directly or indirectly manipulate, control, modify, move, actuate, initiate or generally affect graphical elements such as cursors, icons, media files, lists, text, all or portions of images, or the like within the GUI. For instance, in the case of a touch screen, a user may directly interact with a graphical element by performing a gesture over the graphical element on the touch screen. Alternatively, a touch pad generally provides indirect interaction. Gestures may also affect non-displayed GUI elements (e.g., causing user interfaces to appear) or may affect other actions within computing system 1003 (e.g., affect a state or mode of a GUI, application, or operating system). Gestures may or may not be performed on touch I/O device 1001 in conjunction with a displayed cursor. For instance, in the case in which gestures are performed on a touchpad, a cursor (or pointer) may be displayed on a display screen or touch screen and the cursor may be controlled via touch input on the touchpad to interact with graphical objects on the display screen. In other examples in which gestures are performed directly on a touch screen, a user may interact directly with objects on the touch screen, with or without a cursor or pointer being displayed on the touch screen.

[0040] Feedback may be provided to the user via communication channel 1002 in response to or based on the touch or near touches on touch I/O device 1001. Feedback may be transmitted optically, mechanically, electrically, olfactory, acoustically, or the like or any combination thereof and in a variable or non-variable manner.

[0041] Attention is now directed towards examples of a system architecture that may be embodied within any portable or non-portable device including but not limited to a communication device (e.g. mobile phone, smart phone), a multi-media device (e.g., MP3 player, TV, radio), a portable or handheld computer (e.g., tablet, netbook, laptop), a desktop computer, an All-In-One desktop, a peripheral device, or any other system or

device adaptable to the inclusion of system architecture 2000, including combinations of two or more of these types of devices. FIG. 7 is a block diagram of one example of system 2000 that generally includes one or more computer-readable mediums 2001, processing system 2004, I/O subsystem 2006, radio frequency (RF) circuitry 2008, audio circuitry 2010, and sensors circuitry 2011. These components may be coupled by one or more communication buses or signal lines 2003.

[0042] It should be apparent that the architecture shown in FIG. 7 is only one example architecture of system 2000, and that system 2000 could have more or fewer components than shown, or a different configuration of components. The various components shown in FIG. 7 can be implemented in hardware, software, firmware or any combination thereof, including one or more signal processing and/or application specific integrated circuits.

[0043] RF circuitry 2008 can be used to send and receive information over a wireless link or network to one or more other devices and includes well-known circuitry for performing this function. RF circuitry 2008 and audio circuitry 2010 can be coupled to processing system 2004 via peripherals interface 2016. Interface 2016 can include various known components for establishing and maintaining communication between peripherals and processing system 2004. Audio circuitry 2010 can be coupled to audio speaker 2050 and microphone 2052 and can include known circuitry for processing voice signals received from interface 2016 to enable a user to communicate in real-time with other users. In some examples, audio circuitry 2010 can include a headphone jack (not shown). Sensors circuitry 2011 can be coupled to various sensors including, but not limited to, one or more Light Emitting Diodes (LEDs) or other light emitters, one or more photodiodes or other light sensors, one or more photothermal sensors, a magnetometer, an accelerometer, a gyroscope, a barometer, a compass, a proximity sensor, a camera, an ambient light sensor, a thermometer, a GPS sensor, and various system sensors which can sense remaining battery life, power consumption, processor speed, CPU load, and the like.

[0044] Peripherals interface 2016 can couple the input and output peripherals of the system to processor 2018 and computer-readable medium 2001. One or more processors 2018 communicate with one or more computer-readable mediums 2001 via controller 2020. Computer-readable medium 2001 can be any device or medium that can

store code and/or data for use by one or more processors 2018. In some examples, medium 2001 can be a non-transitory computer-readable storage medium. Medium 2001 can include a memory hierarchy, including but not limited to cache, main memory and secondary memory. The memory hierarchy can be implemented using any combination of RAM (*e.g.*, SRAM, DRAM, DDRAM), ROM, FLASH, magnetic and/or optical storage devices, such as disk drives, magnetic tape, CDs (compact disks) and DVDs (digital video discs). Medium 2001 may also include a transmission medium for carrying information-bearing signals indicative of computer instructions or data (with or without a carrier wave upon which the signals are modulated). For example, the transmission medium may include a communications network, including but not limited to the Internet (also referred to as the World Wide Web), intranet(s), Local Area Networks (LANs), Wide Local Area Networks (WLANs), Storage Area Networks (SANs), Metropolitan Area Networks (MAN) and the like.

[0045] One or more processors 2018 can run various software components stored in medium 2001 to perform various functions for system 2000. In some examples, the software components can include operating system 2022, communication module (or set of instructions) 2024, touch processing module (or set of instructions) 2026, graphics module (or set of instructions) 2028, and one or more applications (or set of instructions) 2030. Each of these modules and above noted applications can correspond to a set of instructions for performing one or more functions described above and the methods described in this application (*e.g.*, the computer-implemented methods and other information processing methods described herein). These modules (*i.e.*, sets of instructions) need not be implemented as separate software programs, procedures or modules, and thus various subsets of these modules may be combined or otherwise re-arranged in various examples. In some examples, medium 2001 may store a subset of the modules and data structures identified above. Furthermore, medium 2001 may store additional modules and data structures not described above.

[0046] Operating system 2022 can include various procedures, sets of instructions, software components and/or drivers for controlling and managing general system tasks (*e.g.*, memory management, storage device control, power management, *etc.*) and facilitates communication between various hardware and software components.

[0047] Communication module 2024 can facilitate communication with other devices over one or more external ports 2036 or via RF circuitry 2008 and can include various software components for handling data received from RF circuitry 2008 and/or external port 2036.

[0048] Graphics module 2028 can include various known software components for rendering, animating and displaying graphical objects on a display surface. In examples in which touch I/O device 2012 is a touch sensing display (e.g., touch screen), graphics module 2028 can include components for rendering, displaying, and animating objects on the touch sensing display.

[0049] One or more applications 2030 can include any applications installed on system 2000, including without limitation, a browser, address book, contact list, email, instant messaging, word processing, keyboard emulation, widgets, JAVA-enabled applications, encryption, digital rights management, voice recognition, voice replication, location determination capability (such as that provided by the global positioning system (GPS)), a music player, *etc.*

[0050] Touch processing module 2026 can include various software components for performing various tasks associated with touch I/O device 2012 including but not limited to receiving and processing touch input received from I/O device 2012 via touch I/O device controller 2032.

[0051] I/O subsystem 2006 can be coupled to touch I/O device 2012 and one or more other I/O devices 2014 for controlling or performing various functions. Touch I/O device 2012 can communicate with processing system 2004 via touch I/O device controller 2032, which can include various components for processing user touch input (e.g., scanning hardware). One or more other input controllers 2034 can receive/send electrical signals from/to other I/O devices 2014. Other I/O devices 2014 may include physical buttons, dials, slider switches, sticks, keyboards, touch pads, additional display screens, or any combination thereof.

[0052] If embodied as a touch screen, touch I/O device 2012 can display visual output to the user in a GUI. The visual output may include text, graphics, video, and any combination thereof. Some or all of the visual output may correspond to user-interface objects. Touch I/O device 2012 can form a touch sensing surface that accepts touch input

from the user. Touch I/O device 2012 and touch screen controller 2032 (along with any associated modules and/or sets of instructions in medium 2001) can detect and track touches or near touches (and any movement or release of the touch) on touch I/O device 2012 and can convert the detected touch input into interaction with graphical objects, such as one or more user-interface objects. In the case in which device 2012 is embodied as a touch screen, the user can directly interact with graphical objects that are displayed on the touch screen. Alternatively, in the case in which device 2012 is embodied as a touch device other than a touch screen (e.g., a touch pad), the user may indirectly interact with graphical objects that are displayed on a separate display screen embodied as I/O device 2014.

[0053] Touch I/O device 2012 may be analogous to the multi-touch sensing surface described in the following U.S. Patents: 6,323,846 (Westerman et al.), 6,570,557 (Westerman et al.), and/or 6,677,932 (Westerman), and/or U.S. Patent Publication 2002/0015024A1, each of which is hereby incorporated by reference.

[0054] In examples for which touch I/O device 2012 is a touch screen, the touch screen may use LCD (liquid crystal display) technology, LPD (light emitting polymer display) technology, OLED (organic LED), or OEL (organic electro luminescence), although other display technologies may be used in other examples.

[0055] Feedback may be provided by touch I/O device 2012 based on the user's touch input as well as a state or states of what is being displayed and/or of the computing system. Feedback may be transmitted optically (e.g., light signal or displayed image), mechanically (e.g., haptic feedback, touch feedback, force feedback, or the like), electrically (e.g., electrical stimulation), olfactory, acoustically (e.g., beep or the like), or the like or any combination thereof and in a variable or non-variable manner.

[0056] System 2000 can also include power system 2044 for powering the various hardware components and may include a power management system, one or more power sources, a recharging system, a power failure detection circuit, a power converter or inverter, a power status indicator and any other components typically associated with the generation, management and distribution of power in portable devices.

[0057] In some examples, peripherals interface 2016, one or more processors 2018, and memory controller 2020 may be implemented on a single chip, such as

processing system 2004. In some other examples, they may be implemented on separate chips.

[0058] Examples of the disclosure can be advantageous in allowing for an electronic device to obtain a heart rate signal with reduced noise due to motion artifacts, making for a more accurate reading of heart rate.

[0059] In some examples, a method of an electronic device including a plurality of light emitters, a plurality of light sensors, and a plurality of light guides is disclosed. The method may include: emitting light from each of the plurality of light emitters through respective light guides, wherein a contacting light guide may be configured to contact tissue of a user and a non-contacting light guide may be configured not to contact tissue of the user; receiving first light information from the contacting light guide; receiving second light information from the non-contacting light guide; and computing a heart rate signal based on the first and second light information. Additionally or alternatively to one or more of the above examples, a surface of the contacting light guide may be curved such that the surface is configured to contact tissue of the user. Additionally or alternatively to one or more of the above examples, the non-contacting light guide may be recessed with respect to the electronic device such that the non-contacting light guide may be configured not to contact tissue of the user. Additionally or alternatively to one or more of the above examples, computing the heart rate signal based on the first and second light information may include performing blind source separation on the first and second light information. Additionally or alternatively to one or more of the above examples, computing the heart rate signal based on the first and second light information may include performing cross-correlation on the first and second light information. Additionally or alternatively to one or more of the above examples, emitting light through the contacting light guide may include emitting light of a plurality of wavelengths through the contacting light guide; and wherein computing the heart rate signal may include performing blind source separation on light information of the plurality of wavelengths. Additionally or alternatively to one or more of the above examples, the plurality of wavelengths may include wavelengths of red, green, and blue light. Additionally or alternatively to one or more of the above examples, one or more of the plurality of light sensors may be in contact with respective light guides through which

light is sensed, and one or more of the plurality of light sensors may be not in contact with respective light guides through which light is sensed.

[0060] In some examples, a non-transitory computer readable medium is disclosed. The non-transitory computer readable medium may contain instructions that, when executed, perform a method of an electronic device including a plurality of light emitters, a plurality of light sensors, and a plurality of light guides. The method may include: emitting light from each of the plurality of light emitters through respective light guides, wherein a contacting light guide may be configured to contact tissue of a user and a non-contacting light may be configured not to contact tissue of the user; receiving first light information from the contacting light guide; receiving second light information from the non-contacting light guide; and computing a heart rate signal based on the first and second light information. Additionally or alternatively to one or more of the above examples, a surface of the contacting light guide may be curved such that the surface is configured to contact tissue of the user. Additionally or alternatively to one or more of the above examples, the non-contacting light guide may be recessed with respect to the electronic device such that the non-contacting light guide may be configured not to contact tissue of the user. Additionally or alternatively to one or more of the above examples, computing the heart rate signal based on the first and second light information may include performing blind source separation on the first and second light information. Additionally or alternatively to one or more of the above examples, computing the heart rate signal based on the first and second light information may include performing cross-correlation on the first and second light information. Additionally or alternatively to one or more of the above examples, emitting light through the contacting light guide may include emitting light of a plurality of wavelengths through the contacting light guide; and wherein computing the heart rate signal may include performing blind source separation on light information of the plurality of wavelengths. Additionally or alternatively to one or more of the above examples, the plurality of wavelengths may include wavelengths of red, green, and blue light. Additionally or alternatively to one or more of the above examples, one or more of the plurality of light sensors may be in contact with respective light guides through which light is sensed, and one or more of the plurality of light sensors may be not in contact with respective light guides through which light is sensed.

[0061] In some examples, an electronic device is disclosed. The electronic device may include: a processor to execute instructions; a plurality of light emitters; a plurality of light sensors; a plurality of light guides; and a memory coupled with the processor to store instructions, which when executed by the processor, may cause the processor to perform operations to generate an application programming interface (API) that allows an API-calling component to perform a method. The method may include: emitting light from each of the plurality of light emitters through respective light guides, wherein a contacting light guide may be configured to contact tissue of a user and a non-contacting light may be configured not to contact tissue of the user; receiving first light information from the contacting light guide; receiving second light information from the non-contacting light guide; and computing a heart rate signal based on the first and second light information. Additionally or alternatively to one or more of the above examples, a surface of the contacting light guide may be curved such that the surface is configured to contact tissue of the user. Additionally or alternatively to one or more of the above examples, the non-contacting light guide may be recessed with respect to the electronic device such that the non-contacting light guide may be configured not to contact tissue of the user. Additionally or alternatively to one or more of the above examples, computing the heart rate signal based on the first and second light information may include performing blind source separation on the first and second light information. Additionally or alternatively to one or more of the above examples, computing the heart rate signal based on the first and second light information may include performing cross-correlation on the first and second light information. Additionally or alternatively to one or more of the above examples, emitting light through the contacting light guide may include emitting light of a plurality of wavelengths through the contacting light guide; and wherein computing the heart rate signal may include performing blind source separation on light information of the plurality of wavelengths. Additionally or alternatively to one or more of the above examples, the plurality of wavelengths may include wavelengths of red, green, and blue light. Additionally or alternatively to one or more of the above examples, one or more of the plurality of light sensors may be in contact with respective light guides through which light is sensed, and one or more of the plurality of light sensors may be not in contact with respective light guides through which light is sensed.

[0062] Although the disclosed examples have been fully described with reference to the accompanying drawings, it is to be noted that various changes and modifications will become apparent to those skilled in the art. Such changes and modifications are to be understood as being included within the scope of the disclosed examples as defined by the appended claims.

WHAT IS CLAIMED IS:

1. A method of an electronic device including a plurality of light emitters, a plurality of light sensors, and a plurality of light guides, the method comprising:
 - emitting light from each of the plurality of light emitters through respective light guides, wherein a contacting light guide is configured to contact tissue of a user and a non-contacting light is configured not to contact tissue of the user;
 - receiving first light information from the contacting light guide;
 - receiving second light information from the non-contacting light guide; and
 - computing a heart rate signal based on the first and second light information.
2. The method of claim 1, wherein a surface of the contacting light guide is curved such that the surface is configured to contact tissue of the user.
3. The method of claim 1, wherein the non-contacting light guide is recessed with respect to the electronic device such that the non-contacting light guide is configured not to contact tissue of the user.
4. The method of claim 1, wherein computing the heart rate signal based on the first and second light information includes performing blind source separation on the first and second light information.
5. The method of claim 1, wherein computing the heart rate signal based on the first and second light information includes performing cross-correlation on the first and second light information.
6. The method of claim 1, wherein emitting light through the contacting light guide includes emitting light of a plurality of wavelengths through the contacting light guide; and
 - wherein computing the heart rate signal includes performing blind source separation on light information of the plurality of wavelengths.

7. The method of claim 6, wherein the plurality of wavelengths include wavelengths of red, green, and blue light.

8. The method of claim 1, wherein one or more of the plurality of light sensors are in contact with respective light guides through which light is sensed, and one or more of the plurality of light sensors are not in contact with respective light guides through which light is sensed.

9. A non-transitory computer readable medium, the computer readable medium containing instructions that, when executed, perform a method of an electronic device including a plurality of light emitters, a plurality of light sensors, and a plurality of light guides, the method comprising:

emitting light from each of the plurality of light emitters through respective light guides, wherein a contacting light guide is configured to contact tissue of a user and a non-contacting light is configured not to contact tissue of the user;

receiving first light information from the contacting light guide;

receiving second light information from the non-contacting light guide; and

computing a heart rate signal based on the first and second light information.

10. The non-transitory computer readable medium of claim 9, wherein a surface of the contacting light guide is curved such that the surface is configured to contact tissue of the user.

11. The non-transitory computer readable medium of claim 9, wherein the non-contacting light guide is recessed with respect to the electronic device such that the non-contacting light guide is configured not to contact tissue of the user.

12. The non-transitory computer readable medium of claim 9, wherein computing the heart rate signal based on the first and second light information includes performing blind source separation on the first and second light information.

13. The non-transitory computer readable medium of claim 9, wherein computing the heart rate signal based on the first and second light information includes performing cross-correlation on the first and second light information.

14. The non-transitory computer readable medium of claim 9, wherein emitting light through the contacting light guide includes emitting light of a plurality of wavelengths through the contacting light guide; and

wherein computing the heart rate signal includes performing blind source separation on light information of the plurality of wavelengths.

15. The non-transitory computer readable medium of claim 14, wherein the plurality of wavelengths include wavelengths of red, green, and blue light.

16. The non-transitory computer readable medium of claim 9, wherein one or more of the plurality of light sensors are in contact with respective light guides through which light is sensed, and one or more of the plurality of light sensors are not in contact with respective light guides through which light is sensed.

17. An electronic device, comprising:

a processor to execute instructions;

a plurality of light emitters;

a plurality of light sensors;

a plurality of light guides; and

a memory coupled with the processor to store instructions, which when executed by the processor, cause the processor to perform operations to generate an application programming interface (API) that allows an API-calling component to perform a method comprising:

emitting light from each of the plurality of light emitters through respective light guides, wherein a contacting light guide is configured to contact tissue of a user and a non-contacting light is configured not to contact tissue of the user;

receiving first light information from the contacting light guide;

receiving second light information from the non-contacting light guide;

and

computing a heart rate signal based on the first and second light information.

18. The electronic device of claim 17, wherein a surface of the contacting light guide is curved such that the surface is configured to contact tissue of the user.

19. The electronic device of claim 17, wherein the non-contacting light guide is recessed with respect to the electronic device such that the non-contacting light guide is configured not to contact tissue of the user.

20. The electronic device of claim 17, wherein computing the heart rate signal based on the first and second light information includes performing blind source separation on the first and second light information.

21. The electronic device of claim 17, wherein computing the heart rate signal based on the first and second light information includes performing cross-correlation on the first and second light information.

22. The electronic device of claim 17, wherein emitting light through the contacting light guide includes emitting light of a plurality of wavelengths through the contacting light guide; and

wherein computing the heart rate signal includes performing blind source separation on light information of the plurality of wavelengths.

23. The electronic device of claim 22, wherein the plurality of wavelengths include wavelengths of red, green, and blue light.

24. The electronic device of claim 17, wherein one or more of the plurality of light sensors are in contact with respective light guides through which light is sensed, and one or more of the plurality of light sensors are not in contact with respective light guides through which light is sensed.

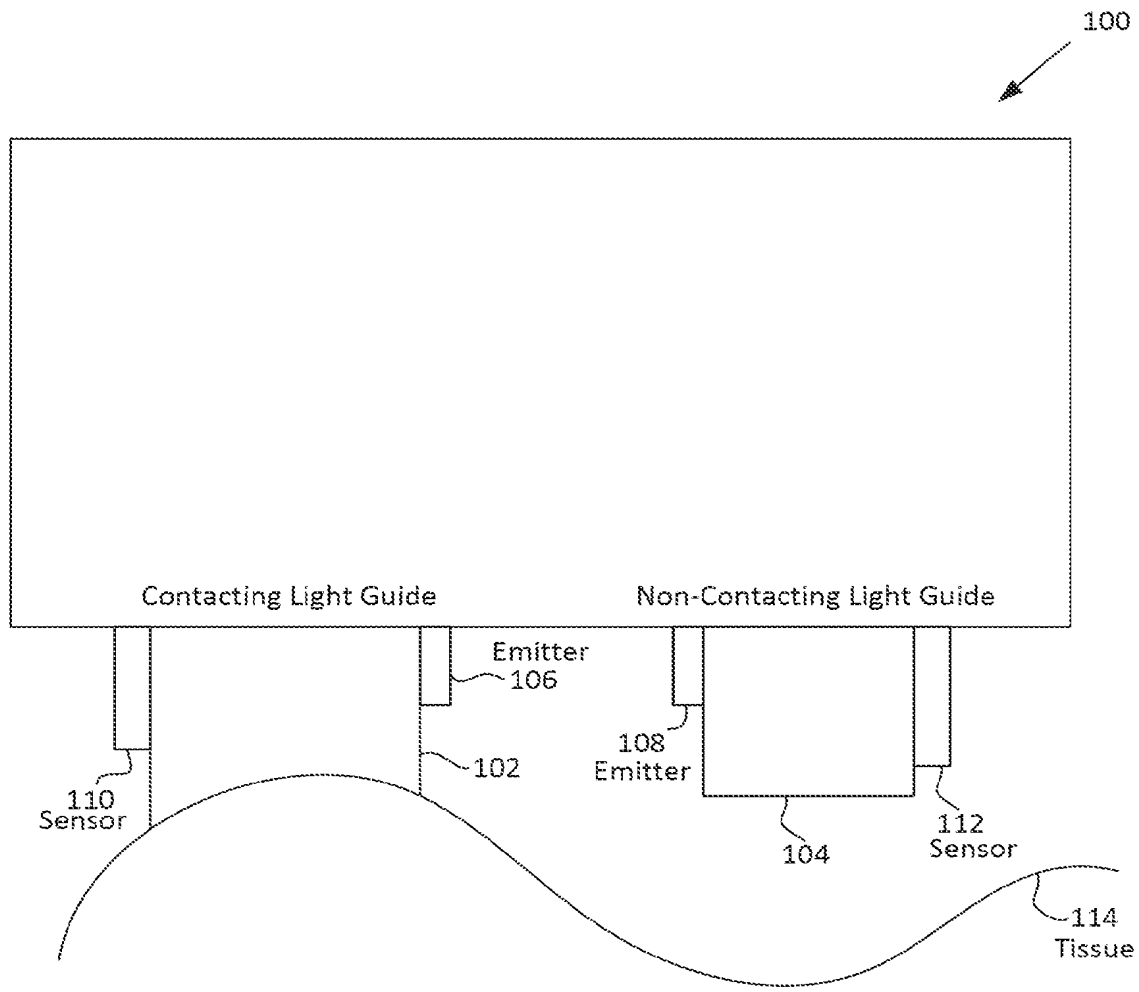

FIG. 1

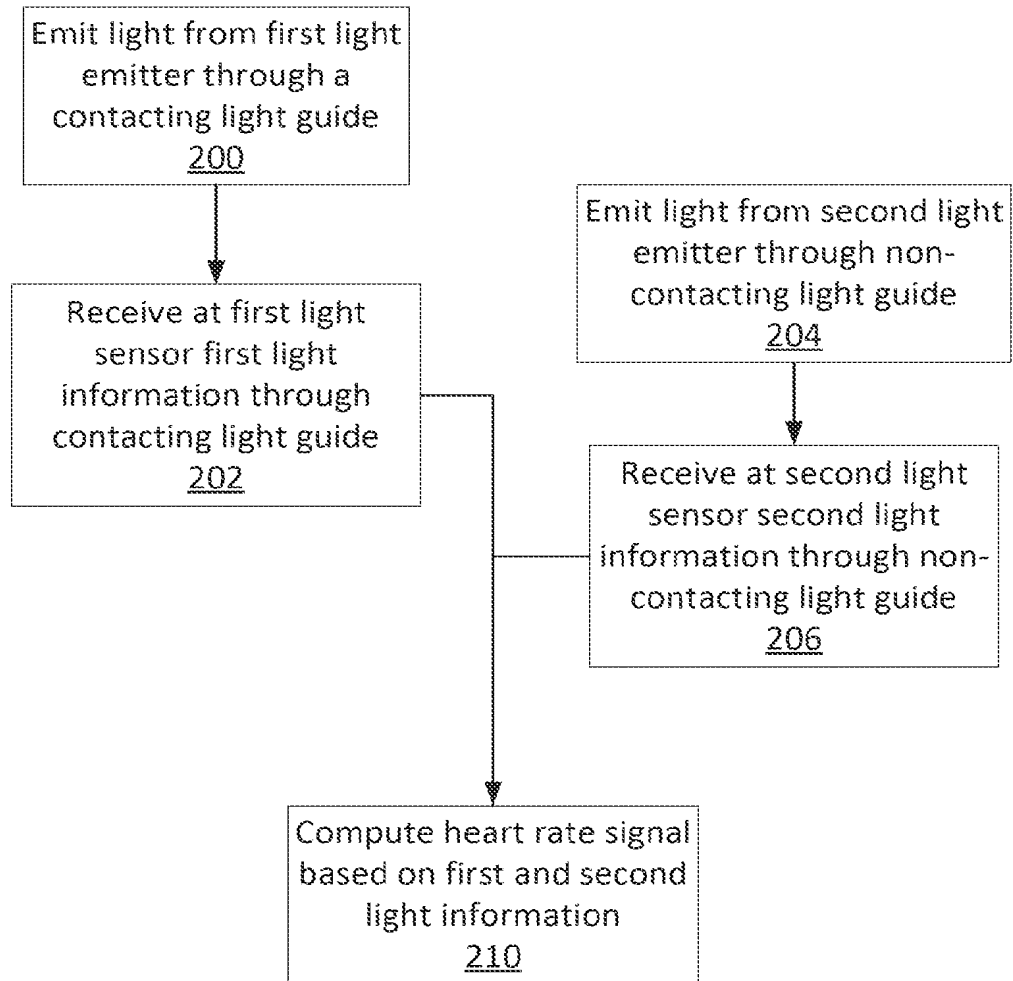

FIG. 2

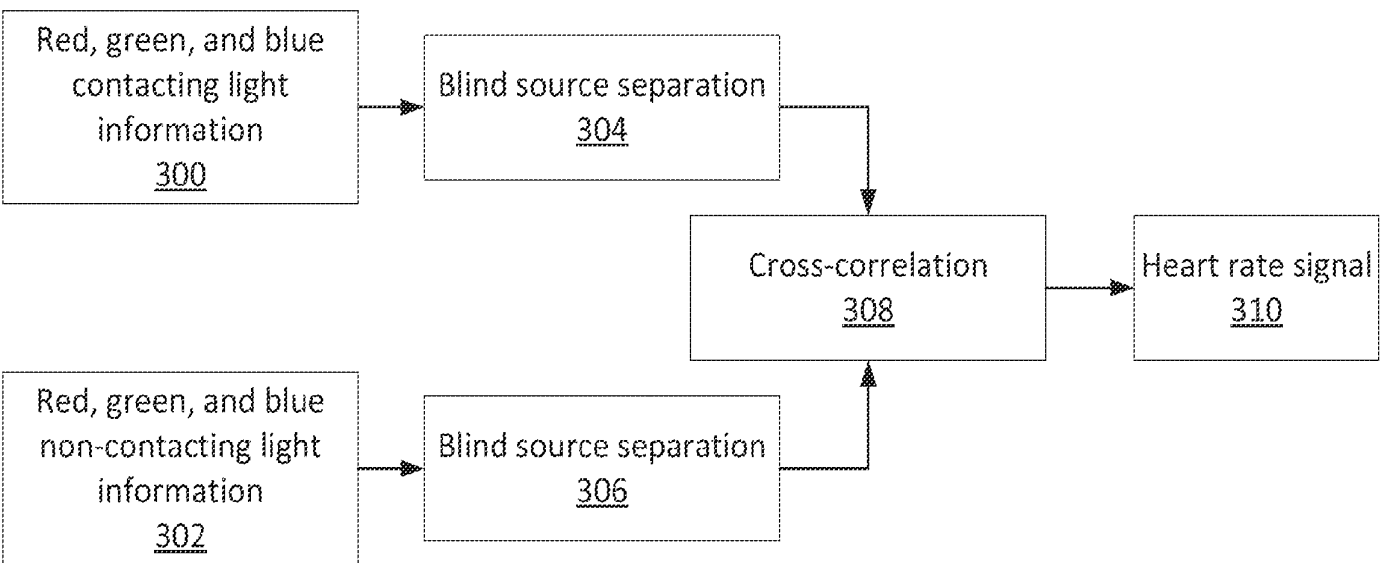

FIG. 3

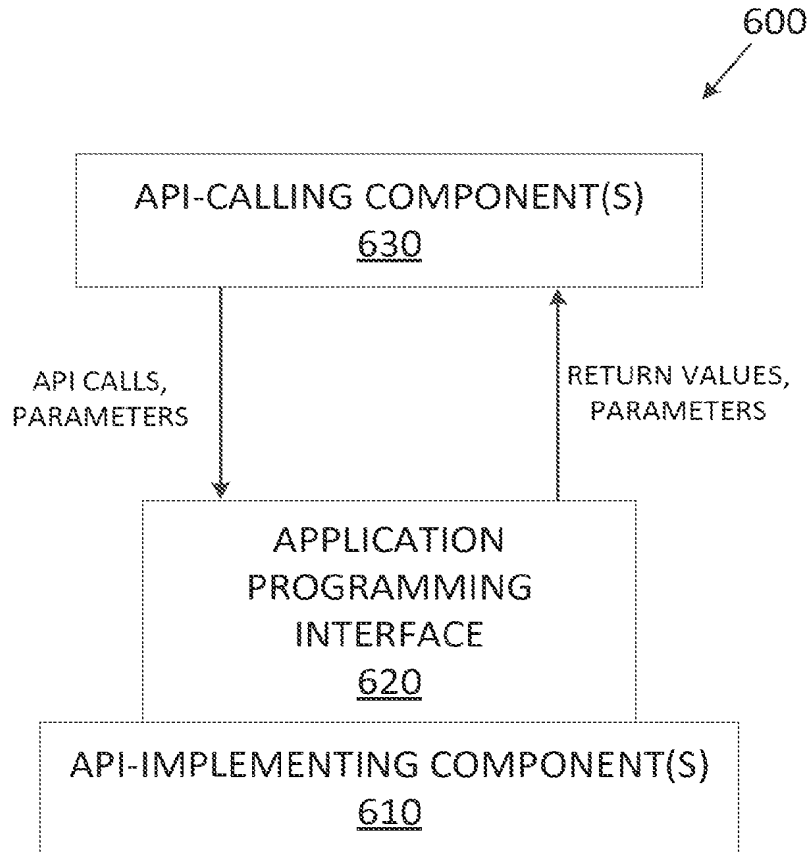

FIG. 4

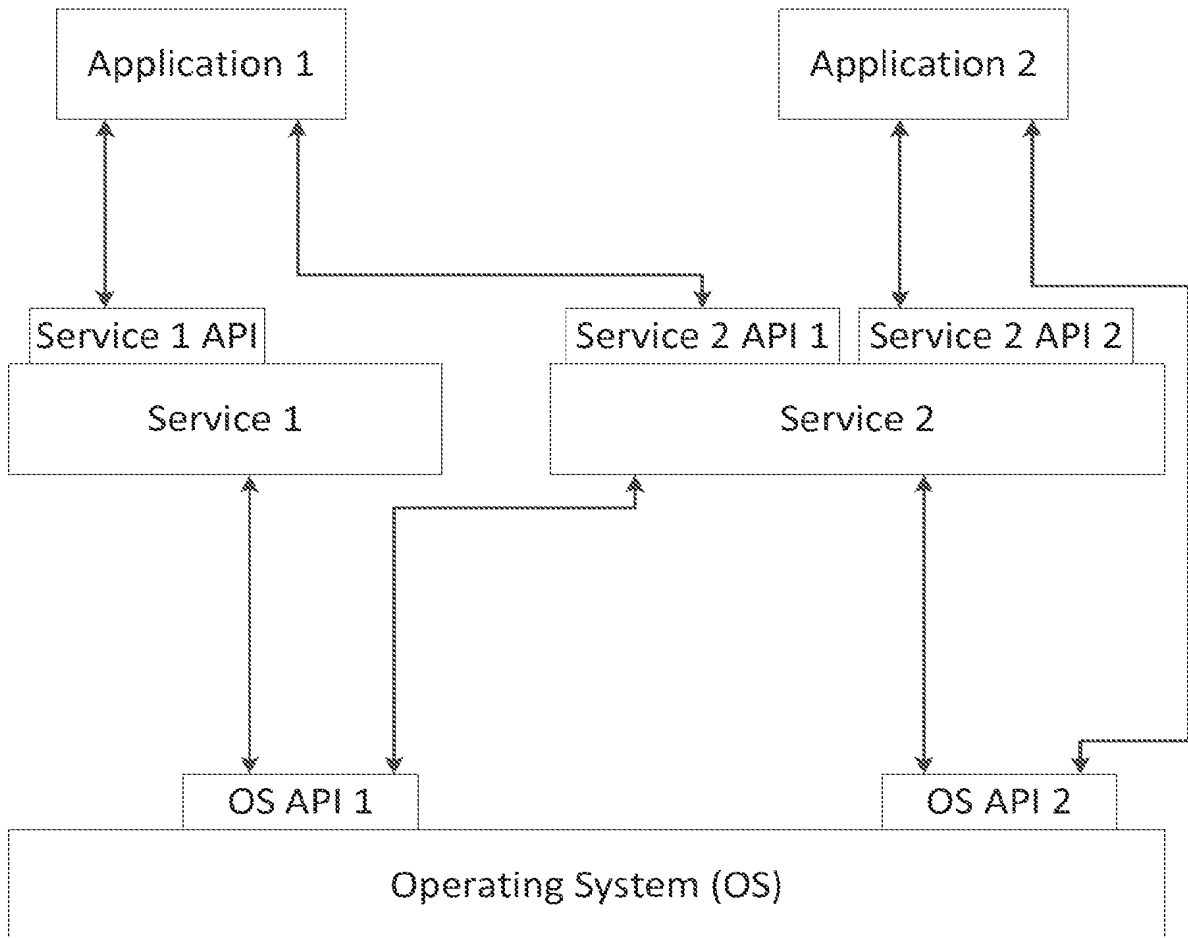

FIG. 5

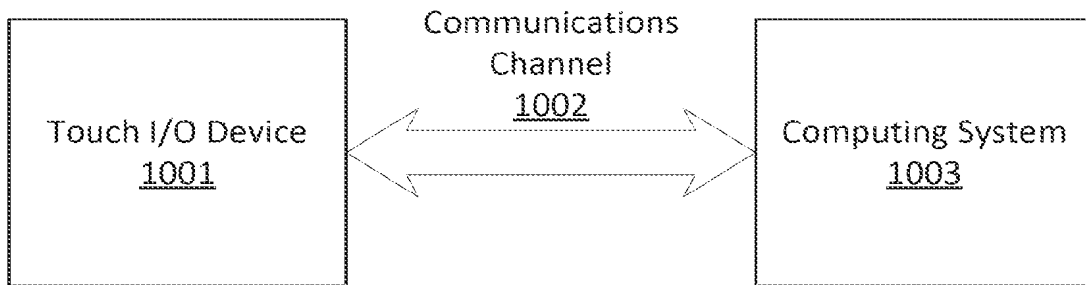

FIG. 6

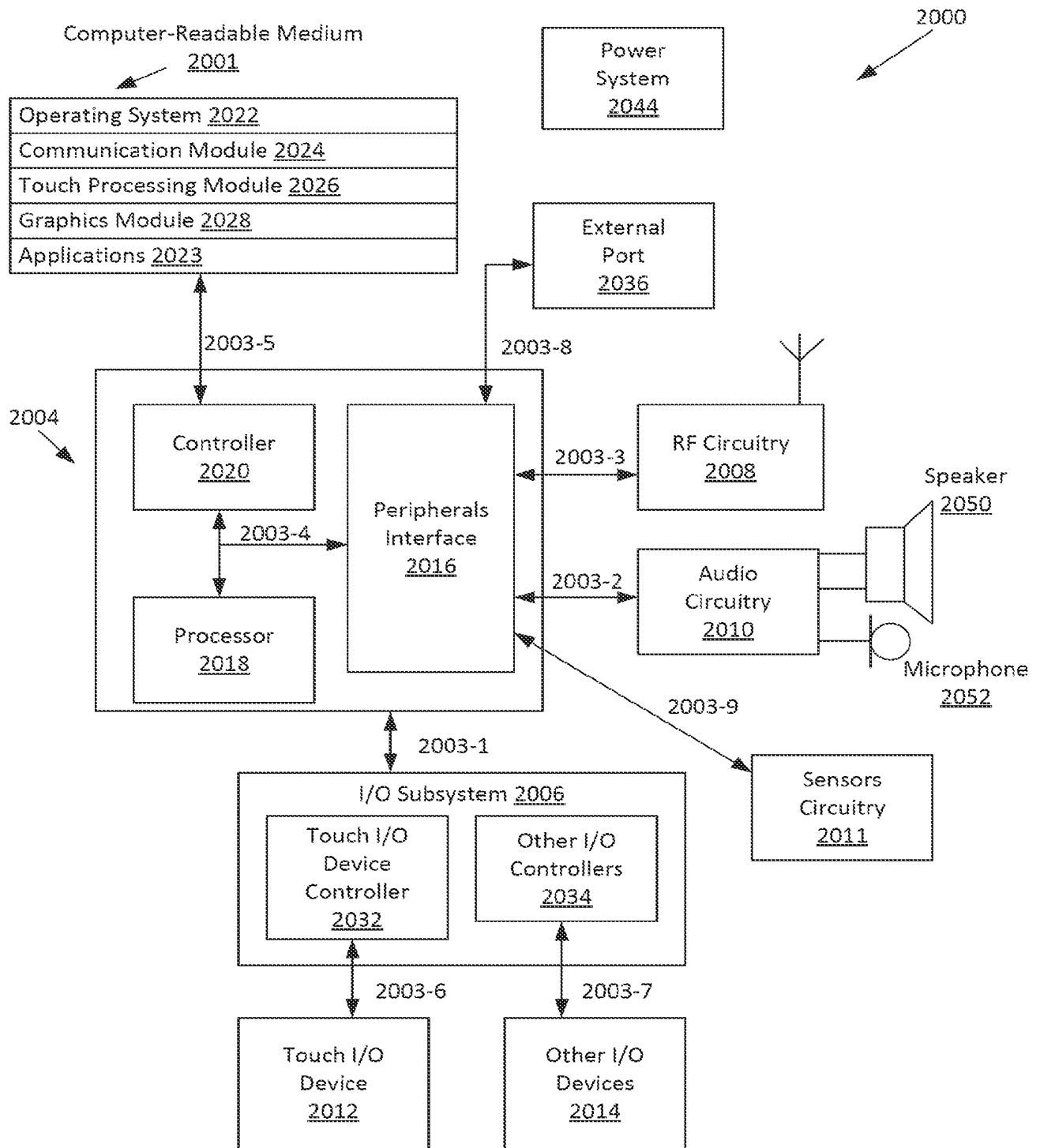

FIG. 7

INTERNATIONAL SEARCH REPORT

International application No
PCT/US2013/073405

A. CLASSIFICATION OF SUBJECT MATTER
 INV. A61B5/024 A61B5/00
 ADD.
 According to International Patent Classification (IPC) or to both national classification and IPC

B. FIELDS SEARCHED
 Minimum documentation searched (classification system followed by classification symbols)
 A61B
 Documentation searched other than minimum documentation to the extent that such documents are included in the fields searched

Electronic data base consulted during the international search (name of data base and, where practicable, search terms used)
 EPO-Internal, WPI Data, BIOSIS, COMPENDEX, EMBASE, INSPEC

C. DOCUMENTS CONSIDERED TO BE RELEVANT

Category*	Citation of document, with indication, where appropriate, of the relevant passages	Relevant to claim No.
X	US 2013/131519 A1 (LEBOEUF STEVEN FRANCIS [US] ET AL) 23 May 2013 (2013-05-23)	1-3, 7-11, 15-19, 23,24
Y	paragraph [0145] - paragraph [0151] paragraph [0182] - paragraph [0191] paragraph [0194] - paragraph [0196] figures 1-6,13-15,20,21	4-6, 12-14, 20-22
Y	US 2013/131474 A1 (GU REN-HAU [TW] ET AL) 23 May 2013 (2013-05-23) paragraph [0065] paragraph [0070]	4,6,12, 14,20,22
Y	US 2008/033266 A1 (DIAB MOHAMED K [US] ET AL) 7 February 2008 (2008-02-07) paragraph [0273] - paragraph [0277] paragraph [0315] - paragraph [0324]	5,13,21
	----- -/--	

Further documents are listed in the continuation of Box C. See patent family annex.

* Special categories of cited documents :

"A" document defining the general state of the art which is not considered to be of particular relevance	"T" later document published after the international filing date or priority date and not in conflict with the application but cited to understand the principle or theory underlying the invention
"E" earlier application or patent but published on or after the international filing date	"X" document of particular relevance; the claimed invention cannot be considered novel or cannot be considered to involve an inventive step when the document is taken alone
"L" document which may throw doubts on priority claim(s) or which is cited to establish the publication date of another citation or other special reason (as specified)	"Y" document of particular relevance; the claimed invention cannot be considered to involve an inventive step when the document is combined with one or more other such documents, such combination being obvious to a person skilled in the art
"O" document referring to an oral disclosure, use, exhibition or other means	"&" document member of the same patent family
"P" document published prior to the international filing date but later than the priority date claimed	

Date of the actual completion of the international search 15 August 2014	Date of mailing of the international search report 22/08/2014
---	--

Name and mailing address of the ISA/ European Patent Office, P.B. 5818 Patentlaan 2 NL - 2280 HV Rijswijk Tel. (+31-70) 340-2040, Fax: (+31-70) 340-3016	Authorized officer Görlach, Tobias
--	---

INTERNATIONAL SEARCH REPORT

International application No
PCT/US2013/073405

C(Continuation). DOCUMENTS CONSIDERED TO BE RELEVANT

Category*	Citation of document, with indication, where appropriate, of the relevant passages	Relevant to claim No.
A	US 2009/088651 A1 (SHUROS ALLAN CHARLES [US] ET AL) 2 April 2009 (2009-04-02) paragraph [0052] paragraph [0064] - paragraph [0071] figures 3A-5 -----	1-24

INTERNATIONAL SEARCH REPORT

Information on patent family members

International application No
PCT/US2013/073405

Patent document cited in search report		Publication date	Patent family member(s)	Publication date
US 2013131519	A1	23-05-2013	NONE	
US 2013131474	A1	23-05-2013	TW 201322056 A US 2013131474 A1	01-06-2013 23-05-2013
US 2008033266	A1	07-02-2008	US 2008033266 A1 US 2009076400 A1 US 2009182211 A1 US 2012165624 A1 US 2012165631 A1 US 2012220843 A1 US 2013345523 A1	07-02-2008 19-03-2009 16-07-2009 28-06-2012 28-06-2012 30-08-2012 26-12-2013
US 2009088651	A1	02-04-2009	EP 2211699 A1 JP 5043193 B2 JP 2010540102 A US 2009088651 A1 WO 2009045811 A1	04-08-2010 10-10-2012 24-12-2010 02-04-2009 09-04-2009

Under the Paperwork Reduction Act of 1995, no persons are required to respond to a collection of information unless it contains a valid OMB control number.

Application Data Sheet 37 CFR 1.76		Attorney Docket Number	OMNI 0105 PUSP1
		Application Number	
Title of Invention	SHORT-WAVE INFRARED SUPER-CONTINUUM LASERS FOR DETECTING COUNTERFEIT OR ILLICIT DRUGS AND PHARMACEUTICAL PROCESS CONTROL		
The application data sheet is part of the provisional or nonprovisional application for which it is being submitted. The following form contains the bibliographic data arranged in a format specified by the United States Patent and Trademark Office as outlined in 37 CFR 1.76. This document may be completed electronically and submitted to the Office in electronic format using the Electronic Filing System (EFS) or the document may be printed and included in a paper filed application.			

Secrecy Order 37 CFR 5.2

<input type="checkbox"/>	Portions or all of the application associated with this Application Data Sheet may fall under a Secrecy Order pursuant to 37 CFR 5.2 (Paper filers only. Applications that fall under Secrecy Order may not be filed electronically.)
--------------------------	---

Inventor Information:

Inventor 1					Remove	
Legal Name						
Prefix	Given Name	Middle Name	Family Name	Suffix		
	Mohammed	N.	Islam			
Residence Information (Select One) <input checked="" type="radio"/> US Residency <input type="radio"/> Non US Residency <input type="radio"/> Active US Military Service						
City	Ann Arbor	State/Province	MI	Country of Residence i	US	
Mailing Address of Inventor:						
Address 1	1718 Newport Creek Drive					
Address 2						
City	Ann Arbor	State/Province	MI			
Postal Code	48103	Country i	US			
All Inventors Must Be Listed - Additional Inventor Information blocks may be generated within this form by selecting the Add button.						Add

Correspondence Information:

Enter either Customer Number or complete the Correspondence Information section below. For further information see 37 CFR 1.33(a).	
<input type="checkbox"/> An Address is being provided for the correspondence information of this application.	
Customer Number	109543
Email Address	Add Email Remove Email

Application Information:

Title of the Invention	SHORT-WAVE INFRARED SUPER-CONTINUUM LASERS FOR DETECTING COUNTERFEIT OR ILLICIT DRUGS AND PHARMACEUTICAL PROCESS CONTROL		
Attorney Docket Number	OMNI 0105 PUSP1	Small Entity Status Claimed	<input checked="" type="checkbox"/>
Application Type	Nonprovisional		
Subject Matter	Utility		
Total Number of Drawing Sheets (if any)	26	Suggested Figure for Publication (if any)	1

Application Data Sheet 37 CFR 1.76	Attorney Docket Number	OMNI 0105 PUSP1
	Application Number	
Title of Invention	SHORT-WAVE INFRARED SUPER-CONTINUUM LASERS FOR DETECTING COUNTERFEIT OR ILLICIT DRUGS AND PHARMACEUTICAL PROCESS CONTROL	

Publication Information:

<input type="checkbox"/>	Request Early Publication (Fee required at time of Request 37 CFR 1.219)
<input type="checkbox"/>	Request Not to Publish. I hereby request that the attached application not be published under 35 U.S.C. 122(b) and certify that the invention disclosed in the attached application has not and will not be the subject of an application filed in another country, or under a multilateral international agreement, that requires publication at eighteen months after filing.

Representative Information:

<p>Representative information should be provided for all practitioners having a power of attorney in the application. Providing this information in the Application Data Sheet does not constitute a power of attorney in the application (see 37 CFR 1.32). Either enter Customer Number or complete the Representative Name section below. If both sections are completed the customer Number will be used for the Representative Information during processing.</p>			
<p>Please Select One:</p> <input checked="" type="radio"/> Customer Number <input type="radio"/> US Patent Practitioner <input type="radio"/> Limited Recognition (37 CFR 11.9)			
Customer Number	109543		

Domestic Benefit/National Stage Information:

<p>This section allows for the applicant to either claim benefit under 35 U.S.C. 119(e), 120, 121, or 365(c) or indicate National Stage entry from a PCT application. Providing this information in the application data sheet constitutes the specific reference required by 35 U.S.C. 119(e) or 120, and 37 CFR 1.78.</p>			
Prior Application Status	Pending	Remove	
Application Number	Continuity Type	Prior Application Number	Filing Date (YYYY-MM-DD)
	Continuation of	14108986	2013-12-17
Prior Application Status	Expired	Remove	
Application Number	Continuity Type	Prior Application Number	Filing Date (YYYY-MM-DD)
14108986	non provisional of	61747487	2012-12-31
<p>Additional Domestic Benefit/National Stage Data may be generated within this form by selecting the Add button.</p>			Add

Foreign Priority Information:

<p>This section allows for the applicant to claim priority to a foreign application. Providing this information in the application data sheet constitutes the claim for priority as required by 35 U.S.C. 119(b) and 37 CFR 1.55(d). When priority is claimed to a foreign application that is eligible for retrieval under the priority document exchange program (PDX) the information will be used by the Office to automatically attempt retrieval pursuant to 37 CFR 1.55(h)(1) and (2). Under the PDX program, applicant bears the ultimate responsibility for ensuring that a copy of the foreign application is received by the Office from the participating foreign intellectual property office, or a certified copy of the foreign priority application is filed, within the time period specified in 37 CFR 1.55(g)(1).</p>
--

Application Data Sheet 37 CFR 1.76		Attorney Docket Number	OMNI 0105 PUSP1
		Application Number	
Title of Invention	SHORT-WAVE INFRARED SUPER-CONTINUUM LASERS FOR DETECTING COUNTERFEIT OR ILLICIT DRUGS AND PHARMACEUTICAL PROCESS CONTROL		
Application Number	Country ⁱ	Filing Date (YYYY-MM-DD)	<input type="button" value="Remove"/>
			Access Code ⁱ (if applicable)
Additional Foreign Priority Data may be generated within this form by selecting the Add button.			<input type="button" value="Add"/>

Statement under 37 CFR 1.55 or 1.78 for AIA (First Inventor to File) Transition Applications

<p>This application (1) claims priority to or the benefit of an application filed before March 16, 2013 and (2) also contains, or contained at any time, a claim to a claimed invention that has an effective filing date on or after March 16, 2013.</p> <p><input type="checkbox"/> NOTE: By providing this statement under 37 CFR 1.55 or 1.78, this application, with a filing date on or after March 16, 2013, will be examined under the first inventor to file provisions of the AIA.</p>
--

Authorization to Permit Access:

<input checked="" type="checkbox"/> Authorization to Permit Access to the Instant Application by the Participating Offices
<p>If checked, the undersigned hereby grants the USPTO authority to provide the European Patent Office (EPO), the Japan Patent Office (JPO), the Korean Intellectual Property Office (KIPO), the World Intellectual Property Office (WIPO), and any other intellectual property offices in which a foreign application claiming priority to the instant patent application is filed access to the instant patent application. See 37 CFR 1.14(c) and (h). This box should not be checked if the applicant does not wish the EPO, JPO, KIPO, WIPO, or other intellectual property office in which a foreign application claiming priority to the instant patent application is filed to have access to the instant patent application.</p> <p>In accordance with 37 CFR 1.14(h)(3), access will be provided to a copy of the instant patent application with respect to: 1) the instant patent application-as-filed; 2) any foreign application to which the instant patent application claims priority under 35 U.S.C. 119(a)-(d) if a copy of the foreign application that satisfies the certified copy requirement of 37 CFR 1.55 has been filed in the instant patent application; and 3) any U.S. application-as-filed from which benefit is sought in the instant patent application.</p> <p>In accordance with 37 CFR 1.14(c), access may be provided to information concerning the date of filing this Authorization.</p>

Applicant Information:

<p>Providing assignment information in this section does not substitute for compliance with any requirement of part 3 of Title 37 of CFR to have an assignment recorded by the Office.</p>
--

Under the Paperwork Reduction Act of 1995, no persons are required to respond to a collection of information unless it contains a valid OMB control number.

Application Data Sheet 37 CFR 1.76	Attorney Docket Number	OMNI 0105 PUSP1
	Application Number	
Title of Invention	SHORT-WAVE INFRARED SUPER-CONTINUUM LASERS FOR DETECTING COUNTERFEIT OR ILLICIT DRUGS AND PHARMACEUTICAL PROCESS CONTROL	

Applicant 1				<input type="button" value="Remove"/>
If the applicant is the inventor (or the remaining joint inventor or inventors under 37 CFR 1.45), this section should not be completed. The information to be provided in this section is the name and address of the legal representative who is the applicant under 37 CFR 1.43; or the name and address of the assignee, person to whom the inventor is under an obligation to assign the invention, or person who otherwise shows sufficient proprietary interest in the matter who is the applicant under 37 CFR 1.46. If the applicant is an applicant under 37 CFR 1.46 (assignee, person to whom the inventor is obligated to assign, or person who otherwise shows sufficient proprietary interest) together with one or more joint inventors, then the joint inventor or inventors who are also the applicant should be identified in this section.				
<input type="button" value="Clear"/>				
<input checked="" type="radio"/> Assignee		<input type="radio"/> Legal Representative under 35 U.S.C. 117		<input type="radio"/> Joint Inventor
<input type="radio"/> Person to whom the inventor is obligated to assign.			<input type="radio"/> Person who shows sufficient proprietary interest	
If applicant is the legal representative, indicate the authority to file the patent application, the inventor is:				
Name of the Deceased or Legally Incapacitated Inventor : <input type="text"/>				
If the Applicant is an Organization check here. <input checked="" type="checkbox"/>				
Organization Name		OMNI MEDSCI, INC.		
Mailing Address Information:				
Address 1		1718 Newport Creek Drive		
Address 2				
City		Ann Arbor	State/Province	MI
Country	US	Postal Code	48103	
Phone Number		Fax Number		
Email Address				
Additional Applicant Data may be generated within this form by selecting the Add button. <input type="button" value="Add"/>				

Assignee Information including Non-Applicant Assignee Information:

Providing assignment information in this section does not substitute for compliance with any requirement of part 3 of Title 37 of CFR to have an assignment recorded by the Office.				
Assignee 1				
Complete this section if assignee information, including non-applicant assignee information, is desired to be included on the patent application publication. An assignee-applicant identified in the "Applicant Information" section will appear on the patent application publication as an applicant. For an assignee-applicant, complete this section only if identification as an assignee is also desired on the patent application publication.				
<input type="button" value="Remove"/>				
If the Assignee is an Organization check here. <input type="checkbox"/>				

Under the Paperwork Reduction Act of 1995, no persons are required to respond to a collection of information unless it contains a valid OMB control number.

Application Data Sheet 37 CFR 1.76	Attorney Docket Number	OMNI 0105 PUSP1
	Application Number	
Title of Invention	SHORT-WAVE INFRARED SUPER-CONTINUUM LASERS FOR DETECTING COUNTERFEIT OR ILLICIT DRUGS AND PHARMACEUTICAL PROCESS CONTROL	

Prefix	Given Name	Middle Name	Family Name	Suffix

Mailing Address Information:

Address 1				
Address 2				
City		State/Province		
Country i		Postal Code		
Phone Number		Fax Number		
Email Address				

Additional Assignee Data may be generated within this form by selecting the Add button.

Signature:

NOTE: This form must be signed in accordance with 37 CFR 1.33. See 37 CFR 1.4 for signature requirements and certifications

Signature	/David S. Bir/		Date (YYYY-MM-DD)	2015-10-01
First Name	David	Last Name	Bir	Registration Number
				38383

Additional Signature may be generated within this form by selecting the Add button.

This collection of information is required by 37 CFR 1.76. The information is required to obtain or retain a benefit by the public which is to file (and by the USPTO to process) an application. Confidentiality is governed by 35 U.S.C. 122 and 37 CFR 1.14. This collection is estimated to take 23 minutes to complete, including gathering, preparing, and submitting the completed application data sheet form to the USPTO. Time will vary depending upon the individual case. Any comments on the amount of time you require to complete this form and/or suggestions for reducing this burden, should be sent to the Chief Information Officer, U.S. Patent and Trademark Office, U.S. Department of Commerce, P.O. Box 1450, Alexandria, VA 22313-1450. DO NOT SEND FEES OR COMPLETED FORMS TO THIS ADDRESS. **SEND TO: Commissioner for Patents, P.O. Box 1450, Alexandria, VA 22313-1450.**

Privacy Act Statement

The Privacy Act of 1974 (P.L. 93-579) requires that you be given certain information in connection with your submission of the attached form related to a patent application or patent. Accordingly, pursuant to the requirements of the Act, please be advised that: (1) the general authority for the collection of this information is 35 U.S.C. 2(b)(2); (2) furnishing of the information solicited is voluntary; and (3) the principal purpose for which the information is used by the U.S. Patent and Trademark Office is to process and/or examine your submission related to a patent application or patent. If you do not furnish the requested information, the U.S. Patent and Trademark Office may not be able to process and/or examine your submission, which may result in termination of proceedings or abandonment of the application or expiration of the patent.

The information provided by you in this form will be subject to the following routine uses:

1. The information on this form will be treated confidentially to the extent allowed under the Freedom of Information Act (5 U.S.C. 552) and the Privacy Act (5 U.S.C. 552a). Records from this system of records may be disclosed to the Department of Justice to determine whether the Freedom of Information Act requires disclosure of these records.
2. A record from this system of records may be disclosed, as a routine use, in the course of presenting evidence to a court, magistrate, or administrative tribunal, including disclosures to opposing counsel in the course of settlement negotiations.
3. A record in this system of records may be disclosed, as a routine use, to a Member of Congress submitting a request involving an individual, to whom the record pertains, when the individual has requested assistance from the Member with respect to the subject matter of the record.
4. A record in this system of records may be disclosed, as a routine use, to a contractor of the Agency having need for the information in order to perform a contract. Recipients of information shall be required to comply with the requirements of the Privacy Act of 1974, as amended, pursuant to 5 U.S.C. 552a(m).
5. A record related to an International Application filed under the Patent Cooperation Treaty in this system of records may be disclosed, as a routine use, to the International Bureau of the World Intellectual Property Organization, pursuant to the Patent Cooperation Treaty.
6. A record in this system of records may be disclosed, as a routine use, to another federal agency for purposes of National Security review (35 U.S.C. 181) and for review pursuant to the Atomic Energy Act (42 U.S.C. 218(c)).
7. A record from this system of records may be disclosed, as a routine use, to the Administrator, General Services, or his/her designee, during an inspection of records conducted by GSA as part of that agency's responsibility to recommend improvements in records management practices and programs, under authority of 44 U.S.C. 2904 and 2906. Such disclosure shall be made in accordance with the GSA regulations governing inspection of records for this purpose, and any other relevant (i.e., GSA or Commerce) directive. Such disclosure shall not be used to make determinations about individuals.
8. A record from this system of records may be disclosed, as a routine use, to the public after either publication of the application pursuant to 35 U.S.C. 122(b) or issuance of a patent pursuant to 35 U.S.C. 151. Further, a record may be disclosed, subject to the limitations of 37 CFR 1.14, as a routine use, to the public if the record was filed in an application which became abandoned or in which the proceedings were terminated and which application is referenced by either a published application, an application open to public inspections or an issued patent.
9. A record from this system of records may be disclosed, as a routine use, to a Federal, State, or local law enforcement agency, if the USPTO becomes aware of a violation or potential violation of law or regulation.

INFORMATION DISCLOSURE STATEMENT BY APPLICANT (Not for submission under 37 CFR 1.99)	Application Number		
	Filing Date		
	First Named Inventor	Mohammed N. ISLAM	
	Art Unit		
	Examiner Name		
	Attorney Docket Number	OMNI 0105 PUSP1	

U.S.PATENTS						Remove
Examiner Initial*	Cite No	Patent Number	Kind Code ¹	Issue Date	Name of Patentee or Applicant of cited Document	Pages,Columns,Lines where Relevant Passages or Relevant Figures Appear
	1					

If you wish to add additional U.S. Patent citation information please click the Add button. Add

U.S.PATENT APPLICATION PUBLICATIONS						Remove
Examiner Initial*	Cite No	Publication Number	Kind Code ¹	Publication Date	Name of Patentee or Applicant of cited Document	Pages,Columns,Lines where Relevant Passages or Relevant Figures Appear
	1					

If you wish to add additional U.S. Published Application citation information please click the Add button. Add

FOREIGN PATENT DOCUMENTS								Remove
Examiner Initial*	Cite No	Foreign Document Number ³	Country Code ² j	Kind Code ⁴	Publication Date	Name of Patentee or Applicant of cited Document	Pages,Columns,Lines where Relevant Passages or Relevant Figures Appear	T ⁵
	1							<input type="checkbox"/>

If you wish to add additional Foreign Patent Document citation information please click the Add button Add

NON-PATENT LITERATURE DOCUMENTS				Remove
Examiner Initials*	Cite No	Include name of the author (in CAPITAL LETTERS), title of the article (when appropriate), title of the item (book, magazine, journal, serial, symposium, catalog, etc), date, pages(s), volume-issue number(s), publisher, city and/or country where published.		T ⁵

**INFORMATION DISCLOSURE
STATEMENT BY APPLICANT**
(Not for submission under 37 CFR 1.99)

Application Number		
Filing Date		
First Named Inventor	Mohammed N. ISLAM	
Art Unit		
Examiner Name		
Attorney Docket Number	OMNI 0105 PUSP1	

1	Hori, Takashi, et al., "Flatly broadened, wideband and low noise supercontinuum generation in highly nonlinear hybrid fiber", OPTICS EXPRESS, Vol. 12, No. 2, January 26, 2004, pages 317-324.	<input type="checkbox"/>
2	Wadsworth, W. J., et al., "Supercontinuum and four-wave mixing with Q-switched pulses in endlessly single-mode photonic crystal fibres", OPTICS EXPRESS, Vol. 12, No. 2, January 26, 2004, pages 299-309.	<input type="checkbox"/>
3	Hilligsoe, Karen Marie, et al., "Supercontinuum generation in a photonic crystal fiber with two zero dispersion wavelengths", OPTICS EXPRESS, Vol. 12, No. 6, March 22, 2004, pages 1045-1054.	<input type="checkbox"/>
4	Venugopalan, V., "Optical Society of America BIOMED Topical Meeting Tutorial on Tissue Optics", April 27, 2004, pages 1-32.	<input type="checkbox"/>
5	Slusher, Richard E., et al., "Large Raman gain and nonlinear phase shifts in high-purity As ₂ So ₃ chalcogenide fibers", J. Opt. Soc. Am. B, Vol. 21, No. 6, June 2004, pages 1146-1155.	<input type="checkbox"/>
6	Leon-Saval, S. G., et al., "Supercontinuum generation in submicron fibre waveguides", OPTICS EXPRESS, Vol. 12, No. 13, June 28, 2004, pages 2864-2869.	<input type="checkbox"/>
7	Nicholson, J. W., et al., "High power, single mode, all-fiber source of femtosecond pulses at 1550 nm and its use in supercontinuum generation", OPTICS EXPRESS, Vol. 12, No. 13, June 28, 2004, pages 3025-3034.	<input type="checkbox"/>
8	Genty, G., et al., "Enhanced bandwidth of supercontinuum generated in microstructured fibers", OPTICS EXPRESS, Vol. 12, No. 15, July 26, 2004, pages 3471-3480.	<input type="checkbox"/>
9	Champert, Pierre-Alain, et al., "White-light supercontinuum generation in normally dispersive optical fiber using original multi-wavelength pumping system", OPTICS EXPRESS, Vol. 12, No. 19, September 20, 2004, pages 4366-4371.	<input type="checkbox"/>
10	Nicholson, J. W., "Supercontinuum generation in ultraviolet-irradiated fibers", OPTICS LETTERS, Vol. 29, No. 20, October 15, 2004, pages 2363-2365.	<input type="checkbox"/>
11	Hori, Takashi, et al., "Experimental and numerical analysis of widely broadened supercontinuum generation in highly nonlinear dispersion-shifted fiber with a femtosecond pulse", J. Opt. Soc. Am. B, Vol. 21, No. 11, November 2004, pages 1969-1980.	<input type="checkbox"/>

**INFORMATION DISCLOSURE
STATEMENT BY APPLICANT**
(Not for submission under 37 CFR 1.99)

Application Number		
Filing Date		
First Named Inventor	Mohammed N. ISLAM	
Art Unit		
Examiner Name		
Attorney Docket Number	OMNI 0105 PUSP1	

12	Demircan, Ayhan, et al., "Supercontinuum generation by the modulation instability", Optics Communications 244, 2005, pages 181-185.	<input type="checkbox"/>
13	Papernyi, S. B., et al., "Sixth-Order Cascaded Raman Amplification", OFC/NFOEC, 2005, 3 pages.	<input type="checkbox"/>
14	Tanaka, Keiji, "Optical nonlinearity in photonic glasses", Journal of Materials Science: Materials in Electronics 16, 2005, pages 633-643.	<input type="checkbox"/>
15	Westbrook, Paul S., "Improved Supercontinuum Generation Through UV Processing of Highly Nonlinear Fibers", Journal of Lightwave Technology, Vol. 23, No. 1, January 2005, pages 13-18.	<input type="checkbox"/>
16	Abeeluck, Akheesh K., et al., "Continuous-wave pumping in the anomalous- and normal dispersion regimes of nonlinear fibers for supercontinuum generation", OPTICS LETTERS, Vol. 30, No. 1, January 1, 2005, pages 61-63.	<input type="checkbox"/>
17	Kutz, J. Nathan, et al., "Enhanced Supercontinuum Generation through Dispersion-Management", OPTICS EXPRESS, Vol. 13, No. 11, May 30, 2005, pages 3989-3998.	<input type="checkbox"/>
18	Lee, Ju Han, et al., "Experimental performance comparison for various continuous-wave supercontinuum schemes: ring cavity and single pass structures", OPTICS EXPRESS, Vol. 13, No. 13, June 27, 2005, pages 4848-4853.	<input type="checkbox"/>
19	Saliminia, A., et al., "Ultra-broad and coherent white light generation in silica glass by focused femtosecond pulses at 1.5pm", OPTICS EXPRESS, Vol. 13, No. 15, July 25, 2005, pages 5731-5738.	<input type="checkbox"/>
20	Takushima, Yuichi, "High average power, depolarized super-continuum generation using a 1.55-um ASE noise source, OPTICS EXPRESS, Vol. 13, No. 15, July 25, 2005, pages 5871.-5877.	<input type="checkbox"/>
21	Travers, J. C., et al., "Extended continuous-wave supercontinuum generation in a low-water-loss holey fiber", OPTICS LETTERS, Vol. 30, No. 15, August 1, 2005, pages 1938-1940.	<input type="checkbox"/>
22	Kobtsev, Serguei M., et al., "Modelling of high-power supercontinuum generation in highly nonlinear, dispersion shifted fibers at CW pump", OPTICS EXPRESS, Vol. 13, No. 18, September 5, 2005, pages 6912-6918.	<input type="checkbox"/>

**INFORMATION DISCLOSURE
STATEMENT BY APPLICANT**
(Not for submission under 37 CFR 1.99)

Application Number		
Filing Date		
First Named Inventor	Mohammed N. ISLAM	
Art Unit		
Examiner Name		
Attorney Docket Number	OMNI 0105 PUSP1	

23	Falk, Peter, et al., "Supercontinuum generation in a photonic crystal fiber with two zero-dispersion wavelengths tapered to normal dispersion at all wavelengths", OPTICS EXPRESS, Vol. 13, No. 19, September 19, 2005, pages 7535-7540.	<input type="checkbox"/>
24	Tombelaine, Vincent, et al., "Ultra wide band supercontinuum generation in air-silica holey fibers by SHG-induced modulation instabilities", OPTICS EXPRESS, Vol. 13, No. 19, September 19, 2005, pages 7399-7404.	<input type="checkbox"/>
25	Lee, Ju Han, et al., "Continuous-wave supercontinuum laser based on an erbium-doped fiber ring cavity incorporating a highly nonlinear optical fiber", OPTICS LETTERS, Vol. 30, No. 19, October 1, 2005, pages 2599-2601.	<input type="checkbox"/>
26	Genty, G., et al., "Supercontinuum generation in large mode-area microstructured fibers", OPTICS EXPRESS, Vol. 13, No. 21, October 17, 2005, pages 8625-8633.	<input type="checkbox"/>
27	Schreiber, T., et al., "Supercontinuum generation by femtosecond single and dual wavelength pumping in photonic crystal fibers with two zero dispersion wavelengths", OPTICS EXPRESS, Vol. 13, No. 23, November 14, 2005, pages 9556-9569.	<input type="checkbox"/>
28	Travers, J. C., et al., "Extended blue supercontinuum generation in cascaded holey fibers", OPTICS LETTERS, Vol. 30, No. 23, December 1, 2005, pages 3132-3134.	<input type="checkbox"/>
29	Hagen, C. L., et al., "Generation of a Continuum Extending to the Midinfrared by Pumping ZBLAN Fiber With an Ultrafast 1550-nm Source", IEEE PHOTONICS TECHNOLOGY LETTERS, Vol. 18, No. 1, January 1, 2006, pages 91-93.	<input type="checkbox"/>
30	Moon, Sucbei, et al., "Generation of octave-spanning supercontinuum with 1550-nm amplified diode-laser pulses and a dispersion-shifted fiber", OPTICS EXPRESS, Vol. 14, No. 1, January 9, 2006, pages 270-278.	<input type="checkbox"/>
31	Fedotova, O., et al., "Supercontinuum generation in planar rib waveguides enabled by anomalous dispersion", OPTICS EXPRESS, Vol. 14, No. 4, February 20, 2006, pages 1512-1517.	<input type="checkbox"/>
32	Harrington, James A., "Infrared Fiber Optics", OSA Handbook, Vol. III, white paper, to be published by McGraw Hill, Undated, 13 pages	<input type="checkbox"/>
33	Aaviksoo, J., et al., "Observation of optical precursors at pulse propagation in GaAs", Physical Review A, Volume 44, Number 9, November 1, 1991, pages R5353-R5356.	<input type="checkbox"/>

**INFORMATION DISCLOSURE
STATEMENT BY APPLICANT**
(Not for submission under 37 CFR 1.99)

Application Number		
Filing Date		
First Named Inventor	Mohammed N. ISLAM	
Art Unit		
Examiner Name		
Attorney Docket Number	OMNI 0105 PUSP1	

34	Boppart, Stephen A., et al., "Imaging developing neural morphology using optical coherence tomography", Journal of Neuroscience Methods 70, 1996, pages 65-72.	<input type="checkbox"/>
35	Boppart, Stephen A., et al., "Noninvasive assessment of the developing Xenopus cardiovascular system using optical coherence tomography", Prec. Natl. Acad. Sci. USA, Vol. 94, April 1997, pages 4256-4261.	<input type="checkbox"/>
36	Tearney, Guillermo J., et al., "In vivo Endoscopic Optical Biopsy with Optical Coherence Tomography", Science, New Series, Volume 276, June 27, 1997, pages 2037-2039.	<input type="checkbox"/>
37	de Boer, Johannes F., et al., "Imaging thermally damaged tissue by polarization sensitive optical coherence tomography", OPTICS EXPRESS 212, Vol. 3, No. 6, September 14, 1998, pages 212-218.	<input type="checkbox"/>
38	Roggan, Andre, et al., "Optical Properties of Circulating Human Blood in the Wavelength Range 400-2500 NM", Journal of Biomedical Optics, Vol. 4, No. 1, January 1999, pages 36-46.	<input type="checkbox"/>
39	de Boer, Johannes F., et al., "Determination of the depth-resolved Stokes parameters of light backscattered from turbid media by use of polarization-sensitive optical coherence tomography", OPTICS LETTERS, Vol. 24, No. 5, March 1, 1999, pages 300-302.	<input type="checkbox"/>
40	Rollins, Andrew M., et al., "Real-time in vivo imaging of human gastrointestinal ultrastructure by use of endoscopic optical coherence tomography with a novel efficient interferometer design", OPTICS LETTERS, Vol. 24, No. 19, October 1, 1999, pages 1358-1360.	<input type="checkbox"/>
41	D'Amico, Anthony V., et al., "Optical Coherence Tomography As A Method For Identifying Benign And Malignant Microscopic Structures In The Prostate Gland", Basic Science, Urology 55 (5), 2000, pages 783-787.	<input type="checkbox"/>
42	Li, Xingde, et al., "Imaging needle for optical coherence tomography", OPTICS LETTERS, Vol. 25, No. 20, October 15, 2000, pages 1520-1522.	<input type="checkbox"/>
43	Oughstun, Kurt E., "Influence of precursor fields on ultrashort pulse autocorrelation measurements and pulse width evolution", OPTICS EXPRESS, Vol. 8, No. 8, April 9, 2001, pages 481-491.	<input type="checkbox"/>
44	Kowalewicz, Andrew M., et al., "Ultrahigh resolution optical coherence tomography using a superluminescent light source" OPTICS EXPRESS 349, Vol. 10, No. 7, April 8, 2002, pages 349-353.	<input type="checkbox"/>

INFORMATION DISCLOSURE STATEMENT BY APPLICANT (Not for submission under 37 CFR 1.99)	Application Number		
	Filing Date		
	First Named Inventor	Mohammed N. ISLAM	
	Art Unit		
	Examiner Name		
	Attorney Docket Number	OMNI 0105 PUSP1	

45	Povazay, B., et al., "Submicrometer axial resolution optical coherence tomography", OPTICS LETTERS, Vol. 27, No. 20, October 15, 2002, pages 1800-1802.	<input type="checkbox"/>
46	Xie, T.-Q., et al., "Detection of tumorigenesis in urinary bladder with optical coherence tomography: optical characterization of morphological changes", OPTICS EXPRESS, Vol. 10, No. 24, December 2, 2002, 2003, pages 1431-1443.	<input type="checkbox"/>
47	Seefeldt, Michael, et al., "Compact white-light source with an average output power of 2.4 Wand 900 nm spectral bandwidth", Optics Communications 216, pages 199-202.	<input type="checkbox"/>
48	Wang, Yimin, et al., "Ultrahigh-resolution optical coherence tomography by broadband continuum generation from a photonic crystal fiber", OPTICS LETTERS, Vol. 28, No. 3, February 1, 2003, pages 182-184.	<input type="checkbox"/>
49	Bizheva, K, et al., "Compact, broad-bandwidth fiberlaserforsub-2-pm axial resolution optical coherence tomography in the 1300-nm wavelength region," OPTICS LETTERS, Vol. 28, No. 9, May 1, 2003, pages 707-709.	<input type="checkbox"/>
50		<input type="checkbox"/>

If you wish to add additional non-patent literature document citation information please click the Add button **Add**

EXAMINER SIGNATURE

Examiner Signature		Date Considered	
--------------------	--	-----------------	--

*EXAMINER: Initial if reference considered, whether or not citation is in conformance with MPEP 609. Draw line through a citation if not in conformance and not considered. Include copy of this form with next communication to applicant.

¹ See Kind Codes of USPTO Patent Documents at www.USPTO.GOV or MPEP 901.04. ² Enter office that issued the document, by the two-letter code (WIPO Standard ST.3). ³ For Japanese patent documents, the indication of the year of the reign of the Emperor must precede the serial number of the patent document. ⁴ Kind of document by the appropriate symbols as indicated on the document under WIPO Standard ST.16 if possible. ⁵ Applicant is to place a check mark here if English language translation is attached.

**INFORMATION DISCLOSURE
STATEMENT BY APPLICANT**
(Not for submission under 37 CFR 1.99)

Application Number		
Filing Date		
First Named Inventor	Mohammed N. ISLAM	
Art Unit		
Examiner Name		
Attorney Docket Number	OMNI 0105 PUSP1	

CERTIFICATION STATEMENT

Please see 37 CFR 1.97 and 1.98 to make the appropriate selection(s):

That each item of information contained in the information disclosure statement was first cited in any communication from a foreign patent office in a counterpart foreign application not more than three months prior to the filing of the information disclosure statement. See 37 CFR 1.97(e)(1).

OR

That no item of information contained in the information disclosure statement was cited in a communication from a foreign patent office in a counterpart foreign application, and, to the knowledge of the person signing the certification after making reasonable inquiry, no item of information contained in the information disclosure statement was known to any individual designated in 37 CFR 1.56(c) more than three months prior to the filing of the information disclosure statement. See 37 CFR 1.97(e)(2).

See attached certification statement.

The fee set forth in 37 CFR 1.17 (p) has been submitted herewith.

A certification statement is not submitted herewith.

SIGNATURE

A signature of the applicant or representative is required in accordance with CFR 1.33, 10.18. Please see CFR 1.4(d) for the form of the signature.

Signature	/David S. Bir/	Date (YYYY-MM-DD)	2015-10-01
Name/Print	David S. Bir	Registration Number	38383

This collection of information is required by 37 CFR 1.97 and 1.98. The information is required to obtain or retain a benefit by the public which is to file (and by the USPTO to process) an application. Confidentiality is governed by 35 U.S.C. 122 and 37 CFR 1.14. This collection is estimated to take 1 hour to complete, including gathering, preparing and submitting the completed application form to the USPTO. Time will vary depending upon the individual case. Any comments on the amount of time you require to complete this form and/or suggestions for reducing this burden, should be sent to the Chief Information Officer, U.S. Patent and Trademark Office, U.S. Department of Commerce, P.O. Box 1450, Alexandria, VA 22313-1450. **DO NOT SEND FEES OR COMPLETED FORMS TO THIS ADDRESS. SEND TO: Commissioner for Patents, P.O. Box 1450, Alexandria, VA 22313-1450.**

Privacy Act Statement

The Privacy Act of 1974 (P.L. 93-579) requires that you be given certain information in connection with your submission of the attached form related to a patent application or patent. Accordingly, pursuant to the requirements of the Act, please be advised that: (1) the general authority for the collection of this information is 35 U.S.C. 2(b)(2); (2) furnishing of the information solicited is voluntary; and (3) the principal purpose for which the information is used by the U.S. Patent and Trademark Office is to process and/or examine your submission related to a patent application or patent. If you do not furnish the requested information, the U.S. Patent and Trademark Office may not be able to process and/or examine your submission, which may result in termination of proceedings or abandonment of the application or expiration of the patent.

The information provided by you in this form will be subject to the following routine uses:

1. The information on this form will be treated confidentially to the extent allowed under the Freedom of Information Act (5 U.S.C. 552) and the Privacy Act (5 U.S.C. 552a). Records from this system of records may be disclosed to the Department of Justice to determine whether the Freedom of Information Act requires disclosure of these records.
2. A record from this system of records may be disclosed, as a routine use, in the course of presenting evidence to a court, magistrate, or administrative tribunal, including disclosures to opposing counsel in the course of settlement negotiations.
3. A record in this system of records may be disclosed, as a routine use, to a Member of Congress submitting a request involving an individual, to whom the record pertains, when the individual has requested assistance from the Member with respect to the subject matter of the record.
4. A record in this system of records may be disclosed, as a routine use, to a contractor of the Agency having need for the information in order to perform a contract. Recipients of information shall be required to comply with the requirements of the Privacy Act of 1974, as amended, pursuant to 5 U.S.C. 552a(m).
5. A record related to an International Application filed under the Patent Cooperation Treaty in this system of records may be disclosed, as a routine use, to the International Bureau of the World Intellectual Property Organization, pursuant to the Patent Cooperation Treaty.
6. A record in this system of records may be disclosed, as a routine use, to another federal agency for purposes of National Security review (35 U.S.C. 181) and for review pursuant to the Atomic Energy Act (42 U.S.C. 218(c)).
7. A record from this system of records may be disclosed, as a routine use, to the Administrator, General Services, or his/her designee, during an inspection of records conducted by GSA as part of that agency's responsibility to recommend improvements in records management practices and programs, under authority of 44 U.S.C. 2904 and 2906. Such disclosure shall be made in accordance with the GSA regulations governing inspection of records for this purpose, and any other relevant (i.e., GSA or Commerce) directive. Such disclosure shall not be used to make determinations about individuals.
8. A record from this system of records may be disclosed, as a routine use, to the public after either publication of the application pursuant to 35 U.S.C. 122(b) or issuance of a patent pursuant to 35 U.S.C. 151. Further, a record may be disclosed, subject to the limitations of 37 CFR 1.14, as a routine use, to the public if the record was filed in an application which became abandoned or in which the proceedings were terminated and which application is referenced by either a published application, an application open to public inspections or an issued patent.
9. A record from this system of records may be disclosed, as a routine use, to a Federal, State, or local law enforcement agency, if the USPTO becomes aware of a violation or potential violation of law or regulation.

INFORMATION DISCLOSURE STATEMENT BY APPLICANT (Not for submission under 37 CFR 1.99)	Application Number		
	Filing Date		
	First Named Inventor	Mohammed N. ISLAM	
	Art Unit		
	Examiner Name		
	Attorney Docket Number	OMNI 0105 PUSP1	

U.S.PATENTS						Remove
Examiner Initial*	Cite No	Patent Number	Kind Code ¹	Issue Date	Name of Patentee or Applicant of cited Document	Pages,Columns,Lines where Relevant Passages or Relevant Figures Appear
	1					

If you wish to add additional U.S. Patent citation information please click the Add button. Add

U.S.PATENT APPLICATION PUBLICATIONS						Remove
Examiner Initial*	Cite No	Publication Number	Kind Code ¹	Publication Date	Name of Patentee or Applicant of cited Document	Pages,Columns,Lines where Relevant Passages or Relevant Figures Appear
	1					

If you wish to add additional U.S. Published Application citation information please click the Add button. Add

FOREIGN PATENT DOCUMENTS								Remove
Examiner Initial*	Cite No	Foreign Document Number ³	Country Code ² j	Kind Code ⁴	Publication Date	Name of Patentee or Applicant of cited Document	Pages,Columns,Lines where Relevant Passages or Relevant Figures Appear	T ⁵
	1							<input type="checkbox"/>

If you wish to add additional Foreign Patent Document citation information please click the Add button Add

NON-PATENT LITERATURE DOCUMENTS				Remove
Examiner Initials*	Cite No	Include name of the author (in CAPITAL LETTERS), title of the article (when appropriate), title of the item (book, magazine, journal, serial, symposium, catalog, etc), date, pages(s), volume-issue number(s), publisher, city and/or country where published.		T ⁵

**INFORMATION DISCLOSURE
STATEMENT BY APPLICANT**
(Not for submission under 37 CFR 1.99)

Application Number		
Filing Date		
First Named Inventor	Mohammed N. ISLAM	
Art Unit		
Examiner Name		
Attorney Docket Number	OMNI 0105 PUSP1	

1	Islam, M. N., et al., "Broad bandwidths from frequency-shifting solitons in fibers", OPTICS LETTERS, Vol. 14, No. 7, April 1, 1989, pages 370-372.	<input type="checkbox"/>
2	Islam, M. N., et al., "Femtosecond distributed soliton spectrum in fibers", J. Opt. Soc. Am. B, Vol. 6, No. 6, June 1989, pages 1149-1158.	<input type="checkbox"/>
3	Busse, Lynda E., et al., "Design Parameters for Fluoride Multimode Fibers", Journal of Lightwave Technology, Vol. 9, No. 7, July 1991, pages 828-831.	<input type="checkbox"/>
4	Wuthrich, Stefan, et al., "Optical damage thresholds at 2.94 um in fluoride glass fibers", APPLIED OPTICS, Vol. 31, No. 27, September 20, 1992, pages 5833-5837.	<input type="checkbox"/>
5	Inoue, H., et al., "Computer simulation of the vibrational spectra and properties of fluoride glasses based on ZrF4", Journal of Non-Crystalline Solids, Vol. 161, 1993, pages 118-122.	<input type="checkbox"/>
6	Mizunami, Toru, et al., "Gain saturation characteristics of Raman amplification in silica and fluoride glass optical fibers", Optics Communications 97, 1993, pages 74-78.	<input type="checkbox"/>
7	Desthieux, B., et al., "111 kW (0. 5 mJ) pulse amplification at 1.5 um using a gated cascade of three erbium-doped fiber amplifiers," Appl. Phys. Lett. Vol. 63, August 2, 1993, pages 586-588.	<input type="checkbox"/>
8	Edwards, Glenn, et al., "Tissue ablation by a free-electron laser tuned to the amide II band", Nature, Vol. 371, September 29, 1994, pages 416-419.	<input type="checkbox"/>
9	Borrelli, N. F., et al., "Resonant and non-resonant effects in photonic glasses", Journal of Non-Crystalline Solids 185, 1995, pages 109-122.	<input type="checkbox"/>
10	Asobe, Masaki, et al., "Third-order nonlinear spectroscopy in As2S3 chalcogenide glass fibers", J. Appl. Phys. 77 (11), June 1, 1995, pages 5518-5523.	<input type="checkbox"/>
11	Jarman, Richard H., "Novel optical fiber lasers", Current Opinion in Solid State and Materials Science, 1996, pages 199-203.	<input type="checkbox"/>

**INFORMATION DISCLOSURE
STATEMENT BY APPLICANT**
(Not for submission under 37 CFR 1.99)

Application Number		
Filing Date		
First Named Inventor	Mohammed N. ISLAM	
Art Unit		
Examiner Name		
Attorney Docket Number	OMNI 0105 PUSP1	

12	latridis, James C., et al., "Is the Nucleus Pulposus a Solid or a Fluid? Mechanical Behaviors of the Nucleus Pulposus of the Human Intervertebral Disc", Spine, Volume 21(10), May 15, 1996, pages 1174-1184.	<input type="checkbox"/>
13	Asobe, Masaki, "Nonlinear Optical Properties of Chalcogenide Glass Fibers and Their Application to All-Optical Switching", Optical Fiber Technology, Volume 3, Article No. OF970214, 1997, pages 142-148.	<input type="checkbox"/>
14	Smektala, F., et al., "Chalcogenide glasses with large non-linear refractive indices", Journal of Non-Crystalline Solids 239, 1998, pages 139-142.	<input type="checkbox"/>
15	Hamilton, James D., et al., "High Frequency Ultrasound Imaging with Optical Arrays", IEEE Transactions on Ultrasonics, Ferroelectrics, and Frequency Control, Vol. 45, No. 1, January 1998, pages 216-235.	<input type="checkbox"/>
16	Hamilton, James D., et al., "High Frequency Ultrasound Imaging Using an Active Optical Detector", IEEE Transactions on Ultrasonics, Ferroelectrics, and Frequency Control, Vol. 45, No. 3, May 1998, pages 719-727.	<input type="checkbox"/>
17	Nowak, G. A., et al., "Low-power high-efficiency wavelength conversion based on modulational instability in high-nonlinearity fiber," OPTICS LETTERS, Vol. 23, No. 12, June 15, 1998, pages 936-938.	<input type="checkbox"/>
18	Cardinal, T., et al., "Non-linear optical properties of chalcogenide glasses in the system As-S-Se", Journal of Non-Crystalline Solids 256 & 257, 1999, pages 353-360.	<input type="checkbox"/>
19	Lucas, Jacques, "Infrared glasses", Current Opinion in Solid State & Materials Science 4, 1999, pages 181-187.	<input type="checkbox"/>
20	Sanghera, J. S., et al., "Active and passive chalcogenide glass optical fibers for IR applications: a review", Journal of Non-Crystalline Solids 256 & 257, 1999, pages 6-16.	<input type="checkbox"/>
21	Nishida, Yoshiki, et al., "Reliability of Fluoride Fiber Module for Optical Amplifier Use", IEEE Photonics Technology Letters, Vol. 11, No. 12, December 1999, pages 1596-1598.	<input type="checkbox"/>
22	Nowak, George A., et al., "Stable supercontinuum generation in short lengths of conventional dispersion-shifted fiber", APPLIED OPTICS, Vol. 38, No. 36, December 20, 1999, pages 7364-7369.	<input type="checkbox"/>

**INFORMATION DISCLOSURE
STATEMENT BY APPLICANT**
(Not for submission under 37 CFR 1.99)

Application Number		
Filing Date		
First Named Inventor	Mohammed N. ISLAM	
Art Unit		
Examiner Name		
Attorney Docket Number	OMNI 0105 PUSP1	

23	Urban, J. P. G., et al., "The Nucleus of the Intervertebral Disc from Development to Degeneration" Amer. Zool., Volume 40, 2000, pages 53-61.	<input type="checkbox"/>
24	Hamilton, James D., et al., "High Frequency Optoacoustic Arrays Using Etalon Detection", IEEE Transactions on Ultrasonics, Ferroelectrics, and Frequency Control, Vol. 47, No. 1, January 2000, pages 160-169.	<input type="checkbox"/>
25	Ranka, Jinendra K., et al., "Visible continuum generation in air-silica microstructure optical fibers with anomalous dispersion at 800 nm", OPTICS LETTERS, Vol. 25, No. 1, January 1, 2000, pages 25-27.	<input type="checkbox"/>
26	Boult, Maggi, et al., "Systematic Review of Percutaneous Endoscopic Laser Discectomy: Update and Re-appraisal", Australian Safety and Efficacy Register of New Interventional Procedures - Surgical Report No. 5, February, 2000, 49 pages.	<input type="checkbox"/>
27	Boult, Maggi, et al., "Percutaneous Endoscopic Laser Discectomy", Systematic Review, Aust. N.Z.J. Surg., Vol. 70, April 7, 2000, pages 475-479.	<input type="checkbox"/>
28	Camacho, Nancy P., et al., "FTIR Microscopic Imaging of Collagen and Proteoglycan in Bovine Cartilage," Biopolymers (Biospectroscopy), Vol. 62, 2001, pages 1-8.	<input type="checkbox"/>
29	Choi, Joon Y., et al., "Thermal, Mechanical, Optical, and Morphologic Changes in Bovine Nucleus Pulposus Induced by Nd:YAG ($\lambda = 1.32 \mu\text{m}$) Laser Irradiation", Lasers in Surgery and Medicine, Vol. 28, 2001, pages 248-254.	<input type="checkbox"/>
30	Hafez, M. I., et al., "The Effect of Irrigation on Peak Temperatures in Nerve Root, Dura, and Intervertebral Disc During Laser-Assisted Foraminoplasty", Lasers in Surgery and Medicine, Vol. 29, 2001, pages 33-37.	<input type="checkbox"/>
31	Jackson, Stuart D., et al., "Theory and numerical simulation of nth-order cascaded Raman fiber lasers", J. Opt. Soc. Am. B, Vol. 18, No. 9, September 2001, pages 1297-1306.	<input type="checkbox"/>
32	Werle, Peter, et al., "Near- and mid-infrared laser-optical sensors for gas analysis", Optics and Lasers in Engineering 37, 2002, pages 101-114.	<input type="checkbox"/>
33	Beck, Mattias, et al., "Continuous Wave Operation of a Mid-Infrared Semiconductor Laser at Room Temperature," SCIENCE Vol. 295, www.sciencemag.org, January 11, 2002, pages 301-305.	<input type="checkbox"/>

**INFORMATION DISCLOSURE
STATEMENT BY APPLICANT**
(Not for submission under 37 CFR 1.99)

Application Number		
Filing Date		
First Named Inventor	Mohammed N. ISLAM	
Art Unit		
Examiner Name		
Attorney Docket Number	OMNI 0105 PUSP1	

34	Harbold, J. M., et al., "Highly nonlinear As-S-Se glasses for all-optical switching", OPTICS LETTERS, Vol. 27, No. 2, January 15, 2002, pages 119-121.	<input type="checkbox"/>
35	Coen, Stephane, et al., "Supercontinuum generation by stimulated Raman scattering and parametric four-wave mixing in photonic crystal fibers", J. Opt. Soc. Am. B, Vol. 19, No. 4, April 2002, pages 753-764.	<input type="checkbox"/>
36	Dudley, John M., et al., "Supercontinuum generation in air-silica microstructured fibers with nanosecond and femtosecond pulse pumping", J. Opt. Soc. Am. B, Vol. 19, No. 4, April 2002, pages 765-771.	<input type="checkbox"/>
37	Harbold, Jeffrey M., et al., "Highly Nonlinear Ge-As-Se and Ge-As-S-Se Glasses for All-Optical Switching", IEEE Photonics Technology Letters, Vol. 14, No. 6, June 2002, pages 822-824.	<input type="checkbox"/>
38	Husakou, Anton V., et al, "Supercontinuum generation, four-wave mixing, and fission of higher-order solitons in photonic-crystal fibers", J. Opt. Soc. Am. B, Vol. 19, No. 9, September 2002, pages 2171-2182.	<input type="checkbox"/>
39	Wadsworth, William J., et al., "Supercontinuum generation in photonic crystal fibers and optical fiber tapers: a novel light source", J. Opt. Soc. Am. B, Vol. 19, No. 9, September 2002, pages 2148-2155.	<input type="checkbox"/>
40	Kumar, V.V. Ravi Kanth, et al, "Extruded soft glass photonic crystal fiber for ultrabroad supercontinuum generation", OPTICS EXPRESS, Vol 10, No. 25, December 16, 2002, pages 1520-1525.	<input type="checkbox"/>
41	Edwards, Glenn S., et al., "Advantage of the Mark-III FEL for biophysical research and biomedical applications", J. Synchrotron Rad. Volume 10, 2003, pages 354-357.	<input type="checkbox"/>
42	Nicholson, J. W., et al., "Pulsed and continuous-wave supercontinuum generation in highly nonlinear, dispersion-shifted fibers", Applied Physics B 77, 2003, pages 211-218.	<input type="checkbox"/>
43	Sobol, Emil, et al., "Time-resolved, light scattering measurements of cartilage and cornea denaturation due to free electron laser radiation", Journal of Biomedical Optics, Vol. 8, No. 2, April 2003, pages 216-222.	<input type="checkbox"/>
44	Nicholson, J. W., et al., "All-fiber, octave-spanning supercontinuum", OPTICS LETTERS, Vol. 28, No. 8, April 15, 2003, pages 643-645.	<input type="checkbox"/>

INFORMATION DISCLOSURE STATEMENT BY APPLICANT (Not for submission under 37 CFR 1.99)	Application Number		
	Filing Date		
	First Named Inventor	Mohammed N. ISLAM	
	Art Unit		
	Examiner Name		
	Attorney Docket Number	OMNI 0105 PUSP1	

45	Faralli, S., et al., "Impact of Double Rayleigh Scattering Noise in Distributed Higher Order Raman Pumping Schemes", IEEE Photonics Technology Letters, Vol. 15, No. 6, June 2003, pages 804-806.	<input type="checkbox"/>
46	"New and Emerging Techniques - Surgical, Rapid Review, Laser Discectomy", Australian Safety and Efficacy Register of New Interventional Procedures - Surgical, June 2003, 12 pages.	<input type="checkbox"/>
47	Avdokhin, A. V., et al., "Continuous-wave, high-power, Raman continuum generation in holey fibers", OPTICS LETTERS, Vol. 28, No. 15, August 1, 2003, pages 1353-1355.	<input type="checkbox"/>
48	Mussot, Arnaud, et al., "Generation of a broadband single-mode supercontinuum in a conventional dispersion-shifted fiber by use of a subnanosecond microchip laser", OPTICS LETTERS, Vol. 28, No. 19, October 1, 2003, pages 1820-1822.	<input type="checkbox"/>
49	Slusher, Richard, et al., "Highly nonlinear composite chalcogenide/polymer fibers", OSA 2004, 1 page.	<input type="checkbox"/>
50	Thongtrangan, Issada, et al., "Minimally invasive spinal surgery: a historical perspective", Neurosurg. Focus, Volume 16, Article 13, January 2004, pages 1-10.	<input type="checkbox"/>

If you wish to add additional non-patent literature document citation information please click the Add button **Add**

EXAMINER SIGNATURE

Examiner Signature		Date Considered	
--------------------	--	-----------------	--

*EXAMINER: Initial if reference considered, whether or not citation is in conformance with MPEP 609. Draw line through a citation if not in conformance and not considered. Include copy of this form with next communication to applicant.

¹ See Kind Codes of USPTO Patent Documents at www.USPTO.GOV or MPEP 901.04. ² Enter office that issued the document, by the two-letter code (WIPO Standard ST.3). ³ For Japanese patent documents, the indication of the year of the reign of the Emperor must precede the serial number of the patent document. ⁴ Kind of document by the appropriate symbols as indicated on the document under WIPO Standard ST.16 if possible. ⁵ Applicant is to place a check mark here if English language translation is attached.

**INFORMATION DISCLOSURE
STATEMENT BY APPLICANT**
(Not for submission under 37 CFR 1.99)

Application Number		
Filing Date		
First Named Inventor	Mohammed N. ISLAM	
Art Unit		
Examiner Name		
Attorney Docket Number	OMNI 0105 PUSP1	

CERTIFICATION STATEMENT

Please see 37 CFR 1.97 and 1.98 to make the appropriate selection(s):

That each item of information contained in the information disclosure statement was first cited in any communication from a foreign patent office in a counterpart foreign application not more than three months prior to the filing of the information disclosure statement. See 37 CFR 1.97(e)(1).

OR

That no item of information contained in the information disclosure statement was cited in a communication from a foreign patent office in a counterpart foreign application, and, to the knowledge of the person signing the certification after making reasonable inquiry, no item of information contained in the information disclosure statement was known to any individual designated in 37 CFR 1.56(c) more than three months prior to the filing of the information disclosure statement. See 37 CFR 1.97(e)(2).

See attached certification statement.

The fee set forth in 37 CFR 1.17 (p) has been submitted herewith.

A certification statement is not submitted herewith.

SIGNATURE

A signature of the applicant or representative is required in accordance with CFR 1.33, 10.18. Please see CFR 1.4(d) for the form of the signature.

Signature	/David S. Bir/	Date (YYYY-MM-DD)	2015-10-01
Name/Print	David S. Bir	Registration Number	38383

This collection of information is required by 37 CFR 1.97 and 1.98. The information is required to obtain or retain a benefit by the public which is to file (and by the USPTO to process) an application. Confidentiality is governed by 35 U.S.C. 122 and 37 CFR 1.14. This collection is estimated to take 1 hour to complete, including gathering, preparing and submitting the completed application form to the USPTO. Time will vary depending upon the individual case. Any comments on the amount of time you require to complete this form and/or suggestions for reducing this burden, should be sent to the Chief Information Officer, U.S. Patent and Trademark Office, U.S. Department of Commerce, P.O. Box 1450, Alexandria, VA 22313-1450. **DO NOT SEND FEES OR COMPLETED FORMS TO THIS ADDRESS. SEND TO: Commissioner for Patents, P.O. Box 1450, Alexandria, VA 22313-1450.**

Privacy Act Statement

The Privacy Act of 1974 (P.L. 93-579) requires that you be given certain information in connection with your submission of the attached form related to a patent application or patent. Accordingly, pursuant to the requirements of the Act, please be advised that: (1) the general authority for the collection of this information is 35 U.S.C. 2(b)(2); (2) furnishing of the information solicited is voluntary; and (3) the principal purpose for which the information is used by the U.S. Patent and Trademark Office is to process and/or examine your submission related to a patent application or patent. If you do not furnish the requested information, the U.S. Patent and Trademark Office may not be able to process and/or examine your submission, which may result in termination of proceedings or abandonment of the application or expiration of the patent.

The information provided by you in this form will be subject to the following routine uses:

1. The information on this form will be treated confidentially to the extent allowed under the Freedom of Information Act (5 U.S.C. 552) and the Privacy Act (5 U.S.C. 552a). Records from this system of records may be disclosed to the Department of Justice to determine whether the Freedom of Information Act requires disclosure of these records.
2. A record from this system of records may be disclosed, as a routine use, in the course of presenting evidence to a court, magistrate, or administrative tribunal, including disclosures to opposing counsel in the course of settlement negotiations.
3. A record in this system of records may be disclosed, as a routine use, to a Member of Congress submitting a request involving an individual, to whom the record pertains, when the individual has requested assistance from the Member with respect to the subject matter of the record.
4. A record in this system of records may be disclosed, as a routine use, to a contractor of the Agency having need for the information in order to perform a contract. Recipients of information shall be required to comply with the requirements of the Privacy Act of 1974, as amended, pursuant to 5 U.S.C. 552a(m).
5. A record related to an International Application filed under the Patent Cooperation Treaty in this system of records may be disclosed, as a routine use, to the International Bureau of the World Intellectual Property Organization, pursuant to the Patent Cooperation Treaty.
6. A record in this system of records may be disclosed, as a routine use, to another federal agency for purposes of National Security review (35 U.S.C. 181) and for review pursuant to the Atomic Energy Act (42 U.S.C. 218(c)).
7. A record from this system of records may be disclosed, as a routine use, to the Administrator, General Services, or his/her designee, during an inspection of records conducted by GSA as part of that agency's responsibility to recommend improvements in records management practices and programs, under authority of 44 U.S.C. 2904 and 2906. Such disclosure shall be made in accordance with the GSA regulations governing inspection of records for this purpose, and any other relevant (i.e., GSA or Commerce) directive. Such disclosure shall not be used to make determinations about individuals.
8. A record from this system of records may be disclosed, as a routine use, to the public after either publication of the application pursuant to 35 U.S.C. 122(b) or issuance of a patent pursuant to 35 U.S.C. 151. Further, a record may be disclosed, subject to the limitations of 37 CFR 1.14, as a routine use, to the public if the record was filed in an application which became abandoned or in which the proceedings were terminated and which application is referenced by either a published application, an application open to public inspections or an issued patent.
9. A record from this system of records may be disclosed, as a routine use, to a Federal, State, or local law enforcement agency, if the USPTO becomes aware of a violation or potential violation of law or regulation.

INFORMATION DISCLOSURE STATEMENT BY APPLICANT (Not for submission under 37 CFR 1.99)	Application Number		
	Filing Date		
	First Named Inventor	Mohammed N. ISLAM	
	Art Unit		
	Examiner Name		
	Attorney Docket Number	OMNI 0105 PUSP1	

U.S.PATENTS						Remove
Examiner Initial*	Cite No	Patent Number	Kind Code ¹	Issue Date	Name of Patentee or Applicant of cited Document	Pages,Columns,Lines where Relevant Passages or Relevant Figures Appear
	1	5747806		1998-05-05	Khalil	
	2	6115673		2000-09-05	Malin	
	3	6512936	B1	2003-01-28	MONFRE	
	4	6534012	B1	2003-04-01	VISWANATHAN	
	5	6640117		2003-10-28	Makarewicz	
	6	6788965	B2	2004-09-07	RUCHTI	
	7	6816241		2004-11-09	Grubisic	
	8	6738652	B2	2004-05-18	MATTU	

**INFORMATION DISCLOSURE
STATEMENT BY APPLICANT**
(Not for submission under 37 CFR 1.99)

Application Number		
Filing Date		
First Named Inventor	Mohammed N. ISLAM	
Art Unit		
Examiner Name		
Attorney Docket Number	OMNI 0105 PUSP1	

9	6587702	B1	2003-07-01	RUCHTI	
10	6864978	B1	2005-03-08	HAZEN	
11	6990364		2006-01-24	Ruchti	
12	7010336	B2	2006-03-07	LORENZ	
13	7133710	B2	2006-11-07	Acosta	
14	7233816	B2	2007-06-19	BLANK	
15	7299080	B2	2007-11-20	Acosta	
16	7317938	B2	2008-01-08	Lorenz	
17	7395158	B2	2008-07-01	Monfre	
18	7519406	B2	2009-04-14	BLANK	
19	7620674	B2	2009-11-17	RUCHTI	

**INFORMATION DISCLOSURE
STATEMENT BY APPLICANT**
(Not for submission under 37 CFR 1.99)

Application Number		
Filing Date		
First Named Inventor	Mohammed N. ISLAM	
Art Unit		
Examiner Name		
Attorney Docket Number	OMNI 0105 PUSP1	

	20	7697966	B2	2010-04-13	MONFRE	
	21	7787924		2010-08-31	Acosta	
	22	8145286		2012-03-27	Arai	
	23	6773922		2004-08-10	JENG	
	24	7807718	B2	2010-10-05	HASHIM	

If you wish to add additional U.S. Patent citation information please click the Add button.

[Add](#)

U.S.PATENT APPLICATION PUBLICATIONS

[Remove](#)

Examiner Initial*	Cite No	Publication Number	Kind Code ¹	Publication Date	Name of Patentee or Applicant of cited Document	Pages,Columns,Lines where Relevant Passages or Relevant Figures Appear
	1	20100331637	A1	2010-12-30	Ting	
	2	20110143364	A1	2011-06-16	KIM	
	3	20030022126	A1	2003-01-30	BUCHALLA	
	4	20060223032	A1	2006-10-05	FRIED	

INFORMATION DISCLOSURE STATEMENT BY APPLICANT (Not for submission under 37 CFR 1.99)	Application Number			
	Filing Date			
	First Named Inventor	Mohammed N. ISLAM		
	Art Unit			
	Examiner Name			
	Attorney Docket Number		OMNI 0105 PUSP1	

5	20100322490	A1	2010-12-23	PAN	
6	20120013722	A1	2012-01-19	WONG	

If you wish to add additional U.S. Published Application citation information please click the Add button. **Add**

FOREIGN PATENT DOCUMENTS

Remove

Examiner Initial*	Cite No	Foreign Document Number ³	Country Code ² j	Kind Code ⁴	Publication Date	Name of Patentee or Applicant of cited Document	Pages, Columns, Lines where Relevant Passages or Relevant Figures Appear	T ⁵
	1							<input type="checkbox"/>

If you wish to add additional Foreign Patent Document citation information please click the Add button **Add**

NON-PATENT LITERATURE DOCUMENTS

Remove

Examiner Initials*	Cite No	Include name of the author (in CAPITAL LETTERS), title of the article (when appropriate), title of the item (book, magazine, journal, serial, symposium, catalog, etc), date, pages(s), volume-issue number(s), publisher, city and/or country where published.	T ⁵
	1	HAZEN, K.H., M.A. Arnold, G.W. Small, "Measurement of glucose and other analytes in undiluted human serum with near-infrared transmission spectroscopy," Analytica Chimica Acta, vol. 371, pp. 255-267 (1998).	<input type="checkbox"/>
	2	MALIN, S.F., T.L. Ruchti, T.B. Blank, S.N. Thennadil, S.L. Monfre, "Noninvasive prediction of glucose by near-infrared diffuse reflectance spectroscopy," Clinical Chemistry, vol. 45, no. 9, pp. 1651-1658 (1999).	<input type="checkbox"/>
	3	Thennadil, S.N., J.L. Rennert, B.J. Wenzel, K.H. Hazen, T.L. Ruchti, M.B. Block, "Comparison of glucose concentration in interstitial fluid, and capillary and venous blood during rapid changes in blood glucose levels," Diabetes Technology & Therapeutics, Vol. 3, No. 3, pp. 357-365 (2001).	<input type="checkbox"/>
	4	TROY, T.L., S.N. Thennadil, "Optical properties of human skin in the near infrared wavelength range of 1000 to 2200nm," Journal of Biomedical Optics, vol. 6, no. 2, pp. 167-176, (2001).	<input type="checkbox"/>

**INFORMATION DISCLOSURE
STATEMENT BY APPLICANT**
(Not for submission under 37 CFR 1.99)

Application Number		
Filing Date		
First Named Inventor	Mohammed N. ISLAM	
Art Unit		
Examiner Name		
Attorney Docket Number	OMNI 0105 PUSP1	

5	BLANK, T.B., T.L. Ruchti, A.D. Lorenz, S.L. Monfre, M.R. Makarewicz, M. Mattu, K.H. Hazen, "Clinical results from a non-invasive blood glucose monitor," Optical Diagnostics and Sensing of Biological Fluids and Glucose and Cholesterol Monitoring II, A.V. Priezhev and G.L. Cote, Editors, Proceedings of SPIE, Vol. 4624, pp. 1019 (2002).	<input type="checkbox"/>
6	YEH, S-J, C.F. Hanna, O.S. Khalil, "Monitoring blood glucose changes in cutaneous tissue by temperature-modulated localized reflectance measurements," Clinical Chemistry, vol. 49, no. 6, pp. 924-934 (2003).	<input type="checkbox"/>
7	MARBACH, R., T. Koschinsky, F.A. Gries, H.M. Heise, "Noninvasive blood glucose assay by near-infrared diffuse reflectance spectroscopy of the human inner lip," Applied Spectroscopy, Vol. 47, no. 7, pp. 875-881 (1993).	<input type="checkbox"/>
8	Enejder, A.M.K., T.G. Scecina, J. Oh, M. Hunter, W.C. Shih, S. Sasic, G.L. Horowitz, M.S. Feld, "Raman spectroscopy for noninvasive glucose measurements," Journal of Biomedical Optics, vol. 10, no. 3, 031114 (2005).	<input type="checkbox"/>
9	Olesberg, J.T., L. Liu, V.V. Zee, M.A. Arnold, "In vivo near-infrared spectroscopy of rat skin tissue with varying blood glucose levels," Analytic Chemistry, vol. 78, no. 1, pp. 215-223 (2006).	<input type="checkbox"/>
10	OLESBERG, J.T., M.A. Arnold, C. Mermelstein, J. Schmitz, J. Wagner, "Tunable laser diode system for noninvasive blood glucose measurements," Applied Spectroscopy, Vol. 59, no. 12, pp. 1480-1484 (2005).	<input type="checkbox"/>
11	HARMAN-BOEHM, I. A. Gal, A.M. Raykhman, J.D. Zahn, E. Naidis, Y. Mayzel, "Noninvasive glucose monitoring: a novel approach," Journal of Diabetes Science and Technology, vol. 3, no. 2 pp. 253-260 (2009).	<input type="checkbox"/>
12	KIM-K.D., G.S. Son, S.S. Lim, S.S. Lee, "Measurement of glucose level exploiting a relative optical absorption at discrete probe wavelengths," Japanese Journal of Applied Physics, vol. 48, 077001 (2009).	<input type="checkbox"/>
13	SMITH, J.L., "The Pursuit of Noninvasive Glucose: Hunting the Deceitful Turkey," 2nd Edition, pp. 1-141 (2011).	<input type="checkbox"/>
14	Pezzaniti, J.L., T.W. Jeng, L. McDowell, G.M. Oosta, "Preliminary investigation of near-infrared spectroscopic measurements of urea, creatinine, glucose, protein and ketone in urine," Clinical Biochemistry, vol. 34, pp. 239-246 (2001).	<input type="checkbox"/>
15	LUSSI, A., R. Hibst, R. Paulus, "Diagnodent: An optical method for caries detection," Journal of Dental Research, vol. 83, special issue C, pp. C80-C83 (2004).	<input type="checkbox"/>

**INFORMATION DISCLOSURE
STATEMENT BY APPLICANT**
(Not for submission under 37 CFR 1.99)

Application Number		
Filing Date		
First Named Inventor	Mohammed N. ISLAM	
Art Unit		
Examiner Name		
Attorney Docket Number	OMNI 0105 PUSP1	

16	REESE, E.L, E.E. Fisher, D.A. Horowitz, "Photoelectric densitometry of the circulation of the human dental pulp," The Journal of the Baltimore College of Dental Surgery, Vol. 26, no. 1, pp. 6-18 (1971).	<input type="checkbox"/>
17	ZAKIAN, C., I. Pretty, R. Ellwood, "Near-infrared hyperspectral imaging of teeth for dental caries detection," Journal of Biomedical Optics, vol. 16, no. 6, 064047 (2009).	<input type="checkbox"/>
18	BELIKOV, A.V., A.V. Skripnik, K.V. Shatilova, "Study of the dynamics of the absorption spectra of human tooth enamel and dentine under heating and ablation by submillisecond pulse radiation of an erbium laser with a generation wavelength of 2.79 um," Optics and Spectroscopy, vol. 109, no. 2, pp. 211-216 (2010).	<input type="checkbox"/>
19	KARLSSON, L. "Caries detection methods based on changes in optical properties between healthy and carious tissue," International Journal of Dentistry, vol. 2010, Article ID 270729, 9 pages (2010).	<input type="checkbox"/>
20	FRIED, D. M. Staninec, C.L. Darling, "Near-infrared imaging of dental decay at 1310nm," Journal of Laser Dentistry, vol. 18, no. 1, pp. 8-16 (2010).	<input type="checkbox"/>
21	BURMEN, M. P. Usenik, A. Fidler, F. Pernus, B. Likar, "A construction of standardized near infrared hyper-spectral teeth database - a first step in the development of reliable diagnostic tool for quantification and early detection of caries," Lasers in Dentistry XVII, edited by P. Rechmann, D. Fried, Proceedings of SPIE, Vol. 7884, Paper 78840E (2011).	<input type="checkbox"/>
22	MAIA, A., L. Karlsson, W. Margulis, A. Gomes, "Evaluation of two imaging techniques: near-infrared transillumination and dental radiographs for the detection of early approximal enamel caries," Dentomaxillofacial Radiology, vol. 40, pp. 429-433 (2011).	<input type="checkbox"/>
23	CHUNG, S., D. Fried, M. Staninec, C.L. Darling, "Multispectral near-IR reflectance and transillumination imaging of teeth," Biomedical Optics Express, Vol. 2, No. 10, pp. 2804-2814 (2011).	<input type="checkbox"/>
24	CHUNG, S., D. Fried, M. Staninec, C.L. Darling, "Near infrared imaging of teeth at wavelengths between 1200 and 1600nm," Proceedings of the Society of Photo Optical Instrument Engineering, paper 7884 (2011).	<input type="checkbox"/>
25	STANINEC, M., S.M. Douglas, C.L. Darling, K. Chan, H. Kang, R. C. Lee, D. Fried, "Nondestructive clinical assessment of occlusal caries lesions using near-IR imaging methods," Lasers in Surgery and Medicine, Vol. 43, No. 10, pp. 951-959 (2011).	<input type="checkbox"/>
26	NISHIZAWA, N., "Generation and application of high-quality supercontinuum sources," Optical Fiber Technology, Vol. 18, pp. 394-402 (2012).	<input type="checkbox"/>

**INFORMATION DISCLOSURE
STATEMENT BY APPLICANT**
(Not for submission under 37 CFR 1.99)

Application Number		
Filing Date		
First Named Inventor	Mohammed N. ISLAM	
Art Unit		
Examiner Name		
Attorney Docket Number	OMNI 0105 PUSP1	

If you wish to add additional non-patent literature document citation information please click the Add button **Add**

EXAMINER SIGNATURE

Examiner Signature		Date Considered	
--------------------	--	-----------------	--

*EXAMINER: Initial if reference considered, whether or not citation is in conformance with MPEP 609. Draw line through a citation if not in conformance and not considered. Include copy of this form with next communication to applicant.

¹ See Kind Codes of USPTO Patent Documents at www.USPTO.GOV or MPEP 901.04. ² Enter office that issued the document, by the two-letter code (WIPO Standard ST.3). ³ For Japanese patent documents, the indication of the year of the reign of the Emperor must precede the serial number of the patent document. ⁴ Kind of document by the appropriate symbols as indicated on the document under WIPO Standard ST.16 if possible. ⁵ Applicant is to place a check mark here if English language translation is attached.

**INFORMATION DISCLOSURE
STATEMENT BY APPLICANT**
(Not for submission under 37 CFR 1.99)

Application Number		
Filing Date		
First Named Inventor	Mohammed N. ISLAM	
Art Unit		
Examiner Name		
Attorney Docket Number	OMNI 0105 PUSP1	

CERTIFICATION STATEMENT

Please see 37 CFR 1.97 and 1.98 to make the appropriate selection(s):

That each item of information contained in the information disclosure statement was first cited in any communication from a foreign patent office in a counterpart foreign application not more than three months prior to the filing of the information disclosure statement. See 37 CFR 1.97(e)(1).

OR

That no item of information contained in the information disclosure statement was cited in a communication from a foreign patent office in a counterpart foreign application, and, to the knowledge of the person signing the certification after making reasonable inquiry, no item of information contained in the information disclosure statement was known to any individual designated in 37 CFR 1.56(c) more than three months prior to the filing of the information disclosure statement. See 37 CFR 1.97(e)(2).

- See attached certification statement.
- The fee set forth in 37 CFR 1.17 (p) has been submitted herewith.
- A certification statement is not submitted herewith.

SIGNATURE

A signature of the applicant or representative is required in accordance with CFR 1.33, 10.18. Please see CFR 1.4(d) for the form of the signature.

Signature	/David S. Bir/	Date (YYYY-MM-DD)	2015-10-01
Name/Print	David S. Bir	Registration Number	38383

This collection of information is required by 37 CFR 1.97 and 1.98. The information is required to obtain or retain a benefit by the public which is to file (and by the USPTO to process) an application. Confidentiality is governed by 35 U.S.C. 122 and 37 CFR 1.14. This collection is estimated to take 1 hour to complete, including gathering, preparing and submitting the completed application form to the USPTO. Time will vary depending upon the individual case. Any comments on the amount of time you require to complete this form and/or suggestions for reducing this burden, should be sent to the Chief Information Officer, U.S. Patent and Trademark Office, U.S. Department of Commerce, P.O. Box 1450, Alexandria, VA 22313-1450. **DO NOT SEND FEES OR COMPLETED FORMS TO THIS ADDRESS. SEND TO: Commissioner for Patents, P.O. Box 1450, Alexandria, VA 22313-1450.**

Privacy Act Statement

The Privacy Act of 1974 (P.L. 93-579) requires that you be given certain information in connection with your submission of the attached form related to a patent application or patent. Accordingly, pursuant to the requirements of the Act, please be advised that: (1) the general authority for the collection of this information is 35 U.S.C. 2(b)(2); (2) furnishing of the information solicited is voluntary; and (3) the principal purpose for which the information is used by the U.S. Patent and Trademark Office is to process and/or examine your submission related to a patent application or patent. If you do not furnish the requested information, the U.S. Patent and Trademark Office may not be able to process and/or examine your submission, which may result in termination of proceedings or abandonment of the application or expiration of the patent.

The information provided by you in this form will be subject to the following routine uses:

1. The information on this form will be treated confidentially to the extent allowed under the Freedom of Information Act (5 U.S.C. 552) and the Privacy Act (5 U.S.C. 552a). Records from this system of records may be disclosed to the Department of Justice to determine whether the Freedom of Information Act requires disclosure of these records.
2. A record from this system of records may be disclosed, as a routine use, in the course of presenting evidence to a court, magistrate, or administrative tribunal, including disclosures to opposing counsel in the course of settlement negotiations.
3. A record in this system of records may be disclosed, as a routine use, to a Member of Congress submitting a request involving an individual, to whom the record pertains, when the individual has requested assistance from the Member with respect to the subject matter of the record.
4. A record in this system of records may be disclosed, as a routine use, to a contractor of the Agency having need for the information in order to perform a contract. Recipients of information shall be required to comply with the requirements of the Privacy Act of 1974, as amended, pursuant to 5 U.S.C. 552a(m).
5. A record related to an International Application filed under the Patent Cooperation Treaty in this system of records may be disclosed, as a routine use, to the International Bureau of the World Intellectual Property Organization, pursuant to the Patent Cooperation Treaty.
6. A record in this system of records may be disclosed, as a routine use, to another federal agency for purposes of National Security review (35 U.S.C. 181) and for review pursuant to the Atomic Energy Act (42 U.S.C. 218(c)).
7. A record from this system of records may be disclosed, as a routine use, to the Administrator, General Services, or his/her designee, during an inspection of records conducted by GSA as part of that agency's responsibility to recommend improvements in records management practices and programs, under authority of 44 U.S.C. 2904 and 2906. Such disclosure shall be made in accordance with the GSA regulations governing inspection of records for this purpose, and any other relevant (i.e., GSA or Commerce) directive. Such disclosure shall not be used to make determinations about individuals.
8. A record from this system of records may be disclosed, as a routine use, to the public after either publication of the application pursuant to 35 U.S.C. 122(b) or issuance of a patent pursuant to 35 U.S.C. 151. Further, a record may be disclosed, subject to the limitations of 37 CFR 1.14, as a routine use, to the public if the record was filed in an application which became abandoned or in which the proceedings were terminated and which application is referenced by either a published application, an application open to public inspections or an issued patent.
9. A record from this system of records may be disclosed, as a routine use, to a Federal, State, or local law enforcement agency, if the USPTO becomes aware of a violation or potential violation of law or regulation.

INFORMATION DISCLOSURE STATEMENT BY APPLICANT (Not for submission under 37 CFR 1.99)	Application Number		
	Filing Date		
	First Named Inventor	Mohammed N. ISLAM	
	Art Unit		
	Examiner Name		
	Attorney Docket Number	OMNI 0105 PUSP1	

U.S.PATENTS						Remove
Examiner Initial*	Cite No	Patent Number	Kind Code ¹	Issue Date	Name of Patentee or Applicant of cited Document	Pages,Columns,Lines where Relevant Passages or Relevant Figures Appear
	1	6885683		2005-04-26	FERMANN ET AL.	
	2	6281471	B1	2001-08-28	SMART	
	3	6340806		2002-01-22	SMART ET AL.	
	4	6301271	B1	2001-10-09	SANDERS ET AL.	
	5	7294105	B1	2007-11-13	ISLAM	

If you wish to add additional U.S. Patent citation information please click the Add button.

Add

U.S.PATENT APPLICATION PUBLICATIONS						Remove
Examiner Initial*	Cite No	Publication Number	Kind Code ¹	Publication Date	Name of Patentee or Applicant of cited Document	Pages,Columns,Lines where Relevant Passages or Relevant Figures Appear
	1	20100046067	A1	2010-02-25	FERMANN ET AL.	

INFORMATION DISCLOSURE STATEMENT BY APPLICANT (Not for submission under 37 CFR 1.99)	Application Number			
	Filing Date			
	First Named Inventor	Mohammed N. ISLAM		
	Art Unit			
	Examiner Name			
	Attorney Docket Number		OMNI 0105 PUSP1	

2	20080105665	A1	2008-05-08	KONDO	
---	-------------	----	------------	-------	--

If you wish to add additional U.S. Published Application citation information please click the Add button. **Add**

FOREIGN PATENT DOCUMENTS								Remove
Examiner Initial*	Cite No	Foreign Document Number ³	Country Code ²	Kind Code ⁴	Publication Date	Name of Patentee or Applicant of cited Document	Pages, Columns, Lines where Relevant Passages or Relevant Figures Appear	T ⁵
	1							<input type="checkbox"/>

If you wish to add additional Foreign Patent Document citation information please click the Add button **Add**

NON-PATENT LITERATURE DOCUMENTS			Remove
Examiner Initials*	Cite No	Include name of the author (in CAPITAL LETTERS), title of the article (when appropriate), title of the item (book, magazine, journal, serial, symposium, catalog, etc), date, pages(s), volume-issue number(s), publisher, city and/or country where published.	T ⁵
	1	ISTEPANIAN, ROBERT H., "The Comparative Performance of Mobile Telemedical Systems based on the IS-54 and GSM Cellular Telephone Standards"; Journal of Telemedicine and Telecare 1999; pp 97-104	<input type="checkbox"/>
	2	ARIS, ISHAK BIN, "An Internet-Based Blood Pressure Monitoring System for Patients"; Journal of Telemedicine and Telecare 2001; pp 51-53.	<input type="checkbox"/>

If you wish to add additional non-patent literature document citation information please click the Add button **Add**

EXAMINER SIGNATURE			
Examiner Signature		Date Considered	

*EXAMINER: Initial if reference considered, whether or not citation is in conformance with MPEP 609. Draw line through a citation if not in conformance and not considered. Include copy of this form with next communication to applicant.

¹ See Kind Codes of USPTO Patent Documents at www.USPTO.GOV or MPEP 901.04. ² Enter office that issued the document, by the two-letter code (WIPO Standard ST.3). ³ For Japanese patent documents, the indication of the year of the reign of the Emperor must precede the serial number of the patent document. ⁴ Kind of document by the appropriate symbols as indicated on the document under WIPO Standard ST.16 if possible. ⁵ Applicant is to place a check mark here if English language translation is attached.

**INFORMATION DISCLOSURE
STATEMENT BY APPLICANT**
(Not for submission under 37 CFR 1.99)

Application Number		
Filing Date		
First Named Inventor	Mohammed N. ISLAM	
Art Unit		
Examiner Name		
Attorney Docket Number	OMNI 0105 PUSP1	

CERTIFICATION STATEMENT

Please see 37 CFR 1.97 and 1.98 to make the appropriate selection(s):

That each item of information contained in the information disclosure statement was first cited in any communication from a foreign patent office in a counterpart foreign application not more than three months prior to the filing of the information disclosure statement. See 37 CFR 1.97(e)(1).

OR

That no item of information contained in the information disclosure statement was cited in a communication from a foreign patent office in a counterpart foreign application, and, to the knowledge of the person signing the certification after making reasonable inquiry, no item of information contained in the information disclosure statement was known to any individual designated in 37 CFR 1.56(c) more than three months prior to the filing of the information disclosure statement. See 37 CFR 1.97(e)(2).

See attached certification statement.

The fee set forth in 37 CFR 1.17 (p) has been submitted herewith.

A certification statement is not submitted herewith.

SIGNATURE

A signature of the applicant or representative is required in accordance with CFR 1.33, 10.18. Please see CFR 1.4(d) for the form of the signature.

Signature	/David S. Bir/	Date (YYYY-MM-DD)	2015-10-01
Name/Print	David S. Bir	Registration Number	38383

This collection of information is required by 37 CFR 1.97 and 1.98. The information is required to obtain or retain a benefit by the public which is to file (and by the USPTO to process) an application. Confidentiality is governed by 35 U.S.C. 122 and 37 CFR 1.14. This collection is estimated to take 1 hour to complete, including gathering, preparing and submitting the completed application form to the USPTO. Time will vary depending upon the individual case. Any comments on the amount of time you require to complete this form and/or suggestions for reducing this burden, should be sent to the Chief Information Officer, U.S. Patent and Trademark Office, U.S. Department of Commerce, P.O. Box 1450, Alexandria, VA 22313-1450. **DO NOT SEND FEES OR COMPLETED FORMS TO THIS ADDRESS. SEND TO: Commissioner for Patents, P.O. Box 1450, Alexandria, VA 22313-1450.**

Privacy Act Statement

The Privacy Act of 1974 (P.L. 93-579) requires that you be given certain information in connection with your submission of the attached form related to a patent application or patent. Accordingly, pursuant to the requirements of the Act, please be advised that: (1) the general authority for the collection of this information is 35 U.S.C. 2(b)(2); (2) furnishing of the information solicited is voluntary; and (3) the principal purpose for which the information is used by the U.S. Patent and Trademark Office is to process and/or examine your submission related to a patent application or patent. If you do not furnish the requested information, the U.S. Patent and Trademark Office may not be able to process and/or examine your submission, which may result in termination of proceedings or abandonment of the application or expiration of the patent.

The information provided by you in this form will be subject to the following routine uses:

1. The information on this form will be treated confidentially to the extent allowed under the Freedom of Information Act (5 U.S.C. 552) and the Privacy Act (5 U.S.C. 552a). Records from this system of records may be disclosed to the Department of Justice to determine whether the Freedom of Information Act requires disclosure of these records.
2. A record from this system of records may be disclosed, as a routine use, in the course of presenting evidence to a court, magistrate, or administrative tribunal, including disclosures to opposing counsel in the course of settlement negotiations.
3. A record in this system of records may be disclosed, as a routine use, to a Member of Congress submitting a request involving an individual, to whom the record pertains, when the individual has requested assistance from the Member with respect to the subject matter of the record.
4. A record in this system of records may be disclosed, as a routine use, to a contractor of the Agency having need for the information in order to perform a contract. Recipients of information shall be required to comply with the requirements of the Privacy Act of 1974, as amended, pursuant to 5 U.S.C. 552a(m).
5. A record related to an International Application filed under the Patent Cooperation Treaty in this system of records may be disclosed, as a routine use, to the International Bureau of the World Intellectual Property Organization, pursuant to the Patent Cooperation Treaty.
6. A record in this system of records may be disclosed, as a routine use, to another federal agency for purposes of National Security review (35 U.S.C. 181) and for review pursuant to the Atomic Energy Act (42 U.S.C. 218(c)).
7. A record from this system of records may be disclosed, as a routine use, to the Administrator, General Services, or his/her designee, during an inspection of records conducted by GSA as part of that agency's responsibility to recommend improvements in records management practices and programs, under authority of 44 U.S.C. 2904 and 2906. Such disclosure shall be made in accordance with the GSA regulations governing inspection of records for this purpose, and any other relevant (i.e., GSA or Commerce) directive. Such disclosure shall not be used to make determinations about individuals.
8. A record from this system of records may be disclosed, as a routine use, to the public after either publication of the application pursuant to 35 U.S.C. 122(b) or issuance of a patent pursuant to 35 U.S.C. 151. Further, a record may be disclosed, subject to the limitations of 37 CFR 1.14, as a routine use, to the public if the record was filed in an application which became abandoned or in which the proceedings were terminated and which application is referenced by either a published application, an application open to public inspections or an issued patent.
9. A record from this system of records may be disclosed, as a routine use, to a Federal, State, or local law enforcement agency, if the USPTO becomes aware of a violation or potential violation of law or regulation.

INFORMATION DISCLOSURE STATEMENT BY APPLICANT (Not for submission under 37 CFR 1.99)	Application Number		
	Filing Date		
	First Named Inventor	Mohammed N. ISLAM	
	Art Unit		
	Examiner Name		
	Attorney Docket Number	OMNI 0105 PUSP1	

U.S.PATENTS						Remove
Examiner Initial*	Cite No	Patent Number	Kind Code ¹	Issue Date	Name of Patentee or Applicant of cited Document	Pages,Columns,Lines where Relevant Passages or Relevant Figures Appear
	1	7787503	B2	2010-08-31	WADSWORTH	
	2	7800818	B2	2010-09-21	MATTSSON	
	3	8000574	B2	2011-08-16	BUCHTER	
	4	6611643	B2	2003-08-26	BIRK	

If you wish to add additional U.S. Patent citation information please click the Add button. Add

U.S.PATENT APPLICATION PUBLICATIONS						Remove
Examiner Initial*	Cite No	Publication Number	Kind Code ¹	Publication Date	Name of Patentee or Applicant of cited Document	Pages,Columns,Lines where Relevant Passages or Relevant Figures Appear
	1					

If you wish to add additional U.S. Published Application citation information please click the Add button. Add

FOREIGN PATENT DOCUMENTS								Remove
Examiner Initial*	Cite No	Foreign Document Number ³	Country Code ² j	Kind Code ⁴	Publication Date	Name of Patentee or Applicant of cited Document	Pages,Columns,Lines where Relevant Passages or Relevant Figures Appear	T ⁵

INFORMATION DISCLOSURE STATEMENT BY APPLICANT (Not for submission under 37 CFR 1.99)	Application Number		
	Filing Date		
	First Named Inventor	Mohammed N. ISLAM	
	Art Unit		
	Examiner Name		
	Attorney Docket Number	OMNI 0105 PUSP1	

1								<input type="checkbox"/>
---	--	--	--	--	--	--	--	--------------------------

If you wish to add additional Foreign Patent Document citation information please click the Add button **Add**

NON-PATENT LITERATURE DOCUMENTS

Remove

Examiner Initials*	Cite No	Include name of the author (in CAPITAL LETTERS), title of the article (when appropriate), title of the item (book, magazine, journal, serial, symposium, catalog, etc), date, pages(s), volume-issue number(s), publisher, city and/or country where published.	T ⁵
	1	SUN, Y., C.F. Booker, S. Kumari, R.N. Day, M. Davidson, A. Periasamy, "Characterization of an orange acceptor fluorescent protein for sensitized spectral fluorescence resonant energy transfer microscopy using a white-light laser," Journal of Biomedical Optics, Vol. 14, no. 5, paper 054009 (2009).	<input type="checkbox"/>
	2	BORLINGHAUS, R., "Colours Count: how the challenge of fluorescence was solved in confocal microscopy," in Modern Research and Educational Topics in Microscopy, A. Mendez-Vilas and J. Diaz, eds, pp. 890-899, Formatex (2007)	<input type="checkbox"/>
	3	BORLINGHAUS, R., "The White Confocal: Continuous Spectral Tuning in Excitation and Emission," in Optical Fluorescence Microscopy, A. Diaspro (Ed), Chapter 2, pp. 37-54, ISBN 978-3-642-15174-3, Springer-Verlag, Berlin (2011).	<input type="checkbox"/>
	4	BORLINGHAUS, R.T., L. Kuschel, "White Light Laser: The Ultimate Source for Confocal Microscopy," http://www.leica-microsystems.com/science-lab/white-light-laser (June 27, 2012).	<input type="checkbox"/>
	5	ZIEGLER, U., A.G. Bittermann, M. Hoechli, "Introduction to Confocal Laser Scanning Microscopy (LEICA)," www.zmb.unizh.ch , May 29, 2013.	<input type="checkbox"/>
	6		<input type="checkbox"/>

If you wish to add additional non-patent literature document citation information please click the Add button **Add**

EXAMINER SIGNATURE

Examiner Signature		Date Considered	
--------------------	--	-----------------	--

*EXAMINER: Initial if reference considered, whether or not citation is in conformance with MPEP 609. Draw line through a citation if not in conformance and not considered. Include copy of this form with next communication to applicant.

**INFORMATION DISCLOSURE
STATEMENT BY APPLICANT**
(Not for submission under 37 CFR 1.99)

Application Number		
Filing Date		
First Named Inventor	Mohammed N. ISLAM	
Art Unit		
Examiner Name		
Attorney Docket Number	OMNI 0105 PUSP1	

¹ See Kind Codes of USPTO Patent Documents at www.USPTO.GOV or MPEP 901.04. ² Enter office that issued the document, by the two-letter code (WIPO Standard ST.3). ³ For Japanese patent documents, the indication of the year of the reign of the Emperor must precede the serial number of the patent document. ⁴ Kind of document by the appropriate symbols as indicated on the document under WIPO Standard ST.16 if possible. ⁵ Applicant is to place a check mark here if English language translation is attached.

**INFORMATION DISCLOSURE
STATEMENT BY APPLICANT**
(Not for submission under 37 CFR 1.99)

Application Number		
Filing Date		
First Named Inventor	Mohammed N. ISLAM	
Art Unit		
Examiner Name		
Attorney Docket Number	OMNI 0105 PUSP1	

CERTIFICATION STATEMENT

Please see 37 CFR 1.97 and 1.98 to make the appropriate selection(s):

That each item of information contained in the information disclosure statement was first cited in any communication from a foreign patent office in a counterpart foreign application not more than three months prior to the filing of the information disclosure statement. See 37 CFR 1.97(e)(1).

OR

That no item of information contained in the information disclosure statement was cited in a communication from a foreign patent office in a counterpart foreign application, and, to the knowledge of the person signing the certification after making reasonable inquiry, no item of information contained in the information disclosure statement was known to any individual designated in 37 CFR 1.56(c) more than three months prior to the filing of the information disclosure statement. See 37 CFR 1.97(e)(2).

See attached certification statement.

The fee set forth in 37 CFR 1.17 (p) has been submitted herewith.

A certification statement is not submitted herewith.

SIGNATURE

A signature of the applicant or representative is required in accordance with CFR 1.33, 10.18. Please see CFR 1.4(d) for the form of the signature.

Signature	/David S. Bir/	Date (YYYY-MM-DD)	2015-10-01
Name/Print	David S. Bir	Registration Number	38383

This collection of information is required by 37 CFR 1.97 and 1.98. The information is required to obtain or retain a benefit by the public which is to file (and by the USPTO to process) an application. Confidentiality is governed by 35 U.S.C. 122 and 37 CFR 1.14. This collection is estimated to take 1 hour to complete, including gathering, preparing and submitting the completed application form to the USPTO. Time will vary depending upon the individual case. Any comments on the amount of time you require to complete this form and/or suggestions for reducing this burden, should be sent to the Chief Information Officer, U.S. Patent and Trademark Office, U.S. Department of Commerce, P.O. Box 1450, Alexandria, VA 22313-1450. **DO NOT SEND FEES OR COMPLETED FORMS TO THIS ADDRESS. SEND TO: Commissioner for Patents, P.O. Box 1450, Alexandria, VA 22313-1450.**

Privacy Act Statement

The Privacy Act of 1974 (P.L. 93-579) requires that you be given certain information in connection with your submission of the attached form related to a patent application or patent. Accordingly, pursuant to the requirements of the Act, please be advised that: (1) the general authority for the collection of this information is 35 U.S.C. 2(b)(2); (2) furnishing of the information solicited is voluntary; and (3) the principal purpose for which the information is used by the U.S. Patent and Trademark Office is to process and/or examine your submission related to a patent application or patent. If you do not furnish the requested information, the U.S. Patent and Trademark Office may not be able to process and/or examine your submission, which may result in termination of proceedings or abandonment of the application or expiration of the patent.

The information provided by you in this form will be subject to the following routine uses:

1. The information on this form will be treated confidentially to the extent allowed under the Freedom of Information Act (5 U.S.C. 552) and the Privacy Act (5 U.S.C. 552a). Records from this system of records may be disclosed to the Department of Justice to determine whether the Freedom of Information Act requires disclosure of these records.
2. A record from this system of records may be disclosed, as a routine use, in the course of presenting evidence to a court, magistrate, or administrative tribunal, including disclosures to opposing counsel in the course of settlement negotiations.
3. A record in this system of records may be disclosed, as a routine use, to a Member of Congress submitting a request involving an individual, to whom the record pertains, when the individual has requested assistance from the Member with respect to the subject matter of the record.
4. A record in this system of records may be disclosed, as a routine use, to a contractor of the Agency having need for the information in order to perform a contract. Recipients of information shall be required to comply with the requirements of the Privacy Act of 1974, as amended, pursuant to 5 U.S.C. 552a(m).
5. A record related to an International Application filed under the Patent Cooperation Treaty in this system of records may be disclosed, as a routine use, to the International Bureau of the World Intellectual Property Organization, pursuant to the Patent Cooperation Treaty.
6. A record in this system of records may be disclosed, as a routine use, to another federal agency for purposes of National Security review (35 U.S.C. 181) and for review pursuant to the Atomic Energy Act (42 U.S.C. 218(c)).
7. A record from this system of records may be disclosed, as a routine use, to the Administrator, General Services, or his/her designee, during an inspection of records conducted by GSA as part of that agency's responsibility to recommend improvements in records management practices and programs, under authority of 44 U.S.C. 2904 and 2906. Such disclosure shall be made in accordance with the GSA regulations governing inspection of records for this purpose, and any other relevant (i.e., GSA or Commerce) directive. Such disclosure shall not be used to make determinations about individuals.
8. A record from this system of records may be disclosed, as a routine use, to the public after either publication of the application pursuant to 35 U.S.C. 122(b) or issuance of a patent pursuant to 35 U.S.C. 151. Further, a record may be disclosed, subject to the limitations of 37 CFR 1.14, as a routine use, to the public if the record was filed in an application which became abandoned or in which the proceedings were terminated and which application is referenced by either a published application, an application open to public inspections or an issued patent.
9. A record from this system of records may be disclosed, as a routine use, to a Federal, State, or local law enforcement agency, if the USPTO becomes aware of a violation or potential violation of law or regulation.



UNITED STATES PATENT AND TRADEMARK OFFICE

UNITED STATES DEPARTMENT OF COMMERCE
United States Patent and Trademark Office
Address: COMMISSIONER FOR PATENTS
P.O. Box 1450
Alexandria, Virginia 22313-1450
www.uspto.gov

Table with 7 columns: APPLICATION NUMBER, FILING or 371(c) DATE, GRP ART UNIT, FIL FEE REC'D, ATTY. DOCKET NO, TOT CLAIMS, IND CLAIMS. Row 1: 14/875,709, 10/06/2015, 2688, 730, OMNI 0105 PUSPI, 20, 3

CONFIRMATION NO. 7496

FILING RECEIPT

109543
Brooks, Kushman P.C./Cheetah Omni MedSci
1000 Town Center
Twenty Second Floor
Southfield, MI 48075



Date Mailed: 10/26/2015

Receipt is acknowledged of this non-provisional patent application. The application will be taken up for examination in due course. Applicant will be notified as to the results of the examination. Any correspondence concerning the application must include the following identification information: the U.S. APPLICATION NUMBER, FILING DATE, NAME OF APPLICANT, and TITLE OF INVENTION. Fees transmitted by check or draft are subject to collection. Please verify the accuracy of the data presented on this receipt. If an error is noted on this Filing Receipt, please submit a written request for a Filing Receipt Correction. Please provide a copy of this Filing Receipt with the changes noted thereon. If you received a "Notice to File Missing Parts" for this application, please submit any corrections to this Filing Receipt with your reply to the Notice. When the USPTO processes the reply to the Notice, the USPTO will generate another Filing Receipt incorporating the requested corrections

Inventor(s)

Mohammed N. Islam, Ann Arbor, MI;

Applicant(s)

OMNI MEDSCI, INC., Ann Arbor, MI;

Power of Attorney: The patent practitioners associated with Customer Number 109543

Domestic Priority data as claimed by applicant

This application is a CON of 14/108,986 12/17/2013 PAT 9164032 which claims benefit of 61/747,487 12/31/2012

Foreign Applications for which priority is claimed (You may be eligible to benefit from the Patent Prosecution Highway program at the USPTO. Please see http://www.uspto.gov for more information.) - None.

Foreign application information must be provided in an Application Data Sheet in order to constitute a claim to foreign priority. See 37 CFR 1.55 and 1.76.

Permission to Access - A proper Authorization to Permit Access to Application by Participating Offices (PTO/SB/39 or its equivalent) has been received by the USPTO.

If Required, Foreign Filing License Granted: 10/22/2015

The country code and number of your priority application, to be used for filing abroad under the Paris Convention, is US 14/875,709

Projected Publication Date: To Be Determined - pending completion of Corrected Papers

Non-Publication Request: No

Early Publication Request: No

** SMALL ENTITY **

Title

SHORT-WAVE INFRARED SUPER-CONTINUUM LASERS FOR DETECTING COUNTERFEIT OR ILLICIT DRUGS AND PHARMACEUTICAL PROCESS CONTROL

Preliminary Class

369

Statement under 37 CFR 1.55 or 1.78 for AIA (First Inventor to File) Transition Applications: No

PROTECTING YOUR INVENTION OUTSIDE THE UNITED STATES

Since the rights granted by a U.S. patent extend only throughout the territory of the United States and have no effect in a foreign country, an inventor who wishes patent protection in another country must apply for a patent in a specific country or in regional patent offices. Applicants may wish to consider the filing of an international application under the Patent Cooperation Treaty (PCT). An international (PCT) application generally has the same effect as a regular national patent application in each PCT-member country. The PCT process **simplifies** the filing of patent applications on the same invention in member countries, but **does not result** in a grant of "an international patent" and does not eliminate the need of applicants to file additional documents and fees in countries where patent protection is desired.

Almost every country has its own patent law, and a person desiring a patent in a particular country must make an application for patent in that country in accordance with its particular laws. Since the laws of many countries differ in various respects from the patent law of the United States, applicants are advised to seek guidance from specific foreign countries to ensure that patent rights are not lost prematurely.

Applicants also are advised that in the case of inventions made in the United States, the Director of the USPTO must issue a license before applicants can apply for a patent in a foreign country. The filing of a U.S. patent application serves as a request for a foreign filing license. The application's filing receipt contains further information and guidance as to the status of applicant's license for foreign filing.

Applicants may wish to consult the USPTO booklet, "General Information Concerning Patents" (specifically, the section entitled "Treaties and Foreign Patents") for more information on timeframes and deadlines for filing foreign patent applications. The guide is available either by contacting the USPTO Contact Center at 800-786-9199, or it can be viewed on the USPTO website at <http://www.uspto.gov/web/offices/pac/doc/general/index.html>.

For information on preventing theft of your intellectual property (patents, trademarks and copyrights), you may wish to consult the U.S. Government website, <http://www.stopfakes.gov>. Part of a Department of Commerce initiative, this website includes self-help "toolkits" giving innovators guidance on how to protect intellectual property in specific countries such as China, Korea and Mexico. For questions regarding patent enforcement issues, applicants may call the U.S. Government hotline at 1-866-999-HALT (1-866-999-4258).

LICENSE FOR FOREIGN FILING UNDER
Title 35, United States Code, Section 184
Title 37, Code of Federal Regulations, 5.11 & 5.15

GRANTED

The applicant has been granted a license under 35 U.S.C. 184, if the phrase "IF REQUIRED, FOREIGN FILING LICENSE GRANTED" followed by a date appears on this form. Such licenses are issued in all applications where the conditions for issuance of a license have been met, regardless of whether or not a license may be required as set forth in 37 CFR 5.15. The scope and limitations of this license are set forth in 37 CFR 5.15(a) unless an earlier license has been issued under 37 CFR 5.15(b). The license is subject to revocation upon written notification. The date indicated is the effective date of the license, unless an earlier license of similar scope has been granted under 37 CFR 5.13 or 5.14.

This license is to be retained by the licensee and may be used at any time on or after the effective date thereof unless it is revoked. This license is automatically transferred to any related applications(s) filed under 37 CFR 1.53(d). This license is not retroactive.

The grant of a license does not in any way lessen the responsibility of a licensee for the security of the subject matter as imposed by any Government contract or the provisions of existing laws relating to espionage and the national security or the export of technical data. Licensees should apprise themselves of current regulations especially with respect to certain countries, of other agencies, particularly the Office of Defense Trade Controls, Department of State (with respect to Arms, Munitions and Implements of War (22 CFR 121-128)); the Bureau of Industry and Security, Department of Commerce (15 CFR parts 730-774); the Office of Foreign Assets Control, Department of Treasury (31 CFR Parts 500+) and the Department of Energy.

NOT GRANTED

No license under 35 U.S.C. 184 has been granted at this time, if the phrase "IF REQUIRED, FOREIGN FILING LICENSE GRANTED" DOES NOT appear on this form. Applicant may still petition for a license under 37 CFR 5.12, if a license is desired before the expiration of 6 months from the filing date of the application. If 6 months has lapsed from the filing date of this application and the licensee has not received any indication of a secrecy order under 35 U.S.C. 181, the licensee may foreign file the application pursuant to 37 CFR 5.15(b).

SelectUSA

The United States represents the largest, most dynamic marketplace in the world and is an unparalleled location for business investment, innovation, and commercialization of new technologies. The U.S. offers tremendous resources and advantages for those who invest and manufacture goods here. Through SelectUSA, our nation works to promote and facilitate business investment. SelectUSA provides information assistance to the international investor community; serves as an ombudsman for existing and potential investors; advocates on behalf of U.S. cities, states, and regions competing for global investment; and counsels U.S. economic development organizations on investment attraction best practices. To learn more about why the United States is the best country in the world to develop technology, manufacture products, deliver services, and grow your business, visit <http://www.SelectUSA.gov> or call +1-202-482-6800.

PATENT APPLICATION FEE DETERMINATION RECORD

Substitute for Form PTO-875

Application or Docket Number
14/875,709

APPLICATION AS FILED - PART I

(Column 1) (Column 2)

FOR	NUMBER FILED	NUMBER EXTRA
BASIC FEE (37 CFR 1.16(a), (b), or (c))	N/A	N/A
SEARCH FEE (37 CFR 1.16(k), (l), or (m))	N/A	N/A
EXAMINATION FEE (37 CFR 1.16(o), (p), or (q))	N/A	N/A
TOTAL CLAIMS (37 CFR 1.16(j))	20	minus 20 = *
INDEPENDENT CLAIMS (37 CFR 1.16(h))	3	minus 3 = *
APPLICATION SIZE FEE (37 CFR 1.16(s))	If the specification and drawings exceed 100 sheets of paper, the application size fee due is \$310 (\$155 for small entity) for each additional 50 sheets or fraction thereof. See 35 U.S.C. 41(a)(1)(G) and 37 CFR 1.16(s).	
MULTIPLE DEPENDENT CLAIM PRESENT (37 CFR 1.16(j))		

* If the difference in column 1 is less than zero, enter "0" in column 2.

SMALL ENTITY

RATE(\$)	FEE(\$)
N/A	70
N/A	300
N/A	360
x 40 =	0.00
x 210 =	0.00
	0.00
	0.00
TOTAL	730

OR OTHER THAN SMALL ENTITY

RATE(\$)	FEE(\$)
N/A	
N/A	
N/A	
TOTAL	

APPLICATION AS AMENDED - PART II

(Column 1) (Column 2) (Column 3)

AMENDMENT A	CLAIMS REMAINING AFTER AMENDMENT		HIGHEST NUMBER PREVIOUSLY PAID FOR	PRESENT EXTRA
	Total (37 CFR 1.16(i))	*	Minus	**
Independent (37 CFR 1.16(h))	*	Minus	***	=
Application Size Fee (37 CFR 1.16(s))				
FIRST PRESENTATION OF MULTIPLE DEPENDENT CLAIM (37 CFR 1.16(j))				

SMALL ENTITY

RATE(\$)	ADDITIONAL FEE(\$)
x =	
x =	
TOTAL ADD'L FEE	

OR OTHER THAN SMALL ENTITY

RATE(\$)	ADDITIONAL FEE(\$)
x =	
x =	
TOTAL ADD'L FEE	

(Column 1) (Column 2) (Column 3)

AMENDMENT B	CLAIMS REMAINING AFTER AMENDMENT		HIGHEST NUMBER PREVIOUSLY PAID FOR	PRESENT EXTRA
	Total (37 CFR 1.16(i))	*	Minus	**
Independent (37 CFR 1.16(h))	*	Minus	***	=
Application Size Fee (37 CFR 1.16(s))				
FIRST PRESENTATION OF MULTIPLE DEPENDENT CLAIM (37 CFR 1.16(j))				

SMALL ENTITY

RATE(\$)	ADDITIONAL FEE(\$)
x =	
x =	
TOTAL ADD'L FEE	

OR OTHER THAN SMALL ENTITY

RATE(\$)	ADDITIONAL FEE(\$)
x =	
x =	
TOTAL ADD'L FEE	

* If the entry in column 1 is less than the entry in column 2, write "0" in column 3.
 ** If the "Highest Number Previously Paid For" IN THIS SPACE is less than 20, enter "20".
 *** If the "Highest Number Previously Paid For" IN THIS SPACE is less than 3, enter "3".
 The "Highest Number Previously Paid For" (Total or Independent) is the highest found in the appropriate box in column 1.



UNITED STATES PATENT AND TRADEMARK OFFICE

UNITED STATES DEPARTMENT OF COMMERCE
United States Patent and Trademark Office
Address: COMMISSIONER FOR PATENTS
P.O. Box 1450
Alexandria, Virginia 22313-1450
www.uspto.gov

Table with 4 columns: APPLICATION NUMBER (14/875,709), FILING OR 371(C) DATE (10/06/2015), FIRST NAMED APPLICANT (Mohammed N. Islam), ATTY. DOCKET NO./TITLE (OMNI 0105 PUSP1)

CONFIRMATION NO. 7496

FORMALITIES LETTER



109543
Brooks, Kushman P.C./Cheetah Omni MedSci
1000 Town Center
Twenty Second Floor
Southfield, MI 48075

Date Mailed: 10/26/2015

NOTICE TO FILE CORRECTED APPLICATION PAPERS

Filing Date Granted

An application number and filing date have been accorded to this application. The application is informal since it does not comply with the regulations for the reason(s) indicated below. Applicant is given TWO MONTHS from the date of this Notice within which to correct the informalities indicated below. Extensions of time may be obtained by filing a petition accompanied by the extension fee under the provisions of 37 CFR 1.136(a).

The required item(s) identified below must be timely submitted to avoid abandonment:

- A substitute specification in compliance with 37 CFR 1.52, 1.121(b)(3), and 1.125, is required. The substitute specification must be submitted with markings and be accompanied by a clean version (without markings) as set forth in 37 CFR 1.125(c) and a statement that the substitute specification contains no new matter (see 37 CFR 1.125(b)). The specification, claims, and/or abstract page(s) submitted is not acceptable and cannot be scanned or properly stored because:
- The application contains drawings, but the specification does not contain a brief description of the several views of the drawings as required by 37 CFR 1.74 and 37 CFR 1.77(b)(9).
- Replacement drawings in compliance with 37 CFR 1.84 and 37 CFR 1.121(d) are required. The drawings submitted are not acceptable because:
- More than one figure is present and each figure is not labeled "Fig." with a consecutive Arabic numeral (1, 2, etc.) or an Arabic numeral and capital letter in the English alphabet (A, B, etc.)(see 37 CFR 1.84(u)(1)). See Figure(s) 9. A brief description of the several views of the drawings (see 37 CFR 1.74) should be added or amended to correspond to the corrected numbering of the figures. See also 37 CFR 1.77(b)(9).

Applicant is cautioned that correction of the above items may cause the specification and drawings page count to exceed 100 pages. If the specification and drawings exceed 100 pages, applicant will need to submit the required application size fee.

Replies must be received in the USPTO within the set time period or must include a proper Certificate of Mailing or Transmission under 37 CFR 1.8 with a mailing or transmission date within the set time period. For more information and a suggested format, see Form PTO/SB/92 and MPEP 512.

Replies should be mailed to:

Mail Stop Missing Parts
Commissioner for Patents
P.O. Box 1450
Alexandria VA 22313-1450

Registered users of EFS-Web may alternatively submit their reply to this notice via EFS-Web, including a copy of this Notice and selecting the document description "Applicant response to Pre-Exam Formalities Notice".
<https://portal.uspto.gov/authenticate/AuthenticateUserLocalEPF.html>

For more information about EFS-Web please call the USPTO Electronic Business Center at 1-866-217-9197 or visit our website at <http://www.uspto.gov/ebc>.

If you are not using EFS-Web to submit your reply, you must include a copy of this notice.

Questions about the contents of this notice and the requirements it sets forth should be directed to the Office of Data Management, Application Assistance Unit, at **(571) 272-4000** or **(571) 272-4200** or **1-888-786-0101**.

/tnnguyen/

IN THE UNITED STATES PATENT AND TRADEMARK OFFICE

In re application of:

Mohammed N. ISLAM

Serial No.: 14/875,709

Filed: October 6, 2015

For: SHORT-WAVE INFRARED SUPER-CONTINUUM LASERS
FOR DETECTING COUNTERFEIT OR ILLICIT DRUGS AND
PHARMACEUTICAL PROCESS CONTROL

Group Art Unit: 2688

Examiner:

Attorney Docket No.: OMNI 0105 PUSP1

RESPONSE TO NOTICE TO FILE CORRECTED PAPERS

Mail Stop Issue Fee
Commissioner for Patents
U.S. Patent and Trademark Office
P.O. Box 1450
Alexandria, VA 22313-1450

Commissioner:

In response to the Notice to File Corrected Application Papers mailed October 26, 2015, Applicant submits herewith a substitute specification with markings accompanied by a clean version (without markings) so that the Brief Description of the Drawings identifies Figures 9A and 9B. The previously submitted drawings have been reviewed and are believed to meet the requirements with respect to each figure being labeled "Fig." with a consecutive Arabic numeral and capital letter in the English alphabet. No new matter has been added.

Please charge any fees or credit any overpayments as a result of the filing of this paper to our Deposit Account No. 02-3978.

Respectfully submitted,

Mohammed N. ISLAM

By: /David S. Bir/

David S. Bir

Reg. No. 38,383

Attorney/Agent for Applicant

Date: November 3, 2015

BROOKS KUSHMAN P.C.
1000 Town Center, 22nd Floor
Southfield, MI 48075-1238
Phone: 248-358-4400
Fax: 248-358-3351

Electronic Acknowledgement Receipt

EFS ID:	23969261
Application Number:	14875709
International Application Number:	
Confirmation Number:	7496
Title of Invention:	SHORT-WAVE INFRARED SUPER-CONTINUUM LASERS FOR DETECTING COUNTERFEIT OR ILLICIT DRUGS AND PHARMACEUTICAL PROCESS CONTROL
First Named Inventor/Applicant Name:	Mohammed N. Islam
Customer Number:	109543
Filer:	David S. Bir/Pamela Demos
Filer Authorized By:	David S. Bir
Attorney Docket Number:	OMNI 0105 PUSP1
Receipt Date:	03-NOV-2015
Filing Date:	06-OCT-2015
Time Stamp:	16:46:57
Application Type:	Utility under 35 USC 111(a)

Payment information:

Submitted with Payment	no
------------------------	----

File Listing:

Document Number	Document Description	File Name	File Size(Bytes)/ Message Digest	Multi Part /.zip	Pages (if appl.)
1	Specification	Specification_Marked_Up_Copy.pdf	233167 <small>1e354df1fb9fa0a4e2f57d541436234f9aa8d ea6</small>	no	41

Warnings:

Information:

2	Specification	Specification_Clean_Copy.pdf	233069	no	41
			99462ab6a858d8c0f7781b2796318fc6a3a727c5		
Warnings:					
Information:					
3	Miscellaneous Incoming Letter	Response_to_Notice_to_File_Corrected_Papers.pdf	18297	no	2
			19b272dee993763cdfef4f47cfb7f6f7b1d72c6f		
Warnings:					
Information:					
Total Files Size (in bytes):			484533		

This Acknowledgement Receipt evidences receipt on the noted date by the USPTO of the indicated documents, characterized by the applicant, and including page counts, where applicable. It serves as evidence of receipt similar to a Post Card, as described in MPEP 503.

New Applications Under 35 U.S.C. 111

If a new application is being filed and the application includes the necessary components for a filing date (see 37 CFR 1.53(b)-(d) and MPEP 506), a Filing Receipt (37 CFR 1.54) will be issued in due course and the date shown on this Acknowledgement Receipt will establish the filing date of the application.

National Stage of an International Application under 35 U.S.C. 371

If a timely submission to enter the national stage of an international application is compliant with the conditions of 35 U.S.C. 371 and other applicable requirements a Form PCT/DO/EO/903 indicating acceptance of the application as a national stage submission under 35 U.S.C. 371 will be issued in addition to the Filing Receipt, in due course.

New International Application Filed with the USPTO as a Receiving Office

If a new international application is being filed and the international application includes the necessary components for an international filing date (see PCT Article 11 and MPEP 1810), a Notification of the International Application Number and of the International Filing Date (Form PCT/RO/105) will be issued in due course, subject to prescriptions concerning national security, and the date shown on this Acknowledgement Receipt will establish the international filing date of the application.

SHORT-WAVE INFRARED SUPER-CONTINUUM LASERS FOR DETECTING
COUNTERFEIT OR ILLICIT DRUGS AND PHARMACEUTICAL PROCESS CONTROL

CROSS-REFERENCE TO RELATED APPLICATIONS

[0001] This application is a continuation of U.S. application Serial No. 14/108,986 filed December 17, 2013, which claims the benefit of U.S. provisional application Serial No. 61/747,487 filed December 31, 2012, the disclosures of which are hereby incorporated in their entirety by reference herein.

[0002] This application is related to U.S. provisional applications Serial Nos. 61/747,477 filed December 31, 2012; Serial No. 61/747,481 filed December 31, 2012; Serial No. 61/747,485 filed December 31, 2012; Serial No. 61/747,472 filed December 31, 2012; Serial No. 61/747,492 filed December 31, 2012; Serial No. 61/747,553 filed December 31, 2012; and Serial No. 61/754,698 filed January 21, 2013, the disclosures of which are hereby incorporated in their entirety by reference herein.

[0003] This application is also related to International Application No. PCT/US2013/075700 (Publication No. WO/2014/105520) entitled Near-Infrared Lasers For Non-Invasive Monitoring Of Glucose, Ketones, HBA1C, And Other Blood Constituents; International Application PCT/US2013/075736 (Publication No. WO/2014/105521) entitled Short-Wave Infrared Super-Continuum Lasers For Early Detection Of Dental Caries; U.S. Application 14/108,995 (Publication No. 2014/0188092) entitled Focused Near-Infrared Lasers For Non-Invasive Vasectomy And Other Thermal Coagulation Or Occlusion Procedures; International Application PCT/US2013/075767 (Publication No. WO/2014/143276) entitled Short-Wave Infrared Super-Continuum Lasers For Natural Gas Leak Detection, Exploration, And Other Active Remote Sensing Applications; U.S. Application 14/108,974 (Publication No. 2014/0188094) entitled Non-Invasive Treatment Of Varicose Veins; and U.S. Application 14/109,007 (Publication No. 2014/0236021) entitled Near-Infrared Super-Continuum Lasers For Early Detection Of Breast And Other Cancers, the disclosures of which are hereby incorporated in their entirety by reference herein.

BACKGROUND AND SUMMARY

[0004] Counterfeiting of pharmaceuticals is a significant issue in the healthcare community as well as for the pharmaceutical industry worldwide. For example, according to the World Health Organization, in 2006 the market for counterfeit drugs worldwide was estimated at around \$43 Billion. Moreover, the use of counterfeit medicines may result in treatment failure or even death. For instance, in 1995 dozens of children in Haiti and Nigeria died after taking counterfeit medicinal syrups that contained diethylene glycol, an industrial solvent. As another example, in Asia one report estimated that 90% of Viagra sold in Shanghai, China, was counterfeit. With more pharmaceuticals being purchased through the internet, the problem of counterfeit drugs coming from across the borders into the United States has been growing rapidly.

[0005] A rapid, non-destructive, non-contact optical method for screening or identification of counterfeit pharmaceuticals is needed. Spectroscopy using near-infrared or short-wave infrared (SWIR) light may provide such a method, because most pharmaceuticals comprise organic compounds that have overtone or combination absorption bands in this wavelength range (e.g., between approximately 1-2.5 microns). Moreover, most drug packaging materials are at least partially transparent in the near-infrared or SWIR, so that drug compositions may be detected and identified through the packaging non-destructively. Also, using a near-infrared or SWIR light source with a spatially coherent beam permits screening at stand-off or remote distances. Beyond identifying counterfeit drugs, the near-infrared or SWIR spectroscopy may have many other beneficial applications. For example, spectroscopy may be used for rapid screening of illicit drugs or to implement process analytical technology in pharmaceutical manufacturing. There are also a wide array of applications in assessment of quality in the food industry, including screening of fruit, vegetables, grains and meats.

[0006] In one embodiment, a near-infrared or SWIR super-continuum (SC) source may be used as the light source for spectroscopy, active remote sensing, or hyper-spectral imaging. One embodiment of the SWIR light source may be an all-fiber integrated SWIR SC source, which leverages the mature technologies from the telecommunications and fiber optics industry. Exemplary fiber-based super-continuum sources may emit light in the near-infrared or SWIR

between approximately 1.4-1.8 microns, 2-2.5 microns, 1.4-2.4 microns, 1-1.8 microns, or any number of other bands. In particular embodiments, the detection system may be a dispersive spectrometer, a Fourier transform infrared spectrometer, or a hyper-spectral imaging detector or camera. In addition, reflection or diffuse reflection light spectroscopy may be implemented using the SWIR light source, where the spectral reflectance can be the ratio of reflected energy to incident energy as a function of wavelength.

[0007] In one embodiment, a measurement system includes a light source configured to generate an output optical beam comprising one or more semiconductor sources configured to generate an input beam, one or more optical amplifiers configured to receive at least a portion of the input beam and to deliver an intermediate beam to an output end of the one or more optical amplifiers, and one or more optical fibers configured to receive at least a portion of the intermediate beam and to deliver at least the portion of the intermediate beam to a distal end of the one or more optical fibers to form a first optical beam. A nonlinear element is configured to receive at least a portion of the first optical beam and to broaden a spectrum associated with the at least a portion of the first optical beam to at least 10nm through a nonlinear effect in the nonlinear element to form the output optical beam with an output beam broadened spectrum, wherein at least a portion of the output beam broadened spectrum comprises a short-wave infrared wavelength between approximately 1400 nanometers and approximately 2500 nanometers, and wherein at least a portion of the one or more fibers is a fused silica fiber with a core diameter less than approximately 400 microns. A measurement apparatus is configured to receive a received portion of the output optical beam and to deliver a delivered portion of the output optical beam to a sample for a non-destructive and non-contact measurement, wherein the delivered portion of the output optical beam is configured to generate a spectroscopy output beam from the sample. A receiver is configured to receive at least a portion of the spectroscopy output beam having a bandwidth of at least 10 nanometers and to process the portion of the spectroscopy output beam to generate an output signal, and wherein at least a part of the delivered portion of the output optical beam is at least partially transmitting through a packaging material covering at least a part of the sample, and wherein the output signal is based on a chemical composition of the sample.

[0008] In another embodiment, a measurement system includes a light source configured to generate an output optical beam comprising a plurality of semiconductor sources configured to generate an input optical beam, a multiplexer configured to receive at least a portion of the input optical beam and to form an intermediate optical beam, and one or more fibers configured to receive at least a portion of the intermediate optical beam and to form the output optical beam, wherein the output optical beam comprises one or more optical wavelengths. A measurement apparatus is configured to receive a received portion of the output optical beam and to deliver a delivered portion of the output optical beam to a sample, wherein the delivered portion of the output optical beam is configured to generate a spectroscopy output beam from the sample. A receiver is configured to receive at least a portion of the spectroscopy output beam and to process the portion of the spectroscopy output beam to generate an output signal, wherein the receiver comprises a Fourier transform infrared (FTIR) spectrometer or a dispersive spectrometer, and wherein at least a part of the delivered portion of the output optical beam is at least partially transmitting through a packaging material covering at least a part of the sample.

[0009] In yet another embodiment, a method of measuring includes generating an output optical beam comprising generating an input optical beam from a plurality of semiconductor sources, multiplexing at least a portion of the input optical beam and forming an intermediate optical beam, and guiding at least a portion of the intermediate optical beam and forming the output optical beam, wherein the output optical beam comprises one or more optical wavelengths. The method may also include receiving a received portion of the output optical beam and delivering a delivered portion of the output optical beam to a sample, wherein the sample comprises an organic compound with an overtone or combinational absorption band in the wavelength range between approximately 1 micron and approximately 2.5 microns. The method may further include generating a spectroscopy output beam having a bandwidth of at least 10 nanometers from the sample using a Fourier transform infrared (FTIR) spectrometer or a dispersive spectrometer, receiving at least a portion of the spectroscopy output beam, and processing the portion of the spectroscopy output beam and generating an output signal.

[0010] With the growing obesity epidemic, the number of individuals with diabetes is increasing dramatically. For example, there are over 200 million people who have diabetes.

Diabetes control requires monitoring of the glucose level, and most glucose measuring systems available commercially require drawing of blood. Depending on the severity of the diabetes, a patient may have to draw blood and measure glucose four to six times a day. This may be extremely painful and inconvenient for many people. In addition, for some groups, such as soldiers in the battlefield, it may be dangerous to have to measure periodically their glucose level with finger pricks.

[0011] Thus, there is an unmet need for non-invasive glucose monitoring (e.g., monitoring glucose without drawing blood). The challenge has been that a non-invasive system requires adequate sensitivity and selectivity, along with repeatability of the results. Yet, this is a very large market, with an estimated annual market of over \$10B in 2011 for self-monitoring of glucose levels.

[0012] One approach to non-invasive monitoring of blood constituents or blood analytes is to use near-infrared spectroscopy, such as absorption spectroscopy or near-infrared diffuse reflection or transmission spectroscopy. Some attempts have been made to use broadband light sources, such as tungsten lamps, to perform the spectroscopy. However, several challenges have arisen in these efforts. First, many other constituents in the blood also have signatures in the near-infrared, so spectroscopy and pattern matching, often called spectral fingerprinting, is required to distinguish the glucose with sufficient confidence. Second, the non-invasive procedures have often transmitted or reflected light through the skin, but skin has many spectral artifacts in the near-infrared that may mask the glucose signatures. Moreover, the skin may have significant water and blood content. These difficulties become particularly complicated when a weak light source is used, such as a lamp. More light intensity can help to increase the signal levels, and, hence, the signal-to-noise ratio.

[0013] As described in this disclosure, by using brighter light sources, such as fiber-based supercontinuum lasers, super-luminescent laser diodes, light-emitting diodes or a number of laser diodes, the near-infrared signal level from blood constituents may be increased. By shining light through the teeth, which have fewer spectral artifacts than skin in the near-infrared, the blood constituents may be measured with less interfering artifacts. Also, by using pattern matching in spectral fingerprinting and various software techniques, the signatures from different constituents in the blood may be identified. Moreover, value-add services may be provided by wirelessly

communicating the monitored data to a handheld device such as a smart phone, and then wirelessly communicating the processed data to the cloud for storing, processing, and transmitting to several locations.

[0014] In various embodiments, a measurement system includes a light source configured to generate an output optical beam that includes one or more semiconductor sources configured to generate an input beam, one or more optical amplifiers configured to receive at least a portion of the input beam and to output an intermediate beam from at least one of the one or more optical amplifiers; and one or more optical fibers configured to receive at least a portion of the intermediate beam and to communicate at least part of the portion of the intermediate beam to a distal end of the one or more optical fibers to form a first optical beam. The light source may also include a nonlinear element configured to receive at least a portion of the first optical beam and to broaden a spectrum associated with the at least a portion of the first optical beam to at least 10nm through a nonlinear effect in the nonlinear element to form the output optical beam with an output beam broadened spectrum. The at least a portion of the output beam broadened spectrum comprises a near-infrared wavelength between approximately 700nm and approximately 2500nm, and at least a portion of the one or more fibers is a fused silica fiber with a core diameter less than approximately 400 microns. The system may also include a measurement apparatus configured to receive a received portion of the output optical beam and to deliver to a sample an analysis output beam, which is a delivered portion of the output optical beam and wherein the delivered portion of the output optical beam is a spatially coherent beam, and a receiver configured to receive and process at least a portion of the analysis output beam reflected or transmitted from the sample having a bandwidth of at least 10 nanometers and to generate an output signal. In addition, a personal device comprising a wireless receiver, a wireless transmitter, a display, a microphone, a speaker, one or more buttons or knobs, a microprocessor and a touch screen may be configured to receive and process at least a portion of the output signal, wherein the personal device is configured to store and display the processed output signal, wherein at least a portion of the processed output signal is configured to be transmitted over a wireless transmission link.

[0015] In another embodiment, a measurement system includes a light source comprising a plurality of semiconductor sources configured to generate an output optical beam with one or more

optical wavelengths, wherein at least a portion of the one or more optical wavelengths is a near-infrared wavelength between 700 nanometers and 2500 nanometers. A measurement apparatus is configured to receive a received portion of the output optical beam and to deliver to a sample an analysis output beam, which is a delivered portion of the output optical beam; and a receiver is configured to receive and process at least a portion of the analysis output beam reflected or transmitted from the sample and to generate an output signal. The system includes a personal device comprising a wireless receiver, a wireless transmitter, a display, a microphone, a speaker, one or more buttons or knobs, a microprocessor and a touch screen, the personal device configured to receive and process at least a portion of the output signal, wherein the personal device is configured to store and display the processed output signal, and wherein at least a portion of the processed output signal is configured to be transmitted over a wireless transmission link, and a remote device configured to receive over the wireless transmission link a received output status comprising the at least a portion of the processed output signal, to buffer the received output status, to process the received output status to generate processed data and to store the processed data.

[0016] Other embodiments may include a measurement system comprising a wearable measurement device for measuring one or more physiological parameters, including a light source comprising a plurality of semiconductor sources configured to generate an output optical beam with one or more optical wavelengths, wherein at least a portion of the one or more optical wavelengths is a near-infrared wavelength between 700 nanometers and 2500 nanometers. The wearable measurement device is configured to receive a received portion of the output optical beam and to deliver to a sample an analysis output beam, which is a delivered portion of the output optical beam. The wearable measurement device further comprises a receiver configured to receive and process at least a portion of the analysis output beam reflected or transmitted from the sample and to generate an output signal. The system also includes a personal device comprising a wireless receiver, a wireless transmitter, a display, a microphone, a speaker, one or more buttons or knobs, a microprocessor and a touch screen, the personal device configured to receive and process at least a portion of the output signal, wherein the personal device is configured to store and display the processed output signal, and wherein at least a portion of the processed output signal is configured to be transmitted over a wireless transmission link and a remote device configured to receive over the

wireless transmission link a received output status comprising the at least a portion of the processed output signal, to buffer the received output status, to process the received output status to generate processed data and to store the processed data, and wherein the remote device is capable of storing a history of at least a portion of the received output status over a specified period of time.

BRIEF DESCRIPTION OF THE DRAWINGS

[0017] For a more complete understanding of the present disclosure, and for further features and advantages thereof, reference is now made to the following description taken in conjunction with the accompanying drawings, in which:

[0018] FIGURE 1 shows the absorbance for two common plastics, polyethylene and polystyrene.

[0019] FIGURE 2 illustrates one example of the difference in near-infrared spectrum between an authentic tablet and a counterfeit tablet.

[0020] FIGURE 3 shows the second derivative of the spectral comparison of Prozac and a similarly formulated generic.

[0021] FIGURE 4 illustrates an example of the near infrared spectra for different pure components of a studied drug.

[0022] FIGURE 5 shows the mid-wave infrared and long-wave infrared absorption spectra for various illicit drugs.

[0023] FIGURE 6 shows the absorbance versus wavelength in the near-infrared region for four classes of illegal drugs.

[0024] FIGURE 7 illustrates the diffuse reflectance near-infrared spectrum of heroin samples.

[0025] FIGURE 8 illustrates the diffuse reflectance near-infrared spectra of different seized illicit drugs containing heroin of different concentrations, along with the spectrum for pure heroin.

[0026] ~~FIGURE 9 lists~~ FIGURES 9A and 9B list possible band assignments for the various spectral features in pure heroin.

[0027] FIGURE 10 shows the diffuse reflectance near-infrared spectra of different compounds that may be frequently employed as cutting agents.

[0028] FIGURE 11 provides one example of a flow-chart in the process analytical technology for the pharmaceutical industry.

[0029] FIGURE 12 illustrates the typical near-infrared spectra of a variety of excipients.

[0030] FIGURE 13 exemplifies the absorbance from the blending process of a pharmaceutical compound.

[0031] FIGURE 14 shows what might be an eventual flow-chart of a smart manufacturing process.

[0032] FIGURE 15A illustrates the near-infrared reflectance spectrum of wheat flour.

[0033] FIGURE 15B shows the near-infrared absorbance spectra obtained in diffusion reflectance mode for a series of whole 'Hass' avocado fruit.

[0034] FIGURE 16A is a schematic diagram of the basic elements of an imaging spectrometer.

[0035] FIGURE 16B illustrates one example of a typical imaging spectrometer used in hyper-spectral imaging systems.

[0036] FIGURE 17 shows one example of the Fourier transform infrared spectrometer.

[0037] FIGURE 18 exemplifies a dual-beam experimental set-up that may be used to subtract out (or at least minimize the adverse effects of) light source fluctuations.

[0038] FIGURE 19 illustrates a block diagram or building blocks for constructing high power laser diode assemblies.

[0039] FIGURE 20 shows a platform architecture for different wavelength ranges for an all-fiber-integrated, high powered, super-continuum light source.

[0040] FIGURE 21 illustrates one embodiment for a short-wave infrared super-continuum light source.

[0041] FIGURE 22 shows the output spectrum from the SWIR SC laser of FIGURE 21 when about a 10m length of fiber for SC generation is used. This fiber is a single-mode, non-dispersion shifted fiber that is optimized for operation near 1550nm.

[0042] FIGURE 23 illustrates high power SWIR-SC lasers that may generate light between approximately 1.4-1.8 microns (top) or approximately 2-2.5 microns (bottom).

[0043] FIGURE 24 schematically shows a medical measurement device as part of a personal or body area network that communicates with another device (e.g., smart phone or tablet) that communicates with the cloud. The cloud may in turn communicate information with the user, healthcare providers, or other designated recipients.

DETAILED DESCRIPTION

[0044] As required, detailed embodiments of the present disclosure are described herein; however, it is to be understood that the disclosed embodiments are merely exemplary of the disclosure that may be embodied in various and alternative forms. The figures are not necessarily to scale; some features may be exaggerated or minimized to show details of particular components. Therefore, specific structural and functional details disclosed herein are not to be interpreted as limiting, but merely as a representative basis for teaching one skilled in the art to variously employ the present disclosure.

[0045] One advantage of optical systems is that they can perform non-contact, stand-off or remote sensing distance spectroscopy of various materials. As an example, optical systems can be used for identification of counterfeit drugs, detection of illicit drugs, or process control in the pharmaceutical industry, especially when the sensing is to be done at remote or stand-off distances in

a non-contact, rapid manner. In general, the near-infrared region of the electromagnetic spectrum covers between approximately 0.7 microns (700nm) to about 2.5 microns (2500nm). However, it may also be advantageous to use just the short-wave infrared (SWIR) between approximately 1.4 microns (1400nm) and about 2.5 microns (2500nm). One reason for preferring the SWIR over the entire NIR may be to operate in the so-called “eye safe” window, which corresponds to wavelengths longer than about 1400nm. Therefore, for the remainder of the disclosure the SWIR will be used for illustrative purposes. However, it should be clear that the discussion that follows could also apply to using the near infrared – NIR -- wavelength range, or other wavelength bands.

[0046] In particular, wavelengths in the eye safe window may not transmit down to the retina of the eye, and therefore, these wavelengths may be less likely to create permanent eye damage from inadvertent exposure. The near-infrared wavelengths have the potential to be dangerous, because the eye cannot see the wavelengths (as it can in the visible), yet they can penetrate and cause damage to the eye. Even if a practitioner is not looking directly at the laser beam, the practitioner’s eyes may receive stray light from a reflection or scattering some surface. Hence, it can always be a good practice to use eye protection when working around lasers. Since wavelengths longer than about 1400nm are substantially not transmitted to the retina or substantially absorbed in the retina, this wavelength range is known as the eye safe window. For wavelengths longer than 1400nm, in general only the cornea of the eye may receive or absorb the light radiation.

[0047] The SWIR wavelength range may be particularly valuable for identifying materials based on their chemical composition because the wavelength range comprises overtones and combination bands for numerous chemical bonds. For example, in the SWIR numerous hydrocarbon chemical compounds have overtone and combinational bands, along with oxygen-hydrogen and carbon-oxygen compounds. Thus, gases, liquids and solids that comprise these chemical compounds may exhibit spectral features in the SWIR wavelength range. In a particular embodiment, the spectra of organic compounds may be dominated by the C-H stretch. The C-H stretch fundamental occurs near 3.4 microns, the first overtone is near 1.7 microns, and a combination band occurs near 2.3 microns.

[0048] One embodiment of remote sensing that is used to identify and classify various materials is so-called “hyper-spectral imaging.” Hyper-spectral sensors may collect information as a set of images, where each image represents a range of wavelengths over a spectral band. Hyper-spectral imaging may deal with imaging narrow spectral bands over an approximately continuous spectral range. As an example, in hyper-spectral imaging a lamp may be used as the light source. However, the incoherent light from a lamp may spatially diffract rapidly, thereby making it difficult to perform spectroscopy at stand-off distances or remote distances. Therefore, it would be advantageous to have a broadband light source covering the SWIR that may be used in place of a lamp to identify or classify materials in remote sensing or stand-off detection applications.

[0049] As used throughout this document, the term “couple” and or “coupled” refers to any direct or indirect communication between two or more elements, whether or not those elements are physically connected to one another. As used throughout this disclosure, the term “spectroscopy” means that a tissue or sample is inspected by comparing different features, such as wavelength (or frequency), spatial location, transmission, absorption, reflectivity, scattering, fluorescence, refractive index, or opacity. In one embodiment, “spectroscopy” may mean that the wavelength of the light source is varied, and the transmission, absorption, fluorescence, or reflectivity of the tissue or sample is measured as a function of wavelength. In another embodiment, “spectroscopy” may mean that the wavelength dependence of the transmission, absorption, fluorescence or reflectivity is compared between different spatial locations on a tissue or sample. As an illustration, the “spectroscopy” may be performed by varying the wavelength of the light source, or by using a broadband light source and analyzing the signal using a spectrometer, wavemeter, or optical spectrum analyzer.

[0050] As used throughout this document, the term “fiber laser” refers to a laser or oscillator that has as an output light or an optical beam, wherein at least a part of the laser comprises an optical fiber. For instance, the fiber in the “fiber laser” may comprise one of or a combination of a single mode fiber, a multi-mode fiber, a mid-infrared fiber, a photonic crystal fiber, a doped fiber, a gain fiber, or, more generally, an approximately cylindrically shaped waveguide or light-pipe. In one embodiment, the gain fiber may be doped with rare earth material, such as ytterbium, erbium, and/or thulium. In another embodiment, the mid-infrared fiber may comprise one or a combination of fluoride fiber, ZBLAN fiber, chalcogenide fiber, tellurite fiber, or germanium doped fiber. In yet

another embodiment, the single mode fiber may include standard single-mode fiber, dispersion shifted fiber, non-zero dispersion shifted fiber, high-nonlinearity fiber, and small core size fibers.

[0051] As used throughout this disclosure, the term “pump laser” refers to a laser or oscillator that has as an output light or an optical beam, wherein the output light or optical beam is coupled to a gain medium to excite the gain medium, which in turn may amplify another input optical signal or beam. In one particular example, the gain medium may be a doped fiber, such as a fiber doped with ytterbium, erbium and/or thulium. In one embodiment, the “pump laser” may be a fiber laser, a solid state laser, a laser involving a nonlinear crystal, an optical parametric oscillator, a semiconductor laser, or a plurality of semiconductor lasers that may be multiplexed together. In another embodiment, the “pump laser” may be coupled to the gain medium by using a fiber coupler, a dichroic mirror, a multiplexer, a wavelength division multiplexer, a grating, or a fused fiber coupler.

[0052] As used throughout this document, the term “super-continuum” and or “supercontinuum” and or “SC” refers to a broadband light beam or output that comprises a plurality of wavelengths. In a particular example, the plurality of wavelengths may be adjacent to one-another, so that the spectrum of the light beam or output appears as a continuous band when measured with a spectrometer. In one embodiment, the broadband light beam may have a bandwidth of at least 10nm. In another embodiment, the “super-continuum” may be generated through nonlinear optical interactions in a medium, such as an optical fiber or nonlinear crystal. For example, the “super-continuum” may be generated through one or a combination of nonlinear activities such as four-wave mixing, parametric amplification, the Raman effect, modulational instability, and self-phase modulation.

[0053] As used throughout this disclosure, the terms “optical light” and or “optical beam” and or “light beam” refer to photons or light transmitted to a particular location in space. The “optical light” and or “optical beam” and or “light beam” may be modulated or unmodulated, which also means that they may or may not contain information. In one embodiment, the “optical light” and or “optical beam” and or “light beam” may originate from a fiber, a fiber laser, a laser, a light emitting diode, a lamp, a pump laser, or a light source.

[0054] As used throughout this disclosure, the term “remote sensing” may include the measuring of properties of an object from a distance, without physically sampling the object, for example by detection of the interactions of the object with an electromagnetic field. In one embodiment, the electromagnetic field may be in the optical wavelength range, including the infrared or SWIR. One particular form of remote sensing may be stand-off detection, which may range exemplary from non-contact up to hundreds of meters away.

IDENTIFICATION OF COUNTERFEIT DRUGS

[0055] Pharmaceutical counterfeiting is a growing and significant issue for the healthcare community as well as the pharmaceutical industry worldwide. As a result of counterfeiting, users may be threatened by substandard drug quality or harmful ingredients, and legitimate companies may lose significant revenues. The definition for “counterfeit drug” by the World Health Organization was as follows: “A counterfeit medicine is one which is deliberately and fraudulently mislabeled with respect to identity and/or source. Counterfeiting can apply to both branded and generic products and counterfeit products may include products with the correct ingredients or with the wrong ingredients, without active ingredients, with insufficient active ingredient or with fake packaging.” Later this definition was slightly modified, “Counterfeiting in relation to medicinal products means the deliberate and fraudulent mislabeling with respect to the identity, composition and/or source of a finished medicinal product, or ingredient for the preparation of a medicinal product.”

[0056] A rapid screening technique such as near-infrared or SWIR spectroscopy could aid in the search for and identification of counterfeit drugs. In particular, using a non-lamp based light source could lead to contact-free control and analysis of drugs. In a particular embodiment, remote sensing, stand-off detection, or hyper-spectral imaging may be used for process control or counterfeit drug identification in a factory or manufacturing setting, or in a retail, wholesale, or warehouse setting. In one embodiment, the light source for remote sensing may direct the light beam toward the region of interest (e.g., conveyor belt, stocking shelves, boxes or cartons, etc), and the diffuse reflected light may then be measured using a detection system. Various kinds of SWIR light sources will be discussed later in this disclosure. The detection system may comprise, in one embodiment, a spectrometer followed by one or more detectors. In another embodiment, the

detection system may be a dispersive element (examples include prisms, gratings, or other wavelength separators) followed by one or more detectors or detector arrays. In yet another embodiment, the detection system may comprise a Fourier transform infrared spectrometer. These are merely specific examples of the detection system, but combinations of these or other detection systems may also be used and are contemplated within the scope of this disclosure.

[0057] For monitoring drugs, the SWIR light source and the detection system could be used in transmission, reflection, fluorescence, or diffuse reflection. Also, different system configurations may also be used and are included in the scope of this disclosure. For example, the light source and detection system may be placed in a fixed location, and for reflection the light source and detectors may be close to one another, while for transmission the light source and detectors may be at different locations. The region of interest may be surveyed, and the light beam may also be scanned to cover an area larger than the light source beam. In yet another embodiment, the system could be placed on a vehicle such as an automobile or a truck, or the light source could be placed on one vehicle, while the detection system is on another vehicle. If the light source and detection system are compact and lightweight, they might even be carried by a person in the field, either in their hands or in a backpack.

[0058] Another advantage of using the near-infrared or SWIR is that most drug packaging materials are at least partially transparent in this wavelength range, so that drug compositions may be detected and identified through the packaging non-destructively. As an example, SWIR light could be used to see through plastics, since the signature for plastics can be subtracted off and there are large wavelength windows where the plastics are transparent. FIGURE 1 illustrates the absorbance 100 for two common plastics: polyethylene 101 and polystyrene 102. Because of the hydro-carbon bonds, there are absorption features near 1.7 microns and 2.2-2.5 microns. In general, the absorption bands in the near infrared are due to overtones and combination bands for various functional group vibrations, including signals from C-H, O-H, C=O, N-H, -COOH, and aromatic C-H groups. It may be difficult to assign an absorption band to a specific functional group due to overlapping of several combinations and overtones. However, with advancements in computational power and chemometrics or multivariate analysis methods, complex systems may be better analyzed. In one embodiment, using software analysis tools the absorption spectrum may be converted to its second

derivative equivalent. The spectral differences may permit a fast, accurate, non-destructive and reliable identification of materials. Although particular derivatives are discussed, other mathematical manipulations may be used in the analysis, and these other techniques are also intended to be covered by this disclosure.

[0059] Spectroscopy in the near-infrared or SWIR may be sensitive to both the chemical and physical nature of the sample composition and may be performed rapidly with minimal sample preparation. For example, near-infrared or SWIR spectroscopy may be used to study the homogeneity of powder samples, particle size determinations, product composition, the determination of the concentrations and distribution of components in solid tablets and content uniformity, among other applications. In yet other embodiments, applications include tablet identification, determination of moisture, residual solvents, active ingredient potency, the study of blending operations, and the detection of capsule tampering.

[0060] FIGURE 2 illustrates one example of the difference in near-infrared spectrum 200 between an authentic tablet and a counterfeit tablet. Two grades of film coated tablets comprising drugs were investigated: curve 201 is the genuine drug, while 202 is a counterfeit drug. These two grades of capsules have noticeably different contents, and the differences are apparent in the near-infrared or SWIR spectra. In some cases the differences may not be as distinct. For these cases, more signal processing may be necessary to distinguish between samples.

[0061] In another embodiment, it may be advantageous to take a first, second or higher order derivative to elucidate the difference between real and counterfeit drugs. For example, FIGURE 3 shows the second derivative 300 of the spectral comparison of Prozac 301 and a similarly formulated generic 302, which had a fluoxetine hydrochloride (10mg). Although the reflectance curves from the two samples are close and, therefore, difficult to distinguish, the second derivative of the data helps to bring out the differences more clearly. Although a second derivative is used in this example, any number of signal processing algorithms and methods may be used, and these are also intended to be covered by this disclosure. For example, partial least square algorithms, multivariate data analysis, principal component analysis, or chemometric software may be implemented without departing from the scope of this disclosure.

[0062] In yet another embodiment, near-infrared or SWIR spectroscopy may be used to measure and calibrate various pharmaceutical formulations based on the active pharmaceutical ingredients and excipients. An excipient may be a pharmacologically inactive substance used as a carrier for the active ingredients of a medication. In some cases, the active substance may not be easily administered and/or absorbed by the human body; in such cases the active ingredient may be dissolved into or mixed with an excipient. Also, excipients are also sometimes used to bulk up formulations that contain very potent active ingredients, to allow for convenient and accurate dosage. In addition to their use in the single-dosage quantity, excipients can be used in the manufacturing process to aid in the handling of the active substance concerned.

[0063] FIGURE 4 shows an example of the near-infrared spectra 400 for different pure components of a studied drug. The spectrum for the active pharmaceutical ingredient (API) 401 is plotted, along with the spectra for five different excipients 402, 403, 404, 405 and 406. Each spectrum has been baseline shifted to avoid overlapping. The near-infrared spectra have been obtained by averaging the spectra of each pixel of an area of a hyper-spectral image. As FIGURE 4 shows, each of the chemical compositions have a distinct spectrum, and the composition of a drug may be decomposed into its constitutive ingredients. These are just some examples of how near-infrared or SWIR spectroscopy may be applied to counterfeit drug detection, but other methods and analysis techniques may also be used without departing from the scope of this disclosure. As one other example, once the active pharmaceutical ingredient and the excipients spectral distribution of a drug formulation are understood, feedback may be provided of this information to the drug development stages.

RAPID SCREENING FOR ILLICIT DRUGS

[0064] Thus, FIGURES 2-4 show that near-infrared or SWIR spectroscopy may be used to identify counterfeit drugs. More generally, various materials including illicit drugs, explosives, fertilizers, vegetation, and paints have features in the near-infrared and SWIR that can be used to identify the various samples, and these applications are also intended to be within the scope of this disclosure. Although stronger features may be found in the mid-infrared, the near-infrared may be easier to measure due to higher quality detection systems, more mature fiber optics and light sources,

and transmission through atmospheric transmission windows. Because of these distinct spectral signatures, these materials could also be detected using active remote sensing, hyper-spectral imaging, or near-infrared or SWIR spectroscopy. As just another example, illicit drugs may be detectable using remote sensing, hyper-spectral imaging, or near-infrared spectroscopy. FIGURE 5 shows the mid-wave infrared and long-wave infrared absorption spectra 500 for various illicit drugs. The absorbance for cocaine 501, methamphetamine 502, MDMA (ecstasy) 503, and heroin 504 are plotted versus wavelength from approximately 2.5-20 microns. Although the fundamental resonances for these drugs may lie in the longer wavelength regions, there are corresponding overtones and combination bands in the SWIR and near-infrared wavelength range. Therefore, the active remote sensing, hyper-spectral imaging, or near-infrared or SWIR spectroscopy techniques described herein may also be applicable to detecting illicit drugs from aircraft, vehicles, or hand held devices.

[0065] The diffuse reflectance technique may be useful with near-infrared or SWIR spectroscopy for rapid identification of illegal drugs due to simple handling and simple use of a search data library created using near-infrared diffuse reflectance. For instance, FIGURE 6 illustrates the absorbance 600 versus wavelength in the near-infrared region for four classes of illegal drugs. In particular, the spectra are shown for methamphetamine (MA) 601, amphetamine (AP) 602, MDMA (street name: ecstasy) 603, and MDA (street name: the love drug) 604. Each of the illegal drugs have unique spectral features in the near-infrared and SWIR. Also, comparing the mid-infrared spectrum for MDMA (503 in FIGURE 5) with the near-infrared spectrum for MDMA (603 in FIGURE 6), it seems clear that the near-infrared region shows overtones and combination bands that should be discernible. Referring to FIGURE 6, sample identification may be accomplished by using the region (indicated by the arrows) where the spectral absorptions may provide specific peaks depending on the drug component.

[0066] In another embodiment, FIGURE 7 shows the diffuse reflectance near-infrared spectrum 700 of heroin samples. Heroin, the 3,6-diacetyl derivative of morphine (hence diacetylmorphine) is an opiate drug synthesized from morphine, which is usually a naturally occurring substance extracted from the seedpod of certain varieties of poppy plants. In particular, 701 is the near-infrared spectrum for an illicit street drug sample, while 702 is the spectra for a pure heroin

standard. The difference between the spectra may arise at least in part from cutting agents. The inset 703 shows the molecular structure for heroin. As in the other examples, the absorption in the near-infrared range is caused by overtone and combination vibrations of O-H, C-H, N-H and C=O groups, which exhibit their fundamental molecular stretching and bending absorption in the mid-infrared range (c.f., the mid-infrared spectrum for heroin is shown 504 in FIGURE 5). These overtone and combination bands do not behave in a simple way, making the near-infrared spectra complex and harder to directly interpret. Also, although the near-infrared signatures may be weaker in magnitude, they are probably easier to detect in the near-infrared, and the sample preparation may also be much simpler in the near-infrared. Moreover, for remote sensing, the near-infrared may be preferable because of atmospheric transmission windows between approximately 1.4-1.8 microns and 2-2.5 microns.

[0067] Pure heroin may be a white powder with a bitter taste that is rarely sold on the streets, while illicit heroin may be a powder varying in color from white to dark brown due to impurities left from the manufacturing process or the presence of additives. The purity of street heroin may also vary widely, as the drug can be mixed with other white powders. The impurity of the drug may often make it difficult to gauge the strength of the dosage, which runs the risk of overdose. One nice feature of near-infrared or SWIR spectroscopy is that the technique may be used in a non-destructive, non-contact manner to determine rapidly the concentration of compounds present in complex samples at percentage levels with very little sample preparation. In a particular embodiment, FIGURE 8 illustrates the diffuse reflectance near-infrared spectra 800 of different seized illicit drugs containing heroin (between 10.7 and 21.8%) compared with the spectrum of pure heroin 801. Curve 802 is for 21.8% by weight, curve 803 is 13.2% by weight, curve 804 is 17% by weight, and curve 805 is 10.7% by weight of heroin. The spectra have been shifted along the vertical axis to better illustrate the differences.

[0068] Although quite complex in the near-infrared, it may be possible to identify from the pure heroin near-infrared spectrum (801 in FIGURE 8 or 702 in FIGURE 7) the main wavelengths related to the most common functional groups in heroin. For example, FIGURE 9 lists possible band assignments 900 for the various spectral features in pure heroin. As can be seen from FIGURE 9,

the absorption in the near-infrared may be mainly due to overtone and combination bands associated with O-H, C-H, N-H and C=O groups.

[0069] As can be appreciated from FIGURE 8, there may be significant differences between the spectrum of pure heroin and sample spectra. These differences may be due to the presence of different compounds used as cutting agents, which can affect the shape and intensity of the near-infrared signals. FIGURE 10 illustrates the diffuse reflectance near-infrared spectra 1000 of different compounds that may be frequently employed as cutting agents. In the bottom of FIGURE 10 are shown the spectra 1008 for pure heroin and the spectra 1007 for a seized illicit street drug sample comprising 21.8% of heroin. The spectra for various cutting agents include: 1001 for flour, 1002 for talcum powder, 1003 for chalk, 1004 for acetylsalicylic acid, 1005 for caffeine, and 1006 for paracetamol. Thus, near-infrared or SWIR spectroscopy may be used to work back to the composition of an unknown drug. Although particular examples of counterfeit and illicit drugs have been described, the near-infrared or SWIR spectroscopy (including diffuse reflectance, reflectance, fluorescence or transmission) may also be applied to the identification of other drugs and substances without departing from the scope of this disclosure. This spectroscopy may be used non-destructively and non-contact over stand-off distances or in remote sensing distances, whether from an airborne, vehicle, hand-held, or stationary platform.

PROCESS ANALYTICAL TECHNOLOGY (PAT)

[0070] One definition of process analytical technology, PAT, is “a system for designing, analyzing and controlling manufacturing through timely evaluations (i.e., during processing) of significant quality and performance attributes of raw and in-process materials and processes, with the goal of ensuring final product quality.” Near-infrared or SWIR spectroscopy may have applications in the PAT of the pharmaceutical industry by providing, for example, quantitative analysis of multiple components in a sample and in pack quantification of drugs in formulation, as well as quality of a drug and quality control of complex excipients used in formulation. The PAT process may benefit from near-infrared or SWIR spectroscopy for some steps, such as: raw material identification, active pharmaceutical ingredient applications, drying, granulation, blend uniformity and content uniformity. Some of the strengths of near-infrared or SWIR spectroscopy include:

radiation has good penetration properties, and, thus, minimal sample preparation may be required; measurement results may be obtained rapidly, and simultaneous measurements may be obtained for several parameters; non-destructive methods with little or no chemical waste; and organic chemicals that comprise most pharmaceutical products have unique spectra in the near-infrared and SWIR ranges, for example.

[0071] FIGURE 11 shows one example of a flow-chart 1100 in the PAT for the pharmaceutical industry. While the center shows the steps of the manufacturing process 1101, the top and bottom sides show where near-infrared spectroscopy could be applicable for lab use 1102 (top) or in process monitoring control 1103 (bottom). Indeed, near-infrared or SWIR spectroscopy has the potential to benefit almost every step in the manufacturing process. Just to provide a few examples of using near-infrared or SWIR spectroscopy in the PAT process, the raw material testing and blending process will be examined briefly.

[0072] At the commencement of manufacture of a drug product, it may be required to identify the correct material and grade of the pharmaceutical excipients to be used in the formulation. FIGURE 12 illustrates the typical near-infrared spectra 1200 for a variety of excipients. Included in the graph 1200 are spectra for: magnesium stearate 1201, sorbitol 1202, mannitol 1203, talc 1204, lactose 1205, starch 1206, maltodextrin 1207, and microcrystalline cellulose 1208. A suitable spectral database may be used to rapidly identify and qualify excipients. One nice aspect of the spectroscopy is that the near-infrared and SWIR are sensitive to both the physical and chemical characteristics of the samples.

[0073] One of the next steps in the manufacture of a dosage form is the blending together of the active component with the excipients to produce a homogeneous blend. In one embodiment, the near-infrared or SWIR spectroscopy apparatus may comprise a fiber-optic probe, which may, for example, interface with the blending vessel. For such a fiber-optic probe, near infrared or SWIR spectra may be collected in real-time from a blending process. FIGURE 13 exemplifies the absorbance 1300 from the blending process. Although the initial spectra 1301 shows differences from the eventual spectra, as the process continues the blend converges to the final spectra 1302 and continues to overlap that spectra. Similar converging or overlapping spectra may also be used to

check the product uniformity at the end of the process. The near-infrared spectra may be acquired in real-time; and, using appropriate data pre-processing and chemometric analysis, blend homogeneity plots may be derived, such as 1300.

[0074] One goal of the manufacturing process and PAT may be the concept of a “smart” manufacturing process, which may be a system or manufacturing operation responding to analytical data generated in real-time. Such a system may also have an in-built “artificial intelligence” as decisions may be made whether to continue a manufacturing operation. For example, with respect to the raw materials, integration of the quality measurement into smart manufacturing processes could be used to improve manufacturing operations by ensuring that the correct materials of the appropriate quality are used in the manufacture. Similarly, a smart blender would be under software control and would respond to the real-time spectral data collected.

[0075] FIGURE 14 illustrates what might be an eventual flow-chart 1400 of a smart manufacturing process. The manufacturing process 1401 may have as input the process feed 1402 and result in a process output 1403. A process controller 1404 may at least partially control the manufacturing process 1401, and the controller 1404 may receive inputs from the closed loop control (process parameters) 1405 as well as the on-line monitoring of process parameters 1406. The feedback loops in the process could refine the manufacturing process 1401 and improve the quality of the process output 1403. These are particular embodiments of the use of near-infrared or SWIR spectroscopy in the PAT of the pharmaceutical industry, but other variations, combinations, and methods may also be used and are intended to be covered by this disclosure.

[0076] The discussion thus far has centered on use of near-infrared or SWIR spectroscopy in applications such as identification of counterfeit drugs, detection of illicit drugs, and pharmaceutical process control. Although drugs and pharmaceuticals are one example, many other fields and applications may also benefit from the use of near infrared or SWIR spectroscopy, and these may also be implemented without departing from the scope of this disclosure. As just another example, near-infrared or SWIR spectroscopy may also be used as an analytic tool for food quality and safety control. Applications in food safety and quality assessment include contaminant detection, defect identification, constituent analysis, and quality evaluation. The techniques described in this

disclosure are particularly valuable when non-destructive testing is desired at stand-off or remote distances.

[0077] In one example, near-infrared or SWIR spectroscopy may be used in cereal breeding. The breeding purposes may require knowledge on both composition and functional properties of grain, while the functionality of wheat grain is an issue for wheat breeders. Most of the wheat functionality parameters depend on the protein-proteinase complex of wheat grain, as well as the condition of the carbohydrate complex. FIGURE 15A illustrates the near-infrared reflectance spectrum 1500 of wheat flour. Since these samples are complex in composition, several organic bonds involving hydrogen vibrate to produce overlapped spectral bands. Thus, the resulting spectrum 1500 appears like a wavy line without clearly defined features. Analytical methods based on this type of spectroscopy may have the potential to improve the quality of final cereal products by testing the products through the entire production process in the processing industry.

[0078] In yet another embodiment, near-infrared or SWIR spectroscopy may be used for the assessment of fruit and vegetable quality. Most commercial quality classification systems for fruit and vegetables are based on external features of the product, such as shape, color, size, weight and blemishes. However, the external appearance of most fruit is generally not an accurate guide to the internal eating quality of the fruit. As an example, for avocado fruit the external color is not a maturity characteristic, and its smell is too weak and appears later in its maturity stage. Analysis of the near-infrared or SWIR absorption spectra may provide qualitative and quantitative determination of many constituents and properties of horticulture produce, including oil, water, protein, pH, acidity, firmness, and soluble solids content or total soluble solids of fresh fruits. FIGURE 15B shows the near-infrared absorbance spectra 1550 obtained in diffusion reflectance mode for a series of whole 'Hass' avocado fruit. Four oil absorption bands are near 2200-2400nm (CH_2 stretch bend and combinations), with weaker absorption around 750nm, 1200nm, and 900-930nm ranges. On the other hand, near 1300-1750nm range may be useful for determining the protein and oil content. The 900-920nm absorbance band may be useful for sugar determination. Although described in the context of grains, fruits, and vegetables, the near-infrared or SWIR spectroscopy may also be valuable for other food quality control and assessment, such as measuring the properties of meats. These and other applications also fall within the scope of this disclosure.

DETECTION SYSTEMS

[0079] The near-infrared or SWIR spectroscopy system, remote sensing system or hyper-spectral imaging system may be on an airborne platform, mounted on a vehicle, a stationary transmission or reflection set-up, or even held by a human for a compact system. For such a system, there are fundamentally two hardware parts: the transmitter or light source and the detection system. Between the two, perhaps in a transmission or reflection setting, may be the sample being tested or measured. Moreover, the output from the detection system may go to a computational system, comprising computers or other processing equipment. The output from the computational system may be displayed graphically as well as with numerical tables and perhaps an identification of the material composition. These are just some of the parts of the systems, but other elements may be added or be eliminated, and these modified configurations are also intended to be covered by this disclosure.

[0080] By use of an active illuminator, a number of advantages may be achieved. First, stand-off or remote distances may be achieved if a non-lamp system is used – i.e., if the beam does not rapidly diffract. Also, higher signal-to-noise ratios may be achieved. For example, one way to improve the signal-to-noise ratio would be to use modulation and lock-in techniques. In one embodiment, the light source may be modulated, and then the detection system would be synchronized with the light source. In a particular embodiment, the techniques from lock-in detection may be used, where narrow band filtering around the modulation frequency may be used to reject noise outside the modulation frequency. In another embodiment, change detection schemes may be used, where the detection system captures the signal with the light source on and with the light source off. Again, for this system the light source may be modulated. Then, the signal with and without the light source is differenced. Change detection may help to identify objects that change in the field of view. In the following some exemplary detection systems are described.

[0081] In one embodiment, a SWIR camera or infrared camera system may be used to capture the images. The camera may include one or more lenses on the input, which may be adjustable. The focal plane assemblies may be made from mercury cadmium telluride material (HgCdTe), and the detectors may also include thermo-electric coolers. Alternately, the image sensors may be made from indium gallium arsenide (InGaAs), and CMOS transistors may be

connected to each pixel of the InGaAs photodiode array. The camera may interface wirelessly or with a cable (e.g., USB, Ethernet cable, or fiber optics cable) to a computer or tablet or smart phone, where the images may be captured and processed. These are a few examples of infrared cameras, but other SWIR or infrared cameras may be used and are intended to be covered by this disclosure.

[0082] In another embodiment, an imaging spectrometer may be used to detect the light received from the sample. For example, FIGURE 16A shows a schematic diagram 1600 of the basic elements of an imaging spectrometer. The input light 1601 from the sample may first be directed by a scanning mirror and/or other optics 1602. An optical dispersing element 1603, such as a grating or prism, in the spectrometer may split the light into many narrow, adjacent wavelength bands, which may then be passed through imaging optics 1604 onto one or more detectors or detector arrays 1605. Some sensors may use multiple detector arrays to measure hundreds of narrow wavelength bands.

[0083] An example of a typical imaging spectrometer 1650 used in hyper-spectral imaging systems is illustrated in FIGURE 16B. In this particular embodiment, the input light may be directed first by a tunable mirror 1651. A front lens 1652 may be placed before the entrance slit 1653 and the collector lens 1654. In this embodiment, the dispersing element is a holographic grating with a prism 1655, which separates the different wavelength bands. Then, a camera lens 1656 may be used to image the wavelengths onto a detector or camera 1657.

[0084] FIGURES 16 provide particular examples, but some of the elements may not be used, or other elements may be added, and these are also intended to be covered by this disclosure. For instance, a scanning spectrometer may be used before the detector, where a grating or dispersive element is scanned to vary the wavelength being measured by the detector. In yet another embodiment, filters may be used before one or more detectors to select the wavelengths or wavelength bands to be measured. This may be particularly useful if only a few bands or wavelengths are to be measured. The filters may be dielectric filters, Fabry-Perot filters, absorption or reflection filters, fiber gratings, or any other wavelength selective filter. In one embodiment, a wavelength division multiplexer, WDM, may be used followed by one or more detectors or detector arrays. One example of a planar wavelength division multiplexer may be a waveguide grating router or an arrayed waveguide grating. The WDM may be fiber coupled, and detectors may be placed

directly at the output or the detectors may be coupled through fibers to the WDM. Some of these components may also be combined with the configurations in FIGURE 16.

[0085] While the above detection systems could be categorized as single path detection systems, it may be advantageous in some cases to use multi-path detection systems. In one embodiment, a detection system from a Fourier transform infrared spectrometer, FTIR, may be used. The received light may be incident on a particular configuration of mirrors, called a Michelson interferometer, that allows some wavelengths to pass through but blocks others due to wave interference. The beam may be modified for each new data point by moving one of the mirrors, which changes the set of wavelengths that pass through. This collected data is called an interferogram. The interferogram is then processed, typically on a computing system, using an algorithm called the Fourier transform. One advantageous feature of FTIR is that it may simultaneously collect spectral data in a wide spectral range.

[0086] FIGURE 17 illustrates one example of the FTIR spectrometer 1700. Light from the near-infrared or SWIR light source 1701 may be collimated and directed to a beam splitter 1702. In one embodiment, the beam splitter 1702 may be a 50:50 beam splitter. One portion of the beam 1703 may be reflected toward a stationary mirror 1704, while the other portion of the beam 1705 may be transmitted towards a moving mirror 1706. Light may be reflected from the two mirrors 1704, 1706 back to the beam splitter 1702, and then a portion of the recombined beam 1707 may be directed toward the sample 1708. The recombined beam 1707 may be focused onto the sample 1708, in one embodiment. On leaving the sample 1708, the light may be refocused or at least collected at a detector 1709. A background interferogram may be obtained by using the set-up 1700 without a sample in the chamber 1708. When a sample is inserted into 1708, the background interferogram may be modulated by the presence of absorption bands in the sample. The FTIR spectrometer may have several advantages compared to a scanning (dispersive) spectrometer. Since all the wavelengths may be collected simultaneously, the FTIR may result in a higher signal-to-noise ratio for a given scan time or a shorter scan time for a given resolution. Moreover, unlike a spectrometer where a slit may limit the amount of the beam detected, the FTIR may accommodate the entire diameter of the beam coming from the light source 1701. The configuration 1700 is one

example of an FTIR, but other configurations may also be used, and these are also intended to be covered by this disclosure.

[0087] In yet another example of multi-beam detection systems, a dual-beam set-up 1800 such as in FIGURE 18 may be used to subtract out (or at least minimize the adverse effects of) light source fluctuations. In one embodiment, the output from an SC source 1801 may be collimated using a CaF₂ lens 1802 and then focused into the entrance slit of the monochromator 1803. At the exit slit, light at the selected wavelength is collimated again and may be passed through a polarizer 1804 before being incident on a calcium fluoride beam splitter 1805. After passing through the beam splitter 1805, the light is split into a sample 1806 and reference 1807 arm to enable ratiometric detection that may cancel out effects of intensity fluctuations in the SC source 1801. The light in the sample arm 1806 passes through the sample of interest and is then focused onto a HgCdTe detector 1808 connected to a pre-amp. A chopper 1802 and lock-in amplifier 1810 setup enable low noise detection of the sample arm signal. The light in the reference arm 1807 passes through an empty container (cuvette, gas cell etc.) of the same kind as used in the sample arm. A substantially identical detector 1809, pre-amp and lock-in amplifier 1810 is used for detection of the reference arm signal. The signal may then be analyzed using a computer system 1811. This is one particular example of a method to remove fluctuations from the light source, but other components may be added and other configurations may be used, and these are also intended to be covered by this disclosure.

[0088] Although particular examples of detection systems have been described, combinations of these systems or other systems may also be used, and these are also within the scope of this disclosure. As one example, environmental fluctuations (such as turbulence or winds) may lead to fluctuations in the beam for active remote sensing or hyper-spectral imaging. A configuration such as FIGURE 18 may be able to remove the effect of environmental fluctuations. Yet another technique may be to “wobble” the light beam after the light source using a vibrating mirror. The motion may lead to the beam moving enough to wash out spatial fluctuations within the beam waist at the sample or detection system. If the vibrating mirror is scanned faster than the integration time of the detectors, then the spatial fluctuations in the beam may be integrated out. Alternately, some sort of synchronous detection system may be used, where the detection is synchronized to the vibrating frequency.

LIGHT SOURCES FOR SWIR AND NEAR INFRARED

[0089] There are a number of light sources that may be used in the near infrared. To be more specific, the discussion below will consider light sources operating in the short wave infrared (SWIR), which may cover the wavelength range of approximately 1400nm to 2500nm. Other wavelength ranges may also be used for the applications described in this disclosure, so the discussion below is merely provided for exemplary types of light sources. The SWIR wavelength range may be valuable for a number of reasons. The SWIR corresponds to a transmission window through water and the atmosphere. Also, the so-called “eye-safe” wavelengths are wavelengths longer than approximately 1400nm as previously described.

[0090] Different light sources may be selected for the SWIR based on the needs of the application. Some of the features for selecting a particular light source include power or intensity, wavelength range or bandwidth, spatial or temporal coherence, spatial beam quality for focusing or transmission over long distance, and pulse width or pulse repetition rate. Depending on the application, lamps, light emitting diodes (LEDs), laser diodes (LD’s), tunable LD’s, super-luminescent laser diodes (SLDs), fiber lasers or super-continuum sources (SC) may be advantageously used. Also, different fibers may be used for transporting the light, such as fused silica fibers, plastic fibers, mid-infrared fibers (e.g., tellurite, chalcogenides, fluorides, ZBLAN, etc), or a hybrid of these fibers.

[0091] Lamps may be used if low power or intensity of light is required in the SWIR, and if an incoherent beam is suitable. In one embodiment, in the SWIR an incandescent lamp that can be used is based on tungsten and halogen, which have an emission wavelength between approximately 500nm to 2500nm. For low intensity applications, it may also be possible to use thermal sources, where the SWIR radiation is based on the black body radiation from the hot object. Although the thermal and lamp based sources are broadband and have low intensity fluctuations, it may be difficult to achieve a high signal-to-noise ratio due to the low power levels. Also, the lamp based sources tend to be energy inefficient.

[0092] In another embodiment, LED's can be used that have a higher power level in the SWIR wavelength range. LED's also produce an incoherent beam, but the power level can be higher than a lamp and with higher energy efficiency. Also, the LED output may more easily be modulated, and the LED provides the option of continuous wave or pulsed mode of operation. LED's are solid state components that emit a wavelength band that is of moderate width, typically between about 20nm to 40nm. There are also so-called super-luminescent LEDs that may even emit over a much wider wavelength range. In another embodiment, a wide band light source may be constructed by combining different LEDs that emit in different wavelength bands, some of which could preferably overlap in spectrum. One advantage of LEDs as well as other solid state components is the compact size that they may be packaged into.

[0093] In yet another embodiment, various types of laser diodes may be used in the SWIR wavelength range. Just as LEDs may be higher in power but narrower in wavelength emission than lamps and thermal sources, the LDs may be yet higher in power but yet narrower in wavelength emission than LEDs. Different kinds of LDs may be used, including Fabry-Perot LDs, distributed feedback (DFB) LDs, distributed Bragg reflector (DBR) LDs. Since the LDs have relatively narrow wavelength range (typically under 10nm), in one embodiment a plurality of LDs may be used that are at different wavelengths in the SWIR. The various LDs may be spatially multiplexed, polarization multiplexed, wavelength multiplexed, or a combination of these multiplexing methods. Also, the LDs may be fiber pig-tailed or have one or more lenses on the output to collimate or focus the light. Another advantage of LDs is that they may be packaged compactly and may have a spatially coherent beam output. Moreover, tunable LDs that can tune over a range of wavelengths are also available. The tuning may be done by varying the temperature, or electrical current may be used in particular structures such as distributed Bragg reflector LDs. In another embodiment, external cavity LDs may be used that have a tuning element, such as a fiber grating or a bulk grating, in the external cavity.

[0094] In another embodiment, super-luminescent laser diodes may provide higher power as well as broad bandwidth. An SLD is typically an edge emitting semiconductor light source based on super-luminescence (e.g., this could be amplified spontaneous emission). SLDs combine the higher power and brightness of LDs with the low coherence of conventional LEDs, and the emission band

for SLD's may be 5nm to 100nm wide, preferably in the 60nm to 100nm range. Although currently SLDs are commercially available in the wavelength range of approximately 400nm to 1700nm, SLDs could and may in the future be made that cover a broader region of the SWIR.

[0095] In yet another embodiment, high power LDs for either direct excitation or to pump fiber lasers and SC light sources may be constructed using one or more laser diode bar stacks. FIGURE 19 shows an example block diagram 1900 with building blocks for constructing the high power LDs. In this embodiment, one or more diode bar stacks 1901 may be used, where the diode bar stack may be an array of several single emitter LDs. Since the fast axis (e.g., vertical direction) may be nearly diffraction limited while the slow-axis (e.g., horizontal axis) may be far from diffraction limited, different collimators 1902 may be used for the two axes.

[0096] The brightness may be increased by spatially combining the beams from multiple stacks 1903. The combiner may include spatial interleaving, wavelength multiplexing, or a combination of the two. Different spatial interleaving schemes may be used, such as using an array of prisms or mirrors with spacers to bend one array of beams into the beam path of the other. In another embodiment, segmented mirrors with alternate high-reflection and anti-reflection coatings may be used. Moreover, the brightness may be increased by polarization beam combining 1904 the two orthogonal polarizations, such as by using a polarization beam splitter. In a particular embodiment, the output may then be focused or coupled into a large diameter core fiber. As an example, typical dimensions for the large diameter core fiber range from diameters of approximately 100 microns to 400 microns or more. Alternatively or in addition, a custom beam shaping module 1905 may be used, depending on the particular application. For example, the output of the high power LD may be used directly 1906, or it may be fiber coupled 1907 to combine, integrate, or transport the high power LD energy. These high power LDs may grow in importance because the LD powers can rapidly scale up. For example, instead of the power being limited by the power available from a single emitter, the power may increase in multiples depending on the number of diodes multiplexed and the size of the large diameter fiber. Although FIGURE 19 is shown as one embodiment, some or all of the elements may be used in a high power LD, or additional elements may also be used.

SWIR SUPER-CONTINUUM LASERS

[0097] Each of the light sources described above have particular strengths, but they also may have limitations. For example, there is typically a trade-off between wavelength range and power output. Also, sources such as lamps, thermal sources, and LEDs produce incoherent beams that may be difficult to focus to a small area and may have difficulty propagating for long distances. An alternative source that may overcome some of these limitations is an SC light source. Some of the advantages of the SC source may include high power and intensity, wide bandwidth, spatially coherent beam that can propagate nearly transform limited over long distances, and easy compatibility with fiber delivery.

[0098] Supercontinuum lasers may combine the broadband attributes of lamps with the spatial coherence and high brightness of lasers. By exploiting a modulational instability initiated supercontinuum (SC) mechanism, an all-fiber-integrated SC laser with no moving parts may be built using commercial-off-the-shelf (COTS) components. Moreover, the fiber laser architecture may be a platform where SC in the visible, near-infrared/SWIR, or mid-IR can be generated by appropriate selection of the amplifier technology and the SC generation fiber. But until recently, SC lasers were used primarily in laboratory settings since typically large, table-top, mode-locked lasers were used to pump nonlinear media such as optical fibers to generate SC light. However, those large pump lasers may now be replaced with diode lasers and fiber amplifiers that gained maturity in the telecommunications industry.

[0099] In one embodiment, an all-fiber-integrated, high-powered SC light source 2000 may be elegant for its simplicity (FIGURE 20). The light may be first generated from a seed laser diode 2001. For example, the seed LD 2001 may be a distributed feedback (DFB) laser diode with a wavelength near 1542nm or 1550 nm, with approximately 0.5–2.0ns pulsed output, and with a pulse repetition rate between one kilohertz to about 100MHz or more. The output from the seed laser diode may then be amplified in a multiple-stage fiber amplifier 2002 comprising one or more gain fiber segments. In a particular embodiment, the first stage pre-amplifier 2003 may be designed for optimal noise performance. For example, the pre-amplifier 2003 may be a standard erbium-doped fiber amplifier or an erbium/ytterbium doped cladding pumped fiber amplifier. Between amplifier

stages 2003 and 2006, it may be advantageous to use band-pass filters 2004 to block amplified spontaneous emission and isolators 2005 to prevent spurious reflections. Then, the power amplifier stage 2006 may use a cladding-pumped fiber amplifier that may be optimized to minimize nonlinear distortion. The power amplifier fiber 2006 may also be an erbium-doped fiber amplifier, if only low or moderate power levels are to be generated.

[0100] The SC generation 2007 may occur in the relatively short lengths of fiber that follow the pump laser. Exemplary SC fiber lengths may range from a few millimeters to 100m or more. In one embodiment, the SC generation may occur in a first fiber 2008 where the modulational-instability initiated pulse break-up occurs primarily, followed by a second fiber 2009 where the SC generation and spectral broadening occurs primarily.

[0101] In one embodiment, one or two meters of standard single-mode fiber (SMF) after the power amplifier stage may be followed by several meters of SC generation fiber. For this example, in the SMF the peak power may be several kilowatts and the pump light may fall in the anomalous group-velocity dispersion regime—often called the soliton regime. For high peak powers in the anomalous dispersion regime, the nanosecond pulses may be unstable due to a phenomenon known as modulational instability, which is basically parametric amplification in which the fiber nonlinearity helps to phase match the pulses. As a consequence, the nanosecond pump pulses may be broken into many shorter pulses as the modulational instability tries to form soliton pulses from the quasi-continuous-wave background. Although the laser diode and amplification process starts with approximately nanosecond-long pulses, modulational instability in the short length of SMF fiber may form approximately 0.5ps to several-picosecond-long pulses with high intensity. Thus, the few meters of SMF fiber may result in an output similar to that produced by mode-locked lasers, except in a much simpler and cost-effective manner.

[0102] The short pulses created through modulational instability may then be coupled into a nonlinear fiber for SC generation. The nonlinear mechanisms leading to broadband SC may include four-wave mixing or self-phase modulation along with the optical Raman effect. Since the Raman effect is self-phase-matched and shifts light to longer wavelengths by emission of optical photons, the SC may spread to longer wavelengths very efficiently. The short-wavelength edge may arise

from four-wave mixing, and often times the short wavelength edge may be limited by increasing group-velocity dispersion in the fiber. In many instances, if the particular fiber used has sufficient peak power and SC fiber length, the SC generation process may fill the long-wavelength edge up to the transmission window.

[0103] Mature fiber amplifiers for the power amplifier stage 2006 include ytterbium-doped fibers (near 1060 nm), erbium-doped fibers (near 1550nm), erbium/ytterbium-doped fibers (near 1550nm), or thulium-doped fibers (near 2000nm). In various embodiments, candidates for SC fiber 2009 include fused silica fibers (for generating SC between 0.8–2.7 μ m), mid-IR fibers such as fluorides, chalcogenides, or tellurites (for generating SC out to 4.5 μ m or longer), photonic crystal fibers (for generating SC between 0.4-1.7 μ m), or combinations of these fibers. Therefore, by selecting the appropriate fiber-amplifier doping for 2006 and nonlinear fiber 2009, SC may be generated in the visible, near-IR/SWIR, or mid-IR wavelength region.

[0104] The configuration 2000 of FIGURE 20 is just one particular example, and other configurations can be used and are intended to be covered by this disclosure. For example, further gain stages may be used, and different types of lossy elements or fiber taps may be used between the amplifier stages. In another embodiment, the SC generation may occur partially in the amplifier fiber and in the pig-tails from the pump combiner or other elements. In yet another embodiment, polarization maintaining fibers may be used, and a polarizer may also be used to enhance the polarization contrast between amplifier stages. Also, not discussed in detail are many accessories that may accompany this set-up, such as driver electronics, pump laser diodes, safety shut-offs, and thermal management and packaging.

[0105] In one embodiment, one example of the SC laser that operates in the SWIR is illustrated in FIGURE 21. This SWIR SC source 2100 produces an output of up to approximately 5W over a spectral range of about 1.5-2.4 microns, and this particular laser is made out of polarization maintaining components. The seed laser 2101 is a distributed feedback (DFB) laser operating near 1542nm producing approximately 0.5nsec pulses at an about 8MHz repetition rate. The pre-amplifier 2102 is forward pumped and uses about 2m length of erbium/ytterbium cladding pumped fiber 2103 (often also called dual-core fiber) with an inner core diameter of 12 microns and

outer core diameter of 130 microns. The pre-amplifier gain fiber 2103 is pumped using a 10W laser diode near 940nm 2105 that is coupled in using a fiber combiner 2104.

[0106] In this particular 5W unit, the mid-stage between amplifier stages 2102 and 2106 comprises an isolator 2107, a band-pass filter 2108, a polarizer 2109 and a fiber tap 2110. The power amplifier 2106 uses an approximately 4m length of the 12/130 micron erbium/ytterbium doped fiber 2111 that is counter-propagating pumped using one or more 30W laser diodes near 940nm 2112 coupled in through a combiner 2113. An approximately 1-2m length of the combiner pig-tail helps to initiate the SC process, and then a length of PM-1550 fiber 2115 (polarization maintaining, single-mode, fused silica fiber optimized for 1550nm) is spliced 2114 to the combiner output.

[0107] If an output fiber of about 10m in length is used, then the resulting output spectrum 2200 is shown in FIGURE 22. The details of the output spectrum 2200 depend on the peak power into the fiber, the fiber length, and properties of the fiber such as length and core size, as well as the zero dispersion wavelength and the dispersion properties. For example, if a shorter length of fiber is used, then the spectrum actually reaches to longer wavelengths (e.g., a 2m length of SC fiber broadens the spectrum to about 2500nm). Also, if extra-dry fibers are used with less O-H content, then the wavelength edge may also reach to a longer wavelength. To generate more spectrum toward the shorter wavelengths, the pump wavelength (in this case around 1542nm) should be close to the zero dispersion wavelength in the fiber. For example, by using a dispersion shifted fiber or so-called non-zero dispersion shifted fiber, the short wavelength edge may shift to shorter wavelengths.

[0108] Although one particular example of a 5W SWIR-SC has been described, different components, different fibers, and different configurations may also be used consistent with this disclosure. For instance, another embodiment of the similar configuration 2100 in FIGURE 21 may be used to generate high powered SC between approximately 1060nm and 1800nm. For this embodiment, the seed laser 2101 may be a distributed feedback laser diode around 1064nm, the pre-amplifier gain fiber 2103 may be a ytterbium-doped fiber amplifier with 10/125 microns dimensions, and the pump laser 2105 may be a 10W laser diode near 915nm. A mode field adapter may be included in the mid-stage, in addition to the isolator 2107, band pass filter 2108, polarizer 2109 and

tap 2110. The gain fiber 2111 in the power amplifier may be an about 20m length of ytterbium-doped fiber with 25/400 microns dimension. The pump 2112 for the power amplifier may be up to six pump diodes providing 30W each near 915nm. For this much pump power, the output power in the SC may be as high as 50W or more.

[0109] In one embodiment, it may be desirous to generate high power SWIR SC over 1.4-1.8 microns and separately 2-2.5 microns (the window between 1.8 and 2 microns may be less important due to the strong water and atmospheric absorption). For example, the top SC source of FIGURE 23 can lead to bandwidths ranging from about 1400nm to 1800nm or broader, while the lower SC source of FIGURE 23 can lead to bandwidths ranging from about 1900nm to 2500nm or broader. Since these wavelength ranges are shorter than about 2500nm, the SC fiber can be based on fused silica fiber. Exemplary SC fibers include standard single-mode fiber SMF, high-nonlinearity fiber, high-NA fiber, dispersion shifted fiber, dispersion compensating fiber, and photonic crystal fibers. Non-fused-silica fibers can also be used for SC generation, including chalcogenides, fluorides, ZBLAN, tellurites, and germanium oxide fibers.

[0110] In one embodiment, the top of FIGURE 23 illustrates an exemplary block diagram for an SC source 2300 capable of generating light between approximately 1400nm and 1800nm or broader. As an example, a pump fiber laser similar to FIGURE 21 can be used as the input to a SC fiber 2309. The seed laser diode 2301 can comprise a DFB laser that generates, for example, several milliwatts of power around 1542nm or 1553nm. The fiber pre-amplifier 2302 can comprise an erbium-doped fiber amplifier or an erbium/ytterbium doped double clad fiber. In this example a mid-stage amplifier 2303 can be used, which can comprise an erbium/ytterbium doped double-clad fiber. A bandpass filter 2305 and isolator 2306 may be used between the pre-amplifier 2302 and mid-stage amplifier 2303. The power amplifier stage 2304 can comprise a larger core size erbium/ytterbium doped double-clad fiber, and another bandpass filter 2307 and isolator 2308 can be used before the power amplifier 2304. The output of the power amplifier can be coupled to the SC fiber 2309 to generate the SC output 2310. This is just one exemplary configuration for an SC source, and other configurations or elements may be used consistent with this disclosure.

[0111] In yet another embodiment, the bottom of FIGURE 23 illustrates a block diagram for an exemplary SC source 2350 capable of generating light between approximately 1900nm and 2500nm or broader. As an example, the seed laser diode 2351 can comprise a DFB or DBR laser that generates, for example, several milliwatts of power around 1542nm or 1553nm. The fiber pre-amplifier 2352 can comprise an erbium-doped fiber amplifier or an erbium/ytterbium doped double-clad fiber. In this example a mid-stage amplifier 2353 can be used, which can comprise an erbium/ytterbium doped double-clad fiber. A bandpass filter 2355 and isolator 2356 may be used between the pre-amplifier 2352 and mid-stage amplifier 2353. The power amplifier stage 2354 can comprise a thulium doped double-clad fiber, and another isolator 2357 can be used before the power amplifier 2354. Note that the output of the mid-stage amplifier 2353 can be approximately near 1542nm, while the thulium-doped fiber amplifier 2354 can amplify wavelengths longer than approximately 1900nm and out to about 2100nm. Therefore, for this configuration wavelength shifting may be required between 2353 and 2354. In one embodiment, the wavelength shifting can be accomplished using a length of standard single-mode fiber 2358, which can have a length between approximately 5m and 50m, for example. The output of the power amplifier 2354 can be coupled to the SC fiber 2359 to generate the SC output 2360. This is just one exemplary configuration for an SC source, and other configurations or elements can be used consistent with this disclosure. For example, the various amplifier stages can comprise different amplifier types, such as erbium doped fibers, ytterbium doped fibers, erbium/ytterbium co-doped fibers and thulium doped fibers. One advantage of the SC lasers illustrated in FIGURES 20, 21, and 23 are that they may use all-fiber components, so that the SC laser can be all-fiber, monolithically integrated with no moving parts. The all-integrated configuration can consequently be robust and reliable.

[0112] FIGURES 20, 21 and 23 are examples of SC light sources that may advantageously be used for near-infrared or SWIR light generation in various spectroscopy, active remote sensing and hyper-spectral imaging applications. However, many other versions of the SC light sources may also be made that are intended to also be covered by this disclosure. For example, the SC generation fiber could be pumped by a mode-locked laser, a gain-switched semiconductor laser, an optically pumped semiconductor laser, a solid state laser, other fiber lasers, or a combination of these types of

lasers. Also, rather than using a fiber for SC generation, either a liquid or a gas cell might be used as the nonlinear medium in which the spectrum is to be broadened.

[0113] Even within the all-fiber versions illustrated such as in FIGURE 21, different configurations could be used consistent with the disclosure. In one embodiment, it may be desirable to have a lower cost version of the SWIR SC laser of FIGURE 21. One way to lower the cost could be to use a single stage of optical amplification, rather than two stages, which may be feasible if lower output power is required or the gain fiber is optimized. For example, the pre-amplifier stage 2102 might be removed, along with at least some of the mid-stage elements. In yet another embodiment, the gain fiber could be double passed to emulate a two stage amplifier. In this example, the pre-amplifier stage 2102 might be removed, and perhaps also some of the mid-stage elements. A mirror or fiber grating reflector could be placed after the power amplifier stage 2106 that may preferentially reflect light near the wavelength of the seed laser 2101. If the mirror or fiber grating reflector can transmit the pump light near 940nm, then this could also be used instead of the pump combiner 2113 to bring in the pump light 2112. The SC fiber 2115 could be placed between the seed laser 2101 and the power amplifier stage 2106 (SC is only generated after the second pass through the amplifier, since the power level may be sufficiently high at that time). In addition, an output coupler may be placed between the seed laser diode 2101 and the SC fiber, which now may be in front of the power amplifier 2106. In a particular embodiment, the output coupler could be a power coupler or divider, a dichroic coupler (e.g., passing seed laser wavelength but outputting the SC wavelengths), or a wavelength division multiplexer coupler. This is just one further example, but a myriad of other combinations of components and architectures could also be used for SC light sources to generate near-infrared or SWIR light that are intended to be covered by this disclosure.

[0114] Described herein are just some examples of the beneficial use of near-infrared or SWIR lasers for spectroscopy, active remote sensing or hyper-spectral imaging. However, many other spectroscopy and identification procedures can use the near-infrared or SWIR light consistent with this disclosure and are intended to be covered by the disclosure. As one example, the fiber-based super-continuum lasers may have a pulsed output with pulse durations of approximately 0.5-2nsec and pulse repetition rates of several Megahertz. Therefore, the near-infrared or SWIR spectroscopy, active remote sensing or hyper-spectral imaging applications may also be combined

with LIDAR-type applications. Namely, the distance or time axis can be added to the information based on time-of-flight measurements. For this type of information to be used, the detection system would also have to be time-gated to be able to measure the time difference between the pulses sent and the pulses received. By calculating the round-trip time for the signal, the distance of the object may be judged. In another embodiment, GPS (global positioning system) information may be added, so the near-infrared or SWIR spectroscopy, active remote sensing or hyper-spectral imagery would also have a location tag on the data. Moreover, the near-infrared or SWIR spectroscopy, active remote sensing or hyper-spectral imaging information could also be combined with two-dimensional or three-dimensional images to provide a physical picture as well as a chemical composition identification of the materials. These are just some modifications of the near-infrared or SWIR spectroscopy, active remote sensing or hyper-spectral imaging system described in this disclosure, but other techniques may also be added or combinations of these techniques may be added, and these are also intended to be covered by this disclosure.

WIRELESS LINK TO THE CLOUD

[0115] The non-invasive blood constituent or analytes measurement device may also benefit from communicating the data output to the “cloud” (e.g., data servers and processors in the web remotely connected) via wired and/or wireless communication strategies. The non-invasive devices may be part of a series of biosensors applied to the patient, and collectively these devices form what might be called a body area network or a personal area network. The biosensors and non-invasive devices may communicate to a smart phone, tablet, personal data assistant, computer, and/or other microprocessor-based device, which may in turn wirelessly or over wire and/or fiber optically transmit some or all of the signal or processed data to the internet or cloud. The cloud or internet may in turn send the data to doctors or health care providers as well as the patients themselves. Thus, it may be possible to have a panoramic, high-definition, relatively comprehensive view of a patient that doctors can use to assess and manage disease, and that patients can use to help maintain their health and direct their own care.

[0116] In a particular embodiment 2400 illustrated in Figure 24, the physiological measurement device or non-invasive blood constituent measurement device 2401 may comprise a

transmitter 2403 to communicate over a first communication link 2404 in the body area network or personal area network to a receiver in a smart phone, tablet cell phone, PDA, or computer 2405. For the measurement device 2401, it may also be advantageous to have a processor 2402 to process some of the physiological data, since with processing the amount of data to transmit may be less (hence, more energy efficient). The first communication link 2404 may operate through the use of one of many wireless technologies such as Bluetooth, Zigbee, WiFi, IrDA (infrared data association), wireless USB, or Z-wave, to name a few. Alternatively, the communication link 2404 may occur in the wireless medical band between 2360 and 2390MHz, which the FCC allocated for medical body area network devices, or in other designated medical device or WMTS bands. These are examples of devices that can be used in the body area network and surroundings, but other devices could also be used and are included in the scope of this disclosure.

[0117] The personal device 2405 may store, process, display, and transmit some of the data from the measurement device 2401. The device 2405 may comprise a receiver, transmitter, display, voice control and speakers, and one or more control buttons or knobs and a touch screen. Examples of the device 2405 include smart phones such as the Apple iPhones® or phones operating on the Android or Microsoft systems. In one embodiment, the device 2405 may have an application, software program, or firmware to receive and process the data from the measurement device 2401. The device 2405 may then transmit some or all of the data or the processed data over a second communication link 2406 to the internet or “cloud” 2407. The second communication link 2406 may advantageously comprise at least one segment of a wireless transmission link, which may operate using WiFi or the cellular network. The second communication link 2406 may additionally comprise lengths of fiber optic and/or communication over copper wires or cables.

[0118] The internet or cloud 2407 may add value to the measurement device 2401 by providing services that augment the physiological data collected. In a particular embodiment, some of the functions performed by the cloud include: (a) receive at least a fraction of the data from the device 2405; (b) buffer or store the data received; (c) process the data using software stored on the cloud; (d) store the resulting processed data; and (e) transmit some or all of the data either upon request or based on an alarm. As an example, the data or processed data may be transmitted 2408

back to the originator (e.g., patient or user), it may be transmitted 2409 to a health care provider or doctor, or it may be transmitted 2410 to other designated recipients.

[0119] The cloud 2407 may provide a number of value-add services. For example, the cloud application may store and process the physiological data for future reference or during a visit with the healthcare provider. If a patient has some sort of medical mishap or emergency, the physician can obtain the history of the physiological parameters over a specified period of time. In another embodiment, if the physiological parameters fall out of acceptable range, alarms may be delivered to the user 2408, the healthcare provider 2409, or other designated recipients 2410. These are just some of the features that may be offered, but many others may be possible and are intended to be covered by this disclosure. As an example, the device 2405 may also have a GPS sensor, so the cloud 2407 may be able to provide time, data and position along with the physiological parameters. Thus, if there is a medical emergency, the cloud 2407 could provide the location of the patient to the healthcare provider 2409 or other designated recipients 2410. Moreover, the digitized data in the cloud 2407 may help to move toward what is often called “personalized medicine.” Based on the physiological parameter data history, medication or medical therapies may be prescribed that are customized to the particular patient.

[0120] Beyond the above benefits, the cloud application 2407 and application on the device 2405 may also have financial value for companies developing measurement devices 2401 such as a non-invasive blood constituent monitor. In the case of glucose monitors, the companies make the majority of their revenue on the measurement strips. However, with a non-invasive monitor, there is no need for strips, so there is less of an opportunity for recurring costs (e.g., the razor/razor blade model does not work for non-invasive devices). On the other hand, people may be willing to pay a periodic fee for the value-add services provided on the cloud 2407. Diabetic patients, for example, would probably be willing to pay a periodic fee for monitoring their glucose levels, storing the history of the glucose levels, and having alarm warnings when the glucose level falls out of range. Similarly, patients taking ketone bodies supplement for treatment of disorders characterized by impaired glucose metabolism (e.g., Alzheimer’s, Parkinson’s, Huntington’s or ALS) may need to monitor their ketone bodies level. These patients would also probably be willing to pay a periodic fee for the value-add services provided on the cloud 2407. Thus, by leveraging the advances in

wireless connectivity and the widespread use of handheld devices such as smart phones that can wirelessly connect to the cloud, businesses can build a recurring cost business model even using non-invasive measurement devices.

[0121] Described herein are just some examples of the beneficial use of near-infrared or SWIR lasers for non-invasive monitoring of glucose, ketones, HbA1c and other blood constituents. However, many other medical procedures can use the near-infrared or SWIR light consistent with this disclosure and are intended to be covered by the disclosure.

[0122] Although the present disclosure has been described in several embodiments, a myriad of changes, variations, alterations, transformations, and modifications may be suggested to one skilled in the art, and it is intended that the present disclosure encompass such changes, variations, alterations, transformations, and modifications as falling within the spirit and scope of the appended claims.

[0123] While exemplary embodiments are described above, it is not intended that these embodiments describe all possible forms of the disclosure. Rather, the words used in the specification are words of description rather than limitation, and it is understood that various changes may be made without departing from the spirit and scope of the disclosure. Additionally, the features of various implementing embodiments may be combined to form further embodiments of the disclosure. While various embodiments may have been described as providing advantages or being preferred over other embodiments with respect to one or more desired characteristics, as one skilled in the art is aware, one or more characteristics may be compromised to achieve desired system attributes, which depend on the specific application and implementation. These attributes include, but are not limited to: cost, strength, durability, life cycle cost, marketability, appearance, packaging, size, serviceability, weight, manufacturability, ease of assembly, etc. The embodiments described herein that are described as less desirable than other embodiments or prior art implementations with respect to one or more characteristics are not outside the scope of the disclosure and may be desirable for particular applications.

SHORT-WAVE INFRARED SUPER-CONTINUUM LASERS FOR DETECTING
COUNTERFEIT OR ILLICIT DRUGS AND PHARMACEUTICAL PROCESS CONTROL

CROSS-REFERENCE TO RELATED APPLICATIONS

[0001] This application is a continuation of U.S. application Serial No. 14/108,986 filed December 17, 2013, which claims the benefit of U.S. provisional application Serial No. 61/747,487 filed December 31, 2012, the disclosures of which are hereby incorporated in their entirety by reference herein.

[0002] This application is related to U.S. provisional applications Serial Nos. 61/747,477 filed December 31, 2012; Serial No. 61/747,481 filed December 31, 2012; Serial No. 61/747,485 filed December 31, 2012; Serial No. 61/747,472 filed December 31, 2012; Serial No. 61/747,492 filed December 31, 2012; Serial No. 61/747,553 filed December 31, 2012; and Serial No. 61/754,698 filed January 21, 2013, the disclosures of which are hereby incorporated in their entirety by reference herein.

[0003] This application is also related to International Application No. PCT/US2013/075700 (Publication No. WO/2014/105520) entitled Near-Infrared Lasers For Non-Invasive Monitoring Of Glucose, Ketones, HBA1C, And Other Blood Constituents; International Application PCT/US2013/075736 (Publication No. WO/2014/105521) entitled Short-Wave Infrared Super-Continuum Lasers For Early Detection Of Dental Caries; U.S. Application 14/108,995 (Publication No. 2014/0188092) entitled Focused Near-Infrared Lasers For Non-Invasive Vasectomy And Other Thermal Coagulation Or Occlusion Procedures; International Application PCT/US2013/075767 (Publication No. WO/2014/143276) entitled Short-Wave Infrared Super-Continuum Lasers For Natural Gas Leak Detection, Exploration, And Other Active Remote Sensing Applications; U.S. Application 14/108,974 (Publication No. 2014/0188094) entitled Non-Invasive Treatment Of Varicose Veins; and U.S. Application 14/109,007 (Publication No. 2014/0236021) entitled Near-Infrared Super-Continuum Lasers For Early Detection Of Breast And Other Cancers, the disclosures of which are hereby incorporated in their entirety by reference herein.

BACKGROUND AND SUMMARY

[0004] Counterfeiting of pharmaceuticals is a significant issue in the healthcare community as well as for the pharmaceutical industry worldwide. For example, according to the World Health Organization, in 2006 the market for counterfeit drugs worldwide was estimated at around \$43 Billion. Moreover, the use of counterfeit medicines may result in treatment failure or even death. For instance, in 1995 dozens of children in Haiti and Nigeria died after taking counterfeit medicinal syrups that contained diethylene glycol, an industrial solvent. As another example, in Asia one report estimated that 90% of Viagra sold in Shanghai, China, was counterfeit. With more pharmaceuticals being purchased through the internet, the problem of counterfeit drugs coming from across the borders into the United States has been growing rapidly.

[0005] A rapid, non-destructive, non-contact optical method for screening or identification of counterfeit pharmaceuticals is needed. Spectroscopy using near-infrared or short-wave infrared (SWIR) light may provide such a method, because most pharmaceuticals comprise organic compounds that have overtone or combination absorption bands in this wavelength range (e.g., between approximately 1-2.5 microns). Moreover, most drug packaging materials are at least partially transparent in the near-infrared or SWIR, so that drug compositions may be detected and identified through the packaging non-destructively. Also, using a near-infrared or SWIR light source with a spatially coherent beam permits screening at stand-off or remote distances. Beyond identifying counterfeit drugs, the near-infrared or SWIR spectroscopy may have many other beneficial applications. For example, spectroscopy may be used for rapid screening of illicit drugs or to implement process analytical technology in pharmaceutical manufacturing. There are also a wide array of applications in assessment of quality in the food industry, including screening of fruit, vegetables, grains and meats.

[0006] In one embodiment, a near-infrared or SWIR super-continuum (SC) source may be used as the light source for spectroscopy, active remote sensing, or hyper-spectral imaging. One embodiment of the SWIR light source may be an all-fiber integrated SWIR SC source, which leverages the mature technologies from the telecommunications and fiber optics industry. Exemplary fiber-based super-continuum sources may emit light in the near-infrared or SWIR

between approximately 1.4-1.8 microns, 2-2.5 microns, 1.4-2.4 microns, 1-1.8 microns, or any number of other bands. In particular embodiments, the detection system may be a dispersive spectrometer, a Fourier transform infrared spectrometer, or a hyper-spectral imaging detector or camera. In addition, reflection or diffuse reflection light spectroscopy may be implemented using the SWIR light source, where the spectral reflectance can be the ratio of reflected energy to incident energy as a function of wavelength.

[0007] In one embodiment, a measurement system includes a light source configured to generate an output optical beam comprising one or more semiconductor sources configured to generate an input beam, one or more optical amplifiers configured to receive at least a portion of the input beam and to deliver an intermediate beam to an output end of the one or more optical amplifiers, and one or more optical fibers configured to receive at least a portion of the intermediate beam and to deliver at least the portion of the intermediate beam to a distal end of the one or more optical fibers to form a first optical beam. A nonlinear element is configured to receive at least a portion of the first optical beam and to broaden a spectrum associated with the at least a portion of the first optical beam to at least 10nm through a nonlinear effect in the nonlinear element to form the output optical beam with an output beam broadened spectrum, wherein at least a portion of the output beam broadened spectrum comprises a short-wave infrared wavelength between approximately 1400 nanometers and approximately 2500 nanometers, and wherein at least a portion of the one or more fibers is a fused silica fiber with a core diameter less than approximately 400 microns. A measurement apparatus is configured to receive a received portion of the output optical beam and to deliver a delivered portion of the output optical beam to a sample for a non-destructive and non-contact measurement, wherein the delivered portion of the output optical beam is configured to generate a spectroscopy output beam from the sample. A receiver is configured to receive at least a portion of the spectroscopy output beam having a bandwidth of at least 10 nanometers and to process the portion of the spectroscopy output beam to generate an output signal, and wherein at least a part of the delivered portion of the output optical beam is at least partially transmitting through a packaging material covering at least a part of the sample, and wherein the output signal is based on a chemical composition of the sample.

[0008] In another embodiment, a measurement system includes a light source configured to generate an output optical beam comprising a plurality of semiconductor sources configured to generate an input optical beam, a multiplexer configured to receive at least a portion of the input optical beam and to form an intermediate optical beam, and one or more fibers configured to receive at least a portion of the intermediate optical beam and to form the output optical beam, wherein the output optical beam comprises one or more optical wavelengths. A measurement apparatus is configured to receive a received portion of the output optical beam and to deliver a delivered portion of the output optical beam to a sample, wherein the delivered portion of the output optical beam is configured to generate a spectroscopy output beam from the sample. A receiver is configured to receive at least a portion of the spectroscopy output beam and to process the portion of the spectroscopy output beam to generate an output signal, wherein the receiver comprises a Fourier transform infrared (FTIR) spectrometer or a dispersive spectrometer, and wherein at least a part of the delivered portion of the output optical beam is at least partially transmitting through a packaging material covering at least a part of the sample.

[0009] In yet another embodiment, a method of measuring includes generating an output optical beam comprising generating an input optical beam from a plurality of semiconductor sources, multiplexing at least a portion of the input optical beam and forming an intermediate optical beam, and guiding at least a portion of the intermediate optical beam and forming the output optical beam, wherein the output optical beam comprises one or more optical wavelengths. The method may also include receiving a received portion of the output optical beam and delivering a delivered portion of the output optical beam to a sample, wherein the sample comprises an organic compound with an overtone or combinational absorption band in the wavelength range between approximately 1 micron and approximately 2.5 microns. The method may further include generating a spectroscopy output beam having a bandwidth of at least 10 nanometers from the sample using a Fourier transform infrared (FTIR) spectrometer or a dispersive spectrometer, receiving at least a portion of the spectroscopy output beam, and processing the portion of the spectroscopy output beam and generating an output signal.

[0010] With the growing obesity epidemic, the number of individuals with diabetes is increasing dramatically. For example, there are over 200 million people who have diabetes.

Diabetes control requires monitoring of the glucose level, and most glucose measuring systems available commercially require drawing of blood. Depending on the severity of the diabetes, a patient may have to draw blood and measure glucose four to six times a day. This may be extremely painful and inconvenient for many people. In addition, for some groups, such as soldiers in the battlefield, it may be dangerous to have to measure periodically their glucose level with finger pricks.

[0011] Thus, there is an unmet need for non-invasive glucose monitoring (e.g., monitoring glucose without drawing blood). The challenge has been that a non-invasive system requires adequate sensitivity and selectivity, along with repeatability of the results. Yet, this is a very large market, with an estimated annual market of over \$10B in 2011 for self-monitoring of glucose levels.

[0012] One approach to non-invasive monitoring of blood constituents or blood analytes is to use near-infrared spectroscopy, such as absorption spectroscopy or near-infrared diffuse reflection or transmission spectroscopy. Some attempts have been made to use broadband light sources, such as tungsten lamps, to perform the spectroscopy. However, several challenges have arisen in these efforts. First, many other constituents in the blood also have signatures in the near-infrared, so spectroscopy and pattern matching, often called spectral fingerprinting, is required to distinguish the glucose with sufficient confidence. Second, the non-invasive procedures have often transmitted or reflected light through the skin, but skin has many spectral artifacts in the near-infrared that may mask the glucose signatures. Moreover, the skin may have significant water and blood content. These difficulties become particularly complicated when a weak light source is used, such as a lamp. More light intensity can help to increase the signal levels, and, hence, the signal-to-noise ratio.

[0013] As described in this disclosure, by using brighter light sources, such as fiber-based supercontinuum lasers, super-luminescent laser diodes, light-emitting diodes or a number of laser diodes, the near-infrared signal level from blood constituents may be increased. By shining light through the teeth, which have fewer spectral artifacts than skin in the near-infrared, the blood constituents may be measured with less interfering artifacts. Also, by using pattern matching in spectral fingerprinting and various software techniques, the signatures from different constituents in the blood may be identified. Moreover, value-add services may be provided by wirelessly

communicating the monitored data to a handheld device such as a smart phone, and then wirelessly communicating the processed data to the cloud for storing, processing, and transmitting to several locations.

[0014] In various embodiments, a measurement system includes a light source configured to generate an output optical beam that includes one or more semiconductor sources configured to generate an input beam, one or more optical amplifiers configured to receive at least a portion of the input beam and to output an intermediate beam from at least one of the one or more optical amplifiers; and one or more optical fibers configured to receive at least a portion of the intermediate beam and to communicate at least part of the portion of the intermediate beam to a distal end of the one or more optical fibers to form a first optical beam. The light source may also include a nonlinear element configured to receive at least a portion of the first optical beam and to broaden a spectrum associated with the at least a portion of the first optical beam to at least 10nm through a nonlinear effect in the nonlinear element to form the output optical beam with an output beam broadened spectrum. The at least a portion of the output beam broadened spectrum comprises a near-infrared wavelength between approximately 700nm and approximately 2500nm, and at least a portion of the one or more fibers is a fused silica fiber with a core diameter less than approximately 400 microns. The system may also include a measurement apparatus configured to receive a received portion of the output optical beam and to deliver to a sample an analysis output beam, which is a delivered portion of the output optical beam and wherein the delivered portion of the output optical beam is a spatially coherent beam, and a receiver configured to receive and process at least a portion of the analysis output beam reflected or transmitted from the sample having a bandwidth of at least 10 nanometers and to generate an output signal. In addition, a personal device comprising a wireless receiver, a wireless transmitter, a display, a microphone, a speaker, one or more buttons or knobs, a microprocessor and a touch screen may be configured to receive and process at least a portion of the output signal, wherein the personal device is configured to store and display the processed output signal, wherein at least a portion of the processed output signal is configured to be transmitted over a wireless transmission link.

[0015] In another embodiment, a measurement system includes a light source comprising a plurality of semiconductor sources configured to generate an output optical beam with one or more

optical wavelengths, wherein at least a portion of the one or more optical wavelengths is a near-infrared wavelength between 700 nanometers and 2500 nanometers. A measurement apparatus is configured to receive a received portion of the output optical beam and to deliver to a sample an analysis output beam, which is a delivered portion of the output optical beam; and a receiver is configured to receive and process at least a portion of the analysis output beam reflected or transmitted from the sample and to generate an output signal. The system includes a personal device comprising a wireless receiver, a wireless transmitter, a display, a microphone, a speaker, one or more buttons or knobs, a microprocessor and a touch screen, the personal device configured to receive and process at least a portion of the output signal, wherein the personal device is configured to store and display the processed output signal, and wherein at least a portion of the processed output signal is configured to be transmitted over a wireless transmission link, and a remote device configured to receive over the wireless transmission link a received output status comprising the at least a portion of the processed output signal, to buffer the received output status, to process the received output status to generate processed data and to store the processed data.

[0016] Other embodiments may include a measurement system comprising a wearable measurement device for measuring one or more physiological parameters, including a light source comprising a plurality of semiconductor sources configured to generate an output optical beam with one or more optical wavelengths, wherein at least a portion of the one or more optical wavelengths is a near-infrared wavelength between 700 nanometers and 2500 nanometers. The wearable measurement device is configured to receive a received portion of the output optical beam and to deliver to a sample an analysis output beam, which is a delivered portion of the output optical beam. The wearable measurement device further comprises a receiver configured to receive and process at least a portion of the analysis output beam reflected or transmitted from the sample and to generate an output signal. The system also includes a personal device comprising a wireless receiver, a wireless transmitter, a display, a microphone, a speaker, one or more buttons or knobs, a microprocessor and a touch screen, the personal device configured to receive and process at least a portion of the output signal, wherein the personal device is configured to store and display the processed output signal, and wherein at least a portion of the processed output signal is configured to be transmitted over a wireless transmission link and a remote device configured to receive over the

wireless transmission link a received output status comprising the at least a portion of the processed output signal, to buffer the received output status, to process the received output status to generate processed data and to store the processed data, and wherein the remote device is capable of storing a history of at least a portion of the received output status over a specified period of time.

BRIEF DESCRIPTION OF THE DRAWINGS

[0017] For a more complete understanding of the present disclosure, and for further features and advantages thereof, reference is now made to the following description taken in conjunction with the accompanying drawings, in which:

[0018] FIGURE 1 shows the absorbance for two common plastics, polyethylene and polystyrene.

[0019] FIGURE 2 illustrates one example of the difference in near-infrared spectrum between an authentic tablet and a counterfeit tablet.

[0020] FIGURE 3 shows the second derivative of the spectral comparison of Prozac and a similarly formulated generic.

[0021] FIGURE 4 illustrates an example of the near infrared spectra for different pure components of a studied drug.

[0022] FIGURE 5 shows the mid-wave infrared and long-wave infrared absorption spectra for various illicit drugs.

[0023] FIGURE 6 shows the absorbance versus wavelength in the near-infrared region for four classes of illegal drugs.

[0024] FIGURE 7 illustrates the diffuse reflectance near-infrared spectrum of heroin samples.

[0025] FIGURE 8 illustrates the diffuse reflectance near-infrared spectra of different seized illicit drugs containing heroin of different concentrations, along with the spectrum for pure heroin.

- [0026] FIGURES 9A and 9B list possible band assignments for the various spectral features in pure heroin.
- [0027] FIGURE 10 shows the diffuse reflectance near-infrared spectra of different compounds that may be frequently employed as cutting agents.
- [0028] FIGURE 11 provides one example of a flow-chart in the process analytical technology for the pharmaceutical industry.
- [0029] FIGURE 12 illustrates the typical near-infrared spectra of a variety of excipients.
- [0030] FIGURE 13 exemplifies the absorbance from the blending process of a pharmaceutical compound.
- [0031] FIGURE 14 shows what might be an eventual flow-chart of a smart manufacturing process.
- [0032] FIGURE 15A illustrates the near-infrared reflectance spectrum of wheat flour.
- [0033] FIGURE 15B shows the near-infrared absorbance spectra obtained in diffusion reflectance mode for a series of whole 'Hass' avocado fruit.
- [0034] FIGURE 16A is a schematic diagram of the basic elements of an imaging spectrometer.
- [0035] FIGURE 16B illustrates one example of a typical imaging spectrometer used in hyper-spectral imaging systems.
- [0036] FIGURE 17 shows one example of the Fourier transform infrared spectrometer.
- [0037] FIGURE 18 exemplifies a dual-beam experimental set-up that may be used to subtract out (or at least minimize the adverse effects of) light source fluctuations.
- [0038] FIGURE 19 illustrates a block diagram or building blocks for constructing high power laser diode assemblies.

[0039] FIGURE 20 shows a platform architecture for different wavelength ranges for an all-fiber-integrated, high powered, super-continuum light source.

[0040] FIGURE 21 illustrates one embodiment for a short-wave infrared super-continuum light source.

[0041] FIGURE 22 shows the output spectrum from the SWIR SC laser of FIGURE 21 when about a 10m length of fiber for SC generation is used. This fiber is a single-mode, non-dispersion shifted fiber that is optimized for operation near 1550nm.

[0042] FIGURE 23 illustrates high power SWIR-SC lasers that may generate light between approximately 1.4-1.8 microns (top) or approximately 2-2.5 microns (bottom).

[0043] FIGURE 24 schematically shows a medical measurement device as part of a personal or body area network that communicates with another device (e.g., smart phone or tablet) that communicates with the cloud. The cloud may in turn communicate information with the user, healthcare providers, or other designated recipients.

DETAILED DESCRIPTION

[0044] As required, detailed embodiments of the present disclosure are described herein; however, it is to be understood that the disclosed embodiments are merely exemplary of the disclosure that may be embodied in various and alternative forms. The figures are not necessarily to scale; some features may be exaggerated or minimized to show details of particular components. Therefore, specific structural and functional details disclosed herein are not to be interpreted as limiting, but merely as a representative basis for teaching one skilled in the art to variously employ the present disclosure.

[0045] One advantage of optical systems is that they can perform non-contact, stand-off or remote sensing distance spectroscopy of various materials. As an example, optical systems can be used for identification of counterfeit drugs, detection of illicit drugs, or process control in the pharmaceutical industry, especially when the sensing is to be done at remote or stand-off distances in

a non-contact, rapid manner. In general, the near-infrared region of the electromagnetic spectrum covers between approximately 0.7 microns (700nm) to about 2.5 microns (2500nm). However, it may also be advantageous to use just the short-wave infrared (SWIR) between approximately 1.4 microns (1400nm) and about 2.5 microns (2500nm). One reason for preferring the SWIR over the entire NIR may be to operate in the so-called “eye safe” window, which corresponds to wavelengths longer than about 1400nm. Therefore, for the remainder of the disclosure the SWIR will be used for illustrative purposes. However, it should be clear that the discussion that follows could also apply to using the near infrared – NIR -- wavelength range, or other wavelength bands.

[0046] In particular, wavelengths in the eye safe window may not transmit down to the retina of the eye, and therefore, these wavelengths may be less likely to create permanent eye damage from inadvertent exposure. The near-infrared wavelengths have the potential to be dangerous, because the eye cannot see the wavelengths (as it can in the visible), yet they can penetrate and cause damage to the eye. Even if a practitioner is not looking directly at the laser beam, the practitioner’s eyes may receive stray light from a reflection or scattering some surface. Hence, it can always be a good practice to use eye protection when working around lasers. Since wavelengths longer than about 1400nm are substantially not transmitted to the retina or substantially absorbed in the retina, this wavelength range is known as the eye safe window. For wavelengths longer than 1400nm, in general only the cornea of the eye may receive or absorb the light radiation.

[0047] The SWIR wavelength range may be particularly valuable for identifying materials based on their chemical composition because the wavelength range comprises overtones and combination bands for numerous chemical bonds. For example, in the SWIR numerous hydrocarbon chemical compounds have overtone and combinational bands, along with oxygen-hydrogen and carbon-oxygen compounds. Thus, gases, liquids and solids that comprise these chemical compounds may exhibit spectral features in the SWIR wavelength range. In a particular embodiment, the spectra of organic compounds may be dominated by the C-H stretch. The C-H stretch fundamental occurs near 3.4 microns, the first overtone is near 1.7 microns, and a combination band occurs near 2.3 microns.

[0048] One embodiment of remote sensing that is used to identify and classify various materials is so-called “hyper-spectral imaging.” Hyper-spectral sensors may collect information as a set of images, where each image represents a range of wavelengths over a spectral band. Hyper-spectral imaging may deal with imaging narrow spectral bands over an approximately continuous spectral range. As an example, in hyper-spectral imaging a lamp may be used as the light source. However, the incoherent light from a lamp may spatially diffract rapidly, thereby making it difficult to perform spectroscopy at stand-off distances or remote distances. Therefore, it would be advantageous to have a broadband light source covering the SWIR that may be used in place of a lamp to identify or classify materials in remote sensing or stand-off detection applications.

[0049] As used throughout this document, the term “couple” and or “coupled” refers to any direct or indirect communication between two or more elements, whether or not those elements are physically connected to one another. As used throughout this disclosure, the term “spectroscopy” means that a tissue or sample is inspected by comparing different features, such as wavelength (or frequency), spatial location, transmission, absorption, reflectivity, scattering, fluorescence, refractive index, or opacity. In one embodiment, “spectroscopy” may mean that the wavelength of the light source is varied, and the transmission, absorption, fluorescence, or reflectivity of the tissue or sample is measured as a function of wavelength. In another embodiment, “spectroscopy” may mean that the wavelength dependence of the transmission, absorption, fluorescence or reflectivity is compared between different spatial locations on a tissue or sample. As an illustration, the “spectroscopy” may be performed by varying the wavelength of the light source, or by using a broadband light source and analyzing the signal using a spectrometer, wavemeter, or optical spectrum analyzer.

[0050] As used throughout this document, the term “fiber laser” refers to a laser or oscillator that has as an output light or an optical beam, wherein at least a part of the laser comprises an optical fiber. For instance, the fiber in the “fiber laser” may comprise one of or a combination of a single mode fiber, a multi-mode fiber, a mid-infrared fiber, a photonic crystal fiber, a doped fiber, a gain fiber, or, more generally, an approximately cylindrically shaped waveguide or light-pipe. In one embodiment, the gain fiber may be doped with rare earth material, such as ytterbium, erbium, and/or thulium. In another embodiment, the mid-infrared fiber may comprise one or a combination of fluoride fiber, ZBLAN fiber, chalcogenide fiber, tellurite fiber, or germanium doped fiber. In yet

another embodiment, the single mode fiber may include standard single-mode fiber, dispersion shifted fiber, non-zero dispersion shifted fiber, high-nonlinearity fiber, and small core size fibers.

[0051] As used throughout this disclosure, the term “pump laser” refers to a laser or oscillator that has as an output light or an optical beam, wherein the output light or optical beam is coupled to a gain medium to excite the gain medium, which in turn may amplify another input optical signal or beam. In one particular example, the gain medium may be a doped fiber, such as a fiber doped with ytterbium, erbium and/or thulium. In one embodiment, the “pump laser” may be a fiber laser, a solid state laser, a laser involving a nonlinear crystal, an optical parametric oscillator, a semiconductor laser, or a plurality of semiconductor lasers that may be multiplexed together. In another embodiment, the “pump laser” may be coupled to the gain medium by using a fiber coupler, a dichroic mirror, a multiplexer, a wavelength division multiplexer, a grating, or a fused fiber coupler.

[0052] As used throughout this document, the term “super-continuum” and or “supercontinuum” and or “SC” refers to a broadband light beam or output that comprises a plurality of wavelengths. In a particular example, the plurality of wavelengths may be adjacent to one-another, so that the spectrum of the light beam or output appears as a continuous band when measured with a spectrometer. In one embodiment, the broadband light beam may have a bandwidth of at least 10nm. In another embodiment, the “super-continuum” may be generated through nonlinear optical interactions in a medium, such as an optical fiber or nonlinear crystal. For example, the “super-continuum” may be generated through one or a combination of nonlinear activities such as four-wave mixing, parametric amplification, the Raman effect, modulational instability, and self-phase modulation.

[0053] As used throughout this disclosure, the terms “optical light” and or “optical beam” and or “light beam” refer to photons or light transmitted to a particular location in space. The “optical light” and or “optical beam” and or “light beam” may be modulated or unmodulated, which also means that they may or may not contain information. In one embodiment, the “optical light” and or “optical beam” and or “light beam” may originate from a fiber, a fiber laser, a laser, a light emitting diode, a lamp, a pump laser, or a light source.

[0054] As used throughout this disclosure, the term “remote sensing” may include the measuring of properties of an object from a distance, without physically sampling the object, for example by detection of the interactions of the object with an electromagnetic field. In one embodiment, the electromagnetic field may be in the optical wavelength range, including the infrared or SWIR. One particular form of remote sensing may be stand-off detection, which may range exemplary from non-contact up to hundreds of meters away.

IDENTIFICATION OF COUNTERFEIT DRUGS

[0055] Pharmaceutical counterfeiting is a growing and significant issue for the healthcare community as well as the pharmaceutical industry worldwide. As a result of counterfeiting, users may be threatened by substandard drug quality or harmful ingredients, and legitimate companies may lose significant revenues. The definition for “counterfeit drug” by the World Health Organization was as follows: “A counterfeit medicine is one which is deliberately and fraudulently mislabeled with respect to identity and/or source. Counterfeiting can apply to both branded and generic products and counterfeit products may include products with the correct ingredients or with the wrong ingredients, without active ingredients, with insufficient active ingredient or with fake packaging.” Later this definition was slightly modified, “Counterfeiting in relation to medicinal products means the deliberate and fraudulent mislabeling with respect to the identity, composition and/or source of a finished medicinal product, or ingredient for the preparation of a medicinal product.”

[0056] A rapid screening technique such as near-infrared or SWIR spectroscopy could aid in the search for and identification of counterfeit drugs. In particular, using a non-lamp based light source could lead to contact-free control and analysis of drugs. In a particular embodiment, remote sensing, stand-off detection, or hyper-spectral imaging may be used for process control or counterfeit drug identification in a factory or manufacturing setting, or in a retail, wholesale, or warehouse setting. In one embodiment, the light source for remote sensing may direct the light beam toward the region of interest (e.g., conveyor belt, stocking shelves, boxes or cartons, etc), and the diffuse reflected light may then be measured using a detection system. Various kinds of SWIR light sources will be discussed later in this disclosure. The detection system may comprise, in one embodiment, a spectrometer followed by one or more detectors. In another embodiment, the

detection system may be a dispersive element (examples include prisms, gratings, or other wavelength separators) followed by one or more detectors or detector arrays. In yet another embodiment, the detection system may comprise a Fourier transform infrared spectrometer. These are merely specific examples of the detection system, but combinations of these or other detection systems may also be used and are contemplated within the scope of this disclosure.

[0057] For monitoring drugs, the SWIR light source and the detection system could be used in transmission, reflection, fluorescence, or diffuse reflection. Also, different system configurations may also be used and are included in the scope of this disclosure. For example, the light source and detection system may be placed in a fixed location, and for reflection the light source and detectors may be close to one another, while for transmission the light source and detectors may be at different locations. The region of interest may be surveyed, and the light beam may also be scanned to cover an area larger than the light source beam. In yet another embodiment, the system could be placed on a vehicle such as an automobile or a truck, or the light source could be placed on one vehicle, while the detection system is on another vehicle. If the light source and detection system are compact and lightweight, they might even be carried by a person in the field, either in their hands or in a backpack.

[0058] Another advantage of using the near-infrared or SWIR is that most drug packaging materials are at least partially transparent in this wavelength range, so that drug compositions may be detected and identified through the packaging non-destructively. As an example, SWIR light could be used to see through plastics, since the signature for plastics can be subtracted off and there are large wavelength windows where the plastics are transparent. FIGURE 1 illustrates the absorbance 100 for two common plastics: polyethylene 101 and polystyrene 102. Because of the hydro-carbon bonds, there are absorption features near 1.7 microns and 2.2-2.5 microns. In general, the absorption bands in the near infrared are due to overtones and combination bands for various functional group vibrations, including signals from C-H, O-H, C=O, N-H, -COOH, and aromatic C-H groups. It may be difficult to assign an absorption band to a specific functional group due to overlapping of several combinations and overtones. However, with advancements in computational power and chemometrics or multivariate analysis methods, complex systems may be better analyzed. In one embodiment, using software analysis tools the absorption spectrum may be converted to its second

derivative equivalent. The spectral differences may permit a fast, accurate, non-destructive and reliable identification of materials. Although particular derivatives are discussed, other mathematical manipulations may be used in the analysis, and these other techniques are also intended to be covered by this disclosure.

[0059] Spectroscopy in the near-infrared or SWIR may be sensitive to both the chemical and physical nature of the sample composition and may be performed rapidly with minimal sample preparation. For example, near-infrared or SWIR spectroscopy may be used to study the homogeneity of powder samples, particle size determinations, product composition, the determination of the concentrations and distribution of components in solid tablets and content uniformity, among other applications. In yet other embodiments, applications include tablet identification, determination of moisture, residual solvents, active ingredient potency, the study of blending operations, and the detection of capsule tampering.

[0060] FIGURE 2 illustrates one example of the difference in near-infrared spectrum 200 between an authentic tablet and a counterfeit tablet. Two grades of film coated tablets comprising drugs were investigated: curve 201 is the genuine drug, while 202 is a counterfeit drug. These two grades of capsules have noticeably different contents, and the differences are apparent in the near-infrared or SWIR spectra. In some cases the differences may not be as distinct. For these cases, more signal processing may be necessary to distinguish between samples.

[0061] In another embodiment, it may be advantageous to take a first, second or higher order derivative to elucidate the difference between real and counterfeit drugs. For example, FIGURE 3 shows the second derivative 300 of the spectral comparison of Prozac 301 and a similarly formulated generic 302, which had a fluoxetine hydrochloride (10mg). Although the reflectance curves from the two samples are close and, therefore, difficult to distinguish, the second derivative of the data helps to bring out the differences more clearly. Although a second derivative is used in this example, any number of signal processing algorithms and methods may be used, and these are also intended to be covered by this disclosure. For example, partial least square algorithms, multivariate data analysis, principal component analysis, or chemometric software may be implemented without departing from the scope of this disclosure.

[0062] In yet another embodiment, near-infrared or SWIR spectroscopy may be used to measure and calibrate various pharmaceutical formulations based on the active pharmaceutical ingredients and excipients. An excipient may be a pharmacologically inactive substance used as a carrier for the active ingredients of a medication. In some cases, the active substance may not be easily administered and/or absorbed by the human body; in such cases the active ingredient may be dissolved into or mixed with an excipient. Also, excipients are also sometimes used to bulk up formulations that contain very potent active ingredients, to allow for convenient and accurate dosage. In addition to their use in the single-dosage quantity, excipients can be used in the manufacturing process to aid in the handling of the active substance concerned.

[0063] FIGURE 4 shows an example of the near-infrared spectra 400 for different pure components of a studied drug. The spectrum for the active pharmaceutical ingredient (API) 401 is plotted, along with the spectra for five different excipients 402, 403, 404, 405 and 406. Each spectrum has been baseline shifted to avoid overlapping. The near-infrared spectra have been obtained by averaging the spectra of each pixel of an area of a hyper-spectral image. As FIGURE 4 shows, each of the chemical compositions have a distinct spectrum, and the composition of a drug may be decomposed into its constitutive ingredients. These are just some examples of how near-infrared or SWIR spectroscopy may be applied to counterfeit drug detection, but other methods and analysis techniques may also be used without departing from the scope of this disclosure. As one other example, once the active pharmaceutical ingredient and the excipients spectral distribution of a drug formulation are understood, feedback may be provided of this information to the drug development stages.

RAPID SCREENING FOR ILLICIT DRUGS

[0064] Thus, FIGURES 2-4 show that near-infrared or SWIR spectroscopy may be used to identify counterfeit drugs. More generally, various materials including illicit drugs, explosives, fertilizers, vegetation, and paints have features in the near-infrared and SWIR that can be used to identify the various samples, and these applications are also intended to be within the scope of this disclosure. Although stronger features may be found in the mid-infrared, the near-infrared may be easier to measure due to higher quality detection systems, more mature fiber optics and light sources,

and transmission through atmospheric transmission windows. Because of these distinct spectral signatures, these materials could also be detected using active remote sensing, hyper-spectral imaging, or near-infrared or SWIR spectroscopy. As just another example, illicit drugs may be detectable using remote sensing, hyper-spectral imaging, or near-infrared spectroscopy. FIGURE 5 shows the mid-wave infrared and long-wave infrared absorption spectra 500 for various illicit drugs. The absorbance for cocaine 501, methamphetamine 502, MDMA (ecstasy) 503, and heroin 504 are plotted versus wavelength from approximately 2.5-20 microns. Although the fundamental resonances for these drugs may lie in the longer wavelength regions, there are corresponding overtones and combination bands in the SWIR and near-infrared wavelength range. Therefore, the active remote sensing, hyper-spectral imaging, or near-infrared or SWIR spectroscopy techniques described herein may also be applicable to detecting illicit drugs from aircraft, vehicles, or hand held devices.

[0065] The diffuse reflectance technique may be useful with near-infrared or SWIR spectroscopy for rapid identification of illegal drugs due to simple handling and simple use of a search data library created using near-infrared diffuse reflectance. For instance, FIGURE 6 illustrates the absorbance 600 versus wavelength in the near-infrared region for four classes of illegal drugs. In particular, the spectra are shown for methamphetamine (MA) 601, amphetamine (AP) 602, MDMA (street name: ecstasy) 603, and MDA (street name: the love drug) 604. Each of the illegal drugs have unique spectral features in the near-infrared and SWIR. Also, comparing the mid-infrared spectrum for MDMA (503 in FIGURE 5) with the near-infrared spectrum for MDMA (603 in FIGURE 6), it seems clear that the near-infrared region shows overtones and combination bands that should be discernible. Referring to FIGURE 6, sample identification may be accomplished by using the region (indicated by the arrows) where the spectral absorptions may provide specific peaks depending on the drug component.

[0066] In another embodiment, FIGURE 7 shows the diffuse reflectance near-infrared spectrum 700 of heroin samples. Heroin, the 3,6-diacetyl derivative of morphine (hence diacetylmorphine) is an opiate drug synthesized from morphine, which is usually a naturally occurring substance extracted from the seedpod of certain varieties of poppy plants. In particular, 701 is the near-infrared spectrum for an illicit street drug sample, while 702 is the spectra for a pure heroin

standard. The difference between the spectra may arise at least in part from cutting agents. The inset 703 shows the molecular structure for heroin. As in the other examples, the absorption in the near-infrared range is caused by overtone and combination vibrations of O-H, C-H, N-H and C=O groups, which exhibit their fundamental molecular stretching and bending absorption in the mid-infrared range (c.f., the mid-infrared spectrum for heroin is shown 504 in FIGURE 5). These overtone and combination bands do not behave in a simple way, making the near-infrared spectra complex and harder to directly interpret. Also, although the near-infrared signatures may be weaker in magnitude, they are probably easier to detect in the near-infrared, and the sample preparation may also be much simpler in the near-infrared. Moreover, for remote sensing, the near-infrared may be preferable because of atmospheric transmission windows between approximately 1.4-1.8 microns and 2-2.5 microns.

[0067] Pure heroin may be a white powder with a bitter taste that is rarely sold on the streets, while illicit heroin may be a powder varying in color from white to dark brown due to impurities left from the manufacturing process or the presence of additives. The purity of street heroin may also vary widely, as the drug can be mixed with other white powders. The impurity of the drug may often make it difficult to gauge the strength of the dosage, which runs the risk of overdose. One nice feature of near-infrared or SWIR spectroscopy is that the technique may be used in a non-destructive, non-contact manner to determine rapidly the concentration of compounds present in complex samples at percentage levels with very little sample preparation. In a particular embodiment, FIGURE 8 illustrates the diffuse reflectance near-infrared spectra 800 of different seized illicit drugs containing heroin (between 10.7 and 21.8%) compared with the spectrum of pure heroin 801. Curve 802 is for 21.8% by weight, curve 803 is 13.2% by weight, curve 804 is 17% by weight, and curve 805 is 10.7% by weight of heroin. The spectra have been shifted along the vertical axis to better illustrate the differences.

[0068] Although quite complex in the near-infrared, it may be possible to identify from the pure heroin near-infrared spectrum (801 in FIGURE 8 or 702 in FIGURE 7) the main wavelengths related to the most common functional groups in heroin. For example, FIGURE 9 lists possible band assignments 900 for the various spectral features in pure heroin. As can be seen from FIGURE 9,

the absorption in the near-infrared may be mainly due to overtone and combination bands associated with O-H, C-H, N-H and C=O groups.

[0069] As can be appreciated from FIGURE 8, there may be significant differences between the spectrum of pure heroin and sample spectra. These differences may be due to the presence of different compounds used as cutting agents, which can affect the shape and intensity of the near-infrared signals. FIGURE 10 illustrates the diffuse reflectance near-infrared spectra 1000 of different compounds that may be frequently employed as cutting agents. In the bottom of FIGURE 10 are shown the spectra 1008 for pure heroin and the spectra 1007 for a seized illicit street drug sample comprising 21.8% of heroin. The spectra for various cutting agents include: 1001 for flour, 1002 for talcum powder, 1003 for chalk, 1004 for acetylsalicylic acid, 1005 for caffeine, and 1006 for paracetamol. Thus, near-infrared or SWIR spectroscopy may be used to work back to the composition of an unknown drug. Although particular examples of counterfeit and illicit drugs have been described, the near-infrared or SWIR spectroscopy (including diffuse reflectance, reflectance, fluorescence or transmission) may also be applied to the identification of other drugs and substances without departing from the scope of this disclosure. This spectroscopy may be used non-destructively and non-contact over stand-off distances or in remote sensing distances, whether from an airborne, vehicle, hand-held, or stationary platform.

PROCESS ANALYTICAL TECHNOLOGY (PAT)

[0070] One definition of process analytical technology, PAT, is “a system for designing, analyzing and controlling manufacturing through timely evaluations (i.e., during processing) of significant quality and performance attributes of raw and in-process materials and processes, with the goal of ensuring final product quality.” Near-infrared or SWIR spectroscopy may have applications in the PAT of the pharmaceutical industry by providing, for example, quantitative analysis of multiple components in a sample and in pack quantification of drugs in formulation, as well as quality of a drug and quality control of complex excipients used in formulation. The PAT process may benefit from near-infrared or SWIR spectroscopy for some steps, such as: raw material identification, active pharmaceutical ingredient applications, drying, granulation, blend uniformity and content uniformity. Some of the strengths of near-infrared or SWIR spectroscopy include:

radiation has good penetration properties, and, thus, minimal sample preparation may be required; measurement results may be obtained rapidly, and simultaneous measurements may be obtained for several parameters; non-destructive methods with little or no chemical waste; and organic chemicals that comprise most pharmaceutical products have unique spectra in the near-infrared and SWIR ranges, for example.

[0071] FIGURE 11 shows one example of a flow-chart 1100 in the PAT for the pharmaceutical industry. While the center shows the steps of the manufacturing process 1101, the top and bottom sides show where near-infrared spectroscopy could be applicable for lab use 1102 (top) or in process monitoring control 1103 (bottom). Indeed, near-infrared or SWIR spectroscopy has the potential to benefit almost every step in the manufacturing process. Just to provide a few examples of using near-infrared or SWIR spectroscopy in the PAT process, the raw material testing and blending process will be examined briefly.

[0072] At the commencement of manufacture of a drug product, it may be required to identify the correct material and grade of the pharmaceutical excipients to be used in the formulation. FIGURE 12 illustrates the typical near-infrared spectra 1200 for a variety of excipients. Included in the graph 1200 are spectra for: magnesium stearate 1201, sorbitol 1202, mannitol 1203, talc 1204, lactose 1205, starch 1206, maltodextrin 1207, and microcrystalline cellulose 1208. A suitable spectral database may be used to rapidly identify and qualify excipients. One nice aspect of the spectroscopy is that the near-infrared and SWIR are sensitive to both the physical and chemical characteristics of the samples.

[0073] One of the next steps in the manufacture of a dosage form is the blending together of the active component with the excipients to produce a homogeneous blend. In one embodiment, the near-infrared or SWIR spectroscopy apparatus may comprise a fiber-optic probe, which may, for example, interface with the blending vessel. For such a fiber-optic probe, near infrared or SWIR spectra may be collected in real-time from a blending process. FIGURE 13 exemplifies the absorbance 1300 from the blending process. Although the initial spectra 1301 shows differences from the eventual spectra, as the process continues the blend converges to the final spectra 1302 and continues to overlap that spectra. Similar converging or overlapping spectra may also be used to

check the product uniformity at the end of the process. The near-infrared spectra may be acquired in real-time; and, using appropriate data pre-processing and chemometric analysis, blend homogeneity plots may be derived, such as 1300.

[0074] One goal of the manufacturing process and PAT may be the concept of a “smart” manufacturing process, which may be a system or manufacturing operation responding to analytical data generated in real-time. Such a system may also have an in-built “artificial intelligence” as decisions may be made whether to continue a manufacturing operation. For example, with respect to the raw materials, integration of the quality measurement into smart manufacturing processes could be used to improve manufacturing operations by ensuring that the correct materials of the appropriate quality are used in the manufacture. Similarly, a smart blender would be under software control and would respond to the real-time spectral data collected.

[0075] FIGURE 14 illustrates what might be an eventual flow-chart 1400 of a smart manufacturing process. The manufacturing process 1401 may have as input the process feed 1402 and result in a process output 1403. A process controller 1404 may at least partially control the manufacturing process 1401, and the controller 1404 may receive inputs from the closed loop control (process parameters) 1405 as well as the on-line monitoring of process parameters 1406. The feedback loops in the process could refine the manufacturing process 1401 and improve the quality of the process output 1403. These are particular embodiments of the use of near-infrared or SWIR spectroscopy in the PAT of the pharmaceutical industry, but other variations, combinations, and methods may also be used and are intended to be covered by this disclosure.

[0076] The discussion thus far has centered on use of near-infrared or SWIR spectroscopy in applications such as identification of counterfeit drugs, detection of illicit drugs, and pharmaceutical process control. Although drugs and pharmaceuticals are one example, many other fields and applications may also benefit from the use of near infrared or SWIR spectroscopy, and these may also be implemented without departing from the scope of this disclosure. As just another example, near-infrared or SWIR spectroscopy may also be used as an analytic tool for food quality and safety control. Applications in food safety and quality assessment include contaminant detection, defect identification, constituent analysis, and quality evaluation. The techniques described in this

disclosure are particularly valuable when non-destructive testing is desired at stand-off or remote distances.

[0077] In one example, near-infrared or SWIR spectroscopy may be used in cereal breeding. The breeding purposes may require knowledge on both composition and functional properties of grain, while the functionality of wheat grain is an issue for wheat breeders. Most of the wheat functionality parameters depend on the protein-proteinase complex of wheat grain, as well as the condition of the carbohydrate complex. FIGURE 15A illustrates the near-infrared reflectance spectrum 1500 of wheat flour. Since these samples are complex in composition, several organic bonds involving hydrogen vibrate to produce overlapped spectral bands. Thus, the resulting spectrum 1500 appears like a wavy line without clearly defined features. Analytical methods based on this type of spectroscopy may have the potential to improve the quality of final cereal products by testing the products through the entire production process in the processing industry.

[0078] In yet another embodiment, near-infrared or SWIR spectroscopy may be used for the assessment of fruit and vegetable quality. Most commercial quality classification systems for fruit and vegetables are based on external features of the product, such as shape, color, size, weight and blemishes. However, the external appearance of most fruit is generally not an accurate guide to the internal eating quality of the fruit. As an example, for avocado fruit the external color is not a maturity characteristic, and its smell is too weak and appears later in its maturity stage. Analysis of the near-infrared or SWIR absorption spectra may provide qualitative and quantitative determination of many constituents and properties of horticulture produce, including oil, water, protein, pH, acidity, firmness, and soluble solids content or total soluble solids of fresh fruits. FIGURE 15B shows the near-infrared absorbance spectra 1550 obtained in diffusion reflectance mode for a series of whole 'Hass' avocado fruit. Four oil absorption bands are near 2200-2400nm (CH_2 stretch bend and combinations), with weaker absorption around 750nm, 1200nm, and 900-930nm ranges. On the other hand, near 1300-1750nm range may be useful for determining the protein and oil content. The 900-920nm absorbance band may be useful for sugar determination. Although described in the context of grains, fruits, and vegetables, the near-infrared or SWIR spectroscopy may also be valuable for other food quality control and assessment, such as measuring the properties of meats. These and other applications also fall within the scope of this disclosure.

DETECTION SYSTEMS

[0079] The near-infrared or SWIR spectroscopy system, remote sensing system or hyper-spectral imaging system may be on an airborne platform, mounted on a vehicle, a stationary transmission or reflection set-up, or even held by a human for a compact system. For such a system, there are fundamentally two hardware parts: the transmitter or light source and the detection system. Between the two, perhaps in a transmission or reflection setting, may be the sample being tested or measured. Moreover, the output from the detection system may go to a computational system, comprising computers or other processing equipment. The output from the computational system may be displayed graphically as well as with numerical tables and perhaps an identification of the material composition. These are just some of the parts of the systems, but other elements may be added or be eliminated, and these modified configurations are also intended to be covered by this disclosure.

[0080] By use of an active illuminator, a number of advantages may be achieved. First, stand-off or remote distances may be achieved if a non-lamp system is used – i.e., if the beam does not rapidly diffract. Also, higher signal-to-noise ratios may be achieved. For example, one way to improve the signal-to-noise ratio would be to use modulation and lock-in techniques. In one embodiment, the light source may be modulated, and then the detection system would be synchronized with the light source. In a particular embodiment, the techniques from lock-in detection may be used, where narrow band filtering around the modulation frequency may be used to reject noise outside the modulation frequency. In another embodiment, change detection schemes may be used, where the detection system captures the signal with the light source on and with the light source off. Again, for this system the light source may be modulated. Then, the signal with and without the light source is differenced. Change detection may help to identify objects that change in the field of view. In the following some exemplary detection systems are described.

[0081] In one embodiment, a SWIR camera or infrared camera system may be used to capture the images. The camera may include one or more lenses on the input, which may be adjustable. The focal plane assemblies may be made from mercury cadmium telluride material (HgCdTe), and the detectors may also include thermo-electric coolers. Alternately, the image sensors may be made from indium gallium arsenide (InGaAs), and CMOS transistors may be

connected to each pixel of the InGaAs photodiode array. The camera may interface wirelessly or with a cable (e.g., USB, Ethernet cable, or fiber optics cable) to a computer or tablet or smart phone, where the images may be captured and processed. These are a few examples of infrared cameras, but other SWIR or infrared cameras may be used and are intended to be covered by this disclosure.

[0082] In another embodiment, an imaging spectrometer may be used to detect the light received from the sample. For example, FIGURE 16A shows a schematic diagram 1600 of the basic elements of an imaging spectrometer. The input light 1601 from the sample may first be directed by a scanning mirror and/or other optics 1602. An optical dispersing element 1603, such as a grating or prism, in the spectrometer may split the light into many narrow, adjacent wavelength bands, which may then be passed through imaging optics 1604 onto one or more detectors or detector arrays 1605. Some sensors may use multiple detector arrays to measure hundreds of narrow wavelength bands.

[0083] An example of a typical imaging spectrometer 1650 used in hyper-spectral imaging systems is illustrated in FIGURE 16B. In this particular embodiment, the input light may be directed first by a tunable mirror 1651. A front lens 1652 may be placed before the entrance slit 1653 and the collector lens 1654. In this embodiment, the dispersing element is a holographic grating with a prism 1655, which separates the different wavelength bands. Then, a camera lens 1656 may be used to image the wavelengths onto a detector or camera 1657.

[0084] FIGURES 16 provide particular examples, but some of the elements may not be used, or other elements may be added, and these are also intended to be covered by this disclosure. For instance, a scanning spectrometer may be used before the detector, where a grating or dispersive element is scanned to vary the wavelength being measured by the detector. In yet another embodiment, filters may be used before one or more detectors to select the wavelengths or wavelength bands to be measured. This may be particularly useful if only a few bands or wavelengths are to be measured. The filters may be dielectric filters, Fabry-Perot filters, absorption or reflection filters, fiber gratings, or any other wavelength selective filter. In one embodiment, a wavelength division multiplexer, WDM, may be used followed by one or more detectors or detector arrays. One example of a planar wavelength division multiplexer may be a waveguide grating router or an arrayed waveguide grating. The WDM may be fiber coupled, and detectors may be placed

directly at the output or the detectors may be coupled through fibers to the WDM. Some of these components may also be combined with the configurations in FIGURE 16.

[0085] While the above detection systems could be categorized as single path detection systems, it may be advantageous in some cases to use multi-path detection systems. In one embodiment, a detection system from a Fourier transform infrared spectrometer, FTIR, may be used. The received light may be incident on a particular configuration of mirrors, called a Michelson interferometer, that allows some wavelengths to pass through but blocks others due to wave interference. The beam may be modified for each new data point by moving one of the mirrors, which changes the set of wavelengths that pass through. This collected data is called an interferogram. The interferogram is then processed, typically on a computing system, using an algorithm called the Fourier transform. One advantageous feature of FTIR is that it may simultaneously collect spectral data in a wide spectral range.

[0086] FIGURE 17 illustrates one example of the FTIR spectrometer 1700. Light from the near-infrared or SWIR light source 1701 may be collimated and directed to a beam splitter 1702. In one embodiment, the beam splitter 1702 may be a 50:50 beam splitter. One portion of the beam 1703 may be reflected toward a stationary mirror 1704, while the other portion of the beam 1705 may be transmitted towards a moving mirror 1706. Light may be reflected from the two mirrors 1704, 1706 back to the beam splitter 1702, and then a portion of the recombined beam 1707 may be directed toward the sample 1708. The recombined beam 1707 may be focused onto the sample 1708, in one embodiment. On leaving the sample 1708, the light may be refocused or at least collected at a detector 1709. A background interferogram may be obtained by using the set-up 1700 without a sample in the chamber 1708. When a sample is inserted into 1708, the background interferogram may be modulated by the presence of absorption bands in the sample. The FTIR spectrometer may have several advantages compared to a scanning (dispersive) spectrometer. Since all the wavelengths may be collected simultaneously, the FTIR may result in a higher signal-to-noise ratio for a given scan time or a shorter scan time for a given resolution. Moreover, unlike a spectrometer where a slit may limit the amount of the beam detected, the FTIR may accommodate the entire diameter of the beam coming from the light source 1701. The configuration 1700 is one

example of an FTIR, but other configurations may also be used, and these are also intended to be covered by this disclosure.

[0087] In yet another example of multi-beam detection systems, a dual-beam set-up 1800 such as in FIGURE 18 may be used to subtract out (or at least minimize the adverse effects of) light source fluctuations. In one embodiment, the output from an SC source 1801 may be collimated using a CaF₂ lens 1802 and then focused into the entrance slit of the monochromator 1803. At the exit slit, light at the selected wavelength is collimated again and may be passed through a polarizer 1804 before being incident on a calcium fluoride beam splitter 1805. After passing through the beam splitter 1805, the light is split into a sample 1806 and reference 1807 arm to enable ratiometric detection that may cancel out effects of intensity fluctuations in the SC source 1801. The light in the sample arm 1806 passes through the sample of interest and is then focused onto a HgCdTe detector 1808 connected to a pre-amp. A chopper 1802 and lock-in amplifier 1810 setup enable low noise detection of the sample arm signal. The light in the reference arm 1807 passes through an empty container (cuvette, gas cell etc.) of the same kind as used in the sample arm. A substantially identical detector 1809, pre-amp and lock-in amplifier 1810 is used for detection of the reference arm signal. The signal may then be analyzed using a computer system 1811. This is one particular example of a method to remove fluctuations from the light source, but other components may be added and other configurations may be used, and these are also intended to be covered by this disclosure.

[0088] Although particular examples of detection systems have been described, combinations of these systems or other systems may also be used, and these are also within the scope of this disclosure. As one example, environmental fluctuations (such as turbulence or winds) may lead to fluctuations in the beam for active remote sensing or hyper-spectral imaging. A configuration such as FIGURE 18 may be able to remove the effect of environmental fluctuations. Yet another technique may be to “wobble” the light beam after the light source using a vibrating mirror. The motion may lead to the beam moving enough to wash out spatial fluctuations within the beam waist at the sample or detection system. If the vibrating mirror is scanned faster than the integration time of the detectors, then the spatial fluctuations in the beam may be integrated out. Alternately, some sort of synchronous detection system may be used, where the detection is synchronized to the vibrating frequency.

LIGHT SOURCES FOR SWIR AND NEAR INFRARED

[0089] There are a number of light sources that may be used in the near infrared. To be more specific, the discussion below will consider light sources operating in the short wave infrared (SWIR), which may cover the wavelength range of approximately 1400nm to 2500nm. Other wavelength ranges may also be used for the applications described in this disclosure, so the discussion below is merely provided for exemplary types of light sources. The SWIR wavelength range may be valuable for a number of reasons. The SWIR corresponds to a transmission window through water and the atmosphere. Also, the so-called “eye-safe” wavelengths are wavelengths longer than approximately 1400nm as previously described.

[0090] Different light sources may be selected for the SWIR based on the needs of the application. Some of the features for selecting a particular light source include power or intensity, wavelength range or bandwidth, spatial or temporal coherence, spatial beam quality for focusing or transmission over long distance, and pulse width or pulse repetition rate. Depending on the application, lamps, light emitting diodes (LEDs), laser diodes (LD’s), tunable LD’s, super-luminescent laser diodes (SLDs), fiber lasers or super-continuum sources (SC) may be advantageously used. Also, different fibers may be used for transporting the light, such as fused silica fibers, plastic fibers, mid-infrared fibers (e.g., tellurite, chalcogenides, fluorides, ZBLAN, etc), or a hybrid of these fibers.

[0091] Lamps may be used if low power or intensity of light is required in the SWIR, and if an incoherent beam is suitable. In one embodiment, in the SWIR an incandescent lamp that can be used is based on tungsten and halogen, which have an emission wavelength between approximately 500nm to 2500nm. For low intensity applications, it may also be possible to use thermal sources, where the SWIR radiation is based on the black body radiation from the hot object. Although the thermal and lamp based sources are broadband and have low intensity fluctuations, it may be difficult to achieve a high signal-to-noise ratio due to the low power levels. Also, the lamp based sources tend to be energy inefficient.

[0092] In another embodiment, LED's can be used that have a higher power level in the SWIR wavelength range. LED's also produce an incoherent beam, but the power level can be higher than a lamp and with higher energy efficiency. Also, the LED output may more easily be modulated, and the LED provides the option of continuous wave or pulsed mode of operation. LED's are solid state components that emit a wavelength band that is of moderate width, typically between about 20nm to 40nm. There are also so-called super-luminescent LEDs that may even emit over a much wider wavelength range. In another embodiment, a wide band light source may be constructed by combining different LEDs that emit in different wavelength bands, some of which could preferably overlap in spectrum. One advantage of LEDs as well as other solid state components is the compact size that they may be packaged into.

[0093] In yet another embodiment, various types of laser diodes may be used in the SWIR wavelength range. Just as LEDs may be higher in power but narrower in wavelength emission than lamps and thermal sources, the LDs may be yet higher in power but yet narrower in wavelength emission than LEDs. Different kinds of LDs may be used, including Fabry-Perot LDs, distributed feedback (DFB) LDs, distributed Bragg reflector (DBR) LDs. Since the LDs have relatively narrow wavelength range (typically under 10nm), in one embodiment a plurality of LDs may be used that are at different wavelengths in the SWIR. The various LDs may be spatially multiplexed, polarization multiplexed, wavelength multiplexed, or a combination of these multiplexing methods. Also, the LDs may be fiber pig-tailed or have one or more lenses on the output to collimate or focus the light. Another advantage of LDs is that they may be packaged compactly and may have a spatially coherent beam output. Moreover, tunable LDs that can tune over a range of wavelengths are also available. The tuning may be done by varying the temperature, or electrical current may be used in particular structures such as distributed Bragg reflector LDs. In another embodiment, external cavity LDs may be used that have a tuning element, such as a fiber grating or a bulk grating, in the external cavity.

[0094] In another embodiment, super-luminescent laser diodes may provide higher power as well as broad bandwidth. An SLD is typically an edge emitting semiconductor light source based on super-luminescence (e.g., this could be amplified spontaneous emission). SLDs combine the higher power and brightness of LDs with the low coherence of conventional LEDs, and the emission band

for SLD's may be 5nm to 100nm wide, preferably in the 60nm to 100nm range. Although currently SLDs are commercially available in the wavelength range of approximately 400nm to 1700nm, SLDs could and may in the future be made that cover a broader region of the SWIR.

[0095] In yet another embodiment, high power LDs for either direct excitation or to pump fiber lasers and SC light sources may be constructed using one or more laser diode bar stacks. FIGURE 19 shows an example block diagram 1900 with building blocks for constructing the high power LDs. In this embodiment, one or more diode bar stacks 1901 may be used, where the diode bar stack may be an array of several single emitter LDs. Since the fast axis (e.g., vertical direction) may be nearly diffraction limited while the slow-axis (e.g., horizontal axis) may be far from diffraction limited, different collimators 1902 may be used for the two axes.

[0096] The brightness may be increased by spatially combining the beams from multiple stacks 1903. The combiner may include spatial interleaving, wavelength multiplexing, or a combination of the two. Different spatial interleaving schemes may be used, such as using an array of prisms or mirrors with spacers to bend one array of beams into the beam path of the other. In another embodiment, segmented mirrors with alternate high-reflection and anti-reflection coatings may be used. Moreover, the brightness may be increased by polarization beam combining 1904 the two orthogonal polarizations, such as by using a polarization beam splitter. In a particular embodiment, the output may then be focused or coupled into a large diameter core fiber. As an example, typical dimensions for the large diameter core fiber range from diameters of approximately 100 microns to 400 microns or more. Alternatively or in addition, a custom beam shaping module 1905 may be used, depending on the particular application. For example, the output of the high power LD may be used directly 1906, or it may be fiber coupled 1907 to combine, integrate, or transport the high power LD energy. These high power LDs may grow in importance because the LD powers can rapidly scale up. For example, instead of the power being limited by the power available from a single emitter, the power may increase in multiples depending on the number of diodes multiplexed and the size of the large diameter fiber. Although FIGURE 19 is shown as one embodiment, some or all of the elements may be used in a high power LD, or additional elements may also be used.

SWIR SUPER-CONTINUUM LASERS

[0097] Each of the light sources described above have particular strengths, but they also may have limitations. For example, there is typically a trade-off between wavelength range and power output. Also, sources such as lamps, thermal sources, and LEDs produce incoherent beams that may be difficult to focus to a small area and may have difficulty propagating for long distances. An alternative source that may overcome some of these limitations is an SC light source. Some of the advantages of the SC source may include high power and intensity, wide bandwidth, spatially coherent beam that can propagate nearly transform limited over long distances, and easy compatibility with fiber delivery.

[0098] Supercontinuum lasers may combine the broadband attributes of lamps with the spatial coherence and high brightness of lasers. By exploiting a modulational instability initiated supercontinuum (SC) mechanism, an all-fiber-integrated SC laser with no moving parts may be built using commercial-off-the-shelf (COTS) components. Moreover, the fiber laser architecture may be a platform where SC in the visible, near-infrared/SWIR, or mid-IR can be generated by appropriate selection of the amplifier technology and the SC generation fiber. But until recently, SC lasers were used primarily in laboratory settings since typically large, table-top, mode-locked lasers were used to pump nonlinear media such as optical fibers to generate SC light. However, those large pump lasers may now be replaced with diode lasers and fiber amplifiers that gained maturity in the telecommunications industry.

[0099] In one embodiment, an all-fiber-integrated, high-powered SC light source 2000 may be elegant for its simplicity (FIGURE 20). The light may be first generated from a seed laser diode 2001. For example, the seed LD 2001 may be a distributed feedback (DFB) laser diode with a wavelength near 1542nm or 1550 nm, with approximately 0.5–2.0ns pulsed output, and with a pulse repetition rate between one kilohertz to about 100MHz or more. The output from the seed laser diode may then be amplified in a multiple-stage fiber amplifier 2002 comprising one or more gain fiber segments. In a particular embodiment, the first stage pre-amplifier 2003 may be designed for optimal noise performance. For example, the pre-amplifier 2003 may be a standard erbium-doped fiber amplifier or an erbium/ytterbium doped cladding pumped fiber amplifier. Between amplifier

stages 2003 and 2006, it may be advantageous to use band-pass filters 2004 to block amplified spontaneous emission and isolators 2005 to prevent spurious reflections. Then, the power amplifier stage 2006 may use a cladding-pumped fiber amplifier that may be optimized to minimize nonlinear distortion. The power amplifier fiber 2006 may also be an erbium-doped fiber amplifier, if only low or moderate power levels are to be generated.

[0100] The SC generation 2007 may occur in the relatively short lengths of fiber that follow the pump laser. Exemplary SC fiber lengths may range from a few millimeters to 100m or more. In one embodiment, the SC generation may occur in a first fiber 2008 where the modulational-instability initiated pulse break-up occurs primarily, followed by a second fiber 2009 where the SC generation and spectral broadening occurs primarily.

[0101] In one embodiment, one or two meters of standard single-mode fiber (SMF) after the power amplifier stage may be followed by several meters of SC generation fiber. For this example, in the SMF the peak power may be several kilowatts and the pump light may fall in the anomalous group-velocity dispersion regime—often called the soliton regime. For high peak powers in the anomalous dispersion regime, the nanosecond pulses may be unstable due to a phenomenon known as modulational instability, which is basically parametric amplification in which the fiber nonlinearity helps to phase match the pulses. As a consequence, the nanosecond pump pulses may be broken into many shorter pulses as the modulational instability tries to form soliton pulses from the quasi-continuous-wave background. Although the laser diode and amplification process starts with approximately nanosecond-long pulses, modulational instability in the short length of SMF fiber may form approximately 0.5ps to several-picosecond-long pulses with high intensity. Thus, the few meters of SMF fiber may result in an output similar to that produced by mode-locked lasers, except in a much simpler and cost-effective manner.

[0102] The short pulses created through modulational instability may then be coupled into a nonlinear fiber for SC generation. The nonlinear mechanisms leading to broadband SC may include four-wave mixing or self-phase modulation along with the optical Raman effect. Since the Raman effect is self-phase-matched and shifts light to longer wavelengths by emission of optical photons, the SC may spread to longer wavelengths very efficiently. The short-wavelength edge may arise

from four-wave mixing, and often times the short wavelength edge may be limited by increasing group-velocity dispersion in the fiber. In many instances, if the particular fiber used has sufficient peak power and SC fiber length, the SC generation process may fill the long-wavelength edge up to the transmission window.

[0103] Mature fiber amplifiers for the power amplifier stage 2006 include ytterbium-doped fibers (near 1060 nm), erbium-doped fibers (near 1550nm), erbium/ytterbium-doped fibers (near 1550nm), or thulium-doped fibers (near 2000nm). In various embodiments, candidates for SC fiber 2009 include fused silica fibers (for generating SC between 0.8–2.7 μ m), mid-IR fibers such as fluorides, chalcogenides, or tellurites (for generating SC out to 4.5 μ m or longer), photonic crystal fibers (for generating SC between 0.4-1.7 μ m), or combinations of these fibers. Therefore, by selecting the appropriate fiber-amplifier doping for 2006 and nonlinear fiber 2009, SC may be generated in the visible, near-IR/SWIR, or mid-IR wavelength region.

[0104] The configuration 2000 of FIGURE 20 is just one particular example, and other configurations can be used and are intended to be covered by this disclosure. For example, further gain stages may be used, and different types of lossy elements or fiber taps may be used between the amplifier stages. In another embodiment, the SC generation may occur partially in the amplifier fiber and in the pig-tails from the pump combiner or other elements. In yet another embodiment, polarization maintaining fibers may be used, and a polarizer may also be used to enhance the polarization contrast between amplifier stages. Also, not discussed in detail are many accessories that may accompany this set-up, such as driver electronics, pump laser diodes, safety shut-offs, and thermal management and packaging.

[0105] In one embodiment, one example of the SC laser that operates in the SWIR is illustrated in FIGURE 21. This SWIR SC source 2100 produces an output of up to approximately 5W over a spectral range of about 1.5-2.4 microns, and this particular laser is made out of polarization maintaining components. The seed laser 2101 is a distributed feedback (DFB) laser operating near 1542nm producing approximately 0.5nsec pulses at an about 8MHz repetition rate. The pre-amplifier 2102 is forward pumped and uses about 2m length of erbium/ytterbium cladding pumped fiber 2103 (often also called dual-core fiber) with an inner core diameter of 12 microns and

outer core diameter of 130 microns. The pre-amplifier gain fiber 2103 is pumped using a 10W laser diode near 940nm 2105 that is coupled in using a fiber combiner 2104.

[0106] In this particular 5W unit, the mid-stage between amplifier stages 2102 and 2106 comprises an isolator 2107, a band-pass filter 2108, a polarizer 2109 and a fiber tap 2110. The power amplifier 2106 uses an approximately 4m length of the 12/130 micron erbium/ytterbium doped fiber 2111 that is counter-propagating pumped using one or more 30W laser diodes near 940nm 2112 coupled in through a combiner 2113. An approximately 1-2m length of the combiner pig-tail helps to initiate the SC process, and then a length of PM-1550 fiber 2115 (polarization maintaining, single-mode, fused silica fiber optimized for 1550nm) is spliced 2114 to the combiner output.

[0107] If an output fiber of about 10m in length is used, then the resulting output spectrum 2200 is shown in FIGURE 22. The details of the output spectrum 2200 depend on the peak power into the fiber, the fiber length, and properties of the fiber such as length and core size, as well as the zero dispersion wavelength and the dispersion properties. For example, if a shorter length of fiber is used, then the spectrum actually reaches to longer wavelengths (e.g., a 2m length of SC fiber broadens the spectrum to about 2500nm). Also, if extra-dry fibers are used with less O-H content, then the wavelength edge may also reach to a longer wavelength. To generate more spectrum toward the shorter wavelengths, the pump wavelength (in this case around 1542nm) should be close to the zero dispersion wavelength in the fiber. For example, by using a dispersion shifted fiber or so-called non-zero dispersion shifted fiber, the short wavelength edge may shift to shorter wavelengths.

[0108] Although one particular example of a 5W SWIR-SC has been described, different components, different fibers, and different configurations may also be used consistent with this disclosure. For instance, another embodiment of the similar configuration 2100 in FIGURE 21 may be used to generate high powered SC between approximately 1060nm and 1800nm. For this embodiment, the seed laser 2101 may be a distributed feedback laser diode around 1064nm, the pre-amplifier gain fiber 2103 may be a ytterbium-doped fiber amplifier with 10/125 microns dimensions, and the pump laser 2105 may be a 10W laser diode near 915nm. A mode field adapter may be included in the mid-stage, in addition to the isolator 2107, band pass filter 2108, polarizer 2109 and

tap 2110. The gain fiber 2111 in the power amplifier may be an about 20m length of ytterbium-doped fiber with 25/400 microns dimension. The pump 2112 for the power amplifier may be up to six pump diodes providing 30W each near 915nm. For this much pump power, the output power in the SC may be as high as 50W or more.

[0109] In one embodiment, it may be desirous to generate high power SWIR SC over 1.4-1.8 microns and separately 2-2.5 microns (the window between 1.8 and 2 microns may be less important due to the strong water and atmospheric absorption). For example, the top SC source of FIGURE 23 can lead to bandwidths ranging from about 1400nm to 1800nm or broader, while the lower SC source of FIGURE 23 can lead to bandwidths ranging from about 1900nm to 2500nm or broader. Since these wavelength ranges are shorter than about 2500nm, the SC fiber can be based on fused silica fiber. Exemplary SC fibers include standard single-mode fiber SMF, high-nonlinearity fiber, high-NA fiber, dispersion shifted fiber, dispersion compensating fiber, and photonic crystal fibers. Non-fused-silica fibers can also be used for SC generation, including chalcogenides, fluorides, ZBLAN, tellurites, and germanium oxide fibers.

[0110] In one embodiment, the top of FIGURE 23 illustrates an exemplary block diagram for an SC source 2300 capable of generating light between approximately 1400nm and 1800nm or broader. As an example, a pump fiber laser similar to FIGURE 21 can be used as the input to a SC fiber 2309. The seed laser diode 2301 can comprise a DFB laser that generates, for example, several milliwatts of power around 1542nm or 1553nm. The fiber pre-amplifier 2302 can comprise an erbium-doped fiber amplifier or an erbium/ytterbium doped double clad fiber. In this example a mid-stage amplifier 2303 can be used, which can comprise an erbium/ytterbium doped double-clad fiber. A bandpass filter 2305 and isolator 2306 may be used between the pre-amplifier 2302 and mid-stage amplifier 2303. The power amplifier stage 2304 can comprise a larger core size erbium/ytterbium doped double-clad fiber, and another bandpass filter 2307 and isolator 2308 can be used before the power amplifier 2304. The output of the power amplifier can be coupled to the SC fiber 2309 to generate the SC output 2310. This is just one exemplary configuration for an SC source, and other configurations or elements may be used consistent with this disclosure.

[0111] In yet another embodiment, the bottom of FIGURE 23 illustrates a block diagram for an exemplary SC source 2350 capable of generating light between approximately 1900nm and 2500nm or broader. As an example, the seed laser diode 2351 can comprise a DFB or DBR laser that generates, for example, several milliwatts of power around 1542nm or 1553nm. The fiber pre-amplifier 2352 can comprise an erbium-doped fiber amplifier or an erbium/ytterbium doped double-clad fiber. In this example a mid-stage amplifier 2353 can be used, which can comprise an erbium/ytterbium doped double-clad fiber. A bandpass filter 2355 and isolator 2356 may be used between the pre-amplifier 2352 and mid-stage amplifier 2353. The power amplifier stage 2354 can comprise a thulium doped double-clad fiber, and another isolator 2357 can be used before the power amplifier 2354. Note that the output of the mid-stage amplifier 2353 can be approximately near 1542nm, while the thulium-doped fiber amplifier 2354 can amplify wavelengths longer than approximately 1900nm and out to about 2100nm. Therefore, for this configuration wavelength shifting may be required between 2353 and 2354. In one embodiment, the wavelength shifting can be accomplished using a length of standard single-mode fiber 2358, which can have a length between approximately 5m and 50m, for example. The output of the power amplifier 2354 can be coupled to the SC fiber 2359 to generate the SC output 2360. This is just one exemplary configuration for an SC source, and other configurations or elements can be used consistent with this disclosure. For example, the various amplifier stages can comprise different amplifier types, such as erbium doped fibers, ytterbium doped fibers, erbium/ytterbium co-doped fibers and thulium doped fibers. One advantage of the SC lasers illustrated in FIGURES 20, 21, and 23 are that they may use all-fiber components, so that the SC laser can be all-fiber, monolithically integrated with no moving parts. The all-integrated configuration can consequently be robust and reliable.

[0112] FIGURES 20, 21 and 23 are examples of SC light sources that may advantageously be used for near-infrared or SWIR light generation in various spectroscopy, active remote sensing and hyper-spectral imaging applications. However, many other versions of the SC light sources may also be made that are intended to also be covered by this disclosure. For example, the SC generation fiber could be pumped by a mode-locked laser, a gain-switched semiconductor laser, an optically pumped semiconductor laser, a solid state laser, other fiber lasers, or a combination of these types of

lasers. Also, rather than using a fiber for SC generation, either a liquid or a gas cell might be used as the nonlinear medium in which the spectrum is to be broadened.

[0113] Even within the all-fiber versions illustrated such as in FIGURE 21, different configurations could be used consistent with the disclosure. In one embodiment, it may be desirable to have a lower cost version of the SWIR SC laser of FIGURE 21. One way to lower the cost could be to use a single stage of optical amplification, rather than two stages, which may be feasible if lower output power is required or the gain fiber is optimized. For example, the pre-amplifier stage 2102 might be removed, along with at least some of the mid-stage elements. In yet another embodiment, the gain fiber could be double passed to emulate a two stage amplifier. In this example, the pre-amplifier stage 2102 might be removed, and perhaps also some of the mid-stage elements. A mirror or fiber grating reflector could be placed after the power amplifier stage 2106 that may preferentially reflect light near the wavelength of the seed laser 2101. If the mirror or fiber grating reflector can transmit the pump light near 940nm, then this could also be used instead of the pump combiner 2113 to bring in the pump light 2112. The SC fiber 2115 could be placed between the seed laser 2101 and the power amplifier stage 2106 (SC is only generated after the second pass through the amplifier, since the power level may be sufficiently high at that time). In addition, an output coupler may be placed between the seed laser diode 2101 and the SC fiber, which now may be in front of the power amplifier 2106. In a particular embodiment, the output coupler could be a power coupler or divider, a dichroic coupler (e.g., passing seed laser wavelength but outputting the SC wavelengths), or a wavelength division multiplexer coupler. This is just one further example, but a myriad of other combinations of components and architectures could also be used for SC light sources to generate near-infrared or SWIR light that are intended to be covered by this disclosure.

[0114] Described herein are just some examples of the beneficial use of near-infrared or SWIR lasers for spectroscopy, active remote sensing or hyper-spectral imaging. However, many other spectroscopy and identification procedures can use the near-infrared or SWIR light consistent with this disclosure and are intended to be covered by the disclosure. As one example, the fiber-based super-continuum lasers may have a pulsed output with pulse durations of approximately 0.5-2nsec and pulse repetition rates of several Megahertz. Therefore, the near-infrared or SWIR spectroscopy, active remote sensing or hyper-spectral imaging applications may also be combined

with LIDAR-type applications. Namely, the distance or time axis can be added to the information based on time-of-flight measurements. For this type of information to be used, the detection system would also have to be time-gated to be able to measure the time difference between the pulses sent and the pulses received. By calculating the round-trip time for the signal, the distance of the object may be judged. In another embodiment, GPS (global positioning system) information may be added, so the near-infrared or SWIR spectroscopy, active remote sensing or hyper-spectral imagery would also have a location tag on the data. Moreover, the near-infrared or SWIR spectroscopy, active remote sensing or hyper-spectral imaging information could also be combined with two-dimensional or three-dimensional images to provide a physical picture as well as a chemical composition identification of the materials. These are just some modifications of the near-infrared or SWIR spectroscopy, active remote sensing or hyper-spectral imaging system described in this disclosure, but other techniques may also be added or combinations of these techniques may be added, and these are also intended to be covered by this disclosure.

WIRELESS LINK TO THE CLOUD

[0115] The non-invasive blood constituent or analytes measurement device may also benefit from communicating the data output to the “cloud” (e.g., data servers and processors in the web remotely connected) via wired and/or wireless communication strategies. The non-invasive devices may be part of a series of biosensors applied to the patient, and collectively these devices form what might be called a body area network or a personal area network. The biosensors and non-invasive devices may communicate to a smart phone, tablet, personal data assistant, computer, and/or other microprocessor-based device, which may in turn wirelessly or over wire and/or fiber optically transmit some or all of the signal or processed data to the internet or cloud. The cloud or internet may in turn send the data to doctors or health care providers as well as the patients themselves. Thus, it may be possible to have a panoramic, high-definition, relatively comprehensive view of a patient that doctors can use to assess and manage disease, and that patients can use to help maintain their health and direct their own care.

[0116] In a particular embodiment 2400 illustrated in Figure 24, the physiological measurement device or non-invasive blood constituent measurement device 2401 may comprise a

transmitter 2403 to communicate over a first communication link 2404 in the body area network or personal area network to a receiver in a smart phone, tablet cell phone, PDA, or computer 2405. For the measurement device 2401, it may also be advantageous to have a processor 2402 to process some of the physiological data, since with processing the amount of data to transmit may be less (hence, more energy efficient). The first communication link 2404 may operate through the use of one of many wireless technologies such as Bluetooth, Zigbee, WiFi, IrDA (infrared data association), wireless USB, or Z-wave, to name a few. Alternatively, the communication link 2404 may occur in the wireless medical band between 2360 and 2390MHz, which the FCC allocated for medical body area network devices, or in other designated medical device or WMTS bands. These are examples of devices that can be used in the body area network and surroundings, but other devices could also be used and are included in the scope of this disclosure.

[0117] The personal device 2405 may store, process, display, and transmit some of the data from the measurement device 2401. The device 2405 may comprise a receiver, transmitter, display, voice control and speakers, and one or more control buttons or knobs and a touch screen. Examples of the device 2405 include smart phones such as the Apple iPhones® or phones operating on the Android or Microsoft systems. In one embodiment, the device 2405 may have an application, software program, or firmware to receive and process the data from the measurement device 2401. The device 2405 may then transmit some or all of the data or the processed data over a second communication link 2406 to the internet or “cloud” 2407. The second communication link 2406 may advantageously comprise at least one segment of a wireless transmission link, which may operate using WiFi or the cellular network. The second communication link 2406 may additionally comprise lengths of fiber optic and/or communication over copper wires or cables.

[0118] The internet or cloud 2407 may add value to the measurement device 2401 by providing services that augment the physiological data collected. In a particular embodiment, some of the functions performed by the cloud include: (a) receive at least a fraction of the data from the device 2405; (b) buffer or store the data received; (c) process the data using software stored on the cloud; (d) store the resulting processed data; and (e) transmit some or all of the data either upon request or based on an alarm. As an example, the data or processed data may be transmitted 2408

back to the originator (e.g., patient or user), it may be transmitted 2409 to a health care provider or doctor, or it may be transmitted 2410 to other designated recipients.

[0119] The cloud 2407 may provide a number of value-add services. For example, the cloud application may store and process the physiological data for future reference or during a visit with the healthcare provider. If a patient has some sort of medical mishap or emergency, the physician can obtain the history of the physiological parameters over a specified period of time. In another embodiment, if the physiological parameters fall out of acceptable range, alarms may be delivered to the user 2408, the healthcare provider 2409, or other designated recipients 2410. These are just some of the features that may be offered, but many others may be possible and are intended to be covered by this disclosure. As an example, the device 2405 may also have a GPS sensor, so the cloud 2407 may be able to provide time, data and position along with the physiological parameters. Thus, if there is a medical emergency, the cloud 2407 could provide the location of the patient to the healthcare provider 2409 or other designated recipients 2410. Moreover, the digitized data in the cloud 2407 may help to move toward what is often called “personalized medicine.” Based on the physiological parameter data history, medication or medical therapies may be prescribed that are customized to the particular patient.

[0120] Beyond the above benefits, the cloud application 2407 and application on the device 2405 may also have financial value for companies developing measurement devices 2401 such as a non-invasive blood constituent monitor. In the case of glucose monitors, the companies make the majority of their revenue on the measurement strips. However, with a non-invasive monitor, there is no need for strips, so there is less of an opportunity for recurring costs (e.g., the razor/razor blade model does not work for non-invasive devices). On the other hand, people may be willing to pay a periodic fee for the value-add services provided on the cloud 2407. Diabetic patients, for example, would probably be willing to pay a periodic fee for monitoring their glucose levels, storing the history of the glucose levels, and having alarm warnings when the glucose level falls out of range. Similarly, patients taking ketone bodies supplement for treatment of disorders characterized by impaired glucose metabolism (e.g., Alzheimer’s, Parkinson’s, Huntington’s or ALS) may need to monitor their ketone bodies level. These patients would also probably be willing to pay a periodic fee for the value-add services provided on the cloud 2407. Thus, by leveraging the advances in

wireless connectivity and the widespread use of handheld devices such as smart phones that can wirelessly connect to the cloud, businesses can build a recurring cost business model even using non-invasive measurement devices.

[0121] Described herein are just some examples of the beneficial use of near-infrared or SWIR lasers for non-invasive monitoring of glucose, ketones, HbA1c and other blood constituents. However, many other medical procedures can use the near-infrared or SWIR light consistent with this disclosure and are intended to be covered by the disclosure.

[0122] Although the present disclosure has been described in several embodiments, a myriad of changes, variations, alterations, transformations, and modifications may be suggested to one skilled in the art, and it is intended that the present disclosure encompass such changes, variations, alterations, transformations, and modifications as falling within the spirit and scope of the appended claims.

[0123] While exemplary embodiments are described above, it is not intended that these embodiments describe all possible forms of the disclosure. Rather, the words used in the specification are words of description rather than limitation, and it is understood that various changes may be made without departing from the spirit and scope of the disclosure. Additionally, the features of various implementing embodiments may be combined to form further embodiments of the disclosure. While various embodiments may have been described as providing advantages or being preferred over other embodiments with respect to one or more desired characteristics, as one skilled in the art is aware, one or more characteristics may be compromised to achieve desired system attributes, which depend on the specific application and implementation. These attributes include, but are not limited to: cost, strength, durability, life cycle cost, marketability, appearance, packaging, size, serviceability, weight, manufacturability, ease of assembly, etc. The embodiments described herein that are described as less desirable than other embodiments or prior art implementations with respect to one or more characteristics are not outside the scope of the disclosure and may be desirable for particular applications.

PATENT APPLICATION FEE DETERMINATION RECORD

Substitute for Form PTO-875

Application or Docket Number
14/875,709

APPLICATION AS FILED - PART I

(Column 1) (Column 2)

FOR	NUMBER FILED	NUMBER EXTRA
BASIC FEE (37 CFR 1.16(a), (b), or (c))	N/A	N/A
SEARCH FEE (37 CFR 1.16(k), (l), or (m))	N/A	N/A
EXAMINATION FEE (37 CFR 1.16(o), (p), or (q))	N/A	N/A
TOTAL CLAIMS (37 CFR 1.16(j))	20	minus 20 = *
INDEPENDENT CLAIMS (37 CFR 1.16(h))	3	minus 3 = *
APPLICATION SIZE FEE (37 CFR 1.16(s))	If the specification and drawings exceed 100 sheets of paper, the application size fee due is \$310 (\$155 for small entity) for each additional 50 sheets or fraction thereof. See 35 U.S.C. 41(a)(1)(G) and 37 CFR 1.16(s).	
MULTIPLE DEPENDENT CLAIM PRESENT (37 CFR 1.16(j))		

* If the difference in column 1 is less than zero, enter "0" in column 2.

SMALL ENTITY

RATE(\$)	FEE(\$)
N/A	70
N/A	300
N/A	360
x 40 =	0.00
x 210 =	0.00
	0.00
TOTAL	730

OR OTHER THAN SMALL ENTITY

RATE(\$)	FEE(\$)
N/A	
N/A	
N/A	
TOTAL	

APPLICATION AS AMENDED - PART II

(Column 1) (Column 2) (Column 3)

AMENDMENT A		CLAIMS REMAINING AFTER AMENDMENT		HIGHEST NUMBER PREVIOUSLY PAID FOR	PRESENT EXTRA
	Total (37 CFR 1.16(i))	*	Minus	**	=
	Independent (37 CFR 1.16(h))	*	Minus	***	=
	Application Size Fee (37 CFR 1.16(s))				
FIRST PRESENTATION OF MULTIPLE DEPENDENT CLAIM (37 CFR 1.16(j))					

SMALL ENTITY

RATE(\$)	ADDITIONAL FEE(\$)
x =	
x =	
TOTAL ADD'L FEE	

OR OTHER THAN SMALL ENTITY

RATE(\$)	ADDITIONAL FEE(\$)
x =	
x =	
TOTAL ADD'L FEE	

(Column 1) (Column 2) (Column 3)

AMENDMENT B		CLAIMS REMAINING AFTER AMENDMENT		HIGHEST NUMBER PREVIOUSLY PAID FOR	PRESENT EXTRA
	Total (37 CFR 1.16(i))	*	Minus	**	=
	Independent (37 CFR 1.16(h))	*	Minus	***	=
	Application Size Fee (37 CFR 1.16(s))				
FIRST PRESENTATION OF MULTIPLE DEPENDENT CLAIM (37 CFR 1.16(j))					

SMALL ENTITY

RATE(\$)	ADDITIONAL FEE(\$)
x =	
x =	
TOTAL ADD'L FEE	

OR OTHER THAN SMALL ENTITY

RATE(\$)	ADDITIONAL FEE(\$)
x =	
x =	
TOTAL ADD'L FEE	

* If the entry in column 1 is less than the entry in column 2, write "0" in column 3.
 ** If the "Highest Number Previously Paid For" IN THIS SPACE is less than 20, enter "20".
 *** If the "Highest Number Previously Paid For" IN THIS SPACE is less than 3, enter "3".
 The "Highest Number Previously Paid For" (Total or Independent) is the highest found in the appropriate box in column 1.



UNITED STATES PATENT AND TRADEMARK OFFICE

UNITED STATES DEPARTMENT OF COMMERCE
United States Patent and Trademark Office
Address: COMMISSIONER FOR PATENTS
P.O. Box 1450
Alexandria, Virginia 22313-1450
www.uspto.gov

Table with 6 columns: APPLICATION NUMBER, FILING or 371(c) DATE, GRP ART UNIT, FIL FEE REC'D, ATTY. DOCKET NO, TOT CLAIMS, IND CLAIMS. Row 1: 14/875,709, 10/06/2015, 2688, 730, OMNI 0105 PUSPI, 20, 3

CONFIRMATION NO. 7496

UPDATED FILING RECEIPT

109543
Brooks, Kushman P.C./Cheetah Omni MedSci
1000 Town Center
Twenty Second Floor
Southfield, MI 48075



Date Mailed: 11/10/2015

Receipt is acknowledged of this non-provisional patent application. The application will be taken up for examination in due course. Applicant will be notified as to the results of the examination. Any correspondence concerning the application must include the following identification information: the U.S. APPLICATION NUMBER, FILING DATE, NAME OF APPLICANT, and TITLE OF INVENTION. Fees transmitted by check or draft are subject to collection. Please verify the accuracy of the data presented on this receipt. If an error is noted on this Filing Receipt, please submit a written request for a Filing Receipt Correction. Please provide a copy of this Filing Receipt with the changes noted thereon. If you received a "Notice to File Missing Parts" for this application, please submit any corrections to this Filing Receipt with your reply to the Notice. When the USPTO processes the reply to the Notice, the USPTO will generate another Filing Receipt incorporating the requested corrections

Inventor(s)

Mohammed N. Islam, Ann Arbor, MI;

Applicant(s)

OMNI MEDSCI, INC., Ann Arbor, MI;

Power of Attorney: The patent practitioners associated with Customer Number 109543

Domestic Priority data as claimed by applicant

This application is a CON of 14/108,986 12/17/2013 PAT 9164032 which claims benefit of 61/747,487 12/31/2012

Foreign Applications for which priority is claimed (You may be eligible to benefit from the Patent Prosecution Highway program at the USPTO. Please see http://www.uspto.gov for more information.) - None.

Foreign application information must be provided in an Application Data Sheet in order to constitute a claim to foreign priority. See 37 CFR 1.55 and 1.76.

Permission to Access - A proper Authorization to Permit Access to Application by Participating Offices (PTO/SB/39 or its equivalent) has been received by the USPTO.

If Required, Foreign Filing License Granted: 10/22/2015

The country code and number of your priority application, to be used for filing abroad under the Paris Convention, is US 14/875,709

Projected Publication Date: 02/18/2016

Non-Publication Request: No

Early Publication Request: No

** SMALL ENTITY **

Title

SHORT-WAVE INFRARED SUPER-CONTINUUM LASERS FOR DETECTING COUNTERFEIT OR ILLICIT DRUGS AND PHARMACEUTICAL PROCESS CONTROL

Preliminary Class

369

Statement under 37 CFR 1.55 or 1.78 for AIA (First Inventor to File) Transition Applications: No

PROTECTING YOUR INVENTION OUTSIDE THE UNITED STATES

Since the rights granted by a U.S. patent extend only throughout the territory of the United States and have no effect in a foreign country, an inventor who wishes patent protection in another country must apply for a patent in a specific country or in regional patent offices. Applicants may wish to consider the filing of an international application under the Patent Cooperation Treaty (PCT). An international (PCT) application generally has the same effect as a regular national patent application in each PCT-member country. The PCT process **simplifies** the filing of patent applications on the same invention in member countries, but **does not result** in a grant of "an international patent" and does not eliminate the need of applicants to file additional documents and fees in countries where patent protection is desired.

Almost every country has its own patent law, and a person desiring a patent in a particular country must make an application for patent in that country in accordance with its particular laws. Since the laws of many countries differ in various respects from the patent law of the United States, applicants are advised to seek guidance from specific foreign countries to ensure that patent rights are not lost prematurely.

Applicants also are advised that in the case of inventions made in the United States, the Director of the USPTO must issue a license before applicants can apply for a patent in a foreign country. The filing of a U.S. patent application serves as a request for a foreign filing license. The application's filing receipt contains further information and guidance as to the status of applicant's license for foreign filing.

Applicants may wish to consult the USPTO booklet, "General Information Concerning Patents" (specifically, the section entitled "Treaties and Foreign Patents") for more information on timeframes and deadlines for filing foreign patent applications. The guide is available either by contacting the USPTO Contact Center at 800-786-9199, or it can be viewed on the USPTO website at <http://www.uspto.gov/web/offices/pac/doc/general/index.html>.

For information on preventing theft of your intellectual property (patents, trademarks and copyrights), you may wish to consult the U.S. Government website, <http://www.stopfakes.gov>. Part of a Department of Commerce initiative, this website includes self-help "toolkits" giving innovators guidance on how to protect intellectual property in specific countries such as China, Korea and Mexico. For questions regarding patent enforcement issues, applicants may call the U.S. Government hotline at 1-866-999-HALT (1-866-999-4258).

LICENSE FOR FOREIGN FILING UNDER
Title 35, United States Code, Section 184
Title 37, Code of Federal Regulations, 5.11 & 5.15

GRANTED

The applicant has been granted a license under 35 U.S.C. 184, if the phrase "IF REQUIRED, FOREIGN FILING LICENSE GRANTED" followed by a date appears on this form. Such licenses are issued in all applications where the conditions for issuance of a license have been met, regardless of whether or not a license may be required as set forth in 37 CFR 5.15. The scope and limitations of this license are set forth in 37 CFR 5.15(a) unless an earlier license has been issued under 37 CFR 5.15(b). The license is subject to revocation upon written notification. The date indicated is the effective date of the license, unless an earlier license of similar scope has been granted under 37 CFR 5.13 or 5.14.

This license is to be retained by the licensee and may be used at any time on or after the effective date thereof unless it is revoked. This license is automatically transferred to any related applications(s) filed under 37 CFR 1.53(d). This license is not retroactive.

The grant of a license does not in any way lessen the responsibility of a licensee for the security of the subject matter as imposed by any Government contract or the provisions of existing laws relating to espionage and the national security or the export of technical data. Licensees should apprise themselves of current regulations especially with respect to certain countries, of other agencies, particularly the Office of Defense Trade Controls, Department of State (with respect to Arms, Munitions and Implements of War (22 CFR 121-128)); the Bureau of Industry and Security, Department of Commerce (15 CFR parts 730-774); the Office of Foreign Assets Control, Department of Treasury (31 CFR Parts 500+) and the Department of Energy.

NOT GRANTED

No license under 35 U.S.C. 184 has been granted at this time, if the phrase "IF REQUIRED, FOREIGN FILING LICENSE GRANTED" DOES NOT appear on this form. Applicant may still petition for a license under 37 CFR 5.12, if a license is desired before the expiration of 6 months from the filing date of the application. If 6 months has lapsed from the filing date of this application and the licensee has not received any indication of a secrecy order under 35 U.S.C. 181, the licensee may foreign file the application pursuant to 37 CFR 5.15(b).

SelectUSA

The United States represents the largest, most dynamic marketplace in the world and is an unparalleled location for business investment, innovation, and commercialization of new technologies. The U.S. offers tremendous resources and advantages for those who invest and manufacture goods here. Through SelectUSA, our nation works to promote and facilitate business investment. SelectUSA provides information assistance to the international investor community; serves as an ombudsman for existing and potential investors; advocates on behalf of U.S. cities, states, and regions competing for global investment; and counsels U.S. economic development organizations on investment attraction best practices. To learn more about why the United States is the best country in the world to develop technology, manufacture products, deliver services, and grow your business, visit <http://www.SelectUSA.gov> or call +1-202-482-6800.



UNITED STATES PATENT AND TRADEMARK OFFICE

UNITED STATES DEPARTMENT OF COMMERCE
United States Patent and Trademark Office
Address: COMMISSIONER FOR PATENTS
P.O. Box 1450
Alexandria, Virginia 22313-1450
www.uspto.gov

Table with 4 columns: APPLICATION NUMBER (14/875,709), FILING OR 371(C) DATE (10/06/2015), FIRST NAMED APPLICANT (Mohammed N. Islam), ATTY. DOCKET NO./TITLE (OMNI 0105 PUSP1)

CONFIRMATION NO. 7496

PUBLICATION NOTICE



109543
Brooks, Kushman P.C./Cheetah Omni MedSci
1000 Town Center
Twenty Second Floor
Southfield, MI 48075

Title: SHORT-WAVE INFRARED SUPER-CONTINUUM LASERS FOR DETECTING COUNTERFEIT OR ILLICIT DRUGS AND PHARMACEUTICAL PROCESS CONTROL

Publication No. US-2016-0047787-A1

Publication Date: 02/18/2016

NOTICE OF PUBLICATION OF APPLICATION

The above-identified application will be electronically published as a patent application publication pursuant to 37 CFR 1.211, et seq. The patent application publication number and publication date are set forth above.

The publication may be accessed through the USPTO's publically available Searchable Databases via the Internet at www.uspto.gov. The direct link to access the publication is currently http://www.uspto.gov/patft/.

The publication process established by the Office does not provide for mailing a copy of the publication to applicant. A copy of the publication may be obtained from the Office upon payment of the appropriate fee set forth in 37 CFR 1.19(a)(1). Orders for copies of patent application publications are handled by the USPTO's Office of Public Records. The Office of Public Records can be reached by telephone at (703) 308-9726 or (800) 972-6382, by facsimile at (703) 305-8759, by mail addressed to the United States Patent and Trademark Office, Office of Public Records, Alexandria, VA 22313-1450 or via the Internet.

In addition, information on the status of the application, including the mailing date of Office actions and the dates of receipt of correspondence filed in the Office, may also be accessed via the Internet through the Patent Electronic Business Center at www.uspto.gov using the public side of the Patent Application Information and Retrieval (PAIR) system. The direct link to access this status information is currently http://pair.uspto.gov/. Prior to publication, such status information is confidential and may only be obtained by applicant using the private side of PAIR.

Further assistance in electronically accessing the publication, or about PAIR, is available by calling the Patent Electronic Business Center at 1-866-217-9197.

Office of Data Management, Application Assistance Unit (571) 272-4000, or (571) 272-4200, or 1-888-786-0101

INFORMATION DISCLOSURE STATEMENT BY APPLICANT (Not for submission under 37 CFR 1.99)	Application Number	14875709
	Filing Date	2015-10-06
	First Named Inventor	Mohammed N. ISLAM
	Art Unit	2884
	Examiner Name	Abra S. Fein
	Attorney Docket Number	POWM 0105 PUSP1

U.S.PATENTS						Remove
Examiner Initial*	Cite No	Patent Number	Kind Code ¹	Issue Date	Name of Patentee or Applicant of cited Document	Pages,Columns,Lines where Relevant Passages or Relevant Figures Appear
	1	6212310	B1	2001-04-03	Waarts, et al.	
	2	7890158	B2	2011-02-15	Rowe, et al.	
	3	8213007	B2	2012-07-03	Wang, et al.	
	4	7848605	B2	2010-12-07	Ridder, et al.	
	5	8158493	B2	2012-04-17	Shah, et al.	

If you wish to add additional U.S. Patent citation information please click the Add button. Add

U.S.PATENT APPLICATION PUBLICATIONS						Remove
Examiner Initial*	Cite No	Publication Number	Kind Code ¹	Publication Date	Name of Patentee or Applicant of cited Document	Pages,Columns,Lines where Relevant Passages or Relevant Figures Appear
	1	20060198397	A1	2006-09-07	Korolev, et al.	

**INFORMATION DISCLOSURE
STATEMENT BY APPLICANT**
(Not for submission under 37 CFR 1.99)

Application Number	14875709
Filing Date	2015-10-06
First Named Inventor	Mohammed N. ISLAM
Art Unit	2884
Examiner Name	Abra S. Fein
Attorney Docket Number	POWM 0105 PUSP1

2	20090105605	A1	2009-04-23	Abreu
3	20100160794	A1	2010-06-24	Banet, et al.
4	20110292376	A1	2011-12-01	Kukushkin, et al.

If you wish to add additional U.S. Published Application citation information please click the Add button.

FOREIGN PATENT DOCUMENTS

Examiner Initial*	Cite No	Foreign Document Number ³	Country Code ² i	Kind Code ⁴	Publication Date	Name of Patentee or Applicant of cited Document	Pages, Columns, Lines where Relevant Passages or Relevant Figures Appear	T ⁵
	1							

If you wish to add additional Foreign Patent Document citation information please click the Add button

NON-PATENT LITERATURE DOCUMENTS

Examiner Initials*	Cite No	Include name of the author (in CAPITAL LETTERS), title of the article (when appropriate), title of the item (book, magazine, journal, serial, symposium, catalog, etc), date, pages(s), volume-issue number(s), publisher, city and/or country where published.	T ⁵
	1		

If you wish to add additional non-patent literature document citation information please click the Add button

EXAMINER SIGNATURE

Examiner Signature	<input type="text"/>	Date Considered	<input type="text"/>
--------------------	----------------------	-----------------	----------------------

*EXAMINER: Initial if reference considered, whether or not citation is in conformance with MPEP 609. Draw line through a citation if not in conformance and not considered. Include copy of this form with next communication to applicant.

**INFORMATION DISCLOSURE
STATEMENT BY APPLICANT**
(Not for submission under 37 CFR 1.99)

Application Number	14875709
Filing Date	2015-10-06
First Named Inventor	Mohammed N. ISLAM
Art Unit	2884
Examiner Name	Abra S. Fein
Attorney Docket Number	POWM 0105 PUSP1

¹ See Kind Codes of USPTO Patent Documents at www.USPTO.GOV or MPEP 901.04. ² Enter office that issued the document, by the two-letter code (WIPO Standard ST.3). ³ For Japanese patent documents, the indication of the year of the reign of the Emperor must precede the serial number of the patent document. ⁴ Kind of document by the appropriate symbols as indicated on the document under WIPO Standard ST.16 if possible. ⁵ Applicant is to place a check mark here if English language translation is attached.

**INFORMATION DISCLOSURE
STATEMENT BY APPLICANT**
(Not for submission under 37 CFR 1.99)

Application Number	14875709		
Filing Date	2015-10-06		
First Named Inventor	Mohammed N. ISLAM		
Art Unit	2884		
Examiner Name	Abra S. Fein		
Attorney Docket Number	POWM 0105 PUSP1		

CERTIFICATION STATEMENT

Please see 37 CFR 1.97 and 1.98 to make the appropriate selection(s):

That each item of information contained in the information disclosure statement was first cited in any communication from a foreign patent office in a counterpart foreign application not more than three months prior to the filing of the information disclosure statement. See 37 CFR 1.97(e)(1).

OR

That no item of information contained in the information disclosure statement was cited in a communication from a foreign patent office in a counterpart foreign application, and, to the knowledge of the person signing the certification after making reasonable inquiry, no item of information contained in the information disclosure statement was known to any individual designated in 37 CFR 1.56(c) more than three months prior to the filing of the information disclosure statement. See 37 CFR 1.97(e)(2).

See attached certification statement.

The fee set forth in 37 CFR 1.17 (p) has been submitted herewith.

A certification statement is not submitted herewith.

SIGNATURE

A signature of the applicant or representative is required in accordance with CFR 1.33, 10.18. Please see CFR 1.4(d) for the form of the signature.

Signature	/David S. Bir/	Date (YYYY-MM-DD)	2016-03-08
Name/Print	David S. Bir	Registration Number	38383

This collection of information is required by 37 CFR 1.97 and 1.98. The information is required to obtain or retain a benefit by the public which is to file (and by the USPTO to process) an application. Confidentiality is governed by 35 U.S.C. 122 and 37 CFR 1.14. This collection is estimated to take 1 hour to complete, including gathering, preparing and submitting the completed application form to the USPTO. Time will vary depending upon the individual case. Any comments on the amount of time you require to complete this form and/or suggestions for reducing this burden, should be sent to the Chief Information Officer, U.S. Patent and Trademark Office, U.S. Department of Commerce, P.O. Box 1450, Alexandria, VA 22313-1450. **DO NOT SEND FEES OR COMPLETED FORMS TO THIS ADDRESS. SEND TO: Commissioner for Patents, P.O. Box 1450, Alexandria, VA 22313-1450.**

Privacy Act Statement

The Privacy Act of 1974 (P.L. 93-579) requires that you be given certain information in connection with your submission of the attached form related to a patent application or patent. Accordingly, pursuant to the requirements of the Act, please be advised that: (1) the general authority for the collection of this information is 35 U.S.C. 2(b)(2); (2) furnishing of the information solicited is voluntary; and (3) the principal purpose for which the information is used by the U.S. Patent and Trademark Office is to process and/or examine your submission related to a patent application or patent. If you do not furnish the requested information, the U.S. Patent and Trademark Office may not be able to process and/or examine your submission, which may result in termination of proceedings or abandonment of the application or expiration of the patent.

The information provided by you in this form will be subject to the following routine uses:

1. The information on this form will be treated confidentially to the extent allowed under the Freedom of Information Act (5 U.S.C. 552) and the Privacy Act (5 U.S.C. 552a). Records from this system of records may be disclosed to the Department of Justice to determine whether the Freedom of Information Act requires disclosure of these records.
2. A record from this system of records may be disclosed, as a routine use, in the course of presenting evidence to a court, magistrate, or administrative tribunal, including disclosures to opposing counsel in the course of settlement negotiations.
3. A record in this system of records may be disclosed, as a routine use, to a Member of Congress submitting a request involving an individual, to whom the record pertains, when the individual has requested assistance from the Member with respect to the subject matter of the record.
4. A record in this system of records may be disclosed, as a routine use, to a contractor of the Agency having need for the information in order to perform a contract. Recipients of information shall be required to comply with the requirements of the Privacy Act of 1974, as amended, pursuant to 5 U.S.C. 552a(m).
5. A record related to an International Application filed under the Patent Cooperation Treaty in this system of records may be disclosed, as a routine use, to the International Bureau of the World Intellectual Property Organization, pursuant to the Patent Cooperation Treaty.
6. A record in this system of records may be disclosed, as a routine use, to another federal agency for purposes of National Security review (35 U.S.C. 181) and for review pursuant to the Atomic Energy Act (42 U.S.C. 218(c)).
7. A record from this system of records may be disclosed, as a routine use, to the Administrator, General Services, or his/her designee, during an inspection of records conducted by GSA as part of that agency's responsibility to recommend improvements in records management practices and programs, under authority of 44 U.S.C. 2904 and 2906. Such disclosure shall be made in accordance with the GSA regulations governing inspection of records for this purpose, and any other relevant (i.e., GSA or Commerce) directive. Such disclosure shall not be used to make determinations about individuals.
8. A record from this system of records may be disclosed, as a routine use, to the public after either publication of the application pursuant to 35 U.S.C. 122(b) or issuance of a patent pursuant to 35 U.S.C. 151. Further, a record may be disclosed, subject to the limitations of 37 CFR 1.14, as a routine use, to the public if the record was filed in an application which became abandoned or in which the proceedings were terminated and which application is referenced by either a published application, an application open to public inspections or an issued patent.
9. A record from this system of records may be disclosed, as a routine use, to a Federal, State, or local law enforcement agency, if the USPTO becomes aware of a violation or potential violation of law or regulation.

Electronic Acknowledgement Receipt

EFS ID:	25135402
Application Number:	14875709
International Application Number:	
Confirmation Number:	7496
Title of Invention:	SHORT-WAVE INFRARED SUPER-CONTINUUM LASERS FOR DETECTING COUNTERFEIT OR ILLICIT DRUGS AND PHARMACEUTICAL PROCESS CONTROL
First Named Inventor/Applicant Name:	Mohammed N. Islam
Customer Number:	109543
Filer:	David S. Bir
Filer Authorized By:	
Attorney Docket Number:	OMNI 0105 PUSP1
Receipt Date:	09-MAR-2016
Filing Date:	06-OCT-2015
Time Stamp:	14:38:03
Application Type:	Utility under 35 USC 111(a)

Payment information:

Submitted with Payment	no
------------------------	----

File Listing:

Document Number	Document Description	File Name	File Size(Bytes)/ Message Digest	Multi Part /.zip	Pages (if appl.)
1	Information Disclosure Statement (IDS) Form (SB08)	Supplemental_IDS.pdf	612404 <small>eea136e7bcc7c79ffd860efd93175dd09e5fd20</small>	no	5

Warnings:

Information:

This Acknowledgement Receipt evidences receipt on the noted date by the USPTO of the indicated documents, characterized by the applicant, and including page counts, where applicable. It serves as evidence of receipt similar to a Post Card, as described in MPEP 503.

New Applications Under 35 U.S.C. 111

If a new application is being filed and the application includes the necessary components for a filing date (see 37 CFR 1.53(b)-(d) and MPEP 506), a Filing Receipt (37 CFR 1.54) will be issued in due course and the date shown on this Acknowledgement Receipt will establish the filing date of the application.

National Stage of an International Application under 35 U.S.C. 371

If a timely submission to enter the national stage of an international application is compliant with the conditions of 35 U.S.C. 371 and other applicable requirements a Form PCT/DO/EO/903 indicating acceptance of the application as a national stage submission under 35 U.S.C. 371 will be issued in addition to the Filing Receipt, in due course.

New International Application Filed with the USPTO as a Receiving Office

If a new international application is being filed and the international application includes the necessary components for an international filing date (see PCT Article 11 and MPEP 1810), a Notification of the International Application Number and of the International Filing Date (Form PCT/RO/105) will be issued in due course, subject to prescriptions concerning national security, and the date shown on this Acknowledgement Receipt will establish the international filing date of the application.



UNITED STATES PATENT AND TRADEMARK OFFICE

UNITED STATES DEPARTMENT OF COMMERCE
United States Patent and Trademark Office
Address: COMMISSIONER FOR PATENTS
P.O. Box 1450
Alexandria, Virginia 22313-1450
www.uspto.gov

Table with 5 columns: APPLICATION NO., FILING DATE, FIRST NAMED INVENTOR, ATTORNEY DOCKET NO., CONFIRMATION NO.
Row 1: 14/875,709, 10/06/2015, Mohammed N. Islam, OMNI 0105 PUSP1, 7496
Row 2: 109543, 7590, 05/26/2016, Brooks, Kushman P.C./Cheetah Omni MedSci, 1000 Town Center, Twenty Second Floor, Southfield, MI 48075, EXAMINER FEIN, ABRA S
Row 3: ART UNIT 2884, PAPER NUMBER
Row 4: NOTIFICATION DATE 05/26/2016, DELIVERY MODE ELECTRONIC

Please find below and/or attached an Office communication concerning this application or proceeding.

The time period for reply, if any, is set in the attached communication.

Notice of the Office communication was sent electronically on above-indicated "Notification Date" to the following e-mail address(es):

docketing@brookskushman.com

Art Unit: 2884

DETAILED ACTION

Notice of Pre-AIA or AIA Status

1. The present application is being examined under the pre-AIA first to invent provisions.

Double Patenting

2. The nonstatutory double patenting rejection is based on a judicially created doctrine grounded in public policy (a policy reflected in the statute) so as to prevent the unjustified or improper timewise extension of the "right to exclude" granted by a patent and to prevent possible harassment by multiple assignees. A nonstatutory double patenting rejection is appropriate where the claims at issue are not identical, but at least one examined application claim is not patentably distinct from the reference claim(s) because the examined application claim is either anticipated by, or would have been obvious over, the reference claim(s). See, e.g., *In re Berg*, 140 F.3d 1428, 46 USPQ2d 1226 (Fed. Cir. 1998); *In re Goodman*, 11 F.3d 1046, 29 USPQ2d 2010 (Fed. Cir. 1993); *In re Longi*, 759 F.2d 887, 225 USPQ 645 (Fed. Cir. 1985); *In re Van Ornum*, 686 F.2d 937, 214 USPQ 761 (CCPA 1982); *In re Vogel*, 422 F.2d 438, 164 USPQ 619 (CCPA 1970); and *In re Thorington*, 418 F.2d 528, 163 USPQ 644 (CCPA 1969).

A timely filed terminal disclaimer in compliance with 37 CFR 1.321(c) or 1.321(d) may be used to overcome an actual or provisional rejection based on a nonstatutory double patenting ground provided the reference application or patent either is shown to be commonly owned with this application, or claims an invention made as a result of activities undertaken within the scope of a joint research agreement. See MPEP § 717.02 for applications subject to examination under the first inventor to file provisions of the AIA as explained in MPEP § 2159. See MPEP §§ 706.02(l)(1) - 706.02(l)(3) for applications not subject to examination under the first inventor to file provisions of the AIA. A terminal disclaimer must be signed in compliance with 37 CFR 1.321(b).

The USPTO Internet website contains terminal disclaimer forms which may be used. Please visit www.uspto.gov/forms/. The filing date of the application in which the form is filed determines what form (e.g., PTO/SB/25, PTO/SB/26, PTO/AIA/25, or PTO/AIA/26) should be used. A web-based eTerminal

Art Unit: 2884

Disclaimer may be filled out completely online using web-screens. An eTerminal Disclaimer that meets all requirements is auto-processed and approved immediately upon submission. For more information about eTerminal Disclaimers, refer to <http://www.uspto.gov/patents/process/file/efs/guidance/eTD-info-l.jsp>.

3. **Claims 1-4** are rejected on the ground of nonstatutory double patenting as being unpatentable over claim 1 of U.S. Patent No. 9,164,032 in view of Banet et al. (US 2010/0160798, hereinafter Banet; pub. Jun. 24, 2010).

4. Regarding **Claim 1**, claim 1 of U.S. Patent No. 9,164,032 sets forth the elements of claim 1 of the instant application with the exception the system further comprises a personal device. Banet teaches a personal device comprising a wireless receiver, a wireless transmitter, a display, a microphone, a speaker, one or more buttons or knobs, a microprocessor, and a touch screen, the personal device configured to receive and process at least a portion of a signal transmitted over a wireless transmission link [0005]. Banet further teaches the benefit of being able to transmit and display information generated [0005]. It would have been obvious to a person of ordinary skill in the art at the time of the invention to combine the measurement system, as claimed by U.S. Patent No. 9,164,032, with a personal device, as taught by Banet, for the benefit of transmitting and displaying information generated.

6. Regarding **Claim 2**, claim 1 of U.S. Patent No. 9,164,032 sets forth the elements of claim 1 of the instant application but does not teach the elements of claim 2. Banet teaches the personal device is a tablet [0005]. It would have been obvious to a person of ordinary skill in the art at the time of the invention to use a tablet for a personal device, since it has been held to be within the general skill of a working in the art to select a known material on the basis of its suitability for the intended use as a matter of obvious design choice. *In re Leshin*, 125 USPQ 416.

7. Regarding **Claim 3**, claim 1 of U.S. Patent No. 9,164,032 sets forth the elements of claim 1 of the instant application but does not teach the elements of claim 3. Banet teaches the output signal comprises one or more physiological parameters (blood pressure) [0005]. Banet further teaches the benefit of showing changes in values of the physiological parameters over periods of time [0080]. It would have been obvious to a person of ordinary skill in the art at the time of the invention to combine the system, as claimed by U.S. Patent No. 9,164,032, with the output signal comprising one or more physiological

Art Unit: 2884

parameters, as taught by Banet, for the benefit of showing changes in values of the physiological parameters over periods of time.

8. Regarding **Claim 4**, claim 1 of U.S. Patent No. 9,164,032 sets forth the elements of claim 1 of the instant application but does not teach the elements of claim 4. Banet teaches a remote device configured to receive over the wireless transmission link a received output status comprising the at least a portion of the processed output signal, to buffer the received output status, to process the received output status to generate processed data and to store the processed data [0005]. Banet further teaches the benefit of being able to transmit and display information generated [0005]. It would have been obvious to a person of ordinary skill in the art at the time of the invention to combine the measurement system, as claimed by U.S. Patent No. 9,164,032, with a remote device, as taught by Banet, for the benefit of transmitting and displaying information generated.

4. These modifications of the primary reference in light of the secondary reference is proper because the applied references are so related that the appearance of features shown in one would suggest the application of those features to the other. See *In re Rosen*, 673 F.2d 388, 213 USPQ 347 (CCPA 1982); *In re Carter*, 673 F.2d 1378, 213 USPQ 625 (CCPA 1982), and *In re Glavas*, 230 F.2d 447, 109 USPQ 50 (CCPA 1956). Further, it is noted that case law has held that a designer skilled in the art is charged with knowledge of the related art; therefore, the combination of old elements, herein, would have been well within the level of ordinary skill. See *In re Antle*, 444 F.2d 1168, 170 USPQ 285 (CCPA 1971) and *In re Naibandian*, 661 F.2d 1214, 211 USPQ 782 (CCPA 1981).

Specification

6. The use of the trademarks Bluetooth, Zigbee, Wifi, IrDA, USB, and iPhone [0116-0117] has been noted in this application. It should be capitalized wherever it appears and be accompanied by the generic terminology.

Although the use of trademarks is permissible in patent applications, the proprietary nature of the marks should be respected and every effort made to prevent their use in any manner which might

Art Unit: 2884

adversely affect their validity as trademarks.

Claim Rejections - 35 USC § 112

5. The following is a quotation of 35 U.S.C. 112(b):
(b) CONCLUSION.—The specification shall conclude with one or more claims particularly pointing out and distinctly claiming the subject matter which the inventor or a joint inventor regards as the invention.

The following is a quotation of 35 U.S.C. 112 (pre-AIA), second paragraph:
The specification shall conclude with one or more claims particularly pointing out and distinctly claiming the subject matter which the applicant regards as his invention.

9. **Claim 7** contains the trademark/trade names Bluetooth and Wifi. Where a trademark or trade name is used in a claim as a limitation to identify or describe a particular material or product, the claim does not comply with the requirements of 35 U.S.C. 112(b) or 35 U.S.C. 112 (pre-AIA), second paragraph. See *Ex parte Simpson*, 218 USPQ 1020 (Bd. App. 1982). The claim scope is uncertain since the trademark or trade name cannot be used properly to identify any particular material or product. A trademark or trade name is used to identify a source of goods, and not the goods themselves. Thus, a trademark or trade name does not identify or describe the goods associated with the trademark or trade name. In the present case, the trademark/trade name is used to identify/describe Bluetooth Special Interest Group and Wi-Fi Alliance, and, accordingly, the identification/description is indefinite.

10. **Claim 18** is rejected under 35 U.S.C. 112(b) or 35 U.S.C. 112 (pre-AIA), second paragraph, as being indefinite for failing to particularly point out and distinctly claim the subject matter which the inventor or a joint inventor, or for pre-AIA the applicant regards as the invention.

11. **Claim 18** recites the limitation "the one or more physiological parameters" in line 2. There is insufficient antecedent basis for this limitation in the claim.

Claim Rejections - 35 USC § 103

12. The following is a quotation of pre-AIA 35 U.S.C. 103(a) which forms the basis for all obviousness rejections set forth in this Office action:

Art Unit: 2884

(a) A patent may not be obtained though the invention is not identically disclosed or described as set forth in section 102 of this title, if the differences between the subject matter sought to be patented and the prior art are such that the subject matter as a whole would have been obvious at the time the invention was made to a person having ordinary skill in the art to which said subject matter pertains. Patentability shall not be negated by the manner in which the invention was made.

13. The factual inquiries set forth in *Graham v. John Deere Co.*, 383 U.S. 1, 148 USPQ 459 (1966), that are applied for establishing a background for determining obviousness under pre-AIA 35 U.S.C.

103(a) are summarized as follows:

1. Determining the scope and contents of the prior art.
2. Ascertaining the differences between the prior art and the claims at issue.
3. Resolving the level of ordinary skill in the pertinent art.
4. Considering objective evidence present in the application indicating obviousness or nonobviousness.

14. **Claims 5, 7-14, and 16-20** are rejected under pre-AIA 35 U.S.C. 103(a) as being unpatentable over Polli et al. (US 2006/0283931, hereinafter Polli) in view of Banet.

15. Regarding **Claim 5**, Polli teaches a measurement system comprising: a light source comprising: a plurality of semiconductor sources configured to generate an output optical beam; a measurement apparatus configured to receive a received portion of the output optical beam and to deliver to a sample an analysis output beam, which is a delivered portion of the output optical beam; and a receiver configured to receive and process at least a portion of the analysis output beam reflected or transmitted from the sample and to generate an output signal with one or more optical wavelengths, wherein at least a portion of the one or more optical wavelengths is a near-infrared wavelength between 700 nanometers and 2500 nanometers [0076; 0013, Polli inherently teaches wavelengths between 700 nanometers and 2500 nanometers since that is the definition of near-infrared]. Polli does not explicitly a personal device and a remote device.

Banet teaches a personal device comprising a wireless receiver, a wireless transmitter, a display, a microphone, a speaker, one or more buttons or knobs, a microprocessor, and a touch screen, the

Art Unit: 2884

personal device configured to receive and process at least a portion of a signal transmitted over a wireless transmission link; a remote device configured to receive over the wireless transmission link a received output status comprising the at least a portion of the processed output signal, to buffer the received output status, to process the received output status to generate processed data and to store the processed data [0005]. Banet further teaches the benefit of being able to transmit and display information generated [0005]. It would have been obvious to a person of ordinary skill in the art at the time of the invention to combine the measurement system, as taught by Polli, with a personal device and remote device, as taught by Banet, for the benefit of transmitting and displaying information generated.

16. Regarding **Claim 7**, Polli as adapted above teaches the system of claim 5. Polli does not teach the wireless transmission link is configured to operate at least in part on Bluetooth or Wifi. Banet teaches the wireless transmission link is configured to operate at least in part on Bluetooth or Wifi [0108] for the benefit of transmitting information [0005]. It would have been obvious to a person of ordinary skill in the art at the time of the invention to combine the system, as taught by Polli as adapted above, with the wireless transmission link being configured to operate at least in part on Bluetooth or Wifi, as taught by Banet, for the benefit of transmitting information.

17. Regarding **Claim 14**, Polli teaches a measurement system comprising: a light source comprising a plurality of semiconductor sources configured to generate an output optical beam; a measurement apparatus configured to receive a received portion of the output optical beam with one or more optical wavelengths, and to deliver to a sample an analysis output beam, which is a delivered portion of the output optical beam; and a receiver configured to receive and process at least a portion of the analysis output beam reflected or transmitted from the sample and to generate an output signal [0076; 0013, Polli inherently teaches wavelengths between 700 nanometers and 2500 nanometers since that is the definition of near-infrared].

Banet teaches wearable measurement device further comprising a personal device comprising a wireless receiver, a wireless transmitter, a display, a microphone, a speaker, one or more buttons or knobs, a microprocessor, and a touch screen, the personal device configured to receive and process at least a portion of a signal transmitted over a wireless transmission link; a remote device configured to

Art Unit: 2884

receive over the wireless transmission link a received output status comprising the at least a portion of the processed output signal, to buffer the received output status, to process the received output status to generate processed data and to store the processed data [0005]. Banet further teaches the benefit of being able to transmit and display information generated [0005]. It would have been obvious to a person of ordinary skill in the art at the time of the invention to combine the measurement system, as taught by Polli, with a personal device and remote device, as taught by Banet, for the benefit of transmitting and displaying information generated. Additionally, it would have been obvious to a person of ordinary skill in the art at the time of the invention to make the measurement system wearable, since it has been held that making an old device portable or movable without producing any new and unexpected results involves only routine skill in the art. *In re Lindberg*, 93 USPQ 23 (CCPA 1952).

18. Regarding **Claim 10-11 and 18**, Polli as adapted above teaches the systems of claims 5 and 14. Polli does not teach the output signal comprises physiological parameters. Banet teaches the output signal comprises one or more physiological parameters, and the remote device is capable of storing a history of at least a portion of the one or more physiological parameters over a specified period of time [0063; 0080], and wherein the remote device is capable of generating an alarm when at least one of the one or more physiological parameters falls out of an acceptable range [0117]. Banet further teaches the benefit of showing changes in values of the physiological parameters over periods of time [0080]. It would have been obvious to a person of ordinary skill in the art at the time of the invention to combine the system, as taught by Polli as adapted above, with the output signal comprising one or more physiological parameters, wherein the remote device is capable of storing a history of at least a portion of the one or more physiological parameters over a specified period of time, wherein the remote device is capable of generating an alarm when at least one of the one or more physiological parameters falls out of an acceptable range, as taught by Banet, for the benefit of showing changes in values of the physiological parameters over periods of time.

19. Regarding **Claims 8 and 17**, Polli as adapted above teaches the systems of claims 5 and 14, but does not teach specifics of the remote device. Banet teaches the remote device is further configured to transmit at least a portion of the processed data to one or more other locations, wherein the one or more

Art Unit: 2884

other locations is selected from the group consisting of the personal device, a doctor, a healthcare provider, a cloud-based server, and one or more designated recipients, and wherein the remote device is capable of transmitting information related to a time and a position associated with the at least a portion of the processed data [0152]. Banet further teaches the benefit of providing medical diagnostic information to medical professionals [0152]. It would have been obvious to a person of ordinary skill in the art at the time of the invention to combine the system, as taught by Polli as adapted above, with having the remote device configured to transmit at least a portion of the processed data to other location, as taught by Banet, for the benefit of providing medical diagnostic information to medical professionals.

20. Regarding **Claims 9 and 16**, Polli as adapted above teaches the systems of claims 5 and 14, but does not teach the personal device is separate from the measurement apparatus and the light source. Banet teaches the personal device is separate from the measurement apparatus and the light source [0005]. Banet further teaches the benefit of using the personal device to monitor information transmitted from the measurement apparatus. It would have been obvious to a person of ordinary skill in the art at the time of the invention to combine the measurement system, as taught by Polli as adapted above, with the personal device being separate from the measurement apparatus and light source, as taught by Banet, for the benefit of the personal device being used to monitor information transmitted from the measurement apparatus using a separate display panel.

21. Regarding **Claims 12 and 20**, Polli as adapted above teaches the systems of claims 5 and 14. Polli does not teach the personal device is selected from the group consisting of a smart phone, a tablet, a personal data assistant, a computer, a microprocessor-based device. Banet teaches the personal device is a tablet [0005]. It would have been obvious to a person of ordinary skill in the art at the time of the invention to use a tablet for a personal device, since it has been held to be within the general skill of a working in the art to select a known material on the basis of its suitability for the intended use as a matter of obvious design choice. *In re Leshin*, 125 USPQ 416.

22. Regarding **Claims 13 and 19**, Polli as adapted above teaches the systems of claims 5 and 14. Polli does not teach the measurement system is capable of performing a non-invasive blood measurement. Banet teaches the measurement system is capable of performing a non-invasive blood

Art Unit: 2884

measurement (Abstract) for the benefit of continuous measurement of blood pressure that does not require any external calibration (Abstract). It would have been obvious to a person of ordinary skill in the art at the time of the invention to combine the measurement system, as taught by Polli as adapted above, with being capable of performing a non-invasive blood measurement, as taught by Banet, for the benefit of continuous measurement of blood pressure that does not require any external calibration.

23. **Claims 6 and 15** are rejected under pre-AIA 35 U.S.C. 103(a) as being unpatentable over Polli and Banet as applied to claims 5 and 14 above, and further in view of Fujimoto et al. (US 2009/0244288, hereinafter Fujimoto; pub. Oct. 1, 2009).

24. Regarding **Claims 6 and 15**, Polli as adapted above teaches the systems of claims 5 and 14. Polli does not teach the semiconductor sources are light emitting diodes operating in pulsed mode. Fujimoto teaches a measurement system wherein semiconductor sources are light emitting diodes operating in pulsed mode [0079]. It would have been obvious to a person of ordinary skill in the art at the time of the invention to use a light emitting diode operating in pulsed mode, since it has been held to be within the general skill of a working in the art to select a known material on the basis of its suitability for the intended use as a matter of obvious design choice. *In re Leshin*, 125 USPQ 416.

Allowable Subject Matter

25. **Claims 1-4** would be allowable if rewritten or amended to overcome the nonstatutory double patenting rejection set forth in this Office action.

26. The following is an examiner's statement of reasons for allowance:

27. Regarding **Claim 1**, Polli teaches a measurement system comprising: a light source configured to generate an output optical beam, comprising: one or more semiconductor sources configured to generate an input beam; a measurement apparatus configured to receive a received portion of the output optical beam, which is a delivered portion of the output optical beam; and a receiver configured to receive and process at least a portion of the analysis output beam reflected or transmitted from the sample and to generate an output signal wherein at least a portion of the output beam broadened spectrum comprises a

Art Unit: 2884

short-wave infrared wavelength between approximately 700 nm and approximately 2500 nm [0076; 0013].

Islam (US 2009/0028193, hereinafter Islam) teaches the use of optical amplifiers configured to receive at least a portion of an input beam and to output an intermediate beam from at least one of the one or more optical amplifiers (Abstract). Buchter et al. (US 8,000,574, hereinafter Buchter) teaches one or more optical fibers configured to receive at least a portion of the intermediate beam and to communicate at least the portion of the intermediate beam to form a first optical beam (col. 8, lines 18-20). Islam (US 2006/0268393, hereinafter Islam 2) teaches a nonlinear element configured to receive at least a portion of an optical beam and to broaden a spectrum associated with at least a portion of that optical beam through a nonlinear effect in the nonlinear element to form an output optical beam with an output beam broadened spectrum [0039]. Banet teaches a personal device comprising a wireless receiver, a wireless transmitter, a display, a microphone, a speaker, one or more buttons or knobs, a microprocessor, and a touch screen, the personal device configured to receive and process at least a portion of a signal transmitted over a wireless transmission link [0005].

Islam (US 2012/0239013, hereinafter Islam 3) teaches a measurement system comprising: a light source configured to generate an output optical beam, comprising: one or more semiconductor sources configured to generate an input beam; one or more optical amplifiers configured to receive at least a portion of the input beam and to deliver an intermediate beam to an output end of the one or more optical amplifiers; and one or more optical fibers configured to receive at least a portion of the intermediate beam and to communicate at least part of the portion of the intermediate beam to form a first optical beam; a nonlinear element configured to receive at least a portion of the first optical beam and to broaden a spectrum associated with the at least a portion of the first optical beam to at least 10nm through a nonlinear effect in the nonlinear element to form the output optical beam with an output beam broadened spectrum (Abstract); and wherein at least a portion of the one or more fibers is a fused silica fiber [0004], a measurement apparatus configured to receive a received portion of the output optical beam and to deliver a delivered portion of the output optical beam to a sample (Fig. 20); and a receiver [0138]. Liu (US 2014/0249427, hereinafter Liu; PCT filed Dec. 15, 2011) teaches a fused silica fiber with a core diameter

Art Unit: 2884

less than approximately 400 microns [0027].

The prior art of record does not disclose or reasonably suggest, along with the other claim limitations, a measurement system comprising: a light source configured to generate an output optical beam, comprising: one or more semiconductor sources, one or more optical amplifiers configured to receive at least a portion of the input beam and to output an intermediate beam from at least one of the one or more optical amplifiers, one or more optical fibers configured to receive at least a portion of the intermediate beam and to communicate at least part of the portion of the intermediate beam to a distal end of the one or more optical fibers to form a first optical beam, and a nonlinear element configured to receive at least a portion of a first optical beam and to broaden a spectrum associated with the at least a portion of the first optical beam to at least 10nm through a nonlinear effect in the nonlinear element to form the output optical beam with an output beam broadened spectrum comprises a short-wave infrared wavelength between approximately 700 nm and approximately 2500 nm; a measurement apparatus; and a receiver, **comprising: namely**, wherein the delivered portion of the output optical beam is a spatially coherent beam.

28. **Claims 2-4** would be allowable due to dependency.

Conclusion

Any inquiry concerning this communication or earlier communications from the examiner should be directed to Abra Fein whose telephone number is (571)272-0552. The examiner can normally be reached on Monday-Friday 8am-5pm EST.

If attempts to reach the examiner by telephone are unsuccessful, the examiner's supervisor, Dave Porta can be reached on 571-272-2444. The fax phone number for the organization where this application or proceeding is assigned is 571-273-8300.

Art Unit: 2884

Information regarding the status of an application may be obtained from the Patent Application Information Retrieval (PAIR) system. Status information for published applications may be obtained from either Private PAIR or Public PAIR. Status information for unpublished applications is available through Private PAIR only. For more information about the PAIR system, see <http://pair-direct.uspto.gov>. Should you have questions on access to the Private PAIR system, contact the Electronic Business Center (EBC) at 866-217-9197 (toll-free). If you would like assistance from a USPTO Customer Service Representative or access to the automated information system, call 800-786-9199 (IN USA OR CANADA) or 571-272-1000.

/DAVID PORTA/
Supervisory Patent Examiner, Art Unit
2884

/A. F./
Examiner, Art Unit 2884

Notice of References Cited	Application/Control No. 14/875,709	Applicant(s)/Patent Under Reexamination ISLAM, MOHAMMED N.	
	Examiner Abra Fein	Art Unit 2884	Page 1 of 1

U.S. PATENT DOCUMENTS

*	Document Number Country Code-Number-Kind Code	Date MM-YYYY	Name	CPC Classification	US Classification
*	A US-2009/0244288 A1	10-2009	FUJIMOTO; Akira	H04N5/2256	348/164
*	B US-2014/0249427 A1	09-2014	Liu; Yang	A61B1/00167	600/477
	C US-				
	D US-				
	E US-				
	F US-				
	G US-				
	H US-				
	I US-				
	J US-				
	K US-				
	L US-				
	M US-				

FOREIGN PATENT DOCUMENTS

*	Document Number Country Code-Number-Kind Code	Date MM-YYYY	Country	Name	CPC Classification
	N				
	O				
	P				
	Q				
	R				
	S				
	T				

NON-PATENT DOCUMENTS

*	Document Number Country Code-Number-Kind Code	Date MM-YYYY	Country	Name	CPC Classification
	Include as applicable: Author, Title Date, Publisher, Edition or Volume, Pertinent Pages)				
	U				
	V				
	W				
	X				

*A copy of this reference is not being furnished with this Office action. (See MPEP § 707.05(a).)
Dates in MM-YYYY format are publication dates. Classifications may be US or foreign.

Receipt date: 03/09/2016

Doc code: IDS

Doc description: Information Disclosure Statement (IDS) Filed

Under the Paperwork Reduction Act of 1995, no persons are required to respond to a collection of information unless it contains a valid OMB control number.

14875709 - GAI: 2884

Approved for use through 07/31/2012. OMB 0651-0031

U.S. Patent and Trademark Office; U.S. DEPARTMENT OF COMMERCE

INFORMATION DISCLOSURE STATEMENT BY APPLICANT (Not for submission under 37 CFR 1.99)	Application Number	14875709
	Filing Date	2015-10-06
	First Named Inventor	Mohammed N. ISLAM
	Art Unit	2884
	Examiner Name	Abra S. Fein
	Attorney Docket Number	POWM 0105 PUSP1

U.S.PATENTS						Remove
Examiner Initial*	Cite No	Patent Number	Kind Code ¹	Issue Date	Name of Patentee or Applicant of cited Document	Pages,Columns,Lines where Relevant Passages or Relevant Figures Appear
	1	6212310	B1	2001-04-03	Waarts, et al.	
	2	7890158	B2	2011-02-15	Rowe, et al.	
	3	8213007	B2	2012-07-03	Wang, et al.	
	4	7848605	B2	2010-12-07	Ridder, et al.	
	5	8158493	B2	2012-04-17	Shah, et al.	

If you wish to add additional U.S. Patent citation information please click the Add button.

Add

U.S.PATENT APPLICATION PUBLICATIONS						Remove
Examiner Initial*	Cite No	Publication Number	Kind Code ¹	Publication Date	Name of Patentee or Applicant of cited Document	Pages,Columns,Lines where Relevant Passages or Relevant Figures Appear
	1	20060198397	A1	2006-09-07	Korolev, et al.	

INFORMATION DISCLOSURE STATEMENT BY APPLICANT (Not for submission under 37 CFR 1.99)	Receipt date: 03/09/2016	Application Number	14875709	14875709 - GAU: 2884
	Filing Date	2015-10-06		
	First Named Inventor	Mohammed N. ISLAM		
	Art Unit	2884		
	Examiner Name	Abra S. Fein		
	Attorney Docket Number	POWM 0105 PUSP1		

2	20090105605	A1	2009-04-23	Abreu
3	20100160794	A1	2010-06-24	Banet, et al.
4	20110292376	A1	2011-12-01	Kukushkin, et al.

If you wish to add additional U.S. Published Application citation information please click the Add button.

FOREIGN PATENT DOCUMENTS

Examiner Initial*	Cite No	Foreign Document Number ³	Country Code ² i	Kind Code ⁴	Publication Date	Name of Patentee or Applicant of cited Document	Pages, Columns, Lines where Relevant Passages or Relevant Figures Appear	T ⁵
	1							

If you wish to add additional Foreign Patent Document citation information please click the Add button.

NON-PATENT LITERATURE DOCUMENTS

Examiner Initials*	Cite No	Include name of the author (in CAPITAL LETTERS), title of the article (when appropriate), title of the item (book, magazine, journal, serial, symposium, catalog, etc), date, pages(s), volume-issue number(s), publisher, city and/or country where published.	T ⁵
	1		

If you wish to add additional non-patent literature document citation information please click the Add button.

EXAMINER SIGNATURE

Examiner Signature	/Abra Fein/	Date Considered	05/12/2016
--------------------	-------------	-----------------	------------

*EXAMINER: Initial if reference considered, whether or not citation is in conformance with MPEP 609. Draw line through a citation if not in conformance and not considered. Include copy of this form with next communication to applicant.

INFORMATION DISCLOSURE STATEMENT BY APPLICANT (Not for submission under 37 CFR 1.99)	Application Number	14875709	14875709 - GAU: 2884
	Filing Date	2015-10-06	
	First Named Inventor	Mohammed N. ISLAM	
	Art Unit	2884	
	Examiner Name	Abra S. Fein	
	Attorney Docket Number	POWM 0105 PUSP1	

¹ See Kind Codes of USPTO Patent Documents at www.USPTO.GOV or MPEP 901.04. ² Enter office that issued the document, by the two-letter code (WIPO Standard ST.3). ³ For Japanese patent documents, the indication of the year of the reign of the Emperor must precede the serial number of the patent document. ⁴ Kind of document by the appropriate symbols as indicated on the document under WIPO Standard ST.16 if possible. ⁵ Applicant is to place a check mark here if English language translation is attached.

INFORMATION DISCLOSURE STATEMENT BY APPLICANT (Not for submission under 37 CFR 1.99)	Application Number	14875709	14875709 - GAU: 2884
	Filing Date	2015-10-06	
	First Named Inventor	Mohammed N. ISLAM	
	Art Unit	2884	
	Examiner Name	Abra S. Fein	
	Attorney Docket Number	POWM 0105 PUSP1	

CERTIFICATION STATEMENT

Please see 37 CFR 1.97 and 1.98 to make the appropriate selection(s):

That each item of information contained in the information disclosure statement was first cited in any communication from a foreign patent office in a counterpart foreign application not more than three months prior to the filing of the information disclosure statement. See 37 CFR 1.97(e)(1).

OR

That no item of information contained in the information disclosure statement was cited in a communication from a foreign patent office in a counterpart foreign application, and, to the knowledge of the person signing the certification after making reasonable inquiry, no item of information contained in the information disclosure statement was known to any individual designated in 37 CFR 1.56(c) more than three months prior to the filing of the information disclosure statement. See 37 CFR 1.97(e)(2).

See attached certification statement.

The fee set forth in 37 CFR 1.17 (p) has been submitted herewith.

A certification statement is not submitted herewith.

SIGNATURE

A signature of the applicant or representative is required in accordance with CFR 1.33, 10.18. Please see CFR 1.4(d) for the form of the signature.

Signature	/David S. Bir/	Date (YYYY-MM-DD)	2016-03-08
Name/Print	David S. Bir	Registration Number	38383

This collection of information is required by 37 CFR 1.97 and 1.98. The information is required to obtain or retain a benefit by the public which is to file (and by the USPTO to process) an application. Confidentiality is governed by 35 U.S.C. 122 and 37 CFR 1.14. This collection is estimated to take 1 hour to complete, including gathering, preparing and submitting the completed application form to the USPTO. Time will vary depending upon the individual case. Any comments on the amount of time you require to complete this form and/or suggestions for reducing this burden, should be sent to the Chief Information Officer, U.S. Patent and Trademark Office, U.S. Department of Commerce, P.O. Box 1450, Alexandria, VA 22313-1450. **DO NOT SEND FEES OR COMPLETED FORMS TO THIS ADDRESS. SEND TO: Commissioner for Patents, P.O. Box 1450, Alexandria, VA 22313-1450.**

Privacy Act Statement

The Privacy Act of 1974 (P.L. 93-579) requires that you be given certain information in connection with your submission of the attached form related to a patent application or patent. Accordingly, pursuant to the requirements of the Act, please be advised that: (1) the general authority for the collection of this information is 35 U.S.C. 2(b)(2); (2) furnishing of the information solicited is voluntary; and (3) the principal purpose for which the information is used by the U.S. Patent and Trademark Office is to process and/or examine your submission related to a patent application or patent. If you do not furnish the requested information, the U.S. Patent and Trademark Office may not be able to process and/or examine your submission, which may result in termination of proceedings or abandonment of the application or expiration of the patent.

The information provided by you in this form will be subject to the following routine uses:

1. The information on this form will be treated confidentially to the extent allowed under the Freedom of Information Act (5 U.S.C. 552) and the Privacy Act (5 U.S.C. 552a). Records from this system of records may be disclosed to the Department of Justice to determine whether the Freedom of Information Act requires disclosure of these records.
2. A record from this system of records may be disclosed, as a routine use, in the course of presenting evidence to a court, magistrate, or administrative tribunal, including disclosures to opposing counsel in the course of settlement negotiations.
3. A record in this system of records may be disclosed, as a routine use, to a Member of Congress submitting a request involving an individual, to whom the record pertains, when the individual has requested assistance from the Member with respect to the subject matter of the record.
4. A record in this system of records may be disclosed, as a routine use, to a contractor of the Agency having need for the information in order to perform a contract. Recipients of information shall be required to comply with the requirements of the Privacy Act of 1974, as amended, pursuant to 5 U.S.C. 552a(m).
5. A record related to an International Application filed under the Patent Cooperation Treaty in this system of records may be disclosed, as a routine use, to the International Bureau of the World Intellectual Property Organization, pursuant to the Patent Cooperation Treaty.
6. A record in this system of records may be disclosed, as a routine use, to another federal agency for purposes of National Security review (35 U.S.C. 181) and for review pursuant to the Atomic Energy Act (42 U.S.C. 218(c)).
7. A record from this system of records may be disclosed, as a routine use, to the Administrator, General Services, or his/her designee, during an inspection of records conducted by GSA as part of that agency's responsibility to recommend improvements in records management practices and programs, under authority of 44 U.S.C. 2904 and 2906. Such disclosure shall be made in accordance with the GSA regulations governing inspection of records for this purpose, and any other relevant (i.e., GSA or Commerce) directive. Such disclosure shall not be used to make determinations about individuals.
8. A record from this system of records may be disclosed, as a routine use, to the public after either publication of the application pursuant to 35 U.S.C. 122(b) or issuance of a patent pursuant to 35 U.S.C. 151. Further, a record may be disclosed, subject to the limitations of 37 CFR 1.14, as a routine use, to the public if the record was filed in an application which became abandoned or in which the proceedings were terminated and which application is referenced by either a published application, an application open to public inspections or an issued patent.
9. A record from this system of records may be disclosed, as a routine use, to a Federal, State, or local law enforcement agency, if the USPTO becomes aware of a violation or potential violation of law or regulation.

Receipt date: 10/06/2015

14875709 - GAI: 2884

Doc code: IDS

Pat. Sec. 101-10

Doc description: Information Disclosure Statement (IDS) Filed

Approved for use through 07/31/2012. OMB 0651-0031

U.S. Patent and Trademark Office; U.S. DEPARTMENT OF COMMERCE

Under the Paperwork Reduction Act of 1995, no persons are required to respond to a collection of information unless it contains a valid OMB control number.

INFORMATION DISCLOSURE STATEMENT BY APPLICANT (Not for submission under 37 CFR 1.99)	Application Number		
	Filing Date		
	First Named Inventor	Mohammed N. ISLAM	
	Art Unit		
	Examiner Name		
	Attorney Docket Number	OMNI 0105 PUSP1	

U.S.PATENTS						Remove
Examiner Initial*	Cite No	Patent Number	Kind Code ¹	Issue Date	Name of Patentee or Applicant of cited Document	Pages,Columns,Lines where Relevant Passages or Relevant Figures Appear
	1	4063106		1977-12-13	Ashkin, et al.	
	2	4158750		1979-06-19	Sakoe, et al.	
	3	4221997		1980-09-09	Flemming	
	4	4275266		1981-06-23	Lasar	
	5	4374618		1983-02-22	Howard	
	6	4403605		1983-09-13	Tanikawa	
	7	4462080		1984-07-24	Johnstone, et al.	
	8	4516207		1985-05-07	Moriyama, et al.	

INFORMATION DISCLOSURE STATEMENT BY APPLICANT (Not for submission under 37 CFR 1.99)	Application Number		14875709 - GAU: 2884	
	Filing Date			
	First Named Inventor	Mohammed N. ISLAM		
	Art Unit			
	Examiner Name			
	Attorney Docket Number		OMNI 0105 PUSP1	

	9	4523884		1985-06-18	Clement, et al.	
	10	4605080		1986-08-12	Lemelson	
	11	4641292		1987-02-03	Tunnell, et al.	
	12	4704696		1987-11-03	Reimer, et al.	
	13	4728974		1988-03-01	Nio, et al.	
	14	4762455		1988-08-09	Coughlan, et al.	
	15	4776016		1988-10-04	Hansen	
	16	4958910		1990-09-25	Taylor, et al.	
	17	4989253		1991-01-29	Liang, et al.	
	18	5078140		1992-01-07	Kwoh	
	19	5084880		1992-01-28	Esterowitz, et al.	

INFORMATION DISCLOSURE STATEMENT BY APPLICANT (Not for submission under 37 CFR 1.99)	Application Number		14875709 - GAU: 2884	
	Filing Date			
	First Named Inventor	Mohammed N. ISLAM		
	Art Unit			
	Examiner Name			
	Attorney Docket Number		OMNI 0105 PUSP1	

	20	5086401		1992-02-04	Glassman, et al.	
	21	5134620		1992-07-28	Huber	
	22	5142930		1992-09-01	Allen, et al.	
	23	5180378		1993-01-19	Kung, et al.	
	24	5191628		1993-03-02	Byron	
	25	5218655		1993-06-08	Mizrahi	
	26	5230023		1993-07-20	Nakano	
	27	5267256		1993-11-30	Saruwatari, et al.	
	28	5267323		1993-11-30	Kimura	
	29	5300097		1994-04-05	Lerner, et al.	
	30	5303148		1994-04-12	Mattson, et al.	

Receipt date: 10/06/2015 INFORMATION DISCLOSURE STATEMENT BY APPLICANT (Not for submission under 37 CFR 1.99)	Application Number		14875709 - GAU: 2884	
	Filing Date			
	First Named Inventor	Mohammed N. ISLAM		
	Art Unit			
	Examiner Name			
	Attorney Docket Number		OMNI 0105 PUSP1	

	31	5305427		1994-04-19	Nagata	
	32	5313306		1994-05-17	Kuban, et al.	
	33	5323404		1994-06-21	Grubb	
	34	5345538		1994-09-06	Narayannan, et al.	
	35	5408409		1995-04-18	Glassman, et al.	
	36	5544654		1996-08-13	Murphy, et al.	
	37	5572999		1996-11-12	Funda, et al.	
	38	5695493		1997-12-09	Nakajima, et al.	
	39	5696778		1997-12-09	MacPherson	
	40	5792204		1998-08-11	Snell	
	41	5812978		1998-09-22	Nolan	

INFORMATION DISCLOSURE STATEMENT BY APPLICANT (Not for submission under 37 CFR 1.99)	Application Number		14875709 - GAU: 2884	
	Filing Date			
	First Named Inventor	Mohammed N. ISLAM		
	Art Unit			
	Examiner Name			
	Attorney Docket Number		OMNI 0105 PUSP1	

	42	5950629		1999-09-14	Taylor, et al.	
	43	5970457		1999-10-19	Brant, et al.	
	44	6014249		2000-01-11	Fermann, et al.	
	45	6185535		2001-02-06	Hedin, et al.	
	46	6200309		2001-03-13	Rice, et al.	
	47	6224542		2001-05-01	Chang, et al.	
	48	6246707		2001-06-12	Yin, et al.	
	49	6273858		2001-08-14	Fox, et al.	
	50	6278975		2001-08-21	Brant, et al.	
	51	6301273		2001-10-09	Sanders, et al.	
	52	6337462		2002-01-08	Smart	

INFORMATION DISCLOSURE STATEMENT BY APPLICANT (Not for submission under 37 CFR 1.99)	Application Number		14875709 - GAU: 2884	
	Filing Date			
	First Named Inventor	Mohammed N. ISLAM		
	Art Unit			
	Examiner Name			
	Attorney Docket Number		OMNI 0105 PUSP1	

	53	6340806		2002-01-22	Smart, et al.	
	54	6350261		2002-02-26	Domankevitz, et al.	
	55	6374006		2002-04-16	Islam, et al.	
	56	6407853		2002-06-18	Samson, et al.	
	57	6436107		2002-08-20	Wang, et al.	
	58	6442430		2002-08-27	Ferek-Petric	
	59	6450172		2002-09-17	Hartlaub, et al.	
	60	6453201		2002-09-17	Daum, et al.	
	61	6458120		2002-10-01	Shen, et al.	
	62	6462500		2002-10-08	L'Hegarat, et al.	
	63	6463361		2002-10-08	Wang, et al.	

INFORMATION DISCLOSURE STATEMENT BY APPLICANT (Not for submission under 37 CFR 1.99)	Application Number		14875709 - GAU: 2884	
	Filing Date			
	First Named Inventor	Mohammed N. ISLAM		
	Art Unit			
	Examiner Name			
	Attorney Docket Number		OMNI 0105 PUSP1	

	64	6567431		2003-05-20	Tabirian, et al.	
	65	6605080		2003-08-12	Altshuler, et al.	
	66	6625180		2003-09-23	Bufetov, et al.	
	67	6631025		2003-10-07	Islam, et al.	
	68	6659999		2003-12-09	Anderson, et al.	
	69	6760148		2004-07-06	Islam	
	70	6885498		2005-04-26	Islam	
	71	6885683		2005-04-26	Fermann, et al.	
	72	6943936		2005-09-13	Islam, et al.	
	73	7027467		2006-04-11	Baev, et al.	
	74	7060061		2006-06-13	Altshuler, et al.	

Receipt date: 10/06/2015 INFORMATION DISCLOSURE STATEMENT BY APPLICANT (Not for submission under 37 CFR 1.99)	Application Number		14875709 - GAU: 2884	
	Filing Date			
	First Named Inventor	Mohammed N. ISLAM		
	Art Unit			
	Examiner Name			
	Attorney Docket Number		OMNI 0105 PUSP1	

	75	7167300		2007-01-23	Fermann, et al.	
	76	7259906		2007-08-21	Islam	
	77	7433116		2008-10-07	Islam	

If you wish to add additional U.S. Patent citation information please click the Add button. **Add**

U.S.PATENT APPLICATION PUBLICATIONS

Remove

Examiner Initial*	Cite No	Publication Number	Kind Code ¹	Publication Date	Name of Patentee or Applicant of cited Document	Pages, Columns, Lines where Relevant Passages or Relevant Figures Appear
	1	20020032468		2002-03-14	Hill, Michael R.S. ; et al.	
	2	20020082612		2002-06-27	Moll, Frederic H. ; et al.	
	3	20020128846		2002-09-12	Miller, Steven C.	
	4	20020178003		2002-11-28	Gehrke, James K. ; et al.	
	5	20040174914		2004-09-09	Fukatsu, Susumu	

If you wish to add additional U.S. Published Application citation information please click the Add button. **Add**

FOREIGN PATENT DOCUMENTS

Remove

INFORMATION DISCLOSURE STATEMENT BY APPLICANT (Not for submission under 37 CFR 1.99)	Application Number		14875709 - GAU: 2884	
	Filing Date			
	First Named Inventor	Mohammed N. ISLAM		
	Art Unit			
	Examiner Name			
	Attorney Docket Number		OMNI 0105 PUSP1	

Examiner Initial*	Cite No	Foreign Document Number ³	Country Code ² ;	Kind Code ⁴	Publication Date	Name of Patentee or Applicant of cited Document	Pages, Columns, Lines where Relevant Passages or Relevant Figures Appear	T ⁵
	1	EP1148666	EP		2001-10-24	Grant Andrew R et al.		<input type="checkbox"/>
	2	WO01150959	WO		2001-07-19	SUHM		<input type="checkbox"/>
	3	WO09715240	WO		1997-05-01	BRANT		<input type="checkbox"/>
	4	WO97049340	WO		1997-12-31	WANG		<input type="checkbox"/>

If you wish to add additional Foreign Patent Document citation information please click the Add button **Add**

NON-PATENT LITERATURE DOCUMENTS

Remove

Examiner Initials*	Cite No	Include name of the author (in CAPITAL LETTERS), title of the article (when appropriate), title of the item (book, magazine, journal, serial, symposium, catalog, etc), date, pages(s), volume-issue number(s), publisher, city and/or country where published.	T ⁵
	1		<input type="checkbox"/>

If you wish to add additional non-patent literature document citation information please click the Add button **Add**

EXAMINER SIGNATURE

Examiner Signature	/Abra Fein/	Date Considered	05/13/2016
--------------------	-------------	-----------------	------------

*EXAMINER: Initial if reference considered, whether or not citation is in conformance with MPEP 609. Draw line through a citation if not in conformance and not considered. Include copy of this form with next communication to applicant.

¹ See Kind Codes of USPTO Patent Documents at www.USPTO.GOV or MPEP 901.04. ² Enter office that issued the document, by the two-letter code (WIPO Standard ST.3). ³ For Japanese patent documents, the indication of the year of the reign of the Emperor must precede the serial number of the patent document. ⁴ Kind of document by the appropriate symbols as indicated on the document under WIPO Standard ST.16 if possible. ⁵ Applicant is to place a check mark here if English language translation is attached.

INFORMATION DISCLOSURE STATEMENT BY APPLICANT (Not for submission under 37 CFR 1.99)	Application Number		14875709 - GAU: 2884
	Filing Date		
	First Named Inventor	Mohammed N. ISLAM	
	Art Unit		
	Examiner Name		
	Attorney Docket Number		OMNI 0105 PUSP1

CERTIFICATION STATEMENT

Please see 37 CFR 1.97 and 1.98 to make the appropriate selection(s):

That each item of information contained in the information disclosure statement was first cited in any communication from a foreign patent office in a counterpart foreign application not more than three months prior to the filing of the information disclosure statement. See 37 CFR 1.97(e)(1).

OR

That no item of information contained in the information disclosure statement was cited in a communication from a foreign patent office in a counterpart foreign application, and, to the knowledge of the person signing the certification after making reasonable inquiry, no item of information contained in the information disclosure statement was known to any individual designated in 37 CFR 1.56(c) more than three months prior to the filing of the information disclosure statement. See 37 CFR 1.97(e)(2).

- See attached certification statement.
- Fee set forth in 37 CFR 1.17 (p) has been submitted herewith.
- None

SIGNATURE

A signature of the applicant or representative is required in accordance with CFR 1.33, 10.18. Please see CFR 1.4(d) for the form of the signature.

Signature	/David S. Bir/	Date (YYYY-MM-DD)	2015-10-01
Name/Print	David S. Bir	Registration Number	38383

This collection of information is required by 37 CFR 1.97 and 1.98. The information is required to obtain or retain a benefit by the public which is to file (and by the USPTO to process) an application. Confidentiality is governed by 35 U.S.C. 122 and 37 CFR 1.14. This collection is estimated to take 1 hour to complete, including gathering, preparing and submitting the completed application form to the USPTO. Time will vary depending upon the individual case. Any comments on the amount of time you require to complete this form and/or suggestions for reducing this burden, should be sent to the Chief Information Officer, U.S. Patent and Trademark Office, U.S. Department of Commerce, P.O. Box 1450, Alexandria, VA 22313-1450. **DO NOT SEND FEES OR COMPLETED FORMS TO THIS ADDRESS. SEND TO: Commissioner for Patents, P.O. Box 1450, Alexandria, VA 22313-1450.**

Privacy Act Statement

The Privacy Act of 1974 (P.L. 93-579) requires that you be given certain information in connection with your submission of the attached form related to a patent application or patent. Accordingly, pursuant to the requirements of the Act, please be advised that: (1) the general authority for the collection of this information is 35 U.S.C. 2(b)(2); (2) furnishing of the information solicited is voluntary; and (3) the principal purpose for which the information is used by the U.S. Patent and Trademark Office is to process and/or examine your submission related to a patent application or patent. If you do not furnish the requested information, the U.S. Patent and Trademark Office may not be able to process and/or examine your submission, which may result in termination of proceedings or abandonment of the application or expiration of the patent.

The information provided by you in this form will be subject to the following routine uses:

1. The information on this form will be treated confidentially to the extent allowed under the Freedom of Information Act (5 U.S.C. 552) and the Privacy Act (5 U.S.C. 552a). Records from this system of records may be disclosed to the Department of Justice to determine whether the Freedom of Information Act requires disclosure of these records.
2. A record from this system of records may be disclosed, as a routine use, in the course of presenting evidence to a court, magistrate, or administrative tribunal, including disclosures to opposing counsel in the course of settlement negotiations.
3. A record in this system of records may be disclosed, as a routine use, to a Member of Congress submitting a request involving an individual, to whom the record pertains, when the individual has requested assistance from the Member with respect to the subject matter of the record.
4. A record in this system of records may be disclosed, as a routine use, to a contractor of the Agency having need for the information in order to perform a contract. Recipients of information shall be required to comply with the requirements of the Privacy Act of 1974, as amended, pursuant to 5 U.S.C. 552a(m).
5. A record related to an International Application filed under the Patent Cooperation Treaty in this system of records may be disclosed, as a routine use, to the International Bureau of the World Intellectual Property Organization, pursuant to the Patent Cooperation Treaty.
6. A record in this system of records may be disclosed, as a routine use, to another federal agency for purposes of National Security review (35 U.S.C. 181) and for review pursuant to the Atomic Energy Act (42 U.S.C. 218(c)).
7. A record from this system of records may be disclosed, as a routine use, to the Administrator, General Services, or his/her designee, during an inspection of records conducted by GSA as part of that agency's responsibility to recommend improvements in records management practices and programs, under authority of 44 U.S.C. 2904 and 2906. Such disclosure shall be made in accordance with the GSA regulations governing inspection of records for this purpose, and any other relevant (i.e., GSA or Commerce) directive. Such disclosure shall not be used to make determinations about individuals.
8. A record from this system of records may be disclosed, as a routine use, to the public after either publication of the application pursuant to 35 U.S.C. 122(b) or issuance of a patent pursuant to 35 U.S.C. 151. Further, a record may be disclosed, subject to the limitations of 37 CFR 1.14, as a routine use, to the public if the record was filed in an application which became abandoned or in which the proceedings were terminated and which application is referenced by either a published application, an application open to public inspections or an issued patent.
9. A record from this system of records may be disclosed, as a routine use, to a Federal, State, or local law enforcement agency, if the USPTO becomes aware of a violation or potential violation of law or regulation.

Receipt date: 10/06/2015

14875709 - GAI: 2884

Doc code: IDS

Pat. Sec. 101-10

Doc description: Information Disclosure Statement (IDS) Filed

Approved for use through 07/31/2012. OMB 0651-0031

U.S. Patent and Trademark Office; U.S. DEPARTMENT OF COMMERCE

Under the Paperwork Reduction Act of 1995, no persons are required to respond to a collection of information unless it contains a valid OMB control number.

INFORMATION DISCLOSURE STATEMENT BY APPLICANT (Not for submission under 37 CFR 1.99)	Application Number		
	Filing Date		
	First Named Inventor	Mohammed N. ISLAM	
	Art Unit		
	Examiner Name		
	Attorney Docket Number	OMNI 0105 PUSP1	

U.S.PATENTS						Remove
Examiner Initial*	Cite No	Patent Number	Kind Code ¹	Issue Date	Name of Patentee or Applicant of cited Document	Pages,Columns,Lines where Relevant Passages or Relevant Figures Appear
	1	6885683		2005-04-26	FERMANN ET AL.	
	2	6281471	B1	2001-08-28	SMART	
	3	6340806		2002-01-22	SMART ET AL.	
	4	6301271	B1	2001-10-09	SANDERS ET AL.	
	5	7294105	B1	2007-11-13	ISLAM	

If you wish to add additional U.S. Patent citation information please click the Add button.

Add

U.S.PATENT APPLICATION PUBLICATIONS						Remove
Examiner Initial*	Cite No	Publication Number	Kind Code ¹	Publication Date	Name of Patentee or Applicant of cited Document	Pages,Columns,Lines where Relevant Passages or Relevant Figures Appear
	1	20100046067	A1	2010-02-25	FERMANN ET AL.	

INFORMATION DISCLOSURE STATEMENT BY APPLICANT (Not for submission under 37 CFR 1.99)	Application Number		14875709 - GAU: 2884	
	Filing Date			
	First Named Inventor	Mohammed N. ISLAM		
	Art Unit			
	Examiner Name			
	Attorney Docket Number		OMNI 0105 PUSP1	

2	20080105665	A1	2008-05-08	KONDO	
---	-------------	----	------------	-------	--

If you wish to add additional U.S. Published Application citation information please click the Add button. **Add**

FOREIGN PATENT DOCUMENTS

Remove

Examiner Initial*	Cite No	Foreign Document Number ³	Country Code ²	Kind Code ⁴	Publication Date	Name of Patentee or Applicant of cited Document	Pages, Columns, Lines where Relevant Passages or Relevant Figures Appear	T ⁵
	1							<input type="checkbox"/>

If you wish to add additional Foreign Patent Document citation information please click the Add button **Add**

NON-PATENT LITERATURE DOCUMENTS

Remove

Examiner Initials*	Cite No	Include name of the author (in CAPITAL LETTERS), title of the article (when appropriate), title of the item (book, magazine, journal, serial, symposium, catalog, etc), date, pages(s), volume-issue number(s), publisher, city and/or country where published.	T ⁵
	1	ISTEPANIAN, ROBERT H., "The Comparative Performance of Mobile Telemedical Systems based on the IS-54 and GSM Cellular Telephone Standards"; Journal of Telemedicine and Telecare 1999; pp 97-104	<input type="checkbox"/>
	2	ARIS, ISHAK BIN, "An Internet-Based Blood Pressure Monitoring System for Patients"; Journal of Telemedicine and Telecare 2001; pp 51-53.	<input type="checkbox"/>

If you wish to add additional non-patent literature document citation information please click the Add button **Add**

EXAMINER SIGNATURE

Examiner Signature	/Abra Fein/	Date Considered	05/13/2016
--------------------	-------------	-----------------	------------

*EXAMINER: Initial if reference considered, whether or not citation is in conformance with MPEP 609. Draw line through a citation if not in conformance and not considered. Include copy of this form with next communication to applicant.

¹ See Kind Codes of USPTO Patent Documents at www.USPTO.GOV or MPEP 901.04. ² Enter office that issued the document, by the two-letter code (WIPO Standard ST.3). ³ For Japanese patent documents, the indication of the year of the reign of the Emperor must precede the serial number of the patent document. ⁴ Kind of document by the appropriate symbols as indicated on the document under WIPO Standard ST.16 if possible. ⁵ Applicant is to place a check mark here if English language translation is attached.

INFORMATION DISCLOSURE STATEMENT BY APPLICANT (Not for submission under 37 CFR 1.99)	Application Number		14875709 - GAU: 2884	
	Filing Date			
	First Named Inventor	Mohammed N. ISLAM		
	Art Unit			
	Examiner Name			
	Attorney Docket Number		OMNI 0105 PUSP1	

CERTIFICATION STATEMENT

Please see 37 CFR 1.97 and 1.98 to make the appropriate selection(s):

That each item of information contained in the information disclosure statement was first cited in any communication from a foreign patent office in a counterpart foreign application not more than three months prior to the filing of the information disclosure statement. See 37 CFR 1.97(e)(1).

OR

That no item of information contained in the information disclosure statement was cited in a communication from a foreign patent office in a counterpart foreign application, and, to the knowledge of the person signing the certification after making reasonable inquiry, no item of information contained in the information disclosure statement was known to any individual designated in 37 CFR 1.56(c) more than three months prior to the filing of the information disclosure statement. See 37 CFR 1.97(e)(2).

See attached certification statement.

The fee set forth in 37 CFR 1.17 (p) has been submitted herewith.

A certification statement is not submitted herewith.

SIGNATURE

A signature of the applicant or representative is required in accordance with CFR 1.33, 10.18. Please see CFR 1.4(d) for the form of the signature.

Signature	/David S. Bir/	Date (YYYY-MM-DD)	2015-10-01
Name/Print	David S. Bir	Registration Number	38383

This collection of information is required by 37 CFR 1.97 and 1.98. The information is required to obtain or retain a benefit by the public which is to file (and by the USPTO to process) an application. Confidentiality is governed by 35 U.S.C. 122 and 37 CFR 1.14. This collection is estimated to take 1 hour to complete, including gathering, preparing and submitting the completed application form to the USPTO. Time will vary depending upon the individual case. Any comments on the amount of time you require to complete this form and/or suggestions for reducing this burden, should be sent to the Chief Information Officer, U.S. Patent and Trademark Office, U.S. Department of Commerce, P.O. Box 1450, Alexandria, VA 22313-1450. **DO NOT SEND FEES OR COMPLETED FORMS TO THIS ADDRESS. SEND TO: Commissioner for Patents, P.O. Box 1450, Alexandria, VA 22313-1450.**

Privacy Act Statement

The Privacy Act of 1974 (P.L. 93-579) requires that you be given certain information in connection with your submission of the attached form related to a patent application or patent. Accordingly, pursuant to the requirements of the Act, please be advised that: (1) the general authority for the collection of this information is 35 U.S.C. 2(b)(2); (2) furnishing of the information solicited is voluntary; and (3) the principal purpose for which the information is used by the U.S. Patent and Trademark Office is to process and/or examine your submission related to a patent application or patent. If you do not furnish the requested information, the U.S. Patent and Trademark Office may not be able to process and/or examine your submission, which may result in termination of proceedings or abandonment of the application or expiration of the patent.

The information provided by you in this form will be subject to the following routine uses:

1. The information on this form will be treated confidentially to the extent allowed under the Freedom of Information Act (5 U.S.C. 552) and the Privacy Act (5 U.S.C. 552a). Records from this system of records may be disclosed to the Department of Justice to determine whether the Freedom of Information Act requires disclosure of these records.
2. A record from this system of records may be disclosed, as a routine use, in the course of presenting evidence to a court, magistrate, or administrative tribunal, including disclosures to opposing counsel in the course of settlement negotiations.
3. A record in this system of records may be disclosed, as a routine use, to a Member of Congress submitting a request involving an individual, to whom the record pertains, when the individual has requested assistance from the Member with respect to the subject matter of the record.
4. A record in this system of records may be disclosed, as a routine use, to a contractor of the Agency having need for the information in order to perform a contract. Recipients of information shall be required to comply with the requirements of the Privacy Act of 1974, as amended, pursuant to 5 U.S.C. 552a(m).
5. A record related to an International Application filed under the Patent Cooperation Treaty in this system of records may be disclosed, as a routine use, to the International Bureau of the World Intellectual Property Organization, pursuant to the Patent Cooperation Treaty.
6. A record in this system of records may be disclosed, as a routine use, to another federal agency for purposes of National Security review (35 U.S.C. 181) and for review pursuant to the Atomic Energy Act (42 U.S.C. 218(c)).
7. A record from this system of records may be disclosed, as a routine use, to the Administrator, General Services, or his/her designee, during an inspection of records conducted by GSA as part of that agency's responsibility to recommend improvements in records management practices and programs, under authority of 44 U.S.C. 2904 and 2906. Such disclosure shall be made in accordance with the GSA regulations governing inspection of records for this purpose, and any other relevant (i.e., GSA or Commerce) directive. Such disclosure shall not be used to make determinations about individuals.
8. A record from this system of records may be disclosed, as a routine use, to the public after either publication of the application pursuant to 35 U.S.C. 122(b) or issuance of a patent pursuant to 35 U.S.C. 151. Further, a record may be disclosed, subject to the limitations of 37 CFR 1.14, as a routine use, to the public if the record was filed in an application which became abandoned or in which the proceedings were terminated and which application is referenced by either a published application, an application open to public inspections or an issued patent.
9. A record from this system of records may be disclosed, as a routine use, to a Federal, State, or local law enforcement agency, if the USPTO becomes aware of a violation or potential violation of law or regulation.

Receipt date: 10/06/2015

14875709 - GAI: 2884

Doc code: IDS

Doc description: Information Disclosure Statement (IDS) Filed

Approved for use through 07/31/2012. OMB 0651-0031
 U.S. Patent and Trademark Office; U.S. DEPARTMENT OF COMMERCE
 Under the Paperwork Reduction Act of 1995, no persons are required to respond to a collection of information unless it contains a valid OMB control number.

INFORMATION DISCLOSURE STATEMENT BY APPLICANT (Not for submission under 37 CFR 1.99)	Application Number		
	Filing Date		
	First Named Inventor	Mohammed N. ISLAM	
	Art Unit		
	Examiner Name		
	Attorney Docket Number	OMNI 0105 PUSP1	

U.S.PATENTS						Remove
Examiner Initial*	Cite No	Patent Number	Kind Code ¹	Issue Date	Name of Patentee or Applicant of cited Document	Pages,Columns,Lines where Relevant Passages or Relevant Figures Appear
	1	6181414		2001-01-30	Raz et al.	
	2	7105823		2006-09-12	Abrahamsson et al.	
	3	8472108		2013-06-25	Islam	

If you wish to add additional U.S. Patent citation information please click the Add button.

Add

U.S.PATENT APPLICATION PUBLICATIONS						Remove
Examiner Initial*	Cite No	Publication Number	Kind Code ¹	Publication Date	Name of Patentee or Applicant of cited Document	Pages,Columns,Lines where Relevant Passages or Relevant Figures Appear
	1	20060283931		2006-12-21	Polli et al.	
	2	20120239013		2012-09-20	Islam	
	3	20130274569		2013-10-17	Islam	

INFORMATION DISCLOSURE STATEMENT BY APPLICANT (Not for submission under 37 CFR 1.99)	Application Number		14875709 - GAU: 2884	
	Filing Date			
	First Named Inventor	Mohammed N. ISLAM		
	Art Unit			
	Examiner Name			
	Attorney Docket Number		OMNI 0105 PUSP1	

4	20140236021	2014-08-21	Islam	
---	-------------	------------	-------	--

If you wish to add additional U.S. Published Application citation information please click the Add button. **Add**

FOREIGN PATENT DOCUMENTS

Remove

Examiner Initial*	Cite No	Foreign Document Number ³	Country Code ²	Kind Code ⁴	Publication Date	Name of Patentee or Applicant of cited Document	Pages, Columns, Lines where Relevant Passages or Relevant Figures Appear	T ⁵
	1							<input type="checkbox"/>

If you wish to add additional Foreign Patent Document citation information please click the Add button **Add**

NON-PATENT LITERATURE DOCUMENTS

Remove

Examiner Initials*	Cite No	Include name of the author (in CAPITAL LETTERS), title of the article (when appropriate), title of the item (book, magazine, journal, serial, symposium, catalog, etc), date, pages(s), volume-issue number(s), publisher, city and/or country where published.	T ⁵
	1	"Application Brief AB-070: The role of infrared microprobe analysis in forensic drug analysis," www.smithsdetection.com, June 27, 2005.	<input type="checkbox"/>
	2	Jasco Application Note No. 200DR0188-E, "Rapid Identification of illegal drug using NIR (identification of MDMA tablet)", September 4, 2008.	<input type="checkbox"/>
	3	PALOU, A. J. CRUZ, M. BLANCO, J. TOMAS, J. DE LOS RIOS, M. ALCALA, "Determination of drug, excipients and coating distribution in pharmaceutical tablets using NIR-CI," Journal of Pharmaceutical Analysis, Vol. 2, no. 2, pp. 90-97 (2012).	<input type="checkbox"/>
	4	ARNOLD, T., M. De BIASIO, R. LEITNER, "Near-Infrared Imaging Spectroscopy for Counterfeit Drug Detection," Next Generation Spectroscopic Technologies IV, edited by M. A. Druy, R.A. Crocombe, Proceedings of SPIE, Vol. 8032, 80320Y-1 to 7, (2011).	<input type="checkbox"/>
	5	WEDDING, B.B., C. WRIGHT, S. GRAUF, R.D. WHITE, "The application of near infrared spectroscopy for the assessment of avocado quality attributes," Infrared Spectroscopy -- Life and Biomedical Sciences, pp. 211-230 (2011).	<input type="checkbox"/>

INFORMATION DISCLOSURE STATEMENT BY APPLICANT (Not for submission under 37 CFR 1.99)	Application Number		14875709 - GAU: 2884
	Filing Date		
	First Named Inventor	Mohammed N. ISLAM	
	Art Unit		
	Examiner Name		
	Attorney Docket Number		OMNI 0105 PUSP1

6	MICHAELS, C.A., T. MASIELLO, P.M. CHU, "Fourier transform spectrometry with a near infrared supercontinuum source," Optical Society of America, CLEO/IQEC Conference, paper CMDD6 (2009).	<input type="checkbox"/>
7	MICHAELS, C.A., T. MASIELLO, P.M. CHU, "Fourier transform spectrometry with a near-infrared supercontinuum source," Applied Spectroscopy, Vol. 63, no. 5, pp. 538-543 (2009).	<input type="checkbox"/>
8	MOROS, J., J. KULIGOWSKI, G. QUINTAS, S. GARRIGUES, M. DeLa GUARDIA, "New cut-off criterion for uninformative variable elimination in multivariate calibration of near-infrared spectra for the determination of heroin in illicit street drugs," Analytica Chimica Acta, Vol. 630, pp. 150-160 (2008).	<input type="checkbox"/>
9	MOROS, J. N. GALLPIENSO, R. VILCHES, S. GARRIGUES, M. DeLa GUARDIA, "Nondestructive direct determination of heroin in seized illicit street drugs by diffuse reflectance near-infrared spectroscopy," Analytical Chemistry, Vol. 80, no. 19, pp. 7257-7265 (October 1, 2008).	<input type="checkbox"/>
10	ROGGO, Y. P. CHALUS, L. MAURER, C. LEMA-MARTINEZ, A. EDMOND, N. JENT, "A review of near infrared spectroscopy and chemometrics in pharmaceutical technologies," Journal of Pharmaceutical and Biomedical Analysis, Vol. 44, pp. 683-700 (2007).	<input type="checkbox"/>
11	POJIC, M. J. MASTILOVIC, N. MAJZEN, "The application of near infrared spectroscopy in wheat quality control," Infrared Spectroscopy - Life and Biomedical Sciences, pp. 167-184 (2012).	<input type="checkbox"/>
12	REICH, G. "Near-infrared spectroscopy and imaging: basic principles and pharmaceutical applications," Advanced Drug Delivery Reviews, vol. 57, pp. 1109-1143 (2005).	<input type="checkbox"/>
13	RODIONOVA, O.Y., L.P. HOUMOLLER, A.L. POMERANTSEV, P. GELADI, J. BURGER, V.L. DOROFEYEV, A.P. ARZAMASTSEV, "NIR spectrometry for counterfeit drug detection: a feasibility study," Analytica Chimica Acta, vol. 549, pp. 151-158 (2005).	<input type="checkbox"/>
14	SCHNEIDER, R.C., K.A. KOVAR, "Analysis of ecstasy tablets: comparison of reflectance and transmittance near infrared spectroscopy," Forensic Science International, vol. 134, pp. 187-195 (2003).	<input type="checkbox"/>
15	OLSEN, B.A., M.W. BORER, F.M. PERRY, R.A. FORBES, "Screening for counterfeit drugs using near-infrared spectroscopy," Pharmaceutical Technology, pp. 62-71 (June 2002).	<input type="checkbox"/>
16	SCAFI, S.H.F., C. PASQUINI, "Identification of counterfeit drugs using near-infrared spectroscopy," Analyst, vol. 126, pp. 2218-2224 (2001).	<input type="checkbox"/>

INFORMATION DISCLOSURE STATEMENT BY APPLICANT (Not for submission under 37 CFR 1.99)	Application Number		14875709 - GAU: 2884	
	Filing Date			
	First Named Inventor	Mohammed N. ISLAM		
	Art Unit			
	Examiner Name			
	Attorney Docket Number	OMNI 0105 PUSP1		

17	SONDERMANN, N., K.A. KOVAR, "Identification of ecstasy in complex matrices using near-infrared spectroscopy," Forensic Science International, vol. 102, pp. 133-147 (1999).	<input type="checkbox"/>
18	RAMBLA, F.J., S. GARRIGUES, M. DeLa GUARDIA, "PLS-NIR determination of total sugar, glucose, fructose and sucrose in aqueous solutions of fruit juices," Analytica Chimica Acta, vol. 344, pp. 41-53 (1997).	<input type="checkbox"/>

If you wish to add additional non-patent literature document citation information please click the Add button **Add**

EXAMINER SIGNATURE

Examiner Signature	/Abra Fein/	Date Considered	05/13/2016
--------------------	-------------	-----------------	------------

*EXAMINER: Initial if reference considered, whether or not citation is in conformance with MPEP 609. Draw line through a citation if not in conformance and not considered. Include copy of this form with next communication to applicant.

¹ See Kind Codes of USPTO Patent Documents at www.USPTO.GOV or MPEP 901.04. ² Enter office that issued the document, by the two-letter code (WIPO Standard ST.3). ³ For Japanese patent documents, the indication of the year of the reign of the Emperor must precede the serial number of the patent document. ⁴ Kind of document by the appropriate symbols as indicated on the document under WIPO Standard ST.16 if possible. ⁵ Applicant is to place a check mark here if English language translation is attached.

INFORMATION DISCLOSURE STATEMENT BY APPLICANT (Not for submission under 37 CFR 1.99)	Application Number		14875709 - GAU: 2884	
	Filing Date			
	First Named Inventor	Mohammed N. ISLAM		
	Art Unit			
	Examiner Name			
	Attorney Docket Number		OMNI 0105 PUSP1	

CERTIFICATION STATEMENT

Please see 37 CFR 1.97 and 1.98 to make the appropriate selection(s):

That each item of information contained in the information disclosure statement was first cited in any communication from a foreign patent office in a counterpart foreign application not more than three months prior to the filing of the information disclosure statement. See 37 CFR 1.97(e)(1).

OR

That no item of information contained in the information disclosure statement was cited in a communication from a foreign patent office in a counterpart foreign application, and, to the knowledge of the person signing the certification after making reasonable inquiry, no item of information contained in the information disclosure statement was known to any individual designated in 37 CFR 1.56(c) more than three months prior to the filing of the information disclosure statement. See 37 CFR 1.97(e)(2).

- See attached certification statement.
- The fee set forth in 37 CFR 1.17 (p) has been submitted herewith.
- A certification statement is not submitted herewith.

SIGNATURE

A signature of the applicant or representative is required in accordance with CFR 1.33, 10.18. Please see CFR 1.4(d) for the form of the signature.

Signature	/David S. Bir/	Date (YYYY-MM-DD)	2015-10-01
Name/Print	David S. Bir	Registration Number	38383

This collection of information is required by 37 CFR 1.97 and 1.98. The information is required to obtain or retain a benefit by the public which is to file (and by the USPTO to process) an application. Confidentiality is governed by 35 U.S.C. 122 and 37 CFR 1.14. This collection is estimated to take 1 hour to complete, including gathering, preparing and submitting the completed application form to the USPTO. Time will vary depending upon the individual case. Any comments on the amount of time you require to complete this form and/or suggestions for reducing this burden, should be sent to the Chief Information Officer, U.S. Patent and Trademark Office, U.S. Department of Commerce, P.O. Box 1450, Alexandria, VA 22313-1450. **DO NOT SEND FEES OR COMPLETED FORMS TO THIS ADDRESS. SEND TO: Commissioner for Patents, P.O. Box 1450, Alexandria, VA 22313-1450.**

Privacy Act Statement

The Privacy Act of 1974 (P.L. 93-579) requires that you be given certain information in connection with your submission of the attached form related to a patent application or patent. Accordingly, pursuant to the requirements of the Act, please be advised that: (1) the general authority for the collection of this information is 35 U.S.C. 2(b)(2); (2) furnishing of the information solicited is voluntary; and (3) the principal purpose for which the information is used by the U.S. Patent and Trademark Office is to process and/or examine your submission related to a patent application or patent. If you do not furnish the requested information, the U.S. Patent and Trademark Office may not be able to process and/or examine your submission, which may result in termination of proceedings or abandonment of the application or expiration of the patent.

The information provided by you in this form will be subject to the following routine uses:

1. The information on this form will be treated confidentially to the extent allowed under the Freedom of Information Act (5 U.S.C. 552) and the Privacy Act (5 U.S.C. 552a). Records from this system of records may be disclosed to the Department of Justice to determine whether the Freedom of Information Act requires disclosure of these records.
2. A record from this system of records may be disclosed, as a routine use, in the course of presenting evidence to a court, magistrate, or administrative tribunal, including disclosures to opposing counsel in the course of settlement negotiations.
3. A record in this system of records may be disclosed, as a routine use, to a Member of Congress submitting a request involving an individual, to whom the record pertains, when the individual has requested assistance from the Member with respect to the subject matter of the record.
4. A record in this system of records may be disclosed, as a routine use, to a contractor of the Agency having need for the information in order to perform a contract. Recipients of information shall be required to comply with the requirements of the Privacy Act of 1974, as amended, pursuant to 5 U.S.C. 552a(m).
5. A record related to an International Application filed under the Patent Cooperation Treaty in this system of records may be disclosed, as a routine use, to the International Bureau of the World Intellectual Property Organization, pursuant to the Patent Cooperation Treaty.
6. A record in this system of records may be disclosed, as a routine use, to another federal agency for purposes of National Security review (35 U.S.C. 181) and for review pursuant to the Atomic Energy Act (42 U.S.C. 218(c)).
7. A record from this system of records may be disclosed, as a routine use, to the Administrator, General Services, or his/her designee, during an inspection of records conducted by GSA as part of that agency's responsibility to recommend improvements in records management practices and programs, under authority of 44 U.S.C. 2904 and 2906. Such disclosure shall be made in accordance with the GSA regulations governing inspection of records for this purpose, and any other relevant (i.e., GSA or Commerce) directive. Such disclosure shall not be used to make determinations about individuals.
8. A record from this system of records may be disclosed, as a routine use, to the public after either publication of the application pursuant to 35 U.S.C. 122(b) or issuance of a patent pursuant to 35 U.S.C. 151. Further, a record may be disclosed, subject to the limitations of 37 CFR 1.14, as a routine use, to the public if the record was filed in an application which became abandoned or in which the proceedings were terminated and which application is referenced by either a published application, an application open to public inspections or an issued patent.
9. A record from this system of records may be disclosed, as a routine use, to a Federal, State, or local law enforcement agency, if the USPTO becomes aware of a violation or potential violation of law or regulation.

Receipt date: 10/06/2015

14875709 - GAI: 2884

Doc code: IDS

Doc description: Information Disclosure Statement (IDS) Filed

Approved for use through 07/31/2012. OMB 0651-0031
 U.S. Patent and Trademark Office; U.S. DEPARTMENT OF COMMERCE
 Under the Paperwork Reduction Act of 1995, no persons are required to respond to a collection of information unless it contains a valid OMB control number.

INFORMATION DISCLOSURE STATEMENT BY APPLICANT (Not for submission under 37 CFR 1.99)	Application Number		
	Filing Date		
	First Named Inventor	Mohammed N. ISLAM	
	Art Unit		
	Examiner Name		
	Attorney Docket Number	OMNI 0105 PUSP1	

U.S.PATENTS						Remove
Examiner Initial*	Cite No	Patent Number	Kind Code ¹	Issue Date	Name of Patentee or Applicant of cited Document	Pages,Columns,Lines where Relevant Passages or Relevant Figures Appear
	1					

If you wish to add additional U.S. Patent citation information please click the Add button. Add

U.S.PATENT APPLICATION PUBLICATIONS						Remove
Examiner Initial*	Cite No	Publication Number	Kind Code ¹	Publication Date	Name of Patentee or Applicant of cited Document	Pages,Columns,Lines where Relevant Passages or Relevant Figures Appear
	1					

If you wish to add additional U.S. Published Application citation information please click the Add button. Add

FOREIGN PATENT DOCUMENTS								Remove
Examiner Initial*	Cite No	Foreign Document Number ³	Country Code ²	Kind Code ⁴	Publication Date	Name of Patentee or Applicant of cited Document	Pages,Columns,Lines where Relevant Passages or Relevant Figures Appear	T ⁵
	1							<input type="checkbox"/>

If you wish to add additional Foreign Patent Document citation information please click the Add button Add

NON-PATENT LITERATURE DOCUMENTS				Remove
Examiner Initials*	Cite No	Include name of the author (in CAPITAL LETTERS), title of the article (when appropriate), title of the item (book, magazine, journal, serial, symposium, catalog, etc), date, pages(s), volume-issue number(s), publisher, city and/or country where published.		T ⁵

INFORMATION DISCLOSURE STATEMENT BY APPLICANT (Not for submission under 37 CFR 1.99)	Application Number		14875709 - GAU: 2884
	Filing Date		
	First Named Inventor	Mohammed N. ISLAM	
	Art Unit		
	Examiner Name		
	Attorney Docket Number		OMNI 0105 PUSP1

1	Hori, Takashi, et al., "Flatly broadened, wideband and low noise supercontinuum generation in highly nonlinear hybrid fiber", OPTICS EXPRESS, Vol. 12, No. 2, January 26, 2004, pages 317-324.	<input type="checkbox"/>
2	Wadsworth, W. J., et al., "Supercontinuum and four-wave mixing with Q-switched pulses in endlessly single-mode photonic crystal fibres", OPTICS EXPRESS, Vol. 12, No. 2, January 26, 2004, pages 299-309.	<input type="checkbox"/>
3	Hilligsoe, Karen Marie, et al., "Supercontinuum generation in a photonic crystal fiber with two zero dispersion wavelengths", OPTICS EXPRESS, Vol. 12, No. 6, March 22, 2004, pages 1045-1054.	<input type="checkbox"/>
4	Venugopalan, V., "Optical Society of America BIOMED Topical Meeting Tutorial on Tissue Optics", April 27, 2004, pages 1-32.	<input type="checkbox"/>
5	Slusher, Richard E., et al., "Large Raman gain and nonlinear phase shifts in high-purity As ₂ So ₃ chalcogenide fibers", J. Opt. Soc. Am. B, Vol. 21, No. 6, June 2004, pages 1146-1155.	<input type="checkbox"/>
6	Leon-Saval, S. G., et al., "Supercontinuum generation in submicron fibre waveguides", OPTICS EXPRESS, Vol. 12, No. 13, June 28, 2004, pages 2864-2869.	<input type="checkbox"/>
7	Nicholson, J. W., et al., "High power, single mode, all-fiber source of femtosecond pulses at 1550 nm and its use in supercontinuum generation", OPTICS EXPRESS, Vol. 12, No. 13, June 28, 2004, pages 3025-3034.	<input type="checkbox"/>
8	Genty, G., et al., "Enhanced bandwidth of supercontinuum generated in microstructured fibers", OPTICS EXPRESS, Vol. 12, No. 15, July 26, 2004, pages 3471-3480.	<input type="checkbox"/>
9	Champert, Pierre-Alain, et al., "White-light supercontinuum generation in normally dispersive optical fiber using original multi-wavelength pumping system", OPTICS EXPRESS, Vol. 12, No. 19, September 20, 2004, pages 4366-4371.	<input type="checkbox"/>
10	Nicholson, J. W., "Supercontinuum generation in ultraviolet-irradiated fibers", OPTICS LETTERS, Vol. 29, No. 20, October 15, 2004, pages 2363-2365.	<input type="checkbox"/>
11	Hori, Takashi, et al., "Experimental and numerical analysis of widely broadened supercontinuum generation in highly nonlinear dispersion-shifted fiber with a femtosecond pulse", J. Opt. Soc. Am. B, Vol. 21, No. 11, November 2004, pages 1969-1980.	<input type="checkbox"/>

INFORMATION DISCLOSURE STATEMENT BY APPLICANT (Not for submission under 37 CFR 1.99)	Application Number		14875709 - GAU: 2884
	Filing Date		
	First Named Inventor	Mohammed N. ISLAM	
	Art Unit		
	Examiner Name		
	Attorney Docket Number		OMNI 0105 PUSP1

12	Demircan, Ayhan, et al., "Supercontinuum generation by the modulation instability", Optics Communications 244, 2005, pages 181-185.	<input type="checkbox"/>
13	Papernyi, S. B., et al., "Sixth-Order Cascaded Raman Amplification", OFC/NFOEC, 2005, 3 pages.	<input type="checkbox"/>
14	Tanaka, Keiji, "Optical nonlinearity in photonic glasses", Journal of Materials Science: Materials in Electronics 16, 2005, pages 633-643.	<input type="checkbox"/>
15	Westbrook, Paul S., "Improved Supercontinuum Generation Through UV Processing of Highly Nonlinear Fibers", Journal of Lightwave Technology, Vol. 23, No. 1, January 2005, pages 13-18.	<input type="checkbox"/>
16	Abeeluck, Akheesh K., et al., "Continuous-wave pumping in the anomalous- and normal dispersion regimes of nonlinear fibers for supercontinuum generation", OPTICS LETTERS, Vol. 30, No. 1, January 1, 2005, pages 61-63.	<input type="checkbox"/>
17	Kutz, J. Nathan, et al., "Enhanced Supercontinuum Generation through Dispersion-Management", OPTICS EXPRESS, Vol. 13, No. 11, May 30, 2005, pages 3989-3998.	<input type="checkbox"/>
18	Lee, Ju Han, et al., "Experimental performance comparison for various continuous-wave supercontinuum schemes: ring cavity and single pass structures", OPTICS EXPRESS, Vol. 13, No. 13, June 27, 2005, pages 4848-4853.	<input type="checkbox"/>
19	Saliminia, A., et al., "Ultra-broad and coherent white light generation in silica glass by focused femtosecond pulses at 1.5pm", OPTICS EXPRESS, Vol. 13, No. 15, July 25, 2005, pages 5731-5738.	<input type="checkbox"/>
20	Takushima, Yuichi, "High average power, depolarized super-continuum generation using a 1.55-um ASE noise source, OPTICS EXPRESS, Vol. 13, No. 15, July 25, 2005, pages 5871.-5877.	<input type="checkbox"/>
21	Travers, J. C., et al., "Extended continuous-wave supercontinuum generation in a low-water-loss holey fiber", OPTICS LETTERS, Vol. 30, No. 15, August 1, 2005, pages 1938-1940.	<input type="checkbox"/>
22	Kobtsev, Serguei M., et al., "Modelling of high-power supercontinuum generation in highly nonlinear, dispersion shifted fibers at CW pump", OPTICS EXPRESS, Vol. 13, No. 18, September 5, 2005, pages 6912-6918.	<input type="checkbox"/>

INFORMATION DISCLOSURE STATEMENT BY APPLICANT (Not for submission under 37 CFR 1.99)	Application Number		14875709 - GAU: 2884
	Filing Date		
	First Named Inventor	Mohammed N. ISLAM	
	Art Unit		
	Examiner Name		
	Attorney Docket Number		OMNI 0105 PUSP1

23	Falk, Peter, et al., "Supercontinuum generation in a photonic crystal fiber with two zero-dispersion wavelengths tapered to normal dispersion at all wavelengths", OPTICS EXPRESS, Vol. 13, No. 19, September 19, 2005, pages 7535-7540.	<input type="checkbox"/>
24	Tombelaine, Vincent, et al., "Ultra wide band supercontinuum generation in air-silica holey fibers by SHG-induced modulation instabilities", OPTICS EXPRESS, Vol. 13, No. 19, September 19, 2005, pages 7399-7404.	<input type="checkbox"/>
25	Lee, Ju Han, et al., "Continuous-wave supercontinuum laser based on an erbium-doped fiber ring cavity incorporating a highly nonlinear optical fiber", OPTICS LETTERS, Vol. 30, No. 19, October 1, 2005, pages 2599-2601.	<input type="checkbox"/>
26	Genty, G., et al., "Supercontinuum generation in large mode-area microstructured fibers", OPTICS EXPRESS, Vol. 13, No. 21, October 17, 2005, pages 8625-8633.	<input type="checkbox"/>
27	Schreiber, T., et al., "Supercontinuum generation by femtosecond single and dual wavelength pumping in photonic crystal fibers with two zero dispersion wavelengths", OPTICS EXPRESS, Vol. 13, No. 23, November 14, 2005, pages 9556-9569.	<input type="checkbox"/>
28	Travers, J. C., et al., "Extended blue supercontinuum generation in cascaded holey fibers", OPTICS LETTERS, Vol. 30, No. 23, December 1, 2005, pages 3132-3134.	<input type="checkbox"/>
29	Hagen, C. L., et al., "Generation of a Continuum Extending to the Midinfrared by Pumping ZBLAN Fiber With an Ultrafast 1550-nm Source", IEEE PHOTONICS TECHNOLOGY LETTERS, Vol. 18, No. 1, January 1, 2006, pages 91-93.	<input type="checkbox"/>
30	Moon, Sucbei, et al., "Generation of octave-spanning supercontinuum with 1550-nm amplified diode-laser pulses and a dispersion-shifted fiber", OPTICS EXPRESS, Vol. 14, No. 1, January 9, 2006, pages 270-278.	<input type="checkbox"/>
31	Fedotova, O., et al., "Supercontinuum generation in planar rib waveguides enabled by anomalous dispersion", OPTICS EXPRESS, Vol. 14, No. 4, February 20, 2006, pages 1512-1517.	<input type="checkbox"/>
32	Harrington, James A., "Infrared Fiber Optics", OSA Handbook, Vol. III, white paper, to be published by McGraw Hill, Undated, 13 pages	<input type="checkbox"/>
33	Aaviksoo, J., et al., "Observation of optical precursors at pulse propagation in GaAs", Physical Review A, Volume 44, Number 9, November 1, 1991, pages R5353-R5356.	<input type="checkbox"/>

INFORMATION DISCLOSURE STATEMENT BY APPLICANT (Not for submission under 37 CFR 1.99)	Application Number		14875709 - GAU: 2884
	Filing Date		
	First Named Inventor	Mohammed N. ISLAM	
	Art Unit		
	Examiner Name		
	Attorney Docket Number		OMNI 0105 PUSP1

34	Boppart, Stephen A., et al., "Imaging developing neural morphology using optical coherence tomography", Journal of Neuroscience Methods 70, 1996, pages 65-72.	<input type="checkbox"/>
35	Boppart, Stephen A., et al., "Noninvasive assessment of the developing Xenopus cardiovascular system using optical coherence tomography", Proc. Natl. Acad. Sci. USA, Vol. 94, April 1997, pages 4256-4261.	<input type="checkbox"/>
36	Teamey, Guillermo J., et al., "In vivo Endoscopic Optical Biopsy with Optical Coherence Tomography", Science, New Series, Volume 276, June 27, 1997, pages 2037-2039.	<input type="checkbox"/>
37	de Boer, Johannes F., et al., "Imaging thermally damaged tissue by polarization sensitive optical coherence tomography", OPTICS EXPRESS 212, Vol. 3, No. 6, September 14, 1998, pages 212-218.	<input type="checkbox"/>
38	Roggan, Andre, et al., "Optical Properties of Circulating Human Blood in the Wavelength Range 400-2500 NM", Journal of Biomedical Optics, Vol. 4, No. 1, January 1999, pages 36-46.	<input type="checkbox"/>
39	de Boer, Johannes F., et al., "Determination of the depth-resolved Stokes parameters of light backscattered from turbid media by use of polarization-sensitive optical coherence tomography", OPTICS LETTERS, Vol. 24, No. 5, March 1, 1999, pages 300-302.	<input type="checkbox"/>
40	Rollins, Andrew M., et al., "Real-time in vivo imaging of human gastrointestinal ultrastructure by use of endoscopic optical coherence tomography with a novel efficient interferometer design", OPTICS LETTERS, Vol. 24, No. 19, October 1, 1999, pages 1358-1360.	<input type="checkbox"/>
41	D'Amico, Anthony V., et al., "Optical Coherence Tomography As A Method For Identifying Benign And Malignant Microscopic Structures In The Prostate Gland", Basic Science, Urology 55 (5), 2000, pages 783-787.	<input type="checkbox"/>
42	Li, Xingde, et al., "Imaging needle for optical coherence tomography", OPTICS LETTERS, Vol. 25, No. 20, October 15, 2000, pages 1520-1522.	<input type="checkbox"/>
43	Oughstun, Kurt E., "Influence of precursor fields on ultrashort pulse autocorrelation measurements and pulse width evolution", OPTICS EXPRESS, Vol. 8, No. 8, April 9, 2001, pages 481-491.	<input type="checkbox"/>
44	Kowalewicz, Andrew M., et al., "Ultra-high resolution optical coherence tomography using a superluminescent light source" OPTICS EXPRESS 349, Vol. 10, No. 7, April 8, 2002, pages 349-353.	<input type="checkbox"/>

INFORMATION DISCLOSURE STATEMENT BY APPLICANT (Not for submission under 37 CFR 1.99)	Application Number		14875709 - GAU: 2884
	Filing Date		
	First Named Inventor	Mohammed N. ISLAM	
	Art Unit		
	Examiner Name		
	Attorney Docket Number		OMNI 0105 PUSP1

45	Povazay, B., et al., "Submicrometer axial resolution optical coherence tomography", OPTICS LETTERS, Vol. 27, No. 20, October 15, 2002, pages 1800-1802.	<input type="checkbox"/>
46	Xie, T.-Q., et al., "Detection of tumorigenesis in urinary bladder with optical coherence tomography: optical characterization of morphological changes", OPTICS EXPRESS, Vol. 10, No. 24, December 2, 2002, 2003, pages 1431-1443.	<input type="checkbox"/>
47	Seefeldt, Michael, et al., "Compact white-light source with an average output power of 2.4 Wand 900 nm spectral bandwidth", Optics Communications 216, pages 199-202.	<input type="checkbox"/>
48	Wang, Yimin, et al., "Ultrahigh-resolution optical coherence tomography by broadband continuum generation from a photonic crystal fiber", OPTICS LETTERS, Vol. 28, No. 3, February 1, 2003, pages 182-184.	<input type="checkbox"/>
49	Bizheva, K, et al., "Compact, broad-bandwidth fiberlaserforsub-2-pm axial resolution optical coherence tomography in the 1300-nm wavelength region," OPTICS LETTERS, Vol. 28, No. 9, May 1, 2003, pages 707-709.	<input type="checkbox"/>
50		<input type="checkbox"/>

If you wish to add additional non-patent literature document citation information please click the Add button **Add**

EXAMINER SIGNATURE

Examiner Signature	/Abra Fein/	Date Considered	05/13/2016
--------------------	-------------	-----------------	------------

*EXAMINER: Initial if reference considered, whether or not citation is in conformance with MPEP 609. Draw line through a citation if not in conformance and not considered. Include copy of this form with next communication to applicant.

¹ See Kind Codes of USPTO Patent Documents at www.USPTO.GOV or MPEP 901.04. ² Enter office that issued the document, by the two-letter code (WIPO Standard ST.3). ³ For Japanese patent documents, the indication of the year of the reign of the Emperor must precede the serial number of the patent document. ⁴ Kind of document by the appropriate symbols as indicated on the document under WIPO Standard ST.16 if possible. ⁵ Applicant is to place a check mark here if English language translation is attached.

INFORMATION DISCLOSURE STATEMENT BY APPLICANT (Not for submission under 37 CFR 1.99)	Application Number		14875709 - GAU: 2884	
	Filing Date			
	First Named Inventor	Mohammed N. ISLAM		
	Art Unit			
	Examiner Name			
	Attorney Docket Number		OMNI 0105 PUSP1	

CERTIFICATION STATEMENT

Please see 37 CFR 1.97 and 1.98 to make the appropriate selection(s):

That each item of information contained in the information disclosure statement was first cited in any communication from a foreign patent office in a counterpart foreign application not more than three months prior to the filing of the information disclosure statement. See 37 CFR 1.97(e)(1).

OR

That no item of information contained in the information disclosure statement was cited in a communication from a foreign patent office in a counterpart foreign application, and, to the knowledge of the person signing the certification after making reasonable inquiry, no item of information contained in the information disclosure statement was known to any individual designated in 37 CFR 1.56(c) more than three months prior to the filing of the information disclosure statement. See 37 CFR 1.97(e)(2).

- See attached certification statement.
- The fee set forth in 37 CFR 1.17 (p) has been submitted herewith.
- A certification statement is not submitted herewith.

SIGNATURE

A signature of the applicant or representative is required in accordance with CFR 1.33, 10.18. Please see CFR 1.4(d) for the form of the signature.

Signature	/David S. Bir/	Date (YYYY-MM-DD)	2015-10-01
Name/Print	David S. Bir	Registration Number	38383

This collection of information is required by 37 CFR 1.97 and 1.98. The information is required to obtain or retain a benefit by the public which is to file (and by the USPTO to process) an application. Confidentiality is governed by 35 U.S.C. 122 and 37 CFR 1.14. This collection is estimated to take 1 hour to complete, including gathering, preparing and submitting the completed application form to the USPTO. Time will vary depending upon the individual case. Any comments on the amount of time you require to complete this form and/or suggestions for reducing this burden, should be sent to the Chief Information Officer, U.S. Patent and Trademark Office, U.S. Department of Commerce, P.O. Box 1450, Alexandria, VA 22313-1450. **DO NOT SEND FEES OR COMPLETED FORMS TO THIS ADDRESS. SEND TO: Commissioner for Patents, P.O. Box 1450, Alexandria, VA 22313-1450.**

Privacy Act Statement

The Privacy Act of 1974 (P.L. 93-579) requires that you be given certain information in connection with your submission of the attached form related to a patent application or patent. Accordingly, pursuant to the requirements of the Act, please be advised that: (1) the general authority for the collection of this information is 35 U.S.C. 2(b)(2); (2) furnishing of the information solicited is voluntary; and (3) the principal purpose for which the information is used by the U.S. Patent and Trademark Office is to process and/or examine your submission related to a patent application or patent. If you do not furnish the requested information, the U.S. Patent and Trademark Office may not be able to process and/or examine your submission, which may result in termination of proceedings or abandonment of the application or expiration of the patent.

The information provided by you in this form will be subject to the following routine uses:

1. The information on this form will be treated confidentially to the extent allowed under the Freedom of Information Act (5 U.S.C. 552) and the Privacy Act (5 U.S.C. 552a). Records from this system of records may be disclosed to the Department of Justice to determine whether the Freedom of Information Act requires disclosure of these records.
2. A record from this system of records may be disclosed, as a routine use, in the course of presenting evidence to a court, magistrate, or administrative tribunal, including disclosures to opposing counsel in the course of settlement negotiations.
3. A record in this system of records may be disclosed, as a routine use, to a Member of Congress submitting a request involving an individual, to whom the record pertains, when the individual has requested assistance from the Member with respect to the subject matter of the record.
4. A record in this system of records may be disclosed, as a routine use, to a contractor of the Agency having need for the information in order to perform a contract. Recipients of information shall be required to comply with the requirements of the Privacy Act of 1974, as amended, pursuant to 5 U.S.C. 552a(m).
5. A record related to an International Application filed under the Patent Cooperation Treaty in this system of records may be disclosed, as a routine use, to the International Bureau of the World Intellectual Property Organization, pursuant to the Patent Cooperation Treaty.
6. A record in this system of records may be disclosed, as a routine use, to another federal agency for purposes of National Security review (35 U.S.C. 181) and for review pursuant to the Atomic Energy Act (42 U.S.C. 218(c)).
7. A record from this system of records may be disclosed, as a routine use, to the Administrator, General Services, or his/her designee, during an inspection of records conducted by GSA as part of that agency's responsibility to recommend improvements in records management practices and programs, under authority of 44 U.S.C. 2904 and 2906. Such disclosure shall be made in accordance with the GSA regulations governing inspection of records for this purpose, and any other relevant (i.e., GSA or Commerce) directive. Such disclosure shall not be used to make determinations about individuals.
8. A record from this system of records may be disclosed, as a routine use, to the public after either publication of the application pursuant to 35 U.S.C. 122(b) or issuance of a patent pursuant to 35 U.S.C. 151. Further, a record may be disclosed, subject to the limitations of 37 CFR 1.14, as a routine use, to the public if the record was filed in an application which became abandoned or in which the proceedings were terminated and which application is referenced by either a published application, an application open to public inspections or an issued patent.
9. A record from this system of records may be disclosed, as a routine use, to a Federal, State, or local law enforcement agency, if the USPTO becomes aware of a violation or potential violation of law or regulation.

Receipt date: 10/06/2015

14875709 - GAI: 2884

Doc code: IDS

Pat. Sec. 101-10

Doc description: Information Disclosure Statement (IDS) Filed

Approved for use through 07/31/2012. OMB 0651-0031

U.S. Patent and Trademark Office; U.S. DEPARTMENT OF COMMERCE

Under the Paperwork Reduction Act of 1995, no persons are required to respond to a collection of information unless it contains a valid OMB control number.

INFORMATION DISCLOSURE STATEMENT BY APPLICANT (Not for submission under 37 CFR 1.99)	Application Number		
	Filing Date		
	First Named Inventor	Mohammed N. ISLAM	
	Art Unit		
	Examiner Name		
	Attorney Docket Number	OMNI 0105 PUSP1	

U.S. PATENTS						Remove
Examiner Initial*	Cite No	Patent Number	Kind Code ¹	Issue Date	Name of Patentee or Applicant of cited Document	Pages, Columns, Lines where Relevant Passages or Relevant Figures Appear
	1	5747806		1998-05-05	Khalil	
	2	6115673		2000-09-05	Malin	
	3	6512936	B1	2003-01-28	MONFRE	
	4	6534012	B1	2003-04-01	VISWANATHAN	
	5	6640117		2003-10-28	Makarewicz	
	6	6788965	B2	2004-09-07	RUCHTI	
	7	6816241		2004-11-09	Grubisic	
	8	6738652	B2	2004-05-18	MATTU	

INFORMATION DISCLOSURE STATEMENT BY APPLICANT (Not for submission under 37 CFR 1.99)	Application Number		14875709 - GAU: 2884	
	Filing Date			
	First Named Inventor	Mohammed N. ISLAM		
	Art Unit			
	Examiner Name			
	Attorney Docket Number		OMNI 0105 PUSP1	

	9	6587702	B1	2003-07-01	RUCHTI	
	10	6864978	B1	2005-03-08	HAZEN	
	11	6990364		2006-01-24	Ruchti	
	12	7010336	B2	2006-03-07	LORENZ	
	13	7133710	B2	2006-11-07	Acosta	
	14	7233816	B2	2007-06-19	BLANK	
	15	7299080	B2	2007-11-20	Acosta	
	16	7317938	B2	2008-01-08	Lorenz	
	17	7395158	B2	2008-07-01	Monfre	
	18	7519406	B2	2009-04-14	BLANK	
	19	7620674	B2	2009-11-17	RUCHTI	

INFORMATION DISCLOSURE STATEMENT BY APPLICANT (Not for submission under 37 CFR 1.99)	Application Number		14875709 - GAU: 2884	
	Filing Date			
	First Named Inventor	Mohammed N. ISLAM		
	Art Unit			
	Examiner Name			
	Attorney Docket Number		OMNI 0105 PUSP1	

	20	7697966	B2	2010-04-13	MONFRE	
	21	7787924		2010-08-31	Acosta	
	22	8145286		2012-03-27	Arai	
	23	6773922		2004-08-10	JENG	
	24	7807718	B2	2010-10-05	HASHIM	

If you wish to add additional U.S. Patent citation information please click the Add button.

[Add](#)

U.S.PATENT APPLICATION PUBLICATIONS

[Remove](#)

Examiner Initial*	Cite No	Publication Number	Kind Code ¹	Publication Date	Name of Patentee or Applicant of cited Document	Pages, Columns, Lines where Relevant Passages or Relevant Figures Appear
	1	20100331637	A1	2010-12-30	Ting	
	2	20110143364	A1	2011-06-16	KIM	
	3	20030022126	A1	2003-01-30	BUCHALLA	
	4	20060223032	A1	2006-10-05	FRIED	

ALL REFERENCES CONSIDERED EXCEPT WHERE LINED THROUGH. /A.F./

INFORMATION DISCLOSURE STATEMENT BY APPLICANT (Not for submission under 37 CFR 1.99)	Application Number		14875709 - GAU: 2884	
	Filing Date			
	First Named Inventor	Mohammed N. ISLAM		
	Art Unit			
	Examiner Name			
	Attorney Docket Number		OMNI 0105 PUSP1	

5	20100322490	A1	2010-12-23	PAN	
6	20120013722	A1	2012-01-19	WONG	

If you wish to add additional U.S. Published Application citation information please click the Add button. **Add**

FOREIGN PATENT DOCUMENTS

Remove

Examiner Initial*	Cite No	Foreign Document Number ³	Country Code ² i	Kind Code ⁴	Publication Date	Name of Patentee or Applicant of cited Document	Pages, Columns, Lines where Relevant Passages or Relevant Figures Appear	T ⁵
	1							<input type="checkbox"/>

If you wish to add additional Foreign Patent Document citation information please click the Add button **Add**

NON-PATENT LITERATURE DOCUMENTS

Remove

Examiner Initials*	Cite No	Include name of the author (in CAPITAL LETTERS), title of the article (when appropriate), title of the item (book, magazine, journal, serial, symposium, catalog, etc), date, pages(s), volume-issue number(s), publisher, city and/or country where published.	T ⁵
	1	HAZEN, K.H., M.A. Arnold, G.W. Small, "Measurement of glucose and other analytes in undiluted human serum with near-infrared transmission spectroscopy," Analytica Chimica Acta, vol. 371, pp. 255-267 (1998).	<input type="checkbox"/>
	2	MALIN, S.F., T.L. Ruchti, T.B. Blank, S.N. Thennadil, S.L. Monfre, "Noninvasive prediction of glucose by near-infrared diffuse reflectance spectroscopy," Clinical Chemistry, vol. 45, no. 9, pp. 1651-1658 (1999).	<input type="checkbox"/>
	3	Thennadil, S.N., J.L. Rennert, B.J. Wenzel, K.H. Hazen, T.L. Ruchti, M.B. Block, "Comparison of glucose concentration in interstitial fluid, and capillary and venous blood during rapid changes in blood glucose levels," Diabetes Technology & Therapeutics, Vol. 3, No. 3, pp. 357-365 (2001).	<input type="checkbox"/>
	4	TROY, T.L., S.N. Thennadil, "Optical properties of human skin in the near infrared wavelength range of 1000 to 2200nm," Journal of Biomedical Optics, vol. 6, no. 2, pp. 167-176, (2001).	<input type="checkbox"/>

INFORMATION DISCLOSURE STATEMENT BY APPLICANT (Not for submission under 37 CFR 1.99)	Application Number		14875709 - GAU: 2884
	Filing Date		
	First Named Inventor	Mohammed N. ISLAM	
	Art Unit		
	Examiner Name		
	Attorney Docket Number		OMNI 0105 PUSP1

5	BLANK, T.B., T.L. Ruchti, A.D. Lorenz, S.L. Monfre, M.R. Makarewicz, M. Mattu, K.H. Hazen, "Clinical results from a non-invasive blood glucose monitor," Optical Diagnostics and Sensing of Biological Fluids and Glucose and Cholesterol Monitoring II, A.V. Priezhev and G.L. Cote, Editors, Proceedings of SPIE, Vol. 4624, pp. 1019 (2002).	<input type="checkbox"/>
6	YEH, S-J, C.F. Hanna, O.S. Khalil, "Monitoring blood glucose changes in cutaneous tissue by temperature-modulated localized reflectance measurements," Clinical Chemistry, vol. 49, no. 6, pp. 924-934 (2003).	<input type="checkbox"/>
7	MARBACH, R., T. Koschinsky, F.A. Gries, H.M. Heise, "Noninvasive blood glucose assay by near-infrared diffuse reflectance spectroscopy of the human inner lip," Applied Spectroscopy, Vol. 47, no. 7, pp. 875-881 (1993).	<input type="checkbox"/>
8	Enejder, A.M.K., T.G. Seccina, J. Oh, M. Hunter, W.C. Shih, S. Sasic, G.L. Horowitz, M.S. Feld, "Raman spectroscopy for noninvasive glucose measurements," Journal of Biomedical Optics, vol. 10, no. 3, 031114 (2005).	<input type="checkbox"/>
9	Olesberg, J.T., L. Liu, V.V. Zee, M.A. Arnold, "In vivo near-infrared spectroscopy of rat skin tissue with varying blood glucose levels," Analytic Chemistry, vol. 78, no. 1, pp. 215-223 (2006).	<input type="checkbox"/>
10	OLESBERG, J.T., M.A. Arnold, C. Mermelstein, J. Schmitz, J. Wagner, "Tunable laser diode system for noninvasive blood glucose measurements," Applied Spectroscopy, Vol. 59, no. 12, pp. 1480-1484 (2005).	<input type="checkbox"/>
11	HARMAN-BOEHM, I. A. Gal, A.M. Raykhman, J.D. Zahn, E. Naidis, Y. Mayzel, "Noninvasive glucose monitoring: a novel approach," Journal of Diabetes Science and Technology, vol. 3, no. 2 pp. 253-260 (2009).	<input type="checkbox"/>
12	KIM-K.D., G.S. Son, S.S. Lim, S.S. Lee, "Measurement of glucose level exploiting a relative optical absorption at discrete probe wavelengths," Japanese Journal of Applied Physics, vol. 48, 077001 (2009).	<input type="checkbox"/>
13	SMITH, J.L., "The Pursuit of Noninvasive Glucose: Hunting the Deceitful Turkey," 2nd Edition, pp. 1-141 (2011).	<input type="checkbox"/>
14	Pezzaniti, J.L., T.W. Jeng, L. McDowell, G.M. Oosta, "Preliminary investigation of near-infrared spectroscopic measurements of urea, creatinine, glucose, protein and ketone in urine," Clinical Biochemistry, vol. 34, pp. 239-246 (2001).	<input type="checkbox"/>
15	LUSSI, A., R. Hibst, R. Paulus, "Diagnodent: An optical method for caries detection," Journal of Dental Research, vol. 83, special issue C, pp. C80-C83 (2004).	<input type="checkbox"/>

INFORMATION DISCLOSURE STATEMENT BY APPLICANT (Not for submission under 37 CFR 1.99)	Receipt date: 10/06/2015	Application Number	14875709 - GAU: 2884
	Filing Date		
	First Named Inventor	Mohammed N. ISLAM	
	Art Unit		
	Examiner Name		
	Attorney Docket Number	OMNI 0105 PUSP1	

16	REESE, E.L, E.E. Fisher, D.A. Horowitz, "Photoelectric densitometry of the circulation of the human dental pulp," The Journal of the Baltimore College of Dental Surgery, Vol. 26, no. 1, pp. 6-18 (1971).	<input type="checkbox"/>
17	ZAKIAN, C., I. Pretty, R. Ellwood, "Near-infrared hyperspectral imaging of teeth for dental caries detection," Journal of Biomedical Optics, vol. 16, no. 6, 064047 (2009).	<input type="checkbox"/>
18	BELIKOV, A.V., A.V. Skripnik, K.V. Shatilova, "Study of the dynamics of the absorption spectra of human tooth enamel and dentine under heating and ablation by submillisecond pulse radiation of an erbium laser with a generation wavelength of 2.79 um," Optics and Spectroscopy, vol. 109, no. 2, pp. 211-216 (2010).	<input type="checkbox"/>
19	KARLSSON, L. "Caries detection methods based on changes in optical properties between healthy and carious tissue," International Journal of Dentistry, vol. 2010, Article ID 270729, 9 pages (2010).	<input type="checkbox"/>
20	FRIED, D. M. Staninec, C.L. Darling, "Near-infrared imaging of dental decay at 1310nm," Journal of Laser Dentistry, vol. 18, no. 1, pp. 8-16 (2010).	<input type="checkbox"/>
21	BURMEN, M. P. Usenik, A. Fidler, F. Pernus, B. Likar, "A construction of standardized near infrared hyper-spectral teeth database - a first step in the development of reliable diagnostic tool for quantification and early detection of caries," Lasers in Dentistry XVII, edited by P. Rechmann, D. Fried, Proceedings of SPIE, Vol. 7884, Paper 78840E (2011).	<input type="checkbox"/>
22	MAIA, A., L. Karlsson, W. Margulis, A. Gomes, "Evaluation of two imaging techniques: near-infrared transillumination and dental radiographs for the detection of early approximal enamel caries," Dentomaxillofacial Radiology, vol. 40, pp. 429-433 (2011).	<input type="checkbox"/>
23	CHUNG, S., D. Fried, M. Staninec, C.L. Darling, "Multispectral near-IR reflectance and transillumination imaging of teeth," Biomedical Optics Express, Vol. 2, No. 10, pp. 2804-2814 (2011).	<input type="checkbox"/>
24	CHUNG, S., D. Fried, M. Staninec, C.L. Darling, "Near infrared imaging of teeth at wavelengths between 1200 and 1600nm," Proceedings of the Society of Photo Optical Instrument Engineering, paper 7884 (2011).	<input type="checkbox"/>
25	STANINEC, M., S.M. Douglas, C.L. Darling, K. Chan, H. Kang, R. C. Lee, D. Fried, "Nondestructive clinical assessment of occlusal caries lesions using near-IR imaging methods," Lasers in Surgery and Medicine, Vol. 43, No. 10, pp. 951-959 (2011).	<input type="checkbox"/>
26	NISHIZAWA, N., "Generation and application of high-quality supercontinuum sources," Optical Fiber Technology, Vol. 18, pp. 394-402 (2012).	<input type="checkbox"/>

INFORMATION DISCLOSURE STATEMENT BY APPLICANT (Not for submission under 37 CFR 1.99)	Application Number		14875709 - GAU: 2884
	Filing Date		
	First Named Inventor	Mohammed N. ISLAM	
	Art Unit		
	Examiner Name		
	Attorney Docket Number	OMNI 0105 PUSP1	

If you wish to add additional non-patent literature document citation information please click the Add button **Add**

EXAMINER SIGNATURE

Examiner Signature	/Abra Fein/	Date Considered	05/13/2016
--------------------	-------------	-----------------	------------

*EXAMINER: Initial if reference considered, whether or not citation is in conformance with MPEP 609. Draw line through a citation if not in conformance and not considered. Include copy of this form with next communication to applicant.

¹ See Kind Codes of USPTO Patent Documents at www.USPTO.GOV or MPEP 901.04. ² Enter office that issued the document, by the two-letter code (WIPO Standard ST.3). ³ For Japanese patent documents, the indication of the year of the reign of the Emperor must precede the serial number of the patent document. ⁴ Kind of document by the appropriate symbols as indicated on the document under WIPO Standard ST.16 if possible. ⁵ Applicant is to place a check mark here if English language translation is attached.

INFORMATION DISCLOSURE STATEMENT BY APPLICANT (Not for submission under 37 CFR 1.99)	Application Number		14875709 - GAU: 2884	
	Filing Date			
	First Named Inventor	Mohammed N. ISLAM		
	Art Unit			
	Examiner Name			
	Attorney Docket Number		OMNI 0105 PUSP1	

CERTIFICATION STATEMENT

Please see 37 CFR 1.97 and 1.98 to make the appropriate selection(s):

That each item of information contained in the information disclosure statement was first cited in any communication from a foreign patent office in a counterpart foreign application not more than three months prior to the filing of the information disclosure statement. See 37 CFR 1.97(e)(1).

OR

That no item of information contained in the information disclosure statement was cited in a communication from a foreign patent office in a counterpart foreign application, and, to the knowledge of the person signing the certification after making reasonable inquiry, no item of information contained in the information disclosure statement was known to any individual designated in 37 CFR 1.56(c) more than three months prior to the filing of the information disclosure statement. See 37 CFR 1.97(e)(2).

- See attached certification statement.
- The fee set forth in 37 CFR 1.17 (p) has been submitted herewith.
- A certification statement is not submitted herewith.

SIGNATURE

A signature of the applicant or representative is required in accordance with CFR 1.33, 10.18. Please see CFR 1.4(d) for the form of the signature.

Signature	/David S. Bir/	Date (YYYY-MM-DD)	2015-10-01
Name/Print	David S. Bir	Registration Number	38383

This collection of information is required by 37 CFR 1.97 and 1.98. The information is required to obtain or retain a benefit by the public which is to file (and by the USPTO to process) an application. Confidentiality is governed by 35 U.S.C. 122 and 37 CFR 1.14. This collection is estimated to take 1 hour to complete, including gathering, preparing and submitting the completed application form to the USPTO. Time will vary depending upon the individual case. Any comments on the amount of time you require to complete this form and/or suggestions for reducing this burden, should be sent to the Chief Information Officer, U.S. Patent and Trademark Office, U.S. Department of Commerce, P.O. Box 1450, Alexandria, VA 22313-1450. **DO NOT SEND FEES OR COMPLETED FORMS TO THIS ADDRESS. SEND TO: Commissioner for Patents, P.O. Box 1450, Alexandria, VA 22313-1450.**

Privacy Act Statement

The Privacy Act of 1974 (P.L. 93-579) requires that you be given certain information in connection with your submission of the attached form related to a patent application or patent. Accordingly, pursuant to the requirements of the Act, please be advised that: (1) the general authority for the collection of this information is 35 U.S.C. 2(b)(2); (2) furnishing of the information solicited is voluntary; and (3) the principal purpose for which the information is used by the U.S. Patent and Trademark Office is to process and/or examine your submission related to a patent application or patent. If you do not furnish the requested information, the U.S. Patent and Trademark Office may not be able to process and/or examine your submission, which may result in termination of proceedings or abandonment of the application or expiration of the patent.

The information provided by you in this form will be subject to the following routine uses:

1. The information on this form will be treated confidentially to the extent allowed under the Freedom of Information Act (5 U.S.C. 552) and the Privacy Act (5 U.S.C. 552a). Records from this system of records may be disclosed to the Department of Justice to determine whether the Freedom of Information Act requires disclosure of these records.
2. A record from this system of records may be disclosed, as a routine use, in the course of presenting evidence to a court, magistrate, or administrative tribunal, including disclosures to opposing counsel in the course of settlement negotiations.
3. A record in this system of records may be disclosed, as a routine use, to a Member of Congress submitting a request involving an individual, to whom the record pertains, when the individual has requested assistance from the Member with respect to the subject matter of the record.
4. A record in this system of records may be disclosed, as a routine use, to a contractor of the Agency having need for the information in order to perform a contract. Recipients of information shall be required to comply with the requirements of the Privacy Act of 1974, as amended, pursuant to 5 U.S.C. 552a(m).
5. A record related to an International Application filed under the Patent Cooperation Treaty in this system of records may be disclosed, as a routine use, to the International Bureau of the World Intellectual Property Organization, pursuant to the Patent Cooperation Treaty.
6. A record in this system of records may be disclosed, as a routine use, to another federal agency for purposes of National Security review (35 U.S.C. 181) and for review pursuant to the Atomic Energy Act (42 U.S.C. 218(c)).
7. A record from this system of records may be disclosed, as a routine use, to the Administrator, General Services, or his/her designee, during an inspection of records conducted by GSA as part of that agency's responsibility to recommend improvements in records management practices and programs, under authority of 44 U.S.C. 2904 and 2906. Such disclosure shall be made in accordance with the GSA regulations governing inspection of records for this purpose, and any other relevant (i.e., GSA or Commerce) directive. Such disclosure shall not be used to make determinations about individuals.
8. A record from this system of records may be disclosed, as a routine use, to the public after either publication of the application pursuant to 35 U.S.C. 122(b) or issuance of a patent pursuant to 35 U.S.C. 151. Further, a record may be disclosed, subject to the limitations of 37 CFR 1.14, as a routine use, to the public if the record was filed in an application which became abandoned or in which the proceedings were terminated and which application is referenced by either a published application, an application open to public inspections or an issued patent.
9. A record from this system of records may be disclosed, as a routine use, to a Federal, State, or local law enforcement agency, if the USPTO becomes aware of a violation or potential violation of law or regulation.

Receipt date: 10/06/2015

14875709 - GAI: 2884

Doc code: IDS

Pat. Sec. 101-10

Doc description: Information Disclosure Statement (IDS) Filed

Approved for use through 07/31/2012. OMB 0651-0031

U.S. Patent and Trademark Office; U.S. DEPARTMENT OF COMMERCE

Under the Paperwork Reduction Act of 1995, no persons are required to respond to a collection of information unless it contains a valid OMB control number.

INFORMATION DISCLOSURE STATEMENT BY APPLICANT (Not for submission under 37 CFR 1.99)	Application Number		
	Filing Date		
	First Named Inventor	Mohammed N. ISLAM	
	Art Unit		
	Examiner Name		
	Attorney Docket Number	OMNI 0105 PUSP1	

U.S.PATENTS						Remove
Examiner Initial*	Cite No	Patent Number	Kind Code ¹	Issue Date	Name of Patentee or Applicant of cited Document	Pages,Columns,Lines where Relevant Passages or Relevant Figures Appear
	1	7787503	B2	2010-08-31	WADSWORTH	
	2	7800818	B2	2010-09-21	MATTSSON	
	3	8000574	B2	2011-08-16	BUCHTER	
	4	6611643	B2	2003-08-26	BIRK	

If you wish to add additional U.S. Patent citation information please click the Add button. Add

U.S.PATENT APPLICATION PUBLICATIONS						Remove
Examiner Initial*	Cite No	Publication Number	Kind Code ¹	Publication Date	Name of Patentee or Applicant of cited Document	Pages,Columns,Lines where Relevant Passages or Relevant Figures Appear
	1					

If you wish to add additional U.S. Published Application citation information please click the Add button. Add

FOREIGN PATENT DOCUMENTS								Remove
Examiner Initial*	Cite No	Foreign Document Number ³	Country Code ² i	Kind Code ⁴	Publication Date	Name of Patentee or Applicant of cited Document	Pages,Columns,Lines where Relevant Passages or Relevant Figures Appear	T ⁵

ALL REFERENCES CONSIDERED EXCEPT WHERE LINED THROUGH. /A.F./

INFORMATION DISCLOSURE STATEMENT BY APPLICANT (Not for submission under 37 CFR 1.99)	Application Number		14875709 - GAU: 2884	
	Filing Date			
	First Named Inventor	Mohammed N. ISLAM		
	Art Unit			
	Examiner Name			
	Attorney Docket Number		OMNI 0105 PUSP1	

	1								<input type="checkbox"/>
--	---	--	--	--	--	--	--	--	--------------------------

If you wish to add additional Foreign Patent Document citation information please click the Add button **Add**

NON-PATENT LITERATURE DOCUMENTS

Remove

Examiner Initials*	Cite No	Include name of the author (in CAPITAL LETTERS), title of the article (when appropriate), title of the item (book, magazine, journal, serial, symposium, catalog, etc), date, pages(s), volume-issue number(s), publisher, city and/or country where published.	T ⁵
	1	SUN, Y., C.F. Booker, S. Kumari, R.N. Day, M. Davidson, A. Periasamy, "Characterization of an orange acceptor fluorescent protein for sensitized spectral fluorescence resonant energy transfer microscopy using a white-light laser," Journal of Biomedical Optics, Vol. 14, no. 5, paper 054009 (2009).	<input type="checkbox"/>
	2	BORLINGHAUS, R., "Colours Count: how the challenge of fluorescence was solved in confocal microscopy," in Modern Research and Educational Topics in Microscopy, A. Mendez-Vilas and J. Diaz, eds, pp. 890-899, Formatex (2007)	<input type="checkbox"/>
	3	BORLINGHAUS, R., "The White Confocal: Continuous Spectral Tuning in Excitation and Emission," in Optical Fluorescence Microscopy, A. Diaspro (Ed), Chapter 2, pp. 37-54, ISBN 978-3-642-15174-3, Springer-Verlag, Berlin (2011).	<input type="checkbox"/>
	4	BORLINGHAUS, R.T., L. Kuschel, "White Light Laser: The Ultimate Source for Confocal Microscopy," http://www.leica-microsystems.com/science-lab/white-light-laser (June 27, 2012).	<input type="checkbox"/>
	5	ZIEGLER, U., A.G. Bittermann, M. Hoehli, "Introduction to Confocal Laser Scanning Microscopy (LEICA)," www.zmb.unizh.ch , May 29, 2013.	<input type="checkbox"/>
	6		<input type="checkbox"/>

If you wish to add additional non-patent literature document citation information please click the Add button **Add**

EXAMINER SIGNATURE

Examiner Signature	/Abra Fein/	Date Considered	05/13/2016
--------------------	-------------	-----------------	------------

*EXAMINER: Initial if reference considered, whether or not citation is in conformance with MPEP 609. Draw line through a citation if not in conformance and not considered. Include copy of this form with next communication to applicant.

INFORMATION DISCLOSURE STATEMENT BY APPLICANT (Not for submission under 37 CFR 1.99)	Application Number		14875709 - GAU: 2884
	Filing Date		
	First Named Inventor	Mohammed N. ISLAM	
	Art Unit		
	Examiner Name		
	Attorney Docket Number	OMNI 0105 PUSP1	

¹ See Kind Codes of USPTO Patent Documents at www.USPTO.GOV or MPEP 901.04. ² Enter office that issued the document, by the two-letter code (WIPO Standard ST.3). ³ For Japanese patent documents, the indication of the year of the reign of the Emperor must precede the serial number of the patent document. ⁴ Kind of document by the appropriate symbols as indicated on the document under WIPO Standard ST.16 if possible. ⁵ Applicant is to place a check mark here if English language translation is attached.

INFORMATION DISCLOSURE STATEMENT BY APPLICANT (Not for submission under 37 CFR 1.99)	Application Number		14875709 - GAU: 2884	
	Filing Date			
	First Named Inventor	Mohammed N. ISLAM		
	Art Unit			
	Examiner Name			
	Attorney Docket Number		OMNI 0105 PUSP1	

CERTIFICATION STATEMENT

Please see 37 CFR 1.97 and 1.98 to make the appropriate selection(s):

That each item of information contained in the information disclosure statement was first cited in any communication from a foreign patent office in a counterpart foreign application not more than three months prior to the filing of the information disclosure statement. See 37 CFR 1.97(e)(1).

OR

That no item of information contained in the information disclosure statement was cited in a communication from a foreign patent office in a counterpart foreign application, and, to the knowledge of the person signing the certification after making reasonable inquiry, no item of information contained in the information disclosure statement was known to any individual designated in 37 CFR 1.56(c) more than three months prior to the filing of the information disclosure statement. See 37 CFR 1.97(e)(2).

- See attached certification statement.
- The fee set forth in 37 CFR 1.17 (p) has been submitted herewith.
- A certification statement is not submitted herewith.

SIGNATURE

A signature of the applicant or representative is required in accordance with CFR 1.33, 10.18. Please see CFR 1.4(d) for the form of the signature.

Signature	/David S. Bir/	Date (YYYY-MM-DD)	2015-10-01
Name/Print	David S. Bir	Registration Number	38383

This collection of information is required by 37 CFR 1.97 and 1.98. The information is required to obtain or retain a benefit by the public which is to file (and by the USPTO to process) an application. Confidentiality is governed by 35 U.S.C. 122 and 37 CFR 1.14. This collection is estimated to take 1 hour to complete, including gathering, preparing and submitting the completed application form to the USPTO. Time will vary depending upon the individual case. Any comments on the amount of time you require to complete this form and/or suggestions for reducing this burden, should be sent to the Chief Information Officer, U.S. Patent and Trademark Office, U.S. Department of Commerce, P.O. Box 1450, Alexandria, VA 22313-1450. **DO NOT SEND FEES OR COMPLETED FORMS TO THIS ADDRESS. SEND TO: Commissioner for Patents, P.O. Box 1450, Alexandria, VA 22313-1450.**

Privacy Act Statement

The Privacy Act of 1974 (P.L. 93-579) requires that you be given certain information in connection with your submission of the attached form related to a patent application or patent. Accordingly, pursuant to the requirements of the Act, please be advised that: (1) the general authority for the collection of this information is 35 U.S.C. 2(b)(2); (2) furnishing of the information solicited is voluntary; and (3) the principal purpose for which the information is used by the U.S. Patent and Trademark Office is to process and/or examine your submission related to a patent application or patent. If you do not furnish the requested information, the U.S. Patent and Trademark Office may not be able to process and/or examine your submission, which may result in termination of proceedings or abandonment of the application or expiration of the patent.

The information provided by you in this form will be subject to the following routine uses:

1. The information on this form will be treated confidentially to the extent allowed under the Freedom of Information Act (5 U.S.C. 552) and the Privacy Act (5 U.S.C. 552a). Records from this system of records may be disclosed to the Department of Justice to determine whether the Freedom of Information Act requires disclosure of these records.
2. A record from this system of records may be disclosed, as a routine use, in the course of presenting evidence to a court, magistrate, or administrative tribunal, including disclosures to opposing counsel in the course of settlement negotiations.
3. A record in this system of records may be disclosed, as a routine use, to a Member of Congress submitting a request involving an individual, to whom the record pertains, when the individual has requested assistance from the Member with respect to the subject matter of the record.
4. A record in this system of records may be disclosed, as a routine use, to a contractor of the Agency having need for the information in order to perform a contract. Recipients of information shall be required to comply with the requirements of the Privacy Act of 1974, as amended, pursuant to 5 U.S.C. 552a(m).
5. A record related to an International Application filed under the Patent Cooperation Treaty in this system of records may be disclosed, as a routine use, to the International Bureau of the World Intellectual Property Organization, pursuant to the Patent Cooperation Treaty.
6. A record in this system of records may be disclosed, as a routine use, to another federal agency for purposes of National Security review (35 U.S.C. 181) and for review pursuant to the Atomic Energy Act (42 U.S.C. 218(c)).
7. A record from this system of records may be disclosed, as a routine use, to the Administrator, General Services, or his/her designee, during an inspection of records conducted by GSA as part of that agency's responsibility to recommend improvements in records management practices and programs, under authority of 44 U.S.C. 2904 and 2906. Such disclosure shall be made in accordance with the GSA regulations governing inspection of records for this purpose, and any other relevant (i.e., GSA or Commerce) directive. Such disclosure shall not be used to make determinations about individuals.
8. A record from this system of records may be disclosed, as a routine use, to the public after either publication of the application pursuant to 35 U.S.C. 122(b) or issuance of a patent pursuant to 35 U.S.C. 151. Further, a record may be disclosed, subject to the limitations of 37 CFR 1.14, as a routine use, to the public if the record was filed in an application which became abandoned or in which the proceedings were terminated and which application is referenced by either a published application, an application open to public inspections or an issued patent.
9. A record from this system of records may be disclosed, as a routine use, to a Federal, State, or local law enforcement agency, if the USPTO becomes aware of a violation or potential violation of law or regulation.

Search Notes 	Application/Control No. 14875709	Applicant(s)/Patent Under Reexamination ISLAM, MOHAMMED N.
	Examiner ABRA FEIN	Art Unit 2884

CPC- SEARCHED		
Symbol	Date	Examiner
G01N33/15, G01N21/359, G01N33/49	5/13/2016	/A.F./

CPC COMBINATION SETS - SEARCHED		
Symbol	Date	Examiner

US CLASSIFICATION SEARCHED			
Class	Subclass	Date	Examiner
250	338.4	5/13/2016	/A.F./

SEARCH NOTES		
Search Notes	Date	Examiner
Inventor Name Search	5/13/2016	/A.F./
EAST text search	5/13/2016	/A.F./
Class 250 text search	5/13/2016	/A.F./
Consultation with Yara Green (class 250)	5/17/2016	/A.F./

INTERFERENCE SEARCH			
US Class/ CPC Symbol	US Subclass / CPC Group	Date	Examiner

/A.F./ Examiner.Art Unit 2884	
----------------------------------	--



UNITED STATES PATENT AND TRADEMARK OFFICE

UNITED STATES DEPARTMENT OF COMMERCE
 United States Patent and Trademark Office
 Address: COMMISSIONER FOR PATENTS
 P.O. Box 1450
 Alexandria, Virginia 22313-1450
 www.uspto.gov

BIB DATA SHEET

CONFIRMATION NO. 7496

SERIAL NUMBER 14/875,709	FILING or 371(c) DATE 10/06/2015 RULE	CLASS 250	GROUP ART UNIT 2884	ATTORNEY DOCKET NO. OMNI 0105 PUSP1	
APPLICANTS OMNI MEDSCI, INC., Ann Arbor, MI; INVENTORS Mohammed N. Islam, Ann Arbor, MI; ** CONTINUING DATA ***** This application is a CON of 14/108,986 12/17/2013 PAT 9164032 which claims benefit of 61/747,487 12/31/2012 ** FOREIGN APPLICATIONS ***** ** IF REQUIRED, FOREIGN FILING LICENSE GRANTED *** SMALL ENTITY ** 10/22/2015					
Foreign Priority claimed <input type="checkbox"/> Yes <input checked="" type="checkbox"/> No 35 USC 119(a-d) conditions met <input type="checkbox"/> Yes <input checked="" type="checkbox"/> No Verified and Acknowledged <u>/ABRA S FEIN/</u> Examiner's Signature	<input type="checkbox"/> Met after Allowance Initials _____	STATE OR COUNTRY MI	SHEETS DRAWINGS 26	TOTAL CLAIMS 20	INDEPENDENT CLAIMS 3
ADDRESS Brooks, Kushman P.C./Cheetah Omni MedSci 1000 Town Center Twenty Second Floor Southfield, MI 48075 UNITED STATES					
TITLE SHORT-WAVE INFRARED SUPER-CONTINUUM LASERS FOR DETECTING COUNTERFEIT OR ILLICIT DRUGS AND PHARMACEUTICAL PROCESS CONTROL					
FILING FEE RECEIVED 730	FEES: Authority has been given in Paper No. _____ to charge/credit DEPOSIT ACCOUNT No. _____ for following:		<input type="checkbox"/> All Fees <input type="checkbox"/> 1.16 Fees (Filing) <input type="checkbox"/> 1.17 Fees (Processing Ext. of time) <input type="checkbox"/> 1.18 Fees (Issue) <input type="checkbox"/> Other _____ <input type="checkbox"/> Credit		

Receipt date: 10/06/2015

14875709 - GAI: 2884

Doc code: IDS

Doc description: Information Disclosure Statement (IDS) Filed

Approved for use through 07/31/2012. OMB 0651-0031
U.S. Patent and Trademark Office; U.S. DEPARTMENT OF COMMERCE

Under the Paperwork Reduction Act of 1995, no persons are required to respond to a collection of information unless it contains a valid OMB control number.

INFORMATION DISCLOSURE STATEMENT BY APPLICANT (Not for submission under 37 CFR 1.99)	Application Number		
	Filing Date		
	First Named Inventor	Mohammed N. ISLAM	
	Art Unit		
	Examiner Name		
	Attorney Docket Number	OMNI 0105 PUSP1	

U.S.PATENTS						Remove
Examiner Initial*	Cite No	Patent Number	Kind Code ¹	Issue Date	Name of Patentee or Applicant of cited Document	Pages,Columns,Lines where Relevant Passages or Relevant Figures Appear
	1					

If you wish to add additional U.S. Patent citation information please click the Add button. Add

U.S.PATENT APPLICATION PUBLICATIONS						Remove
Examiner Initial*	Cite No	Publication Number	Kind Code ¹	Publication Date	Name of Patentee or Applicant of cited Document	Pages,Columns,Lines where Relevant Passages or Relevant Figures Appear
	1					

If you wish to add additional U.S. Published Application citation information please click the Add button. Add

FOREIGN PATENT DOCUMENTS								Remove
Examiner Initial*	Cite No	Foreign Document Number ³	Country Code ²	Kind Code ⁴	Publication Date	Name of Patentee or Applicant of cited Document	Pages,Columns,Lines where Relevant Passages or Relevant Figures Appear	T ⁵
	1							<input type="checkbox"/>

If you wish to add additional Foreign Patent Document citation information please click the Add button Add

NON-PATENT LITERATURE DOCUMENTS				Remove
Examiner Initials*	Cite No	Include name of the author (in CAPITAL LETTERS), title of the article (when appropriate), title of the item (book, magazine, journal, serial, symposium, catalog, etc), date, pages(s), volume-issue number(s), publisher, city and/or country where published.		T ⁵

INFORMATION DISCLOSURE STATEMENT BY APPLICANT (Not for submission under 37 CFR 1.99)	Application Number		14875709 - GAU: 2884
	Filing Date		
	First Named Inventor	Mohammed N. ISLAM	
	Art Unit		
	Examiner Name		
	Attorney Docket Number		OMNI 0105 PUSP1

1	Pan, Yingtian, et al., "Hand-held arthroscopic optical coherence tomography for in vivo high-resolution imaging of articular cartilage", Journal of Biomedical Optics 8(4), October 2003, pages 648-654.	<input type="checkbox"/>
2	Xie, Tuqiang, et al., "Endoscopic optical coherence tomography with a modified microelectromechanical systems mirror for detection of bladder cancers", APPLIED OPTICS, Vol. 42, No. 31, November 1, 2003, pages 6422-6426.	<input type="checkbox"/>
3	Dubois, A., et al., "Three-dimensional cellular-level imaging using full-field optical coherence tomography", Physics in Medicine and Biology, Phys. Med. Biol. 49, 2004, pages 1227-1234.	<input type="checkbox"/>
4	Park, Jesung, et al., "Analysis of birefringent image in the retinal nerve fiber layer by polarization sensitive optical coherence tomography", Ophthalmic Technologies XIV, Proceedings of SPIE, Vol. 5314, 2004, pages 188-194.	<input type="checkbox"/>
5	Unterhuber, A., et al., "Advances in broad bandwidth light sources for ultrahigh resolution optical coherence tomography", Physics in Medicine and Biology, Phys. Med. Biol. 49, 2004, pages 1235-1246.	<input type="checkbox"/>
6	Drexler, Wolfgang, "Ultrahigh-resolution optical coherence tomography", Journal of Biomedical Optics, Vol. 9, No. 1, January/February 2004, pages 47-74.	<input type="checkbox"/>
7	Schmitt, Joseph, et al., "Intravascular Optical Coherence Tomography Opens a Window Onto Coronary Artery Disease", Optics & Photonics News, February 2004, pages 20-25.	<input type="checkbox"/>
8	Nassif, N.A., et al., "In vivo high-resolution video-rate spectral-domain optical coherence tomography of the human retina and optic nerve", OPTICS EXPRESS, Vol. 12, No. 3, February 9, 2004, pages 367-376.	<input type="checkbox"/>
9	Choi, Seung-Ho, et al., "Observation of Optical Precursors in Water", Physical Review Letters, Volume 92, Number 19, May 14, 2004, pages 193903-1-193903-3.	<input type="checkbox"/>
10	Pierce, Mark C., et al., "Advances in Optical Coherence Tomography imaging for Dermatology", Optical Coherence Tomography Advances, The Journal of Investigative Dermatology, September 3, 2004, pages 458-463.	<input type="checkbox"/>
11	"State-Specific Trends in Chronic Kidney Failure - United States, 1990-2001", Morbidity and Mortality Weekly Report, Department of Health and Human Services Centers for Disease Control and Prevention, Vol. 53, No. 39, copied from internet: file://C:\Documents and Settings\eturl\\Desktop\State-Specific Trends in Chronic Kidney ... 2/12/10, October 8, 2004, pages 918-920.	<input type="checkbox"/>

INFORMATION DISCLOSURE STATEMENT BY APPLICANT (Not for submission under 37 CFR 1.99)	Receipt date: 10/06/2015	Application Number	14875709 - GAU: 2884
		Filing Date	
		First Named Inventor	Mohammed N. ISLAM
		Art Unit	
		Examiner Name	
		Attorney Docket Number	OMNI 0105 PUSP1

12	I.B. Ads, A.A.E. Wagie, N.B. Mariun, A.B.E. Jammal, "An Internet-based blood pressure monitoring system for patients," Journal of Telemedicine and Telecare, 2001, pp. 51-53	<input type="checkbox"/>
13	R.H. Istepanian, B. Woodward, P.A. Bales, S. Chen, B. Luk, "The comparative performance of mobile telemedical systems based on the IS-54 and GSM cellular telephone standards," Journal of Telemedicine and Telecare, 1999, pp. 97-104	<input type="checkbox"/>
14	Shaw, et al, IR Supercontinuum Generation in As-Se Photonic Crystal Fiber, Optical Society of America, Copyright 2005, 3 pages	<input type="checkbox"/>
15	PCT/US06/44451, Notification of Transmittal of the International Search Report and the Written Opinion of the International Searching Authority, or the Declaration, November 29, 2007, 12 pages	<input type="checkbox"/>
16	G.S. Edwards et al., "Free-electron-laser-based biophysical and biomedical instrumentation," American Institute of Physics, Vol. 74, No. 7, July 2003, pp. 3207-3245	<input type="checkbox"/>
17	Computer Motion, Inc., "501(k) Summary -ZEUS® MicroWrist™ Surgical System and Accessories," September 24, 2002, 6 pages	<input type="checkbox"/>
18	Computer Motion, Inc. "HERMES™ O.R. Control Center - 510(k) Summary of Safety and Effectiveness," October 11, 2002, 5 pages	<input type="checkbox"/>
19	K.M. Joos, et al. "Optic Nerve Sheath Fenestration with a Novel Wavelength Produced by the Free Electron Laser (FEL)," Lasers in Surgery and Medicine, 27: 2000,191-205	<input type="checkbox"/>
20	J. Sanghera, I. Aggarwal, "IR Fiber Optics at NRL," undated, 10 pages	<input type="checkbox"/>
21	J. Sanghera, L.B. Shaw, I.D. Aggarwal, "Applications of chalcogenide glass optical fibers," Academic of Science, 2003, pp. 1-11	<input type="checkbox"/>
22	B. Rigas, P.T.T. Wong, "Human Colon Adenocarcinoma Cell Lines Display Infrared Spectroscopic Features," Cancer Research, January 1, 1992, pp. 84-88	<input type="checkbox"/>

Receipt date: 10/06/2015 INFORMATION DISCLOSURE STATEMENT BY APPLICANT (Not for submission under 37 CFR 1.99)	Application Number		14875709 - GAU: 2884
	Filing Date		
	First Named Inventor	Mohammed N. ISLAM	
	Art Unit		
	Examiner Name		
	Attorney Docket Number	OMNI 0105 PUSP1	

23	G. Edwards, et al., "Comparison of OPA and Mark-III FEL for Tissue Ablation at 6.45 Microns," Department of Physics and Free Electron Laser Laboratory, Duke University, 2002, 7 pages	<input type="checkbox"/>
24	Glenn Edwards, "Biomedical and potential clinical applications for pulsed lasers operating near 6.45 um," Society of Photo-Optical Instrumentation Engineers, 1995, 2 pages	<input type="checkbox"/>
25	PASSAT, "Solid-State Lasers and Optical Components," July 14, 2003, 5 pages	<input type="checkbox"/>
26	P.A. Thielen and L.B. Shaw, et al., "Small-core As-Se fiber for Raman amplification," OPTICS LETI-ERS, Vol. 28, No. 16, August 15, 2003, 3 pages	<input type="checkbox"/>
27	R.Rox Anderson, et al., "Selective Photothermolysis: Precise Microsurgery by Selective Absorption of Pulsed Radiation," Department of Dermatology, Harvard Medical School, Science, Vol. 220, April 29, 1983, 4 pages	<input type="checkbox"/>
28	U.S. Appln. Serial No. 10/652,276, "System and Method for Voice Control of Medical devices," by Mohammed N. Islam, abandoned (074036.0129) Date filed: August 29, 2003	<input type="checkbox"/>
29	U.S. Appln. Serial No. 10/757,341, "System and Method for Voice Control of Medical devices," by Mohammed N. Islam, issued (074036.0132) Date filed: January 13, 2004	<input type="checkbox"/>
30	U.S. Appln. Serial No. 12/206432, "System and Method for Voice Control of Medical Devices," by Mohammed N. Islam, pending (074036.0154) Date filed: September 8, 2008	<input type="checkbox"/>
31	U.S. Patent and Trademark Office, Office Action for USSN 12/206,432, filed 09/08/2008, Mohammed N, Islam, Attorney Docket No. 074036.0154, Date filed: March 12, 2009	<input type="checkbox"/>
32	U.S. Patent and Trademark Office, Notice of Allowance and Fee(s) Due for USSN 12/206,432, filed 09/08/2008, Mohammed N. Islam, Attorney Docket No. 074036.0154, Date filed: August 28, 2009	<input type="checkbox"/>

If you wish to add additional non-patent literature document citation information please click the Add button [Add](#)

INFORMATION DISCLOSURE STATEMENT BY APPLICANT (Not for submission under 37 CFR 1.99)	Application Number		14875709 - GAU: 2884	
	Filing Date			
	First Named Inventor	Mohammed N. ISLAM		
	Art Unit			
	Examiner Name			
	Attorney Docket Number		OMNI 0105 PUSP1	

EXAMINER SIGNATURE			
Examiner Signature	/Abra Fein/	Date Considered	05/13/2016

*EXAMINER: Initial if reference considered, whether or not citation is in conformance with MPEP 609. Draw line through a citation if not in conformance and not considered. Include copy of this form with next communication to applicant.

¹ See Kind Codes of USPTO Patent Documents at www.USPTO.GOV or MPEP 901.04. ² Enter office that issued the document, by the two-letter code (WIPO Standard ST.3). ³ For Japanese patent documents, the indication of the year of the reign of the Emperor must precede the serial number of the patent document. ⁴ Kind of document by the appropriate symbols as indicated on the document under WIPO Standard ST.16 if possible. ⁵ Applicant is to place a check mark here if English language translation is attached.

INFORMATION DISCLOSURE STATEMENT BY APPLICANT (Not for submission under 37 CFR 1.99)	Application Number		14875709 - GAU: 2884	
	Filing Date			
	First Named Inventor	Mohammed N. ISLAM		
	Art Unit			
	Examiner Name			
	Attorney Docket Number		OMNI 0105 PUSP1	

CERTIFICATION STATEMENT

Please see 37 CFR 1.97 and 1.98 to make the appropriate selection(s):

That each item of information contained in the information disclosure statement was first cited in any communication from a foreign patent office in a counterpart foreign application not more than three months prior to the filing of the information disclosure statement. See 37 CFR 1.97(e)(1).

OR

That no item of information contained in the information disclosure statement was cited in a communication from a foreign patent office in a counterpart foreign application, and, to the knowledge of the person signing the certification after making reasonable inquiry, no item of information contained in the information disclosure statement was known to any individual designated in 37 CFR 1.56(c) more than three months prior to the filing of the information disclosure statement. See 37 CFR 1.97(e)(2).

- See attached certification statement.
- The fee set forth in 37 CFR 1.17 (p) has been submitted herewith.
- A certification statement is not submitted herewith.

SIGNATURE

A signature of the applicant or representative is required in accordance with CFR 1.33, 10.18. Please see CFR 1.4(d) for the form of the signature.

Signature	/David S. Bir/	Date (YYYY-MM-DD)	2015-10-01
Name/Print	David S. Bir	Registration Number	38383

This collection of information is required by 37 CFR 1.97 and 1.98. The information is required to obtain or retain a benefit by the public which is to file (and by the USPTO to process) an application. Confidentiality is governed by 35 U.S.C. 122 and 37 CFR 1.14. This collection is estimated to take 1 hour to complete, including gathering, preparing and submitting the completed application form to the USPTO. Time will vary depending upon the individual case. Any comments on the amount of time you require to complete this form and/or suggestions for reducing this burden, should be sent to the Chief Information Officer, U.S. Patent and Trademark Office, U.S. Department of Commerce, P.O. Box 1450, Alexandria, VA 22313-1450. **DO NOT SEND FEES OR COMPLETED FORMS TO THIS ADDRESS. SEND TO: Commissioner for Patents, P.O. Box 1450, Alexandria, VA 22313-1450.**

Privacy Act Statement

The Privacy Act of 1974 (P.L. 93-579) requires that you be given certain information in connection with your submission of the attached form related to a patent application or patent. Accordingly, pursuant to the requirements of the Act, please be advised that: (1) the general authority for the collection of this information is 35 U.S.C. 2(b)(2); (2) furnishing of the information solicited is voluntary; and (3) the principal purpose for which the information is used by the U.S. Patent and Trademark Office is to process and/or examine your submission related to a patent application or patent. If you do not furnish the requested information, the U.S. Patent and Trademark Office may not be able to process and/or examine your submission, which may result in termination of proceedings or abandonment of the application or expiration of the patent.

The information provided by you in this form will be subject to the following routine uses:

1. The information on this form will be treated confidentially to the extent allowed under the Freedom of Information Act (5 U.S.C. 552) and the Privacy Act (5 U.S.C. 552a). Records from this system of records may be disclosed to the Department of Justice to determine whether the Freedom of Information Act requires disclosure of these records.
2. A record from this system of records may be disclosed, as a routine use, in the course of presenting evidence to a court, magistrate, or administrative tribunal, including disclosures to opposing counsel in the course of settlement negotiations.
3. A record in this system of records may be disclosed, as a routine use, to a Member of Congress submitting a request involving an individual, to whom the record pertains, when the individual has requested assistance from the Member with respect to the subject matter of the record.
4. A record in this system of records may be disclosed, as a routine use, to a contractor of the Agency having need for the information in order to perform a contract. Recipients of information shall be required to comply with the requirements of the Privacy Act of 1974, as amended, pursuant to 5 U.S.C. 552a(m).
5. A record related to an International Application filed under the Patent Cooperation Treaty in this system of records may be disclosed, as a routine use, to the International Bureau of the World Intellectual Property Organization, pursuant to the Patent Cooperation Treaty.
6. A record in this system of records may be disclosed, as a routine use, to another federal agency for purposes of National Security review (35 U.S.C. 181) and for review pursuant to the Atomic Energy Act (42 U.S.C. 218(c)).
7. A record from this system of records may be disclosed, as a routine use, to the Administrator, General Services, or his/her designee, during an inspection of records conducted by GSA as part of that agency's responsibility to recommend improvements in records management practices and programs, under authority of 44 U.S.C. 2904 and 2906. Such disclosure shall be made in accordance with the GSA regulations governing inspection of records for this purpose, and any other relevant (i.e., GSA or Commerce) directive. Such disclosure shall not be used to make determinations about individuals.
8. A record from this system of records may be disclosed, as a routine use, to the public after either publication of the application pursuant to 35 U.S.C. 122(b) or issuance of a patent pursuant to 35 U.S.C. 151. Further, a record may be disclosed, subject to the limitations of 37 CFR 1.14, as a routine use, to the public if the record was filed in an application which became abandoned or in which the proceedings were terminated and which application is referenced by either a published application, an application open to public inspections or an issued patent.
9. A record from this system of records may be disclosed, as a routine use, to a Federal, State, or local law enforcement agency, if the USPTO becomes aware of a violation or potential violation of law or regulation.

Receipt date: 10/06/2015

14875709 - GAI: 2884

Doc code: IDS

Doc description: Information Disclosure Statement (IDS) Filed

Approved for use through 07/31/2012. OMB 0651-0031
 U.S. Patent and Trademark Office; U.S. DEPARTMENT OF COMMERCE
 Under the Paperwork Reduction Act of 1995, no persons are required to respond to a collection of information unless it contains a valid OMB control number.

INFORMATION DISCLOSURE STATEMENT BY APPLICANT (Not for submission under 37 CFR 1.99)	Application Number		
	Filing Date		
	First Named Inventor	Mohammed N. ISLAM	
	Art Unit		
	Examiner Name		
	Attorney Docket Number	POWM 0105 PUSP1	

U.S.PATENTS						Remove
Examiner Initial*	Cite No	Patent Number	Kind Code ¹	Issue Date	Name of Patentee or Applicant of cited Document	Pages,Columns,Lines where Relevant Passages or Relevant Figures Appear
	1	8157730	B2	2012-04-17	LeBoeuf, et al.	
	2	8430310	B1	2013-04-30	Ho, et al.	
	3	8509882	B2	2013-08-13	Albert, et al.	
	4	8788002	B2	2014-07-22	LeBoeuf, et al.	
	5	8948832	B2	2015-02-03	Hong, et al.	

If you wish to add additional U.S. Patent citation information please click the Add button.

Add

U.S.PATENT APPLICATION PUBLICATIONS						Remove
Examiner Initial*	Cite No	Publication Number	Kind Code ¹	Publication Date	Name of Patentee or Applicant of cited Document	Pages,Columns,Lines where Relevant Passages or Relevant Figures Appear
	1	20080086318	A1	2008-04-10	Gilley, et al.	

INFORMATION DISCLOSURE STATEMENT BY APPLICANT (Not for submission under 37 CFR 1.99)	Application Number		14875709 - GAU: 2884	
	Filing Date			
	First Named Inventor	Mohammed N. ISLAM		
	Art Unit			
	Examiner Name			
	Attorney Docket Number		POWM 0105 PUSP1	

2	20090287067	A1	2009-11-19	Dorogusker, et al.	
3	20130281795	A1	2013-10-24	Varadan	
4	20140081100	A1	2014-03-20	Muhsin, et al.	
5	20150011851	A1	2015-01-08	Mehta, et al.	

If you wish to add additional U.S. Published Application citation information please click the Add button. **Add**

FOREIGN PATENT DOCUMENTS

Remove

Examiner Initial*	Cite No	Foreign Document Number ³	Country Code ² i	Kind Code ⁴	Publication Date	Name of Patentee or Applicant of cited Document	Pages, Columns, Lines where Relevant Passages or Relevant Figures Appear	T ⁵
	1	WO2013012938		A1	2013-01-24	Raskin, et al.		<input type="checkbox"/>
	2	WO2015084376		A1	2015-06-11	Han, et al.		<input type="checkbox"/>

If you wish to add additional Foreign Patent Document citation information please click the Add button **Add**

NON-PATENT LITERATURE DOCUMENTS

Remove

Examiner Initials*	Cite No	Include name of the author (in CAPITAL LETTERS), title of the article (when appropriate), title of the item (book, magazine, journal, serial, symposium, catalog, etc), date, pages(s), volume-issue number(s), publisher, city and/or country where published.	T ⁵
	1		<input type="checkbox"/>

If you wish to add additional non-patent literature document citation information please click the Add button **Add**

INFORMATION DISCLOSURE STATEMENT BY APPLICANT (Not for submission under 37 CFR 1.99)	Application Number		14875709 - GAU: 2884	
	Filing Date			
	First Named Inventor	Mohammed N. ISLAM		
	Art Unit			
	Examiner Name			
	Attorney Docket Number	POWM 0105 PUSP1		

EXAMINER SIGNATURE			
Examiner Signature	/Abra Fein/	Date Considered	05/13/2016

*EXAMINER: Initial if reference considered, whether or not citation is in conformance with MPEP 609. Draw line through a citation if not in conformance and not considered. Include copy of this form with next communication to applicant.

¹ See Kind Codes of USPTO Patent Documents at www.USPTO.GOV or MPEP 901.04. ² Enter office that issued the document, by the two-letter code (WIPO Standard ST.3). ³ For Japanese patent documents, the indication of the year of the reign of the Emperor must precede the serial number of the patent document. ⁴ Kind of document by the appropriate symbols as indicated on the document under WIPO Standard ST.16 if possible. ⁵ Applicant is to place a check mark here if English language translation is attached.

INFORMATION DISCLOSURE STATEMENT BY APPLICANT (Not for submission under 37 CFR 1.99)	Application Number		14875709 - GAU: 2884	
	Filing Date			
	First Named Inventor	Mohammed N. ISLAM		
	Art Unit			
	Examiner Name			
	Attorney Docket Number	POWM 0105 PUSP1		

CERTIFICATION STATEMENT

Please see 37 CFR 1.97 and 1.98 to make the appropriate selection(s):

That each item of information contained in the information disclosure statement was first cited in any communication from a foreign patent office in a counterpart foreign application not more than three months prior to the filing of the information disclosure statement. See 37 CFR 1.97(e)(1).

OR

That no item of information contained in the information disclosure statement was cited in a communication from a foreign patent office in a counterpart foreign application, and, to the knowledge of the person signing the certification after making reasonable inquiry, no item of information contained in the information disclosure statement was known to any individual designated in 37 CFR 1.56(c) more than three months prior to the filing of the information disclosure statement. See 37 CFR 1.97(e)(2).

- See attached certification statement.
- The fee set forth in 37 CFR 1.17 (p) has been submitted herewith.
- A certification statement is not submitted herewith.

SIGNATURE

A signature of the applicant or representative is required in accordance with CFR 1.33, 10.18. Please see CFR 1.4(d) for the form of the signature.

Signature	/David S. Bir/	Date (YYYY-MM-DD)	2015-10-01
Name/Print	David S. Bir	Registration Number	38383

This collection of information is required by 37 CFR 1.97 and 1.98. The information is required to obtain or retain a benefit by the public which is to file (and by the USPTO to process) an application. Confidentiality is governed by 35 U.S.C. 122 and 37 CFR 1.14. This collection is estimated to take 1 hour to complete, including gathering, preparing and submitting the completed application form to the USPTO. Time will vary depending upon the individual case. Any comments on the amount of time you require to complete this form and/or suggestions for reducing this burden, should be sent to the Chief Information Officer, U.S. Patent and Trademark Office, U.S. Department of Commerce, P.O. Box 1450, Alexandria, VA 22313-1450. **DO NOT SEND FEES OR COMPLETED FORMS TO THIS ADDRESS. SEND TO: Commissioner for Patents, P.O. Box 1450, Alexandria, VA 22313-1450.**

Privacy Act Statement

The Privacy Act of 1974 (P.L. 93-579) requires that you be given certain information in connection with your submission of the attached form related to a patent application or patent. Accordingly, pursuant to the requirements of the Act, please be advised that: (1) the general authority for the collection of this information is 35 U.S.C. 2(b)(2); (2) furnishing of the information solicited is voluntary; and (3) the principal purpose for which the information is used by the U.S. Patent and Trademark Office is to process and/or examine your submission related to a patent application or patent. If you do not furnish the requested information, the U.S. Patent and Trademark Office may not be able to process and/or examine your submission, which may result in termination of proceedings or abandonment of the application or expiration of the patent.

The information provided by you in this form will be subject to the following routine uses:

1. The information on this form will be treated confidentially to the extent allowed under the Freedom of Information Act (5 U.S.C. 552) and the Privacy Act (5 U.S.C. 552a). Records from this system of records may be disclosed to the Department of Justice to determine whether the Freedom of Information Act requires disclosure of these records.
2. A record from this system of records may be disclosed, as a routine use, in the course of presenting evidence to a court, magistrate, or administrative tribunal, including disclosures to opposing counsel in the course of settlement negotiations.
3. A record in this system of records may be disclosed, as a routine use, to a Member of Congress submitting a request involving an individual, to whom the record pertains, when the individual has requested assistance from the Member with respect to the subject matter of the record.
4. A record in this system of records may be disclosed, as a routine use, to a contractor of the Agency having need for the information in order to perform a contract. Recipients of information shall be required to comply with the requirements of the Privacy Act of 1974, as amended, pursuant to 5 U.S.C. 552a(m).
5. A record related to an International Application filed under the Patent Cooperation Treaty in this system of records may be disclosed, as a routine use, to the International Bureau of the World Intellectual Property Organization, pursuant to the Patent Cooperation Treaty.
6. A record in this system of records may be disclosed, as a routine use, to another federal agency for purposes of National Security review (35 U.S.C. 181) and for review pursuant to the Atomic Energy Act (42 U.S.C. 218(c)).
7. A record from this system of records may be disclosed, as a routine use, to the Administrator, General Services, or his/her designee, during an inspection of records conducted by GSA as part of that agency's responsibility to recommend improvements in records management practices and programs, under authority of 44 U.S.C. 2904 and 2906. Such disclosure shall be made in accordance with the GSA regulations governing inspection of records for this purpose, and any other relevant (i.e., GSA or Commerce) directive. Such disclosure shall not be used to make determinations about individuals.
8. A record from this system of records may be disclosed, as a routine use, to the public after either publication of the application pursuant to 35 U.S.C. 122(b) or issuance of a patent pursuant to 35 U.S.C. 151. Further, a record may be disclosed, subject to the limitations of 37 CFR 1.14, as a routine use, to the public if the record was filed in an application which became abandoned or in which the proceedings were terminated and which application is referenced by either a published application, an application open to public inspections or an issued patent.
9. A record from this system of records may be disclosed, as a routine use, to a Federal, State, or local law enforcement agency, if the USPTO becomes aware of a violation or potential violation of law or regulation.

Receipt date: 10/06/2015

14875709 - GAI: 2884

Doc code: IDS

Doc description: Information Disclosure Statement (IDS) Filed

Approved for use through 07/31/2012. OMB 0651-0031
 U.S. Patent and Trademark Office; U.S. DEPARTMENT OF COMMERCE
 Under the Paperwork Reduction Act of 1995, no persons are required to respond to a collection of information unless it contains a valid OMB control number.

INFORMATION DISCLOSURE STATEMENT BY APPLICANT (Not for submission under 37 CFR 1.99)	Application Number		
	Filing Date		
	First Named Inventor	Mohammed N. ISLAM	
	Art Unit		
	Examiner Name		
	Attorney Docket Number	OMNI 0105 PUSP1	

U.S.PATENTS						Remove
Examiner Initial*	Cite No	Patent Number	Kind Code ¹	Issue Date	Name of Patentee or Applicant of cited Document	Pages,Columns,Lines where Relevant Passages or Relevant Figures Appear
	1	6246896	B1	2001-06-12	DUMOULIN	
	2	6285897	B1	2001-09-04	KILCOYNE	
	3	6847336	B1	2005-01-25	LEMELSON	

If you wish to add additional U.S. Patent citation information please click the Add button.

Add

U.S.PATENT APPLICATION PUBLICATIONS						Remove
Examiner Initial*	Cite No	Publication Number	Kind Code ¹	Publication Date	Name of Patentee or Applicant of cited Document	Pages,Columns,Lines where Relevant Passages or Relevant Figures Appear
	1					

If you wish to add additional U.S. Published Application citation information please click the Add button.

Add

FOREIGN PATENT DOCUMENTS								Remove
Examiner Initial*	Cite No	Foreign Document Number ³	Country Code ² i	Kind Code ⁴	Publication Date	Name of Patentee or Applicant of cited Document	Pages,Columns,Lines where Relevant Passages or Relevant Figures Appear	T ⁵
	1							<input type="checkbox"/>

ALL REFERENCES CONSIDERED EXCEPT WHERE LINED THROUGH. /A.F./

INFORMATION DISCLOSURE STATEMENT BY APPLICANT (Not for submission under 37 CFR 1.99)	Application Number		14875709 - GAU: 2884
	Filing Date		
	First Named Inventor	Mohammed N. ISLAM	
	Art Unit		
	Examiner Name		
	Attorney Docket Number		OMNI 0105 PUSP1

If you wish to add additional Foreign Patent Document citation information please click the Add button **Add**

NON-PATENT LITERATURE DOCUMENTS **Remove**

Examiner Initials*	Cite No	Include name of the author (in CAPITAL LETTERS), title of the article (when appropriate), title of the item (book, magazine, journal, serial, symposium, catalog, etc), date, pages(s), volume-issue number(s), publisher, city and/or country where published.	T ⁵
	1		<input type="checkbox"/>

If you wish to add additional non-patent literature document citation information please click the Add button **Add**

EXAMINER SIGNATURE

Examiner Signature	/Abra Fein/	Date Considered	05/13/2016
--------------------	-------------	-----------------	------------

*EXAMINER: Initial if reference considered, whether or not citation is in conformance with MPEP 609. Draw line through a citation if not in conformance and not considered. Include copy of this form with next communication to applicant.

¹ See Kind Codes of USPTO Patent Documents at www.USPTO.GOV or MPEP 901.04. ² Enter office that issued the document, by the two-letter code (WIPO Standard ST.3). ³ For Japanese patent documents, the indication of the year of the reign of the Emperor must precede the serial number of the patent document. ⁴ Kind of document by the appropriate symbols as indicated on the document under WIPO Standard ST.16 if possible. ⁵ Applicant is to place a check mark here if English language translation is attached.

INFORMATION DISCLOSURE STATEMENT BY APPLICANT (Not for submission under 37 CFR 1.99)	Application Number		14875709 - GAU: 2884	
	Filing Date			
	First Named Inventor	Mohammed N. ISLAM		
	Art Unit			
	Examiner Name			
	Attorney Docket Number		OMNI 0105 PUSP1	

CERTIFICATION STATEMENT

Please see 37 CFR 1.97 and 1.98 to make the appropriate selection(s):

That each item of information contained in the information disclosure statement was first cited in any communication from a foreign patent office in a counterpart foreign application not more than three months prior to the filing of the information disclosure statement. See 37 CFR 1.97(e)(1).

OR

That no item of information contained in the information disclosure statement was cited in a communication from a foreign patent office in a counterpart foreign application, and, to the knowledge of the person signing the certification after making reasonable inquiry, no item of information contained in the information disclosure statement was known to any individual designated in 37 CFR 1.56(c) more than three months prior to the filing of the information disclosure statement. See 37 CFR 1.97(e)(2).

- See attached certification statement.
- The fee set forth in 37 CFR 1.17 (p) has been submitted herewith.
- A certification statement is not submitted herewith.

SIGNATURE

A signature of the applicant or representative is required in accordance with CFR 1.33, 10.18. Please see CFR 1.4(d) for the form of the signature.

Signature	/David S. Bir/	Date (YYYY-MM-DD)	2015-10-01
Name/Print	David S. Bir	Registration Number	38383

This collection of information is required by 37 CFR 1.97 and 1.98. The information is required to obtain or retain a benefit by the public which is to file (and by the USPTO to process) an application. Confidentiality is governed by 35 U.S.C. 122 and 37 CFR 1.14. This collection is estimated to take 1 hour to complete, including gathering, preparing and submitting the completed application form to the USPTO. Time will vary depending upon the individual case. Any comments on the amount of time you require to complete this form and/or suggestions for reducing this burden, should be sent to the Chief Information Officer, U.S. Patent and Trademark Office, U.S. Department of Commerce, P.O. Box 1450, Alexandria, VA 22313-1450. **DO NOT SEND FEES OR COMPLETED FORMS TO THIS ADDRESS. SEND TO: Commissioner for Patents, P.O. Box 1450, Alexandria, VA 22313-1450.**

Privacy Act Statement

The Privacy Act of 1974 (P.L. 93-579) requires that you be given certain information in connection with your submission of the attached form related to a patent application or patent. Accordingly, pursuant to the requirements of the Act, please be advised that: (1) the general authority for the collection of this information is 35 U.S.C. 2(b)(2); (2) furnishing of the information solicited is voluntary; and (3) the principal purpose for which the information is used by the U.S. Patent and Trademark Office is to process and/or examine your submission related to a patent application or patent. If you do not furnish the requested information, the U.S. Patent and Trademark Office may not be able to process and/or examine your submission, which may result in termination of proceedings or abandonment of the application or expiration of the patent.

The information provided by you in this form will be subject to the following routine uses:

1. The information on this form will be treated confidentially to the extent allowed under the Freedom of Information Act (5 U.S.C. 552) and the Privacy Act (5 U.S.C. 552a). Records from this system of records may be disclosed to the Department of Justice to determine whether the Freedom of Information Act requires disclosure of these records.
2. A record from this system of records may be disclosed, as a routine use, in the course of presenting evidence to a court, magistrate, or administrative tribunal, including disclosures to opposing counsel in the course of settlement negotiations.
3. A record in this system of records may be disclosed, as a routine use, to a Member of Congress submitting a request involving an individual, to whom the record pertains, when the individual has requested assistance from the Member with respect to the subject matter of the record.
4. A record in this system of records may be disclosed, as a routine use, to a contractor of the Agency having need for the information in order to perform a contract. Recipients of information shall be required to comply with the requirements of the Privacy Act of 1974, as amended, pursuant to 5 U.S.C. 552a(m).
5. A record related to an International Application filed under the Patent Cooperation Treaty in this system of records may be disclosed, as a routine use, to the International Bureau of the World Intellectual Property Organization, pursuant to the Patent Cooperation Treaty.
6. A record in this system of records may be disclosed, as a routine use, to another federal agency for purposes of National Security review (35 U.S.C. 181) and for review pursuant to the Atomic Energy Act (42 U.S.C. 218(c)).
7. A record from this system of records may be disclosed, as a routine use, to the Administrator, General Services, or his/her designee, during an inspection of records conducted by GSA as part of that agency's responsibility to recommend improvements in records management practices and programs, under authority of 44 U.S.C. 2904 and 2906. Such disclosure shall be made in accordance with the GSA regulations governing inspection of records for this purpose, and any other relevant (i.e., GSA or Commerce) directive. Such disclosure shall not be used to make determinations about individuals.
8. A record from this system of records may be disclosed, as a routine use, to the public after either publication of the application pursuant to 35 U.S.C. 122(b) or issuance of a patent pursuant to 35 U.S.C. 151. Further, a record may be disclosed, subject to the limitations of 37 CFR 1.14, as a routine use, to the public if the record was filed in an application which became abandoned or in which the proceedings were terminated and which application is referenced by either a published application, an application open to public inspections or an issued patent.
9. A record from this system of records may be disclosed, as a routine use, to a Federal, State, or local law enforcement agency, if the USPTO becomes aware of a violation or potential violation of law or regulation.

Receipt date: 10/06/2015

14875709 - GAI: 2884

Doc code: IDS

Doc description: Information Disclosure Statement (IDS) Filed

Approved for use through 07/31/2012. OMB 0651-0031
 U.S. Patent and Trademark Office; U.S. DEPARTMENT OF COMMERCE
 Under the Paperwork Reduction Act of 1995, no persons are required to respond to a collection of information unless it contains a valid OMB control number.

INFORMATION DISCLOSURE STATEMENT BY APPLICANT (Not for submission under 37 CFR 1.99)	Application Number		
	Filing Date		
	First Named Inventor	Mohammed N. ISLAM	
	Art Unit		
	Examiner Name		
	Attorney Docket Number	OMNI 0105 PUSP1	

U.S.PATENTS						Remove
Examiner Initial*	Cite No	Patent Number	Kind Code ¹	Issue Date	Name of Patentee or Applicant of cited Document	Pages,Columns,Lines where Relevant Passages or Relevant Figures Appear
	1					

If you wish to add additional U.S. Patent citation information please click the Add button. Add

U.S.PATENT APPLICATION PUBLICATIONS						Remove
Examiner Initial*	Cite No	Publication Number	Kind Code ¹	Publication Date	Name of Patentee or Applicant of cited Document	Pages,Columns,Lines where Relevant Passages or Relevant Figures Appear
	1					

If you wish to add additional U.S. Published Application citation information please click the Add button. Add

FOREIGN PATENT DOCUMENTS								Remove
Examiner Initial*	Cite No	Foreign Document Number ³	Country Code ² j	Kind Code ⁴	Publication Date	Name of Patentee or Applicant of cited Document	Pages,Columns,Lines where Relevant Passages or Relevant Figures Appear	T ⁵
	1							<input type="checkbox"/>

If you wish to add additional Foreign Patent Document citation information please click the Add button Add

NON-PATENT LITERATURE DOCUMENTS				Remove
Examiner Initials*	Cite No	Include name of the author (in CAPITAL LETTERS), title of the article (when appropriate), title of the item (book, magazine, journal, serial, symposium, catalog, etc), date, pages(s), volume-issue number(s), publisher, city and/or country where published.		T ⁵

INFORMATION DISCLOSURE STATEMENT BY APPLICANT (Not for submission under 37 CFR 1.99)	Application Number		14875709 - GAU: 2884
	Filing Date		
	First Named Inventor	Mohammed N. ISLAM	
	Art Unit		
	Examiner Name		
	Attorney Docket Number		OMNI 0105 PUSP1

1	Islam, M. N., et al., "Broad bandwidths from frequency-shifting solitons in fibers", OPTICS LETTERS, Vol. 14, No. 7, April 1, 1989, pages 370-372.	<input type="checkbox"/>
2	Islam, M. N., et al., "Femtosecond distributed soliton spectrum in fibers", J. Opt. Soc. Am. B, Vol. 6, No. 6, June 1989, pages 1149-1158.	<input type="checkbox"/>
3	Busse, Lynda E., et al., "Design Parameters for Fluoride Multimode Fibers", Journal of Lightwave Technology, Vol. 9, No. 7, July 1991, pages 828-831.	<input type="checkbox"/>
4	Wuthrich, Stefan, et al., "Optical damage thresholds at 2.94 um in fluoride glass fibers", APPLIED OPTICS, Vol. 31, No. 27, September 20, 1992, pages 5833-5837.	<input type="checkbox"/>
5	Inoue, H., et al., "Computer simulation of the vibrational spectra and properties of fluoride glasses based on ZrF4", Journal of Non-Crystalline Solids, Vol. 161, 1993, pages 118-122.	<input type="checkbox"/>
6	Mizunami, Toru, et al., "Gain saturation characteristics of Raman amplification in silica and fluoride glass optical fibers", Optics Communications 97, 1993, pages 74-78.	<input type="checkbox"/>
7	Desthieux, B., et al., "111 kW (0. 5 mJ) pulse amplification at 1.5 um using a gated cascade of three erbium-doped fiber amplifiers," Appl. Phys. Lett. Vol. 63, August 2, 1993, pages 586-588.	<input type="checkbox"/>
8	Edwards, Glenn, et al., "Tissue ablation by a free-electron laser tuned to the amide II band", Nature, Vol. 371, September 29, 1994, pages 416-419.	<input type="checkbox"/>
9	Borrelli, N. F., et al., "Resonant and non-resonant effects in photonic glasses", Journal of Non-Crystalline Solids 185, 1995, pages 109-122.	<input type="checkbox"/>
10	Asobe, Masaki, et al., "Third-order nonlinear spectroscopy in As2S3 chalcogenide glass fibers", J. Appl. Phys. 77 (11), June 1, 1995, pages 5518-5523.	<input type="checkbox"/>
11	Jarman, Richard H., "Novel optical fiber lasers", Current Opinion in Solid State and Materials Science, 1996, pages 199-203.	<input type="checkbox"/>

Receipt date: 10/06/2015 INFORMATION DISCLOSURE STATEMENT BY APPLICANT (Not for submission under 37 CFR 1.99)	Application Number		14875709 - GAU: 2884
	Filing Date		
	First Named Inventor	Mohammed N. ISLAM	
	Art Unit		
	Examiner Name		
	Attorney Docket Number	OMNI 0105 PUSP1	

12	latridis, James C., et al., "Is the Nucleus Pulposus a Solid or a Fluid? Mechanical Behaviors of the Nucleus Pulposus of the Human Intervertebral Disc", Spine, Volume 21(10), May 15, 1996, pages 1174-1184.	<input type="checkbox"/>
13	Asobe, Masaki, "Nonlinear Optical Properties of Chalcogenide Glass Fibers and Their Application to All-Optical Switching", Optical Fiber Technology, Volume 3, Article No. OF970214, 1997, pages 142-148.	<input type="checkbox"/>
14	Smektala, F., et al., "Chalcogenide glasses with large non-linear refractive indices", Journal of Non-Crystalline Solids 239, 1998, pages 139-142.	<input type="checkbox"/>
15	Hamilton, James D., et al., "High Frequency Ultrasound Imaging with Optical Arrays", IEEE Transactions on Ultrasonics, Ferroelectrics, and Frequency Control, Vol. 45, No. 1, January 1998, pages 216-235.	<input type="checkbox"/>
16	Hamilton, James D., et al., "High Frequency Ultrasound Imaging Using an Active Optical Detector", IEEE Transactions on Ultrasonics, Ferroelectrics, and Frequency Control, Vol. 45, No. 3, May 1998, pages 719-727.	<input type="checkbox"/>
17	Nowak, G. A., et al., "Low-power high-efficiency wavelength conversion based on modulational instability in high-nonlinearity fiber," OPTICS LETTERS, Vol. 23, No. 12, June 15, 1998, pages 936-938.	<input type="checkbox"/>
18	Cardinal, T., et al., "Non-linear optical properties of chalcogenide glasses in the system As-S-Se", Journal of Non-Crystalline Solids 256 & 257, 1999, pages 353-360.	<input type="checkbox"/>
19	Lucas, Jacques, "Infrared glasses", Current Opinion in Solid State & Materials Science 4, 1999, pages 181-187.	<input type="checkbox"/>
20	Sanghera, J. S., et al., "Active and passive chalcogenide glass optical fibers for IR applications: a review", Journal of Non-Crystalline Solids 256 & 257, 1999, pages 6-16.	<input type="checkbox"/>
21	Nishida, Yoshiki, et al., "Reliability of Fluoride Fiber Module for Optical Amplifier Use", IEEE Photonics Technology Letters, Vol. 11, No. 12, December 1999, pages 1596-1598.	<input type="checkbox"/>
22	Nowak, George A., et al., "Stable supercontinuum generation in short lengths of conventional dispersion-shifted fiber", APPLIED OPTICS, Vol. 38, No. 36, December 20, 1999, pages 7364-7369.	<input type="checkbox"/>

INFORMATION DISCLOSURE STATEMENT BY APPLICANT (Not for submission under 37 CFR 1.99)	Application Number		14875709 - GAU: 2884
	Filing Date		
	First Named Inventor	Mohammed N. ISLAM	
	Art Unit		
	Examiner Name		
	Attorney Docket Number		OMNI 0105 PUSP1

23	Urban, J. P. G., et al., "The Nucleus of the Intervertebral Disc from Development to Degeneration" Amer. Zool., Volume 40, 2000, pages 53-61.	<input type="checkbox"/>
24	Hamilton, James D., et al., "High Frequency Optoacoustic Arrays Using Etalon Detection", IEEE Transactions on Ultrasonics, Ferroelectrics, and Frequency Control, Vol. 47, No. 1, January 2000, pages 160-169.	<input type="checkbox"/>
25	Ranka, Jinendra K., et al., "Visible continuum generation in air-silica microstructure optical fibers with anomalous dispersion at 800 nm", OPTICS LETTERS, Vol. 25, No. 1, January 1, 2000, pages 25-27.	<input type="checkbox"/>
26	Boult, Maggi, et al., "Systematic Review of Percutaneous Endoscopic Laser Discectomy: Update and Re-appraisal", Australian Safety and Efficacy Register of New Interventional Procedures - Surgical Report No. 5, February, 2000, 49 pages.	<input type="checkbox"/>
27	Boult, Maggi, et al., "Percutaneous Endoscopic Laser Discectomy", Systematic Review, Aust. N.Z.J. Surg., Vol. 70, April 7, 2000, pages 475-479.	<input type="checkbox"/>
28	Camacho, Nancy P., et al., "FTIR Microscopic Imaging of Collagen and Proteoglycan in Bovine Cartilage," Biopolymers (Biospectroscopy), Vol. 62, 2001, pages 1-8.	<input type="checkbox"/>
29	Choi, Joon Y., et al., "Thermal, Mechanical, Optical, and Morphologic Changes in Bovine Nucleus Pulposus Induced by Nd:YAG ($\lambda = 1.32 \mu\text{m}$) Laser Irradiation", Lasers in Surgery and Medicine, Vol. 28, 2001, pages 248-254.	<input type="checkbox"/>
30	Hafez, M. I., et al., "The Effect of Irrigation on Peak Temperatures in Nerve Root, Dura, and Intervertebral Disc During Laser-Assisted Foraminoplasty", Lasers in Surgery and Medicine, Vol. 29, 2001, pages 33-37.	<input type="checkbox"/>
31	Jackson, Stuart D., et al., "Theory and numerical simulation of nth-order cascaded Raman fiber lasers", J. Opt. Soc. Am. B, Vol. 18, No. 9, September 2001, pages 1297-1306.	<input type="checkbox"/>
32	Werle, Peter, et al., "Near- and mid-infrared laser-optical sensors for gas analysis", Optics and Lasers in Engineering 37, 2002, pages 101-114.	<input type="checkbox"/>
33	Beck, Mattias, et al., "Continuous Wave Operation of a Mid-Infrared Semiconductor Laser at Room Temperature," SCIENCE Vol. 295, www.sciencemag.org, January 11, 2002, pages 301-305.	<input type="checkbox"/>

INFORMATION DISCLOSURE STATEMENT BY APPLICANT (Not for submission under 37 CFR 1.99)	Application Number		14875709 - GAU: 2884
	Filing Date		
	First Named Inventor	Mohammed N. ISLAM	
	Art Unit		
	Examiner Name		
	Attorney Docket Number		OMNI 0105 PUSP1

34	Harbold, J. M., et al., "Highly nonlinear As-S-Se glasses for all-optical switching", OPTICS LETTERS, Vol. 27, No. 2, January 15, 2002, pages 119-121.	<input type="checkbox"/>
35	Coen, Stephane, et al., "Supercontinuum generation by stimulated Raman scattering and parametric four-wave mixing in photonic crystal fibers", J. Opt. Soc. Am. B, Vol. 19, No. 4, April 2002, pages 753-764.	<input type="checkbox"/>
36	Dudley, John M., et al., "Supercontinuum generation in air-silica microstructured fibers with nanosecond and femtosecond pulse pumping", J. Opt. Soc. Am. B, Vol. 19, No. 4, April 2002, pages 765-771.	<input type="checkbox"/>
37	Harbold, Jeffrey M., et al., "Highly Nonlinear Ge-As-Se and Ge-As-S-Se Glasses for All-Optical Switching", IEEE Photonics Technology Letters, Vol. 14, No. 6, June 2002, pages 822-824.	<input type="checkbox"/>
38	Husakou, Anton V., et al, "Supercontinuum generation, four-wave mixing, and fission of higher-order solitons in photonic-crystal fibers", J. Opt. Soc. Am. B, Vol. 19, No. 9, September 2002, pages 2171-2182.	<input type="checkbox"/>
39	Wadsworth, William J., et al., "Supercontinuum generation in photonic crystal fibers and optical fiber tapers: a novel light source", J. Opt. Soc. Am. B, Vol. 19, No. 9, September 2002, pages 2148-2155.	<input type="checkbox"/>
40	Kumar, V.V. Ravi Kanth, et al, "Extruded soft glass photonic crystal fiber for ultrabroad supercontinuum generation", OPTICS EXPRESS, Vol 10, No. 25, December 16, 2002, pages 1520-1525.	<input type="checkbox"/>
41	Edwards, Glenn S., et al., "Advantage of the Mark-III FEL for biophysical research and biomedical applications", J. Synchrotron Rad. Volume 10, 2003, pages 354-357.	<input type="checkbox"/>
42	Nicholson, J. W., et al., "Pulsed and continuous-wave supercontinuum generation in highly nonlinear, dispersion-shifted fibers", Applied Physics B 77, 2003, pages 211-218.	<input type="checkbox"/>
43	Sobol, Emil, et al., "Time-resolved, light scattering measurements of cartilage and cornea denaturation due to free electron laser radiation", Journal of Biomedical Optics, Vol. 8, No. 2, April 2003, pages 216-222.	<input type="checkbox"/>
44	Nicholson, J. W., et al., "All-fiber, octave-spanning supercontinuum", OPTICS LETTERS, Vol. 28, No. 8, April 15, 2003, pages 643-645.	<input type="checkbox"/>

INFORMATION DISCLOSURE STATEMENT BY APPLICANT (Not for submission under 37 CFR 1.99)	Application Number		14875709 - GAU: 2884	
	Filing Date			
	First Named Inventor	Mohammed N. ISLAM		
	Art Unit			
	Examiner Name			
	Attorney Docket Number		OMNI 0105 PUSP1	

45	Faralli, S., et al., "Impact of Double Rayleigh Scattering Noise in Distributed Higher Order Raman Pumping Schemes", IEEE Photonics Technology Letters, Vol. 15, No. 6, June 2003, pages 804-806.	<input type="checkbox"/>
46	"New and Emerging Techniques - Surgical, Rapid Review, Laser Discectomy", Australian Safety and Efficacy Register of New Interventional Procedures - Surgical, June 2003, 12 pages.	<input type="checkbox"/>
47	Avdokhin, A. V., et al., "Continuous-wave, high-power, Raman continuum generation in holey fibers", OPTICS LETTERS, Vol. 28, No. 15, August 1, 2003, pages 1353-1355.	<input type="checkbox"/>
48	Mussot, Arnaud, et al., "Generation of a broadband single-mode supercontinuum in a conventional dispersion-shifted fiber by use of a subnanosecond microchip laser", OPTICS LETTERS, Vol. 28, No. 19, October 1, 2003, pages 1820-1822.	<input type="checkbox"/>
49	Slusher, Richard, et al., "Highly nonlinear composite chalcogenide/polymer fibers", OSA 2004, 1 page.	<input type="checkbox"/>
50	Thongtrangan, Issada, et al., "Minimally invasive spinal surgery: a historical perspective", Neurosurg. Focus, Volume 16, Article 13, January 2004, pages 1-10.	<input type="checkbox"/>

If you wish to add additional non-patent literature document citation information please click the Add button **Add**

EXAMINER SIGNATURE

Examiner Signature	/Abra Fein/	Date Considered	05/13/2016
--------------------	-------------	-----------------	------------

*EXAMINER: Initial if reference considered, whether or not citation is in conformance with MPEP 609. Draw line through a citation if not in conformance and not considered. Include copy of this form with next communication to applicant.

¹ See Kind Codes of USPTO Patent Documents at www.USPTO.GOV or MPEP 901.04. ² Enter office that issued the document, by the two-letter code (WIPO Standard ST.3). ³ For Japanese patent documents, the indication of the year of the reign of the Emperor must precede the serial number of the patent document. ⁴ Kind of document by the appropriate symbols as indicated on the document under WIPO Standard ST.16 if possible. ⁵ Applicant is to place a check mark here if English language translation is attached.

INFORMATION DISCLOSURE STATEMENT BY APPLICANT (Not for submission under 37 CFR 1.99)	Application Number		14875709 - GAU: 2884	
	Filing Date			
	First Named Inventor	Mohammed N. ISLAM		
	Art Unit			
	Examiner Name			
	Attorney Docket Number		OMNI 0105 PUSP1	

CERTIFICATION STATEMENT

Please see 37 CFR 1.97 and 1.98 to make the appropriate selection(s):

That each item of information contained in the information disclosure statement was first cited in any communication from a foreign patent office in a counterpart foreign application not more than three months prior to the filing of the information disclosure statement. See 37 CFR 1.97(e)(1).

OR

That no item of information contained in the information disclosure statement was cited in a communication from a foreign patent office in a counterpart foreign application, and, to the knowledge of the person signing the certification after making reasonable inquiry, no item of information contained in the information disclosure statement was known to any individual designated in 37 CFR 1.56(c) more than three months prior to the filing of the information disclosure statement. See 37 CFR 1.97(e)(2).

- See attached certification statement.
- The fee set forth in 37 CFR 1.17 (p) has been submitted herewith.
- A certification statement is not submitted herewith.

SIGNATURE

A signature of the applicant or representative is required in accordance with CFR 1.33, 10.18. Please see CFR 1.4(d) for the form of the signature.

Signature	/David S. Bir/	Date (YYYY-MM-DD)	2015-10-01
Name/Print	David S. Bir	Registration Number	38383

This collection of information is required by 37 CFR 1.97 and 1.98. The information is required to obtain or retain a benefit by the public which is to file (and by the USPTO to process) an application. Confidentiality is governed by 35 U.S.C. 122 and 37 CFR 1.14. This collection is estimated to take 1 hour to complete, including gathering, preparing and submitting the completed application form to the USPTO. Time will vary depending upon the individual case. Any comments on the amount of time you require to complete this form and/or suggestions for reducing this burden, should be sent to the Chief Information Officer, U.S. Patent and Trademark Office, U.S. Department of Commerce, P.O. Box 1450, Alexandria, VA 22313-1450. **DO NOT SEND FEES OR COMPLETED FORMS TO THIS ADDRESS. SEND TO: Commissioner for Patents, P.O. Box 1450, Alexandria, VA 22313-1450.**

Privacy Act Statement

The Privacy Act of 1974 (P.L. 93-579) requires that you be given certain information in connection with your submission of the attached form related to a patent application or patent. Accordingly, pursuant to the requirements of the Act, please be advised that: (1) the general authority for the collection of this information is 35 U.S.C. 2(b)(2); (2) furnishing of the information solicited is voluntary; and (3) the principal purpose for which the information is used by the U.S. Patent and Trademark Office is to process and/or examine your submission related to a patent application or patent. If you do not furnish the requested information, the U.S. Patent and Trademark Office may not be able to process and/or examine your submission, which may result in termination of proceedings or abandonment of the application or expiration of the patent.

The information provided by you in this form will be subject to the following routine uses:

1. The information on this form will be treated confidentially to the extent allowed under the Freedom of Information Act (5 U.S.C. 552) and the Privacy Act (5 U.S.C. 552a). Records from this system of records may be disclosed to the Department of Justice to determine whether the Freedom of Information Act requires disclosure of these records.
2. A record from this system of records may be disclosed, as a routine use, in the course of presenting evidence to a court, magistrate, or administrative tribunal, including disclosures to opposing counsel in the course of settlement negotiations.
3. A record in this system of records may be disclosed, as a routine use, to a Member of Congress submitting a request involving an individual, to whom the record pertains, when the individual has requested assistance from the Member with respect to the subject matter of the record.
4. A record in this system of records may be disclosed, as a routine use, to a contractor of the Agency having need for the information in order to perform a contract. Recipients of information shall be required to comply with the requirements of the Privacy Act of 1974, as amended, pursuant to 5 U.S.C. 552a(m).
5. A record related to an International Application filed under the Patent Cooperation Treaty in this system of records may be disclosed, as a routine use, to the International Bureau of the World Intellectual Property Organization, pursuant to the Patent Cooperation Treaty.
6. A record in this system of records may be disclosed, as a routine use, to another federal agency for purposes of National Security review (35 U.S.C. 181) and for review pursuant to the Atomic Energy Act (42 U.S.C. 218(c)).
7. A record from this system of records may be disclosed, as a routine use, to the Administrator, General Services, or his/her designee, during an inspection of records conducted by GSA as part of that agency's responsibility to recommend improvements in records management practices and programs, under authority of 44 U.S.C. 2904 and 2906. Such disclosure shall be made in accordance with the GSA regulations governing inspection of records for this purpose, and any other relevant (i.e., GSA or Commerce) directive. Such disclosure shall not be used to make determinations about individuals.
8. A record from this system of records may be disclosed, as a routine use, to the public after either publication of the application pursuant to 35 U.S.C. 122(b) or issuance of a patent pursuant to 35 U.S.C. 151. Further, a record may be disclosed, subject to the limitations of 37 CFR 1.14, as a routine use, to the public if the record was filed in an application which became abandoned or in which the proceedings were terminated and which application is referenced by either a published application, an application open to public inspections or an issued patent.
9. A record from this system of records may be disclosed, as a routine use, to a Federal, State, or local law enforcement agency, if the USPTO becomes aware of a violation or potential violation of law or regulation.

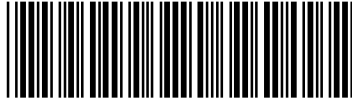
Index of Claims 	Application/Control No. 14875709	Applicant(s)/Patent Under Reexamination ISLAM, MOHAMMED N.
	Examiner ABRA FEIN	Art Unit 2884

✓	Rejected
=	Allowed

-	Cancelled
÷	Restricted

N	Non-Elected
I	Interference

A	Appeal
O	Objected

Claims renumbered in the same order as presented by applicant
 CPA
 T.D.
 R.1.47

CLAIM		DATE							
Final	Original	05/13/2016							
	1	✓							
	2	✓							
	3	✓							
	4	✓							
	5	✓							
	6	✓							
	7	✓							
	8	✓							
	9	✓							
	10	✓							
	11	✓							
	12	✓							
	13	✓							
	14	✓							
	15	✓							
	16	✓							
	17	✓							
	18	✓							
	19	✓							
	20	✓							

EAST Search History

EAST Search History (Prior Art)

Ref #	Hits	Search Query	DBs	Default Operator	Plurals	Time Stamp
S1	1	(14/108986).APP.	US-PGPUB; USPAT	OR	OFF	2015/06/15 12:07
S2	1029	(250/338.4).OCLS.	US-PGPUB; USPAT	OR	OFF	2015/06/15 12:07
S3	269	((Mohammed) near2 (Islam)).INV.	US-PGPUB; USPAT	OR	ON	2015/06/15 12:07
S4	7	((("6885683") or ("6281471") or ("6340806") or ("6301271") or ("7294105") or ("20100046067") or ("20080105665")).PN.	US-PGPUB; USPAT	OR	OFF	2015/06/15 12:08
S5	52	((("5084880") or ("5180378") or ("5400165") or ("5458122") or ("5617871") or ("5631758") or ("5687734") or ("5696778") or ("5704351") or ("5718234") or ("5748103") or ("5855550") or ("5862803") or ("5847305") or ("5912749") or ("5944659") or ("5957854") or ("6014249") or ("6043927") or ("6289238") or ("6333803") or ("6364834") or ("6381391") or ("6402691") or ("6407853") or ("6441747") or ("6443890") or ("6454705") or ("6480656") or ("6549702") or ("6603910") or ("6659947") or ("6802811") or ("7167300") or ("7209657") or ("7263288") or ("7519253") or ("20020013518") or ("20020019584") or ("20020032468") or ("20020082612") or ("20020109621") or ("20020115914") or ("20020178003") or ("20040174914") or ("20040240037") or ("20050111511") or ("20060245461") or ("20060268393") or ("20070078348") or ("20090028193") or ("20090204110")).PN.	US-PGPUB; USPAT	OR	OFF	2015/06/15 12:12
S6	4	((("7787503") or ("7800818") or ("8000574") or ("6611643")).PN.	US-PGPUB; USPAT	OR	OFF	2015/06/15 12:13
S7	82	((("4063106") or ("4158750") or ("4221997") or ("4275266") or ("4374618") or ("4403605") or ("4462080") or ("4516207") or ("4523884") or ("4605080") or ("4641292") or ("4704696") or ("4728974") or ("4762455") or ("4776016") or ("4958910") or	US-PGPUB; USPAT	OR	OFF	2015/06/15 12:19

		("4989253") or ("5078140") or ("5084880") or ("5086401") or ("5134620") or ("5142930") or ("5180378") or ("5191628") or ("5218655") or ("5230023") or ("5267256") or ("5267323") or ("5300097") or ("5303148") or ("5305427") or ("5313306") or ("5323404") or ("5345538") or ("5408409") or ("5544654") or ("5572999") or ("5695493") or ("5696778") or ("5792204") or ("5812978") or ("5950629") or ("5970457") or ("6014249") or ("6185535") or ("6200309") or ("6224542") or ("6246707") or ("6273858") or ("6278975") or ("6301273") or ("6337462") or ("6340806") or ("6350261") or ("6374006") or ("6407853") or ("6436107") or ("6442430") or ("6450172") or ("6453201") or ("6458120") or ("6462500") or ("6463361") or ("6567431") or ("6605080") or ("6625180") or ("6631025") or ("6659999") or ("6760148") or ("6885498") or ("6885683") or ("6943936") or ("7027467") or ("7060061") or ("7167300") or ("7259906") or ("7433116") or ("20020032468") or ("20020082612") or ("20020128846") or ("20020178003") or ("20040174914")).PN.				
S8	3	((("6246896") or ("6285897") or ("6847336"))).PN.	US- PGPUB; USPAT	OR	OFF	2015/06/15 12:21
S9	30	((("5747806") or ("5115673") or ("6512936") or ("6534012") or ("6640117") or ("6788965") or ("6816241") or ("6738652") or ("6587702") or ("6864978") or ("6990364") or ("7010336") or ("7133710") or ("7233816") or ("7299080") or ("7317938") or ("7395158") or ("7519406") or ("7620674") or ("7697966") or ("7787924") or ("8145286") or ("6773922") or ("7807718") or ("20100331637") or ("20110143364") or ("20030022126") or ("20060223032") or ("20100322490") or ("20120013722"))).PN.	US- PGPUB; USPAT	OR	OFF	2015/06/15 12:54
S10	2	((("8472108") or ("20130274569"))).PN.	US- PGPUB; USPAT	OR	OFF	2015/06/15 12:54
S11	168	S4 S5 S6 S7 S8 S9 S10	US- PGPUB; USPAT; EPO; JPO; DERWENT	OR	ON	2015/06/15 13:07
S12	2	((12/206432) or (10/652276) or	US-	OR	OFF	2015/06/15

		(10/757341)).APP.	PGPUB; USPAT			14:48
S13	5	((("WOadj2014105520") or ("WOadj2014143276A9") or ("WOadj2014143276") or ("WOadj2013148656") or ("EPadj2831566") or ("WOadj2013148666") or ("EPadj2831565") or ("20130265568") or ("WOadj2014105521") or ("8859969") or ("20130256534") or ("20140236021") or ("CAadj2648549") or ("WOadj2007117867") or ("20060283931") or ("EPadj2011047") or ("EPadj1671094") or ("WOadj2005031302")).PN.	US- PGPUB; USPAT	OR	OFF	2015/06/15 14:51
S14	16	WO adj "2014105520" WO adj 2014143276A9 WO adj "2014143276" WO adj "2013148656" EP adj "2831566" WO adj "2013148666" EP adj "2831565" "20130265568" WO adj "2014105521" "8859969" "20130256534" "20140236021" CA adj "2648549" WO adj "2007117867" "20060283931" EP adj "2011047" EP adj "1671094" WO adj "2005031302"	US- PGPUB; USPAT; EPO; JPO; DERWENT	OR	ON	2015/06/15 14:51
S15	7	((("6885683") or ("6281471") or ("6340806") or ("6301271") or ("7294105") or ("20100046067") or ("20080105665")).PN.	US- PGPUB; USPAT	OR	OFF	2015/06/16 09:37
S16	52	((("5084880") or ("5180378") or ("5400165") or ("5458122") or ("5617871") or ("5631758") or ("5687734") or ("5696778") or ("5704351") or ("5718234") or ("5748103") or ("5855550") or ("5862803") or ("5847305") or ("5912749") or ("5944659") or ("5957854") or ("6014249") or ("6043927") or ("6289238") or ("6333803") or ("6364834") or ("6381391") or ("6402691") or ("6407853") or ("6441747") or ("6443890") or ("6454705") or ("6480656") or ("6549702") or ("6603910") or ("6659947") or ("6802811") or ("7167300") or ("7209657") or ("7263288") or ("7519253") or ("20020013518") or ("20020019584") or ("20020032468") or ("20020082612") or ("20020109621") or ("20020115914") or ("20020178003") or ("20040174914") or ("20040240037") or ("20050111511") or ("20060245461") or ("20060268393") or ("20070078348") or ("20090028193") or ("20090204110")).PN.	US- PGPUB; USPAT	OR	OFF	2015/06/16 09:37
S17	4	((("7787503") or ("7800818") or ("8000574") or ("6611643")).PN.	US- PGPUB; USPAT	OR	OFF	2015/06/16 09:37
S18	82	((("4063106") or ("4158750") or ("4221997") or ("4275266") or ("4374618") or ("4403605") or ("4462080") or ("4516207") or	US- PGPUB; USPAT	OR	OFF	2015/06/16 09:37

		("4523884") or ("4605080") or ("4641292") or ("4704696") or ("4728974") or ("4762455") or ("4776016") or ("4958910") or ("4989253") or ("5078140") or ("5084880") or ("5086401") or ("5134620") or ("5142930") or ("5180378") or ("5191628") or ("5218655") or ("5230023") or ("5267256") or ("5267323") or ("5300097") or ("5303148") or ("5305427") or ("5313306") or ("5323404") or ("5345538") or ("5408409") or ("5544654") or ("5572999") or ("5695493") or ("5696778") or ("5792204") or ("5812978") or ("5950629") or ("5970457") or ("6014249") or ("6185535") or ("6200309") or ("6224542") or ("6246707") or ("6273858") or ("6278975") or ("6301273") or ("6337462") or ("6340806") or ("6350261") or ("6374006") or ("6407853") or ("6436107") or ("6442430") or ("6450172") or ("6453201") or ("6458120") or ("6462500") or ("6463361") or ("6567431") or ("6605080") or ("6625180") or ("6631025") or ("6659999") or ("6760148") or ("6885498") or ("6885683") or ("6943936") or ("7027467") or ("7060061") or ("7167300") or ("7259906") or ("7433116") or ("20020032468") or ("20020082612") or ("20020128846") or ("20020178003") or ("20040174914")).PN.				
S19	3	(("6246896") or ("6285897") or ("6847336")).PN.	US- PGPUB; USPAT	OR	OFF	2015/06/16 09:37
S20	30	(("5747806") or ("5115673") or ("6512936") or ("6534012") or ("6640117") or ("6788965") or ("6816241") or ("6738652") or ("6587702") or ("6864978") or ("6990364") or ("7010336") or ("7133710") or ("7233816") or ("7299080") or ("7317938") or ("7395158") or ("7519406") or ("7620674") or ("7697966") or ("7787924") or ("8145286") or ("6773922") or ("7807718") or ("20100331637") or ("20110143364") or ("20030022126") or ("20060223032") or ("20100322490") or ("20120013722")).PN.	US- PGPUB; USPAT	OR	OFF	2015/06/16 09:37
S21	2	(("8472108") or ("20130274569")).PN.	US- PGPUB; USPAT	OR	OFF	2015/06/16 09:37
S22	168	S15 S16 S17 S18 S19 S20 S21	US- PGPUB; USPAT;	OR	ON	2015/06/16 09:37

			EPO; JPO; DERWENT			
S23	2	((12/206432) or (10/652276) or (10/757341)).APP.	US-PGPUB; USPAT	OR	OFF	2015/06/16 09:37
S24	5	(("WOadj2014105520") or ("WOadj2014143276A9") or ("WOadj2014143276") or ("WOadj2013148656") or ("EPadj2831566") or ("WOadj2013148666") or ("EPadj2831565") or ("20130265568") or ("WOadj2014105521") or ("8859969") or ("20130256534") or ("20140236021") or ("CAadj2648549") or ("WOadj2007117867") or ("20060283931") or ("EPadj2011047") or ("EPadj1671094") or ("WOadj2005031302")).PN.	US-PGPUB; USPAT	OR	OFF	2015/06/16 09:37
S25	16	WO adj "2014105520" WO adj 2014143276A9 WO adj "2014143276" WO adj "2013148656" EP adj "2831566" WO adj "2013148666" EP adj "2831565" "20130265568" WO adj "2014105521" "8859969" "20130256534" "20140236021" CA adj "2648549" WO adj "2007117867" "20060283931" EP adj "2011047" EP adj "1671094" WO adj "2005031302"	US-PGPUB; USPAT; EPO; JPO; DERWENT	OR	ON	2015/06/16 09:37
S26	185	S22 S23 S24 S25	US-PGPUB; USPAT; EPO; JPO; DERWENT	OR	ON	2015/06/16 09:37
S27	126	S26 and ((light near2 source)(near-infrared near-IR IR infrared NIR)SWIR(super near continuum super-continuum supercontinuum) SC (short near wave near infrared)(short near wave near IR))	US-PGPUB; USPAT; EPO; JPO; DERWENT	OR	ON	2015/06/16 09:44
S28	1	S26 and ((light near2 source)(near-infrared near-IR IR infrared NIR)SWIR(super near continuum super-continuum supercontinuum) SC (short near wave near infrared)(short near wave near IR)) same semiconductor same (multiplexer multiplexor)	US-PGPUB; USPAT; EPO; JPO; DERWENT	OR	ON	2015/06/16 09:46
S29	24	S26 and ((light near2 source)(near-infrared near-IR IR infrared NIR)SWIR(super near continuum super-continuum supercontinuum) SC (short near wave near infrared)(short near wave near IR)) and semiconductor and(multiplexer multiplexor)	US-PGPUB; USPAT; EPO; JPO; DERWENT	OR	ON	2015/06/16 09:47
S30	24	S26 and ((light near2 source)(near-infrared near-IR IR infrared NIR)SWIR(super near continuum super-continuum supercontinuum) SC (short near wave near infrared)(short near wave near IR)) and semiconductor\$5 and(multiplexer multiplexor)	US-PGPUB; USPAT; EPO; JPO; DERWENT	OR	ON	2015/06/16 09:47
S31	21	S26 and ((light near2 source)(near-infrared near-IR NIR)SWIR(super near continuum super-continuum supercontinuum) SC	US-PGPUB; USPAT;	OR	ON	2015/06/16 09:48

		(short near wave near infrared)(short near wave near IR) and semiconductor\$5 and(multiplexer multiplexor)	EPO; JPO; DERWENT			
S32	648	((light near2 source)(near-infrared near-IR NIR)SWIR(super near continuum super-continuum supercontinuum) SC (short near wave near infrared)(short near wave near IR) same semiconductor\$5 same (multiplexer multiplexor)	US-PGPUB; USPAT; EPO; JPO; DERWENT	OR	ON	2015/06/16 10:05
S33	123	((light near2 source)(near-infrared near-IR NIR)SWIR(super near continuum super-continuum supercontinuum) SC (short near wave near infrared)(short near wave near IR) same (semiconductor\$5 with amplif\$6)same fiber same (multiplexer multiplexor)	US-PGPUB; USPAT; EPO; JPO; DERWENT	OR	ON	2015/06/16 10:08
S34	5	((light near2 source)(near-infrared near-IR NIR)SWIR(super near continuum super-continuum supercontinuum) SC (short near wave near infrared)(short near wave near IR) same (semiconductor\$5 with amplif\$6)same fiber same (multiplexer multiplexor)same sample	US-PGPUB; USPAT; EPO; JPO; DERWENT	OR	ON	2015/06/16 10:37
S35	6	S25 and (semiconductor\$5 multiplex\$5)	US-PGPUB; USPAT; EPO; JPO; DERWENT	OR	ON	2015/06/16 10:50
S36	2	S25 and (multiplex\$5)	US-PGPUB; USPAT; EPO; JPO; DERWENT	OR	ON	2015/06/16 10:50
S37	6	S25 and (semiconductor\$5 multiplex\$5 mux)	US-PGPUB; USPAT; EPO; JPO; DERWENT	OR	ON	2015/06/16 10:51
S38	8	S25 and (laser (super near luminesc\$5 near diode)LED (light near emit\$5 near diode))	US-PGPUB; USPAT; EPO; JPO; DERWENT	OR	ON	2015/06/16 10:53
S39	9	S25 and (fiber)	US-PGPUB; USPAT; EPO; JPO; DERWENT	OR	ON	2015/06/16 10:54
S40	1	S25 and (FTIR)	US-PGPUB; USPAT; EPO; JPO; DERWENT	OR	ON	2015/06/16 10:56
S41	4	S25 and (fourier)	US-PGPUB; USPAT; EPO; JPO; DERWENT	OR	ON	2015/06/16 10:59
S42	4	S25 and (fourier with (IR infrared infrared))	US-PGPUB;	OR	ON	2015/06/16 10:59

			USPAT; EPO; JPO; DERWENT			
S43	4	S25 and (fourier near4 (IR infrared infra-red))	US-PGPUB; USPAT; EPO; JPO; DERWENT	OR	ON	2015/06/16 10:59
S44	575	((light near2 source)(near-infrared near-IR NIR)SWIR(super near continuum super-continuum supercontinuum) SC (short near wave near infrared)(short near wave near IR) same (multiplexer multiplexor)same sample	US-PGPUB; USPAT; EPO; JPO; DERWENT	OR	ON	2015/06/16 11:21
S45	8428	((light near2 source)(near-infrared near-IR NIR)SWIR(super near continuum super-continuum supercontinuum) SC (short near wave near infrared)(short near wave near IR) same (multiplexer multiplexor)	US-PGPUB; USPAT; EPO; JPO; DERWENT	OR	ON	2015/06/16 11:21
S46	3	((light near2 source)(near-infrared near-IR NIR)SWIR(super near continuum super-continuum supercontinuum) SC (short near wave near infrared)(short near wave near IR) same (multiplexer multiplexor) same (pharmaceutical counterfeit illicit contraband)	US-PGPUB; USPAT; EPO; JPO; DERWENT	OR	ON	2015/06/16 11:22
S47	59	(multiplexer multiplexor) same (pharmaceutical counterfeit illicit contraband)	US-PGPUB; USPAT; EPO; JPO; DERWENT	OR	ON	2015/06/16 13:07
S48	4	(multiplexer multiplexor) same (pharmaceutical counterfeit illicit contraband) and "250".clas.	US-PGPUB; USPAT; EPO; JPO; DERWENT	OR	ON	2015/06/16 13:08
S49	23	(multiplexer multiplexor) same (pharmaceutical counterfeit illicit contraband) and fiber	US-PGPUB; USPAT; EPO; JPO; DERWENT	OR	ON	2015/06/16 13:12
S50	2	(multiplexer multiplexor) same (pharmaceutical counterfeit illicit contraband) and fiber and "250".clas.	US-PGPUB; USPAT; EPO; JPO; DERWENT	OR	ON	2015/06/16 13:12
S51	23	(multiplexer multiplexor) same (pharmaceutical counterfeit illicit contraband)and fiber	US-PGPUB; USPAT; EPO; JPO; DERWENT	OR	ON	2015/06/16 13:12
S52	7	(multiplexer multiplexor) same (pharmaceutical counterfeit illicit contraband)same fiber	US-PGPUB; USPAT; EPO; JPO; DERWENT	OR	ON	2015/06/16 13:12
S53	115	S26 and fiber	US-PGPUB; USPAT; EPO; JPO;	OR	ON	2015/06/16 13:14

			DERWENT			
S54	43	S26 and(fiber with beam)	US- PGPUB; USPAT; EPO; JPO; DERWENT	OR	ON	2015/06/16 13:14
S55	2	S26 and(fiber with beam)and "250".clas.	US- PGPUB; USPAT; EPO; JPO; DERWENT	OR	ON	2015/06/16 13:14
S56	9	S26 and(FTIR FT-IR ("fourier transform infrared"))	US- PGPUB; USPAT; EPO; JPO; DERWENT	OR	ON	2015/06/16 13:20
S57	270	((Mohammed) near2 (Islam)).INV.	US- PGPUB; USPAT	OR	ON	2015/06/16 13:22
S58	67	S57 and multiplexer.clm.	US- PGPUB; USPAT	OR	ON	2015/06/16 13:22
S59	21	S57 and ((multiplexer and semiconductor and fibers).clm.)	US- PGPUB; USPAT	OR	ON	2015/06/16 13:23
S60	2	S57 and ((multiplexer and semiconductor and fibers and FTIR).clm.)	US- PGPUB; USPAT	OR	ON	2015/06/16 13:23
S61	125	S57 and (broaden\$5)	US- PGPUB; USPAT	OR	ON	2015/06/16 16:17
S62	64	S57 and (broaden\$5 with (nonlinear non-linear))	US- PGPUB; USPAT	OR	ON	2015/06/16 16:17
S63	29	S57 and (broaden\$5 with (nonlinear non-linear) with spectrum)	US- PGPUB; USPAT	OR	ON	2015/06/16 16:17
S64	9	S57 and (broaden\$5 near4(nonlinear non-linear) with spectrum)	US- PGPUB; USPAT	OR	ON	2015/06/16 16:17
S65	2	S57 and (organic with (overtone (combination\$5 absor%8)))	US- PGPUB; USPAT	OR	ON	2015/06/16 16:31
S66	2	S57 and (organic with (overtone (combination\$5 near absor\$8)))	US- PGPUB; USPAT	OR	ON	2015/06/16 16:32
S67	206	(organic with (overtone (combination\$5 near absor\$8)))	US- PGPUB; USPAT	OR	ON	2015/06/16 16:32
S68	62	(organic with (overtone))	US- PGPUB; USPAT	OR	ON	2015/06/16 16:40
S69	14	(organic with (overtone))and "250".clas.	US- PGPUB; USPAT	OR	ON	2015/06/16 16:40
S70	1	("6105823").PN.	US- PGPUB; USPAT	OR	OFF	2015/06/17 16:05

S71	320	abrahamsson.in.	US-PGPUB; USPAT; EPO; JPO; DERWENT	OR	ON	2015/06/17 16:05
S72	4	abrahamsson.in. and multiplexer	US-PGPUB; USPAT; EPO; JPO; DERWENT	OR	ON	2015/06/17 16:06
S73	1034	(250/338.4).OCLS.	US-PGPUB; USPAT	OR	OFF	2015/07/23 13:49
S74	5	((light near2 source)(near-infrared near-IR NIR)SWIR(super near continuum super-continuum supercontinuum) SC (short near wave near infrared)(short near wave near IR) same (semiconduct\$5 with amplif\$6)same fiber same (multiplexer multiplexor)same sample	US-PGPUB; USPAT; EPO; JPO; DERWENT	OR	ON	2015/07/23 13:49
S75	2	(multiplexer multiplexor) same (pharmaceutical counterfeit illicit contraband) and fiber and "250".clas.	US-PGPUB; USPAT; EPO; JPO; DERWENT	OR	ON	2015/07/23 13:50
S76	125	((light near2 source)(near-infrared near-IR NIR)SWIR(super near continuum super-continuum supercontinuum) SC (short near wave near infrared)(short near wave near IR) same (semiconduct\$5 with amplif\$6)same fiber same (multiplexer multiplexor)	US-PGPUB; USPAT; EPO; JPO; DERWENT	OR	ON	2015/07/23 13:50
S77	8	(multiplexer multiplexor) same (pharmaceutical counterfeit illicit contraband)same fiber	US-PGPUB; USPAT; EPO; JPO; DERWENT	OR	ON	2015/07/23 13:50
S78	14	(organic with (overtone))and "250".clas.	US-PGPUB; USPAT	OR	ON	2015/07/23 13:50
S79	1	(sample) with (overtone or "combinational absorption band") with(wavelength near range) .cm.	US-PGPUB; USPAT	OR	ON	2015/07/23 13:53
S81	7	250/338.4 and @pd> "20150625"	US-PGPUB; USPAT; EPO; JPO; DERWENT	OR	ON	2015/07/24 11:51
S89	1	("20100161794").PN.	US-PGPUB; USPAT	OR	OFF	2016/05/13 11:39
S90	606	banet.in.	US-PGPUB; USPAT; EPO; JPO; DERWENT	OR	ON	2016/05/13 11:40
S91	5	(US-20060283931-\$ or US-20090028193-\$ or US-20100160798-\$).did. or (US-8000574-\$ or US-6181414-\$).did.	US-PGPUB; USPAT	OR	ON	2016/05/13 11:58

S92	0	S91 and (LED light near emit\$7 near diode) with puls\$5	US-PGPUB; USPAT; EPO; JPO; DERWENT	OR	ON	2016/05/13 11:58
S93	93	(near-infrared near-IR)with(LED light near emit\$7 near diode) with puls\$5	US-PGPUB; USPAT; EPO; JPO; DERWENT	OR	ON	2016/05/13 11:59
S94	8	(near-infrared near-IR)with(LED light near emit\$7 near diode) with puls\$5 and "250".clas.	US-PGPUB; USPAT; EPO; JPO; DERWENT	OR	ON	2016/05/13 11:59
S95	1059	(250/338.4).CCLS.	US-PGPUB; USPAT	OR	OFF	2016/05/13 13:56

5/ 13/ 2016 2:05:13 PM

C:\Users\afein\Documents\EAST\Workspaces\14\14875709.wsp

Receipt date: 10/06/2015

14875709 - GAI: 2884

Doc code: IDS

Pat. Sec. 101-10

Doc description: Information Disclosure Statement (IDS) Filed

Approved for use through 07/31/2012. OMB 0651-0031

U.S. Patent and Trademark Office; U.S. DEPARTMENT OF COMMERCE

Under the Paperwork Reduction Act of 1995, no persons are required to respond to a collection of information unless it contains a valid OMB control number.

INFORMATION DISCLOSURE STATEMENT BY APPLICANT (Not for submission under 37 CFR 1.99)	Application Number		
	Filing Date		
	First Named Inventor	Mohammed N. ISLAM	
	Art Unit		
	Examiner Name		
	Attorney Docket Number	OMNI 0105 PUSP1	

U.S.PATENTS						Remove
Examiner Initial*	Cite No	Patent Number	Kind Code ¹	Issue Date	Name of Patentee or Applicant of cited Document	Pages,Columns,Lines where Relevant Passages or Relevant Figures Appear
	1	5084880		1992-01-28	Esterowitz, et al.	
	2	5180378		1993-01-19	Kung, et al.	
	3	5400165		1995-03-21	Gnauck, et al.	
	4	5458122		1995-10-17	Hethuin	
	5	5617871		1997-04-08	Burrows	
	6	5631758		1997-05-20	Knox, et al.	
	7	5687734		1997-11-18	Dempsey, et al.	
	8	5696778		1997-12-09	MacPherson	

Receipt date: 10/06/2015 INFORMATION DISCLOSURE STATEMENT BY APPLICANT (Not for submission under 37 CFR 1.99)	Application Number		14875709 - GAU: 2884	
	Filing Date			
	First Named Inventor	Mohammed N. ISLAM		
	Art Unit			
	Examiner Name			
	Attorney Docket Number		OMNI 0105 PUSP1	

	9	5704351		1998-01-06	Mortara, et al.	
	10	5718234		1998-02-17	Warden, et al.	
	11	5748103		1998-05-05	Flach, et al.	
	12	5855550		1999-01-05	Lai, et al.	
	13	5862803		1999-01-26	Besson, et al.	
	14	5867305		1999-02-02	Waarts, et al.	
	15	5912749		1999-06-15	Harstead, et al.	
	16	5944659		1999-08-31	Flach, et al.	
	17	5957854		1999-09-28	Besson, et al.	
	18	6014249		2000-01-11	Fermann, et al.	
	19	6043927		2000-03-28	Islam	

INFORMATION DISCLOSURE STATEMENT BY APPLICANT (Not for submission under 37 CFR 1.99)	Application Number		14875709 - GAU: 2884	
	Filing Date			
	First Named Inventor	Mohammed N. ISLAM		
	Art Unit			
	Examiner Name			
	Attorney Docket Number		OMNI 0105 PUSP1	

	20	6289238		2001-09-11	Besson, et al.	
	21	6333803		2001-12-25	Kurotori, et al.	
	22	6364834		2002-04-02	Reuss, et al.	
	23	6381391		2002-04-30	Islam, et al.	
	24	6402691		2002-06-11	Peddicord, et al.	
	25	6407853		2002-06-18	Samson, et al.	
	26	6441747		2002-08-27	Khair, et al.	
	27	6443890		2002-09-03	Schulze, et al.	
	28	6454705		2002-09-24	Cosentino, et al.	
	29	6480656		2002-11-12	Islam, et al.	
	30	6549702		2003-04-15	Islam, et al.	

INFORMATION DISCLOSURE STATEMENT BY APPLICANT (Not for submission under 37 CFR 1.99)	Application Number		14875709 - GAU: 2884	
	Filing Date			
	First Named Inventor	Mohammed N. ISLAM		
	Art Unit			
	Examiner Name			
	Attorney Docket Number		OMNI 0105 PUSP1	

	31	6603910		2003-08-05	Islam, et al.	
	32	6659947		2003-12-09	Carter, et al.	
	33	6802811		2004-10-12	Slepian	
	34	7167300		2007-01-23	Fermann, et al.	
	35	7209657		2007-04-24	Islam	
	36	7263288		2007-08-28	Islam	
	37	7519253		2009-04-14	Islam	

If you wish to add additional U.S. Patent citation information please click the Add button.

Add

U.S.PATENT APPLICATION PUBLICATIONS

Remove

Examiner Initial*	Cite No	Publication Number	Kind Code ¹	Publication Date	Name of Patentee or Applicant of cited Document	Pages, Columns, Lines where Relevant Passages or Relevant Figures Appear
	1	20020013518		2002-01-31	West, Kenneth G. ; et al.	
	2	20020019584		2002-02-14	Schulze, Arthur E. ; et al.	

INFORMATION DISCLOSURE STATEMENT BY APPLICANT (Not for submission under 37 CFR 1.99)	Application Number		14875709 - GAU: 2884	
	Filing Date			
	First Named Inventor	Mohammed N. ISLAM		
	Art Unit			
	Examiner Name			
	Attorney Docket Number		OMNI 0105 PUSP1	

3	20020032468		2002-03-14	Hill, Michael R.S. ; et al.	
4	20020082612		2002-06-27	Moll, Frederic H. ; et al.	
5	20020109621		2002-08-15	Khair, Mohammad ; et al.	
6	20020115914		2002-08-22	Russ, Tomas	
7	20020178003		2002-11-28	Gehrke, James K. ; et al.	
8	20040174914		2004-09-09	Fukatsu, Susumu	
9	20040240037		2004-12-02	Harter, Donald J.	
10	20050111500		2005-05-26	Harter, Donald J. ; et al.	
11	20060245461		2006-11-02	Islam; Mohammed N.	
12	20060268393		2006-11-30	Islam; Mohammed N.	
13	20070078348		2007-04-05	Holman; Hoi-Ying N.	

INFORMATION DISCLOSURE STATEMENT BY APPLICANT (Not for submission under 37 CFR 1.99)	Application Number		14875709 - GAU: 2884	
	Filing Date			
	First Named Inventor	Mohammed N. ISLAM		
	Art Unit			
	Examiner Name			
	Attorney Docket Number		OMNI 0105 PUSP1	

14	20090028193		2009-01-29	Islam; Mohammed N.	
15	20090204110		2009-08-13	Islam; Mohammed N.	

If you wish to add additional U.S. Published Application citation information please click the Add button. **Add**

FOREIGN PATENT DOCUMENTS

Remove

Examiner Initial*	Cite No	Foreign Document Number ³	Country Code ² i	Kind Code ⁴	Publication Date	Name of Patentee or Applicant of cited Document	Pages, Columns, Lines where Relevant Passages or Relevant Figures Appear	T ⁵
	1	200189362	WO		2001-11-29	West Kenneth G et al.		<input type="checkbox"/>
	2	200227640	WO		2002-04-04	Whittington Charles Lynn et al.		<input type="checkbox"/>
	3	200228123	WO		2002-04-04	Whittington Charles Lynn		<input type="checkbox"/>

If you wish to add additional Foreign Patent Document citation information please click the Add button **Add**

NON-PATENT LITERATURE DOCUMENTS

Remove

Examiner Initials*	Cite No	Include name of the author (in CAPITAL LETTERS), title of the article (when appropriate), title of the item (book, magazine, journal, serial, symposium, catalog, etc), date, pages(s), volume-issue number(s), publisher, city and/or country where published.	T ⁵
	1		<input type="checkbox"/>

If you wish to add additional non-patent literature document citation information please click the Add button **Add**

EXAMINER SIGNATURE

Examiner Signature	/Abra Fein/	Date Considered	05/13/2016
--------------------	-------------	-----------------	------------

*EXAMINER: Initial if reference considered, whether or not citation is in conformance with MPEP 609. Draw line through a citation if not in conformance and not considered. Include copy of this form with next communication to applicant.

INFORMATION DISCLOSURE STATEMENT BY APPLICANT (Not for submission under 37 CFR 1.99)	Application Number		14875709 - GAU: 2884	
	Filing Date			
	First Named Inventor	Mohammed N. ISLAM		
	Art Unit			
	Examiner Name			
	Attorney Docket Number	OMNI 0105 PUSP1		

¹ See Kind Codes of USPTO Patent Documents at www.USPTO.GOV or MPEP 901.04. ² Enter office that issued the document, by the two-letter code (WIPO Standard ST.3). ³ For Japanese patent documents, the indication of the year of the reign of the Emperor must precede the serial number of the patent document. ⁴ Kind of document by the appropriate symbols as indicated on the document under WIPO Standard ST.16 if possible. ⁵ Applicant is to place a check mark here if English language translation is attached.

INFORMATION DISCLOSURE STATEMENT BY APPLICANT (Not for submission under 37 CFR 1.99)	Application Number		14875709 - GAU: 2884	
	Filing Date			
	First Named Inventor	Mohammed N. ISLAM		
	Art Unit			
	Examiner Name			
	Attorney Docket Number		OMNI 0105 PUSP1	

CERTIFICATION STATEMENT

Please see 37 CFR 1.97 and 1.98 to make the appropriate selection(s):

That each item of information contained in the information disclosure statement was first cited in any communication from a foreign patent office in a counterpart foreign application not more than three months prior to the filing of the information disclosure statement. See 37 CFR 1.97(e)(1).

OR

That no item of information contained in the information disclosure statement was cited in a communication from a foreign patent office in a counterpart foreign application, and, to the knowledge of the person signing the certification after making reasonable inquiry, no item of information contained in the information disclosure statement was known to any individual designated in 37 CFR 1.56(c) more than three months prior to the filing of the information disclosure statement. See 37 CFR 1.97(e)(2).

See attached certification statement.

Fee set forth in 37 CFR 1.17 (p) has been submitted herewith.

None

SIGNATURE

A signature of the applicant or representative is required in accordance with CFR 1.33, 10.18. Please see CFR 1.4(d) for the form of the signature.

Signature	/David S. Bir/	Date (YYYY-MM-DD)	2015-10-01
Name/Print	David S. Bir	Registration Number	38383

This collection of information is required by 37 CFR 1.97 and 1.98. The information is required to obtain or retain a benefit by the public which is to file (and by the USPTO to process) an application. Confidentiality is governed by 35 U.S.C. 122 and 37 CFR 1.14. This collection is estimated to take 1 hour to complete, including gathering, preparing and submitting the completed application form to the USPTO. Time will vary depending upon the individual case. Any comments on the amount of time you require to complete this form and/or suggestions for reducing this burden, should be sent to the Chief Information Officer, U.S. Patent and Trademark Office, U.S. Department of Commerce, P.O. Box 1450, Alexandria, VA 22313-1450. **DO NOT SEND FEES OR COMPLETED FORMS TO THIS ADDRESS. SEND TO: Commissioner for Patents, P.O. Box 1450, Alexandria, VA 22313-1450.**

Privacy Act Statement

The Privacy Act of 1974 (P.L. 93-579) requires that you be given certain information in connection with your submission of the attached form related to a patent application or patent. Accordingly, pursuant to the requirements of the Act, please be advised that: (1) the general authority for the collection of this information is 35 U.S.C. 2(b)(2); (2) furnishing of the information solicited is voluntary; and (3) the principal purpose for which the information is used by the U.S. Patent and Trademark Office is to process and/or examine your submission related to a patent application or patent. If you do not furnish the requested information, the U.S. Patent and Trademark Office may not be able to process and/or examine your submission, which may result in termination of proceedings or abandonment of the application or expiration of the patent.

The information provided by you in this form will be subject to the following routine uses:

1. The information on this form will be treated confidentially to the extent allowed under the Freedom of Information Act (5 U.S.C. 552) and the Privacy Act (5 U.S.C. 552a). Records from this system of records may be disclosed to the Department of Justice to determine whether the Freedom of Information Act requires disclosure of these records.
2. A record from this system of records may be disclosed, as a routine use, in the course of presenting evidence to a court, magistrate, or administrative tribunal, including disclosures to opposing counsel in the course of settlement negotiations.
3. A record in this system of records may be disclosed, as a routine use, to a Member of Congress submitting a request involving an individual, to whom the record pertains, when the individual has requested assistance from the Member with respect to the subject matter of the record.
4. A record in this system of records may be disclosed, as a routine use, to a contractor of the Agency having need for the information in order to perform a contract. Recipients of information shall be required to comply with the requirements of the Privacy Act of 1974, as amended, pursuant to 5 U.S.C. 552a(m).
5. A record related to an International Application filed under the Patent Cooperation Treaty in this system of records may be disclosed, as a routine use, to the International Bureau of the World Intellectual Property Organization, pursuant to the Patent Cooperation Treaty.
6. A record in this system of records may be disclosed, as a routine use, to another federal agency for purposes of National Security review (35 U.S.C. 181) and for review pursuant to the Atomic Energy Act (42 U.S.C. 218(c)).
7. A record from this system of records may be disclosed, as a routine use, to the Administrator, General Services, or his/her designee, during an inspection of records conducted by GSA as part of that agency's responsibility to recommend improvements in records management practices and programs, under authority of 44 U.S.C. 2904 and 2906. Such disclosure shall be made in accordance with the GSA regulations governing inspection of records for this purpose, and any other relevant (i.e., GSA or Commerce) directive. Such disclosure shall not be used to make determinations about individuals.
8. A record from this system of records may be disclosed, as a routine use, to the public after either publication of the application pursuant to 35 U.S.C. 122(b) or issuance of a patent pursuant to 35 U.S.C. 151. Further, a record may be disclosed, subject to the limitations of 37 CFR 1.14, as a routine use, to the public if the record was filed in an application which became abandoned or in which the proceedings were terminated and which application is referenced by either a published application, an application open to public inspections or an issued patent.
9. A record from this system of records may be disclosed, as a routine use, to a Federal, State, or local law enforcement agency, if the USPTO becomes aware of a violation or potential violation of law or regulation.

INFORMATION DISCLOSURE STATEMENT BY APPLICANT (Not for submission under 37 CFR 1.99)	Application Number	14875709
	Filing Date	2015-10-06
	First Named Inventor	Mohammed N. ISLAM
	Art Unit	2884
	Examiner Name	Abra S. Fein
	Attorney Docket Number	OMNI 0105 PUSP1

U.S.PATENTS						Remove
Examiner Initial*	Cite No	Patent Number	Kind Code ¹	Issue Date	Name of Patentee or Applicant of cited Document	Pages,Columns,Lines where Relevant Passages or Relevant Figures Appear
	1	7771320	B2	2010-08-10	Riley, et al.	
	2	6619835	B2	2003-09-16	Kita	
	3	9326712	B1	2016-05-03	Kiani	
	4	5267152	A	1993-11-30	Yang et al.	
	5	7356364	B1	2008-04-08	Bullock et al.	
	6	5246004		1993-09-21	Clarke, et al.	
	7	8472108		2013-06-25	Islam	
If you wish to add additional U.S. Patent citation information please click the Add button.						Add
U.S.PATENT APPLICATION PUBLICATIONS						Remove

**INFORMATION DISCLOSURE
STATEMENT BY APPLICANT**
(Not for submission under 37 CFR 1.99)

Application Number		14875709
Filing Date		2015-10-06
First Named Inventor	Mohammed N. ISLAM	
Art Unit		2884
Examiner Name	Abra S. Fein	
Attorney Docket Number		OMNI 0105 PUSP1

Examiner Initial*	Cite No	Publication Number	Kind Code ¹	Publication Date	Name of Patentee or Applicant of cited Document	Pages, Columns, Lines where Relevant Passages or Relevant Figures Appear
	1	20100217102	A1	2010-08-26	LeBoeuf, et al.	
	2	20120310062	A1	2012-12-06	Li, et al.	
	3	20120316455	A1	2012-12-13	Rahman, et al.	
	4	20140275854	A1	2014-09-18	Venkatraman, et al.	
	5	20140275852	A1	2014-09-18	Hong, et al.	
	6	20160045118	A1	2016-02-18	Kiani	
	7	20110208015	A1	2011-08-25	Welch, et al.	
	8	20110040197	A1	2011-02-17	Welch et al.	
	9	20070021670	A1	2007-01-25	Mandelis et al.	
	10	20110282167	A1	2011-11-17	Ridder et al.	

**INFORMATION DISCLOSURE
STATEMENT BY APPLICANT**
(Not for submission under 37 CFR 1.99)

Application Number	14875709
Filing Date	2015-10-06
First Named Inventor	Mohammed N. ISLAM
Art Unit	2884
Examiner Name	Abra S. Fein
Attorney Docket Number	OMNI 0105 PUSP1

11	20130274569	2013-10-17	Islam
----	-------------	------------	-------

If you wish to add additional U.S. Published Application citation information please click the Add button.

FOREIGN PATENT DOCUMENTS

Examiner Initial*	Cite No	Foreign Document Number ³	Country Code ² i	Kind Code ⁴	Publication Date	Name of Patentee or Applicant of cited Document	Pages, Columns, Lines where Relevant Passages or Relevant Figures Appear	T ⁵
	1							

If you wish to add additional Foreign Patent Document citation information please click the Add button.

NON-PATENT LITERATURE DOCUMENTS

Examiner Initials*	Cite No	Include name of the author (in CAPITAL LETTERS), title of the article (when appropriate), title of the item (book, magazine, journal, serial, symposium, catalog, etc), date, pages(s), volume-issue number(s), publisher, city and/or country where published.	T ⁵
	1	U.S. Provisional Application No. 61/350,673; titled: OPTICOUSTIC SENSOR; Inventor: Massi Joe E. Kiani; filed on June 2, 2010.	
	2	International Search Report and Written Opinion for International Application No. PCT/US2013/075700 dated April 24, 2014	
	3	International Preliminary Report on Patentability for International Application No. PCT/US2013/075700 dated July 9, 2015	
	4	Ooi ET, Zhang XQ, Chen JH, Soh PH, Ng K, Yeo JH, "Non-invasive glucose measurement using multiple laser diodes," Optical Diagnostic and Sensing VII, edited by Gerard L. Cote, Alexander V. Priezzhev, Proc. of SPIE Vol. 6445, 64450K , (2007).	
	5	Schulz, I., J. Putzger, A. Niklas, M. Brandt, A. Jager, A. Hardt, S. Knorz, K.A. Hiller, S. Loffler, G. Schmalz, S.N. Danilov, S. Giglberger, M. Hirmer, S.D. Ganichev, G. Monkman, "PPG signal acquisition and analysis on in vitro tooth model for dental pulp vitality assessment," ARC Submission 16, (2012).	

**INFORMATION DISCLOSURE
STATEMENT BY APPLICANT**
(Not for submission under 37 CFR 1.99)

Application Number	14875709
Filing Date	2015-10-06
First Named Inventor	Mohammed N. ISLAM
Art Unit	2884
Examiner Name	Abra S. Fein
Attorney Docket Number	OMNI 0105 PUSP1

6	Drexler, C., Hirmer, M., Danilov, S., Giglberger, S., Putzger, J., Niklas, A., Jager, A., Hiller, K., Loffler, S., Schmalz, G., Redlich, B., Schulz, I., Monkman, G., Ganichev, S. "Infrared spectroscopy for clinical diagnosis of dental pulp vitality." Infrared, Millimeter, and Terahertz Waves (IRMMW-THz), 2012 37th International Conference on. IEEE (2012).
7	Hirmer, Marion, Danilov, Sergey, Giglberger, Stephan, Putzger, Jurgen, Niklas, Andreas, Jager, Andreas, Hiller, Karl-Anton, Loffler, Susanne, Schmalz, Gottfried, Redlich, Britta, Schulz, Irene, Monkman, Gareth, Ganichev, Sergey. "Spectroscopic Study of Human Teeth and Blood from Visible to Terahertz Frequencies for Clinical Diagnosis of Dental Pulp Vitality." Journal of Infrared, Millimeter, and Terahertz Waves 33.3 (2012): 366-375.
8	Na, J, J.H. Baek, S.Y. Ryu, C. Lee, B.H. Lee, "Tomographic imaging of incipient dental-caries using optical coherence tomography and comparison with various modalities," Optical Review, vol. 16, no. 4, pp. 426-431 (2009).

If you wish to add additional non-patent literature document citation information please click the Add button

EXAMINER SIGNATURE

Examiner Signature	<input type="text"/>	Date Considered	<input type="text"/>
--------------------	----------------------	-----------------	----------------------

*EXAMINER: Initial if reference considered, whether or not citation is in conformance with MPEP 609. Draw line through a citation if not in conformance and not considered. Include copy of this form with next communication to applicant.

¹ See Kind Codes of USPTO Patent Documents at www.USPTO.GOV or MPEP 901.04. ² Enter office that issued the document, by the two-letter code (WIPO Standard ST.3). ³ For Japanese patent documents, the indication of the year of the reign of the Emperor must precede the serial number of the patent document. ⁴ Kind of document by the appropriate symbols as indicated on the document under WIPO Standard ST.16 if possible. ⁵ Applicant is to place a check mark here if English language translation is attached.

INFORMATION DISCLOSURE STATEMENT BY APPLICANT (Not for submission under 37 CFR 1.99)	Application Number	14875709
	Filing Date	2015-10-06
	First Named Inventor	Mohammed N. ISLAM
	Art Unit	2884
	Examiner Name	Abra S. Fein
	Attorney Docket Number	OMNI 0105 PUSP1

CERTIFICATION STATEMENT

Please see 37 CFR 1.97 and 1.98 to make the appropriate selection(s):

That each item of information contained in the information disclosure statement was first cited in any communication from a foreign patent office in a counterpart foreign application not more than three months prior to the filing of the information disclosure statement. See 37 CFR 1.97(e)(1).

OR

That no item of information contained in the information disclosure statement was cited in a communication from a foreign patent office in a counterpart foreign application, and, to the knowledge of the person signing the certification after making reasonable inquiry, no item of information contained in the information disclosure statement was known to any individual designated in 37 CFR 1.56(c) more than three months prior to the filing of the information disclosure statement. See 37 CFR 1.97(e)(2).

See attached certification statement.

The fee set forth in 37 CFR 1.17 (p) has been submitted herewith.

A certification statement is not submitted herewith.

SIGNATURE

A signature of the applicant or representative is required in accordance with CFR 1.33, 10.18. Please see CFR 1.4(d) for the form of the signature.

Signature	/David S. Bir/	Date (YYYY-MM-DD)	2016-06-22
Name/Print	David S. Bir	Registration Number	38383

This collection of information is required by 37 CFR 1.97 and 1.98. The information is required to obtain or retain a benefit by the public which is to file (and by the USPTO to process) an application. Confidentiality is governed by 35 U.S.C. 122 and 37 CFR 1.14. This collection is estimated to take 1 hour to complete, including gathering, preparing and submitting the completed application form to the USPTO. Time will vary depending upon the individual case. Any comments on the amount of time you require to complete this form and/or suggestions for reducing this burden, should be sent to the Chief Information Officer, U.S. Patent and Trademark Office, U.S. Department of Commerce, P.O. Box 1450, Alexandria, VA 22313-1450. **DO NOT SEND FEES OR COMPLETED FORMS TO THIS ADDRESS. SEND TO: Commissioner for Patents, P.O. Box 1450, Alexandria, VA 22313-1450.**

Privacy Act Statement

The Privacy Act of 1974 (P.L. 93-579) requires that you be given certain information in connection with your submission of the attached form related to a patent application or patent. Accordingly, pursuant to the requirements of the Act, please be advised that: (1) the general authority for the collection of this information is 35 U.S.C. 2(b)(2); (2) furnishing of the information solicited is voluntary; and (3) the principal purpose for which the information is used by the U.S. Patent and Trademark Office is to process and/or examine your submission related to a patent application or patent. If you do not furnish the requested information, the U.S. Patent and Trademark Office may not be able to process and/or examine your submission, which may result in termination of proceedings or abandonment of the application or expiration of the patent.

The information provided by you in this form will be subject to the following routine uses:

1. The information on this form will be treated confidentially to the extent allowed under the Freedom of Information Act (5 U.S.C. 552) and the Privacy Act (5 U.S.C. 552a). Records from this system of records may be disclosed to the Department of Justice to determine whether the Freedom of Information Act requires disclosure of these records.
2. A record from this system of records may be disclosed, as a routine use, in the course of presenting evidence to a court, magistrate, or administrative tribunal, including disclosures to opposing counsel in the course of settlement negotiations.
3. A record in this system of records may be disclosed, as a routine use, to a Member of Congress submitting a request involving an individual, to whom the record pertains, when the individual has requested assistance from the Member with respect to the subject matter of the record.
4. A record in this system of records may be disclosed, as a routine use, to a contractor of the Agency having need for the information in order to perform a contract. Recipients of information shall be required to comply with the requirements of the Privacy Act of 1974, as amended, pursuant to 5 U.S.C. 552a(m).
5. A record related to an International Application filed under the Patent Cooperation Treaty in this system of records may be disclosed, as a routine use, to the International Bureau of the World Intellectual Property Organization, pursuant to the Patent Cooperation Treaty.
6. A record in this system of records may be disclosed, as a routine use, to another federal agency for purposes of National Security review (35 U.S.C. 181) and for review pursuant to the Atomic Energy Act (42 U.S.C. 218(c)).
7. A record from this system of records may be disclosed, as a routine use, to the Administrator, General Services, or his/her designee, during an inspection of records conducted by GSA as part of that agency's responsibility to recommend improvements in records management practices and programs, under authority of 44 U.S.C. 2904 and 2906. Such disclosure shall be made in accordance with the GSA regulations governing inspection of records for this purpose, and any other relevant (i.e., GSA or Commerce) directive. Such disclosure shall not be used to make determinations about individuals.
8. A record from this system of records may be disclosed, as a routine use, to the public after either publication of the application pursuant to 35 U.S.C. 122(b) or issuance of a patent pursuant to 35 U.S.C. 151. Further, a record may be disclosed, subject to the limitations of 37 CFR 1.14, as a routine use, to the public if the record was filed in an application which became abandoned or in which the proceedings were terminated and which application is referenced by either a published application, an application open to public inspections or an issued patent.
9. A record from this system of records may be disclosed, as a routine use, to a Federal, State, or local law enforcement agency, if the USPTO becomes aware of a violation or potential violation of law or regulation.

Electronic Patent Application Fee Transmittal

Application Number:	14875709			
Filing Date:	06-Oct-2015			
Title of Invention:	SHORT-WAVE INFRARED SUPER-CONTINUUM LASERS FOR DETECTING COUNTERFEIT OR ILLICIT DRUGS AND PHARMACEUTICAL PROCESS CONTROL			
First Named Inventor/Applicant Name:	Mohammed N. Islam			
Filer:	David S. Bir/Pamela Demos			
Attorney Docket Number:	OMNI 0105 PUSP1			
Filed as Small Entity				
Filing Fees for Utility under 35 USC 111(a)				
Description	Fee Code	Quantity	Amount	Sub-Total in USD(\$)
Basic Filing:				
Pages:				
Claims:				
Miscellaneous-Filing:				
Petition:				
Patent-Appeals-and-Interference:				
Post-Allowance-and-Post-Issuance:				
Extension-of-Time:				

Description	Fee Code	Quantity	Amount	Sub-Total in USD(\$)
Miscellaneous:				
Submission- Information Disclosure Stmt	2806	1	90	90
Total in USD (\$)				90

Electronic Acknowledgement Receipt

EFS ID:	26136687
Application Number:	14875709
International Application Number:	
Confirmation Number:	7496
Title of Invention:	SHORT-WAVE INFRARED SUPER-CONTINUUM LASERS FOR DETECTING COUNTERFEIT OR ILLICIT DRUGS AND PHARMACEUTICAL PROCESS CONTROL
First Named Inventor/Applicant Name:	Mohammed N. Islam
Customer Number:	109543
Filer:	David S. Bir
Filer Authorized By:	
Attorney Docket Number:	OMNI 0105 PUSP1
Receipt Date:	22-JUN-2016
Filing Date:	06-OCT-2015
Time Stamp:	17:29:55
Application Type:	Utility under 35 USC 111(a)

Payment information:

Submitted with Payment	yes
Payment Type	Deposit Account
Payment was successfully received in RAM	\$90
RAM confirmation Number	4396
Deposit Account	023978
Authorized User	BIR, DAVID S.

The Director of the USPTO is hereby authorized to charge indicated fees and credit any overpayment as follows:

Charge any Additional Fees required under 37 CFR 1.16 (National application filing, search, and examination fees)

Charge any Additional Fees required under 37 CFR 1.17 (Patent application and reexamination processing fees)

File Listing:					
Document Number	Document Description	File Name	File Size(Bytes)/ Message Digest	Multi Part /.zip	Pages (if appl.)
1	Non Patent Literature	ISR_and_WO.pdf	2432619	no	15
			7d24707f10549aff20794fba6af5aa2b455db702		
Warnings:					
Information:					
2	Non Patent Literature	IPRP.pdf	2048361	no	10
			886f28553ff80f85158927da96fe5a2994810146		
Warnings:					
Information:					
3	Non Patent Literature	Provisional_Application_61350673.pdf	3855731	no	22
			8c99530daa6b316f5ff7b72b409523d8456756b5		
Warnings:					
Information:					
4	Information Disclosure Statement (IDS) Form (SB08)	Supplemental_IDS.pdf	613766	no	6
			52fb660c832fbc63601a090bf6d14666858105b		
Warnings:					
Information:					
5	Non Patent Literature	2007-Ooi-GlucoSTATS.pdf	492976	no	14
			5b44216c10b13f2bc2a67589ba2201693f4d79ff		
Warnings:					
Information:					
6	Non Patent Literature	2009-Na-Tomographic_Imaging_and_comparisons.pdf	1199064	no	12
			413a9d31fb2524de77569a8ca4556c6a326c4382		
Warnings:					
Information:					
7	Non Patent Literature	2012-Drexler-Infrared_Spectroscopy_Pulp_Vitalit.pdf	346446	no	1
			52c37eb2ebc63dc535eaaa08259ac9098b48a888		
Warnings:					
Information:					

8	Non Patent Literature	2012-Hirmer-Spectroscopy_study_of_teeth.pdf	814060 39d86dd593cbbfb9affc43f9b985f4203c388664	no	10
Warnings:					
Information:					
9	Non Patent Literature	2012-Schulz-PPG_Signal.pdf	544826 15ad6e46b3b0cef66e3d18c2d42b11a07bb8d224	no	5
Warnings:					
Information:					
10	Fee Worksheet (SB06)	fee-info.pdf	30678 c0045a6f5eec952dec580512b85536d714f1d569	no	2
Warnings:					
Information:					
Total Files Size (in bytes):				12378527	
<p>This Acknowledgement Receipt evidences receipt on the noted date by the USPTO of the indicated documents, characterized by the applicant, and including page counts, where applicable. It serves as evidence of receipt similar to a Post Card, as described in MPEP 503.</p> <p><u>New Applications Under 35 U.S.C. 111</u> If a new application is being filed and the application includes the necessary components for a filing date (see 37 CFR 1.53(b)-(d) and MPEP 506), a Filing Receipt (37 CFR 1.54) will be issued in due course and the date shown on this Acknowledgement Receipt will establish the filing date of the application.</p> <p><u>National Stage of an International Application under 35 U.S.C. 371</u> If a timely submission to enter the national stage of an international application is compliant with the conditions of 35 U.S.C. 371 and other applicable requirements a Form PCT/DO/EO/903 indicating acceptance of the application as a national stage submission under 35 U.S.C. 371 will be issued in addition to the Filing Receipt, in due course.</p> <p><u>New International Application Filed with the USPTO as a Receiving Office</u> If a new international application is being filed and the international application includes the necessary components for an international filing date (see PCT Article 11 and MPEP 1810), a Notification of the International Application Number and of the International Filing Date (Form PCT/RO/105) will be issued in due course, subject to prescriptions concerning national security, and the date shown on this Acknowledgement Receipt will establish the international filing date of the application.</p>					

PATENT COOPERATION TREATY

From the INTERNATIONAL SEARCHING AUTHORITY

To:
 BIR, DAVID S.

 BROOKS KUSHMAN P.C. 1000 TOWN CENTER TWENTY-
 SECOND FLOOR SOUTHFIELD MI 48075 USA

PCT

**NOTIFICATION OF TRANSMITTAL OF
 THE INTERNATIONAL SEARCH REPORT AND
 THE WRITTEN OPINION OF THE INTERNATIONAL
 SEARCHING AUTHORITY, OR THE DECLARATION**

(PCT Rule 44.1)

Date of mailing
 (day/month/year) 24 April 2014 (24.04.2014)

Applicant's or agent's file reference OMNI010IPCT	FOR FURTHER ACTION See paragraphs 1 and 4 below
International application No. PCT/US2013/075700	International filing date (day/month/year) 17 December 2013 (17.12.2013)
Applicant OMNI MEDSCI, INC.	

- The applicant is hereby notified that the international search report and the written opinion of the International Searching Authority have been established and are transmitted herewith.
Filing of amendments and statement under Article 19:
 The applicant is entitled, if he so wishes, to amend the claims of the international application (see Rule 46):
When? The time limit for filing such amendments is normally two months from the date of transmittal of the international search report.
Where? Directly to the International Bureau of WIPO, 34 chemin des Colombettes
 1211 Geneva 20, Switzerland, Facsimile No.: +41 22 338 82 70
For more detailed instructions, see PCT Applicant's Guide, International Phase, paragraphs 9.004 - 9.011.
- The applicant is hereby notified that no international search report will be established and that the declaration under Article 17(2)(a) to that effect and the written opinion of the International Searching Authority are transmitted herewith.
- With regard to any protest** against payment of (an) additional fee(s) under Rule 40.2, the applicant is notified that:
 the protest together with the decision thereon has been transmitted to the International Bureau together with any request to forward the texts of both the protest and the decision thereon to the designated Offices.
 no decision has been made yet on the protest; the applicant will be notified as soon as a decision is made.
- 4. Reminders**
 The applicant may submit comments on an informal basis on the written opinion of the International Searching Authority to the International Bureau. The International Bureau will send a copy of such comments to all designated Offices unless an international preliminary examination report has been or is to be established. Following the expiration of 30 months from the priority date, these comments will also be made available to the public.

 Shortly after the expiration of **18 months** from the priority date, the international application will be published by the International Bureau. If the applicant wishes to avoid or postpone publication, a notice of withdrawal of the international application, or of the priority claim, must reach the International Bureau before the completion of the technical preparations for international publication (Rules 90bis.1 and 90bis.3).

 Within **19 months** from the priority date, but only in respect of some designated Offices, a demand for international preliminary examination must be filed if the applicant wishes to postpone the entry into the national phase **until 30 months** from the priority date (in some Offices even later); otherwise, the applicant must, **within 20 months** from the priority date, perform the prescribed acts for entry into the national phase before those designated Offices.
 In respect of other designated Offices, the time limit of **30 months** (or later) will apply even if no demand is filed within 19 months.

 For details about the applicable time limits, Office by Office, see www.wipo.int/pct/en/texts/time_limits.html and the PCT Applicant's Guide, National Chapters.

Name and mailing address of the ISA/KR International Application Division Korean Intellectual Property Office 189 Cheongsu-ro, Seo-gu, Daejeon Metropolitan City, 302-701. Republic of Korea Facsimile No. 82-42-472-7140	Authorized officer COMMISSIONER Telephone No. 82-42-481-8754	
--	--	---

* Attention

Copies of the documents cited in the international search report can be searched in the following Korean Intellectual Property Office English website for six months(expire date : **2014.10.24**) from the date of mailing of the international search report.

<http://www.kipo.go.kr/en/> => PCT Services => PCT Services

ID : PCT international application number

PW : **Z92JGD54**

Inquiries related to PCT International Search Report or Written Opinion prepared by KIPO as an International Searching Authority can be answered not only by KIPO but also through IPKC (Intellectual Property Korea Center), located in Vienna, VA, which functions as a PCT Help Desk for PCT applicants.

Homepage: <http://www.ipkcenter.com>

Email: ipkc@ipkcenter.com

PATENT COOPERATION TREATY

PCT

INTERNATIONAL SEARCH REPORT

(PCT Article 18 and Rules 43 and 44)

Applicant's or agent's file reference OMNI0101PCT	FOR FURTHER ACTION see Form PCT/ISA/220 as well as, where applicable, item 5 below.	
International application No. PCT/US2013/075700	International filing date (<i>day/month/year</i>) 17 December 2013 (17.12.2013)	(Earliest) Priority Date (<i>day/month/year</i>) 31 December 2012 (31.12.2012)
Applicant OMNI MEDSCI, INC.		

This International search report has been prepared by this International Searching Authority and is transmitted to the applicant according to Article 18. A copy is being transmitted to the International Bureau.

This international search report consists of a total of 4 sheets.

It is also accompanied by a copy of each prior art document cited in this report.

1. **Basis of the report**

a. With regard to the **language**, the international search was carried out on the basis of:

- the international application in the language in which it was filed
 a translation of the international application into _____, which is the language of a translation furnished for the purposes of international search (Rules 12.3(a) and 23.1(b))

b. This international search report has been established taking into account the **rectification of an obvious mistake** authorized by or notified to this Authority under Rule 91 (Rule 43.6bis(a)).

c. With regard to any **nucleotide and/or amino acid sequence** disclosed in the international application, see Box No. I.

2. **Certain claims were found unsearchable** (See Box No. II)

3. **Unity of invention is lacking** (See Box No. III)

4. With regard to the **title**,

- the text is approved as submitted by the applicant.
 the text has been established by this Authority to read as follows:

5. With regard to the **abstract**,

- the text is approved as submitted by the applicant.
 the text has been established, according to Rule 38.2, by this Authority as it appears in Box No. IV. The applicant may, within one month from the date of mailing of this international search report, submit comments to this Authority.

6. With regard to the **drawings**,

- a. the figure of the **drawings** to be published with the abstract is Figure No. 1
 as suggested by the applicant.
 as selected by this Authority, because the applicant failed to suggest a figure.
 as selected by this Authority, because this figure better characterizes the invention.
- b. none of the figures is to be published with the abstract.

INTERNATIONAL SEARCH REPORT

International application No.
PCT/US2013/075700**A. CLASSIFICATION OF SUBJECT MATTER****A61B 5/1477(2006.01)i**

According to International Patent Classification (IPC) or to both national classification and IPC

B. FIELDS SEARCHED

Minimum documentation searched (classification system followed by classification symbols)

A61B 5/1477; G06F 15/42; A61B 18/22; A61B 6/00; A61B 5/1455; A61B 5/00

Documentation searched other than minimum documentation to the extent that such documents are included in the fields searched

Korean utility models and applications for utility models

Japanese utility models and applications for utility models

Electronic data base consulted during the international search (name of data base and, where practicable, search terms used)

eKOMPASS(KIPO internal) & Keywords: near-infrared, laser, diagnosis, non-invasive, tooth, glucose and blood

C. DOCUMENTS CONSIDERED TO BE RELEVANT

Category*	Citation of document, with indication, where appropriate, of the relevant passages	Relevant to claim No.
X	US 2012-0239013 A1 (ISLAM, MOHAMMED N.) 20 September 2012 See abstract, paragraphs [0004]-[0015], [0059], [0136]-[0139], claims 30-40, and figures 7, 19-20.	1-20
A	US 2007-0021670 A1 (MANDELIS, ANDREAS et al.) 25 January 2007 See abstract, claims 1-28, and figure 1.	1-20
A	US 2011-0282167 A1 (RIDDER, TRENT et al.) 17 November 2011 See abstract, and claims 1-18.	1-20
A	US 5267152 A (YANG, WON S. et al.) 30 November 1993 See abstract, claim 1-3, and figure 1.	1-20
A	US 7356364 B1 (BULLOCK, AUDRA M. et al.) 08 April 2008 See abstract, and claims 14-20.	1-20

 Further documents are listed in the continuation of Box C. See patent family annex.

* Special categories of cited documents:

"A" document defining the general state of the art which is not considered to be of particular relevance

"E" earlier application or patent but published on or after the international filing date

"L" document which may throw doubts on priority claim(s) or which is cited to establish the publication date of another citation or other special reason (as specified)

"O" document referring to an oral disclosure, use, exhibition or other means

"P" document published prior to the international filing date but later than the priority date claimed

"T" later document published after the international filing date or priority date and not in conflict with the application but cited to understand the principle or theory underlying the invention

"X" document of particular relevance; the claimed invention cannot be considered novel or cannot be considered to involve an inventive step when the document is taken alone

"Y" document of particular relevance; the claimed invention cannot be considered to involve an inventive step when the document is combined with one or more other such documents, such combination being obvious to a person skilled in the art

"&" document member of the same patent family

Date of the actual completion of the international search

23 April 2014 (23.04.2014)

Date of mailing of the international search report

24 April 2014 (24.04.2014)

Name and mailing address of the ISA/KR

 International Application Division
 Korean Intellectual Property Office
 189 Cheongso-ro, Seo-gu, Daejeon Metropolitan City, 302-701,
 Republic of Korea

Facsimile No. +82-42-472-7140

Authorized officer

CHOI, Sang Won

Telephone No. +82-42-481-8291



INTERNATIONAL SEARCH REPORT

Information on patent family members

International application No.

PCT/US2013/075700

Patent document cited in search report	Publication date	Patent family member(s)	Publication date		
US 2012-0239013 A1	20/09/2012	CA 2623380 A1	31/05/2007		
		CA 2623380 C	11/02/2014		
		EP 1949151 A2	30/07/2008		
		EP 1949151 A4	06/11/2013		
		US 2009-0028193 A1	29/01/2009		
		US 2009-0204110 A1	13/08/2009		
		US 2014-0001364 A1	02/01/2014		
		US 7519253 B2	14/04/2009		
		US 8055108 B2	08/11/2011		
		US 8391660 B2	05/03/2013		
		WO 2007-061732 A2	31/05/2007		
		WO 2007-061732 A3	28/02/2008		
		US 2007-0021670 A1	25/01/2007	AU 2006-272332 A1	25/01/2007
				AU 2006-272332 B2	01/11/2012
BR PI0613428 A2	30/10/2012				
CA 2615017 A1	25/01/2007				
CN 101262822 A	10/09/2008				
CN 101262822 B	20/11/2013				
EP 1906835 A1	09/04/2008				
EP 1906835 A4	31/07/2013				
IL 138747 D0	07/08/2008				
JP 2009-501579 A	22/01/2009				
JP 2013-172975 A	05/09/2013				
KR 10-2008-0051129 A	10/06/2008				
NZ 565509 A	26/08/2011				
US 8306608 B2	06/11/2012				
WO 2007-009234 A1	25/01/2007				
ZA 200801139 A	31/12/2008				
US 2011-0282167 A1	17/11/2011	CN 102365047 A	29/02/2012		
		EP 2389100 A1	30/11/2011		
		EP 2389100 A4	22/05/2013		
		JP 2012-515630 A	12/07/2012		
		US 2010-0010325 A1	14/01/2010		
		US 8174394 B2	08/05/2012		
		WO 2010-085716 A1	29/07/2010		
US 5267152 A	30/11/1993	CN 1025410 C	13/07/1994		
		CN 1051297 A	15/05/1991		
		CN 1051297 C0	01/05/1994		
		EP 0426358 A1	08/05/1991		
		EP 0426358 B1	12/05/1999		
		JP 03-146032 A	21/06/1991		
		JP 05-081253 B	12/11/1993		
		JP 10-000181 U	25/08/1998		
		JP 2588468 Y2	30/10/1998		
		KR 10-1992-0002091 A	28/02/1992		
		KR 10-1993-0011586 B1	13/12/1993		

INTERNATIONAL SEARCH REPORT
Information on patent family members

International application No.
PCT/US2013/075700

Patent document cited in search report	Publication date	Patent family member(s)	Publication date
US 7356364 B1	08/04/2008	None	

PATENT COOPERATION TREATY

From the
INTERNATIONAL SEARCHING AUTHORITY

To:
BIR, DAVID S.

BROOKS KUSHMAN P.C. 1000 TOWN CENTER
TWENTY-SECOND FLOOR SOUTHFIELD MI 48075 USA

PCT

WRITTEN OPINION OF THE
INTERNATIONAL SEARCHING AUTHORITY

(PCT Rule 43bis.1)

Date of mailing
(day/month/year) **24 April 2014 (24.04.2014)**

Applicant's or agent's file reference
OMNI0101PCT

FOR FURTHER ACTION
See paragraph 2 below

International application No.
PCT/US2013/075700

International filing date (day/month/year)
17 December 2013 (17.12.2013)

Priority date(day/month/year)
31 December 2012 (31.12.2012)

International Patent Classification (IPC) or both national classification and IPC
A61B 5/1477(2006.01)I

Applicant
OMNI MEDSCI, INC.

1. This opinion contains indications relating to the following items:



- Box No. I Basis of the opinion
- Box No. II Priority
- Box No. III Non-establishment of opinion with regard to novelty, inventive step and industrial applicability
- Box No. IV Lack of unity of invention
- Box No. V Reasoned statement under Rule 43bis.1(a)(i) with regard to novelty, inventive step and industrial applicability; citations and explanations supporting such statement
- Box No. VI Certain documents cited
- Box No. VII Certain defects in the international application
- Box No. VIII Certain observations on the international application

2. FURTHER ACTION

If a demand for international preliminary examination is made, this opinion will be considered to be a written opinion of the International Preliminary Examining Authority ("IPEA") except that this does not apply where the applicant chooses an Authority other than this one to be the IPEA and the chosen IPEA has notified the International Bureau under Rule 66.1bis(b) that written opinions of this International Searching Authority will not be so considered.

If this opinion is, as provided above, considered to be a written opinion of the IPEA, the applicant is invited to submit to the IPEA a written reply together, where appropriate, with amendments, before the expiration of 3 months from the date of mailing of Form PCT/ISA/220 or before the expiration of 22 months from the priority date, whichever expires later.

For further options, see Form PCT/ISA/220.

<p>Name and mailing address of the ISA/KR International Application Division Korean Intellectual Property Office 189 Cheongsan-ro, Seo-gu, Daejeon Metropolitan City, 302-701, Republic of Korea Facsimile No. +82-42-472-7140</p> 	<p>Date of completion of this opinion 23 April 2014 (23.04.2014)</p>	<p>Authorized officer CHOI, Sang Won Telephone No. +82-42-481-8291</p> 
--	---	--

WRITTEN OPINION OF THE
INTERNATIONAL SEARCHING AUTHORITY

International application No.
PCT/US2013/075700

Box No. I Basis of this opinion

1. With regard to the **language**, this opinion has been established on the basis of :
 - the international application in the language in which it was filed
 - a translation of the international application into _____ which is the language of a translation furnished for the purposes of international search (Rules 12.3(a) and 23.1(b))
2. This opinion has been established taking into account the **rectification of an obvious mistake** authorized by or notified to this Authority under Rule 91 (Rule 43*bis*.1(a))
3. With regard to any **nucleotide and/or amino acid sequence** disclosed in the international application, this opinion has been established on the basis of a sequence listing filed or furnished:
 - a. (means)
 - on paper
 - in electronic form
 - b. (time)
 - in the international application as filed.
 - together with the international application in electronic form.
 - subsequently to this Authority for the purposes of search.
4. In addition, in the case that more than one version or copy of a sequence listing has been filed or furnished, the required statements that the information in the subsequent or additional copies is identical to that in the application as filed or does not go beyond the application as filed, as appropriate, were furnished.
5. Additional comments:

**WRITTEN OPINION OF THE
INTERNATIONAL SEARCHING AUTHORITY**

International application No.
PCT/US2013/075700

Box No. V Reasoned statement under Rule 43bis.1(a)(i) with regard to novelty, inventive step or industrial applicability; citations and explanations supporting such statement

1. Statement

Novelty (N)	Claims	1-20	YES
	Claims	NONE	NO
Inventive step (IS)	Claims	NONE	YES
	Claims	1-20	NO
Industrial applicability (IA)	Claims	1-20	YES
	Claims	NONE	NO

2. Citations and explanations :

Reference is made to the following document:

D1: US 2012-0239013 A1 (ISLAM, MOHAMMED N.) 20 September 2012

1. Novelty and Inventive Step

1.1. Claim 1

The subject-matter of claim 1 relates to a diagnostic system comprising:

(a) a light source configured to generate an output optical beam, comprising: (a-1) semiconductor sources configured to generate an input beam; (a-2) optical amplifiers configured to receive at least a portion of the input beam and to deliver an intermediate beam to an output end of the optical fibers; (a-3) optical fibers configured to receive at least a portion of the intermediate beam and to deliver the portion of the intermediate beam to a distal end of the optical fibers to form a first optical beam; and (a-4) a nonlinear element configured to receive at least a portion of the first optical beam and to broaden a spectrum associated with the at least a portion of the first optical beam to at least 10nm through a nonlinear effect in the nonlinear element to form the output optical beam with an output beam broadened spectrum, wherein a portion of the output beam broadened spectrum comprises a short-wave infrared wavelength approximately 1400-2500 nm, and wherein a portion of the one of more fibers is a fused silica fiber with a core diameter less than approximately 400 microns; (b) an interface device configured to receive a received portion of the output optical beam and to deliver portion of the output optical beam to a sample, wherein the delivered portion of the output optical beam is configured to generate a spectroscopy output beam from the sample; and (c) a receiver configured to receive at least a portion of the spectroscopy output beam having a bandwidth of 10nm and to process the portion of the spectroscopy output beam to generate an output signal representing at least in part a property of hydro-carbon bonds.

D1, which is considered to be the closest prior art to the subject matter of claim 1, discloses an optical system for use in a medical procedure, the system comprising: (a-1') a plurality of semiconductor laser diodes, each of the diodes

Continued on Supplemental Box

WRITTEN OPINION OF THE
INTERNATIONAL SEARCHING AUTHORITY

International application No.

PCT/US2013/075700

Supplemental Box

In case the space in any of the preceding boxes is not sufficient.
Continuation of: Box No. V

being capable of generating an optical beam that is optically coupled to a beam combiner; (a-3') a first stage optical fiber optically coupled to the beam combiner and (a-2') optical amplifiers, wherein the first stage optical fiber receives the optical beams and forms a corresponding pump beam having a wavelength range between approximately 1700 nm and 1750 nm; (a-3') a second stage light guide optically coupled to the first stage optical fiber, the second stage light guide adapted to propagate the pump beam; and (b') a lens subsystem adapted to receive and deliver at least a portion of the pump beam to target portions of tissue (see claims 35 and 39 and paragraph [0007]). D1 further discloses that the optical system can be chemical sensing systems comprising (c') a detection system collecting at least a fraction of the light and being coupled to the detector and a receiver for sensing characteristic of specific types of chemical bonds (see paragraphs [0136]-[0137]) and that the first fiber can be made fused silica (see paragraph [0011]) and is coupled to (a-4') a nonlinear element which is capable of broadening the pump optical spectral width to at least 100 nm through a nonlinear effect in the element (see paragraph [0007]).

Claim 1 differs from D1 in that the optical fibers are the fused silica fiber with the core diameter 400 microns. However, the diameter of the fiber can be easily optimized by repeated experiments practiced by a person skilled in the art. Accordingly, a person skilled in the art would easily conceive the idea of employing the feature of claim 1. Therefore, claim 1 lacks an inventive step under PCT Article 33(3).

1.2. Claims 2-5

Claims 2-5 are dependent on claim 1.

Claim 2 further comprises the interface device further comprising a replaceable insert. The additional feature of claim 2 is merely a matter of design option when the general technical knowledge about the state of the art is used. Accordingly, claim 2 would have been obvious over D1. Therefore, claim 2 lacks an inventive step under PCT Article 33(3).

Claim 3 further comprises the sample comprising at least in part enamel, dentine and blood and the output signal representing at least in part a property of the blood. The additional feature of claim 3 is considered to be a minor difference over the disclosure of D1 that the target portions of tissue comprise protein, amino acids, or amide groups, which falls under the general knowledge of a person skilled in the art (see claim 36). Accordingly, claim 3 would have been obvious over D1. Therefore, claim 3 lacks an inventive step under PCT Article 33(3).

Continued on The Next Page

WRITTEN OPINION OF THE
INTERNATIONAL SEARCHING AUTHORITY

International application No.

PCT/US2013/075700

Supplemental Box

In case the space in any of the preceding boxes is not sufficient.
Continuation of: Previous Page

Claim 4 further comprises the input beam comprising a repetition rate approximately 1kHz-100MHz. The additional feature of claim 4 can be easily optimized by repeated experiments practiced by a person skilled in the art, considering that at least the portion of the pump beam has a repetition rate between continuous wave and several Megahertz (see claim 35 in D1). Accordingly, claim 4 would have been obvious over D1. Therefore, claim 4 lacks an inventive step under PCT Article 33(3).

Claim 5 further comprises the receiver further comprising a wireless transmitter configured to communicate a wireless signal associated with the output signal to a network. The additional feature of claim 5 is considered to be a minor difference over the disclosure of D1 in that the optical fibers include super-continuum (SC) generation (see paragraph [0004]) and that a chemical sensing system using an SC light source may lead remote detection of chemical species (see paragraphs [0138]-[0139]), which falls under the general knowledge of a person skilled in the art. Accordingly, a person skilled in the art would easily conceive the idea of employing the feature of claim 5. Therefore, claim 5 lacks an inventive step under PCT Article 33(3).

1.3. Claim 6

Claim 6 relates to a measurement system comprising: (a) a light source generating an output optical beam, comprising (a-1) a plurality of semiconductor sources generating an input optical beam, (a-2) a multiplexer configured to receive at least a portion of the input optical beam and to form an intermediate optical beam, and (a-3) one or more fibers configured to receive at least a portion of the intermediate optical beam and to form the output optical beam, wherein the output optical beam comprises one or more optical wavelengths; (b) an interface device configured to receive a received portion of the output optical beam and to deliver a delivered portion of the output optical beam to a sample comprising at least in part enamel, dentine and pulp, wherein the delivered portion of the output optical beam is configured to generate a spectroscopy output beam from the sample; and (c) a receiver configured to receive at least a portion of the spectroscopy output beam and to process the portion of the spectroscopy output beam to generate an output signal representing at least in part a property of blood contained within the pulp.

D1, which is considered to be the closest prior art to the subject matter of claim 6, discloses an optical system for use in a medical procedure, the system comprising: (a-1') a plurality of semiconductor laser diodes, each of the diodes being capable of generating an optical beam that is optically coupled to a beam combiner; (a-3') a first stage optical fiber optically coupled to the beam combiner and (a-2') optical amplifiers capable of amplifying the pump signal, wherein the first stage optical fiber receives the optical beams and forms a corresponding pump

Continued on The Next Page

WRITTEN OPINION OF THE
INTERNATIONAL SEARCHING AUTHORITY

International application No.

PCT/US2013/075700

Supplemental Box

In case the space in any of the preceding boxes is not sufficient,
Continuation of: Previous Page

beam having a wavelength range between approximately 1700 nm and 1750 nm; (a-3'') a second stage light guide optically coupled to the first stage optical fiber, the second stage light guide adapted to propagate the pump beam; and (b') a lens subsystem adapted to receive and deliver at least a portion of the pump beam to target portions of tissue (see claims 35 and 39 and paragraph [0007]). D1 further discloses that the optical system can be a chemical sensing systems comprising (c') a detection system collecting at least a fraction of the light and being coupled to the detector and receiver for sensing characteristic of specific types of chemical bonds (see paragraphs [0136]-[0137]).

Claim 6 differs from D1 in that the light source comprises the multiplexer, that the sample comprises at least in part enamel, dentine and pulp and that the output signal represents at least in part a property of blood contained within the pulp. However, considering that amplified spontaneous emission (ASE) from the amplifier is controlled by an add/drop multiplexer (see paragraph [0059]) and that the target portions of tissue comprise protein, amino acids, or amide groups (see claim 36), such a slight constructional change in the system of D1 comes within the scope of the customary practice followed by a person skilled in the art. Accordingly, a person skilled in the art would easily conceive the idea of employing the feature of claim 6. Therefore, claim 6 lacks an inventive step under PCT Article 33(3).

1.4. Claims 7-11 and 14-16

Claims 7-11, 14-16 are dependent on claim 6.

Claim 7 further comprises the light source comprising a super-continuum laser. The additional feature of claim 7 is a minor difference over the disclosure of D1 in that super-continuum (SC) light source could be used in chemical sensing (see paragraph [0015]), which falls under the general knowledge of a person skilled in the art. Accordingly, claim 7 would have been obvious over D1. Therefore, claim 7 lacks an inventive step under PCT Article 33(3).

Claim 8 further comprises the light source comprising a super-luminescent diode. The additional feature of claim 8 is merely a matter of design option when the general technical knowledge about the state of the art is used. Accordingly, claim 8 would have been obvious over D1. Therefore, claim 8 lacks an inventive step under PCT Article 33(3).

Claim 9 further comprises the light source comprising a light emitting diode. The additional feature of claim 9 is merely a matter of design option when the general technical knowledge about the state of the art is used. Accordingly, claim 9 would have been obvious over D1. Therefore, claim 9 lacks an inventive step under PCT

Continued on The Next Page

WRITTEN OPINION OF THE
INTERNATIONAL SEARCHING AUTHORITY

International application No.

PCT/US2013/075700

Supplemental Box

In case the space in any of the preceding boxes is not sufficient.
Continuation of: Previous Page

Article 33(3).

Claim 10 further comprises at least a portion of the one or more optical wavelengths comprising a short-wave infrared wavelength approximately 1400-2500nm. The additional feature of claim 10 is a minor difference over the disclosure of D1 in that the pump beam wavelength is in a wavelength range between approximately 1700 nm and 1750 nm, which falls under the general knowledge of a person skilled in the art (see claim 39). Accordingly, claim 10 would have been obvious over D1. Therefore, claim 10 lacks an inventive step under PCT Article 33(3).

Claim 11 further comprises the property of the blood comprising a glucose level. The additional feature of claim 11 is merely a matter of design option when the general technical knowledge about the state of the art is used. Accordingly, claim 11 would have been obvious over D1. Therefore, claim 11 lacks an inventive step under PCT Article 33(3).

Claim 14 further comprises the delivered portion of the output optical beam transmitted through the sample. The additional feature of claim 14 is a minor difference over the disclosure of D1 in that the pump beam wavelength is selected to obtain a desired penetration depth (see claim 35), which falls under the general knowledge of a person skilled in the art. Accordingly, claim 14 would have been obvious over D1. Therefore, claim 14 lacks an inventive step under PCT Article 33(3).

Claim 15 further comprises the interface device further comprising a replaceable insert. The additional feature of claim 15 is merely a matter of design option when the general technical knowledge about the state of the art is used. Accordingly, claim 15 would have been obvious over D1. Therefore, claim 15 lacks an inventive step under PCT Article 33(3).

Claim 16 further comprises the receiver configured to process the portion of the spectroscopy output beam using a pattern matching methodology. The additional feature of claim 16 is a minor difference over the disclosure of D1 in that super-continuum (SC) broadband source could be particularly useful for spectral fingerprinting and that the relative magnitudes at different wavelengths or a particular spectral pattern of absorption or reflection can be pattern matched to identify the chemical of interest (see paragraph [0137]), which falls under the general knowledge of a person skilled in the art. Accordingly, claim 16 would have been obvious over D1. Therefore, claim 16 lacks an inventive step under PCT Article 33(3).

Continued on The Next Page

WRITTEN OPINION OF THE
INTERNATIONAL SEARCHING AUTHORITY

International application No.

PCT/US2013/075700

Supplemental Box

In case the space in any of the preceding boxes is not sufficient.
Continuation of: Previous Page

1.5. Claims 12-13

Claims 12-13 are dependent on claim 11.

Claims 12-13 further comprise at least a portion of the one or more optical wavelengths which comprises a short-wave infrared wavelength approximately 1587-1750nm (claim 12) and near 2120nm, 2270nm or 2320 nm (claim 13). Claims 12-13 differ from D1 in the wavelength. However, the selection of the wavelength can be easily optimized by repeated experiments practiced by a person skilled in the art. Accordingly, claims 12-13 would have been obvious over D1. Therefore, claims 12-13 lack an inventive step under PCT Article 33(3).

1.6. Claim 17

Claim 17 relates to a method of measuring comprising: (a) generating an output optical beam, comprising (a-1) generating an input optical beam from a plurality of semiconductor sources, (a-2) multiplexing at least a portion of the input optical beam and forming an intermediate optical beam and (a-3) guiding at least a portion of the intermediate optical beam and forming the output optical beam, wherein the output optical beam comprises one or more optical wavelengths; (b) receiving a received portion of the output optical beam and delivering a delivered portion of the output optical beam to a sample, wherein the sample comprises at least in part enamel, dentine and pulp; (c) generating a spectroscopy output beam from the sample; (d) receiving at least a portion of the spectroscopy output beam; and (e) processing the portion of the spectroscopy output beam and generating an output signal representing at least in part a property of blood contained within the pulp.

D1, which is considered to be the closest prior art to the subject matter of claim 17, discloses a method for performing a medical procedure, the method comprising the steps of: (a') generating one or more optical beams utilizing a plurality of semiconductor laser diodes; (a-1') optically coupling the one or more optical beams to a beam combiner; (a-2') receiving at a first stage optical fiber the one or more optical beams and forming a corresponding pump beam having at least one wavelength; (a-3') propagating the pump beam in a second stage light guide optically coupled to the first stage optical fiber; and (b') receiving and delivering at least a portion of the pump beam with a lens subsystem to target portions of tissue (see claim 30). D1 further discloses that a method of generating broadband light by (c') generating a pump signal comprises broadening the pump optical spectral width to at least 100 nm using a nonlinear effect (see paragraph [0009]).

Claim 17 differs from D1 in the steps of (d) receiving the spectroscopy output beam and (e) processing the portion of the spectroscopy output beam and generating the output signal. Furthermore, claim 17 differs from D1 in that the sample comprises

Continued on The Next Page

WRITTEN OPINION OF THE
INTERNATIONAL SEARCHING AUTHORITY

International application No.

PCT/US2013/075700

Supplemental Box

In case the space in any of the preceding boxes is not sufficient,
Continuation of: Previous Page

enamel, dentine and pulp. However, the steps of (d) receiving and (e) processing are merely matters of design option when the general technical knowledge about the state of the art is used. And the sample comprising at least in part enamel, dentine and pulp is a minor difference over the disclosure of D1 in that the target portions of tissue comprise protein, amino acids, or amide groups (see claim 36), which falls under the general knowledge of a person skilled in the art. Accordingly, claim 17 would have been obvious over D1. Therefore, claim 17 lacks an inventive step under PCT Article 33(3).

1.7. Claims 18-20

Claims 18-20 are dependent on claim 17.

Claim 18 further comprises the one or more optical wavelengths comprising a short-wave infrared wavelength approximately 1400-2500nm. The additional feature of claim 18 is a minor difference over the disclosure of D1 in that the pump beam wavelength is in a wavelength range between approximately 1700 nm and 1750 nm, which falls under the general knowledge of a person skilled in the art (see claim 31). Accordingly, claim 18 would have been obvious over D1. Therefore, claim 18 lacks an inventive step under PCT Article 33(3).

Claim 19 further comprises the property of the blood comprising a glucose level. The additional feature of claim 19 is merely a matter of design option when the general technical knowledge about the state of the art is used. Accordingly, claim 19 would have been obvious over D1. Therefore, claim 19 lacks an inventive step under PCT Article 33(3).

Claim 20 further comprises communicating a wireless signal associated with the output signal to a network. The additional feature of claim 20 is considered to be a minor difference over the disclosure of D1 in that the optical fibers include super-continuum (SC) generation (see paragraph [0004]) and that a chemical sensing system using a SC light source may lead remote detection of chemical species (see paragraphs [0138]-[0139]), which falls under the general knowledge of a person skilled in the art. Accordingly, claim 20 would have been obvious over D1. Therefore, claim 20 lacks an inventive step under PCT Article 33(3).

2. Industrial Applicability

Claims 1-20 are industrially applicable under PCT Article 33(4).

PATENT COOPERATION TREATY

PCT

INTERNATIONAL PRELIMINARY REPORT ON PATENTABILITY

(Chapter I of the Patent Cooperation Treaty)

(PCT Rule 44bis)

Applicant's or agent's file reference OMNI0101PCT	FOR FURTHER ACTION		See item 4 below
International application No. PCT/US2013/075700	International filing date (<i>day/month/year</i>) 17 December 2013 (17.12.2013)	Priority date (<i>day/month/year</i>) 31 December 2012 (31.12.2012)	
International Patent Classification (8th edition unless older edition indicated) See relevant information in Form PCT/ISA/237			
Applicant OMNI MEDSCI, INC.			

- This international preliminary report on patentability (Chapter I) is issued by the International Bureau on behalf of the International Searching Authority under Rule 44 bis.1(a).
- This REPORT consists of a total of 10 sheets, including this cover sheet.

In the attached sheets, any reference to the written opinion of the International Searching Authority should be read as a reference to the international preliminary report on patentability (Chapter I) instead.
- This report contains indications relating to the following items:

<input checked="" type="checkbox"/>	Box No. I	Basis of the report
<input type="checkbox"/>	Box No. II	Priority
<input type="checkbox"/>	Box No. III	Non-establishment of opinion with regard to novelty, inventive step and industrial applicability
<input type="checkbox"/>	Box No. IV	Lack of unity of invention
<input checked="" type="checkbox"/>	Box No. V	Reasoned statement under Article 35(2) with regard to novelty, inventive step or industrial applicability; citations and explanations supporting such statement
<input type="checkbox"/>	Box No. VI	Certain documents cited
<input type="checkbox"/>	Box No. VII	Certain defects in the international application
<input type="checkbox"/>	Box No. VIII	Certain observations on the international application
- The International Bureau will communicate this report to designated Offices in accordance with Rules 44bis.3(c) and 93bis.1 but not, except where the applicant makes an express request under Article 23(2), before the expiration of 30 months from the priority date (Rule 44bis .2).

	Date of issuance of this report 30 June 2015 (30.06.2015)
The International Bureau of WIPO 34, chemin des Colombettes 1211 Geneva 20, Switzerland	Authorized officer Kihwan Moon
Facsimile No. +41 22 338 82 70	e-mail: pt01.pct@wipo.int

PATENT COOPERATION TREATY

From the
INTERNATIONAL SEARCHING AUTHORITY

PCT

WRITTEN OPINION OF THE
INTERNATIONAL SEARCHING AUTHORITY

(PCT Rule 43bis.1)

To:
BIR, DAVID S.

BROOKS KUSHMAN P.C. 1000 TOWN CENTER
TWENTY-SECOND FLOOR SOUTHFIELD MI 48075 USA

Date of mailing
(day/month/year) **24 April 2014 (24.04.2014)**

Applicant's or agent's file reference
OMNI0101PCT

FOR FURTHER ACTION
See paragraph 2 below

International application No.
PCT/US2013/075700

International filing date (day/month/year)
17 December 2013 (17.12.2013)

Priority date(day/month/year)
31 December 2012 (31.12.2012)

International Patent Classification (IPC) or both national classification and IPC
A61B 5/1477(2006.01)i

Applicant
OMNI MEDSCI, INC.

1. This opinion contains indications relating to the following items:

- Box No. I Basis of the opinion
- Box No. II Priority
- Box No. III Non-establishment of opinion with regard to novelty, inventive step and industrial applicability
- Box No. IV Lack of unity of invention
- Box No. V Reasoned statement under Rule 43bis.1(a)(i) with regard to novelty, inventive step and industrial applicability; citations and explanations supporting such statement
- Box No. VI Certain documents cited
- Box No. VII Certain defects in the international application
- Box No. VIII Certain observations on the international application

2. **FURTHER ACTION**

If a demand for international preliminary examination is made, this opinion will be considered to be a written opinion of the International Preliminary Examining Authority ("IPEA") except that this does not apply where the applicant chooses an Authority other than this one to be the IPEA and the chosen IPEA has notified the International Bureau under Rule 66.1bis(b) that written opinions of this International Searching Authority will not be so considered.

If this opinion is, as provided above, considered to be a written opinion of the IPEA, the applicant is invited to submit to the IPEA a written reply together, where appropriate, with amendments, before the expiration of 3 months from the date of mailing of Form PCT/ISA/220 or before the expiration of 22 months from the priority date, whichever expires later.

For further options, see Form PCT/ISA/220.

Name and mailing address of the ISA/KR
International Application Division
Korean Intellectual Property Office
189 Cheongsa-ro, Seo-gu, Daejeon
Metropolitan City, 302-701, Republic of Korea
Facsimile No. +82-42-472-7140

Date of completion of this opinion

23 April 2014 (23.04.2014)

Authorized officer

CHOI, Sang Won

Telephone No. +82-42-481-8291



WRITTEN OPINION OF THE
INTERNATIONAL SEARCHING AUTHORITY

International application No.
PCT/US2013/075700

Box No. I Basis of this opinion

1. With regard to the **language**, this opinion has been established on the basis of :
 - the international application in the language in which it was filed
 - a translation of the international application into _____ which is the language of a translation furnished for the purposes of international search (Rules 12.3(a) and 23.1(b))
2. This opinion has been established taking into account the **rectification of an obvious mistake** authorized by or notified to this Authority under Rule 91 (Rule 43*bis*.1(a))
3. With regard to any **nucleotide and/or amino acid sequence** disclosed in the international application, this opinion has been established on the basis of a sequence listing filed or furnished:
 - a. (means)
 - on paper
 - in electronic form
 - b. (time)
 - in the international application as filed.
 - together with the international application in electronic form.
 - subsequently to this Authority for the purposes of search.
4. In addition, in the case that more than one version or copy of a sequence listing has been filed or furnished, the required statements that the information in the subsequent or additional copies is identical to that in the application as filed or does not go beyond the application as filed, as appropriate, were furnished.
5. Additional comments:

**WRITTEN OPINION OF THE
INTERNATIONAL SEARCHING AUTHORITY**

International application No.
PCT/US2013/075700

Box No. V Reasoned statement under Rule 43bis.1(a)(i) with regard to novelty, inventive step or industrial applicability; citations and explanations supporting such statement

1. Statement

Novelty (N)	Claims	<u>1-20</u>	YES
	Claims	<u>NONE</u>	NO
Inventive step (IS)	Claims	<u>NONE</u>	YES
	Claims	<u>1-20</u>	NO
Industrial applicability (IA)	Claims	<u>1-20</u>	YES
	Claims	<u>NONE</u>	NO

2. Citations and explanations :

Reference is made to the following document:

D1: US 2012-0239013 A1 (ISLAM, MOHAMMED N.) 20 September 2012

1. Novelty and Inventive Step

1.1. Claim 1

The subject-matter of claim 1 relates to a diagnostic system comprising:

(a) a light source configured to generate an output optical beam, comprising: (a-1) semiconductor sources configured to generate an input beam; (a-2) optical amplifiers configured to receive at least a portion of the input beam and to deliver an intermediate beam to an output end of the optical fibers; (a-3) optical fibers configured to receive at least a portion of the intermediate beam and to deliver the portion of the intermediate beam to a distal end of the optical fibers to form a first optical beam; and (a-4) a nonlinear element configured to receive at least a portion of the first optical beam and to broaden a spectrum associated with the at least a portion of the first optical beam to at least 10nm through a nonlinear effect in the nonlinear element to form the output optical beam with an output beam broadened spectrum, wherein a portion of the output beam broadened spectrum comprises a short-wave infrared wavelength approximately 1400-2500 nm, and wherein a portion of the one of more fibers is a fused silica fiber with a core diameter less than approximately 400 microns; (b) an interface device configured to receive a received portion of the output optical beam and to deliver portion of the output optical beam to a sample, wherein the delivered portion of the output optical beam is configured to generate a spectroscopy output beam from the sample; and (c) a receiver configured to receive at least a portion of the spectroscopy output beam having a bandwidth of 10nm and to process the portion of the spectroscopy output beam to generate an output signal representing at least in part a property of hydro-carbon bonds.

D1, which is considered to be the closest prior art to the subject matter of claim 1, discloses an optical system for use in a medical procedure, the system comprising: (a-1') a plurality of semiconductor laser diodes, each of the diodes

Continued on Supplemental Box

Supplemental Box

In case the space in any of the preceding boxes is not sufficient.

Continuation of: Box No. V

being capable of generating an optical beam that is optically coupled to a beam combiner; (a-3') a first stage optical fiber optically coupled to the beam combiner and (a-2') optical amplifiers, wherein the first stage optical fiber receives the optical beams and forms a corresponding pump beam having a wavelength range between approximately 1700 nm and 1750 nm; (a-3') a second stage light guide optically coupled to the first stage optical fiber, the second stage light guide adapted to propagate the pump beam; and (b') a lens subsystem adapted to receive and deliver at least a portion of the pump beam to target portions of tissue (see claims 35 and 39 and paragraph [0007]). D1 further discloses that the optical system can be chemical sensing systems comprising (c') a detection system collecting at least a fraction of the light and being coupled to the detector and a receiver for sensing characteristic of specific types of chemical bonds (see paragraphs [0136]-[0137]) and that the first fiber can be made fused silica (see paragraph [0011]) and is coupled to (a-4') a nonlinear element which is capable of broadening the pump optical spectral width to at least 100 nm through a nonlinear effect in the element (see paragraph [0007]).

Claim 1 differs from D1 in that the optical fibers are the fused silica fiber with the core diameter 400 microns. However, the diameter of the fiber can be easily optimized by repeated experiments practiced by a person skilled in the art. Accordingly, a person skilled in the art would easily conceive the idea of employing the feature of claim 1. Therefore, claim 1 lacks an inventive step under PCT Article 33(3).

1.2. Claims 2-5

Claims 2-5 are dependent on claim 1.

Claim 2 further comprises the interface device further comprising a replaceable insert. The additional feature of claim 2 is merely a matter of design option when the general technical knowledge about the state of the art is used. Accordingly, claim 2 would have been obvious over D1. Therefore, claim 2 lacks an inventive step under PCT Article 33(3).

Claim 3 further comprises the sample comprising at least in part enamel, dentine and blood and the output signal representing at least in part a property of the blood. The additional feature of claim 3 is considered to be a minor difference over the disclosure of D1 that the target portions of tissue comprise protein, amino acids, or amide groups, which falls under the general knowledge of a person skilled in the art (see claim 36). Accordingly, claim 3 would have been obvious over D1. Therefore, claim 3 lacks an inventive step under PCT Article 33(3).

Continued on The Next Page

Supplemental Box

In case the space in any of the preceding boxes is not sufficient.

Continuation of: Previous Page

Claim 4 further comprises the input beam comprising a repetition rate approximately 1kHz-100MHz. The additional feature of claim 4 can be easily optimized by repeated experiments practiced by a person skilled in the art, considering that at least the portion of the pump beam has a repetition rate between continuous wave and several Megahertz (see claim 35 in D1). Accordingly, claim 4 would have been obvious over D1. Therefore, claim 4 lacks an inventive step under PCT Article 33(3).

Claim 5 further comprises the receiver further comprising a wireless transmitter configured to communicate a wireless signal associated with the output signal to a network. The additional feature of claim 5 is considered to be a minor difference over the disclosure of D1 in that the optical fibers include super-continuum (SC) generation (see paragraph [0004]) and that a chemical sensing system using an SC light source may lead remote detection of chemical species (see paragraphs [0138]-[0139]), which falls under the general knowledge of a person skilled in the art. Accordingly, a person skilled in the art would easily conceive the idea of employing the feature of claim 5. Therefore, claim 5 lacks an inventive step under PCT Article 33(3).

1.3. Claim 6

Claim 6 relates to a measurement system comprising: (a) a light source generating an output optical beam, comprising (a-1) a plurality of semiconductor sources generating an input optical beam, (a-2) a multiplexer configured to receive at least a portion of the input optical beam and to form an intermediate optical beam, and (a-3) one or more fibers configured to receive at least a portion of the intermediate optical beam and to form the output optical beam, wherein the output optical beam comprises one or more optical wavelengths; (b) an interface device configured to receive a received portion of the output optical beam and to deliver a delivered portion of the output optical beam to a sample comprising at least in part enamel, dentine and pulp, wherein the delivered portion of the output optical beam is configured to generate a spectroscopy output beam from the sample; and (c) a receiver configured to receive at least a portion of the spectroscopy output beam and to process the portion of the spectroscopy output beam to generate an output signal representing at least in part a property of blood contained within the pulp.

D1, which is considered to be the closest prior art to the subject matter of claim 6, discloses an optical system for use in a medical procedure, the system comprising: (a-1') a plurality of semiconductor laser diodes, each of the diodes being capable of generating an optical beam that is optically coupled to a beam combiner; (a-3') a first stage optical fiber optically coupled to the beam combiner and (a-2') optical amplifiers capable of amplifying the pump signal, wherein the first stage optical fiber receives the optical beams and forms a corresponding pump

Continued on The Next Page

Supplemental Box

In case the space in any of the preceding boxes is not sufficient.

Continuation of: Previous Page

beam having a wavelength range between approximately 1700 nm and 1750 nm; (a-3'') a second stage light guide optically coupled to the first stage optical fiber, the second stage light guide adapted to propagate the pump beam; and (b') a lens subsystem adapted to receive and deliver at least a portion of the pump beam to target portions of tissue (see claims 35 and 39 and paragraph [0007]). D1 further discloses that the optical system can be a chemical sensing systems comprising (c') a detection system collecting at least a fraction of the light and being coupled to the detector and receiver for sensing characteristic of specific types of chemical bonds (see paragraphs [0136]-[0137]).

Claim 6 differs from D1 in that the light source comprises the multiplexer, that the sample comprises at least in part enamel, dentine and pulp and that the output signal represents at least in part a property of blood contained within the pulp. However, considering that amplified spontaneous emission (ASE) from the amplifier is controlled by an add/drop multiplexer (see paragraph [0059]) and that the target portions of tissue comprise protein, amino acids, or amide groups (see claim 36), such a slight constructional change in the system of D1 comes within the scope of the customary practice followed by a person skilled in the art. Accordingly, a person skilled in the art would easily conceive the idea of employing the feature of claim 6. Therefore, claim 6 lacks an inventive step under PCT Article 33(3).

1.4. Claims 7-11 and 14-16

Claims 7-11, 14-16 are dependent on claim 6.

Claim 7 further comprises the light source comprising a super-continuum laser. The additional feature of claim 7 is a minor difference over the disclosure of D1 in that super-continuum (SC) light source could be used in chemical sensing (see paragraph [0015]), which falls under the general knowledge of a person skilled in the art. Accordingly, claim 7 would have been obvious over D1. Therefore, claim 7 lacks an inventive step under PCT Article 33(3).

Claim 8 further comprises the light source comprising a super-luminescent diode. The additional feature of claim 8 is merely a matter of design option when the general technical knowledge about the state of the art is used. Accordingly, claim 8 would have been obvious over D1. Therefore, claim 8 lacks an inventive step under PCT Article 33(3).

Claim 9 further comprises the light source comprising a light emitting diode. The additional feature of claim 9 is merely a matter of design option when the general technical knowledge about the state of the art is used. Accordingly, claim 9 would have been obvious over D1. Therefore, claim 9 lacks an inventive step under PCT

Continued on The Next Page

Supplemental Box

In case the space in any of the preceding boxes is not sufficient.
Continuation of: Previous Page

Article 33(3).

Claim 10 further comprises at least a portion of the one or more optical wavelengths comprising a short-wave infrared wavelength approximately 1400-2500nm. The additional feature of claim 10 is a minor difference over the disclosure of D1 in that the pump beam wavelength is in a wavelength range between approximately 1700 nm and 1750 nm, which falls under the general knowledge of a person skilled in the art (see claim 39). Accordingly, claim 10 would have been obvious over D1. Therefore, claim 10 lacks an inventive step under PCT Article 33(3).

Claim 11 further comprises the property of the blood comprising a glucose level. The additional feature of claim 11 is merely a matter of design option when the general technical knowledge about the state of the art is used. Accordingly, claim 11 would have been obvious over D1. Therefore, claim 11 lacks an inventive step under PCT Article 33(3).

Claim 14 further comprises the delivered portion of the output optical beam transmitted through the sample. The additional feature of claim 14 is a minor difference over the disclosure of D1 in that the pump beam wavelength is selected to obtain a desired penetration depth (see claim 35), which falls under the general knowledge of a person skilled in the art. Accordingly, claim 14 would have been obvious over D1. Therefore, claim 14 lacks an inventive step under PCT Article 33(3).

Claim 15 further comprises the interface device further comprising a replaceable insert. The additional feature of claim 15 is merely a matter of design option when the general technical knowledge about the state of the art is used. Accordingly, claim 15 would have been obvious over D1. Therefore, claim 15 lacks an inventive step under PCT Article 33(3).

Claim 16 further comprises the receiver configured to process the portion of the spectroscopy output beam using a pattern matching methodology. The additional feature of claim 16 is a minor difference over the disclosure of D1 in that super-continuum (SC) broadband source could be particularly useful for spectral fingerprinting and that the relative magnitudes at different wavelengths or a particular spectral pattern of absorption or reflection can be pattern matched to identify the chemical of interest (see paragraph [0137]), which falls under the general knowledge of a person skilled in the art. Accordingly, claim 16 would have been obvious over D1. Therefore, claim 16 lacks an inventive step under PCT Article 33(3).

Continued on The Next Page

Supplemental Box

In case the space in any of the preceding boxes is not sufficient.

Continuation of: Previous Page

1.5. Claims 12-13

Claims 12-13 are dependent on claim 11.

Claims 12-13 further comprise at least a portion of the one or more optical wavelengths which comprises a short-wave infrared wavelength approximately 1587-1750nm (claim 12) and near 2120nm, 2270nm or 2320 nm (claim 13). Claims 12-13 differ from D1 in the wavelength. However, the selection of the wavelength can be easily optimized by repeated experiments practiced by a person skilled in the art. Accordingly, claims 12-13 would have been obvious over D1. Therefore, claims 12-13 lack an inventive step under PCT Article 33(3).

1.6. Claim 17

Claim 17 relates to a method of measuring comprising: (a) generating an output optical beam, comprising (a-1) generating an input optical beam from a plurality of semiconductor sources, (a-2) multiplexing at least a portion of the input optical beam and forming an intermediate optical beam and (a-3) guiding at least a portion of the intermediate optical beam and forming the output optical beam, wherein the output optical beam comprises one or more optical wavelengths; (b) receiving a received portion of the output optical beam and delivering a delivered portion of the output optical beam to a sample, wherein the sample comprises at least in part enamel, dentine and pulp; (c) generating a spectroscopy output beam from the sample; (d) receiving at least a portion of the spectroscopy output beam; and (e) processing the portion of the spectroscopy output beam and generating an output signal representing at least in part a property of blood contained within the pulp.

D1, which is considered to be the closest prior art to the subject matter of claim 17, discloses a method for performing a medical procedure, the method comprising the steps of: (a') generating one or more optical beams utilizing a plurality of semiconductor laser diodes; (a-1') optically coupling the one or more optical beams to a beam combiner; (a-2') receiving at a first stage optical fiber the one or more optical beams and forming a corresponding pump beam having at least one wavelength; (a-3') propagating the pump beam in a second stage light guide optically coupled to the first stage optical fiber; and (b') receiving and delivering at least a portion of the pump beam with a lens subsystem to target portions of tissue (see claim 30). D1 further discloses that a method of generating broadband light by (c') generating a pump signal comprises broadening the pump optical spectral width to at least 100 nm using a nonlinear effect (see paragraph [0009]).

Claim 17 differs from D1 in the steps of (d) receiving the spectroscopy output beam and (e) processing the portion of the spectroscopy output beam and generating the output signal. Furthermore, claim 17 differs from D1 in that the sample comprises

Continued on The Next Page

Supplemental Box

In case the space in any of the preceding boxes is not sufficient.

Continuation of: Previous Page

enamel, dentine and pulp. However, the steps of (d) receiving and (e) processing are merely matters of design option when the general technical knowledge about the state of the art is used. And the sample comprising at least in part enamel, dentine and pulp is a minor difference over the disclosure of D1 in that the target portions of tissue comprise protein, amino acids, or amide groups (see claim 36), which falls under the general knowledge of a person skilled in the art. Accordingly, claim 17 would have been obvious over D1. Therefore, claim 17 lacks an inventive step under PCT Article 33(3).

1.7. Claims 18-20

Claims 18-20 are dependent on claim 17.

Claim 18 further comprises the one or more optical wavelengths comprising a short-wave infrared wavelength approximately 1400-2500nm. The additional feature of claim 18 is a minor difference over the disclosure of D1 in that the pump beam wavelength is in a wavelength range between approximately 1700 nm and 1750 nm, which falls under the general knowledge of a person skilled in the art (see claim 31). Accordingly, claim 18 would have been obvious over D1. Therefore, claim 18 lacks an inventive step under PCT Article 33(3).

Claim 19 further comprises the property of the blood comprising a glucose level. The additional feature of claim 19 is merely a matter of design option when the general technical knowledge about the state of the art is used. Accordingly, claim 19 would have been obvious over D1. Therefore, claim 19 lacks an inventive step under PCT Article 33(3).

Claim 20 further comprises communicating a wireless signal associated with the output signal to a network. The additional feature of claim 20 is considered to be a minor difference over the disclosure of D1 in that the optical fibers include super-continuum (SC) generation (see paragraph [0004]) and that a chemical sensing system using a SC light source may lead remote detection of chemical species (see paragraphs [0138]-[0139]), which falls under the general knowledge of a person skilled in the art. Accordingly, claim 20 would have been obvious over D1. Therefore, claim 20 lacks an inventive step under PCT Article 33(3).

2. Industrial Applicability

Claims 1-20 are industrially applicable under PCT Article 33(4).

Electronic Petition Request	TERMINAL DISCLAIMER TO OBIVIATE A DOUBLE PATENTING REJECTION OVER A "PRIOR" PATENT
Application Number	14875709
Filing Date	06-Oct-2015
First Named Inventor	Mohammed Islam
Attorney Docket Number	OMNI 0105 PUSP1
Title of Invention	SHORT-WAVE INFRARED SUPER-CONTINUUM LASERS FOR DETECTING COUNTERFEIT OR ILLICIT DRUGS AND PHARMACEUTICAL PROCESS CONTROL

- Filing of terminal disclaimer does not obviate requirement for response under 37 CFR 1.111 to outstanding Office Action
- This electronic Terminal Disclaimer is not being used for a Joint Research Agreement.

Owner	Percent Interest
OMNI MEDSCI, INC.	100%

The owner(s) with percent interest listed above in the instant application hereby disclaims, except as provided below, the terminal part of the statutory term of any patent granted on the instant application which would extend beyond the expiration date of the full statutory term of prior patent number(s)

9164032

as the term of said prior patent is presently shortened by any terminal disclaimer. The owner hereby agrees that any patent so granted on the instant application shall be enforceable only for and during such period that it and the prior patent are commonly owned. This agreement runs with any patent granted on the instant application and is binding upon the grantee, its successors or assigns.

In making the above disclaimer, the owner does not disclaim the terminal part of the term of any patent granted on the instant application that would extend to the expiration date of the full statutory term of the prior patent, "as the term of said prior patent is presently shortened by any terminal disclaimer," in the event that said prior patent later:

- expires for failure to pay a maintenance fee;
- is held unenforceable;
- is found invalid by a court of competent jurisdiction;
- is statutorily disclaimed in whole or terminally disclaimed under 37 CFR 1.321;
- has all claims canceled by a reexamination certificate;
- is reissued; or
- is in any manner terminated prior to the expiration of its full statutory term as presently shortened by any terminal disclaimer.

Terminal disclaimer fee under 37 CFR 1.20(d) is included with Electronic Terminal Disclaimer request.

I certify, in accordance with 37 CFR 1.4(d)(4), that the terminal disclaimer fee under 37 CFR 1.20(d) required for this terminal disclaimer has already been paid in the above-identified application.

Applicant claims the following fee status:

- Small Entity
- Micro Entity
- Regular Undiscounted

I hereby declare that all statements made herein of my own knowledge are true and that all statements made on information and belief are believed to be true; and further that these statements were made with the knowledge that willful false statements and the like so made are punishable by fine or imprisonment, or both, under Section 1001 of Title 18 of the United States Code and that such willful false statements may jeopardize the validity of the application or any patent issued thereon.

THIS PORTION MUST BE COMPLETED BY THE SIGNATORY OR SIGNATORIES

I certify, in accordance with 37 CFR 1.4(d)(4) that I am:

- An attorney or agent registered to practice before the Patent and Trademark Office who is of record in this application

Registration Number 38383
- A sole inventor
- A joint inventor; I certify that I am authorized to sign this submission on behalf of all of the inventors as evidenced by the power of attorney in the application
- A joint inventor; all of whom are signing this request

Signature	/David S. Bir/
Name	David S. Bir

*Statement under 37 CFR 3.73(b) is required if terminal disclaimer is signed by the assignee (owner).
Form PTO/SB/96 may be used for making this certification. See MPEP § 324.

Electronic Patent Application Fee Transmittal

Application Number:	14875709			
Filing Date:	06-Oct-2015			
Title of Invention:	SHORT-WAVE INFRARED SUPER-CONTINUUM LASERS FOR DETECTING COUNTERFEIT OR ILLICIT DRUGS AND PHARMACEUTICAL PROCESS CONTROL			
First Named Inventor/Applicant Name:	Mohammed N. Islam			
Filer:	David S. Bir			
Attorney Docket Number:	OMNI 0105 PUSP1			
Filed as Small Entity				
Filing Fees for Utility under 35 USC 111(a)				
Description	Fee Code	Quantity	Amount	Sub-Total in USD(\$)
Basic Filing:				
Statutory or Terminal Disclaimer	2814	1	160	160
Pages:				
Claims:				
Miscellaneous-Filing:				
Petition:				
Patent-Appeals-and-Interference:				
Post-Allowance-and-Post-Issuance:				

Description	Fee Code	Quantity	Amount	Sub-Total in USD(\$)
Extension-of-Time:				
Miscellaneous:				
Total in USD (\$)				160

Doc Code: DISQ.E.FILE

Document Description: Electronic Terminal Disclaimer – Approved

Application No.: 14875709

Filing Date: 06-Oct-2015

Applicant/Patent under Reexamination: Islam et al.

Electronic Terminal Disclaimer filed on July 6, 2016

APPROVED

This patent is subject to a terminal disclaimer

DISAPPROVED

Approved/Disapproved by: Electronic Terminal Disclaimer automatically approved by EFS-Web

U.S. Patent and Trademark Office

Electronic Acknowledgement Receipt

EFS ID:	26267267
Application Number:	14875709
International Application Number:	
Confirmation Number:	7496
Title of Invention:	SHORT-WAVE INFRARED SUPER-CONTINUUM LASERS FOR DETECTING COUNTERFEIT OR ILLICIT DRUGS AND PHARMACEUTICAL PROCESS CONTROL
First Named Inventor/Applicant Name:	Mohammed N. Islam
Customer Number:	109543
Filer:	David S. Bir
Filer Authorized By:	
Attorney Docket Number:	OMNI 0105 PUSP1
Receipt Date:	06-JUL-2016
Filing Date:	06-OCT-2015
Time Stamp:	13:43:12
Application Type:	Utility under 35 USC 111(a)

Payment information:

Submitted with Payment	yes
Payment Type	Deposit Account
Payment was successfully received in RAM	\$160
RAM confirmation Number	11144
Deposit Account	023978
Authorized User	BIR, DAVID S.

The Director of the USPTO is hereby authorized to charge indicated fees and credit any overpayment as follows:

Charge any Additional Fees required under 37 CFR 1.16 (National application filing, search, and examination fees)

Charge any Additional Fees required under 37 CFR 1.17 (Patent application and reexamination processing fees)

--	--	--	--	--	--

File Listing:

Document Number	Document Description	File Name	File Size(Bytes)/ Message Digest	Multi Part /.zip	Pages (if appl.)
1	Electronic Terminal Disclaimer-Filed	eTerminal-Disclaimer.pdf	33577	no	2
			7b8826c29299fc83a86b8bd69b3996dc48212488		

Warnings:

Information:

2	Fee Worksheet (SB06)	fee-info.pdf	30467	no	2
			9f9ec3fdce950455489d277615dbcdeb1a241c78		

Warnings:

Information:

Total Files Size (in bytes):	64044
-------------------------------------	-------

This Acknowledgement Receipt evidences receipt on the noted date by the USPTO of the indicated documents, characterized by the applicant, and including page counts, where applicable. It serves as evidence of receipt similar to a Post Card, as described in MPEP 503.

New Applications Under 35 U.S.C. 111

If a new application is being filed and the application includes the necessary components for a filing date (see 37 CFR 1.53(b)-(d) and MPEP 506), a Filing Receipt (37 CFR 1.54) will be issued in due course and the date shown on this Acknowledgement Receipt will establish the filing date of the application.

National Stage of an International Application under 35 U.S.C. 371

If a timely submission to enter the national stage of an international application is compliant with the conditions of 35 U.S.C. 371 and other applicable requirements a Form PCT/DO/EO/903 indicating acceptance of the application as a national stage submission under 35 U.S.C. 371 will be issued in addition to the Filing Receipt, in due course.

New International Application Filed with the USPTO as a Receiving Office

If a new international application is being filed and the international application includes the necessary components for an international filing date (see PCT Article 11 and MPEP 1810), a Notification of the International Application Number and of the International Filing Date (Form PCT/RO/105) will be issued in due course, subject to prescriptions concerning national security, and the date shown on this Acknowledgement Receipt will establish the international filing date of the application.

IN THE UNITED STATES PATENT AND TRADEMARK OFFICE

In re application of:

Mohammed N. ISLAM

Serial No.: 14/875,709

Filed: October 06, 2015

For: SHORT-WAVE INFRARED SUPER-CONTINUUM LASERS
FOR DETECTING COUNTERFEIT OR ILLICIT DRUGS AND
PHARMACEUTICAL PROCESS CONTROL

Group Art Unit: 2884

Examiner: Fein, Abra S.

Attorney Docket No.: OMNI 0105 PUSP1

AMENDMENT UNDER 37 C.F.R. § 1.111

Mail Stop Amendment
Commissioner for Patents
U.S. Patent and Trademark Office
P.O. Box 1450
Alexandria, VA 22313-1450

Commissioner:

In response to the Office Action mailed May 26, 2016, please amend the above-identified application as follows:

Amendments to the Specification:

Please amend Paragraphs [0015] – [0016] as shown below:

[0015] In another embodiment, a measurement system includes a light source comprising a plurality of semiconductor sources that are light emitting diodes, the light emitting diodes configured to generate an output optical beam with one or more optical wavelengths, wherein at least a portion of the one or more optical wavelengths is a near-infrared wavelength between 700 nanometers and 2500 nanometers. The light source is configured to increase signal-to-noise ratio by increasing a light intensity from at least one of the plurality of semiconductor sources and by increasing a pulse rate of at least one of the plurality of semiconductor sources. A measurement ~~An apparatus comprising a plurality of lenses is configured to receive a received-portion of the output optical beam and to deliver to a sample an analysis output beam to a sample, which is a delivered portion of the output optical beam; and a~~ A receiver is configured to receive and process at least a portion of the analysis output beam reflected or transmitted from the sample and to generate an output signal. The system includes a personal device comprising a wireless receiver, a wireless transmitter, a display, a microphone, a speaker, one or more buttons or knobs, a microprocessor and a touch screen, the personal device configured to receive and process at least a portion of the output signal, wherein the personal device is configured to store and display the processed output signal, and wherein at least a portion of the processed output signal is configured to be transmitted over a wireless transmission link, and a remote device configured to receive over the wireless transmission link a received output status comprising the at least a portion of the processed output signal, ~~to buffer the received output status, to process the received output status to generate processed data and to store the processed data.~~

[0016] Other embodiments may include a measurement system comprising a wearable measurement device for measuring one or more physiological parameters, including a light source comprising a plurality of semiconductor sources that are light emitting diodes, the light emitting diodes configured to generate an output optical beam with one or more optical wavelengths, wherein at least a portion of the one or more optical wavelengths is a near-infrared wavelength between 700 nanometers and 2500 nanometers. The light source is configured to increase signal-to-noise ratio by increasing a light intensity from at least one of the plurality of semiconductor sources and by increasing a pulse rate of at least one of the plurality of

semiconductor sources. The wearable measurement device comprises a plurality of lenses is configured to receive a ~~received~~ portion of the output optical beam and to deliver ~~to a sample~~ an analysis output beam to a sample, ~~which is a delivered portion of the output optical beam~~. The wearable measurement device further comprises a receiver configured to receive and process at least a portion of the analysis output beam reflected or transmitted from the sample and to generate an output signal. The system also includes a personal device comprising a wireless receiver, a wireless transmitter, a display, a microphone, a speaker, one or more buttons or knobs, a microprocessor and a touch screen, the personal device configured to receive and process at least a portion of the output signal, wherein the personal device is configured to store and display the processed output signal, and wherein at least a portion of the processed output signal is configured to be transmitted over a wireless transmission ~~link-link~~ and. The system also includes a remote device configured to receive over the wireless transmission link a received output status comprising the at least a portion of the processed output signal, ~~to buffer the received output status~~, to process the received output status to generate processed data and to store the processed data, ~~and~~ wherein the remote device is capable of storing a history of at least a portion of the received output status over a specified period of time.

Please amend Paragraphs [0116]- [0117] as shown below:

[0116] In a particular embodiment 2400 illustrated in Figure 24, the physiological measurement device or non-invasive blood constituent measurement device 2401 may comprise a transmitter 2403 to communicate over a first communication link 2404 in the body area network or personal area network to a receiver in a smart phone, tablet cell phone, PDA, or computer 2405. For the measurement device 2401, it may also be advantageous to have a processor 2402 to process some of the physiological data, since with processing the amount of data to transmit may be less (hence, more energy efficient). The first communication link 2404 may operate through the use of one of many wireless technologies such as ~~Bluetooth, Zigbee, WiFi, IrDA (infrared data association), wireless USB, or Z-wave~~ BLUETOOTH, ZIGBEE, WI-FI, IRDA (infrared data association), wireless USB, or Z-WAVE, to name a few. Alternatively, the communication link 2404 may occur in the wireless medical band between 2360 and 2390MHz, which the FCC allocated for medical body area network devices, or in other designated medical

device or WMTS bands. These are examples of devices that can be used in the body area network and surroundings, but other devices could also be used and are included in the scope of this disclosure.

[0117] The personal device 2405 may store, process, display, and transmit some of the data from the measurement device 2401. The device 2405 may comprise a receiver, transmitter, display, voice control and speakers, and one or more control buttons or knobs and a touch screen. Examples of the device 2405 include smart phones such as the Apple ~~IPHONE~~^{iPhone}~~®~~ or phones operating on the ~~Android~~^{ANDROID} or Microsoft systems. In one embodiment, the device 2405 may have an application, software program, or firmware to receive and process the data from the measurement device 2401. The device 2405 may then transmit some or all of the data or the processed data over a second communication link 2406 to the internet or “cloud” 2407. The second communication link 2406 may advantageously comprise at least one segment of a wireless transmission link, which may operate using ~~WiFi~~^{WI-FI} or the cellular network. The second communication link 2406 may additionally comprise lengths of fiber optic and/or communication over copper wires or cables.

Please delete the Abstract and replace with the attached abstract provided on a separate sheet of paper pursuant to 37 C.F.R. § 1.72(b).

ABSTRACT

A measurement system includes a wearable measurement device for measuring one or more physiological parameters, including a light source comprising a plurality of light emitting diodes (LEDs) configured to generate an output optical beam with a near-infrared wavelength between 700 nanometers and 2500 nanometers. The light source is configured to increase signal-to-noise ratio by increasing a light intensity and pulse rate of the LEDs. The system includes a plurality of lenses configured to receive the output optical beam and to deliver an analysis output beam to a sample. The wearable measurement device includes a receiver configured to process the analysis output beam reflected or transmitted from the sample and to generate an output signal that may be transmitted to a remote device configured to process the received output status to generate processed data and to store the processed data.

Amendments to the Claims:

This listing of claims will replace all prior versions, and listings, of claims in the application:

1. (Original) A measurement system comprising:

a light source configured to generate an output optical beam, comprising:

one or more semiconductor sources configured to generate an input beam;

one or more optical amplifiers configured to receive at least a portion of the input beam and to output an intermediate beam from at least one of the one or more optical amplifiers; and

one or more optical fibers configured to receive at least a portion of the intermediate beam and to communicate at least part of the portion of the intermediate beam to a distal end of the one or more optical fibers to form a first optical beam;

a nonlinear element configured to receive at least a portion of the first optical beam and to broaden a spectrum associated with the at least a portion of the first optical beam to at least 10nm through a nonlinear effect in the nonlinear element to form the output optical beam with an output beam broadened spectrum; and

wherein at least a portion of the output beam broadened spectrum comprises a near-infrared wavelength between approximately 700nm and approximately 2500nm, and wherein at least a portion of the one or more fibers is a fused silica fiber with a core diameter less than approximately 400 microns;

a measurement apparatus configured to receive a received portion of the output optical beam and to deliver to a sample an analysis output beam, which is a delivered portion of the output optical beam and wherein the delivered portion of the output optical beam is a spatially coherent beam;

a receiver configured to receive and process at least a portion of the analysis output beam reflected or transmitted from the sample having a bandwidth of at least 10 nanometers and to generate an output signal; and

a personal device comprising a wireless receiver, a wireless transmitter, a display, a microphone, a speaker, one or more buttons or knobs, a microprocessor and a touch screen, the personal device configured to receive and process at least a portion of the output signal, wherein the personal device is configured to store and display the processed output signal, and wherein at least a portion of the processed output signal is configured to be transmitted over a wireless transmission link.

2. (Original) The system of Claim 1, wherein the personal device is selected from the group consisting of a smart phone, a tablet, a personal data assistant, a computer, and a microprocessor-based device.

3. (Original) The system of Claim 1, wherein the output signal comprises one or more physiological parameters.

4. (Original) The system of Claim 1, further comprising a remote device configured to receive over the wireless transmission link a received output status comprising the at least a portion of the processed output signal, to buffer the received output status, to process the received output status to generate processed data and to store the processed data.

5. (Currently Amended) A measurement system comprising:

a light source comprising a plurality of semiconductor sources that are light emitting diodes, the light emitting diodes configured to generate an output optical beam with one or more optical wavelengths, wherein at least a portion of the one or more optical wavelengths is a near-infrared wavelength between 700 nanometers and 2500 ~~nanometers;~~nanometers.

the light source configured to increase signal-to-noise ratio by increasing a light intensity from at least one of the plurality of semiconductor sources and by increasing a pulse rate of at least one of the plurality of semiconductor sources;

~~a measurement~~ an apparatus comprising a plurality of lenses configured to receive a ~~received~~ portion of the output optical beam and to deliver ~~to a sample~~ an analysis output beam to a sample, which is a delivered portion of the output optical beam; and

a receiver configured to receive and process at least a portion of the analysis output beam reflected or transmitted from the sample and to generate an output signal;

a personal device comprising a wireless receiver, a wireless transmitter, a display, a microphone, a speaker, one or more buttons or knobs, a microprocessor and a touch screen, the personal device configured to receive and process at least a portion of the output signal, wherein the personal device is configured to store and display the processed output signal, and wherein at least a portion of the processed output signal is configured to be transmitted over a wireless transmission link; and

a remote device configured to receive over the wireless transmission link a ~~received~~ an output status comprising the at least a portion of the processed output signal, ~~to buffer the received output status,~~ to process the received output status to generate processed data and to store the processed data.

6. (Currently Amended) The system of Claim 5, wherein the ~~semiconductor sources are light emitting diodes operating in pulsed mode~~ receiver is configured to be synchronized to the light source.

7. (Currently Amended) The system of Claim 5, wherein ~~the wireless transmission link is configured to operate at least in part on Bluetooth or WiFi~~ at least one of the light emitting diodes emits light with a bandwidth between 20 nanometers to 40 nanometers.

8. (Original) The system of Claim 5, wherein the remote device is further configured to transmit at least a portion of the processed data to one or more other locations, wherein the one or more other locations is selected from the group consisting of the personal device, a doctor, a healthcare provider, a cloud-based server and one or more designated recipients, and wherein the remote device is capable of transmitting information related to a time and a position associated with the at least a portion of the processed data.

9. (Currently Amended) The system of Claim 5, wherein the receiver is located a first distance from a first one of the plurality of light emitting diodes and a different, second distance from a second one of the plurality of light emitting diodes such that the receiver receives a first signal from the first light emitting diode and a second signal from the second light emitting diode~~personal device is a separate device from the measurement apparatus and the light source.~~

10. (Original) The system of Claim 5, wherein the output signal comprises one or more physiological parameters, and the remote device is capable of storing a history of at least a portion of the one or more physiological parameters over a specified period of time.

11. (Currently Amended) The system of ~~Claim 10~~Claim 9, wherein the output signal is generated in part by comparing the first and second signals~~remote device is capable of generating an alarm when at least one of the one or more physiological parameters falls out of an acceptable range.~~

12. (Currently Amended) The system of Claim 5, wherein the receiver further comprises one or more filters in front of one of more detectors to select a fraction of the one or more optical wavelengths~~personal device is selected from the group consisting of a smart phone, a tablet, a personal data assistant, a computer, and a microprocessor based device.~~

13. (Currently Amended) The system of Claim 5, wherein the output optical beam comprises a plurality of optical wavelengths, and the output signal is generated in part by comparing signals at different optical wavelengths~~measurement system is capable of performing a non-invasive blood measurement.~~

14. (Currently Amended) A measurement system comprising:
a wearable measurement device for measuring one or more physiological parameters, including a light source comprising a plurality of semiconductor sources that are light emitting diodes, the light emitting diodes configured to generate an output optical beam with one or more optical wavelengths, wherein at least a portion of the one or more optical

wavelengths is a near-infrared wavelength between 700 nanometers and 2500 ~~nanometers;nanometers.~~

the light source configured to increase signal-to-noise ratio by increasing a light intensity from at least one of the plurality of semiconductor sources and by increasing a pulse rate of at least one of the plurality of semiconductor sources;

the wearable measurement device comprising a plurality of lenses configured to receive a ~~received~~ portion of the output optical beam and to deliver ~~to a sample~~ an analysis output beam to a sample, which is a delivered portion of the output optical beam;

the wearable measurement device further comprising a receiver configured to receive and process at least a portion of the analysis output beam reflected or transmitted from the sample and to generate an output signal;

a personal device comprising a wireless receiver, a wireless transmitter, a display, a microphone, a speaker, one or more buttons or knobs, a microprocessor and a touch screen, the personal device configured to receive and process at least a portion of the output signal, wherein the personal device is configured to store and display the processed output signal, and wherein at least a portion of the processed output signal is configured to be transmitted over a wireless transmission link; and

a remote device configured to receive over the wireless transmission link a ~~received~~ an output status comprising the at least a portion of the processed output signal, ~~to buffer the received output status,~~ to process the received output status to generate processed data and to store the processed data, and wherein the remote device is capable of storing a history of at least a portion of the received output status over a specified period of time.

15. (Currently Amended) The system of Claim 14, wherein the receiver is configured to be synchronized to pulses of the light sources~~semiconductor sources are light emitting diodes operating in pulsed mode.~~

16. (Currently Amended) The system of Claim 14, wherein at least one of the light emitting diodes emits light with a bandwidth between approximately 20 nanometers to approximately 40 nanometers.~~the personal device is a separate device from the wearable measurement device.~~

17. (Original) The system of Claim 14, wherein the remote device is further configured to transmit at least a portion of the processed data to one or more other locations, wherein the one or more other locations is selected from the group consisting of the personal device, a doctor, a healthcare provider, a cloud-based server and one or more designated recipients, and wherein the remote device is capable of transmitting information related to a time and a position associated with the at least a portion of the processed data.

18. (Currently Amended) The system of Claim 14, wherein the receiver is located a first distance from a first one of the plurality of light emitting diodes and a different, second distance from a second one of the plurality of light emitting diodes such that the receiver receives a first signal from the first light emitting diode and a second signal from the second light emitting diode~~remote device is capable of generating an alarm when at least one of the one or more physiological parameters falls out of an acceptable range.~~

19. (Currently Amended) The system of ~~Claim 14~~Claim 18, wherein the output signal is generated in part by comparing the first and second signals~~measurement system is capable of performing a non-invasive blood measurement.~~

20. (Currently Amended) The system of Claim 14, wherein the receiver further comprises one or more filters in front of one of more detectors to select a fraction of the one or more optical wavelengths~~personal device is selected from the group consisting of a smart phone, a tablet, a personal data assistant, a computer, and a microprocessor based device.~~

Remarks

In the Office Action mailed May 26, 2016, claims 1-4 are rejected on the ground of nonstatutory double patenting as being unpatentable over claim 1 of U.S. Patent No. 9,164,032 in view of Banet et al. (US 2010/0160798 A1). Claim 18 was rejected under 35 U.S.C. § 112(b) or 35 U.S.C. § 112 (pre-AIA), second paragraph, as having insufficient antecedent basis. Claims 5, 7-14, and 16-20 are rejected under pre-AIA 35 U.S.C. § 103(a) as being unpatentable over Polli et al. (US 2006/0283931 A1) in view of Banet. Claims 6 and 15 are rejected under pre-AIA 35 U.S.C. § 103(a) as being unpatentable over Polli and Banet, and further in view of Fujimoto et al. (US 2009/0244288 A1).

Claims 1-20 are pending, with claims 1, 5, and 14 being independent. Claims 5-7, 9, 11-16, and 18-20 have been amended. No new subject matter has been added.

Reconsideration and re-examination of the application as amended is respectfully requested.

Specification

The rejection noted that the specification contained references to various trademarks. Applicant has amended the specification accordingly pursuant to MPEP §608.01(v).

Double Patenting Rejection

Claims 1-4 are rejected on the ground of nonstatutory double patenting as being unpatentable over claim 1 of U.S. Patent No. 9,164,032 in view of Banet et al. (US 2010/0160798 A1).

Applicant will submit a Terminal Disclaimer to obviate the rejection.

Rejection Under 35 U.S.C. § 112

Claims 7 and 18 were rejected under 35 U.S.C. § 112(b) or 35 U.S.C. § 112 (pre-AIA), second paragraph, as being indefinite. Claims 7 and 18 have been amended such that the rejection has been obviated.

Rejection Under 35 U.S.C. § 103(a)

Claims 5, 7-14, and 16-20 are rejected under pre-AIA 35 U.S.C. § 103(a) as being unpatentable over Polli et al. (US 2006/0283931 A1) in view of Banet. Claims 6 and 15 are rejected under pre-AIA 35 U.S.C. § 103(a) as being unpatentable over Polli and Banet, and further in view of Fujimoto et al. (US 2009/0244288 A1). Applicant respectfully disagrees and traverses the rejection. However, independent claims 5 and 14 have been amended to more particularly point out the claimed subject matter.

Applicant respectfully submits that the proposed combination of Polli et al. and Banet taken as a whole fails to disclose or suggest all of the features of amended independent claims 5 and 14 such as a light source configured to increase signal-to-noise ratio as disclosed and claimed by Applicant, for example. As such, Applicant respectfully requests reconsideration and withdrawal of the rejection under 35 U.S.C. § 103.

Summary

Applicant has made a genuine effort to respond to the rejections and advance prosecution of this application. Applicant respectfully submits that all formal and substantive requirements for patentability have been met and that this case is in condition for allowance, which action is respectfully requested.

The Examiner is requested to telephone the undersigned to discuss resolution of any remaining issues.

No additional fee is believed be due as a result of filing this paper. However, please charge any fees or credit any overpayments as a result of the filing of this paper to Deposit Account No. 02-3978.

Respectfully submitted,

Mohammed N. ISLAM

By: /David S. Bir/
David S. Bir
Reg. No. 38,383
Attorney/Agent for Applicant

Date: July 6, 2016

BROOKS KUSHMAN P.C.
1000 Town Center, 22nd Floor
Southfield, MI 48075-1238
Phone: 248-358-4400
Fax: 248-358-3351

Electronic Acknowledgement Receipt

EFS ID:	26268183
Application Number:	14875709
International Application Number:	
Confirmation Number:	7496
Title of Invention:	SHORT-WAVE INFRARED SUPER-CONTINUUM LASERS FOR DETECTING COUNTERFEIT OR ILLICIT DRUGS AND PHARMACEUTICAL PROCESS CONTROL
First Named Inventor/Applicant Name:	Mohammed N. Islam
Customer Number:	109543
Filer:	David S. Bir
Filer Authorized By:	
Attorney Docket Number:	OMNI 0105 PUSP1
Receipt Date:	06-JUL-2016
Filing Date:	06-OCT-2015
Time Stamp:	15:06:46
Application Type:	Utility under 35 USC 111(a)

Payment information:

Submitted with Payment	no
------------------------	----

File Listing:

Document Number	Document Description	File Name	File Size(Bytes)/ Message Digest	Multi Part /.zip	Pages (if appl.)
1		Response_to_OA_dtd_5_26_16.pdf	85915 4f15a174a203c2fe639430a44c6546201e468166	yes	14

Multipart Description/PDF files in .zip description			
Document Description		Start	End
Amendment/Req. Reconsideration-After Non-Final Reject		1	1
Specification		2	4
Abstract		5	5
Claims		6	11
Applicant Arguments/Remarks Made in an Amendment		12	14

Warnings:

Information:

Total Files Size (in bytes):

85915

This Acknowledgement Receipt evidences receipt on the noted date by the USPTO of the indicated documents, characterized by the applicant, and including page counts, where applicable. It serves as evidence of receipt similar to a Post Card, as described in MPEP 503.

New Applications Under 35 U.S.C. 111

If a new application is being filed and the application includes the necessary components for a filing date (see 37 CFR 1.53(b)-(d) and MPEP 506), a Filing Receipt (37 CFR 1.54) will be issued in due course and the date shown on this Acknowledgement Receipt will establish the filing date of the application.

National Stage of an International Application under 35 U.S.C. 371

If a timely submission to enter the national stage of an international application is compliant with the conditions of 35 U.S.C. 371 and other applicable requirements a Form PCT/DO/EO/903 indicating acceptance of the application as a national stage submission under 35 U.S.C. 371 will be issued in addition to the Filing Receipt, in due course.

New International Application Filed with the USPTO as a Receiving Office

If a new international application is being filed and the international application includes the necessary components for an international filing date (see PCT Article 11 and MPEP 1810), a Notification of the International Application Number and of the International Filing Date (Form PCT/RO/105) will be issued in due course, subject to prescriptions concerning national security, and the date shown on this Acknowledgement Receipt will establish the international filing date of the application.

Under the Paperwork Reduction Act of 1995, no persons are required to respond to a collection of information unless it displays a valid OMB control number.

PATENT APPLICATION FEE DETERMINATION RECORD Substitute for Form PTO-875	Application or Docket Number 14/875,709	Filing Date 10/06/2015	<input type="checkbox"/> To be Mailed
---	---	----------------------------------	---------------------------------------

ENTITY: LARGE SMALL MICRO

APPLICATION AS FILED – PART I

FOR	NUMBER FILED	NUMBER EXTRA	RATE (\$)	FEE (\$)
<input checked="" type="checkbox"/> BASIC FEE <small>(37 CFR 1.16(a), (b), or (c))</small>	N/A	N/A	N/A	140
<input checked="" type="checkbox"/> SEARCH FEE <small>(37 CFR 1.16(k), (l), or (m))</small>	N/A	N/A	N/A	300
<input checked="" type="checkbox"/> EXAMINATION FEE <small>(37 CFR 1.16(o), (p), or (q))</small>	N/A	N/A	N/A	360
TOTAL CLAIMS <small>(37 CFR 1.16(i))</small>	20 minus 20 =	* 0	x \$40 =	0
INDEPENDENT CLAIMS <small>(37 CFR 1.16(h))</small>	3 minus 3 =	* 0	x \$210 =	0
<input type="checkbox"/> APPLICATION SIZE FEE <small>(37 CFR 1.16(s))</small>	If the specification and drawings exceed 100 sheets of paper, the application size fee due is \$310 (\$155 for small entity) for each additional 50 sheets or fraction thereof. See 35 U.S.C. 41(a)(1)(G) and 37 CFR 1.16(s).			
<input type="checkbox"/> MULTIPLE DEPENDENT CLAIM PRESENT <small>(37 CFR 1.16(j))</small>				
* If the difference in column 1 is less than zero, enter "0" in column 2.			TOTAL	800

APPLICATION AS AMENDED – PART II

	(Column 1)	(Column 2)	(Column 3)	PRESENT EXTRA	RATE (\$)	ADDITIONAL FEE (\$)
AMENDMENT	07/06/2016	CLAIMS REMAINING AFTER AMENDMENT	HIGHEST NUMBER PREVIOUSLY PAID FOR			
	Total <small>(37 CFR 1.16(i))</small>	* 20	Minus	** 20	= 0	x \$40 = 0
	Independent <small>(37 CFR 1.16(h))</small>	* 3	Minus	***3	= 0	x \$210 = 0
	<input type="checkbox"/> Application Size Fee <small>(37 CFR 1.16(s))</small>					
<input type="checkbox"/> FIRST PRESENTATION OF MULTIPLE DEPENDENT CLAIM <small>(37 CFR 1.16(j))</small>						
					TOTAL ADD'L FEE	0

	(Column 1)	(Column 2)	(Column 3)	PRESENT EXTRA	RATE (\$)	ADDITIONAL FEE (\$)
AMENDMENT		CLAIMS REMAINING AFTER AMENDMENT	HIGHEST NUMBER PREVIOUSLY PAID FOR			
	Total <small>(37 CFR 1.16(i))</small>	*	Minus	**	=	x \$ =
	Independent <small>(37 CFR 1.16(h))</small>	*	Minus	***	=	x \$ =
	<input type="checkbox"/> Application Size Fee <small>(37 CFR 1.16(s))</small>					
<input type="checkbox"/> FIRST PRESENTATION OF MULTIPLE DEPENDENT CLAIM <small>(37 CFR 1.16(j))</small>						
					TOTAL ADD'L FEE	

* If the entry in column 1 is less than the entry in column 2, write "0" in column 3.
 ** If the "Highest Number Previously Paid For" IN THIS SPACE is less than 20, enter "20".
 *** If the "Highest Number Previously Paid For" IN THIS SPACE is less than 3, enter "3".
 The "Highest Number Previously Paid For" (Total or Independent) is the highest number found in the appropriate box in column 1.

LIE
 DIANE JOHNSON

This collection of information is required by 37 CFR 1.16. The information is required to obtain or retain a benefit by the public which is to file (and by the USPTO to process) an application. Confidentiality is governed by 35 U.S.C. 122 and 37 CFR 1.14. This collection is estimated to take 12 minutes to complete, including gathering, preparing, and submitting the completed application form to the USPTO. Time will vary depending upon the individual case. Any comments on the amount of time you require to complete this form and/or suggestions for reducing this burden, should be sent to the Chief Information Officer, U.S. Patent and Trademark Office, U.S. Department of Commerce, P.O. Box 1450, Alexandria, VA 22313-1450. DO NOT SEND FEES OR COMPLETED FORMS TO THIS ADDRESS. **SEND TO: Commissioner for Patents, P.O. Box 1450, Alexandria, VA 22313-1450.**

If you need assistance in completing the form, call 1-800-PTO-9199 and select option 2.

INFORMATION DISCLOSURE STATEMENT BY APPLICANT (Not for submission under 37 CFR 1.99)	Application Number	14875709
	Filing Date	2015-10-06
	First Named Inventor	Mohammed N. ISLAM
	Art Unit	2884
	Examiner Name	Abra S. Fein
	Attorney Docket Number	OMNI 0105 PUSP1

U.S.PATENTS							Remove
Examiner Initial*	Cite No	Patent Number	Kind Code ¹	Issue Date	Name of Patentee or Applicant of cited Document	Pages,Columns,Lines where Relevant Passages or Relevant Figures Appear	
	1	8180422	B2	2012-05-15	Rebec		

If you wish to add additional U.S. Patent citation information please click the Add button.

U.S.PATENT APPLICATION PUBLICATIONS							Remove
Examiner Initial*	Cite No	Publication Number	Kind Code ¹	Publication Date	Name of Patentee or Applicant of cited Document	Pages,Columns,Lines where Relevant Passages or Relevant Figures Appear	
	1						

If you wish to add additional U.S. Published Application citation information please click the Add button.

FOREIGN PATENT DOCUMENTS								Remove
Examiner Initial*	Cite No	Foreign Document Number ³	Country Code ² i	Kind Code ⁴	Publication Date	Name of Patentee or Applicant of cited Document	Pages,Columns,Lines where Relevant Passages or Relevant Figures Appear	T ⁵
	1	102010012987	DE	A1	2010-10-07	FRAUNHOFER GES FORSCHUNG		
	2	2005013843	WO	A2	2005-02-17	The Regents of the University of California		
	3	2007061772	WO	A2	2007-05-31	OMNI SCIENCES, INC.		

INFORMATION DISCLOSURE STATEMENT BY APPLICANT (Not for submission under 37 CFR 1.99)	Application Number	14875709
	Filing Date	2015-10-06
	First Named Inventor	Mohammed N. ISLAM
	Art Unit	2884
	Examiner Name	Abra S. Fein
	Attorney Docket Number	OMNI 0105 PUSP1

4	2009130464	WO	A1	2009-10-29	UNIVERSITY OF MANCHESTER	
---	------------	----	----	------------	--------------------------	--

If you wish to add additional Foreign Patent Document citation information please click the Add button

NON-PATENT LITERATURE DOCUMENTS

Examiner Initials*	Cite No	Include name of the author (in CAPITAL LETTERS), title of the article (when appropriate), title of the item (book, magazine, journal, serial, symposium, catalog, etc), date, pages(s), volume-issue number(s), publisher, city and/or country where published.	T ⁵
	1	VINAY V. ALEXANDER ET AL.; Modulation Instability High Power All-Fiber Supercontinuum Lasers And Their Applications; Optical Fiber Technology 18; 2012; pages 349-374.	
	2	ROBERT S. JONES ET AL.; Near-Infrared Transillumination At 1310-nm For The Imaging Of Early Dental Decay; Volume 11, No. 18; Optics Express 2259; September 8, 2003	
	3	Extended European Search Report for European Application No. 13867874.3 dated July 15, 2016	
	4	Extended European Search Report for European Application No. 13867892.5 dated July 22, 2016	

If you wish to add additional non-patent literature document citation information please click the Add button

EXAMINER SIGNATURE

Examiner Signature	<input type="text"/>	Date Considered	<input type="text"/>
--------------------	----------------------	-----------------	----------------------

*EXAMINER: Initial if reference considered, whether or not citation is in conformance with MPEP 609. Draw line through a citation if not in conformance and not considered. Include copy of this form with next communication to applicant.

¹ See Kind Codes of USPTO Patent Documents at www.USPTO.GOV or MPEP 901.04. ² Enter office that issued the document, by the two-letter code (WIPO Standard ST.3). ³ For Japanese patent documents, the indication of the year of the reign of the Emperor must precede the serial number of the patent document. ⁴ Kind of document by the appropriate symbols as indicated on the document under WIPO Standard ST.16 if possible. ⁵ Applicant is to place a check mark here if English language translation is attached.

INFORMATION DISCLOSURE STATEMENT BY APPLICANT (Not for submission under 37 CFR 1.99)	Application Number	14875709
	Filing Date	2015-10-06
	First Named Inventor	Mohammed N. ISLAM
	Art Unit	2884
	Examiner Name	Abra S. Fein
	Attorney Docket Number	OMNI 0105 PUSP1

CERTIFICATION STATEMENT

Please see 37 CFR 1.97 and 1.98 to make the appropriate selection(s):

That each item of information contained in the information disclosure statement was first cited in any communication from a foreign patent office in a counterpart foreign application not more than three months prior to the filing of the information disclosure statement. See 37 CFR 1.97(e)(1).

OR

That no item of information contained in the information disclosure statement was cited in a communication from a foreign patent office in a counterpart foreign application, and, to the knowledge of the person signing the certification after making reasonable inquiry, no item of information contained in the information disclosure statement was known to any individual designated in 37 CFR 1.56(c) more than three months prior to the filing of the information disclosure statement. See 37 CFR 1.97(e)(2).

See attached certification statement.

The fee set forth in 37 CFR 1.17 (p) has been submitted herewith.

A certification statement is not submitted herewith.

SIGNATURE

A signature of the applicant or representative is required in accordance with CFR 1.33, 10.18. Please see CFR 1.4(d) for the form of the signature.

Signature	/David S. Bir/	Date (YYYY-MM-DD)	2016-07-21
Name/Print	David S. Bir	Registration Number	38383

This collection of information is required by 37 CFR 1.97 and 1.98. The information is required to obtain or retain a benefit by the public which is to file (and by the USPTO to process) an application. Confidentiality is governed by 35 U.S.C. 122 and 37 CFR 1.14. This collection is estimated to take 1 hour to complete, including gathering, preparing and submitting the completed application form to the USPTO. Time will vary depending upon the individual case. Any comments on the amount of time you require to complete this form and/or suggestions for reducing this burden, should be sent to the Chief Information Officer, U.S. Patent and Trademark Office, U.S. Department of Commerce, P.O. Box 1450, Alexandria, VA 22313-1450. **DO NOT SEND FEES OR COMPLETED FORMS TO THIS ADDRESS. SEND TO: Commissioner for Patents, P.O. Box 1450, Alexandria, VA 22313-1450.**

Privacy Act Statement

The Privacy Act of 1974 (P.L. 93-579) requires that you be given certain information in connection with your submission of the attached form related to a patent application or patent. Accordingly, pursuant to the requirements of the Act, please be advised that: (1) the general authority for the collection of this information is 35 U.S.C. 2(b)(2); (2) furnishing of the information solicited is voluntary; and (3) the principal purpose for which the information is used by the U.S. Patent and Trademark Office is to process and/or examine your submission related to a patent application or patent. If you do not furnish the requested information, the U.S. Patent and Trademark Office may not be able to process and/or examine your submission, which may result in termination of proceedings or abandonment of the application or expiration of the patent.

The information provided by you in this form will be subject to the following routine uses:

1. The information on this form will be treated confidentially to the extent allowed under the Freedom of Information Act (5 U.S.C. 552) and the Privacy Act (5 U.S.C. 552a). Records from this system of records may be disclosed to the Department of Justice to determine whether the Freedom of Information Act requires disclosure of these records.
2. A record from this system of records may be disclosed, as a routine use, in the course of presenting evidence to a court, magistrate, or administrative tribunal, including disclosures to opposing counsel in the course of settlement negotiations.
3. A record in this system of records may be disclosed, as a routine use, to a Member of Congress submitting a request involving an individual, to whom the record pertains, when the individual has requested assistance from the Member with respect to the subject matter of the record.
4. A record in this system of records may be disclosed, as a routine use, to a contractor of the Agency having need for the information in order to perform a contract. Recipients of information shall be required to comply with the requirements of the Privacy Act of 1974, as amended, pursuant to 5 U.S.C. 552a(m).
5. A record related to an International Application filed under the Patent Cooperation Treaty in this system of records may be disclosed, as a routine use, to the International Bureau of the World Intellectual Property Organization, pursuant to the Patent Cooperation Treaty.
6. A record in this system of records may be disclosed, as a routine use, to another federal agency for purposes of National Security review (35 U.S.C. 181) and for review pursuant to the Atomic Energy Act (42 U.S.C. 218(c)).
7. A record from this system of records may be disclosed, as a routine use, to the Administrator, General Services, or his/her designee, during an inspection of records conducted by GSA as part of that agency's responsibility to recommend improvements in records management practices and programs, under authority of 44 U.S.C. 2904 and 2906. Such disclosure shall be made in accordance with the GSA regulations governing inspection of records for this purpose, and any other relevant (i.e., GSA or Commerce) directive. Such disclosure shall not be used to make determinations about individuals.
8. A record from this system of records may be disclosed, as a routine use, to the public after either publication of the application pursuant to 35 U.S.C. 122(b) or issuance of a patent pursuant to 35 U.S.C. 151. Further, a record may be disclosed, subject to the limitations of 37 CFR 1.14, as a routine use, to the public if the record was filed in an application which became abandoned or in which the proceedings were terminated and which application is referenced by either a published application, an application open to public inspections or an issued patent.
9. A record from this system of records may be disclosed, as a routine use, to a Federal, State, or local law enforcement agency, if the USPTO becomes aware of a violation or potential violation of law or regulation.

Electronic Acknowledgement Receipt

EFS ID:	26415939
Application Number:	14875709
International Application Number:	
Confirmation Number:	7496
Title of Invention:	SHORT-WAVE INFRARED SUPER-CONTINUUM LASERS FOR DETECTING COUNTERFEIT OR ILLICIT DRUGS AND PHARMACEUTICAL PROCESS CONTROL
First Named Inventor/Applicant Name:	Mohammed N. Islam
Customer Number:	109543
Filer:	David S. Bir
Filer Authorized By:	
Attorney Docket Number:	OMNI 0105 PUSP1
Receipt Date:	21-JUL-2016
Filing Date:	06-OCT-2015
Time Stamp:	19:43:11
Application Type:	Utility under 35 USC 111(a)

Payment information:

Submitted with Payment	no
------------------------	----

File Listing:

Document Number	Document Description	File Name	File Size(Bytes)/ Message Digest	Multi Part /.zip	Pages (if appl.)
1	Foreign Reference	DE102010012987_w_English_A bstract.pdf	2308892 <small>19a13bcfd1f90066341fc61d3872cf49f9ecf99b</small>	no	18

Warnings:

Information:					
2	Foreign Reference	WO2005013843A21.pdf	1823144	no	38
			d0f26f4dfa27ba56005e4b853c676efb32bb60b4		
Warnings:					
Information:					
3	Foreign Reference	WO2007061732A21.pdf	3281087	no	66
			244aee080f51028c732f98646f80712be6da9344		
Warnings:					
Information:					
4	Foreign Reference	WO2009130464A11.pdf	3470704	no	76
			6dd8b21777a346ab09fa106e24bb268a8312b2cc		
Warnings:					
Information:					
5	Non Patent Literature	7_15_16_Extended_EP_Search_Report.pdf	215929	no	7
			efb9e67dba62b2dbdd534b8e980cea139aed67c6		
Warnings:					
Information:					
6	Non Patent Literature	7_22_16_Extended_EP_Search_Report.pdf	302860	no	8
			0f6974bf4daac07487859da4be4359d2c040fbee		
Warnings:					
Information:					
7	Non Patent Literature	Jones_et_al_Near_Infrared_transillumination.pdf	1755277	no	7
			59fbb6e4b86ff9091b27def3ab10847a00b6e5e		
Warnings:					
Information:					
8	Non Patent Literature	Vinay_v_Alexander_Modulation_instability_initiated_high_power.pdf	2561554	no	26
			7105a4b8acaa1c8377f01c8ef10ce6e3ef8e7416		
Warnings:					
Information:					

9	Information Disclosure Statement (IDS) Form (SB08)	Supplemental_IDS.pdf	612885	no	4
			24897f42631ad0a3e5a25e4511ba58a84d62b65f		

Warnings:

Information:

Total Files Size (in bytes):	16332332
-------------------------------------	----------

This Acknowledgement Receipt evidences receipt on the noted date by the USPTO of the indicated documents, characterized by the applicant, and including page counts, where applicable. It serves as evidence of receipt similar to a Post Card, as described in MPEP 503.

New Applications Under 35 U.S.C. 111

If a new application is being filed and the application includes the necessary components for a filing date (see 37 CFR 1.53(b)-(d) and MPEP 506), a Filing Receipt (37 CFR 1.54) will be issued in due course and the date shown on this Acknowledgement Receipt will establish the filing date of the application.

National Stage of an International Application under 35 U.S.C. 371

If a timely submission to enter the national stage of an international application is compliant with the conditions of 35 U.S.C. 371 and other applicable requirements a Form PCT/DO/EO/903 indicating acceptance of the application as a national stage submission under 35 U.S.C. 371 will be issued in addition to the Filing Receipt, in due course.

New International Application Filed with the USPTO as a Receiving Office

If a new international application is being filed and the international application includes the necessary components for an international filing date (see PCT Article 11 and MPEP 1810), a Notification of the International Application Number and of the International Filing Date (Form PCT/RO/105) will be issued in due course, subject to prescriptions concerning national security, and the date shown on this Acknowledgement Receipt will establish the international filing date of the application.

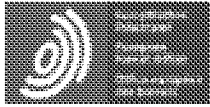

Espacenet

Bibliographic data: DE102010012987 (A1) — 2010-10-07

Method for attaching optical transmission element on e.g. finger nail, of body of sportsman for determining e.g. glucose content of blood, involves attaching optical transmission element and optical detector element to parts of body

Inventor(s): VELTEN THOMAS [DE]; SCHOLZ OLIVER [DE] ± (VELTEN, THOMAS, ; SCHOLZ, OLIVER)

Applicant(s): FRAUNHOFER GES FORSCHUNG [DE] ± (FRAUNHOFER-GESELLSCHAFT ZUR FOERDERUNG DER ANGEWANDTEN FORSCHUNG E.V)

Classification: - **international:** **A61B5/0205; A61B5/1455; A61B6/00; A61C19/04**
 - **cooperative:** **A61B5/14532; A61B5/1455; A61B5/682;**
A61B5/6826; A61B5/6838; A61C19/043;
A61B5/7207

Application number: DE20101012987 20100326

Priority number (s): DE20101012987 20100326 ; DE20091015118 20090331

Abstract of DE102010012987 (A1)

The method involves irradiating light of predetermined wavelength in a measuring volume (12) within a human or animal body. A scattered part of the light irradiated in the measuring volume is detected by an optical detector element (2). An optical transmission element (1) and the optical detector element are attached to multiple parts of the body, where the parts are mechanically fixed and accessible without surgical interferences. The optical transmission element and the optical detector element are fastened next to each other. An independent claim is also included for an arrangement for attaching an optical transmission element.

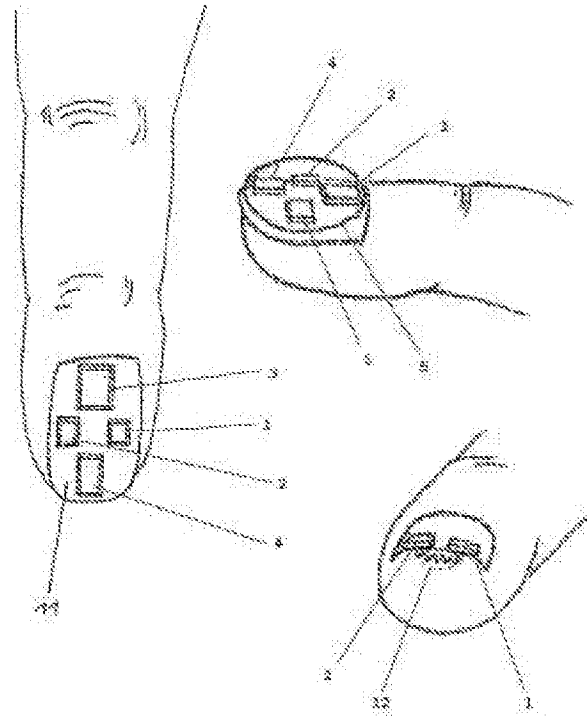



(10) **DE 10 2010 012 987 A1** 2010.10.07

(12) **Offenlegungsschrift**

(21) Aktenzeichen: **10 2010 012 987.9**
(22) Anmeldetag: **26.03.2010**
(43) Offenlegungstag: **07.10.2010**

(51) Int Cl.⁸: **A61B 6/00** (2006.01)
A61B 5/0205 (2006.01)
A61B 5/1455 (2006.01)
A61C 19/04 (2006.01)

(66) Innere Priorität:
10 2009 015 118.4 31.03.2009

(74) Vertreter:
**Gagel, R., Dipl.-Phys.Univ. Dr.rer.nat., Pat.-Anw.,
81241 München**

(71) Anmelder:
**Fraunhofer-Gesellschaft zur Förderung der
angewandten Forschung e.V., 80686 München, DE**

(72) Erfinder:
**Velten, Thomas, Dr., 66507 Reifenberg, DE;
Schoiz, Oliver, Dr., 66119 Saarbrücken, DE**

Prüfungsantrag gemäß § 44 PatG ist gestellt.

Die folgenden Angaben sind den vom Anmelder eingereichten Unterlagen entnommen

(54) Bezeichnung: **Verfahren zum Anbringen und eine Anordnung eines optischen Sende- bzw. Detektorelements**

(57) Zusammenfassung: Die vorliegende Erfindung betrifft ein Verfahren und eine Anordnung zur Erfassung von Daten eines menschlichen oder tierischen Körpers. Hierbei wird mit wenigstens einem optischen Sendeelement Licht mindestens einer vorgegebenen Wellenlänge in ein Messvolumen innerhalb des menschlichen oder tierischen Körpers eingestrahlt und mit wenigstens einem optischen Detektorelement wenigstens ein transmittierter, reflektierter, remittierter oder diffus gestreuter Teil des in das Messvolumen eingestrahlt Lichts detektiert. Die Befestigung des wenigstens einen optischen Sendeelements und des wenigstens einen optischen Detektorelements erfolgt mit wenigstens einem Befestigungsmittel ausschließlich an einem oder mehreren mechanisch festen und ohne chirurgische Eingriffe zugänglichen Körperteilen. Dadurch können die Messdaten mit erhöhter Verlässlichkeit, insbesondere weitgehend ohne Bewegungsartefakte, erfasst werden.

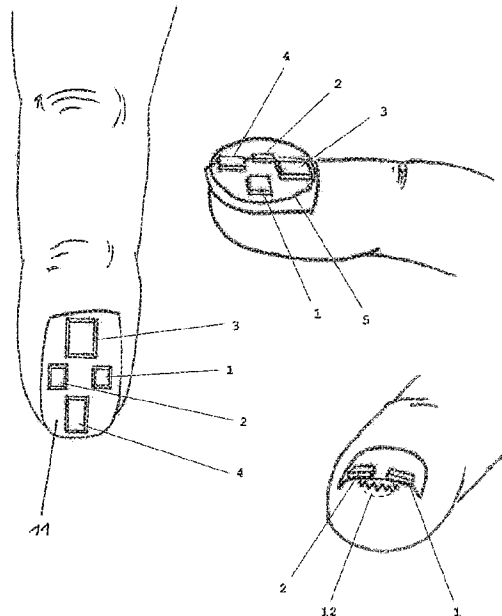

Beschreibung

Technisches Anwendungsgebiet

[0001] Die Erfindung bezieht sich auf ein Verfahren zum Anbringen und eine Anordnung eines optischen Sende- bzw. Detektorelements eines Messgerätes.

Stand der Technik

[0002] Mit optischen Verfahren können beispielsweise der Glukosegehalt des Blutes oder die Herzfrequenz (Puls) und/oder die Sauerstoffsättigung des Blutes (Pulsoximetrie) erfasst werden.

[0003] Bei der Pulsoximetrie wird gut durchblutetes Gewebe mit Licht von zwei oder mehr verschiedenen Wellenlängen durchstrahlt und von einem dem Sender gegenüberliegenden Detektor empfangen. Das Spektrum des empfangenen Lichtes enthält die Informationen über Herzfrequenz und Sauerstoffsättigung. Die Signalauswertung basiert auf dem Lambert-Beer'schen Gesetz, nach dem die Konzentration eines Stoffes aus der Absorption in einer Lösung bestimmt werden kann. In der praktischen Anwendung sind die strengen Randbedingungen des Lambert-Beer'schen Gesetzes jedoch nicht vollständig erfüllt. Es existieren viele andere Substanzen im Blut, die neben den wichtigen Absorbieren Oxi-Hämoglobin und Hämoglobin ebenfalls Licht absorbieren, wie z. B. Carboxihämoglobin und Methämoglobin. Deren Beitrag zur Absorption kann nur durch Messung bei zusätzlichen Wellenlängen bestimmt werden, d. h. falls nur bei zwei Wellenlängen gemessen wird, bewirken diese Substanzen einen durch das Messprinzip bedingten Messfehler.

[0004] Darüber hinaus erreicht ein Teil des Lichts, welches in das Gewebe eingestrahlt wird, aufgrund von Reflexionen nicht den Detektor.

[0005] Weitere wichtige Fehlerquellen sind Bewegungsartefakte, wobei externe und interne Bewegungsartefakte unterschieden werden. Externe Bewegungsartefakte beruhen im Wesentlichen auf einer Relativbewegung zwischen Sensor und Patient. Insbesondere genügen bei herkömmlichen Fingerclipsensoren bereits kleine Handbewegungen, Zittern oder Erschütterungen, bspw. während des Krankentransports, um Bewegungsartefakte hervorzurufen. Unter Umständen können diese zu so großen Störungen führen, dass nur noch ein ungenügendes Signal-Rausch-Verhältnis gegeben ist. Interne Bewegungsartefakte entstehen durch Umlagerungen venösen Blutes im Applikationsort.

[0006] Insgesamt führen kleinste Bewegungen zu einer Veränderung des Messvolumens. Ein Ansatz, Bewegungsartefakte zu unterdrücken bzw. ein durch Bewegungen beeinträchtigtes Signal-Rausch-Ver-

hältnis zu verbessern, besteht darin, eine statistische Auswertung der Messwerte vorzunehmen. Insbesondere können bei Vorliegen einer hohen Anzahl von Messwerten regellos auftretende, unkorrekte Messwerte durch eine Mittelwertbildung geringer bewertet werden.

[0007] Kommerzielle Pulsoximeter arbeiten mit zwei oder mehr Wellenlängen, elektronischen Filtern und speziellen Kalibrieralgorithmen, um die Verlässlichkeit der Messung zu erhöhen. Speziell die Unterdrückung der Bewegungsartefakte ist ein großes Problem, vor allem im Wellnessbereich, wenn beispielsweise die Herzfrequenz während körperlicher Aktivitäten wie Laufen oder Radfahren gemessen werden soll. Die Adaption an den Patienten muss praktikabel und tolerabel sein. Deshalb verwenden bestehende Geräte relativ lockere Applikationen in Form von Finger- bzw. Ohrclipsen oder Finger- bzw. Zehenbändern.

[0008] Neben dem vorstehend beschriebenen Verfahren, das auf einer Messung von transmittiertem Licht beruht, gibt es auch Pulsoximeter, bei denen Sender und Detektor nebeneinander angeordnet sind und bei denen die Sauerstoffsättigung und die Herzfrequenz über ein sog. Reflexionsverfahren ermittelt werden. Die Messsonden werden beispielsweise mittels Bändern auf der Stirn, auf der Brust, am Oberarm oder am Finger fixiert oder aber auch über eine Art Haken in der Haut verankert, wie der WO 2007/012931 zu entnehmen ist.

[0009] Die Aufgabe der vorliegenden Erfindung besteht darin, ein Verfahren und eine Anordnung anzugeben, mit denen Messdaten eines menschlichen oder tierischen Körpers nicht-invasiv, einfach, kostengünstig und mit erhöhter Verlässlichkeit erfasst werden können. Insbesondere sollen Bewegungsartefakte weitgehend unterdrückt werden.

Darstellung der Erfindung

[0010] Die vorstehende Aufgabe wird mit dem Verfahren gemäß Patentanspruch 1 und den Anordnungen gemäß den Patentansprüchen 6 und 8 gelöst. Vorteilhafte Ausgestaltungen des Verfahrens sowie der Anordnungen sind Gegenstand der abhängigen Patentansprüche oder lassen sich der nachfolgenden Beschreibung sowie den Ausführungsbeispielen entnehmen.

[0011] Das vorgeschlagene Verfahren bezieht sich auf das Anbringen wenigstens eines optischen Sendeelements, mit dem Licht mindestens einer vorgegebenen Wellenlänge in ein Messvolumen innerhalb eines menschlichen oder tierischen Körpers einstrahlbar ist, und wenigstens eines optischen Detektorelements, mit dem wenigstens ein transmittierter, reflektierter, remittierter oder diffus gestreuter Teil des

in das Messvolumen eingestrahlten Lichts detektierbar ist. Das Verfahren zeichnet sich dadurch aus, dass die Befestigung des wenigstens einen optischen Sendeelements und des wenigstens einen optischen Detektorelements ausschließlich an einem oder mehreren mechanisch festen und ohne chirurgische Eingriffe zugänglichen Körperteilen erfolgt. Insbesondere erfolgt die Befestigung also ohne Einbeziehung von mechanisch weichem Gewebe, wie bspw. Haut mit darunterliegendem Muskel-, Fett- oder sonstigem Weichgewebe, das das oder die mechanisch festen Körperteile umgibt.

[0012] Durch die ausschließliche Befestigung an mechanisch festen Körperteilen werden Bewegungsartefakte oder Fehler durch ein sich änderndes Messvolumen wie sie beispielsweise bei den oben genannten Pulsoximetrieverfahren auftreten, unterdrückt.

[0013] Besonders bevorzugt werden das wenigstens eine optische Sendeelement, insbesondere eine oder mehrere lichtemittierende Dioden (LED), und das wenigstens eine optische Detektorelement (optischer Sensor), insbesondere eine oder mehrere Photodioden, nebeneinander an einem Fingernagel oder einem Fußnagel befestigt. Das Licht einer oder mehrerer unterschiedlicher Wellenlängen wird in ein durchblutetes Gewebe enthaltendes Messvolumen unterhalb des Fingernagels oder des Fußnagels eingestrahlt. Die Messung erfolgt im sog. Reflexionsverfahren, d. h. mittels des optischen Sensors wird das durch das Messvolumen reflektierte, remittierte und/oder diffus in Richtung des optischen Detektorelements gestreute Licht detektiert. Der optische Sensor und das optische Sendeelement können insbesondere in einer miniaturisierten Einheit integriert sein oder aber einzeln nebeneinander auf dem Fingernagel oder Fußnagel angebracht sein. Durch die ausschließliche Befestigung der Sensoren bzw. der miniaturisierten Einheit am Nagel, beispielsweise durch Ankleben ausschließlich auf dem Nagel oder durch mechanische Befestigung (z. B. mit einer Art Klammer), kommt es bei Bewegung des Fingers oder der Zehe weder zu einer relativen Verschiebung zwischen optischem Sendeelement und optischem Detektorelement noch verändern sich Kräfte, die auf die Anordnung wirken.

[0014] In einer bevorzugten Ausführungsform erfolgt die Befestigung mittels Ankleben, wobei Klebstoffe auf anorganischer oder organischer Basis oder auch Lacke eingesetzt werden. Besonders bevorzugt sind dabei Klebstoffe oder Lacke, die einerseits einen festen, verschiebefreien Sitz des wenigstens einen optischen Sendeelements bzw. des wenigstens einen optischen Detektorelements oder der miniaturisierten Einheit gewährleisten, die jedoch unter bestimmten Bedingungen wieder ablösbar sind. Dies können beispielsweise Klebstoffe sein, die unter ultraviolettem Licht ablösbar sind. Solche Klebstoffe

kommen beispielsweise bei „UV-Tapes for Wafer Dicing“ der japanischen Firma FURUKAWA ELECTRIC CO., LTD. zum Einsatz. Alternativ können Lacke oder Klebstoffe eingesetzt werden, die mit geeigneten chemischen Lösemitteln ablösbar sind.

[0015] In einer weiteren bevorzugten Ausführungsform erfolgt die Befestigung mit einer oder mehreren Klammern, die am Finger- oder Zehennagel befestigt werden. Insgesamt sind alle Befestigungsarten bevorzugt, die ein „Wackeln“ des befestigten Sensors unterbinden.

[0016] In einer weiteren bevorzugten Ausführungsform werden das wenigstens eine optische Sendeelement und das optische Detektorelement an einem oder mehreren Zähnen derart befestigt, dass das wenigstens eine optische Sendeelement palatinal und das wenigstens eine optische Detektorelement labial oder das wenigstens eine optische Sendeelement labial und das wenigstens eine optische Detektorelement palatinal angeordnet sind und dass ein zwischen dem wenigstens einen optischen Sendeelement und dem wenigstens einen optischen Detektorelement befindliches Zahnfleisch, insbesondere die sog. Interdentalspapille, durchstrahlt wird. Die Messung erfolgt im Transmissionsverfahren, d. h. das wenigstens eine optische Sendeelement und das wenigstens eine optische Detektorelement sind auf gegenüberliegenden Seiten des Messvolumens angeordnet und es wird das durch das (durchblutete Gewebe enthaltende) Messvolumen transmittierte Licht erfasst.

[0017] In einer alternativen, bevorzugten Ausführungsform wird das wenigstens eine optische Sendeelement an einem ersten Zahn und das wenigstens eine optische Detektorelement an demselben Zahn oder an einem zum ersten Zahn benachbarten zweiten Zahn angebracht und ein zwischen dem wenigstens einen optischen Sendeelement und dem wenigstens einen optischen Detektorelement befindliches Zahnfleisch durchstrahlt. Hierbei kann das optische Sendeelement und/oder das optische Detektorelement in einer Zahnfleischtasche des betreffenden Zahns angeordnet werden. Die Anordnung in einer Zahnfleischtasche ist vor allem dann vorteilhaft, wenn das wenigstens eine optische Sendeelement und das wenigstens eine optische Detektorelement an demselben Zahn angebracht sind. Die Messung erfolgt im Transmissionsverfahren, d. h. das wenigstens eine optische Sendeelement und das wenigstens eine optische Detektorelement sind auf gegenüberliegenden Seiten des Messvolumens angeordnet und es wird das durch das (durchblutete Gewebe enthaltende) Messvolumen transmittierte Licht erfasst.

[0018] Unabhängig vom Ort der Befestigung und der Art des Messverfahrens (Reflexions- oder Transmissionsverfahren) ist bevorzugt, dass eine Ansteu-

ereinheit das wenigstens eine optische Sendeelement so ansteuert, dass dieses das Licht bei mindestens einer vorgegebenen Wellenlänge in das Messvolumen einstrahlt, dass ein Signal des wenigstens einen optischen Detektorelements an eine Verarbeitungs- und/oder Auswerteeinheit weitergeleitet wird und dass ein verarbeitetes und/oder ausgewertetes Signal an eine Speichereinheit weitergeleitet und/oder an einer Anzeigeeinheit angezeigt wird.

[0019] Des Weiteren ist eine Alarmfunktion bevorzugt, die im Falle einer Unter- oder Überschreitung von für die erfassten Daten vorgegebenen Grenzwerten ein Alarmsignal ausgibt, beispielsweise in Form eines akustischen, mechanischen (z. B. Vibration), elektrischen (z. B. Kribbelgefühl als Folge einer schwachen Elektrostimulation), biochemischen (Duft) oder optischen Alarmsignals.

[0020] Die Weiterleitung des Signals des wenigstens einen optischen Detektorelements erfolgt bevorzugt drahtgebunden oder drahtlos über ein optisches, elektromagnetisches oder akustisches Übertragungsverfahren. Insbesondere können die Signale hierzu analog oder digital aufbereitet werden.

[0021] Besonders bevorzugt ist, Licht mehrerer unterschiedlicher Wellenlängen einzustrahlen, wobei unter Licht elektromagnetische Strahlung in einem Wellenlängenbereich von 300 nm bis 1500 nm verstanden wird. Die Einstrahlung erfolgt vorzugsweise mittels mehrerer Laserdioden, die ausreichend schmalbandig sind. Die Einstrahlung mindestens zweier Messsignale unterschiedlicher Wellenlängen kann insbesondere gleichzeitig oder bevorzugt nacheinander in zeitlichem Abstand erfolgen. Besonders bevorzugt erfolgt die Einstrahlung des Lichts bei einer ersten Wellenlänge von 660 nm und bei einer zweiten Wellenlänge von 940 nm.

[0022] Insbesondere werden bei einer gleichzeitigen Einstrahlung der mindestens zwei Messsignale unterschiedlicher Wellenlänge mittels mindestens zweier Laserdioden mehrere verschiedene Detektoren vorgesehen, die jeweils schmalbandig genug sind, um die Intensität der empfangenen Messsignale bei den einzelnen Wellenlängen getrennt zu ermitteln und so eine Auswertung zu ermöglichen.

[0023] In einer bevorzugten Ausführungsform wird das Licht bei jeder Wellenlänge in Form von Lichtpulsen abgegeben, wobei die Wiederholrate der Lichtpulse im Bereich von 500 Hz bis 100 kHz liegen kann. Insbesondere können die Pulse der verschiedenen Wellenlänge zeitlich zueinander verschoben erfolgen, so dass zu jedem Zeitpunkt nur das Licht bei einer Wellenlänge ausgestrahlt wird. Vorteilhaft ist hierbei, dass zur Detektion lediglich ein breitbandiger Detektor eingesetzt werden muss. Zu beachten ist, dass der zeitliche Abstand zwischen den ausgesandten

Messsignalen unterschiedlicher Wellenlänge sehr kurz im Vergleich zur Periodendauer des Pulsschlags sein muss, z. B. kleiner 50 Millisekunden. Im Falle längerer Verzögerungszeiten könnte man nicht mehr von identischen Proben- bzw. Messvolumen für die verschiedenen Wellenlängen ausgehen, da allein der Pulsschlag schon das Probevolumen verändert. Andererseits muss der zeitliche Abstand so groß sein, dass der Detektor in der Lage ist, die Pulse zu trennen. Sonst sind die Intensitäten der unterschiedlichen Wellenlängen nicht einzeln ermittelbar.

[0024] Insbesondere eignet sich das erfindungsgemäße Verfahren zur Anbringung von Teilen eines mobilen Messgerätes, mit dem Daten eines menschlichen oder tierischen Körpers erfasst werden können. Derartige mobile Messgeräte können beispielsweise von einer zu untersuchenden bzw. zu überwachenden Person bzw. einem Sportler mitgeführt werden.

[0025] Eine erfindungsgemäße Anordnung mit wenigstens einem optischen Sendeelement, mit dem Licht mindestens einer vorgebbaren Wellenlänge in ein Messvolumen innerhalb eines menschlichen oder tierischen Körpers einstrahlbar ist, mit wenigstens einem optischen Detektorelement, mit dem wenigstens ein transmittierter, reflektierter, remittierter oder diffus gestreuter Teil des in das Messvolumen eingestrahlt Lichts detektierbar ist, mit einer Ansteuereinheit zur Ansteuerung des wenigstens einen optischen Sendeelements, mit einer Verarbeitungs- und/oder Auswerteeinheit sowie mit einer Speichereinheit und/oder einer Anzeigeeinheit, zeichnet sich dadurch aus, dass sie wenigstens ein Befestigungsmittel aufweist, mit dem das wenigstens eine optische Sendeelement und das wenigstens eine optische Detektorelement ausschließlich an einem oder mehreren mechanisch festen und ohne chirurgischen Eingriff zugänglichen Körperteilen befestigbar ist.

[0026] Unter der ausschließlichen Befestigung an einem oder mehreren mechanisch festen und ohne chirurgischen Eingriff zugänglichen Körperteilen ist zu verstehen, dass keine den oder die mechanisch festen und ohne chirurgischen Eingriff zugänglichen Körperteile umgebenden Weichgewebe mit in die Befestigung einbezogen werden. Selbstverständlich kann die Befestigung des wenigstens einen optischen Sendeelements und des wenigstens einen optischen Detektorelements dabei direkt oder indirekt, beispielsweise über einen Träger, erfolgen.

[0027] Besonders bevorzugt ist, dass als Befestigungsmittel eine Klammer vorgesehen ist, die an den einen oder die mehreren mechanisch festen und ohne chirurgischen Eingriff zugänglichen Körperteile, insbesondere einen Finger- oder Fußnagel oder ein oder mehrere Zähne, angepasst ist. Alternativ ist bevorzugt, dass als Befestigungsmittel selbstklebende Klebeflächen an den zu befestigenden Elementen

vorgesehen sind, die ein Ankleben am Applikationsort, z. B. an einem Finger- oder Fußnagel oder an einem oder mehreren Zähnen ermöglichen. Unter den zu befestigenden Elementen sind insbesondere diskrete optische Sendeelemente, diskrete optische Empfangselemente, elektronischen Baugruppen, die zumindest Teile der Ansteuer- und/oder Verarbeitungs- und/oder Auswert- und/oder Speichereinheit enthalten, integrierte Einheiten aus den vorstehend genannten Bauelementen/Baugruppen oder zugehörige Träger zu verstehen.

[0028] Die erfindungsgemäße Anordnung mit wenigstens einem optischen Sendeelement, mit dem Licht mindestens einer vorgebbaren Wellenlänge in ein Messvolumen innerhalb des menschlichen oder tierischen Körpers einstrahlbar ist, mit wenigstens einem optischen Detektorelement, mit dem wenigstens ein transmittierter, reflektierter, remittierter oder diffus gestreuter Teil des in das Messvolumen eingestrahnten Lichts detektierbar ist, mit einer Ansteuereinheit zur Ansteuerung des wenigstens einen optischen Sendeelements, mit einer Verarbeitungs- und/oder Auswerteeinheit sowie mit einer Speichereinheit und/oder einer Anzeigeeinheit, zeichnet sich dadurch aus, dass das wenigstens eine optische Sendeelement und das wenigstens eine optische Detektorelement ausschließlich an einem mechanisch festen und ohne chirurgischen Eingriff zugänglichen Körperteil befestigt sind.

[0029] In einer bevorzugten Ausführungsform ist das wenigstens eine optische Sendeelement und das wenigstens eine optische Detektorelement nebeneinander an einem Fingernagel oder einem Fußnagel befestigt.

[0030] In einer weiteren bevorzugten Ausführungsform sind das wenigstens eine optische Sendeelement und das wenigstens eine optische Detektorelement an einem oder mehreren Zähnen derart befestigt, dass das wenigstens eine optische Sendeelement palatinal und das wenigstens eine optische Detektorelement labial oder das wenigstens eine optische Sendeelement labial und das wenigstens eine optische Detektorelement palatinal angeordnet ist und ein zwischen dem wenigstens einen optischen Sendeelement und dem wenigstens einen optischen Detektorelement befindlicher Raum enthält zumindest teilweise Zahnfleisch.

[0031] In einer weiteren bevorzugten Anordnung ist das wenigstens eine optische Sendeelement an einem ersten Zahn angebracht und das wenigstens eine optische Detektorelement an einem zum ersten Zahn benachbarten zweiten Zahn angebracht und ein zwischen dem wenigstens einen optischen Sendeelement und dem wenigstens einen optischen Detektorelement befindlicher Raum enthält zumindest teilweise Zahnfleisch.

[0032] Desweiteren ist bevorzugt, dass eine Ansteuereinheit zur Ansteuerung des optischen Sendeelementes vorgesehen ist, mit der Licht einer oder mehrerer unterschiedlicher Wellenlängen gleichzeitig oder zeitversetzt erzeugt werden kann. Insbesondere kann das Licht jeder Wellenlänge in Form von Lichtpulsen abgegeben werden, wobei die Wiederholrate der Lichtpulse im Bereich von 500 Hz bis 100 kHz liegen kann. Insbesondere können die Pulse der verschiedenen Wellenlänge zeitlich zueinander verschoben erfolgen, so dass zu jedem Zeitpunkt nur das Licht einer Wellenlänge ausgestrahlt wird. Die Ansteuereinheit übernimmt bevorzugt auch die zeitliche Koordination des wenigstens einen optischen Sendeelements und des wenigstens einen optischen Detektorelements. Dies kann eine mit einem Taktgeber und entsprechenden Teilern ausgestattete finite Zustandsmaschine sein, die als festverdrahteter Schaltkreis, vorzugsweise als anwendungsspezifischer integrierter Schaltkreis (ASIC), oder als ein programmierbarer Schaltkreis ausgeführt ist (z. B. FPGA). Eine Realisierung mit Hilfe eines Mikrocontrollers, der die zeitliche Abfolge der Lichtpulse und/oder die Auswertung der Empfangssignale vornimmt, ist ebenfalls möglich. In einer alternativen Ausgestaltung sind die Pulse der verschiedenen Wellenlängen unterschiedlich lang. Obwohl das optische Detektorelement nur eine Intensität eines Lichtsignals erfasst, kann anhand der zeitlichen Dauer des gemessenen Pulses mittels der Auswerteeinheit auf die gesendete Wellenlänge zurückgeschlossen werden. Die Detektoreinheit detektiert bzw. misst bevorzugt im Dauerbetrieb. Eine aktive zeitliche Koordination zwischen optischem Sender und Empfänger ist in diesem Falle nicht erforderlich.

[0033] In einer bevorzugten Ausführungsform erfolgt in der Verarbeitungseinheit eine digitale oder analoge Aufbereitung oder Vorverarbeitung der Signale des wenigstens einen optischen Detektorelements, wie z. B. Verstärkung, Filterung, A/D-Wandlung und evtl. auch Zwischenspeicherung. Des Weiteren weist die Anordnung bevorzugt eine Auswerteeinrichtung auf, in der die Signale des wenigstens einen optischen Detektorelements oder die verarbeiteten Signale ausgewertet und eventuell auch zwischengespeichert werden, insbesondere hinsichtlich Pulsfrequenz und/oder Sauerstoffsättigung. Bevorzugt erfolgt eine Übermittlung der verarbeiteten Signale drahtlos an die Auswerteeinrichtung, die beispielsweise in einer Armbanduhr untergebracht ist.

[0034] Als Energieversorgungseinheit ist bevorzugt eine Batterie vorgesehen. Alternativ können beispielsweise auch Solarzellen oder Thermogeneratoren vorgesehen werden. Insbesondere können auch mehrere Energieversorgungseinheiten vorgesehen sein. Eine weitere Möglichkeit der Energieversorgung besteht darin, die erforderliche Energie induktiv drahtlos bereitzustellen. Hierfür muss ein Feldgene-

rator ein ausreichend starkes magnetisches Wechselfeld erzeugen, welches das hier betrachtete Messgerät mit Hilfe einer Empfangsspule zur Energiegewinnung „anzapft“.

[0035] Besonders bevorzugt ist eine Zusammenfassung von Systemkomponenten in Einheiten, die jeweils in eine Kapselung integriert sind. Beispielsweise können das wenigstens eine optische Sendeelement, die Ansteuereinheit und eine erste Energieversorgungseinheit in einer ersten Einheit integriert und das wenigstens eine optische Detektorelement, eine zweite Energieversorgung und die Verarbeitungseinheit und/oder eine Auswerteeinheit und/oder ein Sendemodul zur drahtlosen Kommunikation in einer zweiten Einheit integriert sein, wobei die einzelnen Komponenten innerhalb der ersten und zweiten Einheit bevorzugt jeweils drahtgebunden verbunden sind.

[0036] Alternativ können das wenigstens eine optische Sendeelement, das wenigstens eine optische Detektorelement, die Ansteuereinheit, eine Energieversorgung, eine Verarbeitungseinheit und/oder eine Auswerteeinheit und/oder ein Sendemodul zur drahtlosen Kommunikation in einer verkapselten Einheit integriert sein, wobei die einzelnen Komponenten innerhalb der verkapselten Einheit bevorzugt drahtgebunden verbunden sind.

[0037] Besonders bevorzugt ist, dass die Fläche der integrierten Einheiten kleiner oder höchstens gleich der Fläche des oder der mechanisch festen Körperteile ist, an denen sie befestigt sind.

[0038] In einer bevorzugten Anordnung ist das wenigstens eine optische Detektorelement drahtgebunden mit einer Verarbeitungseinheit und diese drahtgebunden oder drahtlos mit einer Auswerteeinheit verbunden.

[0039] In einer weiteren bevorzugten Anordnung ist die Auswerteeinheit in einer Armbanduhr oder in einem Kopfhörer integriert, die bzw. der mit einem Detektormodul für die drahtlose Kommunikation mit dem zugeordneten Sendemodul ausgestattet sind. Alternativ ist in der Armbanduhr oder in dem Kopfhörer lediglich das Detektormodul für die drahtlose Kommunikation mit dem Sendemodul integriert und die eigentliche Auswertung erfolgt in einer Auswerteeinheit, die in einem Mobiltelefon oder in einem PDA (Personal Digital Assistant), also einem Minicomputer/Organizer, integriert ist und die drahtgebunden mit dem in der Armbanduhr oder dem Kopfhörer integrierten Detektormodul verbunden ist.

[0040] Die Anordnung lässt sich besonders vorteilhaft zur Ermittlung einer Sauerstoffsättigung des Blutes und/oder der Herzfrequenz oder des Pulses einsetzen. Des Weiteren lässt sich die Anordnung vor-

teilhaft zur Ermittlung des Glukosegehalts des Blutes einsetzen. Weiterhin lässt sich die Anordnung vorteilhaft zur Bestimmung des Wassergehalts des Blutes einsetzen, um beispielsweise eine Dehydrierung zu detektieren.

[0041] In einer weiteren Ausgestaltung ist die erfindungsgemäße, im Mund angeordnete Vorrichtung vorteilhaft mit einem Temperatursensor und einer entsprechend weitergebildeten Signalverarbeitung/Auswerteeinheit kombiniert. Die Temperaturerfassung kann vorteilhaft optisch, wie in üblichen im Ohr messenden Thermometern, oder elektrisch mittels elektrischer Temperatursensoren, erfolgen.

Kurze Beschreibung der Zeichnungen

[0042] Fig. 1 zeigt auf einem Fingernagel angeordnete Systemkomponenten

[0043] Fig. 2 zeigt ein erstes Ausführungsbeispiel von an benachbarten Zähnen angeordneten Systemkomponenten

[0044] Fig. 3 zeigt ein zweites Ausführungsbeispiel von an benachbarten Zähnen angeordneten Systemkomponenten

[0045] Fig. 4 zeigt in einer Kapselung angeordnete Systemkomponenten

[0046] Fig. 5 zeigt eine Kapselung mit einer Klammer

[0047] Fig. 6 zeigt ein Blockschaltbild eines erfindungsgemäßen Gesamtsystems

Wege zur Ausführung der Erfindung

[0048] Die der Erfindung zugrunde liegende Idee der Anordnung optischer Sendeelemente auf mechanisch festen und leicht zugänglichen Körperteilen ist besonders dann vorteilhaft einsetzbar, wenn diese bei Platzierung auf weichem Untergrund kein zuverlässiges Signal geben. Die Unzuverlässigkeit der Signale kann beispielsweise darin begründet sein, dass bei Körperbewegungen Bewegungsartefakte auftreten. Am Beispiel eines auf einem Fingernagel (Fig. 1) bzw. an benachbarten Zähnen (Fig. 2 und Fig. 3) platzierten Systems aus optischem Sendeelement 1 und optischem Detektorelement 2 soll im Folgenden beschrieben werden, wie sich die Erfindung vorteilhaft zur Messung der Sauerstoffsättigung und/oder Pulsfrequenz einsetzen lässt. Diese Beispiele sollen die Erfindung lediglich erläutern, nicht aber einschränken.

[0049] Die Fig. 1 zeigt in vereinfachender schematischer Weise einen Fingernagel 11, auf den eine miniaturisierte Einheit aus wenigstens einem optischen

Detektorelement (Sensor) **2** und wenigstens einem optischen Sendeelement **1** auf dem Fingernagel **11** so aufgeklebt werden, dass auch über längere Zeiträume, z. B. Stunden, keine Verschiebung möglich ist. Die miniaturisierte Einheit kann dabei beispielsweise die Erscheinungsform eines künstlichen Fingernagels aufweisen, der bei Bedarf entfernt bzw. ausgetauscht werden kann. Durch die miniaturisierte Einheit werden die gewöhnlichen Lebensabläufe nicht beeinträchtigt. Die von dem mindestens einen optischen Sendeelement **1** ausgestrahlten Lichtsignale einer oder mehrerer unterschiedlicher Wellenlängen werden in dem durchbluteten Gewebe **12** reflektiert, remittiert oder diffus gestreut. Die reflektierten, remittierten oder diffus gestreuten Lichtsignale werden durch das mindestens eine optische Detektorelement **2** detektiert. Neben der oben beschriebenen Anordnung könnten einzelne Komponenten, z. B. das wenigstens eine optische Detektorelement **2**, das wenigstens eine optische Sendeelement **1**, eine Verarbeitungseinheit **3** und eine Energieversorgungseinheit **4**, auch diskret, d. h. nicht in einem gemeinsamen Gehäuse/Kapselung **5** angeordnet sein. Dann sollten die diskret angeordneten Komponenten aber drahtgebunden verbunden sein.

[0050] Die Sensorsignale werden nach einer Vorverarbeitung in der Verarbeitungseinheit **3**, dazu zählen Filterung, Verstärkung, möglicherweise Differenzbildung, gegebenenfalls Digitalisierung, drahtgebunden oder ggf. drahtlos an einen Empfänger (beispielsweise in Form einer nicht dargestellten Armbanduhr oder eines nicht dargestellten Kopfhörers) übermittelt, der die Sensorsignale auswertet. Alternativ wertet der Empfänger die Signale nicht aus, sondern sendet sie an eine Auswerteeinheit weiter, die beispielsweise in einem nicht dargestellten Mobiltelefon oder in einem nicht dargestellten PDA (Personal Digital Assistant) integriert ist. Aus den bei bestimmten Wellenlängen bzw. Wellenlängenkombinationen erfassten Sensorsignalen lässt sich unter Heranziehung von individuellen Kalibrierungen beispielsweise die prozentuale Sauerstoffsättigung oder aber auch der Blutzuckergehalt des Blutes ermitteln, das in dem untersuchten Gewebe zirkuliert. Aus dem zeitlichen Verlauf der Sensorsignale lässt sich insbesondere die Herzfrequenz (Puls) ermitteln. Die individuellen Kalibrierungen berücksichtigen den Einfluss des einzelnen Individuums als auch den Messort und können eine empirische Kalibration durch invasive arterielle O₂-Messung umfassen.

[0051] In Fig. 2 ist eine Anordnung dargestellt, bei der die Einheiten **8** und **9** an zwei benachbarten Zähnen labial, d. h. lippenseitig, befestigt sind. Dabei umfasst die Einheit **8** den optischen Detektor **2**, d. h. das mindestens eine optische Detektorelement, die Verarbeitungseinheit **3**, in der die Signal(vor)verarbeitung erfolgt, eine Einheit **13** zur drahtlosen Kommunikation zwischen Verarbeitungseinheit **3** und Auswerteeinheit **14** sowie eine Energieversorgungseinheit **4**.

Die Einheit **9** umfasst dagegen den optischen Sender **1** mit mindestens einem optischen Sendeelement, die Ansteuereinheit **15** sowie eine zweite Energieversorgungseinheit **17** (vgl. Fig. 6).

[0052] Alternativ dazu können die Einheiten **8** und **9** auch palatinal, d. h. gaumenseitig, angeordnet sein. Sender und Empfänger sind dabei so platziert, dass ein Teil des Zahnfleischs zwischen den Zähnen durchstrahlt wird. Dabei empfängt der Detektor **2**, d. h. das optische Detektorelement, das durch das Zahnfleisch **12** diffus gestreute Licht.

[0053] In einer bevorzugten Ausgestaltung des erfindungsgemäßen Messsystems sind die beiden Einheiten **8** und **9** separat gekapselt. Dabei dienen entweder die Kapselungen **5** selbst oder eine zusätzlich verwendete und bevorzugt mit der jeweiligen Kapselung fest verbundene Klammer **10** als Mittel zur Befestigung des Systems an einem Zahn bzw. an mehreren benachbarten Zähnen (vgl. Fig. 4/5). Die verarbeiteten Sensorsignale werden analog zu obigem Ausführungsbeispiel verarbeitet und drahtgebunden oder ggf. drahtlos an einen Empfänger (beispielsweise in Form einer Armbanduhr oder eines Kopfhörers) übermittelt, der die verarbeiteten Sensorsignale auswertet. Alternativ wertet der Empfänger die Signale nicht aus, sondern sendet sie an eine Auswerteeinheit weiter, die beispielsweise in ein Mobiltelefon oder in einen PDA (Personal Digital Assistant) integriert ist.

[0054] Aufgrund der notwendigen Miniaturisierung ist das System vorteilhafter so gestaltet, dass der Anwender es nach Belieben ein- und ausschalten kann. Bei einer induktiven Energieversorgung kann dies einfach durch (De-)Aktivieren eines hierfür notwendigen Generators geschehen, der beispielsweise wie die Auswerteeinheit in einer Armbanduhr, einem Kopfhörer, einem Mobiltelefon oder einem PDA untergebracht ist. In einem batteriebetriebenen Fall sollte das An- und Abschalten des Systems vorteilhafterweise über eine Bedienschnittstelle erfolgen, die auch beispielsweise in einer Armbanduhr, einem Kopfhörer, einem Mobiltelefon oder einem PDA untergebracht ist.

[0055] In Fig. 3 ist eine Anordnung dargestellt, bei der sich die in der Einheit **9** integrierten Sendekomponenten und die in der Einheit **8** integrierten Detektorkomponenten auf verschiedenen Seiten der Zähne **6, 7** befinden (Sender palatinal und Empfänger labial oder Sender labial und Empfänger palatinal (bevorzugt)). In einer ersten Ausgestaltung sind dabei die Einheiten **8** und **9** von je einer Kapselung umgeben. Bei dieser Anordnung wird die sog. Interdentalspaltlinie durchstrahlt. Die gekapselten Einheiten werden bevorzugt an den Zähnen **6, 7** festgeklammert, da im Vergleich zu einer Klebung das Anbringen und

Entfernen problemlos möglich ist. Die Weiterverarbeitung und Weiterleitung der Sensorsignale kann wie im vorangehenden Ausführungsbeispiel beschrieben erfolgen.

[0056] In einer weiteren Ausgestaltung (**Fig. 4**) sind alle Komponenten so wie in **Fig. 3** angeordnet, jedoch von einer einzigen Kapselung **5** umgeben. Dies hat den Vorteil, dass das System einfacher anzubringen und zu entfernen ist. Überdies weist die Kapselung **5** dann eine kleinere Oberfläche auf, wodurch sich eine geringere Gefahr für das Eindringen von Feuchtigkeit ergibt.

[0057] In **Fig. 5** ist nur die Kapselung **5**, jedoch nicht die Systemkomponenten dargestellt. Dabei dient entweder die Kapselung **5** selbst oder eine zusätzlich verwendete und bevorzugt mit der Kapselung fest verbundene Klammer **10** als Mittel zur Befestigung des Systems an den Zähnen **6, 7**. Die in **Fig. 5** skizzierte Methode der Befestigung ist auch dann einsetzbar, wenn sich alle Systemkomponenten auf einer Seite der Zähne (palatinal oder labial) befinden.

[0058] Die erfindungsgemäße Anordnung kann selbstverständlich nicht nur wie abgebildet an den Oberkieferzähnen realisiert werden, sondern selbstverständlich auch an den Unterkieferzähnen.

[0059] **Fig. 6** zeigt eine bevorzugte Zusammenfassung von Systemkomponenten in Einheiten, die jeweils in eine Kapselung integriert sind. Gemäß **Fig. 6** sind das wenigstens eine optische Sendeelement **1**, die Ansteuereinheit **15** und eine erste Energieversorgungseinheit **4** in einer ersten Einheit **9** integriert. Das wenigstens eine optische Detektorelement **2**, eine zweite Energieversorgung **16**, die Verarbeitungseinheit **3** und ein Sendemodul zur drahtlosen Kommunikation **13'** sind in einer zweiten Einheit **9** integriert. Dabei sind die einzelnen Komponenten innerhalb der ersten und zweiten Einheit **8, 9** bevorzugt jeweils drahtgebunden verbunden. Beide Einheiten **8, 9** sind beispielsweise auf einem Finger- oder Zehennagel **11** oder an Zähnen **6, 7** befestigt.

[0060] Das Detektormodul **13''** für die drahtlose Kommunikation, eine Auswerteeinheit **14**, eine Speichereinheit **18**, eine weitere Energieversorgungseinheit **17** sowie eine Anzeige **19** bilden eine dritte Einheit. Diese kann beispielsweise in einem Kopfhörer, einer Armbanduhr oder einem Mobiltelefon oder PDA untergebracht sein.

[0061] Das erfindungsgemäße Verfahren und die erfindungsgemäße Anordnung mit der ausschließlichen Befestigung des wenigstens einen optischen Sendeelements und des wenigstens einen optischen Detektorelements an einem oder mehreren mechanisch festen und ohne chirurgische Eingriffe zugänglichen Körperteilen ermöglicht es beispielsweise

auch, dass einem Freizeitsportler während der Ausübung seines Sportes Informationen über Puls und Sauerstoffsättigung mit Hilfe eines transportablen bzw. mobilen Messgerätes angezeigt werden.

Bezugszeichenliste

1	Optischer Sender, optisches Sendeelement
2	Optischer Detektor, optisches Detektorelement
3	Verarbeitungseinheit
4, 16, 17	Energieversorgungseinheit
5	Kapselung
6	Erster Zahn im Querschnitt (Draufsicht)
7	Zweiter Zahn im Querschnitt (Draufsicht)
8	Einheit, welche folgende Systemkomponenten enthält: optischer Detektor, Verarbeitungseinheit, Sendeeinheit für drahtlose Kommunikation, Energieversorgungseinheit
9	Einheit, welche folgende Systemkomponenten enthält: Optischer Sender, Ansteuereinheit, Energieversorgungseinheit
10	Befestigungsmittel, Klammer
11	Fingernagel, Fußnagel
12	Durchstrahlter Raum (Messvolumen)
13', 13''	Sende-, Empfangsmodul zur drahtlosen Kommunikation
14	Auswerteeinheit
15	Ansteuereinheit
18	Speichereinheit
19	Anzeigeeinheit

ZITATE ENTHALTEN IN DER BESCHREIBUNG

Diese Liste der vom Anmelder aufgeführten Dokumente wurde automatisiert erzeugt und ist ausschließlich zur besseren Information des Lesers aufgenommen. Die Liste ist nicht Bestandteil der deutschen Patent- bzw. Gebrauchsmusteranmeldung. Das DPMA übernimmt keinerlei Haftung für etwaige Fehler oder Auslassungen.

Zitierte Patentliteratur

- WO 2007/012931 [0008]

Patentansprüche

1. Verfahren zum Anbringen wenigstens eines optischen Sendeelements (1), mit dem Licht mindestens einer vorgegebenen Wellenlänge in ein Messvolumen (12) innerhalb eines menschlichen oder tierischen Körpers einstrahlbar ist, und wenigstens eines optischen Detektorelements (2), mit dem wenigstens ein transmittierter, reflektierter, remittierter oder diffus gestreuter Teil des in das Messvolumen (12) eingestrahlten Lichts detektierbar ist, **dadurch gekennzeichnet**, dass die Befestigung des wenigstens einen optischen Sendeelements (1) und des wenigstens einen optischen Detektorelements (2) ausschließlich an einem oder mehreren mechanisch festen und ohne chirurgische Eingriffe zugänglichen Körperteilen erfolgt.

2. Verfahren nach Anspruch 1, dadurch gekennzeichnet, dass das wenigstens eine optische Sendeelement (1) und das optische Detektorelement (2) nebeneinander an einem Fingernagel oder einem Fußnagel (11) befestigt werden und dass die Einstrahlung des Lichts in ein Messvolumen (12) unter dem Fingernagel oder Fußnagel (11) erfolgt.

3. Verfahren nach Anspruch 1, dadurch gekennzeichnet, dass das wenigstens eine optische Sendeelement (1) und das optische Detektorelement (2) an einem oder mehreren Zähnen (6, 7) derart befestigt werden, dass das wenigstens eine optische Sendeelement (1) palatinal und das wenigstens eine optische Detektorelement (2) labial oder das wenigstens eine optische Sendeelement (1) labial und das wenigstens eine optische Detektorelement (2) palatinal angeordnet werden und dass ein zwischen dem wenigstens einen optischen Sendeelement (1) und dem wenigstens einen optischen Detektorelement (2) befindliches Zahnfleisch durchstrahlt wird.

4. Verfahren nach Anspruch 1, dadurch gekennzeichnet, dass das wenigstens eine optische Sendeelement (1) an einem ersten Zahn (6) angebracht wird und das wenigstens eine optische Detektorelement (2) an demselben Zahn (6) oder an einem zum ersten Zahn (6) benachbarten zweiten Zahn (7) angebracht wird und dass ein zwischen dem wenigstens einen optischen Sendeelement (1) und dem wenigstens einen optischen Detektorelement (2) befindliches Zahnfleisch durchstrahlt wird.

5. Verfahren nach einem der Ansprüche 1 bis 4, dadurch gekennzeichnet, dass eine Ansteuereinheit (15) das wenigstens eine optische Sendeelement (1) so ansteuert, dass dieses das Licht mindestens einer vorgegebenen Wellenlänge in das Messvolumen (12) einstrahlt, dass ein Signal des wenigstens einen optischen Detektorelements (2) an eine Verarbeitungs-

(3) und/oder Auswerteeinheit (14) weitergeleitet wird und dass ein verarbeitetes und/oder ausgewertetes Signal an eine Speichereinheit (18) weitergeleitet und/oder an einer Anzeigeeinheit (19) angezeigt wird.

6. Anordnung mit wenigstens einem optischen Sendeelement (1), mit dem Licht mindestens einer vorgebbaren Wellenlänge in ein Messvolumen (12) innerhalb eines menschlichen oder tierischen Körpers einstrahlbar ist, mit wenigstens einem optischen Detektorelement (2), mit dem wenigstens ein transmittierter, reflektierter, remittierter oder diffus gestreuter Teil des in das Messvolumen (12) eingestrahlten Lichts detektierbar ist, mit einer Ansteuereinheit (15) zur Ansteuerung des wenigstens einen optischen Sendeelements (1), mit einer Verarbeitungs- (3) und/oder Auswerteeinheit (14) sowie mit einer Speichereinheit (18) und/oder einer Anzeigeeinheit (19), dadurch gekennzeichnet, dass die Anordnung wenigstens ein Befestigungsmittel (10) aufweist, mit dem das wenigstens eine optische Sendeelement (1) und das wenigstens eine optische Detektorelement (2) ausschließlich an einem oder mehreren mechanisch festen und ohne chirurgischen Eingriff zugänglichen Körperteilen befestigbar ist.

7. Anordnung nach Anspruch 6, dadurch gekennzeichnet, dass als Befestigungsmittel (10) eine Klammer vorgesehen ist, die an den einen oder die mehreren mechanisch festen und ohne chirurgischen Eingriff zugänglichen Körperteile, insbesondere einen Finger- oder Fußnagel (11) oder ein oder mehrere Zähne (6, 7), angepasst ist.

8. Anordnung mit wenigstens einem optischen Sendeelement (1), mit dem Licht mindestens einer vorgebbaren Wellenlänge in ein Messvolumen (12) innerhalb eines menschlichen oder tierischen Körpers einstrahlbar ist, mit wenigstens einem optischen Detektorelement (2), mit dem wenigstens ein transmittierter, reflektierter, remittierter oder diffus gestreuter Teil des in das Messvolumen (12) eingestrahlten Lichts detektierbar ist, mit einer Ansteuereinheit (15) zur Ansteuerung des wenigstens einen optischen Sendeelements (1), mit einer Verarbeitungs- (3) und/oder Auswerteeinheit (14) sowie mit einer Speichereinheit (18) und/oder einer Anzeigeeinheit (19), dadurch gekennzeichnet, dass das wenigstens eine optische Sendeelement (1) und das wenigstens eine optische Detektorelement (2) ausschließlich an einem oder mehreren mechanisch festen und ohne chirurgischen Eingriff zugänglichen Körperteilen befestigt sind.

9. Anordnung nach Anspruch 8, dadurch gekennzeichnet, dass das wenigstens eine optische Sendeelement (1) und das wenigstens eine optische Detektorelement (2) nebeneinander an einem Fingernagel oder einem Fußnagel (11) befestigt sind.

10. Anordnung nach Anspruch 8, dadurch gekennzeichnet, dass das wenigstens eine optische Sendeelement (1) und das wenigstens eine optische Detektorelement (2) an einem oder mehreren Zähnen (6, 7) derart befestigt sind, dass das wenigstens eine optische Sendeelement (1) palatinal und das wenigstens eine optische Detektorelement (2) labial oder das wenigstens eine optische Sendeelement (1) labial und das wenigstens eine optische Detektorelement (2) palatinal angeordnet ist und dass ein zwischen dem wenigstens einen optischen Sendeelement (1) und dem wenigstens einen optischen Detektorelement (2) befindlicher Raum zumindest teilweise Zahnfleisch enthält.

11. Anordnung nach Anspruch 8, dadurch gekennzeichnet, dass das wenigstens eine optische Sendeelement (1) an einem ersten Zahn (6) angebracht ist und das wenigstens eine optische Detektorelement (2) an demselben Zahn (6) oder an einem zum ersten Zahn (6) benachbarten zweiten Zahn (7) angebracht ist und dass ein zwischen dem wenigstens einen optischen Sendeelement (1) und dem wenigstens einen optischen Detektorelement (2) befindlicher Raum zumindest teilweise Zahnfleisch enthält.

Es folgen 5 Blatt Zeichnungen

Anhängende Zeichnungen

Fig 1

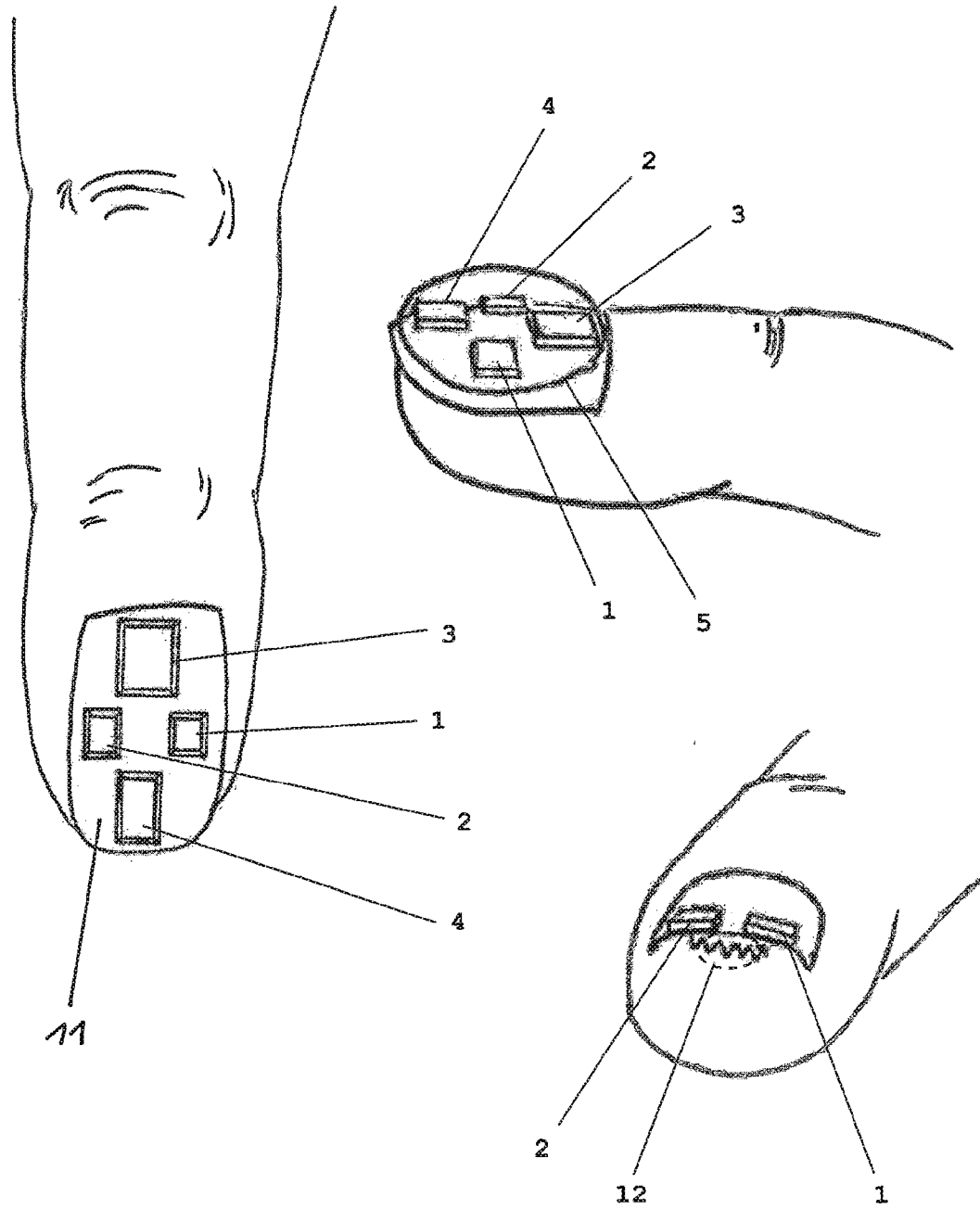

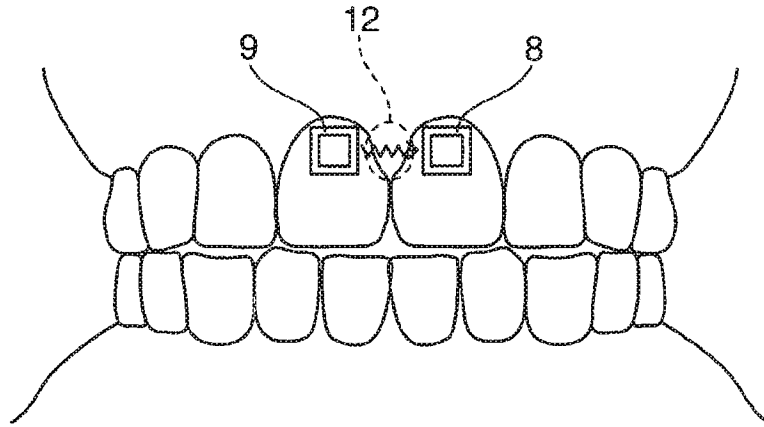

Fig. 2

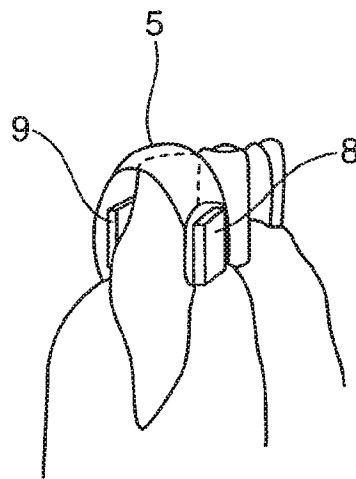

Fig. 4

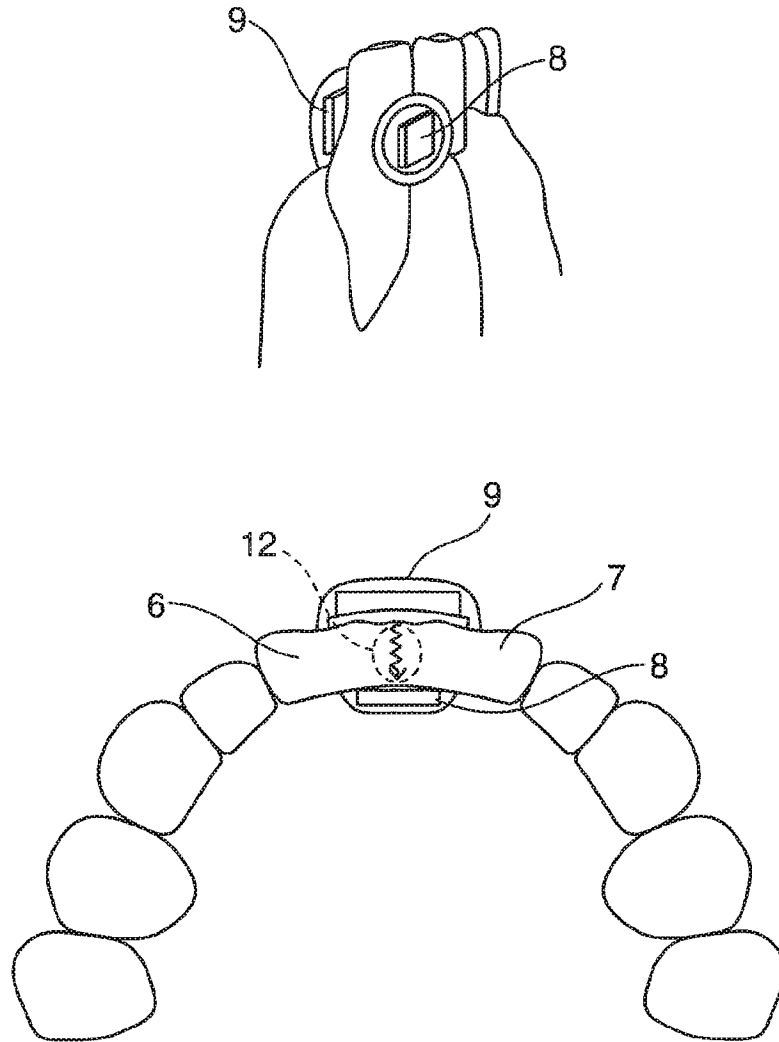

Fig. 3

Fig 5

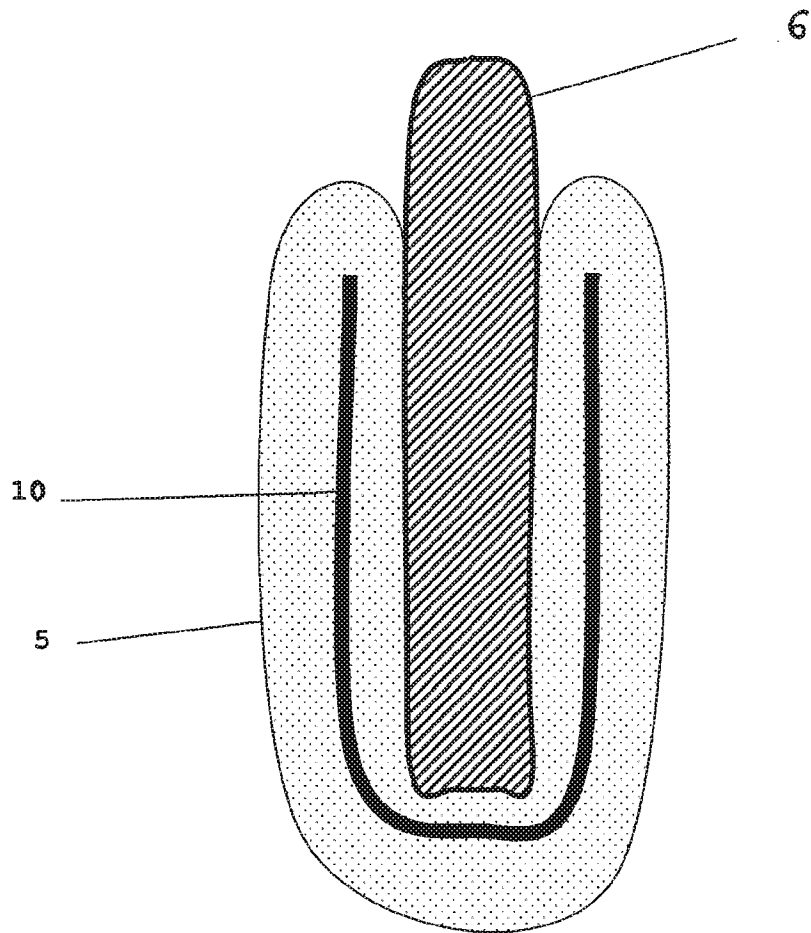
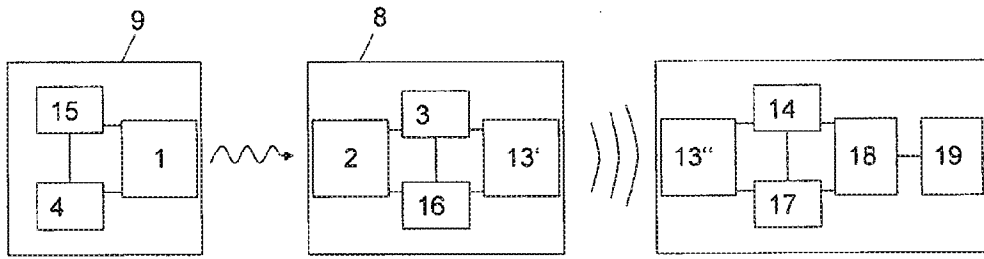
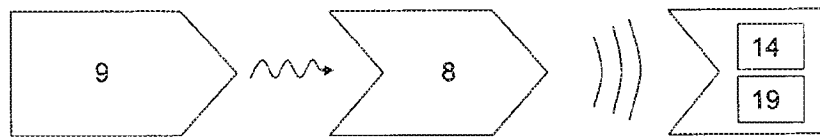

Fig 6



(19) World Intellectual Property Organization
International Bureau



(43) International Publication Date
17 February 2005 (17.02.2005)

PCT

(10) International Publication Number
WO 2005/013843 A2

- (51) International Patent Classification⁷: A61C
- (21) International Application Number: PCT/US2004/025872
- (22) International Filing Date: 6 August 2004 (06.08.2004)
- (25) Filing Language: English
- (26) Publication Language: English
- (30) Priority Data: 60/493,569 8 August 2003 (08.08.2003) US
- (71) Applicant (for all designated States except US): THE REGENTS OF THE UNIVERSITY OF CALIFORNIA [US/US]; 1111 Franklin Street, 12th floor, Oakland, CA 94607-5200 (US).
- (72) Inventors; and
- (75) Inventors/Applicants (for US only): FRIED, Daniel [US/US]; 1200 35th Avenue, San Francisco, CA 94122 (US). JONES, Robert [US/US]; 95 Behr Avenue #303, San Francisco, CA 94131 (US).
- (74) Agent: O'BANION, John, P.; O'Banion & Ritchey LLP, 400 Capitol Mall, Suite 1550, Sacramento, CA 95814 (US).

(81) Designated States (unless otherwise indicated, for every kind of national protection available): AE, AG, AL, AM, AT, AU, AZ, BA, BB, BG, BR, BW, BY, BZ, CA, CH, CN, CO, CR, CU, CZ, DE, DK, DM, DZ, EC, EE, EG, ES, FI, GB, GD, GE, GH, GM, HR, HU, ID, IL, IN, IS, JP, KE, KG, KP, KR, KZ, LC, LK, LR, LS, LT, LU, LV, MA, MD, MG, MK, MN, MW, MX, MZ, NA, NI, NO, NZ, OM, PG, PH, PL, PT, RO, RU, SC, SD, SE, SG, SK, SL, SY, TJ, TM, TN, TR, TT, TZ, UA, UG, US, UZ, VC, VN, YU, ZA, ZM, ZW.

(84) Designated States (unless otherwise indicated, for every kind of regional protection available): ARIPO (BW, GH, GM, KE, LS, MW, MZ, NA, SD, SL, SZ, TZ, UG, ZM, ZW), Eurasian (AM, AZ, BY, KG, KZ, MD, RU, TJ, TM), European (AT, BE, BG, CH, CY, CZ, DE, DK, EE, ES, FI, FR, GB, GR, HU, IE, IT, LU, MC, NL, PL, PT, RO, SE, SI, SK, TR), OAPI (BF, BJ, CF, CG, CI, CM, GA, GN, GQ, GW, ML, MR, NE, SN, TD, TG).

Published: — without international search report and to be republished upon receipt of that report

[Continued on next page]

(54) Title: NEAR-INFRARED TRANSILLUMINATION FOR THE IMAGING OF EARLY DENTAL DECAY

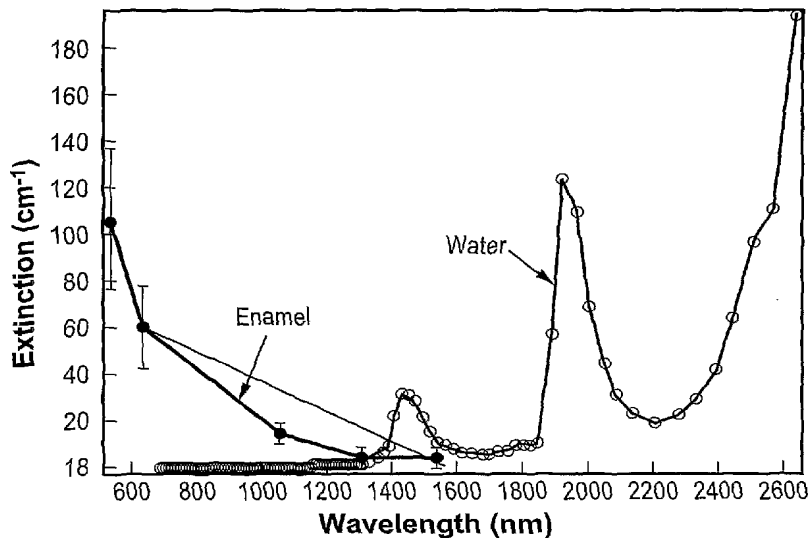

(57) Abstract: A method for detecting tooth decay and other tooth anomalies wherein a tooth is transilluminated with a near-infrared light source preferably in the range from approximately 795-nm to approximately 1600-nm, more preferably in the range from approximately 830-nm to approximately 1550-nm, more preferably in the range from approximately 1285-nm to approximately 1335-nm, and more preferably at a wavelength of approximately 1310-nm, and the light passing through the tooth is imaged for determining an area of decay in the tooth. The light source is a fiber optic bundle coupled to a halogen lamp or more preferably a superluminescent diode, and the imaging device is preferably a CCD camera or a focal plane array (FPA).

WO 2005/013843 A2



For two-letter codes and other abbreviations, refer to the "Guidance Notes on Codes and Abbreviations" appearing at the beginning of each regular issue of the PCT Gazette.

TITLE OF THE INVENTION
NEAR-INFRARED TRANSILLUMINATION FOR
THE IMAGING OF EARLY DENTAL DECAY

5 CROSS-REFERENCE TO RELATED APPLICATIONS

[0001] This application claims priority from U.S. provisional application serial number 60/493,569 filed on August 8, 2003, the entirety of which is herein incorporated by reference.

10 STATEMENT REGARDING FEDERALLY SPONSORED RESEARCH
OR DEVELOPMENT

[0002] This invention was made with Government support under Grant No. 1-R01 DE14698 and Grant No. T32 DE07306-07 awarded by NIH/NICDR. The Government has certain rights in this invention.

15 INCORPORATION-BY-REFERENCE OF MATERIAL
SUBMITTED ON A COMPACT DISC

[0003] Not Applicable

20 BACKGROUND OF THE INVENTION

1. Field of the Invention

[0004] This invention pertains generally to detection of dental caries by transillumination of a tooth, and more particularly to transillumination at wavelengths that are not subject to scattering by sound tooth enamel and identification of dental caries in interproximal sites between teeth.

2. Incorporation by Reference of Publications

[0005] The following publications are incorporated by reference herein in their entirety:

[0006] J. D. B. Featherstone and D. Young, "The need for new caries detection methods," Lasers in Dentistry V, San Jose, CA, Proc. SPIE **3593**, 134-140 (1999).

[0007] J. Peltola and J. Wolf, " Fiber optics transillumination in caries

diagnosis," Proc Finn Dent Soc, **77**, 240-244 (1981).

[0008] J. Barenie, G. Leske, and L. W. Ripa, "The use of fiber optic transillumination for the detection of proximal caries," Oral Surg, **36**, 891-897 (1973).

5 [0009] R. D. Holt and M. R. Azevedo, "Fiber optic transillumination and radiographs in diagnosis of approximal caries in primary teeth," Community Dent Health, **6**, 239-247 (1989).

[0010] C. M. Mitropoulis, "The use of fiber optic transillumination in the diagnosis of posterior approximal caries in clinical trials," Caries Res, **19**, 379-384, (1985).

10 [0011] A. Peers, F. J. Hill, C. M. Mitropoulos, and P. J. Holloway, "Validity and reproducibility of clinical examination, fibre-optic transillumination, and bite-wing radiology for the diagnosis of small approximal carious lesions." Caries Res., **27**, 307-311 (1993).

15 [0012] C. M. Pine, "Fiber-Optic Transillumination (FOTI) in Caries Diagnosis," in *Early Detection of Dental Caries*, G. S. Stookey, ed., (Indiana Press, Indianapolis, Ind. 1996).

[0013] J. Vaarkamp, J. J. t. Bosch, E. H. Verdonschot, and E. M. Bronkhorst, "The real performance of bitewing radiography and fiber-optic transillumination for approximal caries diagnosis," J Dent Res, **79**, 1747-1751 (2000).

20 [0014] A. Schneiderman, M. Elbaum, T. Schultz, S. Keem, M. Greenebaum, and J. Driller, "Assessment of Dental caries with Digital Imaging Fiber-Optic Transillumination (DIFOTI):In vitro Study," Caries Res., **31**, 103-110 (1997).

[0015] D. Fried, J. D. B. Featherstone, R. E. Glana, and W. Seka, "The nature of light scattering in dental enamel and dentin at visible and near-IR wavelengths," Appl. Optics, **34**, 1278-1285 (1995).

[0016] R. Jones and D. Fried, "Attenuation of 1310 and 1550-nm laser light through dental enamel," in Lasers in Dentistry VIII, San Jose, Proc. SPIE **4610**, 187-190 (June 2002).

30 [0017] G. M. Hale and M. R. Querry, "Optical constants of water in the 200-nm to 200- μ m wavelength region.," Appl. Optics, **12**, 555-563 (1973).

[0018] D. Spitzer and J. J. ten Bosch, "The absorption and scattering of light in

bovine and human dental enamel," *Calcif. Tiss. Res.*, **17**, 129-137 (1975).

[0019] S. Keem and M. Elbaum, "Wavelet representations for monitoring changes in teeth imaged with digital imaging fiber-optic transillumination," *IEEE Trans Med Imaging*, **16**, 653-63 (1997).

5 3. Incorporation by Reference of Patents

[0020] The following U.S. patents which describe transillumination techniques and devices are incorporated by reference herein in their entirety:

[0021] U.S. No. 6,341,957

[0022] U.S. No. 6,243,601

10 [0023] U.S. No. 6,201,880

4. Description of Related Art

[0024] During the past century, the nature of dental decay or dental caries has changed dramatically due to the addition of fluoride to the drinking water, the widespread use of fluoride dentifrices and rinses, and improved dental hygiene. Despite these advances, however, dental decay continues to be the leading cause of tooth loss in the United States. By age 17, 80% of children have experienced at least one cavity. In addition, two-thirds of adults in the age range of 35 to 44 have lost at least one permanent tooth to caries. Older adults suffer tooth loss due to the problem of root caries.

20 [0025] Today, almost all new decay occurs in the occlusal pits and fissures of the posterior dentition and the interproximal contact sites between teeth. These early carious lesions are often obscured or "hidden" in the complex and convoluted topography of the pits and fissures or are concealed by debris that frequently accumulates in those regions of the posterior teeth. Such decay, particularly in the early stages, is difficult to detect using the dentist's existing armamentarium of dental x-rays and the dental explorer (a metal mechanical probe). Therefore, new imaging technologies are needed for the early detection of such lesions.

30 [0026] Moreover, the treatment for early dental decay or caries is shifting away from aggressive cavity preparations that attempt to completely remove demineralized tooth structure toward non-surgical or minimally invasive restorative techniques. In non-surgical therapy, a clinician prescribes

antibacterial rinses, fluoride treatments, and dietary changes in attempt to naturally remineralize the decay before it becomes irreversible. The success of this type of therapy is contingent on early caries detection and also requires imaging modalities that can safely and accurately monitor the success of such treatment. Conventional x-rays do not precisely measure the lesion depth of early dental decay, and due to ionizing radiation exposure are not indicated for regular monitoring. These constraints and limitations are the impetus for investigating optical imaging systems that could detect early dental decay, while providing the biologically compatible wavelengths that facilitate frequent screening.

[0027] Before the advent of x-rays, dentists used light for the detection of caries lesions. In the past 30 years, the development of high intensity fiber-optic illumination sources has resurrected this method for caries detection. Previous groups pursuing visible light transillumination, have used or proposed more advanced imaging techniques like temporal or coherence gating and sophisticated image processing algorithms to enhance the imaging and detection of dental decay.

[0028] Fiber-optic transillumination (FOTI) is one technology being developed for the detection of interproximal lesions. One digital-based system, DIFOTITM (Digital Imaging Fiber-Optic Transillumination) from Electro-Optical Sciences, Inc., that utilizes visible light, has recently received FDA approval. During FOTI a carious lesion appears dark upon transillumination because of decreased transmission due to increased scattering and absorption by the lesion. However, the strong light scattering of sound dental enamel at visible wavelengths, 400-nm to 700-nm, inhibits imaging through the tooth.

BRIEF SUMMARY OF THE INVENTION

[0029] The present invention is directed to the detection, diagnosis, and imaging of carious dental tissue. The invention resolves changes in the state of mineralization of dental hard tissues with sufficient depth resolution to be useful for the clinical diagnosis and longitudinal monitoring of lesion progression. One aspect of the invention is to provide system and method for the detection, diagnosis, and imaging of early caries lesions and/or for the

monitoring of lesion progression. Another aspect of the invention is to provide a near-infrared transillumination system and method for the detection and imaging of early interproximal caries lesions. A further aspect of the invention is to provide a near-infrared transillumination system and method for the detection of cracks and imaging the areas around composite restorations.

5
[0030] In one mode, near-IR light at 1310-nm is used for the detection and imaging of interproximal caries lesions where a high contrast between sound enamel and simulated lesions is exhibited. In addition, occlusal lesions, root caries, secondary decay around composite restorations, and cracks and defects in the tooth enamel can be seen.

10
[0031] In accordance with one aspect of the invention, a method for detecting tooth anomalies comprises transilluminating a tooth with light having a wavelength in the range from approximately 795-nm to approximately 1600-nm, and the step of imaging light passing through said tooth for determining an anomaly or area of decay in said tooth. In accordance with other aspects of the present invention, a tooth is transilluminated with near-infrared light at a wavelength more preferably in the range from approximately 830-nm to approximately 1550-nm, more preferably in the range from approximately 1285-nm to approximately 1335-nm, and more preferably at a wavelength of approximately 1310-nm.

15
20
[0032] In another mode, the light is filtered to remove extraneous light. The light may be polarized with one or more polarizing filters to remove light not passing through said tooth. The polarizing filters are preferably crossed high-extinction polarizing filters. The method may also comprise filtering said light with a bandpass filter to remove light outside a specified bandwidth.

25
[0033] Generally, transilluminating a tooth comprises directing light from a near-infrared light source at a surface of said tooth. The light source may be a fiber-optic bundle coupled to a halogen lamp, a superluminescent laser diode, or similar IR source.

30
[0034] In one mode of the invention, the light source may be manipulated behind the tooth to direct said light at a lingual surface of the tooth. Alternatively, the light source may be manipulated in front of said tooth to

direct said light at a facial surface of the tooth.

[0035] In one embodiment, the step of imaging light passing through the tooth comprises detecting intensity of light passing through the tooth at a plurality of spatial positions, developing a spatial profile of the detected light intensity, using the spatial intensity profile to identify an area in said tooth exhibiting intensity gradients, designating said area of said tooth exhibiting intensity gradients as an area of tooth decay. In another embodiment, detected light intensity is compared over at least a portion of said spatial positions for determining an area of decay in said tooth and an area of the tooth exhibiting a lower detected light intensity than an at least partially surrounding area is designated as an area of tooth decay.

[0036] In one aspect of the invention, the step of detecting the intensity of light passing through said tooth comprises directing a first detector at an aspect of the tooth, such as a facial aspect of the tooth, an occlusal aspect of the tooth, an opposite aspect of the tooth from the light source, or the same aspect of the tooth as the light source.

[0037] According to another embodiment of the invention, a second detector a second detector may at a different aspect of the tooth than the first detector. For example, the second detector may be directed at an occlusal aspect of the tooth while the first detector is directed at a facial aspect of the tooth. The detector may comprise a focal plane array, near-infrared CCD camera, or the like.

[0038] The method may be used to determine anomalies such as an area of decay, a crack, a composite restoration, and dental caries in an occlusal site or interproximal contact site between said tooth and an adjacent tooth of said tooth.

[0039] According to another aspect of the invention, a system for detecting tooth decay comprises a near-infrared light source emitting light having a wavelength in the range from approximately 785-nm to approximately 1600-nm wherein the light source is configured to transilluminate a tooth, and means for imaging light passing through said tooth and determining an area of decay in said tooth. In accordance with other aspects of the present

invention, a light source has a wavelength more preferably in the range from approximately 830-nm to approximately 1550-nm, more preferably in the range from approximately 1285-nm to approximately 1335-nm, and more preferably at a wavelength of approximately 1310-nm. In one mode, the light source comprises a polarized light source. In another mode, the light source comprises an unpolarized light source. In one embodiment, the light source comprises a fiber-optic bundle coupled to a halogen lamp. In another embodiment, the light source comprises a superluminescent diode (SLD). In still another embodiment, the imaging means comprises a CCD camera. In another embodiment, the imaging means comprises a focal plane array (FPA).

[0040] According to yet another aspect of the invention, a system for detecting a tooth anomaly comprises a near-infrared light source having a wavelength in the range from approximately 795-nm to approximately 1600-nm, wherein the light source is configured to transilluminate a tooth. The system further includes an imaging device configured to detect intensity of light from said light source passing through said tooth, whereby an anomaly in said tooth can be determined from intensity of light detected by said imaging device.

[0041] Further aspects of the invention will be brought out in the following portions of the specification, wherein the detailed description is for the purpose of fully disclosing preferred embodiments of the invention without placing limitations thereon.

BRIEF DESCRIPTION OF THE SEVERAL VIEWS OF THE DRAWING(S)

[0042] The invention will be more fully understood by reference to the following drawings which are for illustrative purposes only:

[0043] FIG. 1 is graph comparing the attenuation coefficient of dental enamel and water as a function of wavelength.

[0044] FIG. 2 is a flowchart of an embodiment of a method for detecting dental caries by near-infrared transillumination according to the present invention.

[0045] FIG. 3 is a schematic diagram of a system for Near-Infrared Transillumination of whole teeth and tooth sections according to the present invention.

[0046] FIG. 4 is a schematic diagram of another system for Near-Infrared Transillumination of whole teeth and tooth sections according to the present invention using two light sources.

5 [0047] FIGS. 5A-5D are views of a tooth with a simulated lesion. FIG. 5A is a side view of a 3-mm thick tooth section with a simulated lesion. FIG. 5B illustrates that the lesion cannot be seen using transillumination with visible light and a CCD camera. FIG. 5C illustrates that the lesion is clearly visible under NIR. FIG. 5D is an x-ray of the section using D-speed film indicates the small contrast difference between the simulated lesion and sound enamel.

10 [0048] FIGS. 6A-6F are NIR transillumination images of tooth sections with simulated lesions are shown for sample thicknesses of 2-mm, 3-mm, 4-mm, 5-mm, 6-mm and 6.75-mm, respectively. The corresponding spatial line profiles are shown on the inset in the lower right of each image, and the measured lesion contrast is shown in the lower left. The left axis represents the pixel intensity ranging from 0 to 4096, and the bottom axis the pixel position
15 through the lesion.

[0049] FIG. 7 is a graph showing the mean \pm s.d lesion contrast plotted versus thickness of plano-parallel enamel samples, n=5.

[0050] FIG. 8 is an NIR image of a whole tooth sample. A natural carious lesion and a composite restoration are seen on the left and right, respectively.
20 The tooth is slightly rotated to present different viewing angles. A crack is also visible in the center of the tooth.

DETAILED DESCRIPTION OF THE INVENTION

[0051] Referring more specifically to the drawings, for illustrative purposes the present invention is embodied in the system(s) and method(s) generally shown in FIG. 2 through FIG. 8. It will be appreciated that the apparatus may vary as to configuration and as to details of the parts, and that the method may vary as to the specific steps and sequence, without departing from the basic concepts as disclosed herein.
25

30 [0052] A principal limiting factor of light in the visible wavelength range from approximately 400-nm to 700-nm being transmitted through a tooth is light scattering in sound enamel and dentin. The present invention overcomes that

limiting factor by employing near-infrared (NIR) for transillumination of a tooth.

The magnitude of light scattering in dental enamel decreases as $1/\lambda^3$, where λ is the wavelength, due to the size of the principal scatterers in the enamel.

5 The attenuation coefficients of dental enamel measured at 1310-nm and 1550-nm were 3.1 cm^{-1} and 3.8 cm^{-1} , respectively. As shown in FIG. 1, the magnitude of scattering at those wavelengths is more than a factor of 30 times lower than in the visible range. This translates to a mean free path of 3.2 mm for 1310-nm photons, indicating that enamel is transparent in the near-infrared (NIR). At longer wavelengths past 1550-nm, the attenuation coefficient is not
10 expected to decrease any further due to the increasing absorption coefficient of water, 12% by volume, in dental enamel.

[0053] As indicated above, at shorter wavelengths the light is subject to scattering. On the other hand, at longer wavelengths, absorption of water in the tissue increases and thereby reduces the penetration of infrared light.

15 **[0054]** Note also that, during the caries process, micropores are formed in the lesion due to partial dissolution of the individual mineral crystals. Such small pores can behave as scattering centers smaller than the wavelength of the light. Accordingly, there can be an increase in both the magnitude of light scattering and the contribution of large angle scattering to the scattering
20 phase function in caries lesions due to the increased microporosity. Changes in the optical constants and scattering phase function of enamel and dentin result in more rapid depolarization of incident polarized light. Accordingly, polarized light (e.g., via linear or circular polarization) will provide a greater image contrast than unpolarized light and can be exploited to aid in the near-
25 infrared optical detection of carious lesions.

[0055] The present invention is particularly useful in detecting occlusal caries (biting surfaces) and interproximal caries or lesions located at interproximal contact sites between adjacent teeth. The present invention is also useful in detecting other anomalies such as root caries, cracks, and imaging around
30 composite restorations.

[0056] Referring to FIG. 2, an exemplary method for detecting tooth anomalies

such as dental decay or caries according to the invention is illustrated. First, a near-infrared light source is positioned adjacent to a tooth to be examined, as shown at block 20. Next, the tooth is transilluminated with the near-infrared light, as shown at block 22. The wavelength of the light is preferably in the range from approximately 795-nm to approximately 1600-nm, more preferably in the range from approximately 830-nm to approximately 1550-nm, more preferably in the range from approximately 1285-nm to approximately 1335-nm, and more preferably at a wavelength of approximately 1310-nm. Use of near-infrared light in these ranges provides deeper depth resolution and improved contrast between sound and carious enamel as compared to light at other wavelengths.

[0057] Once the tooth is transilluminated, the intensity of the light passing through the tooth at a plurality of spatial positions is detected, thereby forming an image of the tooth structure, as shown at block 24. The detected light intensity over at least a portion of the spatial positions is then compared so that an area of tooth decay can be identified, as shown at block 26. This is preferably accomplished by developing a spatial profile so that intensity gradients can be seen. An area of the tooth that exhibits a lower detected light intensity than an at least partially surrounding area is indicative of an area of tooth decay. While contrast alone can be used as an indicator of tooth decay, more preferably the existence of a defined boundary or edge between areas exhibiting intensity gradients is a more accurate indicator. It will be appreciated, of course, that a dentist or trained clinician will review and evaluate the images to distinguish lesions from, for example, areas containing fillings, composite restorations, or other non-dental caries areas that effect intensity gradients in the image. Note that the incident light is preferably linearly polarized and, preferably, only light in the orthogonal polarization state is measured.

[0058] An exemplary NIR imaging device 30 is shown schematically in FIG 3. Light 50 is emitted from a light source 32, through polarizer 38 and aperture 34 toward tooth or series of teeth 36. Light source 32 preferably comprises a broadband light source, such as fiber-optic bundle coupled to a halogen lamp,

or a superluminescent laser diode (SLD). It was found that the speckle of conventional narrow bandwidth diode lasers such as a 50-mW 1310-nm source, Model QLD-1300-50 (Qphotonics Inc., Chesapeake, VA) interfered significantly with image resolution and were not optimal for the present invention.

5
[0059] Crossed near-IR polarizers, 38, 40 are used to remove light that directly illuminated the array without passing through the tooth. In a clinical situation, the light passing between the teeth will saturate the image preventing detection. Dental enamel is birefringent and, therefore, the polarization state of the light passing through the tooth may be altered to reduce extinction. 10
Polarization gating using crossed high extinction polarizers 38, 40 removes extraneous light that does not pass through the tooth and exploits the native birefringence of the tooth enamel to rotate the plane of polarization so that only light that passes through the tooth is measured. Caries lesions 15
depolarize light which provides better image contrast between sound and carious tissue

[0060] Light passing through tooth 36 and polarizer 40 is further filtered with bandpass filter 42 to remove all light outside the spectral region of interest.

20
[0061] The light is then focused with lens 44 and picked up with detector 46 to acquire images of tooth or teeth 36. In a preferred embodiment, detector 46 comprises a near-infrared (NIR) InGaAs focal plane array (FPA).

[0062] The illuminating light intensity of light source 32, the diameter of aperture 34, and the distance of the light source to tooth 36, may all be adjusted to obtain the maximum contrast between the lesion and the surrounding enamel without saturation of the InGaAs FPA around the lesion area. 25

[0063] Alternatively, detector 46 may comprise a CCD camera with the IR filter 42 and a 70-nm bandpass filter centered at approximately 830-nm. Alternatively, the bandpass filter may be removed. Imaging with a near-IR 30
CCD camera is less expensive with an InGaAs detector, but does not perform as well as an InGaAs detector. As another alternative, transillumination can also be conducted using a CCD camera with a near-infrared phosphor in the

range of approximately 1000-nm to approximately 1600-nm.

5 [0064] In yet another alternative embodiment, image quality may be improved by utilizing biocompatible index matching fluids and gels and/or solid materials of high refractive index to reduce reflection, total internal reflection, and refraction at the tooth entrance and exit surfaces. Such materials would be placed on the end of the illumination source 32 and/or the detector 46 and would make physical contact with the tooth surface

10 [0065] Now referring to Figure 4, an alternative embodiment of NIR imaging device 60 is shown schematically for imaging tooth 36. This device 60 may be used for the near-IR imaging of occlusal and pit and fissure lesions by placing light source 62 on the facial aspect 68 or lingual aspect 70 of the tooth and placing a second imaging source 66 above the occlusal surface 72 of the tooth 36 in addition to the first imaging source 68 either the facial or lingual aspects, 68, 70. Detection of light 50 along different axes may be achieved with a combination of prisms, mirrors or optical fiber components. For 15 example, the imaging fiber optic bundle 62 could be fitted with a 90° prism (not shown) and connected to a near-IR imaging camera. Alternatively, the light source may also be placed in any combination of these viewing angles, including having the light source and imager on the same aspect of the tooth.

20 *EXAMPLE 1*

(Sample Preparation)

[0066] Thirty plano-parallel sections of enamel of various thicknesses (2-mm, 3-mm, 4-mm, 5-mm, 6-mm, and 6.75-mm) were prepared from non-carious human teeth. These sections were stored in a moist environment to preserve 25 tissue hydration with 0.1% thymol added to prevent bacterial growth. Uniform scattering phantoms simulating dental decay were produced midway through each section by drilling 1-mm diameter x 1.2-mm deep cavities in the proximal region of each sample and filling the cavities with hydroxyapatite paste. A thin layer of unfilled composite resin was applied to the outside of the filled cavity 30 to seal the hydroxyapatite within the prepared tooth cavity.

(NIR Imaging)

[0067] Both a 150-watt halogen lamp, Visar™ (Den-Mat, Santa Maria, CA),

and a 1310-nm superluminescent diode (SLD) with an output power of 3.5 mW and a bandwidth of 25-30 nm, Model QSDM-1300-5 (Qphotonics Inc., Chesapeake, VA) were separately used as the illumination source.

5 [0068] Model K46-252 (Edmund Scientific, Barrington, NJ) crossed near-IR polarizers were used to remove light that directly illuminated the array without passing through the tooth. A 50-nm bandpass filter centered at 1310-nm Model BP-1300-090B (Spectrogon US, Parsippany, NJ) was used to remove all light outside the spectral region of interest.

10 [0069] A near-infrared (NIR) InGaAs focal plane array (FPA) having a resolution of 318 x 252 pixels was used to acquire all of the images. The particular FPA used was an Alpha NIRTTM (Indigo Systems, Goleta, Ca) with an InfinimiteTM lens (Infinity, Boulder, Co).

[0070] The acquired 12-bit digital images were analyzed using IRVistaTM software (Indigo Systems, Goleta, Ca).

15 [0071] The illuminating light intensity, source to sample distance, and the aperture diameter were adjusted for each sample to obtain the maximum contrast between the lesion and the surrounding enamel.

20 [0072] Although the 3.5-mW SLD source provided similar image quality to the halogen lamp source, all the images illustrated herein were acquired using the fiber-optic illuminator. Due to the natural tooth contours, the sides near the simulated lesions in the tooth sections were masked with putty to ensure that light traveled the full width of the sample. This masking is not applicable in a clinical situation and was not necessary to acquire images of whole teeth.

25 [0073] In addition, good images of teeth were obtained using the 3.5 mW SLD operating at 1310-nm. This is important because this illumination source is very compact and can be easily placed in the oral cavity. Furthermore, the SLD is much more compact than the illumination source used for DiFOTI and can be integrated into a small dental explorer and manipulated behind the teeth for collection of images using the camera.

30 *(Visible and X-ray Imaging)*

[0074] A tooth section of minimal sample thickness, 3-mm, was chosen for comparison of the NIR transillumination system with conventional visible light

FOTI and x-ray transillumination. For visible light transillumination, the same fiber-optic illuminator was used to illuminate the section and a color 1/3" CCD camera with a resolution of 450 lines, Model DFK 5002/N, (Imaging Source, Charlotte, NC) equipped with the same Infinimite™ lens recorded the projection image. The corresponding x-ray image was acquired by placing the section directly on Ultra-Speed™ D-speed film (Kodak, Rochester, NY) using 75 kVp, 15 mA, and 12 impulses.

(Image Analysis)

[0075] The coordinates of each simulated lesion were known prior to analyzing the contrast of each lesion. The mean pixel intensity of the lesion and the enamel above and below the lesion was measured using the IRvista™ software. Lesion contrast was calculated for each sample as follows:

$$\text{Lesion Contrast (C)} = (I_E - I_L) / I_E,$$

where I_E is the mean intensity of the enamel bordering the lesion and I_L is the mean intensity of the lesion. Lesion contrast is defined as a ratio that will vary from zero (0) to one (1). For each of the six sample thicknesses measured, the mean lesion contrast was calculated and plotted versus sample thickness.

[0076] Although contrast is important, the boundary or edge between the lesion and the sound tooth structure is central to detection of the lesion.

Therefore, the spatial intensity profile of a lesion with its surrounding enamel was analyzed. An intensity profile was mapped from a (1) distinct line in six sample images representing each thickness.

RESULTS

[0077] Visible light, NIR and X-ray images of a simulated lesion placed in one of the 3-mm thick tooth sections are shown in FIG. 5A-5D. The lesion cannot be seen using visible light transillumination, however the lesion is clearly visible with high contrast using NIR light transillumination. A radiographic image of the tooth section using D-speed film shows a low lesion contrast, or a small contrast difference between the lesion and the surrounding enamel.

[0078] The lesion contrast was calculated for all thirty of the enamel sections under NIR illumination. Representative spatial intensity profiles from six of the

samples of each thickness and the corresponding images are shown in FIG. 6A-6F. From these profiles, the edge or boundary between the sound enamel and the lesion is clearly demarcated in all six of the sections. The image contrast plotted vs. section thickness is shown in FIG. 7. A lesion contrast of greater than 0.35 was seen in all the sections with the exception of the 6-mm samples. A 0.35 lesion contrast is equivalent to a lesion intensity that is 65% of the surrounding enamel.

[0079] For 6-mm samples, a mean lesion contrast of 0.16 was calculated. A steep intensity gradient is visible between the surrounding enamel and the lesion. This gradient is less pronounced for sections greater than 4-mm thick, especially on the lower border of the lesion. A NIR image of a whole tooth sample with a natural lesion 84, depicted in FIG. 8, illustrates that a natural lesion 84 can be resolved with the same success as the simulated lesions placed in plano-parallel sections. A composite filling 86 is also visible on the opposite side of the tooth in FIG. 8, indicating that there is also high contrast between composite filling materials and sound tooth structure.

DISCUSSION OF EXPERIMENTAL RESULTS

[0080] The high contrast and intensity profiles of the simulated lesions with the surrounding enamel indicate the significant potential of NIR transillumination for imaging dental caries. Since the clinical use of transillumination is to detect interproximal lesions, it is important to note that forty of the sixty-four interproximal surfaces in the mouth would require imaging through less than 5-mm of enamel. This study suggests that resolving caries lesions through 5-mm of enamel is clinically feasible. This is further demonstrated by the NIR imaging of whole teeth with natural decay.

[0081] During the transillumination of whole tooth samples, polarization gating with crossed polarizers was critical for preventing the illuminating light from saturating the InGaAs array near the area of the lesion "shadow". This technique will also be important in a clinical setting where adjacent tooth surfaces will reflect, but not depolarize the light, and could interfere with the accuracy of the projection image.

[0082] During demineralization of enamel in the caries process, preferential

dissolution of the mineral phase creates pores that highly scatter light. The simulated lesions in our study are primarily made up of isotropic scatterers, with scattering occurring at the grain boundaries in the hydroxyapatite powder. Therefore, such simulated lesions may possibly overestimate the magnitude of scattering in natural caries lesions; however, creating more accurate optical simulated lesions requires an intimate understanding of the fundamental optical properties of carious tissue that has yet to be determined.

5
[0083] It was found that 1310-nm is optimal for both high transmission through sound dental enamel and for achieving high contrast between caries lesions and sound enamel.

10
[0084] Simulated lesions composed of an unorganized paste of hydroxyapatite, strongly scatter the 1310-nm light, which provides high contrast with the transparent sound enamel. Optical transillumination is similar to other projection imaging modalities like conventional x-rays, however the image contrast arises from changes in tissue scattering as opposed to variations in tissue density. Therefore, this method can be more sensitive than x-rays for resolving early caries lesions. Clinicians are trained to diagnose at the low lesion contrast depicted in the radiograph of FIG. 5D, but the high contrast in the NIR image suggests that the simulated lesions are more sensitive to optical detection. This is due to the fact that the simulated lesions have only slightly lower density than the sound enamel but strongly scatter NIR light.

15
20
[0085] In addition, favorable images to a depth of 4-mm to 5-mm were obtained using a CCD camera with the IR filter removed operating at approximately 830-nm.

25
[0086] As can be seen, therefore, there are several advantages between the present invention and known systems that use DiFOTI or other FOTI techniques. These include:

[0087] (a) Illumination

30 [0088] The DiFOTI system and other FOTI systems utilize an unfiltered fiber-optic illuminator with most intensity in the visible range, as opposed to the broadband near-IR illumination sources of the present invention. Tests

revealed that narrow band sources such as conventional laser diodes generate too much laser speckle for imaging. Successful results were achieved with a fiber-optic illuminator having either a 50-nm bandpass filter centered at 1310-nm or a 70-nm bandpass filter centered at 830-nm. Test results were also favorable (speckle-free) with a low cost 3.5 mW, single mode fiber pigtailed, superluminescent laser diode operating at 1310-nm with a bandwidth of 25-nm to 30-nm.

[0089] (b) Image processing

[0090] DiFOTI utilizes proprietary image processing techniques to improve image quality. Although imaging processing techniques may be used in conjunction with the current invention, post imaging digital processing methods is generally not required to improve performance.

[0091] (c) Performance

[0092] The images collected with FOTI and DiFOTI are not true projection or transillumination images, since the penetration of visible light or the mean-free path is less than 100- μ m in enamel. The way these systems work is that light migrates through the enamel of the tooth, backlighting the lesion for better contrast. That means that these systems must have a direct line of sight to the lesion surface. Therefore, they cannot be used to determine how far a lesion has penetrated through the enamel since they can only view the lesion surface.

[0093] The present invention acquires true projection images similar to x-rays by imaging through the full thickness of the enamel. In those images, the camera does not have a direct line of site to the lesion surface. This is possible because of the increase in the mean free path of enamel, that is optimum at 1310-nm - 3.3 mm.

[0094] Although the description above contains many details, these should not be construed as limiting the scope of the invention but as merely providing illustrations of some of the presently preferred embodiments of this invention. Therefore, it will be appreciated that the scope of the present invention fully encompasses other embodiments which may become obvious to those skilled in the art, and that the scope of the present invention is accordingly to be

limited by nothing other than the appended claims, in which reference to an element in the singular is not intended to mean "one and only one" unless explicitly so stated, but rather "one or more." All structural, chemical, and functional equivalents to the elements of the above-described preferred
5 embodiment that are known to those of ordinary skill in the art are expressly incorporated herein by reference and are intended to be encompassed by the present claims. Moreover, it is not necessary for a device or method to address each and every problem sought to be solved by the present invention, for it to be encompassed by the present claims. Furthermore, no element,
10 component, or method step in the present disclosure is intended to be dedicated to the public regardless of whether the element, component, or method step is explicitly recited in the claims. No claim element herein is to be construed under the provisions of 35 U.S.C. 112, sixth paragraph, unless the element is expressly recited using the phrase "means for."

CLAIMS

What is claimed is:

1. A method for detecting tooth anomalies, comprising:
5 transilluminating a tooth with light having a wavelength in the range from approximately 795-nm to approximately 1600-nm; and
imaging light passing through said tooth for determining an anomaly in said tooth.
- 10 2. A method as recited in claim 1, wherein said light has a wavelength in the range from approximately 830-nm to approximately 1550-nm.
3. A method as recited in claim 1, wherein said light has a wavelength in the range from approximately 1285-nm to approximately 1335-nm.
15
4. A method as recited in claim 1, wherein said light has a wavelength of approximately 1310-nm.
5. A method as recited in claim 1, further comprising:
20 filtering said light to remove extraneous light.
6. A method as recited in claim 5, wherein filtering said light comprises polarizing said light with one or more polarizing filters to remove light not passing through said tooth.
25
7. A method as recited in claim 6, wherein said one or more polarizing filters comprises crossed high-extinction polarizing filters.
8. A method as recited in claim 5, further comprising:
30 filtering said light with a bandpass filter to remove light outside a specified bandwidth.

9. A method as recited in claim 1, wherein transilluminating a tooth comprises directing light from a near-infrared light source at a surface of said tooth.

10. A method as recited in claim 9, wherein the light source comprises a
5 fiber-optic bundle coupled to a halogen lamp.

11. A method as recited in claim 9, wherein the light source comprises a superluminescent laser diode.

10 12. A method as recited in claim 9, wherein directing light from a light source comprises manipulating the light source behind said tooth to direct said light at a lingual surface of the tooth.

15 13. A method as recited in claim 10, wherein directing light from a light source comprises manipulating the light source in front of said tooth to direct said light at a facial surface of the tooth.

20 14. A method as in claim 1, wherein transilluminating a tooth comprises simultaneously directing light from a near-infrared light source at a surface of a plurality of teeth.

15. A method as recited in claim 9, wherein said step of imaging light passing through said tooth, comprises:

25 detecting intensity of light passing through said tooth at a plurality of spatial positions;

developing a spatial profile of said detected light intensity;

using said spatial intensity profile, identifying an area in said tooth exhibiting intensity gradients; and

30 designating said area of said tooth exhibiting intensity gradients as an area of tooth decay.

16. A method as recited in claim 15, wherein the step of detecting intensity

of light passing through said tooth comprises directing a first detector at an aspect of the tooth.

5 17. A method as in claim 16, wherein the first detector is directed at a facial aspect of the tooth.

18. A method as in claim 16, wherein the first detector is directed at an occlusal aspect of the tooth.

10 19. A method as in claim 16, wherein the first detector is directed at an opposite aspect of the tooth from the light source.

15 20. A method as in claim 16, wherein the first detector is directed at the same aspect of the tooth as the light source.

21. A method as in claim 16, further comprising directing a second detector at a different aspect of the tooth than the first detector.

20 22. A method as in claim 21, wherein the second detector is directed at an occlusal aspect of the tooth and the first detector is directed at a facial aspect of the tooth.

25 23. A method as in claim 16, wherein the detector comprises a focal plane array.

24. A method as in claim 16, wherein the detector comprises a near-infrared CCD camera.

30 25. A method as in claim 24, wherein said light has a wavelength of 830-nm.

26. A method as in claim 1, wherein imaging light passing through said

tooth comprises determining an area of decay in said tooth.

27. A method as in claim 1, wherein imaging light passing through said tooth comprises determining a crack in said tooth.

5

28. A method as in claim 1, wherein imaging light passing through said tooth comprises determining an anomaly around a composite restoration in said tooth.

10

29. A method as in claim 26, further comprising identifying dental caries in an occlusal site of said tooth.

30. A method as in claim 26, further comprising identifying dental caries in an interproximal contact site between said tooth and an adjacent tooth.

15

31. A method of detecting tooth decay, comprising:
transilluminating a tooth with a near-infrared light source having a wavelength in the range from approximately 795-nm to approximately 1600-nm;
detecting intensity of light passing through said tooth at a plurality of spatial
20 positions;
comparing detected light intensity for at least a portion of said spatial positions; and
designating an area of said tooth exhibiting a lower detected light intensity than an at least partially surrounding area as an area of tooth decay.

25

32. A method of detecting tooth decay, comprising:
transilluminating a tooth with a near-infrared light source having a wavelength in the range from approximately 795-nm to approximately 1600-nm;
detecting intensity of light passing through said tooth at a plurality of spatial
30 positions;
developing a spatial profile of said detected light intensity;
using said spatial intensity profile, identifying areas in said tooth exhibiting

intensity gradients; and

designating said area of said tooth exhibiting intensity gradients as an area of tooth decay.

5 33. A method of detecting dental caries in interproximal contact sites between adjacent teeth, comprising:

 positioning a near-infrared light source having a wavelength in the range from approximately 795-nm to approximately 1600-nm adjacent to a tooth;

 transilluminating said tooth with said light source;

10 detecting intensity of light passing through said tooth at a plurality of spatial positions;

 developing a spatial profile of said detected light intensity;

 using said spatial intensity profile, identifying areas in said tooth exhibiting intensity gradients; and

15 designating said area of said tooth exhibiting intensity gradients as an area of tooth decay.

 34. A method as in any one of claims 1, 31, 32, and 33, wherein said light has a wavelength in the range from approximately 830-nm to approximately 1550-nm,

 35. A method as in any one of claims 1, 31, 32, and 33, wherein said light has a wavelength in the range from approximately 1285-nm to approximately 1335-nm.

25 36. A method as in any one of claims 1, 31, 32, and 33, wherein said light has a wavelength of approximately 1310-nm.

 37. A method as in any one of claims 31, 32, and 33, further comprising:
30 filtering said light with one or more polarizing filters to remove extraneous light not passing through said tooth.

38. A method as in any one of claims 31, 32, and 33, wherein transilluminating a tooth comprises directing light from a near-infrared light source at a surface of said tooth.

5 39. A method as recited in claim 38, wherein the light source comprises a fiber-optic bundle coupled to a halogen lamp.

40. A method as recited in claim 38, wherein the light source comprises a superluminescent laser diode.

10

41. A system for detecting tooth decay, comprising:
a near-infrared light source emitting light having a wavelength in the range from approximately 795-nm to approximately 1600-nm;
said light source configured to transilluminate a tooth; and
15 means for imaging light passing through said tooth and determining an area of decay in said tooth.

42. A system as recited in claim 41, wherein the means for imaging light comprises a focal plane array.

20

43. A system as recited in claim 41, wherein the means for imaging light comprises a near-infrared CCD camera.

44. A system for detecting a tooth anomaly, the system comprising:
25 a near-infrared light source having a wavelength in the range from approximately 795-nm to approximately 1600-nm;
said light source configured to transilluminate a tooth; and
an imaging device configured to detect intensity of light from said light source passing through said tooth;
30 whereby an anomaly in said tooth can be determined from intensity of light detected by said imaging device.

45. A system as in either of claims 41 or 44, wherein said light has a wavelength in the range from approximately 830-nm to approximately 1550-nm

46. A system as in either of claims 41 or 44, wherein said light has a
5 wavelength in the range from approximately 1285-nm to approximately 1335-nm.

47. A system as in either of claims 41 or 44, wherein said light has a wavelength of approximately 1310-nm.

10 48. A system as in either of claims 41 or 44, further comprising:
one or more polarizing filters to remove light not passing through said tooth.

49. A system as recited in claim 48, wherein said one or more polarizing filters comprises crossed high-extinction polarizing filters.

15

50. A system as in either of claims 41 or 44, further comprising:
a bandpass filter to remove light outside a specified bandwidth.

51. A system as in either of claims 41 or 44, wherein the light source
20 comprises a fiber-optic bundle coupled to a halogen lamp.

52. A system as in either of claims 41 or 44, wherein the light source comprises a superluminescent laser diode.

25 53. A system as in either of claims 41 or 44, wherein the light source is configured to be positioned behind said tooth to direct said light at a lingual surface of the tooth.

30 54. A system as in either of claims 41 or 44, wherein the light source is configured to be positioned in front of said tooth to direct said light at a facial surface of the tooth.

55. A system as recited in claim 44, wherein the imaging device comprises a first detector.

56. A system as recited in claim 55, wherein the first detector is configured
5 to be directed at a facial aspect of the tooth.

57. A system as in claim 55, wherein the first detector is directed at an occlusal aspect of the tooth.

10 58. A system as in claim 55, wherein the first detector is directed at an opposite aspect of the tooth from the light source.

59. A system as in claim 55, wherein the first detector is directed at the same aspect of the tooth as the light source.

15

60. A system as in claim 59, wherein the imaging device further comprises a second detector directed at a different aspect of the tooth than the first detector.

61. A system as in claim 59, wherein the second detector is directed at an
20 occlusal aspect of the tooth and the first detector is directed at a facial aspect of the tooth.

62. A system as in claim 55, wherein the detector comprises a focal plane
array.

25

63. A system as in claim 55, wherein the detector comprises a near-infrared CCD camera.

64. A system as in claim 63, wherein said light has a wavelength of 830-
30 nm.

65. A method as in claim 44, wherein imaging light passing through said

tooth comprises determining an area of decay in said tooth.

66. A method as in claim 65, wherein said area of decay comprises decay in an occlusal site of said tooth.

5

67. A method as in claim 65, wherein said area of decay comprises decay in an interproximal contact site between said tooth and an adjacent tooth.

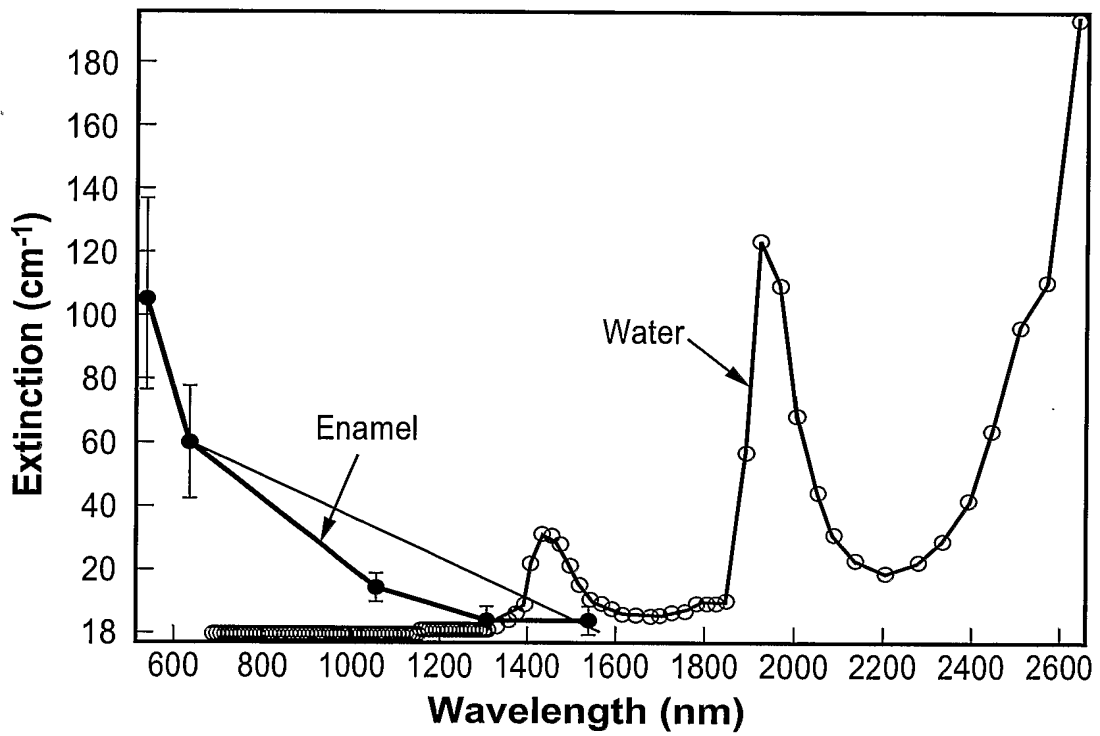

FIG. 1

2/9

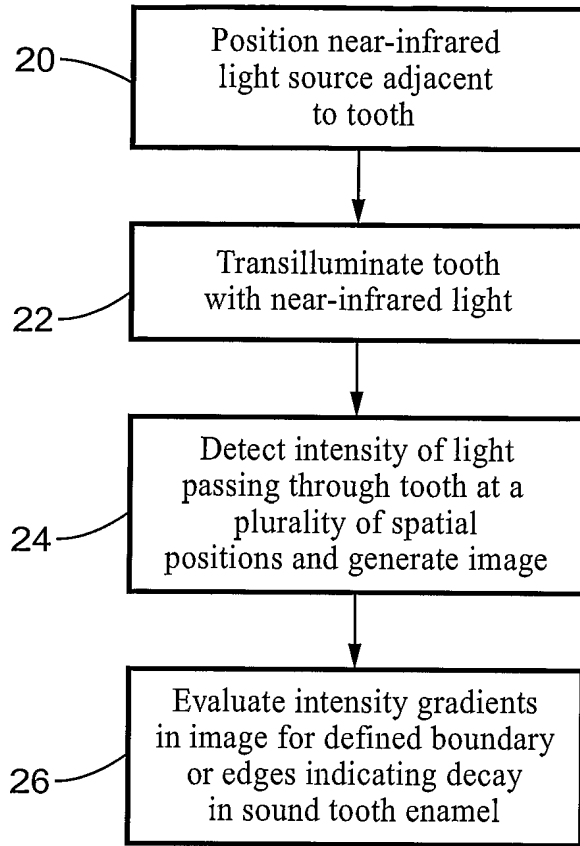

FIG. 2

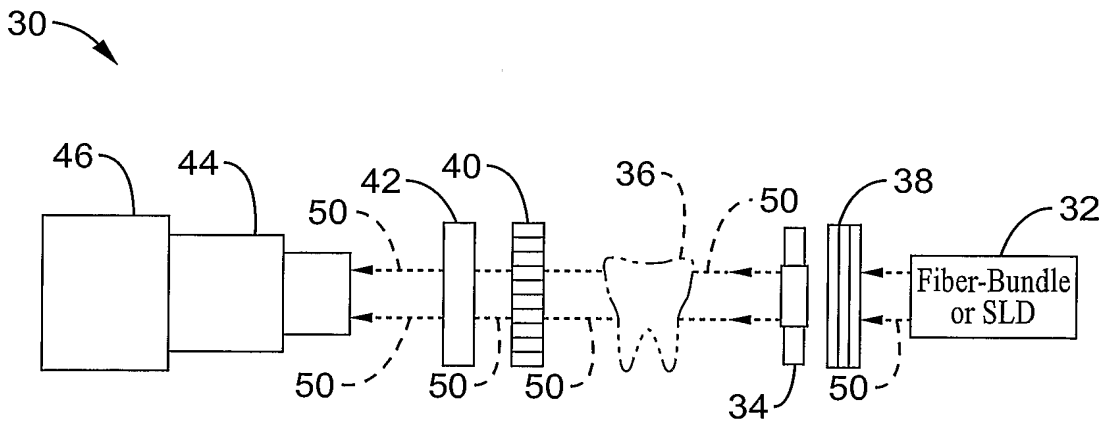

FIG. 3

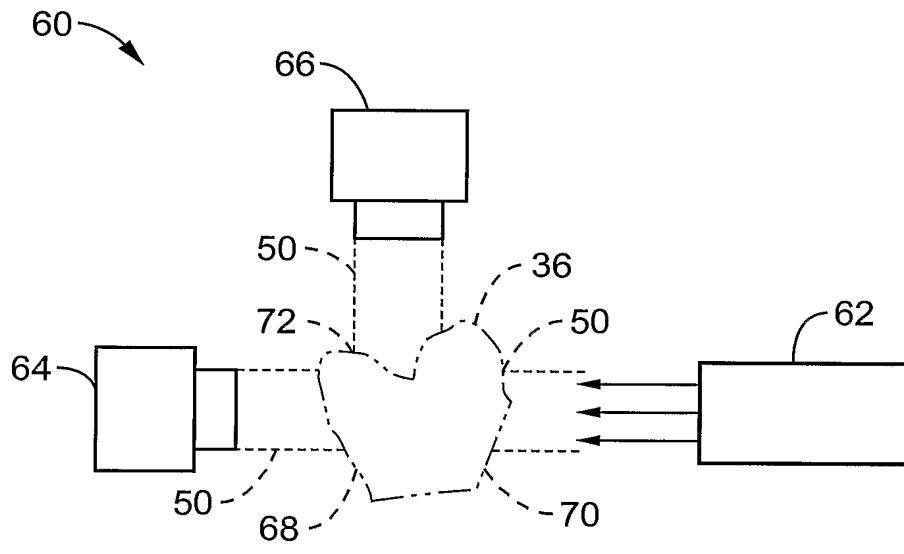
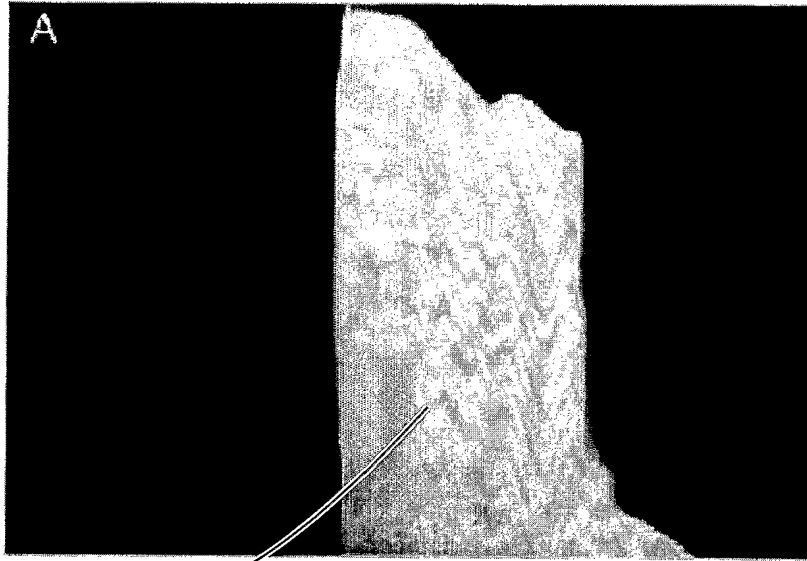

FIG. 4



80

FIG. 5A

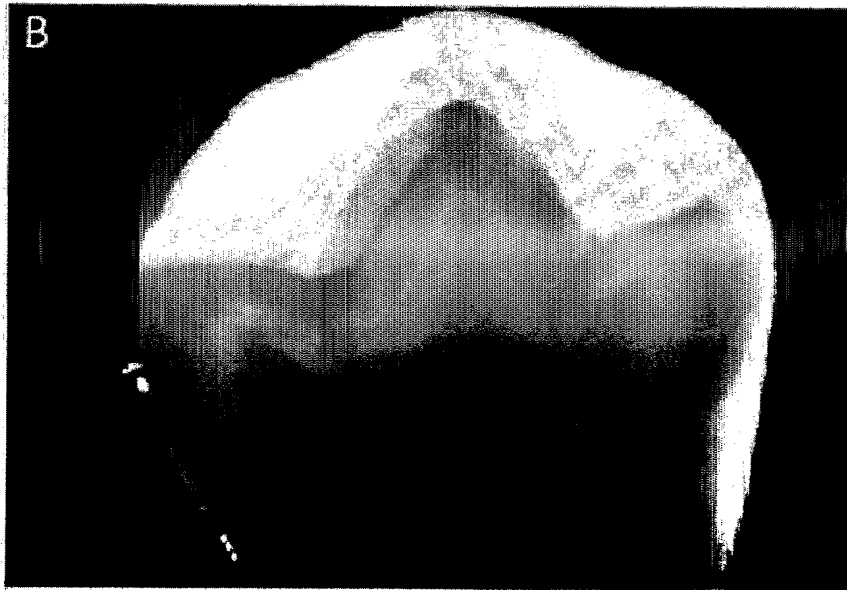

FIG. 5B

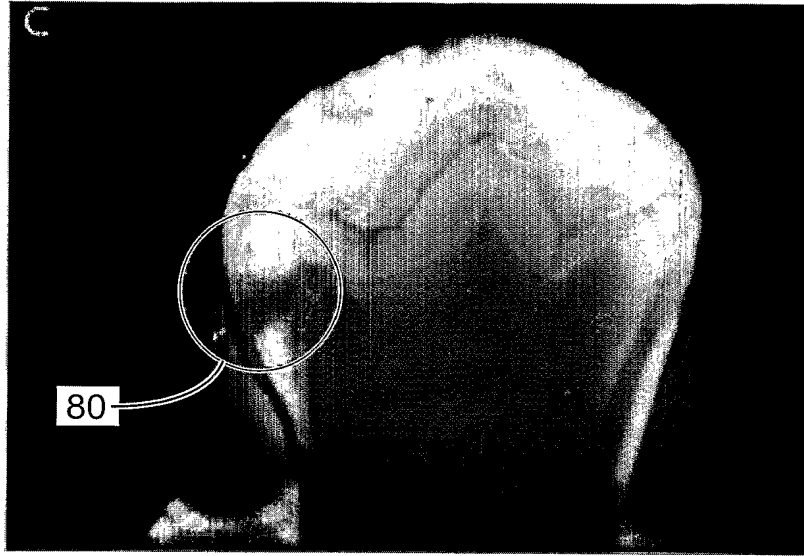

FIG. 5C

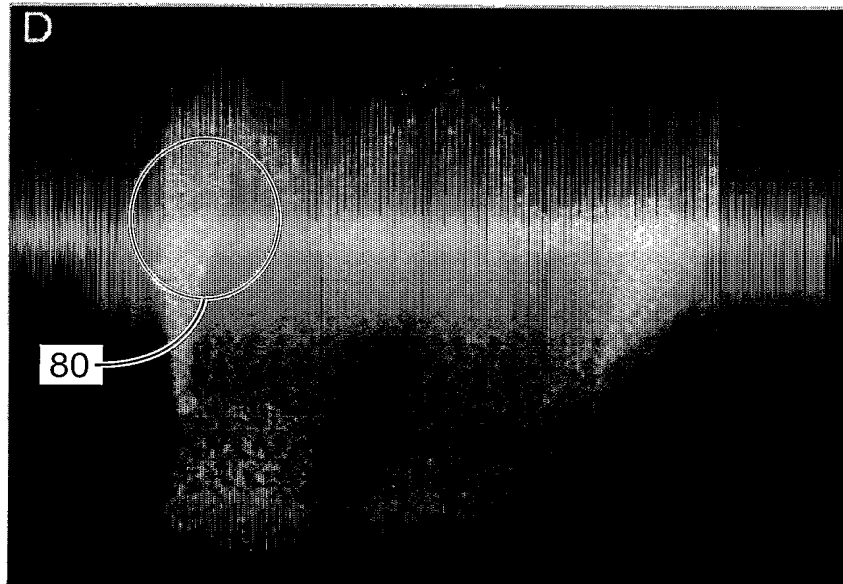

FIG. 5D

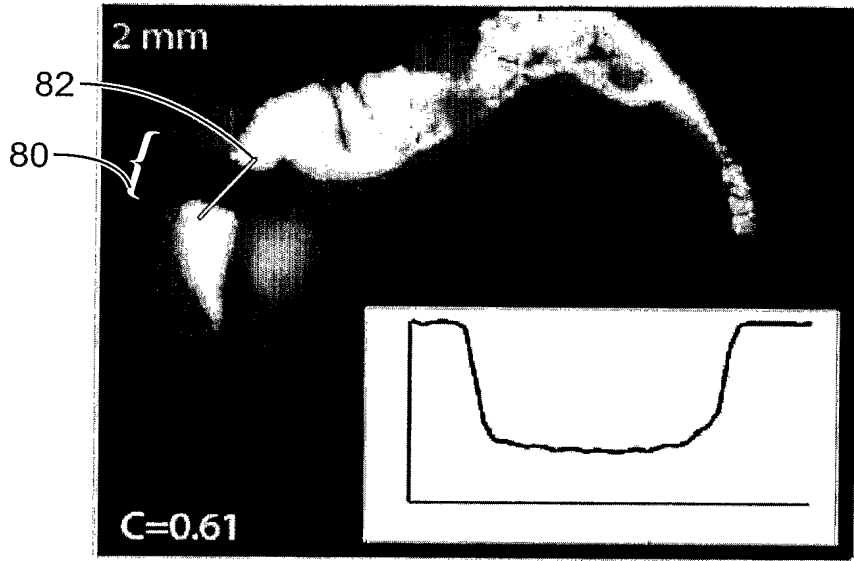

FIG. 6A

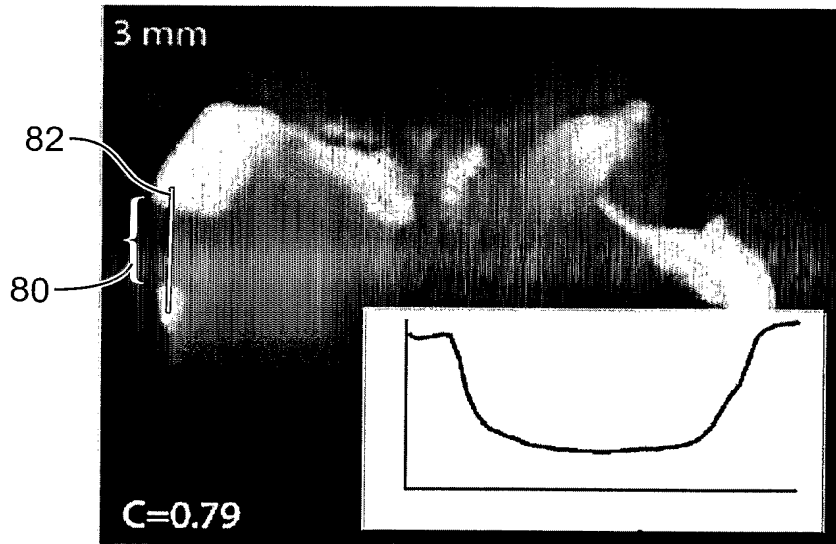

FIG. 6B

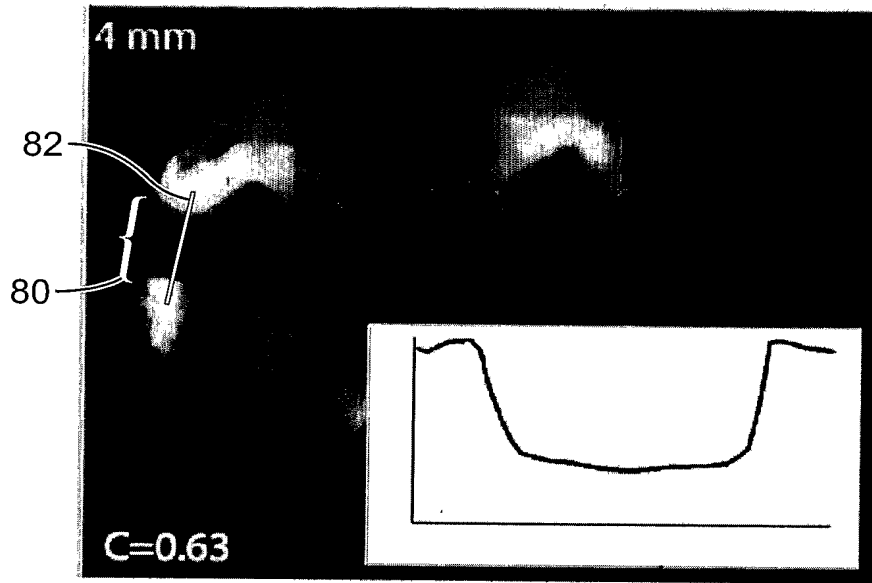

FIG. 6C

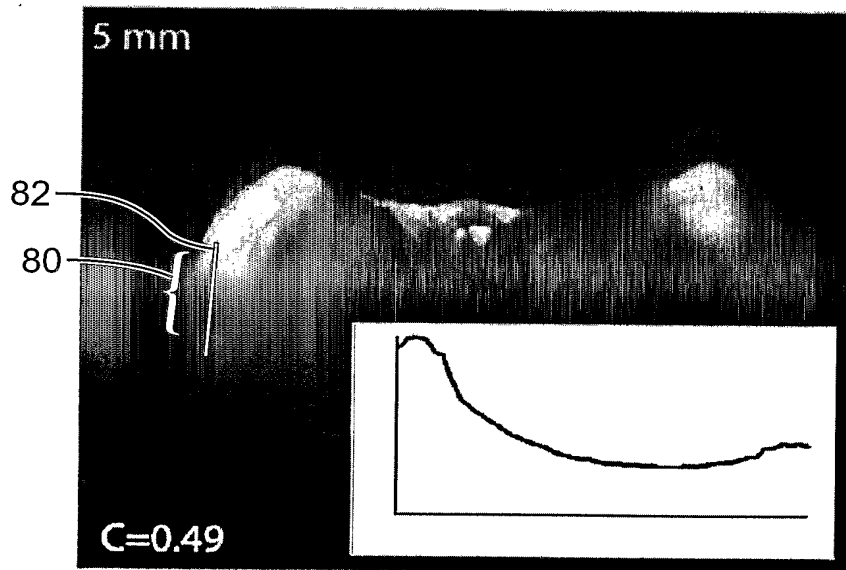

FIG. 6D

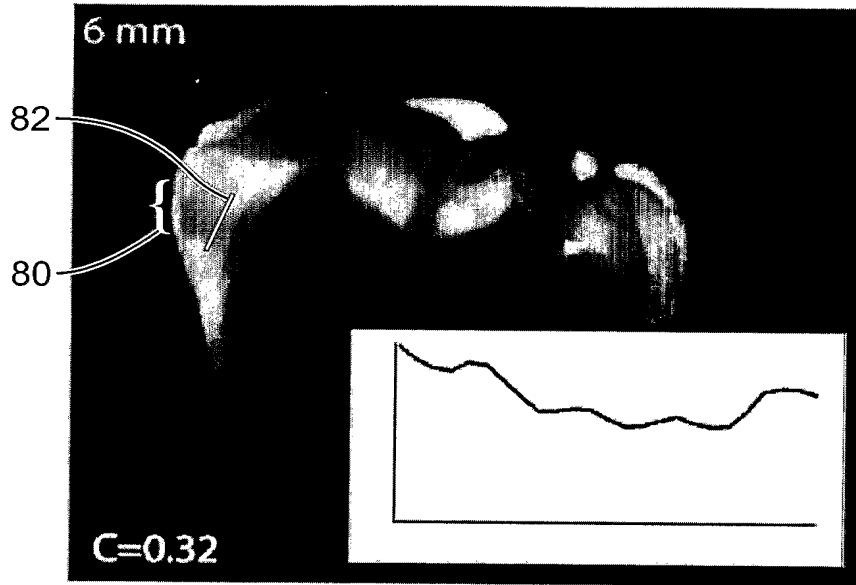

FIG. 6E

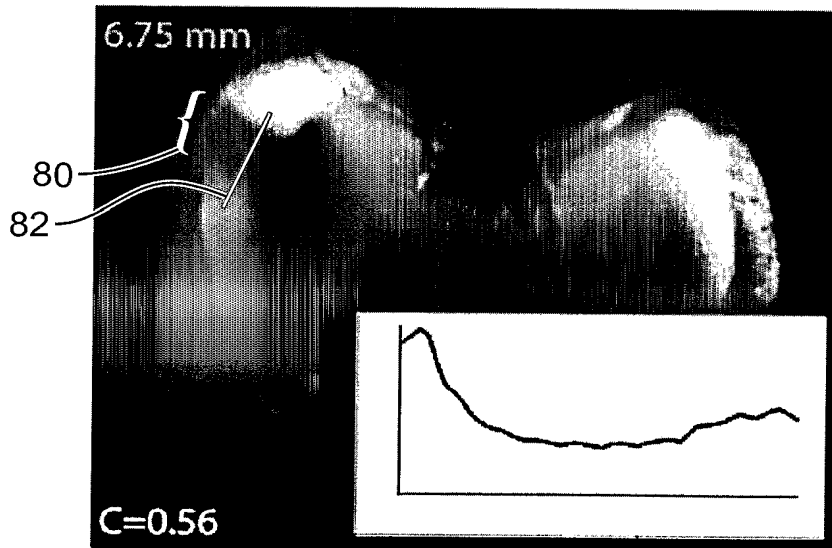

FIG. 6F

9/9

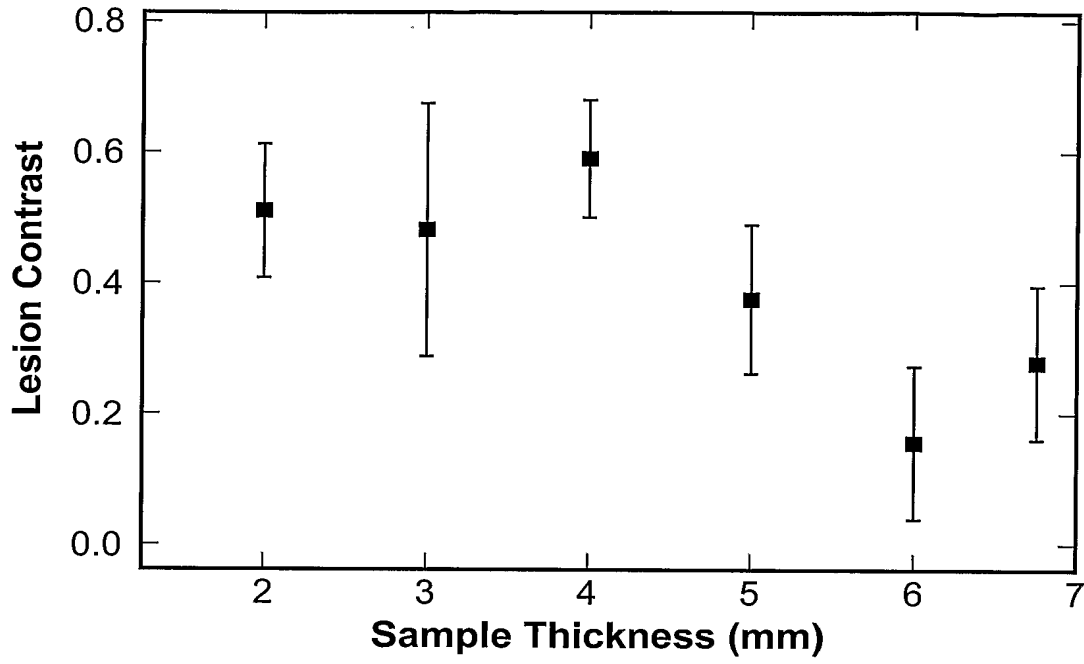

FIG. 7

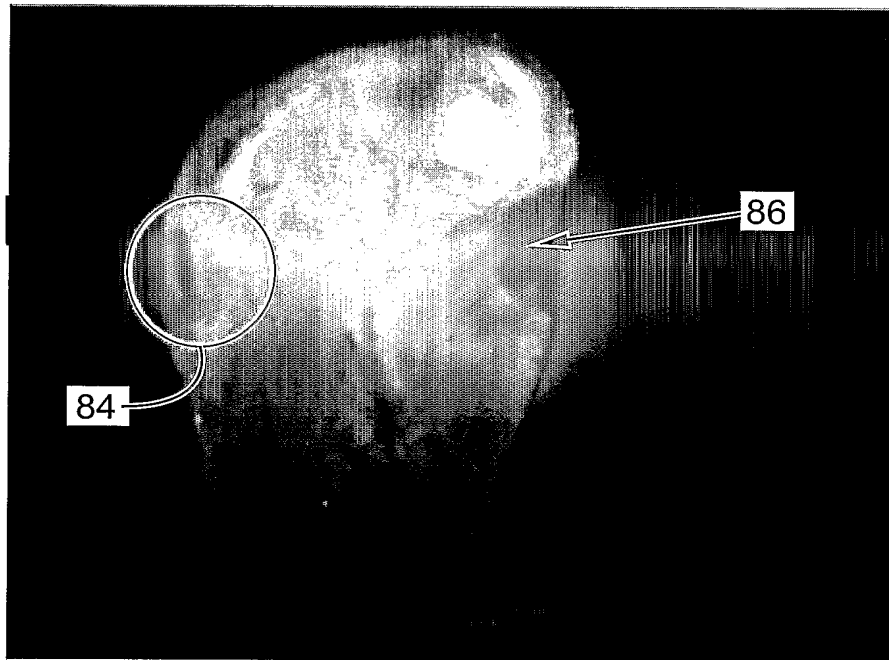

FIG. 8

(19) World Intellectual Property Organization
International Bureau



(43) International Publication Date
31 May 2007 (31.05.2007)

PCT

(10) International Publication Number
WO 2007/061732 A2

(51) International Patent Classification:
H01S 3/30 (2006.01)

AT, AU, AZ, BA, BB, BG, BR, BW, BY, BZ, CA, CH, CN, CO, CR, CU, CZ, DE, DK, DM, DZ, EC, EE, EG, ES, FI, GB, GD, GE, GH, GM, GT, HN, HR, HU, ID, IL, IN, IS, JP, KE, KG, KM, KN, KP, KR, KZ, LA, LC, LK, LR, LS, LT, LU, LV, LY, MA, MD, MG, MK, MN, MW, MX, MY, MZ, NA, NG, NI, NO, NZ, OM, PG, PH, PL, PT, RO, RS, RU, SC, SD, SE, SG, SK, SL, SM, SV, SY, TJ, TM, TN, TR, TT, TZ, UA, UG, US, UZ, VC, VN, ZA, ZM, ZW.

(21) International Application Number:
PCT/US2006/044451

(22) International Filing Date:
16 November 2006 (16.11.2006)

(25) Filing Language: English

(84) Designated States (unless otherwise indicated, for every kind of regional protection available): ARIPO (BW, GH, GM, KE, LS, MW, MZ, NA, SD, SL, SZ, TZ, UG, ZM, ZW), Eurasian (AM, AZ, BY, KG, KZ, MD, RU, TJ, TM), European (AT, BE, BG, CH, CY, CZ, DE, DK, EE, ES, FI, FR, GB, GR, HU, IE, IS, IT, LT, LU, LV, MC, NL, PL, PT, RO, SE, SI, SK, TR), OAPI (BF, BJ, CF, CG, CI, CM, GA, GN, GQ, GW, ML, MR, NE, SN, TD, TG).

(26) Publication Language: English

(30) Priority Data:
60/738,389 18 November 2005 (18.11.2005) US
11/599,950 15 November 2006 (15.11.2006) US

(71) Applicant (for all designated States except US): OMNI SCIENCES, INC. [US/US]; 647 Spring Valley Drive, Barton Hills Village, Ann Arbor, MI 48105 (US).

Declarations under Rule 4.17:

- as to applicant's entitlement to apply for and be granted a patent (Rule 4.17(ii))
- as to the applicant's entitlement to claim the priority of the earlier application (Rule 4.17(iii))

(72) Inventor; and

(75) Inventor/Applicant (for US only): ISLAM, Mohammed, N. [US/US]; 647 Spring Valley Drive, Barton Hills Village, Ann Arbor, MI 48105 (US).

Published:

- without international search report and to be republished upon receipt of that report

(74) Agent: GAFFNEY, Brian, J.; Baker Botts L.L.P., 2001 Ross Avenue, Suite 600, Dallas, TX 75201 (US).

For two-letter codes and other abbreviations, refer to the "Guidance Notes on Codes and Abbreviations" appearing at the beginning of each regular issue of the PCT Gazette.

(81) Designated States (unless otherwise indicated, for every kind of national protection available): AE, AG, AL, AM,

(54) Title: BROADBAND OR MID-INFRARED FIBER LIGHT SOURCES

(57) Abstract: A broadband light source includes one or more laser diodes that are capable of generating a pump signal having a wavelength shorter than 2.5 microns, a pulse width of at least 100 picoseconds and a pump optical spectral width. The light source also includes one or more optical amplifiers that are coupled to the pump signal and are capable of amplifying the pump signal to a peak power of at least 500W. The light source further includes a first fiber that is coupled to the one or more optical amplifiers. The first fiber including an anomalous group-velocity dispersion regime and a modulational instability mechanism that operates to modulate the pump signal. In one particular embodiment, the pump signal wavelength resides in the anomalous group-velocity dispersion regime of the first fiber and where different intensities in the pump signal can cause relative motion between different parts of the modulated pump signal produced through modulational instability in the first fiber. The light source also including a nonlinear element that is coupled to the first fiber that is capable of broadening the pump optical spectral width to at least 100nm through a nonlinear effect in the nonlinear element.

WO 2007/061732 A2

BROADBAND OR MID-INFRARED FIBER LIGHT SOURCES

RELATED APPLICATION

This application claims priority to U.S. Provisional Patent Application Serial No. 60/738,389, filed November 18, 2005, entitled "BROADBAND OR MID-INFRARED FIBER LIGHT SOURCES."

5

TECHNICAL FIELD OF THE INVENTION

This invention relates in general to broadband or mid-infrared light based systems, and more particularly to a system and method for generating wavelengths between approximately 0.4 to 5 microns or more based on fiber optic technologies or optical waveguides.

10

OVERVIEW

Broadband light sources, super-continuum sources, and Mid-Infrared Fiber Light (MIRFIL) sources are described that generate wavelength in the mid-infrared (mid-IR being wavelengths substantially between 2 to 5 microns) based on nonlinear processes in optical fibers. Examples of nonlinear processes in optical fibers include super-continuum (SC) generation, modulational instability (MI), cascaded Raman wavelength shifting (CRWS), and four-wave mixing (4WM). Examples of optical fibers include fused silica fibers, fluoride fibers, chalcogenide fibers, and tellurite fibers.

Current techniques of generating mid-IR light include the use of optical parametric oscillators (OPOs) or optical parametric amplifiers (OPAs). However, OPOs and OPAs are generally expensive, complicated, and involve moving parts that are prone to mis-alignment. Alternative techniques for generating mid-IR light involve the use of quantum cascade lasers (QCL). However, QCL's are generally difficult to operate at wavelengths shorter than about 4.4 microns, they put out low output powers, they have relatively low efficiency, and they often required pulsed operation or cryogenic cooling.

A simpler technique for generating mid-IR light is to use laser diodes to pump optical fibers. The MIRFIL can exemplary involve the generation of mid-IR light in optical fibers by pumping with a variety of lasers including laser diodes, solid state lasers, or cladding-pumped fiber lasers. In one embodiment, SC generation is achieved to simultaneously generate a wide band of wavelengths, which can advantageously be used to mimic the black body radiation of hot metal objects or to perform spectral fingerprinting to identify one or more chemical species. The fiber based MIRFIL can be lighter, more robust, more compact, simpler and less costly than the OPA or OPO alternatives. Moreover, the MIRFIL can produce a single spatial mode with minimal requirements for optical alignments. In a preferred embodiment, nanosecond pulses are used to generate mid-IR light. In addition, the MIRFIL approach leverages the enormous investment in telecommunications technologies and the mature fiber platform.

SUMMARY OF EXAMPLE EMBODIMENTS

One embodiment of a broadband light source comprises one or more laser diodes capable of generating a pump signal with a wavelength shorter than 2.5 microns and a pulse width of at least 100 picoseconds. The one or more laser diodes
5 are coupled to one or more optical amplifiers, which are capable of amplifying the pump signal to a peak power of at least 500W. A first fiber is further coupled to the one or more optical amplifiers, wherein the pump signal wavelength falls in an anomalous group-velocity dispersion regime of the first fiber, wherein the pump signal is modulated using a modulational instability mechanism in the first fiber, and
10 wherein different intensities of the pump signal can cause relative motion between different parts of the modulated pump signal produced through modulational instability in the first fiber. A nonlinear element is coupled to the first fiber, and the nonlinear element is capable of broadening the pump optical spectral width to at least 100nm through a nonlinear effect in the element.

15 In another embodiment, a mid-infrared light source comprises one or more laser diodes comprising a wavelength and a pulse width of at least 100 picoseconds. One or more optical amplifiers are coupled to the pump signal and are capable of amplifying the pump signal. Further, one or more fibers are coupled to the optical amplifiers. In the fibers, the pump signal wavelength falls in the anomalous group-
20 velocity dispersion regime for at least a fraction of the one or more fibers, and the pump signal is modulated using a modulational instability mechanism. A nonlinear element is coupled to the one or more fibers and is capable of generating a super-continuum with a substantially continuous spectrum from at least the pump signal wavelength out to 2.6 microns or longer and wherein the nonlinear element introduces
25 less than 10 decibels of power loss at 2.6 microns.

A further embodiment involves a method of generating broadband light by generating a pump signal, wherein the pump signal comprises a wavelength shorter than 2.5 microns and a pulse width of at least 100 picoseconds. The method further comprises the step of amplifying the pump signal to a peak power of at least 500W,
30 modulating at least a fraction of the pump signal using a modulational instability mechanism, and broadening the pump optical spectral width to at least 100nm using a nonlinear effect.

In yet another embodiment, a MIRFIL can use technologies that have been developed for telecommunications. For example, the pump laser can be a laser diode
35 followed by multiple stages of optical amplifiers. The pump can use continuous wave

(CW) or quasi-CW light, which may comprise pulses broader than approximately 100 picoseconds. In a preferred embodiment, the mid-IR light generation may occur in an open loop of fiber, preferably a fiber that transmits light into the mid-IR. Advantageously, only a short length of fiber can be used, such as less than about 100
5 meters, preferably less than about 20m, and even more preferably less than about 10m. With this configuration, wavelengths can be generated in the fiber beyond approximately 1.8 microns, preferably beyond approximately 2.2 microns, and even more preferably beyond 2.5 microns.

In a particular embodiment, a MIRFIL can use a laser diode driven pump laser
10 that outputs CW or quasi-CW pulses (greater than approximately 100 picoseconds) followed by a series of fibers, wherein the first length of fiber can be made from fused silica and can be used to break the CW or quasi-CW light into pulses based on the modulational instability (MI) or parametric amplification effect, and then another length of mid-IR fiber, such as ZBLAN, fluoride, tellurite, or a semiconductor
15 waveguide can be used to broaden the spectrum, through the nonlinearity in the medium and a mechanism such as self-phase modulation. In a preferred embodiment, some curvature in the temporal domain can help to generate the super-continuum by causing relative motion between the MI generated pulses. Also, there can advantageously be exchange of energy between MI generated pulses through the
20 Raman effect in the medium. The design of such a MIRFIL can be that the MI-induced pulse break-up may occur primarily in the first section, and the nonlinear spectrum generation may occur primarily in the second section. In a preferred embodiment, the length of the fused silica fiber can be under 10 meters, and the length of the mid-IR fiber can be less than 20 meters.

In another embodiment, super-continuum (SC) generation from the visible or
25 near-IR wavelength range can be accomplished using nanosecond pulse pumping. The SC generation can exemplarily be initiated using modulational instability (MI). In a preferred embodiment, the seed for MI may arise from the amplified spontaneous emission from the optical amplifiers or from a near-IR light source, such as a laser
30 diode. In a particular embodiment using fused silica fiber, the SC can cover the wavelength range substantially between approximately 0.8 microns to approximately 2.8 microns. In another particular embodiment using ZBLAN fluoride fiber, the SC can cover the wavelength range substantially between approximately 0.8 microns to approximately 4.5 microns. With control of the fiber loss from the material or from
35 bend induced loss, as well with tailoring the composition of the fluoride fiber, the

long wavelength edge of the SC may be pushed out to 5.3 microns or longer. In a preferred embodiment, it may be valuable to add a wavelength conversion stage. In addition, it may be advantageous to have a pulse compression stage following the MI pulse break-up.

5 In yet another embodiment, wavelength conversion into the mid-IR wavelength range can be achieved based on four-wave mixing (4WM) in fibers. 4WM usually requires phase matching, and a new window for phase matching permits phase matching into the mid-IR. In a preferred embodiment, the phase matching wavelengths can be tuned by adjusting the fiber dispersion profile and
10 tuning the seed wavelength in the near-IR. In a particular embodiment, a solid core or photonic crystal fiber can be used with a tailored dispersion profile, a seed wavelength from a laser diode or a tunable laser in the near-IR can be used to convert light from a near-IR pump to the mid-IR wavelength range.

 In another embodiment, the power for the MIRFIL can be scaled up by using a
15 higher power pump laser, such as a cladding pumped fiber amplifier, a cladding pumped fiber laser or a solid state diode-pumped light source. Based on the damage threshold of the particular fiber employed, the core size of the fiber can also be increased to increase the power throughput and output power.

 The fiber based mid-IR light source may be an enabling technology for a
20 number of applications. For example, the broadband mid-IR light source may be useful for infrared counter-measures for aircraft protection. Also, the SC light source could be used in chemical sensing, for non-contact or remote sensing of firearms, weapons, drugs. The SC source could also be used for industrial chemical sensing, such as in advanced semiconductor process control, combustion monitoring, or
25 chemical plant process control. Other potential applications include bio-medical imaging and ablation. Moreover, the broadband SC light source could advantageously be used in an optical coherence tomography configuration for semiconductor wafer imaging or defect location. In addition, the broadband light source could be instrumental for applications in the last mile solution, such as fiber to
30 the home, node, neighborhood, curb, premise, etc. More specifically, the broadband light source could enable wavelength division multiplexed or lambda passive optical networks.

 Depending on the specific features implemented, particular embodiments of the present invention may exhibit some, none, or all of the following technical
35 advantages. Various embodiments may be capable of covering other wavelength

ranges or multiple wavelength ranges. For example, SC generation can cover the visible wavelength range from approximately 0.4 microns to 0.6 microns by using a dual pumping scheme. Some embodiments may be capable of generating bands of wavelengths rather a continuous range of wavelengths, and the bands of wavelengths
5 may also be tunable or adjustable.

Other technical advantages will be readily apparent to one skilled in the art from the following figures, description and claims. Moreover, while specific advantages have been enumerated, various embodiments may include all, some or none of the enumerated advantages.

BRIEF DESCRIPTION OF THE FIGURES

To provide a more complete understanding of the present invention and certain features and advantages, thereof, reference is made to the following description taken in conjunction with the accompanying drawings in which:

5 Figure 1 illustrates a calculated group velocity dispersion for fused silica fiber (top), fluoride fiber (second from top), sulfide fiber (third from top) and selenide fiber (bottom).

 Figure 2 illustrates different positions of the pump and zero dispersion wavelength for (a) fused silica fiber; (b) fluoride fiber; and (c) chalcogenide fiber.

10 Figure 3 illustrates modulational instability in the time domain.

 Figure 4 illustrates modulational instability in the frequency or wavelength domain.

 Figure 5 illustrates simulations of pulse propagation in fiber.

15 Figure 6 illustrates simulations of pulse propagation in longer fiber lengths.

 Figure 7 illustrates the experimental set-up for a particular embodiment of the pump laser.

 Figure 8 illustrates a high power pump experimental configuration.

20 Figure 9 illustrates the spectrum from high nonlinearity fiber with a zero dispersion wavelength of ~1544nm. (a) 3m length of non-dried fiber; (b) 5m length of extra-dried fiber.

 Figure 10 illustrates: (a) Spectrum as a function of high nonlinearity fiber length following a ~2m length of SMF fiber. (b) Complete SC spectrum from ~2m SMF plus 15cm of high nonlinearity fiber.

25 Figure 11 illustrates: (a) Autocorrelation showing the pulse break-up through modulational instability after 3m of SMF at 1kW peak power. (b) Spectrum for same case with 1kW peak power.

30 Figure 12 illustrates the attenuation constant (dB/km) for different ZBLAN fluoride fibers used in the experiments. (a) 1.25, (b) 1.75 and (c) 2.75 micron cut-off wavelength.

 Figure 13 illustrates: (a) Comparison of fluoride super-continuum for different fiber lengths following a ~2m length of SMF fused silica fiber; and (b) Spectrum from ~5m length of the second fluoride fiber (Figure 12b) following ~2m length of SMF fused silica fiber.

Figure 14 illustrates: (a) the long wavelength side of the super-continuum spectrum from different lengths of the third fluoride fiber (Figure 12c) following an approximately 1m length of fused silica SMF fiber. The long wavelength edge reaches to ~4.5--4.6 microns; (b) Power evolution of the spectrum from ~2m length of the third fluoride fiber (Figure 12c) following an approximately 1m length of fused silica SMF fiber; and (c) overall calibrated spectrum from ~7m of the third fluoride fiber (Figure 12c) following an approximately 1m length of fused silica SMF fiber.

Figure 15 illustrates the calculated modulational instability gain for 3.5kW at 1630nm and 0,1,2 and 3.5kW at 1635nm.

Figure 16 illustrates a generalized model for super-continuum generation from quasi-CW or CW pumping. Note that some, all, or none of the illustrated boxes may be involved in SC generation. Further, other boxes can also be added within the scope of the disclosure.

Figure 17 illustrates cascaded Raman wavelength shifting data from (a) WS#884 Corning fiber measured with an optical spectrum analyzer; (b) WS#884 Corning fiber at higher power and measured with a spectrometer.

Figure 18 illustrates the phase mismatch in a fluoride fiber with zero dispersion wavelength near 1.7 microns.

Figure 19 illustrates an exemplary experimental configuration for testing four-wave-mixing.

Figure 20 illustrates an exemplary spectral fingerprinting system block diagram. Note that some, all, or none of the illustrated boxes may be involved in spectral fingerprinting. Further, other boxes can also be added within the scope of the disclosure.

DETAILED DESCRIPTION OF EXAMPLE EMBODIMENTS

Mid-IR light can be generated based on super-continuum in fused silica fibers and mid-IR fibers. Nonlinear waveguides other than fibers can also be used to generate the super-continuum. In one embodiment, SC has been demonstrated
5 experimentally from ~0.8 to ~4.5 microns in ZBLAN fluoride fibers and from ~0.9 to ~2.8 microns in high-nonlinearity (HiNL) fused silica fiber. The SC originates for laser diode pumping, and modulational instability (MI) initiated SC generation leads to a significant simplification by reducing or eliminating the need for expensive, complicated, mode-locked lasers. In another embodiment, three orders of cascaded
10 Raman wavelength shifting (CRWS) can be observed in sulfide-based chalcogenide fibers below the damage threshold. In one particular embodiment, the pump source comprises a laser diode followed by several stages of erbium-doped fiber amplifiers, in some cases also including a mid-stage modulator. Since in this embodiment the SC or CRWS occurs in meters to 10's of meters of fiber, the entire mid-IR light source
15 can be compact, lightweight, inexpensive and rugged. Although particular experimental conditions are described in the following, other configurations, materials and fiber types can be used within the scope of the invention.

Fiber Dispersion Can Determine SC vs. Cascaded Raman Shifting

To organize and explain the experimental results in various types of fibers
20 tested, a theoretical framework is first established. Various nonlinear processes are observed in fibers, included CRWS and MI. In turn, MI can give rise to the generation of broadband SC. Whether CRWS or SC occurs first in a fiber depends on the wavelength of the pump or the shifted pump with respect to the zero dispersion wavelength λ_0 . When the pump is at a wavelength shorter than the zero dispersion
25 wavelength (so-called normal dispersion regime), then CRWS can be first observed. When the pump is at a wavelength longer than the zero dispersion wavelength (so-called anomalous dispersion regime), then MI and SC can be first observed. When the pump lies in the normal dispersion regime, it can experience CRWS, but when the cascaded Raman order shifts into the anomalous dispersion regime, then MI and SC
30 can occur. Thus, to understand the nonlinear spectrum generated in fibers, the position of the zero dispersion wavelength can indicate the expected behavior.

In the Raman effect, a strong pump beam coupled into the fiber can shake the glass matrix, which emits vibrational mode (so-called optical phonons), and then can provide gain to longer wavelengths. The Raman effect can be self-phase matched,
35 and hence the process does not generally require tuning and it can be more-or-less

independent of wavelength (the gain coefficient does scale inversely with wavelength, however). One attribute of the Raman effect is that a number of optical phonons can be emitted, or the wavelength can be shifted down through a cascaded Raman process sequentially to longer and longer wavelengths. This emission of a plurality of
5 phonons to shift more than one Raman order is the CRWS phenomena that can be observed in the normal dispersion regime.

Either pure continuous wave (CW) light or quasi-CW light, such as nanosecond or longer pulses, are generally unstable when launched in the anomalous dispersion regime. In particular, the interaction between the nonlinearity and
10 anomalous dispersion can break the quasi-CW inputs into a train of solitons in a process called modulational instability. MI can be considered as a parametric four-wave-mixing process in which the non-linearity explicitly enters the phase matching condition. Note that MI for a single pump wavelength generally phase matches in the anomalous dispersion regime. When MI occurs the peak powers reached in the fiber
15 can be much higher than the powers launched in the quasi-CW light, since the quasi-CW background is usually compressed into short pulses. Further, a curvature in the pulse in time or a range of intensities can lead to collision and energy exchange between the MI-generated pulses, which can be advantageous for SC generation.

For pumping in the anomalous dispersion regime, the combined effects of MI
20 and stimulated Raman scattering can lead to SC generation. MI can cause the break-up of the cw light into short temporal pulses such that those nonlinear phenomena that normally occur for pulsed pumping conditions can also contribute to the SC generation. In contrast, for normal dispersion pumping, CRWS generally occurs first in the fiber, since MI does not generally phase match for a single pump wavelength.
25 As the higher Stokes orders fall into the anomalous-dispersion regime, MI can occur and lead to SC generation.

Because of the relevance of the group velocity dispersion (GVD) for determining the nonlinear behavior observed, a brief review is provided of fiber dispersion. GVD arises because different frequencies of light travel at different
30 speeds in an optical fiber. The total GVD in the fiber is generally the sum of the material dispersion and the waveguide dispersion $D_{total} \approx D_m + D_w$. The zero dispersion wavelength of a fiber λ_0 corresponds to the wavelength where the total dispersion crosses through zero.

The waveguide dispersion arises because the mode distribution between the fiber's core and cladding changes with wavelength. In a solid core fiber, the waveguide dispersion is usually negative, and, therefore, can generally shift the zero dispersion wavelength to longer wavelengths. It should be noted that in
5 microstructure fibers, the zero dispersion wavelength can be shifted to any desired wavelength. Therefore, microstructure fibers can be useful for matching the zero dispersion wavelength to the laser wavelength when the laser wavelength falls outside of the usual telecommunications window between ~1.3 and ~1.6 microns.

The material dispersion curves for different fibers tested in the exemplary
10 experiments are illustrated in Figure 1. In particular, the curves are calculated from published index-of-refraction for different glasses. The index is given analytically and the dispersion, which is proportional to the second derivative of the index, is calculated numerically. For fused silica fiber **110**, the zero dispersion wavelength can be close to 1300nm, corresponding to the material dispersion zero. Using
15 dispersion shifted fibers, the zero dispersion wavelength can be shifted to longer wavelengths. For fluoride fibers **120**, the zero dispersion wavelength can be calculated to be approximately 1620nm. Note that the dispersion slope for the fluoride fiber appears to be much flatter than for fused silica fiber. The calculated dispersions for chalcogenide fibers, such as the sulfide fiber **130** and selenide fiber
20 **140** show a zero dispersion wavelength beyond 5 microns.

Based on the theoretical discussion above and the exemplary use of a pump wavelength near ~1553nm, the behavior for different fiber types illustrated in Fig. 1 can be predicted. In fused silica fiber, MI-initiated SC generation is expected (Fig. 2a). For the fluoride fiber, at first cascaded Raman wavelength shifting is expected
25 **220**, but after one or two Stokes orders SC should be generated (Fig. 2b). Finally, for the chalcogenide fibers, CRWS is expected out to beyond 5 microns (Fig. 2c).

Because of the relevance of modulational instability (MI), a brief review is also provided next. MI can be a parametric four-wave-mixing process in which the anomalous group velocity dispersion and nonlinearity generally work together to turn
30 CW or quasi-CW light into short pulses. MI can lead to a significant system simplification in SC generation because the CW or quasi-CW light can evolve into narrow and high peak power soliton pulses, thus reducing or limiting the need for modelocked lasers for SC generation. As a simple illustration, Fig. 3 shows the time domain evolution of quasi-CW pulses in the anomalous dispersion regime. Noise
35 perturbations (such as different longitudinal modes from the laser diode or the

amplified spontaneous emission from the optical amplifiers) can cause temporal perturbations to grow **310**, leading to the formation of a train of soliton pulses **320** through MI. As an alternative technique, a seed laser at a wavelength separated from the pump can be used to initiate MI. Then, the combined effect of MI and stimulated
5 Raman scattering (SRS) can lead to the red-shifted pulses to move with respect to the blue-shifted pulses, causing a further increase in the peak intensity **340**. If the intensity is nearly flat, then a train of solitons could be generated, but these pulses may not move with respect to each other. If the pulses have a non-uniform temporal profile or if a intensity modulation is introduced on the pump light, then the non-
10 uniform pump intensity can lead to movement of the MI-generated pulses with respect to each other. Then, energy exchange can occur between the pulses through the Raman effect.

Figure 4 illustrates the spectral domain evolution corresponding to the time-domain description of Fig. 3. The original laser frequency is given by **410**. MI can
15 lead to the generation of sidebands on the Stokes and anti-Stokes side of the original laser frequency **420**. Although only one set of sidebands are illustrated, in general there can be several sideband frequencies generated approximately symmetrically around the original laser beam. Then, when MI and SRS interact, SRS leads to a transfer of energy from the short wavelength side to the long wavelength side **430**.

20 The dynamics of the collision of soliton pulses can be quite complicated, and it may be easier to illustrate through computer simulations. As an example, Figs. 5 and 6 show simulations of the break-up of quasi-CW pulses and then the onset of SC generation. Figure 5 shows the initial break-up of the quasi-CW pulse **510** into solitons **540**, and then the shift in energy to the longer wavelength side through SRS
25 (left side **550** is time domain, right side **560** is frequency domain). Figure 6 shows the time-domain collision process further down the fiber, as the onset of continuum generation is seen on the computer. The red-shifted pulses **670** travel through the blue-shifted pulses **680** because of the anomalous GVD, and then the red-shifted pulses **670** can rob energy from the blue-shifted pulses **680** through SRS (also
30 sometimes called the soliton self-frequency effect). As Figure 6 illustrates, relative motion between pulses can lead to collision and the consequent exchange of energy between pulses. Thus, a non-uniform temporal profile or an intensity modulation of some sort may be required to cause high peak power pulses that lead to SC generation. This complicated collision process can give rise to narrow, high peak
35 power pulses **670**, **650**, **660**, which are responsible for the SC.

The simulations of Figure 6 also show that asymmetric pulses 650,660 can arise from the soliton collision process. The asymmetry in the resulting pulses can also lead to an asymmetric spectrum. For instance, it is known that self-steepening of pulses can lead to a larger frequency broadening on the blue-side of the spectrum (i.e.,
5 the short wavelength side of the spectrum). Moreover, asymmetric temporal profiles of pulses lead to asymmetric spectral broadening through self-phase modulation. It should also be noted that the four-photon process is in energy, rather than wavelength. Thus, two pump photons can lead to the generation of Stokes and anti-Stokes photons.

Whether CRSW or MI is first seen in the fiber generally depends on the
10 threshold for the different nonlinearities. For instance, in fused silica fiber the MI threshold can be $\sim 5X$ less than the Raman threshold. There are generally two components for the Kerr nonlinearity n_2 : $\sim 4/5$ of n_2 is electronic in nature (instantaneous and arising from the UV resonances), while $\sim 1/5$ of n_2 is from Raman-active vibrations (imaginary part of this is the Raman gain coefficient). Whereas MI
15 usually benefits from the full n_2 , CRWS usually only benefits from the Raman-active vibrations. However, the Raman effect is generally self-phase matched, while MI usually requires phase matching. Moreover, MI phase matches for a single pump wavelength typically in the anomalous group velocity dispersion regime. Therefore, in the normal dispersion regime CRWS usually has a lower threshold and MI does not
20 usually phase match for a single pump wavelength. On the other hand, in the anomalous dispersion regime MI can have a lower threshold, and it can initiate the pulse break-up that gives rise to SC generation through a combination of SRS, self-phase modulation and other nonlinearities.

Although particular examples of physical phenomena have been described for
25 MI or CRWS and subsequent SC generation, other techniques are also possible for MI, CRWS and SC. As one particular example, the use of multiple pump wavelengths can lead to MI and SC even in the normal dispersion regime. As another example, the pulse break-up through MI may not need to be as thorough as shown in the simulations to lead to SC generation. Thus, many other combinations of physical
30 phenomena can lead to MI, SC and CRWS.

Pump Laser for Testing Nonlinear Shifting in Various Fibers

As one particular embodiment, experiments have been conducted on nonlinear wavelength shifting in different fiber types, including fused silica (high-nonlinearity fiber – HiNL – as well as dispersion compensating fiber), chalcogenide fibers
35 (arsenic-tri-sulfide), and fluoride (heavy metal fluoride ZBLAN – ZrF_4 - BaF_2 - LaF_3 -

AlF₃-NaF). For the experimental embodiment, the pump set-up uses a pulsed laser diode (~1.8nsec pulses near 1553nm) followed by several stages of erbium-doped fiber amplifiers. Peak powers up to ~3kW can be generated by altering the duty cycle of the laser diode from a few hundred kHz down to 5 kHz.

5 The experimental configuration for the pump laser used to test the different fibers is shown in Fig. 7. Light originates from a distributed feedback (DFB) laser diode 705 at 1553nm. This light is amplified in a low-noise pre-amplifier 710, which comprises an erbium-doped fiber amplifier (EDFA). The light is boosted in a power amplifier 740 at the last stage. In between, filters 720,735 and modulators 715 are used to control the amplified spontaneous emission (ASE).

10 The set-up 700 emulates a Q-switched laser system. Although the laser diode cannot easily be Q-switched, the EDFAs have a long upper state lifetime and store up energy between pulses. Thus, a low duty cycle during which the laser diode is turned on can lead to a larger energy per pulse. However, an ASE problem arises because
15 when the laser diode is off, the optical amplifier continues to be pumped and ASE is emitted by the EDFAs. This ASE leads to inefficiency because it can deplete some of the energy from the power amplifier, which ideally would store up more energy before the next laser diode pulse passes.

20 To solve this problem, one solution that can be used is to block the ASE during the times that the laser diode is off. As a starting point, the experimental configuration of Fig. 7 can be used to reduce the ASE background. A fiber pigtailed modulator 715 can be placed between the pre-amplifier 710 and the power amplifier 730,740. The modulator window can be synchronized to the laser diode drive 760, and the delay to the pre-amplifier EDFA can be compensated by using a variable
25 electrical delay line 755. The modulator 715 is placed initially at the mid-stage point to optimize the noise figure of the overall amplifier. Also, a low-power EDFA 730 is added after the modulator 715 to compensate for the modulator insertion loss. A tunable spectral filter 735 is also used to limit the out-of-band ASE entering the power amplifier 740. Finally, the light is coupled to the high-power EDFA stage 740. As an
30 alternative, the modulator can be eliminated by using narrow-band, fiber grating based filters to minimize the effect of the ASE. The temporal modulator is used in this particular embodiment. However, there are many other embodiments and methods of controlling the level of ASE from the amplifier. As another example, narrow band filters or add/drop multiplexers could be used to control the ASE

contribution. In other embodiments, the length of gain fiber and the direction and number of pumps could be optimized to minimize the level of ASE.

5 A second problem that may arise in the last stage power amplifier is nonlinear fiber effects, which then can limit the useable power from the pump system. The last amplifier stage comprises as an example two WDM couplers (for coupling in and removing any residual 980nm pump) surrounding a highly-doped, large core size, single spatial mode EDFA gain fiber. The gain fiber is selected in this instance to minimize the nonlinear limitations in the final amplifier stage. For example, the high doping level means that a short fiber length can be used, and the large core size means
10 that the intensity is kept as low as consistent with a single spatial mode. In this particular embodiment, the power amplifier uses a ~1.2m length of gain fiber, and a forward pump is used in addition to a backward pump. With this set-up, the peak power for 5kHz repetition rate approaches ~2.5kW without any significant nonlinear effect in the amplifier.

15 One aspect of using nanosecond pulses with peak powers up to ~2-3kW is that the average power can be scaled up by increasing the repetition rate and using larger lasers, such as cladding pumped fiber amplifiers or lasers. For example, average powers in the range of 1kW to 15kW are available from commercially available cladding-pumped fiber lasers. Moreover, fiber lasers can be modulated or Q-switched
20 or a modulator can be placed after the fiber laser to generate nanosecond pulses relatively easily. Cladding pumped fiber lasers can operate at a number of wavelengths. For instance, ytterbium-doped cladding pumped fiber lasers operate near 1 micron, erbium-doped cladding pumped fiber lasers operate near 1.55 microns, and thulium-doped cladding pumped fiber lasers operate near 2 microns.
25 Alternatively, the laser could a solid state laser or a diode-pumped laser. Although a few examples of high power lasers are mentioned above, many other lasers can be used consistent with the scope of this disclosure.

In one particular embodiment, a high power pump can comprise a seed laser diode that may be modulated followed by several stages of amplifiers that are single-
30 mode fibers or cladding pumped fiber amplifiers. For example, the first stage pre-amplifier can be a single-mode fiber, such as an erbium-doped fiber amplifier. Then, the power amplifier can comprise one or more stages of cladding-pumped fiber amplifiers. In a cladding pumped fiber amplifier, the pump propagates through a fiber cross-sectional area that is typically larger than a signal cross-sectional area. A
35 cladding-pumped fiber amplifier may comprise a fiber with a core for a signal and the

pump that zig-zags through the signal and provides gain. As one particular example, the cladding-pumped fiber amplifier may be a double clad fiber, with the signal propagating through the core and the pump propagating through the inner cladding. For high gain systems, the cladding-mode fiber amplifier may also be a large mode
5 area fiber, which generally means that the core is large enough to support several modes. The cladding-pumped fiber amplifier can be doped with erbium or a combination of erbium and ytterbium. Spectral and/or temporal filters may be advantageously used between different amplifier stages to control the level of amplifier spontaneous emission. Also, particularly in the last few stages of
10 amplification, it may be advantageous to counter-propagate the pump from the signal, thereby reducing the nonlinear effects in the amplifier.

In one preferred embodiment, the pump laser **800** can be a modulated laser diode **820** followed by a parametric amplifier **860**. For example, Figure 8 illustrates a cladding pumped optical parametric amplifier system **800** that can generate peak
15 powers in excess of 10kW with nanosecond pulses. The configuration comprises laser diodes **810,820**, cladding pumped ytterbium-doped fiber amplifiers **830**, and an optical parametric amplifier **860**. The top arm **870** of Fig. 8 corresponds to the pump, while the bottom arm **880** corresponds to the signal seed. In particular, a laser diode **810** (either Fabry-Perot or distributed Bragg reflector – DBR) launches the pump light
20 at approximately 1064nm. This is first passed through a pre-amplifier, which comprises a single-mode fiber doped with ytterbium. Then, the output of the pre-amplifier is sent to a power amplifier, which comprises a cladding-pumped, multi-mode ytterbium-doped fiber amplifier **850**. The power amplifier is purposely made with a large core fiber so as to enable high power amplification (i.e., large gain
25 volume) while minimizing nonlinear effects (i.e., large effective area).

The signal seed originates in the lower arm **880** from a 1550nm laser diode **820**, such as a DBR, DFB or Fabry-Perot laser diode. The light from the seed laser diode **820** is pre-amplified in a single-mode, EDFA **840** in this embodiment. Then, the about 1550nm seed is boosted in a power amplifier, which in this preferred
30 embodiment is an optical parametric amplifier **860** (OPA). The OPA **860** comprises a periodically-poled lithium niobate crystal in a preferred embodiment. The OPA crystal can be in length between several millimeters to several centimeters. The pump at 1064nm **850** and the seed at 1550nm **880** are made collinear through the OPA crystal **860**, and the 1550nm light is power amplified through the OPA process.

Although one example of the OPA is discussed here, many other power boosting methods can be used within the scope of this disclosure.

Another aspect of the laser is that it is relatively simple to modulate the mid-IR light or the SC light. Rather than implementing a mid-IR modulator or a very
5 broadband modulator, the modulation can be done on the pump laser. For example, the pump laser can be modulated directly (i.e., modulating the pump laser diodes or the power supply) or externally modulated (i.e., place a modulator after the pump laser). Then, in the SC generation process, the modulation is transferred to the entire
10 broadband spectrum. In other words, all of the optical processing can be performed at the pump wavelength, and then the light can be shifted to other wavelengths in the last step. This approach is particularly attractive when the pump laser is at a telecommunications wavelength, since many modulator technologies are available for telecom wavelengths.

The pump laser described above is just one embodiment of the pump laser, but
15 many other pump lasers can be used. For example, the pump laser can be a cladding-pumped fiber amplifier or laser, a diode-pumped solid state laser, or either of the lasers followed by a cascaded Raman wavelength shifter. The cascaded Raman wavelength shifter may be an open loop piece of fiber, or cascaded resonators formed by placing gratings on one or more ends of the fiber. Thus, many different
20 configurations for the pump laser can be used consistent with the SC or wavelength conversion process.

To generate light in the mid-IR, one exemplary strategy is to test a number of different kinds of fibers. The starting point may be to use fused silica (SiO₂) fiber, since it is of the highest quality and because it is the best characterized fiber. For
25 example, fused silica fiber is the basis of most fiber optics communications. In addition, fused silica fiber has among the highest damage threshold (~50 MW/cm²), which means that it can extend to the highest output powers. Moreover, the physics of fused silica is well understood and the parameter values can be measured carefully, permitting detailed understanding of the mechanisms behind SC generation and
30 wavelength conversion. Furthermore, the dispersion can be tailored in fused silica fiber, different types of fibers can be spliced together to create a particular dispersion profile, and more exotic fiber geometries, such as photonic crystal fibers or microstructure fibers, can be implemented in fused silica.

Although fused silica is the starting point, the transmission of fused silica is
35 limited in the mid-IR. Therefore, with the understanding gained from fused silica, the

next step in the strategy can be to use fibers that transmit in the mid-IR. One attractive candidate for mid-IR transmission is ZBLAN fluoride fibers. These fibers have been made single and multi-mode for over 25 years. They have been used extensively in telecommunications, for example as praseodymium-doped fiber
5 amplifiers and erbium-doped fluoride fiber amplifiers. The fluoride fibers also have relatively low loss and relatively high damage threshold (depending on the impurity concentration, typically between ~ 10 to ~ 20 MW/cm²). Furthermore, by adjusting the composition of the fluoride fibers, the low-loss transmission band can be extended out to between ~ 4.5 microns and ~ 5.5 microns.

10 Beyond ZBLAN fluoride fibers, other fibers or waveguides could also be candidates for mid-IR light generation. As one example, tellurite fibers (TeO₂) can be used as mid-IR fibers. Tellurite glass compositions show enhanced Raman scattering behavior. By optimizing these oxide glass compositions with heavy-metal-oxides, fiber can be made that have high nonlinearity with transparency in the mid-IR
15 wavelength range. Moreover, the tellurite fibers have been measured to have a damage threshold of ~ 13 GW/cm². Other examples of mid-IR fibers include chalcogenide fibers (telluride, sulfide, selenide, as particular examples), sapphire fibers, AgBrCl fibers, etc.

As another example, silicon or other semiconductor waveguides could be used
20 to generate mid-IR light. Silicon waveguides are expected to transmit light over the entire mid-IR wavelength band. Also, by making curves or S-type (i.e., waveguide going back and forth three times on a chip), relatively long lengths (i.e., several or tens of centimeters) of waveguide can be used. The use of silicon or other semiconductor waveguides is particularly effective if a pre-stage of fused silica fiber
25 is first used to initiate the MI (discussed further below). In this case, the semiconductor waveguide serves primarily as the transparent, nonlinear element to lead to spectral broadening.

Although particular fiber types or waveguide structures have been described for advantageously generating super-continuum, other materials, compositions and
30 guided wave structures can be used consistent with the disclosure.

SC out to mid-IR in Fused Silica Fiber

The exemplary experiments use different lengths of fused silica fiber, which are a series of high-nonlinearity (HiNL) fibers made by Corning. The fibers have a zero dispersion wavelength between ~ 1500 nm and ~ 1950 nm. Some of the fibers had
35 extra drying steps to remove to the extent possible the OH content, using steps that are

commercially done for SMF-e Corning fiber. Lengths ranging from 1 to 13m provide the broadest width of super-continuum in these particular experiments. Although these particular lengths were used in the experiments, other lengths can be used within the scope of the disclosure.

5 As an example of the SC spectrum from fused silica fiber, Figure 9a shows the spectrum obtained **920** at ~2.4kW peak power in a 3 meter length of HiNL fiber. For this particular fiber no additional drying steps were taken to reduce the OH content, so a large OH absorption line may be expected around 2.7 microns. At this pump power, the spectrum **920** is seen to stretch from ~0.85nm to ~2600nm (2.6 microns). The
10 features **925** around 1553nm are the residual pump from the laser diode, and the peaks near 1530nm are due to the ASE from the EDFA's. A fairly smooth spectrum **920** is observed over the large spectral range. One reason for the edge of the spectrum around ~2600nm might be that the edge of the water absorption line is responsible for the cut-off. Another reason might be that at these long wavelengths the modes are
15 weakly guided, and, hence, they are much more susceptible to bend induced loss.

To reduce the effects of bend-induced loss, the fiber can be laid out loosely. To reduce the effects of water absorption, the fibers can be dried using techniques used in commercial fibers, such as Corning's SMF-28e fiber or Lucent's (now OFS Fitel's) All-Wave fiber. To test this hypothesis, a new batch of HiNL fibers were
20 made that were treated using the extra drying steps. As an example, Figure 9b illustrates the SC spectrum from 5 meter length of extra-dried, HiNL fiber with zero dispersion wavelength around 1544nm. The spectra **930**, **940**, **950** are shown as a function of different pump powers, and the spectrum is observed to reach out to ~2700 or ~2800nm. Therefore, the extra drying steps to enable the expansion to the
25 longer wavelength side by about 100 to 200nm. The HiNL fibers used in these experiments have a nonlinearity about 9 times larger than standard SMF-28 fused silica fiber.

The edge of the SC spectrum could potentially be due to the vibrational absorption in the fused silica glass. If the edge of the spectrum is limited by the fiber
30 loss, then it would be consistent that the spectrum might extend to longer wavelengths if the fiber length were to be reduced. However, sufficient fiber length is required to generate the full spectrum as well. In other words, there is a minimum length required to generate the spectrum, but then further propagation in the lossy fiber only reduces the long wavelength edge of the spectrum.

To understand this fiber loss limited spectrum further, a series of experiments were conducted at a pump peak power of $\sim 3\text{kW}$. First, an $\sim 2\text{m}$ of standard single-mode fiber (SMF-28) is used to cause the nanosecond pulses to break up through MI. In fact, at these power levels SC can be already generated in the SMF fiber, with a reach out to $\sim 2500\text{nm}$. Then, the output of the SMF fiber is coupled to different lengths of HiNL fiber with a zero dispersion wavelength near 1544nm . The data **1000** is illustrated in Figure 10a. The fiber length is varied from 20m **1020** to 10m **1030** to 5m **1040** to 1m and shorter **1050**. As the fiber length is reduced, the long wavelength edge of the SC appears to push out to longer wavelengths. The levels of the SC are also plotted correctly relative to each other. In other words, as the fiber length is reduced, not only does the long wavelength edge appear to push out, but also the level of the SC can increase. The broadest spectrum is reached with about 15cm of HiNL fiber, where the spectrum reaches beyond $\sim 2800\text{nm}$. The total spectrum **1010** from the $\sim 2\text{m}$ of SMF plus 15cm of HiNL is plotted in Figure 10b.

The spectra of Figure 10 illustrates why others performing SC experiments may not have reached out as far in wavelength as the experiments described. Since the SC generation appears to be loss limited at the long wavelength side, the fiber length should be long enough to generate the spectrum through nonlinear effects, but not longer than that. In other words, optimizing the length of the fiber can be a procedure that can help to generate spectra as far as possible on the long wavelength side.

The data of Figure 10 also suggests a strategy or recipe for generating the SC. First, a pre-stage of standard single mode fiber (SMF) can be used to break-up the pulses through modulational instability. Although SMF is used in this example, the fiber can be any number of fibers that exhibit MI, such as fibers who fall into the anomalous dispersion regime at the pump wavelength. To illustrate the pulse break-up, Figure 11a shows the autocorrelation **1100** of the pulse at the output of a 3m length of SMF for 1kW peak power, and Figure 11b shows the spectrum **1110** at the output of the same fiber. As can be seen, wavelength sidebands are generated by MI, which causes the pulse to have undulations with pulse widths down into the sub-picosecond range. Different power levels can experience break-up in different fiber lengths. For instance, if the peak power is closer to $\sim 3\text{kW}$, then the optimal length for pulse break-up is closer to $\sim 1\text{m}$ of SMF. Thus, in the pre-stage fiber it is desired to have a break-up of the CW or quasi-CW pulses into shorter pulses through MI, but not the complete generation of the SC spectrum. In other words, the pre-stage fiber and the MI phenomena serve to emulate the picosecond or femtosecond pulses that

are normally used to generate SC, but the natural physics of the fiber can accomplish the pulses without the need for expensive and complicated modelocking schemes.

The second step of the strategy or recipe can be to use a nonlinear element with at least partial transparency over the wavelength range of interest to broaden out
5 the spectrum and to smoothen the spectrum into a SC. As one example, the dominant mechanism in the second stage can be self-phase modulation, where the nonlinearity for the high peak power pulses leads to spectral broadening. In addition, the Raman effect can also be effective in transferring energy from the short wavelength side to the long wavelength side, or more generally from shorter wavelengths to longer
10 wavelengths. In the case of fused silica fiber, the second stage can be a relatively short length of HiNL fiber, as shown in Figure 10. Alternately, the fiber can be a ZBLAN or fluoride fiber that can permit generation of light further out to closer to ~4.5 microns. Other examples of nonlinear elements that can be used in the second stage include chalcogenide fibers, silicon waveguides, tellurite fibers, and other
15 semiconductor waveguides. Alternatively, hollow core fibers can be used, where a nonlinear material, such as CS₂ or nonlinear gasses, can be used to fill the hollow core.

Although a two stage strategy or recipe is given as an example, more steps can be used to optimize the SC generation. For example, the first stage can be a set of
20 fibers spliced or coupled together to achieve a particular dispersion profile. In one preferred embodiment, the fibers can be coupled to achieve a dispersion decreasing or dispersion increasing profile. Moreover, a number of stages of the nonlinear element can be used. In one preferred embodiment, the transparency region can be expanded in subsequent stages. In another embodiment, single mode as well as multimode
25 fibers can be used in combination to obtain a high output power from the SC generation.

Although these experiments suggest that fused silica can generate SC out to ~2.8 microns, the composition of fused silica can be altered to potentially achieve a wider wavelength range. As one particular example, fibers could be made from
30 synthetic fused silica. For synthetic fused silica, there is a drop in transmission between ~2.6 to ~2.8 microns, which is probably due to the water absorption (OH absorption). The transmission through this wavelength range could be increased by using extra drying steps to minimize the OH content. Note, however, that there can be a transmission window between approximately 3 and 4 microns. Thus, with an
35 appropriate fused silica composition, it may be possible to generate SC out to ~3.6 to

~4 microns. This is just one example of varying the composition, but other compositions of fused silica could also be advantageous for SC generation into the mid-IR.

SC Generation in Fluoride Fibers

5 For mid-IR generation, fibers that have lower loss than fused silica include chalcogenide fibers, tellurite fibers, and fluoride fibers. One of the more mature of the fluoride fibers is the heavy metal fluoride ZBLAN ($\text{ZrF}_4\text{-BaF}_2\text{-LaF}_3\text{-AlF}_3\text{-NaF}$). One advantage of the fluoride fiber is that the loss coefficient can be more than two orders-of-magnitude lower than chalcogenide fibers over the wavelength range
10 between ~2-5 μm . The Raman gain coefficient can be about ~2-3x larger than in fused silica fiber. Moreover, the peak of the Raman gain falls at $\sim 600\text{ cm}^{-1}$, and fluoride fibers tend to be more mature technology with higher laser damage thresholds and no evidence of photo-darkening. For example, Alcatel and others made erbium-doped amplifiers and praeodymium doped amplifiers based on ZBLAN fiber in the
15 1980's and 1990's.

Three lengths of ZBLAN fluoride fiber were obtained for exemplary experiments of SC generation. The first fiber is 45m long with a core diameter of ~5.7 microns and a cladding diameter of 125 microns and a cut-off wavelength of ~1.25 microns. The second fiber is a 85m length of fiber with a core diameter of ~6.5
20 microns and a cut-off wavelength at ~1.75 microns. A third fiber is ~20m long with a core diameter of ~7 microns, a cladding diameter of 125 microns, and a cut-off wavelength of ~2.75 microns (the longer cut-off is achieved by using a higher numerical aperture of ~0.3). For all these fibers the loss between 1.25 and 2.7 microns can be less than 10dB/km (0.01dB/m). There is a loss peak around 1 micron and another loss peak centered around 2.9 microns, and at these peaks the loss is
25 between 30-50dB/km. For the third fiber, the attenuation out to 4 microns is measured to be under 1dB/m, and the attenuation beyond 4 microns is 1 dB/m at 4.3 microns, 2.25 dB/m at 4.5 microns, and 8 dB/m at 4.8 microns. Based on the experience from fused silica fiber, SC generation should advantageously have a long
30 wavelength edge out to where the fiber has a loss of ~1 dB/m to ~2 dB/m. Therefore, the SC generation may be able to reach out to ~4.5 to ~4.6 microns in the ZBLAN fibers.

The loss spectra measured over a limited wavelength range is shown in Figure 12 for the three fibers measured to date. As the cut-off wavelength increases, the loss
35 at the longer wavelengths appears to decrease. This may indicate that the loss at the

longer wavelength arises at least in part from bend induced loss. The rule-of-thumb for bend induced loss is that the fiber can be well guided at least up to a wavelength that is ~ 1.5 times the cut-off wavelength. Based on this rule, the first fiber **1210** should have minimal bend induced loss up to at least 1.9 microns, the second fiber **1220** should have minimal bend induced loss up to at least 2.63 microns, and the third fiber **1230** should have minimal bend induced loss up to at least 4.2 microns.

As the pump power is increased in the fluoride fiber, Raman wavelength shifting is first observed experimentally. Then, SC generation occurs after the Raman order crosses to the long wavelength side of the zero dispersion wavelength. For the 85m length of fluoride fiber of Fig. 12b, the SC spectrum with an input peak pump power of ~ 2.5 kW stretches from ~ 850 nm to ~ 3600 nm, and over the mid-IR region the spectral density ranges from -18 dBm/nm to -30 dBm/nm. As another example, in 40m of the first fiber of Figure 12a, the spectrum is found to reach only out to ~ 3050 nm. The peak power launched in this case was ~ 3.5 kW. The magnitude of the long wavelength edge of the spectrum does appear to be correlated with the shorter cut-off wavelength in this fiber. In other words, the longer the cut-off wavelength, the further that the long wavelength side of the SC spectrum extends out to.

One main difference between the fused silica SC and the fluoride SC is the wavelength range expected. Whereas the glass transmission in fused silica would appear to limit the SC range to below 3 microns, because of the low loss in the fluoride fibers out to approximately 5 microns, the SC can continue to wavelengths longer than 3 microns. Moreover, since the dispersion slope is less in the fluoride fibers compared to fused silica (Fig. 1), the MI bandwidth for phase matching can be much larger, giving rise possibly to broader bandwidth SC generation.

The hypothesis is that the sharp wavelength edge observed in the exemplary ZBLAN fluoride fiber SC experiments arise from fiber bend induced losses. i.e., As the wavelength increases, the mode diameter increases and more of the mode penetrates into the cladding and is weakly guided. Several data points support the hypothesis of the spectral edge arising from the bend induced loss in the fiber. First, when the fluoride fiber was wound on a ~ 8 inch spool, the edge of the spectrum reached to ~ 3400 nm. When the same fiber was loosely laid in a drum, the spectral edge shifted toward longer wavelengths out to ~ 3600 nm. Second, the bend induced loss is measured at 3.3 microns. For a bend diameter of 50, 100 and 200 mm, the percent loss at 3.3 microns is 85%, 3% and 1%, respectively. Therefore, the SC in the

ZBLAN fluoride fiber should cover a wider range of the mid-IR when the bend induced is better controlled.

Using a Fused Silica Pre-stage before the Fluoride Fiber

By using an appropriate length of fused silica pre-stage before the fluoride
5 fiber, the length of fluoride fiber can be reduced and the spectral extent can be optimized. As an example, consider the second fluoride fiber (specifications in Fig. 12b). In the above described experiment, an approximately 85m length of fiber was used to generate a spectrum out to ~3500nm. The same fiber is tested by first using an approximately 2m length of standard single-mode fused silica fiber (SMF). The
10 output from the ~2m of SMF is then butt-coupled or mechanically spliced to the fluoride fiber of Figure 12b. In Figure 13a the long wavelength side of the spectrum is illustrated for different lengths of the fluoride fiber at approximately 3kW of peak power. For a ~1.8m length of fluoride fiber, the spectrum 1310 reaches out to approximately 3100nm, meaning that this fiber length is too short for the full spectral
15 extent generation. On the other hand, at a ~6m length of fluoride fiber, the spectrum 1310 reaches beyond the spectral range reached in ~72m of the same fiber 1320. Therefore, for the particular circumstances of this experiment, the optimum length of the fluoride fiber is probably greater than 6m, but shorter than 72m.

The spectrum 1340 corresponding to using 5m of the fluoride fiber from Fig.
20 12b after ~2m of SMF pre-stage fiber is illustrated in Figure 13b. The peak pump power in this case is ~3kW, and the spectrum 1340 is seen to cover the range from ~800nm to ~3600nm. The short wavelength side of the spectrum is collected using an optical spectrum analyzer, the long wavelength side is collected using a grating spectrometer. The gap in the middle is due to filters use to insure that only the first
25 order light of the grating is collected, and the higher orders from shorter wavelengths is blocked. Thus, with the appropriate pre-stage used to break up the pulses through MI, the fiber length required can reduce from greater than 70m down to less than 10m.

The third fluoride fiber (characteristics in Fig. 12c) has a cut-off wavelength
30 of ~2.75 microns, which would mean that the bend induced loss should be well controlled to beyond ~4.2 microns. To optimize the long wavelength edge from this fiber, the pre-stage fiber of SMF fused silica was first optimized in length. For example, at a peak pump power of ~2.5-3kW, it was found that approximately 1m of SMF fiber with a zero dispersion wavelength around 1.3 microns gave the broadest
35 spectrum. In other words, at this power level the pre-stage SMF fiber helps to break

the pulses up through the MI mechanism. Then, the pre-stage SMF fiber is butt coupled or mechanically spliced to short lengths of the third fluoride fiber.

Figure 14a illustrates the long wavelength side of the SC spectrum from approximately 1m of SMF fiber pre-stage followed by different lengths between approximately 2 and 7m of the third fluoride fiber (Fig. 12c). For the 2 meter of fluoride fiber, the spectrum **1410** covers the wavelength range from the near-IR out to ~4.2 microns. However, at the pump power used of ~2.5kW peak, the spectrum in this short length starts to drop off at around 3 microns, suggesting that the fiber length may be too short for the full spectral generation at this power level. When a ~4.5 meter length of the same fiber is used, the spectrum **1430** reaches out to ~4.4 to ~4.5 microns. When the length is further increased to ~7m, the edge moves out slightly to approximately ~4.5 to ~4.6 microns, but also the spectrum **1440** becomes more square-like (i.e., higher spectral density further out in wavelength). Thus, for the particular pre-stage SMF fiber and the pump power level, the optimal length for the third fluoride fiber would appear to be 4.5 meters or longer.

Figure 14b illustrates the experimentally obtained power evolution of the spectrum from ~2m of the third fluoride fiber following an approximately 1m length of SMF fiber pre-stage. As the power increases, the spectrum **1450**, **1460**, **1470**, **1480** is observed to increase in spectral density and also shift out to slightly longer wavelengths. As the plot shows, the spectrum is fairly well evolved by ~2kW of peak pump power, in this particular example.

The complete calibrated spectrum **1490** from ~7m of the third fluoride fiber following ~1m of SMF pre-stage is shown in Figure 14c. The long wavelength edge of the spectrum extends out beyond ~4600nm, and the short wavelength edge of the spectrum extends beyond ~800nm. The complete spectrum **1490** is obtained by connecting the spectrum from an optical spectrum analyzer below ~1750nm with the longer wavelength data from the spectrometer followed by a cooled InSb detector. The data from the OSA is calibrated to obtain the spectral density in dBm/nm. The narrow peak near 1553nm corresponds to the residual pump, and the peak near 980nm is the residual forward pump from the power EDFA stage. Furthermore, the bump near 980nm corresponds to the ASE from the EDFA in the vicinity of the pump. The peak power from the pump is approximately ~4kW, and the overall spectrum is seen to be quite smooth. The fiber output from the SC fiber yields an average power of ~20mW for this particular experiment. From the spectrum and the measured output

power, the conversion efficiency of the pump light to the SC spectrum is approximately 50% or better.

One significant feature of the SC can be a high spectral density over a wide wavelength range. For example, the spectrum **1490** in Figures 14c shows that over a large part of the spectrum the average spectral density is between -25 and -18dBm/nm (note that 1dBm=1mW). However, this is the average spectral density for a very low duty cycle pulse. For instance, with the ~2nsec pulses and 5kHz repetition rate used in these experiments, the duty cycle is 1:100,000. Therefore, during the time that the pulses are on, the actual peak spectral density is more like +25 to +32dBm/nm. Thus, for a 10nm bandwidth that might be used in spectral fingerprinting, the peak power is greater than 3W. For a 100nm bandwidth that may be seen by one of the detectors in a heat sinking missile (e.g., as in typical in infrared counter measures), the peak power is greater than 30W. The pulsed mode used in the current experiments can be useful for lock-in or phase locked techniques that use detection systems such as box-car averagers, such as might be used in spectral fingerprinting. In other words, to avoid collecting noise during the off-state of the light, the detection system can advantageously only measure or record data during the on-state of the MIRFIL. In comparison to a broadband lamp, the average spectral density in the SC is about 3×10^3 brighter than a lamp and the peak spectral density in the SC is about 3×10^8 brighter than a lamp. Thus, such a broadband mid-IR source can enable white light interferometry measurements with very high sensitivity.

Another feature of the SC **1490** is the remarkably smooth spectrum over a wide spectral range. Because of the relatively stable pump laser input to the SC fiber, it is believed that shot-to-shot the spectrum is the same. In fact, this is a valuable attribute for spectroscopy. However, during the pump pulse, the less than 2nsec pulse probably has a range of intensities. The different values of the intensity may in turn be responsible for different parts of the spectrum. As a consequence of averaging over all the values of the intensities, the resulting spectrum may be quite smooth. This hypothesis also suggests a method of tailoring or adjusting the spectral shape of the SC. One way would be to use wavelength filters, such as gain equalizers or dynamic gain equalizers. However, another technique could be to modulate the time domain of the pump pulse, and then this temporal modulation could translate on to the spectrum as different parts of the pulse contribute to different parts of the spectrum.

There can be a number of techniques used to expand the long wavelength edge of the SC generation in optical fibers. In one embodiment, the composition of the

fluoride glass can be changed to permit transmission out to longer wavelengths. The fibers described thus far are zirconium fluoride glass, with an exemplary composition for the ZBLAN of (mole%): ZrF₄ (57), BaF₂ (34), LaF₃ (5), AlF₃ (4). For the ZBLAN or more generally the zirconium fluoride fibers, the transmission edge of 1 dB/m at 4.3 microns is fairly common, and it the IR edge does not shift very easily. On the other hand, fluoride glass fiber that does not contain zirconium fluoride fiber or other short-IR-edged compounds may enable transmission to longer wavelengths. By changing the composition, the long wavelength edge can be found to extend beyond ~5.4 microns. Therefore, if the SC generation were implemented in such a fiber, the edge of the SC might be expected to reach beyond 5 microns. For long wavelength performance, the cut-off wavelength for the fiber should probably be beyond 2 microns, preferably beyond 2.5 or 3 microns, to control the bend induced loss at the longer wavelengths. The core size can also be advantageously relatively small (e.g., less than a core diameter of 12 microns, more preferably less than 10 microns) to reduce the power requirements for the SC generation. However, larger core sizes may also be used to increase the overall output power from the SC spectrum.

Other embodiments of fluoride fiber can also be used to extend the long wavelength edge or to optimize the shape of the SC spectrum. In one embodiment, the pump wavelength could be made closer to the zero dispersion wavelength of the fiber, or a cascaded Raman shifted order of the pump could fall closer to the zero dispersion wavelength of the fiber. In a preferred embodiment, the pump or the shifted pump wavelength would fall slightly to the long wavelength side of the zero dispersion wavelength. This would lead to MI with a broad gain spectral width. In another embodiment, a hybrid configuration of different fluoride fibers could be used to effectively taper the core size of the chain, either downward or upward. In yet another embodiment the wavelength dependence of the core and cladding material can be selected so that the numerical aperture (NA) increases with increasing wavelength. For a step-index fiber, the $NA = \sqrt{n_1^2 - n_2^2}$, where n_1 is the index of the core and n_2 is the index of the cladding. Therefore, if the difference between the two indices of refraction increases with increasing wavelength, then the NA will increase. As the NA is increased, the waveguide will be better guiding and the effect of bend induced loss will be lowered.

As an alternative, fibers made from different materials can also be used to increase the wavelength extent of the SC. Another option for mid-IR fibers are

tellurite (TeO_2) glass fibers. Recently, there has been growing interest in the TeO_2 -based glasses because of their strong nonlinear properties and capacity for doping with high concentrations of rare-earth elements. Hence, these glasses can be appropriate for a wide range of devices including lasers, amplifiers, and mid-IR wavelength converters. Several preliminary studies have been reported in the literature regarding the glass properties. For example, depending on the doping details, the Raman gain coefficient can range from 30 times larger than fused silica to 45 to 95 times larger than fused silica. In addition, the Raman gain band in the TeO_2 glasses can be up to a factor of two wider in bandwidth than fused silica. Moreover, the damage threshold for the TeO_2 glasses is measured to be approximately 15-20 GW/cm^2 , which is about a factor of two or three smaller than fused silica at 50 GW/cm^2 . For the tellurite fibers the nonlinearity can be strongly dependent on the material composition, and the zero dispersion wavelength can also vary with material composition. In addition, the tellurite fibers may transmit light at least out to 4 microns, and even out to 5 microns in bulk glass. According to some reports, at 4 microns the theoretical background loss (i.e., material loss) can be somewhere above 10 dB/m . The minimum loss in tellurite fiber would be around 3 microns, and the value of the loss should be between 5 – 10 dB/m in the fiber at 3 microns. In yet other embodiments, materials made in waveguides may be advantageous for mid-IR light generation. For example, if the pulse break-up first occurs in fused silica fiber, then the nonlinear spectral broadening for SC generation can occur in silicon or other semiconductor waveguides.

Given that only certain range of fiber parameters are available in the fluoride fibers and that step-index fiber can only provide limited control over the dispersion profile, an additional degree of freedom for the mid-IR fibers may be helpful. The use of two pump wavelengths may provide this optimization option. With the two pump case, MI can occur with either pump in the anomalous or normal dispersion regime. Thus, whereas for the single pump case MI phase matches when the pump is in the anomalous dispersion regime, the addition of a second pump relaxes this constraint. As an example, Figure 15 illustrates the use to two pump wavelengths falling in the anomalous dispersion regime in the ZBLAN fluoride fiber. In particular, the zero dispersion wavelength from material dispersion is at 1628nm, and pumps at 1630 and 1635nm are assumed. The pump at 1630nm is assumed to be 3.5kW peak power, and the pump at 1635nm is varied at 0 1510, 1kW 1520, 2kW 1530 and 3.5kW 1540. As the second pump is increased, the gain bandwidth

stretches from 3.7 microns to 4.2 microns, 4.9 microns and approximately 6 microns. These two pump wavelengths can be implemented directly with EDFA amplification (using co-called L-band amplifiers), or they can be generated near 1530nm, and then one Raman wavelength shift can be used to transfer the energy closer to 1630nm. In
5 another embodiment, an additional degree of freedom can be obtained in fluoride fibers by using microstructure fiber geometries, which are also often called photonic crystal fibers.

Another aspect of the MIRFIL is that the average power can be increased to >500mW from the current ~20mW average power. For the higher powers, one
10 change could be to use a higher power pump laser. Examples of higher power pump lasers include solid-state lasers, diode-pumped laser systems including solid state lasers, cladding pumped fiber amplifiers and lasers, and optical parametric oscillators or amplifiers. To improve the efficiency and power, longer wavelength (~2 microns) and higher power solid state lasers or cladding pumped fiber amplifiers or lasers can
15 also be used. For instance, holmium or thulium lasers provide light near 2 microns in wavelength. As the powers are increased, another change can be to use larger core size fibers, so that the intensities can remain below the damage threshold while the overall output power can be increased. For example, different core sizes of fluoride fibers are already commercially available. In addition, the HiNL fused silica fibers
20 could possible be pulled to larger sizes, although care will be needed not to change the zero dispersion wavelength in these fibers.

Although a number of embodiments of using fluoride fibers to generate SC into the mid-IR are described, other configurations and fiber types can also be used to alter the shape of the SC spectrum or to extend the wavelength range of the SC
25 generation.

Generalization of SC or Wavelength Conversion and Using Semiconductor Waveguides

The results in the fused silica and fluoride fibers suggest a more general model of optimizing SC generation or wavelength conversion (further discussed in a few
30 sections below). One example of the generalized model is illustrated in Figure 16. The light originates from a pump laser **1610**, which can a laser diode followed by EDFA's, cladding pumped fiber amplifiers or lasers, diode-pumped solid state lasers, diode-pumped fiber lasers, or any number of light sources in the near-IR wavelength range. It may be desirable to include a wavelength shifter **1640** (dotted line boxes
35 correspond to different optional elements in the optimized set-up). As an illustration,

the wavelength shifter **1640** might be a Raman wavelength shifter, a cascaded Raman oscillator, an optical parametric oscillator or an optical parametric amplifier. In addition, it may be advantageous to introduce light from a seed laser **1650**, which can be a laser diode, a tunable laser diode, a fiber laser, a solid state laser, or another super-continuum source. In the case of the experiments to date, the seed light may be arising from the ASE from the optical amplifiers. However, if the optical amplifier is not used, then it may be advantageous to introduce a seed laser light to lower the threshold or control the wavelength of the modulational instability in the next stage.

The first stage may be used to cause break-up **1620** of the CW or quasi-CW light into pulses or solitons through the MI effect. The first stage **1620** can advantageously be implemented in optical fibers, and for a single pump wavelength the MI phase matches in the anomalous group velocity dispersion regime. If the pulses are nano-second (i.e., longer than approximately 100psec, or even longer than about 30psec) or quasi-CW light, there may be enough intensity modulation to cause collisions between different soliton pulses. Otherwise, in a preferred embodiment an intensity modulator can be used to create a distribution of intensities, which in turn can lead to a collision between soliton pulses. The intensity modulation may also help to create a smooth spectrum, due to the distribution of pump intensities.

In some cases, it may be further advantageous to have a mid-stage **1660** after the MI-initiated pulse break-up stage. This mid-stage, for example, can have a pulse sharpener **1660**, which helps to compress the soliton pulses and/or create more modulation sidebands in the frequency domain. Examples of the mid-stage include optical fibers, dispersion decreasing fibers, tapered fibers, grating compressors, or other examples of pulse compressors, whether they are implemented in optical fibers or bulk optics. This mid-stage can additionally help by increasing the peak intensity of the pulses. As such, the mid-stage can also include optical amplifiers.

The second stage can then include a nonlinear element for SC generation **1630** or wavelength conversion **1670**. The non-linear element can help to generate SC or new wavelengths based on four-wave mixing processes. For SC generation, the nonlinearity in the second stage can give rise to spectral broadening through self-phase or cross-phase modulation. Although the nonlinear properties of this second stage is one of the important parameters, it may also be desirable to have some dispersion to cause pulse walk-off or pulse motion. Such pulse motion may help to smoothen the spectrum or create even higher peak intensities. It may also be advantageous for the second stage to be at least partially transparent over the

wavelength of interest. For example, for mid-IR conversion, it may be advantageous for the second stage to be transparent over much of the mid-IR wavelength range. Examples of the second stage include different optical fibers, including HiNL, ZBLAN, fluoride, tellurite, chalcogenide, or even semiconductor doped glasses or waveguides.

Although most of the experiments presented have used mid-IR fibers or fused silica fibers, in the more generalized model other elements such as semiconductor waveguides or nonlinear crystal material could be used in the second stage. As one particular example, a silicon waveguide could be used as the second stage. The nonlinearity in silicon is about four-orders-of-magnitude higher than in silica fiber. The band gap in silicon is around 1.1 microns, so silicon is transparent (at least in a linear sense) for wavelengths longer than 1.1 microns and throughout the mid-IR wavelength range. Therefore, it is advantageous to have a pump wavelength below the band gap of silicon. However, for a pump wavelength between approximately 1.1 and 2.2 microns, the pump will experience two-photon absorption (TPA). In turn, the carriers generated through TPA can induce free-carrier absorption.

One method to overcome the TPA-induced free carrier absorption is to embed the silicon waveguide in a P-I-N diode configuration, particularly with the PIN diode reverse biased. As an illustration, the waveguide may fall in the I (intrinsic) region, and the electric field from the reverse biased diode can help to quickly sweep out the electrons and holes created by the TPA effect. Although this technique reduces the free carrier absorption, it does not prevent the TPA effect. Furthermore, the silicon waveguide in a PIN diode can be enhanced in a number of ways. For instance, the length of the waveguide can be extended by using multiple zig-zags, such as in a S-configuration. Moreover, the pump light can be multiple passed by placing coatings on the semiconductor wafer or mirrors around the wafer. In a preferred embodiment, one side of the chip may be coated for high reflectivity, while the other side can be anti-reflection coated or dichroic coated. Another advantageous configuration can modulate the applied voltage to the PIN diode to control the loss in the waveguide. As an example, this modulation could control the long wavelength edge of the SC spectrum or could be used to put codes onto the SC spectrum.

The silicon PIN waveguide is just one example of the nonlinear element **1630** or **1670** that could be used for SC generation. There are many other semiconductor or other materials that could alternatively be used. For instance, a waveguide can be made in a wide-gap semiconductor, where the band gap is at shorter wavelength than

the TPA edge. This would avoid the TPA problem, thereby removing the necessity of using a PIN for carrier sweep-out. Alternately, a more atomic-like material can be used, such as quantum dots, so the material does not have a conduction band and the associated TPA problems. Moreover, other nonlinear crystals could be used, such as
5 lithium niobate or periodically-poled lithium niobate. Furthermore, different fiber configurations could be used. For example, a hollow core fiber or capillary could be used that is filled with a nonlinear liquid, such as CS₂. Other fiber types could also be used, such as tellurites, chalcogenides, or photonic crystal fibers.

Cascaded Raman Wavelength Shifting in Chalcogenide Fibers

10 Chalcogenide fibers represent another alternative of fiber types for mid-IR light generation. Examples of chalcogenide fibers include sulfide (typically transmitting out to approximately 6 microns), selenide (typically transmitting out to approximately 9 microns) and telluride (typically transmitting out to 11 microns). Technical feasibility has been demonstrated for cascaded Raman wavelength shifting
15 in chalcogenide fibers. In a particular embodiment, samples of arsenic-tri-sulfide fibers were obtained. The testing started with a 20m length of fiber number WS-884, which has a slight selenide doping, a core size of approximately 6.5 microns, and a numerical aperture of ~0.22. For example, Figure 17 shows the spectral output from about 12m of the WS#884 fiber for different input peak powers. The second cascaded
20 Raman order can be observed at ~200W peak power input to the chalcogenide fiber. Also, this second cascade order can be repeatable, and it grows to a noticeable strength by ~235W peak input power 1710 (this is power incident on the fiber, not necessarily the fiber coupled into the fiber).

To generate and measure the spectrum beyond the second Raman cascade
25 order 1770, the light from the mid-IR fiber can preferably be sent to an optical spectrometer that is optimized for the near to mid-IR. In particular, a 0.3m spectrometer is used that has a grating with 300 grooves/mm. The numerical aperture for the fiber output is optimized to couple into the spectrometer using lenses that are transmitting in the mid-IR, such as calcium fluoride lenses. The detector used is a
30 modified InGaAs detector, which has high sensitivity out to 2.6 microns. To minimized the effect of the water absorption line around 1.9 microns, a dry nitrogen as is used to purge the interior of the spectrometer.

Figure 17b illustrates the spectrum 1740 at the output of fiber WS#884 measured using the optical spectrometer. With the extended range of the
35 spectrometer and the nitrogen purge, the third Raman cascade order 1780 can be

observed. The pump power incident on the sulfide fiber is now raised to approximately 350W. As the pump power is raised, the third order 1780 cascaded Raman wavelength shift grows. It should be noted that the actual third order shift is probably higher in magnitude, since the path from the fiber to the spectrometer is not
5 purged and there may still be residual moisture in the spectrometer chamber. Further orders of cascaded Raman wavelength shifting may be limited by damage at the input to the fiber as the pump power is raised.

The results from the chalcogenide fibers could be improved using a number of techniques. Different fiber sizes will be tested to see if the fiber core is more uniform
10 or continuous in the larger core size fibers. Gallium on the two ends of fiber can be used to test for the guiding properties of the lowest order mode in different fiber lengths. The ends of the sulfide fiber may also be encapsulated to remove heat and, thereby, to increase the damage threshold.

As another alternative, selenide fibers could be used, which are interesting
15 because they should have an order of magnitude larger Raman gain coefficient compared to the fibers tested. One question is the value of the damage threshold power for the selenide fibers. If the damage threshold is the same in the selenide fibers as the sulfide fibers that have been tested, then a significant improvement in CRWS might be expected. However, the index-of-refraction variation with
20 temperature $\partial n/\partial T$ can be positive in the chalcogenide fibers, and the value can be an order of magnitude larger in the selenide fibers compared to sulfide fibers. Therefore, one concern may be that catastrophic self-focusing might occur in the selenide fibers due to thermal effects from light absorption. In addition, the selenide fibers have a bandgap of $\sim 750\text{nm}$, which is closer to the pump wavelength than the sulfide fibers
25 (band gap around $\sim 520\text{nm}$). Thus, a second concern arises from photo-darkening effects arising from two-photon absorption. To overcome photo-darkening concerns, it might be worth trying a hybrid approach, where light is first shifted in fused silica out to $\sim 2\text{-}2.8$ microns, and then the light is coupled into the chalcogenide fibers for further shifting. An alternative approach will be to pump the chalcogenide fibers with
30 thulium lasers (either fiber based or solid state lasers), so the shifting starts from around 2 microns. Although particular schemes are described for CRWS in chalcogenide fibers, a myriad of other techniques and materials can be used for generating light using CRWS into the mid-infrared.

Wavelength Conversion Based on Four-Wave Mixing

There are applications, such as spectral fingerprinting, where SC generation can be very valuable. Also, SC could benefit infrared counter-measures (IRCM), because it becomes virtually undefeatable because the broad spectrum mimics the black body radiation from hot metal objects. However, there are many cases where
5 only a narrow band of frequencies in the mid-IR may be desired. For example, laser ablation typically only uses a band of frequencies, and IRCM traditionally uses three frequency windows in the mid-IR. For these cases where only a few mid-IR wavelengths are required, SC can be inefficient, since the energy may be spread over a wide spectral range. Wavelength conversion of the pump wavelength to a set of
10 frequencies in the mid-IR would be significantly more efficient.

Because of the similarity of the experimental set-up and the same underlying physics at work, one question is when does SC generation occur and when does wavelength conversion occur. The MI process can be used to convert the CW or quasi-CW (e.g., nanosecond pulses) to short pulses required for many of the nonlinear
15 phenomena, thereby reducing or eliminating the need for modelocked lasers. Also, for the single pump wavelength case MI phase matches in the anomalous group-velocity dispersion regime. Therefore, the first step for either SC or wavelength conversion can be to propagate the light in a length of anomalous dispersion fiber (i.e., soliton regime of the fiber). The main difference in outcome may depend on
20 how long the pulses are permitted to propagate in the soliton regime of the fiber.

To distinguish SC generation from the wavelength conversion processes, it is worth first examining the onset of the SC generation process. As an example, Figures 5 and 6 show simulations of the break-up of quasi-CW pulses through MI and then the onset of SC generation. Figure 5 shows the initial break-up of the quasi-CW pulse
25 into solitons, and then the Raman effect shift in energy to the longer wavelength side (left side is time and right side is frequency domain). Thus, the broad quasi-CW input is broken into a train of solitons.

Figure 6 shows one example of the time-domain collision process further down the fiber, as the onset of SC generation can be seen on the computer. The red-
30 shifted pulses travel through the blue-shifted pulses because of the anomalous dispersion, and then the red-shifted pulses rob energy from the blue-shifted pulses through the Raman effect. This complicated collision process may give rise to narrow, high peak power pulses, which can lead to SC generation. The generation of the large super-pulses in Fig. 6 may be advantageous for achieving the extremely high
35 intensities and the run-away effect that give rise to SC generation. Note that the

collision of the pulses occurs because self-phase modulation leads to the initial red-shifting of the leading edge of the pulse (i.e., the part of the pulse that occurs earlier in time). Then in the anomalous dispersion regime the red-shifted pulses travel slower, causing the pulses in the leading edge of the pulses to pass through the pulses in the trailing edge of the pulse (Fig. 6). As the red-shifted pulses travel through the other soliton pulses, through the Raman process the red-shifted pulses grow in energy and further narrow.

In order to observe wavelength conversion through four-wave-mixing (4WM), the MI break-up of the pulses as seen in Fig. 5 can be advantageous, but the super-pulse creation process of Fig. 6 that leads to SC generation should preferably be avoided. As a specific example, the purpose of the ~0.5m length of standard SMF fiber (fiber that can be in the soliton regime or anomalous dispersion regime) in the experiments is to convert the ~1.8nsec pulses from the laser into the short soliton pulses. This length may be intentionally kept short to avoid the collision phenomena of Fig. 6.

Depending on the wavelength conversion mechanism, different strategies can be used to avoid the collision and super-pulse creation of Fig. 6 in the second stage of fiber. As an example, to observe wavelength conversion through 4WM, the second stage fiber is selected to operate in the normal dispersion regime. Since the red-shifted pulses travel faster than the blue-shifted pulses in the normal dispersion regime, the collision and super-pulse formation of Fig. 6 are avoided. For single pump wavelength seeded MI, anomalous dispersion is required for phase matching. Therefore, by using normal dispersion in the second stage, the run-away effect of MI can be avoided, and 4WM can phase match to provide the wavelength conversion.

Four-wave mixing is a four-photon process where two pump photons combine to produce a Stokes wavelength (longer wavelength) and an anti-Stokes wavelength. One aspect of 4WM is that phase matching is required between the four waves. For instance, the wave vector mismatch is given by

$$\Delta k = 2k_p - k_s - k_a = 2 \frac{n_p \omega_p}{c} - \frac{n_s \omega_s}{c} - \frac{n_a \omega_a}{c}$$

and the conversion efficiency is given by

$$\eta_{AWM} = (\gamma PL)^2 \frac{\sin^2\left(\frac{\Delta k L}{2}\right)}{\left(\frac{\Delta k L}{2}\right)^2}$$

Normally, high efficiency for the 4WM process can be obtained near the zero dispersion wavelength. However, a new regime of phase matching can be advantageously used that enables mid-IR light generation, since this new regime is distant from the zero dispersion wavelength. As one example, the 4WM wave vector mismatch **1800** is calculated and plotted in Figure 18. Assuming a zero dispersion wavelength near 1.7 microns for the fluoride fiber, the wave vector mismatch can be small close to zero dispersion, such as for wavelengths around 1.6 to 1.8 microns. However, there turns out to be another zero crossing in this case around 1.02 microns. The 4WM efficiency turns out to be large above 1.5 microns, but also large in the vicinity of 1.02 microns. Although this second window generally is found to be narrower bandwidth, it can give rise to wavelength conversion into the mid-IR. For instance, for a pump wavelength of 1553nm and the anti-Stokes wavelength of 1020nm, the Stokes light generated would be in the vicinity of 3.36 microns.

As the zero dispersion wavelength and the dispersion profile of the fiber is changed, the position for this mid-IR light wavelength conversion can change. For instance, the following table shows different examples of the calculated and measured 4WM peak for different fibers measured.

λ_0 (um)	Theoretical Peak (um)	Experimental Peak (um)
1.56	1.37	1.40 (→ 1.75)
1.57*	1.25	1.23 (→ 2.11)
1.61*	1.12	1.17 (→ 2.31)
1.70#	1.01	1.02 (→ 3.25)

Experimental confirmation can also seen of this new regime of phase matching for 4WM in different fused silica and fluoride fibers. As a particular example, the experimental set-up for testing 4WM wavelength conversion is illustrated in Figure 19. The pump **1910** is similar to that of the SC experiments. However, at the output of the power amplifier is a WDM **1930** or power dividing coupler to inject a seed wavelength **1920**, and this is followed exemplarily by an approximately 0.5 meter length of SMF fiber **1940** (this fiber, in many cases, can just be the fiber pigtails of the coupler). This pre-stage fiber may serve to break up the pulses through MI, but the length is maintained short enough to attempt to avoid SC generation. Then, the output of the SMF pre-stage fiber is coupled to various fibers **1950**, which are preferably in the normal dispersion regime for the pump wavelength. In a preferred embodiment, a seed laser diode would be placed at the anti-Stokes

wavelength, and the Stokes wavelength would be generated through the 4WM process.

The data above suggests a procedure for wavelength conversion of light into the mid-IR wavelength range, particularly when there is a target wavelength desired for a particular application. First, the dispersion of the fiber can be tailed to phase match at a target wavelength. The fiber dispersion can be tailored by changing the zero dispersion wavelength, adjusting the dispersion slope, or perhaps by using more exotic fibers such as micro-structure fibers that can have more than one zero dispersion wavelength. Then, if the pump is for example within the telecommunications band, then tune the wavelength of the pump laser to obtain the correct target wavelength. The pump laser could be a tunable laser, or the pump laser could be laser diodes of different wavelengths, for example laser diodes that are on the ITU wavelength grid. With the appropriate adjustment of the phase matching condition, then introduce a seed laser at the anti-Stokes wavelength. Since the anti-Stokes wavelength falls in the near-IR wavelength range, one example of a seed laser would be laser diodes. With the introduction of the anti-Stokes wavelength, mid-IR light on the Stokes side should result, so long as the fiber can transmit light at the particular mid-IR wavelength. Thus, as an example light out to ~2.7 microns might be generated in fused silica fiber, light out to ~4.4 micron might be generated in ZBLAN fluoride fiber, and light out to ~5.5 microns might be generated in the extended band fluoride fiber. In a preferred embodiment, a fused silica fiber pre-stage can be used to generate pulses through MI, and then the wavelength conversion would be in fiber where the pump wavelength falls in the normal dispersion regime. Although one particular method of wavelength converting light into the mid-infrared regime is suggested, numerous other techniques can be used within the scope of the present disclosure.

Applications of MIRFIL Sources

Several differentiators for the MIRFIL fiber-based sources include:

- Maturity of underlying technology
- For SC, emulate black body radiation or attractive source for spectral fingerprinting or last mile solutions in telecommunications
- For wavelength conversion, simple tuning over wide wavelength range
- Excellent beam quality ($M^2 < 1.4$, as an example)

- Advantages of fibers, such as compact, robust, lightweight, and no moving parts
- Potential room temperature operation with flexible repetition rate from CW to MHz or higher
- 5 • Power scalable to ~10W or more by using larger core size fibers and higher pump powers.

On this last point, the scalability of the power by pumping with a cladding pumped fiber laser can be quite attractive. As an example, in the last several years the CW power from cladding pumped fiber lasers has increased from 10's of Watts to a
10 time-average power of 15kW in 2005. Moreover, pumping with a cladding pumped fiber laser could enable an all-fiber integrated MIRFIL. The SC generation or wavelength conversion fibers (whether one, two or more stages) could be coupled to this pump unit using either fusion splicing, mechanical splicing, or free space or bulk optical coupling. Then, the resulting unit could be an all-fiber, high power MIRFIL.
15 As mentioned before, cladding pumped fiber lasers can operate at exemplary wavelengths near 1 microns, 1.55 microns or 2 microns, depending on the dopants in the fiber. Although a particular monolithically integrated MIRFIL is illustrated, many other configurations and pumping techniques can be used within the scope of the present disclosure.

20 The MIRFIL may be used for applications where light in the mid-IR wavelength range (exemplary 2 to 5 microns) is advantageous. For example, the mid-IR is known as the spectral fingerprint region, because many chemicals have their rotational and vibrational resonances at least in part in the mid-IR wavelength range. Also, the mid-IR can be important for heat sensing, since black body radiation from
25 "hot objects," such as plumes or hot metal, falls at least in part in the mid-IR. Moreover, for applications in the life sciences, laser ablation near 3.6 or 6.45 microns could be advantageous, since the protein and amide group absorption can exceed the water absorption. Also, mid-IR light near the peak of the water absorption could lead to high-resolution photo-acoustic imaging, which can be important for applications
30 such as laser keratectomy. These are exemplary applications of mid-infrared light sources, but many other applications fall within the scope of the present disclosure.

The early adaptors of the MIRFIL laser technology may be in military related markets for chemical sensing and infrared counter-measures (IRCM). However, there are also commercial markets for the same kind of MIRFIL laser units. For example, a
35 similar laser that is used for chemical sensing can be used in the commercial sector

for industrial chemical plant control, advanced semiconductor processing, combustion monitoring and bio-medical diagnostics. Similarly, a similar laser that is used for IRCM can be used in the commercial sector for bio-medical laser ablation.

5 The first application to use the MIRFIL may be chemical sensing systems products. In particular, the wavelengths of IR absorption bands are characteristic of specific types of chemical bonds and every molecule has a unique IR spectrum (fingerprint). IR spectroscopy finds its greatest utility for identification of organic and organo-metallic molecules. There are three IR spectroscopy technologies employed in point detectors: Fourier transform IR (FTIR) spectroscopy, photo-
10 acoustic infrared spectroscopy, and filter based IR spectroscopy.

The SC broadband source could be particularly useful for spectral fingerprinting. In several chemical sensing detection systems, a narrow line width, tunable laser may be used to perform spectral fingerprinting. Instead of this approach, the SC based spectral fingerprinting can be much more like white light spectroscopy.
15 In other words, the SC may permit simultaneous monitoring over a wide spectral range. In one embodiment, the spectra at several wavelengths can be used to advantageously identify a chemical species. In another embodiment for absorption or reflection spectroscopy, several wavelengths of the absorption or reflection can be measured either simultaneously or in some time sequential fashion. Then, the relative
20 magnitudes at different wavelengths or a particular spectral pattern of absorption or reflection can be pattern matched to identify the chemical of interest. Such a technique has the potential of having high selectivity, since the monitoring can be accomplished over a wider spectral range and since the spectral pattern matching can compare a number of features.

25 An exemplary system 2000 for performing spectral fingerprinting or using the SC light source is illustrated in Figure 20. The chemical sensing systems can include a light source 2010, such as the MIRFIL light source, filters, and a lens system to transmit through a sample or sample volume 2030. There may be a reference path 2020 for calibrating the system. In another embodiment, the reference path may
30 substantially coincide with the sample path 2030, but the two can be time multiplexed – i.e., the reference signal may be at a different time than the sample signal. The sample path 2030 can collect the light in transmission or reflection, depending on whether the detector is integrated with the light source or in a different location. The light detection system 2040 collects at least a fraction of the light, and data collection
35 and analysis computer software 2050 may be coupled to the detector and receiver

(i.e., electronics behind the detector). As an example, the light detection system 2040 can include a grating and a linear array of mid-IR semiconductor detectors or multi-spectral detectors. Alternately, the detection system 2040 can be a moving grating and slit or a MEMS-based grating followed by a detector. In a preferred embodiment, when a particular wavelength range is being detected, narrow-band detectors or filters followed by detectors could be used to select only the wavelength of interest and reject the noise and signals at other wavelengths. One advantage of the system 2000 of Figure 20 is that it may lead to non-contact, remote detection of chemical species. In such a system, some of the important issues are the sensitivity and selectivity or interference between the signatures of different chemicals.

Systems such as 2000 can be used for chemical sensing for military applications as well as industrial plant monitoring systems. For example, chemical sensing can be used to detect chemical warfare agents, which are chemical substances that are intended for use in warfare or terrorist activities to harm people through their physiological effects. The most common chemical agents include nerve agents, blister agents and arsenical vesicants. Moreover, chemical sensing can be used for weapons detection, since residue from gun powder can be sensed using remote or non-contact optical spectroscopy techniques. In addition, toxic industrial materials are chemicals other than chemical warfare agents that have harmful effects on humans. These are used in a variety of settings such as manufacturing facilities, maintenance areas, and general storage areas.

In one embodiment, the spectral fingerprinting system can be used for firearms detection. For example, firearms detection can be implemented by searching for the composition of gun powder. One chief ingredient in smokeless gun powder is nitro-cellulose, which has clear spectral features centered around 2.86 microns and 3.45 microns. Although there are also lines at 6 microns on beyond, many chemicals have a lot of lines in that wavelength range, so it may be difficult to separate one chemical from another. Beyond nitro-cellulose, there are also a number of additives in smokeless gun powder, an example of which is provided in the table below.

Component	Function	Typical chemicals
Plasticizer	Organic materials added to aid fabrication of propellants and explosive mixtures	Dibutyl Phthalate
Primer	Initiate the propellant in emanation	Lead azide Lead stypnate Telracone Barium nitrate Stenidium nitrate
Stabilizers	Organic materials that retard decomposition of other constituents during storage	Diphenylamine Ethyl Centralite
Propellant	Organic materials that undergo rapid combustion	Nitroglycerin

30

Diphenyl amine, which is used extensively as a stabilizer, shows clear spectral signatures centered around 2.94, 3.33 and 3.85 microns. Dibutyl phthalate, which is used as a plasticizer, shows an absorption peak around 3.4 to 3.55 microns. Lead azide, which is used as a primer, has a peak absorption around 4.8 microns. Other
 5 examples of primers include tetracene (broad absorption between approximately 2.8 and 4 microns), barium nitrate (absorption peaks near 2.94 and 4.2 microns), and strontium nitrate (absorption peaks around 2.94 and 4.15 microns). Thus, many of the components of smokeless gun powder have signatures in the mid-IR between 2 to 5 microns.

10 In another embodiment, the spectral fingerprinting system can be used for IED (improvised explosives detection) or weapons detection. Many of the explosives have modified benzene rings, and the benzene rings have a resonance around 3.2 microns. Although there are a lot of absorption lines from 6-10 microns and in the terahertz region, it may be difficult to sort out one chemical from another (i.e., there may be too
 15 much interference, leading to poor selectivity). Cleaner, more discrete, signatures are seen in the mid-IR, so although the level of absorption may not be as great, the selectivity may be better. Examples of explosives and their approximate mid-IR lines include the following:

	PETN (pentaerythritol tetranitrate)	2.67, 3.57, 4.25 microns
20	RDX (cyclotrimethylenetrinitramine)	2.9, 3.23 microns
	TNT	2.9, 3.23 microns
	Tetryl (2,4,6-Trinitrophenylmethylnitroamine)	2.9, 3.23 microns
	HMX	2.9, 3.3 microns
	Ammonium nitrate	broad centered 3.23, narrow 4.1 microns

25 There are other applications in chemical sensing for the spectral fingerprinting system as well. For example, the system can be used for drug detection or chemical weapons agent detection. As an illustration, drugs such as cocaine, methamphetamine, MDMA (ecstasy) and heroin have distinct optical spectral signatures in the wavelength range from 2-5 microns. In one embodiment, the use of
 30 a broadband source covering a large fraction of the mid-IR between 2 to 5 microns can be used to advantageously detect various drugs. Moreover, many of the chemical weapons agents, such as sarin, cyclosarin, soman, tabun, sulfur mustard, nitrogen mustard, VX and lewisite, have absorption features in the 3 to 4 micron window, particularly centered around 3.3 microns. Thus, non-contact, remote detection of

drugs, weapons, firearms, and chemical agents could advantageously be implemented with a spectral fingerprinting system utilizing the SC source.

Beyond chemical sensing, another application for the high power version of the MIRFIL in military and homeland security might be in IRCM, particularly for the commercial air fleet. For instance, much of the black body radiation falls in the wavelength range covered by the SC sources described between ~1 microns and ~4.5 microns. In one embodiment, the SC spectrum could be carved or shaped using spectral filters to resemble the spectrum for hot metal or plume.

Other chemical sensing applications for the SC source or wavelength conversion source include semiconductor process control, combustion monitoring and industrial chemical. For example, the chemicals in the semiconductor growth chamber can be monitored to provide a real time feedback signal to an advanced process control engine. By using the SC, a number of chemical species can even be monitored simultaneously. Examples of chemicals that are relevant for semiconductor processing include monitoring HCl and HBr for plasma etching or monitoring CxFy for gate etching. Alternatively, the chemicals in combustion chamber can be monitored using spectral fingerprinting. Most applications relevant to gas dynamic and combustion flows are based on absorption by low-molecular weight molecules with well resolved transitions – such as O₂, H₂O, CO, CO₂, NO, NO₂, OH, NH₃, HF, H₂S, CH₄, as particular examples. Because of current limitations arising from a lack of convenient mid-infrared sources, the absorption measurements today for chemical sensing may be performed on overtone and combinational vibrational absorption bands, which typically fall in the near IR where laser diodes are available. However, typical line strengths of these transitions are two or three orders-of-magnitude below the fundamental vibrational transitions in the mid-IR. Therefore, by using SC in the mid-IR wavelength range, a much stronger signal can potentially be obtained by operating at the fundamental wavelength of the transitions.

Another application for the MIRFIL based on SC generation or wavelength conversion is in bio-medical ablation or imaging. As an example, the protein absorption dominates over water absorption between ~3.6 microns and ~4 microns and again near 6.1 microns and 6.45 microns. By using laser ablation in one of these windows, the protein can be denatured (for example, by relying on the amino acid absorption) before boiling the water, thereby resulting in less collateral damage. One example of the value of avoiding the collateral damage could be in cosmetic surgery. For instance, cosmetic surgery is often used to remove wrinkles or unwanted skin or

tissue, but discoloration or scars from heating might be undesirable. By denaturing the protein with minimum collateral damage, the unwanted skin or tissue or wrinkles could be removed without scarring or skin discoloration. To achieve the wavelength range of interest, SC generation or wavelength conversion could be used based on
5 4WM. This is one example of a mid-infrared light source for biomedical applications, but many other configurations can be used within the scope of the present disclosure.

The above example uses mid-IR light in applications at wavelengths where the protein absorption exceeds the water absorption. However, there are several instances where the optimal use of the mid-IR light can be at wavelengths where the water
10 absorption dominates. In a particular embodiment, the mid-IR light can be used at a wavelength of strong water absorption, such as close to 2.9-3.1 microns, so that a short ultrasonic or acoustic wave can be launched for high-resolution ultrasound imaging. The wavelength of strong water can be selected to minimize the absorption length of the mid-IR light in the water. In a preferred embodiment, the pulse width of
15 the mid-IR light is under 100nsec, under 10nsec or under 2nsec. These wavelengths and pulse widths are exemplary, but many other ranges of values can be used.

For the short pulses and absorption lengths, the resulting wave then acts as an acoustic impulse. As an example, one particular embodiment where the acoustic
20 impulses can be beneficial is in precise cornea thickness measurements (pachymetry) made during planning for laser keratectomy. Precise thickness measurements can be obtained with high-frequency ultrasound. The use of optical pulses at wavelengths of high water absorption to create the acoustic pulses lends itself to a non-contact procedure for ultrasonic measurements. On benefit of using an all-optical method to
25 generate the acoustic wave can be that it enables simple integration with laser ablation systems. Thus, measurements and laser ablation can be done in one procedure sequentially without need for moving instruments or patients. More generally, laser-induced ultrasonics operating near the water absorption lines can be used to map out many different materials and biological systems. For these types of application, it could be more advantageous to wavelength conversion based on 4WM, so only
30 a narrow band of wavelengths near the water absorption are generated, rather than the entire SC spectrum.

Another potential application for the SC generation can be to use the MIRFIL in Optical Coherence Tomography (OCT) systems used in bio-medical imaging and
35 diagnostics. Over the past two decades, OCT has been established as a diagnostic technique for minimally invasive, high-resolution, cross-sectional imaging in a variety

of medical fields. The OCT system comprises a broadband, low-coherence light source, a fiber-based Michelson interferometer, a sample scanning and positioning stage, and a detector followed by electronics. OCT is analogous to conventional ultrasonic pulse-echo imaging, except that it does not require direct contact with the tissue that is being investigated and it measures echo delay and the intensity of the back-reflected infrared light rather than acoustic waves from internal tissue structures. The light source used in OCT helps to determine the instrument properties in terms of the spectral bandwidth (axial resolution), center wavelength (penetration depth), power density (data acquisition time), cost and size. The SC light source that provides broad bandwidth without using a modelocked laser could lead to micron level resolution for OCT systems without using an expensive light source.

OCT is usually used for biological systems. However, the SC light source could also be advantageously be used with OCT for sub-surface defect detection in semiconductors, ceramics, or other solid state materials. As an illustration, OCT could be used to inspect silicon wafers before they are processed. This could permit sorting of the wafers (i.e., charge a premium for better wafers) and avoiding the cost of processing poor quality wafers. Alternately, OCT could be used to inspect multi-layered structures. By using SC light beyond 1.1 microns, which falls below the bandgap of silicon, the light can penetrate into the chip or wafer. Also, by using longer wavelengths, the scattering loss is reduced. Furthermore, because of the broadband spectrum, the depth resolution of OCT can be at the sub-micron level. Thus, sub-micron to several micron sized defects could be inspected using the SC-light source based OCT.

Typical OCT systems operate point-by-point, which may be too slow for some of the wafer or chip inspection applications. The speed is limited both because imaging is done point-by-point, as well as because one arm of the OCT is moved to achieve the depth resolution. As an alternative, methods used in spectral domain OCT can be used to avoid moving one arm of the interferometer, and by using a line scan the point-by-point scanning could be avoided. As an example, the light from the output of the SC source could be stretched onto a line using a cylindrical lens or an appropriate optical lensing system. The resulting line of light could be split using a beam splitter to a reference arm with a reference mirror or sample and the sample arm. The sample can be located in the sample arm, and the sample can be moved below the light to scan line by line. The return beams from the reference arm and sample arm can be recombined at the beam splitter, and an imaging lens can then be

used to image it into a spectrometer. In one particular embodiment, the spectrometer could be dispersive optics, such as a grating or a lens, which could take each point of light and spread it into a spectrum to be detected by a detector array. By processing the multi-spectral data from each spatial point, the location of the reflection from the sample can be detected. Thus, instead of using a movement of the reference arm, the Fourier transform of the interference data may be processed to obtain the height of the reflection.

Yet another application of the SC source is in the so-called "last mile solution" in telecommunications. The last mile solution includes the technologies related to fiber-to-the-X (FTTx), where X can exemplarily be home, node, neighborhood, curb, or premise. As one example, the SC source can be an enabling technology for wavelength division multiplexed passive optical networks (λ -PONS). In a λ -PONS based FTTx system, each location can receive one or more wavelengths. A challenge for λ -PONS is the multi-wavelength light source, which may reside at the central office or other telecommunications location. The SC source can advantageously provide a potentially low-cost solution for the multi-wavelength light source.

In one particular embodiment, the SC source can be coupled to one or more modulators and a wavelength division multiplexer to implement the FTTx multi-wavelength light source. As an example, the SC source could advantageously emit wavelengths covering the low loss window in optical fibers, advantageously between 1250nm and 1750nm. For this example, the entire SC source could be implemented in fused silica fiber. Then, the output from the SC source can be separated into multiple wavelength channels, using, for example, a wavelength division multiplexer. Each wavelength can then be modulated using a modulator. The modulated wavelength signals can then be combined and coupled to the output fiber for propagation over the FTTx system. In addition, in the FTTx system the power splitters may be replaced with wavelength division multiplexers. Examples of wavelength division multiplexers include arrayed waveguide gratings, waveguide grating routers, dielectric coated beam splitters, and bulk optical gratings.

In another embodiment, the FTTx multi-wavelength light source could comprise a SC source coupled to a dispersive pulse stretcher, one or more high-speed modulators, and a wavelength division multiplexer to separate the wavelengths. Advantageously, the SC source could advantageously emit wavelengths covering the low loss window in optical fibers, particularly between 1250nm and 1750nm. The

dispersive pulse stretcher can then broaden the SC pulse, spreading the wavelengths so the channels occupy different time slots. The one or more high speed modulators can be used to time sequentially encode the different channels, and then the wavelength division multiplexer is used to separate the wavelength channels in the

5 FTTx system.

Although the present invention has been described in several embodiments, a myriad of changes, variations, alterations, transformations, and modifications may be suggested to one skilled in the art, and it is intended that the present invention encompass such changes, variations, alterations, transformations, and modifications as

10 falling within the spirit and scope of the appended claims.

WHAT IS CLAIMED IS:

1. A broadband light source comprising:
one or more laser diodes capable of generating a pump signal comprising a wavelength shorter than 2.5 microns, a pulse width of at least 100 picoseconds and a
5 pump optical spectral width;
one or more optical amplifiers coupled to the pump signal and capable of amplifying the pump signal to a peak power of at least 500W;
a first fiber coupled to the one or more optical amplifiers, the first fiber comprising an anomalous group-velocity dispersion regime and a modulational
10 instability mechanism that modulates the pump signal, wherein the pump signal wavelength resides in the anomalous group-velocity dispersion regime of the first fiber, and wherein different intensities in the pump signal can cause relative motion between different parts of the modulated pump signal produced through modulational instability in the first fiber; and
15 a nonlinear element coupled to the first fiber capable of broadening the pump optical spectral width to at least 100nm through a nonlinear effect in the nonlinear element.
2. The broadband light source of Claim 1, wherein the one or more
20 optical amplifiers are selected from the group consisting of a rare-earth doped fiber amplifier, a thulium-doped fiber amplifier, an erbium-doped fiber amplifier, a semiconductor optical amplifier, a Raman amplifier, and a cladding pumped fiber amplifier.
- 25 3. The broadband light source of Claim 1, wherein the first fiber is selected from the group consisting of a fused silica fiber, a standard single-mode fiber, a high-nonlinearity fiber, a dispersion-shifted fiber, a non-zero dispersion shifted fiber, a microstructure fiber and a dispersion compensating fiber.
- 30 4. The broadband light source of Claim 1, wherein the nonlinear element is selected from the group consisting of a high-nonlinearity fiber, a dispersion-compensating fiber, a ZBLAN fiber, a fluoride fiber, a tellurite fiber, a chalcogenide fiber, a semiconductor waveguide, a PIN silicon waveguide, a photonic crystal fiber, and a hollow core fiber filled with a nonlinear liquid or gas.

35

5. The broadband light source of Claim 1, wherein the nonlinear element comprises a length 15 meters or less.
6. The broadband light source of Claim 1, wherein the nonlinear effect of
5 the nonlinear element is selected from the group consisting of self-phase modulation, self-steepening, a Raman effect, four-wave mixing, and cross-phase modulation.
7. The broadband light source of Claim 1, further comprising one or more
10 optical filters coupled to the one or more optical amplifiers to control a level of amplified spontaneous emission, wherein the one or more optical filters are selected from the group consisting of spectral filters and temporal filters.
8. The broadband light source of Claim 1, wherein at least a portion of
15 the one or more optical amplifiers comprises a cladding-pumped fiber amplifier pumped by a plurality of multi-mode pump lasers comprising at least a second wavelength, wherein the second wavelength is substantially different than the pump signal wavelength.
9. The broadband light source of Claim 1, wherein a long wavelength
20 edge of the pump optical spectral width after the nonlinear element is at substantially 2.6 microns or longer.
10. The broadband light source of Claim 1, wherein a center wavelength
25 for the pump optical spectral width after the nonlinear element is capable of being adjusted by a device selected from the group consisting of dispersion management in the nonlinear element and a seed laser.
11. The broadband light source of Claim 1, wherein the light source is
30 used in a last mile telecommunications system by coupling the light source to one or more modulators and a wavelength separator.

12. A mid-infrared light source comprising:
one or more laser diodes capable of generating a pump signal comprising at least one wavelength and a pulse width of at least 100 picoseconds;
one or more optical amplifiers coupled to the pump signal and capable of
5 amplifying the pump signal;
one or more fibers coupled to the one or more optical amplifiers, at least one of the one or more fibers comprising an anomalous group-velocity dispersion regime and a modulational instability mechanism that modulates the at least one wavelength of the pump signal in at least a portion of the at least one of the one or more fibers,
10 wherein the at least one wavelength of the pump signal resides in the anomalous group-velocity dispersion regime for at least a fraction of the at least one of the one or more fibers; and
a nonlinear element coupled to the one or more fibers capable of generating a super-continuum with a substantially continuous spectrum from at least the at least
15 one wavelength of the pump signal to 2.6 microns or longer and wherein the nonlinear element introduces less than 10 decibels of power loss at 2.6 microns.
13. The light source of Claim 12, wherein at least a portion of the one or more amplifiers is a rare-earth doped fiber amplifier, wherein at least a portion of the
20 one or more fibers is fused silica fiber, and wherein at least a portion of the nonlinear element is a light guide selected from the group consisting of a high-nonlinearity fiber, a dispersion-compensating fiber, a ZBLAN fiber, a fluoride fiber, a tellurite fiber, a chalcogenide fiber, a semiconductor waveguide, a PIN silicon waveguide, a photonic crystal fiber, and a hollow core fiber filled with a nonlinear liquid or gas.
- 25
14. The light source of Claim 12, wherein the super-continuum is used to emulated at least in part a black body radiation from a heated object or in a spectral fingerprinting system, where the substantially continuous spectrum is used to monitor substantially simultaneously a number of absorption lines and wherein a chemical
30 species is identified by a pattern of absorption lines.
15. The light source of Claim 14, wherein a signal-to-noise ratio is increased by selectively rejecting noise during times when the super-continuum is not emitted using a technique selected from the group consisting of a time modulation
35 technique and a time gated detection technique.

16. The light source of Claim 12, wherein at least a part of the one or more optical amplifiers is a cladding-pumped fiber amplifier pumped by a plurality of multi-mode pump lasers comprising at least a second wavelength different than the at
5 least one wavelength of the pump signal.

17. A method of generating broadband light comprising the steps of:
generating a pump signal, wherein the pump signal comprises at least one
wavelength shorter than 2.5 microns, a pulse width of at least 100 picoseconds and a
5 pump optical spectral width;
amplifying the pump signal to a peak power of at least 500 watts;
modulating at least a fraction of the pump signal using a modulational
instability mechanism, wherein different intensities in the pump signal leads to
relative motion between different portions of the pump signal; and
10 broadening the pump optical spectral width to at least 100nm using a nonlinear
effect.
18. The method of Claim 17, wherein the pump signal is amplified in a
cladding pumped fiber amplifier pumped by a plurality of multi-mode pump lasers
15 comprising at least a second wavelength different than the at least one wavelength of
the pump signal.
19. The method of Claim 17, wherein the broadband light is used for
emulating black body radiation, identifying particular chemical species, transmitting
20 in a last mile telecommunications system, or ablating proteins or tissue in biological
systems.
20. The method of Claim 17, wherein a power associated with the at least
100nm pump optical spectral width can be increased by increasing a pulse repetition
25 rate of the pump signal.

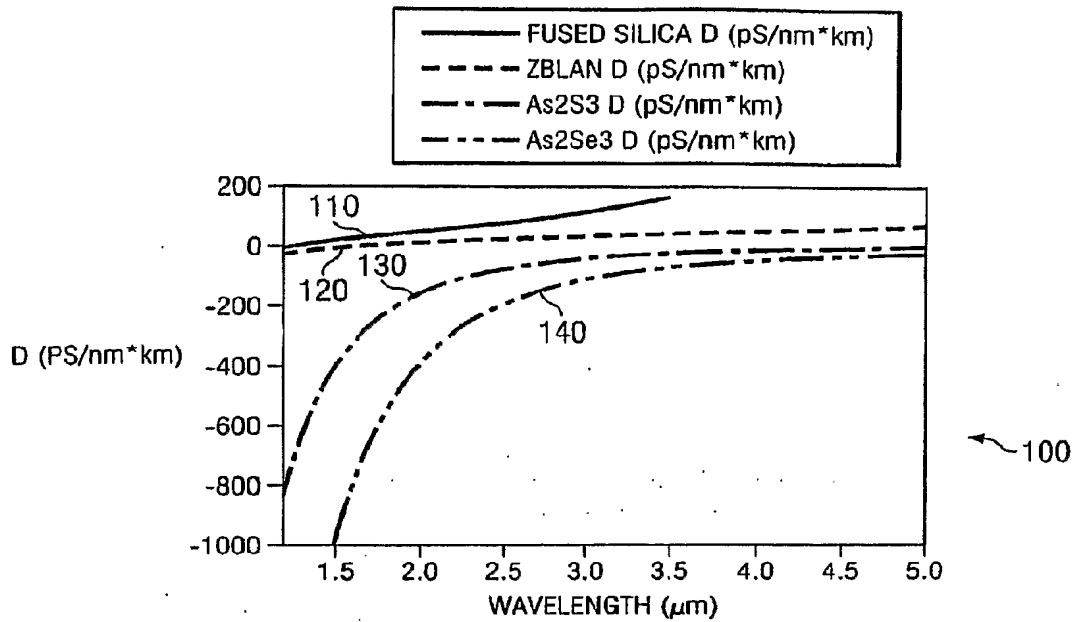

FIG. 1

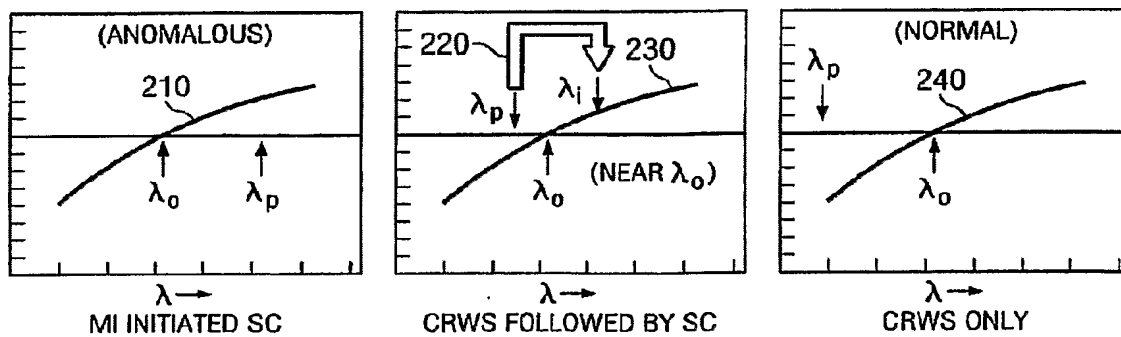

FIG. 2

SUBSTITUTE SHEET (RULE 26)

FIG. 3

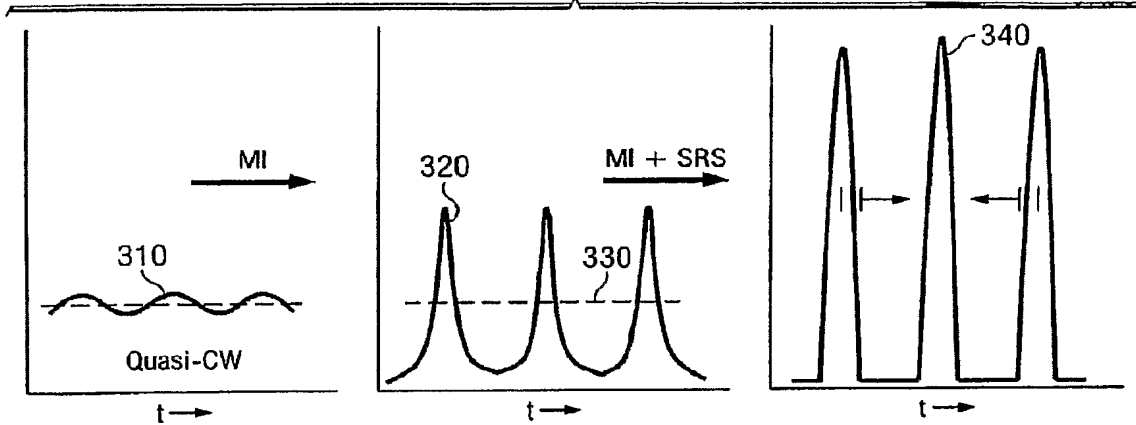
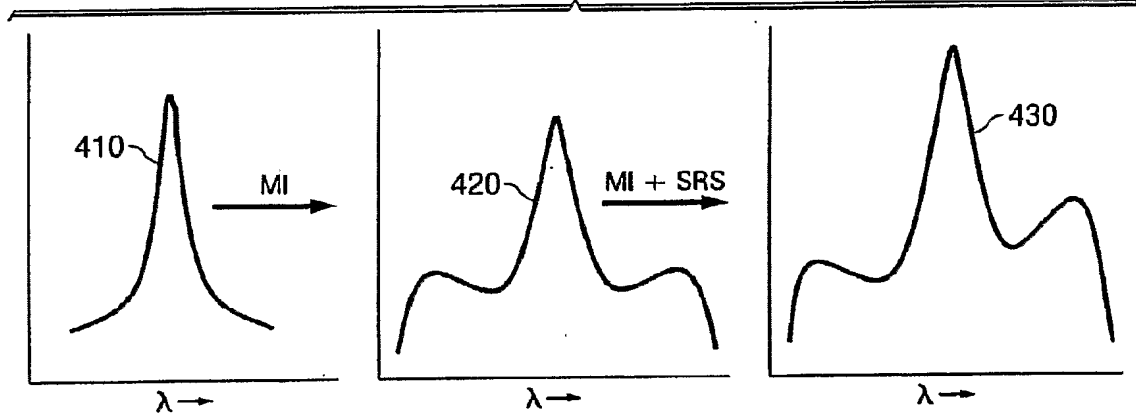

FIG. 4



SUBSTITUTE SHEET (RULE 26)

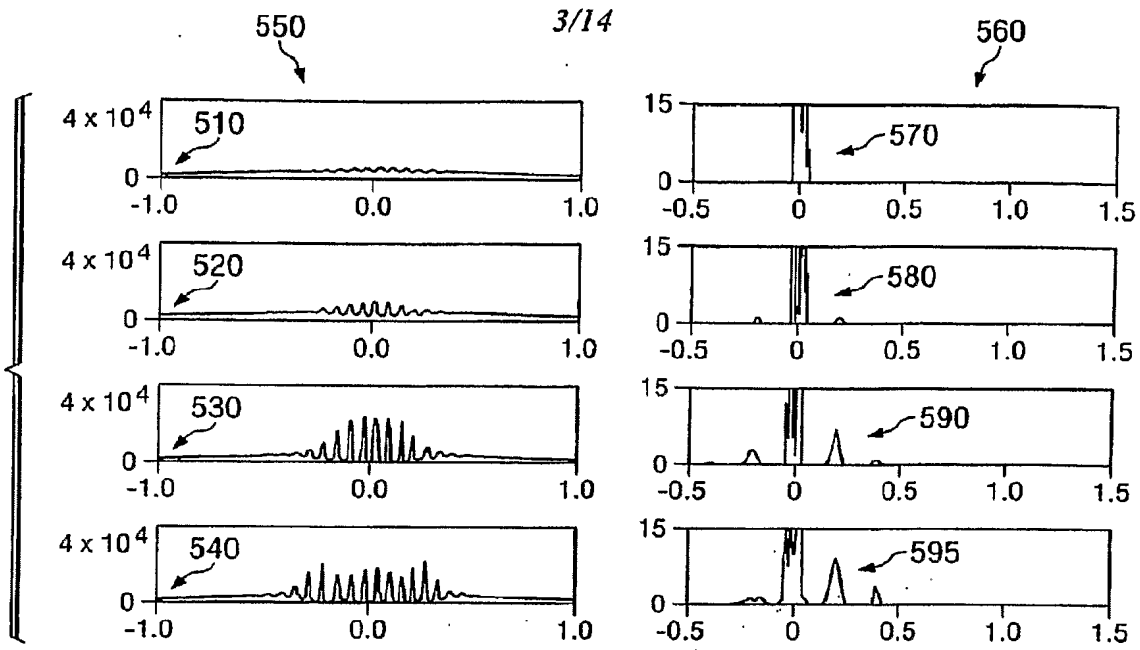

FIG. 5

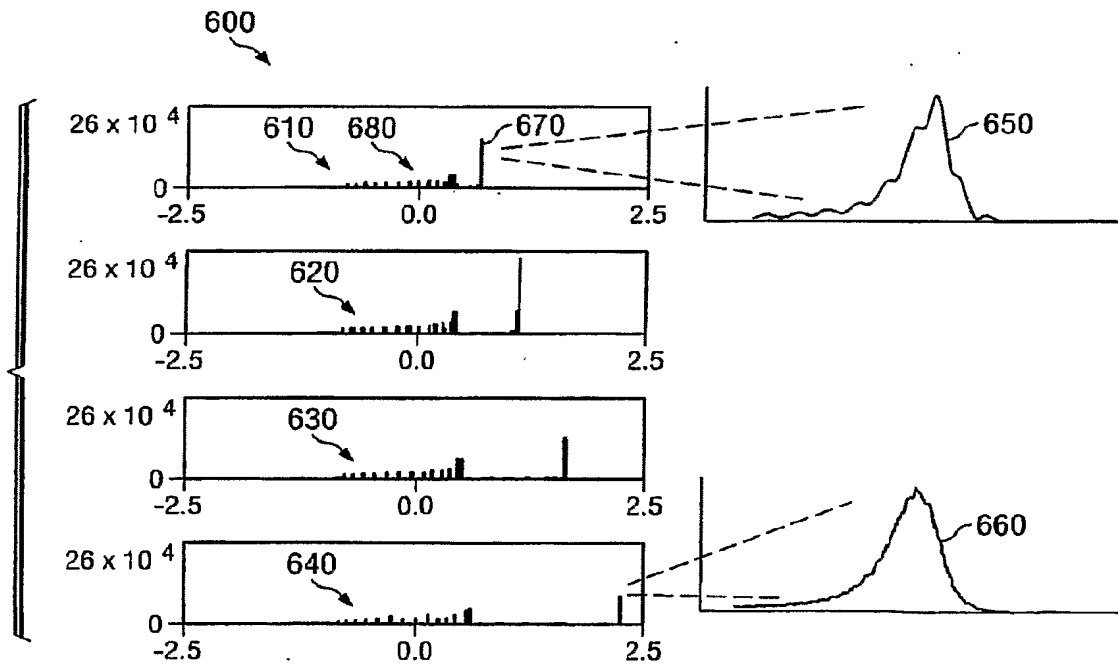

FIG. 6

SUBSTITUTE SHEET (RULE 26)

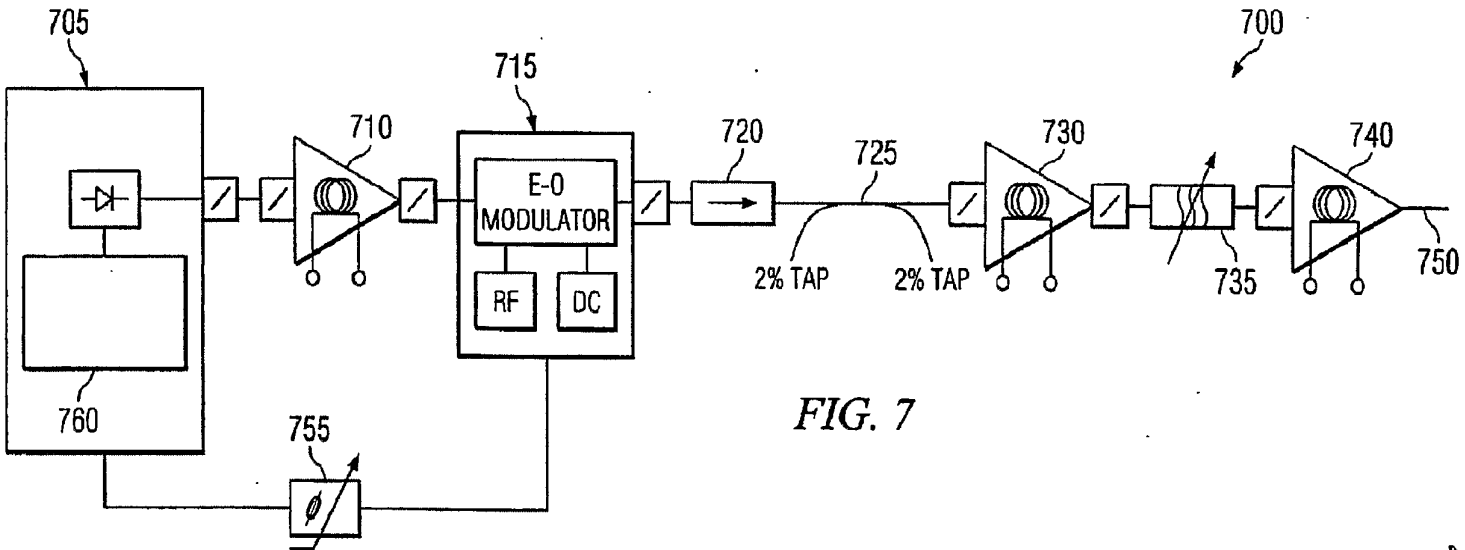

FIG. 7

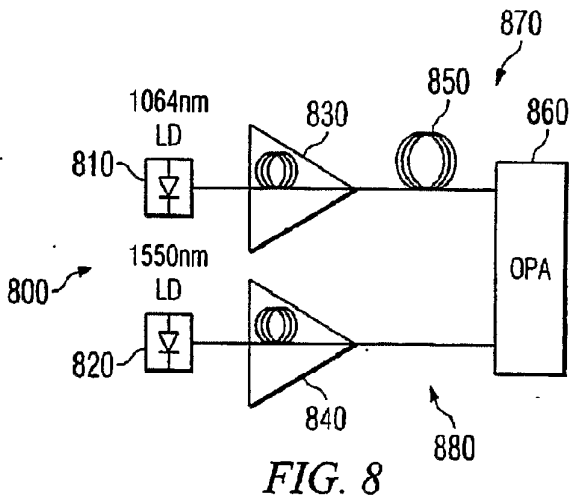

FIG. 8

SUBSTITUTE SHEET (RULE 26)

5/14

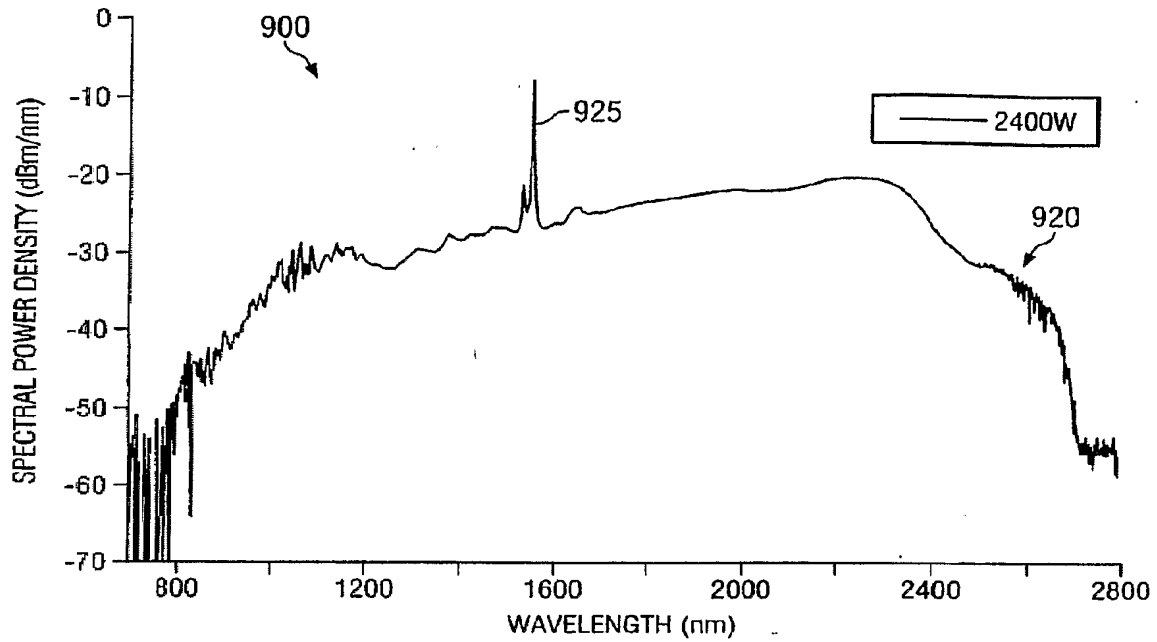

FIG. 9a

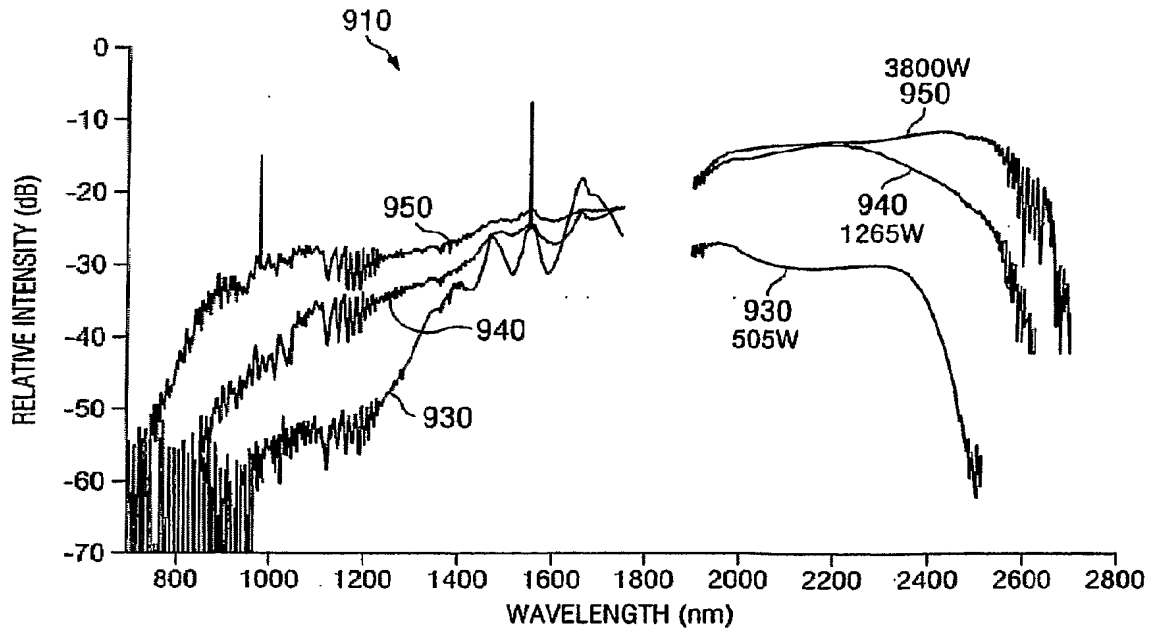

FIG. 9b

SUBSTITUTE SHEET (RULE 26)

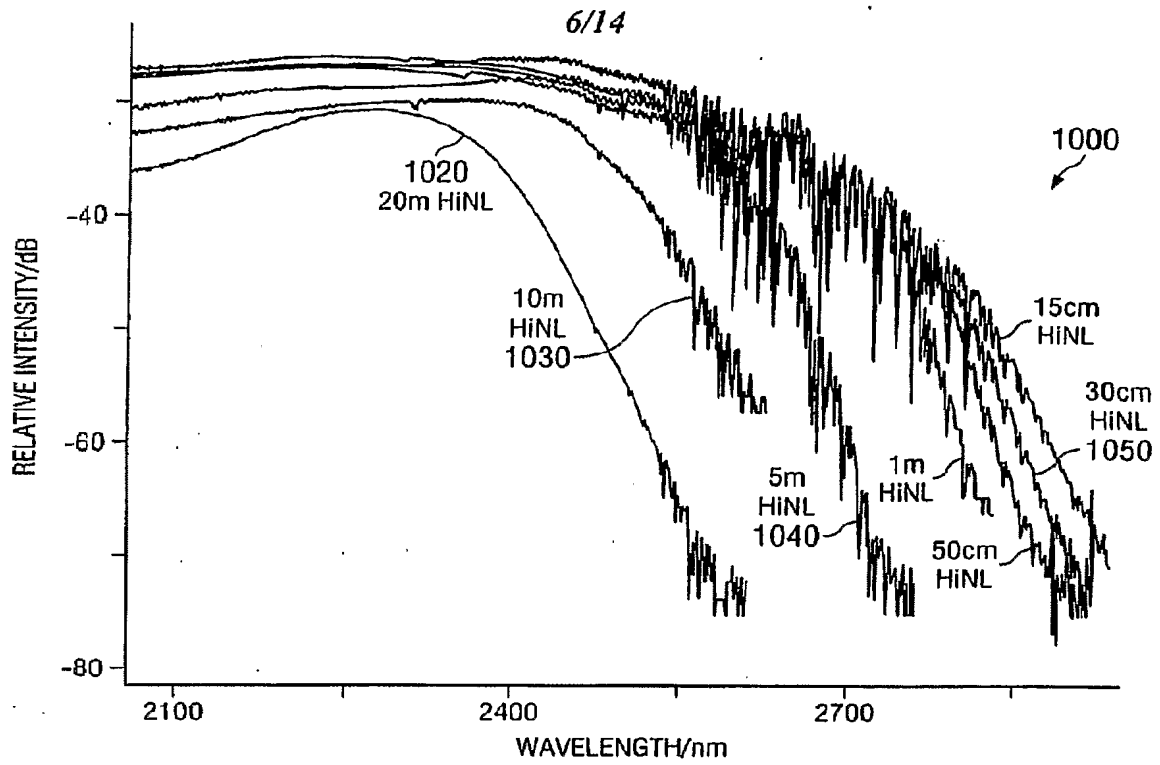

FIG. 10a

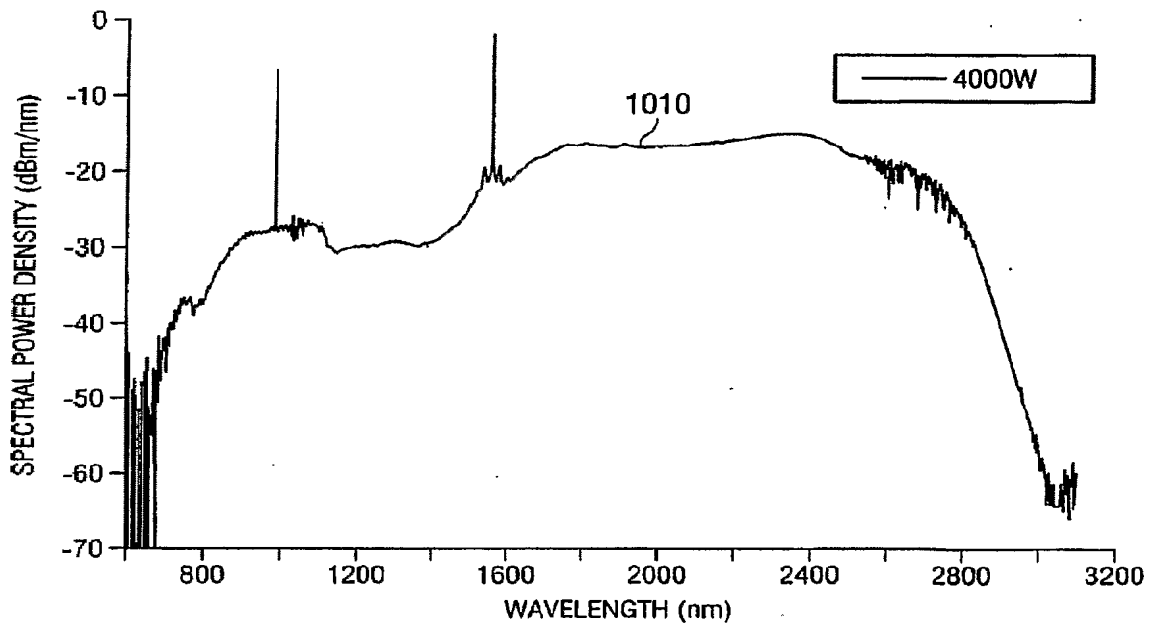

FIG. 10b

SUBSTITUTE SHEET (RULE 26)

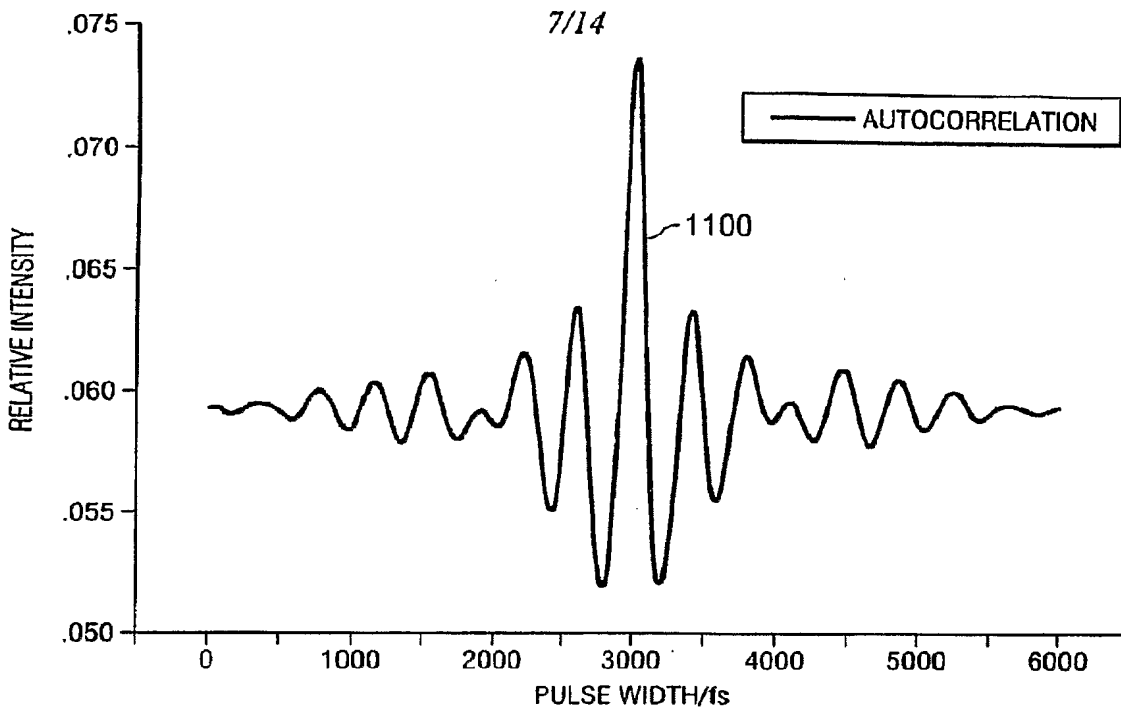

FIG. 11a

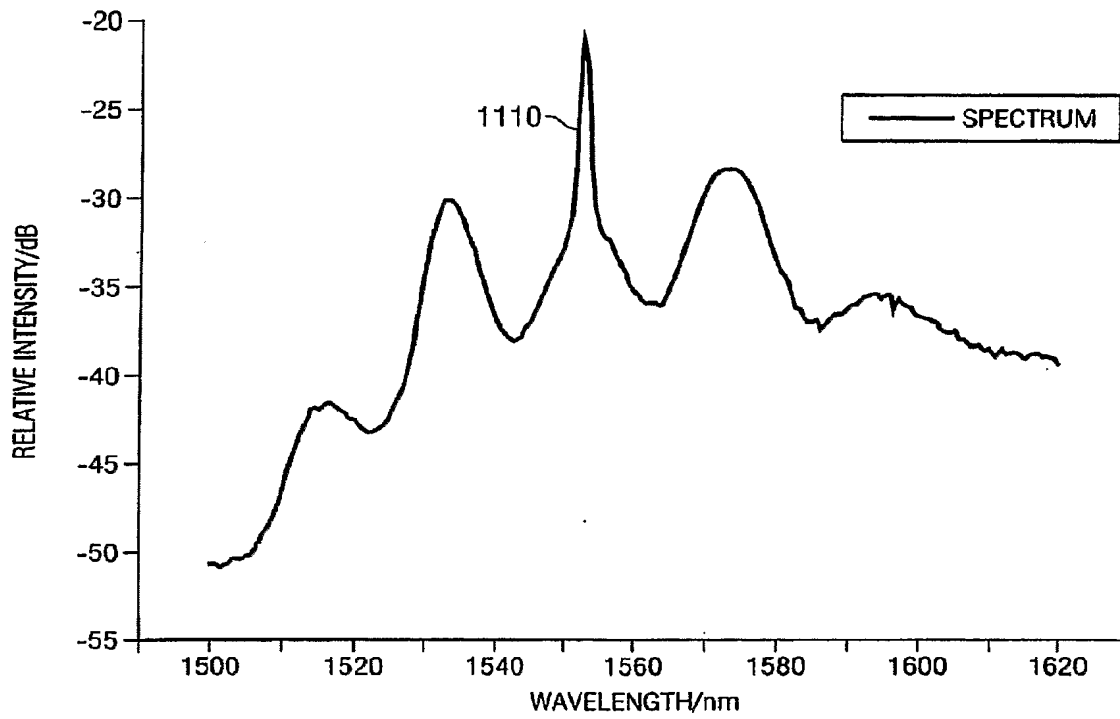

FIG. 11b

SUBSTITUTE SHEET (RULE 26)

8/14

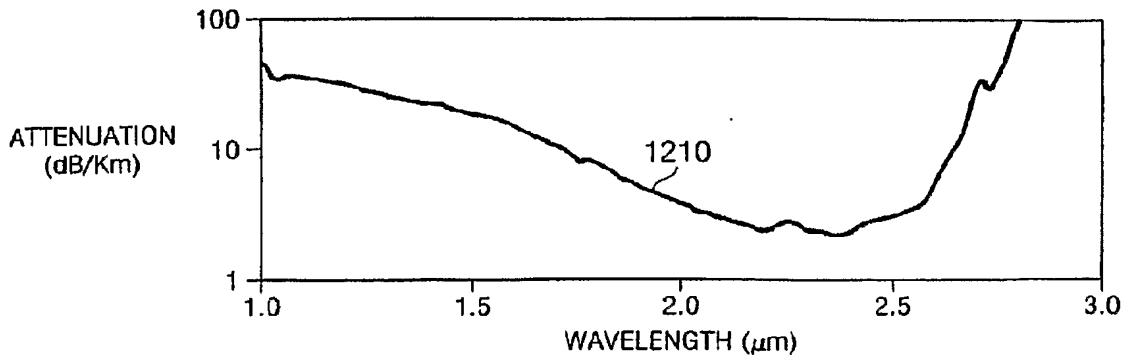

FIG. 12a

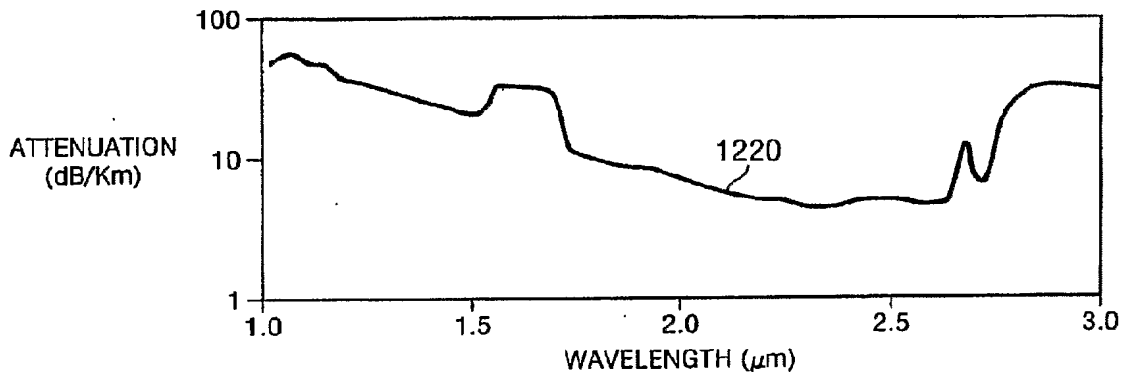

FIG. 12b

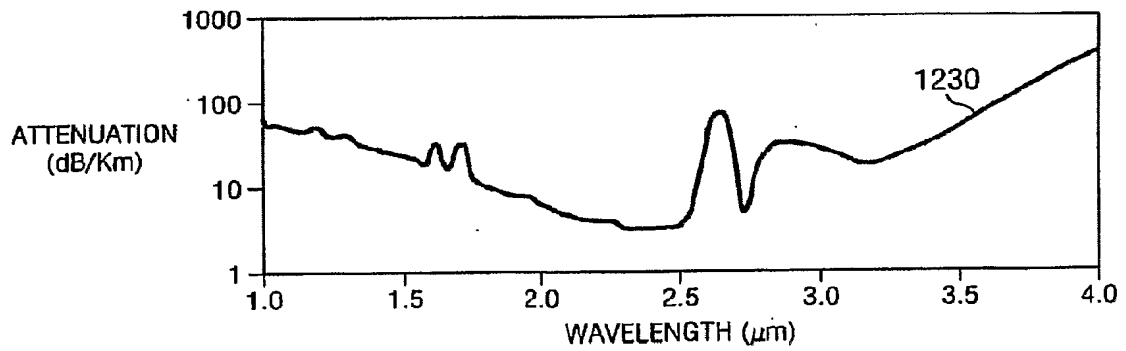

FIG. 12c

SUBSTITUTE SHEET (RULE 26)

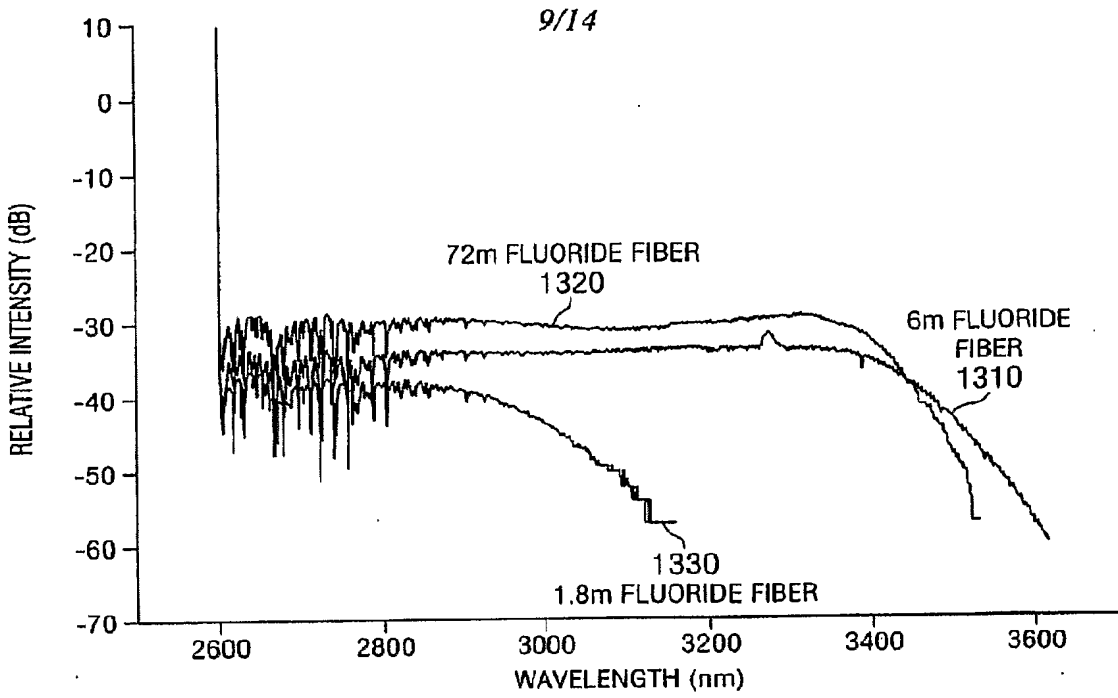

FIG. 13a

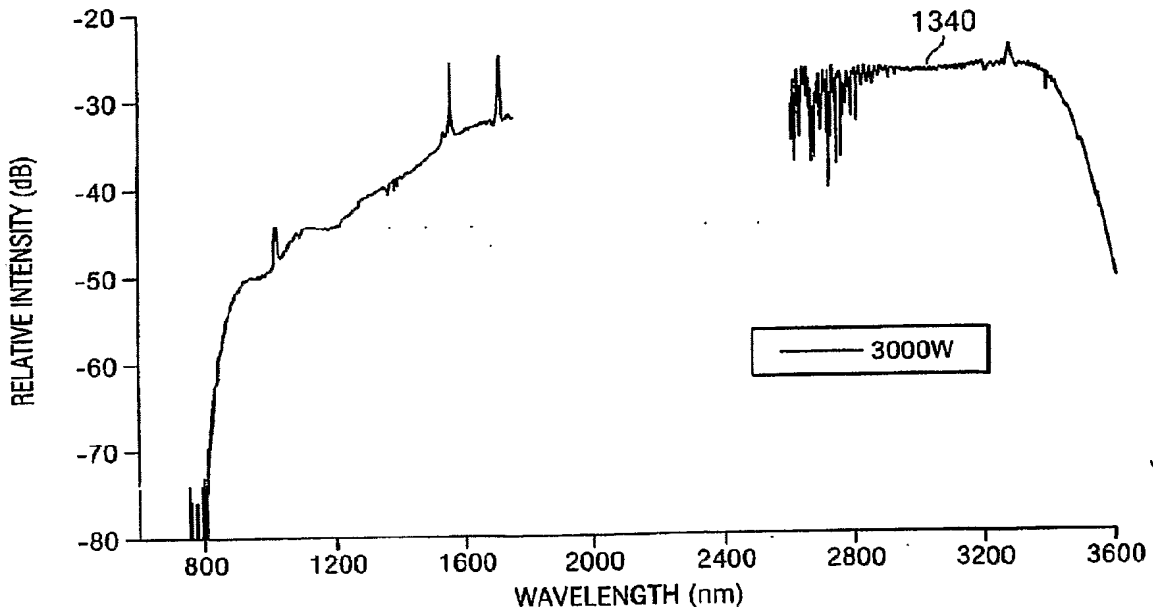

FIG. 13b

SUBSTITUTE SHEET (RULE 26)

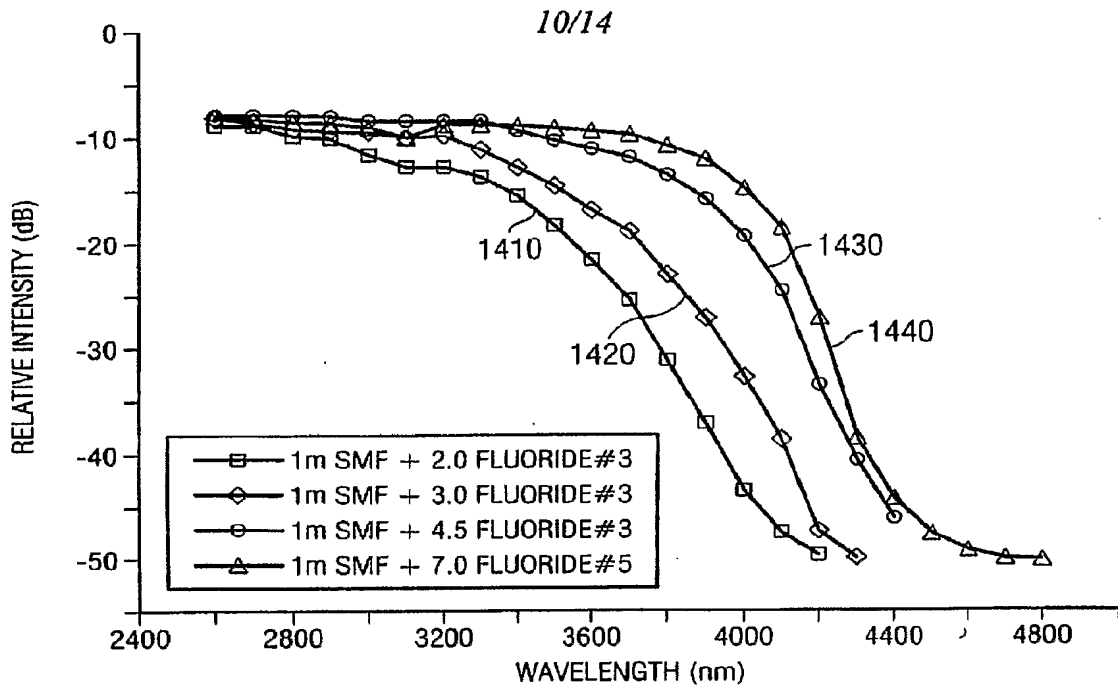

FIG. 14a

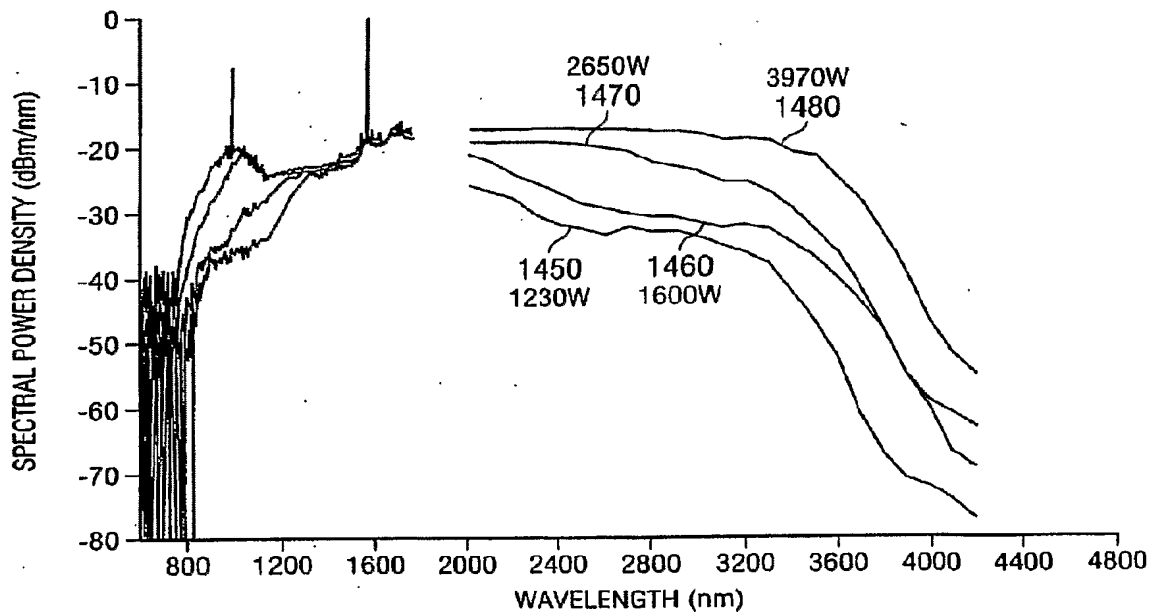

FIG. 14b

SUBSTITUTE SHEET (RULE 26)

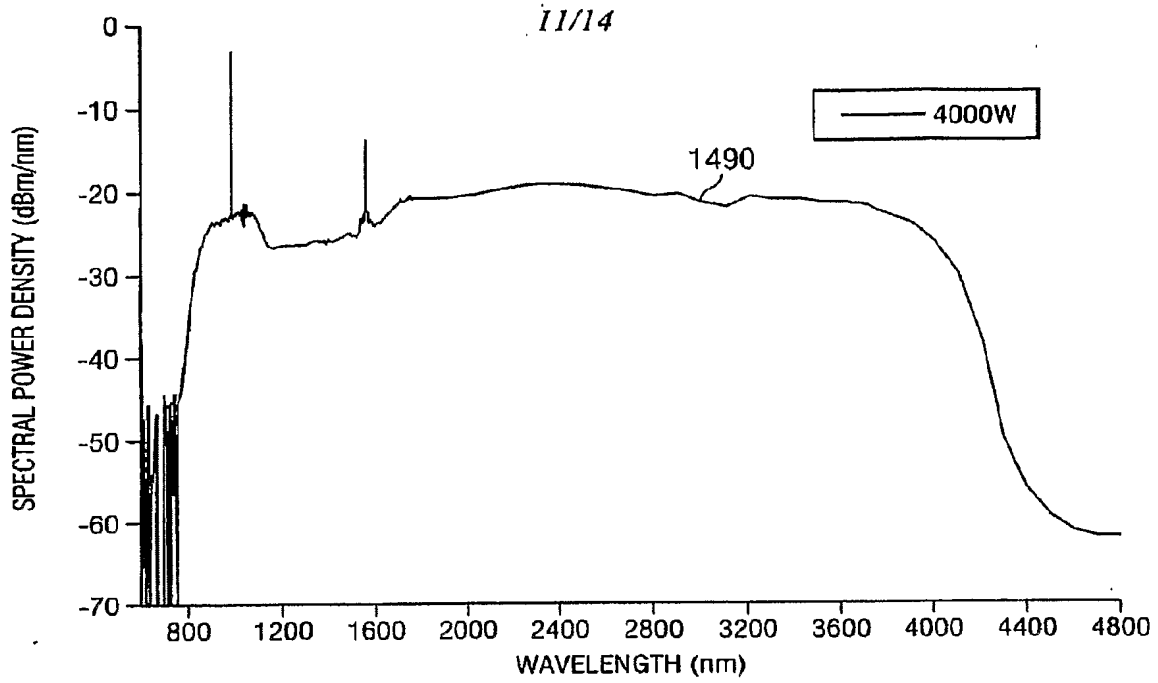

FIG. 14c

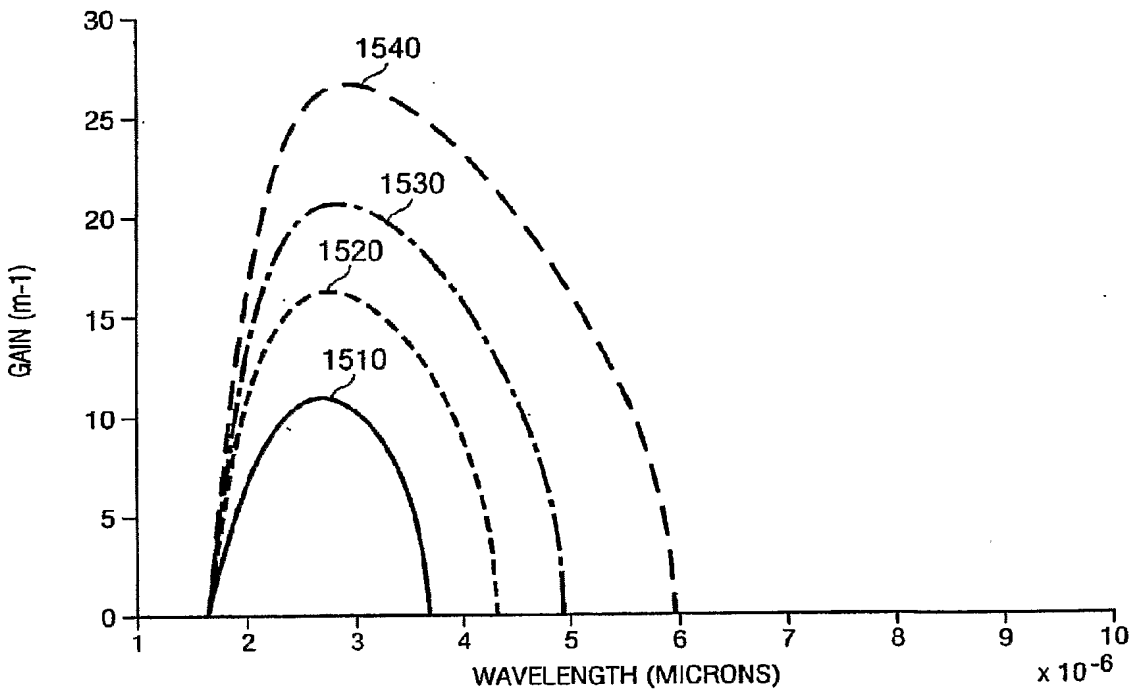
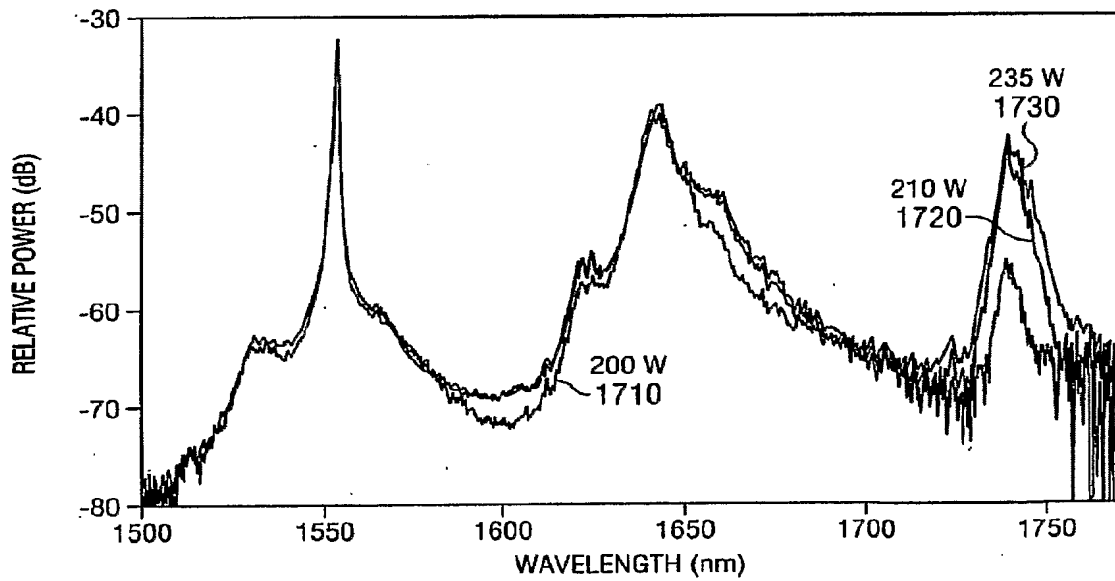
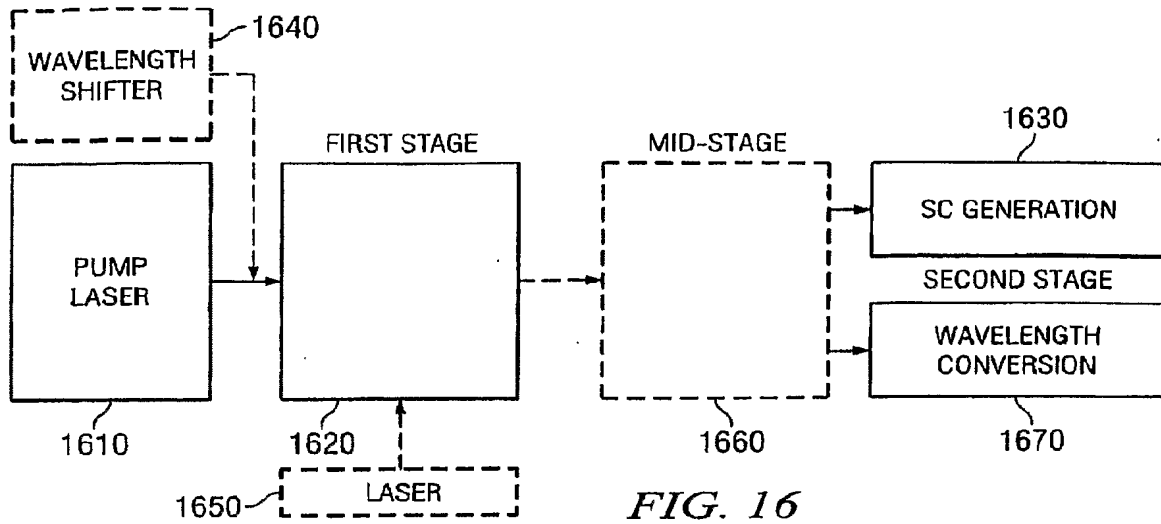

FIG. 15

SUBSTITUTE SHEET (RULE 26)

12/14



SUBSTITUTE SHEET (RULE 26)

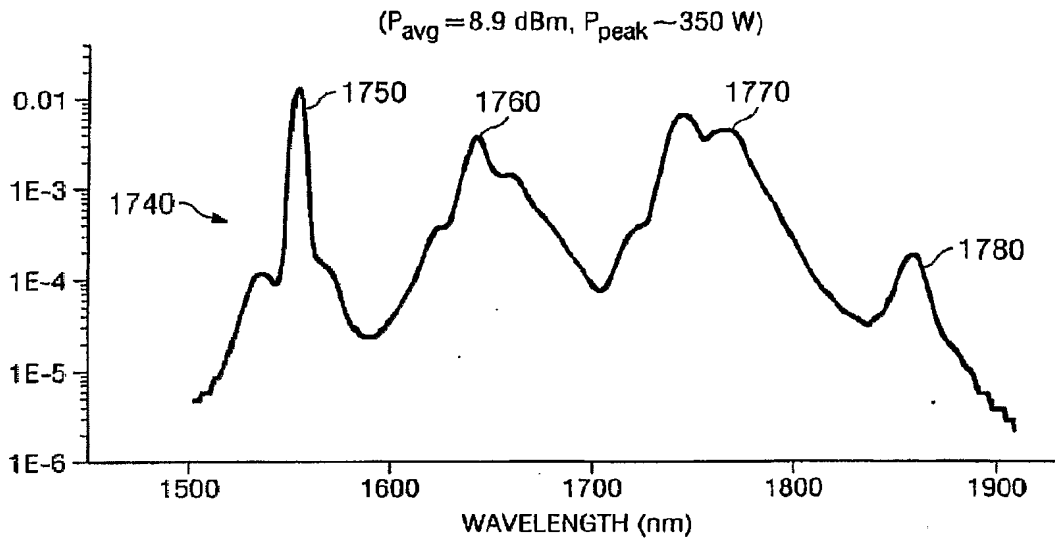

FIG. 17b

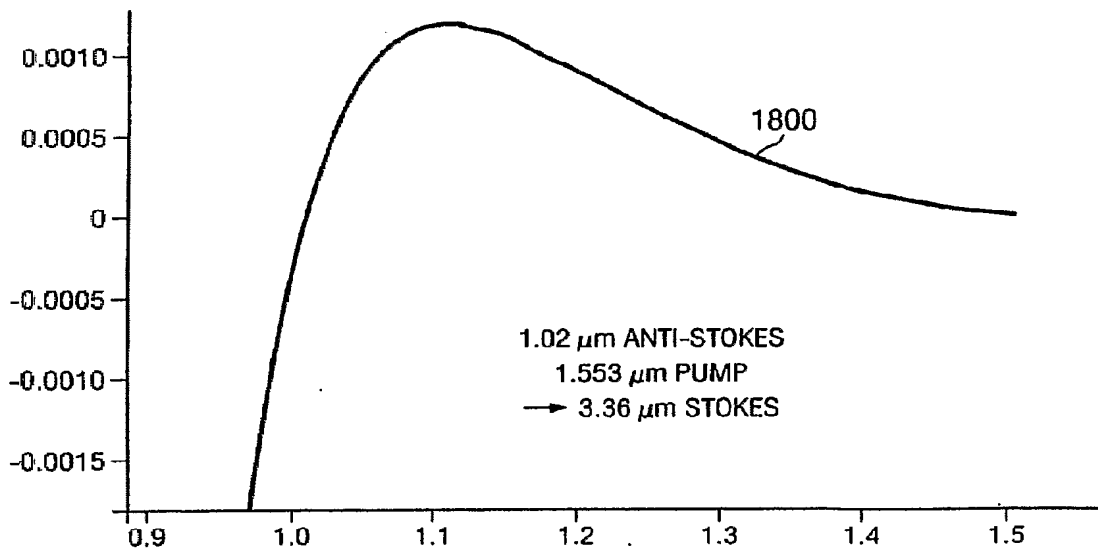
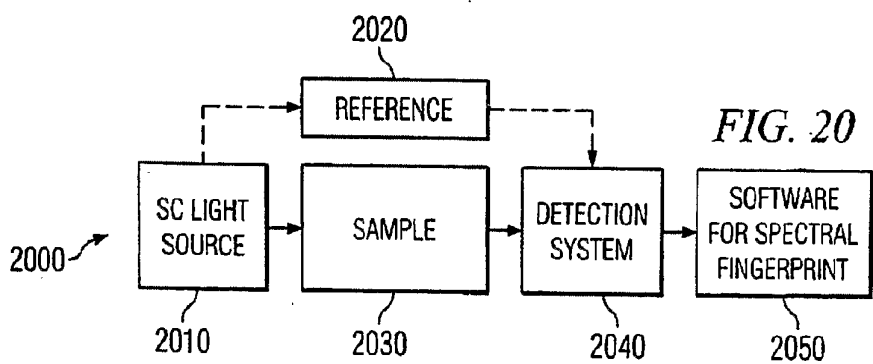
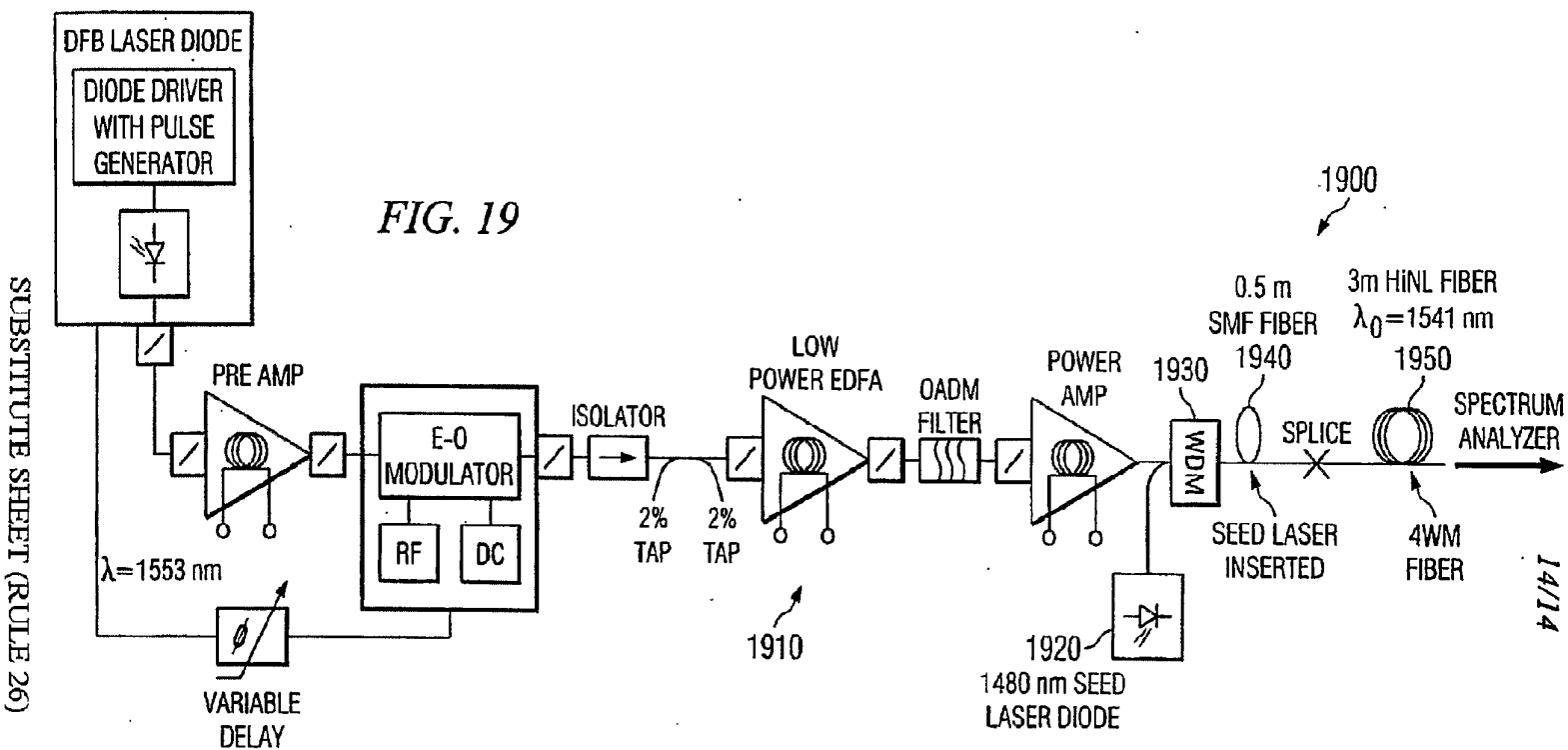

FIG. 18

SUBSTITUTE SHEET (RULE 26)



(19) World Intellectual Property Organization
International Bureau



(10) International Publication Number
WO 2009/130464 A1

(43) International Publication Date
29 October 2009 (29.10.2009)

(51) International Patent Classification:
A61B 5/00 (2006.01) A61B 1/24 (2006.01)

(74) Agents: HACKNEY, Nigel et al.; Mewburn Ellis LLP,
33 Gutter Lane, London, Greater London EC2V 8AS
(GB).

(21) International Application Number:
PCT/GB2009/001032

(81) Designated States (unless otherwise indicated, for every kind of national protection available): AE, AG, AL, AM, AO, AT, AU, AZ, BA, BB, BG, BH, BR, BW, BY, BZ, CA, CH, CN, CO, CR, CU, CZ, DE, DK, DM, DO, DZ, EC, EE, EG, ES, FI, GB, GD, GE, GH, GM, GT, HN, HR, HU, ID, IL, IN, IS, JP, KE, KG, KM, KN, KP, KR, KZ, LA, LC, LK, LR, LS, LT, LU, LY, MA, MD, ME, MG, MK, MN, MW, MX, MY, MZ, NA, NG, NI, NO, NZ, OM, PG, PH, PL, PT, RO, RS, RU, SC, SD, SE, SG, SK, SL, SM, ST, SV, SY, TJ, TM, TN, TR, TT, TZ, UA, UG, US, UZ, VC, VN, ZA, ZM, ZW.

(22) International Filing Date:
23 April 2009 (23.04.2009)

(25) Filing Language: English

(26) Publication Language: English

(30) Priority Data:
0807611.9 25 April 2008 (25.04.2008) GB

(71) Applicant (for all designated States except US): THE UNIVERSITY OF MANCHESTER [GB/GB]; Oxford Road, Manchester M13 9PL (GB).

(84) Designated States (unless otherwise indicated, for every kind of regional protection available): ARIPO (BW, GH, GM, KE, LS, MW, MZ, NA, SD, SL, SZ, TZ, UG, ZM, ZW), Eurasian (AM, AZ, BY, KG, KZ, MD, RU, TJ, TM), European (AT, BE, BG, CH, CY, CZ, DE, DK, EE, ES, FI, FR, GB, GR, HR, HU, IE, IS, IT, LT, LU, LV, MC, MK, MT, NL, NO, PL, PT, RO, SE, SI, SK, TR), OAPI (BF, BJ, CF, CG, CI, CM, GA, GN, GQ, GW, ML, MR, NE, SN, TD, TG).

(72) Inventors; and

(75) Inventors/Applicants (for US only): ZAKIAN, Christian [MX/GB]; Dental Health Unit, The University of Manchester, Skelton House, Manchester Science Park, Lloyd Street North Manchester M15 6SH (GB). PRETTY, Iain [GB/GB]; Dental Health Unit, The University of Manchester, Skelton House, Manchester Science Park, Lloyd Street North Manchester M15 6SH (GB). ELLWOOD, Roger [GB/GB]; Dental Health Unit, The University of Manchester, Skelton House, Manchester Science Park, Lloyd Street North Manchester M15 6SH (GB).

Published:

— with international search report (Art. 21(3))

(54) Title: DENTAL IMAGING AND APPARATUS THEREFOR

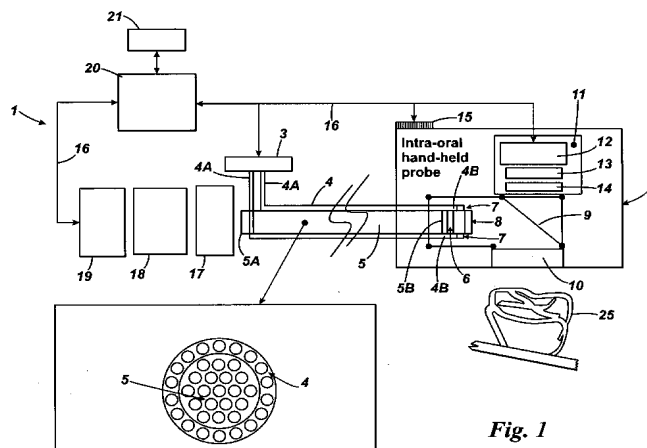

Fig. 1

(57) Abstract: Apparatus and method for imaging a tooth. The apparatus includes: illumination means arranged to generate first and second infra-red light; and image data acquisition means arranged for receiving infra-red light originating from the illumination means and returned from an illuminated tooth. The image data acquisition means includes infra-red pixel sensor means responsive to said returned infra-red light to generate image pixel values for a first image of the illuminated tooth using first infra-red light and for a second image of the illuminated tooth using second infra-red light. The apparatus further includes data processing means to use one or more image pixel values of the first image to calculate a first reflectance value, and to use one or more image pixel values of the second image to calculate a second reflectance value, and to determine from the first and second reflectance values a measure of the degree of enamel lesion (Se) and/or dentin lesion (Sd) present in the part.



WO 2009/130464 A1

DENTAL IMAGING AND APPARATUS THEREFOR

The present invention relates to methods and apparatus for the imaging of teeth and particularly, though not exclusively, for
5 imaging lesions or for processing such data.

Dental caries is a dynamic disease characterised by tooth demineralization leading to an increase in the porosity of the enamel surface. The result is commonly known as "white spots"
10 and is due to the white appearance created by the increase of refraction index of de-mineralized enamel. Leaving these lesions untreated can potentially lead to dental cavities which may reach the dentin and pulp of the tooth, and may eventually cause tooth loss. Occlusal and approximal tooth
15 surfaces are among the sites most susceptible to demineralization due the acid attack from bacterial by-products.

The use of preventive agents to inhibit, or reverse, the demineralization process is predicated on the detection of
20 lesions at an early stage. However, detecting early lesions is difficult.

Non-invasive detection of white spots may employ an estimation of surface porosity or mineral loss. Although radiographic
25 methods are suitable for approximal surface lesion detection, they offer a reduced utility for screening early caries in occlusal surfaces. In addition, radiographic methods are not ideal due to the patient exposure to x-rays and to their lack of sensitivity at very early stages of the disease.
30 Electrical caries monitoring enables only single point measurements.

Optical methods offer non-destructive monitoring of early
35 tooth enamel de-mineralization.

Current imaging methods are based on the observation of changes in light transport within the tooth, namely

absorption, scattering and/or fluorescence of light. Porous media scatters more the light than uniform media and stain tends to absorb the light. Trans-illumination is a method that looks for shadows created by pumping white light from one side of the tooth, as viewed from the opposite side. Such shadows may correspond to regions where light is scattered away and/or absorbed. This technique is difficult to employ quantitatively due to an uneven light distribution inside the tooth. Quantitative light fluorescence (QLF) is an imaging method that relies on the natural fluorescence by teeth. This fluorescence acts as an internal source of light that will try to escape through the surface of the tooth. With appropriate filters, one may observe the fluorescent light and may quantify the loss of mineral by visualizing dark patches or shadows produced by scattering and/or absorption of fluorescent light. However this technique is unsuitable when trying to discriminate between white spots and stain as both produce the similar effect.

Stain is commonly observed in the occlusal sites of teeth and this obscures the true detection of caries. Stain, therefore, is one of the most confounding factors in the detection of early caries lesions.

The present invention may desirably be employed in addressing or overcoming limitations in the prior art.

At its most general, the invention proposed is spectral measurement or imaging of a tooth in infra-red light (e.g. the near infra-red (NIR) spectral region) to produce data to enable identification and/or quantification of lesions on a tooth (e.g. occlusal tooth surfaces) using the spectral signatures of water absorption and the effect of porosity or demineralisation in the scattering of light by a tooth.

Near-infrared (NIR) light has a number of advantages for use in caries detection as compared to visible light since it

suffers a lower degree absorption by stain and may penetrate deeper into a target tooth. Infra-red light may be employed (e.g. for Hyperspectral images) having a wavelength from 1000nm to 2500nm or more. The measured effects of infra-red light scattering by porous enamel and absorption thereof by water in dentin may be used to quantify the lesion extension and generate a caries score quantifying the degree of lesion. Analysis of the reflectance spectra of a target tooth illuminated by infra-red light may identify infra-red wavelength values, or ranges, of illuminating light returned from a tooth which exhibit reflectance values characteristic of scattering by porous or demineralized enamel or absorption thereof by water in the tooth (e.g. in dentin).

Histological examination of ground target teeth, made after the spectral measurements have shown that a caries score obtained according to an aspect of the invention, correlates significantly (Pearson's correlation of 0.89, $p < 0.01$) with the corresponding histological score. Results yield a sensitivity of 75% and a specificity of 87.5% for enamel lesions and a sensitivity of 87.5% and a specificity of 100% for dentine lesions. The nature of the technique may provide a number of advantages including, desirably, the ability to spatially map the lesion distribution rather than only obtaining single-point measurements. The technique may be non-invasive, and/or non-contact and and/or stain-insensitive.

Using light in the infra-red, e.g. near infra-red, region of the electromagnetic spectrum may overcome difficulties associated with scattering and absorption. Scattering in enamel is reduced and absorption by stain is low when infra-red light is employed. In fact, the scattering by enamel tissues reduces in the form of $1/\lambda^3$ laser wavelengths, λ , of 512 nm, 632 nm and 1053 nm at least. In addition, a higher transparency for 1310nm wavelength light than for 1550nm wavelength light in sound enamel suggests that water in the enamel attenuates the light at higher wavelengths. Stimulated

lesions in tooth samples up to 6.75mm in thickness can be resolved with a contrast ratio greater than 0.35 as between sound and demineralised enamel by using light of wavelength 1310nm.

5

In a first of its aspects, the invention may provide apparatus for imaging a tooth including: illumination means arranged to generate first infra-red light with a first wavelength having a value within a range of values corresponding to an infra-red spectral absorption band of water (e.g. a spectral absorption band of water within a tooth, such as within enamel and/or within dentin), to generate second infra-red light with a second wavelength having a value within a range of values corresponding to an infra-red spectral reflection band characteristic of scattering from demineralised tooth enamel, and for illuminating a tooth therewith; image data acquisition means arranged for receiving infra-red light originating from the illumination means and returned from an illuminated tooth, and including infra-red pixel sensor means responsive to said returned infra-red light to generate image pixel values for a first image of the illuminated tooth using first infra-red light and not second infra-red light and to generate image pixel values for a second image of the illuminated tooth using second infra-red light and not first infra-red light, and to provide such image pixel values for use.

In this way, a signature of enamel lesion and/or a signature of dentin lesion may be sought in the spectrally selected image data for a tooth. In generating corresponding spectrally separated images, one may ensure that corresponding parts of each image may be identified as being associated with a common part of a tooth. This avoids misalignment or movement problems common in single-point data acquisition methods.

35

The infra-red pixel sensor array may comprise a CCD sensor array, or an InGaAs sensor array, or a sensor array such as a

Mercury Cadmium Telluride (MCT) sensor array. An InGaAs sensor array may have a spectral response that covers up to 1700nm whereas MCT sensor array may be responsive to infra-red wavelengths up to 2500nm.

5

The infra-red pixel sensor array may be preferentially responsive to near-infrared wavelengths such as wavelengths in the range 0.8 microns to 2.5 microns, or 1.0 microns to 2.5 microns. The second wavelength may have a value which also falls within a range of values corresponding to an infra-red spectral absorption band of water (e.g. water in a tooth). The illumination means may be arranged to generate infra-red light with a third wavelength (other than the first or second wavelength) having a value within a range of values corresponding to an infra-red spectral absorption band of water (e.g. water in a tooth) and/or within a range of values corresponding to an infra-red spectral reflection band characteristic of scattering from demineralised tooth enamel.

10

15

20

25

30

35

The infra-red pixel sensor means may be arranged to be responsive to returned infra-red light originating from the illumination means to generate third image pixel values for a third image of the illuminated tooth using third infra-red light and not first nor second infra-red light. The apparatus may provide such third image pixel values for use, such as for use in detecting therein a signature of enamel lesion and/or dentin lesion. Most preferably, the infra-red pixel sensor means is responsive to returned infra-red light of a reference wavelength other than the first, second or third wavelengths, and originating from the illumination means, to generate reference image pixel values or for a reference image of the illuminated tooth using the reference infra-red light, and to provide them for use. The reference image pixel values may be used by the apparatus in, for example, normalising any image pixel value of any one, some or all of first, second or third images.

Preferably all of the first, second, third and reference infra-red wavelengths are less than 3 microns in size, e.g. within the near-IR band (e.g. from 0.8 microns to 2.5 microns). It has been found that infra-red wavelengths exceeding about 3 microns suffer significant attenuation in tooth enamel. This may reduce the intensity of illuminating infra-red light reaching dentin underneath such enamel, and may, to a varying extent, confound generation of a spectral signature in returned infra-red light characteristic of water within dentin indicative of dentin lesion.

The first wavelength may be a value chosen from the range 1410nm - 1470nm. The second wavelength may be a value chosen from the range 1580nm - 1640nm. The third wavelength may be a value chosen from the range 1880nm - 1940nm. The reference wavelength may be a value chosen from the range 1060nm - 1120nm. In each case, the wavelength may be within a narrower range being one half, or one third, or one sixth, of the size of the respective range given above, centred upon the same central wavelength as in the ranges given above.

The image data acquisition means may include optical input means via which the apparatus is arranged to receive infra-red light returned from an illuminated tooth in a direction substantially parallel with, or subtending an acute angle with respect to, a direction of illumination by the illumination means.

For example, back-scattering or back-reflection of illuminating light is preferred since the spectral signature of back-scattered light may be relatively strong in such circumstances when arising due to porosity in the tooth enamel. Also, this simplifies the arrangement and use of the apparatus and allows for a compact probe-like apparatus.

The illumination means may comprise optical output means with an optical axis along which the apparatus is arranged to

output said infrared light to illuminate a tooth. The image data acquisition means may include optical input means comprising an optical axis along which the apparatus is arranged to receive infrared light returned from an
5 illuminated tooth and which is substantially parallel to, or subtends an acute angle with respect to, the optical axis of the illumination means. Thus, back-scattering of infra-red light from the illumination means by an illuminated tooth, and to the optical input means may be provided. Preferably, the
10 subtended angle is as small as is practicable, such as 5° or less, or less than 2° or less than 1°.

The image data acquisition means may include camera means including a pixel sensor array responsive to visible light
15 returned from an illuminated tooth to form one or more image pixel values representing an image of at least a part of the tooth.

Accordingly, a "visible" image, i.e. representing what may be
20 perceived by the human eye, may be simultaneously or contemporaneously created to permit images of the tooth formed using infra-red light to be compared with the "visible" image. The visible image may be co-registered or pixel-wise aligned with images formed using infra-red light to permit a pixel(s)
25 selected in the "visible" image to directly identify a pixel(s) in an image of the same target formed using infra-red, by association with the same tooth part.

The apparatus may include infra-red optical filter means
30 selectively operable in a first state to transmit infra-red light originating from the illumination means having said first wavelength and to substantially prevent transmission therethrough of infra-red light having said second wavelength, and in a second state to transmit infra-red light originating
35 from the illumination means having said second wavelength and to substantially prevent transmission therethrough of infra-red light having said first wavelength. The infra-red optical

filter means may be selectively operable in a third state to transmit infra-red light originating from the illumination means having said third wavelength and to substantially prevent transmission therethrough of infra-red light having any of said first wavelength and said second wavelength. The infra-red optical filter means may be selectively operable in a fourth state to transmit infra-red light originating from the illumination means having a reference (fourth) wavelength and to substantially prevent transmission therethrough of infra-red light having any of the first, second, or third wavelengths. Thus, spectrally separated and distinct first, second, third or reference infra-red image data may be acquired in this way, or otherwise. In alternatives, the illumination means may comprise means for separately (physically) generating infra-red light spectrally separated in this way for illuminating a tooth. Examples include an array of separate infra-red light sources (e.g. LEDs) each one of which is arranged to generate only one of the first, second, third and reference wavelengths. A visible light source may be provided separately in this way for use in enabling said "visible" images. In other examples, the infra-red pixel sensor means may comprise separate groups of pixel sensors in which each pixel sensor of a respective group is served by a dedicated one of a plurality of different infra-red optical filters. For example, four separate pixel sensor arrays may be provided each one of which is served by a respective one of four different infra-red optical filters arranged to transmit a respective one (only) of the first, second, third and reference infra-red wavelengths discussed above. The separate groups of pixel sensors may be arranged in a common overall pixel array (e.g. pixel sensor chip) overlaying separate individual sensor pixels of which (e.g. separately or in defined areas) are respective infra-red optical filters. In this example, the infra-red pixel sensor means may comprise an active-pixel sensor array in which individual pixels of the sensor are addressable such that pixel sensor signals from individual sensor pixels associated

with a predetermined filter may be individually obtained and identified as such. The arrangement, in this example, may be analogous to the Bayer-type filter arrangement common in commercial digital cameras.

5

The infra-red optical filter means may be arranged in optical communication with the infra-red pixel sensor means to filter infra-red light directed to the infra-red pixel sensor means by the image data acquisition means.

10

The illumination means may include light-source means which may be operable to generate light including said first and second wavelengths and preferably said third wavelength and/or said reference wavelength (e.g. a broadband visible and near-IR source). The infra-red optical filter means may be arranged in optical communication with the light-source means to filter light generated by the light-source means for illuminating a tooth with infra-red radiation transmitted by the infra-red optical filter means.

20

The illumination means may comprise light-source means operable to generate light including said first and second wavelengths, (and preferably also the third and/or reference wavelength, and preferably visible wavelengths) and optical output means remotely or locally in optical communication with the light-source means via output optical waveguide means and arranged to output from the apparatus light generated by the light-source means to illuminate a tooth.

25

30

The apparatus may include optical input means remotely or locally in optical communication with the infra-red pixel sensor means via input optical means (e.g. optical waveguide means) and arranged to receive infra-red light returned from an illuminated tooth and to direct the returned infra-red

35

light to the (local or remote) infra-red pixel sensor means for sensing thereby. The optical input means may not be remote, and may be housed within or otherwise an attachable or

integral part of a unit or probe device containing the infra-red pixel sensor means. The illumination means may be similarly so housed within or attachable to the unit or probe device.

5

The apparatus may include an intra-oral probe (e.g. hand held) comprising the optical input means and the optical output means. This probe may be remote from image pixel sensor means and/or the illumination means, or the probe may include the
10 image pixel sensor means and/or the illumination means.

15

For example, the probe may comprise any one, some or all of: the infra-red pixel sensor means; the illumination means; the infra-red optical filter means; any optical elements
intermediate the infra-red pixel sensor means and the optical
input means for collecting, focussing, collimating or
otherwise preparing returned infra-red light. The probe may
comprise such elements in a detachable unit attachable to the
rest of the probe via attachment means or adapter means to
20 place those elements in operable and optical communication
with the optical input/output means.

20

25

Thus, different detachable such units may be provided having different operating characteristics (e.g. filters,
illumination means or light source, sensor array etc) as
required, enabling rapid and simple alteration of the
operating characteristics of the probe as a whole.

30

The input optical waveguide means may comprise one or more
optical fibres which collectively define an aligned optical
fibre bundle.

35

The output optical waveguide means may comprise one or more
optical fibres collectively defining an aligned optical
bundle.

Optionally, at least a terminal end of the output optical waveguide means is adjacent the optical input means.

Optionally, the terminal end of the output optical waveguide
5 comprises a bundle of optical fibres the ends of which form a ring circumscribing the output optical waveguide.

The illumination means may comprise first optical polarizer means for polarizing according to a first polarization axis
10 infra-red radiation generated by the illumination means, and the image data acquisition means comprises second optical polarizer means for polarizing according to a second polarization axis transverse to the first polarization axis
15 infra-red radiation received thereby from an illuminated tooth. The first and second optical polarizer means may be individually arranged to linearly polarise light, or to elliptically or circularly polarise light received thereby. Preferably, each is arranged to linearly (or optionally elliptically) polarise light, and may be such that the first
20 and second optical polarisers define a pair of crossed polarisers. Specular reflections of light from tooth enamel tends to at least partially polarise un-polarised incident light, or put another way, specular reflections from a tooth surface preferentially select polarised light. Illuminating
25 light returned from a tooth by a scattering process (e.g. multiple reflections) tends to de-polarise polarised incident light. Consequently, requiring returned light to pass through a polarising filter with a polarising characteristic converse to that of the filter through which illuminating light passed,
30 to some extent removes from returned light those parts preserving the converse polarisation (e.g. specularly reflected light).

The optional use of circular polarisers to polarise light
35 returned from an illuminated tooth has been found to enhance image contrast and definition.

The image data acquisition means may comprise focussing means arranged to form upon the infra-red pixel sensor means a real optical image using infra-red light received by the image data acquisition means from an illuminated tooth. Alternatively, or
5 additionally, the image data acquisition means may comprise within-probe focussing means arranged to form a focused image upon a terminal optical input end of an aligned optical fibre bundle defining the input optical waveguide means, using return illuminating infra-red light. Most preferably the input
10 end of the input optical waveguide comprises a flat surface collectively formed by a plurality of closely-packed ends of optical fibres. In this way, the light of a focused infra-red image may be transmitted, conveyed or guided from within the probe to the infra-red pixel sensor means (optionally remote).
15 The focussing means (intra-probe or remote) may possess a controllable "zoom" function (e.g. a variable focal length) controllable by the user of the apparatus.

The optical filter means, the focussing means and infra-red
20 pixel sensor means may be each in mutual optical communication and locally or remotely in optical communication with the optical input means (e.g. via said input optical waveguide means when remote).

25 Preferably, the illumination means is arranged to deliver full-field illumination to the tooth to be imaged, in other words to illuminate the whole area of the tooth which is to be imaged, e.g. substantially the whole exposed area of the tooth. In this way, the image pixel values of the area which
30 is to be imaged can be generated without requiring the illumination means to be scanned across the area, as might be required if the illumination means only delivered only point-like illumination. The illumination means may be arranged to deliver full-field illumination e.g. by selection of suitable
35 light source means and/or output optical waveguide means.

Similarly, it is also preferable for the infra-red pixel sensor means to be arranged to detect or capture a full-field image of the tooth, in other words to capture an image of the tooth without it having to be scanned across the tooth. For
5 example, the infra-red pixel sensor means may comprise an infra-red pixel sensor array as described above. Thus, it is preferable for the apparatus to work on a full-field principle, in which the whole area which is to be imaged of the tooth is illuminated and a corresponding image captured,
10 rather than scanning a point-like illumination across the tooth.

The apparatus may include image processing means arranged to receive said pixel image values for producing one or more of
15 said first, second, third, reference and/or "visible-light" images therefrom.

The image processing means may be arranged to co-register a said first image and a said second image in respect of a
20 common imaged subject, thereby to associate a given image pixel of the first image with a respective image pixel of the second image representing the same part of the imaged subject.

Such co-registration may be performed as between either or
25 both of the first and second images and any or all of the third image and/or the reference infra-red image, and/or any visible image produced by the camera means.

The apparatus may include data processing means arranged in
30 respect of a given part of the imaged subject to use one or more image pixel values of the first image to calculate a first reflectance value (R_1) associated with the part, and to use one or more image pixel values of the second image to calculate a second reflectance value (R_2) associated with the
35 part, and to determine from the first and second reflectance values a measure of the degree of enamel lesion (S_e) and/or dentin lesion (S_d) present in the part. It should be clear that

in some embodiments, the data processing means may be arranged to determine only a measure of the degree of enamel lesion (S_e) or only a measure of the degree of dentin lesion (S_d) present in the part. However, it is preferable for the data processing means to be arranged to determine both a measure of the degree of enamel lesion (S_e) and a measure of the degree of dentin lesion (S_d) present in the part.

The data processing means may be arranged, in respect of a given said part of the imaged subject, to use one or more image pixel values of the third image to calculate a third reflectance value (R_3) associated with the part, and to determine using first and/or second and/or third reflectance values; a measure of the degree of enamel lesion and/or dentin lesion.

The data processing means may be arranged to use said measure of the degree of enamel lesion (S_e) and said measure of the degree of dentin lesion (S_d) to calculate a measure ($S_{carries}$) of the degree of caries present in the part.

The spectral intensity of a pixel value may be normalised to the reflectance (R_{ref}) obtained at a reference wavelength (e.g. 1090nm) which, preferably corresponds with the highest reflectance (least extinction). The degree of enamel, S_e , and dentin, S_d , lesions may be calculated as follows:

$$S_e = S_e^{(1)} = \frac{R_2}{R_{ref}}$$

or

$$S_e = S_e^{(2)} = \frac{R_1 - R_3}{R_{ref}}$$

$$S_d = \frac{R_2 - R_1}{R_{ref}}$$

The equation for $S_e^{(2)}$ results in a measure of lesion which has been found to be less susceptible to being influenced by, or confounded by, the effects of specular reflections at the ranges of wavelengths suggested above.

5

A caries score, S_{caries} , may be calculated as a combination of S_e and S_d . The combination is preferably a weighted algebraic sum of the two terms S_e and S_d , for example, with variable weight factor p :

10

$$S_{caries} = p \left(\frac{S_e - K_e}{N_e} \right) + (1-p) \left(1 + \frac{S_d - K_d}{N_d} \right)$$

15

Here, K_x and N_x are an enamel ($x : e$) and dentin ($x : d$) score calibration offset and normalisation factor, respectively. In addition, one may specify that $p = 1$ if

$$\left(1 + \frac{S_d - K_d}{N_d} \right) < S_{dth}$$

20

where S_{dth} represents a dentin lesion threshold, otherwise $p = 0$. Outliers and noise introduced into the data by specular reflections may be removed by limiting the values of the numerators in the equation for S_{caries} to the range $0 < (S_e - K_e) < M_e$ and $0 < (S_d - K_d) < M_d$; here M_e and M_d denote the upper limits. Values outside these limits may be set to zero. The computer means may be operable to perform any one, some or all of the above processing of data.

25

30

The infra-red pixel sensor means may be responsive to said returned infra-red light to generate image pixel values for a third image of the illuminated tooth using third infra-red light and not first infra-red light nor second infra-red light, and to provide such image pixel values for use.

35

The infra-red optical filter means may be selectively operable in a third state to transmit infra-red light originating from the illumination means having said third wavelength and to

substantially prevent transmission therethrough of infra-red light having any of said first wavelength and said second wavelength.

5 The data processor means may be arranged to use one or more image pixel values of the third image to calculate a third reflectance value associated with the part, and to determine the measure of the degree of enamel lesion (S_e) and/or dentin lesion (S_d) present in the part using the third reflectance
10 value.

The first wavelength value may be between 1300nm and 1550nm, and the second wavelength value may be between 1550nm and 1800nm. The first wavelength value may be between 1400nm and
15 1500nm, such as about 1440nm, and the second wavelength value may be between 1550nm and 1650nm, such as about 1610nm.

It is to be understood that the foregoing may represent a physical realisation or implementation of a corresponding
20 method of imaging or measuring a property of a tooth, and that such corresponding methods are encompassed in by the invention.

In a second of its aspects, the invention may provide a method
25 for imaging a tooth including: generating first infra-red light with a first wavelength having a value within a range of values corresponding to an infra-red spectral absorption band of water (e.g. a spectral absorption band of water within a tooth, such as within enamel and/or within dentin), generating
30 second infra-red light with a second wavelength having a value within a range of values corresponding to an infra-red spectral reflection band characteristic of scattering from demineralised tooth enamel, and illuminating a tooth therewith; receiving at infra-red pixel sensor means first and
35 second infra-red light returned from an illuminated tooth and therewith generating image pixel values for a first image of the illuminated tooth using first infra-red light and not

second infra-red light and generating image pixel values for a second image of the illuminated tooth using second infra-red light and not first infra-red light, and providing such image pixel values for use.

5

The method may include receiving infra-red light returned from an illuminated tooth in a direction substantially parallel with, or subtending an acute angle with respect to, a direction of said illumination.

10

The method may include providing optical output means comprising an optical axis and therealong outputting said infrared light to illuminate a tooth, and providing optical input means comprising an optical axis and therealong receiving infrared light returned from an illuminated tooth for subsequent receipt at the infra-red pixel sensor means wherein the said optical axes are substantially parallel, or subtend an acute angle with respect to each other.

15

20

The method may include generating third image pixel values for a third image of the illuminated tooth using third infra-red light returned from the tooth and not first nor second infra-red light. The third image pixel values may be provided for use, such as for use in detecting therein a signature of enamel lesion and/or dentin lesion. The method may include receiving returned infra-red light of a reference wavelength other than the first, second or third wavelengths, and originating from the illumination means, and generating reference image pixel values or for a reference image of the illuminated tooth using the reference infra-red light, and to providing them for use. The reference image pixel values may be used by the apparatus in, for example, normalising any image pixel value of any one, some or all of first, second or third images.

25

30

35

Preferably all of the first, second, third and reference infra-red wavelengths are less than 3 microns in size, e.g.

within the near-IR band (e.g. from 0.8 microns to 2.5 microns). The first wavelength may be a value chosen from the range 1410nm - 1470nm. The second wavelength may be a value chosen from the range 1580nm - 1640nm. The third wavelength
5 may be a value chosen from the range 1880nm - 1940nm. The reference wavelength may be a value chosen from the range 1060nm - 1120nm. In each case, the wavelength may be within a narrower range being one half, or one third, or one sixth, of the size of the respective range given above, centred upon the
10 same central wavelength as in the ranges given above.

The method may include forming an image representing at least a part of the illuminated tooth using visible light returned therefrom. The method may include co-registering the
15 visible-light image or pixel-wise aligned with images formed using infra-red light to permit a pixel(s) selected in the "visible" image to directly identify a pixel(s) in an image of the same target formed using infra-red, by association with the same tooth part.

20 The method may include generating light for illuminating the tooth and in a first instance, filtering the light by transmitting through a filter means parts of said light having said first wavelength and substantially preventing
25 transmission through the filter means of parts of said light having said second wavelength; and in a second instance, filtering the light by transmitting through the filter means parts of said light having said second wavelength and substantially preventing transmission through the filter means
30 parts of said light having said first wavelength. The method may include filtering the light by transmitting infra-red light originating from the illumination means having said third wavelength and to substantially preventing transmission of infra-red light having any of said first wavelength and
35 said second wavelength. The method may include filtering the light by transmitting infra-red light originating from the illumination means having a reference (fourth) wavelength and

to substantially preventing transmission of infra-red light having any of the first, second, or third wavelengths.

The method may include performing said filtering on light
5 directed to the infra-red pixel sensor means.

The method may include performing said filtering on light for illuminating a tooth.

10 The method may include generating said light remotely from, or locally at, said tooth, guiding the generating light to the proximity of the tooth, and illuminating the tooth with the guided light.

15 The method may include guiding said returned infra-red light to a location local to, or remote from, the point of receipt of the returned light and generating image pixel values using said returned, guided light at said local or remote location.

20 The method may be performed using an intra-oral probe.

The method may include polarizing according to a first polarization axis infra-red radiation generated for illuminating a tooth, and polarizing according to a second
25 polarization axis transverse to the first polarization axis infra-red radiation returned from the illuminated tooth. The first and second polarization may be individually linear polarization, or to elliptical or circular polarization. Preferably, each is linear (or optionally elliptical)
30 polarization, and the first and second polarization axes may together define crossed polarization axes.

The method may include forming upon an infra-red pixel sensor means a real optical image using said infra-red light returned
35 from an illuminated tooth.

The method may include producing one or more of said first, second, third, reference and/or "visible-light" images from said returned light.

- 5 The method may include co-registering a said first image and a said second image in respect of a common imaged subject, thereby to associate a given image pixel of the first image with a respective image pixel of the second image representing the same part of the imaged subject. Such co-registration may
10 be performed as between either or both of the first and second images and any or all of the third image and/or the reference infra-red image, and/or any visible image produced by the camera means.
- 15 Preferably, the method includes full-field illumination of the tooth, e.g. as described in connection with the first aspect of the invention. Preferably, the method includes detecting or capturing of a full-field image of the tooth, e.g. as described in connection with the first aspect of the
20 invention.

The method may include, in respect of a given part of the imaged subject, calculating a first reflectance value associated with the part using one or more image pixel values
25 of the first image, and calculating a second reflectance value associated with the part using one or more image pixel values of the second image, and determining from the first and second reflectance values a measure of the degree of enamel lesion (S_e) and/or dentin lesion (S_d) present in the part.

30 The method may include generating image pixel values for a third image of the illuminated tooth using third infra-red light returned from the tooth and not first infra-red light nor second infra-red light, and providing such image pixel
35 values for use.

The method may include generating light for illuminating the tooth and in a third instance, filtering the light by transmitting through a filter means parts of said light having said third wavelength and substantially preventing
5 transmission through the filter means of parts of said light having any of said first wavelength and said second wavelength.

The method may include calculating a third reflectance value
10 associated with the part using one or more image pixel values of the third image, and determining the measure of the degree of enamel lesion (S_e) and/or dentin lesion (S_d) present in the part using the third reflectance value.

15 The first wavelength value may be between 1300nm and 1550nm, and the second wavelength value may be between 1550nm and 1800nm. The first wavelength value may be between 1400nm and 1500nm, such as 1440nm or thereabouts, and the second
20 wavelength value may be between 1550nm and 1650nm, such as 1610nm or thereabouts.

The method may include, in respect of a given said part of the imaged subject, using one or more image pixel values of the third image to calculate a third reflectance value (R_3)
25 associated with the part, and determining using first and/or second and/or third reflectance values, a measure of the degree of enamel lesion and/or dentin lesion.

The method may include calculating a measure (S_{carries}) of the
30 degree of caries present in the part using said measure of the degree of enamel lesion (S_e) and said measure of the degree of dentin lesion (S_d). The spectral intensity of a pixel value may be normalised to the reflectance (R_{ref}) obtained at a reference wavelength (e.g. 1090nm).

35 The degree of enamel, S_e , and dentin, S_d , lesions may be calculated according to the method as follows:

$$S_e = S_e^{(1)} = \frac{R_2}{R_{ref}}$$

or

$$S_e = S_e^{(2)} = \frac{R_1 - R_3}{R_{ref}}$$

$$S_d = \frac{R_2 - R_1}{R_{ref}}$$

5 A caries score, S_{caries} , may be calculated as a combination of S_e and S_d . The combination is preferably a weighted algebraic sum of the two terms S_e and S_d , for example, with variable weight factor p :

$$10 \quad S_{caries} = p \left(\frac{S_e - K_e}{N_e} \right) + (1 - p) \left(1 + \frac{S_d - K_d}{N_d} \right)$$

Here, K_x and N_x are an enamel ($x : e$) and dentin ($x : d$) score calibration offset and normalisation factor, respectively. In addition, one may specify that $p = 1$ if

15

$$\left(1 + \frac{S_d - K_d}{N_d} \right) < S_{dth}$$

where S_{dth} represents a dentin lesion threshold, otherwise $p = 0$. Outliers and noise introduced into the data by specular reflections may be removed by limiting the values of the
 20 numerators in the equation for S_{caries} to the range $0 < (S_e - K_e) < M_e$ and $0 < (S_d - K_d) < M_d$; here M_e and M_d denote the upper limits. Values outside these limits may be set to zero.

In a third of its aspects, the invention may provide a
 25 computer programmed to implement the method of the second aspect of the invention.

In a fourth aspect, the invention may provide a computer program product comprising a computer-readable medium

containing computer executable instructions which implement the method (in part or in full) of the invention in its second aspect when executed on a computer.

5 In a fifth aspect, the invention may provide a computer program containing computer executable instructions which implement the method of the second aspect when executed on a computer.

10 In a sixth of its aspects, the invention may provide an apparatus and/or quantitative method for dental caries detection, according to any aspect above, and may be employed to assist in determining the presence of occlusal enamel and/or dentin lesions.

15 The invention also includes any combination of the aspects and preferred features described except where such a combination is clearly impermissible or expressly avoided.

20 Preferred embodiments will now be described, by way of example only, with reference to the accompanying drawings of which:

Figure 1 schematically illustrates apparatus including a hand-held intra-oral probe and remote components;

25 Figure 2 illustrates a selection of spectral images. On the top left is a picture of a tooth taken using visible light. The remaining reflectance images are obtained using near infra-red (NIR) light at the wavelengths indicated;

30 Figure 3 illustrates NIR spectral reflectance curves from an occlusal tooth surface. The figure shows the reflectance for sound enamel (diamond symbols), an enamel lesion region (asterisks *) and a dentin lesion region (circles °). The inset picture shows the location of the points selected within the tooth for this example. Vertical dotted lines in the graph of Figure 3 indicate the wavelengths chosen for the NIR images
35 of Figure 2;

Figure 4 illustrates examples of teeth with different carious lesions. Left-hand images show a picture for each

tooth obtained in visible light. Central images show the corresponding histological section which is indicated by the straight line traversing the tooth picture, and an arrow indicates the point of view of the section. The right-hand
5 images show the NIR caries maps, spatially scored using a numerical caries score, S_{caries} , for each tooth;

Figure 5 illustrates a correlation plot of the histological score and the average maximum NIR caries score, S_{caries} within the map region corresponding to the histological
10 section;

Figure 6 illustrates NIR images of highly stained occlusal tooth surfaces taken using light of 1250nm wavelength. The absorption by stain is minimal;

Figure 7 illustrates apparatus including a hand-held
15 intra-oral probe and remote computing components.

In the figures like items are assigned like reference symbols for consistency.

20 Figure 1 illustrates schematically an apparatus 1 for imaging a tooth.

The apparatus includes an intra-oral hand-held probe 2 dimensioned to be held in the hand of a user and at least
25 partly inserted into the mouth of a patient immediately adjacent a target tooth.

The apparatus includes an infra-red camera 19 and an illumination light source 3 each remote from the probe 2 and
30 each in optical communication with the probe 2 via a respective one of two aligned optical fibre bundles (4, 5). The illumination light means is arranged to generate light of a broadband spectral content covering visible light and near-
infra-red light (e.g. including wavelengths in a range from
35 300nm to 2500nm or more, preferably inclusive of all such wavelengths), and to output generated light to an input end 4A of a first of the two aligned optical fibre bundles 4 for

transmission therealong to an output end 4B thereof housed in the probe 2 for output from the probe in illuminating a target tooth 25.

5 Preferably, the illumination light source 3 and the optical fibre bundles 4,5 are arranged to deliver full-field illumination to the target tooth 25. The infra-red camera 19 is likewise arranged to detect or capture full-field images. That is, the apparatus works on a full-field principle in
10 which a whole area of the target tooth 25 is illuminated and a corresponding image captured, rather than scanning a point-like illumination across the surface of the tooth.

The infra-red camera 19 contains an infra-red pixel sensor array (not shown) responsive to infra-red radiation incident upon in to generate one or more image pixel values, and to output the pixel value(s) for use. A second of the two aligned optical fibre bundles 5 places the probe 2 in optical communication with an infra-red camera 19, and possesses an
20 optical input end 5B housed within the probe 2 and arranged to receive light returned from a target tooth 25, and to guide the returned light to an optical output end 5A thereof for receipt by the infra-red pixel sensor array of the infra-red camera.

25 Immediately adjacent the optical input end 5B of the second aligned optical fibre bundle 5, and housed within the probe, is one or more input image collecting optical element 6 (e.g. one or more lenses) arranged in optical communication with the
30 optical input end of the second aligned optical fibre bundle. The input image collecting optical element possesses an optical axis co-linear with that of the optical input end of the second aligned optical fibre bundle, and is adapted and arranged, or controllable, to gather light received thereby
35 and to direct the gathered light into the optical input end of the second aligned optical fibre bundle. The image-collecting optical element 6 is arranged and controllable to form a

focused optical image upon the exposed terminal optical input end 5B of the second aligned optical fibre bundle 5 using returned infra-red light from the target tooth 25. In this way, a focused image of the target tooth 25 may be transmitted
5 along the second aligned optical fibre bundle 5 to the infra-red camera 19. In effect, the second aligned optical fibre bundle 5 serves to optically place the infra-red pixel sensor array of the infra-red camera 19 effectively or notionally within the intra-oral hand-held probe 2, without being
10 physically present there. That is to say, the flat surface collectively formed by the plurality of closely-packed optical fibre ends defining the optical input end 5B of the second aligned optical fibre bundle, acts as a proxy imaging surface.

15 Indeed, in alternative examples of the invention, such as is schematically illustrated in figure 7, the second aligned optical fibre bundle 5 may be dispensed with and a detachably attachable unit 50 may be provided containing an infra-red camera 19, and additional optical elements e.g. a filter unit
20 18, imaging optical element(s) 17, illumination light source 3, and aligned optical fibre bundle 4 for guiding light generated by the illumination means outwardly of the detachable unit 50. The detachable unit 50 may include an optical window 35 with which the imaging optical element(s)
25 17, the filter unit 18, the infra-red camera 19, the illumination light source 3 and the first aligned optical fibre bundle 4 are in optical communication to enable light from the illumination light source 3 to exit the detachable unit 50, and to allow returned light to pass into the
30 detachable unit 50 through the optical elements, the filter unit, and to the infra-red camera therein. In this alternative example, a second optical window 30 is provided at a surface of the hand-held probe 2 positioned relative to a plurality of positioning lugs 40 arranged and dimensioned to intimately
35 receive the detachable unit at that part thereof containing the input/output window 35 thereof. The lugs 40 may be arranged to enable a snap-fit connection or a screw-fit

connection or any other suitable connection as may be desirable. The dimensioning of the relevant receivable part of the detachable unit 50 and the receiving lugs 40 is such as to align, in register, the input/output window 35 of a detachable
5 unit 50 with the input/output window 30 of the hand-held probe 2. This enables optical communication between the optical elements within the detachable probe and associated optical elements within the hand-held probe. Reference numerals employed in figure 7 identify the same articles as described
10 with reference to figure 1 herein.

Adjacent the input image collecting optical element 6, and in optical communication therewith, is an input optical linear polarising filter 8 arranged to receive light returned from an
15 illuminated target tooth 25 and to transmit substantially only that part of the received light which is linearly polarised light according to the polarisation axis defined by the filter, for transmission through the input image collecting optical element 6 and along the second aligned optical fibre
20 bundle 5 for receipt by the infra-red camera 19.

The first aligned optical fibre bundle 4 comprises a group of optically aligned (i.e. with parallel optical axes) optical fibres which collectively envelop the second aligned optical
25 fibre bundle 5 thereby forming therearound, in cross-section, a ring or annulus of optical fibres.

The optical input end 4A of the first aligned optical fibre bundle adjacent the illumination light source 3, is spaced
30 from the second aligned optical fibre bundle 5 by a diversion or bifurcation of the optical fibres of the first aligned bundle from those of the second aligned optical fibre bundle, at a location between the probe 2 and the infra-red camera 19. This permits the illumination light source 3 to be located at
35 any convenient location separated from the optical output end 5A of the second aligned optical fibre bundle 5 and any elements of the apparatus following that (e.g. IR camera 19).

The optical output end 4B of each optical fibre of the first aligned optical fibre bundle 4, housed within the probe 2, is in immediate optical communication with an output optical
5 linear polarising filter 7 arranged to receive light guided from the illumination light source 3 along the first aligned fibre bundle 4, and to transmit light linearly polarised according to the linear polarisation axis of the output
10 optical linear polarising filter for illuminating a target tooth 25.

The linear polarisation axis of the output optical linear polarising filter 7 is aligned to be perpendicular to the axis of linear polarisation of the input optical linear polarising
15 filter 8. This reduces the content, within light returned to the probe from an illuminated tooth 25, of light resulting from specular reflection from a surface of the illuminated tooth. Polarised light transmitted by the output optical
20 linear polarising filter, specularly reflected from a tooth surface, tends to preserve its initial state of polarisation. Consequently, such preserved polarisation prevents transmission of such light through the input optical linear
25 polarising filter thereby at least to some extent eliminating specularly reflected light which has not undergone de-polarisation by scattering within the material (e.g. enamel) of the target tooth.

A beam-splitting mirror 9 is arranged in optical communication with both the optical output end 4B of the first aligned
30 optical fibre bundle and the optical input end 5B of the second aligned optical fibre bundle so as to receive light output by the output linear optical polarising filter 7 and to reflect such received light through an angle (e.g. 90°) to direct the light outwardly of the probe 2 via a transparent
35 protective window 10 of the probe. The beam-splitting mirror 9 is also arranged to receive via the protective window 10 light returned from the target tooth 25 and to reflect a

portion of the returned light towards the input optical linear polariser 8 for subsequent transmission to the infra-red camera 19. The beam-splitting mirror 9 is arranged to transmit at least a portion of the visible light (e.g. between
5 25% and 50%) returned from the tooth 25 such that the light transmitted thereby is received by a reference imaging camera 11 responsive thereto to form an image of the target tooth using optically visible light.

10 The reference imaging camera preferably comprises a colour camera including a pixel-sensor imaging array 12 responsive to visible light to generate image pixel values for use in generating an image. The reference imaging camera includes an optical filter 14 located between the beam-splitting mirror 9
15 and the pixel-sensor array 12 and arranged to transmit wavelengths of light corresponding to visible light for receipt by the pixel-sensor array. Located between the filter 14 and the pixel-sensor array 12 is an imaging optical element 13, or optical train, comprising lenses or the like arranged
20 to form an image on the pixel-sensor array 12 using light transmitted thereto by the filter 14. The imaging optical element 13 is preferably adapted for forming images over the whole visible light spectrum and the pixel-sensor array 12 is preferably a colour pixel-sensor array adapted to form colour
25 images.

A control panel 15 is arranged upon the probe and comprises one or more control buttons, or other manually operable control user-interfaces (not shown), enabling the user to
30 control functions and operations of the probe by hand.

The control panel may be arranged to control any one or more of: the capturing of images by the reference camera 11 (e.g. act as a "shoot" button); the capturing of images by the IR
35 camera unit 19; the intensity of illuminating light produced by the illumination light source 3; the filtering state of the filter unit 18; the focussing of the image collecting optics

6; the optical magnification provided by (e.g. zoom) the image collecting optics 6.

5 A remote imaging optical element(s) 17 and a filter unit 18 are arranged in successive common optical communication with, and between, the optical output end 5A of the second aligned optical fibre bundle 5, distal the probe 2, and the infra-red imaging camera 19.

10 The remote imaging optical element(s) 17 comprises one or more lens elements, or the like, arranged to form from light received thereby from the second aligned optical fibre bundle 5 an image of the target tooth 25 from which the light in question was returned.

15

The filter unit 18 is arranged to receive light output by the remote imaging optical element(s) 17 and to transmit, according to the optical transmission characteristics of the filter unit, portions of received light to the infra-red pixel sensor array of the infra-red camera 19. The remote imaging optical element(s) 17 may be arranged or controllable for form a focused image on the infra-red pixel sensor array via the filtering optics of the filter unit 18. The filter unit may comprise a liquid-crystal variable optical filter element

20

25

possessing a selectively variable optical transmission spectral characteristic and being controllable to selectively transmit optical radiation only within any one of a number of selected wavelength bandwidths (e.g. infra-red radiation).

30

Alternatively, the filter unit 18 may comprise a filter wheel including a plurality of separate dedicated filter elements (e.g. glass filters of the like) each possessing a fixed spectral transmission characteristic and each being selectively movable into the path of light output by the imaging optics 17 thereby to filter that light for subsequent

35

transmission to the infra-red camera 19.

The filtering unit is arranged to selectively filter light received thereby according to any selected one of three pass-band transmission spectral characteristics with each pass-band preferably centred upon a respective desired wavelength value
5 (e.g. a value selected from: 1090nm, 1440nm, 1610nm).

A first pass band of the filtering unit may be a pass band which extends from 1300nm to 1550nm, or from 1400nm to 1500nm, and may be centred on 1440nm. A second pass band may extend
10 from 1550nm to 1800nm, or from 1550nm to 1650nm, and may be centred on 1610nm. A reference pass band of the filtering unit may be a pass band which extends from 1000nm to 1150nm, or from 1050nm to 1130nm, and may be centred upon 1090nm. A third
15 pass band of the filtering unit may be a pass band which extends from 1850nm to 1970nm, or from 1880nm to 1940nm, and may be centred upon 1910nm. The pass band width of any one or more, or each, of the filter pass bands is preferably from
10nm to 15nm in extent. However, the pass band width in question may be up to 60nm in extent, or thereabouts. The pass
20 band width in question may be any size less than 60nm and preferably wholly falls within a range of wavelengths which is 60nm in extent and is centred upon a value selected from:
1090nm, 1440nm, 1610nm.

25 Accordingly, operation of the filtering unit enables the infra-red camera to generate image pixel values representative of a respective one of three different images formed using light of a corresponding one of three different infra-red
wavelengths. Reflectance values may be calculated from two of
30 the three images using pixel values of the third image to normalise the reflectance values. Reflectance values may be used to calculate a measure of lesion (e.g. a carries score) a given imaged part of the tooth common to all three images.

35 The apparatus further includes a computer 20, such as a personal computer or the like, arranged to receive image pixel values representative of images formed upon the infra-red

pixel sensor array of the infra-red camera 19, and to process those pixel values as discussed below.

5 The illumination source 3, the control panel 15 of the probe 2, and the reference imaging camera 11 of the probe 2, are each also in communication with the computer 20 via a data transmission link 16 via which control data and image data are passed between the elements of the apparatus interconnected thereby.

10 A control foot switch 21 is connected in operable communication with the computer 20 and is arranged to control any one or more of: the capturing of images by the reference camera 11 (e.g. act as a "shoot" button); the capturing of
15 images by the IR camera unit 19; the intensity of illuminating light produced by the illumination light source 3; the filtering state of the filter unit 18; the focussing of the image collecting optics 6; the optical magnification provided by (e.g. zoom) the image collecting optics 6. The
20 implementation of these functions via the control foot switch enables a user to control the operation of the probe 2 without having to manually operate elements of the control panel 15 when it is desirable not to move or shake the probe - such as when "shooting" images in use or the like.

25 The computer includes image processing means (e.g. implemented using software) arranged to receive pixel image values from the infra-red camera and to produce images therefrom. The image processing means is arranged to co-register separately
30 acquired images of a common target tooth 25, each obtained using a different selected respective filter of the filter unit, thereby to associate a given image pixel of the any one co-registered image with a respective image pixel of any other co-registered image representing the same part of the imaged
35 subject. This a reflectance spectrum or profile to be generated in respect of each such co-registered pixel value, thereby providing a hyper-spectral image data set to be

formed. The reference image pixel values generated by the reference camera 11 are also received by the computer (via data transmission line 16) and are co-registered with images containing the same target tooth 25 via the IR camera 19 at
5 different IR wavelengths. Thus, a "visible light" reference image may be provided representing the imaged tooth as would be perceived by the user regarding the tooth, together with two or three corresponding (and co-registered) images of the target tooth taken using one of two or three different infra-
10 red (IR) wavelengths of light. The image processing means preferably permits the user to select upon the reference image of the tooth a pixel representing a given location on the tooth, and in response to such selection may present and one or more of: the pixel values of the corresponding IR images
15 co-registered with the reference image corresponding to the selected location on the tooth; reflectance values of the selected location in respect of the wavelengths of light employed to generate the IR images; a measure of lesion present in the tooth at the selected region of the tooth; a
20 carries score in respect of the selected region of the tooth.

In one example, the computer includes data processing means is arranged, in respect of a given part of the imaged tooth, to use one or more image pixel values of a first IR image (taken
25 using a first IR wavelength or pass-band) to calculate a first reflectance value associated with the part, and to use one or more image pixel values of a second IR image (taken using a second IR wavelength or pass-band different from the first) to calculate a second reflectance value associated with the same
30 tooth part. The data processing means of the computer determines from the first and second reflectance values a measure of the degree of enamel lesion (S_e) and/or dentin lesion (S_d) present in the common tooth part. An example is given below.

35

The data processing means may be arranged to use this measure of the degree of enamel lesion (S_e) and the measure of the

degree of dentin lesion (S_d) to calculate a measure (S_{caries}) of the degree of caries present in the part. An example is given below.

5 Well defined signatures have been observed in reflectance (R) spectra from teeth at NIR wavelengths. Reflectance (R) above 1400nm tend to be higher for the decayed areas and in particular at 1610nm. NIR reflectance dips (i.e. NIR absorption) are pronounced by dentin lesion, and especially at
10 1440nm.

A first pass band of the filtering unit may be a pass band which extends from 1300nm to 1550nm, or from 1400nm to 1500nm, and may be centred on 1440nm. A second pass band may extend
15 from 1550nm to 1800nm, or from 1550nm to 1650nm, and may be centred on 1610nm. A reference pass band of the filtering unit may be a pass band which extends from 1000nm to 1150nm, or from 1050nm to 1130nm, and may be centred upon 1090nm. A third
20 pass band of the filtering unit may be a pass band which extends from 1850nm to 1970nm, or from 1880nm to 1940nm, and may be centred upon 1910nm. The pass band width of any one or more, or each, of the filter pass bands is preferably from 10nm to 15nm in extent. However, the pass band width in
25 question may be up to 60nm in extent, or thereabouts. The pass band width in question may be any size less than 60nm and preferably wholly falls within a range of wavelengths which is 60nm in extent and is centred upon a value selected from: 1090nm, 1440nm, 1610nm, 1910nm.

30 The computer 20 is arranged to process pixel values (correlated to spectral intensity) at each IR image pixel by normalising it to (e.g. dividing it by) the corresponding (co-registered) image pixel value associated with a reference reflectance (R) e.g. obtained at the wavelength with the
35 highest reflectance (least extinction) e.g. 1090nm. The degree of enamel, S_e , and dentin, S_d , lesions are to be calculated by the computer as follows:

$$S_e = S_e^{(1)} = \frac{R(1610nm)}{R(1090nm)} \quad \text{or} \quad S_e = S_e^{(1)} = \frac{R(1440nm) - R(1910nm)}{R(1090nm)}$$

5
$$S_d = \frac{R(1610nm) - R(1440nm)}{R(1090nm)}$$

As can be seen from figure 3, a rise in reflectance occurs at around 1900nm and is associated with the scattering of infra-
 red light from demineralised tooth enamel. In demineralised
 10 enamel, light is scattered more than in sound enamel. Scattered intensity is typically a function of wavelength, that is to say, the amount of light scattered tends to drop in inverse proportion to wavelength increases. In a non-absorbing medium the wavelength dependence becomes apparent when
 15 comparing the reflectance intensities of two spectral regions. In such a case, demineralised enamel presents a scattering characteristic in the spectral reflectance thereof. The degree of enamel lesion $S_e^{(2)}$ is suitable for use to enhance the effect of scattering of light and to separate the influence of
 20 absorption by water. Two spectral dips occur in the spectrum of figure 3 at about 1440nm and 1910nm, and a comparison of the reflectance intensities at these wavelengths is employed. By looking at the intensity of these two dips, when scattering dominates over water absorption, the dips may become less
 25 pronounced, but the wavelength dependence introduced by scattering will become stronger. In this way, the relative rise in reflectance at 1910nm is principally due to enamel demineralisation, and the relationship between the two spectral intensities employed in the measure $S_e^{(2)}$ is used to
 30 unveil this feature.

The computer is arranged to calculate the caries score, S_{caries} , as follows:

$$S_{caries} = p \left(\frac{S_e - K_e}{N_e} \right) + (1-p) \left(1 + \frac{S_d - K_d}{N_d} \right)$$

Here, K_x and N_x are the enamel ($x : e$) and dentin ($x : d$) score calibration offset and normalisation factor, respectively. In
 5 addition, $p = 1$ if

$$\left(1 + \frac{S_d - K_d}{N_d} \right) < S_{dth}$$

where S_{dth} represents the dentin lesion threshold, otherwise $p =$
 0.

10

An example of another implementation of the invention follows using sample target teeth.

15

Twelve extracted human teeth (premolars and molars) with natural lesions of various degrees were acquired. Soft tissues were removed from the collected teeth and these were thoroughly cleaned. Each tooth was stored in a separate container with distilled water and 0.5% thymol to keep them hydrated and sterile and therefore free from bacteria. Note
 20 that the teeth were kept for at least 2 hours in the bottle containers before any (hyperspectral) images were taken to get the measurements closer to the natural hydration conditions. The excess of water on the occlusal surfaces was however gently wiped off using cotton.

25

A near-infrared (NIR) hyperspectral camera was used to capture the spectral reflectance from the samples. The instrument images a line of vision at a time and diffracts the light onto a 2-dimensional pixel-sensor array by means of a diffraction
 30 grating. A complete stack of spectral images (spectral data cube) is obtained by translating the sample at constant speed and line-imaging synchronously. The spectral analysis range was from 1000 nm to 2500 nm with a spectral resolution of 10 nm. Figure 1 shows an image of the system set-up. Note that a

two-side illumination using halogen lamps was configured to reduce the effect of shadowing.

Acquired reflectance data, a dark current measurement associated with the data acquired (for noise subtraction), reflectance spectra of a reference object and its associated dark current measurement were used as follows to calibrate spectral reflectance data, this calculation being performed for each image pixel value:

$$R(\lambda) = \frac{R_r(\lambda) - D_r}{W_{ref}(\lambda) - D_w} W_{spec}(\lambda) \quad \text{eq. (1)}$$

Here $R(\lambda)$, $R_r(\lambda)$ and $W_{ref}(\lambda)$ are the calibrated, raw and white reference measurements at wavelength λ , respectively. $W_{spec}(\lambda)$ corresponds to a white reference reflectance at wavelength λ . In addition, D_r and D_w are the dark current noise measurements obtained for the raw white reference reflectance data.

Histological information was obtained for all samples after obtaining the NIR hyperspectral images. The teeth were grounded along the transversal plane to their surface. Sub-millimetres grounding steps were performed and a photograph was taken after each step. The histology scoring was done for the slide showing the most representative lesion for each tooth. The score was given based on the criteria shown in Table I.

Score	Code: Lesion depth
0	S : Sound
1	E1 : 1/3 enamel
2	E2 : 2/3 enamel
3	EDJ: enamel-dentin junction
4	D1 : 1/3 dentin
5	D2 : 2/3 dentin

6	D3 : to the pulp
---	------------------

As an example, a selection of the spectral images obtained from an occlusal tooth surface is shown in Figure 2 at the wavelengths indicated. It is possible to see that the reflectance intensity drops at higher wavelengths.

A typical reflectance spectrum for sound material, white spot material (enamel lesion) and a dentin lesion material is shown in Figure 3. Well defined signatures can be observed among the three cases. For instance, reflectance above 1400nm is clearly higher for the decayed areas and in particular at 1610nm. However, the absorption dips are further pronounced for the case of dentin lesion, and specially at 1440nm.

The spectral intensity at each pixel was normalised to the reflectance obtained at 1090 nm since this the wavelength with the highest reflectance (least extinction). The degree of enamel, S_e , and dentin, S_d , lesions were therefore calculated as follows:

$$S_e = \frac{R(1610nm)}{R(1090)} \tag{eq. (2)}$$

$$S_d = \frac{R(1610nm) - R(1440nm)}{R(1090)} \tag{eq. (3)}$$

A caries score, S_{caries} , was calculated as a combination of S_e and S_d and was designed to account for the deepest lesion observed by the NIR spectrum as follows:

$$S_{caries} = p \left(\frac{S_e - K_e}{N_e} \right) + (1 - p) \left(1 + \frac{S_d - K_d}{N_d} \right) \tag{eq. (4)}$$

Here, K_x and N_x are the enamel ($x : e$) and dentin ($x : d$) score calibration offset and normalisation factor, respectively. In addition, $p = 1$ if

$$\left(1 + \frac{S_d - K_d}{N_d}\right) < S_{dth}$$

where S_{dth} represents the dentin lesion threshold, otherwise $p = 0$.

5

Outliers and noise introduced by specular reflections were removed by limiting the values of the numerators in Equation 4 to the range $0 < (S_e - K_e) < M_e$ and $0 < (S_d - K_d) < M_d$; here M_e and M_d denote the upper limits. Values outside these limits were set to zero.

10

In order to fix the range of S_{caries} from 0 to 2, the normalization factors in Equation 4 were expressed as $N_e = M_e/S_{dth}$ and $N_d = M_d$. Therefore for values in the range of $0 < S_{caries} \leq S_{dth}$ the score indicates an enamel lesion and for $S_{caries} > S_{dth}$ the score indicates a dentin lesion. Note that sound areas have a value of $S_{caries} = 0$.

15

The calibration values for the equations above were obtained empirically. For our case, results were best described with $S_{dth} = 1.1$, $K_e = 0.14$, $K_d = 0.05$, $M_e = 0.35$, and $M_d = 0.15$.

20

Twelve teeth with different lesion degrees were imaged and processed following the method described above. As an example, coded S_{caries} maps for four teeth are shown in Figure 4. The associated pictures and the selected histological sections chosen are also shown.

25

Note that the extension of the lesion is not evident from the pictures in Figure 4 (which rely on visible wavelengths). It is possible to see however that the caries score maps clearly depict the lesion spatial distribution. This is due to the longer light penetration of NIR wavelengths through enamel. In addition, the depth of the lesions can be confirmed from the histological sections. The arrows pointing toward the colour pictures of Figure 4 indicate the point of view of the

30

35

histological section, which is indicated by the straight line traversing a given picture of a tooth.

5 For the examples presented in Figure 4, lesions in Tooth A rest within the enamel, having $S_{caries} < 1.1$, whereas the lesions in Teeth B, C and D reach the dentin, having $S_{caries} > 1.1$. These observations can be confirmed with the histological sections which are scored as EDJ for Tooth A and D2 for Teeth B, C and D. The black points highlighted in each carries score map
10 image (by an arrow) correspond to the maximum scores found within the region corresponding to the histological section and the average value is indicated by the arrow.

15 Hidden lesions, such as the one in Tooth D, are of particular interest since visual inspection does not reveal them easily and they could be left untreated increasing the risk of tooth loss. It is clear from the histology section that the damage has reached the dentin for this case and this is adequately indicated by values of $S_{caries} > 1.1$ around the decayed region.

20 Detection of caries in pits and fissures is of great interest among the dental practitioners since demineralisation commonly starts in these sites and the detection of them is not always obvious, especially in the presence of stain. The decay in the
25 fissure pattern of Tooth A can be easily discriminated in the S_{caries} map; the demineralised part of the "U"-shaped fissure of this tooth is well described and confirmed with the histological section. Enamel demineralisation in the fissure pattern of the remaining teeth shown in Figure 4 are also
30 depicted by their corresponding S_{caries} map but it is the deepest tooth lesion the one considered for our statistical analysis below.

35 The NIR images are to some extent affected by specular reflection, especially around the edges and the crests of the teeth where reflections are expected to be strong. These reflections act as a noise factor, especially for the

calculation of S_e in Equation 2 above. Note that the stain and pigmentation in all teeth did not show a significant interference with the measurements.

- 5 The NIR image processing algorithm discriminates well between sound enamel, enamel lesions and dentin lesions.

A region from each of the S_{caries} maps corresponding to the selected histological section was obtained. A histogram of the
10 values obtained across this region was calculated and the value corresponding to the highest bin with more than five pixels was extracted. This reduces or removes false maxima that could be caused by specular reflections. The average of the values within the extracted bin was used as an indication
15 of the maximum S_{caries} score in the region and was compared to the histology score.

Figure 5 shows a correlation graph between the two scores and a Pearson correlation 0.89 significant at a level $p < 0.01$ was
20 found. In addition, a sensitivity of 75% and a specificity of 87.5% for enamel lesions and a sensitivity of 87.5% and a specificity of 100% for dentine lesions were found using the NIR spectral imaging method.

25 Detecting early stages of tooth decay is advantageous as it is reversible and the progression to a stage where restorative intervention is required might therefore be avoided. Screening early lesions in occlusal pits and fissures is advantageous
30 since these regions have a higher susceptibility to bacterial deposition and therefore demineralisation. Visual inspection and radiography are commonly used in the clinic to perform this task; however, such methods lack the sensitivity needed to detect early stages of the disease and also the ability to quantify its progression.

35

Hyperspectral imaging is a powerful method used to interrogate the spectral characteristics of samples in a two-dimensional

space. This is now found to be of particular use when studying teeth due to their inherent heterogeneous occlusal geometry and associated lesion distribution. This method may be employed according to the present invention which demonstrates the ability of NIR spectral imaging to quantify caries lesions from occlusal surfaces. A light reflectance configuration, preferably back-scattering of light, is preferably employed in the invention since uniform illumination of the tooth is easily achieved. Imaging with NIR wavelengths means that stain no longer represents a strong confounding factor when detecting tooth demineralization.

Figure 6 shows an example of the reflectance obtained at a wavelength of 1250 nm for three heavily stained teeth. It is possible to observe that the absorption of light by stain is minimal and confirms previous reported observations employing NIR wavelengths.

Note that the spectral intensity dips observed in the reflectance spectra shown in Figure 3 correspond to the absorption peaks of water. In addition, the expected raise in light scattering caused by white spot lesions can be observed in the spectra as a background intensity across all wavelengths. The results obtained for the different lesions suggest that, as the cavity reaches the dentin, the lesion size increases and the amount of water within increases too. For early enamel demineralization, the effect is rather observed as an augmented light scattered intensity at the surface due to the porous structure of the lesion. These physical effects may be used, according to the invention, as a mechanism to quantify the extension of tooth decay. Use of the reflectance at 1440 nm and 1610 nm, such as presented in Equation 4, is suitable (though other wavelengths may be considered) since these wavelengths appear to be most affected by water absorption and scattering as shown in Figure 3 for enamel and dentin lesions. Sound regions of the teeth show a reduced reflectance at wavelengths above 1450 nm; this may be

caused by an increase in the absorption of light by hydroxyapatite and/or collagen; decayed areas have a reduced amount of mineral and/or organic material and this may explain the observed higher reflectance at such wavelengths.

5

Although special attention may be paid in pixel data processing algorithms discussed above, to remove the influence of specular reflections from reflectance data, measured pixel data values may still be affected by this source of noise, in particular at the edges and crests of the tooth present strong reflections are expected.

In another example, the filtering unit is arranged to selectively filter light received thereby according to any selected one of four pass-band transmission spectral characteristics with each pass-band preferably centred upon a respective desired wavelength value (e.g. a value selected from: 1090nm, 1440nm, 1610nm, 1910nm).

The above examples are intended for illustration and are not intended to be limiting. Variants and modifications to the examples, such as would be readily apparent to the skilled person, may be made without departing from the scope of the invention.

25

The following statements provide general expressions of the disclosure herein.

A. Apparatus for imaging a tooth including:

5 illumination means arranged to generate first infra-red light with a first wavelength having a value within a range of values corresponding to an infra-red spectral absorption band of water, to generate second infra-red light with a second wavelength having a value within a range of values
10 corresponding to an infra-red spectral reflection band characteristic of scattering from demineralised tooth enamel, and for illuminating a tooth therewith;

image data acquisition means arranged for receiving infra-red light originating from the illumination means and returned
15 from an illuminated tooth, and including infra-red pixel sensor means responsive to said returned infra-red light to generate image pixel values for a first image of the illuminated tooth using first infra-red light and not second infra-red light and to generate image pixel values for a
20 second image of the illuminated tooth using second infra-red light and not first infra-red light, and to provide such image pixel values for use.

B. Apparatus according to any preceding statement in which
25 the image data acquisition means includes optical input means via which the apparatus is arranged to receive infra-red light returned from an illuminated tooth in a direction substantially parallel with, or subtending an acute angle with respect to, a direction of illumination by the illumination
30 means.

C. Apparatus according to any preceding statement in which the illumination means comprises optical output means with an optical axis along which the apparatus is arranged to output
35 said infrared light to illuminate a tooth, and the image data acquisition means includes optical input means comprising an optical axis along which the apparatus is arranged to receive

infrared light returned from an illuminated tooth and which is substantially parallel to, or subtends an acute angle with respect to, the optical axis of the illumination means.

5 D. Apparatus according to any preceding statement in which the image data acquisition means includes camera means including a pixel sensor array responsive to visible light returned from an illuminated tooth to form one or more image pixel values representing an image of at least a part of the
10 tooth.

E. Apparatus according to any preceding statement including infra-red optical filter means selectively operable in a first state to transmit infra-red light originating from the
15 illumination means having said first wavelength and to substantially prevent transmission therethrough of infra-red light having said second wavelength, and in a second state to transmit infra-red light originating from the illumination means having said second wavelength and to substantially
20 prevent transmission therethrough of infra-red light having said first wavelength.

F. Apparatus according to statement E in which the infra-red optical filter means is arranged in optical communication with
25 the infra-red pixel sensor means to filter infra-red light directed to the infra-red pixel sensor means by the image data acquisition means.

G. Apparatus according to statement E in which the
30 illumination means comprises light-source means operable to generate light including said first and second wavelengths, wherein the infra-red optical filter means is arranged in optical communication with the light-source means to filter light generated by the light-source means for illuminating a
35 tooth with infra-red radiation transmitted by the infra-red optical filter means.

H. Apparatus according to any preceding statement in which the illumination means comprises light-source means operable to generate light including said first and second wavelengths, and optical output means remotely in optical communication
5 with the light-source means via output optical waveguide means and arranged to output from the apparatus light generated by the light-source means to illuminate a tooth.

I. Apparatus according to any preceding statement including
10 optical input means remotely in optical communication with the infra-red pixel sensor means via input optical waveguide means and arranged to receive infra-red light returned from an illuminated tooth and to direct the returned infra-red light to the remote infra-red pixel sensor means for sensing
15 thereby.

J. Apparatus according to statement H and statement I including a remote intra-oral probe comprising the optical input means and the optical output means.
20

K. Apparatus according to statement J in which the input optical waveguide means comprises one or more optical fibres which collectively define an aligned optical fibre bundle.

25 L. Apparatus according to statement J or K in which the output optical waveguide means comprises one or more optical fibres collectively defining an aligned optical bundle.

M. Apparatus according to statements J to L in which at
30 least a terminal end of the output optical waveguide means is adjacent the optical input means.

N. Apparatus according to statement M in which the terminal end of the output optical waveguide comprises a bundle of
35 optical fibres the ends of which form a ring circumscribing the output optical waveguide.

O. Apparatus according to any preceding statement in which the illumination means comprises first optical polarizer means for polarizing according to a first polarization axis infra-red radiation generated by the illumination means, and the
5 image data acquisition means comprises second optical polarizer means for polarizing according to a second polarization axis transverse to the first polarization axis infra-red radiation received thereby from an illuminated
10 tooth.

P. Apparatus according to any preceding statement in which the image data acquisition means comprises focussing means arranged to form upon the infra-red pixel sensor means a real optical image using infra-red light received by the image data
15 acquisition means from an illuminated tooth.

Q. Apparatus according to statement P when dependent upon statement E and statement I in which the optical filter means, the focussing means and infra-red pixel sensor means are each
20 in mutual optical communication and remotely in optical communication with the optical input means via said input optical waveguide means.

R. Apparatus according to any preceding statement including
25 image processing means arranged to receive said pixel image values for producing one or more of said first and second images therefrom.

S. Apparatus according to statement R in which the image
30 processing means is arranged to co-register a said first image and a said second image in respect of a common imaged subject, thereby to associate a given image pixel of the first image with a respective image pixel of the second image representing the same part of the imaged subject.
35

T. Apparatus according to any preceding statement including data processing means arranged in respect of a given part of

the imaged subject to use one or more image pixel values of the first image to calculate a first reflectance value associated with the part, and to use one or more image pixel values of the second image to calculate a second reflectance value associated with the part, and to determine from the first and second reflectance values a measure of the degree of enamel lesion (S_e) and/or dentin lesion (S_d) present in the part.

10 U. Apparatus according to statement T in which the data processing means is arranged to use said measure of the degree of enamel lesion (S_e) and said measure of the degree of dentin lesion (S_d) to calculate a measure (S_{caries}) of the degree of caries present in the part.

15 V. Apparatus according to any preceding statement in which the infra-red pixel sensor means is responsive to said returned infra-red light to generate image pixel values for a reference image of the illuminated tooth using reference
20 infra-red light and not first infra-red light nor second infra-red light, and to provide such image pixel values for use.

W. Apparatus according to statements E and V at least in
25 which the infra-red optical filter means is selectively operable in a third state to transmit infra-red light originating from the illumination means having said reference wavelength and to substantially prevent transmission
therethrough of infra-red light having any of said first
30 wavelength and said second wavelength.

X. Apparatus according to statement T and statement V or statement W in which the data processor means is arranged to use one or more image pixel values of the reference image to
35 calculate a reference reflectance value associated with the part, and to determine the measure of the degree of enamel

lesion (S_e) and/or dentin lesion (S_d) present in the part using the reference reflectance value.

5 Y. Apparatus according to any preceding statement in which the first wavelength value is between 1300nm and 1550nm, and the second wavelength value is between 1550nm and 1800nm.

10 Z. Apparatus according to statement Y in which the first wavelength value is between 1400nm and 1500nm, such as 1440nm, and the second wavelength value is between 1550nm and 1650nm, such as 1610nm.

15 ZA. A method for imaging a tooth including:
generating first infra-red light with a first wavelength having a value within a range of values corresponding to an infra-red spectral absorption band of water, generating second infra-red light with a second wavelength having a value within a range of values corresponding to an infra-red spectral reflection band characteristic of scattering from
20 demineralised tooth enamel, and illuminating a tooth therewith;

receiving at infra-red pixel sensor means first and second infra-red light returned from an illuminated tooth and therewith generating image pixel values for a first image of
25 the illuminated tooth using first infra-red light and not second infra-red light and generating image pixel values for a second image of the illuminated tooth using second infra-red light and not first infra-red light, and providing such image pixel values for use.

30

ZB. A method according to statement ZA including receiving infra-red light returned from an illuminated tooth in a direction substantially parallel with, or subtending an acute angle with respect to, a direction of said illumination.

35

ZC. A method according to any of statements ZA to ZB including providing optical output means comprising an optical

axis and therealong outputting said infrared light to illuminate a tooth, and providing optical input means comprising an optical axis and therealong receiving infrared light returned from an illuminated tooth for subsequent receipt at the infra-red pixel sensor means wherein the said optical axes are substantially parallel, or subtend an acute angle with respect to each other.

ZD. A method according to any of statements ZA to ZC including forming an image representing at least a part of the illuminated tooth using visible light returned therefrom.

ZE. A method according to any of statements ZA to ZD including generating light for illuminating the tooth and in a first instance, filtering the light by transmitting through a filter means parts of said light having said first wavelength and substantially preventing transmission through the filter means of parts of said light having said second wavelength; and in a second instance, filtering the light by transmitting through the filter means parts of said light having said second wavelength and substantially preventing transmission through the filter means parts of said light having said first wavelength.

ZF. A method according to statement ZE including performing said filtering on light directed to the infra-red pixel sensor means.

ZG. A method according to statement ZE including performing said filtering on light for illuminating a tooth.

ZH. A method according to any of statements ZA to ZG including generating said light remotely from said tooth, guiding the generating light to the proximity of the tooth, and illuminating the tooth with the guided light.

ZI. A method according to any of statements ZA to ZH including guiding said returned infra-red light to a location remote from the point of receipt of the returned light and generating image pixel values using said returned, guided
5 light at said remote location.

ZJ. A method according to any of statements ZA to ZI performed using an intra-oral probe.

10 ZK. A method according to any of statements ZA to ZJ including polarizing according to a first polarization axis infra-red radiation generated for illuminating a tooth, and polarizing according to a second polarization axis transverse to the first polarization axis infra-red radiation returned
15 from the illuminated tooth.

ZL. A method according to any of statements ZA to ZK including forming upon an infra-red pixel sensor means a real optical image using said infra-red light returned from an
20 illuminated tooth.

ZM. A method according to any of statements ZA to ZL including producing one or more of said first and second images from said returned light.
25

ZN. A method according to statement ZM including co-registering a said first image and a said second image in respect of a common imaged subject, thereby to associate a given image pixel of the first image with a respective image
30 pixel of the second image representing the same part of the imaged subject.

ZO. A method according to any of statements ZA to ZN including generating image pixel values for a reference image
35 of the illuminated tooth using reference infra-red light returned from the tooth and not first infra-red light nor

second infra-red light, and providing such image pixel values for use.

5 ZP. A method according to statement Z0 including, in respect of a given part of the imaged subject, calculating a first reflectance value R_1 associated with the part using one or more image pixel values of the first image, calculating a second reflectance value R_2 associated with the part using one or more image pixel values of the second image, calculating a
10 reference reflectance value R_{ref} associated with the part using one or more image pixel values of the third image and determining from the first, second and reference reflectance values the values of the ratios R_1/R_{ref} and R_2/R_{ref} and providing the ratio values for use.

15

ZQ. A method according to statement ZP including calculating a value $(R_2/R_{ref} - R_1/R_{ref})$ and providing the value for use.

ZR. A method according to any of statements ZA to ZQ
20 including generating light for illuminating the tooth and in a third instance, filtering the light by transmitting through a filter means parts of said light having said reference wavelength and substantially preventing transmission through the filter means of parts of said light having any of said
25 first wavelength and said second wavelength.

ZS. A method according to any of statements ZA to ZR in which the first wavelength value is between 1300nm and 1550nm, and the second wavelength value is between 1550nm and 1800nm.

30

ZT. A method according to statement ZS in which the first wavelength value is between 1400nm and 1500nm, such as 1440nm, and the second wavelength value is between 1550nm and 1650nm, such as 1610nm.

35

ZU. A computer programmed to implement the method of any of statements ZM to ZQ.

ZV. A computer program product comprising a computer-readable medium containing computer executable instructions which implement the method of any of statements ZM to ZQ when
5 executed on a computer.

ZW. A computer program containing computer executable instructions which implement the method of any of statements ZM to ZQ when executed on a computer.
10

ZX. Apparatus according to any of statements A to Z including computer means programmed for use in implementing the method of any of statements ZA to ZT.

15 ZY. A computer program product comprising a computer-readable medium containing computer executable instructions for use in implementing the method of any of statements ZA to ZT when executed on apparatus according to statement ZX.

20 ZZ. A computer program containing computer executable instructions which implement the method of any of statements ZA to ZT when executed on apparatus according to statement ZX.

CLAIMS:

1. Apparatus for imaging a tooth including:

illumination means arranged to generate first infra-red
5 light with a first wavelength having a value within a range of
values corresponding to an infra-red spectral absorption band
of water, to generate second infra-red light with a second
wavelength having a value within a range of values
10 corresponding to an infra-red spectral reflection band
characteristic of scattering from demineralised tooth enamel,
and for illuminating a tooth therewith;

image data acquisition means arranged for receiving
infra-red light originating from the illumination means and
returned from an illuminated tooth, and including infra-red
15 pixel sensor means responsive to said returned infra-red light
to generate image pixel values for a first image of the
illuminated tooth using first infra-red light and not second
infra-red light and to generate image pixel values for a
second image of the illuminated tooth using second infra-red
20 light and not first infra-red light, and to provide such image
pixel values for use; and

data processing means arranged in respect of a given part
of the imaged subject to use one or more image pixel values of
the first image to calculate a first reflectance value
25 associated with the part, and to use one or more image pixel
values of the second image to calculate a second reflectance
value associated with the part, and to determine from the
first and second reflectance values a measure of the degree of
enamel lesion (S_e) and/or dentin lesion (S_d) present in the
30 part.

2. Apparatus according to any preceding claim in which the
image data acquisition means includes optical input means via
which the apparatus is arranged to receive infra-red light
35 returned from an illuminated tooth in a direction
substantially parallel with, or subtending an acute angle with

respect to, a direction of illumination by the illumination means.

3. Apparatus according to any preceding claim in which the
5 illumination means comprises optical output means with an
optical axis along which the apparatus is arranged to output
said infrared light to illuminate a tooth, and the image data
acquisition means includes optical input means comprising an
10 optical axis along which the apparatus is arranged to receive
infrared light returned from an illuminated tooth and which is
substantially parallel to, or subtends an acute angle with
respect to, the optical axis of the illumination means.

4. Apparatus according to any preceding claim in which the
15 data processing means is arranged to use said measure of the
degree of enamel lesion (S_e) and said measure of the degree of
dentin lesion (S_d) to calculate a measure (S_{caries}) of the degree
of caries present in the part.

20 5. Apparatus according to any preceding claim in which the
image data acquisition means includes camera means including a
pixel sensor array responsive to visible light returned from
an illuminated tooth to form one or more image pixel values
representing an image of at least a part of the tooth.

25 6. Apparatus according to any preceding claim including
infra-red optical filter means selectively operable in a first
state to transmit infra-red light originating from the
illumination means having said first wavelength and to
30 substantially prevent transmission therethrough of infra-red
light having said second wavelength, and in a second state to
transmit infra-red light originating from the illumination
means having said second wavelength and to substantially
prevent transmission therethrough of infra-red light having
35 said first wavelength.

7. Apparatus according to claim 6 in which the infra-red optical filter means is arranged in optical communication with the infra-red pixel sensor means to filter infra-red light directed to the infra-red pixel sensor means by the image data acquisition means.

5

8. Apparatus according to claim 7 in which the illumination means comprises light-source means operable to generate light including said first and second wavelengths, wherein the infra-red optical filter means is arranged in optical communication with the light-source means to filter light generated by the light-source means for illuminating a tooth with infra-red radiation transmitted by the infra-red optical filter means.

10
15

9. Apparatus according to any preceding claim in which the illumination means comprises light-source means operable to generate light including said first and second wavelengths, and optical output means remotely in optical communication with the light-source means via output optical waveguide means and arranged to output from the apparatus light generated by the light-source means to illuminate a tooth.

20

10. Apparatus according to any preceding claim including optical input means remotely in optical communication with the infra-red pixel sensor means via input optical waveguide means and arranged to receive infra-red light returned from an illuminated tooth and to direct the returned infra-red light to the remote infra-red pixel sensor means for sensing thereby.

25
30

11. Apparatus according to claim 9 and claim 10 including a remote intra-oral probe comprising the optical input means and the optical output means.

35

12. Apparatus according to claim 11 in which the input optical waveguide means comprises one or more optical fibres which collectively define an aligned optical fibre bundle.

5 13. Apparatus according to claim 11 or 12 in which the output optical waveguide means comprises one or more optical fibres collectively defining an aligned optical bundle.

10 14. Apparatus according to claims 11 to 13 in which at least a terminal end of the output optical waveguide means is adjacent the optical input means.

15 15. Apparatus according to claim 14 in which the terminal end of the output optical waveguide comprises a bundle of optical fibres the ends of which form a ring circumscribing the output optical waveguide.

20 16. Apparatus according to any preceding claim in which the illumination means comprises first optical polarizer means for polarizing according to a first polarization axis infra-red radiation generated by the illumination means, and the image data acquisition means comprises second optical polarizer means for polarizing according to a second polarization axis transverse to the first polarization axis infra-red radiation received thereby from an illuminated tooth.

30 17. Apparatus according to any preceding claim in which the image data acquisition means comprises focussing means arranged to form upon the infra-red pixel sensor means a real optical image using infra-red light received by the image data acquisition means from an illuminated tooth.

35 18. Apparatus according to claim 17 when dependent upon claim 6 and claim 10 in which the optical filter means, the focussing means and infra-red pixel sensor means are each in mutual optical communication and remotely in optical

communication with the optical input means via said input optical waveguide means.

19. Apparatus according to any preceding claim including
5 image processing means arranged to receive said pixel image values for producing one or more of said first and second images therefrom.

20. Apparatus according to claim 19 in which the image
10 processing means is arranged to co-register a said first image and a said second image in respect of a common imaged subject, thereby to associate a given image pixel of the first image with a respective image pixel of the second image representing the same part of the imaged subject.

21. Apparatus according to any preceding claim in which the
15 infra-red pixel sensor means is responsive to said returned infra-red light to generate image pixel values for a reference image of the illuminated tooth using reference infra-red light and not first infra-red light nor second infra-red light, and to provide such image pixel values for use.

22. Apparatus according to claims 6 and 21 at least in which
25 the infra-red optical filter means is selectively operable in a third state to transmit infra-red light originating from the illumination means having said reference wavelength and to substantially prevent transmission therethrough of infra-red light having any of said first wavelength and said second wavelength.

30
23. Apparatus according to claim 21 or claim 22 in which the data processor means is arranged to use one or more image pixel values of the reference image to calculate a reference reflectance value associated with the part, and to determine
35 the measure of the degree of enamel lesion (S_e) and/or dentin lesion (S_d) present in the part using the reference reflectance value.

24. Apparatus according to any preceding claim in which the first wavelength value is between 1300nm and 1550nm, and the second wavelength value is between 1550nm and 1800nm.

5

25. Apparatus according to claim 24 in which the first wavelength value is between 1400nm and 1500nm, such as 1440nm, and the second wavelength value is between 1550nm and 1650nm, such as 1610nm.

10

26. A method for imaging a tooth including:

generating first infra-red light with a first wavelength having a value within a range of values corresponding to an infra-red spectral absorption band of water, generating second
15 infra-red light with a second wavelength having a value within a range of values corresponding to an infra-red spectral reflection band characteristic of scattering from demineralised tooth enamel, and illuminating a tooth therewith;

20

receiving at infra-red pixel sensor means first and second infra-red light returned from an illuminated tooth and therewith generating image pixel values for a first image of the illuminated tooth using first infra-red light and not
25 second infra-red light and generating image pixel values for a second image of the illuminated tooth using second infra-red light and not first infra-red light, and providing such image pixel values for use; and

30

in respect of a given part of the imaged subject, calculating a first reflectance value associated with the part using one or more image pixel values of the first image, and
35 calculating a second reflectance value associated with the part using one or more image pixel values of the second image, and determining from the first and second reflectance values a measure of the degree of enamel lesion (S_e) and/or dentin lesion (S_d) present in the part.

27. A method according to claim 26 including receiving infra-red light returned from an illuminated tooth in a direction substantially parallel with, or subtending an acute angle with respect to, a direction of said illumination.

5

28. A method according to any of claims 26 to 27 including providing optical output means comprising an optical axis and therealong outputting said infrared light to illuminate a tooth, and providing optical input means comprising an optical
10 axis and therealong receiving infrared light returned from an illuminated tooth for subsequent receipt at the infra-red pixel sensor means wherein the said optical axes are substantially parallel, or subtend an acute angle with respect to each other.

15

29. A method according to any of claims 26 to 28 including forming an image representing at least a part of the illuminated tooth using visible light returned therefrom.

20

30. A method according to any of claims 26 to 29 including generating light for illuminating the tooth and in a first instance, filtering the light by transmitting through a filter means parts of said light having said first wavelength and substantially preventing transmission through the filter means
25 of parts of said light having said second wavelength; and in a second instance, filtering the light by transmitting through the filter means parts of said light having said second wavelength and substantially preventing transmission through the filter means parts of said light having said first
30 wavelength.

35

31. A method according to claim 30 including performing said filtering on light directed to the infra-red pixel sensor means.

32. A method according to claim 30 including performing said filtering on light for illuminating a tooth.

33. A method according to any of claims 26 to 32 including
generating said light remotely from said tooth, guiding the
generating light to the proximity of the tooth, and
5 illuminating the tooth with the guided light.

34. A method according to any of claims 26 to 33 including
guiding said returned infra-red light to a location remote
from the point of receipt of the returned light and generating
10 image pixel values using said returned, guided light at said
remote location.

35. A method according to any of claims 26 to 34 performed
using an intra-oral probe.
15

36. A method according to any of claims 26 to 35 including
polarizing according to a first polarization axis infra-red
radiation generated for illuminating a tooth, and polarizing
according to a second polarization axis transverse to the
20 first polarization axis infra-red radiation returned from the
illuminated tooth.

37. A method according to any of claims 26 to 36 including
forming upon an infra-red pixel sensor means a real optical
25 image using said infra-red light returned from an illuminated
tooth.

38. A method according to any of claims 26 to 37 including
producing one or more of said first and second images from
30 said returned light.

39. A method according to claim 38 including co-registering a
said first image and a said second image in respect of a
common imaged subject, thereby to associate a given image
35 pixel of the first image with a respective image pixel of the
second image representing the same part of the imaged subject.

40. A method according to any of claims 26 to 39 including generating image pixel values for a reference image of the illuminated tooth using reference infra-red light returned from the tooth and not first infra-red light nor second infra-red light, and providing such image pixel values for use.

41. A method according to claim 40 including, in respect of the given part of the imaged subject, calculating a first reflectance value R_1 associated with the part using one or more image pixel values of the first image, calculating a second reflectance value R_2 associated with the part using one or more image pixel values of the second image, calculating a reference reflectance value R_{ref} associated with the part using one or more image pixel values of the third image and determining from the first, second and reference reflectance values the values of the ratios R_1/R_{ref} and R_2/R_{ref} and providing the ratio values for use.

42. A method according to claim 41 including calculating a value $(R_2/R_{ref} - R_1/R_{ref})$ and providing the value for use.

43. A method according to any of claims 26 to 42 including generating light for illuminating the tooth and in a third instance, filtering the light by transmitting through a filter means parts of said light having said reference wavelength and substantially preventing transmission through the filter means of parts of said light having any of said first wavelength and said second wavelength.

44. A method according to any of claims 26 to 43 in which the first wavelength value is between 1300nm and 1550nm, and the second wavelength value is between 1550nm and 1800nm.

45. A method according to claim 44 in which the first wavelength value is between 1400nm and 1500nm, such as 1440nm, and the second wavelength value is between 1550nm and 1650nm, such as 1610nm.

46. A method according to any of claims 26 to 45 including calculating a measure (S_{carries}) of the degree of caries present in the part using said measure of the degree of enamel lesion (S_e) and said measure of the degree of dentin lesion (S_d).

5

47. A computer programmed to implement the method of any of claims 26 to 46.

48. A computer program product comprising a computer-readable medium containing computer executable instructions which
10 implement the method of any of claims 26 to 46 when executed on a computer.

49. A computer program containing computer executable
15 instructions which implement the method of any of claims 26 to 46 when executed on a computer.

50. Apparatus according to any of claims 1 to 25 including computer means programmed for use in implementing the method
20 of any of claims 26 to 46.

51. A computer program product comprising a computer-readable medium containing computer executable instructions for use in implementing the method of any of claims 26 to 46 when
25 executed on apparatus according to claim 50.

52. A computer program containing computer executable instructions which implement the method of any of claims 26 to 46 when executed on apparatus according to claim 50.

30

53. A method substantially as described in any one embodiment hereinbefore with reference to, or substantially as illustrated in, any of the accompanying drawings.

35 54. Apparatus substantially as described in any one embodiment hereinbefore with reference to, or substantially as illustrated in, any of the accompanying drawings.

1/7

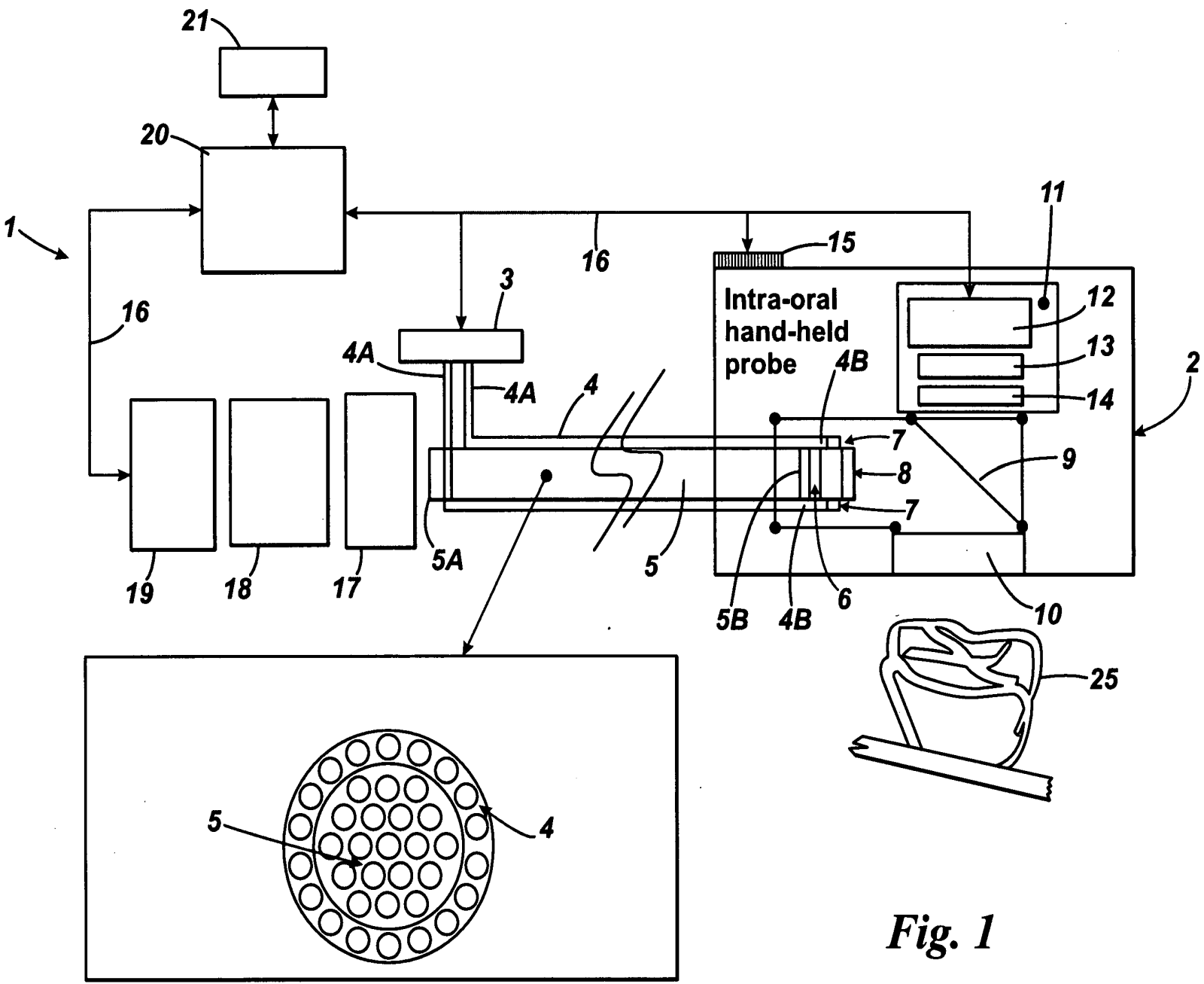

Fig. 1

2/7

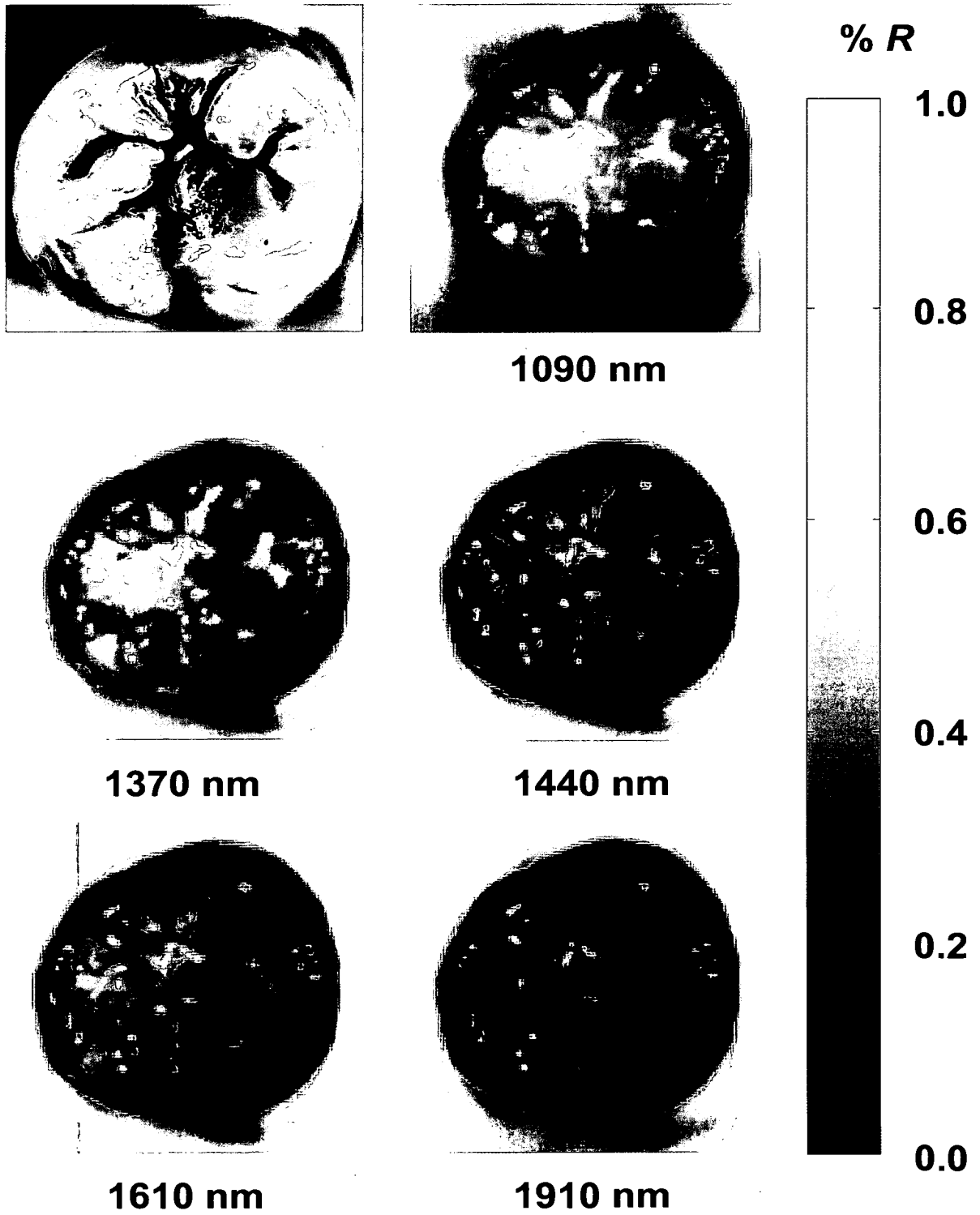

Fig. 2

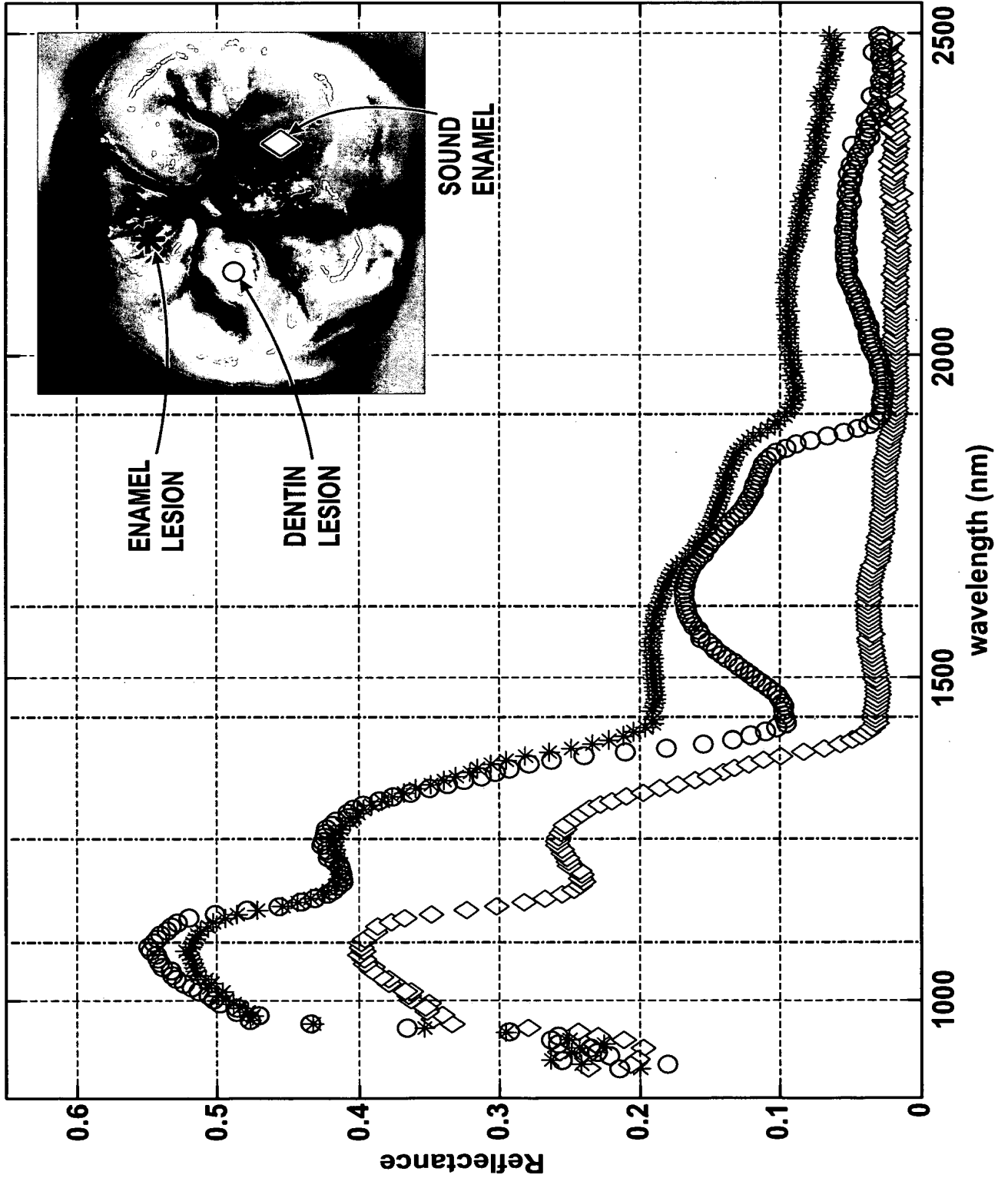

Fig. 3

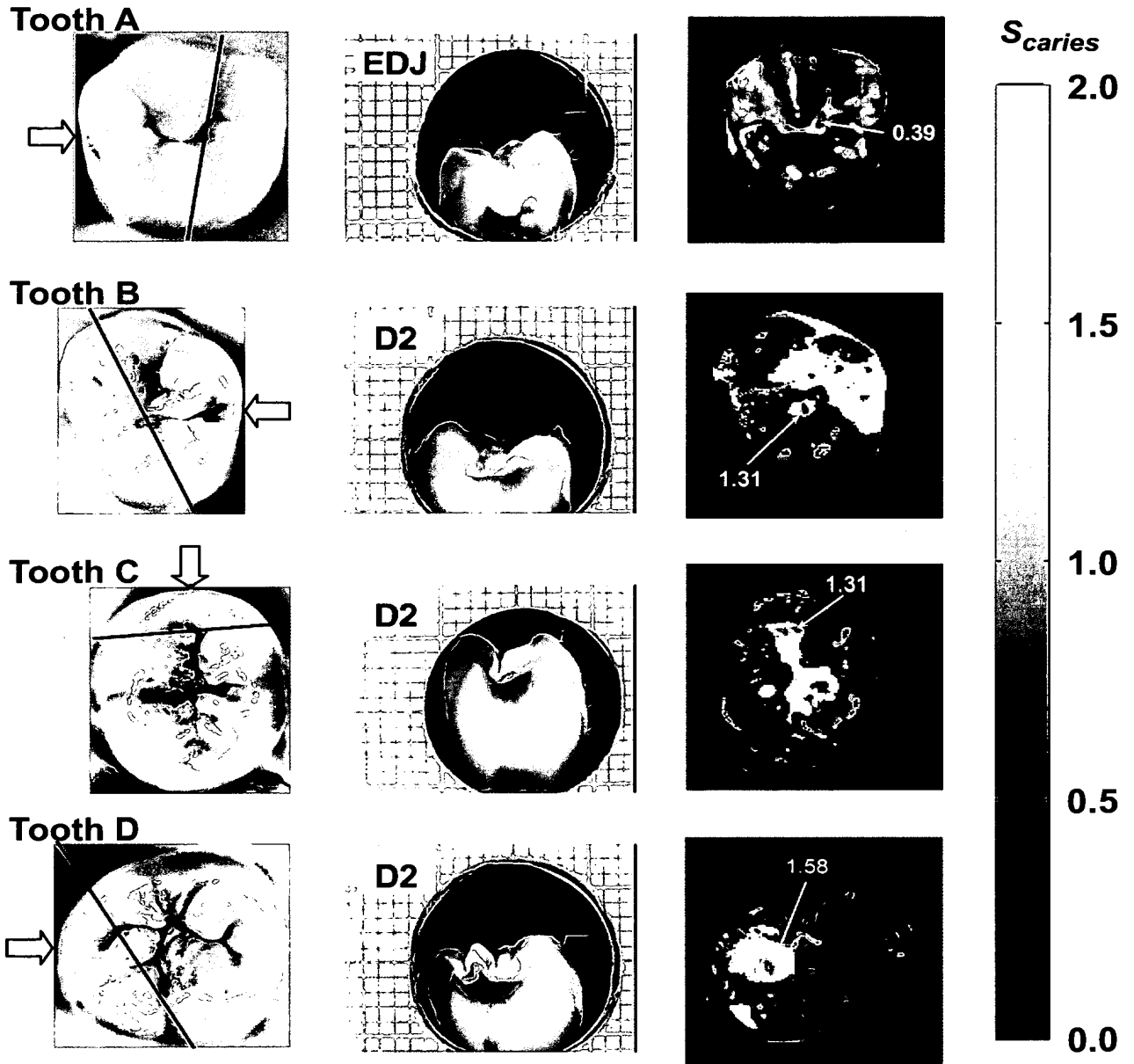

Fig. 4

5/7

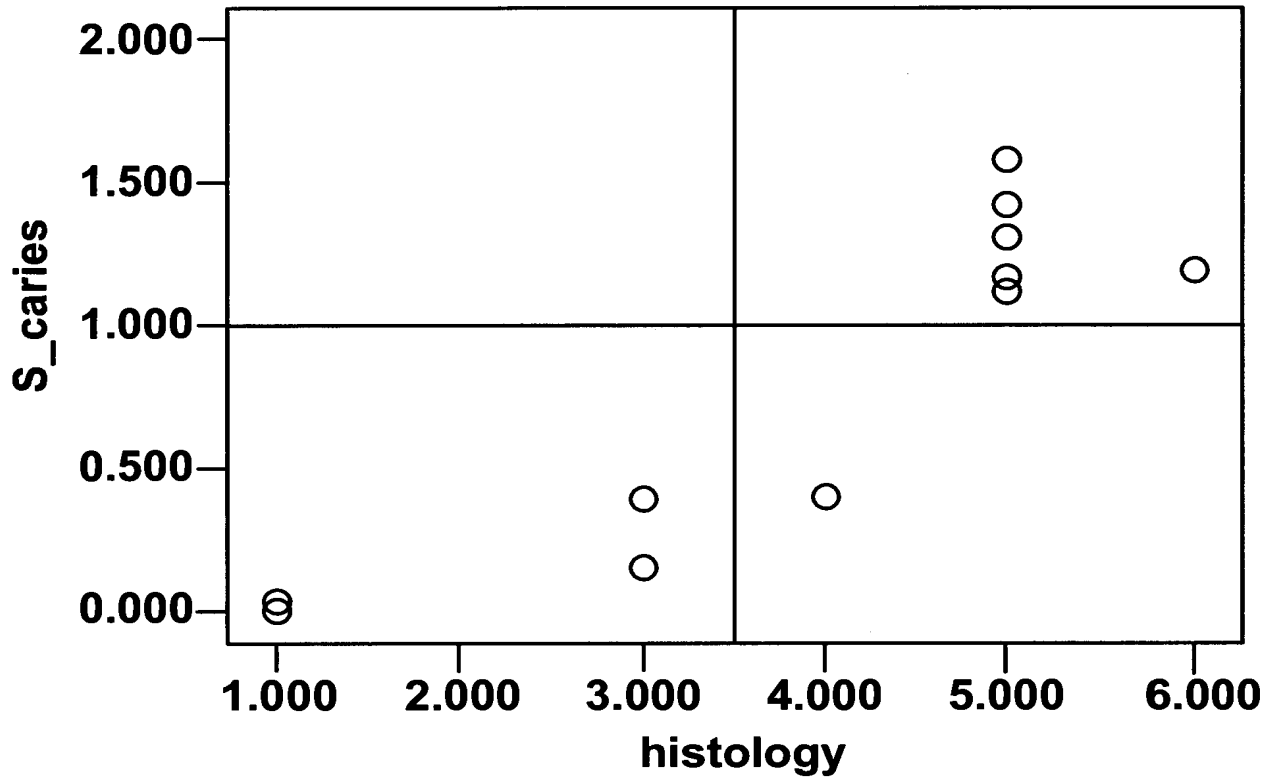

Fig. 5

6/7

Fig. 6



7/7

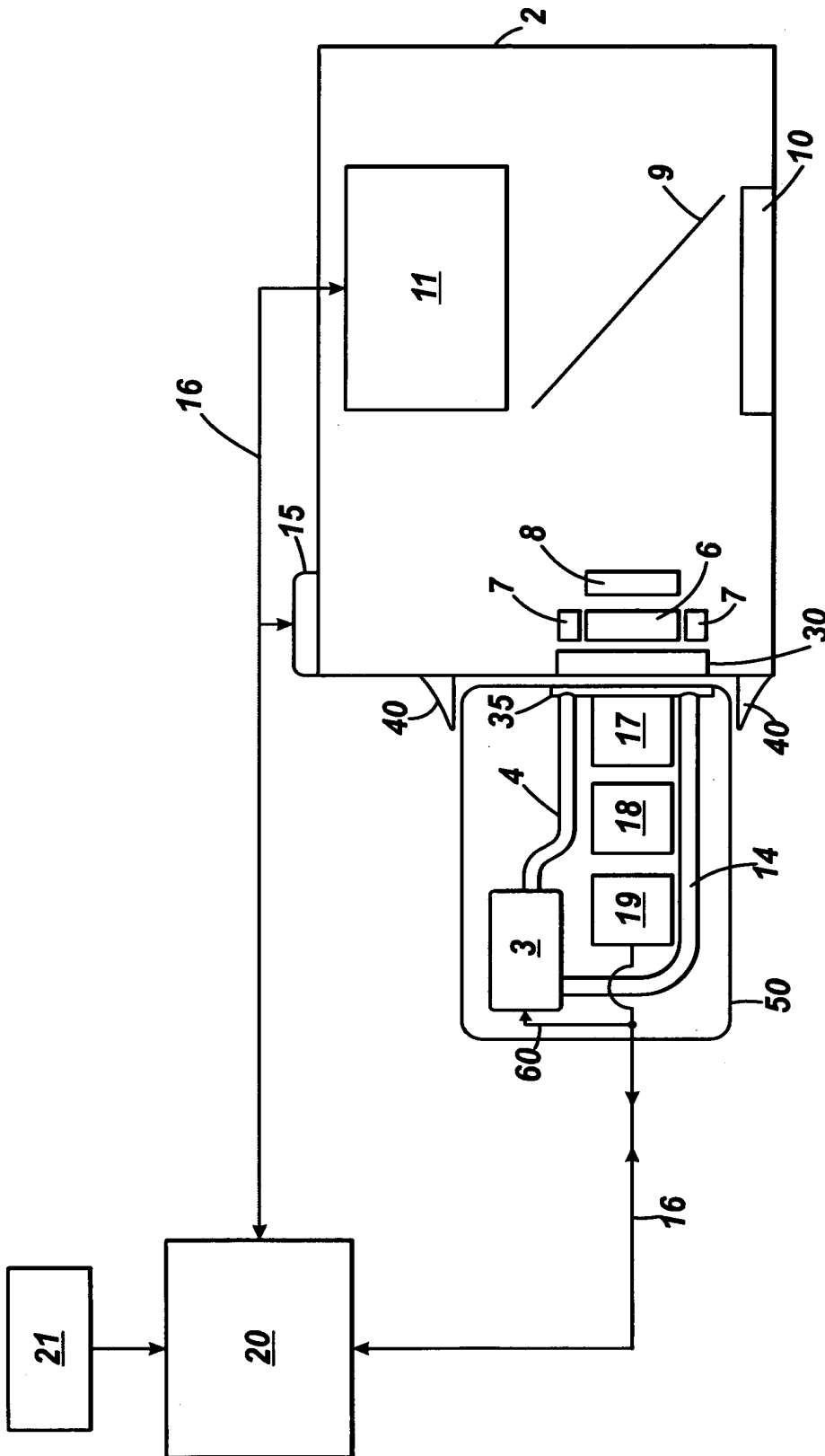

Fig. 7

INTERNATIONAL SEARCH REPORT

International application No
PCT/GB2009/001032

A. CLASSIFICATION OF SUBJECT MATTER
INV. A61B5/00
ADD. A61B1/24

According to International Patent Classification (IPC) or to both national classification and IPC

B. FIELDS SEARCHED
Minimum documentation searched (classification system followed by classification symbols)
A61B

Documentation searched other than minimum documentation to the extent that such documents are included in the fields searched

Electronic data base consulted during the international search (name of data base and, where practical, search terms used)
EPO-Internal

C. DOCUMENTS CONSIDERED TO BE RELEVANT		
Category*	Citation of document, with indication, where appropriate, of the relevant passages	Relevant to claim No.
Y	US 2007/134615 A1 (LOVELY PETER S [US]) 14 June 2007 (2007-06-14) paragraphs [0044], [0048], [0055], [0066], [0075], [0079] - [0086], [0090]; figures 8,10,11	1-52
Y	US 2005/181333 A1 (KARAZIVAN NAIM [CA] ET AL) 18 August 2005 (2005-08-18) paragraphs [0030] - [0036], [0038], [0043], [0046], [0068]	1-52
A	WO 98/52460 A (MEDICAL LASER TECHNOLOGIES LIM [GB]; COLLES MICHAEL JOHN [GB]) 26 November 1998 (1998-11-26) page 3, line 9 - page 4, line 14 page 6, lines 27-32 page 7, line 16 - page 10, line 11 page 10, line 35 - page 11, line 3	1,26
-/--		

Further documents are listed in the continuation of Box C. See patent family annex.

* Special categories of cited documents :

A document defining the general state of the art which is not considered to be of particular relevance

E earlier document but published on or after the international filing date

L document which may throw doubts on priority claim(s) or which is cited to establish the publication date of another citation or other special reason (as specified)

O document referring to an oral disclosure, use, exhibition or other means

P document published prior to the international filing date but later than the priority date claimed

T later document published after the international filing date or priority date and not in conflict with the application but cited to understand the principle or theory underlying the invention

X document of particular relevance; the claimed invention cannot be considered novel or cannot be considered to involve an inventive step when the document is taken alone

Y document of particular relevance; the claimed invention cannot be considered to involve an inventive step when the document is combined with one or more other such documents, such combination being obvious to a person skilled in the art.

* & * document member of the same patent family

Date of the actual completion of the international search 27 July 2009	Date of mailing of the international search report 04/08/2009
---	--

Name and mailing address of the ISA/ European Patent Office, P.B. 5818 Patentlaan 2 NL - 2280 HV Rijswijk Tel. (+31-70) 340-2040, Fax: (+31-70) 340-3016	Authorized officer Kronberger, Raphael
--	---

INTERNATIONAL SEARCH REPORT

International application No

PCT/GB2009/001032

C(Continuation). DOCUMENTS CONSIDERED TO BE RELEVANT		
Category*	Citation of document, with indication, where appropriate, of the relevant passages	Relevant to claim No.
P,X	EP 2 042 085 A (DEGUDENT GMBH [DE]) 1 April 2009 (2009-04-01) paragraphs [0004], [0006], [0007], [0012] - [0016], [0027], [0041], [0051]	1,26
A	HSIAO-CHUAN WANG ET AL: "Selection of an appropriate laser wavelength for launching surface acoustic waves on tooth enamel" OPTICAL FIBRE TECHNOLOGY/AUSTRALIAN OPTICAL SOCIETY, 2006. ACOFT/AOS 2006. AUSTRALIAN CONFERENCE ON, IEEE, PISCATAWAY, NJ, USA, 10 July 2006 (2006-07-10), pages 99-101, XP031252053 ISBN: 978-0-9775657-1-9 Section IV. Conclusion figures 2,3	24,25, 44,45
A	US 5 570 182 A (NATHEL HOWARD [US] ET AL) 29 October 1996 (1996-10-29) column 1, lines 47-64 column 4, lines 25-53 column 7, lines 44-64	1,26
A	US 2004/236232 A1 (JONUSAUSKAS GEDIMINAS [FR] ET AL) 25 November 2004 (2004-11-25) paragraphs [0002], [0014], [0015], [0017] - [0022], [0040] - [0043], [0051] - [0056]; figures 3,4	1,26

FURTHER INFORMATION CONTINUED FROM PCT/ISA/ 210

Continuation of Box II.2

Claims Nos.: 53,54

Claims 53,54 are not in compliance with the provisions of clarity of Article 6 PCT, as it is not possible for a skilled person to establish the exact subject-matter for which protection is sought. The non-compliance with the substantive provisions is to such an extent, that no search was performed for these claims.

The applicant's attention is drawn to the fact that claims relating to inventions in respect of which no international search report has been established need not be the subject of an international preliminary examination (Rule 66.1(e) PCT). The applicant is advised that the EPO policy when acting as an International Preliminary Examining Authority is normally not to carry out a preliminary examination on matter which has not been searched. This is the case irrespective of whether or not the claims are amended following receipt of the search report or during any Chapter II procedure. If the application proceeds into the regional phase before the EPO, the applicant is reminded that a search may be carried out during examination before the EPO (see EPO Guideline C-VI, 8.2), should the problems which led to the Article 17(2)PCT declaration be overcome.

INTERNATIONAL SEARCH REPORT

International application No.
PCT/GB2009/001032

Box No. II Observations where certain claims were found unsearchable (Continuation of item 2 of first sheet)

This international search report has not been established in respect of certain claims under Article 17(2)(a) for the following reasons:

1. Claims Nos.:
because they relate to subject matter not required to be searched by this Authority, namely:

2. Claims Nos.: 53, 54
because they relate to parts of the international application that do not comply with the prescribed requirements to such an extent that no meaningful international search can be carried out, specifically:
see FURTHER INFORMATION sheet PCT/ISA/210

3. Claims Nos.:
because they are dependent claims and are not drafted in accordance with the second and third sentences of Rule 6.4(a).

Box No. III Observations where unity of invention is lacking (Continuation of item 3 of first sheet)

This International Searching Authority found multiple inventions in this international application, as follows:

1. As all required additional search fees were timely paid by the applicant, this international search report covers allsearchable claims.

2. As all searchable claims could be searched without effort justifying an additional fees, this Authority did not invite payment of additional fees.

3. As only some of the required additional search fees were timely paid by the applicant, this international search report covers only those claims for which fees were paid, specifically claims Nos.:

4. No required additional search fees were timely paid by the applicant. Consequently, this international search report is restricted to the invention first mentioned in the claims; it is covered by claims Nos.:

Remark on Protest

- The additional search fees were accompanied by the applicant's protest and, where applicable, the payment of a protest fee.
- The additional search fees were accompanied by the applicant's protest but the applicable protest fee was not paid within the time limit specified in the invitation.
- No protest accompanied the payment of additional search fees.

INTERNATIONAL SEARCH REPORT

Information on patent family members

International application No PCT/GB2009/001032

Patent document cited in search report	Publication date	Patent family member(s)	Publication date
US 2007134615	A1	14-06-2007	NONE
US 2005181333	A1	18-08-2005	AU 2003229419 A1 11-11-2003 AU 2009200072 A1 05-02-2009 WO 03094771 A2 20-11-2003 CA 2385981 A1 08-11-2003 CN 1703162 A 30-11-2005 EP 1501407 A2 02-02-2005 JP 2005524483 T 18-08-2005 MX PA04011069 A 14-02-2005 NZ 536730 A 27-04-2007
WO 9852460	A	26-11-1998	AU 7543398 A 11-12-1998 EP 0984717 A1 15-03-2000
EP 2042085	A	01-04-2009	DE 102007046228 A1 09-04-2009 US 2009087811 A1 02-04-2009
US 5570182	A	29-10-1996	NONE
US 2004236232	A1	25-11-2004	CA 2448936 A1 05-12-2002 EP 1392158 A1 03-03-2004 FR 2825260 A1 06-12-2002 WO 02096281 A1 05-12-2002 JP 2004526550 T 02-09-2004



UNITED STATES PATENT AND TRADEMARK OFFICE

UNITED STATES DEPARTMENT OF COMMERCE
United States Patent and Trademark Office
Address: COMMISSIONER FOR PATENTS
P.O. Box 1450
Alexandria, Virginia 22313-1450
www.uspto.gov

Table with 5 columns: APPLICATION NO., FILING DATE, FIRST NAMED INVENTOR, ATTORNEY DOCKET NO., CONFIRMATION NO.
Row 1: 14/875,709, 10/06/2015, Mohammed N. Islam, OMNI 0105 PUSP1, 7496
Row 2: 109543, 7590, 10/21/2016, Brooks, Kushman P.C./Cheetah Omni MedSci, 1000 Town Center, Twenty Second Floor, Southfield, MI 48075, EXAMINER FEIN, ABRA S
Row 3: ART UNIT 2884, PAPER NUMBER
Row 4: NOTIFICATION DATE 10/21/2016, DELIVERY MODE ELECTRONIC

Please find below and/or attached an Office communication concerning this application or proceeding.

The time period for reply, if any, is set in the attached communication.

Notice of the Office communication was sent electronically on above-indicated "Notification Date" to the following e-mail address(es):

docketing@brookskushman.com

Art Unit: 2884

DETAILED ACTION

Notice of Pre-AIA or AIA Status

1. The present application is being examined under the pre-AIA first to invent provisions.

Terminal Disclaimer

2. The terminal disclaimer filed on 07/06/2016 disclaiming the terminal portion of any patent granted on this application which would extend beyond the expiration date of US 9,164,032 has been reviewed and is accepted. The terminal disclaimer has been recorded.
3. In view of the terminal disclaimer, the previous Double Patenting rejection is withdrawn.

Response to Amendment

4. The amendment filed 07/06/2016 has been accepted and entered. Accordingly, Claims 5-7, 9, 11-16, 18-20, and the Specification have been amended.
5. Clams 1-20 have been pending.
6. In view of the amendment, the previous rejection to the Specification has been withdrawn.
7. In view of the amendment, the previous rejection to claims 7 and 18 under 35 U.S.C. 112, second paragraph, has been withdrawn.

Response to Arguments

8. In view of the amendment, the previous rejection to claims 5-20 under 35 U.S.C. 103(a) has been withdrawn, however upon further consideration in view of the amendment, a new ground(s) of rejection is made in view of Kleppe et al. (US 2011/0267688, hereinafter Kleppe; pub. Nov. 3, 2011), Fidler et al. (US 2013/0327966; pub. Dec. 12, 2013), and Doppke et al. (US 2005/0133691, hereinafter Doppke; pub. Jun. 23, 2005).

Art Unit: 2884

Claim Rejections - 35 USC § 103

9. In the event the determination of the status of the application as subject to AIA 35 U.S.C. 102 and 103 (or as subject to pre-AIA 35 U.S.C. 102 and 103) is incorrect, any correction of the statutory basis for the rejection will not be considered a new ground of rejection if the prior art relied upon, and the rationale supporting the rejection, would be the same under either status.

10. The text of those sections of Title 35, U.S. Code not included in this action can be found in a prior Office action.

11. The factual inquiries set forth in *Graham v. John Deere Co.*, 383 U.S. 1, 148 USPQ 459 (1966), that are applied for establishing a background for determining obviousness under pre-AIA 35 U.S.C.

103(a) are summarized as follows:

1. Determining the scope and contents of the prior art.
2. Ascertaining the differences between the prior art and the claims at issue.
3. Resolving the level of ordinary skill in the pertinent art.
4. Considering objective evidence present in the application indicating obviousness or nonobviousness.

12. **Claims 5, 8, 10, 12, 14, 17, and 20** are rejected under pre-AIA 35 U.S.C. 103(a) as being unpatentable over Polli et al. (US 2006/0283931, hereinafter Polli) in view of Banet, Rubio Guivernau et al. (US 2014/0078510, hereinafter Rubio Guivernau; PCT filed May 18, 2012), and Kleppe et al. (US 2011/0267688, hereinafter Kleppe; pub. Nov. 3, 2011).

13. Regarding **Claim 5**, Polli teaches a measurement system comprising: a light source comprising: a plurality of semiconductor sources configured to generate an output optical beam; an apparatus configured to receive a received portion of the output optical beam and to deliver an analysis output beam to a sample; a receiver configured to receive and process at least a portion of the analysis output beam reflected or transmitted from the sample and to generate an output signal with one or more optical wavelengths, wherein at least a portion of the one or more optical wavelengths is a near-infrared wavelength between 700 nanometers and 2500 nanometers [0076; 0013, Polli inherently teaches

Art Unit: 2884

wavelengths between 700 nanometers and 2500 nanometers since that is the definition of near-infrared].

Polli does not explicitly a personal device and a remote device.

Banet teaches a personal device comprising a wireless receiver, a wireless transmitter, a display, a microphone, a speaker, one or more buttons or knobs, a microprocessor, and a touch screen, the personal device configured to receive and process at least a portion of a signal transmitted over a wireless transmission link; a remote device configured to receive over the wireless transmission link an output status comprising the at least a portion of the processed output signal to process the received output status to generate processed data and to store the processed data [0005], further comprising a light source comprising a plurality of semiconductor source that are light emitting diodes [0043]. Banet further teaches the benefit of being able to transmit and display information generated [0005]. It would have been obvious to a person of ordinary skill in the art at the time of the invention to combine the measurement system, as taught by Polli, with a personal device and remote device, as taught by Banet, for the benefit of transmitting and displaying information generated.

Rubio Guivernau teaches an apparatus comprising a plurality of lenses configured to receive a portion of the output beam (CLM 9). Rubio Guivernau further teaches the benefit of optical power efficiency [0049]. It would have been obvious to a person of ordinary skill in the art at the time of the invention to combine the measurement system, as taught by Polli, with the plurality of lenses configured to receive a portion of the output beam, as taught by Rubio Guivernau, for the benefit of optical power efficiency.

Kleppe teaches a correlation between a signal-to-noise ratio and pulse rate/light intensity [0115]. Kleppe further teaches the benefit of obtaining an optimum detection signal [0115]. It would have been obvious to a person of ordinary skill in the art at the time of the invention to combine the measurement system, as taught by Polli, with correlation a signal-to-noise ratio with a pulse rate and light intensity, as taught by Kleppe, for the benefit of obtaining an optimum detection signal.

14. Regarding **Claim 14**, Polli teaches a measurement system comprising: a light source comprising a plurality of semiconductor sources configured to generate an output optical beam; a measurement apparatus configured to receive a received portion of the output optical beam with one or more optical

Art Unit: 2884

wavelengths, and to deliver an analysis output beam to a sample; and a receiver configured to receive and process at least a portion of the analysis output beam reflected or transmitted from the sample and to generate an output signal [0076; 0013, Polli inherently teaches wavelengths between 700 nanometers and 2500 nanometers since that is the definition of near-infrared].

Banet teaches wearable measurement device further comprising a personal device comprising a wireless receiver, a wireless transmitter, a display, a microphone, a speaker, one or more buttons or knobs, a microprocessor, and a touch screen, the personal device configured to receive and process at least a portion of a signal transmitted over a wireless transmission link; a remote device configured to receive over the wireless transmission link an output status comprising the at least a portion of the processed output signal, to process the received output status to generate processed data and to store the processed data [0005], further comprising a light source comprising a plurality of semiconductor source that are light emitting diodes [0043]. Banet further teaches the benefit of being able to transmit and display information generated [0005]. It would have been obvious to a person of ordinary skill in the art at the time of the invention to combine the measurement system, as taught by Polli, with a personal device and remote device, as taught by Banet, for the benefit of transmitting and displaying information generated.

Rubio Guivernau teaches an apparatus comprising a plurality of lenses configured to receive a portion of the output beam (CLM 9). Rubio Guivernau further teaches the benefit of optical power efficiency [0049]. It would have been obvious to a person of ordinary skill in the art at the time of the invention to combine the measurement system, as taught by Polli, with the plurality of lenses configured to receive a portion of the output beam, as taught by Rubio Guivernau, for the benefit of optical power efficiency.

Kleppe teaches a correlation between a signal-to-noise ratio and pulse rate/light intensity [0115]. Kleppe further teaches the benefit of obtaining an optimum detection signal [0115]. It would have been obvious to a person of ordinary skill in the art at the time of the invention to combine the measurement system, as taught by Polli, with correlation a signal-to-noise ratio with a pulse rate and light intensity, as taught by Kleppe, for the benefit of obtaining an optimum detection signal.

Art Unit: 2884

15. Regarding **Claims 8 and 17**, Polli as adapted above teaches the systems of claims 5 and 14, but does not teach specifics of the remote device. Banet teaches the remote device is further configured to transmit at least a portion of the processed data to one or more other locations, wherein the one or more other locations is selected from the group consisting of the personal device, a doctor, a healthcare provider, a cloud-based server, and one or more designated recipients, and wherein the remote device is capable of transmitting information related to a time and a position associated with the at least a portion of the processed data [0152]. Banet further teaches the benefit of providing medical diagnostic information to medical professionals [0152]. It would have been obvious to a person of ordinary skill in the art at the time of the invention to combine the system, as taught by Polli as adapted above, with having the remote device configured to transmit at least a portion of the processed data to other location, as taught by Banet, for the benefit of providing medical diagnostic information to medical professionals.

16. Regarding **Claim 10**, Polli as adapted above teaches the systems of claims 5 and 14. Polli does not teach the output signal comprises physiological parameters. Banet teaches the output signal comprises one or more physiological parameters, and the remote device is capable of storing a history of at least a portion of the one or more physiological parameters over a specified period of time [0063; 0080]. Banet further teaches the benefit of showing changes in values of the physiological parameters over periods of time [0080]. It would have been obvious to a person of ordinary skill in the art at the time of the invention to combine the system, as taught by Polli as adapted above, with the output signal comprising one or more physiological parameters, wherein the remote device is capable of storing a history of at least a portion of the one or more physiological parameters over a specified period of time, as taught by Banet, for the benefit of showing changes in values of the physiological parameters over periods of time.

17. Regarding **Claims 12 and 20**, Polli as adapted above teaches the measurement system of claims 5 and 14. Polli does not teach the receiver further comprises one or more filters in front of one or more detectors. Kleppe teaches the use of a filter F in front of a detector [0040]. It would have been obvious to a person of ordinary skill in the art at the time of the invention to have the receiver further comprise a

Art Unit: 2884

filter, since it has been held to be within the general skill of a working in the art to select a known material on the basis of its suitability for the intended use as a matter of obvious design choice. *In re Leshin*, 125 USPQ 416.

18. **Claims 6-7, 9, 15-16, and 18** are rejected under pre-AIA 35 U.S.C. 103(a) as being unpatentable over Polli and Banet, Rubio Guivernau, and Kleppe as applied to claims 5 and 14 above, and further in view of Fidler et al. (US 2013/0327966, hereinafter Fidler et al.; pub. Dec. 12, 2013).

19. Regarding **Claims 6 and 15**, Polli as adapted above teaches the system of claims 5 and 14. Polli does not teach the receiver is configured to be synchronized to the light source. Fidler teaches the receiver is configured to be synchronized to the light source (Fig. 5). The combination of the measurement system, as taught by Polli, with the receiver being configured to be synchronized to the light source, as taught by Fidler, would have been obvious to a person of ordinary skill in the art at the time of the invention to try, as a person with ordinary skill has good reason to choose from a finite number of identified, predictable solutions, with a reasonable expectation of success, since there are a limited number of ways in which the receiver and light source can be configured together.

20. Regarding **Claims 7 and 16**, Polli as adapted above teaches the system of Claims 5 and 14. Polli does not teach at least one of the light emitting diodes emits light with a bandwidth between 20 nanometers to 40 nanometers. Fidler teaches that conventional LEDs have a bandwidth of approximately 30nm, falling between 20nm to 40nm [0080]. It would have been obvious to a person of ordinary skill in the art at the time of the invention to combine the system, as taught by Polli, with the light emitting diodes having a bandwidth between 20nm and 40nm, as taught by Fidler, for the benefit of using what is conventionally known in the art.

21. Regarding **Claims 9 and 18**, Polli as adapted above teaches the system of claims 5 and 14. Polli does not teach the receiver is located a first distance from a first one of the plurality of light emitting diodes and a different, second distance from a second one of the plurality of light emitting diodes such that the receiver receives a first signal from the first light emitting diode and a second signal from the second light emitting diode. Fidler teaches a receiver is located a first distance from a first one of the

Art Unit: 2884

plurality of light emitting diodes and a different, second distance from a second one of the plurality of light emitting diodes such that the receiver receives a first signal from the first light emitting diode and a second signal from the second light emitting diode (Fig. 5; [0012; 0064]). The combination of the measurement system, as taught by Polli, with the receiver being a first distance from a first one of the plurality of light emitting diodes and a different, second distance from a second one of the plurality of light emitting diodes, as taught by Fidler, would have been obvious to a person of ordinary skill in the art at the time of the invention to try, as a person with ordinary skill has good reason to choose from a finite number of identified, predictable solutions, with a reasonable expectation of success, since there are a limited number of ways in which the receivers and light emitting diodes can be arranged.

22. **Claims 11, 13, and 19** is rejected under pre-AIA 35 U.S.C. 103(a) as being unpatentable over Polli and Banet, Rubio Guivernau, Kleppe, and Fidler as applied to claims 9 and 18 above, and further in view of Doppke et al. (US 2005/0133691, hereinafter Doppke; pub. Jun. 23, 2005).

23. Regarding **Claims 11 and 19**, Polli as adapted above teaches the measurement system of claims 9 and 18. Polli does not teach the output signal is generated in part by comparing the first and second signals. Doppke teaches output signals generated in response to a comparison of signals received on the first and second input terminals (CLM 18). Doppke further teaches the benefit of determining the presence of signal detection (CLM 2). It would have been obvious to a person of ordinary skill in the art at the time of the invention to combine the measurement system of Polli as adapted above, with the output signal being generated in part by comparing the first and second signals, as taught by Doppke, for the benefit of determining the presence of signal detection.

24. Regarding **Claim 13**, Polli as adapted above teaches the measurement system of claim 5. Polli does not teach the output optical beam comprises a plurality of optical wavelengths, and the output signal is generated in part by comparing signals at different optical wavelengths. Fidler teaches the output optical beam comprises a plurality of optical wavelengths (Fig. 5). The combination of the measurement system, as taught by Polli as adapted above, with the beam comprising a plurality of optical wavelengths, as taught by Fidler, would have been obvious to a person of ordinary skill in the art at the time of the

Art Unit: 2884

invention to try, as a person with ordinary skill has good reason to choose from a finite number of identified, predictable solutions, with a reasonable expectation of success, since there are a limited number of ways in which the optical wavelengths can either be the same or different. Doppke teaches output signals generated in response to a comparison of signals received on the first and second input terminals (CLM 18). Doppke further teaches the benefit of determining the presence of signal detection (CLM 2). It would have been obvious to a person of ordinary skill in the art at the time of the invention to combine the measurement system of Polli as adapted above, with the output signal being generated in part by comparing the first and second signals, as taught by Doppke, for the benefit of determining the presence of signal detection.

Allowable Subject Matter

25. **Claims 1-4** are allowed.

26. The following is an examiner's statement of reasons for allowance:

27. Regarding **Claim 1**, Polli et al. (US 2006/0283931, hereinafter Polli) teaches a measurement system comprising: a light source configured to generate an output optical beam, comprising: one or more semiconductor sources configured to generate an input beam; a measurement apparatus configured to receive a received portion of the output optical beam, which is a delivered portion of the output optical beam; and a receiver configured to receive and process at least a portion of the analysis output beam reflected or transmitted from the sample and to generate an output signal wherein at least a portion of the output beam broadened spectrum comprises a short-wave infrared wavelength between approximately 700 nm and approximately 2500 nm [0076; 0013].

Islam (US 2009/0028193, hereinafter Islam) teaches the use of optical amplifiers configured to receive at least a portion of an input beam and to output an intermediate beam from at least one of the one or more optical amplifiers (Abstract).

Buchter et al. (US 8,000,574, hereinafter Buchter) teaches one or more optical fibers configured to receive at least a portion of the intermediate beam and to communicate at least the portion of the intermediate beam to form a first optical beam (col. 8, lines 18-20).

Art Unit: 2884

Islam (US 2006/0268393, hereinafter Islam 2) teaches a nonlinear element configured to receive at least a portion of an optical beam and to broaden a spectrum associated with at least a portion of that optical beam through a nonlinear effect in the nonlinear element to form an output optical beam with an output beam broadened spectrum [0039]. Buchter further teaches a supercontinuum radiation source that has a high degree of spatial coherence compared to thermal light sources (col. 1, lines 13-17).

Banet et al. (US 2010/0160798, hereinafter Banet; pub. Jun. 24, 2010) teaches a personal device comprising a wireless receiver, a wireless transmitter, a display, a microphone, a speaker, one or more buttons or knobs, a microprocessor, and a touch screen, the personal device configured to receive and process at least a portion of a signal transmitted over a wireless transmission link [0005].

Islam (US 2012/0239013, hereinafter Islam 3) teaches a measurement system comprising: a light source configured to generate an output optical beam, comprising: one or more semiconductor sources configured to generate an input beam; one or more optical amplifiers configured to receive at least a portion of the input beam and to deliver an intermediate beam to an output end of the one or more optical amplifiers; and one or more optical fibers configured to receive at least a portion of the intermediate beam and to communicate at least part of the portion of the intermediate beam to form a first optical beam; a nonlinear element configured to receive at least a portion of the first optical beam and to broaden a spectrum associated with the at least a portion of the first optical beam to at least 10nm through a nonlinear effect in the nonlinear element to form the output optical beam with an output beam broadened spectrum (Abstract); and wherein at least a portion of the one or more fibers is a fused silica fiber [0004], a measurement apparatus configured to receive a received portion of the output optical beam and to deliver a delivered portion of the output optical beam to a sample (Fig. 20); and a receiver [0138].

Liu (US 2014/0249427, hereinafter Liu; PCT filed Dec. 15, 2011) teaches a fused silica fiber with a core diameter less than approximately 400 microns [0027].

Although each aspect of the claim is taught individually by multiple references, there is insufficient motivation to render the claim obvious and to combine all seven references. The prior art of record does not disclose or reasonably suggest, along with the other claim limitations, a measurement system comprising: a light source configured to generate an output optical beam, comprising: one or more

Art Unit: 2884

semiconductors sources, one or more optical amplifiers configured to receive at least a portion of the input beam and to output an intermediate beam from at least one of the one or more optical amplifiers, one or more optical fibers configured to receive at least a portion of the intermediate beam and to communicate at least part of the portion of the intermediate beam to a distal end of the one or more optical fibers to form a first optical beam, and a nonlinear element configured to receive at least a portion of a first optical beam and to broaden a spectrum associated with the at least a portion of the first optical beam to at least 10nm through a nonlinear effect in the nonlinear element to form the output optical beam with an output beam broadened spectrum comprises a short-wave infrared wavelength between approximately 700 nm and approximately 2500 nm; a measurement apparatus configured to receive a received portion of the output optical beam and to deliver to a sample an analysis output beam, which is a delivered portion of the output optical beam and wherein the delivered portion of the output optical beam is a spatially coherent beam; a receiver; and a personal device.

28. **Claims 2-4** are allowable due to dependency.

Conclusion

29. Applicant's amendment necessitated the new ground(s) of rejection presented in this Office action. Accordingly, **THIS ACTION IS MADE FINAL**. See MPEP § 706.07(a). Applicant is reminded of the extension of time policy as set forth in 37 CFR 1.136(a).

A shortened statutory period for reply to this final action is set to expire THREE MONTHS from the mailing date of this action. In the event a first reply is filed within TWO MONTHS of the mailing date of this final action and the advisory action is not mailed until after the end of the THREE-MONTH shortened statutory period, then the shortened statutory period will expire on the date the advisory action is mailed, and any extension fee pursuant to 37 CFR 1.136(a) will be calculated from the mailing date of the advisory action. In no event, however, will the statutory period for reply expire later than SIX MONTHS from the date of this final action.

Art Unit: 2884

Any inquiry concerning this communication or earlier communications from the examiner should be directed to Abra Fein whose telephone number is (571)272-0552. The examiner can normally be reached on Monday-Friday 8am-5pm EST.

If attempts to reach the examiner by telephone are unsuccessful, the examiner's supervisor, Dave Porta can be reached on 571-272-2444. The fax phone number for the organization where this application or proceeding is assigned is 571-273-8300.

Information regarding the status of an application may be obtained from the Patent Application Information Retrieval (PAIR) system. Status information for published applications may be obtained from either Private PAIR or Public PAIR. Status information for unpublished applications is available through Private PAIR only. For more information about the PAIR system, see <http://pair-direct.uspto.gov>. Should you have questions on access to the Private PAIR system, contact the Electronic Business Center (EBC) at 866-217-9197 (toll-free). If you would like assistance from a USPTO Customer Service Representative or access to the automated information system, call 800-786-9199 (IN USA OR CANADA) or 571-272-1000.

/DAVID PORTA/
Supervisory Patent Examiner, Art Unit
2884

/A. F./
Examiner, Art Unit 2884

Notice of References Cited	Application/Control No. 14/875,709	Applicant(s)/Patent Under Reexamination ISLAM, MOHAMMED N.	
	Examiner Abra Fein	Art Unit 2884	Page 1 of 1

U.S. PATENT DOCUMENTS

*		Document Number Country Code-Number-Kind Code	Date MM-YYYY	Name	CPC Classification	US Classification
*	A	US-2014/0078510 A1	03-2014	Rubio Guivernau; Jose Luis	G01B9/02091	356/479
*	B	US-2011/0267688 A1	11-2011	Kleppe; Ingo	G02B21/0036	359/385
*	C	US-2013/0327966 A1	12-2013	Fidler; Franz	G02B26/04	250/578.1
*	D	US-2005/0133691 A1	06-2005	Doppke, Harald	H04B10/6933	250/214A
	E	US-				
	F	US-				
	G	US-				
	H	US-				
	I	US-				
	J	US-				
	K	US-				
	L	US-				
	M	US-				

FOREIGN PATENT DOCUMENTS

*		Document Number Country Code-Number-Kind Code	Date MM-YYYY	Country	Name	CPC Classification
	N					
	O					
	P					
	Q					
	R					
	S					
	T					

NON-PATENT DOCUMENTS

*		Include as applicable: Author, Title Date, Publisher, Edition or Volume, Pertinent Pages)
	U	
	V	
	W	
	X	

*A copy of this reference is not being furnished with this Office action. (See MPEP § 707.05(a).)
Dates in MM-YYYY format are publication dates. Classifications may be US or foreign.

Receipt date: 06/22/2016

14875709 - GAI: 2884

Doc code: IDS

Pat. Sec. 101-10

Doc description: Information Disclosure Statement (IDS) Filed

Approved for use through 07/31/2012. OMB 0651-0031

U.S. Patent and Trademark Office; U.S. DEPARTMENT OF COMMERCE

Under the Paperwork Reduction Act of 1995, no persons are required to respond to a collection of information unless it contains a valid OMB control number.

INFORMATION DISCLOSURE STATEMENT BY APPLICANT (Not for submission under 37 CFR 1.99)	Application Number	14875709
	Filing Date	2015-10-06
	First Named Inventor	Mohammed N. ISLAM
	Art Unit	2884
	Examiner Name	Abra S. Fein
	Attorney Docket Number	OMNI 0105 PUSP1

U.S.PATENTS						Remove
Examiner Initial*	Cite No	Patent Number	Kind Code ¹	Issue Date	Name of Patentee or Applicant of cited Document	Pages,Columns,Lines where Relevant Passages or Relevant Figures Appear
	1	7771320	B2	2010-08-10	Riley, et al.	
	2	6619835	B2	2003-09-16	Kita	
	3	9326712	B1	2016-05-03	Kiani	
	4	5267152	A	1993-11-30	Yang et al.	
	5	7356364	B1	2008-04-08	Bullock et al.	
	6	5246004		1993-09-21	Clarke, et al.	
	7	8472108		2013-06-25	Islam	
If you wish to add additional U.S. Patent citation information please click the Add button.						Add
U.S.PATENT APPLICATION PUBLICATIONS						Remove

Receipt date: 06/22/2016

Application Number	14875709	14875709 - GAU: 2884
Filing Date	2015-10-06	
First Named Inventor	Mohammed N. ISLAM	
Art Unit	2884	
Examiner Name	Abra S. Fein	
Attorney Docket Number	OMNI 0105 PUSP1	

**INFORMATION DISCLOSURE
STATEMENT BY APPLICANT**
(Not for submission under 37 CFR 1.99)

Examiner Initial*	Cite No	Publication Number	Kind Code ¹	Publication Date	Name of Patentee or Applicant of cited Document	Pages, Columns, Lines where Relevant Passages or Relevant Figures Appear
	1	20100217102	A1	2010-08-26	LeBoeuf, et al.	
	2	20120310062	A1	2012-12-06	Li, et al.	
	3	20120316455	A1	2012-12-13	Rahman, et al.	
	4	20140275854	A1	2014-09-18	Venkatraman, et al.	
	5	20140275852	A1	2014-09-18	Hong, et al.	
	6	20160045118	A1	2016-02-18	Kiani	
	7	20110208015	A1	2011-08-25	Welch, et al.	
	8	20110040197	A1	2011-02-17	Welch et al.	
	9	20070021670	A1	2007-01-25	Mandelis et al.	
	10	20110282167	A1	2011-11-17	Ridder et al.	

INFORMATION DISCLOSURE STATEMENT BY APPLICANT (Not for submission under 37 CFR 1.99)	Application Number	14875709	14875709 - GAU: 2884
	Filing Date	2015-10-06	
	First Named Inventor	Mohammed N. ISLAM	
	Art Unit	2884	
	Examiner Name	Abra S. Fein	
	Attorney Docket Number	OMNI 0105 PUSP1	

11	20130274569	2013-10-17	Islam
----	-------------	------------	-------

If you wish to add additional U.S. Published Application citation information please click the Add button.

FOREIGN PATENT DOCUMENTS

Examiner Initial*	Cite No	Foreign Document Number ³	Country Code ²	Kind Code ⁴	Publication Date	Name of Patentee or Applicant of cited Document	Pages, Columns, Lines where Relevant Passages or Relevant Figures Appear	T ⁵
	1							

If you wish to add additional Foreign Patent Document citation information please click the Add button.

NON-PATENT LITERATURE DOCUMENTS

Examiner Initials*	Cite No	Include name of the author (in CAPITAL LETTERS), title of the article (when appropriate), title of the item (book, magazine, journal, serial, symposium, catalog, etc), date, pages(s), volume-issue number(s), publisher, city and/or country where published.	T ⁵
	1	J.S. Provisional Application No. 61/350,673; titled: OPTICOUSTIC SENSOR; Inventor: Massi Joe E. Kiani; filed on June 2, 2010.	
	2	International Search Report and Written Opinion for International Application No. PCT/US2013/075700 dated April 24, 2014	
	3	International Preliminary Report on Patentability for International Application No. PCT/US2013/075700 dated July 9, 2015	
	4	Ooi ET, Zhang XQ, Chen JH, Soh PH, Ng K, Yeo JH, "Non-invasive glucose measurement using multiple laser diodes," Optical Diagnostic and Sensing VII, edited by Gerard L. Cote, Alexander V. Priezhev, Proc. of SPIE Vol. 6445, 64450K , (2007).	
	5	Schulz, I., J. Putzger, A. Niklas, M. Brandt, A. Jager, A. Hardt, S. Knorz, K.A. Hiller, S. Loffler, G. Schmalz, S.N. Danilov, S. Giglberger, M. Hirner, S.D. Ganichev, G. Monkman, "PPG signal acquisition and analysis on in vitro tooth model for dental pulp vitality assessment," ARC Submission 16, (2012).	

INFORMATION DISCLOSURE STATEMENT BY APPLICANT (Not for submission under 37 CFR 1.99)	Application Number	14875709	14875709 - GAU: 2884
	Filing Date	2015-10-06	
	First Named Inventor	Mohammed N. ISLAM	
	Art Unit	2884	
	Examiner Name	Abra S. Fein	
	Attorney Docket Number	OMNI 0105 PUSP1	

6	Drexler, C., Hirmer, M., Danilov, S., Giglberger, S., Putzger, J., Niklas, A., Jager, A., Hiller, K., Loffler, S., Schmalz, G., Redlich, B., Schulz, I., Monkman, G., Ganichev, S. "Infrared spectroscopy for clinical diagnosis of dental pulp vitality." Infrared, Millimeter, and Terahertz Waves (IRMMW-THz), 2012 37th International Conference on. IEEE (2012).
7	Hirmer, Marion, Danilov, Sergey, Giglberger, Stephan, Putzger, Jurgen, Niklas, Andreas, Jager, Andreas, Hiller, Karl-Anton, Loffler, Susanne, Schmalz, Gottfried, Redlich, Britta, Schulz, Irene, Monkman, Gareth, Ganichev, Sergey. "Spectroscopic Study of Human Teeth and Blood from Visible to Terahertz Frequencies for Clinical Diagnosis of Dental Pulp Vitality." Journal of Infrared, Millimeter, and Terahertz Waves 33.3 (2012): 366-375.
8	Na, J, J.H. Baek, S.Y. Ryu, C. Lee, B.H. Lee, "Tomographic imaging of incipient dental-caries using optical coherence tomography and comparison with various modalities," Optical Review, vol. 16, no. 4, pp. 426-431 (2009).

If you wish to add additional non-patent literature document citation information please click the Add button

EXAMINER SIGNATURE

Examiner Signature	/Abra Fein/	Date Considered	10/11/2016
--------------------	-------------	-----------------	------------

*EXAMINER: Initial if reference considered, whether or not citation is in conformance with MPEP 609. Draw line through a citation if not in conformance and not considered. Include copy of this form with next communication to applicant.

¹ See Kind Codes of USPTO Patent Documents at www.USPTO.GOV or MPEP 901.04. ² Enter office that issued the document, by the two-letter code (WIPO Standard ST.3). ³ For Japanese patent documents, the indication of the year of the reign of the Emperor must precede the serial number of the patent document. ⁴ Kind of document by the appropriate symbols as indicated on the document under WIPO Standard ST.16 if possible. ⁵ Applicant is to place a check mark here if English language translation is attached.

INFORMATION DISCLOSURE STATEMENT BY APPLICANT (Not for submission under 37 CFR 1.99)	Application Number	14875709	14875709 - GAU: 2884
	Filing Date	2015-10-06	
	First Named Inventor	Mohammed N. ISLAM	
	Art Unit	2884	
	Examiner Name	Abra S. Fein	
	Attorney Docket Number	OMNI 0105 PUSP1	

CERTIFICATION STATEMENT

Please see 37 CFR 1.97 and 1.98 to make the appropriate selection(s):

That each item of information contained in the information disclosure statement was first cited in any communication from a foreign patent office in a counterpart foreign application not more than three months prior to the filing of the information disclosure statement. See 37 CFR 1.97(e)(1).

OR

That no item of information contained in the information disclosure statement was cited in a communication from a foreign patent office in a counterpart foreign application, and, to the knowledge of the person signing the certification after making reasonable inquiry, no item of information contained in the information disclosure statement was known to any individual designated in 37 CFR 1.56(c) more than three months prior to the filing of the information disclosure statement. See 37 CFR 1.97(e)(2).

See attached certification statement.

The fee set forth in 37 CFR 1.17 (p) has been submitted herewith.

A certification statement is not submitted herewith.

SIGNATURE

A signature of the applicant or representative is required in accordance with CFR 1.33, 10.18. Please see CFR 1.4(d) for the form of the signature.

Signature	/David S. Bir/	Date (YYYY-MM-DD)	2016-06-22
Name/Print	David S. Bir	Registration Number	38383

This collection of information is required by 37 CFR 1.97 and 1.98. The information is required to obtain or retain a benefit by the public which is to file (and by the USPTO to process) an application. Confidentiality is governed by 35 U.S.C. 122 and 37 CFR 1.14. This collection is estimated to take 1 hour to complete, including gathering, preparing and submitting the completed application form to the USPTO. Time will vary depending upon the individual case. Any comments on the amount of time you require to complete this form and/or suggestions for reducing this burden, should be sent to the Chief Information Officer, U.S. Patent and Trademark Office, U.S. Department of Commerce, P.O. Box 1450, Alexandria, VA 22313-1450. **DO NOT SEND FEES OR COMPLETED FORMS TO THIS ADDRESS. SEND TO: Commissioner for Patents, P.O. Box 1450, Alexandria, VA 22313-1450.**

Privacy Act Statement

The Privacy Act of 1974 (P.L. 93-579) requires that you be given certain information in connection with your submission of the attached form related to a patent application or patent. Accordingly, pursuant to the requirements of the Act, please be advised that: (1) the general authority for the collection of this information is 35 U.S.C. 2(b)(2); (2) furnishing of the information solicited is voluntary; and (3) the principal purpose for which the information is used by the U.S. Patent and Trademark Office is to process and/or examine your submission related to a patent application or patent. If you do not furnish the requested information, the U.S. Patent and Trademark Office may not be able to process and/or examine your submission, which may result in termination of proceedings or abandonment of the application or expiration of the patent.

The information provided by you in this form will be subject to the following routine uses:

1. The information on this form will be treated confidentially to the extent allowed under the Freedom of Information Act (5 U.S.C. 552) and the Privacy Act (5 U.S.C. 552a). Records from this system of records may be disclosed to the Department of Justice to determine whether the Freedom of Information Act requires disclosure of these records.
2. A record from this system of records may be disclosed, as a routine use, in the course of presenting evidence to a court, magistrate, or administrative tribunal, including disclosures to opposing counsel in the course of settlement negotiations.
3. A record in this system of records may be disclosed, as a routine use, to a Member of Congress submitting a request involving an individual, to whom the record pertains, when the individual has requested assistance from the Member with respect to the subject matter of the record.
4. A record in this system of records may be disclosed, as a routine use, to a contractor of the Agency having need for the information in order to perform a contract. Recipients of information shall be required to comply with the requirements of the Privacy Act of 1974, as amended, pursuant to 5 U.S.C. 552a(m).
5. A record related to an International Application filed under the Patent Cooperation Treaty in this system of records may be disclosed, as a routine use, to the International Bureau of the World Intellectual Property Organization, pursuant to the Patent Cooperation Treaty.
6. A record in this system of records may be disclosed, as a routine use, to another federal agency for purposes of National Security review (35 U.S.C. 181) and for review pursuant to the Atomic Energy Act (42 U.S.C. 218(c)).
7. A record from this system of records may be disclosed, as a routine use, to the Administrator, General Services, or his/her designee, during an inspection of records conducted by GSA as part of that agency's responsibility to recommend improvements in records management practices and programs, under authority of 44 U.S.C. 2904 and 2906. Such disclosure shall be made in accordance with the GSA regulations governing inspection of records for this purpose, and any other relevant (i.e., GSA or Commerce) directive. Such disclosure shall not be used to make determinations about individuals.
8. A record from this system of records may be disclosed, as a routine use, to the public after either publication of the application pursuant to 35 U.S.C. 122(b) or issuance of a patent pursuant to 35 U.S.C. 151. Further, a record may be disclosed, subject to the limitations of 37 CFR 1.14, as a routine use, to the public if the record was filed in an application which became abandoned or in which the proceedings were terminated and which application is referenced by either a published application, an application open to public inspections or an issued patent.
9. A record from this system of records may be disclosed, as a routine use, to a Federal, State, or local law enforcement agency, if the USPTO becomes aware of a violation or potential violation of law or regulation.

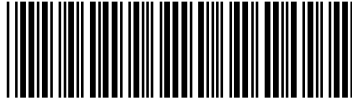
Index of Claims 	Application/Control No. 14875709	Applicant(s)/Patent Under Reexamination ISLAM, MOHAMMED N.
	Examiner ABRA FEIN	Art Unit 2884

✓	Rejected
=	Allowed

-	Cancelled
÷	Restricted

N	Non-Elected
I	Interference

A	Appeal
O	Objected

Claims renumbered in the same order as presented by applicant
 CPA
 T.D.
 R.1.47

CLAIM		DATE							
Final	Original	05/13/2016	10/11/2016						
	1	✓	=						
	2	✓	=						
	3	✓	=						
	4	✓	=						
	5	✓	✓						
	6	✓	✓						
	7	✓	✓						
	8	✓	✓						
	9	✓	✓						
	10	✓	✓						
	11	✓	✓						
	12	✓	✓						
	13	✓	✓						
	14	✓	✓						
	15	✓	✓						
	16	✓	✓						
	17	✓	✓						
	18	✓	✓						
	19	✓	✓						
	20	✓	✓						

EAST Search History

EAST Search History (Prior Art)

Ref #	Hits	Search Query	DBs	Default Operator	Plurals	Time Stamp
S1	1	(14/108986).APP.	US-PGPUB; USPAT	OR	OFF	2015/06/15 12:07
S2	1029	(250/338.4).CCLS.	US-PGPUB; USPAT	OR	OFF	2015/06/15 12:07
S3	269	((Mohammed) near2 (Islam)).INV.	US-PGPUB; USPAT	OR	ON	2015/06/15 12:07
S4	7	(("6885683") or ("6281471") or ("6340806") or ("6301271") or ("7294105") or ("20100046067") or ("20080105665")).PN.	US-PGPUB; USPAT	OR	OFF	2015/06/15 12:08
S5	52	(("5084880") or ("5180378") or ("5400165") or ("5458122") or ("5617871") or ("5631758") or ("5687734") or ("5696778") or ("5704351") or ("5718234") or ("5748103") or ("5855550") or ("5862803") or ("5847305") or ("5912749") or ("5944659") or ("5957854") or ("6014249") or ("6043927") or ("6289238") or ("6333803") or ("6364834") or ("6381391") or ("6402691") or ("6407853") or ("6441747") or ("6443890") or ("6454705") or ("6480656") or ("6549702") or ("6603910") or ("6659947") or ("6802811") or ("7167300") or ("7209657") or ("7263288") or ("7519253") or ("20020013518") or ("20020019584") or ("20020032468") or ("20020082612") or ("20020109621") or ("20020115914") or ("20020178003") or ("20040174914") or ("20040240037") or ("20050111511") or ("20060245461") or ("20060268393") or ("20070078348") or ("20090028193") or ("20090204110")).PN.	US-PGPUB; USPAT	OR	OFF	2015/06/15 12:12
S6	4	(("7787503") or ("7800818") or ("8000574") or ("6611643")).PN.	US-PGPUB; USPAT	OR	OFF	2015/06/15 12:13
S7	82	(("4063106") or ("4158750") or ("4221997") or ("4275266") or ("4374618") or ("4403605") or ("4462080") or ("4516207") or ("4523884") or ("4605080") or ("4641292") or ("4704696") or ("4728974") or ("4762455") or ("4776016") or ("4958910") or	US-PGPUB; USPAT	OR	OFF	2015/06/15 12:19

		("4989253") or ("5078140") or ("5084880") or ("5086401") or ("5134620") or ("5142930") or ("5180378") or ("5191628") or ("5218655") or ("5230023") or ("5267256") or ("5267323") or ("5300097") or ("5303148") or ("5305427") or ("5313306") or ("5323404") or ("5345538") or ("5408409") or ("5544654") or ("5572999") or ("5695493") or ("5696778") or ("5792204") or ("5812978") or ("5950629") or ("5970457") or ("6014249") or ("6185535") or ("6200309") or ("6224542") or ("6246707") or ("6273858") or ("6278975") or ("6301273") or ("6337462") or ("6340806") or ("6350261") or ("6374006") or ("6407853") or ("6436107") or ("6442430") or ("6450172") or ("6453201") or ("6458120") or ("6462500") or ("6463361") or ("6567431") or ("6605080") or ("6625180") or ("6631025") or ("6659999") or ("6760148") or ("6885498") or ("6885683") or ("6943936") or ("7027467") or ("7060061") or ("7167300") or ("7259906") or ("7433116") or ("20020032468") or ("20020082612") or ("20020128846") or ("20020178003") or ("20040174914").PN.				
S8	3	((("6246896") or ("6285897") or ("6847336")).PN.	US- PGPUB; USPAT	OR	OFF	2015/06/15 12:21
S9	30	((("5747806") or ("5115673") or ("6512936") or ("6534012") or ("6640117") or ("6788965") or ("6816241") or ("6738652") or ("6587702") or ("6864978") or ("6990364") or ("7010336") or ("7133710") or ("7233816") or ("7299080") or ("7317938") or ("7395158") or ("7519406") or ("7620674") or ("7697966") or ("7787924") or ("8145286") or ("6773922") or ("7807718") or ("20100331637") or ("20110143364") or ("20030022126") or ("20060223032") or ("20100322490") or ("20120013722")).PN.	US- PGPUB; USPAT	OR	OFF	2015/06/15 12:54
S10	2	((("8472108") or ("20130274569")).PN.	US- PGPUB; USPAT	OR	OFF	2015/06/15 12:54
S11	168	S4 S5 S6 S7 S8 S9 S10	US- PGPUB; USPAT; EPO; JPO; DERWENT	OR	ON	2015/06/15 13:07
S12	2	((12/206432) or (10/652276) or	US-	OR	OFF	2015/06/15

		(10/757341)).APP.	PGPUB; USPAT			14:48
S13	5	((("WOadj2014105520") or ("WOadj2014143276A9") or ("WOadj2014143276") or ("WOadj2013148656") or ("EPadj2831566") or ("WOadj2013148666") or ("EPadj2831565") or ("20130265568") or ("WOadj2014105521") or ("8859969") or ("20130256534") or ("20140236021") or ("CAadj2648549") or ("WOadj2007117867") or ("20060283931") or ("EPadj2011047") or ("EPadj1671094") or ("WOadj2005031302"))).PN.	US- PGPUB; USPAT	OR	OFF	2015/06/15 14:51
S14	16	WO adj "2014105520" WO adj "2014143276A9" WO adj "2014143276" WO adj "2013148656" EP adj "2831566" WO adj "2013148666" EP adj "2831565" "20130265568" WO adj "2014105521" "8859969" "20130256534" "20140236021" CA adj "2648549" WO adj "2007117867" "20060283931" EP adj "2011047" EP adj "1671094" WO adj "2005031302"	US- PGPUB; USPAT; EPO; JPO; DERWENT	OR	ON	2015/06/15 14:51
S15	7	((("6885683") or ("6281471") or ("6340806") or ("6301271") or ("7294105") or ("20100046067") or ("20080105665"))).PN.	US- PGPUB; USPAT	OR	OFF	2015/06/16 09:37
S16	52	((("5084880") or ("5180378") or ("5400165") or ("5458122") or ("5617871") or ("5631758") or ("5687734") or ("5696778") or ("5704351") or ("5718234") or ("5748103") or ("5855550") or ("5862803") or ("5847305") or ("5912749") or ("5944659") or ("5957854") or ("6014249") or ("6043927") or ("6289238") or ("6333803") or ("6364834") or ("6381391") or ("6402691") or ("6407853") or ("6441747") or ("6443890") or ("6454705") or ("6480656") or ("6549702") or ("6603910") or ("6659947") or ("6802811") or ("7167300") or ("7209657") or ("7263288") or ("7519253") or ("20020013518") or ("20020019584") or ("20020032468") or ("20020082612") or ("20020109621") or ("20020115914") or ("20020178003") or ("20040174914") or ("20040240037") or ("20050111511") or ("20060245461") or ("20060268393") or ("20070078348") or ("20090028193") or ("20090204110"))).PN.	US- PGPUB; USPAT	OR	OFF	2015/06/16 09:37
S17	4	((("7787503") or ("7800818") or ("8000574") or ("6611643"))).PN.	US- PGPUB; USPAT	OR	OFF	2015/06/16 09:37
S18	82	((("4063106") or ("4158750") or ("4221997") or ("4275266") or ("4374618") or ("4403605") or	US- PGPUB; USPAT	OR	OFF	2015/06/16 09:37

		("4462080") or ("4516207") or ("4523884") or ("4605080") or ("4641292") or ("4704696") or ("4728974") or ("4762455") or ("4776016") or ("4958910") or ("4989253") or ("5078140") or ("5084880") or ("5086401") or ("5134620") or ("5142930") or ("5180378") or ("5191628") or ("5218655") or ("5230023") or ("5267256") or ("5267323") or ("5300097") or ("5303148") or ("5305427") or ("5313306") or ("5323404") or ("5345538") or ("5408409") or ("5544654") or ("5572999") or ("5695493") or ("5696778") or ("5792204") or ("5812978") or ("5950629") or ("5970457") or ("6014249") or ("6185535") or ("6200309") or ("6224542") or ("6246707") or ("6273858") or ("6278975") or ("6301273") or ("6337462") or ("6340806") or ("6350261") or ("6374006") or ("6407853") or ("6436107") or ("6442430") or ("6450172") or ("6453201") or ("6458120") or ("6462500") or ("6463361") or ("6567431") or ("6605080") or ("6625180") or ("6631025") or ("6659999") or ("6760148") or ("6885498") or ("6885683") or ("6943936") or ("7027467") or ("7060061") or ("7167300") or ("7259906") or ("7433116") or ("20020032468") or ("20020082612") or ("20020128846") or ("20020178003") or ("20040174914")).PN.				
S19	3	(("6246896") or ("6285897") or ("6847336")).PN.	US- PGPUB; USPAT	OR	OFF	2015/06/16 09:37
S20	30	(("5747806") or ("5115673") or ("6512936") or ("6534012") or ("6640117") or ("6788965") or ("6816241") or ("6738652") or ("6587702") or ("6864978") or ("6990364") or ("7010336") or ("7133710") or ("7233816") or ("7299080") or ("7317938") or ("7395158") or ("7519406") or ("7620674") or ("7697966") or ("7787924") or ("8145286") or ("6773922") or ("7807718") or ("20100331637") or ("20110143364") or ("20030022126") or ("20060223032") or ("20100322490") or ("20120013722")).PN.	US- PGPUB; USPAT	OR	OFF	2015/06/16 09:37
S21	2	(("8472108") or ("20130274569")).PN.	US- PGPUB; USPAT	OR	OFF	2015/06/16 09:37
S22	168	S15 S16 S17 S18 S19 S20 S21	US- PGPUB;	OR	ON	2015/06/16 09:37

			USPAT; EPO; JPO; DERWENT			
S23	2	((12/206432) or (10/652276) or (10/757341)).APP.	US- PGPUB; USPAT	OR	OFF	2015/06/16 09:37
S24	5	(("WOadj2014105520") or ("WOadj2014143276A9") or ("WOadj2014143276") or ("WOadj2013148656") or ("EPadj2831566") or ("WOadj2013148666") or ("EPadj2831565") or ("20130265568") or ("WOadj2014105521") or ("8859969") or ("20130256534") or ("20140236021") or ("CAadj2648549") or ("WOadj2007117867") or ("20060283931") or ("EPadj2011047") or ("EPadj1671094") or ("WOadj2005031302")).PN.	US- PGPUB; USPAT	OR	OFF	2015/06/16 09:37
S25	16	WO adj "2014105520" WO adj 2014143276A9 WO adj "2014143276" WO adj "2013148656" EP adj "2831566" WO adj "2013148666" EP adj "2831565" "20130265568" WO adj "2014105521" "8859969" "20130256534" "20140236021" CA adj "2648549" WO adj "2007117867" "20060283931" EP adj "2011047" EP adj "1671094" WO adj "2005031302"	US- PGPUB; USPAT; EPO; JPO; DERWENT	OR	ON	2015/06/16 09:37
S26	185	S22 S23 S24 S25	US- PGPUB; USPAT; EPO; JPO; DERWENT	OR	ON	2015/06/16 09:37
S27	126	S26 and ((light near2 source)(near-infrared near-IR IR infrared NIR)SWIR(super near continuum super-continuum supercontinuum) SC (short near wave near infrared)(short near wave near IR))	US- PGPUB; USPAT; EPO; JPO; DERWENT	OR	ON	2015/06/16 09:44
S28	1	S26 and ((light near2 source)(near-infrared near-IR IR infrared NIR)SWIR(super near continuum super-continuum supercontinuum) SC (short near wave near infrared)(short near wave near IR)) same semiconductor same (multiplexer multiplexor)	US- PGPUB; USPAT; EPO; JPO; DERWENT	OR	ON	2015/06/16 09:46
S29	24	S26 and ((light near2 source)(near-infrared near-IR IR infrared NIR)SWIR(super near continuum super-continuum supercontinuum) SC (short near wave near infrared)(short near wave near IR)) and semiconductor and(multiplexer multiplexor)	US- PGPUB; USPAT; EPO; JPO; DERWENT	OR	ON	2015/06/16 09:47
S30	24	S26 and ((light near2 source)(near-infrared near-IR IR infrared NIR)SWIR(super near continuum super-continuum supercontinuum) SC (short near wave near infrared)(short near wave near IR)) and semiconduct\$5 and(multiplexer multiplexor)	US- PGPUB; USPAT; EPO; JPO; DERWENT	OR	ON	2015/06/16 09:47

S31	21	S26 and ((light near2 source)(near-infrared near-IR NIR)SWIR(super near continuum super-continuum supercontinuum) SC (short near wave near infrared)(short near wave near IR)) and semiconduct\$5 and(multiplexer multiplexor)	US-PGPUB; USPAT; EPO; JPO; DERWENT	OR	ON	2015/06/16 09:48
S32	648	((light near2 source)(near-infrared near-IR NIR)SWIR(super near continuum super-continuum supercontinuum) SC (short near wave near infrared)(short near wave near IR)) same semiconduct\$5 same (multiplexer multiplexor)	US-PGPUB; USPAT; EPO; JPO; DERWENT	OR	ON	2015/06/16 10:05
S33	123	((light near2 source)(near-infrared near-IR NIR)SWIR(super near continuum super-continuum supercontinuum) SC (short near wave near infrared)(short near wave near IR)) same (semiconduct\$5 with amplif\$6)same fiber same (multiplexer multiplexor)	US-PGPUB; USPAT; EPO; JPO; DERWENT	OR	ON	2015/06/16 10:08
S34	5	((light near2 source)(near-infrared near-IR NIR)SWIR(super near continuum super-continuum supercontinuum) SC (short near wave near infrared)(short near wave near IR)) same (semiconduct\$5 with amplif\$6)same fiber same (multiplexer multiplexor)same sample	US-PGPUB; USPAT; EPO; JPO; DERWENT	OR	ON	2015/06/16 10:37
S35	6	S25 and (semiconduct\$5 multiplex\$5)	US-PGPUB; USPAT; EPO; JPO; DERWENT	OR	ON	2015/06/16 10:50
S36	2	S25 and (multiplex\$5)	US-PGPUB; USPAT; EPO; JPO; DERWENT	OR	ON	2015/06/16 10:50
S37	6	S25 and (semiconduct\$5 multiplex\$5 mux)	US-PGPUB; USPAT; EPO; JPO; DERWENT	OR	ON	2015/06/16 10:51
S38	8	S25 and (laser (super near luminesc\$5 near diode)LED (light near emit\$5 near diode))	US-PGPUB; USPAT; EPO; JPO; DERWENT	OR	ON	2015/06/16 10:53
S39	9	S25 and (fiber)	US-PGPUB; USPAT; EPO; JPO; DERWENT	OR	ON	2015/06/16 10:54
S40	1	S25 and (FTIR)	US-PGPUB; USPAT; EPO; JPO; DERWENT	OR	ON	2015/06/16 10:56
S41	4	S25 and (fourier)	US-PGPUB; USPAT;	OR	ON	2015/06/16 10:59

			EPO; JPO; DERWENT			
S42	4	S25 and (fourier with (IR infrared infra-red))	US- PGPUB; USPAT; EPO; JPO; DERWENT	OR	ON	2015/06/16 10:59
S43	4	S25 and (fourier near4 (IR infrared infra-red))	US- PGPUB; USPAT; EPO; JPO; DERWENT	OR	ON	2015/06/16 10:59
S44	575	((light near2 source)(near-infrared near-IR NIR)SWIR(super near continuum super-continuum supercontinuum) SC (short near wave near infrared)(short near wave near IR) same (multiplexer multiplexer) same sample	US- PGPUB; USPAT; EPO; JPO; DERWENT	OR	ON	2015/06/16 11:21
S45	8428	((light near2 source)(near-infrared near-IR NIR)SWIR(super near continuum super-continuum supercontinuum) SC (short near wave near infrared)(short near wave near IR) same (multiplexer multiplexer)	US- PGPUB; USPAT; EPO; JPO; DERWENT	OR	ON	2015/06/16 11:21
S46	3	((light near2 source)(near-infrared near-IR NIR)SWIR(super near continuum super-continuum supercontinuum) SC (short near wave near infrared)(short near wave near IR) same (multiplexer multiplexer) same (pharmaceutical counterfeit illicit contraband)	US- PGPUB; USPAT; EPO; JPO; DERWENT	OR	ON	2015/06/16 11:22
S47	59	(multiplexer multiplexer) same (pharmaceutical counterfeit illicit contraband)	US- PGPUB; USPAT; EPO; JPO; DERWENT	OR	ON	2015/06/16 13:07
S48	4	(multiplexer multiplexer) same (pharmaceutical counterfeit illicit contraband) and "250".clas.	US- PGPUB; USPAT; EPO; JPO; DERWENT	OR	ON	2015/06/16 13:08
S49	23	(multiplexer multiplexer) same (pharmaceutical counterfeit illicit contraband) and fiber	US- PGPUB; USPAT; EPO; JPO; DERWENT	OR	ON	2015/06/16 13:12
S50	2	(multiplexer multiplexer) same (pharmaceutical counterfeit illicit contraband) and fiber and "250".clas.	US- PGPUB; USPAT; EPO; JPO; DERWENT	OR	ON	2015/06/16 13:12
S51	23	(multiplexer multiplexer) same (pharmaceutical counterfeit illicit contraband) and fiber	US- PGPUB; USPAT; EPO; JPO; DERWENT	OR	ON	2015/06/16 13:12
S52	7	(multiplexer multiplexer) same (pharmaceutical counterfeit illicit contraband) same fiber	US- PGPUB; USPAT; EPO; JPO; DERWENT	OR	ON	2015/06/16 13:12

S53	115	S26 and fiber	US-PGPUB; USPAT; EPO; JPO; DERWENT	OR	ON	2015/06/16 13:14
S54	43	S26 and(fiber with beam)	US-PGPUB; USPAT; EPO; JPO; DERWENT	OR	ON	2015/06/16 13:14
S55	2	S26 and(fiber with beam)and "250".clas.	US-PGPUB; USPAT; EPO; JPO; DERWENT	OR	ON	2015/06/16 13:14
S56	9	S26 and(FTIR FT-IR ("fourier transform infrared"))	US-PGPUB; USPAT; EPO; JPO; DERWENT	OR	ON	2015/06/16 13:20
S57	270	((Mohammed) near2 (Islam)).INV.	US-PGPUB; USPAT	OR	ON	2015/06/16 13:22
S58	67	S57 and multiplexer.clm.	US-PGPUB; USPAT	OR	ON	2015/06/16 13:22
S59	21	S57 and ((multiplexer and semiconductor and fibers).clm.)	US-PGPUB; USPAT	OR	ON	2015/06/16 13:23
S60	2	S57 and ((multiplexer and semiconductor and fibers and FTIR).clm.)	US-PGPUB; USPAT	OR	ON	2015/06/16 13:23
S61	125	S57 and (broaden\$5)	US-PGPUB; USPAT	OR	ON	2015/06/16 16:17
S62	64	S57 and (broaden\$5 with (nonlinear nonlinear))	US-PGPUB; USPAT	OR	ON	2015/06/16 16:17
S63	29	S57 and (broaden\$5 with (nonlinear nonlinear) with spectrum)	US-PGPUB; USPAT	OR	ON	2015/06/16 16:17
S64	9	S57 and (broaden\$5 near4(nonlinear nonlinear) with spectrum)	US-PGPUB; USPAT	OR	ON	2015/06/16 16:17
S65	2	S57 and (organic with (overtone (combination\$5 absor%8)))	US-PGPUB; USPAT	OR	ON	2015/06/16 16:31
S66	2	S57 and (organic with (overtone (combination\$5 near absor\$8)))	US-PGPUB; USPAT	OR	ON	2015/06/16 16:32
S67	206	(organic with (overtone (combination\$5 near absor\$8)))	US-PGPUB; USPAT	OR	ON	2015/06/16 16:32
S68	62	(organic with (overtone))	US-PGPUB; USPAT	OR	ON	2015/06/16 16:40
S69	14	(organic with (overtone))and "250".clas.	US-PGPUB;	OR	ON	2015/06/16 16:40

			USPAT			
S70	1	("6105823").PN.	US-PGPUB; USPAT	OR	OFF	2015/06/17 16:05
S71	320	abrahamsson.in.	US-PGPUB; USPAT; EPO; JPO; DERWENT	OR	ON	2015/06/17 16:05
S72	4	abrahamsson.in. and multiplexer	US-PGPUB; USPAT; EPO; JPO; DERWENT	OR	ON	2015/06/17 16:06
S73	1034	(250/338.4).CCLS.	US-PGPUB; USPAT	OR	OFF	2015/07/23 13:49
S74	5	((light near2 source)(near-infrared near-IR) SWIR(super near continuum supercontinuum supercontinuum) SC (short near wave near infrared)(short near wave near IR) same (semiconduct\$5 with amplif\$6)same fiber same (multiplexer multiplexer)same sample	US-PGPUB; USPAT; EPO; JPO; DERWENT	OR	ON	2015/07/23 13:49
S75	2	(multiplexer multiplexer) same (pharmaceutical counterfeit illicit contraband) and fiber and "250".clas.	US-PGPUB; USPAT; EPO; JPO; DERWENT	OR	ON	2015/07/23 13:50
S76	125	((light near2 source)(near-infrared near-IR) SWIR(super near continuum supercontinuum supercontinuum) SC (short near wave near infrared)(short near wave near IR) same (semiconduct\$5 with amplif\$6)same fiber same (multiplexer multiplexer)	US-PGPUB; USPAT; EPO; JPO; DERWENT	OR	ON	2015/07/23 13:50
S77	8	(multiplexer multiplexer) same (pharmaceutical counterfeit illicit contraband)same fiber	US-PGPUB; USPAT; EPO; JPO; DERWENT	OR	ON	2015/07/23 13:50
S78	14	(organic with (overtone))and "250".clas.	US-PGPUB; USPAT	OR	ON	2015/07/23 13:50
S79	1	(sample) with (overtone or "combinational absorption band") with(wavelength near range) .clm.	US-PGPUB; USPAT	OR	ON	2015/07/23 13:53
S81	7	250/338.4 and @pd> "20150625"	US-PGPUB; USPAT; EPO; JPO; DERWENT	OR	ON	2015/07/24 11:51
S89	1	("20100161794").PN.	US-PGPUB; USPAT	OR	OFF	2016/05/13 11:39
S90	606	banet.in.	US-PGPUB; USPAT; EPO; JPO;	OR	ON	2016/05/13 11:40

			DERWENT			
S91	5	(US-20060283931-\$ or US-20090028193-\$ or US-20100160798-\$).did. or (US-8000574-\$ or US-6181414-\$).did.	US-PGPUB; USPAT	OR	ON	2016/05/13 11:58
S92	0	S91 and (LED light near emit\$7 near diode) with puls\$5	US-PGPUB; USPAT; EPO; JPO; DERWENT	OR	ON	2016/05/13 11:58
S93	93	(near-infrared near-IR)with(LED light near emit\$7 near diode) with puls\$5	US-PGPUB; USPAT; EPO; JPO; DERWENT	OR	ON	2016/05/13 11:59
S94	8	(near-infrared near-IR)with(LED light near emit\$7 near diode) with puls\$5 and "250".clas.	US-PGPUB; USPAT; EPO; JPO; DERWENT	OR	ON	2016/05/13 11:59
S95	1059	(250/338.4).OCLS.	US-PGPUB; USPAT	OR	OFF	2016/05/13 13:56
S96	1	("9164032").PN.	US-PGPUB; USPAT	OR	OFF	2016/05/17 14:53
S97	1	("0612310").PN.	US-PGPUB; USPAT	OR	OFF	2016/05/17 15:31
S98	1	("20140249427").PN.	US-PGPUB; USPAT	OR	OFF	2016/05/17 15:32
S99	1067	(250/338.4).OCLS.	US-PGPUB; USPAT	OR	OFF	2016/10/11 11:38
S100	0	(light near source) with increas\$4 near2 signal\$to\$noise near ratio with light near intensit\$4 with semiconduct\$4 with pulse near2 rate	US-PGPUB; USPAT; EPO; JPO; DERWENT	OR	ON	2016/10/11 11:39
S101	0	(light near source) with increas\$4 near2 signal\$to\$noise near ratio with light near intensit\$4 with semiconduct\$4	US-PGPUB; USPAT; EPO; JPO; DERWENT	OR	ON	2016/10/11 11:40
S102	0	(light near source) with increas\$4 near2 "signal to noise" near ratio with light near intensit\$4 with semiconduct\$4	US-PGPUB; USPAT; EPO; JPO; DERWENT	OR	ON	2016/10/11 11:40
S103	0	(light near source) with increas\$4 near2 "signal to noise" near ratio with light near intensit\$4	US-PGPUB; USPAT; EPO; JPO; DERWENT	OR	ON	2016/10/11 11:57
S104	0	(light) with increas\$4 near2 "signal to noise" near ratio with light near intensit\$4	US-PGPUB; USPAT; EPO; JPO; DERWENT	OR	ON	2016/10/11 11:58

S105	0	(source) with increas\$4 near2 "signal to noise" near ratio with light near intensit\$4	US-PGPUB; USPAT; EPO; JPO; DERWENT	OR	ON	2016/10/11 11:58
S106	0	increas\$4 near2 "signal to noise" near ratio with light near intensit\$4	US-PGPUB; USPAT; EPO; JPO; DERWENT	OR	ON	2016/10/11 11:58
S107	136	increas\$4 near2 "signal to noise" near ratio	US-PGPUB; USPAT; EPO; JPO; DERWENT	OR	ON	2016/10/11 11:58
S108	0	increas\$4 near2 "signal to noise" near ratio with (increas\$4 near2 light near intensit\$4)	US-PGPUB; USPAT; EPO; JPO; DERWENT	OR	ON	2016/10/11 11:59
S109	0	increas\$4 near2 "signal to noise" near ratio with (light near intensit\$4)	US-PGPUB; USPAT; EPO; JPO; DERWENT	OR	ON	2016/10/11 11:59
S110	1	increas\$4 near2 "signal to noise" near ratio with (intensit\$4)	US-PGPUB; USPAT; EPO; JPO; DERWENT	OR	ON	2016/10/11 11:59
S111	31	"signal to noise" near ratio with (intensit\$4)	US-PGPUB; USPAT; EPO; JPO; DERWENT	OR	ON	2016/10/11 12:04
S112	1	increas\$4 near4 "signal to noise" near ratio with (intensit\$4)	US-PGPUB; USPAT; EPO; JPO; DERWENT	OR	ON	2016/10/11 12:05
S113	1	(increas\$4 near4 "signal to noise ratio") with (intensit\$4)	US-PGPUB; USPAT; EPO; JPO; DERWENT	OR	ON	2016/10/11 12:06
S114	0	(increas\$4 near4 "signal to noise ratio") with (pulse near rate)	US-PGPUB; USPAT; EPO; JPO; DERWENT	OR	ON	2016/10/11 12:06
S115	10	(increas\$4 near4 (signal near2 noise near ratio)) with (pulse near rate)	US-PGPUB; USPAT; EPO; JPO; DERWENT	OR	ON	2016/10/11 12:06
S116	2	(increas\$4 near4 (signal near2 noise near ratio)) with increas\$4 near2(pulse near rate)	US-PGPUB; USPAT; EPO; JPO; DERWENT	OR	ON	2016/10/11 12:07

S117	7	(US-20060283931-\$ or US-20090028193-\$ or US-20100160798-\$ or US-20090244288-\$ or US-20140249427-\$).did. or (US-8000574-\$ or US-6181414-\$).did.	US-PGPUB; USPAT	OR	ON	2016/10/11 13:22
S118	5	S117 and (lens lenses)	US-PGPUB; USPAT; EPO; JPO; DERWENT	OR	ON	2016/10/11 13:22
S119	1	S117 and ((lens lenses)with sample)	US-PGPUB; USPAT; EPO; JPO; DERWENT	OR	ON	2016/10/11 13:23
S120	1	S117 and ((lenses)with sample)	US-PGPUB; USPAT; EPO; JPO; DERWENT	OR	ON	2016/10/11 13:24
S121	0	S117 and ((plurality near2 lenses)with sample)	US-PGPUB; USPAT; EPO; JPO; DERWENT	OR	ON	2016/10/11 13:25
S122	3	((plurality near2 lenses)with (output near2 beam) near4 sample)	US-PGPUB; USPAT; EPO; JPO; DERWENT	OR	ON	2016/10/11 13:25
S123	491	(G01N33/15.cpc. G01N21/359.cpc. G01N33/49.cpc.)and @pd> "20160513"	US-PGPUB; USPAT; EPO; JPO; DERWENT	OR	ON	2016/10/11 14:02
S132	1	("8180422").PN.	US-PGPUB; USPAT	OR	OFF	2016/10/11 14:45
S133	19	((("8180422") or ("7771320") or ("6619835") or ("9326712") or ("5267152") or ("7356364") or ("5246004") or ("8472108") or ("20100217102") or ("20120310062") or ("20120316455") or ("20140275854") or ("20140275852") or ("20160045118") or ("20110208015") or ("20110040197") or ("20070021670") or ("20110282167") or ("20130274569")).PN.	US-PGPUB; USPAT	OR	OFF	2016/10/11 14:48
S134	0	S133 and signal adj to adj noise near2 ratio	US-PGPUB; USPAT; EPO; JPO; DERWENT	OR	ON	2016/10/11 14:49

EAST Search History (Interference)

Ref #	Hits	Search Query	DBs	Default Operator	Plurals	Time Stamp
S80	0	(sample) with (overtone or "combinational absorption band") with(wavelength near	USPAT	OR	ON	2015/07/23 13:53

		range) .clm.				
S82	7	250/338.4 and @pd> "20150625"	USPAT	OR	ON	2015/07/24 11:51
S83	47202	G01N 21/35 and @pd> "20150625"	USPAT	OR	ON	2015/07/24 11:51
S84	54478	A61B 5/1455 and @pd> "20150625"	USPAT	OR	ON	2015/07/24 11:51
S86	54480	A61B 5/0075 and @pd> "20150625"	USPAT	OR	ON	2015/07/24 11:52
S87	9513	H01S 3/302 and @pd> "20150625"	USPAT	OR	ON	2015/07/24 11:52
S88	0	(S82 S83 S84 S86 S87)and (non-destructive with non-contact with measur\$5) with deliver\$5.clm.	USPAT	OR	ON	2015/07/24 11:54
S128	71	(G01N33/15.cpc. G01N21/359.cpc. G01N33/49.cpc.)and @pd> "20160513"	USPAT	OR	ON	2016/10/11 14:02
S130	45	250/338.4 and @pd> "20160513"	USPAT	OR	ON	2016/10/11 14:02
S131	0	(increas\$4 near4 (signal near2 noise near ratio)) with increas\$4 near2(pulse near rate).clm.	USPAT	OR	ON	2016/10/11 14:35

10/ 11/ 2016 2:51:49 PM

C:\ Users\ afein\ Documents\ EAST\ Workspaces\ 14\ 14875709.wsp

Receipt date: 07/21/2016

14875709 - CALL: 2884

Doc code: IDS

Pat. Sec. 101-10

Doc description: Information Disclosure Statement (IDS) Filed

Approved for use through 07/31/2012. OMB 0651-0031
U.S. Patent and Trademark Office; U.S. DEPARTMENT OF COMMERCE

Under the Paperwork Reduction Act of 1995, no persons are required to respond to a collection of information unless it contains a valid OMB control number.

INFORMATION DISCLOSURE STATEMENT BY APPLICANT (Not for submission under 37 CFR 1.99)	Application Number	14875709
	Filing Date	2015-10-06
	First Named Inventor	Mohammed N. ISLAM
	Art Unit	2884
	Examiner Name	Abra S. Fein
	Attorney Docket Number	OMNI 0105 PUSP1

U.S.PATENTS							Remove
Examiner Initial*	Cite No	Patent Number	Kind Code ¹	Issue Date	Name of Patentee or Applicant of cited Document	Pages,Columns,Lines where Relevant Passages or Relevant Figures Appear	
	1	8180422	B2	2012-05-15	Rebec		

If you wish to add additional U.S. Patent citation information please click the Add button.

U.S.PATENT APPLICATION PUBLICATIONS							Remove
Examiner Initial*	Cite No	Publication Number	Kind Code ¹	Publication Date	Name of Patentee or Applicant of cited Document	Pages,Columns,Lines where Relevant Passages or Relevant Figures Appear	
	1						

If you wish to add additional U.S. Published Application citation information please click the Add button.

FOREIGN PATENT DOCUMENTS								Remove
Examiner Initial*	Cite No	Foreign Document Number ³	Country Code ² i	Kind Code ⁴	Publication Date	Name of Patentee or Applicant of cited Document	Pages,Columns,Lines where Relevant Passages or Relevant Figures Appear	T ⁵
	1	102010012987	DE	A1	2010-10-07	FRAUNHOFER GES FORSCHUNG		
	2	2005013843	WO	A2	2005-02-17	The Regents of the University of California		
	3	2007061772	WO	A2	2007-05-31	OMNI SCIENCES, INC.		

ALL REFERENCES CONSIDERED EXCEPT WHERE LINED THROUGH. /A.F./

INFORMATION DISCLOSURE STATEMENT BY APPLICANT (Not for submission under 37 CFR 1.99)	Application Number		14875709	14875709 - GAU: 2884
	Filing Date		2015-10-06	
	First Named Inventor	Mohammed N. ISLAM		
	Art Unit	2884		
	Examiner Name	Abra S. Fein		
	Attorney Docket Number	OMNI 0105 PUSP1		

4	2009130464	WO	A1	2009-10-29	UNIVERSITY OF MANCHESTER		
---	------------	----	----	------------	--------------------------	--	--

If you wish to add additional Foreign Patent Document citation information please click the Add button

NON-PATENT LITERATURE DOCUMENTS

Examiner Initials*	Cite No	Include name of the author (in CAPITAL LETTERS), title of the article (when appropriate), title of the item (book, magazine, journal, serial, symposium, catalog, etc), date, pages(s), volume-issue number(s), publisher, city and/or country where published.	T ⁵
	1	VINAY V. ALEXANDER ET AL.; Modulation Instability High Power All-Fiber Supercontinuum Lasers And Their Applications; Optical Fiber Technology 18; 2012; pages 349-374.	
	2	ROBERT S. JONES ET AL.; Near-Infrared Transillumination At 1310-nm For The Imaging Of Early Dental Decay; Volume 11, No. 18; Optics Express 2259; September 8, 2003	
	3	Extended European Search Report for European Application No. 13867874.3 dated July 15, 2016	
	4	Extended European Search Report for European Application No. 13867892.5 dated July 22, 2016	

If you wish to add additional non-patent literature document citation information please click the Add button

EXAMINER SIGNATURE

Examiner Signature	/Abra Fein/	Date Considered	10/11/2016
--------------------	-------------	-----------------	------------

*EXAMINER: Initial if reference considered, whether or not citation is in conformance with MPEP 609. Draw line through a citation if not in conformance and not considered. Include copy of this form with next communication to applicant.

¹ See Kind Codes of USPTO Patent Documents at www.USPTO.GOV or MPEP 901.04. ² Enter office that issued the document, by the two-letter code (WIPO Standard ST.3). ³ For Japanese patent documents, the indication of the year of the reign of the Emperor must precede the serial number of the patent document. ⁴ Kind of document by the appropriate symbols as indicated on the document under WIPO Standard ST.16 if possible. ⁵ Applicant is to place a check mark here if English language translation is attached.

INFORMATION DISCLOSURE STATEMENT BY APPLICANT (Not for submission under 37 CFR 1.99)	Application Number	14875709	14875709 - GAU: 2884
	Filing Date	2015-10-06	
	First Named Inventor	Mohammed N. ISLAM	
	Art Unit	2884	
	Examiner Name	Abra S. Fein	
	Attorney Docket Number	OMNI 0105 PUSP1	

CERTIFICATION STATEMENT

Please see 37 CFR 1.97 and 1.98 to make the appropriate selection(s):

That each item of information contained in the information disclosure statement was first cited in any communication from a foreign patent office in a counterpart foreign application not more than three months prior to the filing of the information disclosure statement. See 37 CFR 1.97(e)(1).

OR

That no item of information contained in the information disclosure statement was cited in a communication from a foreign patent office in a counterpart foreign application, and, to the knowledge of the person signing the certification after making reasonable inquiry, no item of information contained in the information disclosure statement was known to any individual designated in 37 CFR 1.56(c) more than three months prior to the filing of the information disclosure statement. See 37 CFR 1.97(e)(2).

See attached certification statement.

The fee set forth in 37 CFR 1.17 (p) has been submitted herewith.

A certification statement is not submitted herewith.

SIGNATURE

A signature of the applicant or representative is required in accordance with CFR 1.33, 10.18. Please see CFR 1.4(d) for the form of the signature.

Signature	/David S. Bir/	Date (YYYY-MM-DD)	2016-07-21
Name/Print	David S. Bir	Registration Number	38383

This collection of information is required by 37 CFR 1.97 and 1.98. The information is required to obtain or retain a benefit by the public which is to file (and by the USPTO to process) an application. Confidentiality is governed by 35 U.S.C. 122 and 37 CFR 1.14. This collection is estimated to take 1 hour to complete, including gathering, preparing and submitting the completed application form to the USPTO. Time will vary depending upon the individual case. Any comments on the amount of time you require to complete this form and/or suggestions for reducing this burden, should be sent to the Chief Information Officer, U.S. Patent and Trademark Office, U.S. Department of Commerce, P.O. Box 1450, Alexandria, VA 22313-1450. **DO NOT SEND FEES OR COMPLETED FORMS TO THIS ADDRESS. SEND TO: Commissioner for Patents, P.O. Box 1450, Alexandria, VA 22313-1450.**

Privacy Act Statement

The Privacy Act of 1974 (P.L. 93-579) requires that you be given certain information in connection with your submission of the attached form related to a patent application or patent. Accordingly, pursuant to the requirements of the Act, please be advised that: (1) the general authority for the collection of this information is 35 U.S.C. 2(b)(2); (2) furnishing of the information solicited is voluntary; and (3) the principal purpose for which the information is used by the U.S. Patent and Trademark Office is to process and/or examine your submission related to a patent application or patent. If you do not furnish the requested information, the U.S. Patent and Trademark Office may not be able to process and/or examine your submission, which may result in termination of proceedings or abandonment of the application or expiration of the patent.

The information provided by you in this form will be subject to the following routine uses:

1. The information on this form will be treated confidentially to the extent allowed under the Freedom of Information Act (5 U.S.C. 552) and the Privacy Act (5 U.S.C. 552a). Records from this system of records may be disclosed to the Department of Justice to determine whether the Freedom of Information Act requires disclosure of these records.
2. A record from this system of records may be disclosed, as a routine use, in the course of presenting evidence to a court, magistrate, or administrative tribunal, including disclosures to opposing counsel in the course of settlement negotiations.
3. A record in this system of records may be disclosed, as a routine use, to a Member of Congress submitting a request involving an individual, to whom the record pertains, when the individual has requested assistance from the Member with respect to the subject matter of the record.
4. A record in this system of records may be disclosed, as a routine use, to a contractor of the Agency having need for the information in order to perform a contract. Recipients of information shall be required to comply with the requirements of the Privacy Act of 1974, as amended, pursuant to 5 U.S.C. 552a(m).
5. A record related to an International Application filed under the Patent Cooperation Treaty in this system of records may be disclosed, as a routine use, to the International Bureau of the World Intellectual Property Organization, pursuant to the Patent Cooperation Treaty.
6. A record in this system of records may be disclosed, as a routine use, to another federal agency for purposes of National Security review (35 U.S.C. 181) and for review pursuant to the Atomic Energy Act (42 U.S.C. 218(c)).
7. A record from this system of records may be disclosed, as a routine use, to the Administrator, General Services, or his/her designee, during an inspection of records conducted by GSA as part of that agency's responsibility to recommend improvements in records management practices and programs, under authority of 44 U.S.C. 2904 and 2906. Such disclosure shall be made in accordance with the GSA regulations governing inspection of records for this purpose, and any other relevant (i.e., GSA or Commerce) directive. Such disclosure shall not be used to make determinations about individuals.
8. A record from this system of records may be disclosed, as a routine use, to the public after either publication of the application pursuant to 35 U.S.C. 122(b) or issuance of a patent pursuant to 35 U.S.C. 151. Further, a record may be disclosed, subject to the limitations of 37 CFR 1.14, as a routine use, to the public if the record was filed in an application which became abandoned or in which the proceedings were terminated and which application is referenced by either a published application, an application open to public inspections or an issued patent.
9. A record from this system of records may be disclosed, as a routine use, to a Federal, State, or local law enforcement agency, if the USPTO becomes aware of a violation or potential violation of law or regulation.

Search Notes 	Application/Control No. 14875709	Applicant(s)/Patent Under Reexamination ISLAM, MOHAMMED N.
	Examiner ABRA FEIN	Art Unit 2884

CPC- SEARCHED		
Symbol	Date	Examiner
G01N33/15, G01N21/359, G01N33/49	5/13/2016	/A.F./

CPC COMBINATION SETS - SEARCHED		
Symbol	Date	Examiner

US CLASSIFICATION SEARCHED			
Class	Subclass	Date	Examiner
250	338.4	5/13/2016	/A.F./
	refreshed	10/11/2016	/A.F./

SEARCH NOTES			
Search Notes	Date	Examiner	
Inventor Name Search	5/13/2016	/A.F./	
EAST text search	5/13/2016	/A.F./	
Class 250 text search	5/13/2016	/A.F./	
Consultation with Yara Green (class 250)	5/17/2016	/A.F./	
EAST text search	10/11/2016	/A.F./	
Consultation with Yara Green (class 250)	10/14/2016	/A.F./	

INTERFERENCE SEARCH			
US Class/ CPC Symbol	US Subclass / CPC Group	Date	Examiner
	claims	10/11/2016	/A.F./
250	338.4	10/11/2016	/A.F./
G01N	G01N3315, G01N1/359, G01N33/49	10/11/2016	/A.F./

/A.F./ Examiner.Art Unit 2884	
----------------------------------	--



UNITED STATES PATENT AND TRADEMARK OFFICE

UNITED STATES DEPARTMENT OF COMMERCE
United States Patent and Trademark Office
Address: COMMISSIONER FOR PATENTS
P.O. Box 1450
Alexandria, Virginia 22313-1450
www.uspto.gov

Table with 5 columns: APPLICATION NO., FILING DATE, FIRST NAMED INVENTOR, ATTORNEY DOCKET NO., CONFIRMATION NO. Includes application details for Mohammed N. Islam and administrative information like EXAMINER FEIN, ABRA S.

Please find below and/or attached an Office communication concerning this application or proceeding.

The time period for reply, if any, is set in the attached communication.

Notice of the Office communication was sent electronically on above-indicated "Notification Date" to the following e-mail address(es):

docketing@brookskushman.com

Applicant-Initiated Interview Summary	Application No. 14/875,709	Applicant(s) ISLAM, MOHAMMED N.	
	Examiner Abra Fein	Art Unit 2884	

All participants (applicant, applicant's representative, PTO personnel):

- (1) Abra Fein. (3) David S. Bir.
(2) Dave Porta. (4) _____.

Date of Interview: 02 November 2016.

Type: Telephonic Video Conference
 Personal [copy given to: applicant applicant's representative]

Exhibit shown or demonstration conducted: Yes No.
If Yes, brief description: _____.

Issues Discussed 101 112 102 103 Others
(For each of the checked box(es) above, please describe below the issue and detailed description of the discussion)

Claim(s) discussed: 6 and 15.

Identification of prior art discussed: Fidler.

Substance of Interview

(For each issue discussed, provide a detailed description and indicate if agreement was reached. Some topics may include: identification or clarification of a reference or a portion thereof, claim interpretation, proposed amendments, arguments of any applied references etc...)

Discussed dependent claim 6 and 15 and agreed that Fidler does not sufficiently teach the receiver is configured to be synchronized to the light source. The Applicant suggested they would likely write dependent claims 6 and 15 into independent claims 5 and 14. An additional prior art search will be conducted.

Applicant recordation instructions: The formal written reply to the last Office action must include the substance of the interview. (See MPEP section 713.04). If a reply to the last Office action has already been filed, applicant is given a non-extendable period of the longer of one month or thirty days from this interview date, or the mailing date of this interview summary form, whichever is later, to file a statement of the substance of the interview

Examiner recordation instructions: Examiners must summarize the substance of any interview of record. A complete and proper recordation of the substance of an interview should include the items listed in MPEP 713.04 for complete and proper recordation including the identification of the general thrust of each argument or issue discussed, a general indication of any other pertinent matters discussed regarding patentability and the general results or outcome of the interview, to include an indication as to whether or not agreement was reached on the issues raised.

Attachment

/A. F./
Examiner, Art Unit 2884

/DAVID PORTA/
Supervisory Patent Examiner, Art Unit 2884

Summary of Record of Interview Requirements

Manual of Patent Examining Procedure (MPEP), Section 713.04, Substance of Interview Must be Made of Record

A complete written statement as to the substance of any face-to-face, video conference, or telephone interview with regard to an application must be made of record in the application whether or not an agreement with the examiner was reached at the interview.

Title 37 Code of Federal Regulations (CFR) § 1.133 Interviews

Paragraph (b)

In every instance where reconsideration is requested in view of an interview with an examiner, a complete written statement of the reasons presented at the interview as warranting favorable action must be filed by the applicant. An interview does not remove the necessity for reply to Office action as specified in §§ 1.111, 1.135. (35 U.S.C. 132)

37 CFR §1.2 Business to be transacted in writing.

All business with the Patent or Trademark Office should be transacted in writing. The personal attendance of applicants or their attorneys or agents at the Patent and Trademark Office is unnecessary. The action of the Patent and Trademark Office will be based exclusively on the written record in the Office. No attention will be paid to any alleged oral promise, stipulation, or understanding in relation to which there is disagreement or doubt.

The action of the Patent and Trademark Office cannot be based exclusively on the written record in the Office if that record is itself incomplete through the failure to record the substance of interviews.

It is the responsibility of the applicant or the attorney or agent to make the substance of an interview of record in the application file, unless the examiner indicates he or she will do so. It is the examiner's responsibility to see that such a record is made and to correct material inaccuracies which bear directly on the question of patentability.

Examiners must complete an Interview Summary Form for each interview held where a matter of substance has been discussed during the interview by checking the appropriate boxes and filling in the blanks. Discussions regarding only procedural matters, directed solely to restriction requirements for which interview recordation is otherwise provided for in Section 812.01 of the Manual of Patent Examining Procedure, or pointing out typographical errors or unreadable script in Office actions or the like, are excluded from the interview recordation procedures below. Where the substance of an interview is completely recorded in an Examiners Amendment, no separate Interview Summary Record is required.

The Interview Summary Form shall be given an appropriate Paper No., placed in the right hand portion of the file, and listed on the "Contents" section of the file wrapper. In a personal interview, a duplicate of the Form is given to the applicant (or attorney or agent) at the conclusion of the interview. In the case of a telephone or video-conference interview, the copy is mailed to the applicant's correspondence address either with or prior to the next official communication. If additional correspondence from the examiner is not likely before an allowance or if other circumstances dictate, the Form should be mailed promptly after the interview rather than with the next official communication.

The Form provides for recordation of the following information:

- Application Number (Series Code and Serial Number)
- Name of applicant
- Name of examiner
- Date of interview
- Type of interview (telephonic, video-conference, or personal)
- Name of participant(s) (applicant, attorney or agent, examiner, other PTO personnel, etc.)
- An indication whether or not an exhibit was shown or a demonstration conducted
- An identification of the specific prior art discussed
- An indication whether an agreement was reached and if so, a description of the general nature of the agreement (may be by attachment of a copy of amendments or claims agreed as being allowable). Note: Agreement as to allowability is tentative and does not restrict further action by the examiner to the contrary.
- The signature of the examiner who conducted the interview (if Form is not an attachment to a signed Office action)

It is desirable that the examiner orally remind the applicant of his or her obligation to record the substance of the interview of each case. It should be noted, however, that the Interview Summary Form will not normally be considered a complete and proper recordation of the interview unless it includes, or is supplemented by the applicant or the examiner to include, all of the applicable items required below concerning the substance of the interview.

A complete and proper recordation of the substance of any interview should include at least the following applicable items:

- 1) A brief description of the nature of any exhibit shown or any demonstration conducted,
- 2) an identification of the claims discussed,
- 3) an identification of the specific prior art discussed,
- 4) an identification of the principal proposed amendments of a substantive nature discussed, unless these are already described on the Interview Summary Form completed by the Examiner,
- 5) a brief identification of the general thrust of the principal arguments presented to the examiner,
(The identification of arguments need not be lengthy or elaborate. A verbatim or highly detailed description of the arguments is not required. The identification of the arguments is sufficient if the general nature or thrust of the principal arguments made to the examiner can be understood in the context of the application file. Of course, the applicant may desire to emphasize and fully describe those arguments which he or she feels were or might be persuasive to the examiner.)
- 6) a general indication of any other pertinent matters discussed, and
- 7) if appropriate, the general results or outcome of the interview unless already described in the Interview Summary Form completed by the examiner.

Examiners are expected to carefully review the applicant's record of the substance of an interview. If the record is not complete and accurate, the examiner will give the applicant an extendable one month time period to correct the record.

Examiner to Check for Accuracy

If the claims are allowable for other reasons of record, the examiner should send a letter setting forth the examiner's version of the statement attributed to him or her. If the record is complete and accurate, the examiner should place the indication, "Interview Record OK" on the paper recording the substance of the interview along with the date and the examiner's initials.

IN THE UNITED STATES PATENT AND TRADEMARK OFFICE

In re application of:

Mohammed N. ISLAM

Serial No.: 14/875,709

Filed: October 6, 2015

For: SHORT-WAVE INFRARED SUPER-CONTINUUM LASERS
FOR DETECTING COUNTERFEIT OR ILLICIT DRUGS AND
PHARMACEUTICAL PROCESS CONTROL

Group Art Unit: 2884

Examiner: Abra S. Fein

Attorney Docket No.: OMNI 0105 PUSP1

**AMENDMENT UNDER 37 C.F.R. § 1.116 FILED WITH AFCP 2.0
REQUEST**

Mail Stop AF
Commissioner for Patents
U.S. Patent and Trademark Office
P.O. Box 1450
Alexandria, VA 22313-1450

Commissioner:

In response to the Final Office Action mailed October 21, 2016, please reconsider and reexamine the application as amended below pursuant to the provisions of the AFCP 2.0 pilot program. A request for consideration under the AFCP 2.0 pilot program is being filed herewith.

Amendments to the Claims:

This listing of claims will replace all prior versions, and listings, of claims in the application:

1. (Original) A measurement system comprising:

a light source configured to generate an output optical beam, comprising:

one or more semiconductor sources configured to generate an input beam;

one or more optical amplifiers configured to receive at least a portion of the input beam and to output an intermediate beam from at least one of the one or more optical amplifiers; and

one or more optical fibers configured to receive at least a portion of the intermediate beam and to communicate at least part of the portion of the intermediate beam to a distal end of the one or more optical fibers to form a first optical beam;

a nonlinear element configured to receive at least a portion of the first optical beam and to broaden a spectrum associated with the at least a portion of the first optical beam to at least 10nm through a nonlinear effect in the nonlinear element to form the output optical beam with an output beam broadened spectrum; and

wherein at least a portion of the output beam broadened spectrum comprises a near-infrared wavelength between approximately 700nm and approximately 2500nm, and wherein at least a portion of the one or more fibers is a fused silica fiber with a core diameter less than approximately 400 microns;

a measurement apparatus configured to receive a received portion of the output optical beam and to deliver to a sample an analysis output beam, which is a delivered portion of the output optical beam and wherein the delivered portion of the output optical beam is a spatially coherent beam;

a receiver configured to receive and process at least a portion of the analysis output beam reflected or transmitted from the sample having a bandwidth of at least 10 nanometers and to generate an output signal; and

a personal device comprising a wireless receiver, a wireless transmitter, a display, a microphone, a speaker, one or more buttons or knobs, a microprocessor and a touch screen, the personal device configured to receive and process at least a portion of the output signal, wherein the personal device is configured to store and display the processed output signal, and wherein at least a portion of the processed output signal is configured to be transmitted over a wireless transmission link.

2. (Original) The system of Claim 1, wherein the personal device is selected from the group consisting of a smart phone, a tablet, a personal data assistant, a computer, and a microprocessor-based device.

3. (Original) The system of Claim 1, wherein the output signal comprises one or more physiological parameters.

4. (Original) The system of Claim 1, further comprising a remote device configured to receive over the wireless transmission link a received output status comprising the at least a portion of the processed output signal, to buffer the received output status, to process the received output status to generate processed data and to store the processed data.

5. (Currently Amended) A measurement system comprising:

a light source comprising a plurality of semiconductor sources that are light emitting diodes, the light emitting diodes configured to generate an output optical beam with one or more optical wavelengths, wherein at least a portion of the one or more optical wavelengths is a near-infrared wavelength between 700 nanometers and 2500 nanometers,

the light source configured to increase signal-to-noise ratio by increasing a light intensity from at least one of the plurality of semiconductor sources and by increasing a pulse rate of at least one of the plurality of semiconductor sources;

an apparatus comprising a plurality of lenses configured to receive a portion of the output optical beam and to deliver an analysis output beam to a sample

a receiver configured to receive and process at least a portion of the analysis output beam reflected or transmitted from the sample and to generate an output signal, wherein the receiver is configured to be synchronized to the light source;

a personal device comprising a wireless receiver, a wireless transmitter, a display, a microphone, a speaker, one or more buttons or knobs, a microprocessor and a touch screen, the personal device configured to receive and process at least a portion of the output signal, wherein the personal device is configured to store and display the processed output signal, and wherein at least a portion of the processed output signal is configured to be transmitted over a wireless transmission link; and

a remote device configured to receive over the wireless transmission link an output status comprising the at least a portion of the processed output signal, to process the received output status to generate processed data and to store the processed data.

6. (Canceled).

7. (Previously Presented) The system of Claim 5, wherein at least one of the light emitting diodes emits light with a bandwidth between 20 nanometers to 40 nanometers.

8. (Original) The system of Claim 5, wherein the remote device is further configured to transmit at least a portion of the processed data to one or more other locations, wherein the one or more other locations is selected from the group consisting of the personal device, a doctor, a healthcare provider, a cloud-based server and one or more designated recipients, and wherein the remote device is capable of transmitting information related to a time and a position associated with the at least a portion of the processed data.

9. (Previously Presented) The system of Claim 5, wherein the receiver is located a first distance from a first one of the plurality of light emitting diodes and a different, second distance from a second one of the plurality of light emitting diodes such that the receiver receives a first signal from the first light emitting diode and a second signal from the second light emitting diode.

10. (Original) The system of Claim 5, wherein the output signal comprises one or more physiological parameters, and the remote device is capable of storing a history of at least a portion of the one or more physiological parameters over a specified period of time.

11. (Previously Presented) The system of Claim 9, wherein the output signal is generated in part by comparing the first and second signals.

12. (Previously Presented) The system of Claim 5, wherein the receiver further comprises one or more filters in front of one of more detectors to select a fraction of the one or more optical wavelengths.

13. (Previously Presented) The system of Claim 5, wherein the output optical beam comprises a plurality of optical wavelengths, and the output signal is generated in part by comparing signals at different optical wavelengths.

14. (Currently Amended) A measurement system comprising:

a wearable measurement device for measuring one or more physiological parameters, including a light source comprising a plurality of semiconductor sources that are light emitting diodes, the light emitting diodes configured to generate an output optical beam with one or more optical wavelengths, wherein at least a portion of the one or more optical wavelengths is a near-infrared wavelength between 700 nanometers and 2500 nanometers,

the light source configured to increase signal-to-noise ratio by increasing a light intensity from at least one of the plurality of semiconductor sources and by increasing a pulse rate of at least one of the plurality of semiconductor sources; the wearable measurement device comprising a plurality of lenses configured to receive a portion of the output optical beam and to deliver an analysis output beam to a sample;

the wearable measurement device further comprising a receiver configured to receive and process at least a portion of the analysis output beam reflected or transmitted from the sample and to generate an output signal, wherein the wearable measurement device receiver is configured to be synchronize to pulses of the light source;

a personal device comprising a wireless receiver, a wireless transmitter, a display, a microphone, a speaker, one or more buttons or knobs, a microprocessor and a touch screen, the personal device configured to receive and process at least a portion of the output signal, wherein the personal device is configured to store and display the processed output signal, and wherein at least a portion of the processed output signal is configured to be transmitted over a wireless transmission link; and

a remote device configured to receive over the wireless transmission link an output status comprising the at least a portion of the processed output signal, to process the received output status to generate processed data and to store the processed data, and wherein the remote device is capable of storing a history of at least a portion of the received output status over a specified period of time.

15. (Canceled).

16. (Previously Presented) The system of Claim 14, wherein at least one of the light emitting diodes emits light with a bandwidth between approximately 20 nanometers to approximately 40 nanometers.

17. (Original) The system of Claim 14, wherein the remote device is further configured to transmit at least a portion of the processed data to one or more other locations, wherein the one or more other locations is selected from the group consisting of the personal device, a doctor, a healthcare provider, a cloud-based server and one or more designated recipients, and wherein the remote device is capable of transmitting information related to a time and a position associated with the at least a portion of the processed data.

18. (Previously Presented) The system of Claim 14, wherein the receiver is located a first distance from a first one of the plurality of light emitting diodes and a different, second distance from a second one of the plurality of light emitting diodes such that the receiver receives a first signal from the first light emitting diode and a second signal from the second light emitting diode.

19. (Previously Presented) The system of Claim 18, wherein the output signal is generated in part by comparing the first and second signals.

20. (Previously Presented) The system of Claim 14, wherein the receiver further comprises one or more filters in front of one of more detectors to select a fraction of the one or more optical wavelengths.

Remarks

In the Office Action mailed October 21, 2016, claims 5, 8, 10, 12, 14, 17, and 20 are rejected under pre-AIA 35 U.S.C. § 103(a) as being unpatentable over Polli et al. (US 2006/0283931 A1) in view of Banet, Rubio Guivernau et al. (US 2014/0078510 A1), and Kleppe et al. (US 2011/0267688 A1). Claims 6-7, 9, 15-16, and 18 are rejected under pre-AIA pre-AIA 35 U.S.C. § 103(a) as being unpatentable over Polliand Banet, Rubio Guivernau, and Kleppe, and further in view of Fidler et al. (US 2013/0327966A1). Claims 11, 13, and 19 are rejected under pre-AIA 35 U.S.C. § 103(a) as being unpatentable over Polli and Banet, Rubio Guivernau, Kleppe, and Fidler, and further in view of Doppke et al. (US 2005/0133691 A1).

Claims 6 and 15 have been canceled without prejudice. Claims 5 and 14 have been amended. Claims 1-5, 7-14, and 16-20 are pending. Reconsideration and re-examination of the application as amended is respectfully requested.

Telephone Interview

Applicant thanks Examiners Fein and Porta for the courtesies extended during the telephone interview on November 2, 2016 to discuss the rejection under 35 U.S.C. §103 with respect to Claims 6 and 15 relative to the disclosure of US 2013/0327966 to Fidler et al. As discussed during the interview, Applicant has incorporated dependent Claim 6 into independent Claim 5, and incorporated dependent Claim 15 into independent Claim 14. The Examiners agreed that Fidler et al. did not disclose the features of dependent Claims 6 and 15, but that an additional search may be performed.

Rejections Under 35 U.S.C. § 103(a)

Claims 5, 8, 10, 12, 14, 17, and 20 were rejected under pre-AIA 35 U.S.C. § 103(a) as being unpatentable over Polli et al. (US 2006/0283931 A1) in view of Banet, Rubio Guivernau et al. (US 2014/0078510 A1), and Kleppe et al. (US 2011/0267688 A1). Applicant respectfully disagrees and traverses the rejection. Applicant does not necessarily agree or acquiesce to the propriety of the combination of references, or the disclosure or teaching of any of the references as set forth in the rejection. However, Applicant has amended independent claims 5 and 14 in light of the indication of other allowable subject matter and the discussion during the telephonic interview solely to advance prosecution of this application to allowance.

Claims 6-7, 9, 15-16, and 18 are rejected under pre-AIA pre-AIA 35 U.S.C. § 103(a) as being unpatentable over Polliand Banet, Rubio Guivernau, and Kleppe, and further in view of Fidler et al. (US 2013/0327966A1). Applicant respectfully disagrees and traverses the rejection. Applicant does not necessarily agree or acquiesce to the propriety of the combination of references, or the disclosure or teaching of any of the references as set forth in the rejection. However, Applicant has amended independent claims 5 and 14 in light of the indication of other allowable subject matter and the discussion during the telephonic interview solely to advance prosecution of this application to allowance. The rejection of these claims is believed to be moot in view of the allowance of independent claims 5 and 14 from which these claims depend.

Claims 11, 13, and 19 are rejected under pre-AIA 35 U.S.C. § 103(a) as being unpatentable over Polli and Banet, Rubio Guivernau, Kleppe, and Fidler, and further in view of Doppke et al. (US 2005/0133691 A1). Applicant respectfully disagrees and traverses the rejection. Applicant does not necessarily agree or acquiesce to the propriety of the combination of references, or the disclosure or teaching of any of the references as set forth in the rejection. However, Applicant has amended independent claims 5 and 14 in light of the indication of other allowable subject matter and the discussion during the telephonic interview solely to advance prosecution of this application to allowance. The rejection of these claims is believed to be moot in view of the allowance of independent claims 5 and 14 from which these claims depend.

**CERTIFICATION AND REQUEST FOR CONSIDERATION UNDER THE
AFTER FINAL CONSIDERATION PILOT PROGRAM 2.0**

Practitioner Docket No.: OMNI 0105 PUSP1	Application No.: 14/875709	Filing Date: 2015-10-6
First Named Inventor: Mohammed N. ISLAM	Title: <small>SHORT-WAVE INFRARED SUPER-CONTINUUM LASERS FOR DETECTING COUNTERFEIT OR ILLIGIT DRUGS AND PHARMACEUTICAL PROCESS CONTROL</small>	
<p>APPLICANT HEREBY CERTIFIES THE FOLLOWING AND REQUESTS CONSIDERATION UNDER THE AFTER FINAL CONSIDERATION PILOT PROGRAM 2.0 (AFCP 2.0) OF THE ACCOMPANYING RESPONSE UNDER 37 CFR 1.116.</p> <ol style="list-style-type: none"> 1. The above-identified application is (i) an original utility, plant, or design nonprovisional application filed under 35 U.S.C. 111(a) [a continuing application (<i>e.g.</i>, a continuation or divisional application) is filed under 35 U.S.C. 111(a) and is eligible under (i)], or (ii) an international application that has entered the national stage in compliance with 35 U.S.C. 371(c). 2. The above-identified application contains an outstanding final rejection. 3. Submitted herewith is a response under 37 CFR 1.116 to the outstanding final rejection. The response includes an amendment to at least one independent claim, and the amendment does not broaden the scope of the independent claim in any aspect. 4. This certification and request for consideration under AFCP 2.0 is the only AFCP 2.0 certification and request filed in response to the outstanding final rejection. 5. Applicant is willing and available to participate in any interview requested by the examiner concerning the present response. 6. This certification and request is being filed electronically using the Office's electronic filing system (EFS-Web). 7. Any fees that would be necessary consistent with current practice concerning responses after final rejection under 37 CFR 1.116, <i>e.g.</i>, extension of time fees, are being concurrently filed herewith. [There is no additional fee required to request consideration under AFCP 2.0.] 8. By filing this certification and request, applicant acknowledges the following: <ul style="list-style-type: none"> • Reissue applications and reexamination proceedings are not eligible to participate in AFCP 2.0. • The examiner will verify that the AFCP 2.0 submission is compliant, <i>i.e.</i>, that the requirements of the program have been met (see items 1 to 7 above). For compliant submissions: <ul style="list-style-type: none"> ○ The examiner will review the response under 37 CFR 1.116 to determine if additional search and/or consideration (i) is necessitated by the amendment and (ii) could be completed within the time allotted under AFCP 2.0. If additional search and/or consideration is required but cannot be completed within the allotted time, the examiner will process the submission consistent with current practice concerning responses after final rejection under 37 CFR 1.116, <i>e.g.</i>, by mailing an advisory action. ○ If the examiner determines that the amendment does not necessitate additional search and/or consideration, or if the examiner determines that additional search and/or consideration is required and could be completed within the allotted time, then the examiner will consider whether the amendment places the application in condition for allowance (after completing the additional search and/or consideration, if required). If the examiner determines that the amendment does not place the application in condition for allowance, then the examiner will contact the applicant and request an interview. <ul style="list-style-type: none"> ▪ The interview will be conducted by the examiner, and if the examiner does not have negotiation authority, a primary examiner and/or supervisory patent examiner will also participate. ▪ If the applicant declines the interview, or if the interview cannot be scheduled within ten (10) calendar days from the date that the examiner first contacts the applicant, then the examiner will proceed consistent with current practice concerning responses after final rejection under 37 CFR 1.116. 		
Signature /David S. Bir/	Date 2016-11-17	
Name (Print/Typed) David S. Bir	Practitioner Registration No. 38383	
Note: This form must be signed in accordance with 37 CFR 1.33. See 37 CFR 1.4(d) for signature requirements and certifications. Submit multiple forms if more than one signature is required, see below*.		
<input checked="" type="checkbox"/> * Total of <u>1</u> forms are submitted.		

Privacy Act Statement

The **Privacy Act of 1974 (P.L. 93-579)** requires that you be given certain information in connection with your submission of the attached form related to a patent application or patent. Accordingly, pursuant to the requirements of the Act, please be advised that: (1) the general authority for the collection of this information is 35 U.S.C. 2(b)(2); (2) furnishing of the information solicited is voluntary; and (3) the principal purpose for which the information is used by the U.S. Patent and Trademark Office is to process and/or examine your submission related to a patent application or patent. If you do not furnish the requested information, the U.S. Patent and Trademark Office may not be able to process and/or examine your submission, which may result in termination of proceedings or abandonment of the application or expiration of the patent.

The information provided by you in this form will be subject to the following routine uses:

1. The information on this form will be treated confidentially to the extent allowed under the Freedom of Information Act (5 U.S.C. 552) and the Privacy Act (5 U.S.C. 552a). Records from this system of records may be disclosed to the Department of Justice to determine whether disclosure of these records is required by the Freedom of Information Act.
2. A record from this system of records may be disclosed, as a routine use, in the course of presenting evidence to a court, magistrate, or administrative tribunal, including disclosures to opposing counsel in the course of settlement negotiations.
3. A record in this system of records may be disclosed, as a routine use, to a Member of Congress submitting a request involving an individual, to whom the record pertains, when the individual has requested assistance from the Member with respect to the subject matter of the record.
4. A record in this system of records may be disclosed, as a routine use, to a contractor of the Agency having need for the information in order to perform a contract. Recipients of information shall be required to comply with the requirements of the Privacy Act of 1974, as amended, pursuant to 5 U.S.C. 552a(m).
5. A record related to an International Application filed under the Patent Cooperation Treaty in this system of records may be disclosed, as a routine use, to the International Bureau of the World Intellectual Property Organization, pursuant to the Patent Cooperation Treaty.
6. A record in this system of records may be disclosed, as a routine use, to another federal agency for purposes of National Security review (35 U.S.C. 181) and for review pursuant to the Atomic Energy Act (42 U.S.C. 218(c)).
7. A record from this system of records may be disclosed, as a routine use, to the Administrator, General Services, or his/her designee, during an inspection of records conducted by GSA as part of that agency's responsibility to recommend improvements in records management practices and programs, under authority of 44 U.S.C. 2904 and 2906. Such disclosure shall be made in accordance with the GSA regulations governing inspection of records for this purpose, and any other relevant (*i.e.*, GSA or Commerce) directive. Such disclosure shall not be used to make determinations about individuals.
8. A record from this system of records may be disclosed, as a routine use, to the public after either publication of the application pursuant to 35 U.S.C. 122(b) or issuance of a patent pursuant to 35 U.S.C. 151. Further, a record may be disclosed, subject to the limitations of 37 CFR 1.14, as a routine use, to the public if the record was filed in an application which became abandoned or in which the proceedings were terminated and which application is referenced by either a published application, an application open to public inspection or an issued patent.
9. A record from this system of records may be disclosed, as a routine use, to a Federal, State, or local law enforcement agency, if the USPTO becomes aware of a violation or potential violation of law or regulation.

Electronic Acknowledgement Receipt

EFS ID:	27547052
Application Number:	14875709
International Application Number:	
Confirmation Number:	7496
Title of Invention:	SHORT-WAVE INFRARED SUPER-CONTINUUM LASERS FOR DETECTING COUNTERFEIT OR ILLICIT DRUGS AND PHARMACEUTICAL PROCESS CONTROL
First Named Inventor/Applicant Name:	Mohammed N. Islam
Customer Number:	109543
Filer:	David S. Bir
Filer Authorized By:	
Attorney Docket Number:	OMNI 0105 PUSP1
Receipt Date:	18-NOV-2016
Filing Date:	06-OCT-2015
Time Stamp:	08:37:01
Application Type:	Utility under 35 USC 111(a)

Payment information:

Submitted with Payment	no
------------------------	----

File Listing:

Document Number	Document Description	File Name	File Size(Bytes)/ Message Digest	Multi Part /.zip	Pages (if appl.)
1		response.pdf	63887 4619ea61c9961c55042005bb0985be9f492c5983	yes	10

Multipart Description/PDF files in .zip description			
Document Description	Start	End	
Response After Final Action	1	1	
Claims	2	7	
Applicant Arguments/Remarks Made in an Amendment	8	10	

Warnings:

Information:

2	After Final Consideration Program Request	AFCP_2_0.pdf	226594	no	2
			b87fa1921f967c09437a8703453c8a0f7f3742d3		

Warnings:

Information:

Total Files Size (in bytes):	290481
-------------------------------------	--------

This Acknowledgement Receipt evidences receipt on the noted date by the USPTO of the indicated documents, characterized by the applicant, and including page counts, where applicable. It serves as evidence of receipt similar to a Post Card, as described in MPEP 503.

New Applications Under 35 U.S.C. 111

If a new application is being filed and the application includes the necessary components for a filing date (see 37 CFR 1.53(b)-(d) and MPEP 506), a Filing Receipt (37 CFR 1.54) will be issued in due course and the date shown on this Acknowledgement Receipt will establish the filing date of the application.

National Stage of an International Application under 35 U.S.C. 371

If a timely submission to enter the national stage of an international application is compliant with the conditions of 35 U.S.C. 371 and other applicable requirements a Form PCT/DO/EO/903 indicating acceptance of the application as a national stage submission under 35 U.S.C. 371 will be issued in addition to the Filing Receipt, in due course.

New International Application Filed with the USPTO as a Receiving Office

If a new international application is being filed and the international application includes the necessary components for an international filing date (see PCT Article 11 and MPEP 1810), a Notification of the International Application Number and of the International Filing Date (Form PCT/RO/105) will be issued in due course, subject to prescriptions concerning national security, and the date shown on this Acknowledgement Receipt will establish the international filing date of the application.

Under the Paperwork Reduction Act of 1995, no persons are required to respond to a collection of information unless it displays a valid OMB control number.

PATENT APPLICATION FEE DETERMINATION RECORD Substitute for Form PTO-875	Application or Docket Number 14/875,709	Filing Date 10/06/2015	<input type="checkbox"/> To be Mailed
---	---	----------------------------------	---------------------------------------

ENTITY: LARGE SMALL MICRO

APPLICATION AS FILED – PART I

FOR	NUMBER FILED	NUMBER EXTRA	RATE (\$)	FEE (\$)
<input type="checkbox"/> BASIC FEE <small>(37 CFR 1.16(a), (b), or (c))</small>	N/A	N/A	N/A	
<input type="checkbox"/> SEARCH FEE <small>(37 CFR 1.16(k), (l), or (m))</small>	N/A	N/A	N/A	
<input type="checkbox"/> EXAMINATION FEE <small>(37 CFR 1.16(o), (p), or (q))</small>	N/A	N/A	N/A	
TOTAL CLAIMS <small>(37 CFR 1.16(i))</small>	minus 20 =	*	X \$ =	
INDEPENDENT CLAIMS <small>(37 CFR 1.16(h))</small>	minus 3 =	*	X \$ =	
<input type="checkbox"/> APPLICATION SIZE FEE <small>(37 CFR 1.16(s))</small>	If the specification and drawings exceed 100 sheets of paper, the application size fee due is \$310 (\$155 for small entity) for each additional 50 sheets or fraction thereof. See 35 U.S.C. 41(a)(1)(G) and 37 CFR 1.16(s).			
<input type="checkbox"/> MULTIPLE DEPENDENT CLAIM PRESENT <small>(37 CFR 1.16(j))</small>				
* If the difference in column 1 is less than zero, enter "0" in column 2.			TOTAL	

APPLICATION AS AMENDED – PART II

	(Column 1)	(Column 2)	(Column 3)	PRESENT EXTRA	RATE (\$)	ADDITIONAL FEE (\$)
AMENDMENT	11/18/2016	CLAIMS REMAINING AFTER AMENDMENT	HIGHEST NUMBER PREVIOUSLY PAID FOR			
	Total <small>(37 CFR 1.16(i))</small>	* 18	Minus	** 20	= 0	X \$40 = 0
	Independent <small>(37 CFR 1.16(h))</small>	* 3	Minus	***3	= 0	X \$210 = 0
	<input type="checkbox"/> Application Size Fee <small>(37 CFR 1.16(s))</small>					
<input type="checkbox"/> FIRST PRESENTATION OF MULTIPLE DEPENDENT CLAIM <small>(37 CFR 1.16(j))</small>						
					TOTAL ADD'L FEE	0

	(Column 1)	(Column 2)	(Column 3)	PRESENT EXTRA	RATE (\$)	ADDITIONAL FEE (\$)
AMENDMENT		CLAIMS REMAINING AFTER AMENDMENT	HIGHEST NUMBER PREVIOUSLY PAID FOR			
	Total <small>(37 CFR 1.16(i))</small>	*	Minus	**	=	X \$ =
	Independent <small>(37 CFR 1.16(h))</small>	*	Minus	***	=	X \$ =
	<input type="checkbox"/> Application Size Fee <small>(37 CFR 1.16(s))</small>					
<input type="checkbox"/> FIRST PRESENTATION OF MULTIPLE DEPENDENT CLAIM <small>(37 CFR 1.16(j))</small>						
					TOTAL ADD'L FEE	

* If the entry in column 1 is less than the entry in column 2, write "0" in column 3.
 ** If the "Highest Number Previously Paid For" IN THIS SPACE is less than 20, enter "20".
 *** If the "Highest Number Previously Paid For" IN THIS SPACE is less than 3, enter "3".
 The "Highest Number Previously Paid For" (Total or Independent) is the highest number found in the appropriate box in column 1.

LIE
TRACEY BELL

This collection of information is required by 37 CFR 1.16. The information is required to obtain or retain a benefit by the public which is to file (and by the USPTO to process) an application. Confidentiality is governed by 35 U.S.C. 122 and 37 CFR 1.14. This collection is estimated to take 12 minutes to complete, including gathering, preparing, and submitting the completed application form to the USPTO. Time will vary depending upon the individual case. Any comments on the amount of time you require to complete this form and/or suggestions for reducing this burden, should be sent to the Chief Information Officer, U.S. Patent and Trademark Office, U.S. Department of Commerce, P.O. Box 1450, Alexandria, VA 22313-1450. DO NOT SEND FEES OR COMPLETED FORMS TO THIS ADDRESS. **SEND TO: Commissioner for Patents, P.O. Box 1450, Alexandria, VA 22313-1450.**

If you need assistance in completing the form, call 1-800-PTO-9199 and select option 2.



NOTICE OF ALLOWANCE AND FEE(S) DUE

109543 7590 01/10/2017
Brooks, Kushman P.C./Cheetah Omni MedSci
1000 Town Center
Twenty Second Floor
Southfield, MI 48075

Table with 2 columns: EXAMINER (FEIN, ABRA S), ART UNIT (2884), PAPER NUMBER

DATE MAILED: 01/10/2017

Table with 5 columns: APPLICATION NO., FILING DATE, FIRST NAMED INVENTOR, ATTORNEY DOCKET NO., CONFIRMATION NO.

14/875,709 10/06/2015 Mohammed N. Islam OMNI 0105 PUSP1 7496
TITLE OF INVENTION: SHORT-WAVE INFRARED SUPER-CONTINUUM LASERS FOR DETECTING COUNTERFEIT OR ILLICIT DRUGS AND PHARMACEUTICAL PROCESS CONTROL

Table with 7 columns: APPLN. TYPE, ENTITY STATUS, ISSUE FEE DUE, PUBLICATION FEE DUE, PREV. PAID ISSUE FEE, TOTAL FEE(S) DUE, DATE DUE

THE APPLICATION IDENTIFIED ABOVE HAS BEEN EXAMINED AND IS ALLOWED FOR ISSUANCE AS A PATENT. PROSECUTION ON THE MERITS IS CLOSED. THIS NOTICE OF ALLOWANCE IS NOT A GRANT OF PATENT RIGHTS. THIS APPLICATION IS SUBJECT TO WITHDRAWAL FROM ISSUE AT THE INITIATIVE OF THE OFFICE OR UPON PETITION BY THE APPLICANT. SEE 37 CFR 1.313 AND MPEP 1308.

THE ISSUE FEE AND PUBLICATION FEE (IF REQUIRED) MUST BE PAID WITHIN THREE MONTHS FROM THE MAILING DATE OF THIS NOTICE OR THIS APPLICATION SHALL BE REGARDED AS ABANDONED. THIS STATUTORY PERIOD CANNOT BE EXTENDED. SEE 35 U.S.C. 151. THE ISSUE FEE DUE INDICATED ABOVE DOES NOT REFLECT A CREDIT FOR ANY PREVIOUSLY PAID ISSUE FEE IN THIS APPLICATION. IF AN ISSUE FEE HAS PREVIOUSLY BEEN PAID IN THIS APPLICATION (AS SHOWN ABOVE), THE RETURN OF PART B OF THIS FORM WILL BE CONSIDERED A REQUEST TO REAPPLY THE PREVIOUSLY PAID ISSUE FEE TOWARD THE ISSUE FEE NOW DUE.

HOW TO REPLY TO THIS NOTICE:

I. Review the ENTITY STATUS shown above. If the ENTITY STATUS is shown as SMALL or MICRO, verify whether entitlement to that entity status still applies.
If the ENTITY STATUS is the same as shown above, pay the TOTAL FEE(S) DUE shown above.
If the ENTITY STATUS is changed from that shown above, on PART B - FEE(S) TRANSMITTAL, complete section number 5 titled "Change in Entity Status (from status indicated above)".
For purposes of this notice, small entity fees are 1/2 the amount of undiscounted fees, and micro entity fees are 1/2 the amount of small entity fees.

II. PART B - FEE(S) TRANSMITTAL, or its equivalent, must be completed and returned to the United States Patent and Trademark Office (USPTO) with your ISSUE FEE and PUBLICATION FEE (if required). If you are charging the fee(s) to your deposit account, section "4b" of Part B - Fee(s) Transmittal should be completed and an extra copy of the form should be submitted. If an equivalent of Part B is filed, a request to reapply a previously paid issue fee must be clearly made, and delays in processing may occur due to the difficulty in recognizing the paper as an equivalent of Part B.

III. All communications regarding this application must give the application number. Please direct all communications prior to issuance to Mail Stop ISSUE FEE unless advised to the contrary.

IMPORTANT REMINDER: Utility patents issuing on applications filed on or after Dec. 12, 1980 may require payment of maintenance fees. It is patentee's responsibility to ensure timely payment of maintenance fees when due.

PART B - FEE(S) TRANSMITTAL

**Complete and send this form, together with applicable fee(s), to: Mail Mail Stop ISSUE FEE
 Commissioner for Patents
 P.O. Box 1450
 Alexandria, Virginia 22313-1450
 or Fax (571)-273-2885**

INSTRUCTIONS: This form should be used for transmitting the ISSUE FEE and PUBLICATION FEE (if required). Blocks 1 through 5 should be completed where appropriate. All further correspondence including the Patent, advance orders and notification of maintenance fees will be mailed to the current correspondence address as indicated unless corrected below or directed otherwise in Block 1, by (a) specifying a new correspondence address; and/or (b) indicating a separate "FEE ADDRESS" for maintenance fee notifications.

CURRENT CORRESPONDENCE ADDRESS (Note: Use Block 1 for any change of address)

109543 7590 01/10/2017
Brooks, Kushman P.C./Cheetah Omni MedSci
 1000 Town Center
 Twenty Second Floor
 Southfield, MI 48075

Note: A certificate of mailing can only be used for domestic mailings of the Fee(s) Transmittal. This certificate cannot be used for any other accompanying papers. Each additional paper, such as an assignment or formal drawing, must have its own certificate of mailing or transmission.

Certificate of Mailing or Transmission

I hereby certify that this Fee(s) Transmittal is being deposited with the United States Postal Service with sufficient postage for first class mail in an envelope addressed to the Mail Stop ISSUE FEE address above, or being facsimile transmitted to the USPTO (571) 273-2885, on the date indicated below.

(Depositor's name)
(Signature)
(Date)

APPLICATION NO.	FILING DATE	FIRST NAMED INVENTOR	ATTORNEY DOCKET NO.	CONFIRMATION NO.
14/875,709	10/06/2015	Mohammed N. Islam	OMNI 0105 PUSP1	7496

TITLE OF INVENTION: SHORT-WAVE INFRARED SUPER-CONTINUUM LASERS FOR DETECTING COUNTERFEIT OR ILLICIT DRUGS AND PHARMACEUTICAL PROCESS CONTROL

APPLN. TYPE	ENTITY STATUS	ISSUE FEE DUE	PUBLICATION FEE DUE	PREV. PAID ISSUE FEE	TOTAL FEE(S) DUE	DATE DUE
nonprovisional	SMALL	\$480	\$0	\$0	\$480	04/10/2017

EXAMINER	ART UNIT	CLASS-SUBCLASS
FEIN, ABRA S	2884	250-338400

<p>1. Change of correspondence address or indication of "Fee Address" (37 CFR 1.363).</p> <p><input type="checkbox"/> Change of correspondence address (or Change of Correspondence Address form PTO/SB/122) attached.</p> <p><input type="checkbox"/> "Fee Address" indication (or "Fee Address" Indication form PTO/SB/47; Rev 03-02 or more recent) attached. Use of a Customer Number is required.</p>	<p>2. For printing on the patent front page, list</p> <p>(1) The names of up to 3 registered patent attorneys or agents OR, alternatively, _____ 1</p> <p>(2) The name of a single firm (having as a member a registered attorney or agent) and the names of up to 2 registered patent attorneys or agents. If no name is listed, no name will be printed. _____ 2</p> <p>_____ 3</p>
---	---

3. ASSIGNEE NAME AND RESIDENCE DATA TO BE PRINTED ON THE PATENT (print or type)

PLEASE NOTE: Unless an assignee is identified below, no assignee data will appear on the patent. If an assignee is identified below, the document has been filed for recordation as set forth in 37 CFR 3.11. Completion of this form is NOT a substitute for filing an assignment.

(A) NAME OF ASSIGNEE _____ (B) RESIDENCE: (CITY and STATE OR COUNTRY) _____

Please check the appropriate assignee category or categories (will not be printed on the patent) : Individual Corporation or other private group entity Government

<p>4a. The following fee(s) are submitted:</p> <p><input type="checkbox"/> Issue Fee</p> <p><input type="checkbox"/> Publication Fee (No small entity discount permitted)</p> <p><input type="checkbox"/> Advance Order - # of Copies _____</p>	<p>4b. Payment of Fee(s): (Please first reapply any previously paid issue fee shown above)</p> <p><input type="checkbox"/> A check is enclosed.</p> <p><input type="checkbox"/> Payment by credit card. Form PTO-2038 is attached.</p> <p><input type="checkbox"/> The director is hereby authorized to charge the required fee(s), any deficiency, or credits any overpayment, to Deposit Account Number _____ (enclose an extra copy of this form).</p>
---	--

5. **Change in Entity Status** (from status indicated above)

Applicant certifying micro entity status. See 37 CFR 1.29

Applicant asserting small entity status. See 37 CFR 1.27

Applicant changing to regular undiscounted fee status.

NOTE: Absent a valid certification of Micro Entity Status (see forms PTO/SB/15A and 15B), issue fee payment in the micro entity amount will not be accepted at the risk of application abandonment.

NOTE: If the application was previously under micro entity status, checking this box will be taken to be a notification of loss of entitlement to micro entity status.

NOTE: Checking this box will be taken to be a notification of loss of entitlement to small or micro entity status, as applicable.

NOTE: This form must be signed in accordance with 37 CFR 1.31 and 1.33. See 37 CFR 1.4 for signature requirements and certifications.

Authorized Signature _____ Date _____

Typed or printed name _____ Registration No. _____



UNITED STATES PATENT AND TRADEMARK OFFICE

UNITED STATES DEPARTMENT OF COMMERCE
United States Patent and Trademark Office
Address: COMMISSIONER FOR PATENTS
P.O. Box 1450
Alexandria, Virginia 22313-1450
www.uspto.gov

Table with 5 columns: APPLICATION NO., FILING DATE, FIRST NAMED INVENTOR, ATTORNEY DOCKET NO., CONFIRMATION NO.
14/875,709 10/06/2015 Mohammed N. Islam OMNI 0105 PUSP1 7496

109543 7590 01/10/2017
Brooks, Kushman P.C./Cheetah Omni MedSci
1000 Town Center
Twenty Second Floor
Southfield, MI 48075

EXAMINER

FEIN, ABRA S

ART UNIT PAPER NUMBER

2884

DATE MAILED: 01/10/2017

Determination of Patent Term Adjustment under 35 U.S.C. 154 (b)

(Applications filed on or after May 29, 2000)

The Office has discontinued providing a Patent Term Adjustment (PTA) calculation with the Notice of Allowance.

Section 1(h)(2) of the AIA Technical Corrections Act amended 35 U.S.C. 154(b)(3)(B)(i) to eliminate the requirement that the Office provide a patent term adjustment determination with the notice of allowance. See Revisions to Patent Term Adjustment, 78 Fed. Reg. 19416, 19417 (Apr. 1, 2013). Therefore, the Office is no longer providing an initial patent term adjustment determination with the notice of allowance. The Office will continue to provide a patent term adjustment determination with the Issue Notification Letter that is mailed to applicant approximately three weeks prior to the issue date of the patent, and will include the patent term adjustment on the patent. Any request for reconsideration of the patent term adjustment determination (or reinstatement of patent term adjustment) should follow the process outlined in 37 CFR 1.705.

Any questions regarding the Patent Term Extension or Adjustment determination should be directed to the Office of Patent Legal Administration at (571)-272-7702. Questions relating to issue and publication fee payments should be directed to the Customer Service Center of the Office of Patent Publication at 1-(888)-786-0101 or (571)-272-4200.

OMB Clearance and PRA Burden Statement for PTOL-85 Part B

The Paperwork Reduction Act (PRA) of 1995 requires Federal agencies to obtain Office of Management and Budget approval before requesting most types of information from the public. When OMB approves an agency request to collect information from the public, OMB (i) provides a valid OMB Control Number and expiration date for the agency to display on the instrument that will be used to collect the information and (ii) requires the agency to inform the public about the OMB Control Number's legal significance in accordance with 5 CFR 1320.5(b).

The information collected by PTOL-85 Part B is required by 37 CFR 1.311. The information is required to obtain or retain a benefit by the public which is to file (and by the USPTO to process) an application. Confidentiality is governed by 35 U.S.C. 122 and 37 CFR 1.14. This collection is estimated to take 12 minutes to complete, including gathering, preparing, and submitting the completed application form to the USPTO. Time will vary depending upon the individual case. Any comments on the amount of time you require to complete this form and/or suggestions for reducing this burden, should be sent to the Chief Information Officer, U.S. Patent and Trademark Office, U.S. Department of Commerce, P.O. Box 1450, Alexandria, Virginia 22313-1450. DO NOT SEND FEES OR COMPLETED FORMS TO THIS ADDRESS. SEND TO: Commissioner for Patents, P.O. Box 1450, Alexandria, Virginia 22313-1450. Under the Paperwork Reduction Act of 1995, no persons are required to respond to a collection of information unless it displays a valid OMB control number.

Privacy Act Statement

The Privacy Act of 1974 (P.L. 93-579) requires that you be given certain information in connection with your submission of the attached form related to a patent application or patent. Accordingly, pursuant to the requirements of the Act, please be advised that: (1) the general authority for the collection of this information is 35 U.S.C. 2(b)(2); (2) furnishing of the information solicited is voluntary; and (3) the principal purpose for which the information is used by the U.S. Patent and Trademark Office is to process and/or examine your submission related to a patent application or patent. If you do not furnish the requested information, the U.S. Patent and Trademark Office may not be able to process and/or examine your submission, which may result in termination of proceedings or abandonment of the application or expiration of the patent.

The information provided by you in this form will be subject to the following routine uses:

1. The information on this form will be treated confidentially to the extent allowed under the Freedom of Information Act (5 U.S.C. 552) and the Privacy Act (5 U.S.C. 552a). Records from this system of records may be disclosed to the Department of Justice to determine whether disclosure of these records is required by the Freedom of Information Act.
2. A record from this system of records may be disclosed, as a routine use, in the course of presenting evidence to a court, magistrate, or administrative tribunal, including disclosures to opposing counsel in the course of settlement negotiations.
3. A record in this system of records may be disclosed, as a routine use, to a Member of Congress submitting a request involving an individual, to whom the record pertains, when the individual has requested assistance from the Member with respect to the subject matter of the record.
4. A record in this system of records may be disclosed, as a routine use, to a contractor of the Agency having need for the information in order to perform a contract. Recipients of information shall be required to comply with the requirements of the Privacy Act of 1974, as amended, pursuant to 5 U.S.C. 552a(m).
5. A record related to an International Application filed under the Patent Cooperation Treaty in this system of records may be disclosed, as a routine use, to the International Bureau of the World Intellectual Property Organization, pursuant to the Patent Cooperation Treaty.
6. A record in this system of records may be disclosed, as a routine use, to another federal agency for purposes of National Security review (35 U.S.C. 181) and for review pursuant to the Atomic Energy Act (42 U.S.C. 218(c)).
7. A record from this system of records may be disclosed, as a routine use, to the Administrator, General Services, or his/her designee, during an inspection of records conducted by GSA as part of that agency's responsibility to recommend improvements in records management practices and programs, under authority of 44 U.S.C. 2904 and 2906. Such disclosure shall be made in accordance with the GSA regulations governing inspection of records for this purpose, and any other relevant (i.e., GSA or Commerce) directive. Such disclosure shall not be used to make determinations about individuals.
8. A record from this system of records may be disclosed, as a routine use, to the public after either publication of the application pursuant to 35 U.S.C. 122(b) or issuance of a patent pursuant to 35 U.S.C. 151. Further, a record may be disclosed, subject to the limitations of 37 CFR 1.14, as a routine use, to the public if the record was filed in an application which became abandoned or in which the proceedings were terminated and which application is referenced by either a published application, an application open to public inspection or an issued patent.
9. A record from this system of records may be disclosed, as a routine use, to a Federal, State, or local law enforcement agency, if the USPTO becomes aware of a violation or potential violation of law or regulation.

Notice of Allowability	Application No.	Applicant(s)	
	Examiner	Art Unit	AIA (First Inventor to File) Status No

-- The MAILING DATE of this communication appears on the cover sheet with the correspondence address--

All claims being allowable, PROSECUTION ON THE MERITS IS (OR REMAINS) CLOSED in this application. If not included herewith (or previously mailed), a Notice of Allowance (PTOL-85) or other appropriate communication will be mailed in due course. **THIS NOTICE OF ALLOWABILITY IS NOT A GRANT OF PATENT RIGHTS.** This application is subject to withdrawal from issue at the initiative of the Office or upon petition by the applicant. See 37 CFR 1.313 and MPEP 1308.

1. This communication is responsive to 11/18/2016.
 A declaration(s)/affidavit(s) under **37 CFR 1.130(b)** was/were filed on _____.
2. An election was made by the applicant in response to a restriction requirement set forth during the interview on _____; the restriction requirement and election have been incorporated into this action.
3. The allowed claim(s) is/are 1-5,7-14 and 16-20. As a result of the allowed claim(s), you may be eligible to benefit from the **Patent Prosecution Highway** program at a participating intellectual property office for the corresponding application. For more information, please see http://www.uspto.gov/patents/init_events/pph/index.jsp or send an inquiry to PPHfeedback@uspto.gov.
4. Acknowledgment is made of a claim for foreign priority under 35 U.S.C. § 119(a)-(d) or (f).

Certified copies:

- a) All b) Some *c) None of the:
1. Certified copies of the priority documents have been received.
 2. Certified copies of the priority documents have been received in Application No. _____.
 3. Copies of the certified copies of the priority documents have been received in this national stage application from the International Bureau (PCT Rule 17.2(a)).

* Certified copies not received: _____.

Applicant has **THREE MONTHS FROM THE "MAILING DATE"** of this communication to file a reply complying with the requirements noted below. Failure to timely comply will result in **ABANDONMENT** of this application.

THIS THREE-MONTH PERIOD IS NOT EXTENDABLE.

5. CORRECTED DRAWINGS (as "replacement sheets") must be submitted.
 including changes required by the attached Examiner's Amendment / Comment or in the Office action of Paper No./Mail Date _____.
Identifying indicia such as the application number (see 37 CFR 1.84(c)) should be written on the drawings in the front (not the back) of each sheet. Replacement sheet(s) should be labeled as such in the header according to 37 CFR 1.121(d).
6. DEPOSIT OF and/or INFORMATION about the deposit of BIOLOGICAL MATERIAL must be submitted. Note the attached Examiner's comment regarding REQUIREMENT FOR THE DEPOSIT OF BIOLOGICAL MATERIAL.

Attachment(s)

- | | |
|--|---|
| <ol style="list-style-type: none"> 1. <input type="checkbox"/> Notice of References Cited (PTO-892) 2. <input type="checkbox"/> Information Disclosure Statements (PTO/SB/08),
Paper No./Mail Date _____ 3. <input type="checkbox"/> Examiner's Comment Regarding Requirement for Deposit
of Biological Material 4. <input type="checkbox"/> Interview Summary (PTO-413),
Paper No./Mail Date _____. | <ol style="list-style-type: none"> 5. <input checked="" type="checkbox"/> Examiner's Amendment/Comment 6. <input checked="" type="checkbox"/> Examiner's Statement of Reasons for Allowance 7. <input type="checkbox"/> Other _____. |
|--|---|

/A. F./
Examiner, Art Unit 2884

Art Unit: 2884

DETAILED ACTION

Notice of Pre-AIA or AIA Status

1. The present application is being examined under the pre-AIA first to invent provisions.

Response to Amendment

2. The After-Final amendment filed 11/18/2016 has been accepted and entered. Accordingly, Claims 5 and 14 have been amended, and Claims 6 and 15 have been canceled.
3. Claims 1-5, 7-14, and 16-20 are pending in this application.

Response to Arguments

4. Applicant's arguments, see pp.1-3, filed 11/18/2016, with respect to Claims 6 and 15 have been fully considered and are persuasive. Claims 6 and 15 have been written into independent claims 5 and 14. The rejection of claims 5 and 14 has been withdrawn.

EXAMINER'S AMENDMENT

5. An examiner's amendment to the record appears below. Should the changes and/or additions be unacceptable to applicant, an amendment may be filed as provided by 37 CFR 1.312. To ensure consideration of such an amendment, it MUST be submitted no later than the payment of the issue fee.

The application has been amended as follows:

Claim 14 (Lines 14-15) – "...wherein the wearable measurement device receiver is configured to be ~~synchronize~~ synchronized to pulses of the light source...."

Allowable Subject Matter

6. **Claims 1-5, 7-14, and 16-20** are allowed.
7. The following is an examiner's statement of reasons for allowance:

Art Unit: 2884

14. Regarding **Claim 1**, Polli et al. (US 2006/0283931, hereinafter Polli) teaches a measurement system comprising: a light source configured to generate an output optical beam, comprising: one or more semiconductor sources configured to generate an input beam; a measurement apparatus configured to receive a received portion of the output optical beam, which is a delivered portion of the output optical beam; and a receiver configured to receive and process at least a portion of the analysis output beam reflected or transmitted from the sample and to generate an output signal wherein at least a portion of the output beam broadened spectrum comprises a short-wave infrared wavelength between approximately 700 nm and approximately 2500 nm [0076; 0013].

Islam (US 2009/0028193, hereinafter Islam) teaches the use of optical amplifiers configured to receive at least a portion of an input beam and to output an intermediate beam from at least one of the one or more optical amplifiers (Abstract).

Buchter et al. (US 8,000,574, hereinafter Buchter) teaches one or more optical fibers configured to receive at least a portion of the intermediate beam and to communicate at least the portion of the intermediate beam to form a first optical beam (col. 8, lines 18-20).

Islam (US 2006/0268393, hereinafter Islam 2) teaches a nonlinear element configured to receive at least a portion of an optical beam and to broaden a spectrum associated with at least a portion of that optical beam through a nonlinear effect in the nonlinear element to form an output optical beam with an output beam broadened spectrum [0039]. Buchter further teaches a supercontinuum radiation source that has a high degree of spatial coherence compared to thermal light sources (col. 1, lines 13-17).

Banet et al. (US 2010/0160798, hereinafter Banet; pub. Jun. 24, 2010) teaches a personal device comprising a wireless receiver, a wireless transmitter, a display, a microphone, a speaker, one or more buttons or knobs, a microprocessor, and a touch screen, the personal device configured to receive and process at least a portion of a signal transmitted over a wireless transmission link [0005].

Islam (US 2012/0239013, hereinafter Islam 3) teaches a measurement system comprising: a light source configured to generate an output optical beam, comprising: one or more semiconductor sources configured to generate an input beam; one or more optical amplifiers configured to receive at least a portion of the input beam and to deliver an intermediate beam to an output end of the one or more optical

Art Unit: 2884

amplifiers; and one or more optical fibers configured to receive at least a portion of the intermediate beam and to communicate at least part of the portion of the intermediate beam to form a first optical beam; a nonlinear element configured to receive at least a portion of the first optical beam and to broaden a spectrum associated with the at least a portion of the first optical beam to at least 10nm through a nonlinear effect in the nonlinear element to form the output optical beam with an output beam broadened spectrum (Abstract); and wherein at least a portion of the one or more fibers is a fused silica fiber [0004], a measurement apparatus configured to receive a received portion of the output optical beam and to deliver a delivered portion of the output optical beam to a sample (Fig. 20); and a receiver [0138].

Liu (US 2014/0249427, hereinafter Liu; PCT filed Dec. 15, 2011) teaches a fused silica fiber with a core diameter less than approximately 400 microns [0027].

Although each aspect of the claim is taught individually by multiple references, there is insufficient motivation to render the claim obvious and to combine all seven references. The prior art of record does not disclose or reasonably suggest, along with the other claim limitations, a measurement system comprising: a light source configured to generate an output optical beam, comprising: one or more semiconductor sources, one or more optical amplifiers configured to receive at least a portion of the input beam and to output an intermediate beam from at least one of the one or more optical amplifiers, one or more optical fibers configured to receive at least a portion of the intermediate beam and to communicate at least part of the portion of the intermediate beam to a distal end of the one or more optical fibers to form a first optical beam, and a nonlinear element configured to receive at least a portion of a first optical beam and to broaden a spectrum associated with the at least a portion of the first optical beam to at least 10nm through a nonlinear effect in the nonlinear element to form the output optical beam with an output beam broadened spectrum comprises a short-wave infrared wavelength between approximately 700 nm and approximately 2500 nm; a measurement apparatus configured to receive a received portion of the output optical beam and to deliver to a sample an analysis output beam, which is a delivered portion of the output optical beam and wherein the delivered portion of the output optical beam is a spatially coherent beam; a receiver; and a personal device.

Art Unit: 2884

8. Regarding **Claim 5**, Polli teaches a measurement system comprising: a light source comprising: a plurality of semiconductor sources configured to generate an output optical beam; an apparatus configured to receive a received portion of the output optical beam and to deliver an analysis output beam to a sample; a receiver configured to receive and process at least a portion of the analysis output beam reflected or transmitted from the sample and to generate an output signal with one or more optical wavelengths, wherein at least a portion of the one or more optical wavelengths is a near-infrared wavelength between 700 nanometers and 2500 nanometers [0076; 0013, Polli inherently teaches wavelengths between 700 nanometers and 2500 nanometers since that is the definition of near-infrared]. Polli does not explicitly a personal device and a remote device.

Banet teaches a personal device comprising a wireless receiver, a wireless transmitter, a display, a microphone, a speaker, one or more buttons or knobs, a microprocessor, and a touch screen, the personal device configured to receive and process at least a portion of a signal transmitted over a wireless transmission link; a remote device configured to receive over the wireless transmission link an output status comprising the at least a portion of the processed output signal to process the received output status to generate processed data and to store the processed data [0005], further comprising a light source comprising a plurality of semiconductor source that are light emitting diodes [0043]. Rubio Guivernau et al. (US 2014/0078510, hereinafter Rubio Guivernau; PCT filed May 18, 2012) teaches an apparatus comprising a plurality of lenses configured to receive a portion of the output beam (CLM 9).

Kleppe et al. (US 2011/0267688, hereinafter Kleppe; pub. Nov. 3, 2011) teaches a correlation between a signal-to-noise ratio and pulse rate/light intensity [0115].

The prior art of record does not disclose or reasonably suggest, along with the other claim limitations, a measurement system comprising: a light source comprising a plurality of semiconductor sources that are light emitting diodes, the light emitting diodes configured to generate an output optical beam with one or more optical wavelengths, wherein at least a portion of the one or more optical wavelengths is a near-infrared wavelength between 700 nanometers and 2500 nanometers, the light source configured to increase signal-to-noise ratio by increasing a light intensity from at least one of the plurality of semiconductor sources and by increasing a pulse rate of at least one of the plurality of

Art Unit: 2884

semiconductor sources; an apparatus comprising a plurality of lenses configured to receive a portion of the output optical beam and to deliver an analysis output beam to a sample; a receiver configured to receive and process at least a portion of the analysis output beam reflected or transmitted from the sample and to generate an output signal; a personal device comprising a wireless receiver, a wireless transmitter, a display, a microphone, a speaker, one or more buttons or knobs, a microprocessor and a touch screen, the personal device configured to receive and process at least a portion of the output signal, wherein the personal device is configured to store and display the processed output signal, and wherein at least a portion of the processed output signal is configured to be transmitted over a wireless transmission link; and a remote device configured to receive over the wireless transmission link an output status comprising the at least a portion of the processed output signal, to process the received output status to generate processed data and to store the processed data, **comprising: namely**, wherein the receiver is configured to be synchronized to the light source. This particular combination is non—obvious to synchronize because the receiver that is synchronized to the light source is also configured to receive and process at least a portion of the analysis output beam reflected or transmitted from the sample and to generate an output signal, and the light source is configured to increase signal-to-noise ratio by increasing a light intensity from at least one of the plurality of semiconductor sources and by increasing a pulse rate of at least one of the plurality of semiconductor sources. Not only is there not prior art of record that teaches this arrangement, but there is also no motivation to reasonably suggest this.

15. Regarding **Claim 14**, Polli teaches a measurement system comprising: a light source comprising a plurality of semiconductor sources configured to generate an output optical beam; a measurement apparatus configured to receive a received portion of the output optical beam with one or more optical wavelengths, and to deliver an analysis output beam to a sample; and a receiver configured to receive and process at least a portion of the analysis output beam reflected or transmitted from the sample and to generate an output signal [0076; 0013, Polli inherently teaches wavelengths between 700 nanometers and 2500 nanometers since that is the definition of near-infrared].

Banet teaches wearable measurement device further comprising a personal device comprising a wireless receiver, a wireless transmitter, a display, a microphone, a speaker, one or more buttons or

Art Unit: 2884

knobs, a microprocessor, and a touch screen, the personal device configured to receive and process at least a portion of a signal transmitted over a wireless transmission link; a remote device configured to receive over the wireless transmission link an output status comprising the at least a portion of the processed output signal, to process the received output status to generate processed data and to store the processed data [0005], further comprising a light source comprising a plurality of semiconductor source that are light emitting diodes [0043]. Banet further teaches the benefit of being able to transmit and display information generated [0005]. It would have been obvious to a person of ordinary skill in the art at the time of the invention to combine the measurement system, as taught by Polli, with a personal device and remote device, as taught by Banet, for the benefit of transmitting and displaying information generated.

Rubio Guivernau teaches an apparatus comprising a plurality of lenses configured to receive a portion of the output beam (CLM 9). Rubio Guivernau further teaches the benefit of optical power efficiency [0049]. It would have been obvious to a person of ordinary skill in the art at the time of the invention to combine the measurement system, as taught by Polli, with the plurality of lenses configured to receive a portion of the output beam, as taught by Rubio Guivernau, for the benefit of optical power efficiency.

Kleppe teaches a correlation between a signal-to-noise ratio and pulse rate/light intensity [0115]. Kleppe further teaches the benefit of obtaining an optimum detection signal [0115]. It would have been obvious to a person of ordinary skill in the art at the time of the invention to combine the measurement system, as taught by Polli, with correlation a signal-to-noise ratio with a pulse rate and light intensity, as taught by Kleppe, for the benefit of obtaining an optimum detection signal.

The prior art of record does not disclose or reasonably suggest, along with the other claim limitations, a measurement system comprising: a wearable measurement device for measuring one or more physiological parameters, including a light source comprising a plurality of semiconductor sources that are light emitting diodes, the light emitting diodes configured to generate an output optical beam with one or more optical wavelengths, wherein at least a portion of the one or more optical wavelengths is a near-infrared wavelength between 700 nanometers and 2500 nanometers, the light source configured to

Art Unit: 2884

increase signal-to-noise ratio by increasing a light intensity from at least one of the plurality of semiconductor sources and by increasing a pulse rate of at least one of the plurality of semiconductor sources; the wearable measurement device comprising a plurality of lenses configured to receive a portion of the output optical beam and to deliver an analysis output beam to a sample; the wearable measurement device further comprising a receiver configured to receive and process at least a portion of the analysis output beam reflected or transmitted from the sample and to generate an output signal; a personal device comprising a wireless receiver, a wireless transmitter, a display, a microphone, a speaker, one or more buttons or knobs, a microprocessor and a touch screen, the personal device configured to receive and process at least a portion of the output signal, wherein the personal device is configured to store and display the processed output signal, and wherein at least a portion of the processed output signal is configured to be transmitted over a wireless transmission link; and a remote device configured to receive over the wireless transmission link an output status comprising the at least a portion of the processed output signal, to process the received output status to generate processed data and to store the processed data, and wherein the remote device is capable of storing a history of at least a portion of the received output status over a specified period of time, **comprising: namely**, wherein the wearable measurement device receiver is configured to be synchronize to pulsed of the light source. This particular combination is non—obvious to synchronize because the receiver that is synchronized to the light source is also configured to receive and process at least a portion of the analysis output beam reflected or transmitted from the sample and to generate an output signal, and the light source is configured to increase signal-to-noise ratio by increasing a light intensity from at least one of the plurality of semiconductor sources and by increasing a pulse rate of at least one of the plurality of semiconductor sources. Not only is there not prior art of record that teaches this arrangement, but there is also no motivation to reasonably suggest this.

9. **Claims 2-4, 7-13, and 16-20** are allowable due to dependency.

10. Any comments considered necessary by applicant must be submitted no later than the payment of the issue fee and, to avoid processing delays, should preferably accompany the issue fee. Such

Art Unit: 2884

submissions should be clearly labeled "Comments on Statement of Reasons for Allowance."

Conclusion

Any inquiry concerning this communication or earlier communications from the examiner should be directed to Abra Fein whose telephone number is (571)272-0552. The examiner can normally be reached on Monday-Friday 8am-5pm EST.

If attempts to reach the examiner by telephone are unsuccessful, the examiner's supervisor, Dave Porta can be reached on 571-272-2444. The fax phone number for the organization where this application or proceeding is assigned is 571-273-8300.

Information regarding the status of an application may be obtained from the Patent Application Information Retrieval (PAIR) system. Status information for published applications may be obtained from either Private PAIR or Public PAIR. Status information for unpublished applications is available through Private PAIR only. For more information about the PAIR system, see <http://pair-direct.uspto.gov>. Should you have questions on access to the Private PAIR system, contact the Electronic Business Center (EBC) at 866-217-9197 (toll-free). If you would like assistance from a USPTO Customer Service Representative or access to the automated information system, call 800-786-9199 (IN USA OR CANADA) or 571-272-1000.

/DAVID PORTA/
Supervisory Patent Examiner, Art Unit
2884

/A. F./
Examiner, Art Unit 2884

Search Notes 	Application/Control No. 14875709	Applicant(s)/Patent Under Reexamination ISLAM, MOHAMMED N.
	Examiner ABRA FEIN	Art Unit 2884

CPC- SEARCHED		
Symbol	Date	Examiner
G01N33/15, G01N21/359, G01N33/49	5/13/2016	/A.F./

CPC COMBINATION SETS - SEARCHED		
Symbol	Date	Examiner

US CLASSIFICATION SEARCHED			
Class	Subclass	Date	Examiner
250	338.4	5/13/2016	/A.F./
	refreshed	10/11/2016	/A.F./
	refreshed	11/23/2016	/A.F./

SEARCH NOTES		
Search Notes	Date	Examiner
Inventor Name Search	5/13/2016	/A.F./
EAST text search	5/13/2016	/A.F./
Class 250 text search	5/13/2016	/A.F./
Consultation with Yara Green (class 250)	5/17/2016	/A.F./
EAST text search	10/11/2016	/A.F./
Consultation with Yara Green (class 250)	10/14/2016	/A.F./
EAST text search	11/23/2016	/A.F./
Class 250 text search	11/23/2016	/A.F./

INTERFERENCE SEARCH			
US Class/ CPC Symbol	US Subclass / CPC Group	Date	Examiner
	claims	10/11/2016	/A.F./
250	338.4	10/11/2016	/A.F./

/A.F./ Examiner.Art Unit 2884	
----------------------------------	--

INTERFERENCE SEARCH

US Class/ CPC Symbol	US Subclass / CPC Group	Date	Examiner
G01N	G01N3315, G01N1/359, G01N33/49	10/11/2016	/A.F./
	claims	11/23/2016	/A.F./

/A.F./
Examiner.Art Unit 2884

Issue Classification 	Application/Control No. 14875709	Applicant(s)/Patent Under Reexamination ISLAM, MOHAMMED N.
	Examiner ABRA FEIN	Art Unit 2884

CPC						
Symbol					Type	Version
G01N		33		15	F	2013-01-01
A61B		5		1455	I	2013-01-01
A61B		5		0075	I	2013-01-01
H01S		3		302	A	2013-01-01
G01J		3		108	I	2013-01-01
G01J		3		28	I	2013-01-01
G01J		2003		104	A	2013-01-01
G01J		3		453	I	2013-01-01
G01N		21		359	I	2013-01-01
G01J		3		14	A	2013-01-01
G01J		3		1838	A	2013-01-01
G01J		2003		2826	A	2013-01-01
A61B		5		0013	I	2013-01-01
A61B		5		0022	I	2013-01-01
A61B		5		0086	I	2013-01-01
A61B		5		0088	I	2013-01-01
A61B		2562		0233	A	2013-01-01
A61B		2562		146	A	2013-01-01
A61B		2576		02	A	2013-01-01
A61B		5		14532	I	2013-01-01
A61B		5		14546	I	2013-01-01
A61B		5		4547	I	2013-01-01
A61B		2562		0238	A	2013-01-01
G01N		33		49	I	2013-01-01
G01N		2201		061	A	2013-01-01
G01N		2201		12	A	2013-01-01
G01N		2201		062	A	2013-01-01

CPC Combination Sets				
Symbol	Type	Set	Ranking	Version

/A.F./ Examiner.Art Unit 2884 (Assistant Examiner)	11/23/2016 (Date)	Total Claims Allowed: 18	
/DAVID PORTA/ Supervisory Patent Examiner.Art Unit 2884 (Primary Examiner)	12/27/2016 (Date)	O.G. Print Claim(s) 1	O.G. Print Figure 18

Issue Classification 	Application/Control No. 14875709	Applicant(s)/Patent Under Reexamination ISLAM, MOHAMMED N.	
	Examiner ABRA FEIN	Art Unit 2884	

/A.F./ Examiner.Art Unit 2884 (Assistant Examiner)	11/23/2016 (Date)	Total Claims Allowed: 18	
/DAVID PORTA/ Supervisory Patent Examiner.Art Unit 2884 (Primary Examiner)	12/27/2016 (Date)	O.G. Print Claim(s) 1	O.G. Print Figure 18

Issue Classification 	Application/Control No. 14875709	Applicant(s)/Patent Under Reexamination ISLAM, MOHAMMED N.
	Examiner ABRA FEIN	Art Unit 2884

<input type="checkbox"/> Claims renumbered in the same order as presented by applicant		<input type="checkbox"/> CPA		<input type="checkbox"/> T.D.		<input type="checkbox"/> R.1.47									
Final	Original	Final	Original	Final	Original	Final	Original	Final	Original	Final	Original	Final	Original	Final	Original
1	1	17	19												
2	2	18	20												
3	3														
4	4														
5	5														
6	7														
7	8														
8	9														
10	10														
9	11														
11	12														
12	13														
13	14														
14	16														
15	17														
16	18														

/A.F./ Examiner.Art Unit 2884 (Assistant Examiner)	11/23/2016 (Date)	Total Claims Allowed: 18	
/DAVID PORTA/ Supervisory Patent Examiner.Art Unit 2884 (Primary Examiner)	12/27/2016 (Date)	O.G. Print Claim(s) 1	O.G. Print Figure 18

EAST Search History

EAST Search History (Prior Art)

Ref #	Hits	Search Query	DBs	Default Operator	Plurals	Time Stamp
S1	1	(14/108986).APP.	US-PGPUB; USPAT	OR	OFF	2015/06/15 12:07
S2	1029	(250/338.4).CCLS.	US-PGPUB; USPAT	OR	OFF	2015/06/15 12:07
S3	269	((Mohammed) near2 (Islam)).INV.	US-PGPUB; USPAT	OR	ON	2015/06/15 12:07
S4	7	(("6885683") or ("6281471") or ("6340806") or ("6301271") or ("7294105") or ("20100046067") or ("20080105665")).PN.	US-PGPUB; USPAT	OR	OFF	2015/06/15 12:08
S5	52	(("5084880") or ("5180378") or ("5400165") or ("5458122") or ("5617871") or ("5631758") or ("5687734") or ("5696778") or ("5704351") or ("5718234") or ("5748103") or ("5855550") or ("5862803") or ("5847305") or ("5912749") or ("5944659") or ("5957854") or ("6014249") or ("6043927") or ("6289238") or ("6333803") or ("6364834") or ("6381391") or ("6402691") or ("6407853") or ("6441747") or ("6443890") or ("6454705") or ("6480656") or ("6549702") or ("6603910") or ("6659947") or ("6802811") or ("7167300") or ("7209657") or ("7263288") or ("7519253") or ("20020013518") or ("20020019584") or ("20020032468") or ("20020082612") or ("20020109621") or ("20020115914") or ("20020178003") or ("20040174914") or ("20040240037") or ("20050111511") or ("20060245461") or ("20060268393") or ("20070078348") or ("20090028193") or ("20090204110")).PN.	US-PGPUB; USPAT	OR	OFF	2015/06/15 12:12
S6	4	(("7787503") or ("7800818") or ("8000574") or ("6611643")).PN.	US-PGPUB; USPAT	OR	OFF	2015/06/15 12:13
S7	82	(("4063106") or ("4158750") or ("4221997") or ("4275266") or ("4374618") or ("4403605") or ("4462080") or ("4516207") or ("4523884") or ("4605080") or ("4641292") or ("4704696") or ("4728974") or ("4762455") or ("4776016") or ("4958910") or	US-PGPUB; USPAT	OR	OFF	2015/06/15 12:19

		("4989253") or ("5078140") or ("5084880") or ("5086401") or ("5134620") or ("5142930") or ("5180378") or ("5191628") or ("5218655") or ("5230023") or ("5267256") or ("5267323") or ("5300097") or ("5303148") or ("5305427") or ("5313306") or ("5323404") or ("5345538") or ("5408409") or ("5544654") or ("5572999") or ("5695493") or ("5696778") or ("5792204") or ("5812978") or ("5950629") or ("5970457") or ("6014249") or ("6185535") or ("6200309") or ("6224542") or ("6246707") or ("6273858") or ("6278975") or ("6301273") or ("6337462") or ("6340806") or ("6350261") or ("6374006") or ("6407853") or ("6436107") or ("6442430") or ("6450172") or ("6453201") or ("6458120") or ("6462500") or ("6463361") or ("6567431") or ("6605080") or ("6625180") or ("6631025") or ("6659999") or ("6760148") or ("6885498") or ("6885683") or ("6943936") or ("7027467") or ("7060061") or ("7167300") or ("7259906") or ("7433116") or ("20020032468") or ("20020082612") or ("20020128846") or ("20020178003") or ("20040174914")).PN.				
S8	3	((("6246896") or ("6285897") or ("6847336")).PN.	US- PGPUB; USPAT	OR	OFF	2015/06/15 12:21
S9	30	((("5747806") or ("5115673") or ("6512936") or ("6534012") or ("6640117") or ("6788965") or ("6816241") or ("6738652") or ("6587702") or ("6864978") or ("6990364") or ("7010336") or ("7133710") or ("7233816") or ("7299080") or ("7317938") or ("7395158") or ("7519406") or ("7620674") or ("7697966") or ("7787924") or ("8145286") or ("6773922") or ("7807718") or ("20100331637") or ("20110143364") or ("20030022126") or ("20060223032") or ("20100322490") or ("20120013722")).PN.	US- PGPUB; USPAT	OR	OFF	2015/06/15 12:54
S10	2	((("8472108") or ("20130274569")).PN.	US- PGPUB; USPAT	OR	OFF	2015/06/15 12:54
S11	168	S4 S5 S6 S7 S8 S9 S10	US- PGPUB; USPAT; EPO; JPO; DERWENT	OR	ON	2015/06/15 13:07
S12	2	((12/206432) or (10/652276) or	US-	OR	OFF	2015/06/15

		(10/757341)).APP.	PGPUB; USPAT			14:48
S13	5	((("WOadj2014105520") or ("WOadj2014143276A9") or ("WOadj2014143276") or ("WOadj2013148656") or ("EPadj2831566") or ("WOadj2013148666") or ("EPadj2831565") or ("20130265568") or ("WOadj2014105521") or ("8859969") or ("20130256534") or ("20140236021") or ("CAadj2648549") or ("WOadj2007117867") or ("20060283931") or ("EPadj2011047") or ("EPadj1671094") or ("WOadj2005031302"))).PN.	US- PGPUB; USPAT	OR	OFF	2015/06/15 14:51
S14	16	WO adj "2014105520" WO adj "2014143276A9" WO adj "2014143276" WO adj "2013148656" EP adj "2831566" WO adj "2013148666" EP adj "2831565" "20130265568" WO adj "2014105521" "8859969" "20130256534" "20140236021" CA adj "2648549" WO adj "2007117867" "20060283931" EP adj "2011047" EP adj "1671094" WO adj "2005031302"	US- PGPUB; USPAT; EPO; JPO; DERWENT	OR	ON	2015/06/15 14:51
S15	7	((("6885683") or ("6281471") or ("6340806") or ("6301271") or ("7294105") or ("20100046067") or ("20080105665"))).PN.	US- PGPUB; USPAT	OR	OFF	2015/06/16 09:37
S16	52	((("5084880") or ("5180378") or ("5400165") or ("5458122") or ("5617871") or ("5631758") or ("5687734") or ("5696778") or ("5704351") or ("5718234") or ("5748103") or ("5855550") or ("5862803") or ("5847305") or ("5912749") or ("5944659") or ("5957854") or ("6014249") or ("6043927") or ("6289238") or ("6333803") or ("6364834") or ("6381391") or ("6402691") or ("6407853") or ("6441747") or ("6443890") or ("6454705") or ("6480656") or ("6549702") or ("6603910") or ("6659947") or ("6802811") or ("7167300") or ("7209657") or ("7263288") or ("7519253") or ("20020013518") or ("20020019584") or ("20020032468") or ("20020082612") or ("20020109621") or ("20020115914") or ("20020178003") or ("20040174914") or ("20040240037") or ("20050111511") or ("20060245461") or ("20060268393") or ("20070078348") or ("20090028193") or ("20090204110"))).PN.	US- PGPUB; USPAT	OR	OFF	2015/06/16 09:37
S17	4	((("7787503") or ("7800818") or ("8000574") or ("6611643"))).PN.	US- PGPUB; USPAT	OR	OFF	2015/06/16 09:37
S18	82	((("4063106") or ("4158750") or ("4221997") or ("4275266") or ("4374618") or ("4403605") or	US- PGPUB; USPAT	OR	OFF	2015/06/16 09:37

		("4462080") or ("4516207") or ("4523884") or ("4605080") or ("4641292") or ("4704696") or ("4728974") or ("4762455") or ("4776016") or ("4958910") or ("4989253") or ("5078140") or ("5084880") or ("5086401") or ("5134620") or ("5142930") or ("5180378") or ("5191628") or ("5218655") or ("5230023") or ("5267256") or ("5267323") or ("5300097") or ("5303148") or ("5305427") or ("5313306") or ("5323404") or ("5345538") or ("5408409") or ("5544654") or ("5572999") or ("5695493") or ("5696778") or ("5792204") or ("5812978") or ("5950629") or ("5970457") or ("6014249") or ("6185535") or ("6200309") or ("6224542") or ("6246707") or ("6273858") or ("6278975") or ("6301273") or ("6337462") or ("6340806") or ("6350261") or ("6374006") or ("6407853") or ("6436107") or ("6442430") or ("6450172") or ("6453201") or ("6458120") or ("6462500") or ("6463361") or ("6567431") or ("6605080") or ("6625180") or ("6631025") or ("6659999") or ("6760148") or ("6885498") or ("6885683") or ("6943936") or ("7027467") or ("7060061") or ("7167300") or ("7259906") or ("7433116") or ("20020032468") or ("20020082612") or ("20020128846") or ("20020178003") or ("20040174914")).PN.				
S19	3	((("6246896") or ("6285897") or ("6847336"))).PN.	US- PGPUB; USPAT	OR	OFF	2015/06/16 09:37
S20	30	((("5747806") or ("5115673") or ("6512936") or ("6534012") or ("6640117") or ("6788965") or ("6816241") or ("6738652") or ("6587702") or ("6864978") or ("6990364") or ("7010336") or ("7133710") or ("7233816") or ("7299080") or ("7317938") or ("7395158") or ("7519406") or ("7620674") or ("7697966") or ("7787924") or ("8145286") or ("6773922") or ("7807718") or ("20100331637") or ("20110143364") or ("20030022126") or ("20060223032") or ("20100322490") or ("20120013722"))).PN.	US- PGPUB; USPAT	OR	OFF	2015/06/16 09:37
S21	2	((("8472108") or ("20130274569"))).PN.	US- PGPUB; USPAT	OR	OFF	2015/06/16 09:37
S22	168	S15 S16 S17 S18 S19 S20 S21	US- PGPUB;	OR	ON	2015/06/16 09:37

			USPAT; EPO; JPO; DERWENT			
S23	2	((12/206432) or (10/652276) or (10/757341)).APP.	US- PGPUB; USPAT	OR	OFF	2015/06/16 09:37
S24	5	(("WOadj2014105520") or ("WOadj2014143276A9") or ("WOadj2014143276") or ("WOadj2013148656") or ("EPadj2831566") or ("WOadj2013148666") or ("EPadj2831565") or ("20130265568") or ("WOadj2014105521") or ("8859969") or ("20130256534") or ("20140236021") or ("CAadj2648549") or ("WOadj2007117867") or ("20060283931") or ("EPadj2011047") or ("EPadj1671094") or ("WOadj2005031302")).PN.	US- PGPUB; USPAT	OR	OFF	2015/06/16 09:37
S25	16	WO adj "2014105520" WO adj 2014143276A9 WO adj "2014143276" WO adj "2013148656" EP adj "2831566" WO adj "2013148666" EP adj "2831565" "20130265568" WO adj "2014105521" "8859969" "20130256534" "20140236021" CA adj "2648549" WO adj "2007117867" "20060283931" EP adj "2011047" EP adj "1671094" WO adj "2005031302"	US- PGPUB; USPAT; EPO; JPO; DERWENT	OR	ON	2015/06/16 09:37
S26	185	S22 S23 S24 S25	US- PGPUB; USPAT; EPO; JPO; DERWENT	OR	ON	2015/06/16 09:37
S27	126	S26 and ((light near2 source)(near-infrared near-IR IR infrared NIR)SWIR(super near continuum super-continuum supercontinuum) SC (short near wave near infrared)(short near wave near IR))	US- PGPUB; USPAT; EPO; JPO; DERWENT	OR	ON	2015/06/16 09:44
S28	1	S26 and ((light near2 source)(near-infrared near-IR IR infrared NIR)SWIR(super near continuum super-continuum supercontinuum) SC (short near wave near infrared)(short near wave near IR)) same semiconductor same (multiplexer multiplexor)	US- PGPUB; USPAT; EPO; JPO; DERWENT	OR	ON	2015/06/16 09:46
S29	24	S26 and ((light near2 source)(near-infrared near-IR IR infrared NIR)SWIR(super near continuum super-continuum supercontinuum) SC (short near wave near infrared)(short near wave near IR)) and semiconductor and(multiplexer multiplexor)	US- PGPUB; USPAT; EPO; JPO; DERWENT	OR	ON	2015/06/16 09:47
S30	24	S26 and ((light near2 source)(near-infrared near-IR IR infrared NIR)SWIR(super near continuum super-continuum supercontinuum) SC (short near wave near infrared)(short near wave near IR)) and semiconduct\$5 and(multiplexer multiplexor)	US- PGPUB; USPAT; EPO; JPO; DERWENT	OR	ON	2015/06/16 09:47

S31	21	S26 and ((light near2 source)(near-infrared near-IR NIR)SWIR(super near continuum super-continuum supercontinuum) SC (short near wave near infrared)(short near wave near IR)) and semiconduct\$5 and(multiplexer multiplexor)	US-PGPUB; USPAT; EPO; JPO; DERWENT	OR	ON	2015/06/16 09:48
S32	648	((light near2 source)(near-infrared near-IR NIR)SWIR(super near continuum super-continuum supercontinuum) SC (short near wave near infrared)(short near wave near IR)) same semiconduct\$5 same (multiplexer multiplexor)	US-PGPUB; USPAT; EPO; JPO; DERWENT	OR	ON	2015/06/16 10:05
S33	123	((light near2 source)(near-infrared near-IR NIR)SWIR(super near continuum super-continuum supercontinuum) SC (short near wave near infrared)(short near wave near IR)) same (semiconduct\$5 with amplif\$6)same fiber same (multiplexer multiplexor)	US-PGPUB; USPAT; EPO; JPO; DERWENT	OR	ON	2015/06/16 10:08
S34	5	((light near2 source)(near-infrared near-IR NIR)SWIR(super near continuum super-continuum supercontinuum) SC (short near wave near infrared)(short near wave near IR)) same (semiconduct\$5 with amplif\$6)same fiber same (multiplexer multiplexor)same sample	US-PGPUB; USPAT; EPO; JPO; DERWENT	OR	ON	2015/06/16 10:37
S35	6	S25 and (semiconduct\$5 multiplex\$5)	US-PGPUB; USPAT; EPO; JPO; DERWENT	OR	ON	2015/06/16 10:50
S36	2	S25 and (multiplex\$5)	US-PGPUB; USPAT; EPO; JPO; DERWENT	OR	ON	2015/06/16 10:50
S37	6	S25 and (semiconduct\$5 multiplex\$5 mux)	US-PGPUB; USPAT; EPO; JPO; DERWENT	OR	ON	2015/06/16 10:51
S38	8	S25 and (laser (super near luminesc\$5 near diode)LED (light near emit\$5 near diode))	US-PGPUB; USPAT; EPO; JPO; DERWENT	OR	ON	2015/06/16 10:53
S39	9	S25 and (fiber)	US-PGPUB; USPAT; EPO; JPO; DERWENT	OR	ON	2015/06/16 10:54
S40	1	S25 and (FTIR)	US-PGPUB; USPAT; EPO; JPO; DERWENT	OR	ON	2015/06/16 10:56
S41	4	S25 and (fourier)	US-PGPUB; USPAT;	OR	ON	2015/06/16 10:59

			EPO; JPO; DERWENT			
S42	4	S25 and (fourier with (IR infrared infra-red))	US- PGPUB; USPAT; EPO; JPO; DERWENT	OR	ON	2015/06/16 10:59
S43	4	S25 and (fourier near4 (IR infrared infra-red))	US- PGPUB; USPAT; EPO; JPO; DERWENT	OR	ON	2015/06/16 10:59
S44	575	((light near2 source)(near-infrared near-IR NIR)SWIR(super near continuum super-continuum supercontinuum) SC (short near wave near infrared)(short near wave near IR) same (multiplexer multiplexer) same sample	US- PGPUB; USPAT; EPO; JPO; DERWENT	OR	ON	2015/06/16 11:21
S45	8428	((light near2 source)(near-infrared near-IR NIR)SWIR(super near continuum super-continuum supercontinuum) SC (short near wave near infrared)(short near wave near IR) same (multiplexer multiplexer)	US- PGPUB; USPAT; EPO; JPO; DERWENT	OR	ON	2015/06/16 11:21
S46	3	((light near2 source)(near-infrared near-IR NIR)SWIR(super near continuum super-continuum supercontinuum) SC (short near wave near infrared)(short near wave near IR) same (multiplexer multiplexer) same (pharmaceutical counterfeit illicit contraband)	US- PGPUB; USPAT; EPO; JPO; DERWENT	OR	ON	2015/06/16 11:22
S47	59	(multiplexer multiplexer) same (pharmaceutical counterfeit illicit contraband)	US- PGPUB; USPAT; EPO; JPO; DERWENT	OR	ON	2015/06/16 13:07
S48	4	(multiplexer multiplexer) same (pharmaceutical counterfeit illicit contraband) and "250".clas.	US- PGPUB; USPAT; EPO; JPO; DERWENT	OR	ON	2015/06/16 13:08
S49	23	(multiplexer multiplexer) same (pharmaceutical counterfeit illicit contraband) and fiber	US- PGPUB; USPAT; EPO; JPO; DERWENT	OR	ON	2015/06/16 13:12
S50	2	(multiplexer multiplexer) same (pharmaceutical counterfeit illicit contraband) and fiber and "250".clas.	US- PGPUB; USPAT; EPO; JPO; DERWENT	OR	ON	2015/06/16 13:12
S51	23	(multiplexer multiplexer) same (pharmaceutical counterfeit illicit contraband) and fiber	US- PGPUB; USPAT; EPO; JPO; DERWENT	OR	ON	2015/06/16 13:12
S52	7	(multiplexer multiplexer) same (pharmaceutical counterfeit illicit contraband) same fiber	US- PGPUB; USPAT; EPO; JPO; DERWENT	OR	ON	2015/06/16 13:12

S53	115	S26 and fiber	US-PGPUB; USPAT; EPO; JPO; DERWENT	OR	ON	2015/06/16 13:14
S54	43	S26 and(fiber with beam)	US-PGPUB; USPAT; EPO; JPO; DERWENT	OR	ON	2015/06/16 13:14
S55	2	S26 and(fiber with beam)and "250".clas.	US-PGPUB; USPAT; EPO; JPO; DERWENT	OR	ON	2015/06/16 13:14
S56	9	S26 and(FTIR FT-IR ("fourier transform infrared"))	US-PGPUB; USPAT; EPO; JPO; DERWENT	OR	ON	2015/06/16 13:20
S57	270	((Mohammed) near2 (Islam)).INV.	US-PGPUB; USPAT	OR	ON	2015/06/16 13:22
S58	67	S57 and multiplexer.clm.	US-PGPUB; USPAT	OR	ON	2015/06/16 13:22
S59	21	S57 and ((multiplexer and semiconductor and fibers).clm.)	US-PGPUB; USPAT	OR	ON	2015/06/16 13:23
S60	2	S57 and ((multiplexer and semiconductor and fibers and FTIR).clm.)	US-PGPUB; USPAT	OR	ON	2015/06/16 13:23
S61	125	S57 and (broaden\$5)	US-PGPUB; USPAT	OR	ON	2015/06/16 16:17
S62	64	S57 and (broaden\$5 with (nonlinear nonlinear))	US-PGPUB; USPAT	OR	ON	2015/06/16 16:17
S63	29	S57 and (broaden\$5 with (nonlinear nonlinear) with spectrum)	US-PGPUB; USPAT	OR	ON	2015/06/16 16:17
S64	9	S57 and (broaden\$5 near4(nonlinear nonlinear) with spectrum)	US-PGPUB; USPAT	OR	ON	2015/06/16 16:17
S65	2	S57 and (organic with (overtone (combination\$5 absor%8)))	US-PGPUB; USPAT	OR	ON	2015/06/16 16:31
S66	2	S57 and (organic with (overtone (combination\$5 near absor\$8)))	US-PGPUB; USPAT	OR	ON	2015/06/16 16:32
S67	206	(organic with (overtone (combination\$5 near absor\$8)))	US-PGPUB; USPAT	OR	ON	2015/06/16 16:32
S68	62	(organic with (overtone))	US-PGPUB; USPAT	OR	ON	2015/06/16 16:40
S69	14	(organic with (overtone))and "250".clas.	US-PGPUB;	OR	ON	2015/06/16 16:40

			USPAT			
S70	1	("6105823").PN.	US-PGPUB; USPAT	OR	OFF	2015/06/17 16:05
S71	320	abrahamsson.in.	US-PGPUB; USPAT; EPO; JPO; DERWENT	OR	ON	2015/06/17 16:05
S72	4	abrahamsson.in. and multiplexer	US-PGPUB; USPAT; EPO; JPO; DERWENT	OR	ON	2015/06/17 16:06
S73	1034	(250/338.4).CCLS.	US-PGPUB; USPAT	OR	OFF	2015/07/23 13:49
S74	5	((light near2 source)(near-infrared near-IR)SWIR(super near continuum super-continuum supercontinuum) SC (short near wave near infrared)(short near wave near IR) same (semiconduct\$5 with amplif\$6)same fiber same (multiplexer multiplexor)same sample	US-PGPUB; USPAT; EPO; JPO; DERWENT	OR	ON	2015/07/23 13:49
S75	2	(multiplexer multiplexor) same (pharmaceutical counterfeit illicit contraband) and fiber and "250".clas.	US-PGPUB; USPAT; EPO; JPO; DERWENT	OR	ON	2015/07/23 13:50
S76	125	((light near2 source)(near-infrared near-IR)SWIR(super near continuum super-continuum supercontinuum) SC (short near wave near infrared)(short near wave near IR) same (semiconduct\$5 with amplif\$6)same fiber same (multiplexer multiplexor)	US-PGPUB; USPAT; EPO; JPO; DERWENT	OR	ON	2015/07/23 13:50
S77	8	(multiplexer multiplexor) same (pharmaceutical counterfeit illicit contraband)same fiber	US-PGPUB; USPAT; EPO; JPO; DERWENT	OR	ON	2015/07/23 13:50
S78	14	(organic with (overtone))and "250".clas.	US-PGPUB; USPAT	OR	ON	2015/07/23 13:50
S79	1	(sample) with (overtone or "combinational absorption band") with(wavelength near range) .clm.	US-PGPUB; USPAT	OR	ON	2015/07/23 13:53
S81	7	250/338.4 and @pd> "20150625"	US-PGPUB; USPAT; EPO; JPO; DERWENT	OR	ON	2015/07/24 11:51
S89	1	("20100161794").PN.	US-PGPUB; USPAT	OR	OFF	2016/05/13 11:39
S90	606	banet.in.	US-PGPUB; USPAT; EPO; JPO;	OR	ON	2016/05/13 11:40

			DERWENT			
S91	5	(US-20060283931-\$ or US-20090028193-\$ or US-20100160798-\$).did. or (US-8000574-\$ or US-6181414-\$).did.	US-PGPUB; USPAT	OR	ON	2016/05/13 11:58
S92	0	S91 and (LED light near emit\$7 near diode) with puls\$5	US-PGPUB; USPAT; EPO; JPO; DERWENT	OR	ON	2016/05/13 11:58
S93	93	(near-infrared near-IR)with(LED light near emit\$7 near diode) with puls\$5	US-PGPUB; USPAT; EPO; JPO; DERWENT	OR	ON	2016/05/13 11:59
S94	8	(near-infrared near-IR)with(LED light near emit\$7 near diode) with puls\$5 and "250".clas.	US-PGPUB; USPAT; EPO; JPO; DERWENT	OR	ON	2016/05/13 11:59
S95	1059	(250/338.4).OCLS.	US-PGPUB; USPAT	OR	OFF	2016/05/13 13:56
S96	1	("9164032").PN.	US-PGPUB; USPAT	OR	OFF	2016/05/17 14:53
S97	1	("0612310").PN.	US-PGPUB; USPAT	OR	OFF	2016/05/17 15:31
S98	1	("20140249427").PN.	US-PGPUB; USPAT	OR	OFF	2016/05/17 15:32
S99	1067	(250/338.4).OCLS.	US-PGPUB; USPAT	OR	OFF	2016/10/11 11:38
S100	0	(light near source) with increas\$4 near2 signal\$to\$noise near ratio with light near intensit\$4 with semiconduct\$4 with pulse near2 rate	US-PGPUB; USPAT; EPO; JPO; DERWENT	OR	ON	2016/10/11 11:39
S101	0	(light near source) with increas\$4 near2 signal\$to\$noise near ratio with light near intensit\$4 with semiconduct\$4	US-PGPUB; USPAT; EPO; JPO; DERWENT	OR	ON	2016/10/11 11:40
S102	0	(light near source) with increas\$4 near2 "signal to noise" near ratio with light near intensit\$4 with semiconduct\$4	US-PGPUB; USPAT; EPO; JPO; DERWENT	OR	ON	2016/10/11 11:40
S103	0	(light near source) with increas\$4 near2 "signal to noise" near ratio with light near intensit\$4	US-PGPUB; USPAT; EPO; JPO; DERWENT	OR	ON	2016/10/11 11:57
S104	0	(light) with increas\$4 near2 "signal to noise" near ratio with light near intensit\$4	US-PGPUB; USPAT; EPO; JPO; DERWENT	OR	ON	2016/10/11 11:58

S105	0	(source) with increas\$4 near2 "signal to noise" near ratio with light near intensit\$4	US-PGPUB; USPAT; EPO; JPO; DERWENT	OR	ON	2016/10/11 11:58
S106	0	increas\$4 near2 "signal to noise" near ratio with light near intensit\$4	US-PGPUB; USPAT; EPO; JPO; DERWENT	OR	ON	2016/10/11 11:58
S107	136	increas\$4 near2 "signal to noise" near ratio	US-PGPUB; USPAT; EPO; JPO; DERWENT	OR	ON	2016/10/11 11:58
S108	0	increas\$4 near2 "signal to noise" near ratio with (increas\$4 near2 light near intensit\$4)	US-PGPUB; USPAT; EPO; JPO; DERWENT	OR	ON	2016/10/11 11:59
S109	0	increas\$4 near2 "signal to noise" near ratio with (light near intensit\$4)	US-PGPUB; USPAT; EPO; JPO; DERWENT	OR	ON	2016/10/11 11:59
S110	1	increas\$4 near2 "signal to noise" near ratio with (intensit\$4)	US-PGPUB; USPAT; EPO; JPO; DERWENT	OR	ON	2016/10/11 11:59
S111	31	"signal to noise" near ratio with (intensit\$4)	US-PGPUB; USPAT; EPO; JPO; DERWENT	OR	ON	2016/10/11 12:04
S112	1	increas\$4 near4 "signal to noise" near ratio with (intensit\$4)	US-PGPUB; USPAT; EPO; JPO; DERWENT	OR	ON	2016/10/11 12:05
S113	1	(increas\$4 near4 "signal to noise ratio") with (intensit\$4)	US-PGPUB; USPAT; EPO; JPO; DERWENT	OR	ON	2016/10/11 12:06
S114	0	(increas\$4 near4 "signal to noise ratio") with (pulse near rate)	US-PGPUB; USPAT; EPO; JPO; DERWENT	OR	ON	2016/10/11 12:06
S115	10	(increas\$4 near4 (signal near2 noise near ratio)) with (pulse near rate)	US-PGPUB; USPAT; EPO; JPO; DERWENT	OR	ON	2016/10/11 12:06
S116	2	(increas\$4 near4 (signal near2 noise near ratio)) with increas\$4 near2(pulse near rate)	US-PGPUB; USPAT; EPO; JPO; DERWENT	OR	ON	2016/10/11 12:07

S117	7	(US-20060283931-\$ or US-20090028193-\$ or US-20100160798-\$ or US-20090244288-\$ or US-20140249427-\$).did. or (US-8000574-\$ or US-6181414-\$).did.	US-PGPUB; USPAT	OR	ON	2016/10/11 13:22
S118	5	S117 and (lens lenses)	US-PGPUB; USPAT; EPO; JPO; DERWENT	OR	ON	2016/10/11 13:22
S119	1	S117 and ((lens lenses)with sample)	US-PGPUB; USPAT; EPO; JPO; DERWENT	OR	ON	2016/10/11 13:23
S120	1	S117 and ((lenses)with sample)	US-PGPUB; USPAT; EPO; JPO; DERWENT	OR	ON	2016/10/11 13:24
S121	0	S117 and ((plurality near2 lenses)with sample)	US-PGPUB; USPAT; EPO; JPO; DERWENT	OR	ON	2016/10/11 13:25
S122	3	((plurality near2 lenses)with (output near2 beam) near4 sample)	US-PGPUB; USPAT; EPO; JPO; DERWENT	OR	ON	2016/10/11 13:25
S123	491	(G01N33/15.cpc. G01N21/359.cpc. G01N33/49.cpc.)and @pd> "20160513"	US-PGPUB; USPAT; EPO; JPO; DERWENT	OR	ON	2016/10/11 14:02
S132	1	("8180422").PN.	US-PGPUB; USPAT	OR	OFF	2016/10/11 14:45
S133	19	((("8180422") or ("7771320") or ("6619835") or ("9326712") or ("5267152") or ("7356364") or ("5246004") or ("8472108") or ("20100217102") or ("20120310062") or ("20120316455") or ("20140275854") or ("20140275852") or ("20160045118") or ("20110208015") or ("20110040197") or ("20070021670") or ("20110282167") or ("20130274569")).PN.	US-PGPUB; USPAT	OR	OFF	2016/10/11 14:48
S134	0	S133 and signal adj to adj noise near2 ratio	US-PGPUB; USPAT; EPO; JPO; DERWENT	OR	ON	2016/10/11 14:49
S135	1	("20110267688").PN.	US-PGPUB; USPAT	OR	OFF	2016/10/14 16:53
S136	348	((light adj emit\$5 adj diode) LED)near4 bandwidth near4 (nm nanometer)	US-PGPUB; USPAT; EPO; JPO;	OR	ON	2016/10/14 17:14

			DERWENT			
S137	2	((light adj emit\$5 adj diode) LED)near4 bandwidth near4 (nm nanometer) with wireless	US-PGPUB; USPAT; EPO; JPO; DERWENT	OR	ON	2016/10/14 17:14
S138	23	((light adj emit\$5 adj diode) LED)near4 bandwidth near4 (nm nanometer) and "250".clas.	US-PGPUB; USPAT; EPO; JPO; DERWENT	OR	ON	2016/10/14 17:15
S139	3214	((light adj emit\$5 adj diode) LED near second)with (second near2 signal)	US-PGPUB; USPAT; EPO; JPO; DERWENT	OR	ON	2016/10/14 17:31
S140	1880	((light adj emit\$5 adj diode) LED near second)with (second near2 signal) same ((light adj emit\$5 adj diode) LED near first)with (first near2 signal)	US-PGPUB; USPAT; EPO; JPO; DERWENT	OR	ON	2016/10/14 17:32
S141	76	((light adj emit\$5 adj diode) LED near second)with (second near2 signal) same ((light adj emit\$5 adj diode) LED near first)with (first near2 signal)and "250".clas.	US-PGPUB; USPAT; EPO; JPO; DERWENT	OR	ON	2016/10/14 17:32
S142	70	((light adj emit\$5 adj diode) LED near second)with (second near2 signal) with ((light adj emit\$5 adj diode) LED near first)with (first near2 signal)and "250".clas.	US-PGPUB; USPAT; EPO; JPO; DERWENT	OR	ON	2016/10/14 17:33
S143	1	((light adj emit\$5 adj diode) LED near second)with (second near2 signal) with ((light adj emit\$5 adj diode) LED near first)with (first near2 signal)same distance and "250".clas.	US-PGPUB; USPAT; EPO; JPO; DERWENT	OR	ON	2016/10/16 20:57
S144	1	((light adj emit\$5 adj diode) LED near second)with (second near2 signal) with ((light adj emit\$5 adj diode) LED near first)with (first near2 signal)with distance and "250".clas.	US-PGPUB; USPAT; EPO; JPO; DERWENT	OR	ON	2016/10/16 20:58
S145	84	(output near signal)with generat\$4 with compar\$5 near4 (first near2 second near2 signals)and "250".clas.	US-PGPUB; USPAT; EPO; JPO; DERWENT	OR	ON	2016/10/16 21:36
S146	28	(output near signal)near4 generat\$4 near4 compar\$5 near4 (first near2 second near2 signals)and "250".clas.	US-PGPUB; USPAT; EPO; JPO; DERWENT	OR	ON	2016/10/16 21:37
S147	11	(US-20060283931-\$ or US-20090028193-\$ or US-20100160798-\$ or US-20090244288-\$ or US-20140249427-\$ or US-20140078510-\$ or US-20110267688-\$ or US-20130327966-\$ or US-20050133691-\$).did. or (US-8000574-\$ or US-6181414-\$).did.	US-PGPUB; USPAT	OR	ON	2016/10/16 21:58
S148	8	S147 and filter	US-PGPUB;	OR	ON	2016/10/16 21:58

			USPAT; EPO; JPO; DERWENT			
S149	4	S147 and filter with detect\$5	US- PGPUB; USPAT; EPO; JPO; DERWENT	OR	ON	2016/10/16 21:58
S150	0	(output near signal)near4 generat\$4 near4 compar\$5 near4 (first near2 second near2 signals)with (different near2 optical near wavelength)and "250".clas.	US- PGPUB; USPAT; EPO; JPO; DERWENT	OR	ON	2016/10/16 22:16
S151	0	(output near signal)near4 generat\$4 near4 compar\$5 near4 (first near2 second near2 signals)with (different near2 optical near wavelength)	US- PGPUB; USPAT; EPO; JPO; DERWENT	OR	ON	2016/10/16 22:16
S152	0	(output near signal)near4 generat\$4 near4 compar\$5 near4 (first near2 second near2 signals)same(different near2 optical near wavelength)	US- PGPUB; USPAT; EPO; JPO; DERWENT	OR	ON	2016/10/16 22:19
S153	0	(output near signal)near4 generat\$4 near4 compar\$5 near4 (first near2 second near2 signals)same(optical near wavelength)	US- PGPUB; USPAT; EPO; JPO; DERWENT	OR	ON	2016/10/16 22:19
S154	0	(output near signal) near4 compar\$5 near4 (first near2 second near2 signals)with (different near2 optical near wavelength)and "250".clas.	US- PGPUB; USPAT; EPO; JPO; DERWENT	OR	ON	2016/10/16 22:22
S155	0	(output near signal) near4 compar\$5 near4 (first near2 second near2 signals)with (different near2 optical near wavelength)same (differen\$4 near2 wavelength)	US- PGPUB; USPAT; EPO; JPO; DERWENT	OR	ON	2016/10/16 22:22
S156	7	(output near signal) near4 compar\$5 near4 (first near2 second near2 signals)same(optical near wavelength)	US- PGPUB; USPAT; EPO; JPO; DERWENT	OR	ON	2016/10/16 22:22
S157	1	("20120239013").PN.	US- PGPUB; USPAT	OR	OFF	2016/10/17 12:51
S158	12	(US-20060283931-\$ or US-20090028193-\$ or US-20100160798-\$ or US-20090244288-\$ or US-20140249427-\$ or US-20140078510-\$ or US-20110267688-\$ or US-20130327966-\$ or US-20050133691-\$ or US-20120239013-\$).did. or (US-8000574-\$ or US-6181414-\$).did.	US- PGPUB; USPAT	OR	ON	2016/11/02 09:32
S159	5	S158 and synchroniz\$6	US- PGPUB; USPAT; EPO; JPO; DERWENT	OR	ON	2016/11/02 09:33
S160	1067	(250/338.4).OCLS.	US-	OR	OFF	2016/11/23

			PGPUB; USPAT			12:53
S161	885	synchroniz\$6 near6 (light near2 source) with receiv\$4	US- PGPUB; USPAT; EPO; JPO; DERWENT	OR	ON	2016/11/23 13:36
S162	192	synchroniz\$6 near6 (light near2 source) with receiv\$4 .clm.	US- PGPUB; USPAT; EPO; JPO; DERWENT	OR	ON	2016/11/23 13:37
S163	0	semiconduct\$4 same synchroniz\$6 near6 (light near2 source) with receiv\$4 with reflect\$4	US- PGPUB; USPAT; EPO; JPO; DERWENT	OR	ON	2016/11/23 13:38
S164	789	((light near source)(LED (light adj emit\$5 adj diode)))near6 synchroniz\$5 near6 receiv\$5	US- PGPUB; USPAT; EPO; JPO; DERWENT	OR	ON	2016/11/23 13:40
S165	0	((light near source)(LED (light adj emit\$5 adj diode)))near6 synchroniz\$5 near6 receiv\$5 near4 reflect\$4 and "250".clas.	US- PGPUB; USPAT; EPO; JPO; DERWENT	OR	ON	2016/11/23 13:40
S166	42	((light near source)(LED (light adj emit\$5 adj diode)))near6 synchroniz\$5 near6 receiv\$5 near4 reflect\$4	US- PGPUB; USPAT; EPO; JPO; DERWENT	OR	ON	2016/11/23 13:41
S167	6	((light near source)(LED (light adj emit\$5 adj diode)))near6 synchroniz\$5 near6 receiv\$5 near4 reflect\$4 with (output)	US- PGPUB; USPAT; EPO; JPO; DERWENT	OR	ON	2016/11/23 13:41

EAST Search History (Interference)

Ref #	Hits	Search Query	DBs	Default Operator	Plurals	Time Stamp
S80	0	(sample) with (overtone or "combinational absorption band") with(wavelength near range) .clm.	USPAT	OR	ON	2015/07/23 13:53
S82	7	250/338.4 and @pd> "20150625"	USPAT	OR	ON	2015/07/24 11:51
S83	47202	G01N 21/35 and @pd> "20150625"	USPAT	OR	ON	2015/07/24 11:51
S84	54478	A61B 5/1455 and @pd> "20150625"	USPAT	OR	ON	2015/07/24 11:51
S86	54480	A61B 5/0075 and @pd> "20150625"	USPAT	OR	ON	2015/07/24 11:52
S87	9513	H01S 3/302 and @pd> "20150625"	USPAT	OR	ON	2015/07/24 11:52
S88	0	(S82 S83 S84 S86 S87)and (non-destructive with non-contact with measur\$5) with deliver\$5.clm.	USPAT	OR	ON	2015/07/24 11:54

S128	71	(G01N33/15.cpc. G01N21/359.cpc. G01N33/49.cpc.)and @pd> "20160513"	USPAT	OR	ON	2016/10/11 14:02
S130	45	250/338.4 and @pd> "20160513"	USPAT	OR	ON	2016/10/11 14:02
S131	0	(increas\$4 near4 (signal near2 noise near ratio)) with increas\$4 near2(pulse near rate).clm.	USPAT	OR	ON	2016/10/11 14:35
S168	105	synchroniz\$6 near6 (light near2 source) with receiv\$4 .clm.	USPAT	OR	ON	2016/11/23 13:37
S169	13	synchroniz\$6 near6 (light near2 source) with receiv\$4 with reflect\$4 .clm.	USPAT	OR	ON	2016/11/23 13:37
S170	0	semiconduct\$4 same synchroniz\$6 near6 (light near2 source) with receiv\$4 with reflect\$4 .clm.	USPAT	OR	ON	2016/11/23 13:38

11/ 23/ 2016 2:41:53 PM

C:\ Users\ afein\ Documents\ EAST\ Workspaces\ 14\ 14875709.wsp

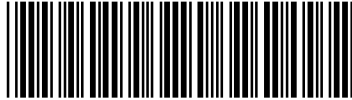
Index of Claims 	Application/Control No. 14875709	Applicant(s)/Patent Under Reexamination ISLAM, MOHAMMED N.
	Examiner ABRA FEIN	Art Unit 2884

✓	Rejected
=	Allowed

-	Cancelled
÷	Restricted

N	Non-Elected
I	Interference

A	Appeal
O	Objected

Claims renumbered in the same order as presented by applicant
 CPA
 T.D.
 R.1.47

CLAIM		DATE							
Final	Original	05/13/2016	10/11/2016	11/23/2016					
1	1	✓	=	=					
2	2	✓	=	=					
3	3	✓	=	=					
4	4	✓	=	=					
5	5	✓	✓	=					
	6	✓	✓	-					
6	7	✓	✓	=					
7	8	✓	✓	=					
8	9	✓	✓	=					
10	10	✓	✓	=					
9	11	✓	✓	=					
11	12	✓	✓	=					
12	13	✓	✓	=					
13	14	✓	✓	=					
	15	✓	✓	-					
14	16	✓	✓	=					
15	17	✓	✓	=					
16	18	✓	✓	=					
17	19	✓	✓	=					
18	20	✓	✓	=					

INFORMATION DISCLOSURE STATEMENT BY APPLICANT (Not for submission under 37 CFR 1.99)	Application Number	14875709
	Filing Date	2015-10-06
	First Named Inventor	Mohammed N. ISLAM
	Art Unit	2884
	Examiner Name	Abra S. Fein
	Attorney Docket Number	OMNI 0105 PUSP1

U.S.PATENTS							Remove
Examiner Initial*	Cite No	Patent Number	Kind Code ¹	Issue Date	Name of Patentee or Applicant of cited Document	Pages,Columns,Lines where Relevant Passages or Relevant Figures Appear	
	1						

If you wish to add additional U.S. Patent citation information please click the Add button.

U.S.PATENT APPLICATION PUBLICATIONS							Remove
Examiner Initial*	Cite No	Publication Number	Kind Code ¹	Publication Date	Name of Patentee or Applicant of cited Document	Pages,Columns,Lines where Relevant Passages or Relevant Figures Appear	
	1	20060058683	A1	2006-03-16	Chance		
	2	20160327476	A1	2016-11-10	ISLAM		

If you wish to add additional U.S. Published Application citation information please click the Add button.

FOREIGN PATENT DOCUMENTS								Remove
Examiner Initial*	Cite No	Foreign Document Number ³	Country Code ²	Kind Code ⁴	Publication Date	Name of Patentee or Applicant of cited Document	Pages,Columns,Lines where Relevant Passages or Relevant Figures Appear	T ⁵
	1	101849821	CN	B	2013-07-04	Univ Huazhong Science Tech	See EP Search Report cited below	
	2	2012135952	WO	A1	2012-10-11	The Governing Council Of The University Of Toronto	See EP Search Report cited below	

INFORMATION DISCLOSURE STATEMENT BY APPLICANT (Not for submission under 37 CFR 1.99)	Application Number	14875709
	Filing Date	2015-10-06
	First Named Inventor	Mohammed N. ISLAM
	Art Unit	2884
	Examiner Name	Abra S. Fein
	Attorney Docket Number	OMNI 0105 PUSP1

If you wish to add additional Foreign Patent Document citation information please click the Add button

NON-PATENT LITERATURE DOCUMENTS

Examiner Initials*	Cite No	Include name of the author (in CAPITAL LETTERS), title of the article (when appropriate), title of the item (book, magazine, journal, serial, symposium, catalog, etc), date, pages(s), volume-issue number(s), publisher, city and/or country where published.	T ⁵
	1	Extended European Search Report for European Application No. 17156625.0 dated March 20, 2017	

If you wish to add additional non-patent literature document citation information please click the Add button

EXAMINER SIGNATURE

Examiner Signature	<input type="text"/>	Date Considered	<input type="text"/>
--------------------	----------------------	-----------------	----------------------

*EXAMINER: Initial if reference considered, whether or not citation is in conformance with MPEP 609. Draw line through a citation if not in conformance and not considered. Include copy of this form with next communication to applicant.

¹ See Kind Codes of USPTO Patent Documents at www.USPTO.GOV or MPEP 901.04. ² Enter office that issued the document, by the two-letter code (WIPO Standard ST.3). ³ For Japanese patent documents, the indication of the year of the reign of the Emperor must precede the serial number of the patent document. ⁴ Kind of document by the appropriate symbols as indicated on the document under WIPO Standard ST.16 if possible. ⁵ Applicant is to place a check mark here if English language translation is attached.

INFORMATION DISCLOSURE STATEMENT BY APPLICANT (Not for submission under 37 CFR 1.99)	Application Number	14875709
	Filing Date	2015-10-06
	First Named Inventor	Mohammed N. ISLAM
	Art Unit	2884
	Examiner Name	Abra S. Fein
	Attorney Docket Number	OMNI 0105 PUSP1

CERTIFICATION STATEMENT

Please see 37 CFR 1.97 and 1.98 to make the appropriate selection(s):

That each item of information contained in the information disclosure statement was first cited in any communication from a foreign patent office in a counterpart foreign application not more than three months prior to the filing of the information disclosure statement. See 37 CFR 1.97(e)(1).

OR

That no item of information contained in the information disclosure statement was cited in a communication from a foreign patent office in a counterpart foreign application, and, to the knowledge of the person signing the certification after making reasonable inquiry, no item of information contained in the information disclosure statement was known to any individual designated in 37 CFR 1.56(c) more than three months prior to the filing of the information disclosure statement. See 37 CFR 1.97(e)(2).

See attached certification statement.

The fee set forth in 37 CFR 1.17 (p) has been submitted herewith.

A certification statement is not submitted herewith.

SIGNATURE

A signature of the applicant or representative is required in accordance with CFR 1.33, 10.18. Please see CFR 1.4(d) for the form of the signature.

Signature	/David S. Bir/	Date (YYYY-MM-DD)	2017-03-28
Name/Print	David S. Bir	Registration Number	38383

This collection of information is required by 37 CFR 1.97 and 1.98. The information is required to obtain or retain a benefit by the public which is to file (and by the USPTO to process) an application. Confidentiality is governed by 35 U.S.C. 122 and 37 CFR 1.14. This collection is estimated to take 1 hour to complete, including gathering, preparing and submitting the completed application form to the USPTO. Time will vary depending upon the individual case. Any comments on the amount of time you require to complete this form and/or suggestions for reducing this burden, should be sent to the Chief Information Officer, U.S. Patent and Trademark Office, U.S. Department of Commerce, P.O. Box 1450, Alexandria, VA 22313-1450. **DO NOT SEND FEES OR COMPLETED FORMS TO THIS ADDRESS. SEND TO: Commissioner for Patents, P.O. Box 1450, Alexandria, VA 22313-1450.**

Privacy Act Statement

The Privacy Act of 1974 (P.L. 93-579) requires that you be given certain information in connection with your submission of the attached form related to a patent application or patent. Accordingly, pursuant to the requirements of the Act, please be advised that: (1) the general authority for the collection of this information is 35 U.S.C. 2(b)(2); (2) furnishing of the information solicited is voluntary; and (3) the principal purpose for which the information is used by the U.S. Patent and Trademark Office is to process and/or examine your submission related to a patent application or patent. If you do not furnish the requested information, the U.S. Patent and Trademark Office may not be able to process and/or examine your submission, which may result in termination of proceedings or abandonment of the application or expiration of the patent.

The information provided by you in this form will be subject to the following routine uses:

1. The information on this form will be treated confidentially to the extent allowed under the Freedom of Information Act (5 U.S.C. 552) and the Privacy Act (5 U.S.C. 552a). Records from this system of records may be disclosed to the Department of Justice to determine whether the Freedom of Information Act requires disclosure of these records.
2. A record from this system of records may be disclosed, as a routine use, in the course of presenting evidence to a court, magistrate, or administrative tribunal, including disclosures to opposing counsel in the course of settlement negotiations.
3. A record in this system of records may be disclosed, as a routine use, to a Member of Congress submitting a request involving an individual, to whom the record pertains, when the individual has requested assistance from the Member with respect to the subject matter of the record.
4. A record in this system of records may be disclosed, as a routine use, to a contractor of the Agency having need for the information in order to perform a contract. Recipients of information shall be required to comply with the requirements of the Privacy Act of 1974, as amended, pursuant to 5 U.S.C. 552a(m).
5. A record related to an International Application filed under the Patent Cooperation Treaty in this system of records may be disclosed, as a routine use, to the International Bureau of the World Intellectual Property Organization, pursuant to the Patent Cooperation Treaty.
6. A record in this system of records may be disclosed, as a routine use, to another federal agency for purposes of National Security review (35 U.S.C. 181) and for review pursuant to the Atomic Energy Act (42 U.S.C. 218(c)).
7. A record from this system of records may be disclosed, as a routine use, to the Administrator, General Services, or his/her designee, during an inspection of records conducted by GSA as part of that agency's responsibility to recommend improvements in records management practices and programs, under authority of 44 U.S.C. 2904 and 2906. Such disclosure shall be made in accordance with the GSA regulations governing inspection of records for this purpose, and any other relevant (i.e., GSA or Commerce) directive. Such disclosure shall not be used to make determinations about individuals.
8. A record from this system of records may be disclosed, as a routine use, to the public after either publication of the application pursuant to 35 U.S.C. 122(b) or issuance of a patent pursuant to 35 U.S.C. 151. Further, a record may be disclosed, subject to the limitations of 37 CFR 1.14, as a routine use, to the public if the record was filed in an application which became abandoned or in which the proceedings were terminated and which application is referenced by either a published application, an application open to public inspections or an issued patent.
9. A record from this system of records may be disclosed, as a routine use, to a Federal, State, or local law enforcement agency, if the USPTO becomes aware of a violation or potential violation of law or regulation.

Electronic Patent Application Fee Transmittal

Application Number:	14875709
Filing Date:	06-Oct-2015
Title of Invention:	SHORT-WAVE INFRARED SUPER-CONTINUUM LASERS FOR DETECTING COUNTERFEIT OR ILLICIT DRUGS AND PHARMACEUTICAL PROCESS CONTROL
First Named Inventor/Applicant Name:	Mohammed N. Islam
Filer:	David S. Bir/Pamela Demos
Attorney Docket Number:	OMNI 0105 PUSP1

Filed as Small Entity

Filing Fees for Utility under 35 USC 111(a)

Description	Fee Code	Quantity	Amount	Sub-Total in USD(\$)
Basic Filing:				
Pages:				
Claims:				
Miscellaneous-Filing:				
Petition:				
Patent-Appeals-and-Interference:				
Post-Allowance-and-Post-Issuance:				
Extension-of-Time:				

Description	Fee Code	Quantity	Amount	Sub-Total in USD(\$)
Miscellaneous:				
SUBMISSION- INFORMATION DISCLOSURE STMT	2806	1	90	90
Total in USD (\$)				90

Electronic Acknowledgement Receipt

EFS ID:	28760998
Application Number:	14875709
International Application Number:	
Confirmation Number:	7496
Title of Invention:	SHORT-WAVE INFRARED SUPER-CONTINUUM LASERS FOR DETECTING COUNTERFEIT OR ILLICIT DRUGS AND PHARMACEUTICAL PROCESS CONTROL
First Named Inventor/Applicant Name:	Mohammed N. Islam
Customer Number:	109543
Filer:	David S. Bir
Filer Authorized By:	
Attorney Docket Number:	OMNI 0105 PUSP1
Receipt Date:	28-MAR-2017
Filing Date:	06-OCT-2015
Time Stamp:	18:41:42
Application Type:	Utility under 35 USC 111(a)

Payment information:

Submitted with Payment	yes
Payment Type	DA
Payment was successfully received in RAM	\$90
RAM confirmation Number	032917INTEFSW00005755023978
Deposit Account	023978
Authorized User	David Bir

The Director of the USPTO is hereby authorized to charge indicated fees and credit any overpayment as follows:

37 CFR 1.16 (National application filing, search, and examination fees)

37 CFR 1.17 (Patent application and reexamination processing fees)

File Listing:					
Document Number	Document Description	File Name	File Size(Bytes)/ Message Digest	Multi Part /.zip	Pages (if appl.)
1	Foreign Reference	CN101849821B_w_English_Ab stract.pdf	803948	no	11
			79c77a191bc5fea399dce69b1ee6ca0b819 1b948		
Warnings:					
Information:					
2	Foreign Reference	WO2012135952A1.pdf	6794485	no	85
			eb8aaf1878815c6629286e4ec2f659979583 9123		
Warnings:					
Information:					
3	Non Patent Literature	EP_Extended_Search_Report. pdf	302980	no	9
			8ea49d8e22aaba43ee5a22d4102e7806b24 f69b4		
Warnings:					
Information:					
4	Information Disclosure Statement (IDS) Form (SB08)	updated_IDS.pdf	612513	no	4
			7f5e448e0d0b588720366ab8c83e5e0b138 a4b49		
Warnings:					
Information:					
5	Fee Worksheet (SB06)	fee-info.pdf	30447	no	2
			1589475d97bdf2f5b8e5a3ace048fa7d93b 70ea		
Warnings:					
Information:					
Total Files Size (in bytes):			8544373		

This Acknowledgement Receipt evidences receipt on the noted date by the USPTO of the indicated documents, characterized by the applicant, and including page counts, where applicable. It serves as evidence of receipt similar to a Post Card, as described in MPEP 503.

New Applications Under 35 U.S.C. 111

If a new application is being filed and the application includes the necessary components for a filing date (see 37 CFR 1.53(b)-(d) and MPEP 506), a Filing Receipt (37 CFR 1.54) will be issued in due course and the date shown on this Acknowledgement Receipt will establish the filing date of the application.

National Stage of an International Application under 35 U.S.C. 371

If a timely submission to enter the national stage of an international application is compliant with the conditions of 35 U.S.C. 371 and other applicable requirements a Form PCT/DO/EO/903 indicating acceptance of the application as a national stage submission under 35 U.S.C. 371 will be issued in addition to the Filing Receipt, in due course.

New International Application Filed with the USPTO as a Receiving Office

If a new international application is being filed and the international application includes the necessary components for an international filing date (see PCT Article 11 and MPEP 1810), a Notification of the International Application Number and of the International Filing Date (Form PCT/RO/105) will be issued in due course, subject to prescriptions concerning national security, and the date shown on this Acknowledgement Receipt will establish the international filing date of the application.



Espacenet

Bibliographic data: CN101849821 (B) — 2012-07-04

Optical fiber near-infrared spectrometer

Inventor(s): HUI GONG; YONG HE; QINGMING LUO; ZHONGXING ZHANG ±
(GONG HUI, ; HE YONG, ; LUO QINGMING, ; ZHANG
ZHONGXING)

Applicant(s): UNIV HUAZHONG SCIENCE TECH ± (HUAZHONG UNIVERSITY
OF SCIENCE & TECHNOLOGY)

Classification: - **international:** **A61B5/026**
- **cooperative:**

Application number: CN20101200035 20100613 Global Dossier

Priority number (s): CN20101200035 20100613

Also published as: CN101849821 (A)

Abstract of CN101849821 (B)

The invention relates to an optical fiber near-infrared spectrometer in the technical field of medical devices. The optical fiber near-infrared spectrometer uses multi-tail optical fiber collimator as light source optical fiber, uses a number lock technology as a technical scheme for weak signal extraction, uses a laser diode with a PD as a light source for sinusoidal modulation, uses an avalanche photodiode (APD) or photomultiplier tube (PMT) as a detector, and uses thick core-diameter plastic optical fiber, liquid-core optical fiber, silica optical fiber, a silica optical fiber bundle or glass optical fiber bundle as detection optical fiber.; The invention has the advantages that the instrument can conduct nondestructive real-time hemodynamic parameter detection to biological tissues sheltered by hairs, the noise level of the instrument is low, the time resolution is high, the stability is high, the price is cheap, the hardware circuit design is greatly simplified and the portability of the instrument is realized.



(12) 发明专利

(10) 授权公告号 CN 101849821 B

(45) 授权公告日 2012.07.04

(21) 申请号 201010200035.1

(22) 申请日 2010.06.13

(73) 专利权人 华中科技大学

地址 430074 湖北省武汉市洪山区珞喻路
1037 号

(72) 发明人 骆清铭 龚辉 张中兴 何勇

(74) 专利代理机构 北京市德权律师事务所
11302

代理人 周发军

(51) Int. Cl.

A61B 5/026(2006.01)

审查员 陈淑珍

权利要求书 1 页 说明书 6 页 附图 2 页

(54) 发明名称

一种光纤近红外光谱检测仪

(57) 摘要

本发明涉及医疗设备技术领域的光纤近红外光谱检测仪,它以多尾纤光纤准直器作为光源光纤,采用数字锁定技术作为微弱信号提取技术方案,以带有 PD 的激光二极管作为光源进行正弦调制,以雪崩光电二极管 APD 或光电倍增管 PMT 作为探测器,以粗芯径塑料光纤、液芯光纤、石英光纤、石英光纤束或玻璃光纤束作为探测光纤。该仪器对即使有毛发遮挡的生物组织也可进行无损实时的血液动力学参数检测,仪器噪声水平低,时间分辨率高,稳定性高,价格便宜,大大简化硬件电路设计,实现了仪器的便携化。

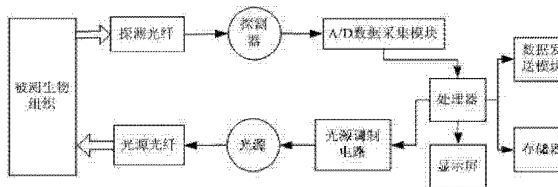

CN 101849821 B

1. 一种近红外光谱检测仪,包括光源,光源光纤,探测光纤,探测器,光源调制电路,A/D数据采集模块和处理器,其特征在于,所述光源光纤为多尾纤光纤准直器,以实现将多个波长的入射光通过不同的尾纤传输到准直器准直透镜的焦点处,从焦点处出射的光经透镜后以平行光均匀入射生物组织。

2. 根据权利要求1所述的近红外光谱检测仪,其特征在于,还包括数字锁定放大器,所述数字锁定放大器连接所述A/D数据采集模块,用于对探测光纤采集到的10pW至nW级微弱信号进行数字化锁定放大提取。

3. 根据权利要求2所述的近红外光谱检测仪,其特征在于,所述数字锁定放大器的功能由处理器或者另外的计算机实现。

4. 根据权利要求3所述的近红外光谱检测仪,其特征在于,所述光源为带有PD的激光二极管,以实现光源的正弦调制,产生正弦光信号。

5. 根据权利要求4所述的近红外光谱检测仪,其特征在于,所述探测光纤为粗芯径塑料光纤,其直径为1mm至3.5mm。

6. 根据权利要求5所述的近红外光谱检测仪,其特征在于,所述探测器为高探测灵敏度、低噪声水平、带有前置放大功能的雪崩光电二极管APD或高探测灵敏度、低噪声水平、带有前置放大功能的光电倍增管PMT,以实现pW级微弱光信号的探测。

7. 根据权利要求6所述的近红外光谱检测仪,其特征在于,它还包括存储器,所述存储器连接所述处理器,接收并存储生理参数变化信息。

8. 根据权利要求7所述的近红外光谱检测仪,其特征在于,还包括显示屏,所述显示屏连接所述处理器,接收并显示所述生理参数变化信息。

9. 根据权利要求8所述的近红外光谱检测仪,其特征在于,还包括数据发送模块,所述数据发送模块连接所述处理器,所述处理器通过所述数据发送模块将所述生理参数变化信息传输给外部PC机,以供外部PC机进行离线分析。

一种光纤近红外光谱检测仪

技术领域

[0001] 本发明涉及医疗设备技术领域的光纤近红外光谱检测仪。

背景技术

[0002] 近红外光谱术是近 20 年来发展起来的一种非侵入式测量血液动力学参数变化的光学成像技术。生物组织对波长为 600~900nm 的近红外光存在低吸收、高散射的特性,因此这一波段的光可以穿透生物组织几个厘米的厚度而对深层生物组织进行探测。近红外光谱术根据成像原理的不同,又可以分为连续光技术、频域调制技术和时间分辨技术。其中,基于修正的 Beer-Lambert 吸收定律的连续光近红外光谱术具有时间分辨率高、测量过程中受运动限制少、成本低、可实现便携化等优势,是目前应用最为广泛的近红外光谱测量技术。

[0003] 目前国内外已有多个便携式近红外检测仪的专利和研制文章报道,国外已有商用产品被广泛应用在脑功能研究、运动肌氧检测、乳腺癌检测等领域。比如,国内公开号 CN101002673A, CN1223858C, CN1540314A, CN1239125C 的仪器;美国 NIM 公司的 Micro-RunMan 仪器, Somanetics 公司的 INVOS 5100 仪器,日本 OMRON 公司的 HE0-200 仪器,意大利 NIROX 公司的 NIMO 仪器等。这些仪器的光源和探测器均是直接与被测生物组织接触,在满足激光安全标准的前提下,以增大光源出光面积进而增大入射生物组织的光功率(最高可达几十毫瓦)。相对较高的入射光功率和较大的探测器光敏面使得这些仪器能够获得较高的信噪比。因此,这些仪器的探头、后续信号处理电路的设计都较易实现,也较易实现便携化。但是,这些仪器由于受探头光源出光面和探测器光敏面尺寸的限制,仅能对没有浓密毛发遮挡的生物组织,如人脑前额叶,肌肉组织,乳房等进行检测,黑色毛发对光的吸收导致这些仪器无法对有头发遮挡的生物组织,如人脑顶叶,枕叶等脑区进行检测,这就使这些仪器的应用范围受到了限制。

[0004] 为了扩大近红外检测仪的应用范围,实现对有毛发遮挡的生物组织的检测,目前国外已有一些公司研制出采用光纤探头的近红外脑功能成像仪。比如,日本日立公司的 ETG-100、ETG-4000、ETG-7000 产品,岛津公司的 OMM-2000、OMM-3000 产品,美国 NIRx 公司的 DYNOT 仪器等。这些仪器光源发出的光先耦合进光纤束,光纤束的出光端与大脑头皮接触将光射入大脑,探测光纤束接收经过大脑吸收和散射后的出射光,并传输给探测器。光纤由于截面小,可以放置在头发间隙中与头皮接触,因此光纤的设计优化了出光面和接光面的面积,从而可以对有头发遮挡的脑区进行探测。为了满足激光安全标准的限制,光源的入射光功率一般只有几 mW。入射光功率的减弱,探测光纤接光面积的变小,导致探测器能接收到的信号非常微弱,一般仅为 10pW 至 nW 量级,因此,这些仪器在设计上对后续弱信号处理硬件电路设计要求非常高,电路设计复杂,一般均采用模拟锁定放大阵列来实现对弱信号的提取,这就导致整个仪器体积庞大,无法实现便携。此外,这些仪器均采用光纤束作为光源光纤和探测光纤,但是众所周知,光纤束不仅存在填充比损耗,而且在频繁使用过程中,极易出现内部单丝折断破损,从而导致光纤传光效率下降,传光不均,并且光纤束造价

昂贵,成本高。因此,这些仪器一般应用在医院内部临床脑功能疾病的检测。

[0005] 对于很多脑功能研究者来说,比如对于认知神经科学研究者来说,他们往往希望能够在真实的生活环境中对人的大脑进行无损检测,以研究大脑的认知活动过程或对脑精神疾病进行检测,这就要求光纤近红外脑功能成像仪尽可能做到便携化,光纤也需要具有不易破损,耐用性高,成本低廉的特点。上述国外的光纤近红外脑功能成像仪,由于受体积和成本的限制,是无法满足认知神经科学研究这一需求的。

发明内容

[0006] 针对目前近红外检测仪器存在的不足,本发明所要解决的问题是提供一种近红外检测仪,该仪器对即使有毛发遮挡的生物组织也可进行无损实时的血液动力学参数检测,并且仪器噪声水平低,时间分辨率高,稳定性高,光纤不易破损,传光均匀,价格便宜,大大简化微弱信号提取的硬件电路设计,真正实现便携化。

[0007] 为解决上述技术问题,本发明提出一种采用数字锁定放大技术的便携式近红外检测仪,包括光源,光源光纤,探测光纤,探测器,光源调制电路,A/D 数据采集模块,处理器,显示屏,存储器和数据发送模块。所述处理器向所述光源调制电路发出控制指令,所述光源调制电路对所述各波长光源分别进行正弦调制发光,所述光源调制电路调节所述光源的正弦发光频率和发光功率,所述光源发出的正弦波光耦合进所述光源光纤,经光源光纤传输入射生物组织,所述探测光纤一端接收经过生物组织吸收和散射后的后向散射光子,并将光子传输给探测光纤另外一端耦合的所述探测器,探测器将接收到的光信号转换为电压信号,并对电压信号进行前置放大后发送到所述 A/D 数据采集模块,所述 A/D 数据采集模块将模拟电压信号转换为数字信号,并将数字信号发送给所述处理器,所述处理器用于对信号进行数字锁定放大提取信号幅值信息,以得到光强变化信息,并通过算法将所述光强变化信息转换成各种生理参数的变化信息,所述显示屏连接所述处理器以显示各种生理参数的变化过程,所述存储器连接所述处理器,对数据进行存储,所述数据发送模块连接所述处理器,可以将各种生理参数的变化信息发送给其他处理器进行离线数据分析;其特征在于,本发明所采用的光源光纤优先选用多尾纤光纤准直器,以实现将多个波长的入射光通过不同的尾纤传输到准直器准直透镜的焦点处,从焦点处出射的光经透镜后以平行光均匀入射生物组织。该设计既可以实现多个波长入射光同时从同一位置均匀入射生物组织,又可以省去传统光纤近红外检测仪光源光纤设计中采用的光纤切换开关和波分复用器,大大简化了系统设计,便于实现系统的便携化。

[0008] 光源光纤设计中选用的光纤准直器的尾纤是普通的多模光纤,准直器前端的准直透镜对从多模光纤传输至透镜焦点处的入射光束进行扩束,从而实现入射光的均匀入射。与传统光纤近红外检测仪的光源光纤采用光纤束的设计相比,该设计可以克服光纤束易出现单丝折断而导致入射生物组织的光不均匀的缺点,并且大大降低了成本。

[0009] 进一步改进的,本发明还包括数字锁定放大器,所述数字锁定放大器连接所述 A/D 数据采集模块,用于对探测光纤采集模块采集到的 10pW 至 nW 级微弱信号进行数字化锁定放大提取。

[0010] 所述数字锁定放大器的功能由处理器或者另外的计算机实现。更具体来说,设输入的模拟信号源为:

[0011]

$$S(t) = dc_s + A_s \cos(2\pi f_m t + \phi_s) \dots \dots \dots (2)$$

[0012] 其中 A_s 为信号幅度, ϕ_s 为信号初相位, f_m 为信号频率。假设以 f_s 采样频率对信号进行采样 N_s 个点, 可以产生离散信号:

$$M[n] = dc_m + A_m \cos\left[\frac{2\pi f_m n}{f_s} + \phi\right], 0 \leq n \leq N_s - 1 \dots \dots \dots (3)$$

[0014] 处理器内部生成的正弦和余弦参考信号为:

$$C[n] = \cos\left[\frac{2\pi f_m n}{f_s}\right] \dots \dots \dots (4)$$

$$S[n] = \sin\left[\frac{2\pi f_m n}{f_s}\right] \dots \dots \dots (5)$$

[0017] 离散的参考信号与离散的测量信号相乘, 展开以后就得到:

$$I[n] = M[n] \times \cos\left[\frac{2\pi f_m n}{f_s}\right] \dots \dots \dots (6)$$

$$I[n] = \frac{1}{2} A_s \cos(\phi_m) + dc_m \cos\left[\frac{2\pi f_m n}{f_s}\right] + \frac{1}{2} A_s \cos\left[\frac{4\pi f_m n}{f_s} + \phi_m\right] \dots \dots \dots (7)$$

$$Q[n] = M[n] \times \sin\left[\frac{2\pi f_m n}{f_s}\right] \dots \dots \dots (8)$$

$$Q[n] = \frac{1}{2} A_s \sin(\phi_m) + dc_m \sin\left[\frac{2\pi f_m n}{f_s}\right] + \frac{1}{2} A_s \sin\left[\frac{4\pi f_m n}{f_s} + \phi_m\right] \dots \dots \dots (9)$$

[0022] $I[n]$ 和 $Q[n]$ 中的第一项是只含有信号幅值和相位信息的直流成分, 对 $I[n]$ 和 $Q[n]$ 进行低通滤波, 去除交流成分, 只保留直流成分, 则得到:

[0023]

$$X[n] \approx \frac{1}{2} A_m \cos(\phi_m) \dots \dots \dots (10)$$

[0024]

$$Y[n] \approx \frac{1}{2} A_m \sin(\phi_m) \dots \dots \dots (11)$$

[0025] 最后进行下面的运算就可以得到下面的幅度信号:

[0026]

$$A_m = 2 \times \sqrt{X^2 + Y^2} \dots \dots \dots (12)$$

[0027] 相对于模拟锁定放大器, 数字锁定放大器在设计上简化了模拟器件的使用, 不仅适合于便携式仪器的设计, 还可以避免直流放大器使用所引入的直流漂移、温漂、非线性误差和增益误差, 因此具有更高的微弱信号提取能力。数字锁定放大器相关运算的数据点数(相对于模拟积分时间常数)和低通滤波器的参数可以根据信号特点的不同而随时进行调节, 具有更高的设计灵活性。

[0028] 本发明中,数字锁定运算需要的正弦和余弦参考信号优选方案为由处理器内部数字合成或者另外的计算机合成处理,这样可以保证两路参考信号同频且初始相位相差 90 度的绝对正交,参考信号不会受到外界噪声干扰。

[0029] 所述探测光纤可以是粗芯径的塑料光纤、液芯光纤、石英光纤中的一种,也可以是石英光纤束和玻璃光纤束。本发明中,优选方案为粗芯径塑料光纤,其直径为 1mm 至 3.5mm,因为与传统采用光纤束作为探测光纤的设计相比,粗芯径塑料光纤在实现大数值孔径的同时,不存在光纤束设计中具有填充比损耗的问题,而且,可以克服光纤束的光纤单丝易折断从而导致传光效率下降的问题,并且大大降低了成本。

[0030] 本发明所采用的光源优选为带有 PD 的激光二极管,以实现光源的正弦调制,产生正弦光信号。光源波长范围为 600~1000nm。但是本发明的光源不仅仅限于激光二极管,也可以是其他可实现正弦调制的近红外光源,如集成近红外激光光源模块。

[0031] 本发明所采用的探测器为高探测灵敏度、低噪声水平、带有前置放大功能的雪崩光电二极管 APD 或光电倍增管 PMT,以实现 pW 级微弱光信号的探测。但是,如有其他光电探测器,在光源波长范围内满足高探测灵敏度、低噪声水平的要求,也可以作为本发明的探测器。

[0032] 所述处理器,可以是嵌入式微处理器,也可以是计算机 CPU。

[0033] 所述处理器,当探测通道增多时,为了保证足够高的时间分辨率,需要提高数字锁定运算的速度,此时处理器可以是计算机集群或者图形处理器 GPU,以实现数据的并行加速处理。

[0034] 作为优选,本发明还包括存储器,所述存储器连接所述处理器,接收并存储所述生理参数变化信息。

[0035] 作为又一优选,本发明还包括显示屏,所述显示屏连接所述处理器,接收并显示所述生理参数变化信息。

[0036] 作为还一优选,本发明还包括数据发送模块,所述数据发送模块连接所述处理器,所述处理器通过所述数据发送模块将所述生理参数变化信息传输给外部 PC 机,以供所述外部 PC 机进行离线分析,数据发送模块的数据发送方式可以是有线数据传输方式,也可以是无无线数据传输方式。

[0037] 本发明采用数字锁定技术作为微弱信号提取的技术方案,以带有 PD 的激光二极管作为光源进行正弦调制,以多尾纤光纤准直器作为光源光纤,以雪崩光电二极管 APD 或光电倍增管 PMT 作为探测器,以粗芯径塑料光纤、液芯光纤、石英光纤、石英光纤束或玻璃光纤束作为探测光纤,设计了一种基于光纤探头的便携式近红外检测仪,该仪器对即使有毛发遮挡的生物组织也可进行无损实时的血液动力学参数检测,仪器噪声水平低,时间分辨率高,稳定性高,价格便宜,大大简化硬件电路设计,实现了仪器的便携化。

附图说明

[0038] 下面结合附图和具体实施方式对本发明的技术方案作进一步具体说明。

[0039] 图 1 为一种便携式光纤近红外检测仪的结构框图。

[0040] 图 2 为本发明实施案例之一基于 PC 机的便携式光纤近红外检测仪的结构框图。

[0041] 图 3 为本发明实施案例之一基于 PC 机的便携式光纤近红外检测仪应用于在体前

臂阻断实验结果图。

具体实施方式

[0042] 便携式光纤近红外检测仪的结构框图如图 1 所示。处理器向光源调制电路发出控制指令,使光源调制电路对光源进行正弦调制发光,光源的正弦发光频率和发光功率均可由光源调制电路进行控制。光源发出的正弦光耦合入光源光纤,经光源光纤传输入射被测生物组织。在被测生物组织表面与光源光纤同侧间隔几厘米距离处放置的探测光纤接收经过生物组织吸收和散射后的后向散射光子,探测光纤将接收的光子传输给探测光纤另外一端耦合的探测器。探测器将接收到的光信号转换为电压信号,并对电压信号进行前置放大后发送到 A/D 数据采集模块。A/D 数据采集模块将模拟电压信号转换为数字信号,并将数字信号发送给处理器。处理器对信号进行数字锁定运算以提取信号幅值信息,即光强变化信息。在处理器内部,光强变化信息再通过修正的 Beer-Lambert 吸收定律转换成血液动力学参数等生理参数的变化信息。然后处理器将生理参数的变化传输到显示屏和存储器进行显示和存储。处理器也可以选择将生理参数变化信息通过数据发送模块发送给其他处理器进行离线数据分析。

[0043] 图 2 所示为本发明实施案例之一,基于 PC 机的便携式光纤近红外检测仪的结构框图。PC 机向下位机微处理器 AT89C2051 发送工作指令,AT89C2051 向直接数字合成正弦波发生芯片 ML2035 发送 16 位频率编码指令,使正弦波发生芯片 ML2035 开始产生特定频率的正弦波驱动信号。正弦波驱动信号驱动 LD 驱动芯片 iC-WJZ 工作,以使 iC-WJZ 输出正弦波驱动电流点亮 690nm 波长 LD 和 850nm 波长 LD。690nm 波长 LD 和 850nm 波长 LD 以与驱动正弦波电流相同的频率发出正弦波光,发出的光分别通过双尾纤光纤准直器的尾纤 1 和尾纤 2 传输到双尾纤光纤准直器前端的准直透镜焦点处,经过准直透镜扩束后,以近似平行光均匀入射被测生物组织。经过生物组织吸收和散射后的后向散射光子被放置在被测生物组织表面的芯径 1 ~ 3.5mm 塑料光纤接收。塑料光纤将接收的光子传输给探测器 APD 模块 C5460-01,探测器将接收到的光信号转换为电压信号,并对电压信号进行前置放大。电压信号直接被数据采集卡 PCI6259 采集传输给 PC 机。PC 机内部对采集到的信号进行数字锁定运算,提取光强变化信息,将光强变化信息转换为血液动力学参数变化,并进行存储和显示。

[0044] 图 3 所示为本发明实施案例之一基于 PC 机的便携式光纤近红外检测仪应用于在体前臂阻断实验结果图。实验过程中,将仪器探头绑在人体前臂,将血压计绷带绑在上臂,通过血压计对上臂加压,以实现前臂血液供应的阻断导通控制。静息状态测量 30s,含氧血红蛋白 HbO_2 ,脱氧血红蛋白 Hb 和血容 Bv 没有变化,因此相对浓度变化为 0。然后加压至 200mmHg,阻断前臂血液的供给和回流。阻断后,前臂由于得不到血液供应,血液也无法回流,因此血容 Bv 基本保持稳定;肌肉组织需要不断消耗氧气,因此 HbO_2 减少,Hb 以同样的速率增加;当减压至正常状态时,淤积的静脉血得到快速释放,大量动脉血迅速涌入,都出现了“过偿”效应;随后 HbO_2 , Hb 和 Bv 逐渐恢复至初始状态。该实验测量的前臂血管内的血液动力学参数的变化与实际的生理变化过程相符合,表明仪器可以对人体的血液动力学参数变化进行有效监测。

[0045] 最后所应说明的是,以上具体实施方式仅用以说明本发明的技术方案而非限制,

尽管参照较佳实施例对本发明进行了详细说明,本领域的普通技术人员应当理解,可以对本发明的技术方案进行修改或者等同替换,而不脱离本发明技术方案的精神和范围,其均应涵盖在本发明的权利要求范围当中。



图 1



图 2

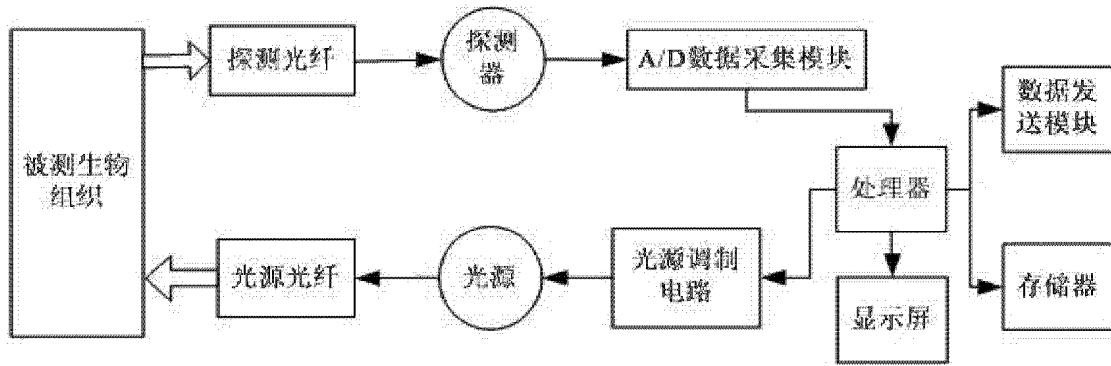

图 3

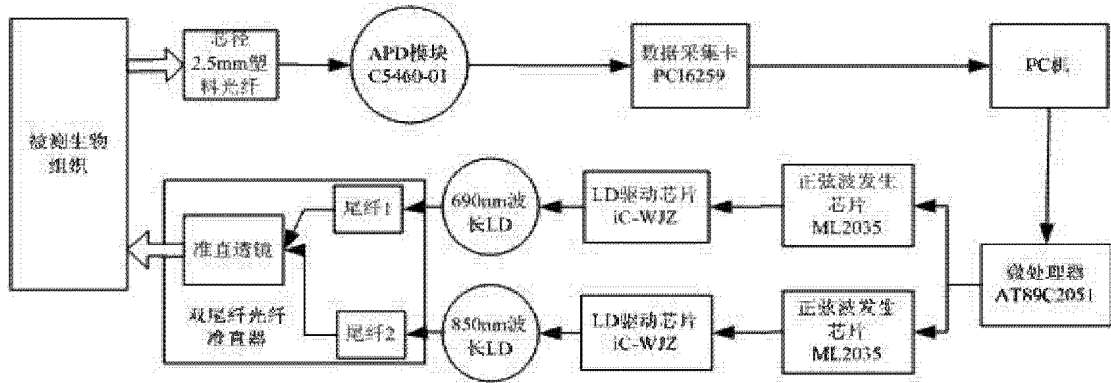

- (51) **International Patent Classification:**
G01N 21/63 (2006.01) H04N 5/33 (2006.01)
A61B 6/14 (2006.01)
- (21) **International Application Number:**
PCT/CA2012/050035
- (22) **International Filing Date:**
20 January 2012 (20.01.2012)
- (25) **Filing Language:** English
- (26) **Publication Language:** English
- (30) **Priority Data:**
61/471,772 5 April 2011 (05.04.2011) US
- (71) **Applicant (for all designated States except US):** THE GOVERNING COUNCIL OF THE UNIVERSITY OF TORONTO [CA/CA]; Simcoe Hall, Room 133S 27 King's College Circle, Toronto, Ontario M5S 1A1 (CA).
- (72) **Inventors; and**
- (71) **Applicants :** MANDELIS, Andreas [CA/CA]; 3 Scarborough Heights Blvd., Toronto, Ontario M1M 2V3 (CA). TABATABAEI, Nima [CA/CA]; Apt. 3109, 38 Elm Street, Toronto, Ontario M5G 2K5 (CA). ABRAMS, Stephen [CA/CA]; 748 Briar Hill Avenue, Toronto, Ontario M6B 1L3 (CA).

- (74) **Agent:** HILL & SCHUMACHER; 264 Avenue Road, Toronto, Ontario M4V 2G7 (CA).
- (81) **Designated States (unless otherwise indicated, for every kind of national protection available):** AE, AG, AL, AM, AO, AT, AU, AZ, BA, BB, BG, BH, BR, BW, BY, BZ, CA, CH, CL, CN, CO, CR, CU, CZ, DE, DK, DM, DO, DZ, EC, EE, EG, ES, FI, GB, GD, GE, GH, GM, GT, HN, HR, HU, ID, IL, IN, IS, JP, KE, KG, KM, KN, KP, KR, KZ, LA, LC, LK, LR, LS, LT, LU, LY, MA, MD, ME, MG, MK, MN, MW, MX, MY, MZ, NA, NG, NI, NO, NZ, OM, PE, PG, PH, PL, PT, QA, RO, RS, RU, RW, SC, SD, SE, SG, SK, SL, SM, ST, SV, SY, TH, TJ, TM, TN, TR, TT, TZ, UA, UG, US, UZ, VC, VN, ZA, ZM, ZW.
- (84) **Designated States (unless otherwise indicated, for every kind of regional protection available):** ARIPO (BW, GH, GM, KE, LR, LS, MW, MZ, NA, RW, SD, SL, SZ, TZ, UG, ZM, ZW), Eurasian (AM, AZ, BY, KG, KZ, MD, RU, TJ, TM), European (AL, AT, BE, BG, CH, CY, CZ, DE, DK, EE, ES, FI, FR, GB, GR, HR, HU, IE, IS, IT, LT, LU, LV, MC, MK, MT, NL, NO, PL, PT, RO, RS, SE, SI, SK, SM, TR), OAPI (BF, BJ, CF, CG, CI, CM, GA, GN, GQ, GW, ML, MR, NE, SN, TD, TG).

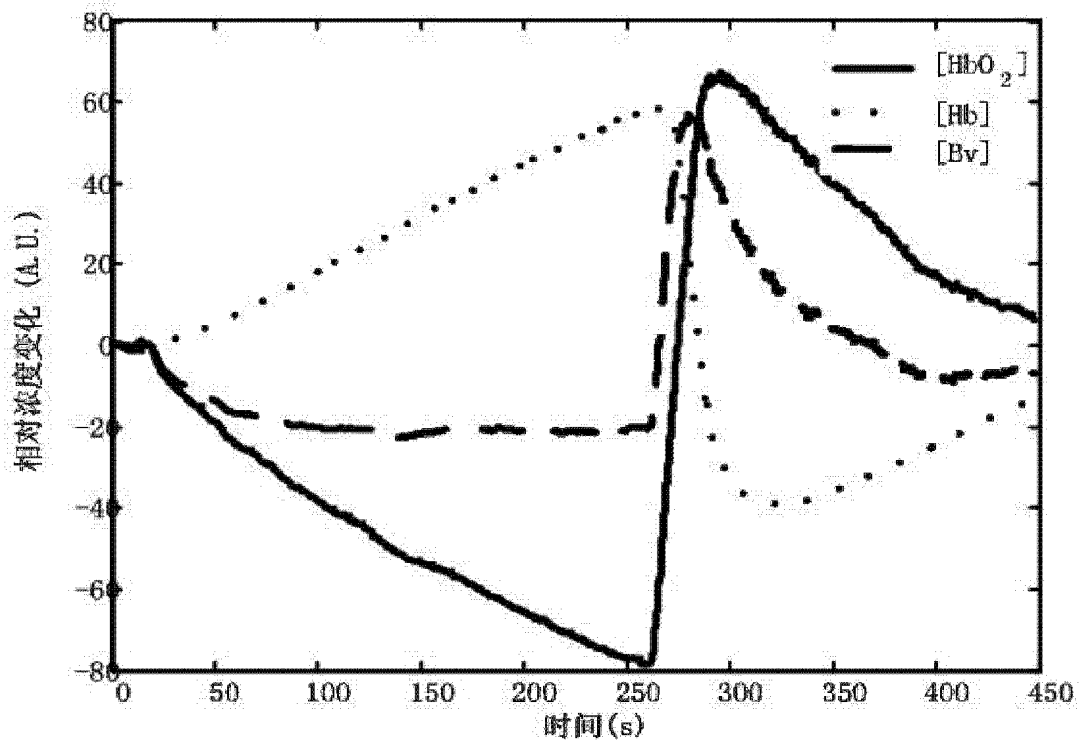
Published:
— with international search report (Art. 21(3))

(54) **Title:** SYSTEMS AND METHODS FOR THERMOPHOTONIC DYNAMIC IMAGING

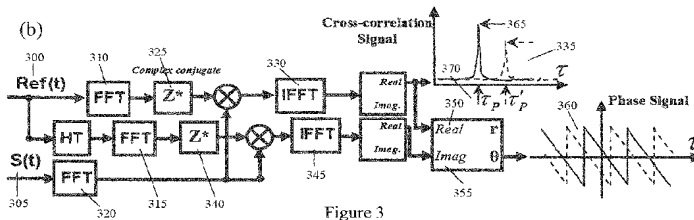
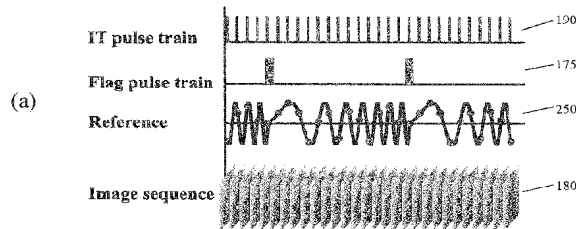

(57) **Abstract:** Systems and methods for improved thermophotonic imaging are provided in which both amplitude and phase image information is obtained with a high signal to noise ratio and depth-resolved capabilities. Image data obtained from an imaging camera is dynamically averaged and subsequently processed to extract amplitude and/or phase image data. The system may be configured for a wide range of imaging modalities, including single frequency modulation (thermophotonic lock-in imaging), Thermal-Wave Radar imaging or Thermophotonic Radar imaging involving chirp modulation, and Binary Phase Coded Modulation. Such imaging modalities may find application in many diverse areas, including non-destructive testing and biomedical diagnostic imaging including the imaging of teeth and monitoring changes in the tooth over time which are due to pathology such as dental caries or erosion.

WO 2012/135952 A1

**SYSTEMS AND METHODS FOR THERMOPHOTONIC DYNAMIC
IMAGING**

CROSS-REFERENCE TO RELATED APPLICATION

This application claims priority to U.S. Provisional Application No. 61/471,772, titled "SYSTEMS AND METHODS FOR THERMOPHOTONIC DYNAMIC IMAGING" and filed on April 5, 2011, the entire contents of which are incorporated herein by reference.

BACKGROUND OF THE INVENTION

This invention relates to systems and methods of non-destructive subsurface imaging. More particularly, this invention relates to systems and methods for thermophotonic imaging.

Thermographic and thermophotonic imaging methods have found widespread use in applications such as non-destructive testing of various materials and biomedical diagnostic imaging. While numerous methods have been developed and described in the literature, most solutions proposed to date have relied on methods involving single frequency analysis of amplitude and phase images. Such methods, while well suited for some specific applications, often fail in applications that demand higher sensitivity. Another disadvantage of known thermographic and thermophotonic imaging methods is the use of low speed imaging techniques, which can place significant limitations on depth and/or spatial resolution.

Accordingly, despite the existence of a number of thermographic and thermophotonic imaging modalities, there remains a need for imaging solutions that deliver higher sensitivity, lower detection limit, increased speed, and improved depth

resolution. In industrial quality control, there is a need for fast and reliable monitoring of substrate integrity and process-induced defects during manufacturing and component reliability testing, for example in identifying subsurface cracks and delaminations in automotive and aerospace components and surface coatings, respectively. In oral health care, there is a need to have an imaging system that can image an entire tooth surface or group of teeth so as to provide the oral health care provider with the location of dental caries or defects in teeth and or dental materials.

As compared to conventional thermographic imaging, which monitors contrast due to thermal and/or mechanical property inhomogeneities of materials (thermographic contrast), thermophotonic imaging, in addition to thermographic contrast, involves amplified contrast due to optical property inhomogeneities. Both modalities are based on the generation and detection of (photo)thermal waves in a sample.

SUMMARY

Systems and methods for improved thermophotonic imaging are provided in which both amplitude and phase image information is obtained with a high signal to noise ratio and depth-resolved capabilities. Image data obtained from an imaging camera is dynamically averaged and subsequently processed to extract amplitude and/or phase image data. The system may be configured for a wide range of imaging modalities, including single frequency modulation (thermophotonic lock-in imaging), Thermal-Wave Radar imaging or Thermophotonic Radar imaging involving chirp modulation, and Binary Phase Coded Modulation. Such imaging modalities may find application in many diverse areas, including non-destructive testing and biomedical diagnostic imaging including the imaging of teeth and monitoring changes in the tooth

over time which are due to pathology such as dental caries or erosion.

In a first aspect, there is provided a method of performing thermophotonic imaging, the method comprising the steps of: providing a sample; providing an optical source having a wavelength selected to generate photothermal radiation within the sample; providing an imaging camera with an optical bandwidth selected for detection of the photothermal radiation; generating a reference waveform comprising a plurality of modulation cycles; producing a modulated optical beam by modulating an intensity of an optical beam emitted by the optical source according to the reference waveform; illuminating the sample with the modulated optical beam;

imaging the photothermal radiation with the imaging camera; recording a plurality of dynamically averaged image frames at time offsets corresponding to different values of the reference waveform; and processing the dynamically averaged image frames and the reference waveform to obtain an image relating to the photothermal radiation.

The dynamically averaged image frames may be obtained according to the following steps: recording a plurality of image frames at times corresponding to different values of the reference waveform; repeating, one or more times, the step of recording the image frames at times corresponding to different values of the reference waveform, and dynamically averaging the recorded images for each the different value of the reference waveform, thereby obtaining dynamically averaged image frames.

The step of recording the plurality of image frames at different values of the reference waveform may comprise recording the plurality of image frames over a single modulation cycle/correlation period, and may be obtained over more than one modulation cycle, where a frame acquisition rate of the imaging camera may less than

a modulation frequency of the reference waveform.

The method may further comprise the step of recording, for each image frame of the plurality of image frames, a substantially instantaneous value of the reference waveform, and may further comprise generating a quadrature waveform based on the reference waveform, and recording, for each image frame of the plurality of image frames, a substantially instantaneous value of the quadrature waveform.

An integration pulse train may be generated comprising a series of pulses, wherein each pulse is generated at a time at which an image frame is acquired by the imaging camera, wherein the step of generating of the reference waveform is triggered according to the integration pulse train. The integration pulse train may be generated by the imaging camera.

A flag pulse train may be generated comprising a series of pulses, wherein each pulse is generated at a commencement of a given modulation cycle/correlation period, and identifying one or both of a beginning and an end of the given modulation cycle/correlation period according to the flag pulse train. A modulation frequency of the reference waveform may be greater than approximately 0.01 Hz.

The reference waveform may comprise a single frequency and wherein the image is obtained by lock-in processing, and the step of processing the dynamically averaged image frames and the reference waveform may comprise, for each pixel in the image frame, performing the steps of: multiplying the dynamically averaged image frames by the reference waveform to obtain in-phase product values; and summing the in-phase product values to obtain an in-phase sum; generating a quadrature waveform based on the reference waveform; multiplying the dynamically averaged image frames by the quadrature waveform to obtain phase-shifted product values; and summing the phase-shifted product values to obtain a phase-shifted sum.

The image may be an amplitude image, and wherein the processing further comprises calculating a magnitude of a complex quantity based on the in-phase sum and the phase-shifted sum. The image may be a phase image wherein the processing further comprises: calculating a phase angle of a complex quantity based on the in-phase sum and the phase-shifted sum.

The reference waveform may comprise multiple frequency components, and the reference waveform may comprise a frequency chirp and may be a binary phase coded waveform.

The image may be a cross-correlation peak amplitude image obtained by the steps of: obtaining a complex cross-correlation signal of the reference waveform and each pixel of the dynamically averaged image frames; and determining, for each the pixel, a peak amplitude value of a peak in a real part of the cross-correlation signal.

The image may be a cross-correlation peak delay image obtained by the steps of: obtaining a complex cross-correlation signal of the reference waveform and each pixel of the dynamically averaged image frames; and determining, for each the pixel, a delay of a peak in a real part of the complex cross-correlation signal.

The image may be a cross-correlation phase image obtained by the steps of: obtaining a first complex cross-correlation signal of the reference waveform and each pixel of the dynamically averaged image frames; obtaining a second complex cross-correlation signal of a quadrature waveform and each pixel of the dynamically averaged image frames, wherein the quadrature waveform is based on the reference waveform; forming a complex quantity comprising a real portion of first complex cross-correlation signal and a real portion of the second complex cross-correlation signal; and obtaining the phase image by determining, for each pixel, a phase angle of the complex quantity at a pre-selected time delay.

The sample may be selected from the group consisting of automotive components, aerospace components, an optical material, a laser material, a biomedical material, and a biological tissue.

The sample may be a material comprising one or more of a subsurface crack and a delamination. The sample may be an unsintered component in a green state.

The method may further comprise the step of determining a case hardness depth.

The sample may be a dental sample, tooth sample or whole groups of teeth. The method may further comprise the step of analyzing the image to determine one or more of a presence and a location of demineralization, erosion or dental caries in the dental or tooth sample. The method may further comprise the step of monitoring an evolution of one or more of demineralization, erosion and dental caries by comparing the image to one or more other images. The sample may be a dental or medical instrument and may be selected from the group consisting of endodontic instruments, catheters and other indwelling instruments.

The wavelength may be selected to lie within a range of approximately 600 nm to 2000 nm. The imaging camera may be selected to have a spectral response overlapping with at least a portion of the mid-infrared spectrum.

In another aspect, there is provided a system for performing thermophotonic imaging, the system comprising: an optical source having a wavelength selected to generate photothermal radiation within a sample; an imaging camera with an optical bandwidth selected for detection of the photothermal radiation, wherein the imaging camera is configured to acquire image frames a given frame rate and output an integration pulse train comprising a series of pulses, each pulse corresponding to a time at which an image frame is acquired by the imaging camera; a waveform

generating system for generating a reference waveform, wherein an output of the waveform generating system is connected to an input of the optical source for modulating an intensity of an optical beam emitted by the optical source; a processor programmed to dynamically average image frames obtained by the imaging camera, and to process the dynamically averaged image frames, the reference waveform and a quadrature waveform based on the reference waveform, to provide one or more of an amplitude image and a phase image; and a memory for storing dynamically averaged image frames.

A modulation frequency of the reference waveform may be greater than approximately 0.01 Hz. The imaging camera may comprise a frame acquisition rate that is less than a modulation frequency of the reference waveform. The wavelength may lie within approximately 600 nm to 2000 nm. A spectral response of the imaging camera may overlap at least a portion of the mid-infrared spectrum.

A further understanding of the functional and advantageous aspects of the disclosure can be realized by reference to the following detailed description and drawings.

BRIEF DESCRIPTION OF THE DRAWINGS

Embodiments will now be described, by way of example only, with reference to the drawings, in which:

Figure 1 shows of a system that may be employed for thermophotonic imaging.

Figure 2 illustrates a method of thermophotonic lock-in imaging.

Figure 3 illustrates thermal-wave radar imaging, where (a) shows the waveforms and frames captured, and (b) provides a flow chart illustrating the method.

Figure 4 (a) illustrates a method of binary phase code imaging. Theoretical simulation of CC signals using frequency (dashed) and phase (solid) modulation for absorbers at depths (b) 50 μm and (c) 1 mm below the surface using thermal and optical properties of dental enamel. Chirp: 0.1-4.9 Hz, 6.4 s; BPC: 2.5 Hz, 16 bit, 6.4 s.

Figure 5 shows (a) an optical image, (b) front (F) and side (S) dental radiographs of sample A1 (human bicuspid tooth) before treatment; and (c) front (F) and side (S) dental radiographs (d) optical image of sample A1 after 10 days of demineralization treatment with an artificial caries solution within the treatment window; thermophotonic lock-in phase images of sample A1 (e) before treatment and after (f) 2, (g) 4, (h) 8, and (i) 10 days of demineralization with an artificial caries solution within the treatment window; (j) phase profiles along the dashed line shown in figure 5i for samples at several demineralization stages (dashed vertical lines show the location of the treatment window); and (k) Transverse micro-radiographic mineral profile along the center of the treatment window of the 10-day demineralized sample.

Figure 6 shows (a) an optical image of sample A2, the occlusal surface of a maxillary molar with stained pits and fissures; thermophotonic (b) amplitude and (c) phase images of sample A2 obtained at 10 Hz; thermophotonic (d) amplitude and (e) phase images of sample A2 obtained at 100 Hz; and (f)-(i) transverse micro-radiographic mineral profiles of points f-i, respectively, as indicated in (e).

Figure 7 provides images of (a) sample B1, (left) the plastic step wedge (right) inside the scattering medium, (b) sample B2, strip pattern left to right: green, transparent, black, and (c) sample B3, where the squares in (c) indicate the locations of two demineralization (artificial caries) treatment windows.

Figure 8 plots thermal wave radar and phase lock-in (LI) imaging of sample

B2 , with LI thermography phase images at (a) 0.01Hz and (b) 1Hz; (c) Cross-correlation (CC) amplitude image (chirp frequency bandwidth: 0.01-1 Hz in 6s); (d) mean horizontal LI phase profile of figure (a); and distribution of (e) LI phase and (f) CC amplitude values over the steps.

Figure 9 plots thermal wave radar imaging of sample B2 using (a) CC amplitude, (b) CC peak delay time, (c) CC phase and their mean horizontal profiles (d), (e), and (f), respectively (chirp frequency bandwidth: 0.01-1 Hz in 6s).

Figure 10 plots thermal wave radar and thermophotonic lock-in imaging of sample B3, showing (a) CC amplitude image, (b) CC peak delay time image, (c) CC phase image (chirp frequency bandwidth: 0.01-1 Hz in 6s); thermophotonic lock-in phase images at (d) 0.01 Hz and (e) 1 Hz; and (f) transverse micro-radiographic mineral profiles at points 1-3 indicated in figure (c)

Figure 11 plots (a) binary phase code and (b) phase LI imaging of sample B1, and distribution of (c) binary phase code image and (d) phase LI image values over the steps of sample B2.

Figure 12 provides thermophotonic lock-in and binary phase code images of sample B3, with thermophotonic lock-in (a) amplitude and (b) phase images 1 Hz; and binary phase code (c) amplitude image (d) peak delay time image and (e) phase image.

Figure 13 (a) Exploded view of the cross-shaped sample simulating two absorbers at different depths. Conventional LIT (b) Amplitude and (c) phase image. binary phase code peak delay time image matched to the camera temporal data of (d) point 1 and (e) point 2, as indicated in part (b), using a 3-bit [1 1 -1] code.

Figure 14 (a) Teeth matrix with hidden inter-proximal early caries. The rectangle shows the imaged area. (b) Conventional LIT and (c) binary phase code

phase images of teeth matrix. (d-f) thermal coherence tomographic images obtained as several delay times differentiating between the defective (e) and healthy (f) regions.

Figure 15 (a) Optical image of goat bone. The rectangle shows the images area. (b) binary phase code phase images at 1 Hz using a 7 bit binary code.

Figure 16 illustrates the method of asynchronous undersampling for lower frame acquisition rate imaging cameras.

DETAILED DESCRIPTION

Various embodiments and aspects of the disclosure will be described with reference to details discussed below. The following description and drawings are illustrative of the disclosure and are not to be construed as limiting the disclosure. Numerous specific details are described to provide a thorough understanding of various embodiments of the present disclosure. However, in certain instances, well-known or conventional details are not described in order to provide a concise discussion of embodiments of the present disclosure. It should be understood that the order of the steps of the methods disclosed herein is immaterial so long as the methods remain operable. Moreover, two or more steps may be conducted simultaneously or in a different order than recited herein unless otherwise specified.

As used herein, the terms, “comprises” and “comprising” are to be construed as being inclusive and open ended, and not exclusive. Specifically, when used in the specification and claims, the terms, “comprises” and “comprising” and variations thereof mean the specified features, steps or components are included. These terms are not to be interpreted to exclude the presence of other features, steps or components.

As used herein, the term “exemplary” means “serving as an example, instance,

or illustration,” and should not be construed as preferred or advantageous over other configurations disclosed herein.

As used herein, the terms “about” and “approximately”, when used in conjunction with ranges of dimensions of particles, compositions of mixtures or other physical properties or characteristics, are meant to cover slight variations that may exist in the upper and lower limits of the ranges of dimensions so as to not exclude embodiments where on average most of the dimensions are satisfied but where statistically dimensions may exist outside this region. It is not the intention to exclude embodiments such as these from the present disclosure.

As used herein, the term “thermophotonic imaging” relates to the generation of images based on thermal infrared photons emitted from surface and subsurface regions of opaque or non-opaque matter, resulting from photothermal excitation of a sample with a light source such as a laser. The emitted infrared photons carry optical absorption information at the excitation wavelength as well as at the detection spectral band determined by the spectral response of the infrared imaging detector. The case of optically opaque samples, conventionally known as “infrared thermographic imaging”, which involves only thermal properties, is understood to be incorporated by implication in the opaque limit of thermophotonic imaging. As compared to conventional thermographic imaging which monitors contrast due to thermal and/or mechanical property inhomogeneities of materials (thermographic contrast), thermophotonic imaging, in addition to thermographic contrast, involves amplified contrast due to optical property inhomogeneities. Both modalities are based on the generation and detection of (photo)thermal waves in a sample.

Embodiments described below provide systems and methods for improved thermophotonic imaging. In a first embodiment, a system and method is provided in

which photothermal image data are dynamically averaged and subsequently processed to determine both amplitude and phase image information with high signal to noise ratio. The system may be configured for a wide range of imaging modalities, including, but not limited to, single frequency modulation (thermophotonic lock-in imaging or thermophotonic lock-in imaging), chirp modulation (thermal-wave radar imaging or thermal wave radar imaging), and binary phase coded modulation (Binary Phase Coding imaging or binary phase code imaging).

Figure 1 shows a schematic of a thermophotonic imaging system 100 that may be utilized for a number of different imaging modalities. System 100 includes imaging camera 110 for detecting and imaging thermophotonic radiation, laser 120 for exciting a photothermal response in a sample 130, data acquisition system 140, and computing system 150 that is interfaced to camera 110 and/or data acquisition system 140 (in the example embodiment shown in Figure 1, computing system 150 is directly interfaced to camera 110 for reading both image data and data acquisition header data in image frames, as described further below). Sample 130 may be positioned using a sample positioning device, such as a 3-axis (XYZ) sample positioning system (not shown).

Laser 120 is modulated to produce a modulated optical beam that is directed onto the surface of an extracted sample tooth 130, which in turn leads to the generation of photothermal radiation from sample 130 that is subsequently detected by imaging camera 110. In order to obtain high signal-to-noise ratio (SNR) via phase-sensitive detection, a synchronous driving and data acquisition approach is employed, in which frames outputted by imaging camera 110 are synchronized with the modulation of laser 110 for further processing.

Referring now to Figure 2, system 100 is further described in the context of a

thermophotonic imaging modality involving thermophotonic lock-in detection, which represents an illustrative yet non-limiting embodiment of an imaging modality compatible with system 100. Data acquisition system 140 generates analog in-phase reference waveform 160 and analog quadrature reference waveform 165, where quadrature waveform 165 is phase shifted by 90° relative to in-phase waveform 160. Alternatively, the quadrature reference waveform may be computed from the Hilbert Transform of the in-phase reference signal.

In-phase waveform 160 is provided to the modulation input 170 of laser system 120, (shown in Figure 1). In response to in-phase waveform 160, the intensity of the emitted laser light is modulated, where the modulation profile of the laser intensity follows that of in-phase waveform 160 plus a DC offset.

Imaging camera 110 obtains image frames at a defined frequency as shown by integration pulse train (IT pulse train) 190 in Figure 2. Integration pulse train 190 is provided (e.g. as a TTL pulse train) from imaging camera 110 to data acquisition system 140 to trigger the generation of in-phase waveform 160 and quadrature waveform 165 by data acquisition system 140. Integration pulse train 190 also triggers the generation of flag pulse train 175 by data acquisition system 140, where flag pulse train 175 provides a “high” pulse at the beginning of each modulation cycle, as shown in Figure 2.

In the embodiment shown in Figure 1, imaging camera 110 is capable of providing a header for each recorded image frame, where the header includes the measurement of two values that are measured at a time that is substantially instantaneous with the detection of an image frame. The two values are obtained from two analog signals corresponding to instantaneous values of waveforms 160 and 165. Data acquisition system 140 provides these waveforms to imaging camera 110 for

inclusion of the two values in the frame header, thereby providing a measurement of their values at a time that is substantially simultaneous to the instant that the frame is captured. Values from flag pulse train 175 are also stored in the frame header to allow for the determination of the beginning of each waveform period, which is used for averaging purposes as further described below. It is to be understood that the direct interfacing of computing system 150 to camera 110, as shown in Figure 1, is but one of many different possible system implementations. In other embodiments, computing system may be interfaced to camera 110 and/or data acquisition system 140 for synchronous acquisition of both image and modulation waveform instantaneous data, as further described below.

During image acquisition, computing system 150 reads image frames from imaging camera 110 via image sequence 180, and queries the frame headers until it finds a frame whose flag pulse train is “high” (the beginning of a modulation cycle). After a “high” pulse is detected, computing system 150 reads a sequence of frames that correspond to one complete modulation cycle, where the number of frames and delay between frame acquisition events is determined based on the frame rate of imaging camera 110 and the modulation frequency of the in-phase waveform 160. The frames are stored in a buffer (e.g. a 3D buffer) in a memory (such as computer RAM). By performing these steps, system 100 obtains a series of individual imaging frames corresponding to one modulation cycle.

To obtain an improved SNR of the acquired image frames, the above steps are repeated and the values for each frame of one complete modulation cycle are averaged in the buffer to reduce the stochastic noise. Most averaging algorithms read the signal corresponding to all recorded cycles and then initiate the averaging processes. Unfortunately, due to the huge flow of data needed to meet the bandwidth

demands of the image frames, such an averaging methodology fails at high frame rates, such as those that are preferably used in the present embodiment.

Accordingly, in a one embodiment, the image frames are dynamically averaged, where the frames corresponding to one modulation cycle are collected and dynamically processed to determine a running average. Initially, a first set of image frames corresponding to a first modulation cycle are collected and stored in a memory location. Subsequently, image frames are obtained for a second modulation cycle, and the recorded image frame values are dynamically averaged. This process is repeated for subsequent modulation cycles, with the averaging based on the number of modulation cycles that have been processed, with the result that an averaged set of image frames with improved SNR is obtained. This provides a dramatic improvement in memory management and speed, and requires significantly less sophisticated computer hardware.

After having obtained an averaged set of image frames over a modulation cycle, the averaged frame sequence, shown at 180 as $f(t)$ in Figure 2, corresponding to averaged image frames, is processed to obtain amplitude and phase images. This is performed by weighting each pixel in the image for each frame obtained, where the pixel value is weighted once by the in-phase reference signal 160 and once by the quadrature reference signal 165 in two separate channels. The weighted sequences are then separately summed to get the S^0 and S^{90} images, as shown in steps 200 and 210 of Figure 2, respectively. Finally, using equation 1 for each pixel the amplitude and phase images are calculated:

$$A = \sqrt{(S^0)^2 + (S^{90})^2} \quad \text{and} \quad \Phi = \arctan(S^{90}/S^0) \quad (1)$$

Computing system 150 may be programmed with a signal acquisition and/or processing program for processing the data received from imaging camera 110 and/or

data acquisition device 140, and for performing the aforementioned averaging steps and calculation of the amplitude and phase images. For example, generic data processing programs may be provided commercially or created for specific applications associated with the thermophotonic imaging modalities disclosed herein. A suitable programming medium for the creation of such a program is the LabView environment. This environment provides a flexible platform for adapting the imaging software to non-destructive / diagnostic groups of equipment (set-ups) for application specific to particular materials and configurations (e.g. engineering materials NDT, biomaterials diagnostics, dental caries imaging).

Unlike lock-in thermography, which is mostly used in non-destructive testing of metals and other opaque structural materials at very low modulation frequencies (on the order of 0.01Hz or so), and in which low camera frame rates (usually 20 fps), and high optical excitation power (high SNR signal) are used without averaging, in thermophotonic imaging of biological samples and industrial materials with defects very close to surface, one may need high frequency thermal waves and low optical excitation power (poor SNR signal) to meet safety criteria. Therefore, in such cases, it can be advantageous to employ very high camera frame rates and a real-time averaging methodology, as provided, according to the present embodiment.

While the above embodiments provide exemplary systems and methods for obtaining thermophotonic images, it is to be understood that the systems and methods may be varied without departing from the spirit and scope of the aforementioned embodiments. For example, referring now to Figure 1, although system 100 is shown as comprising computing system 150 and data acquisition system 140, these elements of the apparatus may be provided in a number of different formats. Computing system 150, which comprises a processor and a memory, may be directly integrated with data

acquisition system 140. For example, data acquisition system 140 may reside in total or in part on a hardware card housed within an apparatus that also comprises a processor and a memory.

Laser system 120 may further comprise additional sub-components or subsystems such as, but not limited to, a laser diode emitter, laser driver, fiber coupled output, collimator, and thermoelectric cooler and controller. In one exemplary embodiment, laser system 120 has two laser diodes so as to provide improved optical contrast of a type of sample through large differential absorption (for example, 808 nm and 1120 nm). Typically, laser diodes are mounted on thermoelectric coolers and the diode assembly is fixed on an air cooled heat sink through a heat conductive thermal pad. The laser light may be delivered to the sample through an optical fiber and a collimator. A collimator and/or spatial filter may be provided to maintain a relatively uniform optical intensity on the interrogated surface. The thermoelectric controller provides the cooling power to the thermoelectric coolers and controls the temperature of the laser diode. The laser driver may be employed to provide the electrical power needed to operate the laser diode and can modulate the laser light intensity according to the analog modulation signal it receives at its "mod in" terminal.

Furthermore, it is to be understood that optical source need not be a coherent light source such as a laser, but may instead be an incoherent source such as a LED, provided that sufficient optical intensity is achieved to obtain a measurable thermophotonic image signal. With the advent of high-power LEDs, one may employ a high-power infrared LED or LED array in place of a laser source. LED arrays are significantly less expensive than laser sources and generally do not require complicated cooling systems. This strategy can be used because in the proposed

methodologies it is the thermal (conductive and radiative) response from the sample that is investigated, and not the purely optical response.

As noted in the example embodiment provided above, data acquisition system 140 is capable of generating and/or providing waveforms 160 and 165 in response to the integration pulse train 175 generated by the imaging camera. In a non-limiting example, data acquisition system may be a DAQ board such as National Instrument Multi Data acquisition device (NI USB-6229 BNC), and the like, which may be directly integrated with or housed within computing system 150. Such a multifunction data acquisition (multiDAQ) system can generate and acquire analog signals simultaneously and has two independent counters and 48 digital I/O channels for synchronization applications. The data acquisition system may be connected to the computer with a USB port and may be configured to communicate with other devices through BNC connections.

Computing system 150 may be interfaced to imaging camera 110 through an interfacing device such as a networking card. For example, the GigE network PCI card may be employed to provide a suitable interface between the camera and the computer for rapidly transferring image frames to the memory of the computing system 150 according to the GigE standard.

As noted above, the sample 130 and/or laser source may be positionable relative to one another. For example, a sample positioning system may be provided that consists of one or more single axis translation stages mounted to move the sample relative to the incident laser beam in X, and optionally Y and Z directions. A rotational stage may be added to this assembly to assist in the placement of the sample in the focal plane of the camera.

While system 100 as disclosed above is capable of averaging numerous modulation cycles of the signals before processing them, it is also possible to perform that averaging based on the computed amplitude and phase images as opposed to the image frames.

Such an embodiment may be achieved by reading, at a given point in time, a sequence of frames corresponding to one or more modulation cycles, processing the image frames as outlined above, and calculating the desired diagnostic images (i.e. amplitude, phase) and then repeating these steps and averaging the amplitude and phase images. While this “processing, then averaging” mode is less effective in eliminating the stochastic noise than the “averaging, then processing” strategy, it requires less sophisticated triggering/synchronization equipment. For example, this embodiment involves the simplification of the control section of the camera and signal processing system with respect to triggering. This approach will yield non-triggered, yet synchronized, data arrays resulting in an image of somewhat compromised quality.

Furthermore, although system 100 is shown in Figure 1 in which the waveforms 160, 165 and 175 are provided by data acquisition system 140 to imaging camera 110 for incorporation of the substantially instantaneously measured values into the frame header, it is to be understood that the values may be provided according to alternative system implementations. Such embodiments may be useful in cases where imaging camera 110 is not equipped or configured for the incorporation of a header in each image frame. For example, in one non-limiting embodiment, the waveforms 160, 165 and 175 may be directly provided to computing system 150 by data acquisition system 140, optionally along with integration pulse train 190 from imaging camera 110 for triggering. Provided that the relative time delay between the

reception of the waveforms and the generation and/or reception of image frames may be determined (for example, by measuring a delay between system components), the appropriate values of the waveforms corresponding to the measurement of image frames may be determined.

Alternatively, the waveforms 160, 165 and 175 may be generated directly by computing system 150 (optionally triggered by integration pulse train 190 provided by imaging camera 110), and the correlation between the appropriate values of the waveforms and the acquisition of image frames may be determined based on a known system delay. These embodiments may be applied to the system shown in Figure 1, or in the system described above in which the synchronization of triggering is not necessary.

In one embodiment, imaging camera 110 is an infrared imaging camera that is sensitive in the infrared spectrum. Imaging camera 110 may incorporate the necessary optical components for the collection and detection of photothermal radiation, or one or more of the optical components may be externally mounted or otherwise provided. For example, imaging camera may include an extension tube supporting an objective lens.

In one exemplary embodiment, imaging camera 110 is a focal plane array (FPA) mid-infrared camera. A suitable but non-limiting example of such a camera is the Cedip Titanium 520M (France), which has a spectral range of 3.6 – 5.1 μm and maximum frame rate of 175 Hz at full frame. The camera's detector array consists of 320x256 Indium Antimonide (InSb) elements with element size of 30x30 μm^2 . An extension tube and a objective lens (such as Cedip MW50 L0106, a 50-mm-focal-length lens) may be employed to obtain a magnification of (for example, of unity) relative to the interrogated surface of sample 130.

While the mid-infrared camera may be preferred for obtaining optimum results for some sample types, one may also employ less expensive near- or far-infrared cameras, generally with the performance trade-off of a reduced signal-to-noise ratio. However, the low signal to noise ratio can be mitigated, at least in part, by a number of methods such as, for example, increasing the number of averages, using matched filtering signal processing methods (thermal wave radar and binary phase code) described above, increasing the optical source intensity, increasing the camera integration time, and/or improving the optical collection efficiency. It is expected to be more effective to employ a far infrared camera to capture thermal infrared photons due to the peak of the blackbody radiation being located in that spectral range, although the spectral transmissivity of the interrogated material must also be considered in determining the thermal infrared photon emission flux to the camera following self-absorption.

Furthermore, in selected embodiments, uncooled imaging cameras may be employed to simplify the system and/or reduce cost. The cooling system of a camera is one of the factors that make the camera expensive. Uncooled cameras are significantly less expensive but at the same time less sensitive. This problem can be solved by increasing compensation for a reduced performance by using one of the mitigating methods described above.

In another embodiment, a camera with a lower frame acquisition rate may be employed. While lowering the frame rate does not significantly affect the performance of thermophotonic lock-in imaging, the sampling period can be critical in matched filtering methodologies (thermal wave radar and binary phase code) as it determines the depth resolution. Two strategies can be followed to overcome the depth resolution limitation while using a low-grade (low frame rate) camera.

In a first method, synchronous/asynchronous undersampling may be employed, whereby the frame rate is chosen such that the data are captured from many modulation cycles instead of just one. This embodiment is illustrated in Figure 16. Although this sampling strategy increases the total sampling duration, this alternative implementation enables the use of a lower-grade camera to access image depth resolution commensurate with that of the foregoing high-grade camera. The combination of critical undersampling determination with the desired thermal-wave depth penetration, and their software implementation thus provide a unique and important benefit to system performance.

The undersampling frequency (f_s) can be determined as follows:

$$f_s = f_{\text{lock-in}} / [m+(1/n)] \quad (1a)$$

where f_s is the undersampling frequency, $f_{\text{lock-in}}$ is the desired lock-in frequency (or alternatively, chirp/binary phase code repetition rate), m is an integer number and is called the order of undersampling, and n is the number of frames per correlation period. In Figure 13, $m=1$ and $n=12$, that is one frame is captured in every $m=1$ modulation cycle and at the end of the process the sampled modulation cycle (i.e. correlation period) consists of $n=12$ frames⁸.

In a second method, artificial oversampling is performed as per the sampling theorem, which states that if the Fourier transform of a function $h(t)$ is zero for all frequencies above a certain frequency f_c , then the continuous function $h(t)$ can be uniquely determined from a knowledge of the sampled values. So, if the function is sampled at $T= 1/2 f_c$, then one can use the expression below to reconstruct the waveform at any sampling/frame rate:

$$h(t) = T \sum_{n=-\infty}^{\infty} h(nT) \frac{\sin(2\pi f_c (t - nT))}{\pi (t - nT)} \quad (2)$$

The methodology is also known as “Sinc interpolation”. Therefore, one can use a low frame rate camera and then use Sinc interpolation to improve the sampling resolution. The determination of cut off frequency, f_c , satisfying the requirement of a predetermined thermal diffusion length (depth resolution) may be performed according to equation 5, as further described below.

An alternative option for an infrared camera for use with system 100 may be provided by modifying a digital visible spectrum camera such as a commercial digital camera or a webcam. Such cameras may be modified to be sensitive in the near-infrared spectral region by removing the infrared filter and then inserting an infrared band pass filter in the optical path of the detector array. The performance degradation that is likely based on use of such a camera may be mitigated, at least in part, by the methods listed above.

An alternative option for an infrared camera for use with system 100 may be provided by modifying a digital visible spectrum camera as noted above and using methods listed above to handle performance degradation. The output from this camera would be in color with color linked to the status of the specimen under examination. In another embodiment, the camera may be a monochrome camera, and the defect region may be displayed in a unique false colour. The defect may be identified automatically by image processing (for example, using known methods to identify regions of an image based on intensity and/or the presence of a border feature). Alternatively, the defect may be identified in response to input from a user or operator viewing the image.

In one example embodiment, the defect size may be correlated with its displayed colour. For example, an area where there is a large defect may be displayed (and optionally imaged) in red while an area which is sound or healthy may be

displayed (and optionally imaged) in green. An area where the defect is small can be displayed (and optionally imaged) in yellow. This gradation from green to yellow to red would help the operator visually understand the relative size of the defect, and in the case of dental imaging, would assist in visually assessing the severity of any detected defects.

Another imaging modality that is suitable with system 100 employs thermal-wave radar imaging. In thermal wave radar imaging chirp modulation is used instead of the aforementioned method of single frequency modulation (thermophotonic lock-in) modality and the matched filtering signal processing method is employed to increase the SNR. For non-opaque targets, this method is referred to “thermophotonic radar imaging”. It should be noted that this methodology is completely different from thermophotonic lock-in imaging and is a depth selective method as opposed to a depth integrated method in thermophotonic lock-in imaging. As a result, thermal wave radar not only probes deeper into a sample, but also provides improved resolution of details and faster image acquisition due to its high SNR (i.e. requires less averaging).

Figure 3(a) explains the thermal wave radar imaging method graphically. As in the thermophotonic lock-in method, a sequence of image frames are acquired in combination with the values indicating the values of the waveforms 160, 165 and 175. The role of the flag pulse train 175, the integration pulse train 190, and the averaging method, are the same as in the thermophotonic lock-in method described above. However, unlike the case of thermophotonic lock-in in which one modulation cycle is being averaged, it is one chirp cycle of the chirped reference signal 250 that is averaged in the thermal wave radar imaging or the thermophotonic radar imaging method.

Figure 3(b) depicts the signal processing block diagram of thermal wave radar

imaging according to the cross-correlation (CC) theory (matched filtering theory):

$$CC(\tau) = \varepsilon \times \mathfrak{F}^{-1} \{ \text{REF}(\omega)^* S(\omega) \} \quad (3)$$

where $\text{REF}(\omega)$ and $S(\omega)$ are the Fourier transforms of the reference/modulation signal ($\text{Ref}(t)$) and the highly noised photothermal signal ($s(t)$), ε is the emissivity and \mathfrak{F}^{-1} and $*$ denote the inverse Fourier transform and complex conjugate operators, respectively. In matched filtering, the role of chirped modulation is to compress the energy delivered by the chirp into a narrow correlation peak which enables imaging with high axial resolution. The result is a reduction in the width of the CC main lobe (peak) and an increase in the amplitude of the peak as the area below it needs to be conserved. In the case of a linear frequency sweep, the signal-to-noise ratio (SNR) gain factor of the ideal matched filter is equal to the time-bandwidth product of the chirp. Theoretical and experimental studies have shown that this increase in SNR also holds in the photothermal fields.

While the amplitude of the CC peak relies strongly on the amplitude of the received signal, its location in the delay time axis (τ_p) is linked to the depth of the signal source. One can further develop this concept by calculating the CC phase (schematically in figure 3(b)) and find:

$$\theta_{CC} = \frac{\varepsilon \times \mathfrak{F}^{-1} \{ \text{REF}(\omega)^* S(\omega) \}}{\varepsilon \times \mathfrak{F}^{-1} \{ [-i \text{sgn}(\omega) \text{REF}(\omega)]^* S(\omega) \}} \quad (4)$$

where $\text{sgn}(\omega)$ and i are the signum function and standard imaginary unit, respectively. The expression inside the squared bracket is the Fourier transform of the quadrature reference signal. The significance of CC phase is that according to equation 4 the emissivity is cancelled out and as a result the CC phase is an emissivity-normalized quantity.

In light of the above, after the averaging step, the temporal signal from each

pixel is processed according to figure 3(b). Initially, the Fourier transform of reference $Ref(t)$ 300, quadrature signal (i.e. Hilbert transformed reference signal), and averaged photothermal signal $S(t)$ 305 are obtained at 310, 315 and 320, respectively. The complex conjugate 325 of the reference spectrum is then multiplied by the spectrum of the photothermal signal which is proportional to the emissivity, and the inverse Fourier transform is obtained at 330, the real part of which generates cross-correlation signal 335. Similarly, the complex conjugate 340 of the Hilbert transform of the reference spectrum is multiplied by the spectrum of the photothermal signal which is also proportional to the emissivity, and the inverse Fourier transform is obtained at 345. The phase signal 360 is then provided by taking, as its real part, the real part 350 of the inverse transform 330, and as its imaginary part, the real part 355 of inverse transform 345.

From these calculated signals, contrast parameters may be generated and displayed as images. The following are a non-limiting list of parameters that may be provided for generating images:

- (a) the *cross-correlation amplitude image*, in which the contrast parameter is the amplitude of the cross-correlation peak;
- (b) the *cross-correlation peak delay time image*, in which the contrast parameter is the location of the cross-correlation peak in the delay time axis (τ_p); and
- (c) the *emissivity normalized cross-correlation phase image*, in which the contrast parameter is the phase value at zero delay time calculated from equation 4.

In one example embodiment, one or more of these images, namely the cross-correlation amplitude image, the cross-correlation peak delay time image, and/or the

emissivity normalized cross-correlation phase image, are generated and employed to infer information about the sample 130.

The above images are to be contrasted with known methods of processing thermophotonic image data. In the Radar sciences, matched filtering has been used since the early 1940s to detect pre-known (deterministic) signals within highly noised channels and to augment the range resolution. In 1986 Mandelis et al. in a series of papers introduced this method to the photothermal field through the mirage (photothermal beam deflection) effect^{4(a-c)}. Recently, Mulaveesala et al.⁵ and Tabatabaei and Mandelis⁶ (Thermal-Wave Radar) have applied this methodology to imaging in the photothermal field. For example, in the method of Mulaveesala et al.⁵(which is based on a pulse compression technique), a completely different approach is taken to calculate a so-called “phase image” from a chirped reference signal. Instead of processing the phase image according to all components in the frequency domain as in equation 4, the method of Mulaveesala et al. is based on demodulating the camera signal at a specific frequency. This method is completely different from the inventive methods disclosed herein and has long been used in the field of Pulse Phase Thermography⁹. More specifically, the phase image of Mulaveesala et al. is obtained by computing the Fourier transform of a pixel signal, and the value of this Fourier transform at the desired frequency will be a complex number. The phase is obtained by calculating, based on this complex frequency, the phase value $\tan^{-1}(\text{imaginary part}/\text{real part})$. In fact, those skilled in the art will appreciate that this approach of phase calculation was first introduced in Pulse Phase Thermography⁹. This phase value is the phase of a single frequency thermal-wave; it is not a true matched filtering/cross-correlation calculation.

In contrast, according to the methodology disclosed herein, which is shown in

the block diagram of Figure 3, the complex conjugate phase is calculated using *all the frequency components of the chirp through cross-correlation/matched filtering* of reference and quadrature signals. In summary, the phase images that are obtained according to the methods of Mulaveesala et al. result in depth integrated images over a thermal diffusion length controlled by the modulation frequency, in contrast to the method disclosed herein which results in depth-resolved (or depth-selective) imaging. The method disclosed herein is the result of correlation processing, otherwise known as “matched filter compression”. As will be seen in the single frequency image of Figs 10d and 10e, compared to the matched filter compression generated images of Figs. 10b and 10c, this difference in approach has huge contrast enhancement implications in favor of matched filter compression.

Furthermore, unlike known imaging modalities such as those disclosed by Mulaveesala et al. , the present embodiments utilize thermophotonic imaging, which is applicable to a wide range of imaging applications beyond opaque sample imaging applications (such as imaging of metals). In particular, and as further described below, the optical scattering and absorption properties of dental and other biomaterials introduce a non-extrapolatable factor in imaging, which cannot be readily perceived by one skilled in the thermographic imaging, as frequency ranges, wavelengths, delay times etc. are all very different and image contrast optimization is controlled by the diffusion-wave centroid determined by the thermal diffusion length and optical absorption depth (or extinction depth, in case of turbid media) according to equation 5(b) as shown below.

Embodiments provided herein also improve over known imaging modalities that employ very low frequencies, such as those typical of thermography. Such methods that rely on low frequencies may be applicable for deep subsurface metal

defects, but are insufficient for thermal-wave radar in materials such as teeth and surface coatings, where high frequencies are needed for critical spatial and temporal (axial) resolution. In contrast to such low-frequency applications, the present embodiments may be employed for frequencies up to several hundred Hz via the aforementioned signal processing and data handling methods. Moreover, the embodiments disclosed herein may be adapted for use with inexpensive slower IR cameras in place of more expensive IR imaging cameras. Accordingly, the embodiments provided herein are especially adapted for thermophotonic imaging of non-opaque solids, but are also valid in the limit of opaque targets upon appropriate parameter adjustment.

The aforementioned embodiment, in which chirp modulation is employed in thermal wave radar imaging and thermophotonic radar imaging, provides a reduction in the width of the cross-correlation peak. This not only improves the depth resolution and allows for depth-selective imaging, but also increases the height of the peak (i.e. SNR) as the area below it needs to be conserved.

In another embodiment, an alternative approach is employed in which binary phase coding is utilized instead of a chirp to obtain an improved SNR. Binary phase coding is an alternative method that uses single frequency modulation but inverts some of the modulation cycles in a prescribed manner in order to achieve this goal. The signal processing method is the same as the aforementioned thermal wave radar imaging and thermophotonic radar imaging embodiment, and uses matched and mismatched filtering to detect a signal source. However, in the case of binary phase code imaging, the modulation waveform is a binary phase coded single frequency waveform. As a result, binary phase code imaging is considered as a narrow-band detection compared to thermal wave radar imaging/thermophotonic radar imaging and

experiences lower background noise level.

Figure 4 illustrates this method graphically for a 3-bit coded signal 260 ([1, 1, -1]) shown at reference waveform 400. The third cycle is inverted with respect to the other cycles to generate the binary phase code waveform, forming a single frequency signal that is coded according to the 3-bit sequence in Table 1.

Table 1. Binary phase code sequences¹⁰.

length <i>N</i>	sequence <i>c_k</i>									filter coefficients <i>w_k</i>						relative efficiency		
3	1	1	-1							1	1	0						66.67 percent
4	1	1	1	-1						1	1	1	-1					100.00 percent
5	1	1	1	1	-1					1	1	1	1	-2				90.00 percent
6	1	1	1	1	1	-1				1	1	1	1	1	-3			76.19 percent
7	1	1	1	1	1	1	-1			1	1	1	1	1	1	-4		64.93 percent
8	1	1	1	1	-1	-1	1	-1		1	1	3	1	-1	-1	3	-1	75.00 percent
9	1	1	1	1	1	-1	1	1		1	1	6	1	1	-4	1	1	60.11 percent
	-1									-4								
10	1	1	1	1	1	-1	1	-1		9	19	1	7	5	-9	25	-1	59.66 percent
	-1	-1								-7	-5							
11	1	1	1	1	1	-1	1	1		71	20	47	17	80	-79	68	53	77.47 percent
	-1	-1	-1							-49	5	-55						
12	1	1	1	1	1	-1	-1	1		2	1	1	2	1	-1	-2	1	88.92 percent
	1	-1	1	-1						1	-2	1	-1					
13	1	1	1	1	1	-1	-1	1		2	2	2	2	2	-3	-3	2	96.15 percent
	1	-1	1	-1	1					2	-3	2	-3	2				
14	1	1	1	1	1	1	-1	-1		1	4	4	1	4	1	-5	-5	82.29 percent
	1	1	-1	1	-1	1				4	4	-5	4	-5	1			
15	1	1	1	1	1	1	-1	1		4	4	-5	4	-5	1			86.81 percent
	-1	-1	1	1	-1	-1	-1											
16	1	1	1	1	1	1	-1	1		3	21	45	39	27	5	-27	39	79.43 percent
	-1	1	-1	-1	1	1	-1	-1		-45	21	-3	-25	43	37	-43	-25	

While the optical excitation is binary phase coded in accordance to weighting sequence c_k in table 1, one can choose to use Matched Filtering (weighting sequence c_k in table 1) or MisMatched filtering (weighting sequence w_k in table 1) as the 300 reference signal in figure 3(b) to calculate the binary phase code amplitude, peak delay time, and phase images using the method illustrated in the block diagram of thermal wave radar or thermophotonic radar imaging modality (shown in Figure 3(b)). The advantage of MisMatched filtering over Matched filtering is the significant reduction of side lobes at the expense of lower SNR¹⁰.

The binary phase code signal, $f(t)$, consists of a single frequency carrier, $C(t)$, and a binary coded envelope, $E(t)$. The signal is formed by either multiplying these components in the time-domain or alternatively by convolving their spectra in the frequency-domain. In general, an arbitrary binary sequence can be defined as $a_j=[a_1, a_2, \dots, a_N]$. In the special case where the temporal length of each code element equals the period of the carrier (T_o), the binary coded envelope can be modeled as a series of rectangular pulses of width T_o and height a_j shifted in the time axis by $(j-0.5) T_o$. Therefore, starting with the Fourier transform of a pulse, the analytical spectrum of the binary coded envelope can be obtained using the time-frequency shifting property of the Fourier transform:

$$\mathfrak{F}\{E(t)\} = E(\omega) = \frac{\sqrt{2\pi}}{\omega_o} \text{Sinc}\left(\frac{\omega}{\omega_o}\right) \sum_{j=1}^N a_j \exp[-i\omega T_o (j-0.5)] \tag{5}$$

where ω_o and i are the carrier angular frequency and the imaginary unit, respectively. Finally, the analytical spectrum of the binary phase coded signal can be calculated through the convolution of equation (5) and the spectrum of the carrier waveform:

$$\mathfrak{F}\{f(t)\} = F(\omega) = \frac{\pi}{i\omega_o} \sum_{j=1}^N \left[a_j \text{Sinc}\left(\frac{\omega - \omega_o}{\omega_o}\right) \exp[-iT_o (j-0.5)(\omega - \omega_o)] - a_j \text{Sinc}\left(\frac{\omega + \omega_o}{\omega_o}\right) \exp[-iT_o (j-0.5)(\omega + \omega_o)] \right] \tag{6}$$

Equation (6) suggests that the spectrum of the binary coded signal consists of a series of weighted “sinc” functions yielding a narrow-band waveform with most of its energy located at the carrier frequency (narrow-band signal).

The thermophotonic response (Planck radiation emission) of a non-opaque turbid medium to a binary phase code excitation can be obtained through coupling of the optical and thermal-wave fields, where the total optical field (coherent + scattered)

is the source of thermal-wave generation. As a simple example, the response of black body absorbers in a turbid medium is investigated. That is, the binary phase code excitation is applied to the surface ($z=0$) of a turbid medium with known scattering and absorption coefficients (μ_s and μ_a , respectively), where, after interaction with the turbid medium, the attenuated light is completely absorbed at $z=l$ and thermal waves are generated. The energy fluence, $I(z)$, of the one-dimensional, uniform, collimated beam normally incident on a homogeneous scattering and absorbing medium has been calculated by Prah *et al.*⁷. Using this approximation, the thermal-wave problem can be formulated by adding a depth dependent source term to the heat diffusion differential equation (due to absorption by the medium) as well as an attenuated heat source at $z=l$ through a boundary condition:

$$\begin{cases} \frac{\partial^2 \theta(z; \omega)}{\partial z^2} - \sigma^2 \theta(z; \omega) = -\frac{\mu_a}{k} I(z) F(\omega) \\ -k \frac{\partial \theta(z; \omega)}{\partial z} \Big|_{z=0} = 0 \\ -k \frac{\partial \theta(z; \omega)}{\partial z} \Big|_{z=l} = I(l) F(\omega) \\ \theta(z; \omega) = \Im \{ T(z, t) - T_\infty \} \end{cases} \quad \begin{matrix} \text{(I)} \\ \text{(II)} \end{matrix} \quad (7)$$

where k , α , and $F(\omega)$ are thermal conductivity, thermal diffusivity and the spectrum of the applied binary phase code excitation **Error! Reference source not found.**, respectively, and $\sigma = \sqrt{i\omega/\alpha}$ is the complex wavenumber. Solving the frequency-domain differential equation subject to the boundary conditions and considering an average value for the infrared absorption coefficient within the spectral range of the detector ($\bar{\mu}_{IR}$), the conductive heat transfer spectrum of the thermophotonic signal can be calculated as:

$$S_c(l; \omega) \propto \bar{\mu}_{IR} \int_0^l \theta(z; \omega) \exp(-\bar{\mu}_{IR} z) dz = \bar{\mu}_{IR} \left[\frac{A}{\sigma - \bar{\mu}_{IR}} (\exp[(\sigma - \bar{\mu}_{IR})l] - 1) - \frac{B}{\sigma + \bar{\mu}_{IR}} (\exp[-(\sigma + \bar{\mu}_{IR})l] - 1) - \frac{C}{\mu_{eff} + \bar{\mu}_{IR}} (\exp[-(\mu_{eff} + \bar{\mu}_{IR})l] - 1) - \frac{D}{\mu_i + \bar{\mu}_{IR}} (\exp[-(\mu_i + \bar{\mu}_{IR})l] - 1) \right]$$

(8)

However, the infrared emission captured by the detector is the superposition of (8) and the direct Planck emission from the black-body absorber, attenuated through the turbid medium (9).

$$S(l; \omega) \propto S_e(l; \omega) + \theta(l; \omega) \exp(-\bar{\mu}_r l) \quad (9)$$

Equations (6) and (9) formulate the spectra of the applied binary phase coded excitation (i.e. the matched/mismatched filter) and the thermophotonic response of a subsurface absorber at depth l to such excitation, respectively. Consequently, one can calculate the matched-filter cross-correlation signal and its phase analytically as (3) and (4), respectively, or experimentally via the algorithm depicted in figure 3(b).

Figures 4(b) and 4(c) plot theoretical comparisons of the CC signals obtained from chirp (dashed lines) and binary phase coded (solid lines) modulation techniques. Optical and thermal properties of dental enamel were used as the properties of the turbid medium. The CC responses clearly show that binary phase code modulation significantly improves the axial resolution (FWHM of the main peaks) as well as the SNR. Moreover, the plots suggest that matched/mismatched filtering using phase modulation can exhibit energy localization normally encountered in propagating hyperbolic wave-fields. As a result, one can obtain localized information from absorbers at different depths by investigating the CC plots at the corresponding delay times or alternatively obtain iso-delay (iso-depth) images in a thermophotonic radar imaging system. Consequently, by scanning the image plane in the delay time axis one can obtain thermal coherence tomographic images and locally resolve absorbers in a diffuse field.

In another example embodiment, the aforementioned systems and methods are employed for the detection and/or monitoring of teeth. Teeth (including enamel, dentin, root and or cementum) are an optically turbid medium, therefore when light enters the tooth it scatters and gets absorbed along its path. Optical extinction depth is defined as the effective depth within which the light can get absorbed and generates heat, including both absorption and scattering effects. Interpolating the enamel extinction coefficient from the IR spectrum of dental enamel reported by Jones and Fried, the optical extinction depth is roughly 250 μm for the 808-nm laser light. However, as photon absorption events are responsible for generating thermal signals, it is the optical absorption depth ($\sim 1 \text{ cm}$) that is the controlling factor, or, more precisely, a superposition of 1) a conduction heat transfer mode whose depth is controlled by the thermal-wave centroid determined by the optical extinction depth and thermal diffusion length; and 2) a radiation heat transfer mode whose depth is controlled by the optical extinction depth: When modulated optical excitation is absorbed inside the tooth, the subsequent heat generation gives two contributions to the infrared camera signal. First, an oscillatory heat distribution (thermal-wave) is formed at or near the surface within a thermal diffusion length (at the modulation frequency of the absorbed optical excitation) which will conductively reach the surface of the tooth and contribute to the camera signal in the form of a depth integral through infrared emission.

Second, direct thermal infrared (Planck) emission occurs from all absorption locations (surface and subsurface) with IR photon back-propagation through the enamel due to the 15 to 20 % transmittance of enamel in the mid-infrared region. Considering the speed of light and the thickness of enamel, the latter contribution is instantaneous and therefore there will be no phase shift between the direct infrared

(Planck) emission responses received from different depths in the tooth. Consequently, it is believed that there will be no contrast contribution from this type of direct emission in the thermophotonic lock-in phase image; however, direct emission will contribute to the amplitude image contrast as these images are concerned with the amplitude of infrared emission (number of IR photons) received at a specific modulation frequency, a function of the local absorption coefficient and optical-to-thermal energy conversion efficiency.

On the other hand, the thermal-wave contribution to the infrared camera signal is not instantaneous as speed of propagation of heat is significantly smaller than that of light. As a result, absorption at different depths will result in different phase values at a fixed modulation frequency. Unlike pure thermal waves generated in opaque media, optically non-saturated photothermal waves carry optical as well as thermal information. The most important feature of thermal waves is that their effective penetration depth can be controlled through the modulation frequency:

$$\mu_{th}(f) = \sqrt{\alpha/\pi f} \quad (10a)$$

and the signal carries optical absorption information from depths $d \leq \mu_{th}(f)$. When the optical extinction depth, $\mu_{ex}(\lambda)$ contribution to the thermal-wave distribution is taken into account, where λ is the wavelength of the optical excitation source, in the concept of the thermophotonic-wave centroid, $L(\omega, \lambda)$:

$$L^{-1}(\omega, \lambda) = \mu_{th}^{-1}(\omega) + \mu_{ex}^{-1}(\lambda) \quad (10b)$$

Equation 10(b) comprises the physical principle on which thermophotonic lock-in imaging hinges. In equation 10(b), μ_{th} , μ_{ex} , α , and f are thermal diffusion length, optical extinction depth, thermal diffusivity, and modulation frequency, respectively.

Therefore, as photothermal-wave generated infrared emission is the dominant source of contrast in thermophotonic lock-in phase images, one can control the imaging depth by adjusting the modulation frequency according to equation 10. Due to the small thermal diffusivity, α , of enamel, dentin and root cementum, the maximum thermal diffusion length (i.e. at modulation frequency ~ 1 Hz) is on the order of ~ 300 μm . Therefore, phase images are best used for detecting inhomogeneities at short subsurface distances within the enamel such as the early demineralization and carious lesions while amplitude images can be used to detect deep features due to the large optical absorption depth of enamel. Moreover, biofilm, surface stains and dental plaque which are expected, in principle, to produce contrast in the thermophotonic lock-in images, they will do so minimally and only in the image amplitude due to their transparency to 808nm NIR excitation source used in this study. The thermophotonic lock-in phase image is physically immune to thin surface absorbers as it is independent of the optical properties of the surface.

The same situation holds for thermal wave radar/thermophotonic radar and binary phase code imaging as well. That is, the cross-correlation amplitude images obtain contributions from both the conductive and direct emission sources while the cross-correlation peak delay time and phase images only receive contribution from the conductive part.

The preceding theoretical arguments related to mechanisms of photothermal generation in teeth and other non-opaque turbid matter are not intended to limit the scope of the embodiments disclosed herein. Moreover, although the above embodiments have been focusing on teeth, it is to be understood that the sample may be any suitable sample that is capable of generating detectable photothermal radiation. For example, sample 130 may be processed or finished material, where the methods

described herein are employed for non-destructive testing purposes, especially those that benefit from the characterization of subsurface absorption. These include, but are not confined to, subsurface cracks and defects in metals and coatings; automotive component inspection and quality assurance, including unsintered parts in the green state; aerospace component inspection such as gears and hardened steels, and the determination of the hardness case depth; optical and laser materials and coatings with visually imperceptible blemishes; coatings and alloys, biomedical materials and soft and hard tissue diagnostics, cracks and defects in dental restorations including direct placed and indirect fabricated prosthetics, defects or ill-fitting prosthetics linked to dental implants, defects at the margins or junctions of tooth and dental restorations, and all other materials applications to which photothermal diagnostics has been and can be applied¹¹. In dental applications, cracks and defects in dental restorations including direct placed and indirect fabricated prosthetics, defects or ill-fitting prosthetics linked to dental implants, defects at the margins or junctions of tooth and dental restorations.

Additional applications of the preceding embodiments to the detection of defects in dental materials includes the following: detecting and monitoring the effect of various agents, treatments and therapies on in-vivo or in-vitro teeth or samples to determine whether or not they create lesions or erosions, stabilize these areas of tissue loss or promote regeneration of lost tissue; detecting and monitoring changes in tooth structure as additional evidence of various disease process such as bruxism, gastro-esophagal reflux, TemporoMandibular Joint Dysfunction, and the like; detecting, examining and scanning a tooth surface whether intact or prepared for the placement of a direct or indirect restoration to ensure that the surface is clean, free of defects including cracks or accumulations of debris, cements, plaque etc. before

placement of the restoration; detecting and monitoring defects and or dental caries around the edges of direct placed (amalgam, composite resin and other) dental materials; detecting and monitoring the integrity of dental materials including detection of cracks, craze lines etc. on both direct placed and indirect fabricated dental prosthetics; detecting and monitoring defects at the margins of dental sealants and caries beneath these dental sealants which are placed in the tooth; detecting and monitoring defects and or dental caries at the margins of indirectly placed dental restorations including full crowns, inlays, onlays, bridges etc. made of gold, composite and or porcelain or other dental materials; detecting, monitoring and confirming the fit and marginal integrity of direct and indirect placed dental materials into prepared tooth surfaces; detecting and monitoring the fit of precision attached dental restorations to ensure that the attachments are completely seated; detecting and monitoring the fit of mesostructures onto osseous integrated dental implants on initial placement and over the lifetime of the prosthesis; detecting and monitoring the integrity of materials used in the manufacture of dental prosthesis including osseous integrated implants, mesostructures and or superstructures, frameworks of fixed and removable prosthesis made of metal alloy, sintered porcelain and other materials; detecting and monitoring carious lesions and or defects around orthodontic brackets and other materials that are bonded on to the tooth surface not excluding bonded bridgework, veneers and retainers or other surface sealants; detecting the pulp chamber and or root canal system inside the tooth surface while performing endodontic therapy; confirming the marginal integrity of the endodontic obturation or filling of the root canal system of a tooth; detecting cracks both on the outside of the tooth surface and from within a cavity preparation or within the confines of the pulp chamber or root canal system; detecting and examining the anatomical structure of

root apices while performing surgery in this area; detecting, examining and locating neurovascular bundle while performing surgery in the maxilla and or mandible; detecting and monitoring the recession or movement or migration of the gingival tissue from the CEJ; detecting and monitoring the evolution of erosion lesions or lesions due to the exposure of acids on the tooth surface or surface of the dental restorative materials; detecting and monitoring the evolution of carious lesions or erosion lesions and how various therapies can enhance, stabilize or reduce lesions size; and incorporating this into a preventive based program that can be used in a clinical practice or a public health programme; combining the images, information into a data base that is patient specific, specific for a particular dental practice, for a particular age group, particular group of teeth, particular sex or ethnic group or particular postal code or geographic region to provide information on the health and status of the teeth, prosthesis or other entities studied; taking the combined images and information from this data base to provide historical information and or epidemiologic information on the caries present, size of lesion, state of dental materials in various environments, and other information on the oral health and integrity of the dental materials and prosthetics; taking the combined images and information from this data base on a patient specific, gender specific or other groupings and comparing it against known risk factors for caries, erosion, bruxism and other oral disorders and conditions to develop a risk profile or risk ranking for a patient or a population group; using the information in this data base to provide guidance on the various therapies, pathologic situations to patients, oral health providers, providers of the various dental programs and manufacturers of the various therapies; and detecting and monitoring the integrity of various dental instruments including but not limited to dental burs, diamond dental burs, surgical elevators,

endodontic files and instruments and or dental scalers and or curettes to ensure that there are no defects that would affect the integrity of the material or instrument while it is being used during a procedure.

The following examples are presented to enable those skilled in the art to understand and to practice embodiments of the present disclosure. They should not be considered as a limitation on the scope of the present embodiments, but merely as being illustrative and representative thereof.

EXAMPLES

Example 1: Early Detection of Dental Caries

In order to apply controlled demineralization to tooth samples, a demineralizing / artificial caries solution was prepared. The solution was an acidified gel, consisting of 0.1 M lactic acid gelled to a thick consistency with 6% w/v hydroxyethylcellulose and the pH adjusted to 4.5 with 0.1 M NaOH. Demineralization with acidified gel approximates the natural carious lesion as it mimics the properties of actual dental plaques in the oral cavity. Previous studies show that this solution can produce a subsurface lesion in enamel with a sound surface layer which is characteristic of an early carious lesion¹.

As it was desired to observe the contrast between demineralized and healthy areas in a whole tooth, a treatment protocol was followed in which the interrogated surface of the sample was covered with two coatings of commercial transparent nail polish except for a rectangular or square window, henceforth referred to as the treatment window. The demineralization on the window was carried out by submerging the sample upside down in a polypropylene test tube containing 30 ml of demineralizing / artificial caries solution. After the treatment period the sample was removed from the gel, rinsed under running tap water for approximately 1 minute and dried in air for 5

minutes. Then, the transparent nail polish was removed from the interrogated surface with acetone and the sample was again rinsed, dried, and stored in the air-tight humid box for at least 24 hours before the imaging. For consecutive demineralization, after the imaging step the sample was again covered with the transparent nail polish (except for the treatment window) and treated / demineralized for additional days in order to investigate the progression of demineralization and evolution of the artificial carious lesion with time.

Figure 5(a) shows an optical image of sample A1 before application of demineralization in the treatment window. The dashed rectangle in this figure shows the area that was imaged using the thermophotonic lock-in system while the solid rectangle depicts the location of the treatment window. The optical image shows traces of a discontinuity on the surface of enamel (feature 1). The two vertical lines on the root area show the approximate lateral position of the treatment window (solid rectangle). These lines were meant to aid the operator with sample alignment and are of no scientific importance. Figure 5(b) “F” shows the dental radiograph of the untreated sample (“before”) at the same view as the optical image and figure 5(b) “S” shows the side view indicated by the arrow in the optical image (Fig. 5(a)). Based on these radiographs and visual examination sample A1 was a healthy tooth before application of artificial caries treatment and it is interesting to see that the discontinuity or crack on the enamel surface (feature 1) could not be resolved in either of the dental radiographs.

Figures 5(b-c) and 5(d) are the x-ray radiographs and the optical image, respectively, taken from sample A1 after 10 days of treatment. None of these images can show even a trace of mineral loss in the treatment window, showing the insensitivity of conventional clinical diagnostic methods to early demineralization or

carious lesion formation. Figure 5(e) depicts the thermophotonic lock-in phase image of sample A1 taken at 10 Hz before application of any treatment. This image not only shows the enamel discontinuity observed in the optical image (feature 1) but also reveals the presence of a vertical crack (feature 2) and the cemento-enamel junction (CEJ, feature 3). Neither the x-ray radiographs (Fig. 5(b)) nor the optical image (Fig. 5(a)), could resolve this vertical crack (feature 2). The reason of the high sensitivity of thermophotonic images to cracks is the fissured nature of cracks which enhances the photothermal temperature field through thermal-wave flux localization generating high contrast.

The appearance of the enamel discontinuity in the phase image (feature 1 in Fig. 5(e)) has similar physical origin to that of cracks. It was postulated that feature 1 was caused by the forces applied during the tooth extraction. The appearance of a dark band in the phase images of figure 5 (feature 3) at the CEJ level suggests the presence of a border between enamel and cementum, remnants of periodontal ligament at this position. According to the dental literature, enamel of the cervical margin of the tooth is one of the locations which favors plaque formation and is therefore prone to demineralization. It can be seen that all the thermophotonic phase images of figure 5 can detect feature 3 (the CEJ) with high sensitivity (contrast). In fact, one of the most important advantages of thermophotonic lock-in imaging compared to single point photothermal radiometric (PTR) measurements is the significant improvement in the wealth of data resulting in excellent contrast and reliability of the results in real time and in direct comparison with conventional dental radiographs. Point-by-point measurements would require much longer time spans to produce surface images, which would be impractical in clinical applications.

Figures 5(f) to 5(i) show the phase images taken at 2, 4, 8, and 10 days of

treatment (mineral loss only within the treatment window), respectively. It should be noted that the same contrast mapping (linear, with identical thresholds) has been used in all thermophotonic lock-in images of figure 5 to ensure the validity of comparison between the images. It can be observed that as treatment time increases the treated window becomes more apparent while the other features in the images remain more or less the same. The mean phase values within the treatment window (empty rectangle in Fig. 1(e)) for the untreated, 2D, 4D, 8D, and 10D samples are found to be -7.47° , -25.22° , -31.75° , -42.07° , and -49.66° , respectively. This monotonic decrease in the phase lag is due to the progression of the lesion into the enamel. As the lesion thickness increases, the thermal-wave centroid shifts closer to the surface, thereby decreasing the phase lag between the applied optical excitation and the received infrared response. The phase lag decreases also with respect to the intact state (“before”).

Feature 4 in figure 5(f) is most probably a material inhomogeneity formed as a result of incomplete removal of nail polish from the enamel surface after the second day of demineralization. The feature disappeared after the next demineralization cycle. It appears that feature 5 is stress-induced cracks that were formed during tooth extraction. The cracks become more apparent toward the later stages of demineralization (Figs 5(e) to 5(i)) due to successive nail polish penetration into them. It has been known that nail polish can penetrate tens of micrometers into dental enamel².

Figure 5(j) is a plot of transverse profiles of the phase images along the dashed line shown in figure 5(i). The dashed vertical lines represent the location of the treatment window (centered at 6.27 mm). It can be seen that as demineralization progresses, the absolute thermophotonic phase values increase within the treatment

window but remain approximately the same outside the treatment window. Furthermore, examination of these phase profiles reveals that the demineralization and artificial lesion has not only propagated vertically into the enamel but has also spread out laterally. However, the extent of the lesion is always maximal within the treatment window and decreases rapidly laterally away from the treatment window. The two dips in the phase values at ~3.9 mm and ~8.8 mm lateral positions are related to the vertical defects at those locations (features 2 and 1, respectively).

Figure 5(k) represents the transverse micro-radiographic mineral profile vertically along the center of the treatment window. Mean lesion depth of 326.4 μm and mineral loss of 5,710 vol% μm was reported by the transverse micro-radiographic software for the lesion produced at the center of the treatment window. It can be seen that the lesion retains a relatively well-preserved surface layer with a moderate mineral loss over a large depth. It is somewhat surprising to find such a deep lesion formed after only 10 days of treatment with the artificial caries gel, but it is a well-known fact that the rate of demineralization can vary greatly among teeth¹.

Figure 6 presents the results obtained from sample A2. Unlike Sample A1, the occlusal surface was investigated for this sample. Figure 6(b) shows the thermophotonic lock-in amplitude image taken at 10 Hz. The amplitude image shows the presence of caries at several locations but the image is rather diffuse. Using this image, four regions of interest (i, f, g, and h) were identified within the imaged area of the optical image (Fig. 6(a)). The thermophotonic lock-in phase image taken at 10 Hz is shown in figure 6(c). No feature can be resolved in the blurry phase image. The reason for such poor resolution is the relatively long, diffusion-limited thermal wavelength at 10 Hz. In fact, in these images the contributions from deeper features have resulted in nuisance interferences superposed on features closer to the surface.

Consequently, to avoid the interfering effects of deep features, it was decided to reduce the thermal wavelength by generating the images at 100 Hz in order to be able to effectively detect the areas of mineral loss in the pits and fissures of the occlusal surface and the near-subsurface regions. The resolution improvement at higher frequencies is a well-known behavior of thermal-waves³ and is clearly visible in the amplitude and phase images obtained at 100 Hz (Figs 6(d) and 6(e)). The pits labeled *f*, *g*, and *h* in figure 6(e) are shown as carious spots, whereas the groove labelled *i* is shown as a healthy bright spot (similar to intact regions in images 5b to 5f). Transverse micro-radiographic profiles are shown in Figures 6i-f of the dark carious regions *f*, *g*, and *h* and of the groove *i*, clearly show the presence of mineral losses at points *f*, *g* and *h* while no significant mineral loss can be observed in the mineral profile obtained at *i*. The transverse micro-radiographic profiles fully validate the results of the non-contacting, non-destructive imaging method.

Example 2a: Non-destructive testing of engineering materials with subsurface absorbers and early detection of dental caries using thermophotonic radar imaging

The physical principles of light absorption/scattering and thermal-wave generation are the same for the various imaging modalities disclosed herein. The difference lies in the applied optical excitation pattern and the subsequent signal processing algorithm. As discussed above, in thermal wave radar (or thermophotonic radar) imaging a chirp excitation is used instead of a single frequency modulation. As a result, according to equation 5a, the thermal diffusion length is not fixed and the generated thermal-waves dynamically scan a series of depths. One of the problems encountered in thermophotonic lock-in imaging is the compromise one needs to make between the maximum detection depth and the depth resolution. While the low

frequency thermal-waves can see deep into the sample, they lack the desired depth resolution; the high frequency thermal-waves, on the other hand, have the exact opposite situation due to the reduced thermal diffusion length.

In order to experimentally investigate the capabilities of the thermophotonic radar method, three samples of engineering and biological materials were designed and prepared. The first sample, B1 400 (Figure 7(a)), is a black plastic step-wedge sample (step height = 200 μm) placed inside a scattering medium (polyvinyl chloride-plastisol (PVCP) with added Titanium dioxide (TiO_2) powder for scattering⁶) such that the first step is located approximately 1 mm below the phantom surface. The second sample, B2 420 (Figure 7(b)), was made using 120 μm -thick Fisher Scientific borosilicate microscope cover slips. The glass was covered by commercial green 430 (on the left) and black 440 (on the right) paints with no paint applied to the center part 450 to form a three-strip pattern. Six additional microscope cover slips were put on the painted slip to simulate 2 absorbers with different absorbing coefficients 720 μm below the surface. To show the application of the Thermophotonic Radar imaging in the dental field, the third sample, B3 460, was chosen to be an extracted human tooth that was locally demineralized using the artificial caries acidic gel within two square shape treatment windows 470, as shown in figure 7(c). The left and right windows were treated / demineralized for 10 and 20 days, respectively.

Figure 8 shows the results obtained from a comparison study on the depth resolution capabilities of thermophotonic lock-in and thermophotonic radar imaging involving sample B1 (FIG. 7(a)). Figures 8(a) and 8(d) show the thermophotonic lock-in phase image obtained at 0.01 Hz and its mean horizontal phase profile, respectively. It can be seen that due to the very large thermal diffusion length at such low modulation frequency it is impossible to resolve the 200- μm -high steps from each

other and as a result the phase image appears as a gradient of colors between the two color bar extremes.

Figure 8(b) shows the thermophotonic lock-in phase image obtained at 1 Hz. The bar plot of figure 8(e) depicts the mean phase values on each step along with their standard deviations. The error bars indicate that statistically only the first two steps can be resolved. Figures 8(a) and (b) clearly show the maximum detection depth/depth resolution trade-off of thermophotonic lock-in imaging.

Figure 8(c) is a CC amplitude image obtained from 0.01-1Hz chirps with duration of 6s (using the exact same experimental conditions as those used for Figures 8(a) and 8(b)) and figure 8(f) depicts the mean CC values on each step. It can be seen that the thermophotonic radar imaging not only resolves the steps but also detects them all. These advantages are due to the fact that the matched filtering/cross correlation process puts most energy of the signal under its main narrow peak, improving depth resolution and greatly enhancing the signal to noise ratio, which equals the time (chirp duration) – bandwidth (chirp frequency content) product, thereby improving maximum detection depth.

Figure 9 depicts the results involving sample B2 (FIG. 7(b)) to compare the three contrast parameters that can be used in thermophotonic radar imaging. Figures 9(a), 9(b), and 9(c) are the images obtained using cross correlation amplitude, peak delay time, and phase, respectively, and figures 9(d), 9(e), and 9(f) show their horizontal mean profiles. It can be seen that the amplitude channel is truly reflecting the amount of energy absorption by the two equally deep absorbers (green and black paints), yielding significantly different CC amplitude values from them. Consequently, the amplitude channel is not a true measure of the depth of the absorber while the CC peak delay time and phase values are truly linked to the depth

of the absorbers as they maintain the same value over the two absorbers regardless of their absorption coefficient (similar to thermophotonic lock-in phase channel). However, in terms of SNR the CC amplitude channel is significantly stronger than peak delay time and phase channels and therefore it may be beneficial to use the amplitude images to complement the information obtained from the phase and peak delay time images.

Figures 10(a)-(c) show the CC amplitude, peak delay time, and phase images obtained from sample B3. In general, tooth demineralization results in more porosity and leads to more light absorption and scattering that consequently increases the amplitude of thermal-waves and shifts the thermophotonic centroid of Eq. 5b (i.e. phase shift) compared to healthy spots. As a result, the artificially created caries is clearly detectable in all CC images (FIGs 10(a)-(c)). However, due to the emissivity-normalized nature of peak delay time and phase channels, more details can be resolved in figures 10(b) and (c) compared to figure 10(a). The higher contrast of the right treatment window indicates a greater mineral loss due to the additional treatment days. On the other hand, thermophotonic lock-in phase images suffer from low depth resolution at 0.01Hz (FIG 10(d)): they cannot probe deep enough at 1Hz (FIG 10(e) and cannot show the additional mineral loss in the right treatment window). Figure 10(f) depicts the transverse micro radiography mineral profiles along points 1-3 depicted in figure 10(c) and are provided as proof of mineral loss within the treatment windows.

Additional applications to engineered automotive and aerospace materials are in detecting metal hardness case depth and case depth non-uniformities using a thermophotonic radar image of the cross-correlation peak delay times which correspond to case hardness depth¹².

Example 2b: Non-destructive testing of engineering materials with subsurface absorbers and early detection of dental caries using binary phase code Imaging

Table 1 (shown above) includes the binary phase codes up to 16 bits. These codes are used as an envelope of a single-frequency modulated signal to yield the reference signal for binary phase code imaging.

Samples B1 and B3 (Figure 7(a) and (c)) were used to study the capabilities of binary phase code imaging. Figure 11 shows the results obtained from sample B1 using a 7-bit binary phase coding on a 1Hz carrier signal (Figures 11 (a) and (c)) as well as those of thermophotonic lock-in imaging at 1Hz (Figures 11 (b) and (d)). It can be seen that due to the advantages of matched filtering/cross-correlation the binary phase code image resolves all the steps while the thermophotonic lock-in image can statistically detect only the first two steps. That is, binary phase code imaging has a significantly better depth resolution compared to thermophotonic lock-in imaging.

Figure 12 shows a similar comparison but on an extracted tooth sample (sample B3, figure 7(c)). While the thermophotonic lock-in amplitude image appears too blurry and the thermophotonic lock-in phase image shows only traces of mineral loss within the treatment windows, the emissivity normalized binary phase code peak delay time and phase images not only detect the regions of mineral loss but also show the additional mineral loss of the right window compared to that of the left window.

Figure 13 depicts a well-known limitation and challenge of diffusion fields: resolving stacked overlapping defects. Figure 13(a) shows an exploded view of a cross-shaped sample made of two strip absorbers. The deeper strip is a black plastic

sample completely absorbing the optical flux, while the shallower strip is a partially absorbing phantom. All other components are transparent polyvinyl chloride-plastisol.

When viewed from the top, the cross sample covers all possible combinations: absorbers at two different depths (the end sections of the absorbing strips, points 1 and 2 in Fig 13(b)) and two absorbers on top of each other (point 3 in Fig 13(b)). Figures 13(b) and 13(c) show the thermophotonic lock-in amplitude and phase images of this sample, respectively. It can be observed that the amplitude image cannot distinguish between the deeper and shallower absorbers (vertical and horizontal strip, respectively). However, the amplitude information can be used to extract and process only those pixels having a high value (i.e. a subsurface absorber). Although the thermophotonic lock-in phase image yields significantly different values over the single absorbers (points 1 and 2) it cannot detect the layered structure of point 3. The axial resolution of both amplitude and phase images is limited by the depth-integrated nature of thermal waves.

Figures 13 (d) and (e) are the binary phase code peak delay time images using the temporal data of points 1 and 2 as the matched filter, respectively. When using the temporal camera data of point 1 as the matched filter, all the diffusion waves originating at the same depth as that of point 1 will have their CC peaks located at $\tau = 0$ (correlogramic image).

A similar situation arises in figure 13(e) for diffusion waves from the shallower absorber using the temporal camera data of point 2 as the matched filter. The fact that the layered structure of point 3 shows a maximum correlation to both data of points 1 and 2 ($\tau_p = 0$) shows that matched-filter binary phase code imaging can resolve the layered structure axially.

This depth resolved phenomenon is normally a property of propagating

hyperbolic wave-fields and not of parabolic (diffusive) fields. The implications of correlographic imaging can open a new field of generating layer-by-layer subsurface thermal coherence tomography (TCT) using naturally incoherent diffusion waves.

Accordingly, according to some embodiments, correlographic imaging may be employed to produce images at constant delay times. Since each delay time corresponds to a given depth, by making the images at different delay times one can make slice by slice images. The example shown in Figure 13 provides experimental demonstration that this method provides depth selective (depth slice) images. Although such images may also be produced using chirped waveforms, binary phase coded waveforms generally provide superior axial resolution.

An illustration of the capabilities of this correlographic binary phase code imaging modality applied to turbid media thermophotonics (biological tissue) is its ability to detect early caries in human teeth which conventional clinical diagnostic modalities, like radiographs, cannot detect. Early caries remove mineral from areas very close to the enamel surface and create micro-pores which trap light photons and eventually promote close-to-surface light absorption/thermal-wave generation. As a result, thermal-waves from early caries travel less distance to reach the interrogated surface and yield higher amplitude and smaller phase lag/delay compared to those of intact regions.

However, an important shortcoming of dental thermophotonic lock-in imaging is its inability to detect interproximal (in between teeth) caries when inspected from the accessible buccal (front) surface. A comparison of thermophotonic lock-in and binary phase code phase images of figure 14(b) and 14(c) under identical experimental conditions, shows how the enhanced axial resolution of the binary phase code imaging can resolve deep interproximal caries. Moreover, by constructing

images (such as amplitude or phase images) at given delay times one can perform depth-selective slicing (thermal coherence tomography) in the turbid medium to resolve the defective regions, figure 14(e), from the intact areas, figure 14(f).

Figure 15(a) shows the optical image of the interrogated surface of a goat bone along with its cross section. The optical image shows that the spongy trabecular bone is covered by the more dense cortical bone on the surface. Figure 15(b) is the phase image obtained using the binary phase code technique. The low carrier frequency of 1 Hz ensures penetration of thermal-waves into the trabecular structure, while the depth-resolved nature of phase modulated matched filtering reveals the trabecular structure that lies right below the cortical overlayer.

Figure 15 demonstrates that the depth-selective thermophotonic radar imaging methods disclosed herein are potentially suitable for the imaging of bone structure. Such imaging can be employed to support the identification of bone osteoporosis, and in particular, early bone osteoporosis. Indeed, the present example imaging methods could be employed for screening of osteoporosis. For example, the measured image may be processed according to known image processing techniques to identify abnormal bone condition, such as, by generating, based on the image, a measure of bone health, and comparing the measure to thresholds, normal ranges, or other calibration parameters. It is noted that at present, direct expenditures for treatment of osteoporotic fracture in the U.S. are estimated at \$10 – \$15 billion annually, and that no imaging methodology currently exists for the early diagnosis of osteoporosis.

Additional applications to engineered automotive and aerospace materials are in detecting metal hardness case depth and case depth non-uniformities using a binary phase code image of the cross-correlation peak delay times which correspond to case hardness depth¹².

The specific embodiments described above have been shown by way of example, and it should be understood that these embodiments may be susceptible to various modifications and alternative forms. It should be further understood that the claims are not intended to be limited to the particular forms disclosed, but rather to cover all modifications, equivalents, and alternatives falling within the spirit and scope of this disclosure.

REFERENCES

1. B. T. Amaechi, S. M. Higham, and W. M. Edgar, "Factors affecting the development of carious lesions in bovine teeth *in vitro*," *Archs. Oral Biol.* **43**, 619–628 (1998).
2. Y. Iijima, O. Takagi, H. Duschner, J. Ruben, and J. Arends, "Influence of nail varnish on the remineralization of enamel single sections assessed by microradiography and confocal laser scanning microscopy," *Caries Res.* **32**, 393–400 (1998).
3. R. J. Jeon, A. Mandelis, V. Sanchez, and S. H. Abrams "Nonintrusive, noncontacting frequency-domain photothermal radiometry and luminescence depth profilometry of carious and artificial subsurface lesions in human teeth," *J. Biomed. Opt.* **9**(4), 804–819 (2004).
- 4a. A. Mandelis, "Frequency Modulated (FM) Time Delay Photoacoustic and Photothermal Wave Spectroscopies. Technique, Instrumentation and Detection. Part I: Theoretical", *Rev. Sci. Instr.* **57** (4), 617 - 621, April, 1986.
- 4b. A. Mandelis, L.M.L. Borm and J. Tiessinga, "Frequency Modulated (FM) Time Delay Photoacoustic and Photothermal Wave Spectroscopies. Technique, Instrumentation and Detection. Part II: Mirage Effect Spectrometer Design and Performance", *Rev. Sci. Instr.* **57** (4), 622 - 629, April, 1986.
- 4c. A. Mandelis, L.M.L. Borm and J. Tiessinga, "Frequency Modulated (FM) Time Delay Photoacoustic and Photothermal Wave Spectroscopies. Technique, Instrumentation and Detection. Part III: Mirage Effect Spectrometer, Dynamic Range and Comparison to Pseudo Random Binary Sequence (PRBS) Method", *Rev. Sci. Instr.* **57** (4), 630 - 635, April, 1986.

5. R. Mulaveesala, J. S. Vaddi, and P. Singh, "Pulse compression approach to infrared non-destructive characterization", *Rev. Sci. Instrum.* **79**, 094901 (2008).
6. N. Tabatabaei and A. Mandelis, "Thermal-Wave Radar: A novel subsurface imaging modality with extended depth-resolution dynamic range" *Rev. Sci. Instrum.* **80**, 034902 (2009).
7. G. M. Spirou, A. A. Oraevsky, A. I. Vitkin, W. M. Whelan, *Phys. Med. Biol.* **50**, N141 (2005).
8. W. Warta, and M. Langenkamp, *Lock-in Thermography: Basics and use for evaluation electronic devices and materials* by O. Breitenstein, , page 31, second edition, Springer.
9. X. Maldague and S. Marinetti, *J. Appl. Phys.* **79**, 2694 (1996).
10. Rohling H., Plagge W., "Mismatched-filter design for periodical binary phased signals", *IEEE Transactions on Aerospace and electric systems*, V25, N6, Nov 1989.
11. A. Mandelis, "Principles and Perspectives on Photothermal and Photoacoustic Phenomena", Elsevier, New York (1992), ISBN 0 444 01641 4; A. Mandelis, "Non-Destructive Evaluation", PTR Prentice Hall, Englewood Cliffs, N.J., (1993), ISBN 0-13-147430-8; Vol. III: "*Life and Earth Sciences*", A. Mandelis and P. Hess, Eds., SPIE Publishing Optical Engineering Press, Bellingham, WA. February 1997, ISBN 0-8194-2450-1.
12. X. Guo, K. Sivagurunathan, J. Garcia, A. Mandelis, S. Giunta, and S. Milletari, "Laser photothermal radiometric instrumentation for fast in-line measurements of industrial steel hardness inspection and quality control", *Appl. Opt.* **48** No. 7, C11 – C23, 1 March 2009.

THEREFORE WHAT IS CLAIMED IS:

1. A method of performing thermophotonic imaging, said method comprising the steps of:

providing a sample;

providing an optical source having a wavelength selected to generate photothermal radiation within said sample;

providing an imaging camera with an optical bandwidth selected for detection of said photothermal radiation;

generating a reference waveform comprising a plurality of modulation cycles;

producing a modulated optical beam by modulating an intensity of an optical beam emitted by said optical source according to said reference waveform;

illuminating said sample with said modulated optical beam;

imaging said photothermal radiation with said imaging camera;

recording a plurality of dynamically averaged image frames at time offsets corresponding to different values of said reference waveform; and

processing said dynamically averaged image frames and said reference waveform to obtain an image relating to said photothermal radiation.

2. The method according to claim 1 wherein said dynamically averaged image frames are obtained according to the following steps:

recording a plurality of image frames at times corresponding to different values of said reference waveform;

repeating, one or more times, said step of recording said image frames at times corresponding to different values of said reference waveform, and dynamically

averaging said recorded image frames for each said different value of said reference waveform, thereby obtaining dynamically averaged image frames.

3. The method according to claim 2 wherein said step of recording said plurality of image frames at different values of said reference waveform comprises recording said plurality of image frames over a single modulation cycle/correlation period.

4. The method according to claim 2 wherein said plurality of image frames at different values of said reference waveform are obtained over more than one modulation cycle.

5. The method according to claim 4 wherein a frame acquisition rate of said imaging camera is less than a modulation frequency of said reference waveform.

6. The method according to claim 2 or 3 further comprising the step of recording, for each image frame of said plurality of image frames, a substantially instantaneous value of said reference waveform.

7. The method according to claim 6 further comprising the step of generating a quadrature waveform based on said reference waveform, and recording, for each image frame of said plurality of image frames, a substantially instantaneous value of said quadrature waveform.

8. The method according to any one of claims 1 to 7 further comprising the step of generating an integration pulse train comprising a series of pulses, wherein each

pulse is generated at a time at which an image frame is acquired by said imaging camera, wherein said step of generating of said reference waveform is triggered according to said integration pulse train.

9. The method according to claim 8 wherein said integration pulse train is generated by said imaging camera.

10. The method according to any one of claims 1 to 9 further comprising the step of generating a flag pulse train comprising a series of pulses, wherein each pulse is generated at a commencement of a given modulation cycle/correlation period, and identifying one or both of a beginning and an end of said given modulation cycle/correlation period according to said flag pulse train.

11. The method according to any one of claims 1 to 10 wherein a modulation frequency of said reference waveform is greater than approximately 0.01 Hz.

12. The method according to any one of claims 1 to 11 wherein said reference waveform comprises a single frequency and wherein said image is obtained by lock-in processing.

13. The method according to claim 12 wherein said step of processing said dynamically averaged image frames and said reference waveform comprises, for each pixel in said image, performing the steps of:

multiplying said dynamically averaged image frames by said reference waveform to obtain in-phase product values; and

summing said in-phase product values to obtain an in-phase sum;
generating a quadrature waveform based on said reference waveform;
multiplying said dynamically averaged image frames by said quadrature
waveform to obtain phase-shifted product values; and
summing said phase-shifted product values to obtain a phase-shifted sum.

14. The method according to claim 13 wherein said image is an amplitude image, and wherein said processing further comprises calculating a magnitude of a complex quantity based on said in-phase sum and said phase-shifted sum.

15. The method according to claim 13 wherein said image is a phase image, and wherein said processing further comprises:

calculating a phase angle of a complex quantity based on said in-phase sum and said phase-shifted sum.

16. The method according to any one of claims 1 to 11 wherein said reference waveform comprises multiple frequency components.

17. The method according to claim 16 wherein said reference waveform comprises a frequency chirp.

18. The method according to claim 16 wherein said reference waveform is a binary phase coded waveform.

19. The method according to any one of claims 16 to 18 wherein said image is a cross-correlation peak amplitude image obtained by the steps of:

obtaining a complex cross-correlation signal of said reference waveform and each pixel of said dynamically averaged image frames; and

determining, for each said pixel, a peak amplitude value of a peak in a real part of said cross-correlation signal.

20. The method according to any one of claims 16 to 18 wherein said image is a cross-correlation peak delay image obtained by the steps of:

obtaining a complex cross-correlation signal of said reference waveform and each pixel of said dynamically averaged image frames; and

determining, for each said pixel, a delay of a peak in a real part of said complex cross-correlation signal.

21. The method according to any one of claims 16 to 18 wherein said image is a cross-correlation phase image obtained by the steps of:

obtaining a first complex cross-correlation signal of said reference waveform and each pixel of said dynamically averaged image frames;

obtaining a second complex cross-correlation signal of a quadrature waveform and each pixel of said dynamically averaged image frames, wherein said quadrature waveform is based on said reference waveform;

forming a complex quantity comprising a real portion of first complex cross-correlation signal and a real portion of said second complex cross-correlation signal; and

obtaining said phase image by determining, for each pixel, a phase angle of said complex quantity at a pre-selected time delay.

22. The method according to any one of claims 1 to 21 wherein said sample is selected from the group consisting of automotive components, aerospace components, an optical material, a laser material, a biomedical material, and a biological tissue.

23. The method according to any one of claims 1 to 22 wherein said sample is a material comprising one or more of a subsurface crack and a delamination.

24. The method according to any one of claims 1 to 21 wherein said sample is an unsintered component in a green state.

25. The method according to any one of claims 1 to 24 further comprising the step of determining a case hardness depth.

26. The method according to any one of claims 1 to 21 wherein said sample is a dental sample, the method including the step of displaying the image.

27. The method according to any one of claims 1 to 21 wherein said sample is a dental or medical instrument.

28. The method according to any one of claims 1 to 21 wherein said sample includes bone, wherein the step of imaging the photothermal radiation with the imaging camera includes imaging photothermal radiation generated within the bone.

29. The method according to claim 28 wherein the bone is covered with tissue, and wherein the optical source is configured for transmitting at least a portion of the incident optical beam through the tissue for the generation of the photothermal radiation within the bone.

30. The method according to claim 28 or 29 further wherein a modulation frequency of the modulated optical beam is selected to support penetration of the photothermal radiation within a trabecular structure of the bone.

31. The method according to any one of claims 28 to 30 further including the step of identifying an onset or presence of osteoporosis in the bone based on the image.

32. The method according to claim 26 further wherein said dental sample is a tooth sample or whole groups of teeth.

33. The method according to claim 26 wherein the dental sample is a tooth, the method further comprising the step of analyzing said image to determine one or more of a presence and a location of demineralization, erosion or dental caries in said tooth.

34. The method according to claim 26 further comprising the step of monitoring an evolution of one or more of demineralization, erosion and dental caries by comparing said image to one or more other images.

35. The method according to claim 26 wherein the image is a first image, the method further comprising the step of obtaining additional image of the dental sample after a time delay, and comparing the first image to the additional image for monitoring changes in the dental sample.

36. The method according to claim 26 wherein the image is a first image, the method further comprising the step of applying a treatment or therapy to said dental sample, obtaining additional image, and comparing the first image to the additional image to assess an efficacy of the treatment or therapy.

37. The method according to claim 26 wherein the dental sample is a tooth surface that is prepared for placement of a direct or indirect restoration, the method including the step of confirming, based on the image, suitability of the tooth surface for placement of the restoration.

38. The method according to claim 26 wherein the dental sample includes a tooth having a dental material placed directly thereon, wherein the image includes a region around an edge of the dental material for detecting or monitoring a defect around the edge of the material.

39. The method according to claim 38 wherein the dental material is a dental sealant.

40. The method according to claim 26 wherein the dental sample includes a tooth having a dental prosthetic, wherein the image includes the dental prosthetic for detecting or monitoring a defect associated with the dental prosthetic.

41. The method according to claim 26 wherein the dental sample includes a tooth having a dental restoration attached thereto, wherein the image includes the dental restoration for detecting or monitoring the attachment of the dental restoration.
42. The method according to claim 26 wherein the dental sample includes a dental implant, wherein the image includes the dental implant for detecting or monitoring the integrity of the dental implant.
43. The method according to claim 26 wherein the image includes at least one of the pulp chamber and root canal system of the dental sample.
44. The method according to claim 26 wherein the image includes the anatomical structure of root apices or the neurovascular bundle.
45. The method according to any one of claims 1 to 44 further comprising the step of identifying a defect region in the image.
46. The method according to claim 45 further comprising the step of displaying the defect region in a colour associated with the defect region.
47. The method according to claim 46 wherein the colour is associated with a relative size of the defect region.

48. The method according to claim 27 wherein said dental or medical instrument is selected from the group consisting of endodontic instruments, catheters and other indwelling instruments.
49. The method according to any one of claims 1 to 47 wherein said wavelength is selected to lie within a range of approximately 600 nm to 2000 nm.
50. The method according to any one of claims 1 to 47 wherein said imaging camera is selected to have a spectral response overlapping with at least a portion of the mid-infrared spectrum.
51. A system for performing thermophotonic imaging, said system comprising:
- an optical source having a wavelength selected to generate photothermal radiation within a sample;
 - an imaging camera with an optical bandwidth selected for detection of said photothermal radiation, wherein said imaging camera is configured to acquire image frames a given frame rate and output an integration pulse train comprising a series of pulses, each pulse corresponding to a time at which an image frame is acquired by said imaging camera;
 - a waveform generating system for generating a reference waveform, wherein an output of said waveform generating system is connected to an input of said optical source for modulating an intensity of an optical beam emitted by said optical source;
 - a processor programmed to dynamically average image frames obtained by said imaging camera, and to process said dynamically averaged image frames, said

reference waveform and a quadrature waveform based on said reference waveform, to provide one or more of an amplitude image and a phase image; and

a memory for storing dynamically averaged image frames.

52. The system according to claim 51 wherein a modulation frequency of said reference waveform is greater than approximately 0.01 Hz.

53. The system according to claim 51 wherein said imaging camera comprises a frame acquisition rate that is less than a modulation frequency of said reference waveform.

54. The system according to any one of claims 51 to 53 wherein said wavelength lies within approximately 600 nm to 2000 nm.

55. The system according to any one of claims 51 to 54 wherein a spectral response of said imaging camera overlaps at least a portion of the mid-infrared spectrum.

56. A method of performing thermophotonic imaging, said method comprising the steps of:

providing a sample;

providing an optical source having a wavelength selected to generate photothermal radiation within said sample;

providing an imaging camera with an optical bandwidth selected for detection of said photothermal radiation;

generating a reference waveform comprising a binary phase coded waveform having a plurality of modulation cycles;

producing a modulated optical beam by modulating an intensity of an optical beam emitted by said optical source according to said reference waveform;

illuminating said sample with said modulated optical beam;

imaging said photothermal radiation with said imaging camera;

recording a plurality of dynamically averaged image frames at time offsets corresponding to different values of said reference waveform; and

processing said dynamically averaged image frames and said reference waveform to obtain an image relating to said photothermal radiation.

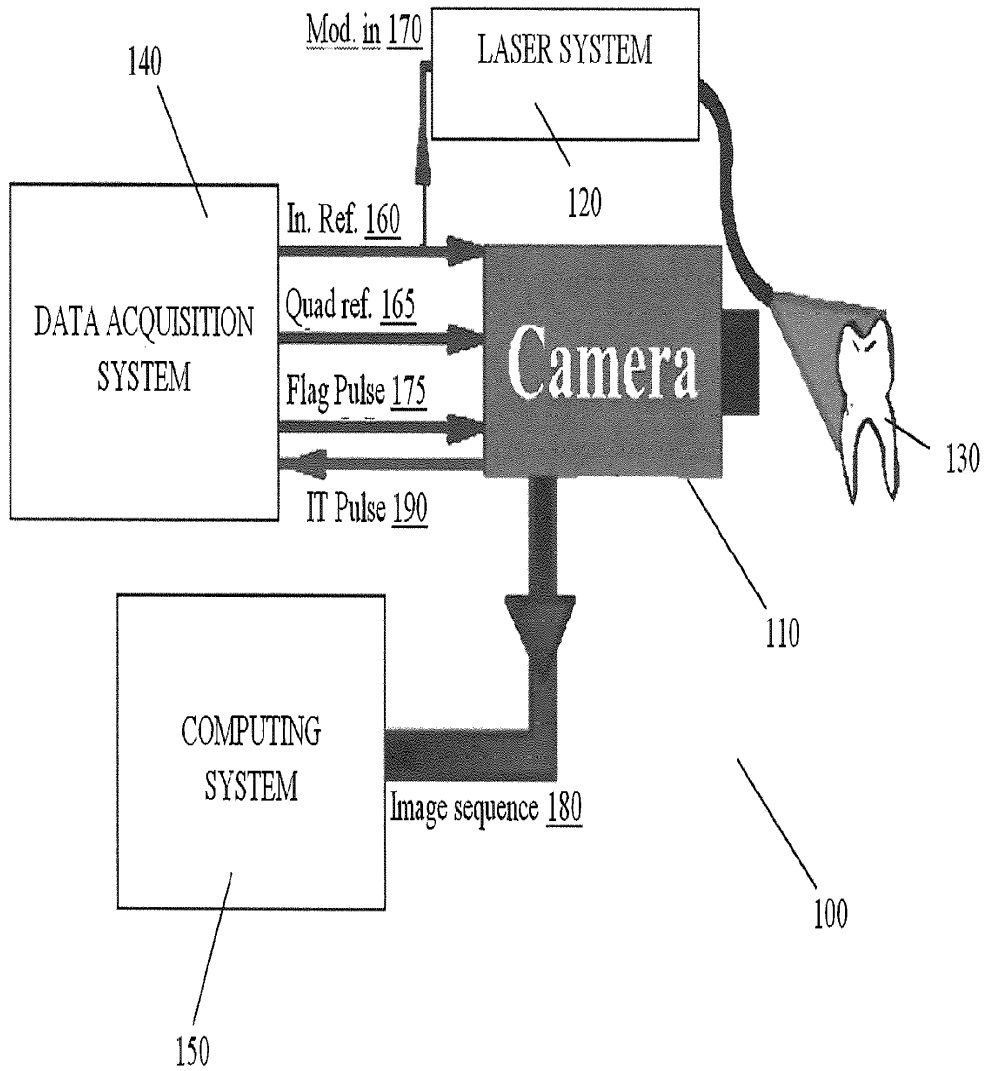

Figure 1

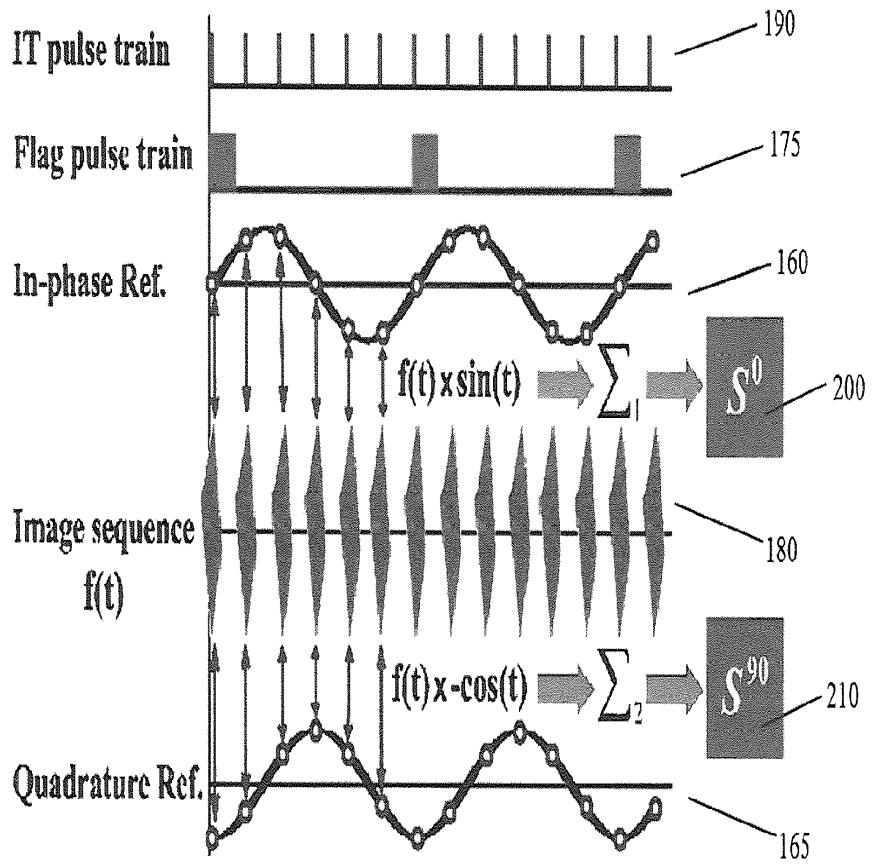

Figure 2

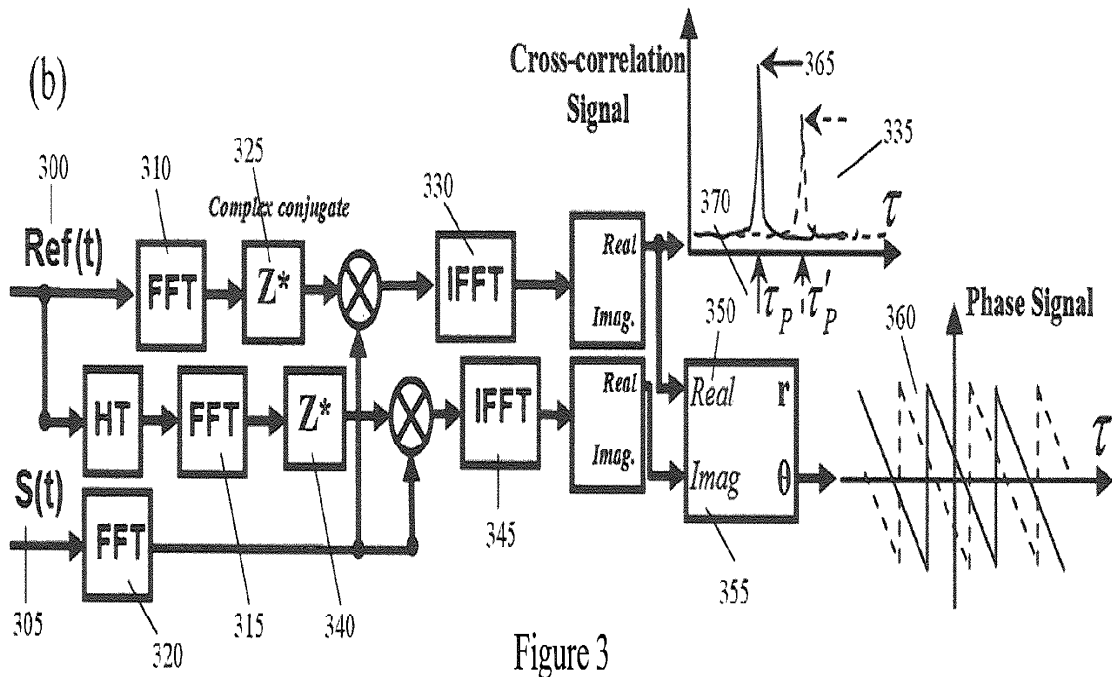
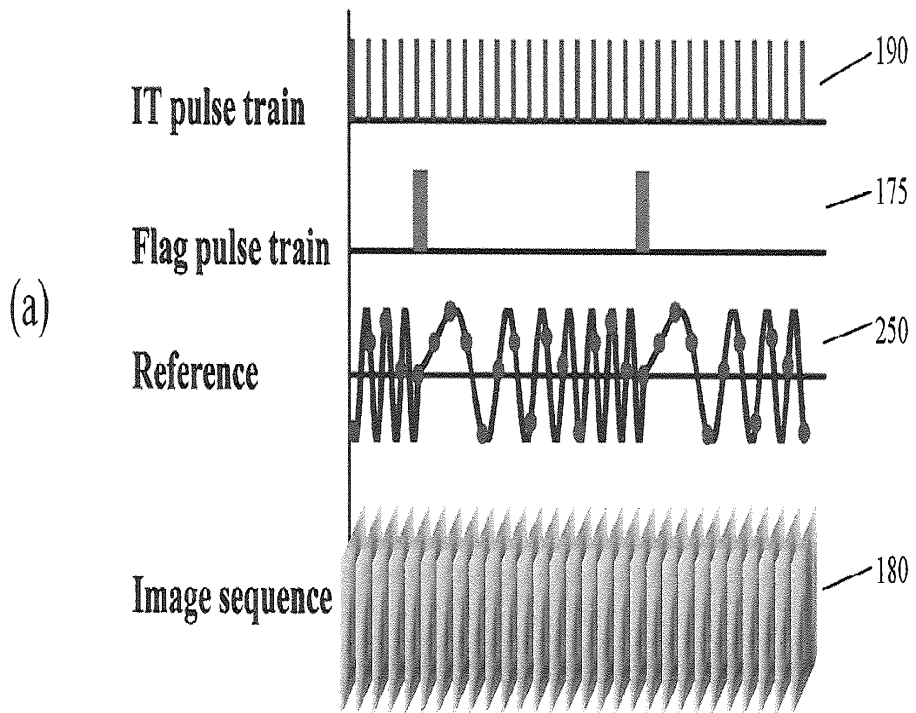

Figure 3

4/14

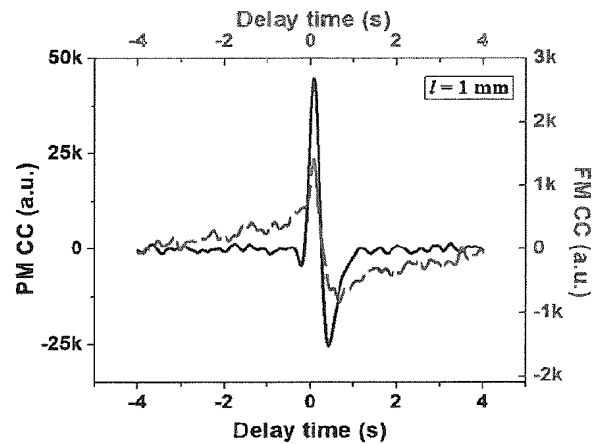
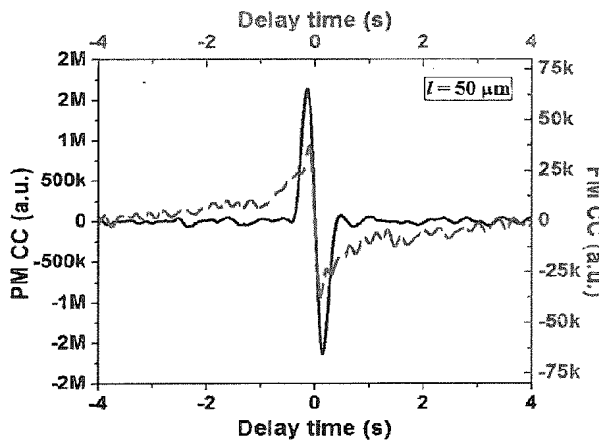
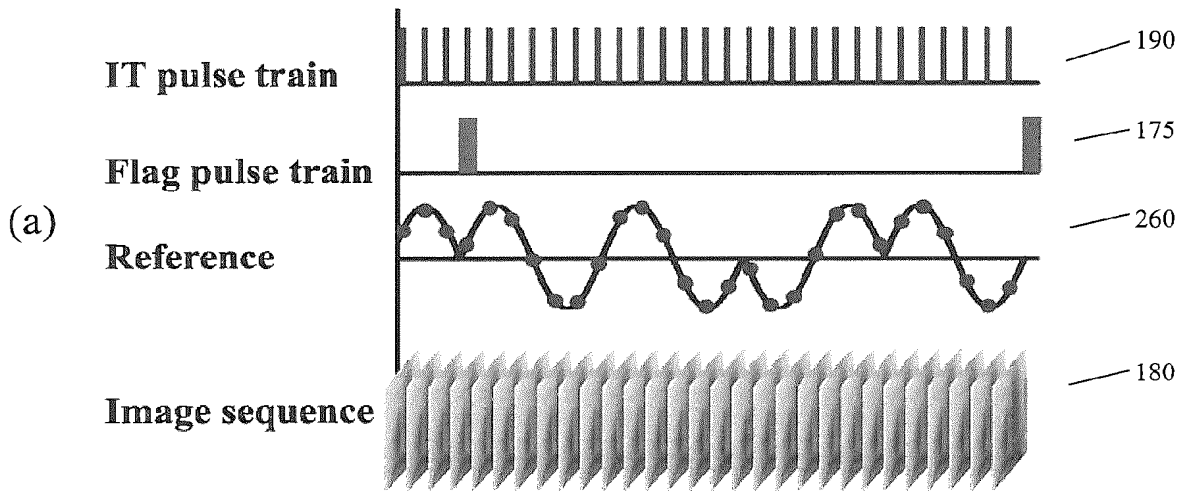

Figure 4

5/14

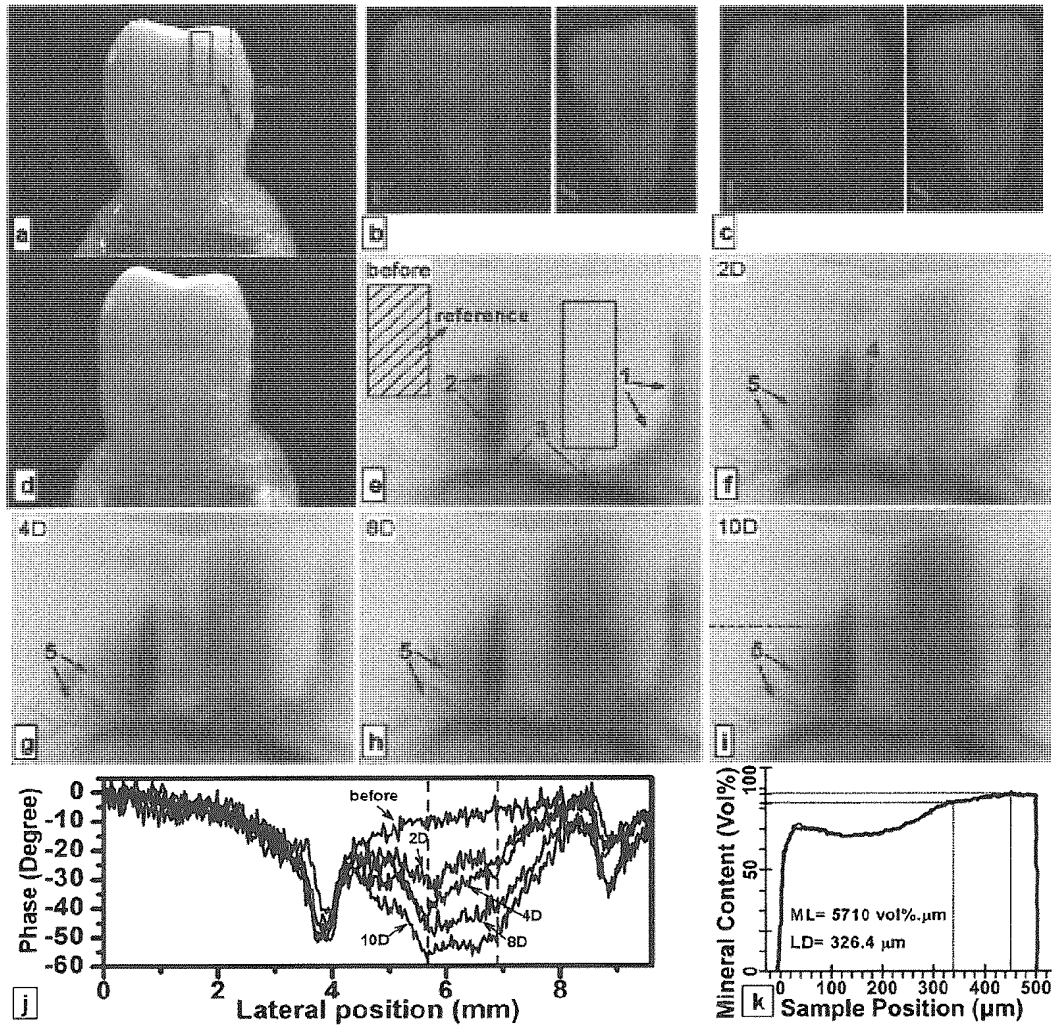

Figure 5

6/14

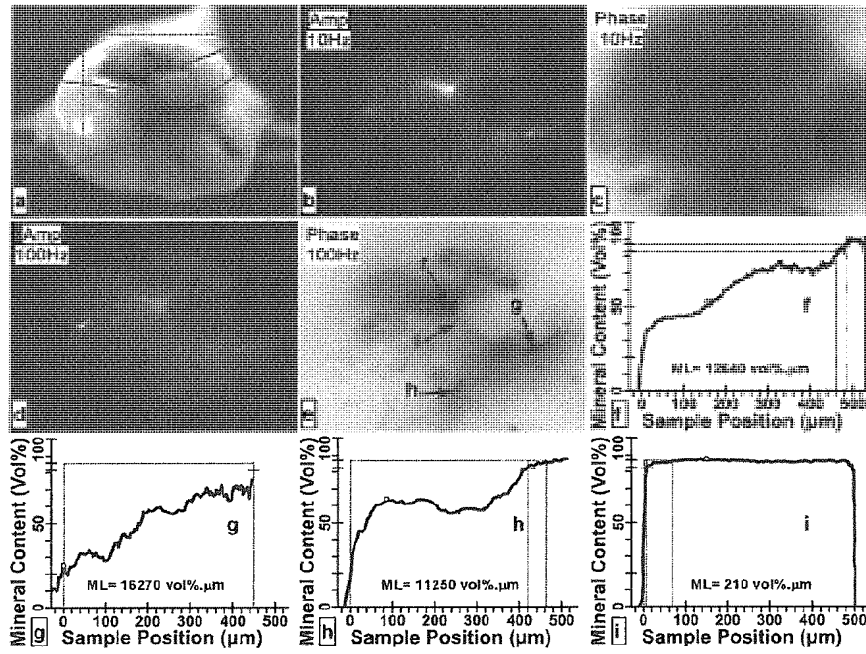

Figure 6

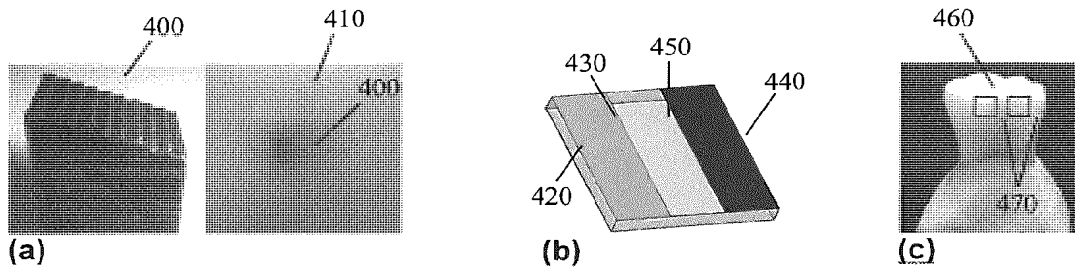

Figure 7

7/14

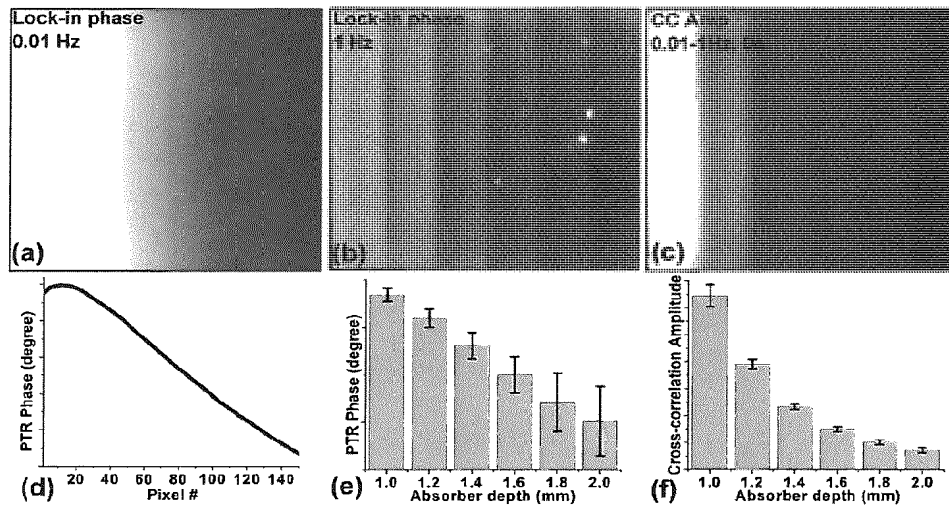

Figure 8

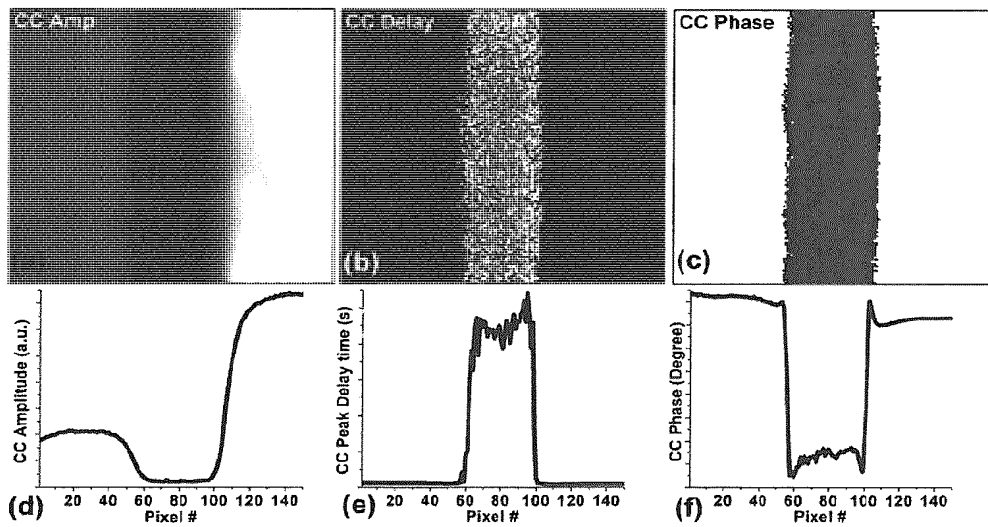

Figure 9

8/14

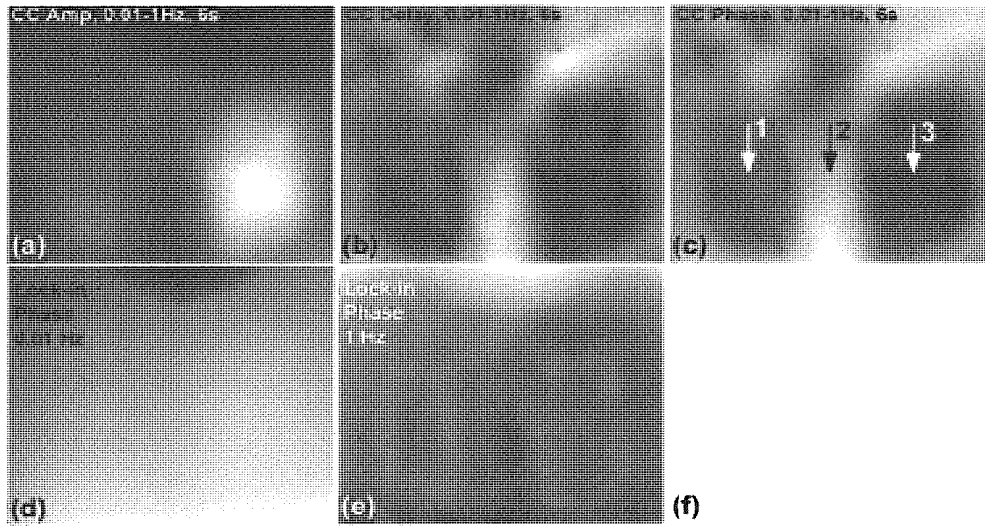

Figure 10

9/14

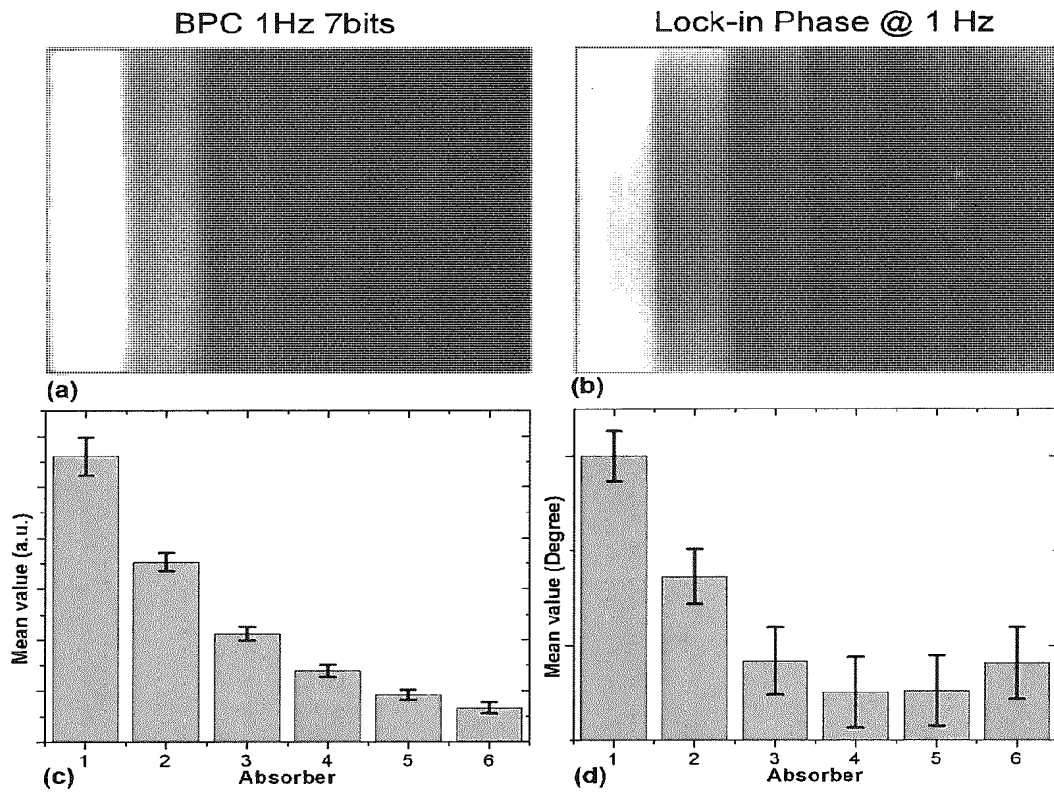

Figure 11

10/14

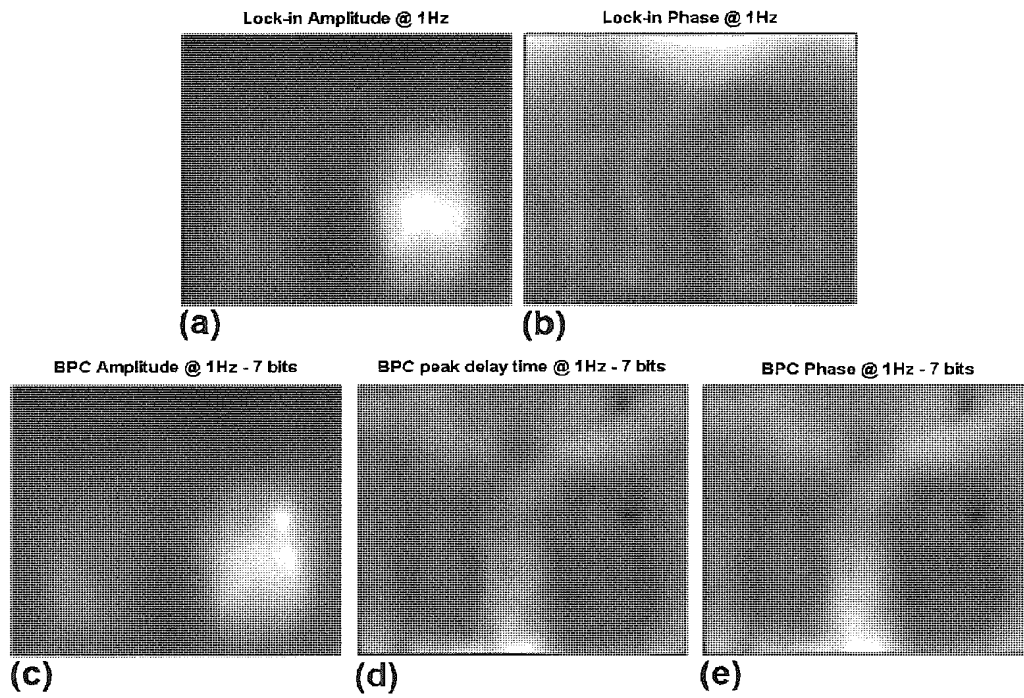

Figure 12

11/14

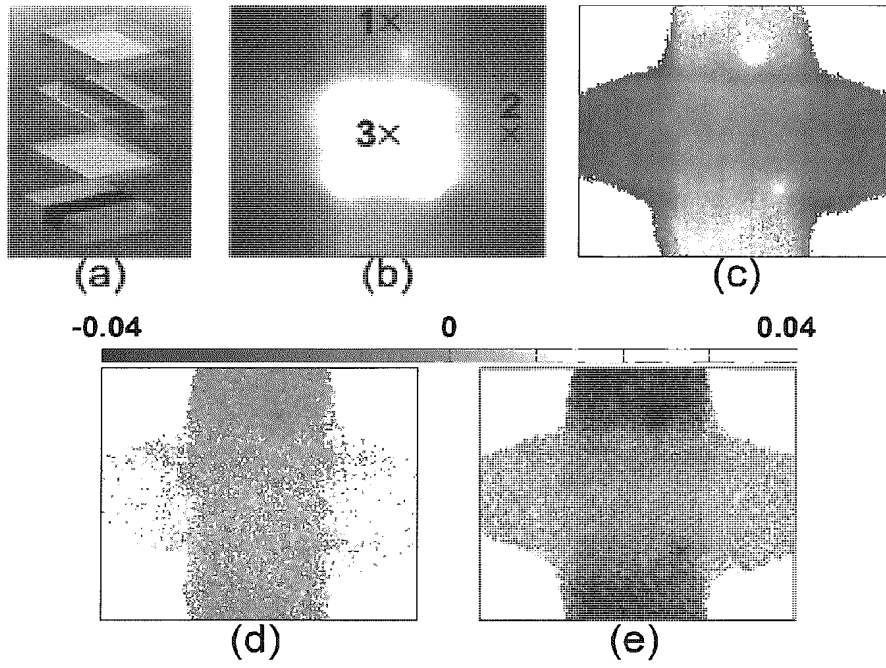

Figure 13

12/14

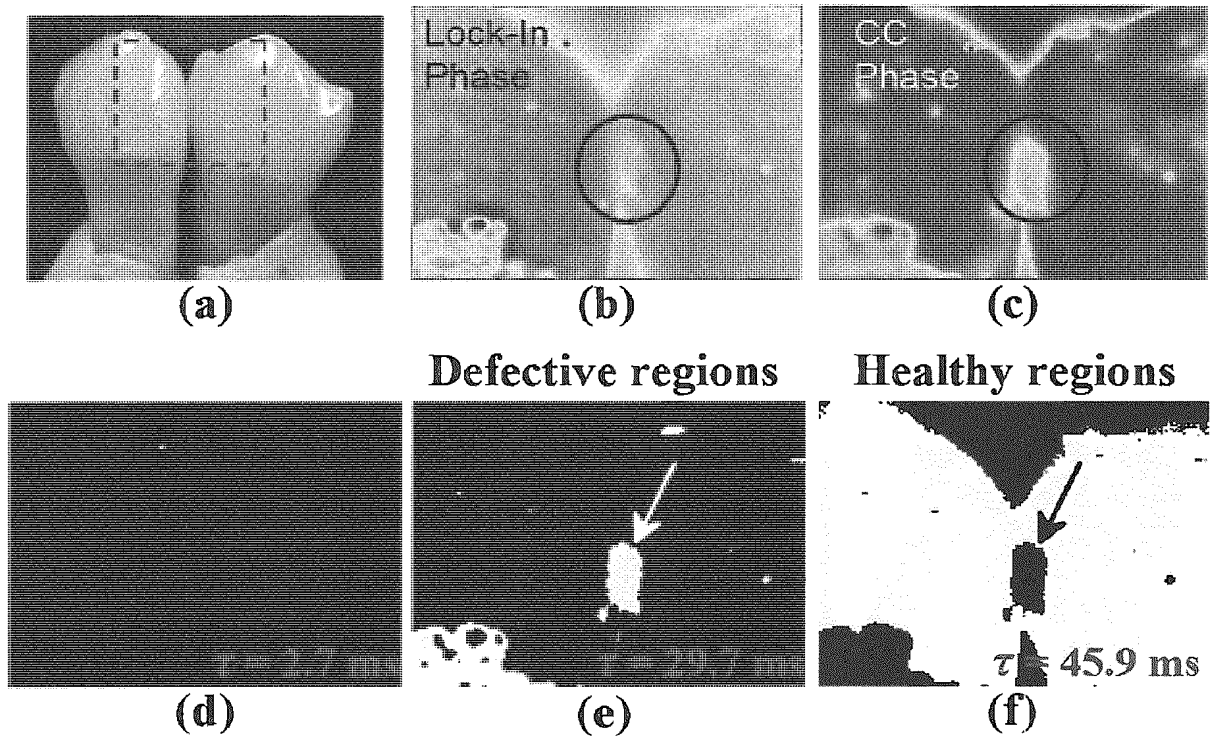
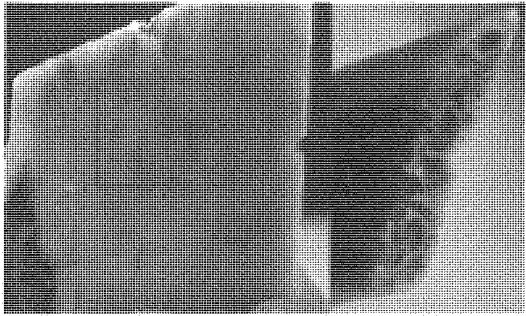
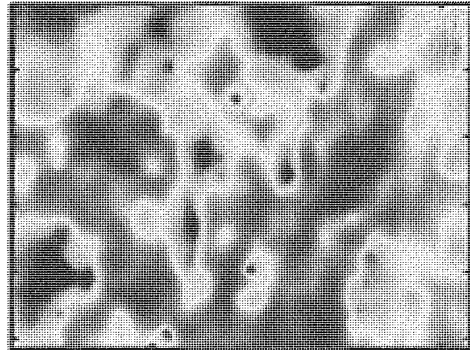

Figure 14

13/14



(a)



(b)

Figure 15

14/14

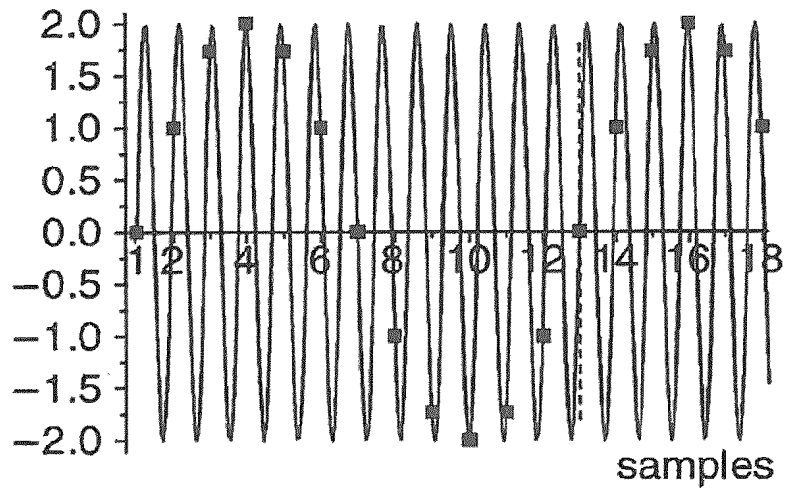

Figure 16

INTERNATIONAL SEARCH REPORT

International application No.
PCT/CA2012/050035

<p>A. CLASSIFICATION OF SUBJECT MATTER IPC: G01N 21/63 (2006.01) , A61B 6/14 (2006.01) , H04N 5/33 (2006.01) According to International Patent Classification (IPC) or to both national classification and IPC</p>		
<p>B. FIELDS SEARCHED</p>		
<p>Minimum documentation searched (classification system followed by classification symbols) IPC: G01N 21/63 (2006.01) , A61B 6/14 (2006.01) , H04N 5/33 (2006.01) (in combination with keywords)</p>		
<p>Documentation searched other than minimum documentation to the extent that such documents are included in the fields searched</p>		
<p>Electronic database(s) consulted during the international search (name of database(s) and, where practicable, search terms used) Total Patent (keywords thermophotonic, thermographic, imaging, reference, waveform, dynamic averaging)</p>		
<p>C. DOCUMENTS CONSIDERED TO BE RELEVANT</p>		
Category*	Citation of document, with indication, where appropriate, of the relevant passages	Relevant to claim No.
A	WO2010065052A1, Herman et al. 10 June 2010 (10-06-2010) (See whole document)	1-35, 37-56
A	EP1258136A2, Shepard et al. 20 November 2002 (20-11-2002) (See whole document)	1-35, 37-56
A	US7551769B2, Enachescu et al. 23 June 2009 (23-06-2009) (See whole document)	1-35, 37-56
A	WO2009123799A1, Ringermacher et al. 08 October 2009 (08-10-2009) (See whole document)	1-35, 37-56
A	WO2011137264A1, Walther et al. 03 November 2011 (03-11-2011) (See whole document)	1-35, 37-56
<p><input type="checkbox"/> Further documents are listed in the continuation of Box C. <input checked="" type="checkbox"/> See patent family annex.</p>		
*	Special categories of cited documents :	"T" later document published after the international filing date or priority date and not in conflict with the application but cited to understand the principle or theory underlying the invention
"A"	document defining the general state of the art which is not considered to be of particular relevance	"X" document of particular relevance, the claimed invention cannot be considered novel or cannot be considered to involve an inventive step when the document is taken alone
"E"	earlier application or patent but published on or after the international filing date	"Y" document of particular relevance, the claimed invention cannot be considered to involve an inventive step when the document is combined with one or more other such documents, such combination being obvious to a person skilled in the art
"L"	document which may throw doubts on priority claim(s) or which is cited to establish the publication date of another citation or other special reason (as specified)	"&" document member of the same patent family
"O"	document referring to an oral disclosure, use, exhibition or other means	
"P"	document published prior to the international filing date but later than the priority date claimed	
<p>Date of the actual completion of the international search 13 June 2012 (13-06-2012)</p>		<p>Date of mailing of the international search report 14 June 2012 (14-06-2012)</p>
<p>Name and mailing address of the ISA/CA Canadian Intellectual Property Office Place du Portage I, C114 - 1st Floor, Box PCT 50 Victoria Street Gatineau, Quebec K1A 0C9 Facsimile No.: 001-819-953-2476</p>		<p>Authorized officer David E. Green (819) 994-8213</p>

INTERNATIONAL SEARCH REPORTInternational application No.
PCT/CA2012/050035**Box No. II Observations where certain claims were found unsearchable (Continuation of item 2 of the first sheet)**

This international search report has not been established in respect of certain claims under Article 17(2)(a) for the following reasons :

1. Claim Nos. : 36
because they relate to subject matter not required to be searched by this Authority, namely :

Claim 36 relates to a method of medical treatment
2. Claim Nos. :
because they relate to parts of the international application that do not comply with the prescribed requirements to such an extent that no meaningful international search can be carried out, specifically :
3. Claim Nos. :
because they are dependent claims and are not drafted in accordance with the second and third sentences of Rule 6.4(a).

Box No. III Observations where unity of invention is lacking (Continuation of item 3 of first sheet)

This International Searching Authority found multiple inventions in this international application, as follows :

1. As all required additional search fees were timely paid by the applicant, this international search report covers all searchable claims.
2. As all searchable claims could be searched without effort justifying additional fees, this Authority did not invite payment of additional fees.
3. As only some of the required additional search fees were timely paid by the applicant, this international search report covers only those claims for which fees were paid, specifically claim Nos. :
4. No required additional search fees were timely paid by the applicant. Consequently, this international search report is restricted to the invention first mentioned in the claims; it is covered by claim Nos. :

- Remark on Protest** The additional search fees were accompanied by the applicant's protest and, where applicable, the payment of a protest fee.
- The additional search fees were accompanied by the applicant's protest but the applicable protest fee was not paid within the time limit specified in the invitation.
- No protest accompanied the payment of additional search fees.

INTERNATIONAL SEARCH REPORT
Information on patent family members

International application No.
PCT/CA2012/050035

Patent Document Cited in Search Report	Publication Date	Patent Family Member(s)	Publication Date
WO2010065052A1	10 June 2010 (10-06-2010)	US2011230942A1	22 September 2011 (22-09-2011)
EP1258136A2	20 November 2002 (20-11-2002)	AT423966T AU1813201A DE60041661D1 EP1258136A4 EP1258136B1 EP1258136B8 JP2004530309A JP4467862B2 US2002044679A1 US6516084B2 US2002172410A1 US6751342B2 US2005008215A1 US7724925B2 WO0141421A2 WO0141421A3 WO02089042A1	15 March 2009 (15-03-2009) 12 June 2001 (12-06-2001) 09 April 2009 (09-04-2009) 20 September 2006 (20-09-2006) 25 February 2009 (25-02-2009) 22 April 2009 (22-04-2009) 30 September 2004 (30-09-2004) 26 May 2010 (26-05-2010) 18 April 2002 (18-04-2002) 04 February 2003 (04-02-2003) 21 November 2002 (21-11-2002) 15 June 2004 (15-06-2004) 13 January 2005 (13-01-2005) 25 May 2010 (25-05-2010) 07 June 2001 (07-06-2001) 06 December 2001 (06-12-2001) 07 November 2002 (07-11-2002)
US7551769B2	23 June 2009 (23-06-2009)	CN1620603A CN100480693C JP2006505764A JP2009008687A US2003137318A1 US6840666B2 US2003222220A1 US7149343B2 US2007036420A1 WO03062809A1	25 May 2005 (25-05-2005) 22 April 2009 (22-04-2009) 16 February 2006 (16-02-2006) 15 January 2009 (15-01-2009) 24 July 2003 (24-07-2003) 11 January 2005 (11-01-2005) 04 December 2003 (04-12-2003) 12 December 2006 (12-12-2006) 15 February 2007 (15-02-2007) 31 July 2003 (31-07-2003)
WO2009123799A1	08 October 2009 (08-10-2009)	CA2718762A1 DE112009000634T5 GB201016950D0 GB2471047A GB2471047B JP2011516837A US2009245321A1	08 October 2009 (08-10-2009) 10 February 2011 (10-02-2011) 24 November 2010 (24-11-2010) 15 December 2010 (15-12-2010) 30 May 2012 (30-05-2012) 26 May 2011 (26-05-2011) 01 October 2009 (01-10-2009)
WO2011137264A1	03 November 2011 (03-11-2011)	None	

PART B - FEE(S) TRANSMITTAL

**Complete and send this form, together with applicable fee(s), to: Mail Mail Stop ISSUE FEE
 Commissioner for Patents
 P.O. Box 1450
 Alexandria, Virginia 22313-1450
 or Fax (571)-273-2885**

INSTRUCTIONS: This form should be used for transmitting the ISSUE FEE and PUBLICATION FEE (if required). Blocks 1 through 5 should be completed where appropriate. All further correspondence including the Patent, advance orders and notification of maintenance fees will be mailed to the current correspondence address as indicated unless corrected below or directed otherwise in Block 1, by (a) specifying a new correspondence address; and/or (b) indicating a separate "FEE ADDRESS" for maintenance fee notifications.

CURRENT CORRESPONDENCE ADDRESS (Note: Use Block 1 for any change of address)

Note: A certificate of mailing can only be used for domestic mailings of the Fee(s) Transmittal. This certificate cannot be used for any other accompanying papers. Each additional paper, such as an assignment or formal drawing, must have its own certificate of mailing or transmission.

109543 7590 01/10/2017
Brooks, Kushman P.C./Cheetah Omni MedSci
 1000 Town Center
 Twenty Second Floor
 Southfield, MI 48075

Certificate of Mailing or Transmission

I hereby certify that this Fee(s) Transmittal is being deposited with the United States Postal Service with sufficient postage for first class mail in an envelope addressed to the Mail Stop ISSUE FEE address above, or being facsimile transmitted to the USPTO (571) 273-2885, on the date indicated below.

(Depositor's name)
(Signature)
(Date)

APPLICATION NO.	FILING DATE	FIRST NAMED INVENTOR	ATTORNEY DOCKET NO.	CONFIRMATION NO.
14/875,709	10/06/2015	Mohammed N. Islam	OMNI 0105 PUSP1	7496

TITLE OF INVENTION: SHORT-WAVE INFRARED SUPER-CONTINUUM LASERS FOR DETECTING COUNTERFEIT OR ILLICIT DRUGS AND PHARMACEUTICAL PROCESS CONTROL

APPLN. TYPE	ENTITY STATUS	ISSUE FEE DUE	PUBLICATION FEE DUE	PREV. PAID ISSUE FEE	TOTAL FEE(S) DUE	DATE DUE
nonprovisional	SMALL	\$480	\$0	\$0	\$480	04/10/2017

EXAMINER	ART UNIT	CLASS-SUBCLASS
FEIN, ABRA S	2884	250-338400

<p>1. Change of correspondence address or indication of "Fee Address" (37 CFR 1.363).</p> <p><input type="checkbox"/> Change of correspondence address (or Change of Correspondence Address form PTO/SB/122) attached.</p> <p><input type="checkbox"/> "Fee Address" indication (or "Fee Address" Indication form PTO/SB/47; Rev 03-02 or more recent) attached. Use of a Customer Number is required.</p>	<p>2. For printing on the patent front page, list</p> <p>(1) The names of up to 3 registered patent attorneys or agents OR, alternatively,</p> <p>(2) The name of a single firm (having as a member a registered attorney or agent) and the names of up to 2 registered patent attorneys or agents. If no name is listed, no name will be printed.</p> <p>1 <u>Brooks Kushman P.C.</u></p> <p>2 _____</p> <p>3 _____</p>
---	--

3. ASSIGNEE NAME AND RESIDENCE DATA TO BE PRINTED ON THE PATENT (print or type)

PLEASE NOTE: Unless an assignee is identified below, no assignee data will appear on the patent. If an assignee is identified below, the document has been filed for recordation as set forth in 37 CFR 3.11. Completion of this form is NOT a substitute for filing an assignment.

(A) NAME OF ASSIGNEE: **Omni Medsci, Inc.**

(B) RESIDENCE: (CITY and STATE OR COUNTRY) **Ann Arbor, MI**

Please check the appropriate assignee category or categories (will not be printed on the patent) : Individual Corporation or other private group entity Government

<p>4a. The following fee(s) are submitted:</p> <p><input checked="" type="checkbox"/> Issue Fee</p> <p><input type="checkbox"/> Publication Fee (No small entity discount permitted)</p> <p><input type="checkbox"/> Advance Order - # of Copies _____</p>	<p>4b. Payment of Fee(s): (Please first reapply any previously paid issue fee shown above)</p> <p><input type="checkbox"/> A check is enclosed.</p> <p><input type="checkbox"/> Payment by credit card. Form PTO-2038 is attached.</p> <p><input checked="" type="checkbox"/> The director is hereby authorized to charge the required fee(s), any deficiency, or credits any overpayment, to Deposit Account Number <u>02-3978</u> (enclose an extra copy of this form).</p>
--	---

5. Change in Entity Status (from status indicated above)

Applicant certifying micro entity status. See 37 CFR 1.29

Applicant asserting small entity status. See 37 CFR 1.27

Applicant changing to regular undiscounted fee status.

NOTE: Absent a valid certification of Micro Entity Status (see forms PTO/SB/15A and 15B), issue fee payment in the micro entity amount will not be accepted at the risk of application abandonment.

NOTE: If the application was previously under micro entity status, checking this box will be taken to be a notification of loss of entitlement to micro entity status.

NOTE: Checking this box will be taken to be a notification of loss of entitlement to small or micro entity status, as applicable.

NOTE: This form must be signed in accordance with 37 CFR 1.31 and 1.33. See 37 CFR 1.4 for signature requirements and certifications.

Authorized Signature /David S. Bir/ Date April 7, 2017

Typed or printed name David S. Bir Registration No. 38,383

Electronic Patent Application Fee Transmittal

Application Number:	14875709
Filing Date:	06-Oct-2015
Title of Invention:	SHORT-WAVE INFRARED SUPER-CONTINUUM LASERS FOR DETECTING COUNTERFEIT OR ILLICIT DRUGS AND PHARMACEUTICAL PROCESS CONTROL
First Named Inventor/Applicant Name:	Mohammed N. Islam
Filer:	David S. Bir/Pamela Demos
Attorney Docket Number:	OMNI 0105 PUSP1

Filed as Small Entity

Filing Fees for Utility under 35 USC 111(a)

Description	Fee Code	Quantity	Amount	Sub-Total in USD(\$)
Basic Filing:				
Pages:				
Claims:				
Miscellaneous-Filing:				
Petition:				
Patent-Appeals-and-Interference:				
Post-Allowance-and-Post-Issuance:				
UTILITY APPL ISSUE FEE	2501	1	480	480

Description	Fee Code	Quantity	Amount	Sub-Total in USD(\$)
Extension-of-Time:				
Miscellaneous:				
Total in USD (\$)				480

Electronic Acknowledgement Receipt

EFS ID:	28859984
Application Number:	14875709
International Application Number:	
Confirmation Number:	7496
Title of Invention:	SHORT-WAVE INFRARED SUPER-CONTINUUM LASERS FOR DETECTING COUNTERFEIT OR ILLICIT DRUGS AND PHARMACEUTICAL PROCESS CONTROL
First Named Inventor/Applicant Name:	Mohammed N. Islam
Customer Number:	109543
Filer:	David S. Bir
Filer Authorized By:	
Attorney Docket Number:	OMNI 0105 PUSP1
Receipt Date:	09-APR-2017
Filing Date:	06-OCT-2015
Time Stamp:	23:02:19
Application Type:	Utility under 35 USC 111(a)

Payment information:

Submitted with Payment	yes
Payment Type	DA
Payment was successfully received in RAM	\$480
RAM confirmation Number	041017INTEFSW00007492023978
Deposit Account	023978
Authorized User	David Bir

The Director of the USPTO is hereby authorized to charge indicated fees and credit any overpayment as follows:

37 CFR 1.16 (National application filing, search, and examination fees)

37 CFR 1.17 (Patent application and reexamination processing fees)

--	--	--	--	--	--

File Listing:

Document Number	Document Description	File Name	File Size(Bytes)/ Message Digest	Multi Part /.zip	Pages (if appl.)
1	Issue Fee Payment (PTO-85B)	Issue_Fee_Transmittal.pdf	369406	no	1
			eac9d4486d55698cd5725a9ce3f3f68f455b039b		

Warnings:

Information:

2	Fee Worksheet (SB06)	fee-info.pdf	30586	no	2
			7e9c1fc0da45399d5cf60bf132021e838871a880		

Warnings:

Information:

Total Files Size (in bytes):	399992
-------------------------------------	--------

This Acknowledgement Receipt evidences receipt on the noted date by the USPTO of the indicated documents, characterized by the applicant, and including page counts, where applicable. It serves as evidence of receipt similar to a Post Card, as described in MPEP 503.

New Applications Under 35 U.S.C. 111

If a new application is being filed and the application includes the necessary components for a filing date (see 37 CFR 1.53(b)-(d) and MPEP 506), a Filing Receipt (37 CFR 1.54) will be issued in due course and the date shown on this Acknowledgement Receipt will establish the filing date of the application.

National Stage of an International Application under 35 U.S.C. 371

If a timely submission to enter the national stage of an international application is compliant with the conditions of 35 U.S.C. 371 and other applicable requirements a Form PCT/DO/EO/903 indicating acceptance of the application as a national stage submission under 35 U.S.C. 371 will be issued in addition to the Filing Receipt, in due course.

New International Application Filed with the USPTO as a Receiving Office

If a new international application is being filed and the international application includes the necessary components for an international filing date (see PCT Article 11 and MPEP 1810), a Notification of the International Application Number and of the International Filing Date (Form PCT/RO/105) will be issued in due course, subject to prescriptions concerning national security, and the date shown on this Acknowledgement Receipt will establish the international filing date of the application.

Doc code: IDS
 Doc description: Information Disclosure Statement (IDS) Filed

PTO/SB/08a (01-10)
 Approved for use through 07/31/2012. OMB 0651-0031
 U.S. Patent and Trademark Office; U.S. DEPARTMENT OF COMMERCE
 Under the Paperwork Reduction Act of 1995, no persons are required to respond to a collection of information unless it contains a valid OMB control number.

INFORMATION DISCLOSURE STATEMENT BY APPLICANT (Not for submission under 37 CFR 1.99)	Application Number	14875709
	Filing Date	2015-10-06
	First Named Inventor	Mohammed N. ISLAM
	Art Unit	2884
	Examiner Name	Abra S. Fein
	Attorney Docket Number	OMNI 0105 PUSP1

U.S.PATENTS							Remove
Examiner Initial*	Cite No	Patent Number	Kind Code ¹	Issue Date	Name of Patentee or Applicant of cited Document	Pages,Columns,Lines where Relevant Passages or Relevant Figures Appear	
	1						

If you wish to add additional U.S. Patent citation information please click the Add button.

Add

U.S.PATENT APPLICATION PUBLICATIONS							Remove
Examiner Initial*	Cite No	Publication Number	Kind Code ¹	Publication Date	Name of Patentee or Applicant of cited Document	Pages,Columns,Lines where Relevant Passages or Relevant Figures Appear	
	1	20060058683	A1	2006-03-16	Chance		
	2	20160327476	A1	2016-11-10	ISLAM		

If you wish to add additional U.S. Published Application citation information please click the Add button.

Add

FOREIGN PATENT DOCUMENTS								Remove
Examiner Initial*	Cite No	Foreign Document Number ³	Country Code ²	Kind Code ⁴	Publication Date	Name of Patentee or Applicant of cited Document	Pages,Columns,Lines where Relevant Passages or Relevant Figures Appear	T ⁵
	1	101849821	CN	B	2013-07-04	Univ Huazhong Science Tech	See EP Search Report cited below	
	2	2012135952	WO	A1	2012-10-11	The Governing Council Of The University Of Toronto	See EP Search Report cited below	

**INFORMATION DISCLOSURE
STATEMENT BY APPLICANT**
(Not for submission under 37 CFR 1.99)

Application Number	14875709	
Filing Date	2015-10-06	
First Named Inventor	Mohammed N. ISLAM	
Art Unit	2884	
Examiner Name	Abra S. Fein	
Attorney Docket Number	OMNI 0105 PUSP1	

If you wish to add additional Foreign Patent Document citation information please click the Add button

NON-PATENT LITERATURE DOCUMENTS

Examiner Initials*	Cite No	Include name of the author (in CAPITAL LETTERS), title of the article (when appropriate), title of the item (book, magazine, journal, serial, symposium, catalog, etc), date, pages(s), volume-issue number(s), publisher, city and/or country where published.	T ⁵
	1	Extended European Search Report for European Application No. 17156625.0 dated March 20, 2017	

If you wish to add additional non-patent literature document citation information please click the Add button

EXAMINER SIGNATURE

Examiner Signature	/ABRA S FEIN/	Date Considered	04/14/2017
--------------------	---------------	-----------------	------------

*EXAMINER: Initial if reference considered, whether or not citation is in conformance with MPEP 609. Draw line through a citation if not in conformance and not considered. Include copy of this form with next communication to applicant.

¹ See Kind Codes of USPTO Patent Documents at www.USPTO.GOV or MPEP 901.04. ² Enter office that issued the document, by the two-letter code (WIPO Standard ST.3). ³ For Japanese patent documents, the indication of the year of the reign of the Emperor must precede the serial number of the patent document. ⁴ Kind of document by the appropriate symbols as indicated on the document under WIPO Standard ST.16 if possible. ⁵ Applicant is to place a check mark here if English language translation is attached.

**INFORMATION DISCLOSURE
STATEMENT BY APPLICANT**
(Not for submission under 37 CFR 1.99)

Application Number		14875709	
Filing Date		2015-10-06	
First Named Inventor	Mohammed N. ISLAM		
Art Unit	2884		
Examiner Name	Abra S. Fein		
Attorney Docket Number	OMNI 0105 PUSP1		

CERTIFICATION STATEMENT

Please see 37 CFR 1.97 and 1.98 to make the appropriate selection(s):

That each item of information contained in the information disclosure statement was first cited in any communication from a foreign patent office in a counterpart foreign application not more than three months prior to the filing of the information disclosure statement. See 37 CFR 1.97(e)(1).

OR

That no item of information contained in the information disclosure statement was cited in a communication from a foreign patent office in a counterpart foreign application, and, to the knowledge of the person signing the certification after making reasonable inquiry, no item of information contained in the information disclosure statement was known to any individual designated in 37 CFR 1.56(c) more than three months prior to the filing of the information disclosure statement. See 37 CFR 1.97(e)(2).

See attached certification statement.

The fee set forth in 37 CFR 1.17 (p) has been submitted herewith.

A certification statement is not submitted herewith.

SIGNATURE

A signature of the applicant or representative is required in accordance with CFR 1.33, 10.18. Please see CFR 1.4(d) for the form of the signature.

Signature	/David S. Bir/	Date (YYYY-MM-DD)	2017-03-28
Name/Print	David S. Bir	Registration Number	38383

This collection of information is required by 37 CFR 1.97 and 1.98. The information is required to obtain or retain a benefit by the public which is to file (and by the USPTO to process) an application. Confidentiality is governed by 35 U.S.C. 122 and 37 CFR 1.14. This collection is estimated to take 1 hour to complete, including gathering, preparing and submitting the completed application form to the USPTO. Time will vary depending upon the individual case. Any comments on the amount of time you require to complete this form and/or suggestions for reducing this burden, should be sent to the Chief Information Officer, U.S. Patent and Trademark Office, U.S. Department of Commerce, P.O. Box 1450, Alexandria, VA 22313-1450. **DO NOT SEND FEES OR COMPLETED FORMS TO THIS ADDRESS. SEND TO: Commissioner for Patents, P.O. Box 1450, Alexandria, VA 22313-1450.**

Privacy Act Statement

The Privacy Act of 1974 (P.L. 93-579) requires that you be given certain information in connection with your submission of the attached form related to a patent application or patent. Accordingly, pursuant to the requirements of the Act, please be advised that: (1) the general authority for the collection of this information is 35 U.S.C. 2(b)(2); (2) furnishing of the information solicited is voluntary; and (3) the principal purpose for which the information is used by the U.S. Patent and Trademark Office is to process and/or examine your submission related to a patent application or patent. If you do not furnish the requested information, the U.S. Patent and Trademark Office may not be able to process and/or examine your submission, which may result in termination of proceedings or abandonment of the application or expiration of the patent.

The information provided by you in this form will be subject to the following routine uses:

1. The information on this form will be treated confidentially to the extent allowed under the Freedom of Information Act (5 U.S.C. 552) and the Privacy Act (5 U.S.C. 552a). Records from this system of records may be disclosed to the Department of Justice to determine whether the Freedom of Information Act requires disclosure of these records.
2. A record from this system of records may be disclosed, as a routine use, in the course of presenting evidence to a court, magistrate, or administrative tribunal, including disclosures to opposing counsel in the course of settlement negotiations.
3. A record in this system of records may be disclosed, as a routine use, to a Member of Congress submitting a request involving an individual, to whom the record pertains, when the individual has requested assistance from the Member with respect to the subject matter of the record.
4. A record in this system of records may be disclosed, as a routine use, to a contractor of the Agency having need for the information in order to perform a contract. Recipients of information shall be required to comply with the requirements of the Privacy Act of 1974, as amended, pursuant to 5 U.S.C. 552a(m).
5. A record related to an International Application filed under the Patent Cooperation Treaty in this system of records may be disclosed, as a routine use, to the International Bureau of the World Intellectual Property Organization, pursuant to the Patent Cooperation Treaty.
6. A record in this system of records may be disclosed, as a routine use, to another federal agency for purposes of National Security review (35 U.S.C. 181) and for review pursuant to the Atomic Energy Act (42 U.S.C. 218(c)).
7. A record from this system of records may be disclosed, as a routine use, to the Administrator, General Services, or his/her designee, during an inspection of records conducted by GSA as part of that agency's responsibility to recommend improvements in records management practices and programs, under authority of 44 U.S.C. 2904 and 2906. Such disclosure shall be made in accordance with the GSA regulations governing inspection of records for this purpose, and any other relevant (i.e., GSA or Commerce) directive. Such disclosure shall not be used to make determinations about individuals.
8. A record from this system of records may be disclosed, as a routine use, to the public after either publication of the application pursuant to 35 U.S.C. 122(b) or issuance of a patent pursuant to 35 U.S.C. 151. Further, a record may be disclosed, subject to the limitations of 37 CFR 1.14, as a routine use, to the public if the record was filed in an application which became abandoned or in which the proceedings were terminated and which application is referenced by either a published application, an application open to public inspections or an issued patent.
9. A record from this system of records may be disclosed, as a routine use, to a Federal, State, or local law enforcement agency, if the USPTO becomes aware of a violation or potential violation of law or regulation.

Receipt date: 10/06/2015

14875709 - GAI: 2884

Doc code: IDS

Pat. Sec. 101-10

Doc description: Information Disclosure Statement (IDS) Filed

Approved for use through 07/31/2012. OMB 0651-0031

U.S. Patent and Trademark Office; U.S. DEPARTMENT OF COMMERCE

Under the Paperwork Reduction Act of 1995, no persons are required to respond to a collection of information unless it contains a valid OMB control number.

INFORMATION DISCLOSURE STATEMENT BY APPLICANT (Not for submission under 37 CFR 1.99)	Application Number		
	Filing Date		
	First Named Inventor	Mohammed N. ISLAM	
	Art Unit		
	Examiner Name		
	Attorney Docket Number	OMNI 0105 PUSP1	

U.S.PATENTS						Remove
Examiner Initial*	Cite No	Patent Number	Kind Code ¹	Issue Date	Name of Patentee or Applicant of cited Document	Pages,Columns,Lines where Relevant Passages or Relevant Figures Appear
	1	5747806		1998-05-05	Khalil	
	2	6115673		2000-09-05	Malin	
	3	6512936	B1	2003-01-28	MONFRE	
Change(s) applied to document, /S.D./ 1/24/2017	4	6534012 6,543,012	B1	2003-04-01	VISWANATHAN	
	5	6640117		2003-10-28	Makarewicz	
	6	6788965	B2	2004-09-07	RUCHTI	
	7	6816241		2004-11-09	Grubisic	
	8	6738652	B2	2004-05-18	MATTU	

INFORMATION DISCLOSURE STATEMENT BY APPLICANT (Not for submission under 37 CFR 1.99)	Application Number		14875709 - GAU: 2884	
	Filing Date			
	First Named Inventor	Mohammed N. ISLAM		
	Art Unit			
	Examiner Name			
	Attorney Docket Number		OMNI 0105 PUSP1	

Examiner Initial*	Cite No	Foreign Document Number ³	Country Code ² ;	Kind Code ⁴	Publication Date	Name of Patentee or Applicant of cited Document	Pages, Columns, Lines where Relevant Passages or Relevant Figures Appear	T ⁵
	1	EP1148666	EP		2001-10-24	Grant Andrew R et al.		<input type="checkbox"/>
Change(s) applied to document, /S.D./ 1/24/2017	2	WO01150950 WO0150959	WO		2001-07-19	SUHM		<input type="checkbox"/>
	3	WO9715240 WO9715240	WO		1997-05-01	BRANT		<input type="checkbox"/>
	4	WO97049340	WO		1997-12-31	WANG		<input type="checkbox"/>

If you wish to add additional Foreign Patent Document citation information please click the Add button **Add**

NON-PATENT LITERATURE DOCUMENTS

Remove

Examiner Initials*	Cite No	Include name of the author (in CAPITAL LETTERS), title of the article (when appropriate), title of the item (book, magazine, journal, serial, symposium, catalog, etc), date, pages(s), volume-issue number(s), publisher, city and/or country where published.	T ⁵
	1		<input type="checkbox"/>

If you wish to add additional non-patent literature document citation information please click the Add button **Add**

EXAMINER SIGNATURE

Examiner Signature	/Abra Fein/	Date Considered	05/13/2016
--------------------	-------------	-----------------	------------

*EXAMINER: Initial if reference considered, whether or not citation is in conformance with MPEP 609. Draw line through a citation if not in conformance and not considered. Include copy of this form with next communication to applicant.

¹ See Kind Codes of USPTO Patent Documents at www.USPTO.GOV or MPEP 901.04. ² Enter office that issued the document, by the two-letter code (WIPO Standard ST.3). ³ For Japanese patent documents, the indication of the year of the reign of the Emperor must precede the serial number of the patent document. ⁴ Kind of document by the appropriate symbols as indicated on the document under WIPO Standard ST.16 if possible. ⁵ Applicant is to place a check mark here if English language translation is attached.



APPLICATION NO.	ISSUE DATE	PATENT NO.	ATTORNEY DOCKET NO.	CONFIRMATION NO.
14/875,709	05/16/2017	9651533	OMNI 0105 PUSP1	7496

109543 7590 04/26/2017
 Brooks, Kushman P.C./Cheetah Omni MedSci
 1000 Town Center
 Twenty Second Floor
 Southfield, MI 48075

ISSUE NOTIFICATION

The projected patent number and issue date are specified above.

Determination of Patent Term Adjustment under 35 U.S.C. 154 (b)
 (application filed on or after May 29, 2000)

The Patent Term Adjustment is 0 day(s). Any patent to issue from the above-identified application will include an indication of the adjustment on the front page.

If a Continued Prosecution Application (CPA) was filed in the above-identified application, the filing date that determines Patent Term Adjustment is the filing date of the most recent CPA.

Applicant will be able to obtain more detailed information by accessing the Patent Application Information Retrieval (PAIR) WEB site (<http://pair.uspto.gov>).

Any questions regarding the Patent Term Extension or Adjustment determination should be directed to the Office of Patent Legal Administration at (571)-272-7702. Questions relating to issue and publication fee payments should be directed to the Application Assistance Unit (AAU) of the Office of Data Management (ODM) at (571)-272-4200.

APPLICANT(s) (Please see PAIR WEB site <http://pair.uspto.gov> for additional applicants):

Mohammed N. Islam, Ann Arbor, MI;
 OMNI MEDSCI, INC., Ann Arbor, MI;

The United States represents the largest, most dynamic marketplace in the world and is an unparalleled location for business investment, innovation, and commercialization of new technologies. The USA offers tremendous resources and advantages for those who invest and manufacture goods here. Through SelectUSA, our nation works to encourage and facilitate business investment. To learn more about why the USA is the best country in the world to develop technology, manufacture products, and grow your business, visit SelectUSA.gov.

IN THE UNITED STATES PATENT AND TRADEMARK OFFICE

In re application of:

MOHAMMED N. ISLAM

Serial No.: 14/875709

Filed: 10/6/2015

For: SHORT-WAVE INFRARED SUPER-CONTINUUM LASERS
FOR DETECTING COUNTERFEIT OR ILLICIT DRUGS AND
PHARMACEUTICAL PROCESS CONTROL

Group Art Unit: 2884

Examiner: FEIN, ABRA S.

Attorney Docket No.: OMNI 0105 PUSP1

REQUEST FOR CERTIFICATE OF CORRECTION

Attention Certificate of Correction Branch
Commissioner for Patents
U.S. Patent & Trademark Office
P.O. Box 1450
Alexandria, VA 22313-1450

Commissioner:

It is requested that a Certificate of Correction be issued for the above-identified patent under the provisions of 37 C.F.R. § 1.322. The corrections noted are as follows:

Column 30, Line 31, Claim 9:
(Page 9, Line 1, Claim 11: Amendment dated July 6, 2016):

After "The system of claim"
Delete "89" and
Insert – 8 --.

Filed herewith is the form for Certificate of Correction (PTO/SB/44). The Commissioner is hereby authorized to charge any additional fees to our Deposit Account No. 02-3978.

Respectfully submitted,

MOHAMMED N. ISLAM

By: /David S. Bir/

David S. Bir

Reg. No. 38,383

Attorney/Agent for Applicant

Date: July 10, 2017

BROOKS KUSHMAN P.C.
1000 Town Center, 22nd Floor
Southfield, MI 48075-1238
Phone: 248-358-4400
Fax: 248-358-3351

**UNITED STATES PATENT AND TRADEMARK OFFICE
CERTIFICATE OF CORRECTION**

Page 1 of 1

PATENT NO.: 9,651,533
APPLICATION NO.: 14/875,709
ISSUE DATE: May 16, 2017
INVENTOR(S): MOHAMMED N. ISLAM (et al.)

It is certified that an error appears or errors appear in the above-identified patent and that said Letters Patent is hereby corrected as shown below:

Column 30, Line 31, Claim 9:

After "The system of claim"
Delete "89" and
Insert – 8 --.

MAILING ADDRESS OF SENDER (Please do not use customer number below):

**BROOKS KUSHMAN P.C.
1000 Town Center, 22nd Floor
Southfield, MI 48075-1238**

Electronic Acknowledgement Receipt

EFS ID:	29733232
Application Number:	14875709
International Application Number:	
Confirmation Number:	7496
Title of Invention:	SHORT-WAVE INFRARED SUPER-CONTINUUM LASERS FOR DETECTING COUNTERFEIT OR ILLICIT DRUGS AND PHARMACEUTICAL PROCESS CONTROL
First Named Inventor/Applicant Name:	Mohammed N. Islam
Customer Number:	109543
Filer:	David S. Bir
Filer Authorized By:	
Attorney Docket Number:	OMNI 0105 PUSP1
Receipt Date:	11-JUL-2017
Filing Date:	06-OCT-2015
Time Stamp:	14:49:30
Application Type:	Utility under 35 USC 111(a)

Payment information:

Submitted with Payment	no
------------------------	----

File Listing:

Document Number	Document Description	File Name	File Size(Bytes)/ Message Digest	Multi Part /.zip	Pages (if appl.)
1	Request for Certificate of Correction	Request_for_Certificate_of_Correction.pdf	18156 <small>476fc9086ed5c96b4662d255de122967b7bba722</small>	no	2

Warnings:

Information:					
2	Request for Certificate of Correction	Certificate_of_Correction.pdf	17852	no	1
			4759ed4cfc0ae94754b08972511ddce66ab4387a		
Warnings:					
Information:					
Total Files Size (in bytes):				36008	
<p>This Acknowledgement Receipt evidences receipt on the noted date by the USPTO of the indicated documents, characterized by the applicant, and including page counts, where applicable. It serves as evidence of receipt similar to a Post Card, as described in MPEP 503.</p> <p><u>New Applications Under 35 U.S.C. 111</u> If a new application is being filed and the application includes the necessary components for a filing date (see 37 CFR 1.53(b)-(d) and MPEP 506), a Filing Receipt (37 CFR 1.54) will be issued in due course and the date shown on this Acknowledgement Receipt will establish the filing date of the application.</p> <p><u>National Stage of an International Application under 35 U.S.C. 371</u> If a timely submission to enter the national stage of an international application is compliant with the conditions of 35 U.S.C. 371 and other applicable requirements a Form PCT/DO/EO/903 indicating acceptance of the application as a national stage submission under 35 U.S.C. 371 will be issued in addition to the Filing Receipt, in due course.</p> <p><u>New International Application Filed with the USPTO as a Receiving Office</u> If a new international application is being filed and the international application includes the necessary components for an international filing date (see PCT Article 11 and MPEP 1810), a Notification of the International Application Number and of the International Filing Date (Form PCT/RO/105) will be issued in due course, subject to prescriptions concerning national security, and the date shown on this Acknowledgement Receipt will establish the international filing date of the application.</p>					

UNITED STATES PATENT AND TRADEMARK OFFICE
CERTIFICATE OF CORRECTION

PATENT NO. : 9,651,533 B2
APPLICATION NO. : 14/875709
DATED : May 16, 2017
INVENTOR(S) : Mohammed N. Islam et al.

Page 1 of 1

It is certified that error appears in the above-identified patent and that said Letters Patent is hereby corrected as shown below:

In the Claims

Column 30, Line 31, Claim 9:

After "The system of claim"

Delete "89" and

Insert -- 8 --.

Signed and Sealed this
Fifteenth Day of August, 2017

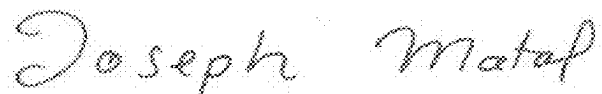

Joseph Matal
*Performing the Functions and Duties of the
Under Secretary of Commerce for Intellectual Property and
Director of the United States Patent and Trademark Office*

AO 120 (Rev. 08/10)

TO: Mail Stop 8 Director of the U.S. Patent and Trademark Office P.O. Box 1450 Alexandria, VA 22313-1450	REPORT ON THE FILING OR DETERMINATION OF AN ACTION REGARDING A PATENT OR TRADEMARK
---	---

In Compliance with 35 U.S.C. § 290 and/or 15 U.S.C. § 1116 you are hereby advised that a court action has been filed in the U.S. District Court Eastern District of Texas on the following

Trademarks or Patents. (the patent action involves 35 U.S.C. § 292.):

DOCKET NO. 2:18-cv-134	DATE FILED 4/6/2018	U.S. DISTRICT COURT Eastern District of Texas
PLAINTIFF Omni MedSci, Inc.		DEFENDANT Apple Inc.
PATENT OR TRADEMARK NO.	DATE OF PATENT OR TRADEMARK	HOLDER OF PATENT OR TRADEMARK
1 9,651,533	5/16/2017	Omni MedSci, Inc.
2 9,757,040	9/12/2017	Omni MedSci, Inc.
3 9,861,286	1/9/2018	Omni MedSci, Inc.
4 9,885,698	2/6/2018	Omni MedSci, Inc.
5		

In the above—entitled case, the following patent(s)/ trademark(s) have been included:

DATE INCLUDED	INCLUDED BY <input type="checkbox"/> Amendment <input type="checkbox"/> Answer <input type="checkbox"/> Cross Bill <input type="checkbox"/> Other Pleading	
PATENT OR TRADEMARK NO.	DATE OF PATENT OR TRADEMARK	HOLDER OF PATENT OR TRADEMARK
1		
2		
3		
4		
5		

In the above—entitled case, the following decision has been rendered or judgement issued:

DECISION/JUDGEMENT

CLERK	(BY) DEPUTY CLERK	DATE
-------	-------------------	------

Copy 1—Upon initiation of action, mail this copy to Director Copy 3—Upon termination of action, mail this copy to Director
 Copy 2—Upon filing document adding patent(s), mail this copy to Director Copy 4—Case file copy