

032304

17281 U.S. PTO

Docket No. 4602-4001  
Express Mail No. EV 383045195 US

27123

↑CUSTOMER NUMBER↑

22859 U.S. PTO  
10/807731

032304

**IN THE UNITED STATES PATENT AND TRADEMARK OFFICE**

**UTILITY APPLICATION AND FEE TRANSMITTAL §(1.53(b))**

Mail Stop Patent Application  
Commissioner for Patents  
P.O. Box 1450  
Alexandria, VA 22313-1450

Sir:

Transmitted herewith for filing is the patent application of

Inventor(s) names and addresses:

(1) Scott McNulty  
22 Ensign Road,  
Rowayton, CT 06853

(2)

Additional inventors are listed on a separate sheet

For: Apparatus, Method and System For A Tunneling Client Access

Enclosed Are:

67 page(s) of specification  
2 page(s) of Abstract  
17 page(s) of claims  
10 sheets of  Formal  Informal drawings  
\_\_\_\_\_ page(s) of Declaration and Power of Attorney

- Unsigned
- Newly Executed
- Copy from prior application
- Deletion of inventors including Signed Statement under 37 C.F.R. §1.63(d)(2)

**REQUEST AND CERTIFICATION UNDER 35 U.S.C. §122(b)(2)(B)(i) (form PTO/SB/35)**

As indicated on the attached Request and Certification, Applicant(s) certify that the invention disclosed in the attached application HAS NOT and WILL NOT be the subject of an application filed in another country, or under a multilateral agreement, that requires publication at eighteen months after filing. Applicant(s) therefore request(s) that the attached application NOT be published under 35 U.S.C. §122(b).

Incorporation by Reference:

The entire disclosure of the prior application, from which a copy of the combined Declaration and Power of Attorney is supplied herein, is considered as being part of the disclosure of the accompanying application and is incorporated herein by reference.

Deletion of Inventors (37 C.F.R. §1.63(d) and §1.33(b))

Signed statement attached deleting inventor(s) named in the prior application serial no. \_\_\_\_\_, filed \_\_\_\_\_.

Microfiche Computer Program (Appendix)

page(s) of Sequence Listing

computer readable disk containing Sequence Listing

Statement under 37 C.F.R. §1.821(f) that computer and paper copies of the Sequence Listing are the same

Assignment Papers (assignment cover sheet and assignment documents)

A check in the amount of \$40.00 for recording the Assignment

Charge the Assignment Recordation Fee to Deposit Account No. 13-4500, Order No. \_\_\_\_\_.

Assignment Papers filed in the parent application Serial No. \_\_\_\_\_

Certification of chain of title pursuant to 37 C.F.R. §3.73(b)

Priority is claimed under 35 U.S.C. §119 for:

Application No(s). \_\_\_\_\_, filed \_\_\_\_\_, in \_\_\_\_\_ (country).

Certified Copy of Priority Document(s) [\_\_\_\_\_]

filed herewith

filed in application Serial No. \_\_\_\_\_, filed \_\_\_\_\_.

English translation document(s) [\_\_\_\_\_]

filed herewith

filed in application Serial No. \_\_\_\_\_, filed \_\_\_\_\_.

Priority is claimed under 35 U.S.C. §119(e) for:

Provisional Application No. \_\_\_\_\_, filed \_\_\_\_\_.

- Information Disclosure Statement
- Copy of [\_\_\_\_\_] cited references
  - PTO Form-1449
  - References cited in parent application Serial No. \_\_\_\_\_, filed \_\_\_\_\_.
- Related Case Statement under 37 C.F.R. §1.98(a)(2)(iii)
- A copy of related pending U.S. Application(s) Serial No(s): \_\_\_\_\_, filed \_\_\_\_\_, respectively, is attached hereto.
  - A copy of related pending U.S. Application(s) entitled, \_\_\_\_\_, filed \_\_\_\_\_ to inventor(s) \_\_\_\_\_, respectively, is attached hereto.
  - A copy of each related application(s) was submitted in parent application serial no. \_\_\_\_\_, filed \_\_\_\_\_.
- Preliminary Amendment
- Return receipt postcard (MPEP 503)
- This is a  continuation  divisional  continuation-in-part of prior application serial no. \_\_\_\_\_, filed \_\_\_\_\_, to which priority under 35 U.S.C. §120 is claimed.
- Cancel in this application original claims \_\_\_\_\_ of the parent application before calculating the filing fee. (At least one original independent claim must be retained for filing purposes.)
  - A Preliminary Amendment is enclosed. (Claims added by this Amendment have been properly numbered consecutively beginning with the number following the highest numbered original claim in the prior application).
- The status of the parent application is as follows:
- A Petition for Extension of Time and a Fee therefor has been or is being filed in the parent application to extend the term for action in the parent application until \_\_\_\_\_.
  - A copy of the Petition for Extension of Time in the co-pending parent application is attached.
  - No Petition for Extension of Time and Fee therefor are necessary in the co-pending parent application.
- Please abandon the parent application at a time while the parent application is pending or at a time when the petition for extension of time in that application is granted and while this application is pending has been granted a filing date, so as to make this application co-pending.
- Transfer the drawing(s) from the parent application to this application
- Amend the specification by inserting before the first line the sentence:  
This is  continuation  divisional  continuation-in-part of co-pending application Serial No. \_\_\_\_\_, filed \_\_\_\_\_.

I. CALCULATION OF APPLICATION FEE				
	Number Filed	Number Extra	Rate	Basic Fee \$770.00/385.00
Total Claims	69- 20 =	49x	\$18.00/ \$9.00	\$ 441.00
Independent Claims	12- 3 =	9x	\$86.00/ \$43.00	\$ 387.00
<input type="checkbox"/> Multiple Dependent Claims		If marked, add fee of \$290.00 (\$145.00)		\$
TOTAL:				\$ 1213.300

- Small entity status is or has been claimed. Reduced fees under 37 C.F.R. §1.9 (f) paid herewith  
\$.
- A check in the amount of \$\_\_\_\_\_ in payment of the application filing fees is attached.
- Charge fee to Deposit Account No. 13-4500, Order No. 4602-4001. A DUPLICATE COPY OF THIS SHEET IS ATTACHED.
- The Commissioner is hereby authorized to charge any additional fees which may be required for filing this application pursuant to 37 CFR §1.16, **including all extension of time fees pursuant to 37 C.F.R. § 1.17 for maintaining copendency** with the parent application, or credit any overpayment to Deposit Account No. 13-4500, Order No. 4602-4001. A DUPLICATE COPY OF THIS SHEET IS ATTACHED.

Respectfully submitted,  
MORGAN & FINNEGAN, L.L.P.

Dated: March 23, 2004

By:

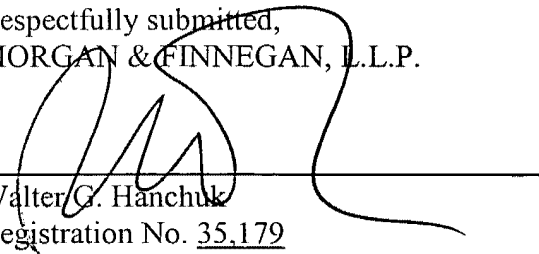
  
Walter G. Hanchuk  
Registration No. 35,179

Correspondence Address:

MORGAN & FINNEGAN, L.L.P.  
345 Park Avenue  
New York, NY 10154-0053  
(212) 758-4800 Telephone  
(212) 751-6849 Facsimile

**IN THE UNITED STATES PATENT AND TRADEMARK OFFICE**

Applicant(s): Scott McNulty  
Serial No.: TBA  
Filed: March 23, 2004  
For: Apparatus, Method and System For A Tunneling Client Access

Group Art Unit: TBA  
Examiner: TBA

**EXPRESS MAIL CERTIFICATE**

Mail Stop  
Commissioner for Patents  
P.O. Box 1450  
Alexandria, VA 22313-1450

Express Mail Label No.: EV 383045195 US

Date of Deposit: March 23, 2004

I hereby certify that the following attached paper(s) and/or fee

1. Utility Application and fee Transmittal enclosing (1 page of cover sheet, 67 pages of specification, 2 page of abstract, 17 pages of claims and 10 sheets of formal drawings (Figs. 1-10)
2. Return postcard

are being deposited with the United States Postal Service "Express Mail Post Office to Addressee" service under 37 C.F.R. §1.10 on the date indicated above and is addressed to Commissioner for Patents, P.O. Box 1450, Alexandria, VA 22313-1450.

Vivian King

(Typed or printed name of person mailing papers(s) and/or fee)

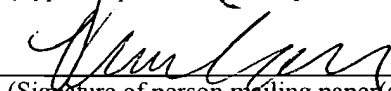

(Signature of person mailing paper(s) and/or fee)

Correspondence Address:

MORGAN & FINNEGAN, L.L.P.  
345 Park Avenue  
New York, NY 10154-0053  
(212) 758-4800 Telephone  
(212) 751-6849 Facsimile

**IN THE UNITED STATES PATENT AND TRADEMARK OFFICE**

UNITED STATES PATENT APPLICATION

**FOR:**

APPARATUS, METHOD AND SYSTEM FOR A TUNNELING CLIENT ACCESS POINT

**INVENTOR:**

SCOTT MCNULTY

**Morgan & Finnegan, L.L.P.**  
345 Park Avenue  
New York, New York 10154-0053  
United States of America

Telephone: (212) 758-4800  
Facsimile: (212) 751-6849

Attorneys for Applicant  
Attorney Docket No.: 4602-4001  
Express Mail Label No.: EV 383045195 US

## **APPARATUS, METHOD AND SYSTEM FOR A TUNNELING CLIENT ACCESS POINT**

### **FIELD**

**[0001]** The present invention is directed generally to an apparatus, method, and system of accessing data, and more particularly, to an apparatus, method and system to execute and process data by tunneling access through a terminal.

### **BACKGROUND**

#### PORTABLE COMPUTING AND STORAGE

**[0002]** Computing devices have been becoming smaller over time. Currently, some of the smallest computing devices are in the form of personal digital assistants (PDAs). Such devices usually come with a touch screen, an input stylus and/or mini keyboard, and battery source. These devices, typically, have storage capacities around 64MB. Examples of these devices include Palm's Palm Pilot.

#### INFORMATION TECHNOLOGY SYSTEMS

**[0003]** Typically, users, which may be people and/or other systems, engage information technology systems (e.g., commonly computers) to facilitate information processing. In turn, computers employ processors to process information; such processors are often referred to as central processing units (CPU). A common form of processor is referred to as a microprocessor. A computer operating system, which, typically, is software executed by CPU on a computer, enables and facilitates users to access and operate computer information technology and resources. Common resources employed in information

technology systems include: input and output mechanisms through which data may pass into and out of a computer; memory storage into which data may be saved; and processors by which information may be processed. Often information technology systems are used to collect data for later retrieval, analysis, and manipulation, commonly, which is facilitated through database software. Information technology systems provide interfaces that allow users to access and operate various system components.

### USER INTERFACE

**[0004]** The function of computer interfaces in some respects is similar to automobile operation interfaces. Automobile operation interface elements such as steering wheels, gearshifts, and speedometers facilitate the access, operation, and display of automobile resources, functionality, and status. Computer interaction interface elements such as checkboxes, cursors, menus, scrollers, and windows (collectively and commonly referred to as widgets) similarly facilitate the access, operation, and display of data and computer hardware and operating system resources, functionality, and status. Operation interfaces are commonly called user interfaces. Graphical user interfaces (GUIs) such as the Apple Macintosh Operating System's Aqua, Microsoft's Windows XP, or Unix's X-Windows provide a baseline and means of accessing and displaying information, graphically, to users.

### NETWORKS

**[0005]** Networks are commonly thought to comprise of the interconnection and interoperation of clients, servers, and intermediary nodes in a graph topology. It should be noted that the term "server" as used herein refers generally to a computer, other device,



software, or combination thereof that processes and responds to the requests of remote users across a communications network. Servers serve their information to requesting “clients.” The term “client” as used herein refers generally to a computer, other device, software, or combination thereof that is capable of processing and making requests and obtaining and  
5 processing any responses from servers across a communications network. A computer, other device, software, or combination thereof that facilitates, processes information and requests, and/or furthers the passage of information from a source user to a destination user is commonly referred to as a “node.” Networks are generally thought to facilitate the transfer of information from source points to destinations. A node specifically tasked with furthering the  
10 passage of information from a source to a destination is commonly called a “router.” There are many forms of networks such as Local Area Networks (LANs), Pico networks, Wide Area Networks (WANs), Wireless Networks (WLANs), etc. For example, the Internet is generally accepted as being an interconnection of a multitude of networks whereby remote clients and servers may access and interoperate with one another.

15

### SUMMARY

[0006] Although all of the aforementioned portable computing systems exist, no effective solution to securely access, execute, and process data is available in an extremely compact form. Currently, PDAs, which are considered among the smallest portable computing solution, are bulky, provide uncomfortably small user interfaces, and require too  
20 much power to maintain their data. Current PDA designs are complicated and cost a lot because they require great processing resources to provide custom user interfaces and

operating systems. Further, current PDAs are generally limited in the amount of data they can store or access. No solution exists that allows users to employ traditional large user interfaces they are already comfortable with, provides greater portability, provides greater memory footprints, draws less power, and provides security for data on the device. As such, the disclosed tunneling client access point (TCAP) is very easy to use; at most it requires the user to simply plug the device into any existing and available desktop or laptop computer, through which, the TCAP can make use of a traditional user interface and input/output (I/O) peripherals, while the TCAP itself, otherwise, provides storage, execution, and/or processing resources. Thus, the TCAP requires no power source to maintain its data and allows for a highly portable “thumb” footprint. Also, by providing the equivalent of a plug-n-play virtual private network (VPN), the TCAP provides certain kinds of accessing of remote data in an easy and secure manner that was unavailable in the prior art.

[0007] In accordance with certain aspects of the disclosure, the above-identified problems of limited computing devices are overcome and a technical advance is achieved in the art of portable computing and data access. An exemplary tunneling client access point (TCAP) includes a method to dispose a portable storage device in communication with a terminal. The method includes providing the memory for access on the terminal, executing processing instructions from the memory on the terminal to access the terminal, communicating through a conduit, and processing the processing instructions.

20 [0008] In accordance with another embodiment, a portable tunneling storage processor is disclosed. The apparatus has a memory and a processor disposed in

communication with the memory, and configured to issue a plurality of processing instructions stored in the memory. Also, the apparatus has a conduit for external communications disposed in communication with the processor, configured to issue a plurality of communication instructions as provided by the processor, configured to issue the  
5 communication instructions as signals to engage in communications with other devices having compatible conduits, and configured to receive signals issued from the compatible conduits.

### BRIEF DESCRIPTION OF THE DRAWINGS

[0009] The accompanying drawings illustrate various non-limiting, example,  
10 inventive aspects in accordance with the present disclosure:

[0010] FIGURE 1 is of a flow diagram illustrating embodiments of a tunneling client access point (TCAP);

[0011] FIGURE 2 is of a flow diagram illustrating embodiments of a system of tunneling client access point and access terminal interaction;

15 [0012] FIGURE 3 is of a flow diagram illustrating embodiments of engaging the tunneling client access point to an access terminal interaction;

[0013] FIGURE 4 is of a flow diagram illustrating embodiments of accessing the tunneling client access point and server through an access terminal;

[0014] FIGURES 5-8 is of a flow diagram illustrating embodiments of facilities, programs, and/or services that the tunneling client access point and server may provide to the user as accessed through an access terminal;

[0015] FIGURE 9 is of a block diagram illustrating embodiments of a tunneling  
5 client access point server controller;

[0016] FIGURE 10 is of a block diagram illustrating embodiments of a tunneling client access point controller;

[0017] The leading number of each reference number within the drawings indicates the first figure in which that reference number is introduced. As such, reference number 101  
10 is first introduced in Figure 1. Reference number 201 is first introduced in Figure 2, etc.

## DETAILED DESCRIPTION

### TOPOLOGY

[0018] Figure 1 illustrates embodiments for a topology between a tunneling client access point (TCAP) (see Figure 10 for more details on the TCAP) and TCAP server (TCAPS) (see Figure 9 for more details on the TCAPS). In this embodiment, a user 133a  
5 may plug-in a TCAP into any number of access terminals 127 located anywhere. Access terminals (ATs) may be any number of computing devices such as servers, workstations, desktop computers, laptops, portable digital assistants (PDAs), and/or the like. The type of AT used is not important other than the device should provide a compatible mechanism of  
10 engagement to the TCAP 130 and provide an operating environment for the user to engage the TCAP through the AT. In one embodiment, the TCAP provides a universal serial bus (USB) connector through which it may plug into an AT. In other embodiment, the TCAP may employ Bluetooth, WiFi and/or other wireless connectivity protocols to connect with ATs that are also so equipped. In one embodiment, the AT provides Java and/or Windows  
15 runtime environments, which allows the TCAP to interact with the input/output mechanisms of the AT. See Figure 9 for more details and embodiments on the types of connections that may be employed by the TCAP. Once the TCAP has engaged with an AT, it can provide the user with access to its storage and processing facilities.

[0019] If the AT is connected to a communication network 113, the TCAP may then  
20 communicate beyond the AT. In one embodiment, the TCAP can provide extended storage and/or processing resources by engaging servers 110, 115, 120, which have access to and can

provide extended storage 105 to the TCAP through the AT. In one embodiment, a single server and storage device may provide such TCAP server support. In another embodiment, server support is provided over a communications network, e.g., the Internet, by an array of front-end load-balancing servers 120. These servers can provide access to storage facilities  
5 within the servers or to remote storage 105 across a communications network 113b, c (e.g., a local area network (LAN)). In such an embodiment, a backend server 110 may offload the front-end server with regard to data access to provide greater throughput. For purposes of load balancing and/or redundancy, a backup server 115 may be similarly situated to provide for access and backup in an efficient manner. In such an embodiment, the back-end servers  
10 may be connected to the front-end servers through a communications network 113b (e.g., wide area network (WAN)). The backend servers 110, 115 may be connected to the remote storage 105 through a communications network 113c as well (e.g., a high speed LAN, fiber-channel, and/or the like).

**[0020]** Thus, to the user 133a, the contents of the TCAP 130 appear on the AT as  
15 being contained on the TCAP 125 even though much of the contents may actually reside on the servers 115, 120 and/or the servers' storage facilities 105. In these ways, the TCAP "tunnels" data through an AT. The data may be provided through the AT's I/O for the user to observe without it actually residing on the AT. Also, the TCAP may tunnel data through an AT across a communications network to access remote servers without requiring its own  
20 more complicated set of peripherals and I/O.

TCAP AND AT INTERACTION

[0021] Figure 2 illustrates embodiments for a system of tunneling client access point (TCAP) (see Figure 10 for more details on the TCAP) and access terminal interaction. Figure 2 provides an overview for TCAP and AT interaction and subsequent figures will provide greater detail on elements of the interaction. In this embodiment, a user engages the TCAP 201. For example, the user may plug the TCAP into an AT via the AT's USB port. Thereafter the user is presented with a login prompt 205 on the AT's display mechanism, e.g., on a video monitor. After a user successfully logs in (for example by providing a user name and password) 204, the TCAP can then accept user inputs from the AT and its peripherals (the TCAP can then also provide output to the user via the AT's peripherals).

[0022] The user may employ the AT's input peripherals as user input devices that control actions on the TCAP. Depending on the user's actions 215, the TCAP can be used by the AT as a storage device from which it can access and store data and programs 225. For example, if the user takes the action of opening a file from the TCAP's memory, e.g., by double clicking on an icon when the TCAP is mounted as a USB drive on the AT, then the AT may treat the TCAP as a memory device and retrieve information from the TCAP 225. If the user's action 215 is one that is directed at executing on the TCAP 215, then the AT will not be involved in any execution. For example, if the user drops an icon representing a graphics file onto a drag-and-drop location visually representing the TCAP, then the file may be copied to the TCAP where it will process and spool the file for sending the graphics file to be printed at a remote location. In such a case, all of the requirements to process and spool

the file are handled by the TCAP's processor and the AT would only be used as a mechanism for user input and output and as a conduit through which the TCAP may send files.

**[0023]** Regardless of if there is an action 215 to execute on the TCAP 220 or to access or store data on the TCAP 225, the AT is used to display the status of any actions 230.

5 At any time the user may select to terminate TCAP related facilities executing either on the AT, a backend server, on the TCAP itself, and/or the like 235. In one embodiment, the user may select a quit option that is displayed on the AT's screen. In another embodiment, the user may simply disengage the TCAP from the AT by severing the connection (e.g., turning power off, physically pulling the device off the AT, turning off wireless transmissions, and/or

10 the like). It should be noted that such abrupt severing may result in the loss of data, file corruption, etc. if the TCAP has not saved data that is on the AT or on some remote server, however, if the TCAP is employing flash like memory, its contents should remain intact.

**[0024]** If there is no instruction signal to terminate the TCAP 235, execution will continue and the TCAP will continue to take and look for input from the user. Of course if

15 the TCAP has been set to perform certain actions, those actions will continue to execute, and the TCAP may respond to remote servers when it is communicating with them through the AT. When the user issues a terminate signal 235, then the TCAP will shut down by saving any data to the TCAP that is in the AT's memory and then terminating any programs executing on both the AT and TCAP that were executed by and/or from the TCAP 240. If no

20 activities are taking place on the TCAP and all the data is written back to the TCAP 240, then the TCAP may optionally unmount itself from the AT's file-system 245. At this point, if



there is a TCAP I/O driver executing on the AT, that driver may be terminated as triggered by the absence of the TCAP at a mount point 250. After the TCAP is unmounted and/or the TCAP I/O driver is terminated, it is safe to disengage the TCAP from the AT.

### TCAP AND AT INTERACTION

5 [0025] Figure 3 illustrates embodiments engaging the tunneling client access point to an access terminal interaction. Examples of engaging the TCAP 301 with an AT were discussed above in Figure 1 127, 130, 133a and Figure 2 201. In one embodiment, the TCAP 130 is engaged with an access terminal 327, 305. As mentioned in Figure 1, the TCAP is capable of engaging with ATs using a number of mechanisms. In one embodiment, the  
10 TCAP has a USB connector for plugging into an AT, which acts as a conduit for power and data transfer. In another embodiment, the TCAP may use Bluetooth to establish a wireless connection with a number of ATs. In another embodiment, the TCAP may employ WiFi. In yet another embodiment, the TCAP may employ multiple communications mechanisms. It should be noted, with some wireless mechanisms like Bluetooth and WiFi, simply coming  
15 into proximity with an AT that is configured for such wireless communication may result in the TCAP engaging with and establish a communications link with the AT. In one embodiment, the TCAP has a “connect” button that will allow such otherwise automatically engaging interactions take place only if the “connect” button is engaged by a user. Such an implementation may provide greater security for users (see Figure 10 for more details on the  
20 TCAP).

[0026] After being engaged 305, the TCAP will then power on. In an embodiment requiring a direct connection, e.g., USB, simply plugging the TCAP into the AT provides power. In a wireless embodiment, the TCAP may be on in a lower powered state or otherwise turned on by engaging the connect button as discussed above. In such an embodiment, the TCAP can employ various on-board power sources (see Figure 10 for more details on the TCAP). The TCAP then may load its own operating system 315. The operating system can provide for interaction with the AT. In one embodiment, a Java runtime is executed on the TCAP, and Java applets communicate with the AT through Java APIs. In another embodiment, a driver is loaded onto the AT, and the on-TCAP Java operating system applets communicate to and through the AT via the driver running on the AT, wherein the driver provides an API through and to which messages may be sent.

[0027] After engaging with the AT, the TCAP can provide its memory space to the AT 320. In one embodiment, the TCAP's memory is mapped and mounted as a virtual disk drive 125 storage 325. In this manner, the TCAP may be accessed and manipulated as a standard storage device through the AT's operating system. Further, the TCAP and in some cases the AT can determine if the AT is capable of accessing program instructions stored in the TCAP's memory 330. In one embodiment, the AT's operating system looks to auto-run a specified file from any drive as it mounts. In such an embodiment, the TCAP's primary interface may be specified in such a boot sequence. For example, under windows, an autorun.inf file can specify the opening of a program from the TCAP by the AT; e.g., OPEN=TCAP.EXE.

[0028] Many operating systems are capable of at least accessing the TCAP as a USB memory drive 330 and mounting its contents as a drive, which usually becomes accessible in file browsing window 125. If the TCAP does not mount, the AT's operating system will usually generate an error informing the user of a mounting problem. If the AT is not capable of executing instruction from the TCAP, a determination is made if an appropriate driver is loaded on the AT to access the TCAP 335. In one embodiment, the TCAP can check to see if an API is running on the AT. For example, the TCAP provide an executable to be launched, e.g., as specified through autorun.inf, and can establish communications through its connection to the AT, e.g., employing TCP/IP communications over the USB port. In such an embodiment, the TCAP can ping the AT for the program, and if an acknowledgement is received, the TCAP has determined that proper drivers and APIs exist. If no such API exists, the TCAP may launch a driver installation program for the AT as through an autorun.inf. In an alternative embodiment, if nothing happens, a user may double click onto an installer program that is stored on the mounted TCAP 342, 340. It should be noted, that although the TCAP's memory space may be mounted, certain areas of the TCAP may be inaccessible until there is an authorization. For example, certain areas and content on the TCAP may be encrypted. It should be noted that any such access terminal modules that drive AT and TCAP interaction may be saved onto the TCAP by copying the module to a mounted TCAP. Nevertheless, if the AT is capable of accessing program instructions in TCAP memory 330, a TCAP driver is loaded on the AT 335, and/or the user engages a program in the TCAP memory 340, then the AT can execute program instructions from the TCAP's memory, which allows the TCAP to use the AT's I/O and allowing the user to interface with TCAP

facilities 345. It should be noted that some ATs may not be able to mount the TCAP at all. In such an instance, the user may have to install the TCAP drivers by downloading them from a server on the Internet, loading them from a diskette or CD, and/or the like. Once the TCAP is engaged to the AT 301, execution may continue 398.

5 TCAP AND AT INTERACTION

[0029] Figure 4 illustrates embodiments accessing the tunneling client access point and server through an access terminal. Upon engaging the TCAP to the AT as described in Figure 3 301, 398, the user may then go on to access the TCAP and its services 498. It should be noted that users may access certain unprotected areas of the TCAP once it has been  
10 mounted, as described in Figure 3. However, to more fully access the TCAP's facilities, the user may be prompted to either login and/or registration window 205a to access the TCAP and its services, which may be displayed on the AT 405. It is important to note that in one embodiment, the execution of the login and/or registration routines are handled by the TCAP's processor. In such an embodiment, the TCAP may run a small Web server providing  
15 login facilities, and connect to other Web based services through the AT's connection to the Internet. Further, the TCAP may employ a basic Web browsing core engine by which it may connect to Web services through the AT's connection to a communications network like the Internet. For purposes of security, in one embodiment, the TCAP may connect to a remote server by employing a secure connection, e.g., HTTPS, VPN, and/or the like.

20 [0030] Upon displaying a login window 405, e.g., 205a, the user may select to register to access the TCAP and its services, or they may simply log in by providing security

verification. In one example, security authorization may be granted by simply providing a user and password as provided through a registration process. In another embodiment, authorization may be granted through biometric data. For example, the TCAP may integrate a fingerprint and/or heat sensor IC into its housing. Employing such a device, and simply by providing one's finger print by laying your finger to the TCAP's surface, would provide the login facility with authorization if the user's finger print matches one that was stored during the registration process.

[0031] If the user does not attempt to login 415, i.e., if the user wishes to register to use the TCAP and its services, then the TCAP can determine if the AT is online 420. This may be accomplished in a number of ways. In one embodiment, the TCAP itself may simply ping a given server and if acknowledgement of receipt is received, the TCAP is online. In another embodiment, the TCAP can query for online status by engaging the AT through the installed APIs. If the AT is not online, then the user may be presented with an error message 425. Thus, if a user does not have a login, and does not have the ability to register, then restricted areas of the TCAP will remain unavailable. Thereafter, flow can continue 498 and the user may have another opportunity to login and/or register. In one embodiment as a login integrity check, the TCAP keeps track of the number of failed attempts to login and/or register and may lock-out all further access if a specified number of failed attempts occurs. In one embodiment, the lockdown may be permanent by erasing all data on the TCAP. In another embodiment, the TCAP will disallow further attempts for a specified period of time.

[0032] If the user is attempting to register 415, and the AT is online 420, then the user may provide registration information 440 into a screen form 440a. Registration information fields may require a user's name, address, email address, credit card information, biometric information (e.g., requiring the user to touch a biometric fingerprint IC on the TCAP), and/or the like. The TCAP may determine if all the information was provided as required for registration and may query backend servers to determine if the user information is unique 445. If the user did not properly fill out the registration information or if another user is already registered, the TCAP can provide an error message to such effect. Also, both the TCAP and its back-end servers may make log entries tracking such failed attempts for purposes of defending against fraud and/or security breaches. The user may then modify the registration information 440 and again attempt to register. Similarly to the login integrity checks, the TCAP can lockout registration attempts if the user fails to register more than some specified number of times.

[0033] Upon providing proper registration information 445 or proper login authentication 415, the TCAP can query backend servers to see if the user is registered. In one embodiment, such verification may be achieved by sending a query to the servers to check its database for the authorization information and/or for duplicate registrations. The servers would then respond providing an acknowledgment of proper registration and authorization to access data on the backend servers. If the users are not registered on the backend servers 430, then the TCAP can provide an error message to the user for display on the AT to such effect 435. In an alternative embodiment, the registration information may be

stored on the TCAP itself. In one embodiment, the registration would be maintained in encrypted form. Thus, the user's login information may be checked relative to the information the TCAP itself, and if there is a match, access may be granted, otherwise an error message will be displayed 435. The TCAP may then continue 498 to operate as if it  
5 were just engaged to the AT.

[0034] If the user is confirmed to be registered 430, then the TCAP may provide options for display 453, 453a. Depending on the context and purpose of a particular TCAP, the options may vary. For example, the a screen 453a may provide the user with the options to access data either online or offline. The user might simply click on a button and gain  
10 secure access to such data that may be decrypted by the TCAP. In one embodiment, the TCAP will determine if the AT is online 455. If this was already determined 420, this check 455 may be skipped.

[0035] If the AT is online 455, optionally, the TCAP determines if the user wishes to synchronize the contents of the TCAP with storage facilities at the backend server 470. In  
15 one embodiment, the user may designate that such synchronization is to always take place. If synchronization is specified 470, then the TCAP will provide and receive updated data to and from the backend servers, overwriting older data with updated versions of the data 475. If the AT is online 455 and/or after any synchronization 475, the TCAP may provide the user with all of its service options as authorized by the account and programs available on the TCAP  
20 and at the backend server 480. Once again, these facilities, programs, and/or services may vary greatly depending on the context and deployment requirements of the user. The options

to be presented to the user from the TCAP or the TCAP services from the backend server, as displayed through the TCAP onto the AT's display 480, are myriad and some example embodiments are provided in Figures 5-8. Upon presenting the user with the options, the user is then able to access, execute, store data and programs on the TCAP and on the remote  
5 server 485. All areas of the TCAP and services are then open, including any encrypted data areas.

[0036] If the AT is not online 455, the TCAP may provide options for the user not including online services 460. In one embodiment, the online options that may be presented on the AT display will be dimmed and/or omitted to reflect the lack of accessibility.  
10 However, the user will be able to access, execute, store data and programs on the TCAP, including any encrypted data areas 465.

#### TCAP FACILITIES AND SERVICES

[0037] Figures 5-8 illustrate embodiments of facilities, programs, and/or services that the tunneling client access point and server may provide to the user as accessed through an  
15 AT. Any particular set of facilities may have a myriad of options. The options and the general nature of the facilities provided on any particular TCAP are dependant upon the requirements of a given set of users. For example, certain groups and/or agencies may require TCAPS to be targeted towards consumer photographs, and may employ TCAPs to further that end. Other groups may require high security facilities, and tailor the TCAPs accordingly.  
20 In various environments, an organization may wish to provide a secure infrastructure to all of its agents for securely accessing the organization's data from anywhere and such an



organization could tailor the TCAPs contents to reflect and respond to its needs. By providing a generalized infrastructure on the TCAP backend servers and within the TCAP by using a generalized processor, the TCAPs may be deployed in numerous environments.

**[0038]** In one particular embodiment as in Figure 5, the TCAP provides facilities to  
5 access, process, and store email, files, music, photos and videos through the TCAP. Upon  
engaging 101 of Figure 1 the TCAP 130 to an AT 307, the TCAP will mount and display  
through the AT's file browser window 125 of Figure 1. As has already described, in the case  
where the AT has no TCAP driver software, the user may double click on the installer  
software stored on the TCAP 507. Doing so will launch the installer software from the  
10 TCAP's memory to execute on the AT, and the user may be presented with a window to  
confirm the desire to install the TCAP software onto the AT 507. Upon confirming the install  
507, the software will install on the AT and the user will be asked to wait as they are apprised  
of the install progress 509.

**[0039]** Upon installation, the TCAP front-end software may execute and present the  
15 user with various options in various and fanciful interface formats 511, 460, 480 of Figure 4.  
In one embodiment, these user interfaces and programs are Java applications that may  
execute on the AT and a present Java runtime. In an alternative embodiment, a small applet  
may run on the AT, but all other activities may execute on the TCAP's processor, which  
would use the AT display only as a display terminal. In the embodiment where the TCAP  
20 executes program instructions, the TCAP may be engaged to receive commands and execute  
by receiving a signal from the access terminal driver instructing it to execute certain program

files or, alternatively, looking to default location and executing program instructions. In yet another embodiment, the TCAP may obtain updated interfaces and programs from a backend server for execution either on the TCAP itself and/or the AT; this may be done by synchronization with the backend server and checking for updates of specified files at the

5 backend server. By engaging the user interface, perhaps by clicking on a button to open the TCAP facilities and services 511, the interface may further unfurl to present options to access said facilities and services 513. Here, the interface may reflect ownership of the TCAP by providing a welcome screen and showing some resources available to the user; for example, a button entitled "My Stuff" may serve as a mechanism to advance the user to a screen where

10 they may access their personal data store. At this point the user may attempt to login to access their data by engaging an appropriate button, which will take them to a screen that will accept login information 519. Alternatively, the user may also register if it is their first time using the TCAP by selecting an appropriate button, which will advance the user to a registration screen 515 wherein the user may enter their name, address, credit card

15 information, etc. Upon successfully providing registration information, the user may be prompted for response to further solicitations on a follow-up screen 517. For example, depending on the services offered for a particular TCAP, the user may be provided certain perks like 5 MB of free online storage on a backend server, free photographic prints, free email access, and/or the like 517.

20 **[0040]** After the user is prompted to login 518 and successfully provides proper login information 519, or after successfully registering 515 and having responded to any

solicitations 517, the user may be provided with general options 521 to access data stored on the TCAP itself 522 or in their online account 520 maintained on a backend server. For example, if the user selects the option to access their online storage 520, they may be presented with more options to interact with email, files, music, photos and videos that are available online 523. Perhaps if the user wished to check their email, the user might select to interact with their email, and a screen allowing them to navigate through their email account(s) would be presented 525. Such online access to data may be facilitated through http protocols whereby the TCAP applications send and receive data through http commands across a communications network interacting with the backend servers and/or other servers.

10 Any received results may be parsed and imbedded in a GUI representation of a Java application. For example, the email facility may run as a Java applet 525 and may employ a POP mail protocol to pull data from a specified mail server to present to the user.

[0041] Similarly, many other facilities may be engaged by the user through the TCAP. In one embodiment, the user may drag 508 a file 506 onto a drag-and-drop zone 505 that is presented on the TCAP interface. Upon so doing, various drag-and-drop options may unfurl and present themselves to the user 550. It should be noted that the file may come from anywhere, i.e., from the AT, the TCAP, and/or otherwise. For example, upon dragging and dropping a graphics file, a user may be prompted with options to order prints, upload the file to an online storage space, save the file to the TCAP's memory space, cancel the action, and/or the like 550. If the user sends the file for storage, or otherwise wishes to see and manage their data, an interface allowing for such management may be presented 555. The

20

interface may organize and allow access to general data, picture, and music formats 554, provide usage statistics (e.g., free space, capacity, used space, etc.) 553, provide actions to manipulate and organize the data 552, provide status on storage usage on the TCAP 551 and online 549, and/or the like.

5 [0042] Should the user engage a user interface element indicating the wish to manipulate their picture data 548, the TCAP interface will update to allow more specific interaction with the user's photos 557. In such a screen, the user may select various stored pictures and then indicate a desire to order photo prints by engaging the appropriate user interface element 558. Should the user indicate their desire for prints 558, they will be  
10 presented with an updated interface allowing the specification of what graphics files they wish to have printed 559. In one embodiment, the users may drag-and-drop files into a drop zone, or otherwise engage file browsing mechanisms 560 that allow for the selection of desired files. Upon having identified the files for prints 559, a user may be presented with an interface allowing for the selection of print sizes and quantities 561. After making such  
15 specifications, the user may be required to provide shipping information 563 and information for payments 565. After providing the billing information to a backend server for processing and approval, the user may be presented with a confirmation interface allowing for editing of the order, providing confirmation of costs, and allowing for submission of a final order for the selected prints 567. Upon submitting the order, the TCAP will process the files for  
20 spooling to a backend server that will accept the order and files, which will be developed as prints and the user's account will be charged accordingly. In one embodiment, all of the

above order and image processing operations occur and execute on the TCAP CPU. For example, the TCAP may employ various rendering technologies, e.g., ghostscript, to allow it to read and save PDFs and other media formats.

**[0043]** Figure 6 goes on to illustrate embodiments and facets of the facilities of Figure 5. The TCAP interface allows the user to perform various actions at any given moment. As has already been discussed in Figure 5, the user may drag 508 a file 506 onto a drag and drop zone 505 so as to provide the file to the TCAP for further manipulation. As in 550 of Figure 5, the user may be presented with various options subsequent to a drag-and-drop operation. Also, the TCAP interface may provide visual feedback that files have been 10 dropped in the drop zone by highlighting the drop zone 505b. Should the user wish, they may close the TCAP interface by engaging a close option 633. Also, the ability to change and/or update their personal information may be accessed through the TCAP interface 616, which would provide a form allowing the user to update their registration information 630. In one 15 embodiment, should the user forget their login information, they may request login help 635 and the TCAP will send their authorization information to the last known email address and inform the user of same 640. Also, the TCAP interface may provide help facilities that may be accessed at any time by simply engaging a help facility user interface element 617. So doing will provide the user with help screen information as to how to interact with the TCAP's facilities 625.

20 **[0044]** Upon providing proper login information 619 and logging-in 619, the user may be presented with a welcome screen with various options to access their data 621 as has

already been discussed in Figure 5, 521. By engaging a user interface element to access online storage 620, the user may be presented with various options to interact with online storage 623, 523 of Figure 5. Should the user wish to interact with data on the TCAP itself, the user may indicate so by engaging the appropriate user interface option 622. So doing will  
5 provide the user with further options related to data stored on the TCAP 655. The user may engage an option to view the storage contents 658 and the TCAP interface will provide a listing of the contents 662, which may be manipulated through selection and drag-and-drop operations with the files.

**[0045]** In one embodiment, the user may order prints of photos 657 from files that are  
10 on the TCAP itself. As discussed in Figure 5, the user may select files for which they desire prints 660. Here, the selected files will first be processed by the TCAP in preparation for sending to backend servers and file manipulations 670. The user may specify various attributes regarding the prints they desire, e.g., the size, number, cropping, red-eye correction, visual effects, and/or the like 661. In one embodiment, such processing occurs on  
15 the TCAP processor, while in other embodiments such processing can take place on the AT or backend server. Once again, the user may provide a shipping address 663, and make a final review to place the order 667. Upon committing to the order 667, the processed files are uploaded to the backend servers that will use the files to generate prints 690. A confirmation screen may then be provided to the user with an order number and other relevant information  
20 695.

[0046] Figure 7 goes on to illustrate embodiments and facets of the facilities of Figures 5-6 as may apply in different environments. As is demonstrated, the look and feel of the TCAP interface is highly malleable and can serve in many environments. Figure 7 illustrates that even within a single organization, various environments might benefit from TCAPs and services tailored to serve such environments 733b-d. In this case TCAPs can serve in consumer 733b, industry trade 733c, corporate 733d, and/or the like environments.

[0047] As has already been discussed, initially in any of the environments, after engaging the TCAP to an AT, the user may be prompted to install the TCAP interface 705 and informed of the installation procedure 710. The user may then be presented with the installed TCAP interface 715, which may be activated by engaging an interface element to unfurl the interface, e.g., in this case by opening the top to a can of soda 717. Opening the interface will present the user with various options as 720, as has already been discussed in Figures 5-6. Similarly the user may login 725 or make a selection to register for various TCAP services and provide the requisite information in the provided form 730. Upon registering and/or logging-in 725, various options may be presented based upon the configuration of the TCAP. For example, if the TCAP was configured and tailored for consumers, then upon logging in 725 the consumer user might be presented 733a-b with various consumer related options 740. Similarly, if the TCAP were tailored for 733a, c the trade industry or 733a, d the corporate environment, options specific to the trade industry 770 and corporate environment 760 may be presented.

**[0048]** In one embodiment, an organization wishing to provide TCAPs to consumers might provide options 740 for free music downloads 743, free Internet radio streaming 748, free news (e.g., provided through an RSS feed from a server) 766, free photo printing 750, free email 740, free coupons 742, free online storage 741, and/or the like. Users could further engage such services (e.g., clicking free music file links for downloading to the TCAP, by ordering prints 750, etc. For example, the user may select files on the TCAP 750, select the types of photos they would like to receive 752, specify a delivery address 754, confirm the order 756 all of which will result in the TCAP processing the files and uploading them to the backend servers for generation of prints (as has already been discussed in Figures 5-6).

**[0049]** In another embodiment, an organization wishing to provide TCAPs to a trade industry might provide options 770 for advertising 780, events 775, promotions 772, and/or the like. It is important to note that information regarding such options may be stored either on the TCAP or at a backend server. In one embodiment, such information may be constantly synchronized from the backend servers to the TCAPs. This would allow an organization to provide updates to the trade industry to all authorized TCAP “key holders.” In such an embodiment, the user may be presented with various advertising related materials for the organization, e.g., print, television, outdoor, radio, web, and/or the like 780. With regard to events, the user may be presented with various related materials for the organization, e.g., trade shows, music regional, sponsorship, Web, and/or the like 775. With regard to promotions, the user may be presented with various related materials for the organization, e.g., rebates, coupons, premiums, and/or the like 772.



**[0050]** In another embodiment, an organization wishing to provide TCAPs to those in the corporate environment and might provide options relating to various corporate entities 760. Selecting any of the corporate entities 760 may provide the user with options to view various reports, presentations, and/or the like, e.g., annual reports, 10K reports, and/or the like 765. Similarly, the reports may reside on the TCAP and/or the corporate TCAP can act as a security key allowing the user to see the latest corporate related materials from a remote backend server.

**[0051]** Figure 8 goes on to illustrate embodiments and facets of the facilities of Figures 5-7 as may apply in different environments. Figure 8 illustrates that TCAPs may serve to provide heightened security to any environment. As has been discussed in previous figures, users may engage the TCAP interface 805 to access various options 810. The TCAP interface is highly adaptable and various services may be presented within it. For example, a stock ticker may be provided as part of the interface in a financial setting 810. Any number of live data feeds may dynamically update on the face of the interface. Upon logging-in 815 or registering a new account 820, the user may be informed that communications that are taking place are secured 825. In one embodiment, various encryption formats may be used by the TCAP to send information securely to the backend servers. It is important to note that in such an embodiment, even if data moving out of the TCAP and across the AT were captured at the AT, such data would not be readable because the data was encrypted by the TCAP's processor. As such, the TCAP acts as a "key" and provides a plug-and-play VPN to users. Such functionality, heretofore, has been very difficult to set up and/or maintain. In this way,

all communications, options presented and views of user data are made available only to the TCAP with the proper decryption key. In heightened security environments, display of TCAP data is provided on the screen only in bitmapped format straight to the video memory of the AT and, therefore, is not stored anywhere else on the AT. This decreases the likelihood of capturing sensitive data. As such, the user may access their data on the TCAP and/or online 830 in a secure form whereby the user may navigate and interact with his/her data and various services 835 in a secure manner.

#### TUNNELING CLIENT ACCESS POINT SERVER CONTROLLER

**[0052]** Figure 9 illustrates one embodiment incorporated into a tunneling client access point server (TCAPS) controller 901. In this embodiment, the TCAP controller 901 may serve to process, store, search, serve, identify, instruct, generate, match, and/or update data in conjunction with a TCAP (see Figure 10 for more details on the TCAP). TCAPS act as backend servers to TCAPs, wherein TCAPS provide storage and/or processing resources to great and/or complex for the TCAP to service itself. In effect, the TCAPS transparently extend the capacity of a TCAP.

**[0053]** In one embodiment, the TCAPS controller 901 may be connected to and/or communicate with entities such as, but not limited to: one or more users from user input devices 911; peripheral devices 912; and/or a communications network 913. The TCAPS controller may even be connected to and/or communicate with a cryptographic processor device 928.

[0054] A TCAPS controller 901 may be based on common computer systems that may comprise, but are not limited to, components such as: a computer systemization 902 connected to memory 929.

Computer Systemization

5 [0055] A computer systemization 902 may comprise a clock 930, central processing unit (CPU) 903, a read only memory (ROM) 906, a random access memory (RAM) 905, and/or an interface bus 907, and most frequently, although not necessarily, are all interconnected and/or communicating through a system bus 904. Optionally, a cryptographic processor 926 may be connected to the system bus. The system clock typically has a crystal  
10 oscillator and provides a base signal. The clock is typically coupled to the system bus and various clock multipliers that will increase or decrease the base operating frequency for other components interconnected in the computer systemization. The clock and various components in a computer systemization drive signals embodying information throughout the system. Such transmission and reception of signals embodying information throughout a  
15 computer systemization may be commonly referred to as communications. These communicative signals may further be transmitted, received, and the cause of return and/or reply signal communications beyond the instant computer systemization to: communications networks, input devices, other computer systemizations, peripheral devices, and/or the like. Of course, any of the above components may be connected directly to one another, connected  
20 to the CPU, and/or organized in numerous variations employed as exemplified by various computer systems.

[0056] The CPU comprises at least one high-speed data processor adequate to execute program modules for executing user and/or system-generated requests. The CPU may be a microprocessor such as AMD's Athlon, Duron and/or Opteron; IBM and/or Motorola's PowerPC; Intel's Celeron, Itanium, Pentium and/or Xeon; and/or the like processor(s). The CPU interacts with memory through signal passing through conductive conduits to execute stored program code according to conventional data processing techniques. Such signal passing facilitates communication within the TCAPS controller and beyond through various interfaces. Should processing requirements dictate a greater amount speed, mainframe and super computer architectures may similarly be employed.

10 Interface Adapters

[0057] Interface bus(es) 907 may accept, connect, and/or communicate to a number of interface adapters, conventionally although not necessarily in the form of adapter cards, such as but not limited to: input output interfaces (I/O) 908, storage interfaces 909, network interfaces 910, and/or the like. Optionally, cryptographic processor interfaces 927 similarly may be connected to the interface bus. The interface bus provides for the communications of interface adapters with one another as well as with other components of the computer systemization. Interface adapters are adapted for a compatible interface bus. Interface adapters conventionally connect to the interface bus via a slot architecture. Conventional slot architectures may be employed, such as, but not limited to: Accelerated Graphics Port (AGP), Card Bus, (Extended) Industry Standard Architecture ((E)ISA), Micro Channel

15  
20

Architecture (MCA), NuBus, Peripheral Component Interconnect (Extended) (PCI(X)), Personal Computer Memory Card International Association (PCMCIA), and/or the like.

5 [0058] Storage interfaces 909 may accept, communicate, and/or connect to a number of storage devices such as, but not limited to: storage devices 914, removable disc devices, and/or the like. Storage interfaces may employ connection protocols such as, but not limited to: (Ultra) (Serial) Advanced Technology Attachment (Packet Interface) ((Ultra) (Serial) ATA(PI)), (Enhanced) Integrated Drive Electronics ((E)IDE), Institute of Electrical and Electronics Engineers (IEEE) 1394, fiber channel, Small Computer Systems Interface (SCSI), Universal Serial Bus (USB), and/or the like.

10 [0059] Network interfaces 910 may accept, communicate, and/or connect to a communications network 913. Network interfaces may employ connection protocols such as, but not limited to: direct connect, Ethernet (thick, thin, twisted pair 10/100/1000 Base T, and/or the like), Token Ring, wireless connection such as IEEE 802.11a-x, and/or the like. A communications network may be any one and/or the combination of the following: a direct  
15 interconnection; the Internet; a Local Area Network (LAN); a Metropolitan Area Network (MAN); an Operating Missions as Nodes on the Internet (OMNI); a secured custom connection; a Wide Area Network (WAN); a wireless network (e.g., employing protocols such as, but not limited to a Wireless Application Protocol (WAP), I-mode, and/or the like); and/or the like. A network interface may be regarded as a specialized form of an input output  
20 interface. Further, multiple network interfaces 910 may be used to engage with various

communications network types 913. For example, multiple network interfaces may be employed to allow for the communication over broadcast, multicast, and/or unicast networks.

**[0100]** Input Output interfaces (I/O) 908 may accept, communicate, and/or connect to user input devices 911, peripheral devices 912, cryptographic processor devices 928, and/or the like. I/O may employ connection protocols such as, but not limited to: Apple Desktop Bus (ADB); Apple Desktop Connector (ADC); audio: analog, digital, monaural, RCA, stereo, and/or the like; IEEE 1394a-b; infrared; joystick; keyboard; midi; optical; PC AT; PS/2; parallel; radio; serial; USB; video interface: BNC, composite, digital, Digital Visual Interface (DVI), RCA, S-Video, VGA, and/or the like; wireless; and/or the like. A common output device is a video display, which typically comprises a Cathode Ray Tube (CRT) or Liquid Crystal Display (LCD) based monitor with an interface (e.g., DVI circuitry and cable) that accepts signals from a video interface. The video interface composites information generated by a computer systemization and generates video signals based on the composited information in a video memory frame. Typically, the video interface provides the composited video information through a video connection interface that accepts a video display interface (e.g., a DVI connector accepting a DVI display cable).

**[0060]** User input devices 911 may be card readers, dongles, finger print readers, gloves, graphics tablets, joysticks, keyboards, mouse (mice), trackballs, trackpads, retina readers, and/or the like.

**[0061]** Peripheral devices 912 may be connected and/or communicate to I/O and/or other facilities of the like such as network interfaces, storage interfaces, and/or the like.

Peripheral devices may be audio devices, cameras, dongles (e.g., for copy protection, ensuring secure transactions with a digital signature, and/or the like), external processors (for added functionality), goggles, microphones, monitors, network interfaces, printers, scanners, storage devices, video devices, visors, and/or the like.

5 [0062] It should be noted that although user input devices and peripheral devices may be employed, the TCAPS controller may be embodied as an embedded, dedicated, and/or headless device, wherein access would be provided over a network interface connection.

[0063] Cryptographic units such as, but not limited to, microcontrollers, processors 926, interfaces 927, and/or devices 928 may be attached, and/or communicate with the  
10 TCAPS controller. A MC68HC16 microcontroller, commonly manufactured by Motorola Inc., may be used for and/or within cryptographic units. Equivalent microcontrollers and/or processors may also be used. The MC68HC16 microcontroller utilizes a 16-bit multiply-and-accumulate instruction in the 16 MHz configuration and requires less than one second to perform a 512-bit RSA private key operation. Cryptographic units support the authentication  
15 of communications from interacting agents, as well as allowing for anonymous transactions. Cryptographic units may also be configured as part of CPU. Other commercially available specialized cryptographic processors include VLSI Technology's 33 MHz 6868 or Semaphore Communications' 40 MHz Roadrunner 184.

#### Memory

20 [0064] Generally, any mechanization and/or embodiment allowing a processor to affect the storage and/or retrieval of information is regarded as memory 929. However,

memory is a fungible technology and resource, thus, any number of memory embodiments may be employed in lieu of or in concert with one another. It is to be understood that a TCAPS controller and/or a computer systemization may employ various forms of memory 929. For example, a computer systemization may be configured wherein the functionality of on-chip CPU memory (e.g., registers), RAM, ROM, and any other storage devices are provided by a paper punch tape or paper punch card mechanism; of course such an embodiment would result in an extremely slow rate of operation. In a typical configuration, memory 929 will include ROM 906, RAM 905, and a storage device 914. A storage device 914 may be any conventional computer system storage. Storage devices may include a drum; a (fixed and/or removable) magnetic disk drive; a magneto-optical drive; an optical drive (i.e., CD ROM/RAM/Recordable (R), ReWritable (RW), DVD R/RW, etc.); and/or other devices of the like. Thus, a computer systemization generally requires and makes use of memory.

#### Module Collection

15 [0065] The memory 929 may contain a collection of program and/or database modules and/or data such as, but not limited to: operating system module(s) 915 (operating system); information server module(s) 916 (information server); user interface module(s) 917 (user interface); Web browser module(s) 918 (Web browser); database(s) 919; cryptographic server module(s) 920 (cryptographic server); TCAPS module(s) 935; and/or the like (i.e., 20 collectively a module collection). These modules may be stored and accessed from the storage devices and/or from storage devices accessible through an interface bus. Although



non-conventional software modules such as those in the module collection, typically, are stored in a local storage device 914, they may also be loaded and/or stored in memory such as: peripheral devices, RAM, remote storage facilities through a communications network, ROM, various forms of memory, and/or the like.

5                    Operating System

[0066]            The operating system module 915 is executable program code facilitating the operation of a TCAPS controller. Typically, the operating system facilitates access of I/O, network interfaces, peripheral devices, storage devices, and/or the like. The operating system may be a highly fault tolerant, scalable, and secure system such as Apple Macintosh OS X  
10 (Server), AT&T Plan 9, Be OS, Linux, Unix, and/or the like operating systems. However, more limited and/or less secure operating systems also may be employed such as Apple  
Macintosh OS, Microsoft DOS, Palm OS, Windows  
2000/2003/3.1/95/98/CE/Millennium/NT/XP (Server), and/or the like. An operating system may communicate to and/or with other modules in a module collection, including itself,  
15 and/or the like. Most frequently, the operating system communicates with other program modules, user interfaces, and/or the like. For example, the operating system may contain, communicate, generate, obtain, and/or provide program module, system, user, and/or data communications, requests, and/or responses. The operating system, once executed by the CPU, may enable the interaction with communications networks, data, I/O, peripheral  
20 devices, program modules, memory, user input devices, and/or the like. The operating system may provide communications protocols that allow the TCAPS controller to communicate

with other entities through a communications network 913. Various communication protocols may be used by the TCAPS controller as a subcarrier transport mechanism for interaction, such as, but not limited to: multicast, TCP/IP, UDP, unicast, and/or the like.

#### Information Server

5 [0067] An information server module 916 is stored program code that is executed by the CPU. The information server may be a conventional Internet information server such as, but not limited to Apache Software Foundation's Apache, Microsoft's Internet Information Server, and/or the. The information server may allow for the execution of program modules through facilities such as Active Server Page (ASP), ActiveX, (ANSI) (Objective-) C (++),  
10 Common Gateway Interface (CGI) scripts, Java, JavaScript, Practical Extraction Report Language (PERL), Python, WebObjects, and/or the like. The information server may support secure communications protocols such as, but not limited to, File Transfer Protocol (FTP); HyperText Transfer Protocol (HTTP); Secure Hypertext Transfer Protocol (HTTPS), Secure Socket Layer (SSL), and/or the like. The information server provides results in the form of  
15 Web pages to Web browsers, and allows for the manipulated generation of the Web pages through interaction with other program modules. After a Domain Name System (DNS) resolution portion of an HTTP request is resolved to a particular information server, the information server resolves requests for information at specified locations on a TCAPS controller based on the remainder of the HTTP request. For example, a request such as  
20 <http://123.124.125.126/myInformation.html> might have the IP portion of the request "123.124.125.126" resolved by a DNS server to an information server at that IP address; that

information server might in turn further parse the http request for the “/myInformation.html” portion of the request and resolve it to a location in memory containing the information “myInformation.html.” Additionally, other information serving protocols may be employed across various ports, e.g., FTP communications across port 21, and/or the like. An information server may communicate to and/or with other modules in a module collection, including itself, and/or facilities of the like. Most frequently, the information server communicates with the TCAPS database 919, operating systems, other program modules, user interfaces, Web browsers, and/or the like.

**[0068]** Access to TCAPS database may be achieved through a number of database bridge mechanisms such as through scripting languages as enumerated below (e.g., CGI) and through inter-application communication channels as enumerated below (e.g., CORBA, WebObjects, etc.). Any data requests through a Web browser are parsed through the bridge mechanism into appropriate grammars as required by the TCAP. In one embodiment, the information server would provide a Web form accessible by a Web browser. Entries made into supplied fields in the Web form are tagged as having been entered into the particular fields, and parsed as such. The entered terms are then passed along with the field tags, which act to instruct the parser to generate queries directed to appropriate tables and/or fields. In one embodiment, the parser may generate queries in standard SQL by instantiating a search string with the proper join/select commands based on the tagged text entries, wherein the resulting command is provided over the bridge mechanism to the TCAPS as a query. Upon generating query results from the query, the results are passed over the bridge mechanism,

and may be parsed for formatting and generation of a new results Web page by the bridge mechanism. Such a new results Web page is then provided to the information server, which may supply it to the requesting Web browser.

[0069] Also, an information server may contain, communicate, generate, obtain,  
5 and/or provide program module, system, user, and/or data communications, requests, and/or responses.

#### User Interface

[0070] A user interface module 917 is stored program code that is executed by the CPU. The user interface may be a conventional graphic user interface as provided by, with,  
10 and/or atop operating systems and/or operating environments such as Apple Macintosh OS, e.g., Aqua, Microsoft Windows (NT/XP), Unix X Windows (KDE, Gnome, and/or the like), and/or the like. The user interface may allow for the display, execution, interaction, manipulation, and/or operation of program modules and/or system facilities through textual and/or graphical facilities. The user interface provides a facility through which users may  
15 affect, interact, and/or operate a computer system. A user interface may communicate to and/or with other modules in a module collection, including itself, and/or facilities of the like. Most frequently, the user interface communicates with operating systems, other program modules, and/or the like. The user interface may contain, communicate, generate, obtain, and/or provide program module, system, user, and/or data communications, requests, and/or  
20 responses.

Web Browser

**[0071]** A Web browser module 918 is stored program code that is executed by the CPU. The Web browser may be a conventional hypertext viewing application such as Microsoft Internet Explorer or Netscape Navigator. Secure Web browsing may be supplied with 128bit (or greater) encryption by way of HTTPS, SSL, and/or the like. Some Web browsers allow for the execution of program modules through facilities such as Java, JavaScript, ActiveX, and/or the like. Web browsers and like information access tools may be integrated into PDAs, cellular telephones, and/or other mobile devices. A Web browser may communicate to and/or with other modules in a module collection, including itself, and/or facilities of the like. Most frequently, the Web browser communicates with information servers, operating systems, integrated program modules (e.g., plug-ins), and/or the like; e.g., it may contain, communicate, generate, obtain, and/or provide program module, system, user, and/or data communications, requests, and/or responses. Of course, in place of a Web browser and information server, a combined application may be developed to perform similar functions of both. The combined application would similarly affect the obtaining and the provision of information to users, user agents, and/or the like from TCAPS enabled nodes. The combined application may be nugatory on systems employing standard Web browsers.

TCAPS Database

**[0072]** A TCAPS database module 919 may be embodied in a database and its stored data. The database is stored program code, which is executed by the CPU; the stored program code portion configuring the CPU to process the stored data. The database may be a

conventional, fault tolerant, relational, scalable, secure database such as Oracle or Sybase. Relational databases are an extension of a flat file. Relational databases consist of a series of related tables. The tables are interconnected via a key field. Use of the key field allows the combination of the tables by indexing against the key field; i.e., the key fields act as dimensional pivot points for combining information from various tables. Relationships generally identify links maintained between tables by matching primary keys. Primary keys represent fields that uniquely identify the rows of a table in a relational database. More precisely, they uniquely identify rows of a table on the "one" side of a one-to-many relationship.

10 [0073] Alternatively, the TCAPS database may be implemented using various standard data-structures, such as an array, hash, (linked) list, struct, structured text file (e.g., XML), table, and/or the like. Such data-structures may be stored in memory and/or in (structured) files. In another alternative, an object-oriented database may be used, such as Frontier, ObjectStore, Poet, Zope, and/or the like. Object databases can include a number of object collections that are grouped and/or linked together by common attributes; they may be related to other object collections by some common attributes. Object-oriented databases perform similarly to relational databases with the exception that objects are not just pieces of data but may have other types of functionality encapsulated within a given object. If the TCAPS database is implemented as a data-structure, the use of the TCAPS database may be integrated into another module such as the TCAPS module. Also, the database may be implemented as a mix of data structures, objects, and relational structures. Databases may be

consolidated and/or distributed in countless variations through standard data processing techniques. Portions of databases, e.g., tables, may be exported and/or imported and thus decentralized and/or integrated. In one embodiment, the database module 919 includes three tables 919a-c. A user accounts table 919a includes fields such as, but not limited to: a user  
5 name, user address, user authorization information (e.g., user name, password, biometric data, etc.), user credit card, organization, organization account, TCAP unique identifier, account creation data, account expiration date; and/or the like. In one embodiment, user accounts may be activated only for set amounts of time and will then expire once a specified date has been reached. An user data table 919b includes fields such as, but not limited to: a  
10 TCAP unique identifier, backup image, data store, organization account, and/or the like. A user programs table 919c includes fields such as, but not limited to: system programs, organization programs, programs to be synchronized, and/or the like. In one embodiment, user programs may contain various user interface primitives, which may serve to update TCAPs. Also, various accounts may require custom database tables depending upon the  
15 environments and the types of TCAPs a TCAPS may need to serve. It should be noted that any unique fields may be designated as a key field throughout. In an alternative embodiment, these tables have been decentralized into their own databases and their respective database controllers (i.e., individual database controllers for each of the above tables). Employing standard data processing techniques, one may further distribute the databases over several  
20 computer systemizations and/or storage devices. Similarly, configurations of the decentralized database controllers may be varied by consolidating and/or distributing the

various database modules 919a-c. The TCAPS may be configured to keep track of various settings, inputs, and parameters via database controllers.

[0074] A TCAPS database may communicate to and/or with other modules in a module collection, including itself, and/or facilities of the like. Most frequently, the TCAPS database communicates with a TCAPS module, other program modules, and/or the like. The  
5 database may contain, retain, and provide information regarding other nodes and data.

#### Cryptographic Server

[0075] A cryptographic server module 920 is stored program code that is executed by the CPU 903, cryptographic processor 926, cryptographic processor interface 927,  
10 cryptographic processor device 928, and/or the like. Cryptographic processor interfaces will allow for expedition of encryption and/or decryption requests by the cryptographic module; however, the cryptographic module, alternatively, may run on a conventional CPU. The cryptographic module allows for the encryption and/or decryption of provided data. The cryptographic module allows for both symmetric and asymmetric (e.g., Pretty Good  
15 Protection (PGP)) encryption and/or decryption. The cryptographic module may employ cryptographic techniques such as, but not limited to: digital certificates (e.g., X.509 authentication framework), digital signatures, dual signatures, enveloping, password access protection, public key management, and/or the like. The cryptographic module will facilitate numerous (encryption and/or decryption) security protocols such as, but not limited to:  
20 checksum, Data Encryption Standard (DES), Elliptical Curve Encryption (ECC), International Data Encryption Algorithm (IDEA), Message Digest 5 (MD5, which is a one



way hash function), passwords, Rivest Cipher (RC5), Rijndael, RSA (which is an Internet encryption and authentication system that uses an algorithm developed in 1977 by Ron Rivest, Adi Shamir, and Leonard Adleman), Secure Hash Algorithm (SHA), Secure Socket Layer (SSL), Secure Hypertext Transfer Protocol (HTTPS), and/or the like. Employing such

5 encryption security protocols, the TCAPS may encrypt all incoming and/or outgoing communications and may serve as node within a virtual private network (VPN) with a wider communications network. The cryptographic module facilitates the process of “security authorization” whereby access to a resource is inhibited by a security protocol wherein the cryptographic module effects authorized access to the secured resource. In addition, the

10 cryptographic module may provide unique identifiers of content, e.g., employing and MD5 hash to obtain a unique signature for an digital audio file. A cryptographic module may communicate to and/or with other modules in a module collection, including itself, and/or facilities of the like. The cryptographic module supports encryption schemes allowing for the secure transmission of information across a communications network to enable a TCAPS

15 module to engage in secure transactions if so desired. The cryptographic module facilitates the secure accessing of resources on TCAPS and facilitates the access of secured resources on remote systems; i.e., it may act as a client and/or server of secured resources. Most frequently, the cryptographic module communicates with information servers, operating systems, other program modules, and/or the like. The cryptographic module may contain,

20 communicate, generate, obtain, and/or provide program module, system, user, and/or data communications, requests, and/or responses.

TCAPS

[0076] A TCAPS module 935 is stored program code that is executed by the CPU. The TCAPS affects accessing, obtaining and the provision of information, services, transactions, and/or the like across various communications networks. The TCAPS enables

5 TCAP users to simply access data and/or services across a communications network in a secure manner. The TCAPS extends the storage and processing capacities and capabilities of TCAPs. The TCAPS coordinates with the TCAPS database to identify interassociated items in the generation of entries regarding any related information. A TCAPS module enabling access of information between nodes may be developed by employing standard development

10 tools such as, but not limited to: (ANSI) (Objective-) C (++), Apache modules, binary executables, Java, Javascript, mapping tools, procedural and object oriented development tools, PERL, Python, shell scripts, SQL commands, web application server extensions, WebObjects, and/or the like. In one embodiment, the TCAPS server employs a cryptographic server to encrypt and decrypt communications. A TCAPS module may communicate to

15 and/or with other modules in a module collection, including itself, and/or facilities of the like. Most frequently, the TCAPS module communicates with a TCAPS database, operating systems, other program modules, and/or the like. The TCAPS may contain, communicate, generate, obtain, and/or provide program module, system, user, and/or data communications, requests, and/or responses.

Distributed TCAP

[0077] The structure and/or operation of any of the TCAPS node controller components may be combined, consolidated, and/or distributed in any number of ways to facilitate development and/or deployment. Similarly, the module collection may be combined  
5 in any number of ways to facilitate deployment and/or development. To accomplish this, one may integrate the components into a common code base or in a facility that can dynamically load the components on demand in an integrated fashion.

[0078] The module collection may be consolidated and/or distributed in countless variations through standard data processing and/or development techniques. Multiple  
10 instances of any one of the program modules in the program module collection may be instantiated on a single node, and/or across numerous nodes to improve performance through load-balancing and/or data-processing techniques. Furthermore, single instances may also be distributed across multiple controllers and/or storage devices; e.g., databases. All program module instances and controllers working in concert may do so through standard data  
15 processing communication techniques.

[0079] The configuration of the TCAPS controller will depend on the context of system deployment. Factors such as, but not limited to, the budget, capacity, location, and/or use of the underlying hardware resources may affect deployment requirements and configuration. Regardless of if the configuration results in more consolidated and/or  
20 integrated program modules, results in a more distributed series of program modules, and/or results in some combination between a consolidated and distributed configuration, data may

be communicated, obtained, and/or provided. Instances of modules consolidated into a common code base from the program module collection may communicate, obtain, and/or provide data. This may be accomplished through intra-application data processing communication techniques such as, but not limited to: data referencing (e.g., pointers),  
5 internal messaging, object instance variable communication, shared memory space, variable passing, and/or the like.

[0080] If module collection components are discrete, separate, and/or external to one another, then communicating, obtaining, and/or providing data with and/or to other module components may be accomplished through inter-application data processing communication  
10 techniques such as, but not limited to: Application Program Interfaces (API) information passage; (distributed) Component Object Model ((D)COM), (Distributed) Object Linking and Embedding ((D)OLE), and/or the like), Common Object Request Broker Architecture (CORBA), process pipes, shared files, and/or the like. Messages sent between discrete  
15 module components for inter-application communication or within memory spaces of a singular module for intra-application communication may be facilitated through the creation and parsing of a grammar. A grammar may be developed by using standard development tools such as lex, yacc, and/or the like, which allow for grammar generation and parsing functionality, which in turn may form the basis of communication messages within and  
20 between modules. Again, the configuration will depend upon the context of system deployment.

TUNNELING CLIENT ACCESS POINT CONTROLLER

**[0081]** Figure 10 illustrates one embodiment incorporated into a tunneling client access point (TCAP) controller 1001. Much of the description of the TCAPS of Figure 9 applies to the TCAP, and as such, the disclosure focuses more upon the variances exhibited in the TCAP. In this embodiment, the TCAP controller 1001 may serve to process, store, search, identify, instruct, generate, match, and/or update data within itself, at a TCAPS, and/or through an AT.

**[0082]** The first and foremost difference between the TCAP and the TCAPS is that the TCAP is very small as was shown 130 of Figure 1. The TCAP may be packaged in plugin sticks, often, smaller than the size of a human thumb. In one embodiment, a TCAP may be hardened for military use. In such an embodiment, the shell 1001 may be composed of metal, and/or other durable composites. Also, components within may be shielded from radiation.

**[0083]** In one embodiment, the TCAP controller 1001 may be connected to and/or communicate with entities such as, but not limited to: one or more users from an access terminal 1011b. The access terminal itself may be connected to peripherals such as user input devices (e.g., keyboard 1012a, mouse 1012b, etc.); and/or a communications network 1013 in manner similar to that described in Figure 9.

**[0084]** A TCAP controller 1001 may be based on common computer systems components that may comprise, but are not limited to, components such as: a computer systemization 1002 connected to memory 1029. Optionally, the TCAP controller 1001 may

convey information 1058, produce output through an output device 1048, and obtain input from control device 1018.

### Control Device

[0085] The control device 1018 may be optionally provided to accept user input to  
5 control access to the TCAP controller. In one embodiment, the control device may provide a keypad 1028. Such a keypad would allow the user to enter passwords, personal identification numbers (PIN), and/or the like.

[0086] In an alternative embodiment, the control device may include a security  
device 1038. In one embodiment, the security device is a fingerprint integrated circuit  
10 (fingerprint IC) that provides biometric fingerprint information such as, but not limited to AuthenTec Inc.'s FingerLoc™ AF-S2™. Either a fingerprint IC and/or other biometric device will provide biometric validation information that may be used to confirm the identity of a TCAP user and ensure that transactions are legitimate. In alternative embodiments, a simple button, heat sensor, and/or other type of user input functionality may be provided  
15 solely and/or in concert with other types of control device types. The control device may be connected to the I/O interface, the system bus, or the CPU directly.

[0087] The output device 1048 is used to provide status information to the user. In one alternative embodiment, the output device is an LCD panel capable of providing alpha numeric and/or graphic displays. In an alternative embodiment, the output device may be a  
20 speaker providing audible signals indicating errors and/or actually streaming information that

is audible to the user, such as voice alerts. The output device may be connected to the I/O interface, the system bus, or the CPU directly.

**[0088]** The conveyance information 1058 component of the TCAP controller may include any number of indicia representing the TCAP's source on the cover 1001. Source  
5 conveying indicia may include, but is not limited to: an owner name 1059 for readily verifying a TCAP user; a photo of the owner 1060 for readily verifying a TCAP controller owner; mark designating the source that issued the TCAP 1061, 1001 such as a corporate logo, and/or the like; fanciful design information 1062 for enhancing the visual appearance of the TCAP; and/or the like. It should be noted that the conveyance information 11421 may be  
10 positioned anywhere on the cover 1189.

#### Computer Systemization

**[0089]** A computer systemization 1002 may comprise a clock 1030, central processing unit (CPU) 1003, a read only memory (ROM) 1006, a random access memory (RAM) 1005, and/or an interface bus 1007, and most frequently, although not necessarily,  
15 are all interconnected and/or communicating through a system bus 1004. Optionally the computer systemization may be connected to an internal power source 1086. Optionally, a cryptographic processor 1026 may be connected to the system bus. The system clock typically has a crystal oscillator and provides a base signal. Of course, any of the above components may be connected directly to one another, connected to the CPU, and/or  
20 organized in numerous variations employed as exemplified by various computer systems.

[0090] The CPU comprises at least one low-power data processor adequate to execute program modules for executing user and/or system-generated requests. The CPU may be a microprocessor such as ARM's Application Cores, Embedded Cores, Secure Cores; Motorola's DragonBall; and/or the like processor(s).

5 Power Source

[0091] The power source 1086 may be of any standard form for powering small electronic circuit board devices such as but not limited to: alkaline, lithium hydride, lithium ion, nickel cadmium, solar cells, and/or the like. In the case of solar cells, the case provides an aperture through which the solar cell protrudes are to receive photonic energy. The power cell 1086 is connected to at least one of the interconnected subsequent components of the TCAP thereby providing an electric current to all subsequent components. In one example, the power cell 1086 is connected to the system bus component 1004. In an alternative embodiment, an outside power source 1086 is provided through a connection across the I/O 1008 interface. For example, a USB and/or IEEE 1394 connection carries both data and power across the connection and is therefore a suitable source of power.

Interface Adapters

[0092] Interface bus(es) 1007 may accept, connect, and/or communicate to a number of interface adapters, conventionally although not necessarily in the form of adapter cards, such as but not limited to: input output interfaces (I/O) 1008, storage interfaces 1009, network interfaces 1010, and/or the like. Optionally, cryptographic processor interfaces 1027 similarly may be connected to the interface bus. The interface bus provides for the



communications of interface adapters with one another as well as with other components of the computer systemization. Interface adapters are adapted for a compatible interface bus. In one embodiment, the interface bus provides I/O 1008 via a USB port. In an alternative embodiment, the interface bus provides I/O via an IEEE 1394 port. In an alternative  
5 embodiment, wireless transmitters are employed by interfacing wireless protocol integrated circuits (ICs) for I/O via the interface bus 1007.

[0093] Storage interfaces 1009 may accept, communicate, and/or connect to a number of storage devices such as, but not limited to: storage devices 1014, removable disc devices, and/or the like. Storage interfaces may employ connection protocols such as, but not  
10 limited to a flash memory connector, and/or the like. In one embodiment, an optional network interface may be provide 1010.

[0101] Input Output interfaces (I/O) 1008 may accept, communicate, and/or connect to an access terminal 1011b.. I/O may employ connection protocols such as, but not limited to: Apple Desktop Bus (ADB); Apple Desktop Connector (ADC); IEEE 1394a-b; infrared;  
15 PC AT; PS/2; parallel; radio; serial; USB, and/or the like; wireless component; and/or the like.

#### Wireless Component

[0102] In one embodiment a wireless component may comprise a Bluetooth chip disposed in communication with a transceiver 1043 and a memory 1029 through the interface  
20 bus 1007 and/or system bus 1004. The transceiver may be either external to the Bluetooth chip, or integrated within the Bluetooth chip itself. The transceiver is a radio frequency (RF)

transceiver operating in the range as required for Bluetooth transmissions. Further, the Bluetooth chip 1044 may integrate an input/output interface (I/O) 1066. The Bluetooth chip and its I/O may be configured to interface with the TCAP controller through the interface bus, the system buss, and/or directly with the CPU. The I/O may be used to interface with

5 other components such as an access terminal 1011b equipped with similar wireless capabilities. In one embodiment, the TCAP may optionally interconnect wirelessly with a peripheral device 912 and/or a control device 911 of Figure 9. In one example embodiment, the I/O may be based on serial line technologies, a universal serial bus (USB) protocol, and/or the like. In an alternative embodiment, the I/O may be based on the ISO 7816-3

10 standard. It should be noted that the Bluetooth chip in an alternative embodiment may be replaced with an IEEE 802.11b wireless chip. In another embodiment, both a Bluetooth chip and an IEEE 802.11b wireless chip may be used to communicate and or bridge communications with respectively enabled devices. It should further be noted that the transceiver 1043 may be used to wirelessly communicate with other devices powered by

15 Bluetooth chips and/or IEEE 802.11b chips and/or the like. The ROM can provide a basic instruction set enabling the Bluetooth chip to use its I/O to communicate with other components. A number of Bluetooth chips are commercially available, and may be used as a Bluetooth chip in the wireless component, such as, but not limited to, CSR's BlueCore line of chips. If IEEE 802.11b functionality is required, a number of chips are commercially

20 available for the wireless component as well.

[0094] Cryptographic units such as, but not limited to, microcontrollers, processors 1026, and/or interfaces 1027 may be attached, and/or communicate with the TCAP controller. A Secure Core component commonly manufactured by ARM, Inc. and may be used for and/or within cryptographic units.

5                    Memory

[0095] Generally, any mechanization and/or embodiment allowing a processor to affect the storage and/or retrieval of information is regarded as memory 1029. However, memory is a fungible technology and resource, thus, any number of memory embodiments may be employed in lieu of or in concert with one another. It is to be understood that a TCAP  
10 controller and/or a computer systemization may employ various forms of memory-1029. In a typical configuration, memory 1029 will include ROM 1006, RAM 1005, and a storage device 1014. A storage device 1014 may be any conventional computer system storage. Storage devices may include flash memory, micro hard drives, and/or the like.

Module Collection

15 [0096] The memory 1029 may contain a collection of program and/or database modules and/or data such as, but not limited to: operating system module(s) 1015 (operating system); information server module(s) 1016 (information server); user interface module(s) 1017 (user interface); Web browser module(s) 1018 (Web browser); database(s) 1019; cryptographic server module(s) 1020 (cryptographic server); access terminal module 1021;  
20 TCAP module(s) 1035; and/or the like (i.e., collectively a module collection). These modules may be stored and accessed from the storage devices and/or from storage devices accessible

through an interface bus. Although non-conventional software modules such as those in the module collection, typically, are stored in a local storage device 1014, they may also be loaded and/or stored in memory such as: peripheral devices, RAM, remote storage facilities through an access terminal, communications network, ROM, various forms of memory, and/or the like. In one embodiment, all data stored in memory is encrypted by employing the cryptographic server 1020 as described in further detail below. In one embodiment, the ROM contains a unique TCAP identifier. For example, the TCAP may contain a unique digital certificate, number, and/or the like, which may be used for purposes of verification and encryption across a network and/or in conjunction with a TCAPS.

#### 10                    Operating System

[0097]            The operating system module 1015 is executable program code facilitating the operation of a TCAP controller. Typically, the operating system facilitates access of I/O, network interfaces, peripheral devices, storage devices, and/or the like. The operating system may be a highly fault tolerant, scalable, and secure system such as Linux, and/or the like operating systems. However, more limited and/or less secure operating systems also may be employed such as Java runtime OS, and/or the like. An operating system may communicate to and/or with other modules in a module collection, including itself, and/or the like. Most frequently, the operating system communicates with other program modules, user interfaces, and/or the like. For example, the operating system may contain, communicate, generate, obtain, and/or provide program module, system, user, and/or data communications, requests, and/or responses. The operating system, once executed by the CPU, may enable the

interaction with an access terminal, communications networks, data, I/O, peripheral devices, program modules, memory, user input devices, and/or the like. The operating system may provide communications protocols that allow the TCAP controller to communicate with other entities through an access terminal. Various communication protocols may be used by the TCAP controller as a subcarrier transport mechanism for interaction, such as, but not limited to: TCP/IP, USB, and/or the like.

#### Information Server

[0098] An information server module 1016 is stored program code that is executed by the CPU. The information server may be a conventional Internet information server such as, but not limited to Apache Software Foundation's Apache, and/or the like. The information server may allow for the execution of program modules through facilities such as: Active Server Page (ASP), ActiveX, (ANSI) (Objective-) C (++), Common Gateway Interface (CGI) scripts, Java, JavaScript, Practical Extraction Report Language (PERL), Python, WebObjects, and/or the like. The information server may support secure communications protocols such as, but not limited to, File Transfer Protocol (FTP); HyperText Transfer Protocol (HTTP); Secure Hypertext Transfer Protocol (HTTPS), Secure Socket Layer (SSL), and/or the like. The information server provides results in the form of Web pages to Web browsers, and allows for the manipulated generation of the Web pages through interaction with other program modules. An information server may communicate to and/or with other modules in a module collection, including itself, and/or facilities of the like. Most frequently,

the information server communicates with the TCAP database 1019, operating systems, other program modules, user interfaces, Web browsers, and/or the like.

**[0099]** Access to TCAP database may be achieved through a number of database bridge mechanisms such as through scripting languages as enumerated below (e.g., CGI) and  
5 through inter-application communication channels as enumerated below (e.g., CORBA, WebObjects, etc.). Any data requests through a Web browser are parsed through the bridge mechanism into appropriate grammars as required by the TCAP. In one embodiment, the information server would provide a Web form accessible by a Web browser. Entries made into supplied fields in the Web form are tagged as having been entered into the particular  
10 fields, and parsed as such. The entered terms are then passed along with the field tags, which act to instruct the parser to generate queries directed to appropriate tables and/or fields. In one embodiment, the parser may generate queries in standard SQL by instantiating a search string with the proper join/select commands based on the tagged text entries, wherein the resulting command is provided over the bridge mechanism to the TCAP as a query. Upon  
15 generating query results from the query, the results are passed over the bridge mechanism, and may be parsed for formatting and generation of a new results Web page by the bridge mechanism. Such a new results Web page is then provided to the information server, which may supply it to the requesting Web browser.

**[00100]** Also, an information server may contain, communicate, generate, obtain,  
20 and/or provide program module, system, user, and/or data communications, requests, and/or responses.

### User Interface

[00101] A user interface module 1017 is stored program code that is executed by the CPU. The user interface may be a conventional graphic user interface as provided by, with, and/or atop operating systems and/or operating environments such as Apple Macintosh OS, e.g., Aqua, Microsoft Windows (NT/XP), Unix X Windows (KDE, Gnome, and/or the like), and/or the like. The TCAP may employ code natively compiled for various operating systems, or code compiled using Java. The user interface may allow for the display, execution, interaction, manipulation, and/or operation of program modules and/or system facilities through textual and/or graphical facilities. The user interface provides a facility through which users may affect, interact, and/or operate a computer system. A user interface may communicate to and/or with other modules in a module collection, including itself, and/or facilities of the like. Most frequently, the user interface communicates with operating systems, other program modules, and/or the like. The user interface may contain, communicate, generate, obtain, and/or provide program module, system, user, and/or data communications, requests, and/or responses.

### Web Browser

[00102] A Web browser module 1018 is stored program code that is executed by the CPU. A small-scale embedded Web browser may allow the TCAP to access and communicate with an attached access terminal, and beyond across a communications network. An example browser is Blazer, Opera, FireFox, etc. A browsing module may contain, communicate, generate, obtain, and/or provide program module, system, user, and/or

data communications, requests, and/or responses. Of course, in place of a Web browser and information server, a combined application may be developed to perform similar functions of both. The combined application would similarly affect the obtaining and the provision of information to users, user agents, and/or the like from TCAP enabled nodes. The combined  
5 application may be nugatory on systems employing standard Web browsers.

#### TCAP Database

[00103] A TCAP database module 1019 may be embodied in a database and its stored data. The database is stored program code, which is executed by the CPU; the stored program code portion configuring the CPU to process the stored data. In one embodiment, the TCAP  
10 database may be implemented using various standard data-structures, such as an array; hash, (linked) list, struct, structured text file (e.g., XML), table, and/or the like. Such data-structures may be stored in memory and/or in (structured) files. If the TCAP database is implemented as a data-structure, the use of the TCAP database may be integrated into another module such as the TCAP module. Databases may be consolidated and/or distributed  
15 in countless variations through standard data processing techniques. Portions of databases, e.g., tables, may be exported and/or imported and thus decentralized and/or integrated. In one embodiment, the database module 1019 includes three tables 1019a-c. A user accounts table 1019a includes fields such as, but not limited to: a user name, user address, user authorization information (e.g., user name, password, biometric data, etc.), user credit card, organization,  
20 organization account, TCAP unique identifier, account creation data, account expiration date; and/or the like. In one embodiment, user accounts may be activated only for set amounts of



time and will then expire once a specified date has been reached. An user data table 1019b includes fields such as, but not limited to: a TCAP unique identifier, backup image, data store, organization account, and/or the like. In one embodiment, the entire TCAP memory 1029 is processed into an image and spooled to a TCAPS for backup storage. A user programs table 1019c includes fields such as, but not limited to: system programs, organization programs, programs to be synchronized, and/or the like. It should be noted that any unique fields may be designated as a key field throughout. In an alternative embodiment, these tables have been decentralized into their own databases and their respective database controllers (i.e., individual database controllers for each of the above tables). Employing standard data processing techniques, one may further distribute the databases over several computer systemizations and/or storage devices. Similarly, configurations of the decentralized database controllers may be varied by consolidating and/or distributing the various database modules 1019a-c. The TCAP may be configured to keep track of various settings, inputs, and parameters via database controllers.

15 [00104] A TCAP database may communicate to and/or with other modules in a module collection, including itself, and/or facilities of the like. Most frequently, the TCAP database communicates with a TCAP module, other program modules, and/or the like. The database may contain, retain, and provide information regarding other nodes and data.

#### Cryptographic Server

20 [00105] A cryptographic server module 1020 is stored program code that is executed by the CPU 1003, cryptographic processor 1026, cryptographic processor interface 1027,

and/or the like. Cryptographic processor interfaces will allow for expedition of encryption and/or decryption requests by the cryptographic module; however, the cryptographic module, alternatively, may run on a conventional CPU. The cryptographic module allows for the encryption and/or decryption of provided data. The cryptographic module allows for both

5 symmetric and asymmetric (e.g., Pretty Good Protection (PGP)) encryption and/or decryption. The cryptographic module may employ cryptographic techniques such as, but not limited to: digital certificates (e.g., X.509 authentication framework), digital signatures, dual signatures, enveloping, password access protection, public key management, and/or the like. The cryptographic module will facilitate numerous (encryption and/or decryption) security

10 protocols such as, but not limited to: checksum, Data Encryption Standard (DES), Elliptical Curve Encryption (ECC), International Data Encryption Algorithm (IDEA), Message Digest 5 (MD5, which is a one way hash function), passwords, Rivest Cipher (RC5), Rijndael, RSA (which is an Internet encryption and authentication system that uses an algorithm developed in 1977 by Ron Rivest, Adi Shamir, and Leonard Adleman), Secure Hash Algorithm (SHA),

15 Secure Socket Layer (SSL), Secure Hypertext Transfer Protocol (HTTPS), and/or the like. The cryptographic module facilitates the process of "security authorization" whereby access to a resource is inhibited by a security protocol wherein the cryptographic module effects authorized access to the secured resource. In addition, the cryptographic module may provide unique identifiers of content, e.g., employing and MD5 hash to obtain a unique signature for

20 an digital audio file. A cryptographic module may communicate to and/or with other modules in a module collection, including itself, and/or facilities of the like. The cryptographic module supports encryption schemes allowing for the secure transmission of information

across a communications network to enable a TCAP module to engage in secure transactions if so desired. The cryptographic module facilitates the secure accessing of resources on TCAP and facilitates the access of secured resources on remote systems; i.e., it may act as a client and/or server of secured resources. Most frequently, the cryptographic module communicates with information servers, operating systems, other program modules, and/or the like. The cryptographic module may contain, communicate, generate, obtain, and/or provide program module, system, user, and/or data communications, requests, and/or responses. In one embodiment, the TCAP employs the cryptographic server to encrypt all data stored in memory 1029 based on the TCAP's unique ID and user's authorization information. In another embodiment, the TCAP employs the cryptographic server to encrypt all data sent through the access terminal based in the TCAP's unique ID and user's authorization information.

### TCAP

**[00106]** A TCAP module 1035 is stored program code that is executed by the CPU. The TCAP affects accessing, obtaining and the provision of information, services, storage, transactions, and/or the like within its memory and/or across various communications networks. The TCAP enables users to simply access data and/or services from any location where an access terminal is available. It provides secure, extremely low powerful and ultra portable access to data and services that were heretofore impossible. The TCAP coordinates with the TCAP database to identify interassociated items in the generation of entries regarding any related information. A TCAP module enabling access of information between

nodes may be developed by employing standard development tools such as, but not limited to: (ANSI) (Objective-) C (++), Apache modules, binary executables, Java, Javascript, mapping tools, procedural and object oriented development tools, PERL, Python, shell scripts, SQL commands, web application server extensions, WebObjects, and/or the like. In

5 one embodiment, the TCAP server employs a cryptographic server to encrypt and decrypt communications. A TCAP module may communicate to and/or with other modules in a module collection, including itself, and/or facilities of the like. Most frequently, the TCAP module communicates with a TCAP database, a TCAP access terminal module 1021 running on an access terminal 1011b, operating systems, other program modules, and/or the like. The

10 TCAP may contain, communicate, generate, obtain, and/or provide program module, system, user, and/or data communications, requests, and/or responses.

#### Access Terminal Module

[00107] An access terminal module 1021 is stored program code that is executed by a CPU. In one embodiment, the TCAP allows the access terminal 1011b to access its memory

15 1029 across its I/O 1008 and the access terminal executes the module. The access terminal module affects accessing, obtaining and the provision of information, services, storage, transactions, and/or the like within the TCAP's and access terminal's memory and/or across various communications networks. The access terminal module 1021 acts as a bridge through which the TCAP can communicate with communications network, and through which users

20 may interact with the TCAP by using the I/O of the access terminal. The access terminal module coordinates with the TCAP module 1035 to send data and communications back and

forth. A access terminal module enabling access of information between the TCAP and access terminal may be developed by employing standard development tools such as, but not limited to: (ANSI) (Objective-) C (++), Apache modules, binary executables, Java, Javascript, mapping tools, procedural and object oriented development tools, PERL, Python, shell scripts, SQL commands, web application server extensions, WebObjects, and/or the like. In one embodiment, the access terminal module is compiled for target access terminal platform, e.g., for Windows. In an alternative embodiment, a processor independent approach is taken, e.g., Java is used, so that the access terminal module will run on multiple platforms. In another embodiment, the TCAP server employs a cryptographic server to encrypt and decrypt communications as between it, the TCAP, and outside servers. A access terminal module may communicate to and/or with other modules in a module collection, including itself, and/or facilities of the like. Most frequently, the access terminal module communicates with a TCAP, , other program modules, and/or the like. The access terminal module may contain, communicate, generate, obtain, and/or provide program module, system, user, and/or data communications, requests, and/or responses.

#### Distributed TCAP

[00108] The structure and/or operation of any of the TCAP node controller components may be combined, consolidated, and/or distributed in any number of ways to facilitate development and/or deployment. Similarly, the module collection may be combined in any number of ways to facilitate deployment and/or development. To accomplish this, one

may integrate the components into a common code base or in a facility that can dynamically load the components on demand in an integrated fashion.

**[00109]** The module collection may be consolidated and/or distributed in countless variations through standard data processing and/or development techniques. Multiple instances of any one of the program modules in the program module collection may be instantiated on a single node, and/or across numerous nodes to improve performance through load-balancing and/or data-processing techniques. Furthermore, single instances may also be distributed across multiple controllers and/or storage devices; e.g., databases. All program module instances and controllers working in concert may do so through standard data processing communication techniques.

**[00110]** The configuration of the TCAP controller will depend on the context of system deployment. Factors such as, but not limited to, the budget, capacity, location, and/or use of the underlying hardware resources may affect deployment requirements and configuration. Regardless of if the configuration results in more consolidated and/or integrated program modules, results in a more distributed series of program modules, and/or results in some combination between a consolidated and distributed configuration, data may be communicated, obtained, and/or provided. Instances of modules consolidated into a common code base from the program module collection may communicate, obtain, and/or provide data. This may be accomplished through intra-application data processing communication techniques such as, but not limited to: data referencing (e.g., pointers),

internal messaging, object instance variable communication, shared memory space, variable passing, and/or the like.

**[00111]** If module collection components are discrete, separate, and/or external to one another, then communicating, obtaining, and/or providing data with and/or to other module components may be accomplished through inter-application data processing communication techniques such as, but not limited to: Application Program Interfaces (API) information passage; (distributed) Component Object Model ((D)COM), (Distributed) Object Linking and Embedding ((D)OLE), and/or the like), Common Object Request Broker Architecture (CORBA), process pipes, shared files, and/or the like. Messages sent between discrete module components for inter-application communication or within memory spaces of a singular module for intra-application communication may be facilitated through the creation and parsing of a grammar. A grammar may be developed by using standard development tools such as lex, yacc, and/or the like, which allow for grammar generation and parsing functionality, which in turn may form the basis of communication messages within and between modules. Again, the configuration will depend upon the context of system deployment.

**[00112]** The entirety of this disclosure (including the Cover Page, Title, Headings, Field, Background, Summary, Brief Description of the Drawings, Detailed Description, Claims, Abstract, Figures, and otherwise) shows by way of illustration various embodiments

in which the claimed inventions may be practiced. The advantages and features of the disclosure are of a representative sample of embodiments only, and are not exhaustive and/or exclusive. They are presented only to assist in understanding and teach the claimed principles. It should be understood that they are not representative of all claimed inventions.

5 As such, certain aspects of the disclosure have not been discussed herein. That alternate embodiments may not have been presented for a specific portion of the invention or that further undescribed alternate embodiments may be available for a portion is not to be considered a disclaimer of those alternate embodiments. It will be appreciated that many of those undescribed embodiments incorporate the same principles of the invention and others

10 are equivalent. Thus, it is to be understood that other embodiments may be utilized and functional, logical, organizational, structural and/or topological modifications may be made without departing from the scope and/or spirit of the disclosure. As such, all examples and/or embodiments are deemed to be non-limiting throughout this disclosure. Also, no inference should be drawn regarding those embodiments discussed herein relative to those not

15 discussed herein other than for purposes of space and reducing repetition. For instance, it is to be understood that the logical and/or topological structure of any combination of any program modules (a module collection), other components and/or any present feature sets as described in the figures and/or throughout are not limited to a fixed operating order and/or arrangement, but rather, any disclosed order is exemplary and all equivalents, regardless of

20 order, are contemplated by the disclosure. Furthermore, it is to be understood that such features are not limited to serial execution, but rather, any number of threads, processes, services, servers, and/or the like that may execute asynchronously, simultaneously,



synchronously, and/or the like are contemplated by the disclosure. As such, some of these features may be mutually contradictory, in that they cannot be simultaneously present in a single embodiment. Similarly, some features are applicable to one aspect of the invention, and inapplicable to others. In addition, the disclosure includes other inventions not presently  
5 claimed. Applicant reserves all rights in those presently unclaimed inventions including the right to claim such inventions, file additional applications, continuations, continuations in part, divisions, and/or the like thereof. As such, it should be understood that advantages, embodiments, examples, functional, features, logical, organizational, structural, topological, and/or other aspects of the disclosure are not to be considered limitations on the disclosure as  
10 defined by the claims or limitations on equivalents to the claims.

1

**CLAIMS**

2

What is claimed is:

3           1.       A portable tunneling storage and processing apparatus, comprising:  
4           a memory,  
5                    wherein the memory contains a unique apparatus identifier,  
6                    wherein the memory contains user verifying information;  
7           a processor disposed in communication with the memory, and configured to issue a  
8 plurality of processing instructions stored in the memory,  
9                    wherein the processing instructions issue signals to:  
10                   provide a terminal access to the memory;  
11                   execute processing instructions from the memory on the terminal to  
12 access the terminal, wherein the terminal acts as a proxy for the terminal's input and output  
13 peripheral devices, and wherein the terminal acts as a network interface proxy;  
14                   process processing instructions, wherein the processing instructions  
15 are stored in the memory, wherein the processing instructions are used to issue signals to  
16 process processing instruction on the processor;  
17                   encrypt the memory based on the apparatus identifier and user  
18 verifying information;  
19                   effect the display of processing activity on the terminal;  
20           a conduit for external communications disposed in communication with the  
21 processor, configured to issue a plurality of communication instructions as provided by the  
22 processor, configured to issue the communication instructions as signals to engage in  
23 communications with other devices having compatible conduits, and configured to receive  
24 signals issued from the compatible conduits, wherein the conduits are USB conduits,

25                    wherein the communication instructions issue signals to:  
26                                 communicate with a terminal;  
27                                 communicate with a server;  
28                    wherein the communication instruction issued signals are encrypted,  
29 wherein the encryption occurs on the processor,  
30                                 wherein received encrypted instruction signals are decrypted, and  
31 wherein decryption occurs on the processor.

1            2.        A portable tunneling storage and processing apparatus, comprising:  
2            a memory,  
3                         wherein the memory contains a unique apparatus identifier;  
4            a processor disposed in communication with the memory, and configured to issue a  
5 plurality of processing instructions stored in the memory,  
6                         wherein the processing instructions issue signals to:  
7                                 provide a terminal access to the memory,  
8                                 process processing instructions,  
9            a conduit for external communications disposed in communication with the  
10 processor, configured to issue a plurality of communication instructions as provided by the  
11 processor, configured to issue the communication instructions as signals to engage in  
12 communications with other devices having compatible conduits, and configured to receive  
13 signals issued from the compatible conduits,  
14                         wherein the communication instructions issue signals to:  
15                                 communicate at a terminal.

1           3.       The apparatus of claim 2, wherein the unique apparatus identifier is a digital  
2 signature.

1           4.       The apparatus of claim 2, wherein the memory contains user verifying  
2 information.

1           5.       The apparatus of claim 4, wherein the user verifying information is a digital  
2 signature.

1           6.       The apparatus of claim 4, wherein the user verifying information is a  
2 username and password.

1           7.       The apparatus of claim 6, further, comprising:

2           wherein the processing instructions issue signals to:

3                       encrypt the memory based on the unique apparatus identifier and user  
4 verifying information.

1           8.       The apparatus of claim 2, further, comprising:

2           wherein the processing instructions issue signals to:

3                       execute processing instructions from the memory on the terminal to access the  
4 terminal.

1           9.       The apparatus of claim 2, wherein the terminal acts as a proxy for the  
2 terminal's input and output peripheral devices, and acts as a network interface proxy.

1           10.      The apparatus of claim 2, wherein the processing instructions are stored on the  
2 memory.

1           11.      The apparatus of claim 2, wherein the processing instructions are obtained  
2 from a server.

1           12.     The apparatus of claim 2, wherein the processing instructions are processed on  
2 the processor.

1           13.     The apparatus of claim 12, wherein the processing instructions are processed  
2 on the processor to process files for printing.

1           14.     The apparatus of claim 2, wherein the processing instructions are processed on  
2 the terminal.

1           15.     The apparatus of claim 2, wherein the processing instructions are processed on  
2 the server.

1           16.     The apparatus of claim 2, further, comprising:  
2           wherein the processing instructions issue signals to:  
3           effect the display of processing activity.

1           17.     The apparatus of claim 16, wherein the display of processing activity occurs  
2 on the terminal.

1           18.     The apparatus of claim 16, wherein the display of processing activity occurs  
2 directly in the terminal's video memory.

1           19.     The apparatus of claim 2, wherein the conduits are USB conduits.

1           20.     The apparatus of claim 2, wherein the conduits are wireless conduits.

1           21.     The apparatus of claim 20, wherein the wireless conduits are Bluetooth.

1           22.     The apparatus of claim 20, wherein the wireless conduits are WiFi.

1           23.     The apparatus of claim 2, further, comprising:  
2           wherein the communication instructions issue signals to:  
3           communicate with a server.

1           24.    The apparatus of claim 23, wherein the communication instruction issued  
2 signals are encrypted.

1           25.    The apparatus of claim 24, wherein the encryption occurs on the processor.

1           26.    The apparatus of claim 24, wherein the encryption occurs on the terminal.

1           27.    The apparatus of claim 24, wherein the encryption occurs on the server.

1           28.    The apparatus of claim 23, wherein received encrypted instruction signals are  
2 decrypted.

1           29.    The apparatus of claim 28, wherein the encryption occurs on the processor.

1           30.    The apparatus of claim 28, wherein the encryption occurs on the terminal.

1           31.    The apparatus of claim 28, wherein the encryption occurs on the server.

1           32.    A method of accessing data, comprising:  
2           engaging a portable storage device with a terminal,  
3                    wherein the portable storage device has a processor,  
4                    wherein the portable storage device connects to the terminal across compatible  
5 conduits for external communications, wherein the storage device has a memory, wherein the  
6 memory and a storage conduit are disposed in communication with the processor, wherein  
7 the conduits are USB conduits;  
8           providing the memory for access on the terminal,  
9                    wherein the memory is mounted on the terminal;  
10          executing processing instructions from the memory on the terminal to access the  
11 terminal;  
12          communicating through the conduit at a terminal,  
13                    wherein the terminal acts as a proxy for the terminal's input and output  
14 peripheral devices, and acts as a network interface proxy,  
15                    wherein communication instruction issued signals are encrypted,  
16                    wherein the encryption occurs on the processor,  
17                    wherein received encrypted instruction signals are decrypted,  
18                    wherein decryption occurs on the processor;  
19          executing processing instructions on the processor,  
20                    wherein the processing instructions are stored on the memory,  
21                    wherein the processing instructions are used to issue signals to process



22 processing instruction on the processor; and

23 effecting the display of processing activity on the terminal.

1 33. A method of accessing data, comprising:

2 disposing a portable storage device in communication with a terminal,

3 wherein the portable storage device has a processor,

4 wherein the storage device connects to the terminal across compatible

5 conduits for external communications, wherein the storage device has a memory, wherein the

6 memory and a storage conduit are disposed in communication with the processor;

7 providing the memory for access on the terminal;

8 executing processing instructions from the memory on the terminal to access the

9 terminal;

10 communicating through the conduit;

11 processing processing instructions.

1 34. The method of claim 33, wherein the conduits are USB conduits.

1 35. The method of claim 33, wherein the conduits are wireless conduits.

1 36. The method of claim 35, wherein the wireless conduits are Bluetooth.

1 37. The method of claim 35, wherein the wireless conduits are WiFi.

1 38. The method of claim 33, wherein the memory is mounted at the terminal.

1 39. The method of claim 33, wherein the communication through the conduit is at

2 the terminal.

1 40. The method of claim 39, wherein the terminal acts as a proxy for the

2 terminal's input and output peripheral devices.

1           41.     The method of claim 39, wherein the terminal acts as a network interface  
2 proxy.

1           42.     The method of claim 33, wherein a communications through the conduit are  
2 encrypted.

1           43.     The method of claim 42, wherein the encryption occurs on the processor.

1           44.     The method of claim 43, wherein the encryption occurs on the processor by  
2 executing communication instructions from memory.

1           45.     The method of claim 42, wherein the encryption occurs on the terminal.

1           46.     The method of claim 42, wherein the encryption occurs on the server.

1           47.     The method of claim 33, wherein received encrypted instruction signals are  
2 decrypted.

1           48.     The method of claim 47, wherein the decryption occurs on the processor.

1           49.     The method of claim 48, wherein the decryption occurs on the processor by  
2 executing communication instructions from memory.

1           50.     The method of claim 47, wherein the decryption occurs on the terminal.

1           51.     The method of claim 47, wherein the decryption occurs on the server.

1           52.     The method of claim 33, wherein the processing instructions are stored in the  
2 memory.

1           53.     The method of claim 33, wherein the processing of processing instructions  
2 occurs on the processor.

1           54.     The method of claim 33, wherein the processing of processing instructions  
2 occurs on the terminal.

1           55.     The method of claim 33, wherein the processing of processing instructions  
2 occurs on the server.

1           56.     The method of claim 33, wherein the processing instructions are used to issue  
2 signals to process processing instruction on the processor.

1           57.     The method of claim 55, wherein the processing instructions are used to issue  
2 signals to process processing instruction on the processor to process files for printing.

1           58.     The method of claim 33, further, comprising:  
2 effecting the display of processing activity.

1           59.     The method of claim 58, wherein the display occurs on the terminal.

1           60.     The method of claim 59, wherein the display occurs on the terminal, by writing  
2 directly into video memory.

1           61.    A system to access data, comprising:  
2           means to engage a portable storage device with a terminal,  
3                    wherein the portable storage device has a processor,  
4                    wherein the portable storage device connects to the terminal across compatible  
5 conduits for external communications, wherein the storage device has a memory, wherein the  
6 memory and a storage conduit are disposed in communication with the processor, wherein  
7 the conduits are USB conduits;  
8           means to provide the memory for access on the terminal,  
9                    wherein the memory is mounted on the terminal;  
10          means to execute processing instructions from the memory on the terminal to access  
11 the terminal;  
12          means to communicate through the conduit at a terminal,  
13                    wherein the terminal acts as a proxy for the terminal's input and output  
14 peripheral devices, and acts as a network interface proxy,  
15                    wherein communication instruction issued signals are encrypted,  
16                    wherein the encryption occurs on the processor,  
17                    wherein received encrypted instruction signals are decrypted,  
18                    wherein decryption occurs on the processor;  
19          means to execute processing instructions on the processor,  
20                    wherein the processing instructions are stored on the memory,  
21                    wherein the processing instructions are used to issue signals to process

22 processing instruction on the processor; and

23 means to effect the display of processing activity on the terminal.

1 62. A system to access data, comprising:

2 means to dispose a portable storage device in communication with a terminal,

3 wherein the portable storage device has a processor,

4 wherein the storage device connects to the terminal across compatible

5 conduits for external communications, wherein the storage device has a memory, wherein the

6 memory and a storage conduit are disposed in communication with the processor;

7 means to provide the memory for access on the terminal;

8 means to execute processing instructions from the memory on the terminal to access

9 the terminal;

10 means to communicate through the conduit;

11 means to process processing instructions.

1           63.     A medium readable by a processor to access data, comprising:  
2           instruction signals in the processor readable medium, wherein the instruction signals  
3     are issuable by the processor to:  
4           engage a portable storage device with a terminal,  
5                     wherein the portable storage device has a processor,  
6                     wherein the portable storage device connects to the terminal across compatible  
7     conduits for external communications, wherein the storage device has a memory, wherein the  
8     memory and a storage conduit are disposed in communication with the processor, wherein  
9     the conduits are USB conduits;  
10          provide the memory for access on the terminal,  
11                     wherein the memory is mounted on the terminal;  
12          execute processing instructions from the memory on the terminal to access the  
13     terminal;  
14          communicate through the conduit at a terminal,  
15                     wherein the terminal acts as a proxy for the terminal's input and output  
16     peripheral devices, and acts as a network interface proxy,  
17                     wherein communication instruction issued signals are encrypted,  
18                     wherein the encryption occurs on the processor,  
19                     wherein received encrypted instruction signals are decrypted,  
20                     wherein decryption occurs on the processor;  
21          execute processing instructions on the processor,  
22                     wherein the processing instructions are stored on the memory,

23                    wherein the processing instructions are used to issue signals to process  
24 processing instruction on the processor; and  
25                    means to effect the display of processing activity on the terminal.

1                    64.     A medium readable by a processor to access data, comprising:

2                    instruction signals in the processor readable medium, wherein the instruction signals  
3 are issuable by the processor to:

4                    dispose a portable storage device in communication with a terminal,

5                    wherein the portable storage device has a processor,

6                    wherein the storage device connects to the terminal across compatible

7 conduits for external communications, wherein the storage device has a memory, wherein the

8 memory and a storage conduit are disposed in communication with the processor;

9                    provide the memory for access on the terminal;

10                    execute processing instructions from the memory on the terminal to access the

11 terminal;

12                    communicate through the conduit;

13                    process processing instructions.

1           65.     An apparatus to access data, comprising:  
2           a memory;  
3           a processor disposed in communication with said memory, and configured to issue a  
4 plurality of processing instructions stored in the memory, wherein the instructions issue  
5 signals to:  
6           engage a portable storage device with a terminal,  
7                 wherein the portable storage device has a processor,  
8                 wherein the portable storage device connects to the terminal across compatible  
9 conduits for external communications, wherein the storage device has a memory, wherein the  
10 memory and a storage conduit are disposed in communication with the processor, wherein  
11 the conduits are USB conduits;  
12           provide the memory for access on the terminal,  
13                 wherein the memory is mounted on the terminal;  
14           execute processing instructions from the memory on the terminal to access the  
15 terminal;  
16           communicate through the conduit at a terminal,  
17                 wherein the terminal acts as a proxy for the terminal's input and output  
18 peripheral devices, and acts as a network interface proxy,  
19                 wherein communication instruction issued signals are encrypted,  
20                 wherein the encryption occurs on the processor,  
21                 wherein received encrypted instruction signals are decrypted,  
22                 wherein decryption occurs on the processor;



23 execute processing instructions on the processor,  
24 wherein the processing instructions are stored on the memory,  
25 wherein the processing instructions are used to issue signals to process  
26 processing instruction on the processor; and  
27 means to effect the display of processing activity on the terminal.

1 66. An apparatus to access data, comprising:

2 a memory;

3 a processor disposed in communication with said memory, and configured to issue a  
4 plurality of processing instructions stored in the memory, wherein the instructions issue  
5 signals to:

6 dispose a portable storage device in communication with a terminal,

7 wherein the portable storage device has a processor,

8 wherein the storage device connects to the terminal across compatible

9 conduits for external communications, wherein the storage device has a memory, wherein the  
10 memory and a storage conduit are disposed in communication with the processor;

11 provide the memory for access on the terminal;

12 execute processing instructions from the memory on the terminal to access the  
13 terminal;

14 communicate through the conduit;

15 process processing instructions.

1           67.     A method of accessing data, comprising:  
2           receiving requests from a terminal,  
3                     wherein a portable storage device is disposed in communication with the  
4 terminal,  
5                     wherein the storage device has a processor,  
6                     wherein the storage device connects to the terminal across compatible  
7 conduits for external communications, wherein the storage device has a memory, wherein the  
8 memory and a storage conduit are disposed in communication with the processor, wherein  
9 the storage device is responsible for generating the received requests;  
10           providing responses to the storage device's requests.

1           68.     A method of accessing data, comprising:  
2           disposing a portable storage device in communication with a terminal,  
3                     wherein the storage device has a processor,  
4                     wherein the storage device connects to the terminal across compatible  
5 conduits for external communications, wherein the storage device has a memory;  
6           employing the terminal for input/output (I/O) control for the portable storage device;  
7           executing instructions on the portable storage device; and  
8           displaying results of execution on the terminal.

1           69.     The method of claim 68, further, comprising:  
2           storing the results of execution on the terminal in the portable storage device's  
3 memory.

1

This Page Is Inserted by IFW Operations  
and is not a part of the Official Record

## **BEST AVAILABLE IMAGES**

Defective images within this document are accurate representations of the original documents submitted by the applicant.

Defects in the images may include (but are not limited to):

- BLACK BORDERS
- TEXT CUT OFF AT TOP, BOTTOM OR SIDES
- FADED TEXT
- ILLEGIBLE TEXT
- SKEWED/SLANTED IMAGES
- COLORED PHOTOS
- BLACK OR VERY BLACK AND WHITE DARK PHOTOS
- GRAY SCALE DOCUMENTS

**IMAGES ARE BEST AVAILABLE COPY.**

**As rescanning documents *will not* correct images,  
please do not report the images to the  
Image Problem Mailbox.**

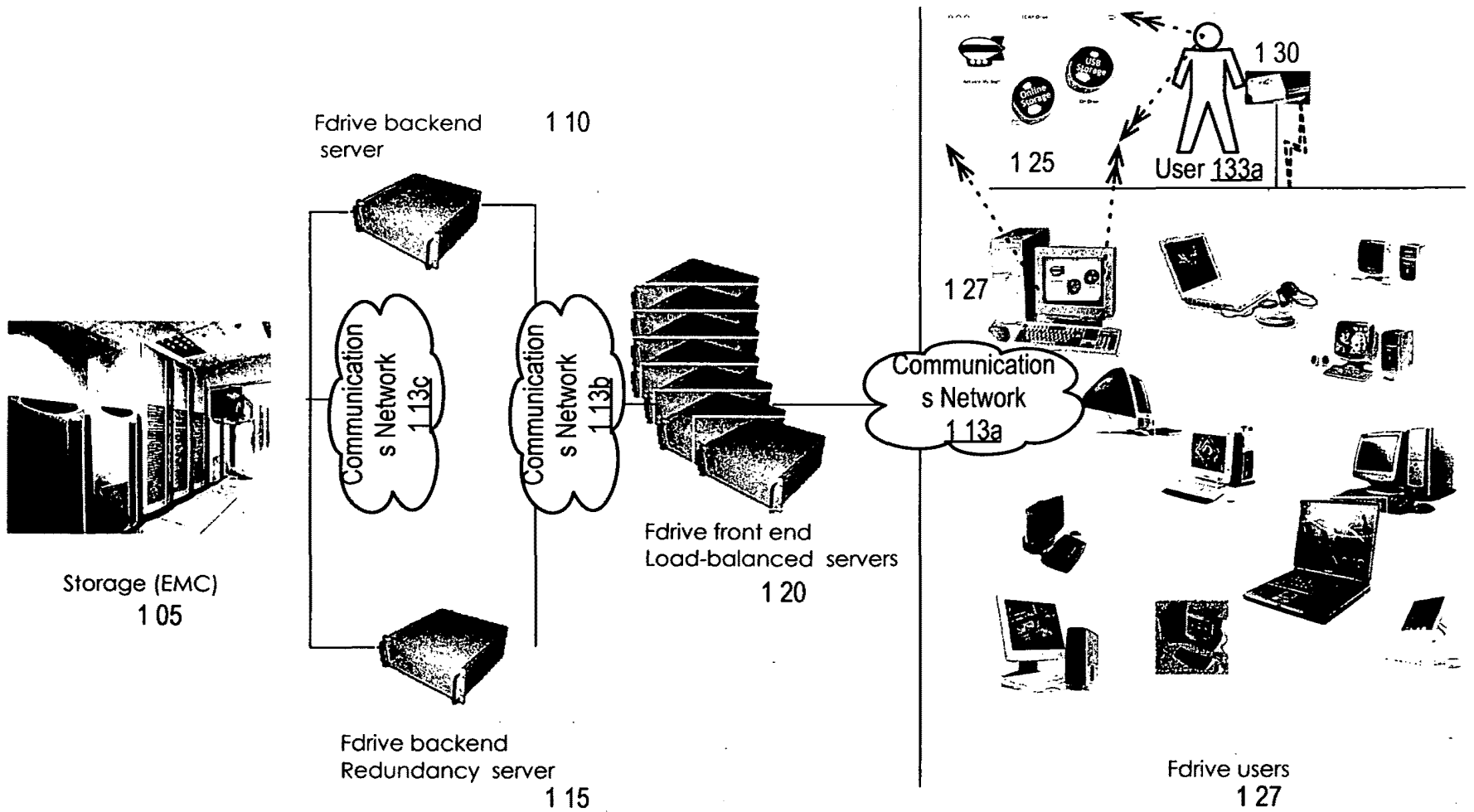

Figure 1

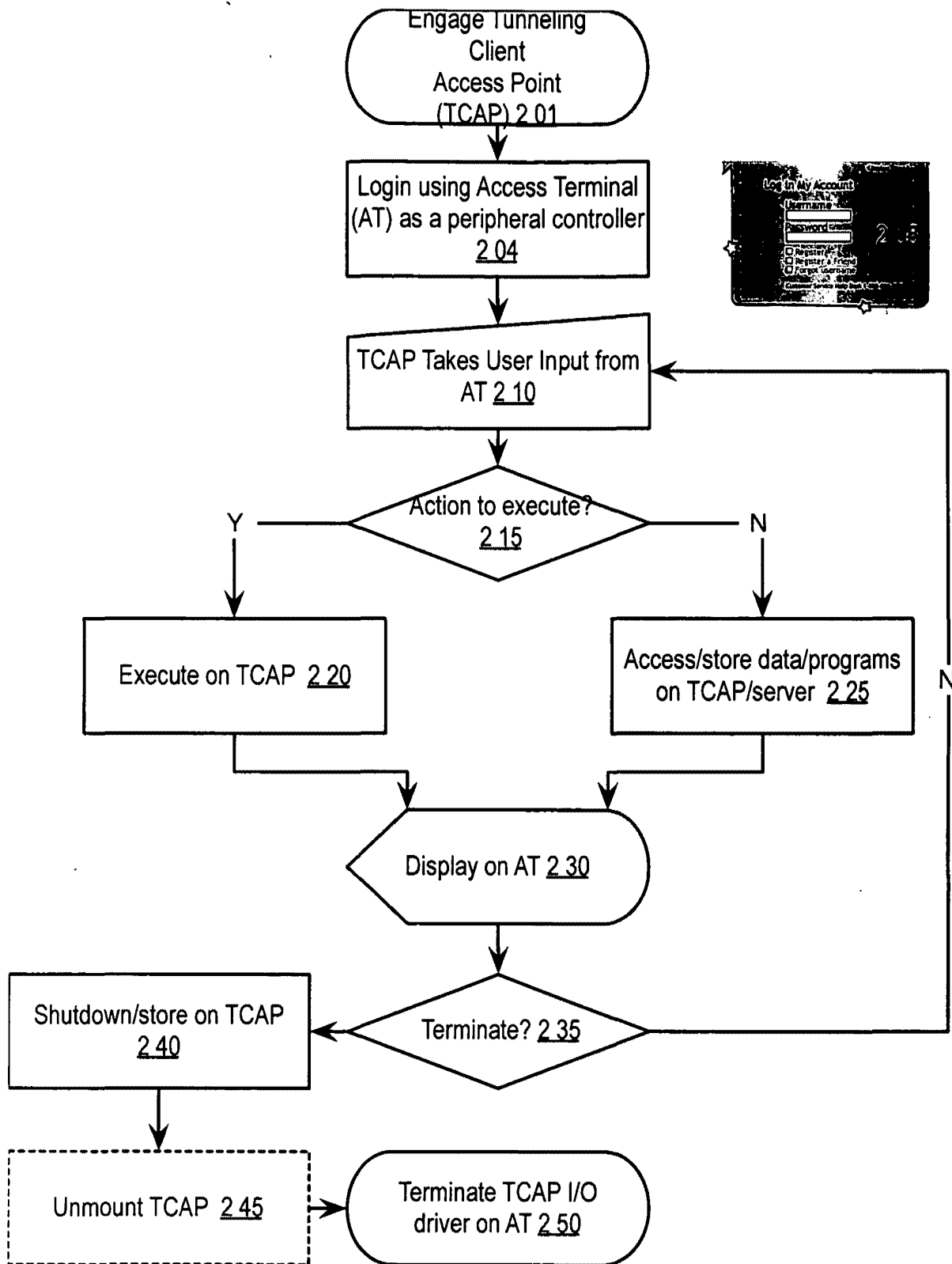

Figure 2

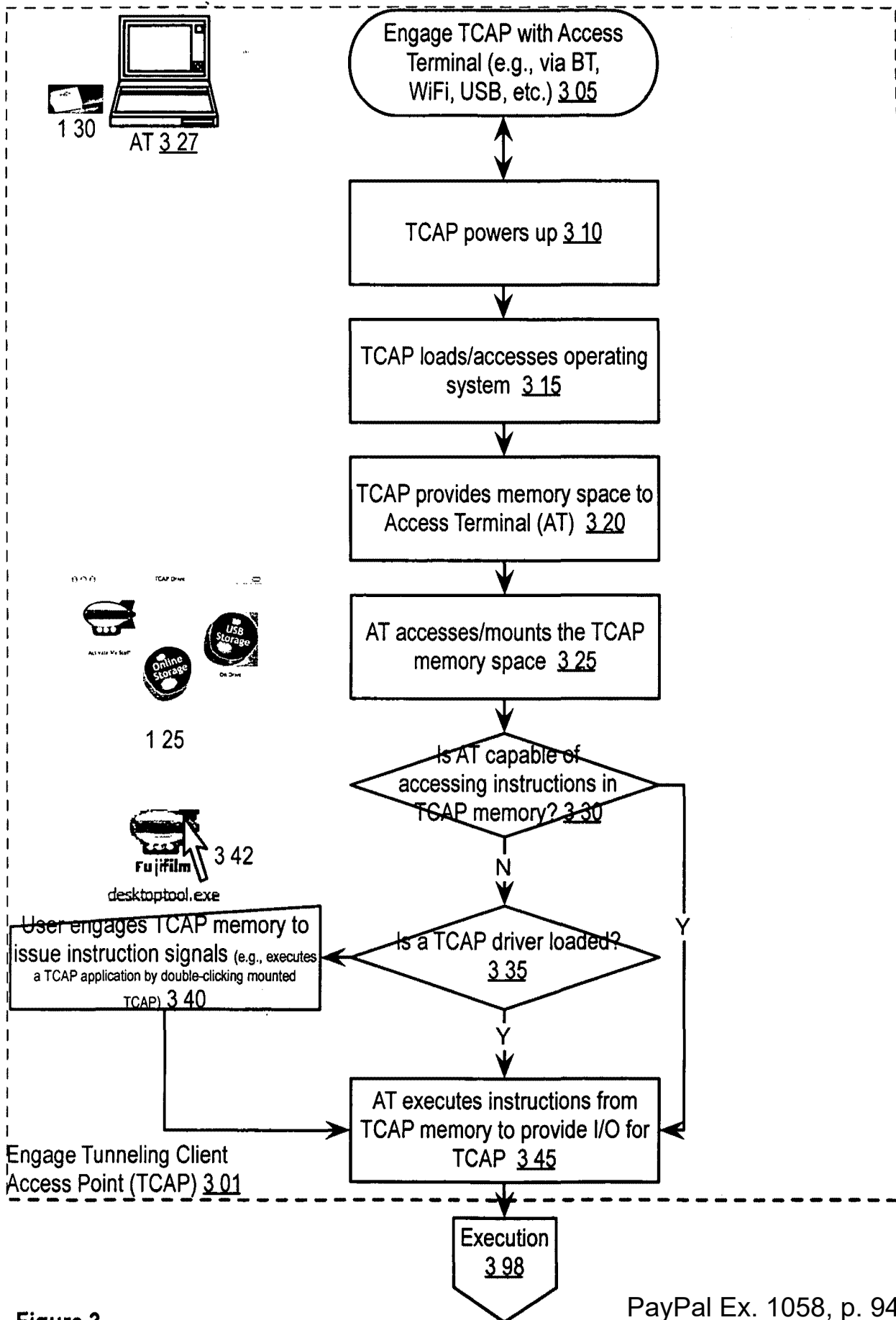

Figure 3

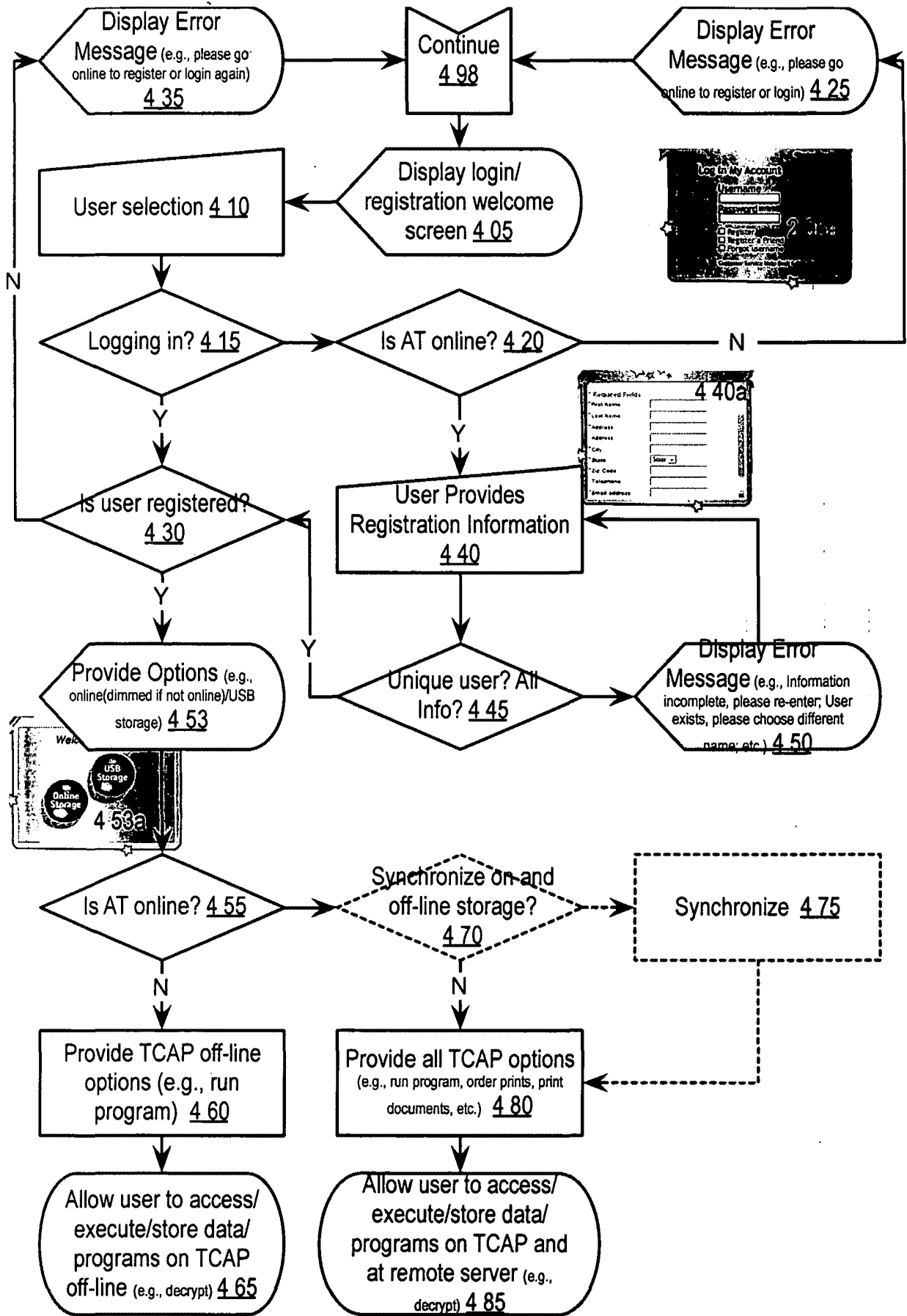

Figure 4

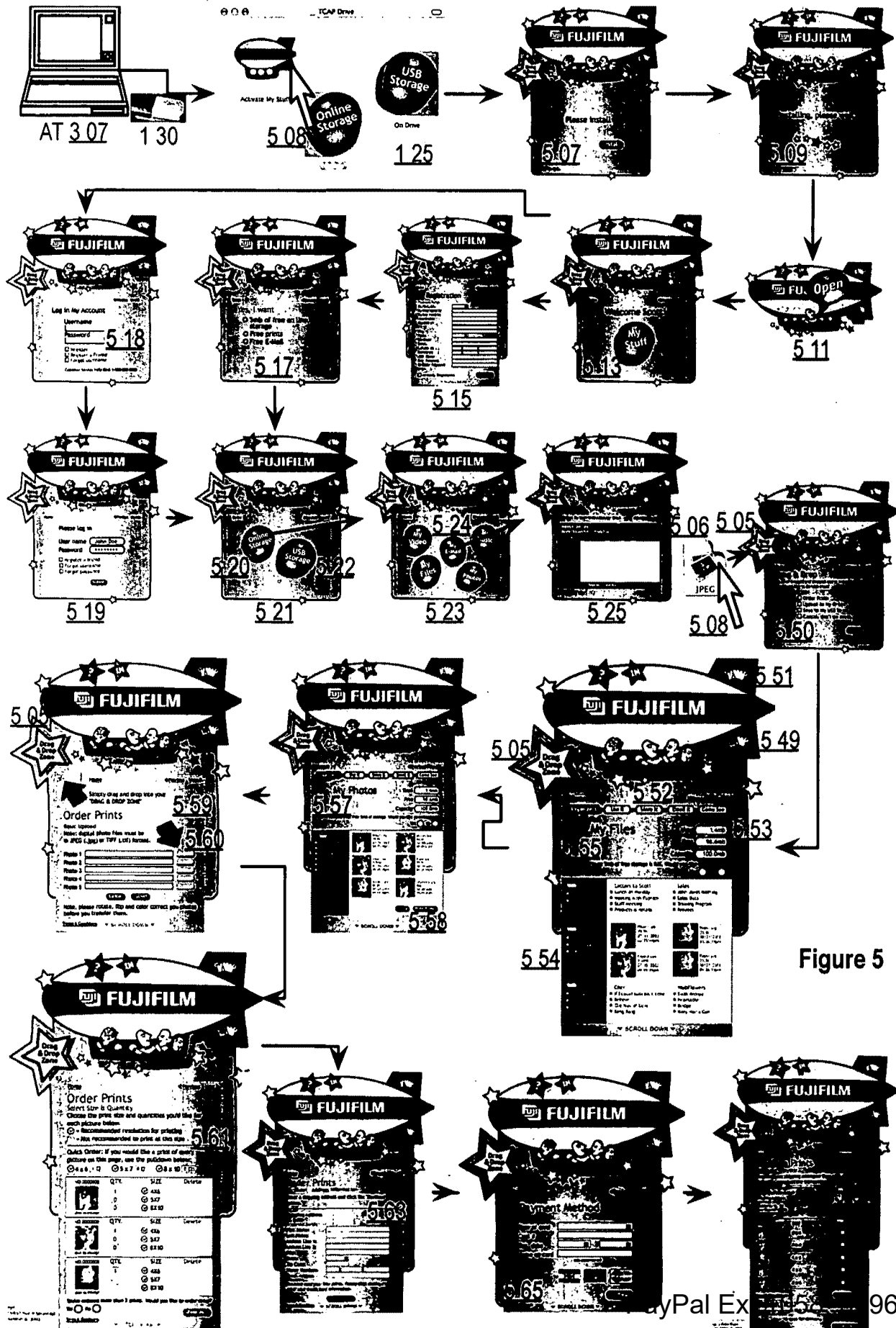

Figure 5



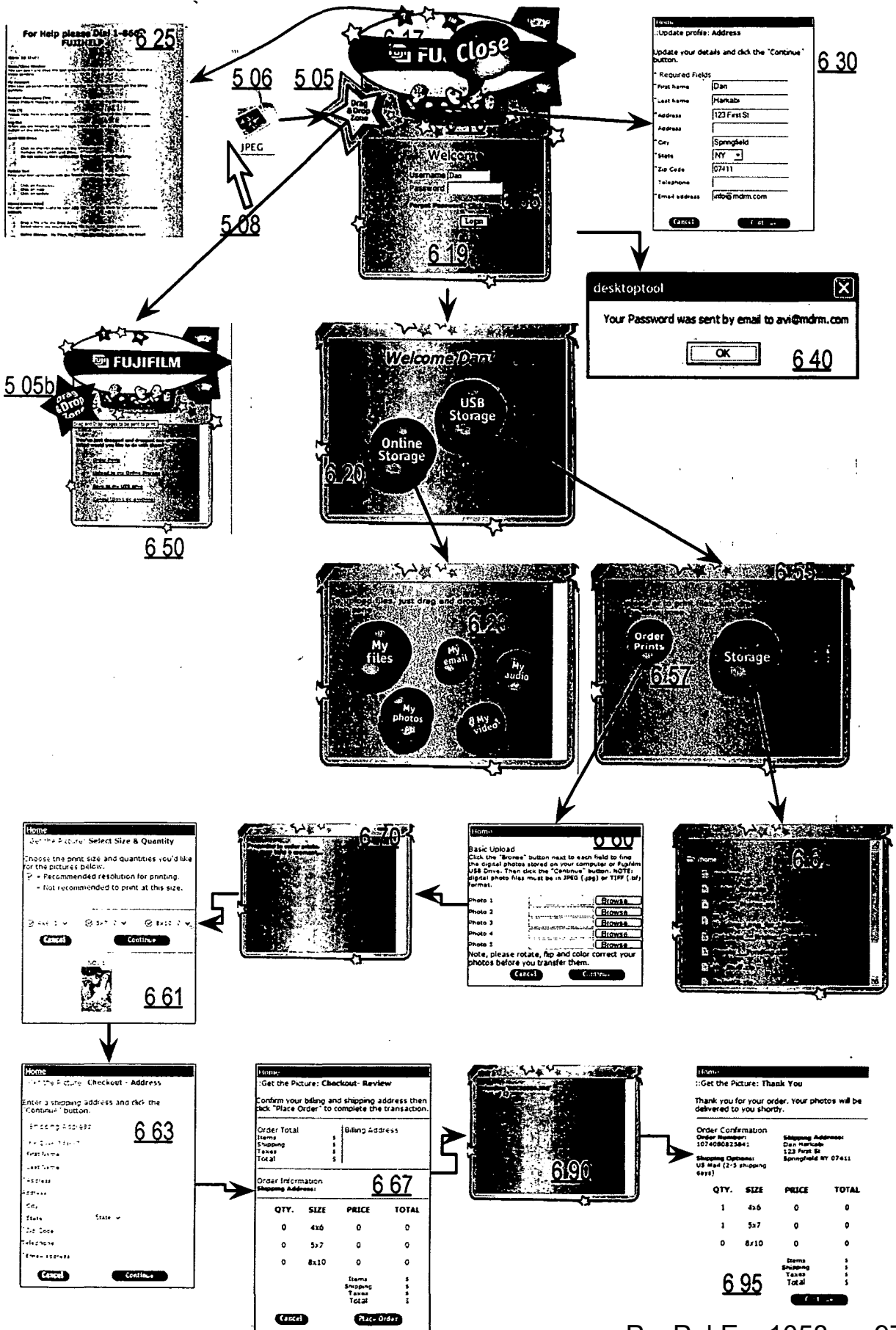

Figure 6

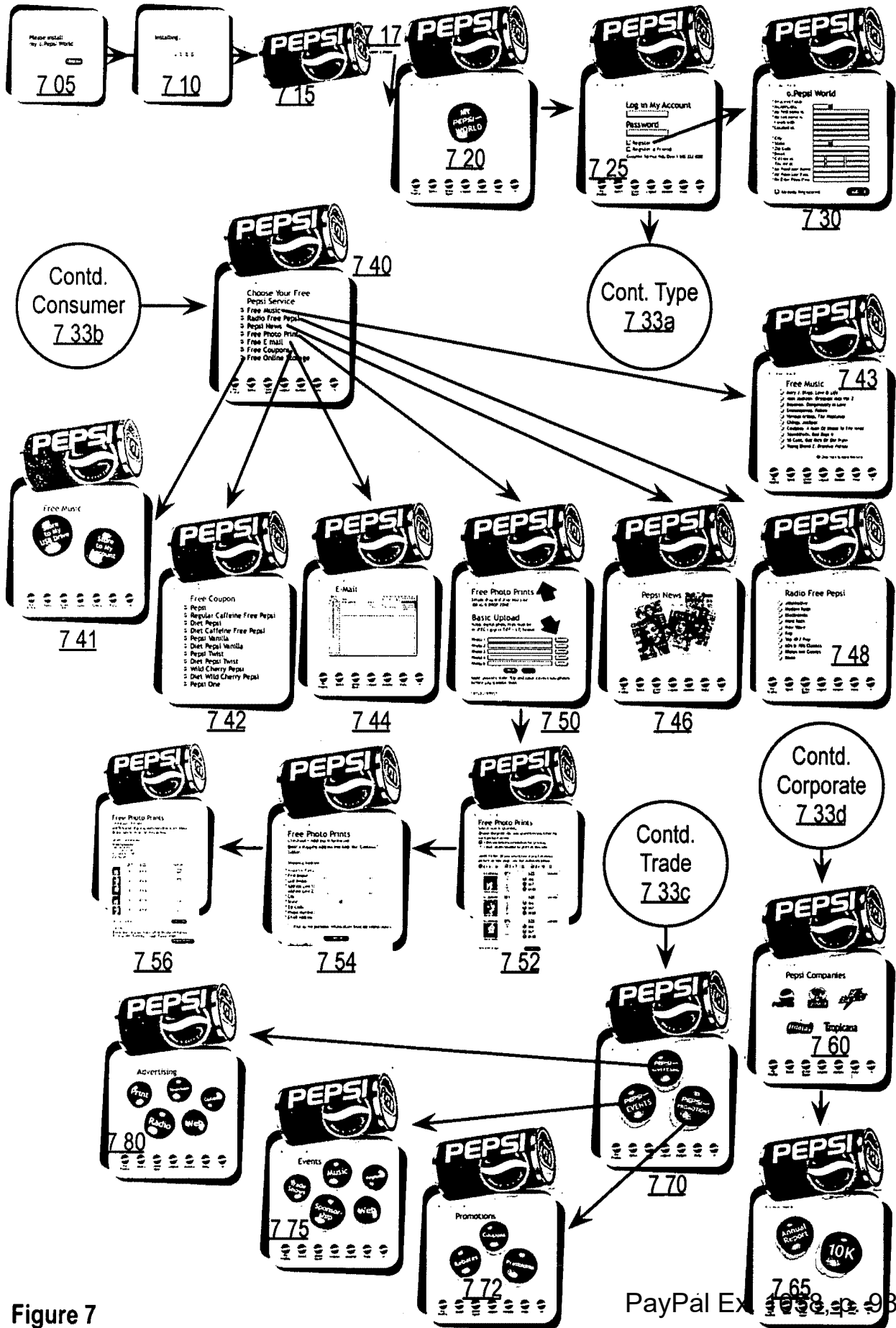

Figure 7

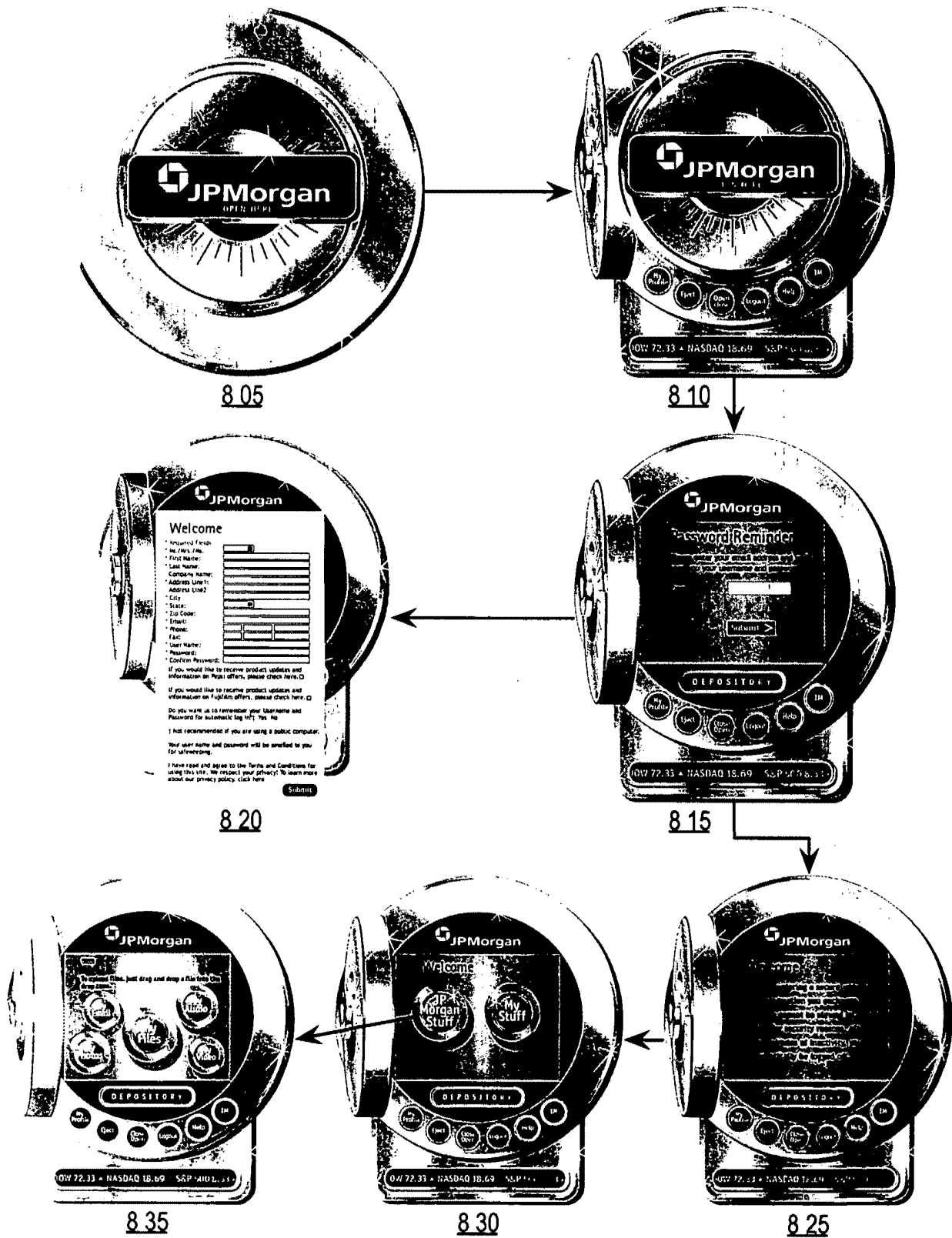

Figure 8

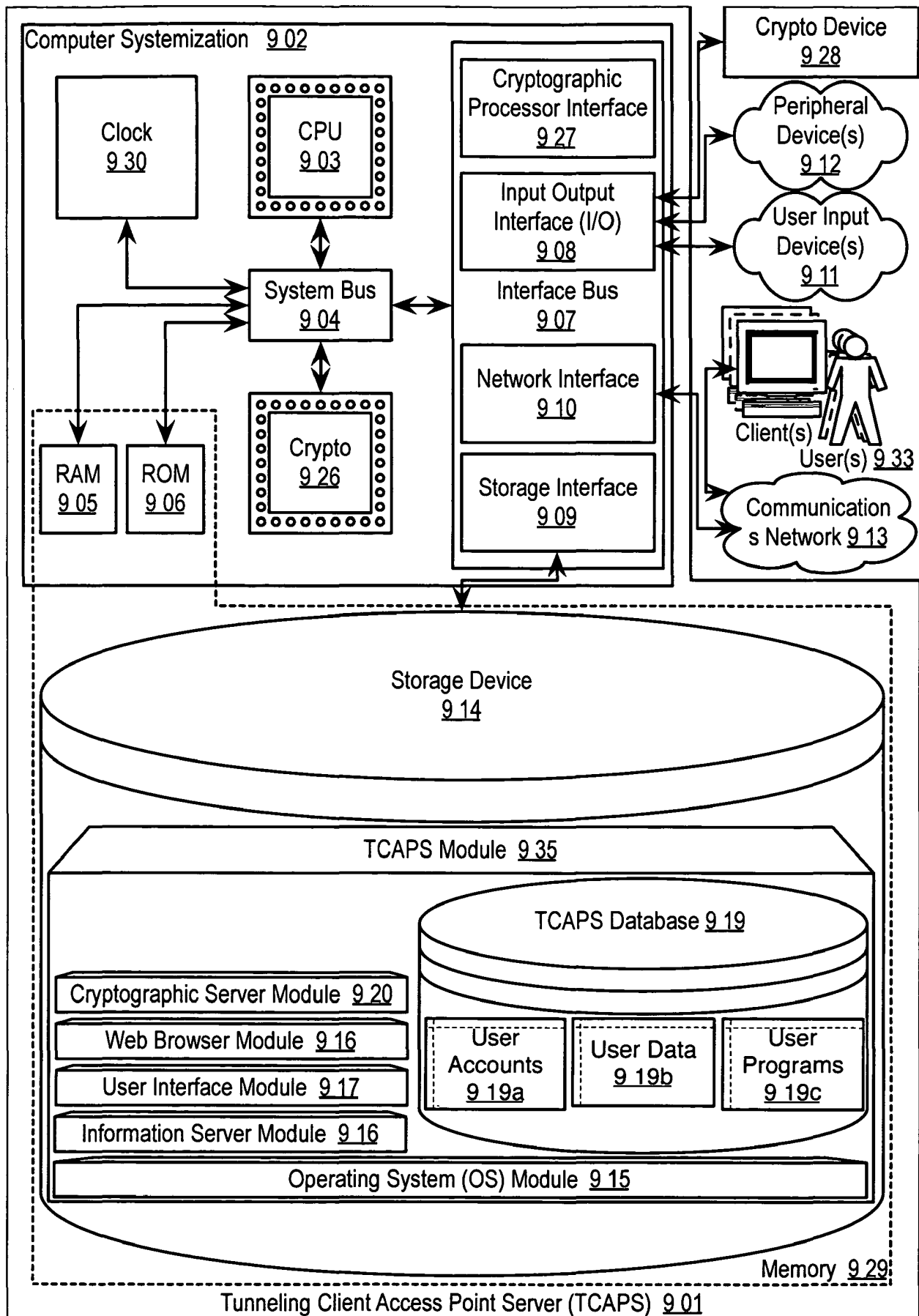

Figure 9

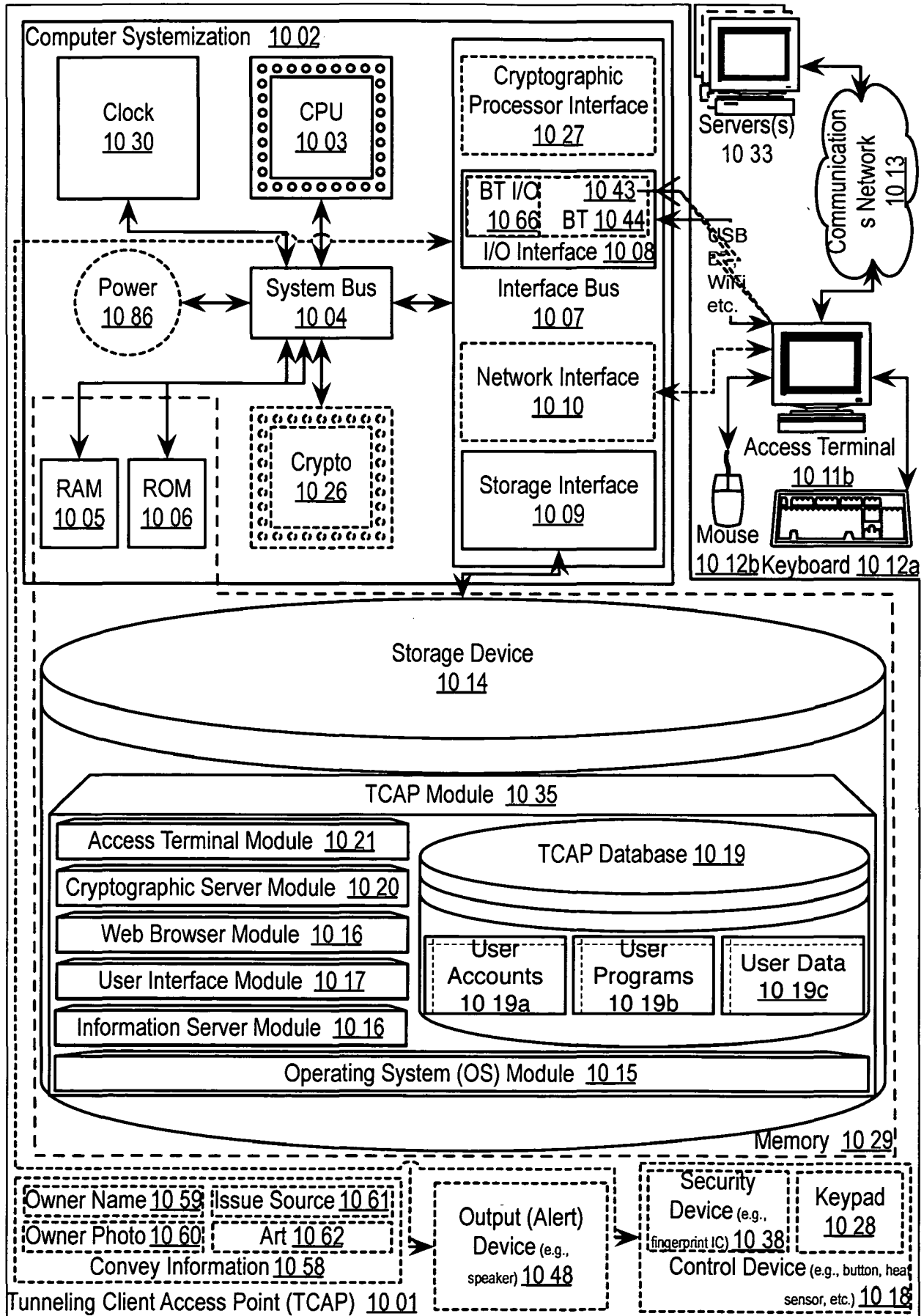

Figure 10

# ARTIFACT SHEET

Enter artifact number below. Artifact number is application number + artifact type code (see list below) + sequential letter (A, B, C ...). The first artifact folder for an artifact type receives the letter A, the second B, etc.. Examples: 59123456PA, 59123456PB, 59123456ZA, 59123456ZB

10807731 CA

Indicate quantity of a single type of artifact received but not scanned. Create individual artifact folder/box and artifact number for each Artifact Type.

- CD(s) containing computer program listing  
Doc Code: Computer      Artifact Type Code: P
- Stapled Set(s) of Extra Color Drawings/Photographs  
Doc Code: Artifact      Artifact Type Code: C
- CD(s) containing pages of specification and/or sequence listing    
Doc Code: Artifact      Artifact Type Code: S
- CD(s) with content unspecified  
Doc Code: Artifact      Artifact Type Code: U
- Microfilm(s)  
Doc Code: Artifact      Artifact Type Code: F
- Video tape(s)  
Doc Code: Artifact      Artifact Type Code: V
- Model(s)  
Doc Code: Artifact      Artifact Type Code: M
- Bound Document(s)  
Doc Code: Artifact      Artifact Type Code: B
- Other, description: \_\_\_\_\_  
Doc Code: Artifact      Artifact Type Code: Z

**PATENT APPLICATION FEE DETERMINATION RECORD**

Effective October 1, 2003

Application or Docket Number

4602-4001

**CLAIMS AS FILED - PART I**

	(Column 1)	(Column 2)
TOTAL CLAIMS	69	
FOR	NUMBER FILED	NUMBER EXTRA
TOTAL CHARGEABLE CLAIMS	69 minus 20 = *	49
INDEPENDENT CLAIMS	2 minus 3 = *	9
MULTIPLE DEPENDENT CLAIM PRESENT	<input type="checkbox"/>	

SMALL ENTITY TYPE

OR OTHER THAN SMALL ENTITY

RATE	FEE
BASIC FEE	385.00
XS 9=	441
X43=	397
+145=	
TOTAL	1213

RATE	FEE
BASIC FEE	770.00
XS18=	
X86=	
+290=	
TOTAL	

\* If the difference in column 1 is less than zero, enter "0" in column 2

**CLAIMS AS AMENDED - PART II**

	(Column 1)	(Column 2)	(Column 3)
AMENDMENT A	CLAIMS REMAINING AFTER AMENDMENT	HIGHEST NUMBER PREVIOUSLY PAID FOR	PRESENT EXTRA
	Total *	Minus **	=
	Independent *	Minus ***	=
FIRST PRESENTATION OF MULTIPLE DEPENDENT CLAIM <input type="checkbox"/>			

SMALL ENTITY OR

OTHER THAN SMALL ENTITY

RATE	ADDITIONAL FEE
XS 9=	
X43=	
+145=	
TOTAL ADDIT. FEE	

RATE	ADDITIONAL FEE
XS18=	
X86=	
+290=	
TOTAL ADDIT. FEE	

	(Column 1)	(Column 2)	(Column 3)
AMENDMENT B	CLAIMS REMAINING AFTER AMENDMENT	HIGHEST NUMBER PREVIOUSLY PAID FOR	PRESENT EXTRA
	Total *	Minus **	=
	Independent *	Minus ***	=
FIRST PRESENTATION OF MULTIPLE DEPENDENT CLAIM <input type="checkbox"/>			

RATE	ADDITIONAL FEE
XS 9=	
X43=	
+145=	
TOTAL ADDIT. FEE	

RATE	ADDITIONAL FEE
XS18=	
X86=	
+290=	
TOTAL ADDIT. FEE	

	(Column 1)	(Column 2)	(Column 3)
AMENDMENT C	CLAIMS REMAINING AFTER AMENDMENT	HIGHEST NUMBER PREVIOUSLY PAID FOR	PRESENT EXTRA
	Total *	Minus **	=
	Independent *	Minus ***	=
FIRST PRESENTATION OF MULTIPLE DEPENDENT CLAIM <input type="checkbox"/>			

RATE	ADDITIONAL FEE
XS 9=	
X43=	
+145=	
TOTAL ADDIT. FEE	

RATE	ADDITIONAL FEE
XS18=	
X86=	
+290=	
TOTAL ADDIT. FEE	

\* If the entry in column 1 is less than the entry in column 2, write "0" in column 3.  
 \*\* If the "Highest Number Previously Paid For" IN THIS SPACE is less than 20, enter "20."  
 \*\*\* If the "Highest Number Previously Paid For" IN THIS SPACE is less than 3, enter "3."  
 The "Highest Number Previously Paid For" (Total or Independent) is the highest number found in the appropriate box in column 1.

PATENT APPLICATION SERIAL NO. \_\_\_\_\_

U.S. DEPARTMENT OF COMMERCE  
PATENT AND TRADEMARK OFFICE  
FEE RECORD SHEET

03/26/2004 MBELETE1 00000050 134500 10807731

01 FC:2001	385.00 DA
02 FC:2201	387.00 DA
03 FC:2202	441.00 DA

PTO-1556  
(5/87)

U.S. Government Printing Office: 2001 — 481-E97/59173

PayPal Ex. 1058, p. 104  
PayPal v. IOENGINE



1  
2  
3  
4  
5  
6  
7  
8  
9  
10  
11  
12  
13  
14  
15  
16  
17  
18  
19  
20  
21

## ABSTRACT

The disclosure details the implementation of an apparatus, method, and system for a tunneling client access point (TCAP). The disclosure teaches a highly secure, portable, power efficient storage and data processing mechanism. The TCAP “tunnels” data through an access terminal (AT). The data may be tunneled through the AT’s input/output facilities. In one example embodiment, the TCAP has no user input or output peripherals. The TCAP connects to an access terminal and a user employs the AT’s user input peripherals for input, and views the TCAPs activities on the AT’s display. This enables the user to observe data stored on the TCAP without it being resident on the AT, which can be useful to maintain higher levels of data security. Also, the TCAP may tunnel data through an AT across a communications network to access remote servers without requiring its own more complicated set of peripherals and I/O. One aspect of the disclosure teaches an elegant user interface for allowing a user to execute and access data from almost any access terminal. The disclosure teaches how to allow users to employ traditional large user interfaces that users are already comfortable with on a device that offers greater portability, greater memory footprints, lower power consumption, and greater data security. As such, the disclosed tunneling client access point is very easy to use; at most it requires the user to simply plug the device into any existing and available desktop or laptop computer, through which, the TCAP can make use of a traditional user interface and peripherals. The disclosure also teaches a TCAP server (TCAPS). The TCAPS extends the storage and processing capacities and capabilities of TCAPs. Also, by providing the equivalent of a plug-n-play virtual private

22 network (VPN), the disclosure teaches how the TCAP provides for certain kinds of accessing  
23 of remote data in an easy and secure manner. The result and manner in which this is  
24 achieved, yields the generation of a never before accessible, novel, non-obvious, yet  
25 extremely useful portable computing and storage device.

**UNITED STATES PATENT AND TRADEMARK OFFICE**

 UNITED STATES DEPARTMENT OF COMMERCE  
 United States Patent and Trademark Office  
 Address: COMMISSIONER FOR PATENTS  
 P.O. Box 1450  
 Alexandria, Virginia 22313-1450  
 www.uspto.gov

APPLICATION NUMBER	FILING OR 371 (c) DATE	FIRST NAMED APPLICANT	ATTORNEY DOCKET NUMBER
10/807,731	03/23/2004	Scott McNulty	4602-4001

 MORGAN & FINNEGAN, L.L.P.  
 345 Park Avenue  
 New York, NY 10154-0053

**CONFIRMATION NO. 4430**
**FORMALITIES LETTER**

\*OC000000012873430\*

Date Mailed: 06/04/2004

**NOTICE TO FILE MISSING PARTS OF NONPROVISIONAL APPLICATION**
**FILED UNDER 37 CFR 1.53(b)**
*Filing Date Granted*
**Items Required To Avoid Abandonment:**

An application number and filing date have been accorded to this application. The item(s) indicated below, however, are missing. Applicant is given **TWO MONTHS** from the date of this Notice within which to file all required items and pay any fees required below to avoid abandonment. Extensions of time may be obtained by filing a petition accompanied by the extension fee under the provisions of 37 CFR 1.136(a).

- The oath or declaration is missing.  
*A properly signed oath or declaration in compliance with 37 CFR 1.63, identifying the application by the above Application Number and Filing Date, is required.*
- To avoid abandonment, a late filing fee or oath or declaration surcharge as set forth in 37 CFR 1.16(e) of \$65 for a small entity in compliance with 37 CFR 1.27, must be submitted with the missing items identified in this letter.

The application is informal since it does not comply with the regulations for the reason(s) indicated below.

The required item(s) identified below must be timely submitted to avoid abandonment:

- A replacement abstract not exceeding 150 words in length and commencing on a separate sheet in compliance with 37 CFR 1.72(b) and 37 CFR 1.121 is required.

**SUMMARY OF FEES DUE:**

Total additional fee(s) required for this application is **\$65** for a Small Entity

- **\$65** Late oath or declaration Surcharge.

Replies should be mailed to: Mail Stop Missing Parts  
 Commissioner for Patents  
 P.O. Box 1450

 PayPal Ex. 1058, p. 107  
 PayPal v. IOENGINE

Alexandria VA 22313-1450

---

*A copy of this notice **MUST** be returned with the reply.*

*Muhammed Hibet*

Customer Service Center

Initial Patent Examination Division (703) 308-1202

PART 3 - OFFICE COPY

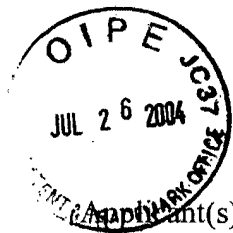

**IN THE UNITED STATES PATENT AND TRADEMARK OFFICE**

Applicant(s): Scott McNulty  
 Group Art Unit: 2661  
 Serial No.: 10/807,731  
 Examiner: TBA  
 Filed: March 23, 2004  
 For: Apparatus, Method and System For A Tunneling Client Access Point

**RESPONSE TO "NOTICE TO FILE MISSING PARTS"**

Commissioner for Patents  
 P.O. Box 1450  
 Alexandria, VA 22313-1450

Sir:

In response to the NOTICE TO FILE MISSING PARTS OF APPLICATION--  
 FILING DATE GRANTED dated June 4, 2004, Applicant(s) submit(s) herewith the following  
 documents for appropriate action by the U.S. Patent and Trademark Office:

- Copy of Notice to File Missing Parts
- Executed Declaration
- Application Filing Fees
- 
- Please charge the required fee of \$ \_\_\_\_\_ to deposit account no. 13-4500, Order No. \_\_\_\_\_
- A check in the amount of \$65.00 in payment of the application filing fees is attached.
- The Commissioner is hereby authorized to charge any additional fees which may be required by this paper, or credit any overpayment to Deposit Account No. 13-4500, Order No. 4602-4001. A DUPLICATE COPY OF THIS SHEET IS ATTACHED.

07/27/2004 YPOLITE1 00000008 10807731  
 01 FC:2051 65.00 0P

Dated: July 23, 2004:

Respectfully submitted,  
 MORGAN & FINNEGAN, L.L.P.

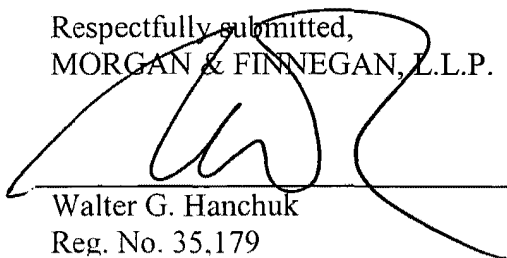

Walter G. Hanchuk  
 Reg. No. 35,179

Correspondence Address:  
 MORGAN & FINNEGAN, L.L.P.  
 345 Park Avenue  
 New York, NY 10154-0053  
 (212) 758-4800 Telephone  
 (212) 751-6849 Facsimile



IFW

PATENT  
Docket No. 4602-4001

IN THE UNITED STATES PATENT AND TRADEMARK OFFICE

Applicant(s): Scott McNulty  
Serial No.: 10/807,731  
Filed: March 23, 2004  
For: Apparatus, Method and System For A Tunneling Client Access Point

Group Art Unit: 2661  
Examiner: TBA

**CERTIFICATE OF MAILING (37 C.F.R. §1.8(a))**

Commissioner for Patents  
P.O. Box 1450  
Alexandria, VA 22313  
Sir:

I hereby certify that the attached:

1. Response to Notice to File Missing Parts;
2. executed Declaration and Power of Attorney
3. a check in the amount of \$65.00
4. Return receipt postcard.

along with any paper(s) referred to as being attached or enclosed and this Certificate of Mailing are being deposited with the United States Postal Service on date shown below with sufficient postage as first-class mail in an envelope addressed to the: Commissioner for Patents, P.O. Box 1450, Alexandria, VA 22313.

Respectfully submitted,  
MORGAN & FINNEGAN, L.L.P.

Dated: July 23, 2004

By: \_\_\_\_\_  
Walter G. Hanchuk  
Reg. No. 35,179

Correspondence Address:  
MORGAN & FINNEGAN, L.L.P.  
345 Park Avenue  
New York, NY 10154-0053  
(212) 758-4800 Telephone  
(212) 751-6849 Facsimile

**COMBINED DECLARATION AND POWER OF ATTORNEY FOR ORIGINAL, DESIGN, NATIONAL STAGE OF PCT, SUPPLEMENTAL, DIVISIONAL, CONTINUATION OR CONTINUATION-IN-PART APPLICATION**



As a below named inventor, I hereby declare that:

My residence, post office address and citizenship are as stated below next to my name,

I believe I am the original, first and sole inventor (if only one name is listed below) or an original, first and joint inventor (if plural names are listed below) of the subject matter which is claimed and for which a patent is sought on the invention entitled:

Apparatus, Method and System For A Tunneling Client Access Point

the specification of which

- a.  is attached hereto
- b.  was filed on March 23, 2004 as application Serial No. 10/807,731 and was amended on . (if applicable).

**PCT FILED APPLICATION ENTERING NATIONAL STAGE**

- c.  was described and claimed in International Application No. filed on and as amended on . (if any).

I hereby state that I have reviewed and understand the contents of the above-identified specification, including the claims, as amended by any amendment referred to above.

I acknowledge the duty to disclose information which is material to patentability as defined in 37 C.F.R. § 1.56.

I hereby specify the following as the correspondence address to which all communications about this application are to be directed:

**SEND CORRESPONDENCE TO:**

- Bar Code label attached (see right)
- Address Shown (see below)

MORGAN & FINNEGAN, L.L.P.  
345 Park Avenue  
New York, N.Y. 10154

**27123**  
↑CUSTOMER NUMBER↑

**DIRECT TELEPHONE CALLS TO:**

- I hereby claim foreign priority benefits under Title 35, United States Code § 119 (a)-(d) or under § 365(b) of any foreign application(s) for patent or inventor's certificate or under § 365(a) of any PCT international application(s) designating at least one country other than the U.S. listed below and also have identified below such foreign application(s) for patent or inventor's certificate or such PCT international application(s) filed by me on the same subject matter having a filing date within twelve (12) months before that of the application on which priority is claimed:
  
- The attached 35 U.S.C. § 119 claim for priority for the application(s) listed below forms a part of this declaration.

Country/PCT	Application Number	Date of filing (day, month, yr)	Date of issue (day, month, yr)	Priority Claimed
				<input type="checkbox"/> Y <input type="checkbox"/> N
				<input type="checkbox"/> Y <input type="checkbox"/> N
				<input type="checkbox"/> Y <input type="checkbox"/> N

- I hereby claim the benefit under 35 U.S.C. § 119(e) of any U.S. provisional application(s) listed below.

Provisional Application No.	Date of filing (day, month, yr)
-----------------------------	---------------------------------

**ADDITIONAL STATEMENTS FOR DIVISIONAL, CONTINUATION OR CONTINUATION-IN-PART OR PCT APPLICATION(S) DESIGNATING THE U.S.**

I hereby claim the benefit under Title 35, United States Code § 120 of any United States application(s) or under § 365(c) of any PCT international application(s) designating the U.S. listed below.

---

US/PCT Application Serial No.	Filing Date	Status (patented, pending, abandoned)/ U.S. application no. assigned (For PCT)
-------------------------------	-------------	--

---

US/PCT Application Serial No.	Filing Date	Status (patented, pending, abandoned)/ U.S. application no. assigned (For PCT)
-------------------------------	-------------	--

- In this continuation-in-part application, insofar as the subject matter of any of the claims of this application is not disclosed in the above listed prior United States or PCT international application(s) in the manner provided by the first paragraph of Title 35, United States Code, § 112, I acknowledge the duty to disclose material information as defined in Title 37, Code of Federal Regulations, § 1.56(a) which occurred between the filing date of the prior application(s) and the national or PCT international filing date of this application.



I hereby declare that all statements made herein of my own knowledge are true and that all statements made on information and belief are believed to be true; and further that these statements were made with the knowledge that willful false statements and the like so made are punishable by fine or Imprisonment, or both, under Section 1001 of Title 18 of the United States Code and that such willful false statements may jeopardize the validity of the application or any patent issued thereon.

I hereby appoint the following attorneys and/or agents with full power of substitution and revocation, to prosecute this application, to receive the patent, and to transact all business in the Patent and Trademark Office connected therewith: David H. Pfeffer (Reg. No. 19,825), Harry C. Marcus (Reg. No. 22,390), Stephen R. Smith (Reg. No. 22,615), Kurt E. Richter (Reg. No. 24,052), Eugene Moroz (Reg. No. 25,237), John F. Sweeney (Reg. No. 27,471), Arnold I. Rady (Reg. No. 26,601), Christopher A. Hughes (Reg. No. 26,914), William S. Feiler (Reg. No. 26,728), Joseph A. Calvaruso (Reg. No. 28,287), James W. Gould (Reg. No. 28,859), Richard C. Komson (Reg. No. 27,913), Israel Blum (Reg. No. 26,710), Bartholomew Verdirame (Reg. No. 28,483), Maria C.H. Lin (Reg. No. 29,323), Joseph A. DeGirolamo (Reg. No. 28,595), Michael P. Dougherty (Reg. No. 32,730), Seth J. Atlas (Reg. No. 32,454), Andrew M. Riddles (Reg. No. 31,657), Bruce D. DeRenzi (Reg. No. 33,676), Mark J. Abate (Reg. No. 32,527), John T. Gallagher (Reg. No. 35,516), Steven F. Meyer (Reg. No. 35,613), Kenneth H. Sonnenfeld (Reg. No. 33,285), Tony V. Pezzano (Reg. No. 38,271), Andrea L. Wayda (Reg. No. 43,979), Walter G. Hanchuk (Reg. No. 35,179), John W. Osborne (Reg. No. 36,231), Robert K. Goethals (Reg. No. 36,813), Peter N. Fill (Reg. No. 38,876), Kenneth S. Weitzman (Reg. No. 36,306), Richard Straussman (Reg. No. 39,847), Stephen J. Manetta (Reg. No. 40,426), Dorothy R. Auth (Reg. No. 36,434) and Michael O. Cummings, (Reg. No. 40,575) of Morgan & Finnegan, L.L.P. whose address is: 345 Park Avenue, New York, New York, 10154; and Michael S. Marcus (Reg. No. 31,727), and John E. Hoel (Reg. No. 26,279), of Morgan & Finnegan, L.L.P., whose address is 1775 Eye Street, Suite 400, Washington, D.C. 20006.

I hereby authorize the U.S. attorneys and/or agents named hereinabove to accept and follow instructions from \_\_\_\_\_ as to any action to be taken in the U.S. Patent and Trademark Office regarding this application without direct communication between the U.S. attorneys and/or agents and me. In the event of a change in the person(s) from whom instructions may be taken I will so notify the U.S. attorneys and/or agents named hereinabove.

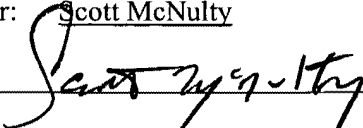
Full name of sole or first inventor:	<u>Scott McNulty</u>	
Inventor's signature*		<u>7-16-04</u> Date
Residence:	<u>22 Ensign Road, Rowayton, CT 06853</u>	
Citizenship:	<u>USA</u>	
Post Office Address:	<u>Same as above</u>	
Full name of second inventor:	_____	
Inventor's signature*	_____	_____
Residence:	_____	
Citizenship:	_____	
Post Office Address:	_____	

ATTACHED IS ADDED PAGE TO COMBINED DECLARATION AND POWER OF ATTORNEY FOR SIGNATURE BY THIRD AND SUBSEQUENT INVENTORS FORM.



\*Before signing this declaration, each person signing must:

1. Review the declaration and verify the correctness of all information therein; and
2. Review the specification and the claims, including any amendments made to the claims

After the declaration is signed, the specification and claims are not to be altered.

To the inventor(s):

The following are cited in or pertinent to the declaration attached to the accompanying application:

Title 37, Code of Federal Regulation, §1.56

Duty to disclose information material to patentability

(a) A patent by its very nature is affected with a public interest. The public interest is best served, and the most effective patent examination occurs when, at the time an application is being examined, the Office is aware of and evaluates the teachings of all information material to patentability. Each individual associated with the filing and prosecution of a patent application has a duty of candor and good faith in dealing with the Office, which includes a duty to disclose to the Office all information known to that individual to be material to patentability as defined in this section. The duty to disclose information exists with respect to each pending claim until the claim is cancelled or withdrawn from consideration, or the application becomes abandoned. Information material to the patentability of a claim that is cancelled or withdrawn from consideration need not be submitted if the information is not material to the patentability of any claim remaining under consideration in the application. There is no duty to submit information which is not material to the patentability of any existing claim. The duty to disclose all information known to be material to patentability is deemed to be satisfied if all information known to be material to patentability of any claim issued in a patent was cited by the Office or submitted to the Office in the manner prescribed by §§ 1.97(b)-(d) patentability of any existing claim. The duty to disclose all information known to be material to patentability is deemed to be satisfied if all information known to be material to patentability of any claim issued in a patent was cited by the Office or submitted to the Office in the manner prescribed by §§ 1.97(b)-(d) and 1.98. However, no patent will be granted on an application in connection with which fraud on the Office was practiced or attempted or the duty of disclosure was violated through bad faith or intentional misconduct. The Office encourages applicants to carefully examine:

- (1) prior art cited in search reports of a foreign patent office in a counterpart application, and
- (2) the closest information over which individuals associated with the filing or prosecution of a patent application believe any pending claim patentably defines, to make sure that any material information contained therein is disclosed to the Office.

(b) Under this section, information is material to patentability when it is not cumulative to information already of record or being made of record in the application, and

- (1) It establishes, by itself or in combination with other information, a prima facie case of unpatentability of a claim; or
- (2) It refutes, or is inconsistent with, a position the applicant takes in:

- (i) Opposing an argument of unpatentability relied on by the Office, or
  - (ii) Asserting an argument of patentability. A prima facie case of unpatentability is established when the information compels a conclusion that a claim is unpatentable under the preponderance of evidence, burden-of-proof standard, giving each term in the claim its broadest reasonable construction consistent with the specification, and before any consideration is given to evidence which may be submitted in an attempt to establish a contrary conclusion of patentability.
- (c) Individuals associated with the filing or prosecution of a patent application within the meaning of this section are:
- (1) Each inventor named in the application;
  - (2) Each attorney or agent who prepares or prosecutes the application; and
  - (3) Every other person who is substantively involved in the preparation or prosecution of the application and who is associated with the inventor, with the assignee or with anyone to whom there is an obligation to assign the application.
- (d) Individuals other than the attorney, agent or inventor may comply with this section by disclosing information to the attorney, agent, or inventor.
- (e) In any continuation-in-part application, the duty under this section includes the duty to disclose to the Office all information known to the person to be material to patentability, as defined in paragraph (b) of this section, which became available between the filing date of the prior application and the National or PCT international filing date of the continuation-in-part application.

Title 35, U.S. Code § 101

Inventions patentable

Whoever invents or discovers any new and useful process, machine, manufacture, or composition of matter, or any new and useful improvement thereof, may obtain a patent therefor, subject to the conditions and requirements of this title.

Title 35 U.S. Code § 102

Conditions for patentability; novelty and loss of right to patent

A person shall be entitled to a patent unless --

- (a) the invention was known or used by others in this country, or patented or described in a printed publication in this or a foreign country, before the invention thereof by the applicant for patent,
- (b) the invention was patented or described in a printed publication in this or foreign country or in public use or on sale in this country, more than one year prior to the date of application for patent in the United States, or
- (c) he has abandoned the invention, or
- (d) the invention was first patented or caused to be patented, or was the subject of an inventor's certificate, by the applicant or his legal representatives or assigns in a foreign country prior to the date of the application for patent in this country on an application for patent or inventor's certificate filed more than twelve months before the filing of the application in the United States, or

- (e) The invention was described in--
- (1) an application for patent, published under section 122(b), by another filed in the United States before the invention by the applicant for patent, except that an international application filed under the treaty defined in section 351(a) shall have the effect under this subsection of a national application published under section 122(b) only if the international application designating the United States was published under Article 21(2)(a) of such treaty in the English language; or
  - (2) a patent granted on an application for patent by another filed in the United States before the invention by the applicant for patent, except that a patent shall not be deemed filed in the United States for the purposes of this subsection based on the filing of an international application filed under the treaty defined in section 351(a); or
- (f) he did not himself invent the subject matter sought to be patented, or
- (g) (1) during the course of an interference conducted under section 135 or section 291, another inventor involved therein establishes, to the extent permitted in section 104, that before such person's invention thereof the invention was made by such other inventor and not abandoned, suppressed, or concealed, or (2) before such person's invention thereof, the invention was made in this country by another inventor who had not abandoned, suppressed, or concealed it. In determining priority of invention under this subsection, there shall be considered not only the respective dates of conception and reduction to practice of the invention, but also the reasonable diligence of one who was first to conceive and last to reduce to practice, from a time prior to conception by the other.

## Title 35, U.S. Code § 103

## 103. Conditions for patentability; non-obvious subject matter

- (a) A patent may not be obtained though the invention is not identically disclosed or described as set forth in section 102 of this title, if the differences between the subject matter sought to be patented and the prior art are such that the subject matter as a whole would have been obvious at the time the invention was made to a person having ordinary skill in the art to which said subject matter pertains. Patentability shall not be negated by the manner in which the invention was made.
- (b) (1) Notwithstanding subsection (a), and upon timely election by the applicant for patent to proceed under this subsection, a biotechnological process using or resulting in a composition of matter that is novel under section 102 and nonobvious under subsection (a) of this section shall be considered nonobvious if--
- (A) claims to the process and the composition of matter are contained in either the same application for patent or in separate applications having the same effective filing date; and
  - (B) the composition of matter, and the process at the time it was invented, were owned by the same person or subject to an obligation of assignment to the same person.
- (2) A patent issued on a process under paragraph (1)--
- (A) shall also contain the claims to the composition of matter used in or made by that process, or
  - (B) shall, if such composition of matter is claimed in another patent, be set to expire on the same date as such other patent, notwithstanding section 154.
- (3) For purposes of paragraph (1), the term "biotechnological process" means--

- (A) a process of genetically altering or otherwise inducing a single- or multi-celled organism to--
    - (i) express an exogenous nucleotide sequence,
    - (ii) inhibit, eliminate, augment, or alter expression of an endogenous nucleotide sequence, or
    - (iii) express a specific physiological characteristic not naturally associated with said organism;
  - (B) cell fusion procedures yielding a cell line that expresses a specific protein, such as a monoclonal antibody; and
  - (C) a method of using a product produced by a process defined by subparagraph (A) or (B), or a combination of subparagraphs (A) and (B).
- (c) Subject matter developed by another person, which qualifies as prior art only under one or more of subsections (e), (f), and (g) of section 102 of this title, shall not preclude patentability under this section where the subject matter and the claimed invention were, at the time the invention was made, owned by the same person or subject to an obligation of assignment to the same person.

Title 35, U.S. Code § 112 (in part)

#### Specification

The specification shall contain a written description of the invention, and of the manner and process of making and using it, in such full, clear, concise and exact terms as to enable any person skilled in the art to which it pertains, or with which it is most nearly connected, to make and use the same, and shall set forth the best mode contemplated by the inventor of carrying out his invention.

Title 35, U.S. Code, § 119

#### Benefit of earlier filing date in foreign country; right of priority

- (a) An application for patent for an invention filed in this country by any person who has, or whose legal representatives or assigns have, previously regularly filed an application for a patent for the same invention in a foreign country which affords similar privileges in the case of applications filed in the United States or to citizens of the United States, or in a WTO member country, shall have the same effect as the same application would have if filed in this country on the date on which the application for patent for the same invention was first filed in such foreign country, if the application in this country is filed within twelve months from the earliest date on which such foreign application was filed; but no patent shall be granted on any application for patent for an invention which had been patented or described in a printed publication in any country more than one year before the date of the actual filing of the application in this country, or which had been in public use or on sale in this country more than one year prior to such filing.
- (b) (1) No application for patent shall be entitled to this right of priority unless a claim is filed in the Patent and Trademark Office, identifying the foreign application by specifying the application number on that foreign application, the intellectual property authority or country in or for which the application was filed, and the date of filing the application, at such time during the pendency of the application as required by the Director.
- (2) The Director may consider the failure of the applicant to file a timely claim for priority as a waiver of any such claim. The Director may establish procedures, including the payment of a surcharge, to accept an unintentionally delayed claim under this section.

- (3) The Director may require a certified copy of the original foreign application, specification, and drawings upon which it is based, a translation if not in the English language, and such other information as the Director considers necessary. Any such certification shall be made by the foreign intellectual property authority in which the foreign application was filed and show the date of the application and of the filing of the specification and other papers.
- (c) In like manner and subject to the same conditions and requirements, the right provided in this section may be based upon a subsequent regularly filed application in the same foreign country instead of the first filed foreign application, provided that any foreign application filed prior to such subsequent application has been withdrawn, abandoned, or otherwise disposed of, without having been laid open to public inspection and without leaving any rights outstanding, and has not served, nor thereafter shall serve, as a basis for claiming a right of priority.
- (d) Applications for inventors' certificates filed in a foreign country in which applicants have a right to apply, at their discretion, either for a patent or for an inventor's certificate shall be treated in this country in the same manner and have the same effect for purpose of the right of priority under this section as applications for patents, subject to the same conditions and requirements of this section as apply to applications for patents, provided such applicants are entitled to the benefits of the Stockholm Revision of the Paris Convention at the time of such filing.
- (e) (1) An application for patent filed under section 111(a) or section 363 of this title for an invention disclosed in the manner provided by the first paragraph of section 112 of this title in a provisional application filed under section 111(b) of this title, by an inventor or inventors named in the provisional application, shall have the same effect, as to such invention, as though filed on the date of the provisional application filed under section 111(b) of this title, if the application for patent filed under section 111(a) or section 363 of this title is filed not later than 12 months after the date on which the provisional application was filed and if it contains or is amended to contain a specific reference to the provisional application. No application shall be entitled to the benefit of an earlier filed provisional application under this subsection unless an amendment containing the specific reference to the earlier filed provisional application is submitted at such time during the pendency of the application as required by the Director. The Director may consider the failure to submit such an amendment within that time period as a waiver of any benefit under this subsection. The Director may establish procedures, including the payment of a surcharge, to accept an unintentionally delayed submission of an amendment under this subsection during the pendency of the application.
- (2) A provisional application filed under section 111(b) of this title may not be relied upon in any proceeding in the Patent and Trademark Office unless the fee set forth in subparagraph (A) or (C) of section 41(a)(1) of this title has been paid.
- (3) If the day that is 12 months after the filing date of a provisional application falls on a Saturday, Sunday, or Federal holiday within the District of Columbia, the period of pendency of the provisional application shall be extended to the next succeeding secular or business day.
- (f) Applications for plant breeder's rights filed in a WTO member country (or in a foreign UPOV Contracting Party) shall have the same effect for the purpose of the right of priority under subsections (a) through (c) of this section as applications for patents, subject to the same conditions and requirements of this section as apply to applications for patents.
- (g) As used in this section--
- (1) the term "WTO member country" has the same meaning as the term is defined in section 104(b)(2) of this title; and
- (2) the term "UPOV Contracting Party" means a member of the International Convention for the Protection of New Varieties of Plants.

Title 35, U.S. Code, § 120

Benefit or earlier filing date in the United States

An application for patent for an invention disclosed in the manner provided by the first paragraph of section 112 of this title in an application previously filed in the United States, or as provided by section 363 of this title, which is filed by an inventor or inventors named in the previously filed application shall have the same effect, as to such invention, as though filed on the date of the prior application, if filed before the patenting or abandonment of or termination of proceedings on the first application or on an application similarly entitled to the benefit of the filing date of the first application and if it contains or is amended to contain a specific reference to the earlier filed application. ***No application shall be entitled to the benefit of an earlier filed application under this section unless an amendment containing the specific reference to the earlier filed application is submitted at such time during the pendency of the application as required by the Director. The Director may consider the failure to submit such an amendment within that time period as a waiver of any benefit under this section. The Director may establish procedures, including the payment of a surcharge, to accept an unintentionally delayed submission of an amendment under this section.***

Please read carefully before signing the Declaration attached to the accompanying Application. If you have any questions, please contact Morgan & Finnegan, L.L.P.



UNITED STATES PATENT AND TRADEMARK OFFICE

UNITED STATES DEPARTMENT OF COMMERCE  
United States Patent and Trademark Office  
Address: COMMISSIONER FOR PATENTS  
P.O. Box 1450  
Alexandria, Virginia 22313-1450  
www.uspto.gov

APPLICATION NUMBER	FILING OR 371 (c) DATE	FIRST NAMED APPLICANT	ATTORNEY DOCKET NUMBER
10/807,731	03/23/2004	Scott McNulty	4602-4001

MORGAN & FINNEGAN, L.L.P.  
345 Park Avenue  
New York, NY 10154-0053

CONFIRMATION NO. 4430

FORMALITIES LETTER



\*OC000000013572410\*

Date Mailed: 08/18/2004

NOTICE OF INCOMPLETE REPLY (NONPROVISIONAL)

Filing Date Granted

The U.S. Patent and Trademark Office has received your reply on 07/26/2004 to the Notice to File Missing Parts (Notice) mailed 06/04/2004 and it has been entered into the nonprovisional application. The reply, however, does not include the following items required in the Notice.

The period of reply remains as set forth in the Notice. You may, however, obtain EXTENSIONS OF TIME under the provisions of 37 CFR 1.136 (a) accompanied by the appropriate fee (37 CFR 1.17(a)).

A complete reply must be timely filed to prevent ABANDONMENT of the above-identified application. Replies should be mailed to: Mail Stop Missing Parts, Commissioner for Patents, P.O. Box 1450, Alexandria VA 22313-1450.

The application is informal since it does not comply with the regulations for the reason(s) indicated below.

The required item(s) identified below must be timely submitted to avoid abandonment:

- A replacement abstract not exceeding 150 words in length and commencing on a separate sheet in compliance with 37 CFR 1.72(b) and 37 CFR 1.121 is required.

Replies should be mailed to: Mail Stop Missing Parts  
Commissioner for Patents  
P.O. Box 1450  
Alexandria VA 22313-1450

A copy of this notice **MUST** be returned with the reply.

  
Customer Service Center  
Initial Patent Examination Division (703) 308-1202

PayPal Ex. 1058, p. 120  
PayPal v. IOENGINE



PART 3 - OFFICE COPY

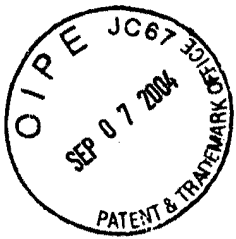

*[Handwritten signature]*

PATENT  
Docket No. 4602-4001

IN THE UNITED STATES PATENT AND TRADEMARK OFFICE

Applicant(s): Scott McNulty  
Serial No.: 10/807,731  
Filed: March 23, 2004  
For: Apparatus, Method and System For A Tunneling Client Access Point

Group Art Unit: 2661  
Examiner: TBA

CERTIFICATE OF MAILING (37 C.F.R. §1.8(a))

Commissioner for Patents  
P.O. Box 1450  
Alexandria, VA 22313  
Sir:

I hereby certify that the attached:

1. Response to Notice to Incomplete Reply
2. Replacement Abstract page
3. Petition and Fee for Extension of Time
3. a check in the amount of \$55.00
4. Return receipt postcard

along with any paper(s) referred to as being attached or enclosed and this Certificate of Mailing are being deposited with the United States Postal Service on date shown below with sufficient postage as first-class mail in an envelope addressed to the: Commissioner for Patents, P.O. Box 1450, Alexandria, VA 22313.

Respectfully submitted,  
MORGAN & FINNEGAN, L.L.P.

*[Handwritten signature]*

Dated: September 3, 2004

By: \_\_\_\_\_  
Walter G. Hanchuk  
Reg. No. 35,179

Correspondence Address:  
MORGAN & FINNEGAN, L.L.P.  
3 World Financial Center  
New York, NY 10281  
212-415-8500

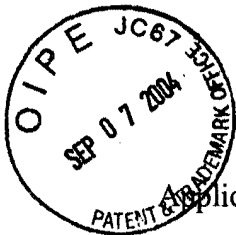

**IN THE UNITED STATES PATENT AND TRADEMARK OFFICE**

Applicant(s): Scott McNulty  
 Serial No.: 10/807,731  
 Filed: March 23, 2004  
 For: Apparatus, Method and System For A Tunneling Client Access Point

Group Art Unit: 2661  
 Examiner: TBA

**RESPONSE TO "NOTICE TO FILE MISSING PARTS"**

Commissioner for Patents  
P.O. Box 1450  
Alexandria, VA 22313-1450

Sir:

In response to the NOTICE TO FILE MISSING PARTS OF APPLICATION--  
FILING DATE GRANTED dated June 4, 2004, Applicant(s) submit(s) herewith the following  
documents for appropriate action by the U.S. Patent and Trademark Office:

- Copy of Notice to Incomplete Reply
- Replacement Abstract page
- Application Filing Fees
- Please charge the required fee of \$ \_\_\_\_\_ to deposit account no. 13-4500, Order No. \_\_\_\_\_.
- A check in the amount of \$0.00 in payment of the application filing fees is attached.
- The Commissioner is hereby authorized to charge any additional fees which may be required by this paper, or credit any overpayment to Deposit Account No. 13-4500, Order No. 4602-4001. A DUPLICATE COPY OF THIS SHEET IS ATTACHED.

Respectfully submitted,  
MORGAN & FINNEGAN, L.L.P.

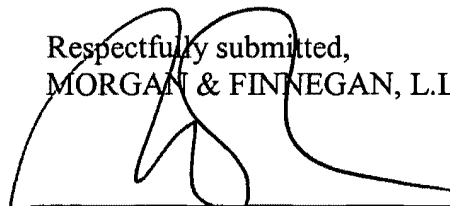

---

Walter G. Hanchuk  
Reg. No. 35,179

Dated: September 1, 2004:

Correspondence Address:  
MORGAN & FINNEGAN, L.L.P.  
3 World Financial Center  
New York, NY 10281  
212-415-8500

## ABSTRACT

The disclosure details the implementation of a tunneling client access point (TCAP) that is a highly secure, portable, power efficient storage and data processing mechanism. The TCAP “tunnels” data through an access terminal’s (AT) input/output facilities. In one embodiment, the TCAP has no user input or output peripherals. The TCAP connects to an access terminal and a user employs the AT’s user input peripherals for input, and views the TCAPs activities on the AT’s display. This enables the user to observe data stored on the TCAP without it being resident on the AT, which can be useful to maintain higher levels of data security. Also, the TCAP may tunnel data through an AT across a communications network to access remote servers. The disclosure teaches how to allow users to employ traditional large user interfaces that users are already comfortable with. The disclosure, also, teaches a plug-n-play virtual private network (VPN).

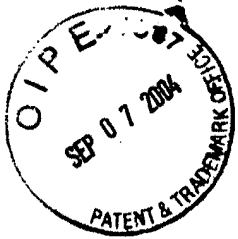

Docket No. 4602-4001

**IN THE UNITED STATES PATENT AND TRADEMARK OFFICE**

Applicant(s): Scott McNulty

Group Art Unit: 2661

Serial No.: 10/807,731

Examiner: TBA

Filed: March 23, 2004

For: Apparatus, Method and System For A Tunneling Client Access Point

**PETITION AND FEE FOR EXTENSION OF TIME (37 C.F.R. § 1.136(a))**

Mail Stop \_\_\_\_\_  
Commissioner for Patents  
P.O. Box 1450  
Alexandria, VA 22313-1450

Sir:

1. This is a petition for an extension of time for filing a Response to Notice to Incomplete Reply
2. The communication in connection with the matter for which this extension is requested
  - is filed herewith.
  - has been filed on \_\_\_\_\_.
3.  Applicant(s) is/are entitled to Small Entity Status.
  - Statement has already been filed

4.	<u>Total Months Requested</u>	<u>Fee for Other than Small Entity</u>	<u>Fee for Small Entity</u>
a.	<input checked="" type="checkbox"/> one month	\$110.00	\$55.00
b.	<input type="checkbox"/> two months	\$420.00	\$210.00
c.	<input type="checkbox"/> three months	\$950.00	\$475.00
d.	<input type="checkbox"/> four months	\$1,480.00	\$740.00
e.	<input type="checkbox"/> five months	\$2,010.00	\$1,005.00

09/09/2004 AADDF01 00000015 10807731

01 FC:2251

55.00 OP

- f.  An extension for \_\_\_\_\_ months has already been secured for filing the above-identified communication and the fee paid therefor of \$\_\_\_\_\_ is deducted from the total fee due for the total months of extension now requested. The fee for this extension (\$ \_\_\_\_\_), minus the fee previously paid (\$\_\_\_\_\_) equals \$\_\_\_\_\_ (total fee due).
5.  A check in the amount of \$55.00 to cover the extension fee is attached.
6.  Charge fee to Deposit Account No. 13-4500, Order No. \_\_\_\_\_. A DUPLICATE COPY OF THIS SHEET IS ATTACHED.
7.  The Commissioner is hereby authorized to charge any additional fees which may be required by this paper, or credit any overpayment to Deposit Account No. 13-4500. Order No. 4602-4001. A DUPLICATE COPY OF THIS SHEET IS ATTACHED.

Respectfully submitted,  
MORGAN & FINNEGAN, L.L.P.

Dated: September 3, 2004

By: \_\_\_\_\_

Walter G. Hanchuk  
Registration No. 35,179

Correspondence Address:

MORGAN & FINNEGAN, L.L.P.  
3 World Financial Center  
New York, NY 10281-2101  
(212) 415-8700 Telephone  
(212) 415-8701 Facsimile



IFW

PATENT  
Docket No. 4602-4001

IN THE UNITED STATES PATENT AND TRADEMARK OFFICE

Applicant(s): Scott McNulty  
Serial No.: 10/807,731  
Filed: March 23, 2004  
For: Apparatus, Method and System For A Tunneling Client Access Point  
Group Art Unit: 2661  
Examiner: TBA

CERTIFICATE OF MAILING (37 C.F.R. §1.8(a))

Commissioner for Patents  
P.O. Box 1450  
Alexandria, VA 22313  
Sir:

I hereby certify that the attached:

1. Request to Rescind Previous Nonpublication Request
2. Return receipt postcard

along with any paper(s) referred to as being attached or enclosed and this Certificate of Mailing are being deposited with the United States Postal Service on date shown below with sufficient postage as first-class mail in an envelope addressed to the: Commissioner for Patents, P.O. Box 1450, Alexandria, VA 22313.

Respectfully submitted,  
MORGAN & FINNEGAN, L.L.P.

Dated: March 24, 2005

By: Daniel C. Sheridan  
Daniel C. Sheridan  
Reg. No. 53,585

Correspondence Address:  
MORGAN & FINNEGAN, L.L.P.  
3 World Financial Center  
New York, NY 10281  
212-415-8500

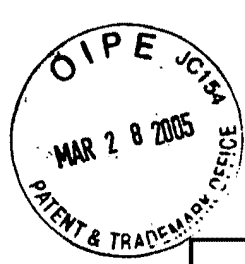

**REQUEST TO RESCIND  
PREVIOUS NONPUBLICATION  
REQUEST  
35 U.S.C. §122(b)(2)(B)(ii)  
  
NOTICE OF FOREIGN FILING  
35 U.S.C. §122(b)(2)(B)(iii)**

Application No.	10/807,731
Filing Date	March 23, 2004
First Named Inventor	Scott McNulty
Group Art Unit	2661
Examiner Name	TBA
Atty Docket No.	4602-4001

**I hereby rescind the previous request that the above-identified application not be published under 35 U.S.C. §122(b)(2)(B)(iii).**

**This document is being submitted within forty-five (45) days of March 22, 2005, the foreign filing date of the application (35 U.S.C. §122(b)(2)(B)(iii)).**

**This request is signed in compliance with 37 C.F.R. §1.33(b).**

**SIGNATURE OF APPLICANT, ATTORNEY, OR AGENT REQUIRED**

Signature	<u><i>Daniel C. Sheridan</i></u>	Date	<u>March 24, 2005</u>
Name			
(Print/Type)	<u>Daniel C. Sheridan</u>	Reg. No. (Atty/Agent)	<u>53,585</u>

Mail Stop PGPUB  
Commissioner for Patents  
P.O. Box 1450  
Alexandria, VA 22313-1450





## UNITED STATES PATENT AND TRADEMARK OFFICE

UNITED STATES DEPARTMENT OF COMMERCE  
 United States Patent and Trademark Office  
 Address: COMMISSIONER FOR PATENTS  
 P.O. Box 1450  
 Alexandria, Virginia 22313-1450  
 www.uspto.gov

APPLICATION NUMBER	FILING/RECEIPT DATE	FIRST NAMED APPLICANT	ATTY. DOCKET NO.
10/807,731	03/23/2004	Scott McNulty	4602-4001

CONFIRMATION NO. 4430

27123  
 MORGAN & FINNEGAN, L.L.P.  
 3 WORLD FINANCIAL CENTER  
 NEW YORK, NY 10281-2101



\*OC00000015681273\*

Date Mailed: 04/07/2005

### Communication Regarding Rescission Of Nonpublication Request and/or Notice of Foreign Filing

Applicant's rescission of the previously-filed nonpublication request and/or notice of foreign filing is acknowledged. The paper has been reflected in the Patent and Trademark Office's (USPTO's) computer records so that the earliest possible projected publication date can be assigned.

The projected publication date is 09/29/2005.

If applicant rescinded the nonpublication request before or on the date of "foreign filing,"<sup>1</sup> then no notice of foreign filing is required.

If applicant foreign filed the application after filing the above application and before filing the rescission, and the rescission did not also include a notice of foreign filing, then a notice of foreign filing (not merely a rescission) is required to be filed within 45 days of the date of foreign filing. See 35 U.S.C. § 122(b)(2)(B)(iii), and Clarification of the United States Patent and Trademark Office's Interpretation of the Provisions of 35 U.S.C. § 122(b)(2)(B)(ii)-(iv), 1272 Off. Gaz. Pat. Office 22 (July 1, 2003).

If a notice of foreign filing is required and is not filed within 45 days of the date of foreign filing, then the application becomes abandoned pursuant to 35 U.S.C. § 122(b)(2)(B)(iii). In this situation, applicant should either file a petition to revive or notify the Office that the application is abandoned. See 37 CFR 1.137(f). Any such petition to revive will be forwarded to the Office of Petitions for a decision. Note that the filing of the petition will not operate to stay any period of reply that may be running against the application.

Questions regarding petitions to revive should be directed to the Office of Petitions at (571) 272-3282. Questions regarding publications of patent applications should be directed to the patent application publication hotline at (703) 605-4283 or by e-mail [pgpub@uspto.gov](mailto:pgpub@uspto.gov).

<sup>1</sup> Note, for purpose of this notice, that "foreign filing" means "filing an application directed to the same invention in another country, or under a multilateral international agreement, that requires publication of applications 18 months after filing".



17231 U.S. PTO

Docket No. 4602-4001

Express Mail No. EV 383045195 US

27123

↑CUSTOMER NUMBER↑

22859 U.S. PTO  
10/807731



**IN THE UNITED STATES PATENT AND TRADEMARK OFFICE**

**UTILITY APPLICATION AND FEE TRANSMITTAL §(1.53(b))**

Mail Stop Patent Application  
Commissioner for Patents  
P.O. Box 1450  
Alexandria, VA 22313-1450

Sir:

Transmitted herewith for filing is the patent application of

Inventor(s) names and addresses:

(1) Scott McNulty  
22 Ensign Road,  
Rowayton, CT 06853

(2)

Additional inventors are listed on a separate sheet

For: Apparatus, Method and System For A Tunneling Client Access

Enclosed Are:

67 page(s) of specification

2 page(s) of Abstract

17 page(s) of claims

10 sheets of  Formal  Informal drawings

\_\_\_\_\_ page(s) of Declaration and Power of Attorney

Unsigned

Newly Executed

Copy from prior application

Deletion of inventors including Signed Statement under 37 C.F.R. §1.63(d)(2)

**REQUEST AND CERTIFICATION UNDER 35 U.S.C. §122(b)(2)(B)(i) (form PTO/SB/35)**

As indicated on the attached Request and Certification, Applicant(s) certify that the invention disclosed in the attached application HAS NOT and WILL NOT be the subject of an application filed in another country, or under a multilateral agreement, that requires publication at eighteen months after filing. Applicant(s) therefore request(s) that the attached application NOT be published under 35 U.S.C. §122(b).

**Incorporation by Reference:**

The entire disclosure of the prior application, from which a copy of the combined Declaration and Power of Attorney is supplied herein, is considered as being part of the disclosure of the accompanying application and is incorporated herein by reference.

**Deletion of Inventors (37 C.F.R. §1.63(d) and §1.33(b))**

Signed statement attached deleting inventor(s) named in the prior application serial no. \_\_\_\_\_, filed \_\_\_\_\_.

**Microfiche Computer Program (Appendix)**

page(s) of Sequence Listing

computer readable disk containing Sequence Listing

Statement under 37 C.F.R. §1.821(f) that computer and paper copies of the Sequence Listing are the same

**Assignment Papers (assignment cover sheet and assignment documents)**

A check in the amount of \$40.00 for recording the Assignment

Charge the Assignment Recordation Fee to Deposit Account No. 13-4500, Order No. \_\_\_\_\_.

Assignment Papers filed in the parent application Serial No. \_\_\_\_\_

**Certification of chain of title pursuant to 37 C.F.R. §3.73(b)**

**Priority is claimed under 35 U.S.C. §119 for:**  
Application No(s). \_\_\_\_\_, filed \_\_\_\_\_, in \_\_\_\_\_ (country).

**Certified Copy of Priority Document(s) [\_\_\_\_\_]**

filed herewith

filed in application Serial No. \_\_\_\_\_, filed \_\_\_\_\_.

**English translation document(s) [\_\_\_\_\_]**

filed herewith

filed in application Serial No. \_\_\_\_\_, filed \_\_\_\_\_.

**Priority is claimed under 35 U.S.C. §119(e) for:**  
Provisional Application No. \_\_\_\_\_, filed \_\_\_\_\_.

- Information Disclosure Statement
- Copy of [\_\_\_\_\_] cited references
  - PTO Form-1449
  - References cited in parent application Serial No. \_\_\_\_\_, filed \_\_\_\_\_.
- Related Case Statement under 37 C.F.R. §1.98(a)(2)(iii)
- A copy of related pending U.S. Application(s) Serial No(s): \_\_\_\_\_, filed \_\_\_\_\_, respectively, is attached hereto.
  - A copy of related pending U.S. Application(s) entitled, \_\_\_\_\_, filed \_\_\_\_\_ to inventor(s) \_\_\_\_\_, respectively, is attached hereto.
  - A copy of each related application(s) was submitted in parent application serial no. \_\_\_\_\_, filed \_\_\_\_\_.
- Preliminary Amendment
- Return receipt postcard (MPEP 503)
- This is a  continuation  divisional  continuation-in-part of prior application serial no. \_\_\_\_\_, filed \_\_\_\_\_, to which priority under 35 U.S.C. §120 is claimed.
- Cancel in this application original claims \_\_\_\_\_ of the parent application before calculating the filing fee. (At least one original independent claim must be retained for filing purposes.)
  - A Preliminary Amendment is enclosed. (Claims added by this Amendment have been properly numbered consecutively beginning with the number following the highest numbered original claim in the prior application).
- The status of the parent application is as follows:
- A Petition for Extension of Time and a Fee therefor has been or is being filed in the parent application to extend the term for action in the parent application until \_\_\_\_\_.
  - A copy of the Petition for Extension of Time in the co-pending parent application is attached.
  - No Petition for Extension of Time and Fee therefor are necessary in the co-pending parent application.
- Please abandon the parent application at a time while the parent application is pending or at a time when the petition for extension of time in that application is granted and while this application is pending has been granted a filing date, so as to make this application co-pending.
- Transfer the drawing(s) from the parent application to this application
- Amend the specification by inserting before the first line the sentence:  
This is  continuation  divisional  continuation-in-part of co-pending application Serial No. \_\_\_\_\_, filed \_\_\_\_\_.

I. CALCULATION OF APPLICATION FEE				
	Number Filed	Number Extra	Rate	Basic Fee \$770.00/385.00
Total Claims	69- 20 =	49x	\$18.00/ \$9.00	\$ 441.00
Independent Claims	12- 3 =	9x	\$86.00/ \$43.00	\$ 387.00
<input type="checkbox"/> Multiple Dependent Claims	If marked, add fee of \$290.00 (\$145.00)			\$
TOTAL:				\$ 1213.300

- Small entity status is or has been claimed. Reduced fees under 37 C.F.R. §1.9 (f) paid herewith \$.
- A check in the amount of \$\_\_\_\_\_ in payment of the application filing fees is attached.
- Charge fee to Deposit Account No. 13-4500, Order No. 4602-4001. A DUPLICATE COPY OF THIS SHEET IS ATTACHED.
- The Commissioner is hereby authorized to charge any additional fees which may be required for filing this application pursuant to 37 CFR §1.16, **including all extension of time fees pursuant to 37 C.F.R. § 1.17 for maintaining copendency with the parent application**, or credit any overpayment to Deposit Account No. 13-4500, Order No. 4602-4001. A DUPLICATE COPY OF THIS SHEET IS ATTACHED.

Respectfully submitted,  
MORGAN & FINNEGAN, L.L.P.

Dated: March 23, 2004

By:

  
Walter G. Hanchuk  
Registration No. 35,179

Correspondence Address:

MORGAN & FINNEGAN, L.L.P.  
345 Park Avenue  
New York, NY 10154-0053  
(212) 758-4800 Telephone  
(212) 751-6849 Facsimile

**IN THE UNITED STATES PATENT AND TRADEMARK OFFICE**

Applicant(s): Scott McNulty  
Serial No.: TBA  
Filed: March 23, 2004  
For: Apparatus, Method and System For A Tunneling Client Access  
Group Art Unit: TBA  
Examiner: TBA

**EXPRESS MAIL CERTIFICATE**

Mail Stop  
Commissioner for Patents  
P.O. Box 1450  
Alexandria, VA 22313-1450

Express Mail Label No.: EV 383045195 US  
Date of Deposit: March 23, 2004

I hereby certify that the following attached paper(s) and/or fee

1. Utility Application and fee Transmittal enclosing (1 page of cover sheet, 67 pages of specification, 2 page of abstract, 17 pages of claims and 10 sheets of formal drawings (Figs. 1-10)
2. Return postcard

are being deposited with the United States Postal Service "Express Mail Post Office to Addressee" service under 37 C.F.R. §1.10 on the date indicated above and is addressed to Commissioner for Patents, P.O. Box 1450, Alexandria, VA 22313-1450.

Vivian King

(Typed or printed name of person mailing papers(s) and/or fee)



(Signature of person mailing paper(s) and/or fee)

Correspondence Address:

MORGAN & FINNEGAN, L.L.P.  
345 Park Avenue  
New York, NY 10154-0053  
(212) 758-4800 Telephone  
(212) 751-6849 Facsimile

**IN THE UNITED STATES PATENT AND TRADEMARK OFFICE**

Applicant(s): Scott McNulty  
Serial No.: 10/807,731 Confirmation No.: 4430  
Group Art Unit: 2661  
Filed: March 23, 2004 Examiner: To Be Assigned  
For: APPARATUS, METHOD AND SYSTEM FOR A TUNNELING CLIENT  
ACCESS POINT

**STATUS INQUIRY**

Commissioner for Patents  
P.O. Box 1450  
Alexandria, VA 22313-1450

Sir:

On March 23, 2004, Applicants filed the above-identified patent application which was assigned U.S. Patent Application Serial No. 10/807,731. As of the date of this letter, Applicant has not received an Official Action from the Patent and Trademark Office.

Accordingly, the Office is respectfully requested to advise Applicant about the status of this application. The Office is urged to telephone the undersigned at the number provided below if any further information is needed.

Respectfully submitted,  
MORGAN & FINNEGAN, L.L.P.

Dated: April 24, 2007

By:

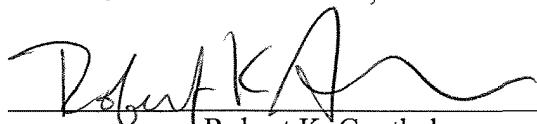

Robert K. Goethals  
Registration No. 36,813

Correspondence Address:  
MORGAN & FINNEGAN, L.L.P.  
3 World Financial Center  
New York, NY 10281-2101  
(212) 415-6729 Telephone  
(212) 415-8701 Facsimile

## Electronic Acknowledgement Receipt

<b>EFS ID:</b>	1711159
<b>Application Number:</b>	10807731
<b>International Application Number:</b>	
<b>Confirmation Number:</b>	4430
<b>Title of Invention:</b>	Apparatus, method and system for a tunneling client access point
<b>First Named Inventor/Applicant Name:</b>	Scott McNulty
<b>Customer Number:</b>	27123
<b>Filer:</b>	Robert Keaney Goethals/Anna Hill
<b>Filer Authorized By:</b>	Robert Keaney Goethals
<b>Attorney Docket Number:</b>	4602-4001
<b>Receipt Date:</b>	24-APR-2007
<b>Filing Date:</b>	23-MAR-2004
<b>Time Stamp:</b>	15:27:37
<b>Application Type:</b>	Utility

### Payment information:

Submitted with Payment	no
------------------------	----

### File Listing:

Document Number	Document Description	File Name	File Size(Bytes)	Multi Part /.zip	Pages (if appl.)
1	Request for status of Application	4602-4001_Status_Inquiry.pdf	41197	no	1

Warnings:

PayPal Ex. 1058, p. 136

PayPal v. IOENGINE



<b>Information:</b>	
<b>Total Files Size (in bytes):</b>	41197
<p><b>This Acknowledgement Receipt evidences receipt on the noted date by the USPTO of the indicated documents, characterized by the applicant, and including page counts, where applicable. It serves as evidence of receipt similar to a Post Card, as described in MPEP 503.</b></p> <p><b><u>New Applications Under 35 U.S.C. 111</u></b> If a new application is being filed and the application includes the necessary components for a filing date (see 37 CFR 1.53(b)-(d) and MPEP 506), a Filing Receipt (37 CFR 1.54) will be issued in due course and the date shown on this Acknowledgement Receipt will establish the filing date of the application.</p> <p><b><u>National Stage of an International Application under 35 U.S.C. 371</u></b> If a timely submission to enter the national stage of an international application is compliant with the conditions of 35 U.S.C. 371 and other applicable requirements a Form PCT/DO/EO/903 indicating acceptance of the application as a national stage submission under 35 U.S.C. 371 will be issued in addition to the Filing Receipt, in due course.</p> <p><b><u>New International Application Filed with the USPTO as a Receiving Office</u></b> If a new international application is being filed and the international application includes the necessary components for an international filing date (see PCT Article 11 and MPEP 1810), a Notification of the International Application Number and of the International Filing Date (Form PCT/RO/105) will be issued in due course, subject to prescriptions concerning national security, and the date shown on this Acknowledgement Receipt will establish the international filing date of the application.</p>	

**IN THE UNITED STATES PATENT AND TRADEMARK OFFICE**

Applicant(s): Scott McNulty

Serial No.: 10/807,731  
Confirmation No.: 4430  
Group Art Unit: 2143

Filed: March 23, 2004  
Examiner: Asgar H. Bilgrami

For: APPARATUS, METHOD AND SYSTEM FOR A TUNNELING CLIENT  
ACCESS POINT

**STATUS INQUIRY**

Commissioner for Patents  
P.O. Box 1450  
Alexandria, VA 22313-1450

Sir:

On March 23, 2004, Applicants filed the above-identified patent application which was assigned U.S. Patent Application Serial No. 10/807,731. As of the date of this letter, Applicant has not received an Official Action from the Patent and Trademark Office.

Accordingly, the Office is respectfully requested to advise Applicant about the status of this application. The Office is urged to telephone the undersigned at the number provided below if any further information is needed.

Respectfully submitted,  
MORGAN & FINNEGAN, L.L.P.

Dated: January 29, 2008

By: \_\_\_\_\_

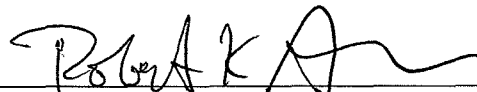

Robert K. Goethals  
Registration No. 36,813

Correspondence Address:  
MORGAN & FINNEGAN, L.L.P.  
3 World Financial Center  
New York, NY 10281-2101  
(212) 415-6729 Telephone  
(212) 415-8701 Facsimile

## Electronic Acknowledgement Receipt

<b>EFS ID:</b>	2783184
<b>Application Number:</b>	10807731
<b>International Application Number:</b>	
<b>Confirmation Number:</b>	4430
<b>Title of Invention:</b>	Apparatus, method and system for a tunneling client access point
<b>First Named Inventor/Applicant Name:</b>	Scott McNulty
<b>Customer Number:</b>	27123
<b>Filer:</b>	Robert Keaney Goethals/Anna Hill
<b>Filer Authorized By:</b>	Robert Keaney Goethals
<b>Attorney Docket Number:</b>	4602-4001
<b>Receipt Date:</b>	29-JAN-2008
<b>Filing Date:</b>	23-MAR-2004
<b>Time Stamp:</b>	15:56:07
<b>Application Type:</b>	Utility under 35 USC 111(a)

### Payment information:

Submitted with Payment	no
------------------------	----

### File Listing:

Document Number	Document Description	File Name	File Size(Bytes) /Message Digest	Multi Part /.zip	Pages (if appl.)
1	Request for status of Application	4602-4001_Status_Inquiry.p df	34146 <small>0ed20c0e2416f95cb94aefaf7060bbb45 c60d882</small>	no	1

### Warnings:

### Information:

PayPal Ex. 1058, p. 139

PayPal v. IOENGINE

This Acknowledgement Receipt evidences receipt on the noted date by the USPTO of the indicated documents, characterized by the applicant, and including page counts, where applicable. It serves as evidence of receipt similar to a Post Card, as described in MPEP 503.

**New Applications Under 35 U.S.C. 111**

If a new application is being filed and the application includes the necessary components for a filing date (see 37 CFR 1.53(b)-(d) and MPEP 506), a Filing Receipt (37 CFR 1.54) will be issued in due course and the date shown on this Acknowledgement Receipt will establish the filing date of the application.

**National Stage of an International Application under 35 U.S.C. 371**

If a timely submission to enter the national stage of an international application is compliant with the conditions of 35 U.S.C. 371 and other applicable requirements a Form PCT/DO/EO/903 indicating acceptance of the application as a national stage submission under 35 U.S.C. 371 will be issued in addition to the Filing Receipt, in due course.

**New International Application Filed with the USPTO as a Receiving Office**

If a new international application is being filed and the international application includes the necessary components for an international filing date (see PCT Article 11 and MPEP 1810), a Notification of the International Application Number and of the International Filing Date (Form PCT/RO/105) will be issued in due course, subject to prescriptions concerning national security, and the date shown on this Acknowledgement Receipt will establish the international filing date of the application.



UNITED STATES PATENT AND TRADEMARK OFFICE

UNITED STATES DEPARTMENT OF COMMERCE
United States Patent and Trademark Office
Address: COMMISSIONER FOR PATENTS
P.O. Box 1450
Alexandria, Virginia 22313-1450
www.uspto.gov

Table with 5 columns: APPLICATION NO., FILING DATE, FIRST NAMED INVENTOR, ATTORNEY DOCKET NO., CONFIRMATION NO. Includes fields for EXAMINER (BILGRAMI, ASGHAR H), ART UNIT (2443), PAPER NUMBER, NOTIFICATION DATE (11/26/2008), and DELIVERY MODE (ELECTRONIC).

Please find below and/or attached an Office communication concerning this application or proceeding.

The time period for reply, if any, is set in the attached communication.

Notice of the Office communication was sent electronically on above-indicated "Notification Date" to the following e-mail address(es):

- PTOPatentCommunications@Morganfinnegan.com
Shopkins@Morganfinnegan.com
jmedina@Morganfinnegan.com

<b>Office Action Summary</b>	<b>Application No.</b> 10/807,731	<b>Applicant(s)</b> MCNULTY, SCOTT	
	<b>Examiner</b> ASGHAR BILGRAMI	<b>Art Unit</b> 2443	

**-- The MAILING DATE of this communication appears on the cover sheet with the correspondence address --**

**Period for Reply**

A SHORTENED STATUTORY PERIOD FOR REPLY IS SET TO EXPIRE 3 MONTH(S) OR THIRTY (30) DAYS, WHICHEVER IS LONGER, FROM THE MAILING DATE OF THIS COMMUNICATION.

- Extensions of time may be available under the provisions of 37 CFR 1.136(a). In no event, however, may a reply be timely filed after SIX (6) MONTHS from the mailing date of this communication.
- If NO period for reply is specified above, the maximum statutory period will apply and will expire SIX (6) MONTHS from the mailing date of this communication.
- Failure to reply within the set or extended period for reply will, by statute, cause the application to become ABANDONED (35 U.S.C. § 133). Any reply received by the Office later than three months after the mailing date of this communication, even if timely filed, may reduce any earned patent term adjustment. See 37 CFR 1.704(b).

**Status**

- 1)  Responsive to communication(s) filed on 23 March 2004.
- 2a)  This action is **FINAL**.
- 2b)  This action is non-final.
- 3)  Since this application is in condition for allowance except for formal matters, prosecution as to the merits is closed in accordance with the practice under *Ex parte Quayle*, 1935 C.D. 11, 453 O.G. 213.

**Disposition of Claims**

- 4)  Claim(s) 1-69 is/are pending in the application.
  - 4a) Of the above claim(s) \_\_\_\_\_ is/are withdrawn from consideration.
- 5)  Claim(s) \_\_\_\_\_ is/are allowed.
- 6)  Claim(s) 1-69 is/are rejected.
- 7)  Claim(s) \_\_\_\_\_ is/are objected to.
- 8)  Claim(s) \_\_\_\_\_ are subject to restriction and/or election requirement.

**Application Papers**

- 9)  The specification is objected to by the Examiner.
- 10)  The drawing(s) filed on 23 March 2004 is/are: a)  accepted or b)  objected to by the Examiner.
  - Applicant may not request that any objection to the drawing(s) be held in abeyance. See 37 CFR 1.85(a).
  - Replacement drawing sheet(s) including the correction is required if the drawing(s) is objected to. See 37 CFR 1.121(d).
- 11)  The oath or declaration is objected to by the Examiner. Note the attached Office Action or form PTO-152.

**Priority under 35 U.S.C. § 119**

- 12)  Acknowledgment is made of a claim for foreign priority under 35 U.S.C. § 119(a)-(d) or (f).
  - a)  All    b)  Some \*    c)  None of:
    - 1.  Certified copies of the priority documents have been received.
    - 2.  Certified copies of the priority documents have been received in Application No. \_\_\_\_\_.
    - 3.  Copies of the certified copies of the priority documents have been received in this National Stage application from the International Bureau (PCT Rule 17.2(a)).

\* See the attached detailed Office action for a list of the certified copies not received.

**Attachment(s)**

- |  |   |
|--|---|
| 1) <input checked="" type="checkbox"/> Notice of References Cited (PTO-892)                                | 4) <input type="checkbox"/> Interview Summary (PTO-413)<br>Paper No(s)/Mail Date. _____ |
| 2) <input type="checkbox"/> Notice of Draftsperson's Patent Drawing Review (PTO-948)                       | 5) <input type="checkbox"/> Notice of Informal Patent Application                       |
| 3) <input type="checkbox"/> Information Disclosure Statement(s) (PTO/SB/08)<br>Paper No(s)/Mail Date _____ | 6) <input type="checkbox"/> Other: _____  |

## DETAILED ACTION

### *Claim Objections*

1. Claims 29-31 are objected to because of the following informalities: Claim 28 describes signal “decryption” functionality whereas its depended claims (29-31) address “encryption” functionality. Appropriate correction is required. For examining purposes Examiner has assumed that claim 29-31 are addressing “decryption” functionality on processor, terminal and server respectively.

### *Claim Rejections - 35 USC § 102*

2. The following is a quotation of the appropriate paragraphs of 35 U.S.C. 102 that form the basis for the rejections under this section made in this Office action:

A person shall be entitled to a patent unless –

(e) the invention was described in (1) an application for patent, published under section 122(b), by another filed in the United States before the invention by the applicant for patent or (2) a patent granted on an application for patent by another filed in the United States before the invention by the applicant for patent, except that an international application filed under the treaty defined in section 351(a) shall have the effects for purposes of this subsection of an application filed in the United States only if the international application designated the United States and was published under Article 21(2) of such treaty in the English language.

3. Claims 1-69 are rejected under 35 U.S.C. 102(e) as being anticipated by Ryan et al (U.S. 7,213,766 B2).

4. As per claims 1, 2, 32, 33, 61-68 Ryan disclosed a method of accessing data, comprising: engaging a portable storage device with a terminal (col.12, lines 58-65) , wherein the portable storage device has a processor (col.13, lines 45-47), wherein the portable storage device connects to the terminal across compatible conduits for external

Art Unit: 2443

communications (col.12, lines 58-65), wherein the storage device has a memory (col.13, lines 6-9), wherein the memory and a storage conduit are disposed in communication with the processor (col.13, lines 45-50), wherein the conduits are USB conduits (col.13, line 50); wherein the communication instructions issue signals to: communicate with a terminal (col.13, lines 61-63); communicate with a server (col.17, lines 47-50); providing the memory for access on the terminal, wherein the memory is mounted on the terminal; executing processing instructions from the memory on the terminal to access the terminal (col.23, lines 43-45); communicating through the conduit at a terminal, wherein the terminal acts as a proxy for the terminal's input and output peripheral devices, and acts as a network interface proxy, wherein communication instruction issued signals are encrypted (col.23, lines 25-42), wherein the encryption occurs on the processor (col.23, lines 25-42) {the encryption in the auto-run application is being implemented by a processor}, wherein received encrypted instruction signals are decrypted, wherein decryption occurs on the processor (col.19, lines 31-40); executing processing instructions on the processor, wherein the processing instructions are stored on the memory (col.19, lines 24, lines 40), wherein the processing instructions are used to issue signals to process processing instruction on the processor (col.11, lines 4-24) ; and effecting the display of processing activity on the terminal (col.21, lines 6-22).

5. As per claim 3 Ryan disclosed the apparatus of claim 2, wherein the unique apparatus identifier is a digital signature (col.23, lines 56-60).



Art Unit: 2443

6. As per claim 4 Ryan disclosed the apparatus of claim 2, wherein the memory contains user verifying information (col.23, lines 56-60).

7. As per claim 5 Ryan disclosed the apparatus of claim 4, wherein the user verifying information is a digital signature (col.23, lines 56-60).

8. As per claim 6 Ryan disclosed the apparatus of claim 4, wherein the user verifying information is a username and password (col.3, lines 18-22).

9. As per claim 7 Ryan disclosed the apparatus of claim 6, further, comprising: wherein the processing instructions issue signals to: encrypt the memory based on the unique apparatus identifier and user verifying information (col.19, lines 31-40).

10. As per claim 8 Ryan disclosed the apparatus of claim 2, further, comprising: wherein the processing instructions issue signals to: execute processing instructions from the memory on the terminal to access the terminal (col.23, lines 25-42).

11. As per claims 9, 40 & 41 Ryan disclosed the apparatus of claim 2, wherein the terminal acts as a proxy for the terminal's input and output peripheral devices, and acts as a network interface proxy (col.23, lines 25-42) {The fact that a user can access the

Art Unit: 2443

respective website on the Internet from any terminal is an indication that the terminal acts as a proxy interface}.

12. As per claims 19 & 52 Ryan disclosed the apparatus of claim 2, wherein the processing instructions are stored on the memory (col.23, lines 43-45).

13. As per claim 11 Ryan disclosed the apparatus of claim 2, wherein the processing instructions are obtained from a server (col.2, lines 66-67 & col.3, lines 1-3).

14. As per claims 12, 53 & 56 Ryan disclosed the apparatus of claim 2, wherein the processing instructions are processed on the processor (col.11, lines 4-24).

15. As per claims 13 & 57 Ryan disclosed the apparatus of claim 12, wherein the processing instructions are processed on the processor to process files for printing (col.5, lines 9-16).

16. As per claims 14 & 54 Ryan disclosed the apparatus of claim 2, wherein the processing instructions are processed on the terminal (col.23, lines 43-45).

Art Unit: 2443

17. As per claims 15 & 55 Ryan disclosed the apparatus of claim 2, wherein the processing instructions are processed on the server (col.17, lines 47-50).

18. As per claims 16 & 58 Ryan disclosed the apparatus of claim 2, further, comprising: wherein the processing instructions issue signals to: effect the display of processing activity (col.21, lines 6-22).

19. As per claims 17 & 59 Ryan disclosed the apparatus of claim 16, wherein the display of processing activity occurs on the terminal (col.21, lines 6-22).

20. As per claims 18 & 60 Ryan disclosed the apparatus of claim 16, wherein the display of processing activity occurs directly in the terminal's video memory (col.17, lines 6-15).

21. As per claims 19 & 34 Ryan disclosed the apparatus of claim 2, wherein the conduits are USB conduits (col.17, lines 50-53).

22. As per claims 20 & 35 Ryan disclosed the apparatus of claim 2, wherein the conduits are wireless conduits (col.17, lines 53-55).

Art Unit: 2443

23. As per claims 21 & 36 Ryan disclosed the apparatus of claim 20, wherein the wireless conduits are Bluetooth (col.17, lines 53-55).

24. As per claims 22 & 37 Ryan disclosed the apparatus of claim 20, wherein the wireless conduits are WiFi (col.12, lines 40-44).

25. As per claim 23 Ryan disclosed the apparatus of claim 2, further, comprising: wherein the communication instructions issue signals to: communicate with a server (col.17, lines 47-50).

26. As per claims 24 & 42 Ryan disclosed the apparatus of claim 23, wherein the communication instruction issued signals are encrypted (col.23, lines 25-42).

27. As per claims 25, 43 & 44 Ryan disclosed the method of claim 43, wherein the encryption occurs on the processor executing communication instructions from memory (col.23, lines 25-42).

28. As per claims 26 & 45 Ryan disclosed the apparatus of claim 24, wherein the encryption occurs on the terminal (col.23, lines 25-42).

Art Unit: 2443

29. As per claims 27 & 46 Ryan disclosed the apparatus of claim 24, wherein the encryption occurs on the server (col.23, lines 25-42).

30. As per claims 28 & 47 Ryan disclosed the apparatus of claim 23, wherein received encrypted instruction signals are decrypted (col.19, lines 31-40).

31. As per claims 29, 48 & 49 Ryan disclosed the method of claim 48, wherein in the decryption occurs on the processor by executing communication instructions from the memory (col.19, lines 31-40).

32. As per claims 30 & 50 Ryan disclosed the apparatus of claim 28, wherein the encryption occurs on the terminal (col.23, lines 43-45).

33. As per claims 31 & 51 Ryan disclosed the apparatus of claim 28, wherein the encryption occurs on the server (col.23, lines 43-45).

34. As per claim 38 Ryan disclosed the method of claim 33, wherein the memory is mounted at the terminal (col.23, lines 43-45).

35. As per claims 39 Ryan disclosed the method of claim 33, wherein the communication through the conduit is at the terminal (col.17, lines 47-55).

Art Unit: 2443

**36.** As per claim 69 Ryan disclosed the method of claim 68, further, comprising:  
storing the results of execution on the terminal in the portable storage device's memory

(Abstract, lines 1-8).

### ***Conclusion***

37. The Prior art made of record and not relied upon is considered pertinent to applicant's disclosure.

38. Gearhart (U.S. Pub. No. 2005/0132183 A1) disclosed method and system for user created personal private network (PPN) with secure communications and data transfers.

39. Steward et al (U.S.6,970, 927 B1) disclosed distributed network communication system which provides different network access features.

Any inquiry concerning this communication or earlier communications from the examiner should be directed to ASGHAR BILGRAMI whose telephone number is (571)272-3907. The examiner can normally be reached on 9-5.

If attempts to reach the examiner by telephone are unsuccessful, the examiner's supervisor, Tonia L.M. Dollinger can be reached on 571-272-4170. The fax phone number for the organization where this application or proceeding is assigned is 571-273-8300.

Art Unit: 2443

Information regarding the status of an application may be obtained from the Patent Application Information Retrieval (PAIR) system. Status information for published applications may be obtained from either Private PAIR or Public PAIR. Status information for unpublished applications is available through Private PAIR only. For more information about the PAIR system, see <http://pair-direct.uspto.gov>. Should you have questions on access to the Private PAIR system, contact the Electronic Business Center (EBC) at 866-217-9197 (toll-free). If you would like assistance from a USPTO Customer Service Representative or access to the automated information system, call 800-786-9199 (IN USA OR CANADA) or 571-272-1000.

/A. B./  
Examiner, Art Unit 2443

/Tonia LM Dollinger/  
Supervisory Patent Examiner, Art Unit 2443

Application/Control Number: 10/807,731  
Art Unit: 2443

Page 11



<b>Notice of References Cited</b>	Application/Control No. 10/807,731	Applicant(s)/Patent Under Reexamination MCNULTY, SCOTT	
	Examiner ASGHAR BILGRAMI	Art Unit 2443	Page 1 of 1

**U.S. PATENT DOCUMENTS**

*	Document Number Country Code-Number-Kind Code	Date MM-YYYY	Name	Classification
*	A US-7,213,766 B2	05-2007	Ryan et al.	235/492
*	B US-2005/0132183 A1	06-2005	Gearhart, Glenn	713/150
*	C US-6,970,927 B1	11-2005	Stewart et al.	709/225
*	D US-7,310,734 B2	12-2007	Boate et al.	713/186
	E US-			
	F US-			
	G US-			
	H US-			
	I US-			
	J US-			
	K US-			
	L US-			
	M US-			

**FOREIGN PATENT DOCUMENTS**

*	Document Number Country Code-Number-Kind Code	Date MM-YYYY	Country	Name	Classification
	N				
	O				
	P				
	Q				
	R				
	S				
	T				

**NON-PATENT DOCUMENTS**

*	Document Number Country Code-Number-Kind Code	Date MM-YYYY	Country	Name	Classification
	Include as applicable: Author, Title Date, Publisher, Edition or Volume, Pertinent Pages)				
	U				
	V				
	W				
	X				

\*A copy of this reference is not being furnished with this Office action. (See MPEP § 707.05(a).)  
Dates in MM-YYYY format are publication dates. Classifications may be US or foreign.

**Application Number**



**Application/Control No.**

10/807,731

**Examiner**

ASGHAR BILGRAMI

**Applicant(s)/Patent under Reexamination**

MCNULTY, SCOTT

**Art Unit**

2443

<b>Search Notes</b>  	<b>Application/Control No.</b>  10807731	<b>Applicant(s)/Patent Under Reexamination</b>  MCNULTY, SCOTT
	<b>Examiner</b>  ASGHAR BILGRAMI	<b>Art Unit</b>  2443

<b>SEARCHED</b>			
<b>Class</b>	<b>Subclass</b>	<b>Date</b>	<b>Examiner</b>
709	250	11/16/2008	AB
713	150	11/16/2008	AB

<b>SEARCH NOTES</b>		
<b>Search Notes</b>	<b>Date</b>	<b>Examiner</b>
EAST	11/16/2008	AB
101 Compliance search	11/16/2008	AB

<b>INTERFERENCE SEARCH</b>			
<b>Class</b>	<b>Subclass</b>	<b>Date</b>	<b>Examiner</b>

/A. B./  
Examiner.Art Unit 2443

<b>Index of Claims</b>  	<b>Application/Control No.</b>  10807731	<b>Applicant(s)/Patent Under Reexamination</b>  MCNULTY, SCOTT
	<b>Examiner</b>  ASGHAR BILGRAMI	<b>Art Unit</b>  2443

✓	<b>Rejected</b>
=	<b>Allowed</b>

-	<b>Cancelled</b>
÷	<b>Restricted</b>

N	<b>Non-Elected</b>
I	<b>Interference</b>

A	<b>Appeal</b>
O	<b>Objected</b>

Claims renumbered in the same order as presented by applicant
  CPA
  T.D.
  R.1.47

CLAIM		DATE							
Final	Original	11/16/2008							
	1	✓							
	2	✓							
	3	✓							
	4	✓							
	5	✓							
	6	✓							
	7	✓							
	8	✓							
	9	✓							
	10	✓							
	11	✓							
	12	✓							
	13	✓							
	14	✓							
	15	✓							
	16	✓							
	17	✓							
	18	✓							
	19	✓							
	20	✓							
	21	✓							
	22	✓							
	23	✓							
	24	✓							
	25	✓							
	26	✓							
	27	✓							
	28	✓							
	29	✓							
	30	✓							
	31	✓							
	32	✓							
	33	✓							
	34	✓							
	35	✓							
	36	✓							

<b>Index of Claims</b>  	<b>Application/Control No.</b>  10807731	<b>Applicant(s)/Patent Under Reexamination</b>  MCNULTY, SCOTT
	<b>Examiner</b>  ASGHAR BILGRAMI	<b>Art Unit</b>  2443

✓	<b>Rejected</b>
=	<b>Allowed</b>

-	<b>Cancelled</b>
÷	<b>Restricted</b>

N	<b>Non-Elected</b>
I	<b>Interference</b>

A	<b>Appeal</b>
O	<b>Objected</b>

Claims renumbered in the same order as presented by applicant
  CPA
  T.D.
  R.1.47

CLAIM		DATE									
Final	Original	11/16/2008									
	37	✓									
	38	✓									
	39	✓									
	40	✓									
	41	✓									
	42	✓									
	43	✓									
	44	✓									
	45	✓									
	46	✓									
	47	✓									
	48	✓									
	49	✓									
	50	✓									
	51	✓									
	52	✓									
	53	✓									
	54	✓									
	55	✓									
	56	✓									
	57	✓									
	58	✓									
	59	✓									
	60	✓									
	61	✓									
	62	✓									
	63	✓									
	64	✓									
	65	✓									
	66	✓									
	67	✓									
	68	✓									
	69	✓									



UNITED STATES PATENT AND TRADEMARK OFFICE

UNITED STATES DEPARTMENT OF COMMERCE  
 United States Patent and Trademark Office  
 Address: COMMISSIONER FOR PATENTS  
 P.O. Box 1450  
 Alexandria, Virginia 22313-1450  
 www.uspto.gov

BIB DATA SHEET

CONFIRMATION NO. 4430

<b>SERIAL NUMBER</b> 10/807,731	<b>FILING or 371(c) DATE</b> 03/23/2004 <b>RULE</b>	<b>CLASS</b> 370	<b>GROUP ART UNIT</b> 2443	<b>ATTORNEY DOCKET NO.</b> 4602-4001	
<b>APPLICANTS</b> Scott McNulty, Rowayton, CT;					
<b>** CONTINUING DATA *****</b>					
<b>** FOREIGN APPLICATIONS *****</b>					
<b>** IF REQUIRED, FOREIGN FILING LICENSE GRANTED ** * SMALL ENTITY **</b> 06/04/2004					
Foreign Priority claimed <input type="checkbox"/> Yes <input checked="" type="checkbox"/> No 35 USC 119(a-d) conditions met <input type="checkbox"/> Yes <input checked="" type="checkbox"/> No Verified and /ASGHAR H BILGRAMI/ Acknowledged _____ Examiner's Signature	<input type="checkbox"/> Met after Allowance AB Initials	<b>STATE OR COUNTRY</b> CT	<b>SHEETS DRAWINGS</b> 10	<b>TOTAL CLAIMS</b> 69	<b>INDEPENDENT CLAIMS</b> 12
<b>ADDRESS</b> MORGAN & FINNEGAN, L.L.P. 3 WORLD FINANCIAL CENTER NEW YORK, NY 10281-2101 UNITED STATES					
<b>TITLE</b> Apparatus, method and system for a tunneling client access point					
<b>FILING FEE RECEIVED</b> 1278	FEES: Authority has been given in Paper No. _____ to charge/credit DEPOSIT ACCOUNT No. _____ for following:		<input type="checkbox"/> All Fees <input type="checkbox"/> 1.16 Fees (Filing) <input type="checkbox"/> 1.17 Fees (Processing Ext. of time) <input type="checkbox"/> 1.18 Fees (Issue) <input type="checkbox"/> Other _____ <input type="checkbox"/> Credit		

## EAST Search History

Ref #	Hits	Search Query	DBs	Default Operator	Plurals	Time Stamp
L2	3	709/250.ccls. and (client or user) same (access) near4 (point) and (portable) with (device or module) same (secure or encrypt\$4)	US-PGPUB; USPAT; USOCR; EPO; DERWENT; IBM_TDB	OR	ON	2008/11/16 16:49
L6	9	709/250.ccls. and (access) near4 (point) same (portable) same (device or module or USB) and (secure or encrypt\$4)	US-PGPUB; USPAT; USOCR; EPO; DERWENT; IBM_TDB	OR	ON	2008/11/16 16:53
L7	9	709/250.ccls. and (access) near4 (point) same (portable or pluggable) same (device or module or USB) and (secure or encrypt \$4)	US-PGPUB; USPAT; USOCR; EPO; DERWENT; IBM_TDB	OR	ON	2008/11/16 16:55
L8	43	709/250.ccls. and (access) same (portable) same (device or module or USB) and (secure or encrypt\$4)	US-PGPUB; USPAT; USOCR; EPO; DERWENT; IBM_TDB	OR	ON	2008/11/16 16:55
L9	6	709/250.ccls. and (access) same (portable) same (device or module or USB) same (secure or encrypt\$4)	US-PGPUB; USPAT; USOCR; EPO; DERWENT; IBM_TDB	OR	ON	2008/11/16 16:55
L10	8	713/150.ccls. and (portable) same (device or module or USB) same (access\$4) same (network or WAN or LAN) same (secure or encrypt\$4)	US-PGPUB; USPAT; USOCR; EPO; DERWENT; IBM_TDB	OR	ON	2008/11/16 17:16
S3	37977	(client or user) same (access) with (point)	US-PGPUB; USPAT; USOCR; EPO; DERWENT; IBM_TDB	OR	ON	2008/11/10 16:39
S4	407	(client or user) same (access) with (point) same (USB)	US-PGPUB; USPAT; USOCR; EPO; DERWENT; IBM_TDB	OR	ON	2008/11/10 16:39

S5	33	(client or user) same (access) with (point) same (USB) same (secure or encrypt\$3) and (portable or mobile or handheld or palm)	US-PGPUB; USPAT; USOCR; EPO; DERWENT; IBM_TDB	OR	ON	2008/11/10 16:43
S6	5	(client or user) same (access) with (point) same (USB or thumb) near3 (drive) same (secure or encrypt\$3)	US-PGPUB; USPAT; USOCR; EPO; DERWENT; IBM_TDB	OR	ON	2008/11/13 10:52
S7	61	(client or user) same (access) adj (point) and (USB or thumb) near3 (drive) same (secure or encrypt\$3)	US-PGPUB; USPAT; USOCR; EPO; DERWENT; IBM_TDB	OR	ON	2008/11/13 10:55
S8	2	(client or user) same (access) adj (point) and (USB or thumb) near3 (drive) same (secure or encrypt\$3) and @ay< "2004,03,24"	US-PGPUB; USPAT; USOCR; EPO; DERWENT; IBM_TDB	OR	ON	2008/11/13 10:56
S14	9318	(remote) same (access) same (point) same ( device or module)	US-PGPUB; USPAT; USOCR; EPO; DERWENT; IBM_TDB	OR	ON	2008/11/13 20:59
S15	4079	(remote) same (access) near4 (point) same ( device or module)	US-PGPUB; USPAT; USOCR; EPO; DERWENT; IBM_TDB	OR	ON	2008/11/13 20:59
S16	8	(remote) same (access) near4 (point) same ( device or module) same (USB) same (secure or encrypt\$4)	US-PGPUB; USPAT; USOCR; EPO; DERWENT; IBM_TDB	OR	ON	2008/11/13 21:01
S17	283	(remote) same (access) near4 (point) same ( device or module) same (secure or encrypt\$4)	US-PGPUB; USPAT; USOCR; EPO; DERWENT; IBM_TDB	OR	ON	2008/11/13 21:03
S18	4	(remote) same (access) near4 (point) same (portable) with (device or module) same (secure or encrypt\$4)	US-PGPUB; USPAT; USOCR; EPO; DERWENT; IBM_TDB	OR	ON	2008/11/13 21:03
S19	1	(remote) same (access) near4 (point) same (portable) with (device or module) same (secure or encrypt\$4) and (USB)	US-PGPUB; USPAT; USOCR; EPO; DERWENT; IBM_TDB	OR	ON	2008/11/13 21:06



S20	688	(client or user) same (access) near4 (point) and (portable) with (device or module) same (secure or encrypt\$4)	US-PGPUB; USPAT; USOCR; EPO; DERWENT; IBM_TDB	OR	ON	2008/11/13 21:08
S21	70	(client or user) same (access) near4 (point) same (portable) with (device or module) same (secure or encrypt\$4)	US-PGPUB; USPAT; USOCR; EPO; DERWENT; IBM_TDB	OR	ON	2008/11/13 21:08
S22	36	(client or user) same (access) near4 (point) same (portable) with (device or module) same (secure or encrypt\$4) and (USB)	US-PGPUB; USPAT; USOCR; EPO; DERWENT; IBM_TDB	OR	ON	2008/11/13 21:09

11/16/2008 5:42:57 PM

C:\Documents and Settings\abilgrami\My Documents\EAST\Workspaces\10807731.wsp



UNITED STATES PATENT AND TRADEMARK OFFICE

UNITED STATES DEPARTMENT OF COMMERCE  
United States Patent and Trademark Office  
Address: COMMISSIONER FOR PATENTS  
P.O. Box 1450  
Alexandria, Virginia 22313-1450  
www.uspto.gov

APPLICATION NUMBER	PATENT NUMBER	GROUP ART UNIT	FILE WRAPPER LOCATION
10/807,731		2443	



**Correspondence Address/Fee Address Change**

The following fields have been set to Customer Number 85775 on 02/13/2009

- Correspondence Address
- Power of Attorney Address

The address of record for Customer Number 85775 is:

85775  
Locke Lord Bissell & Liddell LLP  
Attn: IP Docketing  
Three World Financial Center  
New York, NY 10281-2101



**UNITED STATES PATENT AND TRADEMARK OFFICE**

UNITED STATES DEPARTMENT OF COMMERCE  
**United States Patent and Trademark Office**  
Address: COMMISSIONER FOR PATENTS  
P.O. Box 1450  
Alexandria, Virginia 22313-1450  
www.uspto.gov

APPLICATION NUMBER	PATENT NUMBER	GROUP ART UNIT	FILE WRAPPER LOCATION
10/807,731		2443	



**Correspondence Address/Fee Address Change**

The following fields have been set to Customer Number 85775 on 03/30/2009

- Correspondence Address
- Maintenance Fee Address
- Power of Attorney Address

The address of record for Customer Number 85775 is:

**85775**  
**Locke Lord Bissell & Liddell LLP**  
**Attn: IP Docketing**  
**Three World Financial Center**  
**New York, NY 10281-2101**

**IN THE UNITED STATES PATENT AND TRADEMARK OFFICE**

Serial No. : 10/807,731 Confirmation : 4430  
Applicant(s) : Scott McNulty  
Filed : March 23, 2004  
Title : APPARATUS, METHOD AND SYSTEM FOR A TUNNELING CLIENT  
ACCESS POINT

Art Unit : 2443  
Examiner : Asghar H. BILGRAMI

Docket No. : 1004294-001US  
Customer No. : 85775

**AMENDMENT UNDER 37 C.F.R. 1.111**

Mail Stop Amendment  
Commissioner for Patents  
P.O. Box 1450  
Alexandria, VA 22313-1450

Sir:

This paper is being filed in response to the non-final Office Action dated November 26, 2008, for which a three month shortened statutory period of time for response expired February 26, 2009. Applicant submits herewith a Petition and Fee for a two month extension of time to file this paper. Reconsideration of this application is respectfully requested in light of this paper, which is set forth as follows:

- **Amendments to the Claims** are reflected in the listing of claims which begins on page 2 of this paper.
- **Remarks** begin on page 17 of this paper.

**Amendments to the Claims:**

This listing of claims will replace all prior listings of claims in the application.

Listing Of Claims:

**Claim 1 (original):** A portable tunneling storage and processing apparatus, comprising:

a memory,

wherein the memory contains a unique apparatus identifier,

wherein the memory contains user verifying information;

a processor disposed in communication with the memory, and configured to issue a plurality of processing instructions stored in the memory,

wherein the processing instructions issue signals to:

provide a terminal access to the memory;

execute processing instructions from the memory on the terminal to access the terminal, wherein the terminal acts as a proxy for the terminal's input and output peripheral devices, and wherein the terminal acts as a network interface proxy;

process processing instructions, wherein the processing instructions are stored in the memory, wherein the processing instructions are used to issue signals to process processing instruction on the processor;

encrypt the memory based on the apparatus identifier and user verifying information;

effect the display of processing activity on the terminal;

a conduit for external communications disposed in communication with the processor, configured to issue a plurality of communication instructions as provided by the processor, configured to issue the communication instructions as signals to engage in communications with

other devices having compatible conduits, and configured to receive signals issued from the compatible conduits, wherein the conduits are USB conduits,

wherein the communication instructions issue signals to:

communicate with a terminal;

communicate with a server;

wherein the communication instruction issued signals are encrypted,  
wherein the encryption occurs on the processor,

wherein received encrypted instruction signals are decrypted, and wherein  
decryption occurs on the processor.

**Claim 2 (currently amended):** A portable tunneling storage and processing apparatus, comprising:

a memory,

wherein the memory contains a unique apparatus identifier;

a processor disposed in communication with the memory, and configured to issue a plurality of processing instructions stored in the memory,

wherein the processing instructions issue signals to:

provide a terminal access to the memory,

process processing instructions,

effect the display of processing activity;

a conduit for external communications disposed in communication with the processor, configured to issue a plurality of communication instructions as provided by the processor, configured to issue the communication instructions as signals to engage in communications with

other devices having compatible conduits, and configured to receive signals issued from the compatible conduits,

wherein the communication instructions issue signals to:

communicate at a terminal.

**Claim 3 (original):** The apparatus of claim 2, wherein the unique apparatus identifier is a digital signature.

**Claim 4 (original):** The apparatus of claim 2, wherein the memory contains user verifying information.

**Claim 5 (original):** The apparatus of claim 4, wherein the user verifying information is a digital signature

**Claim 6 (original):** The apparatus of claim 4, wherein the user verifying information is a username and password.

**Claim 7 (original):** The apparatus of claim 6, further, comprising:

wherein the processing instructions issue signals to:

encrypt the memory based on the unique apparatus identifier and user verifying information.

**Claim 8 (original):** The apparatus of claim 2, further, comprising:

wherein the processing instructions issue signals to:

execute processing instructions from the memory on the terminal to access the terminal.

**Claim 9 (original):** The apparatus of claim 2, wherein the terminal acts as a proxy for the terminal's input and output peripheral devices, and acts as a network interface proxy.

**Claim 10 (original):** The apparatus of claim 2, wherein the processing instructions are stored on the memory.

**Claim 11 (original):** The apparatus of claim 2, wherein the processing instructions are obtained from a server.

**Claim 12 (original):** The apparatus of claim 2, wherein the processing instructions are processed on the processor.

**Claim 13 (original):** The apparatus of claim 12, wherein the processing instructions are processed on the processor to process files for printing.

**Claim 14 (original):** The apparatus of claim 2, wherein the processing instructions are processed on the terminal.

**Claim 15 (original):** The apparatus of claim 2, wherein the processing instructions are processed on the server.

**Claim 16 (canceled):** ~~The apparatus of claim 2, further, comprising:~~

~~wherein the processing instructions issue signals to:~~

~~effect the display of processing activity.~~

**Claim 17 (original):** The apparatus of claim 16, wherein the display of processing activity occurs on the terminal

**Claim 18 (original):** The apparatus of claim 16, wherein the display of processing activity occurs directly in the terminal's video memory.

**Claim 19 (original):** The apparatus of claim 2, wherein the conduits are USB conduits.

**Claim 20 (original):** The apparatus of claim 2, wherein the conduits are wireless conduits.



**Claim 21 (original):** The apparatus of claim 20, wherein the wireless conduits are Bluetooth.

**Claim 22 (original):** The apparatus of claim 20, wherein the wireless conduits are WiFi.

**Claim 23 (original):** The apparatus of claim 2, further, comprising:

wherein the communication instructions issue signals to:

communicate with a server.

**Claim 24 (original):** The apparatus of claim 23, wherein the communication instruction issued signals are encrypted.

**Claim 25 (original):** The apparatus of claim 24, wherein the encryption occurs on the processor.

**Claim 26 (original):** The apparatus of claim 24, wherein the encryption occurs on the terminal.

**Claim 27 (original):** The apparatus of claim 24, wherein the encryption occurs on the server.

**Claim 28 (original):** The apparatus of claim 23, wherein received encrypted instruction signals are decrypted.

**Claim 29 (currently amended):** The apparatus of claim 28, wherein the ~~encryption~~ decryption occurs on the processor.

**Claim 30 (currently amended):** The apparatus of claim 28, wherein the ~~encryption~~ decryption occurs on the terminal.

**Claim 31 (currently amended):** The apparatus of claim 28, wherein the ~~encryption~~ decryption occurs on the server.

**Claim 32 (original):** A method of accessing data, comprising:

engaging a portable storage device with a terminal,

wherein the portable storage device has a processor,

wherein the portable storage device connects to the terminal across compatible conduits for external communications, wherein the storage device has a memory, wherein the memory and a storage conduit are disposed in communication with the processor, wherein the conduits are USB conduits;

providing the memory for access on the terminal,

wherein the memory is mounted on the terminal;

executing processing instructions from the memory on the terminal to access the terminal;

communicating through the conduit at a terminal,

wherein the terminal acts as a proxy for the terminal's input and output peripheral devices, and acts as a network interface proxy,

wherein communication instruction issued signals are encrypted,

wherein the encryption occurs on the processor,

wherein received encrypted instruction signals are decrypted,

wherein decryption occurs on the processor;

executing processing instructions on the processor,

wherein the processing instructions are stored on the memory,

wherein the processing instructions are used to issue signals to process processing instruction on the processor; and

effecting the display of processing activity on the terminal.

**Claim 33 (original):** A method of accessing data, comprising:

disposing a portable storage device in communication with a terminal,

wherein the portable storage device has a processor,

wherein the storage device connects to the terminal across compatible conduits for external communications, wherein the storage device has a memory, wherein the memory and a storage conduit are disposed in communication with the processor;

providing the memory for access on the terminal;

executing processing instructions from the memory on the terminal to access the terminal;

communicating through the conduit;

processing processing instructions.

**Claim 34 (original):** The method of claim 33, wherein the conduits are USB conduits.

**Claim 36 (original):** The method of claim 33, wherein the conduits are wireless conduits.

**Claim 36 (original):** The method of claim 35, wherein the wireless conduits are Bluetooth.

**Claim 37 (original):** The method of claim 35, wherein the wireless conduits are WiFi.

**Claim 38 (original):** The method of claim 33, wherein the memory is mounted at the terminal.

**Claim 39 (original):** The method of claim 33, wherein the communication through the conduit is at the terminal.

**Claim 40 (original):** The method of claim 39, wherein the terminal acts as a proxy for the terminal's input and output peripheral devices.

**Claim 41 (original):** The method of claim 39, wherein the terminal acts as a network interface proxy.

**Claim 42 (original):** The method of claim 33, wherein a communications through the conduit are encrypted.

**Claim 43 (original):** The method of claim 42, wherein the encryption occurs on the processor.

**Claim 44 (original):** The method of claim 43, wherein the encryption occurs on the processor by executing communication instructions from memory.

**Claim 45 (original):** The method of claim 42, wherein the encryption occurs on the terminal.

**Claim 46 (original):** The method of claim 42, wherein the encryption occurs on the server.

**Claim 47 (original):** The method of claim 33, wherein received encrypted instruction signals are decrypted.

**Claim 48 (original):** The method of claim 47, wherein the decryption occurs on the processor.

**Claim 49 (original):** The method of claim 48, wherein the decryption occurs on the processor by executing communication instructions from memory.

**Claim 50 (original):** The method of claim 47, wherein the decryption occurs on the terminal.

**Claim 51 (original):** The method of claim 47, wherein the decryption occurs on the server.

**Claim 52 (original):** The method of claim 33, wherein the processing instructions are stored in the memory.

**Claim 53 (original):** The method of claim 33, wherein the processing of processing instructions occurs on the processor.

**Claim 54 (original):** The method of claim 33, wherein the processing of processing instructions occurs on the terminal.

**Claim 55 (original):** The method of claim 33, wherein the processing of processing instructions occurs on the server.

**Claim 56 (original):** The method of claim 33, wherein the processing instructions are used to issue signals to process processing instruction on the processor.

**Claim 57 (original):** The method of claim 55, wherein the processing instructions are used to issue signals to process processing instruction on the processor to process files for printing.

**Claim 58 (original):** The method of claim 33, further, comprising:  
effecting the display of processing activity.

**Claim 59 (original):** The method of claim 58, wherein the display occurs on the terminal.

**Claim 60 (original):** The method of claim 59 wherein the display occurs on the terminal by writing directly into video memory.

**Claim 61 (original):** A system to access data, comprising:  
means to engage a portable storage device with a terminal,  
wherein the portable storage device has a processor,

wherein the portable storage device connects to the terminal across compatible conduits for external communications, wherein the storage device has a memory, wherein the memory and a storage conduit are disposed in communication with the processor, wherein the conduits are USB conduits;

means to provide the memory for access on the terminal,

wherein the memory is mounted on the terminal;

means to execute processing instructions from the memory on the terminal to access the terminal;

means to communicate through the conduit at a terminal,

wherein the terminal acts as a proxy for the terminal's input and output peripheral devices, and acts as a network interface proxy,

wherein communication instruction issued signals are encrypted,

wherein the encryption occurs on the processor,

wherein received encrypted instruction signals are decrypted,

wherein decryption occurs on the processor;

means to execute processing instructions on the processor,

wherein the processing instructions are stored on the memory,

wherein the processing instructions are used to issue signals to process processing instruction on the processor; and

means to effect the display of processing activity on the terminal.

**Claim 62 (original):** A system to access data, comprising:

means to dispose a portable storage device in communication with a terminal,

wherein the portable storage device has a processor,

wherein the storage device connects to the terminal across compatible conduits for external communications, wherein the storage device has a memory, wherein the memory and a storage conduit are disposed in communication with the processor;

means to provide the memory for access on the terminal;

means to execute processing instructions from the memory on the terminal to access the terminal;

means to communicate through the conduit;

means to process processing instructions.

**Claim 63 (original):** A medium readable by a processor to access data, comprising:

instruction signals in the processor readable medium, wherein the instruction signals are issuable by the processor to:

engage a portable storage device with a terminal,

wherein the portable storage device has a processor,

wherein the portable storage device connects to the terminal across compatible conduits for external communications, wherein the storage device has a memory, wherein the memory and a storage conduit are disposed in communication with the processor, wherein the conduits are USB conduits;

provide the memory for access on the terminal,

wherein the memory is mounted on the terminal;

execute processing instructions from the memory on the terminal to access the terminal;

communicate through the conduit at a terminal,

wherein the terminal acts as a proxy for the terminal's input and output peripheral devices, and acts as a network interface proxy,

wherein communication instruction issued signals are encrypted,

wherein the encryption occurs on the processor,

wherein received encrypted instruction signals are decrypted,

wherein decryption occurs on the processor;

execute processing instructions on the processor,

wherein the processing instructions are stored on the memory,

wherein the processing instructions are used to issue signals to process processing instruction on the processor; and

means to effect the display of processing activity on the terminal.

**Claim 64 (original):** A medium readable by a processor to access data, comprising:

instruction signals in the processor readable medium, wherein the instruction signals are issuable by the processor to:

dispose a portable storage device in communication with a terminal,

wherein the portable storage device has a processor,

wherein the storage device connects to the terminal across compatible conduits for external communications, wherein the storage device has a memory, wherein the memory and a storage conduit are disposed in communication with the processor;

provide the memory for access on the terminal;

execute processing instructions from the memory on the terminal to access the terminal;



communicate through the conduit;

process processing instructions.

**Claim 65 (original):** An apparatus to access data, comprising:

a memory;

a processor disposed in communication with said memory, and configured to issue a plurality of processing instructions stored in the memory, wherein the instructions issue signals to:

engage a portable storage device with a terminal,

wherein the portable storage device has a processor,

wherein the portable storage device connects to the terminal across compatible conduits for external communications, wherein the storage device has a memory, wherein the memory and a storage conduit are disposed in communication with the processor, wherein the conduits are USB conduits;

provide the memory for access on the terminal,

wherein the memory is mounted on the terminal;

execute processing instructions from the memory on the terminal to access the terminal;

communicate through the conduit at a terminal,

wherein the terminal acts as a proxy for the terminal's input and output peripheral devices, and acts as a network interface proxy,

wherein communication instruction issued signals are encrypted,

wherein the encryption occurs on the processor,

wherein received encrypted instruction signals are decrypted,

wherein decryption occurs on the processor;

execute processing instructions on the processor,

wherein the processing instructions are stored on the memory,

wherein the processing instructions are used to issue signals to process processing instruction on the processor; and

means to effect the display of processing activity on the terminal.

**Claim 66 (original):** An apparatus to access data, comprising:

a memory;

a processor disposed in communication with said memory, and configured to issue a plurality of processing instructions stored in the memory, wherein the instructions issue signals to:

dispose a portable storage device in communication with a terminal,

wherein the portable storage device has a processor,

wherein the storage device connects to the terminal across compatible conduits for external communications, wherein the storage device has a memory, wherein the memory and a storage conduit are disposed in communication with the processor;

provide the memory for access on the terminal;

execute processing instructions from the memory on the terminal to access the terminal;

communicate through the conduit;

process processing instructions.

**Claim 67 (original):** A method of accessing data, comprising:

receiving requests from a terminal,

wherein a portable storage device is disposed in communication with the terminal,

wherein the storage device has a processor,

wherein the storage device connects to the terminal across compatible conduits for external communications, wherein the storage device has a memory, wherein the memory and a storage conduit are disposed in communication with the processor, wherein the storage device is responsible for generating the received requests;

providing responses to the storage device's requests.

**Claim 68 (original):** A method of accessing data, comprising:

disposing a portable storage device in communication with a-terminal,

wherein the storage device has a processor,

wherein the storage device connects to the terminal across compatible conduits for external communications, wherein the storage device has a memory;

employing the terminal for input/output (I/O) control for the portable storage device;

executing instructions on the portable storage device; and

displaying results of execution on the terminal.

**Claim 69 (original):** The method of claim 68, further, comprising:

storing the results of execution on the terminal in the portable storage device's memory.

**REMARKS**

Reconsideration of the above-identified application in view of the foregoing amendments and following remarks is respectfully requested.

A. Status of the Claims and Explanation of Amendments

Claims 2 and 29-31 have been amended. Claims 1-15 and 17-69 are pending. Claim 16 has been cancelled without prejudice. The Examiner has asserted that the subject matter of claims 1-69 is not patentable because it fails to satisfy the novelty requirement. Specifically, the Examiner has rejected these claims under 35 U.S.C. § 102(e) as being anticipated by the disclosure in U.S. Patent No. 7,213,766 to Ryan et al. ("Ryan").

The Examiner has also objected to claims 29-31 because claim 28 describes signal "decryption" functionality whereas its dependent claims (29-31) are directed to "encryption" functionality. Applicant has amended dependent claims 29-31 to recite the "decryption" functionality of claim 28 to correct the informality identified by the Examiner.

B. Ryan Does Not Qualify as a Prior Art Reference Under 35 U.S.C. § 102(e)

The Patent Office has rejected claims 1-69 under 35 U.S.C. 102(e) as being anticipated by Ryan. Applicant first traverses this rejection on the grounds that the Patent Office failed to qualify the relevant disclosures in Ryan upon which the rejections are based under 35 U.S.C. § 102(e). Specifically, Ryan claims priority to three provisional applications: U.S. Ser. No. 60/520,698 filed November 17, 2003; U.S. Ser. No. 60/562,204 filed April 14, 2004; U.S. Ser. No. 60/602,595 filed August 18, 2004. The present application was filed on March 23, 2004. Therefore, only the disclosure in Ryan that is properly supported by the disclosure in U.S. Ser. No. 60/520,698 (filed November 17, 2003) qualifies as prior art to the present application under 35 U.S.C. § 102(e).

In order to apply Ryan as a prior art reference under 35 U.S.C. § 102(e), the Patent Office must establish that the disclosures in Ryan which forms the basis of the rejections were properly supported by the disclosure in U.S. Ser. No. 60/520,698. (*See* MPEP § 706.02(f)(1)(B)). The Patent Office has made no such finding here. Accordingly, the Patent Office's rejection under 35 U.S.C. § 102(e) is defective and should be withdrawn.

C. The Pending Claims Of The Present Application Are Patentably Distinct Over Ryan

To the extent supported by the provisional application U.S. Ser. No. 60/520,698, Ryan discloses a "personal token apparatus" that "is capable of loading and storing information" and then "using the stored information or value via its contactless interface." In essence, the apparatus in Ryan is merely a storage device.

With regard to independent claims 1, 2 (as amended), 32, 61, 63, 65, and 68, applicant respectfully submits that Ryan does not disclose, teach or suggest effecting or means to effect "the display of processing activity on the terminal." Ryan discloses an apparatus with an LCD display 510 for displaying messages. (*See* Ryan, col. 21, lines 7-19). The LCD display has to have its own battery source. (*Id.*) Ryan discloses that an example of the display is "a small one or two line LCD display panel." (*Id.* at col. 24, lines 33-35). Clearly, Ryan's LCD display is a part of the apparatus. Furthermore, because the apparatus in Ryan is merely a storage device, the apparatus in Ryan cannot in any way effect the "display of processing activity *on the terminal*, as recited in claims 1, 32, 61, 63, 65, and 68.

With regard to independent claims 33, 62, 64, and 66, applicant respectfully submits that Ryan does not include any disclosure, teaching or suggestion of executing "processing instructions from the memory on the terminal to access the terminal," which qualifies as prior art under 35 U.S.C. §102(e). Specifically, the disclosures in Ryan relied on by

Appl. No. 10/807,731  
Paper dated April 27, 2009  
Reply to Office Action dated November 26, 2008

the Patent Office in rejecting these claims are not supported by the subject matter disclosed in U.S. Ser. No. 60/520,698. Therefore, it is respectfully submitted that these claims are allowable and the 35 U.S.C. §102(e) rejection be withdrawn.

With regard to independent claim 67, applicant respectfully submits that Ryan does not include any disclosure, teaching or suggestion of “receiving requests from a terminal ... wherein the storage device is responsible for generating the received requests.” Specifically, applicant respectfully submits that the Patent Office has failed to cite any subject matter in Ryan that shows this limitation. Therefore, it is respectfully submitted that this claim is allowable and the 35 U.S.C. §102(e) rejection be withdrawn.

Because dependent claims 3-15, 17-31, 34-60, and 69 depend from and, therefore, include all the limitations of allowable independent claims, applicant respectfully submits that these claims are also allowable and the 35 U.S.C. §102(e) rejections be withdrawn.

### **CONCLUSION**

For at least the above-stated reasons, this application is respectfully asserted to be in condition for allowance. An early and favorable examination on the merits is requested. In the event that a telephone conference would facilitate the examination of this application in any way, the Examiner is invited to contact the undersigned at the number provided.

Appl. No. 10/807,731  
Paper dated April 27, 2009  
Reply to Office Action dated November 26, 2008

THE COMMISSIONER IS HEREBY AUTHORIZED TO CHARGE ANY ADDITIONAL FEES WHICH MAY BE REQUIRED FOR THE TIMELY CONSIDERATION OF THIS AMENDMENT UNDER 37 C.F.R. §§ 1.16 AND 1.17, OR CREDIT ANY OVERPAYMENT TO DEPOSIT ACCOUNT NO. 50-4827, ORDER NO. 1004294-001US.

Respectfully submitted,  
Locke Lord Bissell & Liddell LLP

Dated: April, 27, 2009

By:

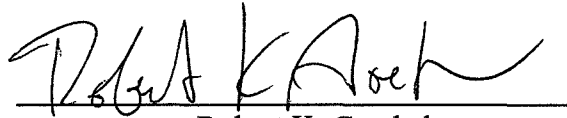

Robert K. Goethals  
Registration No. 36,813

Correspondence Address:

Locke Lord Bissell & Liddell LLP  
3 World Financial Center  
New York, NY 10281-2101  
(212) 415-8522 Telephone  
(212) 303-2754 Facsimile

**IN THE UNITED STATES PATENT AND TRADEMARK OFFICE**

Serial No.: 10/807,731 Confirmation No.: 4430

Applicant(s): Scott McNulty Group Art Unit: 2443  
 Examiner: Asghar H. BILGRAMI

Filed: March 23, 2004 Customer No.: 85775

For: APPARATUS, METHOD AND SYSTEM FOR A TUNNELING CLIENT ACCESS POINT

**PETITION AND FEE FOR EXTENSION OF TIME (37 C.F.R. § 1.136(a))**

Mail Stop Amendment  
 Commissioner for Patents  
 P.O. Box 1450  
 Alexandria, VA 22313-1450

Sir:

1. This is a petition for an extension of time for an Amendment under 37 C.F.R. 1.111
2. The communication in connection with the matter for which this extension is requested
  - is filed herewith.
  - has been filed on \_\_\_\_\_.

3.  Applicant(s) is/are entitled to Small Entity Status.
  - Statement has already been filed

4.	<u>Total Months Requested</u>	<u>Fee for Other than Small Entity</u>	<u>Fee for Small Entity</u>
a.	<input type="checkbox"/> one month	\$130.00	\$65.00
b.	<input checked="" type="checkbox"/> two months	\$490.00	\$245.00
c.	<input type="checkbox"/> three months	\$1,110.00	\$555.00
d.	<input type="checkbox"/> four months	\$1,730.00	\$865.00
e.	<input type="checkbox"/> five months	\$2,350.00	\$1,175.00
f.	<input type="checkbox"/> An extension for _____ months has already been secured for filing the above-identified communication and the fee paid therefor of \$_____ is deducted from the total fee due for the total months of extension now requested. The fee for this extension (\$ _____), minus the fee previously paid (\$ _____) equals \$_____ (total fee due).		



5.  A check in the amount of \$\_\_\_\_\_ to cover the extension fee is attached.
6.  Charge fee to Deposit Account No. 504827, Order No. 1004294-001US.
7.  The Commissioner is hereby authorized to charge any additional fees which may be required by this paper, or credit any overpayment to Deposit Account No. 504827, Order No. 1004294-001US.

Respectfully submitted,  
LOCKE LORD BISSELL & LIDDELL LLP

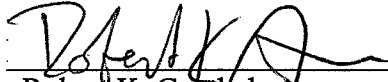

Robert K. Goethals  
Registration No. 36,813

Dated: April 27, 2009

Correspondence Address:

Address Associated With Customer Number:

85775

(212) 415-8600 Telephone

(212) 303-2754 Facsimile

## Electronic Patent Application Fee Transmittal

<b>Application Number:</b>	10807731
<b>Filing Date:</b>	23-Mar-2004
<b>Title of Invention:</b>	Apparatus, method and system for a tunneling client access point
<b>First Named Inventor/Applicant Name:</b>	Scott McNulty
<b>Filer:</b>	Robert Keaney Goethals/Anna Hill
<b>Attorney Docket Number:</b>	4602-4001

Filed as Small Entity

### Utility under 35 USC 111(a) Filing Fees

Description	Fee Code	Quantity	Amount	Sub-Total in USD(\$)
<b>Basic Filing:</b>				
<b>Pages:</b>				
<b>Claims:</b>				
<b>Miscellaneous-Filing:</b>				
<b>Petition:</b>				
<b>Patent-Appeals-and-Interference:</b>				
<b>Post-Allowance-and-Post-Issuance:</b>				
<b>Extension-of-Time:</b>				
Extension - 2 months with \$0 paid	2252	1	245	245

Description	Fee Code	Quantity	Amount	Sub-Total in USD(\$)
<b>Miscellaneous:</b>				
<b>Total in USD (\$)</b>				<b>245</b>

## Electronic Acknowledgement Receipt

<b>EFS ID:</b>	5226064
<b>Application Number:</b>	10807731
<b>International Application Number:</b>	
<b>Confirmation Number:</b>	4430
<b>Title of Invention:</b>	Apparatus, method and system for a tunneling client access point
<b>First Named Inventor/Applicant Name:</b>	Scott McNulty
<b>Customer Number:</b>	85775
<b>Filer:</b>	Robert Keane Goethals/Anna Hill
<b>Filer Authorized By:</b>	Robert Keane Goethals
<b>Attorney Docket Number:</b>	4602-4001
<b>Receipt Date:</b>	27-APR-2009
<b>Filing Date:</b>	23-MAR-2004
<b>Time Stamp:</b>	16:28:33
<b>Application Type:</b>	Utility under 35 USC 111(a)

### Payment information:

Submitted with Payment	yes
Payment Type	Deposit Account
Payment was successfully received in RAM	\$245
RAM confirmation Number	2793
Deposit Account	504827
Authorized User	

The Director of the USPTO is hereby authorized to charge indicated fees and credit any overpayment as follows:

Charge any Additional Fees required under 37 C.F.R. Section 1.17 (Patent application and reexamination processing fees)

Charge any Additional Fees required under 37 C.F.R. Section 1.21 (Miscellaneous fees and charges)

PayPal Ex. 1058, p. 188  
PayPal v. IOENGINE

**File Listing:**

Document Number	Document Description	File Name	File Size(Bytes)/ Message Digest	Multi Part /.zip	Pages (if appl.)
1		1004294-001US_Response.pdf	780114 873f4de2ba0db99ef183c143b4798ad9f473971e	yes	20
<b>Multipart Description/PDF files in .zip description</b>					
<b>Document Description</b>			<b>Start</b>	<b>End</b>	
Amendment/Req. Reconsideration-After Non-Final Reject			1	1	
Claims			2	16	
Applicant Arguments/Remarks Made in an Amendment			17	20	
<b>Warnings:</b>					
<b>Information:</b>					
2	Extension of Time	1004294-001US_Extension.pdf	62376 086cc12f2c14b2870163f272b34d82454751809a	no	2
<b>Warnings:</b>					
<b>Information:</b>					
3	Fee Worksheet (PTO-875)	fee-info.pdf	30089 76f6e54d4466d1f6e1f45a2a28b10453b9dbf755	no	2
<b>Warnings:</b>					
<b>Information:</b>					
<b>Total Files Size (in bytes):</b>			872579		

This Acknowledgement Receipt evidences receipt on the noted date by the USPTO of the indicated documents, characterized by the applicant, and including page counts, where applicable. It serves as evidence of receipt similar to a Post Card, as described in MPEP 503.

**New Applications Under 35 U.S.C. 111**

If a new application is being filed and the application includes the necessary components for a filing date (see 37 CFR 1.53(b)-(d) and MPEP 506), a Filing Receipt (37 CFR 1.54) will be issued in due course and the date shown on this Acknowledgement Receipt will establish the filing date of the application.

**National Stage of an International Application under 35 U.S.C. 371**

If a timely submission to enter the national stage of an international application is compliant with the conditions of 35 U.S.C. 371 and other applicable requirements a Form PCT/DO/EO/903 indicating acceptance of the application as a national stage submission under 35 U.S.C. 371 will be issued in addition to the Filing Receipt, in due course.

**New International Application Filed with the USPTO as a Receiving Office**

If a new international application is being filed and the international application includes the necessary components for an international filing date (see PCT Article 11 and MPEP 1810), a Notification of the International Application Number and of the International Filing Date (Form PCT/RO/105) will be issued in due course, subject to prescriptions concerning national security, and the date shown on this Acknowledgement Receipt will establish the international filing date of the application.

**IN THE UNITED STATES PATENT AND TRADEMARK OFFICE**

Serial No. : 10/807,731 Confirmation : 4430  
Applicant(s) : Scott McNulty  
Filed : March 23, 2004  
Title : APPARATUS, METHOD AND SYSTEM FOR A TUNNELING CLIENT  
ACCESS POINT

Art Unit : 2443  
Examiner : Asghar H. BILGRAMI

Docket No. : 1004294.001US  
Customer No. : 85775

**SUPPLEMENTAL AMENDMENT**

Mail Stop Amendment  
Commissioner for Patents  
P.O. Box 1450  
Alexandria, VA 22313-1450

Sir:

Applicant hereby submits this Supplemental Amendment for consideration.

Applicant hereby submits herewith an Amendment Fee Transmittal. Reconsideration of this application is respectfully requested in light of this paper, which is set forth as follows:

- **Amendments to the Claims** are reflected in the listing of claims which begins on page 2 of this paper.
- **Remarks** begin on page 18 of this paper.

**Amendments to the Claims:**

This listing of claims will replace all prior listings of claims in the application.

Listing Of Claims:

**Claim 1 (currently amended):** A portable tunneling storage and processing apparatus, comprising:

a memory,

wherein the memory contains a unique apparatus identifier,

wherein the memory contains user verifying information;

a processor disposed in communication with the memory, and configured to issue a plurality of processing instructions stored in the memory,

wherein the processing instructions issue signals to:

provide a terminal with access to the memory;

execute processing instructions from the memory ~~on the terminal to~~  
provide the portable tunneling storage and processing apparatus with access to the terminal,  
wherein the terminal acts as a proxy to the portable tunneling storage and processing apparatus  
for the terminal's input and output peripheral devices, ~~and~~ wherein the terminal acts as a network  
interface proxy to the portable tunneling storage and processing apparatus, and wherein the  
processing instructions are executed on the terminal;

process processing instructions, wherein the processing instructions are stored in the memory, wherein the processing instructions are used to issue signals to process processing instruction on the processor;

encrypt data stored in the memory based on the apparatus identifier and the user verifying information;

effect the display of processing activity on the terminal display device;

a conduit for external communications disposed in communication with the processor, configured to issue a plurality of communication instructions as provided by the processor, configured to issue the communication instructions as signals to engage in communications with other devices having compatible conduits, and configured to receive signals issued from the compatible conduits, wherein the conduits are USB conduits,

wherein the communication instructions issue signals to:

communicate with [[a]] the terminal;

communicate with a server;

wherein the communication instruction issued signals are encrypted, wherein the encryption occurs on the processor,

wherein received encrypted instruction signals are decrypted, and wherein the decryption occurs on the processor.

**Claim 2 (currently amended):** A portable tunneling storage and processing apparatus, comprising:

a memory,

wherein the memory contains a unique apparatus identifier;

a processor disposed in communication with the memory, and configured to issue a plurality of processing instructions stored in the memory,

wherein the processing instructions issue signals to:

provide a terminal access to the memory,

process processing instructions,



effect the display of processing activity on the terminal;

a conduit for external communications disposed in communication with the processor, configured to issue a plurality of communication instructions as provided by the processor, configured to issue the communication instructions as signals to engage in communications with other devices having compatible conduits, and configured to receive signals issued from the compatible conduits,

wherein the communication instructions issue signals to:

communicate ~~at a~~ with the terminal.

**Claim 3 (original):** The apparatus of claim 2, wherein the unique apparatus identifier is a digital signature.

**Claim 4 (original):** The apparatus of claim 2, wherein the memory contains user verifying information.

**Claim 5 (original):** The apparatus of claim 4, wherein the user verifying information is a digital signature

**Claim 6 (original):** The apparatus of claim 4, wherein the user verifying information is a username and password.

**Claim 7 (currently amended):** The apparatus of claim 6, ~~further, comprising:~~ wherein the processing instructions issue signals to ~~[[:]]~~ encrypt the memory based on the unique apparatus identifier and user verifying information.

**Claim 8 (currently amended):** The apparatus of claim 2, ~~further, comprising:~~ wherein the processing instructions issue signals to ~~[[:]]~~ execute processing instructions from the memory ~~on the terminal~~ to access the terminal, wherein the processing instructions are executed on the terminal.

**Claim 9 (currently amended):** The apparatus of claim 2 ~~8~~, wherein the terminal acts as a proxy to the portable tunneling storage and processing apparatus for the terminal's input and output peripheral devices, and acts as a network interface proxy to the portable tunneling storage and processing apparatus.

**Claim 10 (original):** The apparatus of claim 2, wherein the processing instructions are stored on the memory.

**Claim 11 (original):** The apparatus of claim 2, wherein the processing instructions are obtained from a server.

**Claim 12 (original):** The apparatus of claim 2, wherein the processing instructions are processed on the processor.

**Claim 13 (original):** The apparatus of claim 12, wherein the processing instructions are processed on the processor to process files for printing.

**Claim 14 (original):** The apparatus of claim 2, wherein the processing instructions are processed on the terminal.

**Claim 15 (original):** The apparatus of claim 2, wherein the processing instructions are processed on the server.

**Claim 16 (canceled):** ~~The apparatus of claim 2, further, comprising:~~

~~wherein the processing instructions issue signals to:~~

~~effect the display of processing activity.~~

**Claim 17 (currently amended):** The apparatus of claim 2, wherein the display of processing activity occurs on the terminal display device.

**Claim 18 (currently amended):** The apparatus of claim ~~16~~ 2, wherein the display of processing activity occurs directly in the terminal's video memory.

**Claim 19 (original):** The apparatus of claim 2, wherein the conduits are USB conduits.

**Claim 20 (original):** The apparatus of claim 2, wherein the conduits are wireless conduits.

**Claim 21 (original):** The apparatus of claim 20, wherein the wireless conduits are Bluetooth.

**Claim 22 (original):** The apparatus of claim 20, wherein the wireless conduits are WiFi.

**Claim 23 (currently amended):** The apparatus of claim 2, ~~further, comprising:~~ wherein the communication instructions issue signals to [[:]] communicate with a server.

**Claim 24 (original):** The apparatus of claim 23, wherein the communication instruction issued signals are encrypted.

**Claim 25 (original):** The apparatus of claim 24, wherein the encryption occurs on the processor.

**Claim 26 (original):** The apparatus of claim 24, wherein the encryption occurs on the terminal.

**Claim 27 (original):** The apparatus of claim 24, wherein the encryption occurs on the server.

**Claim 28 (previously presented):** The apparatus of claim 23, wherein received encrypted instruction signals are decrypted.

**Claim 29 (previously presented):** The apparatus of claim 28, wherein the decryption occurs on the processor.

**Claim 30 (previously presented):** The apparatus of claim 28, wherein the decryption occurs on the terminal.

**Claim 31 (previously presented):** The apparatus of claim 28, wherein the decryption occurs on the server.

**Claim 32 (currently amended):** A method of accessing data, comprising:

engaging a portable storage device with a terminal,

wherein the portable storage device has a processor,

wherein the portable storage device connects to the terminal across compatible conduits for external communications, wherein the portable storage device has a memory, wherein the memory and a storage conduit are disposed in communication with the processor; ~~wherein the conduits are USB conduits;~~

providing the memory for access on the terminal,

wherein the memory is mounted on the terminal;

executing processing instructions from the memory ~~on the terminal~~ to access the terminal, wherein the processing instructions are executed on the terminal;

communicating through the conduit at ~~[[a]]~~ the terminal,

wherein the portable storage device has access to the terminal such that the terminal acts as a proxy to the portable storage device for the terminal's input and output peripheral devices, and acts as a network interface proxy to the portable storage device,

wherein communication instruction issued signals are encrypted,

wherein the encryption occurs on the processor,

wherein received encrypted instruction signals are decrypted,

wherein the decryption occurs on the processor;

executing processing instructions on the processor,

wherein the processing instructions are stored on the memory,

wherein the processing instructions are used to issue signals to process processing instruction on the processor; and

effecting the display of processing activity on the terminal.

**Claim 33 (original):** A method of accessing data, comprising:

disposing a portable storage device in communication with a terminal,

wherein the portable storage device has a processor,

wherein the portable storage device connects to the terminal across compatible conduits for external communications, wherein the portable storage device has a memory, wherein the memory and a storage conduit are disposed in communication with the processor;

providing the memory for access on the terminal;

executing processing instructions from the memory ~~on the terminal~~ to access the terminal, wherein the processing instructions are executed on the terminal;

communicating through the conduits connecting the portable storage device to the terminal;

processing processing instructions.

**Claim 34 (currently amended):** The method of claim 33, wherein the conduits connecting the portable storage device to the terminal are USB conduits.

**Claim 36 ~~35~~ (currently amended):** The method of claim 33, wherein the conduits connecting the portable storage device to the terminal are wireless conduits.

**Claim 36 (original):** The method of claim 35, wherein the wireless conduits are Bluetooth.

**Claim 37 (original):** The method of claim 35, wherein the wireless conduits are WiFi.

**Claim 38 (original):** The method of claim 33, wherein the memory is mounted at the terminal.

**Claim 39 (original):** The method of claim 33, wherein the communication through the conduit is at the terminal.

**Claim 40 (currently amended):** The method of claim 39, wherein the terminal acts as a proxy to the portable storage device for the terminal's input and output peripheral devices.

**Claim 41 (currently amended):** The method of claim 39, wherein the terminal acts as a network interface proxy to the portable storage device.

**Claim 42 (currently amended):** The method of claim 33, wherein ~~[[a]]~~ the communications through the conduit connecting the portable storage device to the terminal are encrypted.

**Claim 43 (original):** The method of claim 42, wherein the encryption occurs on the processor.

**Claim 44 (currently amended):** The method of claim 43, wherein the encryption occurs on the processor by executing communication instructions from the memory.

**Claim 45 (original):** The method of claim 42, wherein the encryption occurs on the terminal.

**Claim 46 (currently amended):** The method of claim 42, wherein the encryption occurs on ~~the~~ a server.

**Claim 47 (original):** The method of claim 33, wherein received encrypted instruction signals are decrypted.

**Claim 48 (original):** The method of claim 47, wherein the decryption occurs on the processor.

**Claim 49 (currently amended):** The method of claim 48, wherein the decryption occurs on the processor by executing communication instructions from the memory.

**Claim 50 (original):** The method of claim 47, wherein the decryption occurs on the terminal.

**Claim 51 (currently amended):** The method of claim 47, wherein the decryption occurs on ~~the~~ a server.

**Claim 52 (original):** The method of claim 33, wherein the processing instructions are stored in the memory.

**Claim 53 (original):** The method of claim 33, wherein the processing of processing instructions occurs on the processor.

**Claim 54 (original):** The method of claim 33, wherein the processing of processing instructions occurs on the terminal.

**Claim 55 (currently amended):** The method of claim 33, wherein the processing of processing instructions occurs on ~~the~~ a server.

**Claim 56 (original):** The method of claim 33, wherein the processing instructions are used to issue signals to process processing instruction on the processor.

**Claim 57 (original):** The method of claim 55, wherein the processing instructions are used to issue signals to process processing instruction on the processor to process files for printing.

**Claim 58 (original):** The method of claim 33, further, comprising:

effecting the display of processing activity.

**Claim 59 (original):** The method of claim 58, wherein the display occurs on the terminal.

**Claim 60 (currently amended):** The method of claim 59 wherein the display occurs ~~on the terminal by writing~~ directly ~~into~~ on the terminal video memory.

**Claim 61 (currently amended):** A system to access data, comprising:

means to engage a portable storage device with a terminal,

wherein the portable storage device has a processor,

wherein the portable storage device connects to the terminal across compatible conduits for external communications, wherein the portable storage device has a memory, wherein the memory and a storage conduit are disposed in communication with the processor; ~~wherein the conduits are USB conduits;~~

means to provide the memory ~~for~~ with access to ~~on~~ the terminal,

wherein the memory is mounted on the terminal;

means to execute processing instructions from the memory ~~on the terminal~~ to access the terminal, wherein the processing instructions are executed on the terminal;

means to communicate through the conduit at ~~[[a]]~~ the terminal,

wherein the terminal acts as a proxy to the portable storage device for the terminal's input and output peripheral devices, and acts as a network interface proxy to the portable storage device,

wherein communication instruction issued signals are encrypted,

wherein the encryption occurs on the processor,

wherein received encrypted instruction signals are decrypted,

wherein the decryption occurs on the processor;

means to execute processing instructions on the processor,

wherein the processing instructions are stored on the memory,

wherein the processing instructions are used to issue signals to process processing instruction on the processor; and

means to effect the display of processing activity on the terminal.



**Claim 62 (currently amended):** A system to access data, comprising:

means to dispose a portable storage device in communication with a terminal,

wherein the portable storage device has a processor,

wherein the portable storage device connects to the terminal across compatible conduits for external communications, wherein the portable storage device has a memory, wherein the memory and a storage conduit are disposed in communication with the processor;

means to provide the memory for access on the terminal;

means to execute processing instructions from the memory ~~on the terminal~~ to access the terminal, wherein the processing instructions are executed on the terminal;

means to communicate through the conduits connecting the portable storage device to the terminal;

means to process processing instructions.

**Claim 63 (currently amended):** A medium readable by a processor to access data, comprising:

instruction signals in the processor readable medium, wherein the instruction signals are issuable by the processor to:

engage a portable storage device with a terminal,

wherein the portable storage device has a processor,

wherein the portable storage device connects to the terminal across compatible conduits for external communications, wherein the portable storage device has a memory, wherein the memory and a storage conduit are disposed in communication with the processor; ~~wherein the conduits are USB conduits;~~

provide the memory for access on the terminal,

wherein the memory is mounted on the terminal;

execute processing instructions from the memory ~~on the terminal~~ to access the terminal,  
wherein the processing instructions are executed on the terminal;

communicate through the conduit at [[a]] the terminal,

wherein the terminal acts as a proxy to the portable storage device for the terminal's input and output peripheral devices, and acts as a network interface proxy to the portable storage device,

wherein communication instruction issued signals are encrypted,

wherein the encryption occurs on the processor,

wherein received encrypted instruction signals are decrypted,

wherein the decryption occurs on the processor;

execute processing instructions on the processor,

wherein the processing instructions are stored on the memory,

wherein the processing instructions are used to issue signals to process processing instruction on the processor; and

means to effect the display of processing activity on the terminal.

**Claim 64 (currently amended):** A medium readable by a processor to access data, comprising:

instruction signals in the processor readable medium, wherein the instruction signals are issuable by the processor to:

~~engage~~ dispose a portable storage device in communication with a terminal,

wherein the portable storage device has a processor,

wherein the portable storage device connects to the terminal across compatible conduits for external communications, wherein the portable storage device has a memory, wherein the memory and a storage conduit are disposed in communication with the processor;

provide the memory for access on the terminal;

execute processing instructions from the memory ~~on the terminal~~ to access the terminal,  
wherein the processing instructions are executed on the terminal;

communicate through the conduits connecting the portable storage device to the terminal;

process processing instructions.

**Claim 65 (currently amended):** An apparatus to access data, comprising:

a memory;

a processor disposed in communication with said memory, and configured to issue a plurality of processing instructions stored in the memory, wherein the instructions issue signals to:

engage a portable storage device with a terminal,

wherein the portable storage device has a processor,

wherein the portable storage device connects to the terminal across compatible conduits for external communications, wherein the portable storage device has a memory, wherein the memory and a storage conduit are disposed in communication with the processor,  
~~wherein the conduits are USB conduits;~~

provide ~~[[ - ]]~~ the memory for access on the terminal,

wherein the memory is mounted on the terminal;

execute processing instructions from the memory ~~on the terminal~~ to access the terminal  
wherein the processing instructions are executed on the terminal;

communicate through the conduit at [[a]] the terminal,

wherein the terminal acts as a proxy to the portable storage device for the terminal's input and output peripheral devices, and acts as a network interface proxy to the portable storage device,

wherein communication instruction issued signals are encrypted,

wherein the encryption occurs on the processor,

wherein received encrypted instruction signals are decrypted,

wherein the decryption occurs on the processor;

execute processing instructions on the processor,

wherein the processing instructions are stored on the memory,

wherein the processing instructions are used to issue signals to process processing instruction on the processor; and

means to effect the display of processing activity on the terminal.

**Claim 66 (currently amended):** An apparatus to access data, comprising:

a memory;

a processor disposed in communication with said memory, and configured to issue a plurality of processing instructions stored in the memory, wherein the instructions issue signals to:

dispose a portable storage device in communication with a terminal,

wherein the portable storage device has a processor,

wherein the portable storage device connects to the terminal across compatible conduits for external communications, wherein the portable storage device has a memory, wherein the memory and a storage conduit are disposed in communication with the processor;

provide the memory for access on the terminal;

execute processing instructions from the memory ~~on the terminal~~ to access the terminal wherein the processing instructions are executed on the terminal;

communicate through the conduits connecting the portable storage device to the terminal;

process processing instructions.

**Claim 67 (currently amended):** A method of accessing data, comprising:

receiving requests from a terminal,

wherein a portable storage device is disposed in communication with the terminal,

wherein the portable storage device has a processor,

wherein the portable storage device connects to the terminal across compatible conduits for external communications, wherein the portable storage device has a memory, wherein the memory and a storage conduit are disposed in communication with the processor, wherein the portable storage device is responsible for generating the received requests;

providing responses to the portable storage device's requests.

**Claim 68 (currently amended):** A method of accessing data, comprising:

disposing a portable storage device in communication with a ~~[[ - ]]~~terminal,

wherein the portable storage device has a processor,

wherein the portable storage device connects to the terminal across compatible conduits for external communications, wherein the portable storage device has a memory;

employing the terminal for input/output (I/O) control for the portable storage device;

executing instructions on the portable storage device; and

displaying results of execution on the terminal.

**Claim 69 (original):** The method of claim 68, further, comprising:

storing the results of execution on the terminal in the portable storage device's memory.

**Claim 70 (new):** The apparatus of claim 32, wherein the conduits connecting the portable storage device to the terminal are USB conduits.

**Claim 71 (new):** The apparatus of claim 32, wherein the conduits connecting the portable storage device to the terminal are wireless conduits.

**Claim 72 (new):** The apparatus of claim 71, wherein the wireless conduits are Bluetooth.

**Claim 73 (new):** The apparatus of claim 71, wherein the wireless conduits are WiFi.

**REMARKS**

Reconsideration of the above-identified application in view of the foregoing amendments and following remarks is respectfully requested.

**I. Status Of Claims**

Claims 1-15 and 17-73 are currently pending in this application by virtue of the foregoing claim amendments. Claims 1, 2, 7-9, 17, 18, 23, 32, 34, 35, 40-42, 44, 46, 49, 51, 55, 60-68 have been amended and new claims 70-73 have been added. No new matter has been added by these claim amendments or new claims. Applicant submits herewith an Amendment Fee Transmittal to cover the fees for new dependent claims 70-73.

The foregoing claim amendments have been made to correct various informalities in the claims and clarify the invention. For example, claims 7, 8 and 23 have been amended, *inter alia*, to correct the formatting of the claims. Claim 9 has been amended to depend from claim 8, instead of claim 2. Claim 18 has been amended to depend from claim 2, instead of canceled claim 16. The first recitation of claim 36 has been renumbered as claim 35. Claims 2, 22, 61, 63 and 65 have been amended, *inter alia*, to correct an informality regarding the prior antecedent basis for the term “terminal.” Claims 44 and 49 have been amended to correct an informality regarding the prior antecedent basis for the term “memory.” Claim 46, 51 and 55 have been amended to correct an informality regarding the lack of antecedent basis for the term “server.”

**CONCLUSION**

Applicant requests an early and favorable examination on the merits. In the event that a telephone conference would facilitate the examination of this application in any way, the Examiner is invited to contact the undersigned at the number provided.

The Commissioner is hereby authorized to charge any additional fees which may be required for the timely consideration of this amendment under I 37 C.F.R. §§ 1.16 AND 1.17, or credit any overpayment to the Deposit Account No. **50-4827**, Order No. **1004294-001US**.

Respectfully submitted,  
Locke Lord Bissell & Liddell LLP

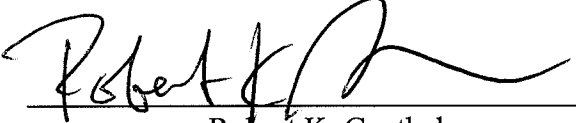
By:   
Robert K. Goethals  
Registration No. 36,813

Dated: July 28, 2009

Correspondence Address:

Locke Lord Bissell & Liddell LLP  
3 World Financial Center  
New York, NY 10281-2101  
(212) 415-8522 Telephone  
(212) 303-2754 Facsimile



**IN THE UNITED STATES PATENT AND TRADEMARK OFFICE**

Serial No.:	10/807,731	Confirmation No.:	4430
Applicant(s):	Scott McNulty	Group Art Unit:	2443
		Examiner:	Asghar H. BILGRAMI
Filed:	March 23, 2004	Customer No.:	85775
For:	APPARATUS, METHOD AND SYSTEM FOR A TUNNELING CLIENT ACCESS POINT		

**AMENDMENT FEE TRANSMITTAL**

Mail Stop Amendment  
Commissioner for Patents  
P.O. Box 1450  
Alexandria, VA 22313-1450

Sir:

Transmitted herewith is an Amendment for the above-identified application.

- No additional fee is required.
- The additional fee has been calculated as shown below:

CLAIMS AS AMENDED

	Claims Remaining After Amendment	Highest No. Covered by Previous Payments	Extra	Rate	Additional Fee
Total Claims*	72	69	3	\$52.00/ \$26.00	\$ 78.00
Independent Claims	12	12	0	\$220.00/ \$110.00	\$ 0
Multiple Dependent Claims	(If claims added by amendment include Multiple Dependent Claim(s) and there was no Multiple Dependent Claim(s) in application before amendment add \$390.00 to additional fee (\$195.00 for small entity).				\$ 0
<b>TOTAL</b>					<b>\$ 78.00</b>

\*Includes all independent and single dependent claims and all claims referred to in multiple dependent claims. See 37 C.F.R. §1.75(c).

- Small entity status is or has been claimed.  
Reduced Fees Under 37 C.F.R. §1.9(f) paid herewith \$78.00
- \_\_\_\_\_ Pages Sequence Listing
- \_\_\_\_\_ Computer disk(s) containing substitute Sequence Listing
- Statement under 37 C.F.R. §1.825(b) that the computer and paper copies of the substitute Sequence Listing are the same.
- A check in the amount of \$\_\_\_\_\_ to cover the filing fee is attached.
- Charge fee to Deposit Account No. **504827**, Order No. 1004294.001US.
- The Commissioner is hereby authorized to charge any additional fees which may be required for filing this amendment, including all fees pursuant to 37 CFR §1.17 for its timely consideration, or credit any overpayment to Deposit Account No. **504827**, Order No. 1004294.001US.

Dated: July 28, 2009

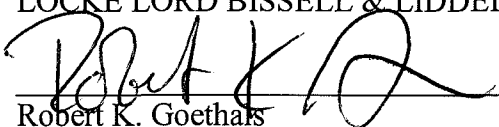
Respectfully submitted,  
LOCKE LORD BISSELL & LIDDELL LLP  
By:   
Robert K. Goethals  
Registration No. 36,813

Correspondence Address:  
Address Associated With Customer Number:  
85775  
(212) 415-8600 Telephone  
(212) 303-2754 Facsimile

## Electronic Patent Application Fee Transmittal

<b>Application Number:</b>	10807731
<b>Filing Date:</b>	23-Mar-2004
<b>Title of Invention:</b>	Apparatus, method and system for a tunneling client access point
<b>First Named Inventor/Applicant Name:</b>	Scott McNulty
<b>Filer:</b>	Robert Keaney Goethals/Anna Hill
<b>Attorney Docket Number:</b>	4602-4001

Filed as Small Entity

### Utility under 35 USC 111(a) Filing Fees

Description	Fee Code	Quantity	Amount	Sub-Total in USD(\$)
<b>Basic Filing:</b>				
<b>Pages:</b>				
<b>Claims:</b>				
Claims in excess of 20	2202	3	26	78

**Miscellaneous-Filing:**

**Petition:**

**Patent-Appeals-and-Interference:**

**Post-Allowance-and-Post-Issuance:**

**Extension-of-Time:**

PayPal Ex. 1058, p. 211  
PayPal v. IOENGINE

Description	Fee Code	Quantity	Amount	Sub-Total in USD(\$)
<b>Miscellaneous:</b>				
<b>Total in USD (\$)</b>				<b>78</b>

## Electronic Acknowledgement Receipt

<b>EFS ID:</b>	5781785
<b>Application Number:</b>	10807731
<b>International Application Number:</b>	
<b>Confirmation Number:</b>	4430
<b>Title of Invention:</b>	Apparatus, method and system for a tunneling client access point
<b>First Named Inventor/Applicant Name:</b>	Scott McNulty
<b>Customer Number:</b>	85775
<b>Filer:</b>	Robert Keane Goethals/Anna Hill
<b>Filer Authorized By:</b>	Robert Keane Goethals
<b>Attorney Docket Number:</b>	4602-4001
<b>Receipt Date:</b>	28-JUL-2009
<b>Filing Date:</b>	23-MAR-2004
<b>Time Stamp:</b>	13:15:56
<b>Application Type:</b>	Utility under 35 USC 111(a)

### Payment information:

Submitted with Payment	yes
Payment Type	Deposit Account
Payment was successfully received in RAM	\$78
RAM confirmation Number	8796
Deposit Account	504827
Authorized User	

The Director of the USPTO is hereby authorized to charge indicated fees and credit any overpayment as follows:

Charge any Additional Fees required under 37 C.F.R. Section 1.17 (Patent application and reexamination processing fees)

Charge any Additional Fees required under 37 C.F.R. Section 1.21 (Miscellaneous fees and charges)

PayPal Ex. 1058, p. 213  
PayPal v. IOENGINE

<b>File Listing:</b>					
<b>Document Number</b>	<b>Document Description</b>	<b>File Name</b>	<b>File Size(Bytes)/ Message Digest</b>	<b>Multi Part /.zip</b>	<b>Pages (if appl.)</b>
1		Supplemental_Amendment.pdf	689057 07c34eaf604358efdb657cdcd926b2d1e9afc997	yes	19
<b>Multipart Description/PDF files in .zip description</b>					
<b>Document Description</b>			<b>Start</b>	<b>End</b>	
Supplemental Response or Supplemental Amendment			1	1	
Claims			2	17	
Applicant Arguments/Remarks Made in an Amendment			18	19	
<b>Warnings:</b>					
<b>Information:</b>					
2	Miscellaneous Incoming Letter	Amendment_Fee_Transmittal.pdf	66562 22f57b67576dd69ebba7dc317fe11b9586474326	no	2
<b>Warnings:</b>					
<b>Information:</b>					
3	Fee Worksheet (PTO-875)	fee-info.pdf	29884 1ffdd896ed3be8ef2bc8c906862d49e314f2476d	no	2
<b>Warnings:</b>					
<b>Information:</b>					
<b>Total Files Size (in bytes):</b>			785503		
<p><b>This Acknowledgement Receipt evidences receipt on the noted date by the USPTO of the indicated documents, characterized by the applicant, and including page counts, where applicable. It serves as evidence of receipt similar to a Post Card, as described in MPEP 503.</b></p> <p><b><u>New Applications Under 35 U.S.C. 111</u></b>  If a new application is being filed and the application includes the necessary components for a filing date (see 37 CFR 1.53(b)-(d) and MPEP 506), a Filing Receipt (37 CFR 1.54) will be issued in due course and the date shown on this Acknowledgement Receipt will establish the filing date of the application.</p> <p><b><u>National Stage of an International Application under 35 U.S.C. 371</u></b>  If a timely submission to enter the national stage of an international application is compliant with the conditions of 35 U.S.C. 371 and other applicable requirements a Form PCT/DO/EO/903 indicating acceptance of the application as a national stage submission under 35 U.S.C. 371 will be issued in addition to the Filing Receipt, in due course.</p> <p><b><u>New International Application Filed with the USPTO as a Receiving Office</u></b>  If a new international application is being filed and the international application includes the necessary components for an international filing date (see PCT Article 11 and MPEP 1810), a Notification of the International Application Number and of the International Filing Date (Form PCT/RO/105) will be issued in due course, subject to prescriptions concerning national security, and the date shown on this Acknowledgement Receipt will establish the international filing date of the application.</p>					

Under the Paperwork Reduction Act of 1995, no persons are required to respond to a collection of information unless it displays a valid OMB control number.

<b>PATENT APPLICATION FEE DETERMINATION RECORD</b> Substitute for Form PTO-875	Application or Docket Number <b>10/807,731</b>	Filing Date <b>03/23/2004</b>	<input type="checkbox"/> To be Mailed
---	---	----------------------------------	---------------------------------------

APPLICATION AS FILED – PART I			OTHER THAN SMALL ENTITY				
(Column 1)		(Column 2)	SMALL ENTITY <input checked="" type="checkbox"/>		OR	SMALL ENTITY	
FOR	NUMBER FILED	NUMBER EXTRA	RATE (\$)	FEE (\$)		RATE (\$)	FEE (\$)
<input type="checkbox"/> BASIC FEE <small>(37 CFR 1.16(a), (b), or (c))</small>	N/A	N/A	N/A		OR	N/A	
<input type="checkbox"/> SEARCH FEE <small>(37 CFR 1.16(k), (l), or (m))</small>	N/A	N/A	N/A			N/A	
<input type="checkbox"/> EXAMINATION FEE <small>(37 CFR 1.16(o), (p), or (q))</small>	N/A	N/A	N/A			N/A	
TOTAL CLAIMS <small>(37 CFR 1.16(i))</small>	minus 20 =	*	X \$ =			X \$ =	
INDEPENDENT CLAIMS <small>(37 CFR 1.16(h))</small>	minus 3 =	*	X \$ =			X \$ =	
<input type="checkbox"/> APPLICATION SIZE FEE <small>(37 CFR 1.16(s))</small>	If the specification and drawings exceed 100 sheets of paper, the application size fee due is \$250 (\$125 for small entity) for each additional 50 sheets or fraction thereof. See 35 U.S.C. 41(a)(1)(G) and 37 CFR 1.16(s).						
<input type="checkbox"/> MULTIPLE DEPENDENT CLAIM PRESENT <small>(37 CFR 1.16(j))</small>							
* If the difference in column 1 is less than zero, enter "0" in column 2.			TOTAL			TOTAL	

APPLICATION AS AMENDED – PART II					OTHER THAN SMALL ENTITY				
(Column 1)		(Column 2)	(Column 3)		SMALL ENTITY		OR	SMALL ENTITY	
AMENDMENT	DATE	CLAIMS REMAINING AFTER AMENDMENT	HIGHEST NUMBER PREVIOUSLY PAID FOR	PRESENT EXTRA	RATE (\$)	ADDITIONAL FEE (\$)		RATE (\$)	ADDITIONAL FEE (\$)
	<b>07/28/2009</b>								
	Total <small>(37 CFR 1.16(i))</small>	* 73	Minus	** 69 = 4	X \$26 =	104	OR	X \$ =	
	Independent <small>(37 CFR 1.16(h))</small>	* 12	Minus	*** 12 = 0	X \$110 =	0	OR	X \$ =	
<input type="checkbox"/> Application Size Fee <small>(37 CFR 1.16(s))</small>									
<input type="checkbox"/> FIRST PRESENTATION OF MULTIPLE DEPENDENT CLAIM <small>(37 CFR 1.16(j))</small>							OR		
					TOTAL ADD'L FEE	<b>104</b>	OR	TOTAL ADD'L FEE	

APPLICATION AS AMENDED – PART II					OTHER THAN SMALL ENTITY				
(Column 1)		(Column 2)	(Column 3)		SMALL ENTITY		OR	SMALL ENTITY	
AMENDMENT	DATE	CLAIMS REMAINING AFTER AMENDMENT	HIGHEST NUMBER PREVIOUSLY PAID FOR	PRESENT EXTRA	RATE (\$)	ADDITIONAL FEE (\$)		RATE (\$)	ADDITIONAL FEE (\$)
	Total <small>(37 CFR 1.16(i))</small>	*	Minus	** =	X \$ =		OR	X \$ =	
	Independent <small>(37 CFR 1.16(h))</small>	*	Minus	*** =	X \$ =		OR	X \$ =	
<input type="checkbox"/> Application Size Fee <small>(37 CFR 1.16(s))</small>									
<input type="checkbox"/> FIRST PRESENTATION OF MULTIPLE DEPENDENT CLAIM <small>(37 CFR 1.16(j))</small>							OR		
					TOTAL ADD'L FEE		OR	TOTAL ADD'L FEE	

\* If the entry in column 1 is less than the entry in column 2, write "0" in column 3.  
 \*\* If the "Highest Number Previously Paid For" IN THIS SPACE is less than 20, enter "20".  
 \*\*\* If the "Highest Number Previously Paid For" IN THIS SPACE is less than 3, enter "3".  
 The "Highest Number Previously Paid For" (Total or Independent) is the highest number found in the appropriate box in column 1.

This collection of information is required by 37 CFR 1.16. The information is required to obtain or retain a benefit by the public which is to file (and by the USPTO to process) an application. Confidentiality is governed by 35 U.S.C. 122 and 37 CFR 1.14. This collection is estimated to take 12 minutes to complete, including gathering, preparing, and submitting the completed application form to the USPTO. Time will vary depending upon the individual case. Any comments on the amount of time you require to complete this form and/or suggestions for reducing this burden, should be sent to the Chief Information Officer, U.S. Patent and Trademark Office, U.S. Department of Commerce, P.O. Box 1450, Alexandria, VA 22313-1450. DO NOT SEND FEES OR COMPLETED FORMS TO THIS ADDRESS. **SEND TO: Commissioner for Patents, P.O. Box 1450, Alexandria, VA 22313-1450.**

If you need assistance in completing the form, call 1-800-PTO-9199 and select option 2.

Legal Instrument Examiner:  
/LINDA WISE/

Document code: WFEE

United States Patent and Trademark Office  
Sales Receipt for Accounting Date: 08/11/2009

LWISE1    SALE #00000003    Mailroom Dt: 07/28/2009    504827    10807731  
                  01    FC : 2202                            26.00 DA





UNITED STATES PATENT AND TRADEMARK OFFICE

UNITED STATES DEPARTMENT OF COMMERCE
United States Patent and Trademark Office
Address: COMMISSIONER FOR PATENTS
P.O. Box 1450
Alexandria, Virginia 22313-1450
www.uspto.gov

Table with 5 columns: APPLICATION NO., FILING DATE, FIRST NAMED INVENTOR, ATTORNEY DOCKET NO., CONFIRMATION NO.
10/807,731 03/23/2004 Scott McNulty 4602-4001 4430

85775 7590 08/07/2009
Locke Lord Bissell & Liddell LLP
Attn: IP Docketing
Three World Financial Center
New York, NY 10281-2101

EXAMINER

BILGRAMI, ASGHAR H

Table with 2 columns: ART UNIT, PAPER NUMBER

2443

Table with 2 columns: NOTIFICATION DATE, DELIVERY MODE

08/07/2009

ELECTRONIC

Please find below and/or attached an Office communication concerning this application or proceeding.

The time period for reply, if any, is set in the attached communication.

Notice of the Office communication was sent electronically on above-indicated "Notification Date" to the following e-mail address(es):

ptopatentcommunication@lockelord.com

**Notice of Non-Compliant  
Amendment (37 CFR 1.121)**

Application No.

10/807,731

Applicant(s)

MCNULTY, SCOTT

Examiner

ASGHAR BILGRAMI

Art Unit

2443

-- The MAILING DATE of this communication appears on the cover sheet with the correspondence address --

The amendment document filed on 28 July 2009 is considered non-compliant because it has failed to meet the requirements of 37 CFR 1.121 or 1.4. In order for the amendment document to be compliant, correction of the following item(s) is required.

THE FOLLOWING MARKED (X) ITEM(S) CAUSE THE AMENDMENT DOCUMENT TO BE NON-COMPLIANT:

- 1. Amendments to the specification:
  - A. Amended paragraph(s) do not include markings.
  - B. New paragraph(s) should not be underlined.
  - C. Other \_\_\_\_\_.
- 2. Abstract:
  - A. Not presented on a separate sheet. 37 CFR 1.72.
  - B. Other \_\_\_\_\_.
- 3. Amendments to the drawings:
  - A. The drawings are not properly identified in the top margin as "Replacement Sheet," "New Sheet," or "Annotated Sheet" as required by 37 CFR 1.121(d).
  - B. The practice of submitting proposed drawing correction has been eliminated. Replacement drawings showing amended figures, without markings, in compliance with 37 CFR 1.84 are required.
  - C. Other \_\_\_\_\_.
- 4. Amendments to the claims:
  - A. A complete listing of all of the claims is not present.
  - B. The listing of claims does not include the text of all pending claims (including withdrawn claims)
  - C. Each claim has not been provided with the proper status identifier, and as such, the individual status of each claim cannot be identified. Note: the status of every claim must be indicated after its claim number by using one of the following status identifiers: (Original), (Currently amended), (Canceled), (Previously presented), (New), (Not entered), (Withdrawn) and (Withdrawn-currently amended).
  - D. The claims of this amendment paper have not been presented in ascending numerical order.
  - E. Other: Independent claim 33 does not have the correct status identifier.
- 5. Other (e.g., the amendment is unsigned or not signed in accordance with 37 CFR 1.4):  
\_\_\_\_\_

For further explanation of the amendment format required by 37 CFR 1.121, see MPEP § 714.

TIME PERIODS FOR FILING A REPLY TO THIS NOTICE:

1. Applicant is given **no new time period** if the non-compliant amendment is an after-final amendment or an amendment filed after allowance. If applicant wishes to resubmit the non-compliant after-final amendment with corrections, the **entire corrected amendment** must be resubmitted.
2. Applicant is given **one month**, or thirty (30) days, whichever is longer, from the mail date of this notice to supply the correction, if the non-compliant amendment is one of the following: a preliminary amendment, a non-final amendment (including a submission for a request for continued examination (RCE) under 37 CFR 1.114), a supplemental amendment filed within a suspension period under 37 CFR 1.103(a) or (c), and an amendment filed in response to a *Quayle* action. If any of above boxes 1. to 4. are checked, the correction required is only the **corrected section** of the non-compliant amendment in compliance with 37 CFR 1.121.

**Extensions of time** are available under 37 CFR 1.136(a) only if the non-compliant amendment is a non-final amendment or an amendment filed in response to a *Quayle* action.

**Failure to timely respond** to this notice will result in:

**Abandonment** of the application if the non-compliant amendment is a non-final amendment or an amendment filed in response to a *Quayle* action; or

**Non-entry** of the amendment if the non-compliant amendment is a preliminary amendment or supplemental amendment.

/Asghar Bilgrami/  
Examiner, Art Unit 2443

/Tonia LM Dollinger/  
Supervisory Patent Examiner, Art Unit 2443

**IN THE UNITED STATES PATENT AND TRADEMARK OFFICE**

Serial No. : 10/807,731 Confirmation : 4430  
Applicant(s) : Scott McNulty  
Filed : March 23, 2004  
Title : Apparatus, Method And System For A Tunneling Client Access Point

Art Unit : 2443  
Examiner : Asghar H. Bilgrami

Docket No. : 1004294.001US  
Customer No. : 85775

**SUPPLEMENTAL AMENDMENT**

Mail Stop Amendment  
Commissioner for Patents  
P.O. Box 1450  
Alexandria, VA 22313-1450

Sir:

On August 7, 2009, the Patent Office issued a Notice of Non-Compliant Amendment under 37 C.F.R. 1.121 in response to applicant's Supplemental Amendment submitted on July 28, 2009. Applicant hereby submits this corrected Supplemental Amendment having the proper status identifier for independent claim 33. Reconsideration of this application is respectfully requested in light of this paper, which is set forth as follows:

- **Amendments to the Claims** are reflected in the listing of claims which begins on page 2 of this paper.
- **Remarks** begin on page 18 of this paper.

**Amendments to the Claims:**

This listing of claims will replace all prior listings of claims in the application.

Listing Of Claims:

**Claim 1 (currently amended):** A portable tunneling storage and processing apparatus, comprising:

a memory,

wherein the memory contains a unique apparatus identifier,

wherein the memory contains user verifying information;

a processor disposed in communication with the memory, and configured to issue a plurality of processing instructions stored in the memory,

wherein the processing instructions issue signals to:

provide a terminal with access to the memory;

execute processing instructions from the memory ~~on the terminal~~ to provide the portable tunneling storage and processing apparatus with access to the terminal, wherein the terminal acts as a proxy to the portable tunneling storage and processing apparatus for the terminal's input and output peripheral devices, and wherein the terminal acts as a network interface proxy to the portable tunneling storage and processing apparatus, and wherein the processing instructions are executed on the terminal;

process processing instructions, wherein the processing instructions are stored in the memory, wherein the processing instructions are used to issue signals to process processing instruction on the processor;

encrypt data stored in the memory based on the apparatus identifier and the user verifying information;

effect the display of processing activity on the terminal display device;

a conduit for external communications disposed in communication with the processor, configured to issue a plurality of communication instructions as provided by the processor, configured to issue the communication instructions as signals to engage in communications with other devices having compatible conduits, and configured to receive signals issued from the compatible conduits, wherein the conduits are USB conduits,

wherein the communication instructions issue signals to:

communicate with [[a]] the terminal;

communicate with a server;

wherein the communication instruction issued signals are encrypted, wherein the encryption occurs on the processor,

wherein received encrypted instruction signals are decrypted, and wherein the decryption occurs on the processor.

**Claim 2 (currently amended):** A portable tunneling storage and processing apparatus, comprising:

a memory,

wherein the memory contains a unique apparatus identifier;

a processor disposed in communication with the memory, and configured to issue a plurality of processing instructions stored in the memory,

wherein the processing instructions issue signals to:

provide a terminal access to the memory,

process processing instructions,

effect the display of processing activity on the terminal;

a conduit for external communications disposed in communication with the processor, configured to issue a plurality of communication instructions as provided by the processor, configured to issue the communication instructions as signals to engage in communications with other devices having compatible conduits, and configured to receive signals issued from the compatible conduits,

wherein the communication instructions issue signals to:

communicate at-a with the terminal.

**Claim 3 (original):** The apparatus of claim 2, wherein the unique apparatus identifier is a digital signature.

**Claim 4 (original):** The apparatus of claim 2, wherein the memory contains user verifying information.

**Claim 5 (original):** The apparatus of claim 4, wherein the user verifying information is a digital signature

**Claim 6 (original):** The apparatus of claim 4, wherein the user verifying information is a username and password.

**Claim 7 (currently amended):** The apparatus of claim 6, ~~further, comprising:~~ wherein the processing instructions issue signals to ~~[[:]]~~ encrypt the memory based on the unique apparatus identifier and user verifying information.

**Claim 8 (currently amended):** The apparatus of claim 2, ~~further, comprising:~~ wherein the processing instructions issue signals to ~~[[:]]~~ execute processing instructions from the memory ~~on the terminal~~ to access the terminal, wherein the processing instructions are executed on the terminal.

**Claim 9 (currently amended):** The apparatus of claim 2 ~~8~~, wherein the terminal acts as a proxy to the portable tunneling storage and processing apparatus for the terminal's input and output peripheral devices, and acts as a network interface proxy to the portable tunneling storage and processing apparatus.

**Claim 10 (original):** The apparatus of claim 2, wherein the processing instructions are stored on the memory.

**Claim 11 (original):** The apparatus of claim 2, wherein the processing instructions are obtained from a server.

**Claim 12 (original):** The apparatus of claim 2, wherein the processing instructions are processed on the processor.

**Claim 13 (original):** The apparatus of claim 12, wherein the processing instructions are processed on the processor to process files for printing.

**Claim 14 (original):** The apparatus of claim 2, wherein the processing instructions are processed on the terminal.

**Claim 15 (original):** The apparatus of claim 2, wherein the processing instructions are processed on the server.

**Claim 16 (canceled):** ~~The apparatus of claim 2, further, comprising:~~

~~wherein the processing instructions issue signals to:~~

~~effect the display of processing activity.~~

**Claim 17 (currently amended):** The apparatus of claim 2, wherein the display of processing activity occurs on the terminal display device.

**Claim 18 (currently amended):** The apparatus of claim ~~16~~ 2, wherein the display of processing activity occurs directly in the terminal's video memory.

**Claim 19 (original):** The apparatus of claim 2, wherein the conduits are USB conduits.

**Claim 20 (original):** The apparatus of claim 2, wherein the conduits are wireless conduits.

**Claim 21 (original):** The apparatus of claim 20, wherein the wireless conduits are Bluetooth.

**Claim 22 (original):** The apparatus of claim 20, wherein the wireless conduits are WiFi.

**Claim 23 (currently amended):** The apparatus of claim 2, ~~further, comprising:~~ wherein the communication instructions issue signals to [[:]] communicate with a server.

**Claim 24 (original):** The apparatus of claim 23, wherein the communication instruction issued signals are encrypted.

**Claim 25 (original):** The apparatus of claim 24, wherein the encryption occurs on the processor.

**Claim 26 (original):** The apparatus of claim 24, wherein the encryption occurs on the terminal.

**Claim 27 (original):** The apparatus of claim 24, wherein the encryption occurs on the server.

**Claim 28 (previously presented):** The apparatus of claim 23, wherein received encrypted instruction signals are decrypted.

**Claim 29 (previously presented):** The apparatus of claim 28, wherein the decryption occurs on the processor.

**Claim 30 (previously presented):** The apparatus of claim 28, wherein the decryption occurs on the terminal.

**Claim 31 (previously presented):** The apparatus of claim 28, wherein the decryption occurs on the server.

**Claim 32 (currently amended):** A method of accessing data, comprising:



engaging a portable storage device with a terminal,

wherein the portable storage device has a processor,

wherein the portable storage device connects to the terminal across compatible conduits for external communications, wherein the portable storage device has a memory, wherein the memory and a storage conduit are disposed in communication with the processor; ~~wherein the conduits are USB conduits;~~

providing the memory for access on the terminal,

wherein the memory is mounted on the terminal;

executing processing instructions from the memory ~~on the terminal~~ to access the terminal, wherein the processing instructions are executed on the terminal;

communicating through the conduit at [[a]] the terminal,

wherein the portable storage device has access to the terminal such that the terminal acts as a proxy to the portable storage device for the terminal's input and output peripheral devices, and acts as a network interface proxy to the portable storage device,

wherein communication instruction issued signals are encrypted,

wherein the encryption occurs on the processor,

wherein received encrypted instruction signals are decrypted,

wherein the decryption occurs on the processor;

executing processing instructions on the processor,

wherein the processing instructions are stored on the memory,

wherein the processing instructions are used to issue signals to process processing instruction on the processor; and

effecting the display of processing activity on the terminal.

**Claim 33 (currently amended):** A method of accessing data, comprising:

disposing a portable storage device in communication with a terminal,

wherein the portable storage device has a processor,

wherein the portable storage device connects to the terminal across compatible conduits for external communications, wherein the portable storage device has a memory, wherein the memory and a storage conduit are disposed in communication with the processor;

providing the memory for access on the terminal;

executing processing instructions from the memory ~~on the terminal~~ to access the terminal, wherein the processing instructions are executed on the terminal;

communicating through the conduits connecting the portable storage device to the terminal;

processing processing instructions.

**Claim 34 (currently amended):** The method of claim 33, wherein the conduits connecting the portable storage device to the terminal are USB conduits.

**Claim 36 ~~35~~ (currently amended):** The method of claim 33, wherein the conduits connecting the portable storage device to the terminal are wireless conduits.

**Claim 36 (original):** The method of claim 35, wherein the wireless conduits are Bluetooth.

**Claim 37 (original):** The method of claim 35, wherein the wireless conduits are WiFi.

**Claim 38 (original):** The method of claim 33, wherein the memory is mounted at the terminal.

**Claim 39 (original):** The method of claim 33, wherein the communication through the conduit is at the terminal.

**Claim 40 (currently amended):** The method of claim 39, wherein the terminal acts as a proxy to the portable storage device for the terminal's input and output peripheral devices.

**Claim 41 (currently amended):** The method of claim 39, wherein the terminal acts as a network interface proxy to the portable storage device.

**Claim 42 (currently amended):** The method of claim 33, wherein ~~[[a]]~~ the communications through the conduit connecting the portable storage device to the terminal are encrypted.

**Claim 43 (original):** The method of claim 42, wherein the encryption occurs on the processor.

**Claim 44 (currently amended):** The method of claim 43, wherein the encryption occurs on the processor by executing communication instructions from the memory.

**Claim 45 (original):** The method of claim 42, wherein the encryption occurs on the terminal.

**Claim 46 (currently amended):** The method of claim 42, wherein the encryption occurs on ~~the~~ a server.

**Claim 47 (original):** The method of claim 33, wherein received encrypted instruction signals are decrypted.

**Claim 48 (original):** The method of claim 47, wherein the decryption occurs on the processor.

**Claim 49 (currently amended):** The method of claim 48, wherein the decryption occurs on the processor by executing communication instructions from the memory.

**Claim 50 (original):** The method of claim 47, wherein the decryption occurs on the terminal.

**Claim 51 (currently amended):** The method of claim 47, wherein the decryption occurs on ~~the~~ a server.

**Claim 52 (original):** The method of claim 33, wherein the processing instructions are stored in the memory.

**Claim 53 (original):** The method of claim 33, wherein the processing of processing instructions occurs on the processor.

**Claim 54 (original):** The method of claim 33, wherein the processing of processing instructions occurs on the terminal.

**Claim 55 (currently amended):** The method of claim 33, wherein the processing of processing instructions occurs on ~~the~~ a server.

**Claim 56 (original):** The method of claim 33, wherein the processing instructions are used to issue signals to process processing instruction on the processor.

**Claim 57 (original):** The method of claim 55, wherein the processing instructions are used to issue signals to process processing instruction on the processor to process files for printing.

**Claim 58 (original):** The method of claim 33, further, comprising:

effecting the display of processing activity.

**Claim 59 (original):** The method of claim 58, wherein the display occurs on the terminal.

**Claim 60 (currently amended):** The method of claim 59 wherein the display occurs ~~on the terminal by writing~~ directly ~~into~~ on the terminal video memory.

**Claim 61 (currently amended):** A system to access data, comprising:

means to engage a portable storage device with a terminal,

wherein the portable storage device has a processor,

wherein the portable storage device connects to the terminal across compatible conduits for external communications, wherein the portable storage device has a memory, wherein the memory and a storage conduit are disposed in communication with the processor; ~~wherein the conduits are USB conduits;~~

means to provide the memory ~~for~~ with access to ~~on~~ the terminal,

wherein the memory is mounted on the terminal;

means to execute processing instructions from the memory ~~on the terminal~~ to access the terminal, wherein the processing instructions are executed on the terminal;

means to communicate through the conduit at ~~[[a]]~~ the terminal,

wherein the terminal acts as a proxy to the portable storage device for the terminal's input and output peripheral devices, and acts as a network interface proxy to the portable storage device,

wherein communication instruction issued signals are encrypted,

wherein the encryption occurs on the processor,

wherein received encrypted instruction signals are decrypted,

wherein the decryption occurs on the processor;

means to execute processing instructions on the processor,

wherein the processing instructions are stored on the memory,

wherein the processing instructions are used to issue signals to process processing instruction on the processor; and

means to effect the display of processing activity on the terminal.

**Claim 62 (currently amended):** A system to access data, comprising:

means to dispose a portable storage device in communication with a terminal,

wherein the portable storage device has a processor,

wherein the portable storage device connects to the terminal across compatible conduits for external communications, wherein the portable storage device has a memory, wherein the memory and a storage conduit are disposed in communication with the processor;

means to provide the memory for access on the terminal;

means to execute processing instructions from the memory ~~on the terminal~~ to access the terminal, wherein the processing instructions are executed on the terminal;

means to communicate through the conduits connecting the portable storage device to the terminal;

means to process processing instructions.

**Claim 63 (currently amended):** A medium readable by a processor to access data, comprising:

instruction signals in the processor readable medium, wherein the instruction signals are issuable by the processor to:

engage a portable storage device with a terminal,

wherein the portable storage device has a processor,

wherein the portable storage device connects to the terminal across compatible conduits for external communications, wherein the portable storage device has a memory, wherein the memory and a storage conduit are disposed in communication with the processor; ~~wherein the conduits are USB conduits;~~

provide the memory for access on the terminal,

wherein the memory is mounted on the terminal;

execute processing instructions from the memory ~~on the terminal~~ to access the terminal,  
wherein the processing instructions are executed on the terminal;

communicate through the conduit at [[a]] the terminal,

wherein the terminal acts as a proxy to the portable storage device for the terminal's input and output peripheral devices, and acts as a network interface proxy to the portable storage device,

wherein communication instruction issued signals are encrypted,

wherein the encryption occurs on the processor,

wherein received encrypted instruction signals are decrypted,

wherein the decryption occurs on the processor;

execute processing instructions on the processor,

wherein the processing instructions are stored on the memory,

wherein the processing instructions are used to issue signals to process processing instruction on the processor; and

means to effect the display of processing activity on the terminal.

**Claim 64 (currently amended):** A medium readable by a processor to access data, comprising:

instruction signals in the processor readable medium, wherein the instruction signals are issuable by the processor to:

engage ~~dispose~~ a portable storage device in communication with a terminal,

wherein the portable storage device has a processor,

wherein the portable storage device connects to the terminal across compatible conduits for external communications, wherein the portable storage device has a memory, wherein the memory and a storage conduit are disposed in communication with the processor;

provide the memory for access on the terminal;

execute processing instructions from the memory ~~on the terminal~~ to access the terminal,  
wherein the processing instructions are executed on the terminal;

communicate through the conduits connecting the portable storage device to the terminal;

process processing instructions.

**Claim 65 (currently amended):** An apparatus to access data, comprising:

a memory;

a processor disposed in communication with said memory, and configured to issue a plurality of processing instructions stored in the memory, wherein the instructions issue signals to:

engage a portable storage device with a terminal,

wherein the portable storage device has a processor,

wherein the portable storage device connects to the terminal across compatible conduits for external communications, wherein the portable storage device has a memory, wherein the memory and a storage conduit are disposed in communication with the processor;  
~~wherein the conduits are USB conduits;~~

provide ~~[[ - ]]~~ the memory for access on the terminal,



wherein the memory is mounted on the terminal;

execute processing instructions from the memory ~~on the terminal~~ to access the terminal  
wherein the processing instructions are executed on the terminal;

communicate through the conduit at [[a]] the terminal,

wherein the terminal acts as a proxy to the portable storage device for the terminal's input and output peripheral devices, and acts as a network interface proxy to the portable storage device,

wherein communication instruction issued signals are encrypted,

wherein the encryption occurs on the processor,

wherein received encrypted instruction signals are decrypted,

wherein the decryption occurs on the processor;

execute processing instructions on the processor,

wherein the processing instructions are stored on the memory,

wherein the processing instructions are used to issue signals to process processing instruction on the processor; and

means to effect the display of processing activity on the terminal.

**Claim 66 (currently amended):** An apparatus to access data, comprising:

a memory;

a processor disposed in communication with said memory, and configured to issue a plurality of processing instructions stored in the memory, wherein the instructions issue signals to:

dispose a portable storage device in communication with a terminal,

wherein the portable storage device has a processor,

wherein the portable storage device connects to the terminal across compatible conduits for external communications, wherein the portable storage device has a memory, wherein the memory and a storage conduit are disposed in communication with the processor;

provide the memory for access on the terminal;

execute processing instructions from the memory ~~on the terminal~~ to access the terminal wherein the processing instructions are executed on the terminal;

communicate through the conduits connecting the portable storage device to the terminal;

process processing instructions.

**Claim 67 (currently amended):** A method of accessing data, comprising:

receiving requests from a terminal,

wherein a portable storage device is disposed in communication with the terminal,

wherein the portable storage device has a processor,

wherein the portable storage device connects to the terminal across compatible conduits for external communications, wherein the portable storage device has a memory, wherein the memory and a storage conduit are disposed in communication with the processor, wherein the portable storage device is responsible for generating the received requests;

providing responses to the portable storage device's requests.

**Claim 68 (currently amended):** A method of accessing data, comprising:

disposing a portable storage device in communication with a [[-]]terminal,

wherein the portable storage device has a processor,

wherein the portable storage device connects to the terminal across compatible conduits for external communications, wherein the portable storage device has a memory;

employing the terminal for input/output (I/O) control for the portable storage device;

executing instructions on the portable storage device; and

displaying results of execution on the terminal.

**Claim 69 (original):** The method of claim 68, further, comprising:

storing the results of execution on the terminal in the portable storage device's memory.

**Claim 70 (new):** The apparatus of claim 32, wherein the conduits connecting the portable storage device to the terminal are USB conduits.

**Claim 71 (new):** The apparatus of claim 32, wherein the conduits connecting the portable storage device to the terminal are wireless conduits.

**Claim 72 (new):** The apparatus of claim 71, wherein the wireless conduits are Bluetooth.

**Claim 73 (new):** The apparatus of claim 71, wherein the wireless conduits are WiFi.

**REMARKS**

Reconsideration of the above-identified application in view of the foregoing amendments and following remarks is respectfully requested.

**I. Status Of Claims**

Claims 1-15 and 17-73 are currently pending in this application by virtue of the foregoing claim amendments. Claims 1, 2, 7-9, 17, 18, 23, 32-34, 35, 40-42, 44, 46, 49, 51, 55, 60-68 have been amended and new claims 70-73 have been added. No new matter has been added by these claim amendments or new claims. Applicant submits herewith an Amendment Fee Transmittal to cover the fees for new dependent claims 70-73.

The foregoing claim amendments have been made to correct various informalities in the claims and clarify the invention. For example, claims 7, 8, and 23 have been amended, *inter alia*, to correct the formatting of the claims. Claim 9 has been amended to depend from claim 8, instead of claim 2. Claim 18 has been amended to depend from claim 2, instead of canceled claim 16. The first recitation of claim 36 has been renumbered as claim 35. Claims 2, 22, 61, 63 and 65 have been amended, *inter alia*, to correct an informality regarding the prior antecedent basis for the term "terminal." Claims 44 and 49 have been amended to correct an informality regarding the prior antecedent basis for the term "memory." Claim 46, 51 and 55 have been amended to correct an informality regarding the lack of antecedent basis for the term "server."

**CONCLUSION**

Applicant requests an early and favorable examination on the merits. In the event that a telephone conference would facilitate the examination of this application in any way, the Examiner is invited to contact the undersigned at the number provided.

**AUTHORIZATION**

The Commissioner is hereby authorized to charge any additional fees which may be required for the timely consideration of this amendment under I 37 C.F.R. §§ 1.16 AND 1.17, or credit any overpayment to the Deposit Account No. **50-4827**, Order No. **1004294-001US**.

Respectfully submitted,  
Locke Lord Bissell & Liddell LLP

Dated: August 10, 2009

By:

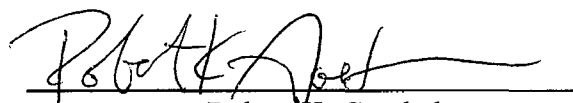

Robert K. Goethals  
Registration No. 36,813

**Correspondence Address:**

Locke Lord Bissell & Liddell LLP  
3 World Financial Center  
New York, NY 10281-2101  
(212) 415-8522 Telephone  
(212) 303-2754 Facsimile

## Electronic Acknowledgement Receipt

<b>EFS ID:</b>	5854544
<b>Application Number:</b>	10807731
<b>International Application Number:</b>	
<b>Confirmation Number:</b>	4430
<b>Title of Invention:</b>	Apparatus, method and system for a tunneling client access point
<b>First Named Inventor/Applicant Name:</b>	Scott McNulty
<b>Customer Number:</b>	85775
<b>Filer:</b>	Robert Keane Goethals/Anna Hill
<b>Filer Authorized By:</b>	Robert Keane Goethals
<b>Attorney Docket Number:</b>	1004294.001US
<b>Receipt Date:</b>	10-AUG-2009
<b>Filing Date:</b>	23-MAR-2004
<b>Time Stamp:</b>	10:07:58
<b>Application Type:</b>	Utility under 35 USC 111(a)

### Payment information:

Submitted with Payment	no
------------------------	----

### File Listing:

Document Number	Document Description	File Name	File Size(Bytes)/ Message Digest	Multi Part /.zip	Pages (if appl.)
1		1004294001US_Supp_Amend ment.PDF	654480 <small>ffb988bb2a6ab4172cc48165a8a5491580e20c6</small>	yes	19

<b>Multipart Description/PDF files in .zip description</b>			
<b>Document Description</b>		<b>Start</b>	<b>End</b>
Supplemental Response or Supplemental Amendment		1	1
Claims		2	17
Applicant Arguments/Remarks Made in an Amendment		18	19

**Warnings:**

**Information:**

<b>Total Files Size (in bytes):</b>	654480
-------------------------------------	--------

This Acknowledgement Receipt evidences receipt on the noted date by the USPTO of the indicated documents, characterized by the applicant, and including page counts, where applicable. It serves as evidence of receipt similar to a Post Card, as described in MPEP 503.

**New Applications Under 35 U.S.C. 111**

If a new application is being filed and the application includes the necessary components for a filing date (see 37 CFR 1.53(b)-(d) and MPEP 506), a Filing Receipt (37 CFR 1.54) will be issued in due course and the date shown on this Acknowledgement Receipt will establish the filing date of the application.

**National Stage of an International Application under 35 U.S.C. 371**

If a timely submission to enter the national stage of an international application is compliant with the conditions of 35 U.S.C. 371 and other applicable requirements a Form PCT/DO/EO/903 indicating acceptance of the application as a national stage submission under 35 U.S.C. 371 will be issued in addition to the Filing Receipt, in due course.

**New International Application Filed with the USPTO as a Receiving Office**

If a new international application is being filed and the international application includes the necessary components for an international filing date (see PCT Article 11 and MPEP 1810), a Notification of the International Application Number and of the International Filing Date (Form PCT/RO/105) will be issued in due course, subject to prescriptions concerning national security, and the date shown on this Acknowledgement Receipt will establish the international filing date of the application.



UNITED STATES PATENT AND TRADEMARK OFFICE

UNITED STATES DEPARTMENT OF COMMERCE
United States Patent and Trademark Office
Address: COMMISSIONER FOR PATENTS
P.O. Box 1450
Alexandria, Virginia 22313-1450
www.uspto.gov

Table with 5 columns: APPLICATION NO., FILING DATE, FIRST NAMED INVENTOR, ATTORNEY DOCKET NO., CONFIRMATION NO. Includes sub-tables for EXAMINER, ART UNIT, PAPER NUMBER, NOTIFICATION DATE, and DELIVERY MODE.

Please find below and/or attached an Office communication concerning this application or proceeding.

The time period for reply, if any, is set in the attached communication.

Notice of the Office communication was sent electronically on above-indicated "Notification Date" to the following e-mail address(es):

ptopatentcommunication@lockelord.com



**Office Action Summary**

<b>Application No.</b> 10/807,731	<b>Applicant(s)</b> MCNULTY, SCOTT	
<b>Examiner</b> ASGHAR BILGRAMI	<b>Art Unit</b> 2443	

-- The MAILING DATE of this communication appears on the cover sheet with the correspondence address --

**Period for Reply**

A SHORTENED STATUTORY PERIOD FOR REPLY IS SET TO EXPIRE 3 MONTH(S) OR THIRTY (30) DAYS, WHICHEVER IS LONGER, FROM THE MAILING DATE OF THIS COMMUNICATION.

- Extensions of time may be available under the provisions of 37 CFR 1.136(a). In no event, however, may a reply be timely filed after SIX (6) MONTHS from the mailing date of this communication.
- If NO period for reply is specified above, the maximum statutory period will apply and will expire SIX (6) MONTHS from the mailing date of this communication.
- Failure to reply within the set or extended period for reply will, by statute, cause the application to become ABANDONED (35 U.S.C. § 133). Any reply received by the Office later than three months after the mailing date of this communication, even if timely filed, may reduce any earned patent term adjustment. See 37 CFR 1.704(b).

**Status**

- 1)  Responsive to communication(s) filed on 10 August 2009.
- 2a)  This action is **FINAL**.                                  2b)  This action is non-final.
- 3)  Since this application is in condition for allowance except for formal matters, prosecution as to the merits is closed in accordance with the practice under *Ex parte Quayle*, 1935 C.D. 11, 453 O.G. 213.

**Disposition of Claims**

- 4)  Claim(s) 1-15 and 17-73 is/are pending in the application.  
4a) Of the above claim(s) \_\_\_\_\_ is/are withdrawn from consideration.
- 5)  Claim(s) \_\_\_\_\_ is/are allowed.
- 6)  Claim(s) 1-15 and 17-73 is/are rejected.
- 7)  Claim(s) \_\_\_\_\_ is/are objected to.
- 8)  Claim(s) \_\_\_\_\_ are subject to restriction and/or election requirement.

**Application Papers**

- 9)  The specification is objected to by the Examiner.
- 10)  The drawing(s) filed on 23 March 2004 is/are: a)  accepted or b)  objected to by the Examiner.  
Applicant may not request that any objection to the drawing(s) be held in abeyance. See 37 CFR 1.85(a).  
Replacement drawing sheet(s) including the correction is required if the drawing(s) is objected to. See 37 CFR 1.121(d).
- 11)  The oath or declaration is objected to by the Examiner. Note the attached Office Action or form PTO-152.

**Priority under 35 U.S.C. § 119**

- 12)  Acknowledgment is made of a claim for foreign priority under 35 U.S.C. § 119(a)-(d) or (f).  
a)  All    b)  Some \*    c)  None of:  
1.  Certified copies of the priority documents have been received.  
2.  Certified copies of the priority documents have been received in Application No. \_\_\_\_\_.  
3.  Copies of the certified copies of the priority documents have been received in this National Stage application from the International Bureau (PCT Rule 17.2(a)).

\* See the attached detailed Office action for a list of the certified copies not received.

**Attachment(s)**

- 1)  Notice of References Cited (PTO-892)
- 2)  Notice of Draftsperson's Patent Drawing Review (PTO-948)
- 3)  Information Disclosure Statement(s) (PTO/SB/08)  
Paper No(s)/Mail Date \_\_\_\_\_.
- 4)  Interview Summary (PTO-413)  
Paper No(s)/Mail Date. \_\_\_\_\_.
- 5)  Notice of Informal Patent Application
- 6)  Other: \_\_\_\_\_.

Art Unit: 2443

## DETAILED ACTION

### ***Claim Rejections - 35 USC § 103***

1. The following is a quotation of 35 U.S.C. 103(a) which forms the basis for all obviousness rejections set forth in this Office action:

(a) A patent may not be obtained though the invention is not identically disclosed or described as set forth in section 102 of this title, if the differences between the subject matter sought to be patented and the prior art are such that the subject matter as a whole would have been obvious at the time the invention was made to a person having ordinary skill in the art to which said subject matter pertains. Patentability shall not be negated by the manner in which the invention was made.

2. Claim 1, 32 & 70-73 are rejected under 35 U.S.C. 103(a) as being unpatentable over Margalit et al (U.S. 6,763,399 B2) and Wilson et al (U.S. PUB. NO. 2005/0197859 A1).

3. As per claim 1 Margalit disclosed a portable tunneling storage and processing apparatus, comprising: a memory, wherein the memory contains a unique apparatus identifier {It is well known for a ROM onboard a USB device to contain the MAC address (I.E unique identifier) of the USB storage device (Thumb drive). All USB devices contain a collection of information about the device, called the descriptors. Device descriptors are retrieved from all devices with the same command. This allows a device driver for the USB bus itself to effectively ask a newly connected device what it is, and expect to get a reasonable response. The descriptors also include a vendor ID (VID), product ID (PID), and revision. For example the vendor IDs are assigned by the standards committee. Product IDs are assigned by each vendor, and the combination of VID and PID are be unique to each released product} (col.3, lines 5-13), wherein the memory

Art Unit: 2443

contains user verifying information (col.1, lines 60-65); a processor disposed in communication with the memory, and configured to issue a plurality of processing instructions stored in the memory (Figure.1, col.2, lines 37-46)., wherein the processing instructions issue signals to: provide a terminal with access to the memory; execute processing instructions from the memory to provide the portable tunneling storage and processing apparatus with access to the terminal and wherein the processing instructions are executed on the terminal {I.E information derived from the USB communication implemented/executed on the terminal to provide authentication, encryption or access control to the terminal} (col.1, lines 52-59); process processing instructions, wherein the processing instructions are stored in the memory (col.3, lines 3—51), wherein the processing instructions are used to issue signals to process processing instruction on the processor (col.3, lines 5-11); encrypt data stored in the memory based on the apparatus identifier and the user verifying information (col.2, lines 57-67); a conduit for external communications disposed in communication with the processor, configured to issue a plurality of communication instructions as provided by the processor, configured to issue the communication instructions as signals to engage in communications with other devices having compatible conduits, and configured to receive signals issued from the compatible conduits, wherein the conduits are USB conduits (col.1, lines 60-67 & col.2, lines 1-11), wherein the communication instructions issue signals to: communicate with the terminal {Margalit specifically states that USB device 10 is configured to interact with any USB host 20 such as but not limited to a personal computer or Macintosh having a USB port. Therefore USB host can be a

Art Unit: 2443

terminal}(Figure.1, Col.2, 57-64); communicate with a server { USB host can also be a server} (Figure.1, Col.2, 57-64); wherein the communication instruction issued signals are encrypted (col.4,lines 31-35), wherein the encryption occurs on the processor, wherein received encrypted instruction signals are decrypted, and wherein the decryption occurs on the processor (col.3, lines 57-63, col.4, lines 5-15 & col.4,lines 31-35). However Margalit did not explicitly disclose wherein the terminal acts as a proxy to the portable tunneling storage and processing apparatus for the terminal's input and output peripheral devices, and wherein the terminal acts as a network interface proxy to the portable tunneling storage and processing apparatus; effect the display of processing activity on the terminal display device (paragraph.37). In the same filed of endeavor Wilson disclosed wherein the terminal acts as a proxy to the portable tunneling storage and processing apparatus for the terminal's input and output peripheral devices (Figure.1, Elements 138 & 140, Paragraphs. 41 & 42), and wherein the terminal acts as a network interface proxy to the portable tunneling storage and processing apparatus (Paragraphs. 41 & 47); effect the display of processing activity on the terminal display device (paragraph.37)

It would have been obvious to one in the ordinary skill in the art at the time the invention was made to have incorporated terminal acting as a proxy/network interface proxy as disclosed by Wilson into the portable tunneling storage device as disclosed by Margalit in order to make the portable apparatus more versatile resulting in a system that is more robust and compatible with multiple devices over a network.

Art Unit: 2443

4. As per claim 32 Margalit disclosed a method of accessing data, comprising: engaging a portable storage device with a terminal, wherein the portable storage device has a processor (col.2, lines 34-46), wherein the portable storage device connects to the terminal across compatible conduits for external communications (col.1, lines 60-67 & col.2, lines 1-2), wherein the portable storage device has a memory, wherein the memory and a storage conduit are disposed in communication with the processor (col.3, lines 5-10); providing the memory for access on the terminal, wherein the memory is mounted on the terminal; executing processing instructions from the memory to access the terminal, wherein the processing instructions are executed on the terminal {I.E information derived from the USB communication implemented/executed on the terminal to provide authentication, encryption or access control to the terminal} (col.1, lines 52-59); communicating through the conduit at the terminal {Margalit specifically states that USB device 10 is configured to interact with any USB host 20 such as but not limited to a personal computer or Macintosh having a USB port. Therefore USB host can be a terminal}(Figure.1, col.1, lines 52-67 & col.2, 57-64); wherein communication instruction issued signals are encrypted (col.4, lines 31-35), wherein the encryption occurs on the processor, wherein received encrypted instruction signals are decrypted, wherein the decryption occurs on the processor (col.3, lines 57-63, col.4, lines 5-15 & col.4 lines 31-35) ; executing processing instructions on the processor (col.3, lines 5-13), wherein the processing instructions are stored on the memory, wherein the processing instructions are used to issue signals to process processing instruction on the processor (col.3, lines 5-13) {merely describing generic functionality of a processor}.

Art Unit: 2443

However Margalit did not explicitly disclose wherein the portable storage device has access to the terminal such that the terminal acts as a proxy to the portable storage device for the terminal's input and output peripheral devices, and acts as a network interface proxy to the portable storage device and affecting the display of processing activity on the terminal. In the same filed of endeavor Wilson disclosed wherein the portable storage device has access to the terminal such that the terminal acts as a proxy to the portable storage device for the terminal's input and output peripheral devices (Figure.1, elements 138 & 140, paragraphs. 41 & 42), and acts as a network interface proxy to the portable storage device (paragraphs.41 & 47) and affecting the display of processing activity on the terminal (paragraph. 37).

It would have been obvious to one in the ordinary skill in the art at the time the invention was made to have incorporated terminal acting as a proxy/network interface proxy as disclosed by Wilson into the method of accessing data comprising a portable storage device as disclosed by Margalit in order to make the portable apparatus more versatile resulting in a system that is more robust and compatible with multiple devices over a network.

5. As per claims 70 Margalit-Wilson disclosed the apparatus of claim 32, wherein the conduits connecting the portable storage device to the terminal are USB conduits.

Art Unit: 2443

6. As per claim 71 Margalit-Wilson disclosed the apparatus of claim 32, wherein the conduits connecting the portable storage device to the terminal are wireless conduits (Wilson, Paragraph.46).

7. As per claim 72 Margalit-Wilson disclosed the apparatus of claim 71, wherein the wireless conduits are Bluetooth (Wilson, Paragraph.46).

8. As per claim 73 Margalit-Wilson disclosed the apparatus of claim 71, wherein the wireless conduits are WiFi (Wilson, Paragraph.46).

***Claim Rejections - 35 USC § 102***

9. The following is a quotation of the appropriate paragraphs of 35 U.S.C. 102 that form the basis for the rejections under this section made in this Office action:

A person shall be entitled to a patent unless –

(e) the invention was described in (1) an application for patent, published under section 122(b), by another filed in the United States before the invention by the applicant for patent or (2) a patent granted on an application for patent by another filed in the United States before the invention by the applicant for patent, except that an international application filed under the treaty defined in section 351(a) shall have the effects for purposes of this subsection of an application filed in the United States only if the international application designated the United States and was published under Article 21(2) of such treaty in the English language.

10. Claims 2-8, 10-14, 19, 23-31, 33, 34, 38, 39, 42-54 & 56 are rejected under 35 U.S.C. 102(e) as being anticipated by Margalit et al (6,763,399 B2).

11. As per claims 2 & 33 Margalit et al disclosed a method of accessing data, comprising: disposing a portable storage device in communication with a terminal (col.2, lines 57-63), wherein the portable storage device has a processor (Figure.1, col.2, lines

Art Unit: 2443

17-20), wherein the portable storage device connects to the terminal across compatible conduits (col.2, lines 6-11) for external communications (col.2, lines 66-67 & col.2, lines 1-2), wherein the portable storage device has a memory (col.2, lines 17-18), wherein the memory and a storage conduit are disposed in communication with the processor (Figure.1, col.2, lines 37-46); providing the memory for access on the terminal ; wherein the memory contains a unique apparatus identifier (col.3, lines 5-13): executing processing instructions from the memory to access the terminal, wherein the processing instructions are executed on the terminal {I.E information derived from the USB communication implemented/executed on the terminal to provide authentication, encryption or access control to the terminal} (col.1, lines 52-59); communicating through the conduits connecting the portable storage device to the terminal (col.1, lines 40-51); Processing processing instructions (col.3, lines 5-13).

12. As per claim 3 Margalit disclosed the apparatus of claim 2, wherein the unique apparatus identifier is a digital signature (col.4, lines 31-35).

13. As per claim 4 Margalit disclosed the apparatus of claim 2, wherein the memory contains user verifying information (col.4, lines 31-35).

14. As per claim 5 Margalit disclosed the apparatus of claim 4, wherein the user verifying information is a digital signature (col.4, lines 31-35).



Art Unit: 2443

15. As per claim 6 Margalit disclosed the apparatus of claim 4, wherein the user verifying information is a username and password ().

16. As per claim 7 Margalit disclosed the apparatus of claim 6, wherein the processing instructions issue signals to encrypt the memory based on the unique apparatus identifier and user verifying information ().

17. As per claim 8 Margalit disclosed the apparatus of claim 2, wherein the processing instructions issue signals to execute processing instructions from the memory to access the terminal wherein the processing instructions are executed on the terminal {I.E information derived from the USB communication implemented/executed on the terminal to provide authentication, encryption or access control to the terminal} (col.1, lines 52-59).

18. As per claims 10 & 52 Margalit disclosed the apparatus of claim 2, wherein the processing instructions are stored on the memory (col.3, lines 5-13).

19. As per claim 11 Margalit disclosed the apparatus of claim 2, wherein the processing instructions are obtained from a server (Col.1, lines 52-59).

Art Unit: 2443

20. As per claims 12, 53 & 56 Margalit disclosed the apparatus of claim 2, wherein the processing instructions are processed on the processor (col.3, lines 5-13).

21. As per claims 14 & 54 Margalit disclosed the apparatus of claim 2, wherein the processing instructions are processed on the terminal (col.1, lines 40-59).

22. As per claims 19 & 34 Margalit disclosed the apparatus of claim 2, wherein the conduits are USB conduits (col.1, lines 66-67 & col.2, lines 1-2).

23. As per claim 23 Margalit disclosed the apparatus of claim 2, wherein the communication instructions issue signals to communicate with a server (col.2, lines 57-59).

24. As per claims 24 & 42 Margalit disclosed the apparatus of claim 23, wherein the communication instruction issued signals are encrypted (col.1, lines 40-51).

25. As per claims 25, 43 & 44 Margalit disclosed the method of claim 43, wherein the encryption occurs on the processor executing communication instructions from memory (col.3, lines 33-41).

Art Unit: 2443

26. As per claims 26 & 45 Margalit disclosed the apparatus of claim 24, wherein the encryption occurs on the terminal (col.1, lines 40-59).

27. As per claims 27 & 46 Margalit disclosed the apparatus of claim 24, wherein the encryption occurs on the server (col.1, lines 40-59).

28. As per claims 28 & 47 Margalit disclosed the apparatus of claim 23, wherein received encrypted instruction signals are decrypted (col.4, lines 31-35).

29. As per claims 29, 48 & 49 Margalit disclosed the method of claim 48, wherein in the decryption occurs on the processor by executing communication instructions from the memory (col.4, lines 31-35).

30. As per claims 30 & 50 Margalit disclosed the apparatus of claim 28, wherein the encryption occurs on the terminal (col.1, lines 40-64 & col.4, lines 31-35).

31. As per claims 31 & 51 Margalit disclosed the apparatus of claim 28, wherein the encryption occurs on the server (col.1, lines 40-64 & col.4, lines 31-35).

32. As per claim 38 Margalit disclosed the method of claim 33, wherein the memory is mounted at the terminal (Figure.1 & col.1, lines 66-67, col.2, lines 1-2).

Art Unit: 2443

33. As per claims 39 Margalit disclosed the method of claim 33, wherein the communication through the conduit is at the terminal (col.1, lines 66-67 & col.2, lines 1-2).

***Claim Rejections - 35 USC § 103***

34. The following is a quotation of 35 U.S.C. 103(a) which forms the basis for all obviousness rejections set forth in this Office action:

(a) A patent may not be obtained though the invention is not identically disclosed or described as set forth in section 102 of this title, if the differences between the subject matter sought to be patented and the prior art are such that the subject matter as a whole would have been obvious at the time the invention was made to a person having ordinary skill in the art to which said subject matter pertains. Patentability shall not be negated by the manner in which the invention was made.

35. Dependent claims 9, 15, 17, 18, 20-22, 35-37, 40, 41, 55, 57 & 58-60 rejected under 35 U.S.C. 103(a) as being unpatentable over Margalit et al (U.S. 2005/0197859 A1) and Manchester et al (U.S. Pub. No. 2005/0198221A1).

36. As per claims 9, 40 & 41 Margalit disclosed the apparatus of claim 8. However Margalit did not explicitly disclose wherein the terminal acts as a proxy to the portable tunneling storage and processing apparatus for the terminal's input and output peripheral devices, and acts as a network interface proxy to the portable tunneling storage and processing apparatus. In the same field of endeavor Manchester disclosed wherein the terminal acts as a proxy to the portable tunneling storage and processing apparatus for the terminal's input and output peripheral devices, and acts as a network

Art Unit: 2443

interface proxy to the portable tunneling storage and processing apparatus  
(Paragraph.s.27 & 28).

It would have been obvious to one in the ordinary skill in the art at the time the invention was made to have incorporated terminal acting as the network interface proxy to the portable tunneling storage and apparatus as shown by Manchester into the apparatus disclosed by Margalit in order to make the apparatus more versatile resulting apparatus that is robust and more compatible.

37. As per claims 13 & 57 Margalit-Manchester disclosed the apparatus of claim 12, wherein the processing instructions are processed on the processor to process files for printing (Manchester, Paragraph.33).

38. As per claims 15 & 55 Margalit-Manchester disclosed the apparatus of claim 2, wherein the processing instructions are processed on the server (Manchester, Paragraph.24 & 28).

39. As per claims 58 Margalit-Manchester disclosed the method of claim 33, further, comprising: affecting the display of processing activity (Manchester, Paragraph.41).

40. As per claims 17 & 59 Margalit-Manchester disclosed the apparatus of claim 2, wherein the display of processing activity occurs on the terminal display device (Manchester, Paragraph.41).

Art Unit: 2443

41. As per claims 18 & 60 Margalit-Manchester disclosed the apparatus of claim 2, wherein the display of processing activity occurs directly in the terminal's video memory (Manchester, Paragraphs.19 & 41).

42. As per claims 20 & 35 Margalit-Manchester disclosed the apparatus of claim 2, wherein the conduits are wireless conduits (Manchester. Paragraph.20 & 22).

43. As per claims 21 & 36 Margalit-Manchester disclosed the apparatus of claim 20, wherein the wireless conduits are Bluetooth (Manchester, Paragraph.26).

44. As per claims 22 & 37 Margalit-Manchester disclosed the apparatus of claim 20, wherein the wireless conduits are WiFi (Manchester, paragraph.26).

***Claim Rejections - 35 USC § 103***

45. The following is a quotation of 35 U.S.C. 103(a) which forms the basis for all obviousness rejections set forth in this Office action:

(a) A patent may not be obtained though the invention is not identically disclosed or described as set forth in section 102 of this title, if the differences between the subject matter sought to be patented and the prior art are such that the subject matter as a whole would have been obvious at the time the

Art Unit: 2443

invention was made to a person having ordinary skill in the art to which said subject matter pertains. Patentability shall not be negated by the manner in which the invention was made.

46. Claims 61-66 are rejected under 35 U.S.C. 103(a) as being unpatentable over Margalit et al (U.S. 2005/0197859 A1) and Wilson et al (U.S. PUB. NO. 2005/0197859 A1).

47. As per claims 61-66 Margalit disclosed a system to access data, comprising: means to engage a portable storage device with a terminal (figure.1, col.1, lines 40-51), wherein the portable storage device has a processor, wherein the portable storage device connects to the terminal across compatible conduits for external communications, wherein the portable storage device has a memory (col.1, lines 60-67 & col.2, lines 1-11), wherein the memory and a storage conduit are disposed in communication with the processor means to provide the memory with access to on the terminal, wherein the memory is mounted on the terminal (col.3, lines 5-18); means to execute processing instructions from the memory to access the terminal (col.3,lines 33-45), wherein the processing instructions are executed on the terminal {I.E information derived from the USB communication implemented/executed on the terminal to provide authentication, encryption or access control to the terminal} (col.1, lines 52-59); means to communicate through the conduit at the terminal (col.1, lines 60-67 & col.2, lines 1-5), wherein communication instruction issued signals are encrypted (col4, lines 31-35), wherein the encryption occurs on the processor, wherein received encrypted instruction signals are decrypted, wherein the decryption occurs on the processor (col.3, lines 57-63, col.4, lines 31-35); means to execute processing instructions on the processor

Art Unit: 2443

(col.3, lines 5-13), wherein the processing instructions are stored on the memory (col.3, lines 5-13), wherein the processing instructions are used to issue signals to process processing instruction on the processor (col.3, lines 5-13) {merely describing generic functionality of a processor}. However Margalit did not explicitly disclose wherein the terminal acts as a proxy to the portable storage device for the terminal's input and output peripheral devices, and acts as a network interface proxy to the portable storage device. In the same filed of endeavor Wilson disclosed wherein the terminal acts as a proxy to the portable storage device for the terminal's input and output peripheral devices (figure. 1, Elements 138 & 140, Paragraphs. 41 & 42), and acts as a network interface proxy to the portable storage device (Paragraphs. 41 & 47) and means to effect the display of processing activity on the terminal (Paragraph.37).

It would have been obvious to one in the ordinary skill in the art at the time the invention was made to have incorporated terminal acting as a proxy/network interface proxy as disclosed by Wilson into the system of accessing data comprising a portable storage device as disclosed by Margalit in order to make the portable apparatus more versatile resulting in a system that is more robust and compatible with multiple devices over a network.

### ***Claim Rejections - 35 USC § 102***

48. The following is a quotation of the appropriate paragraphs of 35 U.S.C. 102 that form the basis for the rejections under this section made in this Office action:

A person shall be entitled to a patent unless –



Art Unit: 2443

(e) the invention was described in (1) an application for patent, published under section 122(b), by another filed in the United States before the invention by the applicant for patent or (2) a patent granted on an application for patent by another filed in the United States before the invention by the applicant for patent, except that an international application filed under the treaty defined in section 351(a) shall have the effects for purposes of this subsection of an application filed in the United States only if the international application designated the United States and was published under Article 21(2) of such treaty in the English language.

49. Claims 67-69 are rejected under 35 U.S.C. 102(e) as being anticipated by Ryan et al (U.S. 7,213766 B2) {Related Provisional Application 60/520698 filed Nov-28-2003}.

50. As per claims 67 & 68 Ryan disclosed a method of accessing data, comprising: receiving requests from a terminal (col.12, lines 58-65), wherein portable storage device is responsible for generating the received requests (col.4, lines 9-32 & col.13, lines 61-63), disposing a portable storage device in communication with a terminal wherein the portable storage device has a processor (col.2, lines 11-25), wherein the portable storage device connects to the terminal across compatible conduits for external communications (col.12, lines 58-65), wherein the portable storage device has a memory (col.2, lines 18-25); employing the terminal for input/output (I/O) control for the portable storage device (col.3, lines 18-23 & col.23, lines 43-45); executing instructions on the portable storage device (col.3, lines 27-35); and displaying results of execution on the terminal (col.3, lines 31-35).

51. As per claim 69 Ryan disclosed the method of claim 68, further, comprising: storing the results of execution on the terminal in the portable storage device's memory (col.11, lines 65-67 & col.12, lines 1-4).

***Response to Arguments***

52. Applicant's arguments on 4/27/2009 with respect to amended independent claims 1, 2, 32, 33-66, 70-73 and their corresponding dependent claims have been considered but are moot in view of the new ground(s) of rejection.

53. Applicant with respect to claim 68 argued that Ryan fails to disclose "the display of processing activity on the terminal".

As to applicant's argument claim 68 does not contain the above limitation. Therefore this argument is irrelevant.

54. Applicant with respect to claim 67 argued that Ryan failed to disclose the limitation "receiving requests from a terminal..."

As to applicant's argument the complete states "receiving requests from a terminal, wherein the portable storage device is responsible for generating the received requests". This limitation is basically defining the communication that occurs between the portable storage device (USB) and a terminal when the USB is inserted/ connected to the terminal. Ryan discloses this process on col.3, lines 18-35 & col.4, lines 9-32 for example initiation of an "auto run program when it is connected to a terminal.

***Conclusion***

55. The Prior art made of record and not relied upon is considered pertinent to applicant's disclosure.

Art Unit: 2443

56. Gearhart (U.S. Pub. No. 2005/0132183 A1) disclosed method and system for user created personal private network (PPN) with secure communications and data transfers.

57. Steward et al (U.S. 6,970,927 B1) disclosed distributed network communication system which provides different network access features.

58. Hendrick (WO 00/49505) disclosed System for automatic connection to a network.

59. Cronic et al (U.S. 7,032,240 B1) disclosed portable authorization device for authorizing use of protected information and associated method.

60. Boate et al (U.S. 7,310,734 B2) disclosed method and system for securing a computer network and personal identification device used therein for controlling access to network components.

### ***Conclusion***

61. **THIS ACTION IS MADE FINAL.** Applicant is reminded of the extension of time policy as set forth in 37 CFR 1.136(a).

A shortened statutory period for reply to this final action is set to expire THREE MONTHS from the mailing date of this action. In the event a first reply is filed within TWO MONTHS of the mailing date of this final action and the advisory action is not

Art Unit: 2443

mailed until after the end of the THREE-MONTH shortened statutory period, then the shortened statutory period will expire on the date the advisory action is mailed, and any extension fee pursuant to 37 CFR 1.136(a) will be calculated from the mailing date of the advisory action. In no event, however, will the statutory period for reply expire later than SIX MONTHS from the mailing date of this final action.

Any inquiry concerning this communication or earlier communications from the examiner should be directed to ASGHAR BILGRAMI whose telephone number is (571)272-3907. The examiner can normally be reached on 9-5.

If attempts to reach the examiner by telephone are unsuccessful, the examiner's supervisor, Tonia L.M. Dollinger can be reached on 571-272-4170. The fax phone number for the organization where this application or proceeding is assigned is 571-273-8300.

Information regarding the status of an application may be obtained from the Patent Application Information Retrieval (PAIR) system. Status information for published applications may be obtained from either Private PAIR or Public PAIR. Status information for unpublished applications is available through Private PAIR only. For more information about the PAIR system, see <http://pair-direct.uspto.gov>. Should you have questions on access to the Private PAIR system, contact the Electronic Business Center (EBC) at 866-217-9197 (toll-free). If you would like assistance from a USPTO Customer Service Representative or access to the automated information system, call 800-786-9199 (IN USA OR CANADA) or 571-272-1000.

Application/Control Number: 10/807,731  
Art Unit: 2443

Page 21

/A. B./  
Examiner, Art Unit 2443

/J Bret Dennison/

Primary Examiner, Art Unit 2443

<b>Notice of References Cited</b>	Application/Control No. 10/807,731	Applicant(s)/Patent Under Reexamination MCNULTY, SCOTT	
	Examiner ASGHAR BILGRAMI	Art Unit 2443	Page 1 of 1

**U.S. PATENT DOCUMENTS**

*		Document Number Country Code-Number-Kind Code	Date MM-YYYY	Name	Classification
*	A	US-6,763,399 B2	07-2004	Margalit et al.	710/13
*	B	US-2005/0197859 A1	09-2005	Wilson et al.	705/002
*	C	US-2005/0198221 A1	09-2005	Manchester et al.	709/220
*	D	US-7,213,766 B2	05-2007	Ryan et al.	235/492
*	E	US-7,032,240 B1	04-2006	Cronce et al.	726/2
*	F	US-2006/0071066 A1	04-2006	Vanzini et al.	235/380
*	G	US-7,310,734 B2	12-2007	Boate et al.	713/186
	H	US-			
	I	US-			
	J	US-			
	K	US-			
	L	US-			
	M	US-			

**FOREIGN PATENT DOCUMENTS**

*		Document Number Country Code-Number-Kind Code	Date MM-YYYY	Country	Name	Classification
1	N	WO 00/49505	02-2000	AU	Hendrick	G06F 13/00
	O					
	P					
	Q					
	R					
	S					
	T					

**NON-PATENT DOCUMENTS**

*		Include as applicable: Author, Title Date, Publisher, Edition or Volume, Pertinent Pages)
	U	
	V	
	W	
	X	

\*A copy of this reference is not being furnished with this Office action. (See MPEP § 707.05(a).)  
Dates in MM-YYYY format are publication dates. Classifications may be US or foreign.

<b>Search Notes</b>  	<b>Application/Control No.</b>  10807731	<b>Applicant(s)/Patent Under Reexamination</b>  MCNULTY, SCOTT
	<b>Examiner</b>  ASGHAR BILGRAMI	<b>Art Unit</b>  2443

SEARCHED			
Class	Subclass	Date	Examiner
709	250	11/16/2008	AB
713	150	11/16/2008	AB
709	220, 250	10/8/2009	AB
713	150	10/8/2009	AB

SEARCH NOTES			
Search Notes	Date	Examiner	
EAST	11/16/2008	AB	
101 Compliance search	11/16/2008	AB	
U.S. PAT, PG-PUB	10/8/2009	AB	
Inventor Name search	10/8/2009	AB	
101 Compliance search	10/8/2009	AB	

INTERFERENCE SEARCH			
Class	Subclass	Date	Examiner

/A. B./ Examiner.Art Unit 2443	
-----------------------------------	--

<b>Index of Claims</b> 	<b>Application/Control No.</b> 10807731	<b>Applicant(s)/Patent Under Reexamination</b> MCNULTY, SCOTT
	<b>Examiner</b> ASGHAR BILGRAMI	<b>Art Unit</b> 2443

✓	<b>Rejected</b>
=	<b>Allowed</b>

-	<b>Cancelled</b>
÷	<b>Restricted</b>

N	<b>Non-Elected</b>
I	<b>Interference</b>

A	<b>Appeal</b>
O	<b>Objected</b>

Claims renumbered in the same order as presented by applicant
  CPA
  T.D.
  R.1.47

CLAIM		DATE							
Final	Original	11/16/2008	10/08/2009						
	1	✓	✓						
	2	✓	✓						
	3	✓	✓						
	4	✓	✓						
	5	✓	✓						
	6	✓	✓						
	7	✓	✓						
	8	✓	✓						
	9	✓	✓						
	10	✓	✓						
	11	✓	✓						
	12	✓	✓						
	13	✓	✓						
	14	✓	✓						
	15	✓	✓						
	16	✓	-						
	17	✓	✓						
	18	✓	✓						
	19	✓	✓						
	20	✓	✓						
	21	✓	✓						
	22	✓	✓						
	23	✓	✓						
	24	✓	✓						
	25	✓	✓						
	26	✓	✓						
	27	✓	✓						
	28	✓	✓						
	29	✓	✓						
	30	✓	✓						
	31	✓	✓						
	32	✓	✓						
	33	✓	✓						
	34	✓	✓						
	35	✓	✓						
	36	✓	✓						



<b>Index of Claims</b>  	<b>Application/Control No.</b>  10807731	<b>Applicant(s)/Patent Under Reexamination</b>  MCNULTY, SCOTT
	<b>Examiner</b>  ASGHAR BILGRAMI	<b>Art Unit</b>  2443

✓	<b>Rejected</b>
=	<b>Allowed</b>

-	<b>Cancelled</b>
÷	<b>Restricted</b>

N	<b>Non-Elected</b>
I	<b>Interference</b>

A	<b>Appeal</b>
O	<b>Objected</b>

Claims renumbered in the same order as presented by applicant
  CPA
  T.D.
  R.1.47

CLAIM		DATE							
Final	Original	11/16/2008	10/08/2009						
	37	✓	✓						
	38	✓	✓						
	39	✓	✓						
	40	✓	✓						
	41	✓	✓						
	42	✓	✓						
	43	✓	✓						
	44	✓	✓						
	45	✓	✓						
	46	✓	✓						
	47	✓	✓						
	48	✓	✓						
	49	✓	✓						
	50	✓	✓						
	51	✓	✓						
	52	✓	✓						
	53	✓	✓						
	54	✓	✓						
	55	✓	✓						
	56	✓	✓						
	57	✓	✓						
	58	✓	✓						
	59	✓	✓						
	60	✓	✓						
	61	✓	✓						
	62	✓	✓						
	63	✓	✓						
	64	✓	✓						
	65	✓	✓						
	66	✓	✓						
	67	✓	✓						
	68	✓	✓						
	69	✓	✓						
	70		✓						
	71		✓						
	72		✓						

<b>Index of Claims</b>  	<b>Application/Control No.</b>  10807731	<b>Applicant(s)/Patent Under Reexamination</b>  MCNULTY, SCOTT
	<b>Examiner</b>  ASGHAR BILGRAMI	<b>Art Unit</b>  2443

✓	<b>Rejected</b>
=	<b>Allowed</b>

-	<b>Cancelled</b>
÷	<b>Restricted</b>

N	<b>Non-Elected</b>
I	<b>Interference</b>

A	<b>Appeal</b>
O	<b>Objected</b>

Claims renumbered in the same order as presented by applicant
  CPA
  T.D.
  R.1.47

CLAIM		DATE							
Final	Original	11/16/2008	10/08/2009						
	73		✓						



UNITED STATES PATENT AND TRADEMARK OFFICE

UNITED STATES DEPARTMENT OF COMMERCE  
 United States Patent and Trademark Office  
 Address: COMMISSIONER FOR PATENTS  
 P.O. Box 1450  
 Alexandria, Virginia 22313-1450  
 www.uspto.gov

BIB DATA SHEET

CONFIRMATION NO. 4430

<b>SERIAL NUMBER</b> 10/807,731	<b>FILING or 371(c) DATE</b> 03/23/2004 <b>RULE</b>	<b>CLASS</b> 370	<b>GROUP ART UNIT</b> 2443	<b>ATTORNEY DOCKET NO.</b> 1004294.001US		
<b>APPLICANTS</b> Scott McNulty, Rowayton, CT;						
** CONTINUING DATA *****						
** FOREIGN APPLICATIONS *****						
** IF REQUIRED, FOREIGN FILING LICENSE GRANTED ** ** SMALL ENTITY ** 06/04/2004						
Foreign Priority claimed <input type="checkbox"/> Yes <input checked="" type="checkbox"/> No	35 USC 119(a-d) conditions met <input type="checkbox"/> Yes <input checked="" type="checkbox"/> No	<input type="checkbox"/> Met after Allowance AB Initials	<b>STATE OR COUNTRY</b> CT	<b>SHEETS DRAWINGS</b> 10	<b>TOTAL CLAIMS</b> 69	<b>INDEPENDENT CLAIMS</b> 12
Verified and /ASGHAR H BILGRAMI/ Acknowledged Examiner's Signature						
<b>ADDRESS</b> Locke Lord Bissell & Liddell LLP Attn: IP Docketing Three World Financial Center New York, NY 10281-2101 UNITED STATES						
<b>TITLE</b> Apparatus, method and system for a tunneling client access point						
<b>FILING FEE RECEIVED</b> 1382	FEES: Authority has been given in Paper No. _____ to charge/credit DEPOSIT ACCOUNT No. _____ for following:		<input type="checkbox"/> All Fees <input type="checkbox"/> 1.16 Fees (Filing) <input type="checkbox"/> 1.17 Fees (Processing Ext. of time) <input type="checkbox"/> 1.18 Fees (Issue) <input type="checkbox"/> Other _____ <input type="checkbox"/> Credit			

## EAST Search History

## EAST Search History (Prior Art)

Ref #	Hits	Search Query	DBs	Default Operator	Plurals	Time Stamp
L2	3	709/220.ccls. and (portable) with (security or secure) with (key) with (terminal or system or device) with (access)	US-PGPUB; USPAT; USOCR; EPO; DERWENT; IBM_TDB	OR	ON	2009/10/08 22:37
L3	45399	(client or user) same (access) with (point)	US-PGPUB; USPAT; USOCR; EPO; DERWENT; IBM_TDB	OR	ON	2009/10/08 22:37
L4	511	(client or user) same (access) with (point) same (USB)	US-PGPUB; USPAT; USOCR; EPO; DERWENT; IBM_TDB	OR	ON	2009/10/08 22:37
L5	42	(client or user) same (access) with (point) same (USB) same (secure or encrypt\$3) and (portable or mobile or handheld or palm)	US-PGPUB; USPAT; USOCR; EPO; DERWENT; IBM_TDB	OR	ON	2009/10/08 22:37
L6	7	(client or user) same (access) with (point) same (USB or thumb) near3 (drive) same (secure or encrypt\$3)	US-PGPUB; USPAT; USOCR; EPO; DERWENT; IBM_TDB	OR	ON	2009/10/08 22:37
L7	77	(client or user) same (access) adj (point) and (USB or thumb) near3 (drive) same (secure or encrypt\$3)	US-PGPUB; USPAT; USOCR; EPO; DERWENT; IBM_TDB	OR	ON	2009/10/08 22:37
L8	2	(client or user) same (access) adj (point) and (USB or thumb) near3 (drive) same (secure or encrypt\$3) and @ay< "2004,03,24"	US-PGPUB; USPAT; USOCR; EPO; DERWENT; IBM_TDB	OR	ON	2009/10/08 22:37
L9	10955	(remote) same (access) same (point) same ( device or module)	US-PGPUB; USPAT; USOCR; EPO; DERWENT; IBM_TDB	OR	ON	2009/10/08 22:37

L10	5209	(remote) same (access) near4 (point) same ( device or module)	US-PGPUB; USPAT; USOCR; EPO; DERWENT; IBM_TDB	OR	ON	2009/10/08 22:37
L11	10	(remote) same (access) near4 (point) same ( device or module) same (USB) same (secure or encrypt\$4)	US-PGPUB; USPAT; USOCR; EPO; DERWENT; IBM_TDB	OR	ON	2009/10/08 22:37
L12	342	(remote) same (access) near4 (point) same ( device or module) same (secure or encrypt\$4)	US-PGPUB; USPAT; USOCR; EPO; DERWENT; IBM_TDB	OR	ON	2009/10/08 22:37
L13	6	(remote) same (access) near4 (point) same (portable) with (device or module) same (secure or encrypt\$4)	US-PGPUB; USPAT; USOCR; EPO; DERWENT; IBM_TDB	OR	ON	2009/10/08 22:37
L14	1	(remote) same (access) near4 (point) same (portable) with (device or module) same (secure or encrypt\$4) and (USB)	US-PGPUB; USPAT; USOCR; EPO; DERWENT; IBM_TDB	OR	ON	2009/10/08 22:37
L15	840	(client or user) same (access) near4 (point) and (portable) with (device or module) same (secure or encrypt\$4)	US-PGPUB; USPAT; USOCR; EPO; DERWENT; IBM_TDB	OR	ON	2009/10/08 22:37
L16	91	(client or user) same (access) near4 (point) same (portable) with (device or module) same (secure or encrypt\$4)	US-PGPUB; USPAT; USOCR; EPO; DERWENT; IBM_TDB	OR	ON	2009/10/08 22:37
L17	43	(client or user) same (access) near4 (point) same (portable) with (device or module) same (secure or encrypt\$4) and (USB)	US-PGPUB; USPAT; USOCR; EPO; DERWENT; IBM_TDB	OR	ON	2009/10/08 22:37
L18	4	709/250.ccls. and (client or user) same (access) near4 (point) and (portable) with (device or module) same (secure or encrypt\$4)	US-PGPUB; USPAT; USOCR; EPO; DERWENT; IBM_TDB	OR	ON	2009/10/08 22:37
L19	12	709/250.ccls. and (access) near4 (point) same (portable) same (device or module or USB) and (secure or encrypt\$4)	US-PGPUB; USPAT; USOCR; EPO; DERWENT; IBM_TDB	OR	ON	2009/10/08 22:37

L20	12	709/250.ccls. and (access) near4 (point) same (portable or pluggable) same (device or module or USB) and (secure or encrypt \$4)	US-PGPUB; USPAT; USOCR; EPO; DERWENT; IBM_TDB	OR	ON	2009/10/08 22:37
L21	50	709/250.ccls. and (access) same (portable) same (device or module or USB) and (secure or encrypt\$4)	US-PGPUB; USPAT; USOCR; EPO; DERWENT; IBM_TDB	OR	ON	2009/10/08 22:37
L22	7	709/250.ccls. and (access) same (portable) same (device or module or USB) same (secure or encrypt\$4)	US-PGPUB; USPAT; USOCR; EPO; DERWENT; IBM_TDB	OR	ON	2009/10/08 22:37
L23	14	713/150.ccls. and (portable) same (device or module or USB) same (access\$4) same (network or WAN or LAN) same (secure or encrypt\$4)	US-PGPUB; USPAT; USOCR; EPO; DERWENT; IBM_TDB	OR	ON	2009/10/08 22:37
L24	90744	(potable) wtih (security) with (key)	US-PGPUB; USPAT; USOCR; EPO; DERWENT; IBM_TDB	OR	ON	2009/10/08 22:37
L25	844045	(portable) wtih (security) with (key)	US-PGPUB; USPAT; USOCR; EPO; DERWENT; IBM_TDB	OR	ON	2009/10/08 22:37
L26	996	(portable) with (security) with (key)	US-PGPUB; USPAT; USOCR; EPO; DERWENT; IBM_TDB	OR	ON	2009/10/08 22:37
L27	1481	(portable) with (security or secure) with (key)	US-PGPUB; USPAT; USOCR; EPO; DERWENT; IBM_TDB	OR	ON	2009/10/08 22:37
L28	283	(portable) near4 (security or secure) near4 (key)	US-PGPUB; USPAT; USOCR; EPO; DERWENT; IBM_TDB	OR	ON	2009/10/08 22:37
L29	1208	(portable) with (security or secure) with (key) same (termial or system or device)	US-PGPUB; USPAT; USOCR; EPO; DERWENT; IBM_TDB	OR	ON	2009/10/08 22:37

L30	220	(portable) with (security or secure) with (key) with (terminal or system or device) with (access)	US-PGPUB; USPAT; USOCR; EPO; DERWENT; IBM_TDB	OR	ON	2009/10/08 22:37
L31	8	(portable) with (security or secure) with (key) with (terminal or system or device) with (access) and (thumb)	US-PGPUB; USPAT; USOCR; EPO; DERWENT; IBM_TDB	OR	ON	2009/10/08 22:37
L32	0	("2007/0170239").URPN.	USPAT	OR	ON	2009/10/08 22:37
L33	220	(portable) with (security or secure) with (key) with (terminal or system or device) with (access)	US-PGPUB; USPAT; USOCR; EPO; DERWENT; IBM_TDB	OR	ON	2009/10/08 22:37
L34	101	(portable) with (security or secure) with (key) with (terminal or system or device) with (access) and (USB)	US-PGPUB; USPAT; USOCR; EPO; DERWENT; IBM_TDB	OR	ON	2009/10/08 22:37
L35	1	("7412514").PN.	USPAT; USOCR	OR	OFF	2009/10/08 22:37
L36	2777	Hendrick.in.	US-PGPUB; USPAT; USOCR; EPO; DERWENT; IBM_TDB	OR	ON	2009/10/08 22:37
L37	10	Hendrick.in. and (portable) with (medium)	US-PGPUB; USPAT; USOCR; EPO; DERWENT; IBM_TDB	OR	ON	2009/10/08 22:37
S3	37977	(client or user) same (access) with (point)	US-PGPUB; USPAT; USOCR; EPO; DERWENT; IBM_TDB	OR	ON	2008/11/10 16:39
S4	407	(client or user) same (access) with (point) same (USB)	US-PGPUB; USPAT; USOCR; EPO; DERWENT; IBM_TDB	OR	ON	2008/11/10 16:39
S5	33	(client or user) same (access) with (point) same (USB) same (secure or encrypt\$3) and (portable or mobile or handheld or palm)	US-PGPUB; USPAT; USOCR; EPO; DERWENT; IBM_TDB	OR	ON	2008/11/10 16:43

S6	5	(client or user) same (access) with (point) same (USB or thumb) near3 (drive) same (secure or encrypt\$3)	US-PGPUB; USPAT; USOCR; EPO; DERWENT; IBM_TDB	OR	ON	2008/11/13 10:52
S7	61	(client or user) same (access) adj (point) and (USB or thumb) near3 (drive) same (secure or encrypt\$3)	US-PGPUB; USPAT; USOCR; EPO; DERWENT; IBM_TDB	OR	ON	2008/11/13 10:55
S8	2	(client or user) same (access) adj (point) and (USB or thumb) near3 (drive) same (secure or encrypt\$3) and @ay<"2004,03,24"	US-PGPUB; USPAT; USOCR; EPO; DERWENT; IBM_TDB	OR	ON	2008/11/13 10:56
S14	9318	(remote) same (access) same (point) same ( device or module)	US-PGPUB; USPAT; USOCR; EPO; DERWENT; IBM_TDB	OR	ON	2008/11/13 20:59
S15	4079	(remote) same (access) near4 (point) same ( device or module)	US-PGPUB; USPAT; USOCR; EPO; DERWENT; IBM_TDB	OR	ON	2008/11/13 20:59
S16	8	(remote) same (access) near4 (point) same ( device or module) same (USB) same (secure or encrypt\$4)	US-PGPUB; USPAT; USOCR; EPO; DERWENT; IBM_TDB	OR	ON	2008/11/13 21:01
S17	283	(remote) same (access) near4 (point) same ( device or module) same (secure or encrypt\$4)	US-PGPUB; USPAT; USOCR; EPO; DERWENT; IBM_TDB	OR	ON	2008/11/13 21:03
S18	4	(remote) same (access) near4 (point) same (portable) with (device or module) same (secure or encrypt\$4)	US-PGPUB; USPAT; USOCR; EPO; DERWENT; IBM_TDB	OR	ON	2008/11/13 21:03
S19	1	(remote) same (access) near4 (point) same (portable) with (device or module) same (secure or encrypt\$4) and (USB)	US-PGPUB; USPAT; USOCR; EPO; DERWENT; IBM_TDB	OR	ON	2008/11/13 21:06
S20	688	(client or user) same (access) near4 (point) and (portable) with (device or module) same (secure or encrypt\$4)	US-PGPUB; USPAT; USOCR; EPO; DERWENT; IBM_TDB	OR	ON	2008/11/13 21:08



S21	70	(client or user) same (access) near4 (point) same (portable) with (device or module) same (secure or encrypt\$4)	US-PGPUB; USPAT; USOCR; EPO; DERWENT; IBM_TDB	OR	ON	2008/11/13 21:08
S22	36	(client or user) same (access) near4 (point) same (portable) with (device or module) same (secure or encrypt\$4) and (USB)	US-PGPUB; USPAT; USOCR; EPO; DERWENT; IBM_TDB	OR	ON	2008/11/13 21:09
S23	3	709/250.ccls. and (client or user) same (access) near4 (point) and (portable) with (device or module) same (secure or encrypt\$4)	US-PGPUB; USPAT; USOCR; EPO; DERWENT; IBM_TDB	OR	ON	2008/11/16 16:49
S24	9	709/250.ccls. and (access) near4 (point) same (portable) same (device or module or USB) and (secure or encrypt\$4)	US-PGPUB; USPAT; USOCR; EPO; DERWENT; IBM_TDB	OR	ON	2008/11/16 16:53
S25	9	709/250.ccls. and (access) near4 (point) same (portable or pluggable) same (device or module or USB) and (secure or encrypt\$4)	US-PGPUB; USPAT; USOCR; EPO; DERWENT; IBM_TDB	OR	ON	2008/11/16 16:55
S26	43	709/250.ccls. and (access) same (portable) same (device or module or USB) and (secure or encrypt\$4)	US-PGPUB; USPAT; USOCR; EPO; DERWENT; IBM_TDB	OR	ON	2008/11/16 16:55
S27	6	709/250.ccls. and (access) same (portable) same (device or module or USB) same (secure or encrypt\$4)	US-PGPUB; USPAT; USOCR; EPO; DERWENT; IBM_TDB	OR	ON	2008/11/16 16:55
S28	8	713/150.ccls. and (portable) same (device or module or USB) same (access\$4) same (network or WAN or LAN) same (secure or encrypt\$4)	US-PGPUB; USPAT; USOCR; EPO; DERWENT; IBM_TDB	OR	ON	2008/11/16 17:16
S29	90670	(potable) wtih (security) with (key)	US-PGPUB; USPAT; USOCR; EPO; DERWENT; IBM_TDB	OR	ON	2009/10/06 12:20
S30	843417	(portable) wtih (security) with (key)	US-PGPUB; USPAT; USOCR; EPO; DERWENT; IBM_TDB	OR	ON	2009/10/06 12:20

S31	996	(portable) with (security) with (key)	US-PGPUB; USPAT; USOCR; EPO; DERWENT; IBM_TDB	OR	ON	2009/10/06 12:20
S32	1481	(portable) with (security or secure) with (key)	US-PGPUB; USPAT; USOCR; EPO; DERWENT; IBM_TDB	OR	ON	2009/10/06 12:21
S33	283	(portable) near4 (security or secure) near4 (key)	US-PGPUB; USPAT; USOCR; EPO; DERWENT; IBM_TDB	OR	ON	2009/10/06 12:21
S35	1208	(portable) with (security or secure) with (key) same (terminal or system or device)	US-PGPUB; USPAT; USOCR; EPO; DERWENT; IBM_TDB	OR	ON	2009/10/06 12:22
S36	220	(portable) with (security or secure) with (key) with (terminal or system or device) with (access)	US-PGPUB; USPAT; USOCR; EPO; DERWENT; IBM_TDB	OR	ON	2009/10/06 12:22
S37	8	(portable) with (security or secure) with (key) with (terminal or system or device) with (access) and (thumb)	US-PGPUB; USPAT; USOCR; EPO; DERWENT; IBM_TDB	OR	ON	2009/10/06 12:35
S38	0	("2007/0170239").URPN.	USPAT	OR	ON	2009/10/06 12:41
S39	220	(portable) with (security or secure) with (key) with (terminal or system or device) with (access)	US-PGPUB; USPAT; USOCR; EPO; DERWENT; IBM_TDB	OR	ON	2009/10/06 12:42
S40	101	(portable) with (security or secure) with (key) with (terminal or system or device) with (access) and (USB)	US-PGPUB; USPAT; USOCR; EPO; DERWENT; IBM_TDB	OR	ON	2009/10/06 12:43
S41	1	("7412514").PN.	USPAT; USOCR	OR	OFF	2009/10/06 13:56
S42	2777	Hendrick.in.	US-PGPUB; USPAT; USOCR; EPO; DERWENT; IBM_TDB	OR	ON	2009/10/08 19:03

S43	10	Hendrick.in. and (portable) with (medium)	US-PGPUB; USPAT; USOCR; EPO; DERWENT; IBM_TDB	OR	ON	2009/10/08 19:04
-----	----	--	---	----	----	---------------------

**10/ 8/ 2009 10:50:57 PM**

**C:\ Documents and Settings\ abilgrami\ My Documents\ EAST\ Workspaces\ 10807731.wsp**

<b>REQUEST FOR CONTINUED EXAMINATION (RCE) TRANSMITTAL</b>  Subsection (b) of 35 U.S.C. §132, effective on May 29, 2000, provides for continued examination of an utility or plant application filed on or after June 8, 1995. See The American Inventors Protection Act of 1999 (AIPA)	Application No.	10/807,731
	Filing Date	March 23, 2004
	First Named Inventor	Scott McNulty
	Group Art Unit	2443
	Examiner Name	Asghar H. Bilgrami
	Atty Docket No.	1004294.001US
	Confirmation No.	4430

This is a Request for Continued Examination (RCE) under 37 C.F.R. §1.114 of the above-identified application.

**NOTE:** 37 C.F.R. §1.114 is effective on May 29, 2000. If the above-identified application was filed prior to May 29, 2000, applicant may wish to consider filing a continued prosecution application (CPA) under 37 C.F.R. §1.53(d) (PTO/SB/29) instead of a RCE to be eligible for the patent term adjustment provisions of the AIPA. See Changes to Application Examination and Provisional Application Practice, Interim Rule, 65 Fed. Reg. 14865 (Mar. 20, 2000), 1233 Off. Gaz. Pat. Office 47 (Apr. 11, 2000), which established RCE practice.

1. **Submission under 37 C.F.R. §1.114**

- a.  Previously submitted
- i.  Consider the amendment(s)/reply under 37 C.F.R. §1.116 previously filed on \_\_\_\_\_.  
(Any unentered amendment(s) referred to above will be entered).
- ii.  Consider the arguments in the Appeal Brief or Reply Brief previously filed on \_\_\_\_\_.  
iii.  Other:
- b.  Enclosed
- i.  Amendment/Reply  
ii.  Affidavit(s)/Declaration(s)  
iii.  Information Disclosure Statement (IDS)  
iv. Other:

2. **Miscellaneous**

- a.  Suspension of action on the above-identified application is requested under 37 C.F.R. §1.103(c) for a period of \_\_\_\_ months. (Period of suspension shall not exceed 3 months; Fee under 37 C.F.R. §1.17(i) required)
- b. Other:

3. **Fees** The RCE fee under C.F.R. §1.17(e) is required by 37 C.F.R. §1.114 when the RCE is filed

- a.  The Director is hereby authorized to charge the following fees, or credit any overpayments, to Deposit Account No. **504827**, Order No. 1004294.001US.
- i.  RCE fee required under 37 C.F.R. §1.17(e)  
ii.  Extension of time fee (37 C.F.R. §§1.136 and 1.17)  
iii.  Other
- b.  Check in the amount of \$ \_\_\_\_\_ enclosed.
- c.  The Director is hereby authorized to charge any additional fees, or credit any overpayments, to Deposit Account No. **504827**, Order No. 1004294.001US

**SIGNATURE OF APPLICANT, ATTORNEY, OR AGENT REQUIRED**

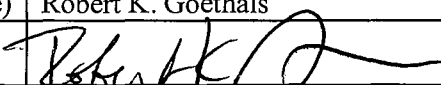
Name (Print/Type)	Robert K. Goethals	Reg. No. (Atty/Agent)	36,813
Signature		Date	April 16, 2010

**IN THE UNITED STATES PATENT AND TRADEMARK OFFICE**

Serial No.: 10/807,731 Confirmation No.: 4430  
Applicant(s): Scott McNulty Group Art Unit: 2443  
Examiner: Asghar H. BILGRAMI  
Filed: March 23, 2004  
Customer No.: 85775  
For: APPARATUS, METHOD AND SYSTEM FOR A TUNNELING CLIENT ACCESS POINT

**INFORMATION DISCLOSURE STATEMENT**

Mail Stop Amendment  
Commissioner for Patents  
P.O. Box 1450  
Alexandria, VA 22313-1450

Sir:

This Information Disclosure Statement is filed in accordance with 37 C.F.R. §§1.56, 1.97 and 1.98. The items listed on Form PTO-1449, a copy of which is enclosed, are made of record to assist the Patent and Trademark Office in its examination of this application. The Examiner is respectfully requested to fully consider the items and to independently ascertain their teaching.

1.  For each of the following items listed on the enclosed copy of Form PTO-1449 that is not in the English language, an English language translation of that item or a portion thereof or a concise explanation of the relevance of that item is enclosed:
  
2.  For each of the following items listed on the enclosed copy of Form PTO-1449 that is not in the English language, a concise explanation of the relevance of that item is incorporated in the specification of the above-identified application.
  
3.  Any copy of the items listed on the enclosed copy of Form PTO-1449 that is not enclosed with this Information Disclosure Statement was previously cited by or submitted to the Patent and Trademark Office in application Serial No. \_\_\_\_\_, filed \_\_\_\_\_.
  
4.  No fee is due under 37 C.F.R. §1.17(p) for this Information Disclosure Statement since it is being filed in compliance with:

- 37 C.F.R. §1.97(b)(1), within three months of the filing date of a national application other than a CPA; or
- 37 C.F.R. §1.97(b)(2), within three months of the date of entry into the national stage as set forth in §1.491 in an international application; or
- 37 C.F.R. §1.97(b)(3), before the mailing date of a first Office action on the merits; or
- 37 C.F.R. §1.97(b)(4) before the mailing date of a first office action after the filing of an RCE under §1.114.
5.  No fee is due under 37 C.F.R. §1.17(p) for this Information Disclosure Statement since it is being filed in compliance with 37 C.F.R. §1.97(c), after the period specified in paragraph 4 above but before the mailing date of a final action or a Notice of Allowance (where there has been no prior final action), and is accompanied by one of the certifications pursuant to 37 C.F.R. §1.97(e) set forth in paragraph 9 below.
6.  A fee is due under 37 C.F.R. §1.17(p) for this Information Disclosure Statement since it is being filed in compliance with 37 C.F.R. §1.97(c), after the period specified in paragraph 4 above but before the mailing date of a final action or a notice of allowance (where there has been no prior final action):
- A check in the amount of \$180.00 is enclosed in payment of the fee.
- Charge the fee to Deposit Account No. 504827, Order No. 1004294.001US.
7.  A fee is due under 37 C.F.R. §1.17(p) for this Information Disclosure Statement since it is being filed in compliance with 37 C.F.R. §1.97(d), after the mailing date of a final action or a notice of allowance, whichever comes first, but before payment of the issue fee, and is accompanied by:
- a. one of the certifications pursuant to 37 C.F.R. §1.97(e) set forth in paragraph 9 below; and
- b. the fee due under 37 C.F.R. §1.17(p) which is paid as set forth in paragraph 11 below.
8.  This Information Disclosure Statement is being filed in compliance with:
- a.  37 C.F.R. §1.313(b)(3) or §1.313(c)(1), after the issue fee has been paid and information cited in this Information Disclosure Statement may render at least one claim unpatentable and is accompanied by the attached Petition To Withdraw Application From Issue and fee pursuant to 37 C.F.R. §1.17(h);
- b.  37 C.F.R. §1.313(c)(2) or §1.313(c)(3), after the issue fee has been paid and information cited in this Information Disclosure Statement is to be considered in a Request for Continued Examination (RCE) or a Continuation application upon abandonment of the instant application and is accompanied by the attached Petition To Withdraw Application From Issue and fee pursuant to 37 C.F.R. §1.17(h).

- c.  The fee due under 37 C.F.R. §§1.17(h) is paid as set forth in paragraph 11 below.
9.  I hereby certify that each item of information contained in this Information Disclosure Statement was first cited in a communication from a foreign patent office in a counterpart foreign application not more than three months prior to the filing of this Information Disclosure Statement.
- I hereby certify that no item of information in the Information Disclosure Statement filed herewith was cited in a communication from a foreign patent office in a counterpart foreign application or, to my knowledge after making reasonable inquiry, was known to any individual designated in §1.56(c) more than three months prior to the filing of this Information Disclosure Statement.
10.  This document is accompanied by  a Search Report  Communication which was cited in a corresponding  PCT or  Foreign counterpart application
11.  A check in the amount of \$ \_\_\_\_\_ is enclosed in payment of the fees due under 37 C.F.R. §§1.17(h) and 1.17(p).
- Charge the fees due under 37 C.F.R. §§1.17(h) and 1.17(p) to Deposit Account No. 504827, Order No. 1004294.001US.
- The Commissioner is hereby authorized to charge any additional fees which may be required for this Information Disclosure Statement, or credit any overpayment to Deposit Account No. 504827, Order No. 1004294.001US.

Respectfully submitted,  
LOCKE LORD BISSELL & LIDDELL LLP

Dated: April 16, 2010

By:

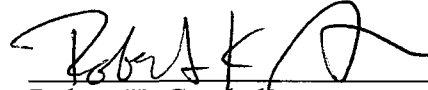

Robert K. Goethals

Registration No. 36,813

Correspondence Address:

Address Associated With Customer Number:

85775

(212) 415-8600 Telephone

(212) 303-2754 Facsimile

<b>FORM PTO-1449A</b>  <b>INFORMATION DISCLOSURE CITATION</b>	Attorney Docket: 1004294.001US	Serial No.: 10/807,731
	Applicant: Scott McNulty	
	Filing Date: March 23, 2004	Group Art Unit: 2443

**U.S. PATENT / PUBLICATION DOCUMENTS**

Examiner Initial	Patent/Publication Number	Publication/Issue Date	Name	Filing Date
	1. 2004/0127254 A1	July 1, 2004	William Ho CHANG	
	2. 7,454,783 B2	Nov. 18, 2008	DUPOUY et al.	
	3.			
	4.			
	5.			
	6.			
	7.			
	8.			
	9.			
	10.			
	11.			
	12.			
	13.			
	14.			

**FOREIGN PATENT DOCUMENTS**

Examiner Initial	Patent Number	Publication Date	Country	Copy Filed	Translation
	15.			<input type="checkbox"/> Yes	<input type="checkbox"/> Yes <input type="checkbox"/> No <input type="checkbox"/> Abstract <input type="checkbox"/> N/A
	16.			<input type="checkbox"/> Yes	<input type="checkbox"/> Yes <input type="checkbox"/> No <input type="checkbox"/> Abstract <input type="checkbox"/> N/A
	17.			<input type="checkbox"/> Yes	<input type="checkbox"/> Yes <input type="checkbox"/> No <input type="checkbox"/> Abstract <input type="checkbox"/> N/A
	18.			<input type="checkbox"/> Yes	<input type="checkbox"/> Yes <input type="checkbox"/> No <input type="checkbox"/> Abstract <input type="checkbox"/> N/A
	19.			<input type="checkbox"/> Yes	<input type="checkbox"/> Yes <input type="checkbox"/> No <input type="checkbox"/> Abstract <input type="checkbox"/> N/A
	20.			<input type="checkbox"/> Yes	<input type="checkbox"/> Yes <input type="checkbox"/> No <input type="checkbox"/> Abstract <input type="checkbox"/> N/A

Examiner	Date Considered
EXAMINER: Initial if reference considered, whether or not citation is in conformance with MPEP §609. Draw line through citation if not in conformance and not considered. Include copy of this form with next communication to Applicant.	



**IN THE UNITED STATES PATENT AND TRADEMARK OFFICE**

Serial No. : 10/807,731 Confirmation No. : 4430  
Applicant(s) : Scott McNulty  
Filed : March 23, 2004  
Title : Apparatus, Method And System For A Tunneling Client Access Point  
Art Unit : 2443  
Examiner : Asghar H. Bilgrami  
Docket No. : 1004294.001US  
Customer No. : 85775

**DECLARATION UNDER 37 C.F.R. § 1.131**

Commissioner for Patents  
P.O. Box 1450  
Alexandria, VA 22313-1450

Sir:

I, Scott McNulty, do declare and state:

1. I am the sole inventor of the subject matter claimed in the above-identified application.
2. I make this Declaration to establish an actual reduction to practice of the invention claimed in this application in the United States at a date prior to December 12, 2002.
3. Prior to December 12, 2002, I developed a working prototype of a portable storage and processing device (“the MediKey prototype”), which embodied the claimed subject matter of the above-identified application. Attached as Exhibit 1 hereto is a photograph of the MediKey prototype. Attached as Exhibits 2-10 is a collection of print-outs of screen shots displayed on the

monitor of a computer terminal to which the MediKey prototype was connected. As explained in more detail below, the photograph attached as Exhibit 1 and the screen shots attached as Exhibits 2-10 evidence the construction, configuration and functionality of a working prototype embodying the claimed subject matter of the above-identified application.

4. As shown in Exhibit 1, the MediKey prototype completed prior to December 12, 2002 comprises “a portable device” having a universal serial bus (USB) “conduit for external communications configured to enable the transmission of a plurality of instructions between the portable device and a terminal” having a compatible USB port. These features of the MediKey prototype are shown in Exhibit 1.

5. Exhibit 2 is a screen shot of the MediKey Properties window for the MediKey prototype completed prior to December 12, 2002. The MediKey Properties window discloses that the MediKey prototype includes “a memory” designated as the E drive (“E:\medkey”) which has a “MediKey Application” stored thereon. The MediKey prototype also included a processor configured to communicate with the memory.

6. The MediKey Application comprises “a plurality of processing instructions” consisting of a collection of executable program modules, including an operating system module, an X-Ray Viewer module, a Web Search module and an Update Modules module, and a collection of other modules comprising “a first set of processing instructions, which when executed, presents an interactive user interface on the terminal display screen, enables the terminal input component to interface with the portable device through the interactive user interface, and provides the portable device with access to the terminal network interface.” The MediKey Application also included encryption capabilities for encrypting instructions issued by the portable device processor to remote devices.

7. The screen shot shown in Exhibit 2 also includes a “Created” field that lists the date on which the working MediKey prototype was completed and tested for operation. The redacted date in the “Created” field is prior to December 12, 2002.

8. Exhibit 3 is a screen shot of the MediKey graphic user interface displayed on the terminal monitor. As shown in Exhibit 3, the MediKey graphic user interface includes several labeled buttons arranged along the left-hand side, each of which is configured to provide access to (1) a data file stored on the portable device memory, (2) an executable program module stored on the portable device memory, (3) a data file stored on a remote storage device and/or (4) an executable program module stored on a remote storage device.

9. Each of the Medications, Medical Problems, Doctor/Insurance Info and Medical Expenses buttons on the MediKey user interface is configured to communicate with an underlying program running on the portable device processor to provide access to a designated data file stored on the portable device memory and display the contents of the file in the lower window on the right-hand side of the MediKey graphic user interface. Screen shots of the MediKey graphic user interface displaying the contents of each of the Medications, Medical Problems, Doctor/Insurance Info and Medical Expenses data files are shown in Exhibits 4-7, respectively.

10. In addition, the underlying program running on the portable device processor is configured to automatically display the contents of the Emergency Information data file in the upper window on the right-hand side of the MediKey graphic user interface. This feature of the MediKey prototype is shown in the screen shot attached as Exhibit 3.

11. The claimed subject matter of the above-identified application calling for “at least one processing instruction (stored on the portable apparatus memory), which when executed by the

portable apparatus processor, causes the portable device processor to execute a second set of processing instructions stored on the memory and effect the display of processing activity on the terminal output device” is evidenced by the operation of the X-Ray Viewer, Web Search and Update features of the MediKey prototype. Actuation of each of these designated buttons for these features presented on the MediKey graphic user interface causes an underlying program module running on the MediKey processor to execute a processing instruction, which, in turn, causes a program module stored on the MediKey memory to execute on the MediKey processor and effect the display of this processing activity on the terminal output device. A more detailed description of this operation of the MediKey prototype in connection with each of the X-Ray Viewer, Web Search and Update features is provided below:

- a. The X-Ray Viewer button is configured to cause an underlying program running on the portable device processor to execute at least one processing instruction which, in turn, causes the portable device processor to execute the X-Ray Viewer program module stored on the portable device memory and provide access to an X-ray data file stored on the portable device memory. When executed, the X-Ray Viewer program module presents an X-Ray Viewer browser window which allows the user to manipulate the view of an X-ray selected from the X-Ray data file stored on the portable device memory. A screen shot showing the X-Ray Viewer browser window displaying an X-Ray selected from the X-Ray data file is attached as Exhibit 8.
- b. The Web Search button is configured to cause an underlying program running on the portable device processor to execute at least one processing

instruction, which, in turn causes the portable device processor to execute a Web Search program module stored on the portable device memory and provide the user with access to data stored on a remote server. When executed by the portable device processor, the Web Search program module presents a Web Search browser window which allows the user to select a web address from the Web Search data file stored on the portable device memory and access data stored on a remote server associated with the selected web address. Exhibit 9 shows a screen shot of the Web Search browser window in which the user has selected the Dr. Koop Medical web address from the list of web addresses provided in the drop-down box and stored on the Web Search data file.

- c. The Update Module button is configured to cause an underlying program running on the portable device processor to execute a processing instruction, which, in turn, causes the portable device processor to execute an Update Module program module stored on the portable device memory and download updated versions of program modules from a remote server onto the portable device memory. When executed, the Update Module program module presents a Update window browser as shown in the screen shot attached as Exhibit 10.

12. The MediKey prototype also embodies the claimed subject matter of the above-identified application directed to a portable device “configured to communicate through the terminal network interface with a device/server/data storage system.” As described below, during operation of the Web Search module the portable device is configured to communicate

with a device/server/data storage system to access/input/modify data stored on device/server/data storage system. In addition, in connection with the operation of the Update module the portable device is configured to communicate with a device/server to download updated programs modules onto the portable device memory. As further explained with regard to the operation of the Update module, the portable device is configured to encrypt the communications issued to the device/server.

- a. In this example of the operation of the Web Search module shown in Exhibit 9, the user has also entered the word “cancer” in the key search term box presented on the Web Search browser window. When the “OK” button is clicked, the Web Search program module accesses the remote server associated with the Dr. Koop Medical web address through the terminal network interface and retrieves data stored on the remote server relating to the “cancer” key search term. In addition, the Web Search program module also enables the user access a secure account maintained on the remote server associated with the Dr. Koop Medical web site and input, access or modify personal health information stored in the secure account.
- b. With reference to the Update module screen shot shown in Exhibit 10. clicking the “Update” button causes the portable device processor to issue an instruction via the terminal network interface to a remote server to download any updated versions of the listed program modules from the remote server onto the portable device memory. The Update instruction issued by the portable device processor is coded with a unique apparatus

identifier specifically associated with the portable device and information identifying the versions of the program modules stored on the portable device memory. Upon receiving the instruction, the remote server confirms the authenticity of the portable device unique apparatus identifier and determines whether any of the program module versions stored on the portable device have been updated. The remote server then downloads any updated versions of the program modules for storage on the portable device memory. All of the communications from the portable device to the remote server are encrypted by the MediKey Application encryption feature.

I declare that all statements made herein of my own knowledge are true and that all statements made on information and belief are believed to be true, and further that these statements were made with the knowledge that willful false statements and the like so made are punishable by fine or imprisonment, or both, under Section 1001 of Title 18 of the United States Code and that such willful false statements may jeopardize the validity of the application or any patent issuing thereon.

Dated: 4-16-2010

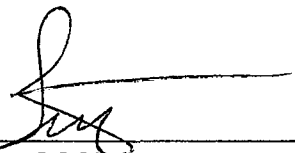
  
\_\_\_\_\_  
Scott McNulty

# EXHIBIT 1



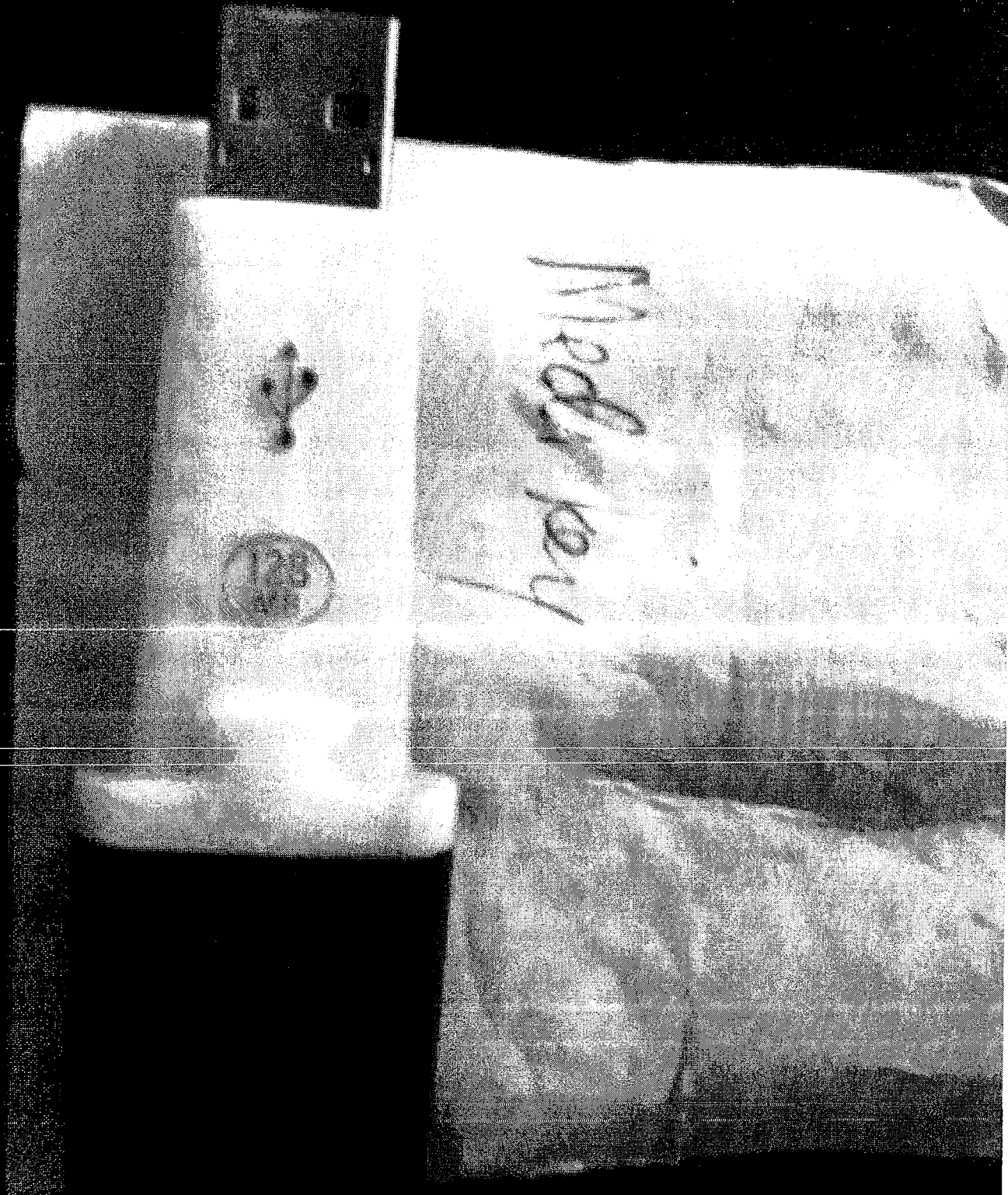

# EXHIBIT 2



General Version Compatibility



MediKey

Type of file: Application

Description: MediKey Application

Location: E:\medkey

Size: 204 KB (208,896 bytes)

Size on disk: 204 KB (208,896 bytes)

Created: REDACTED

Modified: REDACTED

Accessed: REDACTED

Attributes:  Read-only  Hidden  Archive

OK

Cancel

Apply

# EXHIBIT 3



Medications

Medical Problems

Doctor/Insurance Info

Medical Expenses

X-Ray Viewer

Web Search

Update Modules

Exit

Emergency Information

Allergies: Dust, Milk, Demerol, Chalk, Mold, Sugar  
Weight: 170 lbs  
Height: 5' 2"  
Blood Pressure: 120/80      REDACTED

# EXHIBIT 4

Medications

Medical Problems

Doctor/Insurance Info

Medical Expenses

X-Ray Viewer

Web Search

Update Modules

Exit

Emergency Information

Allergies: Dust, Milk, Demerol, Chalk, Mold, Sugar  
 Weight: 170 lbs  
 Height: 5' 2"  
 Blood Pressure: 120/80      REDACTED

Medications

For Thyroid Cancer

Synthroid                      175 mcgm

For Heart Precautionary

Aspirin                          81 mg

For Diabets

Chromium picolinate        1000 mcg  
 Alpha Lipoic Acid            60 mg

For Enlarged Prostate

Saw Palmetto                  320 mg

For General Well-Being

Ester-C                          500 mg (+62 mg calcium ascorbate)  
 Calcium citrate                500 mg

# EXHIBIT 5



Medications

Medical Problems

Doctor/Insurance Info

Medical Expenses

X-Ray Viewer

Web Search

Update Modules

Exit

Emergency Information

Allergies: Dust, Milk, Demerol, Chalk, Mold, Sugar

Weight: 170 lbs

Height: 5' 2"

Blood Pressure: 120/80 REDACTED

Known Medical Problems

Thyroid Cancer

Heart Precautionary

Diabetes

Enlarged Prostate

# EXHIBIT 6

Medications

Medical Problems

Doctor/Insurance Info

Medical Expenses

X-Ray Viewer

Web Search

Update Modules

Exit

Emergency Information

Allergies: Dust, Milk, Demerol, Chalk, Mold, Sugar

Weight: 170 lbs

Height: 5' 2"

Blood Pressure: 120/80 REDACTED

Doctor's Information

Dr. Knowitall

293 Any Street

Any Town, Any State 12345

Insurance Information

United Health of U.S.A.

789 That Street

That Town, That State 98734

Policy Number: 1213EAD39873B

# EXHIBIT 7

Medications

Medical Problems

Doctor/Insurance Info

Medical Expenses

X-Ray Viewer

Web Search

Update Modules

Exit

Emergency Information

Allergies: Dust, Milk, Demerol, Chalk, Mold, Sugar

Weight: 170 lbs

Height: 5' 2"

Blood Pressure: 120/80 REDACTED

Medical Expenses

# EXHIBIT 8

Medications

Medical Problems

Doctor/Insurance Info

Medical Expenses

X-Ray Viewer

Web Search

Update Modules

Exit

Emergency Information

Allergies: Dust, Milk, Demerol, Chalk, Mold, Sugar

Weight: 170 lbs

Height: 5' 2"

Blood Pressure: 120/80 REDACTED

X-Ray Viewer



Select X-Ray

Rad49.jpg

Actual Size

Exit

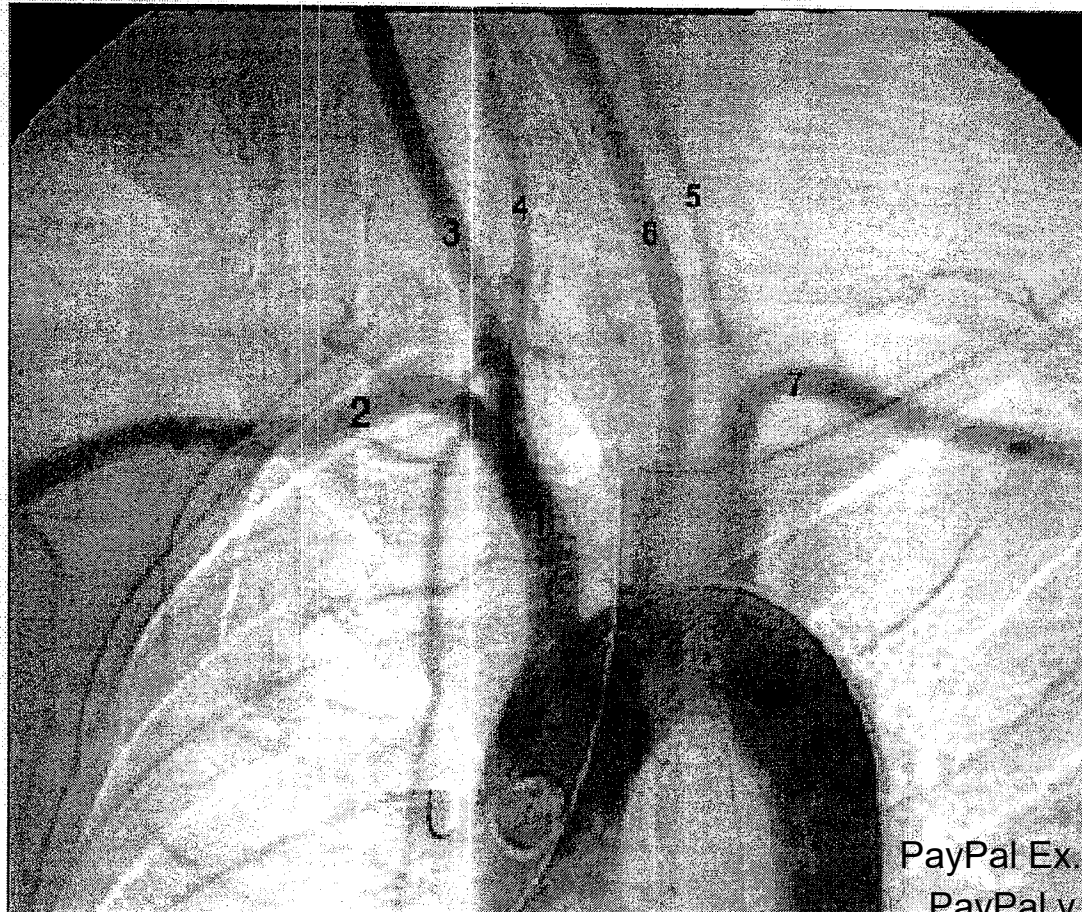

# EXHIBIT 9



Medications

Medical Problems

Doctor/Insurance Info

Medical Expenses

X-Ray Viewer

Web Search

Update Modules

Exit

Emergency Information

Allergies: Dust, Milk, Demerol, Chalk, Mold, Sugar

Weight: 170 lbs

Height: 5' 2"

Blood Pressure: 120/80 REDACTED

Web Search

cancer

Dr. Koop (Gen. Medical Site)

OK

Cancel

# EXHIBIT 10

- Medications

---

- Medical Problems

---

- Doctor/Insurance Info

---

- Medical Expenses

---

- X-Ray Viewer

---

- Web Search

---

  
  
  
  
  
  
  
  
  
  
- Update Modules

---

- Exit

### Emergency Information

Allergies: Dust, Milk, Demerol, Chalk, Mold, Sugar  
 Weight: 170 lbs  
 Height: 5' 2"                      REDACTED  
 Blood Pressure: 120/80

**Update** ✖

---

Emergency Information  
 Medications  
 Medical Problems  
 Doctor/Insurance Info  
 Medical Expenses  
 X-Ray Viewer  
 Web Search

Medications

For Thyroid

Synthroid

For Heart P

Aspirin

For Diabets

Chromium p  
Alpha Lipoid

For Enlarged Prostate

Saw Palmetto                      320 mg

For General Well-Being

Ester-C                              500 mg (+62 mg calcium ascorbate)  
 Calcium citrate                      500 mg

## Electronic Patent Application Fee Transmittal

<b>Application Number:</b>	10807731
<b>Filing Date:</b>	23-Mar-2004
<b>Title of Invention:</b>	Apparatus, method and system for a tunneling client access point
<b>First Named Inventor/Applicant Name:</b>	Scott McNulty
<b>Filer:</b>	Robert Keaney Goethals
<b>Attorney Docket Number:</b>	1004294.001US

Filed as Small Entity

### Utility under 35 USC 111(a) Filing Fees

Description	Fee Code	Quantity	Amount	Sub-Total in USD(\$)
<b>Basic Filing:</b>				
<b>Pages:</b>				
<b>Claims:</b>				
Claims in excess of 20	2202	75	26	1950

**Miscellaneous-Filing:**

**Petition:**

**Patent-Appeals-and-Interference:**

**Post-Allowance-and-Post-Issuance:**

**Extension-of-Time:**

PayPal Ex. 1058, p. 308  
PayPal v. IOENGINE

Description	Fee Code	Quantity	Amount	Sub-Total in USD(\$)
Extension - 3 months with \$0 paid	2253	1	555	555
<b>Miscellaneous:</b>				
Request for continued examination	2801	1	405	405
Submission- Information Disclosure Stmt	1806	1	180	180
<b>Total in USD (\$)</b>				<b>3090</b>

## Electronic Acknowledgement Receipt

<b>EFS ID:</b>	7435075
<b>Application Number:</b>	10807731
<b>International Application Number:</b>	
<b>Confirmation Number:</b>	4430
<b>Title of Invention:</b>	Apparatus, method and system for a tunneling client access point
<b>First Named Inventor/Applicant Name:</b>	Scott McNulty
<b>Customer Number:</b>	85775
<b>Filer:</b>	Robert Keaney Goethals
<b>Filer Authorized By:</b>	
<b>Attorney Docket Number:</b>	1004294.001US
<b>Receipt Date:</b>	16-APR-2010
<b>Filing Date:</b>	23-MAR-2004
<b>Time Stamp:</b>	22:53:04
<b>Application Type:</b>	Utility under 35 USC 111(a)

### Payment information:

Submitted with Payment	yes
Payment Type	Deposit Account
Payment was successfully received in RAM	\$3090
RAM confirmation Number	6145
Deposit Account	504827
Authorized User	

### File Listing:

Document Number	Document Description	File Name	File Size (Bytes)	Multi-Part	Pages (if appl.)
			1058	310	

1		amendment_.pdf	1901316 1730442fd88aae2b6410a2104d74ab67ba014546	yes	43
<b>Multipart Description/PDF files in .zip description</b>					
		<b>Document Description</b>	<b>Start</b>	<b>End</b>	
		Amendment After Final	1	1	
		Claims	2	28	
		Applicant Arguments/Remarks Made in an Amendment	29	43	
<b>Warnings:</b>					
<b>Information:</b>					
2	Extension of Time	Extension_.pdf	52581 ce6ed0f1801566dd11c483c9d80fd4b46415c9e0	no	2
<b>Warnings:</b>					
<b>Information:</b>					
3	Request for Continued Examination (RCE)	RCE_.pdf	57855 891797a63f86977f0309e8912e7cd0e3bd6cdce1	no	1
<b>Warnings:</b>					
This is not a USPTO supplied RCE SB30 form.					
<b>Information:</b>					
4	Information Disclosure Statement (IDS) Filed (SB/08)	IDS_.pdf	175694 4eb2ca5f449f728b2abadcea16aa05d97a9b27fd	no	4
<b>Warnings:</b>					
<b>Information:</b>					
This is not an USPTO supplied IDS fillable form					
5	Rule 130, 131 or 132 Affidavits	Declaration_.pdf	2362756 5911372e7e15295016273a69ae332015c823cca6	no	27
<b>Warnings:</b>					
<b>Information:</b>					
6	Fee Worksheet (PTO-875)	fee-info.pdf	35190 1f1873c523f51fb3c8f3a948869b36591988ab2e	no	2
<b>Warnings:</b>					
<b>Information:</b>					
<b>Total Files Size (in bytes):</b>			4585392		

**This Acknowledgement Receipt evidences receipt on the noted date by the USPTO of the indicated documents, characterized by the applicant, and including page counts, where applicable. It serves as evidence of receipt similar to a Post Card, as described in MPEP 503.**

**New Applications Under 35 U.S.C. 111**

**If a new application is being filed and the application includes the necessary components for a filing date (see 37 CFR 1.53(b)-(d) and MPEP 506), a Filing Receipt (37 CFR 1.54) will be issued in due course and the date shown on this Acknowledgement Receipt will establish the filing date of the application.**

**National Stage of an International Application under 35 U.S.C. 371**

**If a timely submission to enter the national stage of an international application is compliant with the conditions of 35 U.S.C. 371 and other applicable requirements a Form PCT/DO/EO/903 indicating acceptance of the application as a national stage submission under 35 U.S.C. 371 will be issued in addition to the Filing Receipt, in due course.**

**New International Application Filed with the USPTO as a Receiving Office**

**If a new international application is being filed and the international application includes the necessary components for an international filing date (see PCT Article 11 and MPEP 1810), a Notification of the International Application Number and of the International Filing Date (Form PCT/RO/105) will be issued in due course, subject to prescriptions concerning national security, and the date shown on this Acknowledgement Receipt will establish the international filing date of the application.**



**IN THE UNITED STATES PATENT AND TRADEMARK OFFICE**

Serial No. : 10/807,731 Confirmation : 4430  
Applicant(s) : Scott McNulty  
Filed : March 23, 2004  
Title : Apparatus, Method And System For A Tunneling Client Access Point

Art Unit : 2443  
Examiner : Asghar H. Bilgrami

Docket No. : 1004294.001US  
Customer No. : 85775

**AMENDMENT AFTER FINAL OFFICE ACTION**

Commissioner for Patents  
P.O. Box 1450  
Alexandria, VA 22313-1450

Sir:

This paper is being filed in response to the Final Office Action dated October 16, 2009. Applicant submits herewith a Request for Continued Examination and a Petition and Fee for a one month extension of time. Reconsideration of this application is respectfully requested in light of this paper, which is set forth as follows:

- **Amendments to the Claims** are reflected in the listing of claims which begins on page **2** of this paper.
- **Remarks** begin on page **29** of this paper.

**Amendments to the Claims:**

This listing of claims will replace all prior listings of claims in the application.

Listing Of Claims:

**Claim 1 (currently amended):** A portable tunneling storage and processing apparatus, comprising:

(a) a conduit for external communications configured to enable the transmission of a plurality of instructions between the portable apparatus and a terminal comprising a terminal processor, a first input component, a first output component comprising a display device, and a network interface, wherein the conduit for external communications comprises a universal serial bus conduit;

(b) a processor; and

(c) a memory configured to communicate with the processor, wherein the memory contains a unique apparatus identifier, and a plurality of processing instructions stored thereon, including:

~~a processor disposed in communication with the memory, and configured to issue a plurality of processing instructions stored in the memory,~~

~~wherein the processing instructions issue signals to:~~

~~provide a terminal with access to the memory;~~

~~execute processing instructions from the memory to provide the portable tunneling storage and processing apparatus with access to the terminal, wherein the terminal acts as a proxy to the portable tunneling storage and processing apparatus for the terminal's input and output peripheral devices, and wherein the terminal acts as a network interface proxy to the portable tunneling storage and processing apparatus, and wherein the processing instructions are executed on the terminal;~~

(1) a first set of processing instructions, which when executed by the terminal processor, enables the first input component to interface with the portable apparatus through an

interactive user interface presented on the terminal display device and provides the portable apparatus with access to the terminal network interface; and

(2) at least one processing instruction, which when executed by the portable apparatus processor, causes the portable apparatus processor to:

(i) process execute a second set of processing instructions, wherein the processing instructions are stored in on the memory, wherein the processing instructions are used to issue signals to process processing instruction on the processor; and

encrypt data stored in the memory based on the apparatus identifier and the user verifying information;

(ii) effect the display of processing activity on the terminal display device;

a conduit for external communications disposed in communication with the processor, configured to issue a plurality of communication instructions as provided by the processor, configured to issue the communication instructions as signals to engage in communications with other devices having compatible conduits, and configured to receive signals issued from the compatible conduits, wherein the conduits are USB conduits,

wherein the portable apparatus is configured communication instructions issue signals to[[:]] communicate with the terminal[[:]] and to communicate through the terminal network interface with a server; device.

wherein the communication instruction issued signals are encrypted, wherein the encryption occurs on the processor,

wherein received encrypted instruction signals are decrypted, and wherein the decryption occurs on the processor.

**Claim 2 (currently amended):** A portable tunneling storage and processing apparatus, comprising:

(a) a conduit for external communications configured to enable the transmission of a plurality of instructions between the portable apparatus and a terminal comprising a terminal processor, a first input component, a first output component and a network interface;

(b) a processor; and

(c) a memory configured to communicate with the processor, wherein the memory contains a unique apparatus identifier; has a plurality of processing instructions stored thereon, including:

~~a processor disposed in communication with the memory, and configured to issue a plurality of processing instructions stored in the memory,~~

~~wherein processing instructions issue signals to:~~

~~provide a terminal access to the memory;~~

(1) a first set of processing instructions, which when executed by the terminal processor, enables the first input component to interface with the portable apparatus through an interactive user interface presented on the first output component; and

(2) at least one processing instruction, which when executed by the portable apparatus processor, causes a second set of process processing instructions to be executed, wherein effect the display of processing activity of the second set of processing instructions is presented on the terminal first output component;

~~a conduit for external communications disposed in communication with the processor, configured to issue a plurality of communication instructions as provided by the processor, configured to issue the communication instructions as signals to engage in communications with other devices having compatible conduits, and configured to receive signals issued from the compatible conduits;~~

wherein the portable apparatus is configured ~~communication instructions issue signals to~~ to~~[:]]~~ communicate with the terminal and to communicate with a device configured to communicate with the terminal.

**Claim 3 (currently amended):** The apparatus of claim 2, wherein the memory contains a unique apparatus identifier is comprising a digital signature.

**Claim 4 (currently amended):** The apparatus of claim 2, wherein the memory contains a unique apparatus identifier and user verifying information.

**Claim 5 (currently amended):** The apparatus of claim 4, wherein the user verifying information is comprises a digital signature.

**Claim 6 (currently amended):** The apparatus of claim 4, wherein the user verifying information is comprises a username and password.

**Claim 7 (currently amended):** The apparatus of claim ~~6~~ 4, wherein the ~~processing instructions issue signals to encrypt~~ plurality of processing instructions stored on the memory includes at least one processing instruction, which when executed by the portable apparatus processor, causes the encryption of data stored on the memory based on the unique apparatus identifier and user verifying information.

**Claim 8 (currently amended):** The apparatus of claim 2, wherein the second set of processing instructions is stored on the terminal ~~issue signals to execute processing instructions from the memory to access the terminal, wherein the processing instructions are executed on the terminal.~~

**Claim 9 (canceled).**

**Claim 10 (currently amended):** The apparatus of claim 2, wherein the second set of processing instructions are is stored on the memory.

**Claim 11 (currently amended):** The apparatus of claim 2, wherein the second set of processing instructions ~~are~~ is obtained from a server configured to communicate with the terminal through the network interface.

**Claim 12 (currently amended):** The apparatus of claim 2, wherein the second set of processing instructions ~~are processed on~~ is executed by the portable apparatus processor.

**Claim 13 (currently amended):** The apparatus of claim 12, wherein the second set of processing instructions ~~are processed on the processor~~ is configured to process files for printing.

**Claim 14 (currently amended):** The apparatus of claim 2, wherein the second set of processing instructions ~~are processed on~~ is executed by the terminal processor.

**Claim 15 (currently amended):** The apparatus of claim 2, wherein the second set of processing instructions ~~are processed on the~~ is executed by a server configured to communicate with the terminal through the network interface.

**Claim 16 (canceled).**

**Claim 17 (currently amended):** The apparatus of claim 2, wherein the terminal comprises a video screen output component and the presentation display of processing activity ~~occurs on the terminal~~ comprises a visual display device on the video screen.

**Claim 18 (currently amended):** The apparatus of claim 2 17, wherein the terminal further comprises a video memory and the display of processing activity occurs directly in on the terminal's video memory.

**Claim 19 (currently amended):** The apparatus of claim 2, wherein the ~~conduits are USB conduits~~ conduit for external communications comprises a universal serial bus conduit.

**Claim 20 (currently amended):** The apparatus of claim 2, wherein the ~~conduits are~~ conduit for external communications comprises a wireless conduits conduit.

**Claim 21 (currently amended):** The apparatus of claim 20, wherein the wireless ~~conduits~~ are conduit is Bluetooth.

**Claim 22 (currently amended):** The apparatus of claim 20, wherein the wireless ~~conduits~~ are conduit is WiFi.

**Claim 23 (currently amended):** The apparatus of claim 2, wherein the device comprises a server and the portable apparatus is configured to issue communication instructions ~~issue signals through the terminal network interface~~ to communicate with ~~[[a]]~~ the server .

**Claim 24 (currently amended):** The apparatus of claim 23, wherein the instructions ~~communication instruction issued signals~~ are encrypted.

**Claim 25 (currently amended):** The apparatus of claim 24, wherein the ~~encryption occurs on the processor~~ portable apparatus is configured to encrypt the instructions.

**Claim 26 (currently amended):** The apparatus of claim 24, wherein the ~~encryption occurs on the terminal~~ is configured to encrypt the instructions.

**Claim 27 (currently amended):** The apparatus of claim 24 ~~23~~, wherein the ~~encryption occurs on the server~~ is configured to issue encrypted instructions to communicate with the portable apparatus.

**Claim 28 (currently amended):** The apparatus of claim 23, wherein the portable apparatus is configured to decrypt received encrypted instruction signals ~~are decrypted instructions~~.

**Claim 29 (currently amended):** The apparatus of claim ~~28~~ 27, wherein the ~~decryption occurs on the portable apparatus~~ processor is configured to decrypt encrypted instructions issued by the server.

**Claim 30 (currently amended):** The apparatus of claim ~~28~~ 27, wherein the ~~decryption occurs on the terminal~~ is configured to decrypt encrypted instructions issued by the server.

**Claim 31 (currently amended):** The apparatus of claim 28 ~~24~~, wherein ~~the decryption occurs on the server~~ is configured to decrypt encrypted instructions.

**Claim 32 (currently amended):** A method of accessing data, comprising:

engaging a portable storage device in communication with a terminal, wherein the portable storage device ~~has~~ comprises a memory having a plurality of processing instructions stored thereon, a processor configured to communicate with the memory, wherein the portable storage device connects to the terminal across compatible conduits and a conduit for external communications, wherein the portable storage device has a memory, wherein the memory and a storage conduit are disposed in communication with the processor and wherein the terminal comprises a terminal processor, a first input component, a first output component comprising a display device, and a network interface;

~~providing the memory for access on the terminal, wherein the memory is mounted on the terminal;~~

executing a first set of processing instructions from the memory to access the terminal enable the first input component to interface with the portable storage device through an interactive user interface presented on the terminal display device and to provide the portable storage device with access to the terminal network interface, wherein the first set of processing instructions are ~~is executed on~~ by the terminal processor;

transmitting a plurality of instructions between the portable storage device and the terminal communicating through the conduit for external communications; at the terminal, wherein the portable storage device has access to the terminal such that the terminal acts as a proxy to the portable storage device for the terminal's input and output peripheral devices, and acts as a network interface proxy to the portable storage device, wherein communication instruction

transmitting a plurality of instructions between the portable storage device and a device configured to communicate with the terminal network interface, wherein the instructions issued signals by the portable storage device are encrypted, wherein the encryption occurs on the



~~processor~~ portable storage device, and wherein received encrypted instruction signals  
instructions received by the portable storage device are decrypted, wherein the decryption occurs  
on the processor portable storage device;

executing at least one processing instruction on the portable storage device processor to  
cause the portable storage device processor to execute a second set of processing instructions on  
the processor, wherein the second set of processing instructions are is stored on the memory,  
wherein the processing instructions are used to issue signals to process processing instruction on  
the processor; and

effecting the display of processing activity on the terminal display device.

**Claim 33 (currently amended):** A method of accessing data, comprising:

disposing a portable storage device in communication with a terminal, wherein the  
portable storage device has comprises a memory having a plurality of processing instructions  
stored thereon, a processor configured to communicate with the memory, wherein the portable  
storage device connects to the terminal across compatible conduits and a conduit for external  
communications, wherein the portable storage device has a memory, wherein the memory and a  
storage conduit are disposed in communication with the processor and wherein the terminal  
comprises a terminal processor, a first input component, a first output component and a network  
interface;

providing the memory for access on the terminal;

executing a first set of processing instructions from the memory to access the terminal  
enable the first input component to interface with the portable storage device through an  
interactive user interface presented on the first output component, wherein the first set of  
processing instructions are is executed on the terminal processor;

transmitting a plurality of instructions between the portable storage device and the  
terminal communicating through the conduits connecting conduit for external communications  
the portable storage device to the terminal;

executing a at least one processing instructions on the portable storage device processor to cause a second set of ~~processing~~ processing instructions to be executed; and

effecting the display of the processing activity of the second set of processing instructions on the first output component.

**Claim 34 (currently amended):** The method of claim 33, wherein the ~~conduits connecting the portable storage device to the terminal are USB conduits~~ conduit for external communications comprises a universal serial bus conduit.

**Claim 35 (currently amended):** The method of claim 33, wherein the ~~conduits connecting the portable storage device to the terminal are~~ conduit for external communications comprises a wireless conduits conduit.

**Claim 36 (currently amended):** The method of claim 35, wherein the wireless ~~conduits are~~ conduit is Bluetooth.

**Claim 37 (currently amended):** The method of claim 35, wherein the wireless ~~conduits are~~ conduit is WiFi.

**Claim 38 (currently amended):** The method of claim 33, ~~wherein~~ further comprising mounting the memory is mounted at on the terminal.

**Claim 39 (canceled).**

**Claim 40 (canceled).**

**Claim 41 (currently amended):** The method of claim ~~39~~ 33, wherein the first set of processing instructions, when executed by the terminal processor, acts as a provides the portable storage device with access to the network interface proxy to the portable storage device.

**Claim 42 (currently amended):** The method of claim 33, wherein ~~the communications through the conduit connecting~~ instructions issued by the portable storage device to the terminal are encrypted.

**Claim 43 (currently amended):** The method of claim 42, wherein the encryption occurs on the ~~processor~~ portable storage device.

**Claim 44 (currently amended):** The method of claim 43, wherein the encryption occurs on the portable storage device processor by executing ~~communication~~ processing instructions from the memory.

**Claim 45 (original):** The method of claim 42, wherein the encryption occurs on the terminal.

**Claim 46 (currently amended):** The method of claim ~~42~~ 41, wherein the ~~encryption occurs on a device~~ comprises a server configured to issue encrypted instructions to communicate with the portable storage device.

**Claim 47 (currently amended):** The method of claim ~~33~~ 46, wherein ~~received~~ encrypted ~~instruction signals~~ instructions issued by the server are decrypted on the portable storage device.

**Claim 48 (currently amended):** The method of claim 47, wherein the decryption occurs on the portable storage device processor.

**Claim 49 (currently amended):** The method of claim 48, wherein the decryption occurs on the portable storage device processor by executing ~~communication~~ processing instructions from the memory.

**Claim 50 (currently amended):** The method of claim ~~47~~ 46, wherein the ~~decryption occurs~~ encrypted instructions issued by the server are decrypted on the terminal.

**Claim 51 (currently amended):** The method of claim ~~47~~ 41, wherein the ~~decryption occurs on a server~~ device comprises a server configured to decrypt encrypted instructions issued by the portable storage device.

**Claim 52 (currently amended):** The method of claim 33, wherein the second set of processing instructions ~~are~~ is stored ~~in~~ on the memory.

**Claim 53 (currently amended):** The method of claim 33, wherein the ~~processing of second set of processing instructions occurs on~~ is executed by the portable storage device processor.

**Claim 54 (currently amended):** The method of claim 33, wherein the ~~processing of second set of processing instructions occurs on~~ is executed by the terminal processor.

**Claim 55 (currently amended):** The method of claim 33, wherein the ~~processing of second set of processing instructions occurs on~~ is executed by a server.

**Claim 56 (currently amended):** The method of claim 33, wherein the second set of processing instructions, when executed, causes ~~are used to issue signals to process processing instruction on~~ the portable storage device processor to execute a third set of processing instructions.

**Claim 57 (currently amended):** The method of claim ~~55~~ 53, wherein the second set of processing instructions are used to issue signals to process processing instruction on the processor is configured to process files for printing.

**Claim 58 (canceled).**

**Claim 59 (currently amended):** The method of claim 33, wherein the terminal further comprises a video screen output component and wherein the presentation of processing activity comprises a visual display occurs on the terminal video screen.

**Claim 60 (currently amended):** The method of claim 59 wherein the terminal further comprises a video memory and wherein the display of processing activity occurs directly on the terminal video memory.

**Claim 61 (currently amended):** A system to access data, comprising:

means to engage a portable storage device in communication with a terminal, wherein the portable storage device ~~has~~ comprises a memory containing a plurality of processing instructions, a processor configured to communicate with the memory, wherein the portable storage device connects to the terminal across compatible conduits and a conduit for external

~~communications, wherein the portable storage device has a memory, wherein the memory and a storage conduit are disposed in communication with the processor and wherein the terminal comprises a terminal processor, a first input component, a first output component comprising a display device, and a network interface;~~

~~means to provide the memory with access to the terminal, wherein the memory is mounted on the terminal;~~

~~means to execute a first set of processing instructions from the memory to access the terminal enable the first input component to interface with the portable storage device through an interactive user interface presented on the first output component and provide the portable storage device with access to the network interface, wherein the first set of processing instructions are is executed on by the terminal processor;~~

~~means to communicate transmit a plurality of instructions between the portable storage device and the terminal through the conduit for external communications at the terminal, wherein the terminal acts as a proxy to the portable storage device for the terminal's input and output peripheral devices, and acts as a network interface proxy to the portable storage device;~~

~~means to transmit a plurality of instructions between the portable storage device and a device configured to communicate with the terminal network interface, wherein instructions communication instruction issued signals by the portable storage device are encrypted, wherein the encryption occurs on the processor portable storage device, and wherein received encrypted instruction signals instructions received by the portable storage device are decrypted, wherein the decryption occurs on the processor portable storage device;~~

~~means to execute a second set of processing instructions on the portable storage device processor, wherein the second set of processing instructions are is stored on the memory, wherein the processing instructions are used to issue signals to process processing instruction on the processor; and~~

~~means to effect the display of processing activity on the terminal display device.~~

**Claim 62 (currently amended):** A system to access data, comprising:

means to dispose a portable storage device in communication with a terminal, wherein the portable storage device ~~has~~ comprises a memory containing a plurality of processing instructions, a processor configured to communicate with the memory, wherein the portable storage device connects to the terminal across compatible conduits and a conduit for external communications, wherein the portable storage device has a memory, wherein the memory and a storage conduit are disposed in communication with the processor and wherein the terminal comprises a terminal processor, a first input component and a first output component;

~~means to provide the memory for access on the terminal;~~

means to execute a first set of processing instructions from the memory to access the terminal enable the first input component to interface with the portable storage device through an interactive user interface presented on the first output component, wherein the first set of processing instructions are is executed on the terminal processor;

means to ~~communicate~~ transmit a plurality of instructions between the portable storage device and the terminal through the conduits connecting conduit for external communications the portable storage device to the terminal;

means to ~~process~~ execute a second set of processing instructions; and

means to effect the display of the processing activity of the second set of processing instructions on the first output component.

**Claim 63 (currently amended):** A computer readable medium readable having a plurality of processing instructions stored thereon, including a first set of processing instructions, which when executed by a computer system comprising a portable device having a processor and a terminal having a processor, to access data, comprising cause the computer system to:

~~instruction signals in the processor readable medium, wherein the instruction signals are issuable by the processor to:~~

~~engage a portable storage device with a terminal;~~

~~wherein the portable storage device has a processor,~~

~~wherein the portable storage device connects to the terminal across compatible conduits for external communications, wherein the portable storage device has a memory, wherein the memory and a storage conduit are disposed in communication with the processor;~~

~~provide the memory for access on the terminal, wherein the memory is mounted on the terminal;~~

present an interactive user interface on an output component of the terminal;

provide the portable device with access of a network interface of the terminal;

enable an input component of the terminal to interface with the portable device through the interactive user interface, wherein the input component causes the portable device processor to execute a second set of processing instructions from the memory to access the terminal computer readable medium to cause the portable device to transmit instructions through the terminal network interface to communicate with a data storage device, wherein the processing instructions are executed on the terminal; and

~~communicate through the conduit at the terminal,~~

~~wherein the terminal acts as a proxy to the portable storage device for the terminal's input and output peripheral devices, and acts as a network interface proxy to the portable storage device,~~

~~wherein communication instruction issued signals are encrypted,~~

~~wherein the encryption occurs on the processor,~~

~~wherein received encrypted instruction signals are decrypted,~~

~~wherein the decryption occurs on the processor;~~

~~execute processing instructions on the processor, wherein the processing instructions are stored on the memory,~~

~~wherein the processing instructions are used to issue signals to process processing instruction on the processor; and~~

~~means to effect the display of processing activity on the terminal output component.~~

**Claim 64 (canceled).**

**Claim 65 (canceled).**

**Claim 66 (canceled).**

**Claim 67 (currently amended):** A method of accessing data, comprising:

enabling a terminal input component to interface with a portable device processor through an interactive user interface presented on a terminal output component, wherein the interactive user interface comprises a first interface element representing an activity request for the portable storage device processor, which when actuated by the first input component issues an activity request to the portable device processor;

presenting the interactive user interface on the first output component;

receiving ~~requests~~ activity requests from ~~[[a]]~~ the terminal input component; and ~~[[,]]~~

~~wherein a portable storage device is disposed in communication with the terminal,~~

~~wherein the portable storage device has a processor,~~

~~wherein the portable storage device connects to the terminal across compatible conduits for external communications, wherein the portable storage device has a memory, wherein the memory and a storage conduit are disposed in communication with the processor, wherein the portable storage device is responsible for generating the received requests;~~

~~providing responses~~ responding to the portable storage device's requests activity requests.

**Claim 68 (canceled).**

**Claim 69 (canceled).**

**Claim 70 (currently amended):** The ~~apparatus~~ method of claim 32, wherein the ~~conduits connecting the portable storage device to the terminal are USB conduits~~ conduit for external communications comprises a universal serial bus conduit.



**Claim 71 (currently amended):** The ~~apparatus~~ method of claim 32, wherein the ~~conduits connecting the portable storage device to the terminal are~~ conduit for external communications comprises a wireless conduit.

**Claim 72 (currently amended):** The ~~apparatus~~ method of claim 71, wherein the wireless ~~conduits are~~ conduit is Bluetooth.

**Claim 73 (currently amended):** The ~~apparatus~~ method of claim 71, wherein the wireless ~~conduits are~~ conduit is WiFi.

**Claim 74 (new):** The apparatus of claim 1, wherein the second set of processing instructions, when executed on the portable apparatus processor, presents the interactive user interface on the first output component.

**Claim 75 (new):** The apparatus of claim 1, wherein the second set of processing instructions, when executed by the portable apparatus processor, causes the encryption of data stored on the memory.

**Claim 76 (new):** The apparatus of claim 75, wherein the data stored on the memory is encrypted based on the unique apparatus identifier.

**Claim 77 (new):** The apparatus of claim 1, wherein the device comprises a data storage system and the portable apparatus is configured to encrypt instructions issued to the data system and decrypt encrypted instructions received from the data storage system.

**Claim 78 (new):** A portable apparatus, comprising:

(a) a conduit for external communications configured to enable the transmission of a plurality of instructions between the portable apparatus and a terminal comprising a terminal processor, a first input component, a first output component and a network interface;

(b) a processor; and

(c) a memory configured to communicate with the processor, wherein the memory has a plurality of processing instructions stored thereon, including a first set of processing

instructions, which when executed, (i) presents an interactive user interface on the first output component, (ii) enables the first input component to interface with the portable apparatus through the interactive user interface, and (iii) provides the portable apparatus with access to the terminal network interface.

**Claim 79 (new):** The portable apparatus of claim 78, wherein the portable apparatus is configured to provide the terminal with access to the first set of processing instructions.

**Claim 80 (new):** The portable apparatus of claim 79, wherein the memory contains a processing instruction, which when executed by the processor, provides the terminal with access to the first set of processing instructions.

**Claim 81 (new):** The portable apparatus of claim 79, wherein the portable apparatus is configured to transmit the first set of processing instructions to the terminal.

**Claim 82 (new):** The portable apparatus of claim 79, wherein the portable apparatus is configured to enable the first set of processing instructions to be loaded onto the terminal.

**Claim 83 (new):** The portable apparatus of claim 79, wherein the portable apparatus is configured to allow the terminal to download the first set of processing instructions from the memory.

**Claim 84 (new):** The portable apparatus of claim 78, wherein the portable apparatus is configured to cause the terminal processor to execute the first set of processing instructions.

**Claim 85 (new):** The portable apparatus of claim 84, wherein the memory contains a processing instruction, which when executed by the processor, causes the terminal processor to execute the first set of processing instructions.

**Claim 86 (new):** The portable apparatus of claim 78, wherein the portable apparatus processor is configured to execute the first set of processing instructions.

**Claim 87 (new):** The portable apparatus of claim 78, wherein the first set of processing instructions comprises a first subset of processing instructions and a second subset of processing instructions.

**Claim 88 (new):** The portable apparatus of claim 87, wherein the portable apparatus is configured to provide the portable apparatus processor with access to the first subset of processing instructions and to provide the terminal with access to the second subset of processing instructions.

**Claim 89 (new):** The portable apparatus of claim 78, wherein the first output component comprises a display device and the interactive user interface comprises a graphic user interface presented on the display device.

**Claim 90 (new):** The portable apparatus of claim 89, wherein the graphic user interface comprises a first interface element representing an activity to be performed by the portable apparatus, which when actuated by the first input component, transmits an instruction to the portable apparatus.

**Claim 91 (new):** The portable apparatus of claim 90, wherein the activity represented by the first interface element comprises executing a second set of processing instructions on the portable apparatus processor.

**Claim 92 (new):** The portable apparatus of claim 91, wherein the second set of processing instructions is stored on the portable apparatus memory.

**Claim 93 (new):** The portable apparatus of claim 91, wherein the second set of processing instructions, when executed by the portable apparatus processor, causes the portable apparatus to transmit an instruction to a device configured to communicate with the terminal.

**Claim 94 (new):** The portable apparatus of claim 89, wherein the graphic user interface comprises a plurality of interface elements representing different activities to be performed by the portable apparatus.

**Claim 95 (new):** The portable apparatus of claim 78, wherein the first output component is an audio output component and the interactive user interface is an audio user interface presented by the audio output component.

**Claim 96 (new):** The portable apparatus of claim 78, wherein the terminal is selected from the group consisting of a personal computer, a laptop computer, a personal digital assistant, a smart phone, and similar devices.

**Claim 97 (new):** The portable apparatus of claim 78, wherein the portable apparatus is configured to issue instructions to communicate through the network interface with a data storage system.

**Claim 98 (new):** The portable apparatus of claim 97, wherein the data storage system comprises a redundant array of independent disks.

**Claim 99 (new):** The portable apparatus of claim 78, wherein the portable apparatus is configured to issue instructions to communicate through the network interface with a device selected from the group consisting of a server, a printer, a copier, and similar devices.

**Claim 100 (new):** The portable apparatus of claim 78, wherein the terminal network interface is configured to communicate with a server, and wherein the first set of processing instructions, when executed, enables the first input component to interface with the server through the interactive user interface presented on the first output component.

**Claim 101 (new):** The portable apparatus of claim 100, wherein the server comprises a memory having a plurality of processing instructions stored thereon and a server processor configured to communicate with the server memory, and wherein the first output component is a display device and the interactive user interface is a graphic user interface presented on the display device.

**Claim 102 (new):** The portable apparatus of claim 101, wherein the graphic user interface comprises a first interface element representing an activity option for the server, which when actuated by the first input component is configured to cause an instruction to be transmitted through terminal network interface to the server.

**Claim 103 (new):** The portable apparatus of claim 102, wherein the activity option represented by the first interface element comprises executing a second set of processing instructions on the server processor.

**Claim 104 (new):** The portable apparatus of claim 103, wherein the second set of processing instructions is stored on the server memory.

**Claim 105 (new):** The apparatus of claim 104, wherein the server is configured to issue an instruction to the terminal, the portable apparatus or a device configured to communicate with the terminal in connection with the execution of the second set of processing instructions.

**Claim 106 (new):** The apparatus of claim 78, wherein the conduit for external communications is a universal serial bus conduit.

**Claim 107 (new):** The apparatus of claim 78, wherein the conduit for external communications is a wireless conduit.

**Claim 108 (new):** The apparatus of claim 105, wherein the wireless conduit is Bluetooth.

**Claim 109 (new):** The apparatus of claim 105, wherein the wireless conduit is WiFi.

**Claim 110 (new):** A portable apparatus, comprising:

(a) a conduit for external communications configured to enable the transmission of a plurality of instructions between the portable apparatus and a terminal comprising a terminal processor, a first input component, a first output component and a network interface;

(b) a processor; and

(c) a memory comprising a random access memory (RAM) configured to communicate with the processor and a read only memory (ROM), wherein the memory has a plurality of processing instructions stored thereon, including a first set of processing instructions, which when executed, (i) presents an interactive user interface on the first output component, (ii) enables the first input component to interface with the portable apparatus through the interactive user interface, and (iii) provides the portable apparatus with access to the terminal network interface.

**Claim 111 (new):** The portable apparatus of claim 110, wherein the first set of processing instructions comprises a first subset of processing instructions stored on the random access memory for execution by the portable apparatus processor and a second subset of processing instructions stored on the read only memory for execution by the terminal processor.

**Claim 112 (new):** The portable apparatus of claim 111, wherein the read only memory has an autorun file stored thereon, which when detected by the terminal, causes the terminal processor to install the second subset of processing instructions on the terminal.

**Claim 113 (new):** The portable apparatus of claim 110, wherein the random access memory is flash memory.

**Claim 114 (new):** A portable apparatus, comprising:

(a) a memory containing a plurality of processing instructions;

(b) a processor configured to communicate with the memory; and

(c) a conduit for external communications configured to enable the transmission of instructions between the portable apparatus and a terminal having a terminal processor, a first input component, a first output component and a network interface, wherein the portable apparatus is configured to provide the terminal with access to a first set of processing instructions, which when executed by the terminal processor, enables the first input component to interface with the portable apparatus through an interactive user interface presented on the first output component.

**Claim 115 (new):** The portable apparatus of claim 114, wherein the first set of processing instructions is stored on the portable apparatus memory.

**Claim 116 (new):** The portable apparatus of claim 115, wherein the portable apparatus is configured to transmit the first set of processing instructions to the terminal.

**Claim 117 (new):** The portable apparatus of claim 115, wherein the portable apparatus is configured to enable the terminal to retrieve the first set of processing instructions from the portable apparatus memory.

**Claim 118 (new):** The portable apparatus of claim 117, wherein the memory contains a second set of processing instructions, which when executed by the portable apparatus processor, enables the terminal to retrieve the first set of processing instructions.

**Claim 119 (new):** The portable apparatus of claim 114, wherein the memory has a second set of processing instructions stored thereon, which when executed by the portable apparatus processor, provides the terminal processor with to access the first set of processing instructions.

**Claim 120 (new):** The portable apparatus of claim 119, wherein the first set of processing instructions is stored on the portable apparatus memory.

**Claim 121 (new):** The portable apparatus of claim 114, wherein the portable apparatus is configured to enable the first set of processing instructions to be loaded onto the terminal.

**Claim 122 (new):** The portable apparatus of claim 121, wherein the first set of processing instructions is stored on the portable apparatus memory.

**Claim 123 (new):** The portable apparatus of claim 121, wherein the memory contains a second set of processing instructions, which when executed by the portable apparatus processor, causes the terminal processor to execute the first set of processing instructions.

**Claim 124 (new):** The portable apparatus of claim 121, wherein the memory contains a second set of processing instructions, which when executed by the portable apparatus processor, causes the first set of processing instructions to be loaded onto the terminal.

**Claim 125 (new):** The portable apparatus of claim 114, wherein the first output component comprises a display device and the interactive user interface comprises a graphic user interface presented on the display device.

**Claim 126 (new):** The portable apparatus of claim 125, wherein the graphic user interface comprises a first interface element representing an activity option for the portable apparatus, which when actuated by the first input component is configured to issue an instruction to the portable apparatus.

**Claim 127 (new):** The portable apparatus of claim 126, wherein the activity option represented by the first interface element comprises executing a second set of processing instructions on the portable apparatus processor.

**Claim 128 (new):** The portable apparatus of claim 127, wherein the second set of processing instructions is stored on the portable apparatus memory.

**Claim 129 (new):** The portable apparatus of claim 127, wherein the portable apparatus is configured to issue an instruction to the terminal or a device configured to communicate with the terminal in connection with the execution of the second set of processing instructions.

**Claim 130 (new):** The portable apparatus of claim 126, wherein the activity option represented by the first interface element comprises storing data on the portable apparatus memory.

**Claim 131 (new):** The portable apparatus of claim 126, wherein the activity option represented by the first interface element comprises accessing data stored on the portable memory.



**Claim 132 (new):** The portable apparatus of claim 125, wherein the graphic user interface comprises a plurality of interface elements representing different activity options for the portable apparatus.

**Claim 133 (new):** The portable apparatus of claim 132, wherein the plurality of interface elements comprise at least one of the group consisting of check boxes, cursors, menus, scrollers, windows and alpha numeric characters.

**Claim 134 (new):** The portable apparatus of claim 125, wherein the display device comprises a video screen.

**Claim 135 (new):** The portable apparatus of claim 125, wherein the display device comprises a touch screen.

**Claim 136 (new):** The portable apparatus of claim 125, wherein the first input component is selected from the group consisting of a mouse, a keyboard, a touchpad, a touch screen, a trackpad, a trackball, a pen, a joystick, a microphone, a camera, a card reader, a retina reader, a fingerprint reader and a scanner.

**Claim 137 (new):** The portable apparatus of claim 114, wherein the first output component is an audio output component and the interactive user interface is an audio user interface presented by the audio output component.

**Claim 138 (new):** The portable apparatus of claim 137, wherein the first input component is selected from the group consisting of a mouse, a keyboard, a touchpad, a touch screen, a trackpad, a trackball, a pen, a joystick, a microphone, a camera, a card reader, a retina reader, a fingerprint reader and a scanner.

**Claim 139 (new):** The portable apparatus of claim 114, wherein the terminal is selected from the group consisting of a personal computer, a laptop computer, a personal digital assistant, a smart phone, and similar devices.

**Claim 140 (new):** The portable apparatus of claim 114, wherein the terminal comprises a network interface and wherein the first set of processing instructions, when executed, provides the portable apparatus with access to the network interface.

**Claim 141 (new):** The portable apparatus of claim 140, wherein the portable apparatus is configured to issue instructions to communicate through the network interface with a data storage system.

**Claim 142 (new):** The portable apparatus of claim 141, wherein the data storage system comprises a redundant array of independent disks.

**Claim 143 (new):** The portable apparatus of claim 140, wherein the portable apparatus is configured to issue instructions to communicate through the network interface with a device selected from the group consisting of a server, a printer, a copier, and similar devices.

**Claim 144 (new):** The portable apparatus of claim 114, wherein the terminal comprises a network interface configured to communicate with a server, and wherein the first set of processing instructions, when executed, enables the first input component to interface with the server through the interactive user interface presented on the first output component.

**Claim 145 (new):** The portable apparatus of claim 144, wherein the server comprises a memory containing a plurality of processing instructions and a processor configured to communicate with the server memory, and wherein the first output component is a display device and the interactive user interface is a graphic user interface presented on the display device.

**Claim 146 (new):** The portable apparatus of claim 145, wherein the graphic user interface comprises a first interface element representing an activity option for the server, which when actuated by the first input component is configured to issue an instruction through terminal network interface to the server.

**Claim 147 (new):** The portable apparatus of claim 146, wherein the activity option represented by the first interface element comprises executing a second set of processing instructions on the server processor.

**Claim 148 (new):** The portable apparatus of claim 147, wherein the second set of processing instructions is stored on the server memory.

**Claim 149 (new):** The apparatus of claim 148, wherein the server is configured to issue an instruction to the terminal, the portable apparatus or a device configured to communicate with the terminal in connection with the execution of the second set of processing instructions.

**Claim 150 (new):** The apparatus of claim 146, wherein the activity option represented by the first interface element comprises storing data on the server memory.

**Claim 151 (new):** The apparatus of claim 146, wherein the activity option represented by the first interface element comprises accessing data stored on the server memory.

**Claim 152 (new):** The apparatus of claim 114, wherein the conduit for external communications is a universal serial bus conduit.

**Claim 153 (new):** The apparatus of claim 114, wherein the conduit for external communications is a wireless conduit.

**Claim 154 (new):** The apparatus of claim 153, wherein the wireless conduit is Bluetooth.

**Claim 155 (new):** The apparatus of claim 152, wherein the wireless conduit is WiFi.

**Claim 156 (new):** The apparatus of claim 114, wherein the terminal network interface is configured to communicate with a server comprising a processor and a memory and the first set of processing instructions is stored on the server memory, wherein at least one of the plurality of processing instructions stored on the portable apparatus memory, when executed by the portable device processor, causes the portable apparatus to transmit to the server an instruction which instructs the server to download the first set of processing instructions to the terminal.

**Claim 157 (new):** The apparatus of claim 156, wherein a unique apparatus identifier is stored on the portable apparatus memory and the instruction transmitted by the portable apparatus to the server is encoded with the unique apparatus identifier, wherein the server is configured to download the first set of processing instructions to the terminal upon verification of the unique apparatus identifier.

**Claim 158 (new):** A portable apparatus, comprising:

(a) a conduit for external communications configured to enable the transmission of a plurality of instructions between the portable apparatus and a terminal comprising a first input component and a first output component;

(b) a processor; and

(c) a memory configured to communicate with the processor, wherein the memory has a plurality of processing instructions stored thereon, including a first set of processing instructions, which when executed by the portable apparatus processor, enables the first input component to interface with the portable apparatus through an interactive user interface presented on the first output component.

**REMARKS**

Reconsideration of the above-identified application in view of the foregoing amendments and following remarks is respectfully requested.

**I. Status Of Claims**

Claims 1-8, 10-15, 17-38, 41-57, 59-63, 67 and 70-158 are currently pending in this application. Claims 1-8, 10-15, 17-38, 41-44, 46-57, 59-63, 67 and 70-73 have been amended, claims 9, 39-40, 58, 64-66 and 68-69 have been canceled, and new claims 74-158 have been added. No new matter has been added by these new claims or amendments.

**II. Declaration Antedating Wilson, Manchester And Ryan**

Submitted herewith is a inventor's declaration under 37 C.F.R. 1.131 establishing an actual reduction to practice of the claimed invention in the United States prior to December 12, 2002, the earliest possible priority dates for Wilson, Manchester and Ryan. The Wilson priority date is apparently January 16, 2004. The earliest possible priority date for Manchester is January 7, 2004. The earliest possible priority date for Ryan is August 18, 2004.

Applicant submits that the accompanying Rule 131 Declaration clearly establishes that the inventor reduced the subject matter of at least claims 1, 2, 32, 33, 61, 62, 63, 67, 78, 110, 114, 158 and dependent claims 10-12, 15, 17-19, 23-25, 27-29, 31, 34, 41, 46-49, 51-53, 59-60, 70, 77, 86, 89-95, 97, 99, 106, 115, 125-134, 136, 139, 140-141, 143 and 152 of the present application prior to December 12, 2002. Therefore, Applicant respectfully submits that Wilson, Manchester and Ryan (each having earliest possible priority dates after December 12, 2002) are not prior art to any of the foregoing claims. Accordingly, applicant respectfully requests the rejections of the foregoing claims based on Wilson, Manchester and Ryan be withdrawn.

The attached declaration also antedates the earliest possible priority dates for the publications cited in the accompanying Information Disclosure Statement submitted the applicant. The earliest possible priority date for U.S. Patent Publication No. US2004/0127254 filed by Chang (“Chang”) is December 12, 2002 and the earliest possible priority date for U.S. Patent No. 7,454,783 to DuPouy et al. (“DuPouy”) is August 8, 2003.

### **III. Claim Rejections**

#### **A. Rejection Of Claims 1, 32 And 70-73 Under 35 U.S.C. §103(a) Based On Margalit And Wilson**

Claims 1, 32 and 70-73 have been rejected under 35 U.S.C. §103(a) as being unpatentable over the combination of Margalit and Wilson. Applicant respectfully traverses the rejection of these claims on the following grounds.

Applicant has amended claims 1, 32 and 70-73 to clarify the present invention and respectfully submits that the invention as recited in these claims is patentably distinguished over Margalit and Wilson.

Applicant’s invention, as set forth in claim 1, is directed to a portable apparatus, comprising:

(a) a conduit for external communications configured to enable the transmission of a plurality of instructions between the portable apparatus and a terminal comprising a terminal processor, a first input component, a first output component comprising a display device, and a network interface, wherein the conduit for external communications comprises a universal serial bus conduit;

(b) a processor; and

(c) a memory configured to communicate with the processor, wherein the memory has a unique apparatus identifier and a plurality of processing instructions stored thereon, including:

(1) a first set of processing instructions, which when executed by the terminal processor, enables the first input component to interface with the portable apparatus through an interactive user interface presented on the terminal display device and provides the portable apparatus with access to the terminal network interface; and

(2) at least one processing instruction, which when executed by the portable apparatus processor, causes the portable apparatus processor to:

(i) execute a second set of processing instructions stored on the memory; and

(ii) effect the display of processing activity on the terminal display device;

wherein the portable apparatus is configured to communicate with the terminal and to communicate through the terminal network interface with a device.

Claim 32 is a method claim containing similar limitations to those recited in claim

1. Claims 70-73 depend from claim 32 and recite limitations directed to the conduit for external communications.

Margalit and Wilson, either alone or taken together, fail to disclose, teach or suggest (1) the functionality of the claimed portable device/method and (2) the interactivity of the claimed portable device with a terminal as recited in the pending claims. More specifically, Margalit and Wilson fail to disclose, teach or suggest (1) a portable apparatus having a memory containing a first set of processing instructions, which when executed, enables a terminal input component to interface with the portable apparatus through an interactive user interface presented on the terminal output device and provides the portable apparatus with access to the terminal network interface, (2) a portable apparatus having a memory containing at least one processing instruction, which when executed by the portable apparatus processor, causes the

portable apparatus processor to execute a second set of processing instructions from the portable apparatus memory, (3) a portable apparatus configured to effect the display of processing activity on the terminal and (4) a portable apparatus configured to communicate through the terminal network interface with a device.

In the first embodiment illustrated in Figure 1, Margalit discloses a conventional memory stick having a processor which functions as a delegate to and acts on instructions provided by the terminal. As expressly stated in Margalit, when this portable storage device is coupled to a terminal, the terminal (host 20) instructs the on-board processor (microprocessor 30) to read or write data on the portable device memory using the same terminal system commands as it would with any other conventional mechanical disk drive (e.g., a floppy disk or a hard disk).

The USB interface chip 40 receives USB packets from the USB host 20, parses the data, and feeds the parsed data to the microprocessor 30. The microprocessor 30 writes the data to, or reads the data from, the firmware memory 50, the RAM 60 or the user's data memory 70, using each memory's protocol.

In read operation, the microprocessor 30 passes that data to the USB interface chip 40 which wraps the data in USB packet format and passes it to the host 20. Col. 3, lns. 6-13 (emphasis added).

In the second embodiment illustrated in Figure 2, Margalit discloses a conventional memory stick having a smart card reader and smart card chip. As with the first embodiment discussed above, Margalit discloses that the processor in the second embodiment (microprocessor 130) acts on instructions provided by the terminal (host 120) to facilitate the transfer of data between the terminal and the smart card chip 170.

The USB interface chip 140 gets USB packets from the USB host 120. The USB interface chip 140 parses the data and passes it to the microprocessor 130. The data, which typically comprises a ISO7816-3 T=0/1 formatted package, is passed by the microprocessor 130 to the smart-card 170 in a ISO7816-3 protocol.



The microprocessor 130 gets the response from the smart card 160 and passes the data to the USB interface chip 140. The USB interface chip 140 wraps the data in USB packet format and passes it to the host 120. Col. 3, Ins. 33-41 (emphasis added).

This flow of data also applies for security functions provided by the smart card chip 170. As explained in Margalit, the security functions performed by smart chip 170 (e.g., encryption, authentication and access control) are all based on the receipt of communications from the terminal.

Preferably the apparatus also includes a microprocessor operative to receive said USB communications from the USB interface, to perform computations thereupon and to provide results of the computations to the data storage unit for storage and/or for encryption and/or for authentication and/or for access control. Col. 1, Ins. 60-65 (emphasis added).

Accordingly, Margalit discloses a memory stick having a processor which acts as a delegate, liaison or slave under the control of the USB host and which merely responds to communications from the USB host.

Contrary to the Examiner's assertion, one of ordinary skill in the art would not understand that any information derived from USB descriptor information obtained from the memory stick in Margalit constitutes processing instructions from the portable apparatus memory that are executed by the USB host in connection with authentication, encryption or access control functions. As clearly explained in Margalit, these security functions are performed by the smart chip residing on the portable device and are responsive to communications received from the USB host. Accordingly, Margalit fails to disclose, teach or suggest a portable apparatus having the functionality recited in the pending claims where the

portable apparatus executes instructions stored on the portable apparatus memory to effect activity by the terminal and portable device processor.

Wilson is directed to a portable storage device for storing and retrieving data from a central computer system. Wilson discloses that a portable storage device 102 is adapted to interface with a reader/writer device 104 which, in turn, is coupled to a computer system 106. Each of the reader/writer device 104 and the computer system 106 include dedicated input and output devices which operate in connection with their respective central processing unit and memory. For example, Wilson discloses in Paragraph 35 that:

Reader/writer device 104 includes a central processing unit (CPU) 110, a portable storage device (PSD) interface 112, a computer system (CS) interface 114, input devices 116, output devices 118, and a memory 120 coupled together via bus 122 over which the various elements may interchange data and information.

In Paragraph 37, Wilson goes on to identify various types and functions of input and output devices 116, 118 which may be used with the reader/writer device 104 to enter and verify user authorization and authentication information.

Input devices 116, e.g., keypads, keyboards, touch displays, biometric readers, etc., are used to enter data/information used in making decisions regarding authentication, authorization, information retrieval access, and information writing access. Information entered through input devices 116 may include a PIN entered by the cardholder (e.g., head of household) of the portable storage device (e.g., smart card) 102, biometric identify information obtained from the holder of the portable storage device (e.g., smart card) 102, and/or a service provider identity number or identity type entered by the service provider. In some embodiments, identity information, e.g., an identity number and/or biometrics pertaining to a patient, may be input through input devices 116. The cardholder and the person receiving the healthcare-related service need not be the same person, e.g., the cardholder may be a parent and the patient may be a dependent child. Output devices 118, e.g., displays, printers, speakers, etc.,

output instructional commands and/or messages to the user, e.g., insert card, enter PIN, access granted, access denied, individual positively identified, etc.

Wilson includes a similar disclosure with regard to the configuration and operation of the computer system 106 which contains the user's medical data/information. Paragraph 40 describes the configuration of the computer system 106 including its dedicated input and output devices 138, 140.

Computer system 106 includes a CPU 132, a reader/writer interface 134, a database interface 136, input devices 138, output devices 140, and a memory 142 coupled together via bus 144 over which the various elements can interchange data and information. Memory 142 includes routines 146 and data/information 148. Routines 146 include a communications module 150 and an applications module 152. CPU 132, e.g., a processor, executes the routines 146 and uses the data/information 148 in memory 142 to operate the computer system 106.

In Paragraph 42, Wilson identifies specific input and output devices 138, 140 which may be used by the service provider to enter and display a user's medical data/information.

Input devices 138 may include, e.g., keypads, keyboards, touch displays, a computer mouse, etc. Input devices 138 may be used by the service provide [sic, provider] to interface with the routines 146, to control other input devices 138 an to control output devices 140. Input devices 138 may include medical instrumentation devices with computer interfaces, e.g., a heart monitoring device, a blood testing device, etc.; these input devices 138 may be used to obtain additional medical related data and information on an individual. Output devices 140, e.g., displays, printers, strip recorders, speakers, etc., may output data and information which has been retrieved from PSD 102 and/or network database 108. Output devices 140 may output processing results, e.g., test results, test images, etc. In addition, output devices 140 may output accounting, administrative, or management type healthcare related data/information, e.g., billing information, appointments, etc.

Wilson further discloses that computer system 106 may also include a database interface 136 such that the user medical data/information 148 stored on the memory of computer system 106 may also be maintained in a remote network database 108 and/or secure central data repository 154.

Database interface 136 is an interface allowing to [sic, the] network database 108 to be coupled to computer system 106 via link 107. In some embodiments, the database interface 136 is a local network interface. In other embodiments, e.g., where the network database 108 is located [at] a remote site, the database interface may include a modem which may provide an Internet interface. [Paragraph 0041]

\* \* \*

Exemplary system 100 optionally includes a (secure) central data repository 154 coupled to computer system 106 via link 156. In some embodiments, encrypted health data/information may be transmitted over link 156 to (secure) central data repository 154. [Paragraph 0047]

Applicant respectfully disagrees with the Examiner's characterization that these disclosures in Wilson describe interaction between the portable storage device 102 and the input devices, output devices or network interface of either the reader/writer device 104 or computer system 106. Specifically, contrary to the Examiner's assertion, Wilson fails to disclose, teach or suggest that (1) the computer system 106 input and output devices 138, 140 interface with the portable storage device 102 or (2) the portable storage device 102 is provided access to the computer system database interface 136. As clearly provided in Wilson, the portable storage device 102 merely stores a compilation of personal data/information entered into the computer system data/information memory module 148 which is accessible through the reader/writer device 104 upon successful user verification.

When portable storage device, e.g., smart card, 102 is interfaced to the reader/writer device 104, medical related information/data may be input and/or output from portable storage device 102 through reader/writer device 104 following authentication and authorization. [Paragraph 0034]

In the same manner as discussed above with regard to the portable storage device in Margalit, the processor 202 in Wilson merely functions as a liaison or delegate in facilitating the transfer of data between the portable storage device memory and the computer system database.

Furthermore, Wilson does not include any disclosure, teaching or suggestion that (1) the portable storage device 102 has a memory containing a set of processing instructions, which when executed, enables the input device 138 to interface with the portable storage device 102 or (2) the portable storage device memory includes at least one processing instruction, which when executed by the portable storage device processor effects the display of processor activity on the reader/writer output display 118.

**B. Rejection Of Claims 2-8, 10-14, 19, 23-31, 33-34, 38-39, 42-54 And 56 Under 35 U.S.C. §102(e) Based On Margalit**

Claims 2-8, 10-14, 19, 23-31, 33-34, 38-39, 42-54 and 56 have been rejected under 35 U.S.C. §102(e) as being anticipated by Margalit.<sup>1</sup> Applicant respectfully traverses the rejection of these claims on the following grounds.

Applicant has amended claims 2-8, 10-14, 19, 23-31, 33-34, 38-44, 46-54 and 56 to clarify the present invention and respectfully submits that the invention as recited in these claims is patentably distinguished over Margalit.

Applicant's invention, as set forth in claim 2, is directed to a portable apparatus, comprising:

---

<sup>1</sup> Applicant has canceled claim 39 therefore rendering the rejection of this claim moot.

(a) a conduit for external communications configured to enable the transmission of a plurality of instructions between the portable apparatus and a terminal comprising a terminal processor, a first input component, a first output component, and a network interface;

(b) a processor; and

(c) a memory configured to communicate with the processor, wherein the memory has a unique apparatus identifier and a plurality of processing instructions stored thereon, including:

(1) a first set of processing instructions, which when executed by the terminal processor, enables the first input component to interface with the portable apparatus through an interactive user interface presented on the first output component; and

(2) at least one processing instruction, which when executed by the portable apparatus processor, causes a second set of processing instructions to be executed, wherein the processing activity of the second set of processing instructions is presented on the first output component;

wherein the portable apparatus is configured to communicate with the terminal and to communicate with a device configured to communicate with the terminal.

Claim 33 is a method claim containing similar limitations to those recited in claim 2. Claims 3-8, 10-14, 19 and 23-31 depend from claim 2 and claims 34, 38, 42-54 and 56 depend from claim 33. These dependent claims are directed to verification, authentication and encryption features of the invention, the source and functionality of the second set of processing instructions and the nature of the conduit for external communication.

As discussed above in response to the rejections of claims 1, 32 and 70-73, Margalit fails to disclose, teach or suggest (1) the functionality of the claimed portable device/method and (2) the interactivity of the claimed portable device with a terminal as recited in the pending claims. More specifically, Margalit fails to disclose, teach or suggest (1) a

portable apparatus having a memory containing a first set of processing instructions, which when executed, enables a terminal input component to interface with the portable apparatus through an interactive user interface presented on the terminal output device, (2) at least one processing instruction, which when executed by the portable apparatus processor, causes a second set of processing instructions to be executed and (3) the presentation of processing activity of the second set of processing instructions on the first output component. Margalit also fails to disclose, teach or suggest the feature in claim 2 directed to a portable apparatus configured to communicate with a device configured to communicate with the terminal.

As discussed above in response to the Examiner's rejection of claims 1, 32 and 70-73 under 35 U.S.C. §103(a) in view of Margalit and Wilson, Margalit discloses that the on-board processor 30, 130 is simply a liaison or delegate and operates in response to instructions provided by the terminal to facilitate the transfer of data between the on-board memory or smart card chip 170 and the terminal (USB host 20, 120). Similarly, the smart chip 170 performs authentication, encryption and access control security functions in response to communications provided by the USB host.

**C. Rejection Of Claims 9, 15, 17-18, 20-22, 35-37, 40-41, 55 And 57-60 Under 35 U.S.C. §103(a) Based On Margalit And Manchester**

Claims 9, 15, 17-18, 20-22, 35-37, 40-41, 55, 57-60 have been rejected under 35 U.S.C. §103(a) as being unpatentable over the combination of Margalit and U.S. Publication No. 2005/0198221 to Manchester et al. ("Manchester"). Applicant respectfully traverses the rejection of these claims on the following grounds.<sup>2</sup>

---

<sup>2</sup> Applicant has canceled claims 40 and 58 rendering the rejection of these claims moot.

Claims 15, 17-18, 20-22 depend from claim 2 and claims 35-37, 40-41, 55, 57 and 59-60 depend from independent claim 33. Applicant respectfully submits that these claims are patentable over any possible combination of Margalit and Manchester for at least the same reasons set forth above in response to the rejections of claims 2 and 33 under 35 U.S.C. §102(e) based on Margalit alone.

In addition, with regard to claim and 41, Manchester fails to disclose, teach or suggest the step of executing a first set of processing instructions from the portable device memory on the terminal processor to provide the portable apparatus with access to the terminal network interface. To the contrary, Manchester simply discloses a conventional arrangement where input and output devices 161, 162, 196 and 197 are dedicated to and controlled by the computer 110. Manchester fails to include any disclosure that would lead one of ordinary skill in the art to understand that (1) input devices 161, 162 are configured to interface with the portable device through an interactive user interface presented on a terminal output or (2) the terminal network interface is configured to interface with the portable device.

Applicant further traverses the Examiner's rejection of claims 13 and 57 on the grounds that Manchester fails to disclose, teach or suggest a second set of processing instructions, which when executed by the portable apparatus processor, process files for printing. Contrary to the Examiner's assertion, Manchester merely discloses that the user may input a request to the terminal processor to print a hard copy of the network settings. Manchester is devoid of any disclosure, teaching or suggestion that the portable apparatus processor processes any processing instructions configured to process files for printing or that the portable apparatus



is configured to effect the execution of processing instructions configured to process files for printing.

**D. Rejection Of Claims 61-66 Under 35 U.S.C. §103(a) Based On Margalit And Wilson**

Claims 61-66 have been rejected under 35 U.S.C. §103(a) as being unpatentable over the combination of Margalit and Wilson. Applicant respectfully traverses the rejection of these claims on the following grounds.<sup>3</sup>

Applicant respectfully submits that claims 61 and 63 are patentably distinct over Margalit and Wilson for at least the same reasons set forth above in response to the rejections of claim 32 under 35 U.S.C. §103(a) based on Margalit and Wilson. Applicant further submits that claim 62 is patentably distinct over Margalit and Wilson for at least the same reasons set forth above in response to the rejection of claim 33 under 35 U.S.C. §102(e) based on Margalit.

**E. Rejection Of Claims 67-69 Under 35 U.S.C. §102(e) Based On Ryan**

Claims 67-69 have been rejected under 35 U.S.C. §102(e) as being anticipated by Ryan.<sup>4</sup> Applicant notes that in view the accompanying Rule 131 inventor declaration establishing an actual reduction to practice of the claimed invention in the United States prior to December 12, 2002, Ryan does not constitute prior art under 35 U.S.C. §102(e). Accordingly, applicant respectfully requests that this rejection be withdrawn.

**F. New Claims 78-158 Are Patentably Distinct Over The Prior Art**

Applicant respectfully submits that new claims 78-158 are in condition for allowance. With regard to claims 78-113, the prior art fails to disclose, teach or suggest, *inter*

---

<sup>3</sup> Applicant has canceled claims 64-66 rendering the rejection of these claims moot.

<sup>4</sup> Applicant has canceled claims 68 and 69 rendering the rejection of these claims moot.

*alia*, a portable apparatus comprising a memory having a first set of processing instructions, which when executed, (i) presents an interactive user interface on a terminal output component, (ii) enables a terminal input component to interface with the portable apparatus through the interactive user interface and (iii) provides the portable apparatus with access to the terminal network interface.

With regard to claims 114-157, the prior art fails to disclose, teach or suggest, *inter alia*, a portable apparatus configured to provide a terminal with access to a first set of processing instructions, which when executed by the terminal processor, enables the terminal input component to interface with the portable apparatus through an interactive user interface presented on the terminal output component.

With regard to claim 158, the prior art fails to disclose, teach or suggest, *inter alia*, a portable apparatus comprising a memory having a first set of processing instructions stored thereon, which when executed by the portable apparatus processor, enables the first input component to interface with the portable apparatus through an interactive user interface presented on the first output component.

### **CONCLUSION**

Applicant requests an early and favorable examination on the merits. In the event that a telephone conference would facilitate the examination of this application in any way, the Examiner is invited to contact the undersigned at the number provided.

**AUTHORIZATION**

The Commissioner is hereby authorized to charge any additional fees which may be required for the timely consideration of this amendment under I 37 C.F.R. §§ 1.16 AND 1.17, or credit any overpayment to the Deposit Account No. **50-4827**, Order No. **1004294-001US**.

Respectfully submitted,  
Locke Lord Bissell & Liddell LLP

Dated: April 16, 2010

By: \_\_\_\_\_

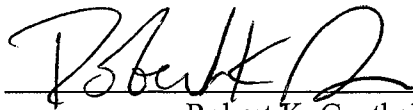

Robert K. Goethals  
Registration No. 36,813

Correspondence Address:

Locke Lord Bissell & Liddell LLP  
3 World Financial Center  
New York, NY 10281-2101  
(212) 415-8522 Telephone  
(212) 303-2754 Facsimile

**IN THE UNITED STATES PATENT AND TRADEMARK OFFICE**

Serial No.: 10/807,731 Confirmation No.: 4430  
 Applicant(s): Scott McNulty Group Art Unit: 2443  
 Examiner: Asghar H. Bilgrami  
 Filed: March 23, 2004 Customer No.: 85775  
 For: APPARATUS, METHOD AND SYSTEM FOR A TUNNELING CLIENT ACCESS POINT

**PETITION AND FEE FOR EXTENSION OF TIME (37 C.F.R. § 1.136(a))**

Mail Stop Amendment  
 Commissioner for Patents  
 P.O. Box 1450  
 Alexandria, VA 22313-1450

Sir:

1. This is a petition for an extension of time for an Amendment & Response and an RCE
2. The communication in connection with the matter for which this extension is requested
  - are filed herewith.
  - has been filed on \_\_\_\_\_.

3.  Applicant(s) is/are entitled to Small Entity Status.
  - Statement has already been filed

4.
 

		<u>Total Months Requested</u>	<u>Fee for Other than Small Entity</u>	<u>Fee for Small Entity</u>
a.	<input type="checkbox"/>	one month	\$130.00	\$65.00
b.	<input type="checkbox"/>	two months	\$490.00	\$245.00
c.	<input checked="" type="checkbox"/>	three months	\$1,110.00	\$555.00
d.	<input type="checkbox"/>	four months	\$1,730.00	\$865.00
e.	<input type="checkbox"/>	five months	\$2,350.00	\$1,175.00
f.	<input type="checkbox"/>	An extension for _____ months has already been secured for filing the above-identified communication and the fee paid therefor of \$_____ is deducted from the total fee due for the total months of extension now requested. The fee for this extension (\$ _____), minus the fee previously paid (\$_____ ) equals \$_____ (total fee due).		

5.  A check in the amount of \$\_\_\_\_\_ to cover the extension fee is attached.
6.  Charge fee to Deposit Account No. 504827, Order No. 1004294.001US.
7.  The Commissioner is hereby authorized to charge any additional fees which may be required by this paper, or credit any overpayment to Deposit Account No. 504827, Order No. 1004294.001US.

Respectfully submitted,  
LOCKE LORD BISSELL & LIDDELL LLP

  
\_\_\_\_\_

Robert K. Goethals  
Registration No. 36,813

Dated: April 16, 2010

Correspondence Address:

Address Associated With Customer Number:  
85775

(212) 415-8600 Telephone

(212) 303-2754 Facsimile

Under the Paperwork Reduction Act of 1995, no persons are required to respond to a collection of information unless it displays a valid OMB control number.

<b>PATENT APPLICATION FEE DETERMINATION RECORD</b> Substitute for Form PTO-875	Application or Docket Number <b>10/807,731</b>	Filing Date <b>03/23/2004</b>	<input type="checkbox"/> To be Mailed
---	---	----------------------------------	---------------------------------------

APPLICATION AS FILED – PART I			OTHER THAN SMALL ENTITY				
FOR	NUMBER FILED (Column 1)	NUMBER EXTRA (Column 2)	RATE (\$)	FEE (\$)		RATE (\$)	FEE (\$)
<input type="checkbox"/> BASIC FEE <small>(37 CFR 1.16(a), (b), or (c))</small>	N/A	N/A	N/A			N/A	
<input type="checkbox"/> SEARCH FEE <small>(37 CFR 1.16(k), (l), or (m))</small>	N/A	N/A	N/A			N/A	
<input type="checkbox"/> EXAMINATION FEE <small>(37 CFR 1.16(o), (p), or (q))</small>	N/A	N/A	N/A			N/A	
TOTAL CLAIMS <small>(37 CFR 1.16(i))</small>	minus 20 =	*	X \$ =		OR	X \$ =	
INDEPENDENT CLAIMS <small>(37 CFR 1.16(h))</small>	minus 3 =	*	X \$ =			X \$ =	
<input type="checkbox"/> APPLICATION SIZE FEE <small>(37 CFR 1.16(s))</small>	If the specification and drawings exceed 100 sheets of paper, the application size fee due is \$250 (\$125 for small entity) for each additional 50 sheets or fraction thereof. See 35 U.S.C. 41(a)(1)(G) and 37 CFR 1.16(s).						
<input type="checkbox"/> MULTIPLE DEPENDENT CLAIM PRESENT <small>(37 CFR 1.16(j))</small>							
* If the difference in column 1 is less than zero, enter "0" in column 2.			TOTAL			TOTAL	

APPLICATION AS AMENDED – PART II					OTHER THAN SMALL ENTITY				
	(Column 1)	(Column 2)	(Column 3)		SMALL ENTITY		OR	OTHER THAN SMALL ENTITY	
<b>AMENDMENT</b>	<b>04/16/2010</b>	CLAIMS REMAINING AFTER AMENDMENT	HIGHEST NUMBER PREVIOUSLY PAID FOR	PRESENT EXTRA	RATE (\$)	ADDITIONAL FEE (\$)		RATE (\$)	ADDITIONAL FEE (\$)
	Total <small>(37 CFR 1.16(i))</small>	* 148	Minus	** 73	=	75		X \$ =	
	Independent <small>(37 CFR 1.16(h))</small>	* 11	Minus	*** 12	=	0		X \$ =	
	<input type="checkbox"/> Application Size Fee <small>(37 CFR 1.16(s))</small>								
<input type="checkbox"/> FIRST PRESENTATION OF MULTIPLE DEPENDENT CLAIM <small>(37 CFR 1.16(j))</small>							OR		
					TOTAL ADD'L FEE	<b>1950</b>		OR	TOTAL ADD'L FEE

	(Column 1)	(Column 2)	(Column 3)		SMALL ENTITY		OR	OTHER THAN SMALL ENTITY	
<b>AMENDMENT</b>		CLAIMS REMAINING AFTER AMENDMENT	HIGHEST NUMBER PREVIOUSLY PAID FOR	PRESENT EXTRA	RATE (\$)	ADDITIONAL FEE (\$)		RATE (\$)	ADDITIONAL FEE (\$)
	Total <small>(37 CFR 1.16(i))</small>	*	Minus	**	=			X \$ =	
	Independent <small>(37 CFR 1.16(h))</small>	*	Minus	***	=			X \$ =	
	<input type="checkbox"/> Application Size Fee <small>(37 CFR 1.16(s))</small>								
<input type="checkbox"/> FIRST PRESENTATION OF MULTIPLE DEPENDENT CLAIM <small>(37 CFR 1.16(j))</small>							OR		
					TOTAL ADD'L FEE			OR	TOTAL ADD'L FEE

\* If the entry in column 1 is less than the entry in column 2, write "0" in column 3.  
 \*\* If the "Highest Number Previously Paid For" IN THIS SPACE is less than 20, enter "20".  
 \*\*\* If the "Highest Number Previously Paid For" IN THIS SPACE is less than 3, enter "3".  
 The "Highest Number Previously Paid For" (Total or Independent) is the highest number found in the appropriate box in column 1.

Legal Instrument Examiner:  
 /Wanda Meredith/

This collection of information is required by 37 CFR 1.16. The information is required to obtain or retain a benefit by the public which is to file (and by the USPTO to process) an application. Confidentiality is governed by 35 U.S.C. 122 and 37 CFR 1.14. This collection is estimated to take 12 minutes to complete, including gathering, preparing, and submitting the completed application form to the USPTO. Time will vary depending upon the individual case. Any comments on the amount of time you require to complete this form and/or suggestions for reducing this burden, should be sent to the Chief Information Officer, U.S. Patent and Trademark Office, U.S. Department of Commerce, P.O. Box 1450, Alexandria, VA 22313-1450. DO NOT SEND FEES OR COMPLETED FORMS TO THIS ADDRESS. **SEND TO: Commissioner for Patents, P.O. Box 1450, Alexandria, VA 22313-1450.**  
 If you need assistance in completing the form, call 1-800-PTO-9199 and select option 2.

Under the Paperwork Reduction Act of 1995, no persons are required to respond to a collection of information unless it displays a valid OMB control number.

<b>PATENT APPLICATION FEE DETERMINATION RECORD</b> Substitute for Form PTO-875	Application or Docket Number <b>10/807,731</b>	Filing Date <b>03/23/2004</b>	<input type="checkbox"/> To be Mailed
---	---	----------------------------------	---------------------------------------

APPLICATION AS FILED – PART I			OTHER THAN SMALL ENTITY				
	(Column 1)	(Column 2)	SMALL ENTITY <input checked="" type="checkbox"/>	OR			
FOR	NUMBER FILED	NUMBER EXTRA	RATE (\$)	FEE (\$)	OR	RATE (\$)	FEE (\$)
<input type="checkbox"/> BASIC FEE <small>(37 CFR 1.16(a), (b), or (c))</small>	N/A	N/A	N/A			N/A	
<input type="checkbox"/> SEARCH FEE <small>(37 CFR 1.16(k), (l), or (m))</small>	N/A	N/A	N/A			N/A	
<input type="checkbox"/> EXAMINATION FEE <small>(37 CFR 1.16(o), (p), or (q))</small>	N/A	N/A	N/A			N/A	
TOTAL CLAIMS <small>(37 CFR 1.16(i))</small>	minus 20 =	*	X \$ =		OR	X \$ =	
INDEPENDENT CLAIMS <small>(37 CFR 1.16(h))</small>	minus 3 =	*	X \$ =			X \$ =	
<input type="checkbox"/> APPLICATION SIZE FEE <small>(37 CFR 1.16(s))</small>	If the specification and drawings exceed 100 sheets of paper, the application size fee due is \$250 (\$125 for small entity) for each additional 50 sheets or fraction thereof. See 35 U.S.C. 41(a)(1)(G) and 37 CFR 1.16(s).						
<input type="checkbox"/> MULTIPLE DEPENDENT CLAIM PRESENT <small>(37 CFR 1.16(j))</small>							
* If the difference in column 1 is less than zero, enter "0" in column 2.			TOTAL			TOTAL	

APPLICATION AS AMENDED – PART II					OTHER THAN SMALL ENTITY				
	(Column 1)	(Column 2)	(Column 3)		SMALL ENTITY	OR			
AMENDMENT	04/16/2010	CLAIMS REMAINING AFTER AMENDMENT	HIGHEST NUMBER PREVIOUSLY PAID FOR	PRESENT EXTRA	RATE (\$)	ADDITIONAL FEE (\$)	OR	RATE (\$)	ADDITIONAL FEE (\$)
	Total <small>(37 CFR 1.16(i))</small>	* 148	Minus ** 73	= 75	X \$26 =	1950	OR	X \$ =	
	Independent <small>(37 CFR 1.16(h))</small>	* 11	Minus *** 12	= 0	X \$110 =	0	OR	X \$ =	
	<input type="checkbox"/> Application Size Fee <small>(37 CFR 1.16(s))</small>								
	<input type="checkbox"/> FIRST PRESENTATION OF MULTIPLE DEPENDENT CLAIM <small>(37 CFR 1.16(j))</small>						OR		
					TOTAL ADD'L FEE	1950	OR	TOTAL ADD'L FEE	

	(Column 1)	(Column 2)	(Column 3)		SMALL ENTITY	OR			
AMENDMENT		CLAIMS REMAINING AFTER AMENDMENT	HIGHEST NUMBER PREVIOUSLY PAID FOR	PRESENT EXTRA	RATE (\$)	ADDITIONAL FEE (\$)	OR	RATE (\$)	ADDITIONAL FEE (\$)
	Total <small>(37 CFR 1.16(i))</small>	*	Minus **	=	X \$ =		OR	X \$ =	
	Independent <small>(37 CFR 1.16(h))</small>	*	Minus ***	=	X \$ =		OR	X \$ =	
	<input type="checkbox"/> Application Size Fee <small>(37 CFR 1.16(s))</small>								
	<input type="checkbox"/> FIRST PRESENTATION OF MULTIPLE DEPENDENT CLAIM <small>(37 CFR 1.16(j))</small>						OR		
					TOTAL ADD'L FEE		OR	TOTAL ADD'L FEE	

\* If the entry in column 1 is less than the entry in column 2, write "0" in column 3.  
 \*\* If the "Highest Number Previously Paid For" IN THIS SPACE is less than 20, enter "20".  
 \*\*\* If the "Highest Number Previously Paid For" IN THIS SPACE is less than 3, enter "3".  
 The "Highest Number Previously Paid For" (Total or Independent) is the highest number found in the appropriate box in column 1.

Legal Instrument Examiner:  
/Wanda Meredith/

This collection of information is required by 37 CFR 1.16. The information is required to obtain or retain a benefit by the public which is to file (and by the USPTO to process) an application. Confidentiality is governed by 35 U.S.C. 122 and 37 CFR 1.14. This collection is estimated to take 12 minutes to complete, including gathering, preparing, and submitting the completed application form to the USPTO. Time will vary depending upon the individual case. Any comments on the amount of time you require to complete this form and/or suggestions for reducing this burden, should be sent to the Chief Information Officer, U.S. Patent and Trademark Office, U.S. Department of Commerce, P.O. Box 1450, Alexandria, VA 22313-1450. DO NOT SEND FEES OR COMPLETED FORMS TO THIS ADDRESS. **SEND TO: Commissioner for Patents, P.O. Box 1450, Alexandria, VA 22313-1450.**

If you need assistance in completing the form, call 1-800-PTO-9199 and select option 2.



UNITED STATES PATENT AND TRADEMARK OFFICE

UNITED STATES DEPARTMENT OF COMMERCE
United States Patent and Trademark Office
Address: COMMISSIONER FOR PATENTS
P.O. Box 1450
Alexandria, Virginia 22313-1450
www.uspto.gov

Table with 5 columns: APPLICATION NO., FILING DATE, FIRST NAMED INVENTOR, ATTORNEY DOCKET NO., CONFIRMATION NO.
10/807,731 03/23/2004 Scott McNulty 1004294.001US 4430

85775 7590 06/04/2010
Locke Lord Bissell & Liddell LLP
Attn: IP Docketing
Three World Financial Center
New York, NY 10281-2101

EXAMINER

BILGRAMI, ASGHAR H

Table with 2 columns: ART UNIT, PAPER NUMBER

2443

Table with 2 columns: NOTIFICATION DATE, DELIVERY MODE

06/04/2010

ELECTRONIC

Please find below and/or attached an Office communication concerning this application or proceeding.

The time period for reply, if any, is set in the attached communication.

Notice of the Office communication was sent electronically on above-indicated "Notification Date" to the following e-mail address(es):

ptopatentcommunication@lockelord.com



<b>Interview Summary</b>	<b>Application No.</b> 10/807,731	<b>Applicant(s)</b> MCNULTY, SCOTT	
	<b>Examiner</b> ASGHAR BILGRAMI	<b>Art Unit</b> 2443	

All participants (applicant, applicant's representative, PTO personnel):

- (1) ASGHAR BILGRAMI. (3) Robert Goethals(36,813).  
(2) Scott Mcnaulty(Inventor). (4) \_\_\_\_\_.

Date of Interview: 27 May 2010.

Type: a)  Telephonic b)  Video Conference  
c)  Personal [copy given to: 1)  applicant 2)  applicant's representative]

Exhibit shown or demonstration conducted: d)  Yes e)  No.

If Yes, brief description: The inventor demonstrated the functionality associated with the USB device and explained the concept behind the invention.

Claim(s) discussed: 1.

Identification of prior art discussed: \_\_\_\_\_.

Agreement with respect to the claims f)  was reached. g)  was not reached. h)  N/A.

Substance of Interview including description of the general nature of what was agreed to if an agreement was reached, or any other comments: Applicant's representative explained the newly presented claim language that taught the invention being claimed. Examiner told the applicant that newly presented claims were much broader than the claims that were previously presented and advised the applicant to incorporate claim 1 in its entirety that was previously presented along with some suggested amendments to expedite the prosecution of this case. No agreement was reached.

(A fuller description, if necessary, and a copy of the amendments which the examiner agreed would render the claims allowable, if available, must be attached. Also, where no copy of the amendments that would render the claims allowable is available, a summary thereof must be attached.)

THE FORMAL WRITTEN REPLY TO THE LAST OFFICE ACTION MUST INCLUDE THE SUBSTANCE OF THE INTERVIEW. (See MPEP Section 713.04). If a reply to the last Office action has already been filed, APPLICANT IS GIVEN A NON-EXTENDABLE PERIOD OF THE LONGER OF ONE MONTH OR THIRTY DAYS FROM THIS INTERVIEW DATE, OR THE MAILING DATE OF THIS INTERVIEW SUMMARY FORM, WHICHEVER IS LATER, TO FILE A STATEMENT OF THE SUBSTANCE OF THE INTERVIEW. See Summary of Record of Interview requirements on reverse side or on attached sheet.

/David E. England/  
Primary Examiner, Art Unit 2443

/Asghar Bilgrami/  
Examiner, Art Unit 2443

## Summary of Record of Interview Requirements

### Manual of Patent Examining Procedure (MPEP), Section 713.04, Substance of Interview Must be Made of Record

A complete written statement as to the substance of any face-to-face, video conference, or telephone interview with regard to an application must be made of record in the application whether or not an agreement with the examiner was reached at the interview.

### Title 37 Code of Federal Regulations (CFR) § 1.133 Interviews Paragraph (b)

In every instance where reconsideration is requested in view of an interview with an examiner, a complete written statement of the reasons presented at the interview as warranting favorable action must be filed by the applicant. An interview does not remove the necessity for reply to Office action as specified in §§ 1.111, 1.135. (35 U.S.C. 132)

#### 37 CFR §1.2 Business to be transacted in writing.

All business with the Patent or Trademark Office should be transacted in writing. The personal attendance of applicants or their attorneys or agents at the Patent and Trademark Office is unnecessary. The action of the Patent and Trademark Office will be based exclusively on the written record in the Office. No attention will be paid to any alleged oral promise, stipulation, or understanding in relation to which there is disagreement or doubt.

The action of the Patent and Trademark Office cannot be based exclusively on the written record in the Office if that record is itself incomplete through the failure to record the substance of interviews.

It is the responsibility of the applicant or the attorney or agent to make the substance of an interview of record in the application file, unless the examiner indicates he or she will do so. It is the examiner's responsibility to see that such a record is made and to correct material inaccuracies which bear directly on the question of patentability.

Examiners must complete an Interview Summary Form for each interview held where a matter of substance has been discussed during the interview by checking the appropriate boxes and filling in the blanks. Discussions regarding only procedural matters, directed solely to restriction requirements for which interview recordation is otherwise provided for in Section 812.01 of the Manual of Patent Examining Procedure, or pointing out typographical errors or unreadable script in Office actions or the like, are excluded from the interview recordation procedures below. Where the substance of an interview is completely recorded in an Examiners Amendment, no separate Interview Summary Record is required.

The Interview Summary Form shall be given an appropriate Paper No., placed in the right hand portion of the file, and listed on the "Contents" section of the file wrapper. In a personal interview, a duplicate of the Form is given to the applicant (or attorney or agent) at the conclusion of the interview. In the case of a telephone or video-conference interview, the copy is mailed to the applicant's correspondence address either with or prior to the next official communication. If additional correspondence from the examiner is not likely before an allowance or if other circumstances dictate, the Form should be mailed promptly after the interview rather than with the next official communication.

The Form provides for recordation of the following information:

- Application Number (Series Code and Serial Number)
- Name of applicant
- Name of examiner
- Date of interview
- Type of interview (telephonic, video-conference, or personal)
- Name of participant(s) (applicant, attorney or agent, examiner, other PTO personnel, etc.)
- An indication whether or not an exhibit was shown or a demonstration conducted
- An identification of the specific prior art discussed
- An indication whether an agreement was reached and if so, a description of the general nature of the agreement (may be by attachment of a copy of amendments or claims agreed as being allowable). Note: Agreement as to allowability is tentative and does not restrict further action by the examiner to the contrary.
- The signature of the examiner who conducted the interview (if Form is not an attachment to a signed Office action)

It is desirable that the examiner orally remind the applicant of his or her obligation to record the substance of the interview of each case. It should be noted, however, that the Interview Summary Form will not normally be considered a complete and proper recordation of the interview unless it includes, or is supplemented by the applicant or the examiner to include, all of the applicable items required below concerning the substance of the interview.

A complete and proper recordation of the substance of any interview should include at least the following applicable items:

- 1) A brief description of the nature of any exhibit shown or any demonstration conducted,
- 2) an identification of the claims discussed,
- 3) an identification of the specific prior art discussed,
- 4) an identification of the principal proposed amendments of a substantive nature discussed, unless these are already described on the Interview Summary Form completed by the Examiner,
- 5) a brief identification of the general thrust of the principal arguments presented to the examiner,  
(The identification of arguments need not be lengthy or elaborate. A verbatim or highly detailed description of the arguments is not required. The identification of the arguments is sufficient if the general nature or thrust of the principal arguments made to the examiner can be understood in the context of the application file. Of course, the applicant may desire to emphasize and fully describe those arguments which he or she feels were or might be persuasive to the examiner.)
- 6) a general indication of any other pertinent matters discussed, and
- 7) if appropriate, the general results or outcome of the interview unless already described in the Interview Summary Form completed by the examiner.

Examiners are expected to carefully review the applicant's record of the substance of an interview. If the record is not complete and accurate, the examiner will give the applicant an extendable one month time period to correct the record.

#### Examiner to Check for Accuracy

If the claims are allowable for other reasons of record, the examiner should send a letter setting forth the examiner's version of the statement attributed to him or her. If the record is complete and accurate, the examiner should place the indication, "Interview Record OK" on the paper recording the substance of the interview along with the date and the examiner's initials.



NOTICE OF ALLOWANCE AND FEE(S) DUE

85775 7590 09/20/2010

Locke Lord Bissell & Liddell LLP
Attn: IP Docketing
Three World Financial Center
New York, NY 10281-2101

EXAMINER: BILGRAMI, ASGHAR H
ART UNIT: 2443
PAPER NUMBER:
DATE MAILED: 09/20/2010

Table with 5 columns: APPLICATION NO., FILING DATE, FIRST NAMED INVENTOR, ATTORNEY DOCKET NO., CONFIRMATION NO.

10/807,731 03/23/2004 Scott McNulty 1004294.001US 4430
TITLE OF INVENTION: APPARATUS, METHOD AND SYSTEM FOR A TUNNELING CLIENT ACCESS POINT (4602-4001)

Table with 7 columns: APPLN. TYPE, SMALL ENTITY, ISSUE FEE DUE, PUBLICATION FEE DUE, PREV. PAID ISSUE FEE, TOTAL FEE(S) DUE, DATE DUE

THE APPLICATION IDENTIFIED ABOVE HAS BEEN EXAMINED AND IS ALLOWED FOR ISSUANCE AS A PATENT. PROSECUTION ON THE MERITS IS CLOSED. THIS NOTICE OF ALLOWANCE IS NOT A GRANT OF PATENT RIGHTS. THIS APPLICATION IS SUBJECT TO WITHDRAWAL FROM ISSUE AT THE INITIATIVE OF THE OFFICE OR UPON PETITION BY THE APPLICANT. SEE 37 CFR 1.313 AND MPEP 1308.

THE ISSUE FEE AND PUBLICATION FEE (IF REQUIRED) MUST BE PAID WITHIN THREE MONTHS FROM THE MAILING DATE OF THIS NOTICE OR THIS APPLICATION SHALL BE REGARDED AS ABANDONED. THIS STATUTORY PERIOD CANNOT BE EXTENDED. SEE 35 U.S.C. 151. THE ISSUE FEE DUE INDICATED ABOVE DOES NOT REFLECT A CREDIT FOR ANY PREVIOUSLY PAID ISSUE FEE IN THIS APPLICATION. IF AN ISSUE FEE HAS PREVIOUSLY BEEN PAID IN THIS APPLICATION (AS SHOWN ABOVE), THE RETURN OF PART B OF THIS FORM WILL BE CONSIDERED A REQUEST TO REAPPLY THE PREVIOUSLY PAID ISSUE FEE TOWARD THE ISSUE FEE NOW DUE.

HOW TO REPLY TO THIS NOTICE:

I. Review the SMALL ENTITY status shown above.
If the SMALL ENTITY is shown as YES, verify your current SMALL ENTITY status:
A. If the status is the same, pay the TOTAL FEE(S) DUE shown above.
B. If the status above is to be removed, check box 5b on Part B - Fee(s) Transmittal and pay the PUBLICATION FEE (if required) and twice the amount of the ISSUE FEE shown above, or

If the SMALL ENTITY is shown as NO:
A. Pay TOTAL FEE(S) DUE shown above, or
B. If applicant claimed SMALL ENTITY status before, or is now claiming SMALL ENTITY status, check box 5a on Part B - Fee(s) Transmittal and pay the PUBLICATION FEE (if required) and 1/2 the ISSUE FEE shown above.

II. PART B - FEE(S) TRANSMITTAL, or its equivalent, must be completed and returned to the United States Patent and Trademark Office (USPTO) with your ISSUE FEE and PUBLICATION FEE (if required). If you are charging the fee(s) to your deposit account, section "4b" of Part B - Fee(s) Transmittal should be completed and an extra copy of the form should be submitted. If an equivalent of Part B is filed, a request to reapply a previously paid issue fee must be clearly made, and delays in processing may occur due to the difficulty in recognizing the paper as an equivalent of Part B.

III. All communications regarding this application must give the application number. Please direct all communications prior to issuance to Mail Stop ISSUE FEE unless advised to the contrary.

IMPORTANT REMINDER: Utility patents issuing on applications filed on or after Dec. 12, 1980 may require payment of maintenance fees. It is patentee's responsibility to ensure timely payment of maintenance fees when due.

**PART B - FEE(S) TRANSMITTAL**

**Complete and send this form, together with applicable fee(s), to: Mail Mail Stop ISSUE FEE  
 Commissioner for Patents  
 P.O. Box 1450  
 Alexandria, Virginia 22313-1450  
 or Fax (571)-273-2885**

INSTRUCTIONS: This form should be used for transmitting the ISSUE FEE and PUBLICATION FEE (if required). Blocks 1 through 5 should be completed where appropriate. All further correspondence including the Patent, advance orders and notification of maintenance fees will be mailed to the current correspondence address as indicated unless corrected below or directed otherwise in Block 1, by (a) specifying a new correspondence address; and/or (b) indicating a separate "FEE ADDRESS" for maintenance fee notifications.

CURRENT CORRESPONDENCE ADDRESS (Note: Use Block 1 for any change of address)

85775 7590 09/20/2010

Locke Lord Bissell & Liddell LLP  
 Attn: IP Docketing  
 Three World Financial Center  
 New York, NY 10281-2101

Note: A certificate of mailing can only be used for domestic mailings of the Fee(s) Transmittal. This certificate cannot be used for any other accompanying papers. Each additional paper, such as an assignment or formal drawing, must have its own certificate of mailing or transmission.

**Certificate of Mailing or Transmission**

I hereby certify that this Fee(s) Transmittal is being deposited with the United States Postal Service with sufficient postage for first class mail in an envelope addressed to the Mail Stop ISSUE FEE address above, or being facsimile transmitted to the USPTO (571) 273-2885, on the date indicated below.

(Depositor's name)
(Signature)
(Date)

APPLICATION NO.	FILING DATE	FIRST NAMED INVENTOR	ATTORNEY DOCKET NO.	CONFIRMATION NO.
10/807,731	03/23/2004	Scott McNulty	1004294.001US (4602-4001)	4430

TITLE OF INVENTION: APPARATUS, METHOD AND SYSTEM FOR A TUNNELING CLIENT ACCESS POINT

APPLN. TYPE	SMALL ENTITY	ISSUE FEE DUE	PUBLICATION FEE DUE	PREV. PAID ISSUE FEE	TOTAL FEE(S) DUE	DATE DUE
nonprovisional	YES	\$755	\$300	\$0	\$1055	12/20/2010

EXAMINER	ART UNIT	CLASS-SUBCLASS
BILGRAMI, ASGHAR H	2443	709-250000

<p>1. Change of correspondence address or indication of "Fee Address" (37 CFR 1.363).</p> <p><input type="checkbox"/> Change of correspondence address (or Change of Correspondence Address form PTO/SB/122) attached.</p> <p><input type="checkbox"/> "Fee Address" indication (or "Fee Address" Indication form PTO/SB/47; Rev 03-02 or more recent) attached. <b>Use of a Customer Number is required.</b></p>	<p>2. For printing on the patent front page, list</p> <p>(1) the names of up to 3 registered patent attorneys or agents OR, alternatively, 1 _____</p> <p>(2) the name of a single firm (having as a member a registered attorney or agent) and the names of up to 2 registered patent attorneys or agents. If no name is listed, no name will be printed. 2 _____</p> <p>3 _____</p>
---	---

3. ASSIGNEE NAME AND RESIDENCE DATA TO BE PRINTED ON THE PATENT (print or type)

PLEASE NOTE: Unless an assignee is identified below, no assignee data will appear on the patent. If an assignee is identified below, the document has been filed for recordation as set forth in 37 CFR 3.11. Completion of this form is NOT a substitute for filing an assignment.

(A) NAME OF ASSIGNEE \_\_\_\_\_ (B) RESIDENCE: (CITY AND STATE OR COUNTRY) \_\_\_\_\_

Please check the appropriate assignee category or categories (will not be printed on the patent) :  Individual  Corporation or other private group entity  Government

<p>4a. The following fee(s) are submitted:</p> <p><input type="checkbox"/> Issue Fee</p> <p><input type="checkbox"/> Publication Fee (No small entity discount permitted)</p> <p><input type="checkbox"/> Advance Order - # of Copies _____</p>	<p>4b. Payment of Fee(s); (Please first reapply any previously paid issue fee shown above)</p> <p><input type="checkbox"/> A check is enclosed.</p> <p><input type="checkbox"/> Payment by credit card. Form PTO-2038 is attached.</p> <p><input type="checkbox"/> The Director is hereby authorized to charge the required fee(s), any deficiency, or credit any overpayment, to Deposit Account Number _____ (enclose an extra copy of this form).</p>
---	--

5. Change in Entity Status (from status indicated above)

a. Applicant claims SMALL ENTITY status. See 37 CFR 1.27.  b. Applicant is no longer claiming SMALL ENTITY status. See 37 CFR 1.27(g)(2).

NOTE: The Issue Fee and Publication Fee (if required) will not be accepted from anyone other than the applicant; a registered attorney or agent; or the assignee or other party in interest as shown by the records of the United States Patent and Trademark Office.

Authorized Signature \_\_\_\_\_ Date \_\_\_\_\_

Typed or printed name \_\_\_\_\_ Registration No. \_\_\_\_\_

This collection of information is required by 37 CFR 1.311. The information is required to obtain or retain a benefit by the public which is to file (and by the USPTO to process) an application. Confidentiality is governed by 35 U.S.C. 122 and 37 CFR 1.14. This collection is estimated to take 12 minutes to complete, including gathering, preparing, and submitting the completed application form to the USPTO. Time will vary depending upon the individual case. Any comments on the amount of time you require to complete this form and/or suggestions for reducing this burden, should be sent to the Chief Information Officer, U.S. Patent and Trademark Office, U.S. Department of Commerce, P.O. Box 1450, Alexandria, Virginia 22313-1450. DO NOT SEND FEES OR COMPLETED FORMS TO THIS ADDRESS. SEND TO: Commissioner for Patents, P.O. Box 1450, Alexandria, Virginia 22313-1450.

Under the Paperwork Reduction Act of 1995, no persons are required to respond to a collection of information unless it displays a valid OMB control number.

PayPal Ex. 1058, p. 364



UNITED STATES PATENT AND TRADEMARK OFFICE

UNITED STATES DEPARTMENT OF COMMERCE
United States Patent and Trademark Office
Address: COMMISSIONER FOR PATENTS
P. O. Box 1450
Alexandria, Virginia 22313-1450
www.uspto.gov

Table with columns: APPLICATION NO., FILING DATE, FIRST NAMED INVENTOR, ATTORNEY DOCKET NO., CONFIRMATION NO.
Row 1: 10/807,731, 03/23/2004, Scott McNulty, 1004294.001US (4602-4001), 4430
Row 2: 85775, 7590, 09/20/2010, [EXAMINER: BILGRAMI, ASGHAR H], [ART UNIT: 2443, PAPER NUMBER]
Text: Locke Lord Bissell & Liddell LLP, Attn: IP Docketing, Three World Financial Center, New York, NY 10281-2101
DATE MAILED: 09/20/2010

Determination of Patent Term Adjustment under 35 U.S.C. 154 (b)
(application filed on or after May 29, 2000)

The Patent Term Adjustment to date is 1168 day(s). If the issue fee is paid on the date that is three months after the mailing date of this notice and the patent issues on the Tuesday before the date that is 28 weeks (six and a half months) after the mailing date of this notice, the Patent Term Adjustment will be 1168 day(s).

If a Continued Prosecution Application (CPA) was filed in the above-identified application, the filing date that determines Patent Term Adjustment is the filing date of the most recent CPA.

Applicant will be able to obtain more detailed information by accessing the Patent Application Information Retrieval (PAIR) WEB site (http://pair.uspto.gov).

Any questions regarding the Patent Term Extension or Adjustment determination should be directed to the Office of Patent Legal Administration at (571)-272-7702. Questions relating to issue and publication fee payments should be directed to the Customer Service Center of the Office of Patent Publication at 1-(888)-786-0101 or (571)-272-4200.

**Notice of Allowability**

<b>Application No.</b>	<b>Applicant(s)</b>	
10/807,731	MCNULTY, SCOTT	
<b>Examiner</b>	<b>Art Unit</b>	
ASGHAR BILGRAMI	2443	

**-- The MAILING DATE of this communication appears on the cover sheet with the correspondence address--**

All claims being allowable, PROSECUTION ON THE MERITS IS (OR REMAINS) CLOSED in this application. If not included herewith (or previously mailed), a Notice of Allowance (PTOL-85) or other appropriate communication will be mailed in due course. **THIS NOTICE OF ALLOWABILITY IS NOT A GRANT OF PATENT RIGHTS.** This application is subject to withdrawal from issue at the initiative of the Office or upon petition by the applicant. See 37 CFR 1.313 and MPEP 1308.

- 1.  This communication is responsive to 8/27/2010.
- 2.  The allowed claim(s) is/are 159-187.
- 3.  Acknowledgment is made of a claim for foreign priority under 35 U.S.C. § 119(a)-(d) or (f).
  - a)  All   b)  Some\*   c)  None   of the:
    - 1.  Certified copies of the priority documents have been received.
    - 2.  Certified copies of the priority documents have been received in Application No. \_\_\_\_\_.
    - 3.  Copies of the certified copies of the priority documents have been received in this national stage application from the International Bureau (PCT Rule 17.2(a)).

\* Certified copies not received: \_\_\_\_\_.

Applicant has THREE MONTHS FROM THE "MAILING DATE" of this communication to file a reply complying with the requirements noted below. Failure to timely comply will result in ABANDONMENT of this application. **THIS THREE-MONTH PERIOD IS NOT EXTENDABLE.**

- 4.  A SUBSTITUTE OATH OR DECLARATION must be submitted. Note the attached EXAMINER'S AMENDMENT or NOTICE OF INFORMAL PATENT APPLICATION (PTO-152) which gives reason(s) why the oath or declaration is deficient.
  - 5.  CORRECTED DRAWINGS ( as "replacement sheets") must be submitted.
    - (a)  including changes required by the Notice of Draftsperson's Patent Drawing Review ( PTO-948) attached
      - 1)  hereto or 2)  to Paper No./Mail Date \_\_\_\_\_.
    - (b)  including changes required by the attached Examiner's Amendment / Comment or in the Office action of Paper No./Mail Date \_\_\_\_\_.
- Identifying indicia such as the application number (see 37 CFR 1.84(c)) should be written on the drawings in the front (not the back) of each sheet. Replacement sheet(s) should be labeled as such in the header according to 37 CFR 1.121(d).**
- 6.  DEPOSIT OF and/or INFORMATION about the deposit of BIOLOGICAL MATERIAL must be submitted. Note the attached Examiner's comment regarding REQUIREMENT FOR THE DEPOSIT OF BIOLOGICAL MATERIAL.

**Attachment(s)**

- 1.  Notice of References Cited (PTO-892)
- 2.  Notice of Draftsperson's Patent Drawing Review (PTO-948)
- 3.  Information Disclosure Statements (PTO/SB/08), Paper No./Mail Date 4/16/2010
- 4.  Examiner's Comment Regarding Requirement for Deposit of Biological Material
- 5.  Notice of Informal Patent Application
- 6.  Interview Summary (PTO-413), Paper No./Mail Date 8/27/2010.
- 7.  Examiner's Amendment/Comment
- 8.  Examiner's Statement of Reasons for Allowance
- 9.  Other \_\_\_\_\_.

/George C Neurauter, Jr./  
Primary Examiner, Art Unit 2443

<b>Interview Summary</b>	<b>Application No.</b> 10/807,731	<b>Applicant(s)</b> MCNULTY, SCOTT	
	<b>Examiner</b> ASGHAR BILGRAMI	<b>Art Unit</b> 2443	

All participants (applicant, applicant's representative, PTO personnel):

(1) ASGHAR BILGRAMI. (3)\_\_\_\_\_.

(2) Robert K. Goethals (36,813). (4)\_\_\_\_\_.

Date of Interview: 27 August 2010.

Type: a)  Telephonic b)  Video Conference  
c)  Personal [copy given to: 1)  applicant 2)  applicant's representative]

Exhibit shown or demonstration conducted: d)  Yes e)  No.  
If Yes, brief description: \_\_\_\_\_.

Claim(s) discussed: 1.

Identification of prior art discussed: \_\_\_\_\_.

Agreement with respect to the claims f)  was reached. g)  was not reached. h)  N/A.

Substance of Interview including description of the general nature of what was agreed to if an agreement was reached, or any other comments: Examiner advised the applicant to also incorporate the encryption and decryption limitation into the newly amended claim limitations of all the independent. No agreement was reached.

(A fuller description, if necessary, and a copy of the amendments which the examiner agreed would render the claims allowable, if available, must be attached. Also, where no copy of the amendments that would render the claims allowable is available, a summary thereof must be attached.)

THE FORMAL WRITTEN REPLY TO THE LAST OFFICE ACTION MUST INCLUDE THE SUBSTANCE OF THE INTERVIEW. (See MPEP Section 713.04). If a reply to the last Office action has already been filed, APPLICANT IS GIVEN A NON-EXTENDABLE PERIOD OF THE LONGER OF ONE MONTH OR THIRTY DAYS FROM THIS INTERVIEW DATE, OR THE MAILING DATE OF THIS INTERVIEW SUMMARY FORM, WHICHEVER IS LATER, TO FILE A STATEMENT OF THE SUBSTANCE OF THE INTERVIEW. See Summary of Record of Interview requirements on reverse side or on attached sheet.

/Asghar Bilgrami/  
Examiner, Art Unit 2443

## Summary of Record of Interview Requirements

### Manual of Patent Examining Procedure (MPEP), Section 713.04, Substance of Interview Must be Made of Record

A complete written statement as to the substance of any face-to-face, video conference, or telephone interview with regard to an application must be made of record in the application whether or not an agreement with the examiner was reached at the interview.

### Title 37 Code of Federal Regulations (CFR) § 1.133 Interviews Paragraph (b)

In every instance where reconsideration is requested in view of an interview with an examiner, a complete written statement of the reasons presented at the interview as warranting favorable action must be filed by the applicant. An interview does not remove the necessity for reply to Office action as specified in §§ 1.111, 1.135. (35 U.S.C. 132)

#### 37 CFR §1.2 Business to be transacted in writing.

All business with the Patent or Trademark Office should be transacted in writing. The personal attendance of applicants or their attorneys or agents at the Patent and Trademark Office is unnecessary. The action of the Patent and Trademark Office will be based exclusively on the written record in the Office. No attention will be paid to any alleged oral promise, stipulation, or understanding in relation to which there is disagreement or doubt.

The action of the Patent and Trademark Office cannot be based exclusively on the written record in the Office if that record is itself incomplete through the failure to record the substance of interviews.

It is the responsibility of the applicant or the attorney or agent to make the substance of an interview of record in the application file, unless the examiner indicates he or she will do so. It is the examiner's responsibility to see that such a record is made and to correct material inaccuracies which bear directly on the question of patentability.

Examiners must complete an Interview Summary Form for each interview held where a matter of substance has been discussed during the interview by checking the appropriate boxes and filling in the blanks. Discussions regarding only procedural matters, directed solely to restriction requirements for which interview recordation is otherwise provided for in Section 812.01 of the Manual of Patent Examining Procedure, or pointing out typographical errors or unreadable script in Office actions or the like, are excluded from the interview recordation procedures below. Where the substance of an interview is completely recorded in an Examiners Amendment, no separate Interview Summary Record is required.

The Interview Summary Form shall be given an appropriate Paper No., placed in the right hand portion of the file, and listed on the "Contents" section of the file wrapper. In a personal interview, a duplicate of the Form is given to the applicant (or attorney or agent) at the conclusion of the interview. In the case of a telephone or video-conference interview, the copy is mailed to the applicant's correspondence address either with or prior to the next official communication. If additional correspondence from the examiner is not likely before an allowance or if other circumstances dictate, the Form should be mailed promptly after the interview rather than with the next official communication.

The Form provides for recordation of the following information:

- Application Number (Series Code and Serial Number)
- Name of applicant
- Name of examiner
- Date of interview
- Type of interview (telephonic, video-conference, or personal)
- Name of participant(s) (applicant, attorney or agent, examiner, other PTO personnel, etc.)
- An indication whether or not an exhibit was shown or a demonstration conducted
- An identification of the specific prior art discussed
- An indication whether an agreement was reached and if so, a description of the general nature of the agreement (may be by attachment of a copy of amendments or claims agreed as being allowable). Note: Agreement as to allowability is tentative and does not restrict further action by the examiner to the contrary.
- The signature of the examiner who conducted the interview (if Form is not an attachment to a signed Office action)

It is desirable that the examiner orally remind the applicant of his or her obligation to record the substance of the interview of each case. It should be noted, however, that the Interview Summary Form will not normally be considered a complete and proper recordation of the interview unless it includes, or is supplemented by the applicant or the examiner to include, all of the applicable items required below concerning the substance of the interview.

A complete and proper recordation of the substance of any interview should include at least the following applicable items:

- 1) A brief description of the nature of any exhibit shown or any demonstration conducted,
- 2) an identification of the claims discussed,
- 3) an identification of the specific prior art discussed,
- 4) an identification of the principal proposed amendments of a substantive nature discussed, unless these are already described on the Interview Summary Form completed by the Examiner,
- 5) a brief identification of the general thrust of the principal arguments presented to the examiner,  
(The identification of arguments need not be lengthy or elaborate. A verbatim or highly detailed description of the arguments is not required. The identification of the arguments is sufficient if the general nature or thrust of the principal arguments made to the examiner can be understood in the context of the application file. Of course, the applicant may desire to emphasize and fully describe those arguments which he or she feels were or might be persuasive to the examiner.)
- 6) a general indication of any other pertinent matters discussed, and
- 7) if appropriate, the general results or outcome of the interview unless already described in the Interview Summary Form completed by the examiner.

Examiners are expected to carefully review the applicant's record of the substance of an interview. If the record is not complete and accurate, the examiner will give the applicant an extendable one month time period to correct the record.

### Examiner to Check for Accuracy

If the claims are allowable for other reasons of record, the examiner should send a letter setting forth the examiner's version of the statement attributed to him or her. If the record is complete and accurate, the examiner should place the indication, "Interview Record OK" on the paper recording the substance of the interview along with the date and the examiner's initials.



### EXAMINER'S AMENDMENT

1. An examiner's amendment to the record appears below. Should the changes and/or additions be unacceptable to applicant, an amendment may be filed as provided by 37 CFR 1.312. To ensure consideration of such an amendment, it **MUST** be submitted no later than the payment of the issue fee.

Authorization for this examiner's amendment was given in a telephone interview with *Robert K. Goethals (36,813)* on 27 August 2010.

The application has been amended as follows:

#### IN THE CLAIMS

**Claims 1 through 158: Cancelled.**

**Claim 159:** A portable tunneling storage and processing apparatus, comprising:

(a) a conduit for external communications configured to enable the transmission of a plurality of communications between the portable apparatus and a terminal comprising a terminal processor, a first input component, a first output component comprising a display device, and a network interface configured to enable the terminal to communicate with at least one network server, wherein the conduit for external communications is a universal serial bus conduit;

(b) a processor; and

(c) a memory configured to communicate with the portable apparatus processor, wherein the memory has a unique apparatus identifier and a plurality of processing instructions stored thereon, including:

(1) a first set of processing instructions, which when executed by the terminal processor, enables a user to employ the first input component and the terminal

Art Unit: 2443

display device to interact with the portable apparatus and provides the portable apparatus with access to the terminal network interface;

(2) at least one processing instruction, which when executed, causes an interactive user interface to be presented on the terminal display device, wherein the interactive user interface is configured to enable the user to:

(i) cause the portable apparatus processor to execute a set of processing instructions stored on the portable apparatus memory; and

(ii) cause the portable apparatus to transmit a request to access a server; and

(3) at least one processing instruction, which when executed by the portable apparatus processor in response to receiving a command resulting from user interaction with the interactive user interface, (i) causes the portable apparatus processor to execute a second set of processing instructions stored on the portable apparatus memory and effect the display of processing activity of the second set of processing instructions on the terminal display device, and (ii) causes the portable apparatus to transmit a request to access a server;

wherein the portable apparatus is configured to communicate with the terminal and to communicate through the terminal network interface with a server, and

wherein the portable apparatus processor is configured to facilitate the storage of encrypted data on the portable apparatus memory, encrypt communications transmitted by the portable apparatus, and decrypt encrypted communications received by the portable apparatus.

**Claim 160:** The portable apparatus of 159, wherein the plurality of processing instructions stored on the portable apparatus memory includes a third set of processing instructions, which when executed, presents the interactive user interface on the terminal display device.

Art Unit: 2443

**Claim 161:** The portable apparatus of claim 160, wherein the third set of processing instructions is executed by the portable apparatus processor.

**Claim 162:** The portable apparatus of claim 160, wherein the third set of processing instructions is executed by the terminal processor.

**Claim 163:** The portable apparatus of claim 159, wherein the portable apparatus is configured to employ a security protocol to encrypt communications transmitted by the portable apparatus.

**Claim 164:** The portable apparatus of claim 163, wherein the security protocol is selected from the group consisting of checksum, Data Encryption Standard (DES), Elliptical Curve Encryption (ECC), International Data Encryption Algorithm (IDEA), Message Digest 5 (MD5) passwords, Rivest Cipher (RC5), Rijndael, RSA, Secure Hash Algorithm (SHA), Secure Socket Layer (SSL), Secure Hypertext Transfer Protocol (HTTPS) and the like.

**Claim 165:** The portable apparatus of claim 159, wherein the portable apparatus is configured to employ a cryptographic technique to encrypt communications transmitted by the portable apparatus.

**Claim 166:** The portable apparatus of claim 165, wherein the cryptographic technique is selected from the group consisting of digital certificates, digital signatures, dual signatures, enveloping, password access protection, public key management and the like.

**Claim 167:** The portable apparatus of claim 159, wherein the portable apparatus is configured to employ the unique apparatus identifier to encrypt communications transmitted by the portable apparatus.

**Claim 168:** The portable apparatus of claim 159, wherein the portable apparatus memory is configured to store user authentication information.

**Claim 169:** The portable apparatus of claim 168, wherein the plurality of processing instruction stored on the portable apparatus memory includes a fourth set of processing

Art Unit: 2443

instructions, which when executed, performs user authentication based on a comparison of user authentication information inputted by a user and user authentication information stored on the portable apparatus memory.

**Claim 170:** The portable apparatus of claim 159, wherein the terminal comprises a video memory and the display of the processing activity of the second set of processing instructions on the terminal display device occurs directly on the terminal video memory.

**Claim 171:** A method implemented on a portable apparatus comprising a processor, a memory having a unique apparatus identifier and a plurality of processing instructions stored thereon, and a universal serial bus conduit for enabling the transmission of a plurality of communications between the portable apparatus and a terminal comprising a terminal processor, an input component, an output component comprising a display device, and a network interface configured to enable the terminal to communicate with at least one network server, the method comprising:

(a) providing the terminal with access to a first set of processing instructions stored on the portable apparatus memory, which when executed by the terminal processor, enables a user to employ the first input component and the terminal display device to interact with the portable apparatus and provides the portable apparatus with access to the terminal network interface;

(b) executing at least one processing instruction stored on the portable apparatus memory to cause an interactive user interface to be presented on the terminal display device, wherein the interactive user interface is configured to enable the user to:

(1) cause the portable apparatus processor to execute a second set of processing instructions stored on the portable apparatus memory; and

(2) cause the portable apparatus to transmit a request to access a server;

Art Unit: 2443

(c) executing a second set of processing instructions stored on the portable apparatus memory in response to receiving a command resulting from user interaction with the interactive user interface;

(d) transmitting a communication through the terminal network interface to request access to a server in response to receiving a command resulting from user interaction with the interactive user interface;

(e) effecting the display of processing activity of the second set of processing instructions on the terminal display device;

(f) facilitating the storage of encrypted data on the portable apparatus memory;

(g) encrypting communications transmitted by the portable apparatus; and

(h) decrypting encrypted communications received by the portable apparatus.

**Claim 172:** The method of claim 171, further comprising executing a third set of processing instructions stored on the portable apparatus memory to present the interactive user interface on the terminal display device.

**Claim 173:** The method of claim 172, further comprising executing the third set of processing instructions on the portable apparatus processor.

**Claim 174:** The method of claim 172, further comprising executing the third set of processing instructions on the terminal processor.

**Claim 175:** The method of claim 171, further comprising employing a security protocol to encrypt communications transmitted by the portable apparatus.

**Claim 176:** The method of claim 171, further comprising employing a cryptographic technique to encrypt communications transmitted by the portable apparatus.

**Claim 177:** The method of claim 171, further comprising employing the unique apparatus identifier to encrypt communications transmitted by the portable apparatus.

Art Unit: 2443

**Claim 178:** A non-transitory computer readable medium containing a plurality of processing instructions to be executed by a computer system comprising a portable device and a terminal, the portable device comprising a universal serial bus conduit for enabling the transmission of a plurality of communications between the portable apparatus and the terminal, a processor and a memory configured to communicate with the processor, and the terminal comprising a terminal processor, an input component, an output component comprising a display device, and a network interface configured to enable the terminal to communicate with at least one network server, the plurality of processing instructions comprising:

(a) a first set of processing instructions, which when executed by the terminal processor, enables a user to employ the first input component and the terminal display device to interact with the portable apparatus and provides the portable apparatus with access to the terminal network interface;

(b) at least one processing instructions, which when executed, causes an interactive user interface to be presented on the terminal display device, wherein the interactive user interface is configured to enable the user to:

(1) cause the portable apparatus processor to execute a set of processing instructions stored on the portable apparatus memory; and

(2) cause the portable apparatus to transmit a request to access a server;

(c) at least one processing instruction, which when executed by the portable apparatus processor in response to receiving a command resulting from user interaction with the interactive user interface, (1) causes the portable apparatus processor to execute a second set of processing instructions stored on the portable apparatus memory and effect the display of processing activity of the second set of processing instructions on the terminal display device, and (2) causes the portable apparatus to transmit a request to access a server; and

Art Unit: 2443

(d) at least one processing instruction, which when executed by the portable apparatus processor, facilitates the storage of encrypted data on the portable apparatus memory, encrypts communications transmitted by the portable apparatus, and decrypts encrypted communications received by the portable apparatus.

**Claim 179:** The non-transitory computer readable medium of claim 178, wherein the at least one processing instructions, which when executed, causes an interactive user interface to be presented on the terminal display device comprises a third set of processing instructions, which when executed, presents the interactive user interface on the terminal display device.

**Claim 180:** The non-transitory computer readable medium of claim 179, wherein the third set of processing instructions is executed by the portable apparatus processor.

**Claim 181:** The non-transitory computer readable medium of claim 179, wherein the third set of processing instructions is executed by the terminal processor.

**Claim 182:** A tunneling, storage and processing system implementing a terminal having a terminal processor, an input device, an output device comprising a display device, and a network interface configured to enable the terminal to communicate with at least one network server, the system comprising:

(a) a server comprising a storage device; and

(b) a portable apparatus comprising a universal serial bus conduit for enabling the transmission of a plurality of communications between the portable apparatus and the terminal, a processor and a memory configured to communicate with the processor, wherein the memory has a unique apparatus identifier and a plurality of processing instructions stored thereon, the portable device configured to:

(1) provide the terminal with access to a first set of processing instructions stored on the portable apparatus memory, which when executed by the terminal processor, enables a user to employ the first input component and the terminal display device to interact with the portable apparatus and provides the portable apparatus with access to the terminal network interface;

Art Unit: 2443

(2) execute at least one processing instruction stored on the portable apparatus memory to cause an interactive user interface to be presented on the terminal display device, wherein the interactive user interface is configured to enable the user to:

(i) cause the portable apparatus processor to execute a second set of processing instructions stored on the portable apparatus memory; and

(ii) cause the portable apparatus to transmit a request to access a server;

(3) execute a second set of processing instructions stored on the portable apparatus memory in response to receiving a command resulting from user interaction with the interactive user interface;

(4) transmit a communication through the terminal network interface to request access to a server in response to receiving a command resulting from user interaction with the interactive user interface;

(5) effect the display of processing activity of the second set of processing instructions on the terminal display device;

(6) facilitate the storage of encrypted data on the portable apparatus memory;

(7) encrypt communications transmitted by the portable apparatus; and

(8) decrypt encrypted communications received by the portable apparatus.

**Claim 183:** The tunneling, storage and processing system of claim 182, wherein the portable apparatus is configured to execute a third set of processing instructions stored on the portable apparatus memory to present the interactive user interface on the terminal display device.

**Claim 184:** The tunneling, storage and processing system of claim 182, wherein the portable apparatus is configured to cause the terminal processor to execute a third set



Art Unit: 2443

of processing instructions stored on the portable apparatus memory to present the interactive user interface on the terminal display device.

**Claim 185:** The tunneling, storage and processing system of claim 182, wherein the portable apparatus is further configured to employ a security protocol to encrypt communications transmitted by the portable apparatus.

**Claim 186:** The tunneling, storage and processing system of claim 182, wherein the portable apparatus is further configured to employ a cryptographic technique to encrypt communications transmitted by the portable apparatus.

**Claim 187:** The tunneling, storage and processing system of claim 182, wherein the portable apparatus is further configured to employ the unique apparatus identifier to encrypt communications transmitted by the portable apparatus.

### ***Allowable Subject Matter***

2. Claims 159 through 187 are allowed.

3. The prior art of record, taken singly or in combination, fails to teach or suggest a method, apparatus and a system for portable tunneling storage and processing apparatus comprising: a universal serial bus conduit for external communications, (b) a processor; and (c) a memory configured to communicate with the portable apparatus processor, wherein the memory has a unique apparatus identifier and a plurality of processing instructions stored thereon, including: (1) a first set of processing instructions, which when executed by the terminal processor, enables a user to employ the first input component and the terminal display device to interact with the portable apparatus and provides the portable apparatus with access to the terminal network interface; (2) at least one processing instruction, which when executed, causes an interactive user interface to be presented on the terminal display device, wherein the

Art Unit: 2443

interactive user interface is configured to enable the user to: (i) cause the portable apparatus processor to execute a set of processing instructions stored on the portable apparatus memory; and (ii) cause the portable apparatus to transmit a request to access a server; and (3) at least one processing instruction, which when executed by the portable apparatus processor in response to receiving a command resulting from user interaction with the interactive user interface, (i) causes the portable apparatus processor to execute a second set of processing instructions stored on the portable apparatus memory and effect the display of processing activity of the second set of processing instructions on the terminal display device, and (ii) causes the portable apparatus to transmit a request to access a server; wherein the portable apparatus is configured to communicate with the terminal and to communicate through the terminal network interface with a server, and wherein the portable apparatus processor is configured to facilitate the storage of encrypted data on the portable apparatus memory, encrypt communications transmitted by the portable apparatus, and decrypt encrypted communications received by the portable apparatus.

4. Any comments considered necessary by applicant must be submitted no later than the payment of the issue fee and, to avoid processing delays, should preferably accompany the issue fee. Such submissions should be clearly labeled "Comments on Statement of Reasons for Allowance."

### ***Conclusion***

Any inquiry concerning this communication or earlier communications from the examiner should be directed to ASGHAR BILGRAMI whose telephone number is (571)272-3907. The examiner can normally be reached on 9-5.

Art Unit: 2443

If attempts to reach the examiner by telephone are unsuccessful, the examiner's supervisor, Tonia L.M. Dollinger can be reached on 571-272-4170. The fax phone number for the organization where this application or proceeding is assigned is 571-273-8300.

Information regarding the status of an application may be obtained from the Patent Application Information Retrieval (PAIR) system. Status information for published applications may be obtained from either Private PAIR or Public PAIR. Status information for unpublished applications is available through Private PAIR only. For more information about the PAIR system, see <http://pair-direct.uspto.gov>. Should you have questions on access to the Private PAIR system, contact the Electronic Business Center (EBC) at 866-217-9197 (toll-free). If you would like assistance from a USPTO Customer Service Representative or access to the automated information system, call 800-786-9199 (IN USA OR CANADA) or 571-272-1000.

/A. B./

Examiner, Art Unit 2443

/George C Neurauter, Jr./

Primary Examiner, Art Unit 2443

<b>Index of Claims</b>  	<b>Application/Control No.</b> 10807731	<b>Applicant(s)/Patent Under Reexamination</b> MCNULTY, SCOTT
	<b>Examiner</b> ASGHAR BILGRAMI	<b>Art Unit</b> 2443

✓	<b>Rejected</b>
=	<b>Allowed</b>

-	<b>Cancelled</b>
÷	<b>Restricted</b>

N	<b>Non-Elected</b>
I	<b>Interference</b>

A	<b>Appeal</b>
O	<b>Objected</b>

Claims renumbered in the same order as presented by applicant
  CPA
  T.D.
  R.1.47

CLAIM		DATE							
Final	Original	11/16/2008	10/08/2009	08/31/2010					
	1	✓	✓	-					
	2	✓	✓	-					
	3	✓	✓	-					
	4	✓	✓	-					
	5	✓	✓	-					
	6	✓	✓	-					
	7	✓	✓	-					
	8	✓	✓	-					
	9	✓	✓	-					
	10	✓	✓	-					
	11	✓	✓	-					
	12	✓	✓	-					
	13	✓	✓	-					
	14	✓	✓	-					
	15	✓	✓	-					
	16	✓	-	-					
	17	✓	✓	-					
	18	✓	✓	-					
	19	✓	✓	-					
	20	✓	✓	-					
	21	✓	✓	-					
	22	✓	✓	-					
	23	✓	✓	-					
	24	✓	✓	-					
	25	✓	✓	-					
	26	✓	✓	-					
	27	✓	✓	-					
	28	✓	✓	-					
	29	✓	✓	-					
	30	✓	✓	-					
	31	✓	✓	-					
	32	✓	✓	-					
	33	✓	✓	-					
	34	✓	✓	-					
	35	✓	✓	-					
	36	✓	✓	-					

<b>Index of Claims</b> 	<b>Application/Control No.</b> 10807731	<b>Applicant(s)/Patent Under Reexamination</b> MCNULTY, SCOTT
	<b>Examiner</b> ASGHAR BILGRAMI	<b>Art Unit</b> 2443

✓	<b>Rejected</b>
=	<b>Allowed</b>

-	<b>Cancelled</b>
÷	<b>Restricted</b>

N	<b>Non-Elected</b>
I	<b>Interference</b>

A	<b>Appeal</b>
O	<b>Objected</b>

Claims renumbered in the same order as presented by applicant
  CPA
  T.D.
  R.1.47

CLAIM		DATE							
Final	Original	11/16/2008	10/08/2009	08/31/2010					
	37	✓	✓	-					
	38	✓	✓	-					
	39	✓	✓	-					
	40	✓	✓	-					
	41	✓	✓	-					
	42	✓	✓	-					
	43	✓	✓	-					
	44	✓	✓	-					
	45	✓	✓	-					
	46	✓	✓	-					
	47	✓	✓	-					
	48	✓	✓	-					
	49	✓	✓	-					
	50	✓	✓	-					
	51	✓	✓	-					
	52	✓	✓	-					
	53	✓	✓	-					
	54	✓	✓	-					
	55	✓	✓	-					
	56	✓	✓	-					
	57	✓	✓	-					
	58	✓	✓	-					
	59	✓	✓	-					
	60	✓	✓	-					
	61	✓	✓	-					
	62	✓	✓	-					
	63	✓	✓	-					
	64	✓	✓	-					
	65	✓	✓	-					
	66	✓	✓	-					
	67	✓	✓	-					
	68	✓	✓	-					
	69	✓	✓	-					
	70		✓	-					
	71		✓	-					
	72		✓	-					

<b>Index of Claims</b> 	<b>Application/Control No.</b> 10807731	<b>Applicant(s)/Patent Under Reexamination</b> MCNULTY, SCOTT
	<b>Examiner</b> ASGHAR BILGRAMI	<b>Art Unit</b> 2443

✓	<b>Rejected</b>
=	<b>Allowed</b>

-	<b>Cancelled</b>
÷	<b>Restricted</b>

N	<b>Non-Elected</b>
I	<b>Interference</b>

A	<b>Appeal</b>
O	<b>Objected</b>

Claims renumbered in the same order as presented by applicant
  CPA
  T.D.
  R.1.47

CLAIM		DATE							
Final	Original	11/16/2008	10/08/2009	08/31/2010					
	73		✓	-					
	74			-					
	75			-					
	76			-					
	77			-					
	78			-					
	79			-					
	80			-					
	81			-					
	82			-					
	83			-					
	84			-					
	85			-					
	86			-					
	87			-					
	88			-					
	89			-					
	90			-					
	91			-					
	92			-					
	93			-					
	94			-					
	95			-					
	96			-					
	97			-					
	98			-					
	99			-					
	100			-					
	101			-					
	102			-					
	103			-					
	104			-					
	105			-					
	106			-					
	107			-					
	108			-					

<b>Index of Claims</b>  	<b>Application/Control No.</b>  10807731	<b>Applicant(s)/Patent Under Reexamination</b>  MCNULTY, SCOTT
	<b>Examiner</b>  ASGHAR BILGRAMI	<b>Art Unit</b>  2443

✓	<b>Rejected</b>
=	<b>Allowed</b>

-	<b>Cancelled</b>
÷	<b>Restricted</b>

N	<b>Non-Elected</b>
I	<b>Interference</b>

A	<b>Appeal</b>
O	<b>Objected</b>

Claims renumbered in the same order as presented by applicant
  CPA
  T.D.
  R.1.47

CLAIM		DATE							
Final	Original	11/16/2008	10/08/2009	08/31/2010					
	109			-					
	110			-					
	111			-					
	112			-					
	113			-					
	114			-					
	115			-					
	116			-					
	117			-					
	118			-					
	119			-					
	120			-					
	121			-					
	122			-					
	123			-					
	124			-					
	125			-					
	126			-					
	127			-					
	128			-					
	129			-					
	130			-					
	131			-					
	132			-					
	133			-					
	134			-					
	135			-					
	136			-					
	137			-					
	138			-					
	139			-					
	140			-					
	141			-					
	142			-					
	143			-					
	144			-					

<b>Index of Claims</b>  	<b>Application/Control No.</b>  10807731	<b>Applicant(s)/Patent Under Reexamination</b>  MCNULTY, SCOTT
	<b>Examiner</b>  ASGHAR BILGRAMI	<b>Art Unit</b>  2443

✓	<b>Rejected</b>
=	<b>Allowed</b>

-	<b>Cancelled</b>
÷	<b>Restricted</b>

N	<b>Non-Elected</b>
I	<b>Interference</b>

A	<b>Appeal</b>
O	<b>Objected</b>

Claims renumbered in the same order as presented by applicant
  CPA
  T.D.
  R.1.47

CLAIM		DATE							
Final	Original	11/16/2008	10/08/2009	08/31/2010					
	145			-					
	146			-					
	147			-					
	148			-					
	149			-					
	150			-					
	151			-					
	152			-					
	153			-					
	154			-					
	155			-					
	156			-					
	157			-					
	158			-					
	159			=					
	160			=					
	161			=					
	162			=					
	163			=					
	164			=					
	165			=					
	166			=					
	167			=					
	168			=					
	169			=					
	170			=					
	171			=					
	172			=					
	173			=					
	174			=					
	175			=					
	176			=					
	177			=					
	178			=					
	179			=					
	180			=					



<b>Index of Claims</b>  	<b>Application/Control No.</b>  10807731	<b>Applicant(s)/Patent Under Reexamination</b>  MCNULTY, SCOTT
	<b>Examiner</b>  ASGHAR BILGRAMI	<b>Art Unit</b>  2443

✓	<b>Rejected</b>
=	<b>Allowed</b>

-	<b>Cancelled</b>
÷	<b>Restricted</b>

N	<b>Non-Elected</b>
I	<b>Interference</b>

A	<b>Appeal</b>
O	<b>Objected</b>

Claims renumbered in the same order as presented by applicant
  CPA
  T.D.
  R.1.47

CLAIM		DATE							
Final	Original	11/16/2008	10/08/2009	08/31/2010					
	181			=					
	182			=					
	183			=					
	184			=					
	185			=					
	186			=					
	187			=					

<b>Issue Classification</b> 	<b>Application/Control No.</b> 10807731	<b>Applicant(s)/Patent Under Reexamination</b> MCNULTY, SCOTT
	<b>Examiner</b> ASGHAR BILGRAMI	<b>Art Unit</b> 2443

ORIGINAL					INTERNATIONAL CLASSIFICATION												
CLASS		SUBCLASS			CLAIMED				NON-CLAIMED								
709		250			G	0	6	F	15 / 16 (2006.0)								
<b>CROSS REFERENCE(S)</b>					H	0	4	L	9 / 00 (2006.0)								
CLASS	SUBCLASS (ONE SUBCLASS PER BLOCK)																
713	150																

<input type="checkbox"/> Claims renumbered in the same order as presented by applicant <input type="checkbox"/> CPA <input type="checkbox"/> T.D. <input type="checkbox"/> R.1.47															
Final	Original	Final	Original	Final	Original	Final	Original	Final	Original	Final	Original	Final	Original	Final	Original
	1		27		53		79		105		131		157	25	183
	2		28		54		80		106		132		158	26	184
	3		29		55		81		107		133	1	159	27	185
	4		30		56		82		108		134	2	160	28	186
	5		31		57		83		109		135	3	161	29	187
	6		32		58		84		110		136	4	162		
	7		33		59		85		111		137	5	163		
	8		34		60		86		112		138	6	164		
	9		35		61		87		113		139	7	165		
	10		36		62		88		114		140	8	166		
	11		37		63		89		115		141	9	167		
	12		38		64		90		116		142	10	168		
	13		39		65		91		117		143	11	169		
	14		40		66		92		118		144	12	170		
	15		41		67		93		119		145	13	171		
	16		42		68		94		120		146	14	172		

/ASGHAR BILGRAMI/ Examiner.Art Unit 2443  (Assistant Examiner)	8/31/2010  (Date)	<b>Total Claims Allowed:</b>  29	
/George C Neurauter, Jr./ Primary Examiner.Art Unit 2443  (Primary Examiner)	09.12.2010  (Date)	O.G. Print Claim(s)  1	O.G. Print Figure  1

<b>Issue Classification</b> 	<b>Application/Control No.</b> 10807731	<b>Applicant(s)/Patent Under Reexamination</b> MCNULTY, SCOTT
	<b>Examiner</b> ASGHAR BILGRAMI	<b>Art Unit</b> 2443

<input type="checkbox"/> <b>Claims renumbered in the same order as presented by applicant</b>														<input type="checkbox"/> <b>CPA</b>		<input type="checkbox"/> <b>T.D.</b>		<input type="checkbox"/> <b>R.1.47</b>	
	17		43		69		95		121		147	15	173						
	18		44		70		96		122		148	16	174						
	19		45		71		97		123		149	17	175						
	20		46		72		98		124		150	18	176						
	21		47		73		99		125		151	19	177						
	22		48		74		100		126		152	20	178						
	23		49		75		101		127		153	21	179						
	24		50		76		102		128		154	22	180						
	25		51		77		103		129		155	23	181						
	26		52		78		104		130		156	24	182						

/ASGHAR BILGRAMI/ Examiner.Art Unit 2443  (Assistant Examiner)	8/31/2010  (Date)	<b>Total Claims Allowed:</b>  29	
/George C Neurauter, Jr./ Primary Examiner.Art Unit 2443  (Primary Examiner)	09.12.2010  (Date)	O.G. Print Claim(s)  1	O.G. Print Figure  1

<b>Search Notes</b>  	<b>Application/Control No.</b>  10807731	<b>Applicant(s)/Patent Under Reexamination</b>  MCNULTY, SCOTT
	<b>Examiner</b>  ASGHAR BILGRAMI	<b>Art Unit</b>  2443

SEARCHED			
Class	Subclass	Date	Examiner
709	250	11/16/2008	AB
713	150	11/16/2008	AB
709	220, 250	8/31/2010	AB
713	150	8/31/2010	AB

SEARCH NOTES		
Search Notes	Date	Examiner
EAST	11/16/2008	AB
101 Compliance search	8/31/2010	AB
U.S. PAT, PG-PUB	8/31/2010	AB
Inventor Name search	10/8/2009	AB
101 Compliance search	10/8/2009	AB
PG-PUB text search of claims	8/31/2010	AB

INTERFERENCE SEARCH			
Class	Subclass	Date	Examiner
U.S PG-PUB		8/31/2010	AB

/A. B./ Examiner.Art Unit 2443	
-----------------------------------	--

## EAST Search History

## EAST Search History (Prior Art)

Ref #	Hits	Search Query	DBs	Default Operator	Plurals	Time Stamp
L1	7	"861133".ap.	US-PGPUB; USPAT; USOCR; EPO; DERWENT; IBM_TDB	OR	ON	2010/08/31 13:00
L2	0	portable.clm. and tunneling.clm. and storage.clm. and processing.clm. and "input.clm" and component.clm. and universal.clm. and serial.clm. and bus.clm. and memory.clm. and instructions.clm. and terminal.clm. and interactive.clm. and command.clm. and "display.clm" and server.clm. and "encrypt.clm" and decrypt.clm.	US-PGPUB; USPAT	OR	ON	2010/08/31 13:08
L3	8	709/250.ccls. and (access) same (portable) same (device or module or USB) same (secure or encrypt\$4)	US-PGPUB; USPAT; USOCR; EPO; DERWENT; IBM_TDB	OR	ON	2010/08/31 13:08
L4	16	713/150.ccls. and (portable) same (device or module or USB) same (access\$4) same (network or WAN or LAN) same (secure or encrypt\$4)	US-PGPUB; USPAT; USOCR; EPO; DERWENT; IBM_TDB	OR	ON	2010/08/31 13:08
L5	2	"7454783".pn.	US-PGPUB; USPAT; USOCR; EPO; DERWENT; IBM_TDB	OR	ON	2010/08/31 13:21
S3	37977	(client or user) same (access) with (point)	US-PGPUB; USPAT; USOCR; EPO; DERWENT; IBM_TDB	OR	ON	2008/11/10 16:39
S4	407	(client or user) same (access) with (point) same (USB)	US-PGPUB; USPAT; USOCR; EPO; DERWENT; IBM_TDB	OR	ON	2008/11/10 16:39

S5	33	(client or user) same (access) with (point) same (USB) same (secure or encrypt\$3) and (portable or mobile or handheld or palm)	US-PGPUB; USPAT; USOCR; EPO; DERWENT; IBM_TDB	OR	ON	2008/11/10 16:43
S6	5	(client or user) same (access) with (point) same (USB or thumb) near3 (drive) same (secure or encrypt\$3)	US-PGPUB; USPAT; USOCR; EPO; DERWENT; IBM_TDB	OR	ON	2008/11/13 10:52
S7	61	(client or user) same (access) adj (point) and (USB or thumb) near3 (drive) same (secure or encrypt\$3)	US-PGPUB; USPAT; USOCR; EPO; DERWENT; IBM_TDB	OR	ON	2008/11/13 10:55
S8	2	(client or user) same (access) adj (point) and (USB or thumb) near3 (drive) same (secure or encrypt\$3) and @ay<"2004,03,24"	US-PGPUB; USPAT; USOCR; EPO; DERWENT; IBM_TDB	OR	ON	2008/11/13 10:56
S14	9318	(remote) same (access) same (point) same ( device or module)	US-PGPUB; USPAT; USOCR; EPO; DERWENT; IBM_TDB	OR	ON	2008/11/13 20:59
S15	4079	(remote) same (access) near4 (point) same ( device or module)	US-PGPUB; USPAT; USOCR; EPO; DERWENT; IBM_TDB	OR	ON	2008/11/13 20:59
S16	8	(remote) same (access) near4 (point) same ( device or module) same (USB) same (secure or encrypt\$4)	US-PGPUB; USPAT; USOCR; EPO; DERWENT; IBM_TDB	OR	ON	2008/11/13 21:01
S17	283	(remote) same (access) near4 (point) same ( device or module) same (secure or encrypt\$4)	US-PGPUB; USPAT; USOCR; EPO; DERWENT; IBM_TDB	OR	ON	2008/11/13 21:03
S18	4	(remote) same (access) near4 (point) same (portable) with (device or module) same (secure or encrypt\$4)	US-PGPUB; USPAT; USOCR; EPO; DERWENT; IBM_TDB	OR	ON	2008/11/13 21:03
S19	1	(remote) same (access) near4 (point) same (portable) with (device or module) same (secure or encrypt\$4) and (USB)	US-PGPUB; USPAT; USOCR; EPO; DERWENT; IBM_TDB	OR	ON	2008/11/13 21:06

S20	688	(client or user) same (access) near4 (point) and (portable) with (device or module) same (secure or encrypt\$4)	US-PGPUB; USPAT; USOCR; EPO; DERWENT; IBM_TDB	OR	ON	2008/11/13 21:08
S21	70	(client or user) same (access) near4 (point) same (portable) with (device or module) same (secure or encrypt\$4)	US-PGPUB; USPAT; USOCR; EPO; DERWENT; IBM_TDB	OR	ON	2008/11/13 21:08
S22	36	(client or user) same (access) near4 (point) same (portable) with (device or module) same (secure or encrypt\$4) and (USB)	US-PGPUB; USPAT; USOCR; EPO; DERWENT; IBM_TDB	OR	ON	2008/11/13 21:09
S23	3	709/250.ccls. and (client or user) same (access) near4 (point) and (portable) with (device or module) same (secure or encrypt\$4)	US-PGPUB; USPAT; USOCR; EPO; DERWENT; IBM_TDB	OR	ON	2008/11/16 16:49
S24	9	709/250.ccls. and (access) near4 (point) same (portable) same (device or module or USB) and (secure or encrypt\$4)	US-PGPUB; USPAT; USOCR; EPO; DERWENT; IBM_TDB	OR	ON	2008/11/16 16:53
S25	9	709/250.ccls. and (access) near4 (point) same (portable or pluggable) same (device or module or USB) and (secure or encrypt \$4)	US-PGPUB; USPAT; USOCR; EPO; DERWENT; IBM_TDB	OR	ON	2008/11/16 16:55
S26	43	709/250.ccls. and (access) same (portable) same (device or module or USB) and (secure or encrypt\$4)	US-PGPUB; USPAT; USOCR; EPO; DERWENT; IBM_TDB	OR	ON	2008/11/16 16:55
S27	6	709/250.ccls. and (access) same (portable) same (device or module or USB) same (secure or encrypt\$4)	US-PGPUB; USPAT; USOCR; EPO; DERWENT; IBM_TDB	OR	ON	2008/11/16 16:55
S28	8	713/150.ccls. and (portable) same (device or module or USB) same (access\$4) same (network or WAN or LAN) same (secure or encrypt\$4)	US-PGPUB; USPAT; USOCR; EPO; DERWENT; IBM_TDB	OR	ON	2008/11/16 17:16
S29	90670	(potable) wtih (security) with (key)	US-PGPUB; USPAT; USOCR; EPO; DERWENT; IBM_TDB	OR	ON	2009/10/06 12:20

S30	843417	(portable) with (security) with (key)	US-PGPUB; USPAT; USOCR; EPO; DERWENT; IBM_TDB	OR	ON	2009/10/06 12:20
S31	996	(portable) with (security) with (key)	US-PGPUB; USPAT; USOCR; EPO; DERWENT; IBM_TDB	OR	ON	2009/10/06 12:20
S32	1481	(portable) with (security or secure) with (key)	US-PGPUB; USPAT; USOCR; EPO; DERWENT; IBM_TDB	OR	ON	2009/10/06 12:21
S33	283	(portable) near4 (security or secure) near4 (key)	US-PGPUB; USPAT; USOCR; EPO; DERWENT; IBM_TDB	OR	ON	2009/10/06 12:21
S35	1208	(portable) with (security or secure) with (key) same (terminal or system or device)	US-PGPUB; USPAT; USOCR; EPO; DERWENT; IBM_TDB	OR	ON	2009/10/06 12:22
S36	220	(portable) with (security or secure) with (key) with (terminal or system or device) with (access)	US-PGPUB; USPAT; USOCR; EPO; DERWENT; IBM_TDB	OR	ON	2009/10/06 12:22
S37	8	(portable) with (security or secure) with (key) with (terminal or system or device) with (access) and (thumb)	US-PGPUB; USPAT; USOCR; EPO; DERWENT; IBM_TDB	OR	ON	2009/10/06 12:35
S38	0	("2007/0170239").URPN.	USPAT	OR	ON	2009/10/06 12:41
S39	220	(portable) with (security or secure) with (key) with (terminal or system or device) with (access)	US-PGPUB; USPAT; USOCR; EPO; DERWENT; IBM_TDB	OR	ON	2009/10/06 12:42
S40	101	(portable) with (security or secure) with (key) with (terminal or system or device) with (access) and (USB)	US-PGPUB; USPAT; USOCR; EPO; DERWENT; IBM_TDB	OR	ON	2009/10/06 12:43
S41	1	("7412514").PN.	USPAT; USOCR	OR	OFF	2009/10/06 13:56



S42	2777	Hendrick.in.	US-PGPUB; USPAT; USOCR; EPO; DERWENT; IBM_TDB	OR	ON	2009/10/08 19:03
S43	10	Hendrick.in. and (portable) with (medium)	US-PGPUB; USPAT; USOCR; EPO; DERWENT; IBM_TDB	OR	ON	2009/10/08 19:04
S44	3	709/220.ccls. and (portable) with (security or secure) with (key) with (terminal or system or device) with (access)	US-PGPUB; USPAT; USOCR; EPO; DERWENT; IBM_TDB	OR	ON	2009/10/08 22:37
S45	45399	(client or user) same (access) with (point)	US-PGPUB; USPAT; USOCR; EPO; DERWENT; IBM_TDB	OR	ON	2009/10/08 22:37
S46	511	(client or user) same (access) with (point) same (USB)	US-PGPUB; USPAT; USOCR; EPO; DERWENT; IBM_TDB	OR	ON	2009/10/08 22:37
S47	42	(client or user) same (access) with (point) same (USB) same (secure or encrypt\$3) and (portable or mobile or handheld or palm)	US-PGPUB; USPAT; USOCR; EPO; DERWENT; IBM_TDB	OR	ON	2009/10/08 22:37
S48	7	(client or user) same (access) with (point) same (USB or thumb) near3 (drive) same (secure or encrypt\$3)	US-PGPUB; USPAT; USOCR; EPO; DERWENT; IBM_TDB	OR	ON	2009/10/08 22:37
S49	77	(client or user) same (access) adj (point) and (USB or thumb) near3 (drive) same (secure or encrypt\$3)	US-PGPUB; USPAT; USOCR; EPO; DERWENT; IBM_TDB	OR	ON	2009/10/08 22:37
S50	2	(client or user) same (access) adj (point) and (USB or thumb) near3 (drive) same (secure or encrypt\$3) and @ay< "2004,03,24"	US-PGPUB; USPAT; USOCR; EPO; DERWENT; IBM_TDB	OR	ON	2009/10/08 22:37
S51	10955	(remote) same (access) same (point) same ( device or module)	US-PGPUB; USPAT; USOCR; EPO; DERWENT; IBM_TDB	OR	ON	2009/10/08 22:37

S52	5209	(remote) same (access) near4 (point) same ( device or module)	US-PGPUB; USPAT; USOCR; EPO; DERWENT; IBM_TDB	OR	ON	2009/10/08 22:37
S53	10	(remote) same (access) near4 (point) same ( device or module) same (USB) same (secure or encrypt\$4)	US-PGPUB; USPAT; USOCR; EPO; DERWENT; IBM_TDB	OR	ON	2009/10/08 22:37
S54	342	(remote) same (access) near4 (point) same ( device or module) same (secure or encrypt\$4)	US-PGPUB; USPAT; USOCR; EPO; DERWENT; IBM_TDB	OR	ON	2009/10/08 22:37
S55	6	(remote) same (access) near4 (point) same (portable) with (device or module) same (secure or encrypt\$4)	US-PGPUB; USPAT; USOCR; EPO; DERWENT; IBM_TDB	OR	ON	2009/10/08 22:37
S56	1	(remote) same (access) near4 (point) same (portable) with (device or module) same (secure or encrypt\$4) and (USB)	US-PGPUB; USPAT; USOCR; EPO; DERWENT; IBM_TDB	OR	ON	2009/10/08 22:37
S57	840	(client or user) same (access) near4 (point) and (portable) with (device or module) same (secure or encrypt\$4)	US-PGPUB; USPAT; USOCR; EPO; DERWENT; IBM_TDB	OR	ON	2009/10/08 22:37
S58	91	(client or user) same (access) near4 (point) same (portable) with (device or module) same (secure or encrypt\$4)	US-PGPUB; USPAT; USOCR; EPO; DERWENT; IBM_TDB	OR	ON	2009/10/08 22:37
S59	43	(client or user) same (access) near4 (point) same (portable) with (device or module) same (secure or encrypt\$4) and (USB)	US-PGPUB; USPAT; USOCR; EPO; DERWENT; IBM_TDB	OR	ON	2009/10/08 22:37
S60	4	709/250.ccls. and (client or user) same (access) near4 (point) and (portable) with (device or module) same (secure or encrypt\$4)	US-PGPUB; USPAT; USOCR; EPO; DERWENT; IBM_TDB	OR	ON	2009/10/08 22:37
S61	12	709/250.ccls. and (access) near4 (point) same (portable) same (device or module or USB) and (secure or encrypt\$4)	US-PGPUB; USPAT; USOCR; EPO; DERWENT; IBM_TDB	OR	ON	2009/10/08 22:37

S62	12	709/250.ccls. and (access) near4 (point) same (portable or pluggable) same (device or module or USB) and (secure or encrypt \$4)	US-PGPUB; USPAT; USOCR; EPO; DERWENT; IBM_TDB	OR	ON	2009/10/08 22:37
S63	50	709/250.ccls. and (access) same (portable) same (device or module or USB) and (secure or encrypt\$4)	US-PGPUB; USPAT; USOCR; EPO; DERWENT; IBM_TDB	OR	ON	2009/10/08 22:37
S64	7	709/250.ccls. and (access) same (portable) same (device or module or USB) same (secure or encrypt\$4)	US-PGPUB; USPAT; USOCR; EPO; DERWENT; IBM_TDB	OR	ON	2009/10/08 22:37
S65	14	713/150.ccls. and (portable) same (device or module or USB) same (access\$4) same (network or WAN or LAN) same (secure or encrypt\$4)	US-PGPUB; USPAT; USOCR; EPO; DERWENT; IBM_TDB	OR	ON	2009/10/08 22:37
S66	90744	(potable) wtih (security) with (key)	US-PGPUB; USPAT; USOCR; EPO; DERWENT; IBM_TDB	OR	ON	2009/10/08 22:37
S67	844045	(portable) wtih (security) with (key)	US-PGPUB; USPAT; USOCR; EPO; DERWENT; IBM_TDB	OR	ON	2009/10/08 22:37
S68	996	(portable) with (security) with (key)	US-PGPUB; USPAT; USOCR; EPO; DERWENT; IBM_TDB	OR	ON	2009/10/08 22:37
S69	1481	(portable) with (security or secure) with (key)	US-PGPUB; USPAT; USOCR; EPO; DERWENT; IBM_TDB	OR	ON	2009/10/08 22:37
S70	283	(portable) near4 (security or secure) near4 (key)	US-PGPUB; USPAT; USOCR; EPO; DERWENT; IBM_TDB	OR	ON	2009/10/08 22:37
S71	1208	(portable) with (security or secure) with (key) same (termial or system or device)	US-PGPUB; USPAT; USOCR; EPO; DERWENT; IBM_TDB	OR	ON	2009/10/08 22:37

S72	220	(portable) with (security or secure) with (key) with (terminal or system or device) with (access)	US-PGPUB; USPAT; USOCR; EPO; DERWENT; IBM_TDB	OR	ON	2009/10/08 22:37
S73	8	(portable) with (security or secure) with (key) with (terminal or system or device) with (access) and (thumb)	US-PGPUB; USPAT; USOCR; EPO; DERWENT; IBM_TDB	OR	ON	2009/10/08 22:37
S74	0	("2007/0170239").URPN.	USPAT	OR	ON	2009/10/08 22:37
S75	220	(portable) with (security or secure) with (key) with (terminal or system or device) with (access)	US-PGPUB; USPAT; USOCR; EPO; DERWENT; IBM_TDB	OR	ON	2009/10/08 22:37
S76	101	(portable) with (security or secure) with (key) with (terminal or system or device) with (access) and (USB)	US-PGPUB; USPAT; USOCR; EPO; DERWENT; IBM_TDB	OR	ON	2009/10/08 22:37
S77	1	("7412514").PN.	USPAT; USOCR	OR	OFF	2009/10/08 22:37
S78	2777	Hendrick.in.	US-PGPUB; USPAT; USOCR; EPO; DERWENT; IBM_TDB	OR	ON	2009/10/08 22:37
S79	10	Hendrick.in. and (portable) with (medium)	US-PGPUB; USPAT; USOCR; EPO; DERWENT; IBM_TDB	OR	ON	2009/10/08 22:37

8/ 31/ 2010 1:37:07 PM

C:\Documents and Settings\abilgrami\My Documents\EAST\Workspaces\10807731.wsp

<b>FORM PTO-1449A</b> <b>INFORMATION DISCLOSURE CITATION</b>	Attorney Docket: 1004294.001US	Serial No.: 10/807,731
	Applicant: Scott McNulty	
	Filing Date: March 23, 2004	Group Art Unit: 2443

**U.S. PATENT / PUBLICATION DOCUMENTS**

Examiner Initial		Patent/Publication Number	Publication/Issue Date	Name	Filing Date
/AB/	1.	2004/0127254 A1	July 1, 2004	William Ho CHANG	
/AB/	2.	7,454,783 B2	Nov. 18, 2008	DUPOUY et al.	
	3.				
	4.				
	5.				
	6.				
	7.				
	8.				
	9.				
	10.				
	11.				
	12.				
	13.				
	14.				

**FOREIGN PATENT DOCUMENTS**

Examiner Initial		Patent Number	Publication Date	Country	Copy Filed	Translation
	15.				<input type="checkbox"/> Yes	<input type="checkbox"/> Yes <input type="checkbox"/> No <input type="checkbox"/> Abstract <input type="checkbox"/> N/A
	16.				<input type="checkbox"/> Yes	<input type="checkbox"/> Yes <input type="checkbox"/> No <input type="checkbox"/> Abstract <input type="checkbox"/> N/A
	17.				<input type="checkbox"/> Yes	<input type="checkbox"/> Yes <input type="checkbox"/> No <input type="checkbox"/> Abstract <input type="checkbox"/> N/A
	18.				<input type="checkbox"/> Yes	<input type="checkbox"/> Yes <input type="checkbox"/> No <input type="checkbox"/> Abstract <input type="checkbox"/> N/A
	19.				<input type="checkbox"/> Yes	<input type="checkbox"/> Yes <input type="checkbox"/> No <input type="checkbox"/> Abstract <input type="checkbox"/> N/A
	20.				<input type="checkbox"/> Yes	<input type="checkbox"/> Yes <input type="checkbox"/> No <input type="checkbox"/> Abstract <input type="checkbox"/> N/A

Examiner <i>/Asghar Bilgrami/</i>	Date Considered 08/31/2010
EXAMINER: Initial if reference considered, whether or not citation is in conformance with MPEP §609. Draw line through citation if not in conformance and not considered. Include copy of this form with next communication to Applicant.	

**PART B - FEE(S) TRANSMITTAL**

Complete and send this form, together with applicable fee(s), to: **Mail** Mail Stop ISSUE FEE  
**Commissioner for Patents**  
**P.O. Box 1450**  
**Alexandria, Virginia 22313-1450**  
 or **Fax** (571)-273-2885

**INSTRUCTIONS:** This form should be used for transmitting the ISSUE FEE and PUBLICATION FEE (if required). Blocks 1 through 5 should be completed where appropriate. All further correspondence including the Patent, advance orders and notification of maintenance fees will be mailed to the current correspondence address as indicated unless corrected below or directed otherwise in Block 1, by (a) specifying a new correspondence address; and/or (b) indicating a separate "FEE ADDRESS" for maintenance fee notifications.

CURRENT CORRESPONDENCE ADDRESS (Note: Use Block 1 for any change of address)

Note: A certificate of mailing can only be used for domestic mailings of the Fee(s) Transmittal. This certificate cannot be used for any other accompanying papers. Each additional paper, such as an assignment or formal drawing, must have its own certificate of mailing or transmission.

85775                      7590                      09/20/2010

Locke Lord Bissell & Liddell LLP  
 Attn: IP Docketing  
 Three World Financial Center  
 New York, NY 10281-2101

**Certificate of Mailing or Transmission**

I hereby certify that this Fee(s) Transmittal is being deposited with the United States Postal Service with sufficient postage for first class mail in an envelope addressed to the Mail Stop ISSUE FEE address above, or being facsimile transmitted to the USPTO (571) 273-2885, on the date indicated below.

(Depositor's name)
(Signature)
(Date)

APPLICATION NO.	FILING DATE	FIRST NAMED INVENTOR	ATTORNEY DOCKET NO.	CONFIRMATION NO.
10/807,731	03/23/2004	Scott McNulty	1004294.001US (4602-4001)	4430

TITLE OF INVENTION: APPARATUS, METHOD AND SYSTEM FOR A TUNNELING CLIENT ACCESS POINT

APPLN. TYPE	SMALL ENTITY	ISSUE FEE DUE	PUBLICATION FEE DUE	PREV. PAID ISSUE FEE	TOTAL FEE(S) DUE	DATE DUE
nonprovisional	YES	\$755	\$300	\$0	\$1055	12/20/2010

EXAMINER	ART UNIT	CLASS-SUBCLASS
BILGRAMI, ASGHAR H	2443	709-250000

<p>1. Change of correspondence address or indication of "Fee Address" (37 CFR 1.363).</p> <p><input type="checkbox"/> Change of correspondence address (or Change of Correspondence Address form PTO/SB/122) attached.</p> <p><input type="checkbox"/> "Fee Address" indication (or "Fee Address" Indication form PTO/SB/47; Rev 03-02 or more recent) attached. Use of a <b>Customer Number is required.</b></p>	<p>2. For printing on the patent front page, list</p> <p>(1) the names of up to 3 registered patent attorneys or agents OR, alternatively,</p> <p>(2) the name of a single firm (having as a member a registered attorney or agent) and the names of up to 2 registered patent attorneys or agents. If no name is listed, no name will be printed.</p> <p>1 <u>Locke Lord Bissell &amp; Liddell LLP</u></p> <p>2 _____</p> <p>3 _____</p>
---	---

3. ASSIGNEE NAME AND RESIDENCE DATA TO BE PRINTED ON THE PATENT (print or type)

PLEASE NOTE: Unless an assignee is identified below, no assignee data will appear on the patent. If an assignee is identified below, the document has been filed for recordation as set forth in 37 CFR 3.11. Completion of this form is NOT a substitute for filing an assignment.

(A) NAME OF ASSIGNEE \_\_\_\_\_ (B) RESIDENCE: (CITY and STATE OR COUNTRY) \_\_\_\_\_

Please check the appropriate assignee category or categories (will not be printed on the patent) :  Individual  Corporation or other private group entity  Government

<p>4a. The following fee(s) are submitted:</p> <p><input checked="" type="checkbox"/> Issue Fee</p> <p><input checked="" type="checkbox"/> Publication Fee (No small entity discount permitted)</p> <p><input type="checkbox"/> Advance Order - # of Copies _____</p>	<p>4b. Payment of Fee(s): (Please first reapply any previously paid issue fee shown above)</p> <p><input type="checkbox"/> A check is enclosed.</p> <p><input type="checkbox"/> Payment by credit card. Form PTO-2038 is attached.</p> <p><input checked="" type="checkbox"/> The Director is hereby authorized to charge the required fee(s), any deficiency, or credit any overpayment, to Deposit Account Number <u>504827</u> (enclose an extra copy of this form).</p>
---	---

5. Change in Entity Status (from status indicated above)

a. Applicant claims SMALL ENTITY status. See 37 CFR 1.27.       b. Applicant is no longer claiming SMALL ENTITY status. See 37 CFR 1.27(g)(2).

Matter No. 1004294.001US

NOTE: The Issue Fee and Publication Fee (if required) will not be accepted from anyone other than the applicant; a registered attorney or agent; or the assignee or other party in interest as shown by the records of the United States Patent and Trademark Office.

Authorized Signature  Date November 15, 2010

Typed or printed name Robert K. Goethals Registration No. 36,813

This collection of information is required by 37 CFR 1.311. The information is required to obtain or retain a benefit by the public which is to file (and by the USPTO to process) an application. Confidentiality is governed by 35 U.S.C. 122 and 37 CFR 1.14. This collection is estimated to take 12 minutes to complete, including gathering, preparing, and submitting the completed application form to the USPTO. Time will vary depending upon the individual case. Any comments on the amount of time you require to complete this form and/or suggestions for reducing this burden, should be sent to the Chief Information Officer, U.S. Patent and Trademark Office, U.S. Department of Commerce, P.O. Box 1450, Alexandria, Virginia 22313-1450. DO NOT SEND FEES OR COMPLETED FORMS TO THIS ADDRESS. SEND TO: Commissioner for Patents, P.O. Box 1450, Alexandria, Virginia 22313-1450.

Under the Paperwork Reduction Act of 1995, no persons are required to respond to a collection of information unless it displays a valid OMB control number.

## Electronic Patent Application Fee Transmittal

<b>Application Number:</b>	10807731
<b>Filing Date:</b>	23-Mar-2004
<b>Title of Invention:</b>	APPARATUS, METHOD AND SYSTEM FOR A TUNNELING CLIENT ACCESS POINT
<b>First Named Inventor/Applicant Name:</b>	Scott McNulty
<b>Filer:</b>	Robert Keaney Goethals/Anna Hill
<b>Attorney Docket Number:</b>	1004294.001 US (4602-4001)

Filed as Small Entity

### Utility under 35 USC 111(a) Filing Fees

Description	Fee Code	Quantity	Amount	Sub-Total in USD(\$)
<b>Basic Filing:</b>				
<b>Pages:</b>				
<b>Claims:</b>				
<b>Miscellaneous-Filing:</b>				
<b>Petition:</b>				
<b>Patent-Appeals-and-Interference:</b>				
<b>Post-Allowance-and-Post-Issuance:</b>				
Utility Appl issue fee	2501	1	755	755
Publ. Fee- early, voluntary, or normal	1504			

Description	Fee Code	Quantity	Amount	Sub-Total in USD(\$)
<b>Extension-of-Time:</b>				
<b>Miscellaneous:</b>				
<b>Total in USD (\$)</b>				<b>1055</b>



## Electronic Acknowledgement Receipt

<b>EFS ID:</b>	8834596
<b>Application Number:</b>	10807731
<b>International Application Number:</b>	
<b>Confirmation Number:</b>	4430
<b>Title of Invention:</b>	APPARATUS, METHOD AND SYSTEM FOR A TUNNELING CLIENT ACCESS POINT
<b>First Named Inventor/Applicant Name:</b>	Scott McNulty
<b>Customer Number:</b>	85775
<b>Filer:</b>	Robert Keaney Goethals/Anna Hill
<b>Filer Authorized By:</b>	Robert Keaney Goethals
<b>Attorney Docket Number:</b>	1004294.001US (4602-4001)
<b>Receipt Date:</b>	15-NOV-2010
<b>Filing Date:</b>	23-MAR-2004
<b>Time Stamp:</b>	12:43:40
<b>Application Type:</b>	Utility under 35 USC 111(a)

### Payment information:

Submitted with Payment	yes
Payment Type	Deposit Account
Payment was successfully received in RAM	\$1055
RAM confirmation Number	9307
Deposit Account	504827
Authorized User	

The Director of the USPTO is hereby authorized to charge indicated fees and credit any overpayment as follows:

Charge any Additional Fees required under 37 C.F.R. Section 1.17 (Patent application and reexamination processing fees)

Charge any Additional Fees required under 37 C.F.R. Section 1.20 (Post Issuance fees)

PayPal Ex. 1058, p. 401  
PayPal v. IOENGINE

Charge any Additional Fees required under 37 C.F.R. Section 1.21 (Miscellaneous fees and charges)

**File Listing:**

Document Number	Document Description	File Name	File Size(Bytes)/ Message Digest	Multi Part /.zip	Pages (if appl.)
1	Issue Fee Payment (PTO-85B)	1004294_001US_IssueFee.pdf	116904 342e185ac5be2c1686b80da3243029a82fab4016	no	1

**Warnings:**

**Information:**

2	Fee Worksheet (PTO-875)	fee-info.pdf	31869 7271a612c39bf8943eaf21e621fe4608a80a661f	no	2
---	-------------------------	--------------	---	----	---

**Warnings:**

**Information:**

<b>Total Files Size (in bytes):</b>			148773		
-------------------------------------	--	--	--------	--	--

**This Acknowledgement Receipt evidences receipt on the noted date by the USPTO of the indicated documents, characterized by the applicant, and including page counts, where applicable. It serves as evidence of receipt similar to a Post Card, as described in MPEP 503.**

**New Applications Under 35 U.S.C. 111**

**If a new application is being filed and the application includes the necessary components for a filing date (see 37 CFR 1.53(b)-(d) and MPEP 506), a Filing Receipt (37 CFR 1.54) will be issued in due course and the date shown on this Acknowledgement Receipt will establish the filing date of the application.**

**National Stage of an International Application under 35 U.S.C. 371**

**If a timely submission to enter the national stage of an international application is compliant with the conditions of 35 U.S.C. 371 and other applicable requirements a Form PCT/DO/EO/903 indicating acceptance of the application as a national stage submission under 35 U.S.C. 371 will be issued in addition to the Filing Receipt, in due course.**

**New International Application Filed with the USPTO as a Receiving Office**

**If a new international application is being filed and the international application includes the necessary components for an international filing date (see PCT Article 11 and MPEP 1810), a Notification of the International Application Number and of the International Filing Date (Form PCT/RO/105) will be issued in due course, subject to prescriptions concerning national security, and the date shown on this Acknowledgement Receipt will establish the international filing date of the application.**

Under the Paperwork Reduction Act of 1995, no persons are required to respond to a collection of information unless it displays a valid OMB control number.

**POWER OF ATTORNEY  
OR  
REVOCATION OF POWER OF ATTORNEY  
WITH A NEW POWER OF ATTORNEY  
AND  
CHANGE OF CORRESPONDENCE ADDRESS**

<b>Application Number</b>	10/807,731
<b>Filing Date</b>	March 23, 2004
<b>First Named Inventor</b>	Scott McNulty
<b>Title</b>	Apparatus ... Tunneling Client Access Point
<b>Art Unit</b>	2443
<b>Examiner Name</b>	Bilgrami, Asghar H.
<b>Attorney Docket Number</b>	1004294.001US

I hereby revoke all previous powers of attorney given in the above-identified application.

 A Power of Attorney is submitted herewith.

OR

 I hereby appoint Practitioner(s) associated with the following Customer Number as my/our attorney(s) or agent(s) to prosecute the application identified above, and to transact all business in the United States Patent and Trademark Office connected therewith:

85775

OR

 I hereby appoint Practitioner(s) named below as my/our attorney(s) or agent(s) to prosecute the application identified above, and to transact all business in the United States Patent and Trademark Office connected therewith:

Practitioner(s) Name	Registration Number

Please recognize or change the correspondence address for the above-identified application to:

 The address associated with the above-mentioned Customer Number.

OR

 The address associated with Customer Number:

OR

 Firm or Individual Name

Address

City

State

Zip

Country

Telephone

Email

I am the:

 Applicant/Inventor.

OR

 Assignee of record of the entire interest. See 37 CFR 3.71.

Statement under 37 CFR 3.73(b) (Form PTO/SB/96) submitted herewith or filed on \_\_\_\_\_

**SIGNATURE of Applicant or Assignee of Record**

Signature

Name

Scott McNulty

Date

Telephone

Title and Company

**NOTE:** Signatures of all the inventors or assignees of record of the entire interest or their representative(s) are required. Submit multiple forms if more than one signature is required, see below\*. \*Total of \_\_\_\_\_ forms are submitted.

This collection of information is required by 37 CFR 1.31, 1.32 and 1.33. The information is required to obtain or retain a benefit by the public which is to file (and by the USPTO to process) an application. Confidentiality is governed by 35 U.S.C. 122 and 37 CFR 1.11 and 1.14. This collection is estimated to take 3 minutes to complete, including gathering, preparing, and submitting the completed application form to the USPTO. Time will vary depending upon the individual case. Any comments on the amount of time you require to complete this form and/or suggestions for reducing this burden, should be sent to the Chief Information Officer, U.S. Patent and Trademark Office, U.S. Department of Commerce, P.O. Box 1450, Alexandria, VA 22313-1450. DO NOT SEND FEES OR COMPLETED FORMS TO THIS ADDRESS. SEND TO: Commissioner for Patents, P.O. Box 1450, Alexandria, VA 22313-1450.

If you need assistance in completing the form, call 1-800-PTO-9199 and select option 2.

## Electronic Acknowledgement Receipt

<b>EFS ID:</b>	8872644
<b>Application Number:</b>	10807731
<b>International Application Number:</b>	
<b>Confirmation Number:</b>	4430
<b>Title of Invention:</b>	APPARATUS, METHOD AND SYSTEM FOR A TUNNELING CLIENT ACCESS POINT
<b>First Named Inventor/Applicant Name:</b>	Scott McNulty
<b>Customer Number:</b>	85775
<b>Filer:</b>	Robert Keaney Goethals/Anna Hill
<b>Filer Authorized By:</b>	Robert Keaney Goethals
<b>Attorney Docket Number:</b>	1004294.001US (4602-4001)
<b>Receipt Date:</b>	19-NOV-2010
<b>Filing Date:</b>	23-MAR-2004
<b>Time Stamp:</b>	09:30:42
<b>Application Type:</b>	Utility under 35 USC 111(a)

### Payment information:

Submitted with Payment	no
------------------------	----

### File Listing:

Document Number	Document Description	File Name	File Size(Bytes)/ Message Digest	Multi Part /.zip	Pages (if appl.)
1	Power of Attorney	POA0001.pdf	85886 <small>80277dbc638e7e06f5ecffe678ad945d41dcad6a</small>	no	1

### Warnings:

### Information:

PayPal Ex. 1058, p. 404  
PayPal v. IOENGINE

**This Acknowledgement Receipt evidences receipt on the noted date by the USPTO of the indicated documents, characterized by the applicant, and including page counts, where applicable. It serves as evidence of receipt similar to a Post Card, as described in MPEP 503.**

**New Applications Under 35 U.S.C. 111**

**If a new application is being filed and the application includes the necessary components for a filing date (see 37 CFR 1.53(b)-(d) and MPEP 506), a Filing Receipt (37 CFR 1.54) will be issued in due course and the date shown on this Acknowledgement Receipt will establish the filing date of the application.**

**National Stage of an International Application under 35 U.S.C. 371**

**If a timely submission to enter the national stage of an international application is compliant with the conditions of 35 U.S.C. 371 and other applicable requirements a Form PCT/DO/EO/903 indicating acceptance of the application as a national stage submission under 35 U.S.C. 371 will be issued in addition to the Filing Receipt, in due course.**

**New International Application Filed with the USPTO as a Receiving Office**

**If a new international application is being filed and the international application includes the necessary components for an international filing date (see PCT Article 11 and MPEP 1810), a Notification of the International Application Number and of the International Filing Date (Form PCT/RO/105) will be issued in due course, subject to prescriptions concerning national security, and the date shown on this Acknowledgement Receipt will establish the international filing date of the application.**



APPLICATION NO.	ISSUE DATE	PATENT NO.	ATTORNEY DOCKET NO.	CONFIRMATION NO.
10/807,731	12/28/2010	7861006	1004294.001US (4602-4001)	4430

85775 7590 12/08/2010  
Locke Lord Bissell & Liddell LLP  
Attn: IP Docketing  
Three World Financial Center  
New York, NY 10281-2101

### ISSUE NOTIFICATION

The projected patent number and issue date are specified above.

#### **Determination of Patent Term Adjustment under 35 U.S.C. 154 (b)** (application filed on or after May 29, 2000)

The Patent Term Adjustment is 1673 day(s). Any patent to issue from the above-identified application will include an indication of the adjustment on the front page.

If a Continued Prosecution Application (CPA) was filed in the above-identified application, the filing date that determines Patent Term Adjustment is the filing date of the most recent CPA.

Applicant will be able to obtain more detailed information by accessing the Patent Application Information Retrieval (PAIR) WEB site (<http://pair.uspto.gov>).

Any questions regarding the Patent Term Extension or Adjustment determination should be directed to the Office of Patent Legal Administration at (571)-272-7702. Questions relating to issue and publication fee payments should be directed to the Application Assistance Unit (AAU) of the Office of Data Management (ODM) at (571)-272-4200.

APPLICANT(s) (Please see PAIR WEB site <http://pair.uspto.gov> for additional applicants):

Scott McNulty, Rowayton, CT;