

Under the Paperwork Reduction Act of 1995 no persons are required to respond to a collection of information unless it displays a valid OMB control number

<b>UTILITY PATENT APPLICATION TRANSMITTAL</b>  <i>(Only for new nonprovisional applications under 37 CFR 1.53(b))</i>	Attorney Docket No.	2855.0050008
	First Named Inventor	James J. FALLON
	Title	See 1 in Addendum
	Express Mail Label No.	

<b>APPLICATION ELEMENTS</b> <i>See MPEP chapter 600 concerning utility patent application contents.</i>	<b>ADDRESS TO:</b> Commissioner for Patents P.O. Box 1450 Alexandria, VA 22313-1450
--	--

1.  **Fee Transmittal Form**  
(PTO/SB/17 or equivalent)
2.  **Applicant asserts small entity status.**  
See 37 CFR 1.27
3.  **Applicant certifies micro entity status.** See 37 CFR 1.29.  
Applicant must attach form PTO/SB/15A or B or equivalent.
4.  **Specification** [Total Pages 35]  
Both the claims and abstract must start on a new page.  
(See MPEP § 608.01(a) for information on the preferred arrangement)
5.  **Drawing(s)** (35 U.S.C. 113) [Total Sheets 4]
6. **Inventor's Oath or Declaration** [Total Pages 2]  
(including substitute statements under 37 CFR 1.64 and assignments serving as an oath or declaration under 37 CFR 1.63(e))
  - a.  Newly executed (original or copy)
  - b.  A copy from a prior application (37 CFR 1.63(d))
7.  **Application Data Sheet** \* See note below.  
See 37 CFR 1.76 (PTO/AIA/14 or equivalent)
8. **CD-ROM or CD-R**  
in duplicate, large table, or Computer Program (Appendix)
  - Landscape Table on CD
9. **Nucleotide and/or Amino Acid Sequence Submission**  
(if applicable, items a. - c. are required)
  - a.  Computer Readable Form (CRF)
  - b.  Specification Sequence Listing on:
    - i.  CD-ROM or CD-R (2 copies); or
    - ii.  Paper
  - c.  Statements verifying identity of above copies

**ACCOMPANYING APPLICATION PAPERS**

10.  **Assignment Papers**  
(cover sheet & document(s))  
Name of Assignee Realtime Data LLC
11.  **37 CFR 3.73(c) Statement**  
(when there is an assignee)  **Power of Attorney**
12.  **English Translation Document**  
(if applicable)
13.  **Information Disclosure Statement**  
(PTO/SB/08 or PTO-1449)  
 Copies of citations attached
14.  **Preliminary Amendment**
15.  **Return Receipt Postcard**  
(MPEP § 503) (Should be specifically itemized)
16.  **Certified Copy of Priority Document(s)**  
(if foreign priority is claimed)
17.  **Nonpublication Request**  
Under 35 U.S.C. 122(b)(2)(B)(i). Applicant must attach form PTO/SB/35 or equivalent.
18.  **Other: Authorization under 37 CFR 1.136(a)(3)**  
See 2 in Addendum

**\*Note:** (1) Benefit claims under 37 CFR 1.78 and foreign priority claims under 1.55 must be included in an Application Data Sheet (ADS).  
 (2) For applications filed under 35 U.S.C. 111, the application must contain an ADS specifying the applicant if the applicant is an assignee, person to whom the inventor is under an obligation to assign, or person who otherwise shows sufficient proprietary interest in the matter. See 37 CFR 1.46(b).

**19. CORRESPONDENCE ADDRESS**

The address associated with Customer Number: 26111 OR  Correspondence address below

Name		Address	
City	State	Zip Code	
Country	Telephone	Email	

Signature	Date
Name (Print/Type) <u>Michael V. Messinger</u>	Registration No. (Attorney/Agent) <u>37,575</u>

This collection of information is required by 37 CFR 1.53(b). The information is required to obtain or retain a benefit by the public which is to file (and by the USPTO to process) an application. Confidentiality is governed by 35 U.S.C. 122 and 37 CFR 1.11 and 1.14. This collection is estimated to take 12 minutes to complete, including gathering, preparing, and submitting the completed application form to the USPTO. Time will vary depending upon the individual case. Any comments on the amount of time you require to complete this form and/or suggestions for reducing this burden, should be sent to the Chief Information Officer, U.S. Patent and Trademark Office, U.S. Department of Commerce, P.O. Box 1450, Alexandria, VA 22313-1450. DO NOT SEND FEES OR COMPLETED FORMS TO THIS ADDRESS. SEND TO: Commissioner for Patents, P.O. Box 1450, Alexandria, VA 22313-1450.

*If you need assistance in completing the form, call 1-800-PTO-9199 and select option 2.*

## Addendum

1. SYSTEM AND METHODS FOR VIDEO AND AUDIO DATA DISTRIBUTION
2. Certification and Request for Prioritized Examination Under 37 C.F.R. 1.102(e)

## TRANSMITTAL FOR POWER OF ATTORNEY TO ONE OR MORE REGISTERED PRACTITIONERS

NOTE: This form is to be submitted with the Power of Attorney by Applicant form (PTO/AIA/82B) to identify the application to which the Power of Attorney is directed, in accordance with 37 CFR 1.5, unless the application number and filing date are identified in the Power of Attorney by Applicant form. If neither form PTO/AIA/82A nor form PTO/AIA/82B identifies the application to which the Power of Attorney is directed, the Power of Attorney will not be recognized in the application.

Application Number	To Be Assigned
Filing Date	Herewith
First Named Inventor	James J. FALLON
Title	SYSTEM AND METHODS FOR VIDEO AND AUDIO DATA DISTRIBUTION
Art Unit	To Be Assigned
Examiner Name	To Be Assigned
Attorney Docket Number	2855.0050008

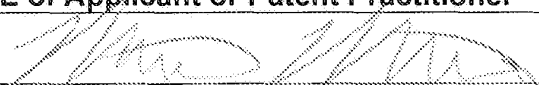
SIGNATURE of Applicant or Patent Practitioner			
Signature		Date (Optional)	12/19/2013
Name	Michael V. Messinger	Registration Number	37,575
Title (if Applicant is a juristic entity)			
Applicant Name (if Applicant is a juristic entity)			

**NOTE:** This form must be signed in accordance with 37 CFR 1.33. See 37 CFR 1.4(d) for signature requirements and certifications. If more than one applicant, use multiple forms.

\*Total of 1 forms are submitted.

This collection of information is required by 37 CFR 1.131, 1.32, and 1.33. The information is required to obtain or retain a benefit by the public which is to file (and by the USPTO to process) an application. Confidentiality is governed by 35 U.S.C. 122 and 37 CFR 1.11 and 1.14. This collection is estimated to take 3 minutes to complete, including gathering, preparing, and submitting the completed application form to the USPTO. Time will vary depending upon the individual case. Any comments on the amount of time you require to complete this form and/or suggestions for reducing this burden, should be sent to the Chief Information Officer, U.S. Patent and Trademark Office, U.S. Department of Commerce, P.O. Box 1450, Alexandria, VA 22313-1450. DO NOT SEND FEES OR COMPLETED FORMS TO THIS ADDRESS. **SEND TO: Commissioner for Patents, P.O. Box 1450, Alexandria, VA 22313-1450.**

If you need assistance in completing the form, call 1-800-PTO-9199 and select option 2. 1787683

Under the Paperwork Reduction Act of 1995, no persons are required to respond to a collection of information unless it displays a valid OMB control number

POWER OF ATTORNEY BY APPLICANT

I hereby revoke all previous powers of attorney given in the application identified in either the attached transmittal letter or the boxes below.

Table with 2 columns: Application Number, Filing Date

(Note: The boxes above may be left blank if information is provided on form PTO/AIA/82A.)

- I hereby appoint the Patent Practitioner(s) associated with the following Customer Number as my/our attorney(s) or agent(s), and to transact all business in the United States Patent and Trademark Office connected therewith for the application referenced in the attached transmittal letter (form PTO/AIA/82A) or identified above: 26111
OR
I hereby appoint Practitioner(s) named in the attached list (form PTO/AIA/82C) as my/our attorney(s) or agent(s), and to transact all business in the United States Patent and Trademark Office connected therewith for the patent application referenced in the attached transmittal letter (form PTO/AIA/82A) or identified above. (Note: Complete form PTO/AIA/82C.)

Please recognize or change the correspondence address for the application identified in the attached transmittal letter or the boxes above to:

- The address associated with the above-mentioned Customer Number
OR
The address associated with Customer Number: 26111
OR

Form fields for Firm or Individual Name, Address, City, State, Zip, Country, Telephone, Email

I am the Applicant (if the Applicant is a juristic entity, list the Applicant name in the box):

Realtime Data, LLC

- Inventor or Joint Inventor (title not required below)
Legal Representative of a Deceased or Legally Incapacitated Inventor (title not required below)
Assignee or Person to Whom the Inventor is Under an Obligation to Assign (provide signer's title if applicant is a juristic entity)
Person Who Otherwise Shows Sufficient Proprietary Interest (e.g., a petition under 37 CFR 1.46(b)(2) was granted in the application or is concurrently being filed with this document) (provide signer's title if applicant is a juristic entity)

SIGNATURE of Applicant for Patent

The undersigned (whose title is supplied below) is authorized to act on behalf of the applicant (e.g., where the applicant is a juristic entity).

Signature, Date (Optional), Name (James J. Fallon), Title (Director, Realtime Data, LLC)

NOTE: Signature - This form must be signed by the applicant in accordance with 37 CFR 1.33. See 37 CFR 1.4 for signature requirements and certifications. If more than one applicant, use multiple forms.

Total of 1 forms are submitted.

This collection of information is required by 37 CFR 1.331, 1.332, and 1.333. The information is required to obtain or retain a benefit by the public which is to file (and by the USPTO to process) an application. Confidentiality is governed by 35 U.S.C. 122 and 37 CFR 1.11 and 1.14. This collection is estimated to take 3 minutes to complete, including gathering, preparing, and submitting the completed application form to the USPTO. Time will vary depending upon the individual case. Any comments on the amount of time you require to complete this form and/or suggestions for reducing this burden, should be sent to the Chief Information Officer, U.S. Patent and Trademark Office, U.S. Department of Commerce, P.O. Box 1450, Alexandria, VA 22313-1450. DO NOT SEND FEES OR COMPLETED FORMS TO THIS ADDRESS. SEND TO: Commissioner for Patents, P.O. Box 1450, Alexandria, VA 22313-1450.

If you need assistance in completing the form, call 1-800-PTO-9199 and select option 2.

Under the Paperwork Reduction Act of 1995, no persons are required to respond to a collection of information unless it contains a valid OMB control number.

<b>Application Data Sheet 37 CFR 1.76</b>		Attorney Docket Number	2855.0050008
		Application Number	
Title of Invention	SYSTEM AND METHODS FOR VIDEO AND AUDIO DATA DISTRIBUTION		
The application data sheet is part of the provisional or nonprovisional application for which it is being submitted. The following form contains the bibliographic data arranged in a format specified by the United States Patent and Trademark Office as outlined in 37 CFR 1.76. This document may be completed electronically and submitted to the Office in electronic format using the Electronic Filing System (EFS) or the document may be printed and included in a paper filed application.			

### Secrecy Order 37 CFR 5.2

Portions or all of the application associated with this Application Data Sheet may fall under a Secrecy Order pursuant to 37 CFR 5.2 (Paper filers only. Applications that fall under Secrecy Order may not be filed electronically.)

### Inventor Information:

<b>Inventor 1</b>					<input type="button" value="Remove"/>
<b>Legal Name</b>					
<b>Prefix</b>	<b>Given Name</b>	<b>Middle Name</b>	<b>Family Name</b>	<b>Suffix</b>	
	James	J.	FALLON		
<b>Residence Information (Select One)</b> <input checked="" type="radio"/> US Residency <input type="radio"/> Non US Residency <input type="radio"/> Active US Military Service					
<b>City</b>	Armonk	<b>State/Province</b>	NY	<b>Country of Residence i</b>	US
<b>Mailing Address of Inventor:</b>					
<b>Address 1</b>	11 Wampus Close				
<b>Address 2</b>					
<b>City</b>	New York	<b>State/Province</b>	NY		
<b>Postal Code</b>	10504	<b>Country i</b>	US		
<b>Inventor 2</b>					<input type="button" value="Remove"/>
<b>Legal Name</b>					
<b>Prefix</b>	<b>Given Name</b>	<b>Middle Name</b>	<b>Family Name</b>	<b>Suffix</b>	
	Stephen	J.	MCERLAIN		
<b>Residence Information (Select One)</b> <input checked="" type="radio"/> US Residency <input type="radio"/> Non US Residency <input type="radio"/> Active US Military Service					
<b>City</b>	Armonk	<b>State/Province</b>	NY	<b>Country of Residence i</b>	US
<b>Mailing Address of Inventor:</b>					
<b>Address 1</b>	11 Wampus Close				
<b>Address 2</b>					
<b>City</b>	New York	<b>State/Province</b>	NY		
<b>Postal Code</b>	10504	<b>Country i</b>	US		
All Inventors Must Be Listed - Additional Inventor Information blocks may be generated within this form by selecting the <b>Add</b> button.					<input type="button" value="Add"/>

### Correspondence Information:

Enter either Customer Number or complete the Correspondence Information section below.  
 For further information see 37 CFR 1.33(a).

Under the Paperwork Reduction Act of 1995, no persons are required to respond to a collection of information unless it contains a valid OMB control number.

<b>Application Data Sheet 37 CFR 1.76</b>		Attorney Docket Number	2855.0050008
		Application Number	
Title of Invention	SYSTEM AND METHODS FOR VIDEO AND AUDIO DATA DISTRIBUTION		

An Address is being provided for the correspondence information of this application.

Customer Number	26111		
Email Address		<input type="button" value="Add Email"/>	<input type="button" value="Remove Email"/>

### Application Information:

Title of the Invention	SYSTEM AND METHODS FOR VIDEO AND AUDIO DATA DISTRIBUTION		
Attorney Docket Number	2855.0050008	Small Entity Status Claimed	<input type="checkbox"/>
Application Type	Nonprovisional		
Subject Matter	Utility		
Total Number of Drawing Sheets (if any)	4	Suggested Figure for Publication (if any)	

### Filing By Reference :

Only complete this section when filing an application by reference under 35 U.S.C. 111(c) and 37 CFR 1.57(a). Do not complete this section if application papers including a specification and any drawings are being filed. Any domestic benefit or foreign priority information must be provided in the appropriate section(s) below (i.e., "Domestic Benefit/National Stage Information" and "Foreign Priority Information").

For the purposes of a filing date under 37 CFR 1.53(b), the description and any drawings of the present application are replaced by this reference to the previously filed application, subject to conditions and requirements of 37 CFR 1.57(a).

Application number of the previously filed application	Filing date (YYYY-MM-DD)	Intellectual Property Authority or Country

### Publication Information:

Request Early Publication (Fee required at time of Request 37 CFR 1.219)

**Request Not to Publish.** I hereby request that the attached application not be published under 35 U.S.C. 122(b) and certify that the invention disclosed in the attached application **has not and will not** be the subject of an application filed in another country, or under a multilateral international agreement, that requires publication at eighteen months after filing.

### Representative Information:

Representative information should be provided for all practitioners having a power of attorney in the application. Providing this information in the Application Data Sheet does not constitute a power of attorney in the application (see 37 CFR 1.32). Either enter Customer Number or complete the Representative Name section below. If both sections are completed the customer Number will be used for the Representative Information during processing.

Please Select One:	<input checked="" type="radio"/> Customer Number	<input type="radio"/> US Patent Practitioner	<input type="radio"/> Limited Recognition (37 CFR 11.9)
Customer Number	26111		

Under the Paperwork Reduction Act of 1995, no persons are required to respond to a collection of information unless it contains a valid OMB control number.

<b>Application Data Sheet 37 CFR 1.76</b>		Attorney Docket Number	2855.0050008
		Application Number	
Title of Invention	SYSTEM AND METHODS FOR VIDEO AND AUDIO DATA DISTRIBUTION		

### Domestic Benefit/National Stage Information:

This section allows for the applicant to either claim benefit under 35 U.S.C. 119(e), 120, 121, or 365(c) or indicate National Stage entry from a PCT application. Providing this information in the application data sheet constitutes the specific reference required by 35 U.S.C. 119(e) or 120, and 37 CFR 1.78.

When referring to the current application, please leave the application number blank.

Prior Application Status	Pending		<input type="button" value="Remove"/>		
Application Number	Continuity Type	Prior Application Number	Filing Date (YYYY-MM-DD)		
	Continuation of	14033245	2013-09-20		
Prior Application Status	Patented		<input type="button" value="Remove"/>		
Application Number	Continuity Type	Prior Application Number	Filing Date (YYYY-MM-DD)	Patent Number	Issue Date (YYYY-MM-DD)
14033245	Continuation of	13154239	2011-06-06	8553759	2013-10-08
Prior Application Status	Patented		<input type="button" value="Remove"/>		
Application Number	Continuity Type	Prior Application Number	Filing Date (YYYY-MM-DD)	Patent Number	Issue Date (YYYY-MM-DD)
13154239	Continuation of	12123081	2008-05-19	8073047	2011-12-06
Prior Application Status	Patented		<input type="button" value="Remove"/>		
Application Number	Continuity Type	Prior Application Number	Filing Date (YYYY-MM-DD)	Patent Number	Issue Date (YYYY-MM-DD)
12123081	Continuation of	10076013	2002-02-13	7386046	2008-06-10
Prior Application Status	Expired		<input type="button" value="Remove"/>		
Application Number	Continuity Type	Prior Application Number	Filing Date (YYYY-MM-DD)		
10076013	Claims benefit of provisional	60268394	2001-02-13		
Additional Domestic Benefit/National Stage Data may be generated within this form by selecting the <b>Add</b> button.					<input type="button" value="Add"/>

### Foreign Priority Information:

This section allows for the applicant to claim priority to a foreign application. Providing this information in the application data sheet constitutes the claim for priority as required by 35 U.S.C. 119(b) and 37 CFR 1.55(d). When priority is claimed to a foreign application that is eligible for retrieval under the priority document exchange program (PDX) the information will be used by the Office to automatically attempt retrieval pursuant to 37 CFR 1.55(h)(1) and (2). Under the PDX program, applicant bears the ultimate responsibility for ensuring that a copy of the foreign application is received by the Office from the participating foreign intellectual property office, or a certified copy of the foreign priority application is filed, within the time period specified in 37 CFR 1.55(g)(1).

<input type="button" value="Remove"/>			
Application Number	Country <sup>i</sup>	Filing Date (YYYY-MM-DD)	Access Code <sup>j</sup> (if applicable)
Additional Foreign Priority Data may be generated within this form by selecting the <b>Add</b> button.			<input type="button" value="Add"/>

Under the Paperwork Reduction Act of 1995, no persons are required to respond to a collection of information unless it contains a valid OMB control number.

<b>Application Data Sheet 37 CFR 1.76</b>		Attorney Docket Number	2855.0050008
		Application Number	
Title of Invention	SYSTEM AND METHODS FOR VIDEO AND AUDIO DATA DISTRIBUTION		

## Statement under 37 CFR 1.55 or 1.78 for AIA (First Inventor to File) Transition Applications

- This application (1) claims priority to or the benefit of an application filed before March 16, 2013 and (2) also contains, or contained at any time, a claim to a claimed invention that has an effective filing date on or after March 16, 2013.
- NOTE: By providing this statement under 37 CFR 1.55 or 1.78, this application, with a filing date on or after March 16, 2013, will be examined under the first inventor to file provisions of the AIA.

## Authorization to Permit Access:

Authorization to Permit Access to the Instant Application by the Participating Offices

If checked, the undersigned hereby grants the USPTO authority to provide the European Patent Office (EPO), the Japan Patent Office (JPO), the Korean Intellectual Property Office (KIPO), the World Intellectual Property Office (WIPO), and any other intellectual property offices in which a foreign application claiming priority to the instant patent application is filed access to the instant patent application. See 37 CFR 1.14(c) and (h). This box should not be checked if the applicant does not wish the EPO, JPO, KIPO, WIPO, or other intellectual property office in which a foreign application claiming priority to the instant patent application is filed to have access to the instant patent application.

In accordance with 37 CFR 1.14(h)(3), access will be provided to a copy of the instant patent application with respect to: 1) the instant patent application-as-filed; 2) any foreign application to which the instant patent application claims priority under 35 U.S.C. 119(a)-(d) if a copy of the foreign application that satisfies the certified copy requirement of 37 CFR 1.55 has been filed in the instant patent application; and 3) any U.S. application-as-filed from which benefit is sought in the instant patent application.

In accordance with 37 CFR 1.14(c), access may be provided to information concerning the date of filing this Authorization.

## Applicant Information:

Providing assignment information in this section does not substitute for compliance with any requirement of part 3 of Title 37 of CFR to have an assignment recorded by the Office.



Under the Paperwork Reduction Act of 1995, no persons are required to respond to a collection of information unless it contains a valid OMB control number.

<b>Application Data Sheet 37 CFR 1.76</b>	Attorney Docket Number	2855.0050008
	Application Number	
Title of Invention	SYSTEM AND METHODS FOR VIDEO AND AUDIO DATA DISTRIBUTION	

<b>Applicant 1</b>				<input type="button" value="Remove"/>
If the applicant is the inventor (or the remaining joint inventor or inventors under 37 CFR 1.45), this section should not be completed. The information to be provided in this section is the name and address of the legal representative who is the applicant under 37 CFR 1.43; or the name and address of the assignee, person to whom the inventor is under an obligation to assign the invention, or person who otherwise shows sufficient proprietary interest in the matter who is the applicant under 37 CFR 1.46. If the applicant is an applicant under 37 CFR 1.46 (assignee, person to whom the inventor is obligated to assign, or person who otherwise shows sufficient proprietary interest) together with one or more joint inventors, then the joint inventor or inventors who are also the applicant should be identified in this section.				
<input type="button" value="Clear"/>				
<input checked="" type="radio"/> Assignee	<input type="radio"/> Legal Representative under 35 U.S.C. 117	<input type="radio"/> Joint Inventor		
<input type="radio"/> Person to whom the inventor is obligated to assign.	<input type="radio"/> Person who shows sufficient proprietary interest			
If applicant is the legal representative, indicate the authority to file the patent application, the inventor is:				
Name of the Deceased or Legally Incapacitated Inventor : <input type="text"/>				
If the Applicant is an Organization check here. <input checked="" type="checkbox"/>				
Organization Name	Realtime Data LLC			
<b>Mailing Address Information:</b>				
Address 1	11 Wampus Close			
Address 2				
City	New York	State/Province	NY	
Country	US	Postal Code	10504	
Phone Number		Fax Number		
Email Address				
Additional Applicant Data may be generated within this form by selecting the Add button. <input type="button" value="Add"/>				

### Assignee Information including Non-Applicant Assignee Information:

Providing assignment information in this section does not substitute for compliance with any requirement of part 3 of Title 37 of CFR to have an assignment recorded by the Office.	
<b>Assignee 1</b>	
Complete this section if assignee information, including non-applicant assignee information, is desired to be included on the patent application publication. An assignee-applicant identified in the "Applicant Information" section will appear on the patent application publication as an applicant. For an assignee-applicant, complete this section only if identification as an assignee is also desired on the patent application publication.	
<input type="button" value="Remove"/>	
If the Assignee or Non-Applicant Assignee is an Organization check here. <input type="checkbox"/>	

Under the Paperwork Reduction Act of 1995, no persons are required to respond to a collection of information unless it contains a valid OMB control number.

<b>Application Data Sheet 37 CFR 1.76</b>		Attorney Docket Number	2855.0050008
		Application Number	
Title of Invention	SYSTEM AND METHODS FOR VIDEO AND AUDIO DATA DISTRIBUTION		

Prefix	Given Name	Middle Name	Family Name	Suffix

**Mailing Address Information For Assignee including Non-Applicant Assignee:**

Address 1				
Address 2				
City		State/Province		
Country i	Postal Code			
Phone Number		Fax Number		
Email Address				

Additional Assignee or Non-Applicant Assignee Data may be generated within this form by selecting the Add button.

**Signature:**

NOTE: This form must be signed in accordance with 37 CFR 1.33. See 37 CFR 1.4 for signature requirements and certifications

<b>Signature</b>	/Michael Messinger/		Date (YYYY-MM-DD)	2013-12-19	
First Name	Michael	Last Name	Messinger	Registration Number	37575

Additional Signature may be generated within this form by selecting the Add button.

This collection of information is required by 37 CFR 1.76. The information is required to obtain or retain a benefit by the public which is to file (and by the USPTO to process) an application. Confidentiality is governed by 35 U.S.C. 122 and 37 CFR 1.14. This collection is estimated to take 23 minutes to complete, including gathering, preparing, and submitting the completed application data sheet form to the USPTO. Time will vary depending upon the individual case. Any comments on the amount of time you require to complete this form and/or suggestions for reducing this burden, should be sent to the Chief Information Officer, U.S. Patent and Trademark Office, U.S. Department of Commerce, P.O. Box 1450, Alexandria, VA 22313-1450. DO NOT SEND FEES OR COMPLETED FORMS TO THIS ADDRESS. **SEND TO: Commissioner for Patents, P.O. Box 1450, Alexandria, VA 22313-1450.**

## Privacy Act Statement

The Privacy Act of 1974 (P.L. 93-579) requires that you be given certain information in connection with your submission of the attached form related to a patent application or patent. Accordingly, pursuant to the requirements of the Act, please be advised that: (1) the general authority for the collection of this information is 35 U.S.C. 2(b)(2); (2) furnishing of the information solicited is voluntary; and (3) the principal purpose for which the information is used by the U.S. Patent and Trademark Office is to process and/or examine your submission related to a patent application or patent. If you do not furnish the requested information, the U.S. Patent and Trademark Office may not be able to process and/or examine your submission, which may result in termination of proceedings or abandonment of the application or expiration of the patent.

The information provided by you in this form will be subject to the following routine uses:

1. The information on this form will be treated confidentially to the extent allowed under the Freedom of Information Act (5 U.S.C. 552) and the Privacy Act (5 U.S.C. 552a). Records from this system of records may be disclosed to the Department of Justice to determine whether the Freedom of Information Act requires disclosure of these records.
2. A record from this system of records may be disclosed, as a routine use, in the course of presenting evidence to a court, magistrate, or administrative tribunal, including disclosures to opposing counsel in the course of settlement negotiations.
3. A record in this system of records may be disclosed, as a routine use, to a Member of Congress submitting a request involving an individual, to whom the record pertains, when the individual has requested assistance from the Member with respect to the subject matter of the record.
4. A record in this system of records may be disclosed, as a routine use, to a contractor of the Agency having need for the information in order to perform a contract. Recipients of information shall be required to comply with the requirements of the Privacy Act of 1974, as amended, pursuant to 5 U.S.C. 552a(m).
5. A record related to an International Application filed under the Patent Cooperation Treaty in this system of records may be disclosed, as a routine use, to the International Bureau of the World Intellectual Property Organization, pursuant to the Patent Cooperation Treaty.
6. A record in this system of records may be disclosed, as a routine use, to another federal agency for purposes of National Security review (35 U.S.C. 181) and for review pursuant to the Atomic Energy Act (42 U.S.C. 218(c)).
7. A record from this system of records may be disclosed, as a routine use, to the Administrator, General Services, or his/her designee, during an inspection of records conducted by GSA as part of that agency's responsibility to recommend improvements in records management practices and programs, under authority of 44 U.S.C. 2904 and 2906. Such disclosure shall be made in accordance with the GSA regulations governing inspection of records for this purpose, and any other relevant (i.e., GSA or Commerce) directive. Such disclosure shall not be used to make determinations about individuals.
8. A record from this system of records may be disclosed, as a routine use, to the public after either publication of the application pursuant to 35 U.S.C. 122(b) or issuance of a patent pursuant to 35 U.S.C. 151. Further, a record may be disclosed, subject to the limitations of 37 CFR 1.14, as a routine use, to the public if the record was filed in an application which became abandoned or in which the proceedings were terminated and which application is referenced by either a published application, an application open to public inspections or an issued patent.
9. A record from this system of records may be disclosed, as a routine use, to a Federal, State, or local law enforcement agency, if the USPTO becomes aware of a violation or potential violation of law or regulation.

# SYSTEM AND METHODS FOR VIDEO AND AUDIO DATA DISTRIBUTION

## CROSS-REFERENCE TO RELATED APPLICATIONS

[0001] This application is a continuation of United States Patent Application No. 14/033,245, filed on September 20, 2013, which is a continuation of United States Patent Application No. 13/154,239, filed on June 6, 2011, now U.S. Patent No. 8,553,759, which is a continuation of United States Patent Application No. 12/123,081, filed on May 19, 2008, now U.S. Patent No. 8,073,047, which is a continuation of United States Patent Application No. 10/076,013, filed on February 13, 2002, now U.S. Patent No. 7,386,046, which claims the benefit of United States Provisional Application No. 60/268,394, filed on February 13, 2001, each of which is fully incorporated herein by reference.

## BACKGROUND

### 1. Technical Field

[0002] The present invention relates generally to data compression and decompression and, in particular, to a system and method for compressing and decompressing data based on an actual or expected throughput (bandwidth) of a system that employs data compression. Additionally the present invention relates to the subsequent storage, retrieval, and management of information in data storage devices utilizing either compression and/or accelerated data storage and retrieval bandwidth.

### 2. Description of the Related Art

[0003] There are a variety of data compression algorithms that are currently available, both well-defined and novel. Many compression algorithms define one or more parameters that can be varied, either dynamically or a-priori, to change the performance characteristics of the algorithm. For example, with a typical dictionary based compression algorithm such as Lempel-Ziv, the size of the dictionary can affect the performance of the algorithm. Indeed, a large dictionary may be employed to yield very good compression ratios but the algorithm may take a long time to execute. If speed were more important than compression ratio, then the algorithm can be limited by selecting a

smaller dictionary, thereby obtaining a much faster compression time, but at the possible cost of a lower compression ratio. The desired performance of a compression algorithm and the system in which the data compression is employed, will vary depending on the application.

[0004] Thus, one challenge in employing data compression for a given application or system is selecting one or more optimal compression algorithms from the variety of available algorithms. Indeed, the desired balance between speed and efficiency is typically a significant factor that is considered in determining which algorithm to employ for a given set of data. Algorithms that compress particularly well usually take longer to execute whereas algorithms that execute quickly usually do not compress particularly well.

[0005] Accordingly, a system and method that would provide dynamic modification of compression system parameters so as to provide an optimal balance between execution speed of the algorithm (compression rate) and the resulting compression ratio, is highly desirable.

[0006] Yet another problem within the current art is data storage and retrieval bandwidth limitations. Modern computers utilize a hierarchy of memory devices. In order to achieve maximum performance levels, modern processors utilize onboard memory and on board cache to obtain high bandwidth access to both program and data. Limitations in process technologies currently prohibit placing a sufficient quantity of onboard memory for most applications. Thus, in order to offer sufficient memory for the operating system(s), application programs, and user data, computers often use various forms of popular off-processor high speed memory including static random access memory (SRAM), synchronous dynamic random access memory (SDRAM), synchronous burst static ram (SBSRAM). Due to the prohibitive cost of the high-speed random access memory, coupled with their power volatility, a third lower level of the hierarchy exists for non-volatile mass storage devices. While mass storage devices offer increased capacity and fairly economical data storage, their data storage and retrieval bandwidth is often much less in relation to the other elements of a computing system.

[0007] Computers systems represent information in a variety of manners. Discrete information such as text and numbers are easily represented in digital data. This type of data representation is known as symbolic digital data. Symbolic digital data is thus an

absolute representation of data such as a letter, figure, character, mark, machine code, or drawing.

[0008] Continuous information such as speech, music, audio, images and video, frequently exists in the natural world as analog information. As is well known to those skilled in the art, recent advances in very large scale integration (VLSI) digital computer technology have enabled both discrete and analog information to be represented with digital data. Continuous information represented as digital data is often referred to as diffuse data. Diffuse digital data is thus a representation of data that is of low information density and is typically not easily recognizable to humans in its native form.

[0009] Modern computers utilize digital data representation because of its inherent advantages. For example, digital data is more readily processed, stored, and transmitted due to its inherently high noise immunity. In addition, the inclusion of redundancy in digital data representation enables error detection and/or correction. Error detection and/or correction capabilities are dependent upon the amount and type of data redundancy, available error detection and correction processing, and extent of data corruption.

[0010] One outcome of digital data representation is the continuing need for increased capacity in data processing, storage, and transmittal. This is especially true for diffuse data where increases in fidelity and resolution create exponentially greater quantities of data. Data compression is widely used to reduce the amount of data required to process, transmit, or store a given quantity of information. In general, there are two types of data compression techniques that may be utilized either separately or jointly to encode/decode data: lossless and lossy data compression.

[0011] Over the last decade, computer processor performance has improved by at least a factor of 50. During this same period, magnetic disk storage has only improved by a factor of 5. Thus one additional problem with the existing art is that memory storage devices severely limit the performance of consumer, entertainment, office, workstation, servers, and mainframe computers for all disk and memory intensive operations.

[0012] For example, magnetic disk mass storage devices currently employed in a variety of home, business, and scientific computing applications suffer from significant seek-time access delays along with profound read/write data rate limitations. Currently the fastest available (15,000) rpm disk drives support only a 40.0 Megabyte per second data rate

(MB/sec). This is in stark contrast to the modern Personal Computer's Peripheral Component Interconnect (PCI) Bus's input/output capability of 512 MB/sec and internal local bus capability of 1600 MB/sec.

[0013] Another problem within the current art is that emergent high performance disk interface standards such as the Small Computer Systems Interface (SCSI-3), iSCSI, Fibre Channel, AT Attachment UltraDMA/100+, Serial Storage Architecture, and Universal Serial Bus offer only higher data transfer rates through intermediate data buffering in random access memory. These interconnect strategies do not address the fundamental problem that all modern magnetic disk storage devices for the personal computer marketplace are still limited by the same typical physical media restriction. In practice, faster disk access data rates are only achieved by the high cost solution of simultaneously accessing multiple disk drives with a technique known within the art as data striping and redundant array of independent disks (RAID).

[0014] RAID systems often afford the user the benefit of increased data bandwidth for data storage and retrieval. By simultaneously accessing two or more disk drives, data bandwidth may be increased at a maximum rate that is linear and directly proportional to the number of disks employed. Thus another problem with modern data storage systems utilizing RAID systems is that a linear increase in data bandwidth requires a proportional number of added disk storage devices.

[0015] Another problem with most modern mass storage devices is their inherent unreliability. Many modern mass storage devices utilize rotating assemblies and other types of electromechanical components that possess failure rates one or more orders of magnitude higher than equivalent solid state devices. RAID systems employ data redundancy distributed across multiple disks to enhance data storage and retrieval reliability. In the simplest case, data may be explicitly repeated on multiple places on a single disk drive, on multiple places on two or more independent disk drives. More complex techniques are also employed that support various trade-offs between data bandwidth and data reliability.

[0016] Standard types of RAID systems currently available include RAID Levels 0, 1, and 5. The configuration selected depends on the goals to be achieved. Specifically data reliability, data validation, data storage /retrieval bandwidth, and cost all play a role in defining the appropriate RAID data storage solution. RAID level 0 entails pure data

striping across multiple disk drives. This increases data bandwidth at best linearly with the number of disk drives utilized. Data reliability and validation capability are decreased. A failure of a single drive results in a complete loss of all data. Thus another problem with RAID systems is that low cost improved bandwidth requires a significant decrease in reliability.

[0017] RAID Level 1 utilizes disk mirroring where data is duplicated on an independent disk subsystem. Validation of data amongst the two independent drives is possible if the data is simultaneously accessed on both disks and subsequently compared. This tends to decrease data bandwidth from even that of a single comparable disk drive. In systems that offer hot swap capability, the failed drive is removed and a replacement drive is inserted. The data on the failed drive is then copied in the background while the entire system continues to operate in a performance degraded but fully operational mode. Once the data rebuild is complete, normal operation resumes. Hence, another problem with RAID systems is the high cost of increased reliability and associated decrease in performance.

[0018] RAID Level 5 employs disk data striping and parity error detection to increase both data bandwidth and reliability simultaneously. A minimum of three disk drives is required for this technique. In the event of a single disk drive failure, that drive may be rebuilt from parity and other data encoded on disk remaining disk drives. In systems that offer hot swap capability, the failed drive is removed and a replacement drive is inserted. The data on the failed drive is then rebuilt in the background while the entire system continues to operate in a performance degraded but fully operational mode. Once the data rebuild is complete, normal operation resumes.

[0019] Thus another problem with redundant modern mass storage devices is the degradation of data bandwidth when a storage device fails. Additional problems with bandwidth limitations and reliability similarly occur within the art by all other forms of sequential, pseudo-random, and random access mass storage devices. Typically mass storage devices include magnetic and optical tape, magnetic and optical disks, and various solid-state mass storage devices. It should be noted that the present invention applies to all forms and manners of memory devices including storage devices utilizing magnetic, optical, neural and chemical techniques or any combination thereof.



[0020] Yet another problem within the current art is the application and use of various data compression techniques. It is well known within the current art that data compression provides several unique benefits. First, data compression can reduce the time to transmit data by more efficiently utilizing low bandwidth data links. Second, data compression economizes on data storage and allows more information to be stored for a fixed memory size by representing information more efficiently.

[0021] For purposes of discussion, data compression is canonically divided into lossy and lossless techniques. Lossy data compression techniques provide for an inexact representation of the original uncompressed data such that the decoded (or reconstructed) data differs from the original unencoded/uncompressed data. Lossy data compression is also known as irreversible or noisy compression. Negentropy is defined as the quantity of information in a given set of data. Thus, one obvious advantage of lossy data compression is that the compression ratios can be larger than that dictated by the negentropy limit, all at the expense of information content. Many lossy data compression techniques seek to exploit various traits within the human senses to eliminate otherwise imperceptible data. For example, lossy data compression of visual imagery might seek to delete information content in excess of the display resolution or contrast ratio of the target display device.

[0022] On the other hand, lossless data compression techniques provide an exact representation of the original uncompressed data. Simply stated, the decoded (or reconstructed) data is identical to the original unencoded/uncompressed data. Lossless data compression is also known as reversible or noiseless compression. Thus, lossless data compression has, as its current limit, a minimum representation defined by the entropy of a given data set.

[0023] A rich and highly diverse set of lossless data compression and decompression algorithms exist within the current art. These range from the simplest “ad hoc” approaches to highly sophisticated formalized techniques that span the sciences of information theory, statistics, and artificial intelligence. One fundamental problem with almost all modern approaches is the compression ratio to encoding and decoding speed achieved. As previously stated, the current theoretical limit for data compression is the entropy limit of the data set to be encoded. However, in practice, many factors actually limit the compression ratio achieved. Most modern compression algorithms are highly

content dependent. Content dependency exceeds the actual statistics of individual elements and often includes a variety of other factors including their spatial location within the data set.

[0024] Of popular compression techniques, arithmetic coding possesses the highest degree of algorithmic effectiveness, and as expected, is the slowest to execute. This is followed in turn by dictionary compression, Huffman coding, and run-length coding with respectively decreasing execute times. What is not apparent from these algorithms, that is also one major deficiency within the current art, is knowledge of their algorithmic efficiency. More specifically, given a compression ratio that is within the effectiveness of multiple algorithms, the question arises as their corresponding efficiency.

[0025] Within the current art there also presently exists a strong inverse relationship between achieving the maximum (current) theoretical compression ratio, which we define as algorithmic effectiveness, and requisite processing time. For a given single algorithm the effectiveness over a broad class of data sets including text, graphics, databases, and executable object code is highly dependent upon the processing effort applied. Given a baseline data set, processor operating speed and target architecture, along with its associated supporting memory and peripheral set, we define algorithmic efficiency as the time required to achieve a given compression ratio. Algorithmic efficiency assumes that a given algorithm is implemented in an optimum object code representation executing from the optimum places in memory. This is almost never achieved in practice due to limitations within modern optimizing software compilers. It should be further noted that an optimum algorithmic implementation for a given input data set may not be optimum for a different data set. Much work remains in developing a comprehensive set of metrics for measuring data compression algorithmic performance, however for present purposes the previously defined terms of algorithmic effectiveness and efficiency should suffice.

[0026] Various solutions to this problem of optimizing algorithmic implementation are found in U.S. Patent Nos. 6,195,024 and 6,309,424, issued on February 27, 2001 and October 30, 2001, respectively, to James Fallon, both of which are entitled "Content Independent Data Compression Method and System," and are incorporated herein by reference. These patents describe data compression methods that provide content-independent data compression, wherein an optimal compression ratio for an encoded stream can be achieved regardless of the data content of the input data stream. As more

fully described in the above incorporated patents, a data compression protocol comprises applying an input data stream to each of a plurality of different encoders to, in effect, generate a plurality of encoded data streams. The plurality of encoders are preferably selected based on their ability to effectively encode different types of input data. The final compressed data stream is generated by selectively combining blocks of the compressed streams output from the plurality of encoders based on one or more factors such as the optimal compression ratios obtained by the plurality of decoders. The resulting compressed output stream can achieve the greatest possible compression, preferably in real-time, regardless of the data content.

[0027] Yet another problem within the current art relates to data management and the use of existing file management systems. Present computer operating systems utilize file management systems to store and retrieve information in a uniform, easily identifiable, format. Files are collections of executable programs and/or various data objects. Files occur in a wide variety of lengths and must be stored within a data storage device. Most storage devices, and in particular, mass storage devices, work most efficiently with specific quantities of data. For example, modern magnetic disks are often divided into cylinders, heads and sectors. This breakout arises from legacy electro-mechanical considerations with the format of an individual sector often some binary multiple of bytes (512, 1024,...). A fixed or variable quantity of sectors housed on an individual track. The number of sectors permitted on a single track is limited by the number of reliable flux reversals that can be encoded on the storage media per linear inch, often referred to as linear bit density. In disk drives with multiple heads and disk media, a single cylinder is comprised of multiple tracks.

[0028] A file allocation table is often used to organize both used and unused space on a mass storage device. Since a file often comprises more than one sector of data, and individual sectors or contiguous strings of sectors may be widely dispersed over multiple tracks and cylinders, a file allocation table provides a methodology of retrieving a file or portion thereof. File allocation tables are usually comprised of strings of pointers or indices that identify where various portions of a file are stored.

[0029] In-order to provide greater flexibility in the management of disk storage at the media side of the interface, logical block addresses have been substituted for legacy cylinder, head, sector addressing. This permits the individual disk to optimize its

mapping from the logical address space to the physical sectors on the disk drive. Advantages with this technique include faster disk accesses by allowing the disk manufacturer greater flexibility in managing data interleaves and other high-speed access techniques. In addition, the replacement of bad media sectors can take place at the physical level and need not be the concern of the file allocation table or host computer. Furthermore, these bad sector replacement maps are definable on a disk by disk basis.

[0030] Practical limitations in the size of the data required to both represent and process an individual data block address, along with the size of individual data blocks, governs the type of file allocation tables currently in use. For example, a 4096 byte logical block size (8 sectors) employed with 32 bit logical block addresses. This yields an addressable data space of 17.59 Terabytes. Smaller logical blocks permit more efficient use of disk space. Larger logical blocks support a larger addressable data space. Thus one limitation within the current art is that disk file allocation tables and associated file management systems are a compromise between efficient data storage, access speed, and addressable data space.

[0031] Data in a computer has various levels of information content. Even within a single file, many data types and formats are utilized. Each data representation has specific meaning and each may hold differing quantities of information. Within the current art, computers process data in a native, uncompressed, format. Thus compressed data must often be decompressed prior to performing various data processing functions or operations. Modern file systems have been designed to work with data in its native format. Thus another significant problem within the current art is that file systems are not able to randomly access compressed data in an efficient manner.

[0032] Further aggravating this problem is the fact that when data is decompressed, processed and recompressed it may not fit back into its original disk space, causing disk fragmentation or complex disk space reallocation requirements. Several solutions exist within the current art including file by file and block structured compressed data management.

[0033] In file by file compression, each file is compressed when stored on disk and decompressed when retrieved. For very small files this technique is often adequate, however for larger files the compression and decompression times are too slow, resulting in inadequate system level performance. In addition, the ability to access randomly

access data within a specific file is lost. The one advantage to file by file compression techniques is that they are easy to develop and are compatible with existing file systems. Thus file by file compressed data management is not an adequate solution.

[0034] Block structured disk compression operates by compressing and decompressing fixed block sizes of data. Block sizes are often fixed, but may be variable in size. A single file usually is comprised of multiple blocks, however a file may be so small as to fit within a single block. Blocks are grouped together and stored in one or more disk sectors as a group of Blocks (GOBs). A group of blocks is compressed and decompressed as a unit, thus there exists practical limitations on the size of GOBs. Most compression algorithms achieve a higher level of algorithmic effectiveness when operating on larger quantities of data. Restated, the larger the quantity of data processed with a uniform information density, the higher the compressions ratio achieved. If GOBs are small compression ratios are low and processing time short. Conversely, when GOBS are large compression ratios are higher and processing time is longer. Large GOBs tend to perform in a manner analogous to file by file compression. The two obvious benefits to block structured disk compression are psuedo-random data access and reduced data compression/decompression processing time.

[0035] Several problems exist within the current art for the management of compressed blocks. One method for storage of compressed files on disk is by contiguously storing all GOBs corresponding to a single file. However as files are processed within the computers, files may grow or shrink in size. Inefficient disk storage results when a substantial file size reduction occurs. Conversely when a file grows substantially, the additional space required to store the data may not be available contiguously. The result of this process is substantial disk fragmentation and slower access times.

[0036] An alternate method is to map compressed GOBs into the next logical free space on the disk. One problem with this method is that average file access times are substantially increased by this technique due to the random data storage. Peak access delays may be reduced since the statistics behave with a more uniform white spectral density, however this is not guaranteed.

[0037] A further layer of complexity is encountered when compressed information is to be managed on more than one data storage device. Competing requirements of data

access bandwidth, data reliability/redundancy, and efficiency of storage space are encountered.

[0038] These and other limitations within the current art are solved with the present invention.

#### SUMMARY OF THE INVENTION

[0039] The present invention is directed to a system and method for compressing and decompressing based on the actual or expected throughput (bandwidth) of a system employing data compression and a technique of optimizing based upon planned, expected, predicted, or actual usage.

[0040] In one aspect of the present invention, a system for providing bandwidth sensitive data compression comprises:

a data compression system for compressing and decompressing data input to the system;

a plurality of compression routines selectively utilized by the data compression system; and

a controller for tracking the throughput of the system and generating a control signal to select a compression routine based on the system throughput. In a preferred embodiment, when the controller determines that the system throughput falls below a predetermined throughput threshold, the controller commands the data compression engine to use a compression routine providing a faster rate of compression so as to increase the throughput.

[0041] In another aspect, a system for providing bandwidth sensitive data compression comprises a plurality of access profiles, operatively accessible by the controller that enables the controller to determine a compression routine that is associated with a data type of the data to be compressed. The access profiles comprise information that enables the controller to select a suitable compression algorithm that provides a desired balance between execution speed (rate of compression) and efficiency (compression ratio).

[0042] In yet another aspect, a system comprises a data storage controller for controlling the compression and storage of compressed data to a storage device and the retrieval and decompression of compressed data from the storage device. The system throughput

tracked by the controller preferably comprises a number of pending access requests to a storage device.

[0043] In another aspect, the system comprises a data transmission controller for controlling the compression and transmission of compressed data, as well as the decompression of compressed data received over a communication channel. The system throughput tracked by the controller comprises a number of pending transmission requests over the communication channel.

[0044] In yet another aspect of the present invention, a method for providing bandwidth sensitive data compression in a data processing system, comprises the steps of:

compressing data using a first compression routine providing a first compression rate;

tracking the throughput of the data processing system to determine if the first compression rate provides a throughput that meets a predetermined throughput threshold; and

compressing data using a second compression routine providing a second compression rate that is greater than the first compression rate, if the tracked throughput does not meet the predetermined throughput threshold.

[0045] Preferably, the first compression routine comprises a default asymmetric routine and wherein the second compression routine comprises a symmetric routine.

[0046] In another aspect, the method comprises processing a user command to load a user-selected compression routine for compressing data.

[0047] In another aspect, the method further comprises processing a user command to compress user-provided data and automatically selecting a compression routine associated with a data type of the user-provided data.

[0048] These and other aspects, features and advantages of the present invention will become apparent from the following detailed description of preferred embodiments, which is to be read in connection with the accompanying drawings.

#### BRIEF DESCRIPTION OF THE DRAWINGS

[0049] Fig. 1 is a high-level block diagram of a system for providing bandwidth sensitive data compression/decompression according to an embodiment of the present invention.

- [0050] Fig. 2 is a flow diagram of a method for providing bandwidth sensitive data compression/decompression according to one aspect of the present invention.
- [0051] Fig. 3 is a block diagram of a preferred system for implementing a bandwidth sensitive data compression/decompression method according to an embodiment of the present invention.
- [0052] Fig. 4A is a diagram of a file system format of a virtual and/or physical disk according to an embodiment of the present invention.
- [0053] Fig. 4B is a diagram of a data structure of a sector map entry of a virtual block table according to an embodiment of the present invention.

#### DETAILED DESCRIPTION OF PREFERRED EMBODIMENTS

- [0054] The present invention is directed to a system and method for compressing and decompressing based on the actual or expected throughput (bandwidth) of a system employing data compression. Although one of ordinary skill in the art could readily envision various implementations for the present invention, a preferred system in which this invention is employed comprises a data storage controller that preferably utilizes a real-time data compression system to provide “accelerated” data storage and retrieval bandwidths. The concept of “accelerated” data storage and retrieval was introduced in co-pending U.S. Patent Application Serial No. 09/266,394, filed March 11, 1999, entitled “System and Methods For Accelerated Data Storage and Retrieval” and co-pending U.S. Patent Application Serial No. 09/481,243, filed January 11, 2000, entitled “System and Methods For Accelerated Data Storage and Retrieval,” both of which are commonly assigned and incorporated herein by reference.
- [0055] In general, as described in the above-incorporated applications, “accelerated” data storage comprises receiving a digital data stream at a data transmission rate which is greater than the data storage rate of a target storage device, compressing the input stream at a compression rate that increases the effective data storage rate of the target storage device and storing the compressed data in the target storage device. For instance, assume that a mass storage device (such as a hard disk) has a data storage rate of 20 megabytes per second. If a storage controller for the mass storage device is capable of compressing (in real time) an input data stream with an average compression rate of 3:1, then data can be stored in the mass storage device at a rate of 60 megabytes per second, thereby



effectively increasing the storage bandwidth (“storewidth”) of the mass storage device by a factor of three. Similarly, accelerated data retrieval comprises retrieving a compressed digital data stream from a target storage device at the rate equal to, e.g., the data access rate of the target storage device and then decompressing the compressed data at a rate that increases the effective data access rate of the target storage device. Advantageously, providing accelerated data storage and retrieval at (or close to) real-time can reduce or eliminate traditional bottlenecks associated with, e.g., local and network disk accesses.

[0056] In a preferred embodiment, the present invention is implemented for providing accelerated data storage and retrieval. In one embodiment, a controller tracks and monitors the throughput (data storage and retrieval) of a data compression system and generates control signals to enable/disable different compression algorithms when, e.g., a bottleneck occurs so as to increase the throughput and eliminate the bottleneck.

[0057] In the following description of preferred embodiments, two categories of compression algorithms are defined - an “asymmetrical” data compression algorithm and a “symmetrical data compression algorithms. An asymmetrical data compression algorithm is referred to herein as one in which the execution time for the compression and decompression routines differ significantly. In particular, with an asymmetrical algorithm, either the compression routine is slow and the decompression routine is fast or the compression routine is fast and the decompression routine is slow. Examples of asymmetrical compression algorithms include dictionary-based compression schemes such as Lempel-Ziv.

[0058] On the other hand, a “symmetrical” data compression algorithm is referred to herein as one in which the execution time for the compression and the decompression routines are substantially similar. Examples of symmetrical algorithms include table-based compression schemes such as Huffman. For asymmetrical algorithms, the total execution time to perform one compress and one decompress of a data set is typically greater than the total execution time of symmetrical algorithms. But an asymmetrical algorithm typically achieves higher compression ratios than a symmetrical algorithm.

[0059] It is to be appreciated that in accordance with the present invention, symmetry may be defined in terms of overall effective bandwidth, compression ratio, or time or any combination thereof. In particular, in instances of frequent data read/writes, bandwidth is the optimal parameter for symmetry. In asymmetric applications such as operating

systems and programs, the governing factor is net decompression bandwidth, which is a function of both compression speed, which governs data retrieval time, and decompression speed, wherein the total governs the net effective data read bandwidth. These factors work in an analogous manner for data storage where the governing factors are both compression ratio (storage time) and compression speed. The present invention applies to any combination or subset thereof, which is utilized to optimize overall bandwidth, storage space, or any operating point in between.

[0060] Referring now to Fig. 1, a high-level block diagram illustrates a system for providing bandwidth sensitive data compression/decompression according to an embodiment of the present invention. In particular, Fig. 1 depicts a host system 10 comprising a controller 11 (e.g., a file management system), a compression/decompression (or data compression) system 12, a plurality of compression algorithms 13, a storage medium 14, and a plurality of data profiles 15. The controller tracks and monitors the throughput (e.g., data storage and retrieval) of the data compression system 12 and generates control signals to enable/disable different compression algorithms 13 when the throughput falls below a predetermined threshold. In one embodiment, the system throughput that is tracked by the controller 11 preferably comprises a number of pending access requests to the memory system.

[0061] The data compression system 12 is operatively connected to the storage medium 14 using suitable protocols to write and read compressed data to and from the storage medium 14. It is to be understood that the storage medium 14 may comprise any form of memory device including all forms of sequential, pseudo-random, and random access storage devices. The storage medium 14 may be volatile or non-volatile in nature, or any combination thereof. Storage medium as known within the current art include all forms of random access memory, magnetic and optical tape, magnetic and optical disks, along with various other forms of solid-state mass storage media. Thus it should be noted that the current invention applies to all forms and manners of storage media including, but not limited to, storage mediums utilizing magnetic, optical, and chemical techniques, or any combination thereof. The data compression system 12 preferably operates in real-time (or substantially real-time) to compress data to be stored on the storage medium 14 and to decompress data that is retrieved from the storage medium 14. In addition, the data compression system 12 may receive data (compressed or not compressed) via an I/O

(input/output) port 16 that is transmitted over a transmission line or communication channel from a remote location, and then process such data (e.g., decompress or compress the data). The data compression system 12 may further transmit data (compressed or decompressed) via the I/O port 16 to another network device for remote processing or storage.

[0062] The controller 11 utilizes information comprising a plurality of data profiles 15 to determine which compression algorithms 13 should be used by the data compression system 12. In a preferred embodiment, the compression algorithms 13 comprise one or more asymmetric algorithms. As noted above, with asymmetric algorithms, the compression ratio is typically greater than the compression ratios obtained using symmetrical algorithms. Preferably, a plurality of asymmetric algorithms are selected to provide one or more asymmetric algorithms comprising a slow compress and fast decompress routine, as well as one or more asymmetric algorithms comprising a fast compress and slow decompress routine.

[0063] The compression algorithms 13 further comprise one or more symmetric algorithms, each having a compression rate and corresponding decompression rate that is substantially equal. Preferably, a plurality of symmetric algorithms are selected to provide a desired range of compression and decompression rates for data to be processed by a symmetric algorithm.

[0064] In a preferred embodiment, the overall throughput (bandwidth) of the host system 10 is one factor considered by the controller 11 in deciding whether to use an asymmetrical or symmetrical compression algorithm for processing data stored to, and retrieved from, the storage medium 14. Another factor that is used to determine the compression algorithm is the type of data to be processed. In a preferred embodiment, the data profiles 15 comprise information regarding predetermined access profiles of different data sets, which enables the controller 11 to select a suitable compression algorithm based on the data type. For instance, the data profiles may comprise a map that associates different data types (based on, e.g., a file extension) with preferred one(s) of the compression algorithms 13. For example, preferred access profiles considered by the controller 11 are set forth in the following table.

<b>Access Profile 1:</b>	<b>Access Profile 2</b>	<b>Access Profile 3</b>
--------------------------	-------------------------	-------------------------

<b>Access Profile 1:</b>	<b>Access Profile 2</b>	<b>Access Profile 3</b>
Data is written to a storage medium once (or very few times) but is read from the storage medium many times	Data is written to the storage medium often but read few Times	The amount of times data is read from and written to the storage medium is substantially the same.

[0065] With Access Profile 1, the decompression routine would be executed significantly more times than the corresponding compression routine. This is typical with operating systems, applications and websites, for example. Indeed, an asymmetrical application can be used to (offline) compress an (OS) operating system, application or Website using a slow compression routine to achieve a high compression ratio. After the compressed OS, application or website is stored, the asymmetric algorithm is then used during runtime to decompress, at a significant rate, the OS, application or website launched or accessed by a user.

[0066] Therefore, with data sets falling within Access Profile 1, it is preferable to utilize an asymmetrical algorithm that provides a slow compression routine and a fast decompression routine so as to provide an increase in the overall system performance as compared the performance that would be obtained using a symmetrical algorithm. Further, the compression ratio obtained using the asymmetrical algorithm would likely be higher than that obtained using a symmetrical algorithm (thus effectively increasing the storage capacity of the storage device).

[0067] With Access Profile 2, the compression routine would be executed significantly more times than the decompression routine. This is typical with a system for automatically updating an inventory database, for example, wherein an asymmetric algorithm that provides a fast compression routine and a slow decompression routine would provide an overall faster (higher throughput) and efficient (higher compression ratio) system performance than would be obtained using a symmetrical algorithm.

[0068] With Access Profile 3, where data is accessed with a similar number of reads and writes, the compression routine would be executed approximately the same number of times as the decompression routine. This is typical of most user-generated data such as documents and spreadsheets. Therefore, it is preferable to utilize a symmetrical algorithm that provides a relatively fast compression and decompression routine. This would result in an overall system performance that would be faster as compared to using an asymmetrical algorithm (although the compression ratio achieved may be lower).

[0069] The following table summarizes the three data access profiles and the type of compression algorithm that would produce optimum throughput.

<b>Access Profile</b>	<b>Example Data Types</b>	<b>Compression Algorithm</b>	<b>Compressed Data Characteristics</b>	<b>Decompression Algorithm</b>
<b>1. Write few, Read many</b>	<b>Operating systems, Programs, Web sites</b>	<b>Asymmetrical (Slow compress)</b>	<b>Very high compression ratio</b>	<b>Asymmetrical (Fast decompress)</b>
<b>2. Write many, Read few</b>	<b>Automatically updated inventory database</b>	<b>Asymmetrical (Fast compress)</b>	<b>Very high compression ratio</b>	<b>Asymmetrical (Slow decompress)</b>
<b>3. Similar number of Reads and Writes</b>	<b>User generated documents</b>	<b>Symmetrical</b>	<b>Standard compression ratio</b>	<b>Symmetrical</b>

[0070] In accordance with the present invention, the access profile of a given data set is known a priori or determined prior to compression so that the optimum category of compression algorithm can be selected. As explained below, the selection process may be performed either manually or automatically by the controller 11 of the data compression system 12. Further, the decision regarding which routines will be used at compression time (write) and at decompression time (read) is preferably made before or at the time of compression. This is because once data is compressed using a certain algorithm, only the matching decompression routine can be used to decompress the data, regardless of how much processing time is available at the time of decompression.

[0071] Referring now to Fig. 2, a flow diagram illustrates a method for providing bandwidth sensitive data compression according to one aspect of the present invention. For purposes of illustration, it is assumed that the method depicted in Fig. 2 is implemented with a disk controller for providing accelerated data storage and retrieval from a hard disk on a PC (personal computer). The data compression system is initialized during a boot-up process after the PC is powered-on and a default compression/decompression routine is instantiated (step 20).

[0072] In a preferred embodiment, the default algorithm comprises an asymmetrical algorithm since an operating system and application programs will be read from hard disk memory and decompressed during the initial use of the host system 10. Indeed, as discussed above, an asymmetric algorithm that provides slow compression and fast

decompression is preferable for compressing operating systems and applications so as to obtain a high compression ratio (to effectively increase the storage capacity of the hard disk) and fast data access (to effectively increase the retrieval rate from the hard disk). The initial asymmetric routine that is applied (by, e.g., a vendor) to compress the operating system and applications is preferably set as the default. The operating system will be retrieved and then decompressed using the default asymmetric routine (step 21).

[0073] During initial runtime, the controller will maintain use the default algorithm until certain conditions are met. For instance, if a read command is received (affirmative result in step 22), the controller will determine whether the data to be read from disk can be compressed using the current routine (step 23). For this determination, the controller could, e.g., read a flag value that indicates the algorithm that was used to compress the file. If the data can be decompressed using the current algorithm (affirmative determination in step 23), then the file will be retrieved and decompressed (step 25). On the other hand, if the data cannot be decompressed using the current algorithm (negative determination in step 23), the controller will issue the appropriate control signal to the compression system to load the algorithm associated with the file (step 24) and, subsequently, decompress the file (step 25).

[0074] If a write command is received (affirmative result in step 26), the data to be stored will be compressed using the current algorithm (step 27). During the process of compression and storing the compressed data, the controller will track the throughput to determine whether the throughput is meeting a predetermined threshold (step 28). For example, the controller may track the number of pending disk accesses (access requests) to determine whether a bottleneck is occurring. If the throughput of the system is not meeting the desired threshold (e.g., the compression system cannot maintain the required or requested data rates)(negative determination in step 28), then the controller will command the data compression system to utilize a compression routine providing faster compression (e.g., a fast symmetric compression algorithm) (step 29) so as to mitigate or eliminate the bottleneck.

[0075] If, on the other hand, the system throughput is meeting or exceeding the threshold (affirmative determination in step 28) and the current algorithm being used is a symmetrical routine (affirmative determination in step 30), in an effort to achieve optimal compression ratios, the controller will command the data compression system to use an

asymmetric compression algorithm (step 31) that may provide a slower rate of compression, but provide efficient compression.

[0076] This process is repeated such that whenever the controller determines that the compression system can maintain the required/requested data throughput using a slow (highly efficient) asymmetrical compression algorithm, the controller will allow the compression system to operate in the asymmetrical mode. This will allow the system to obtain maximum storage capacity on the disk. Further, the controller will command the compression system to use a symmetric routine comprising a fast compression routine when the desired throughput is not met. This will allow the system to, e.g., service the backlogged disk accesses. Then, when the controller determines that the required/requested data rates are subsequently lower and the compression system can maintain the data rate, the controller can command the compression system to use a slower (but more efficient) asymmetric compression algorithm.

[0077] With the above-described method depicted in Fig. 2, the selection of the compression routine is performed automatically by the controller so as to optimize system throughput. In another embodiment, a user that desires to install a program or text files, for example, can command the system (via a software utility) to utilize a desired compression routine for compressing and storing the compressed program or files to disk. For example, for a power user, a GUI menu can be displayed that allows the user to directly select a given algorithm. Alternatively, the system can detect the type of data being installed or stored to disk (via file extension, etc.) and automatically select an appropriate algorithm using the Access Profile information as described above. For instance, the user could indicate to the controller that the data being installed comprises an application program which the controller would determine falls under Access Profile 1. The controller would then command the compression engine to utilize an asymmetric compression algorithm employing a slow compression routine and a fast decompression routine. The result would be a one-time penalty during program installation (slow compression), but with fast access to the data on all subsequent executions (reads) of the program, as well as a high compression ratio.

[0078] It is to be appreciated that the present invention may be implemented in any data processing system, device, or apparatus using data compression. For instance, the present invention may be employed in a data transmission controller in a network environment to

provide accelerated data transmission over a communication channel (i.e., effectively increase the transmission bandwidth by compressing the data at the source and decompressing data at the receiver, in real-time).

[0079] Further, the present invention can be implemented with a data storage controller utilizing data compression and decompression to provided accelerated data storage and retrieval from a mass storage device. Exemplary embodiments of preferred data storage controllers in which the present invention may be implemented are described, for example, in U.S. Patent Application Serial No. 09/775,905, filed on February 2, 2001, entitled "Data Storewidth Accelerator", which is commonly assigned and fully incorporated herein by reference.

[0080] Fig. 3 illustrates a preferred embodiment of a data storage controller 120 as described in the above-incorporated U.S. Serial No. 09/775,905 for implementing a bandwidth sensitive data compression protocol as described herein. The data storage controller 120 comprises a DSP (digital signal processor) 121 (or any other micro-processor device) that implements a data compression/decompression routine. The DSP 121 preferably employs a plurality of symmetric and asymmetric compression/decompression as described herein. The data storage controller 120 further comprises at least one programmable logic device 122 (or volatile logic device). The programmable logic device 122 preferably implements the logic (program code) for instantiating and driving both a disk interface 114 and a bus interface 115 and for providing full DMA (direct memory access) capability for the disk and bus interfaces 114, 115. Further, upon host computer power-up and/or assertion of a system-level "reset" (e.g., PCI Bus reset), the DSP 121 initializes and programs the programmable logic device 122 before of the completion of initialization of the host computer. This advantageously allows the data storage controller 120 to be ready to accept and process commands from the host computer (via the bus 116) and retrieve boot data from the disk (assuming the data storage controller 120 is implemented as the boot device and the hard disk stores the boot data (e.g., operating system, etc.))

[0081] The data storage controller 120 further comprises a plurality of memory devices including a RAM (random access memory) device 123 and a ROM (read only memory) device 124 (or FLASH memory or other types of non-volatile memory). The RAM device 123 is utilized as on-board cache and is preferably implemented as SDRAM. The



ROM device 124 is utilized for non-volatile storage of logic code associated with the DSP 121 and configuration data used by the DSP 121 to program the programmable logic device 122.

[0082] The DSP 121 is operatively connected to the memory devices 123, 124 and the programmable logic device 122 via a local bus 125. The DSP 121 is also operatively connected to the programmable logic device 122 via an independent control bus 126. The programmable logic device 122 provides data flow control between the DSP 121 and the host computer system attached to the bus 116, as well as data flow control between the DSP 121 and the storage device. A plurality of external I/O ports 127 are included for data transmission and/or loading of one or more programmable logic devices. Preferably, the disk interface 114 driven by the programmable logic device 122 supports a plurality of hard drives.

[0083] The data storage controller 120 further comprises computer reset and power up circuitry 128 (or "boot configuration circuit") for controlling initialization (either cold or warm boots) of the host computer system and data storage controller 120. A preferred boot configuration circuit and preferred computer initialization systems and protocols are described in U.S. Patent Application Serial No. 09/775,897, filed on February 2, 2001, entitled "System and Methods For Computer Initialization," which is commonly assigned and incorporated herein by reference. Preferably, the boot configuration circuit 128 is employed for controlling the initializing and programming the programmable logic device 122 during configuration of the host computer system (i.e., while the CPU of the host is held in reset). The boot configuration circuit 128 ensures that the programmable logic device 122 (and possibly other volatile or partially volatile logic devices) is initialized and programmed before the bus 116 (such as a PCI bus) is fully reset. In particular, when power is first applied to the boot configuration circuit 128, the boot configuration circuit 128 generates a control signal to reset the local system (e.g., data storage controller 120) devices such as a DSP, memory, and I/O interfaces. Once the local system is powered-up and reset, the controlling device (such as the DSP 121) will then proceed to automatically determine the system environment and configure the local system to work within that environment. By way of example, the DSP 121 of the data storage controller 120 would sense that the data storage controller 120 is on a PCI computer bus (expansion bus) and has attached to it a hard disk on an IDE interface. The DSP 121 would then load the

appropriate PCI and IDE interfaces into the programmable logic device 122 prior to completion of the host system reset. Once the programmable logic device 122 is configured for its environment, the boot device controller is reset and ready to accept commands over the bus 116.

**[0084]** It is to be understood that the data storage controller 120 may be utilized as a controller for transmitting data (compressed or uncompressed) to and from remote locations over the DSP I/O ports 127 or bus 116, for example. Indeed, the I/O ports 127 of the DSP 121 may be used for transmitting data (compressed or uncompressed) that is either retrieved from the disk or received from the host system via the bus 116, to remote locations for processing and/or storage. Indeed, the I/O ports 127 may be operatively connected to other data storage controllers or to a network communication channels. Likewise, the data storage controller 120 may receive data (compressed or uncompressed) over the I/O ports 127 of the DSP 121 from remote systems that are connected to the I/O ports 127 of the DSP, for local processing by the data storage controller 120. For instance, a remote system may remotely access the data storage controller 120 (via the I/O ports of the DSP or the bus 116) to utilize the data compression, in which case the data storage controller 120 would transmit the compressed data back to the system that requested compression.

**[0085]** In accordance with the present invention, the system (e.g., data storage controller 120) preferably boots-up in a mode using asymmetrical data compression. It is to be understood that the boot process would not be affected whether the system boots up defaulting to an asymmetrical mode or to a symmetrical mode. This is because during the boot process of the computer, it is reading the operating system from the disk, not writing. However, once data is written to the disk using a compression algorithm, it must retrieve and read the data using the corresponding decompression algorithm.

**[0086]** As the user creates, deletes and edits files, the data storage controller 120 will preferably utilize an asymmetrical compression routine that provides slow compression and fast decompression. Since using the asymmetrical compression algorithm will provide slower compression than a symmetrical algorithm, the file system of the computer will track whether the data storage controller 120 has disk accesses pending. If the data storage controller 120 does have disk accesses pending and the system is starting to slow down, the file management system will command the data storage controller 120

to use a faster symmetrical compression algorithm. If there are no disk access requests pending, the file management system will leave the disk controller in the mode of using the asymmetrical compression algorithm.

[0087] If the data storage controller 120 was switched to using a symmetrical algorithm, the file management system will preferably signal the controller to switch back to a default asymmetrical algorithm when, e.g., the rate of the disk access requests slow to the point where there are no pending disk accesses.

[0088] At some point a user may decide to install software or load files onto the hard disk. Before installing the software, for example, as described above, the user could indicate to the data storage controller 120 (via a software utility) to enter and remain in an asymmetric mode using an asymmetric compression algorithm with a slow compression routine and a very fast decompression routine. The disk controller would continue to use the asymmetrical algorithm until commanded otherwise, regardless of the number of pending disk accesses. Then, after completing the software installation, the user would then release the disk controller from this “asymmetrical only” mode of operation (via the software utility).

[0089] Again, when the user is not commanding the data storage controller 120 to remain in a certain mode, the file management system will determine whether the disk controller should use the asymmetrical compression algorithms or the symmetrical compression algorithms based on the amount of backlogged disk activity. If the backlogged disk activity exceeds a threshold, then the file management system will preferably command the disk controller to use a faster compression algorithm, even though compression performance may suffer. Otherwise, the file management system will command the disk controller to use the asymmetrical algorithm that will yield greater compression performance.

[0090] It is to be appreciated that the data compression methods described herein by be integrated or otherwise implemented with the content independent data compression methods described in the above-incorporated U.S. Patent Nos. 6,195,024 and 6,309,424.

[0091] Fig. 4A is a diagram of a file system format of a virtual and/or physical disk according to an embodiment of the present invention.

[0092] In yet another embodiment of the present invention, a virtual file management system is utilized to store, retrieve, or transmit compressed and/or accelerated data. In

one embodiment of the present invention, a physical or virtual disk is utilized employing a representative file system format as illustrated in Fig. 4A. As shown in Fig. 4A, a virtual file system format comprises one or more data items. For instance, a "Superblock" denotes a grouping of configuration information necessary for the operation of the disk management system. The Superblock typically resides in the first sector of the disk. Additional copies of the Superblock are preferably maintained on the disk for backup purposes. The number of copies will depend on the size of the disk. One sector is preferably allocated for each copy of the Superblock on the disk, which allows storage to add additional parameters for various applications. The Superblock preferably comprises information such as (i) compress size; (ii) virtual block table address; (iii) virtual block table size; (iv) allocation size; (v) number of free sectors (approximate); (vi) ID ("Magic") number; and (vii) checksum.

**[0093]** The "compress size" refers to the maximum uncompressed size of data that is grouped together for compression (referred to as a "data chunk"). For example, if the compress size is set to 16k and a 40k data block is sent to the disk controller for storage, it would be divided into two 16k chunks and one 8k chunk. Each chunk would be compressed separately and possess its own header. As noted above, for many compression algorithms, increasing the compression size will increase the compression ratio obtained. However, even when a single byte is needed from a compressed data chunk, the entire chunk must be decompressed, which is a tradeoff with respect to using a very large compression size.

**[0094]** The "virtual block table address" denotes the physical address of the virtual block table. The "virtual block table size" denotes the size of the virtual block table.

**[0095]** The "allocation size" refers to the minimum number of contiguous sectors on the disk to reserve for each new data entry. For example, assuming that 4 sectors are allowed for each allocation and that a compressed data entry requires only 1 sector, then the remaining 3 sectors would be left unused. Then, if that piece of data were to be appended, there would be room to increase the data while remaining contiguous on the disk. Indeed, by maintaining the data contiguously, the speed at which the disk can read and write the data will increase. Although the controller preferably attempts to keep these unused sectors available for expansion of the data, if the disk were to fill up, the controller could use such sectors to store new data entries. In this way, a system can be

configured to achieve greater speed, while not sacrificing disk space. Setting the allocation size to 1 sector would effectively disable this feature.

[0096] The “number Of free sectors” denotes the number of physical free sectors remaining on the disk. The ID (“Magic) number” identifies this data as a Superblock. The “checksum” comprises a number that changes based on the data in the Superblock and is used for error checking. Preferably, this number is chosen so that all of the words in the Superblock (including the checksum) added up are equal to zero.

[0097] Fig. 4B is a diagram of a data structure of a sector map entry of a virtual block table according to an embodiment of the present invention.

[0098] The “virtual block table” (VET) comprises a number of “sector map” entries, one for each grouping of compressed data (or chunks). The VET may reside anywhere on the disk. The size of the VBT will depend on how much data is on the disk. Each sector map entry comprises 8 bytes. Although there is preferably only one VBT on the disk, each chunk of compressed data will have a copy of its sector map entry in its header. If the VBT were to become corrupted, scanning the disk for all sector maps could create a new one.

[0099] The term “type” refers to the sector map type. For example, a value of “00” corresponds to this sector map definition. Other values are preferably reserved for future redefinitions of the sector map.

[00100] A “C Type” denotes a compression type. A value of “000” will correspond to no compression. Other values are defined as required depending on the application. This function supports the use of multiple compression algorithms along with the use of various forms of asymmetric data compression.

[00101] The “C Info” comprises the compression information needed for the given compression type. These values are defined depending on the application. In addition, the data may be tagged based on its use - for example operating system “00”, Program “01”, or data “10”. Frequency of use or access codes may also be included. The size of this field may be greatly expanded to encode statistics supporting these items including, for example, cumulative number of times accessed, number of times accessed within a given time period or CPU clock cycles, and other related data.

- [0100] The “sector count” comprises the number of physical sectors on the disk that are used for this chunk of compressed data. The “LBA” refers to the logical block address, or physical disk address, for this chunk of compressed data.
- [0101] Referring back to Fig. 4A, each “Data” block represent each data chunk comprising a header and compressed data. The data chunk may up anywhere from 1 to 256 sectors on the disk. Each compressed chunk of data is preferably preceded on the disk by a data block header that preferably comprises the following information: (i) sector map; (ii) VBI; (iii) ID (“Magic”) Number; and (iv) checksum.
- [0102] The “sector map” comprises a copy of the sector map entry in the VBT for this data chunk. The “VBI” is the Virtual Block Index, which is the index into the VBT that corresponds to this data chunk. The “ID (“Magic) Number” identifies this data as a data block header. The “checksum” number will change based on the data in the header and is used for error checking. This number is preferably chosen such that the addition of all the words in the header (including the checksum) will equal zero.
- [0103] It should be noted that the present invention is not limited to checksums but may employ any manner of error detection and correction techniques, utilizing greatly expanded fields error detection and/or correction.
- [0104] It should be further noted that additional fields may be employed to support encryption, specifically an identifier for encrypted or unencrypted data along with any parameters necessary for routing or processing the data to an appropriate decryption module or user.
- [0105] The virtual size of the disk will depend on the physical size of the disk, the compress size selected, and the expected compression ratio. For example, assume there is a 75GB disk with a selected compress size expecting a 3:1 compression ratio, the virtual disk size would be 225GB. This will be the maximum amount of uncompressed data that the file system will be able to store on the disk.
- [0106] If the number chosen is too small, then the entire disk will not be utilized. Consider the above example where a system comprises a 75GB disk and a 225GB virtual size. Assume that in actuality during operation the average compression ratio obtained is 5:1. Whereas this could theoretically allow 375GB to be stored on the 75GB disk, in practice, only 225GB would be able to be stored on the disk before a “disk full” message is received. Indeed, with a 5:1 compression ratio, the 225GB of data would only take up

45GB on the disk leaving 30GB unused. Since the operating system would think the disk is full, it would not attempt to write any more information to the disk.

[0107] On the other hand, if the number chosen is too large, then the disk will fill up when the operating system would still indicate that there was space available on the disk. Again consider the above example where a system comprises a 75GB disk and a 225GB virtual size. Assume further that during operation, the average compression ratio actually obtained is only 2:1. In this case, the physical disk would be full after writing 150GB to it, but the operating system would still think there is 75GB remaining. If the operating system tried to write more information to the disk, an error would occur.

[0108] Thus, in another embodiment of the present invention, the virtual size of the disk is dynamically altered based upon the achieved compression ratio. In one embodiment, a running average may be utilized to reallocate the virtual disk size. Alternatively, certain portions of the ratios may already be known - such as a preinstalled operating system and programs. Thus, this ratio is utilized for that portion of the disk, and predictive techniques are utilized for the balance of the disk or disks.

[0109] Yet in another embodiment, users are prompted for setup information and the computer selects the appropriate virtual disk(s) size or selects the best method of estimation based on, e.g., a high level menu of what is the purpose of this computer: home, home office, business, server. Another submenu may ask for the expected data mix, word, excel, video, music, etc. Then, based upon expected usage and associated compression ratios (or the use of already compressed data in the event of certain forms of music and video) the results are utilized to set the virtual disk size.

[0110] It should be noted that the present invention is independent of the number or types of physical or virtual disks, and indeed may be utilized with any type of storage.

[0111] It is to be understood that the systems and methods described herein may be implemented in various forms of hardware, software, firmware, special purpose processors, or a combination thereof. In particular, the present invention may be implemented as an application comprising program instructions that are tangibly embodied on a program storage device (e.g., magnetic floppy disk, RAM, ROM, CD ROM, etc.) and executable by any device or machine comprising suitable architecture. It is to be further understood that, because some of the constituent system components and process steps depicted in the accompanying Figures are preferably implemented in

software, the actual connections between such components and steps may differ depending upon the manner in which the present invention is programmed. Given the teachings herein, one of ordinary skill in the related art will be able to contemplate these and similar implementations or configurations of the present invention.

**[0112]** Although illustrative embodiments have been described herein with reference to the accompanying drawings, it is to be understood that the present system and method is not limited to those precise embodiments, and that various other changes and modifications may be affected therein by one skilled in the art without departing from the scope or spirit of the invention. All such changes and modifications are intended to be included within the scope of the invention as defined by the appended claims.



WHAT IS CLAIMED IS:

1. A method, comprising:  
determining a parameter or an attribute of a data block having video or audio data;  
selecting a compression algorithm from among a plurality of compression algorithms to apply to the data block based upon the determined parameter or attribute and a bandwidth of a transmission line or of a communication channel; and  
compressing the data block with the selected compression algorithm after selecting the compression algorithm.
2. The method of claim 1, further comprising:  
storing the compressed data block.
3. The method of claim 2, further comprising:  
retrieving at least some of the compressed data block based upon the bandwidth of the transmission line or of the communication channel or a user command.
4. The method of claim 1, wherein at least one of the plurality of compression algorithms is asymmetric.
5. The method of claim 1, further comprising:  
decompressing the data block prior to compressing the data block with the selected compression algorithm.
6. The method of claim 1, wherein selecting comprises:  
selecting the compression algorithm to apply to the data block based upon the determined parameter or attribute, the bandwidth of the transmission line or of the communication channel, and a frequency of access of the data block.
7. The method of claim 1, wherein compressing comprises:  
compressing the data block with the selected compression algorithm based upon a user command.

8. An apparatus, comprising:

a controller configured to:

determine a parameter or an attribute of a data block having video or audio data,

and

select a compression algorithm from among the determine plurality of compression algorithms to apply to the data block based upon the determined parameter or attribute and a bandwidth of a transmission line or of a communication channel; and

a data compression system configured to compress the data block with the selected compression algorithm.

9. The apparatus of claim 8, further comprising:

a storage medium configured to store the compressed data block.

10. The apparatus of claim 9, wherein the data compression system is further configured to retrieve at least some of the compressed data block from the storage medium based upon the bandwidth of the transmission line or of the communication channel or a user command.

11. The apparatus of claim 9, wherein the data compression system is further configured to:

retrieve at least some of the compressed data block from the storage medium based upon the bandwidth of the transmission line or of the communication channel; and

retrieve at least some of a second compressed data block, compressed with a second compression algorithm from among the plurality of compression algorithms, from the storage medium based upon a second bandwidth of the transmission line or of communication channel,

wherein second compressed data block is different from the selected compression algorithm, and

wherein the second bandwidth of the transmission line or of communication channel is different from the bandwidth of the transmission line and of the communication channel.

12. The apparatus of claim 8, wherein at least one of the plurality of compression algorithms is asymmetric.

13. The apparatus of claim 8, wherein the data compression system is further configured to decompress the data block prior compressing the data block with the selected compression algorithm.

14. The apparatus of claim 8, wherein the controller is further configured to select a second compression algorithm from among the plurality compression algorithms to apply to the compressed data block based upon a second bandwidth of the transmission line or of communication channel, the second bandwidth of the transmission line or of communication channel differing from the bandwidth of the transmission line or of communication channel.

15. The apparatus of claim 8, wherein the controller is configured to select the compression algorithm to apply to the data block based upon the determined parameter or attribute, the bandwidth of the transmission line or of the communication channel, and a frequency of access of the data block.

16. The apparatus of claim 8, wherein the data compression system is configured to compress the data block with the selected compression algorithm based upon a user command.

17. A method, comprising:  
determining a plurality of compression algorithms;  
selecting a compression algorithm from among the determined plurality of compression algorithms based upon a frequency of access of a data block; and  
compressing the data block with the selected compression algorithm.

18. The method of claim 17, further comprising:  
storing the compressed data block.

19. The method of claim 17, wherein at least one of the plurality of compression algorithms is asymmetric.

20. The method of claim 17, further comprising:  
decompressing the data block prior to compressing the data block with the selected compression algorithm.

21. The method of claim 17, further comprising:  
selecting a second compression algorithm from among the determined plurality compression algorithms to apply to the compressed data block based upon a bandwidth of a transmission line or of a communication channel.

22. The method of claim 18, further comprising:  
retrieving at least some of the compressed data block based upon a bandwidth of a transmission line or of a communication channel or a user command.

23. The method of claim 17, wherein compressing comprises:  
compressing the data block with the selected compression algorithm based upon a user command.

24. An apparatus, comprising:  
a controller configured to:  
determine a plurality of compression algorithms, and  
select a compression algorithm from among the determined plurality of compression algorithms based upon a frequency of access of a data block; and  
a data compression system configured to compress the data block with the selected compression algorithm.

25. The apparatus of claim 24, further comprising:  
a storage medium configured to store the compressed data block.

26. The apparatus of claim 24, wherein at least one of the plurality of compression algorithms is asymmetric.

27. The apparatus of claim 25, wherein the data compression system is further configured to decompress the data block prior to compressing the data block with the selected compression algorithm.

28. The apparatus of claim 24, wherein the controller is further configured to select a second compression algorithm from among the determined plurality compression of algorithms to apply to the compressed data block based upon a bandwidth of a transmission line or of a communication channel.

29. The apparatus of claim 25, wherein the data compression system is further configured to retrieve at least some of the compressed data block from the storage medium based upon a bandwidth of a transmission line or of a communication channel or a user command.

30. The apparatus of claim 23, wherein the data compression system is configured to compress the data block with the selected compression algorithm based upon a user command.

ABSTRACT OF THE DISCLOSURE

Data compression and decompression methods for compressing and decompressing data based on an actual or expected throughput (bandwidth) of a system. In one embodiment, a controller tracks and monitors the throughput (data storage and retrieval) of a data compression system and generates control signals to enable/disable different compression algorithms when, e.g., a bottleneck occurs so as to increase the throughput and eliminate the bottleneck.

1748070\_1.DOC

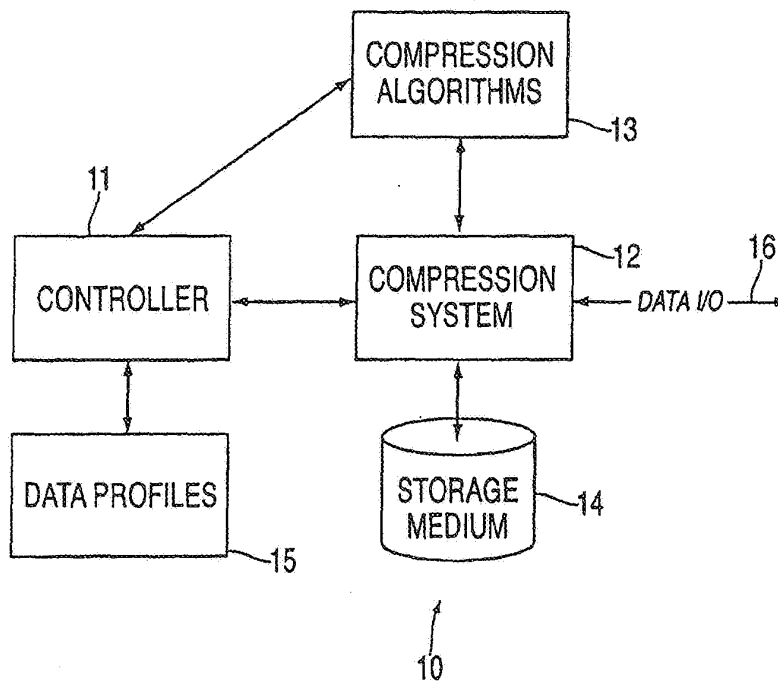

FIG. 1

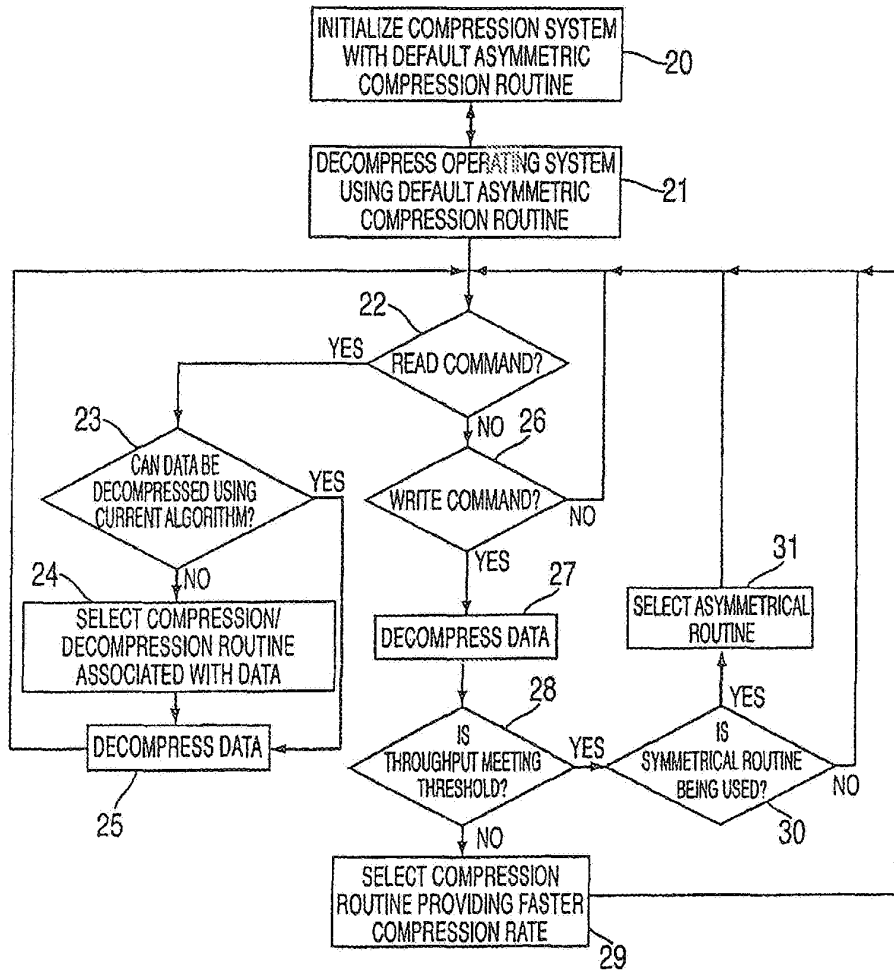

FIG. 2



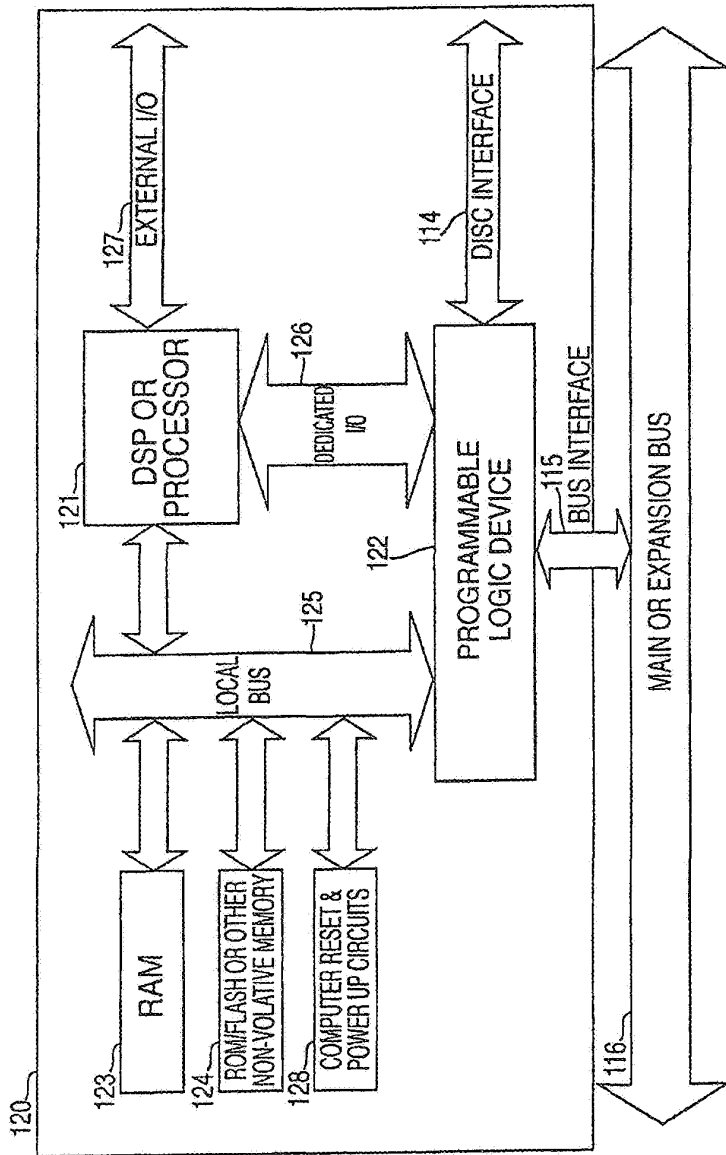

FIG. 3

PHYSICAL DISK

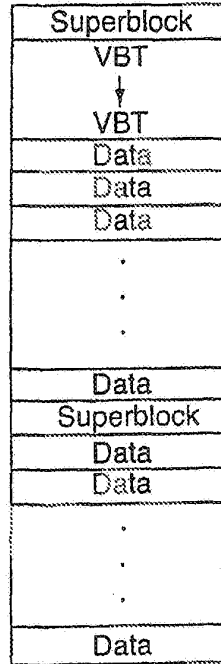

FIG. 4A

SECTOR MAP DEFINITION

SECTOR MAP

Type	2 bits
C Type	3 bits
C Info	19 bits
Sector Count	8 bits
LBA	32 bits

FIG. 4B

Electronic Patent Application Fee Transmittal				
<b>Application Number:</b>				
<b>Filing Date:</b>				
<b>Title of Invention:</b>	System and Methods for Video and Audio Data Distribution			
<b>First Named Inventor/Applicant Name:</b>	James J. FALLON			
<b>Filer:</b>	Michael V. Messinger/Lauren Harrison			
<b>Attorney Docket Number:</b>	2855.0050008			
Filed as Large Entity				
<b>Track I Prioritized Examination - Nonprovisional Application under 35 USC 111(a) Filing Fees</b>				
Description	Fee Code	Quantity	Amount	Sub-Total in USD(\$)
<b>Basic Filing:</b>				
Utility application filing	1011	1	280	280
Utility Search Fee	1111	1	600	600
Utility Examination Fee	1311	1	720	720
Request for Prioritized Examination	1817	1	4000	4000
<b>Pages:</b>				
<b>Claims:</b>				
Claims in Excess of 20	1202	10	80	800
Independent claims in excess of 3	1201	1	420	420

Description	Fee Code	Quantity	Amount	Sub-Total in USD(\$)
<b>Miscellaneous-Filing:</b>				
Publ. Fee- Early, Voluntary, or Normal	1504	1	300	300
PROCESSING FEE, EXCEPT PROV. APPLS.	1830	1	140	140
<b>Petition:</b>				
<b>Patent-Appeals-and-Interference:</b>				
<b>Post-Allowance-and-Post-Issuance:</b>				
<b>Extension-of-Time:</b>				
<b>Miscellaneous:</b>				
<b>Total in USD (\$)</b>				<b>7260</b>

## Electronic Acknowledgement Receipt

<b>EFS ID:</b>	17714259
<b>Application Number:</b>	14134926
<b>International Application Number:</b>	
<b>Confirmation Number:</b>	7069
<b>Title of Invention:</b>	System and Methods for Video and Audio Data Distribution
<b>First Named Inventor/Applicant Name:</b>	James J. FALLON
<b>Customer Number:</b>	26111
<b>Filer:</b>	Michael V. Messinger/Lauren Harrison
<b>Filer Authorized By:</b>	Michael V. Messinger
<b>Attorney Docket Number:</b>	2855.0050008
<b>Receipt Date:</b>	19-DEC-2013
<b>Filing Date:</b>	
<b>Time Stamp:</b>	17:20:19
<b>Application Type:</b>	Utility under 35 USC 111(a)

### Payment information:

Submitted with Payment	yes
Payment Type	Credit Card
Payment was successfully received in RAM	\$7260
RAM confirmation Number	5804
Deposit Account	
Authorized User	

### File Listing:

Document Number	Document Description	File Name	File Size(Bytes)/ Message Digest	Multi Part /.zip	Pages (if appl.)
-----------------	----------------------	-----------	-------------------------------------	------------------	------------------

1		28550050008fd.pdf	6453890	yes	10
			5ad89bdd15f3b862f864d37090a9bd5efb88f300		
<b>Multipart Description/PDF files in .zip description</b>					
		<b>Document Description</b>	<b>Start</b>	<b>End</b>	
		Miscellaneous Incoming Letter	1	2	
		Transmittal of New Application	3	4	
		TrackOne Request	5	5	
		Authorization for Extension of Time all replies	6	6	
		Oath or Declaration filed	7	8	
		Power of Attorney	9	10	
<b>Warnings:</b>					
<b>Information:</b>					
2	Application Data Sheet	28550050008ADS.pdf	1561576	no	7
			19f4e9d1c2d48d520002d5191b064781b5b51405		
<b>Warnings:</b>					
<b>Information:</b>					
3		28550050008spec.pdf	22816171	yes	35
			b634e3a83f8d58cf151be03a64add21f2d44d5af		
<b>Multipart Description/PDF files in .zip description</b>					
		<b>Document Description</b>	<b>Start</b>	<b>End</b>	
		Specification	1	29	
		Claims	30	34	
		Abstract	35	35	
<b>Warnings:</b>					
<b>Information:</b>					
4	Drawings-only black and white line drawings	28550050008drawings.pdf	748094	no	4
			060d730f2dd285c3d7d8adcec8823e9ba714d1ca		
<b>Warnings:</b>					
<b>Information:</b>					

5	Fee Worksheet (SB06)	fee-info.pdf	43001 c9701eeaa98103b197370b92a1dbfed6c9496bd9	no	2
<b>Warnings:</b>					
<b>Information:</b>					
<b>Total Files Size (in bytes):</b>				31622732	
<p><b>This Acknowledgement Receipt evidences receipt on the noted date by the USPTO of the indicated documents, characterized by the applicant, and including page counts, where applicable. It serves as evidence of receipt similar to a Post Card, as described in MPEP 503.</b></p> <p><b><u>New Applications Under 35 U.S.C. 111</u></b>  <b>If a new application is being filed and the application includes the necessary components for a filing date (see 37 CFR 1.53(b)-(d) and MPEP 506), a Filing Receipt (37 CFR 1.54) will be issued in due course and the date shown on this Acknowledgement Receipt will establish the filing date of the application.</b></p> <p><b><u>National Stage of an International Application under 35 U.S.C. 371</u></b>  <b>If a timely submission to enter the national stage of an international application is compliant with the conditions of 35 U.S.C. 371 and other applicable requirements a Form PCT/DO/EO/903 indicating acceptance of the application as a national stage submission under 35 U.S.C. 371 will be issued in addition to the Filing Receipt, in due course.</b></p> <p><b><u>New International Application Filed with the USPTO as a Receiving Office</u></b>  <b>If a new international application is being filed and the international application includes the necessary components for an international filing date (see PCT Article 11 and MPEP 1810), a Notification of the International Application Number and of the International Filing Date (Form PCT/RO/105) will be issued in due course, subject to prescriptions concerning national security, and the date shown on this Acknowledgement Receipt will establish the international filing date of the application.</b></p>					

MICHAEL V. MESSINGER  
DIRECTOR  
(202) 772-8667  
MIKEM@SKGF.COM



December 19, 2013

Commissioner for Patents  
PO Box 1450  
Alexandria, VA 22313-1450

Re: U.S. Non-Provisional Utility Patent Application under 37 C.F.R. § 1.53(b)  
(Continuation of Appl. No. 14/033,245; Filed: September 20, 2013)  
Appl. No. To Be Assigned; Filed: Herewith  
For: **SYSTEM AND METHODS FOR VIDEO AND AUDIO DATA  
DISTRIBUTION**  
Inventors: FALLON *et al.*  
Our Ref: 2855.0050008

Commissioner:

The following documents are transmitted herewith for appropriate action by the U.S. Patent and Trademark Office:

1. Utility Patent Application Transmittal (PTO/AIA/15);
2. Certification and Request for Prioritized Examination Under 37 CFR 1.102(e);
3. Payment made via EFS-Web for \$7,250.00 to cover:

<u>\$4,000.00</u>	Request for Prioritized Examination (Track 1);
<u>\$ 130.00</u>	Track 1 Processing Fee
<u>\$1,600.00</u>	Patent Application fee (including basic filing, search, and examination fees);
<u>\$ 300.00</u>	Publication Fee; and
<u>\$1,220.00</u>	Excess claims fee;
4. Authorization to Treat a Reply As Incorporating An Extension of Time Under 37 C.F.R. § 1.136(a)(3);
5. U.S. Utility Patent Application entitled:  
**SYSTEM AND METHODS FOR VIDEO AND AUDIO DATA  
DISTRIBUTION**  
and naming as inventors:



Commissioner for Patents  
December 19, 2013  
Page 2

**James J. FALLON and Stephen J. MCERLAIN**

the application consisting of:

- a. An Application Data Sheet (37 C.F.R. § 1.76);
  - b. A signed Inventors' Declaration;
  - c. A specification containing:
    - i. 29 pages of description prior to the claims;
    - ii. 5 pages of claims (30 claims);
    - iii. a one (1) page abstract;
  - d. 4 sheets of drawings: (Figures 1, 2, 3, and 4A-4B); and
6. An executed Power of Attorney by Applicant (PTO/AIA/82B) and the Transmittal for Power of Attorney form (PTO/AIA/82A).

The above-listed documents are filed electronically through EFS-Web.

Fee payment is provided via EFS-Web. The U.S. Patent and Trademark Office is hereby authorized to charge any fee deficiency, or credit any overpayment, to our Deposit Account No. 19-0036.

Respectfully submitted,

STERNE, KESSLER, GOLDSTEIN & FOX P.L.L.C.

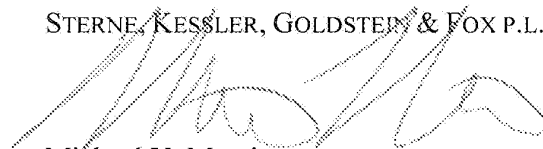

Michael V. Messinger  
Attorney for Applicant  
Registration No. 37,575

MVM/MRM/leh  
Enclosures

1787479\_1

**CERTIFICATION AND REQUEST FOR PRIORITIZED EXAMINATION  
 UNDER 37 CFR 1.102(e)** (Page 1 of 1)

First Named Inventor:	James J. FALLON	Nonprovisional Application Number (if known):	To Be Assigned
Title of Invention:	SYSTEM AND METHODS FOR VIDEO AND AUDIO DATA DISTRIBUTION		

**APPLICANT HEREBY CERTIFIES THE FOLLOWING AND REQUESTS PRIORITIZED EXAMINATION FOR THE ABOVE-IDENTIFIED APPLICATION.**

1. The processing fee set forth in 37 CFR 1.17(i), the prioritized examination fee set forth in 37 CFR 1.17(c), and if not already paid, the publication fee set forth in 37 CFR 1.18(d) have been filed with the request. The basic filing fee, search fee, examination fee, and any required excess claims and application size fees are filed with the request or have been already been paid.
2. The application contains or is amended to contain no more than four independent claims and no more than thirty total claims, and no multiple dependent claims.
3. The applicable box is checked below:
  - I.  **Original Application (Track One) - Prioritized Examination under § 1.102(e)(1)**
    - i. (a) The application is an original nonprovisional utility application filed under 35 U.S.C. 111(a). This certification and request is being filed with the utility application via EFS-Web.  
 ---OR---
      - (b) The application is an original nonprovisional plant application filed under 35 U.S.C. 111(a). This certification and request is being filed with the plant application in paper.
    - ii. An executed oath or declaration under 37 CFR 1.63 is filed with the application.
  - II.  **Request for Continued Examination - Prioritized Examination under § 1.102(e)(2)**
    - i. A request for continued examination has been filed with, or prior to, this form.
    - ii. If the application is a utility application, this certification and request is being filed via EFS-Web.
    - iii. The application is an original nonprovisional utility application filed under 35 U.S.C. 111(a), or is a national stage entry under 35 U.S.C. 371.
    - iv. This certification and request is being filed prior to the mailing of a first Office action responsive to the request for continued examination.
    - v. No prior request for continued examination has been granted prioritized examination status under 37 CFR 1.102(e)(2).

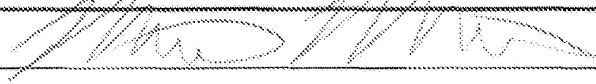
Signature		Date	December 19, 2013
Name (Print/Typed)	Michael V. Messinger	Practitioner Registration Number	37,575

*Note: Signatures of all the inventors or assignees of record of the entire interest or their representative(s) are required in accordance with 37 CFR 1.33 and 11.18. Please see 37 CFR 1.4(d) for the form of the signature. If necessary, submit multiple forms for more than one signature. see below\*.*

\*Total of 1 forms are submitted.

IN THE UNITED STATES PATENT AND TRADEMARK OFFICE

In re application of:

Realtime Data LLC

Appl. No.: To Be Assigned

(Continuation of Appl. No. 14/033,245; Filed:  
September 20, 2013)

Filed: Herewith

For: **SYSTEM AND METHODS FOR VIDEO  
AND AUDIO DATA DISTRIBUTION**

Confirmation No.: To Be Assigned

Art Unit: To Be Assigned

Examiner: To Be Assigned

Atty. Docket: 2855.0050008

**Authorization to Treat a Reply as Incorporating an  
Extension of Time Under 37 C.F.R. § 1.136(a)(3)**

Commissioner for Patents  
PO Box 1450  
Alexandria, VA 22313-1450

Commissioner:

The U.S. Patent and Trademark Office is hereby authorized to treat any concurrent or future reply that requires a petition for an extension of time under this paragraph for its timely submission, as incorporating a petition for extension of time for the appropriate length of time. The U.S. Patent and Trademark Office is hereby authorized to charge all required extension of time fees to our Deposit Account No. 19-0036, if such fees are not otherwise provided for in such reply.

Respectfully submitted,  
STERNE, KESSLER, GOLDSTEIN & FOX P.L.L.C.

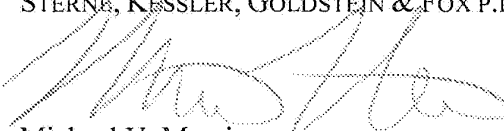

Michael V. Messinger  
Attorney for Applicant  
Registration No. 37,575

Date: December 19, 2013

1100 New York Avenue, N.W.  
Washington, D.C. 20005-3934  
(202) 371-2600

Under the Paperwork Reduction Act of 1995, no persons are required to respond to a collection of information unless it displays a valid OMB control number.

**DECLARATION (37 CFR 1.63) FOR UTILITY OR DESIGN APPLICATION USING AN APPLICATION DATA SHEET (37 CFR 1.76)**

Title of invention	SYSTEM AND METHODS FOR VIDEO AND AUDIO DATA DISTRIBUTION
--------------------	--

As the below named inventor, I hereby declare that:

This declaration is directed to:  The attached application, or  
 United States application or PCT international application number \_\_\_\_\_  
filed on \_\_\_\_\_

The above-identified application was made or authorized to be made by me.

I believe that I am the original inventor or an original joint inventor of a claimed invention in the application.

I hereby acknowledge that any willful false statement made in this declaration is punishable under 18 U.S.C. 1001 by fine or imprisonment of not more than five (5) years, or both.

**WARNING:**

Petitioner/applicant is cautioned to avoid submitting personal information in documents filed in a patent application that may contribute to identity theft. Personal information such as social security numbers, bank account numbers, or credit card numbers (other than a check or credit card authorization form PTO-2038 submitted for payment purposes) is never required by the USPTO to support a petition or an application. If this type of personal information is included in documents submitted to the USPTO, petitioners/applicants should consider redacting such personal information from the documents before submitting them to the USPTO. Petitioner/applicant is advised that the record of a patent application is available to the public after publication of the application (unless a non-publication request in compliance with 37 CFR 1.213(a) is made in the application) or issuance of a patent. Furthermore, the record from an abandoned application may also be available to the public if the application is referenced in a published application or an issued patent (see 37 CFR 1.14). Checks and credit card authorization forms PTO-2038 submitted for payment purposes are not retained in the application file and therefore are not publicly available.

**LEGAL NAME OF INVENTOR**

Inventor: James J. FALLON Date (Optional): 12/12/13

Signature: 

Note: An application data sheet (PTO/SB/14 or equivalent), including naming the entire inventive entity, must accompany this form or must have been previously filed. Use an additional PTO/AIA/01 form for each additional inventor.

This collection of information is required by 35 U.S.C. 115 and 37 CFR 1.63. The information is required to obtain or retain a benefit by the public which is to file (and by the USPTO to process) an application. Confidentiality is governed by 35 U.S.C. 122 and 37 CFR 1.11 and 1.14. This collection is estimated to take 1 minute to complete, including gathering, preparing, and submitting the completed application form to the USPTO. Time will vary depending upon the individual case. Any comments on the amount of time you require to complete this form and/or suggestions for reducing this burden, should be sent to the Chief Information Officer, U.S. Patent and Trademark Office, U.S. Department of Commerce, P.O. Box 1450, Alexandria, VA 22313-1450. DO NOT SEND FEES OR COMPLETED FORMS TO THIS ADDRESS. SEND TO: Commissioner for Patents, P.O. Box 1450, Alexandria, VA 22313-1450.

If you need assistance in completing the form, call 1-800-PTO-9199 and select option 2.

Under the Paperwork Reduction Act of 1995, no persons are required to respond to a collection of information unless it displays a valid OMB control number.

**DECLARATION (37 CFR 1.63) FOR UTILITY OR DESIGN APPLICATION USING AN  
APPLICATION DATA SHEET (37 CFR 1.76)**

<b>Title of Invention</b>	SYSTEM AND METHODS FOR VIDEO AND AUDIO DATA DISTRIBUTION
<p>As the below named inventor, I hereby declare that:</p> <p>This declaration is directed to: <input checked="" type="checkbox"/> The attached application, or  <input type="checkbox"/> United States application or PCT international application number _____  filed on _____.</p> <p>The above-identified application was made or authorized to be made by me.</p> <p>I believe that I am the original inventor or an original joint inventor of a claimed invention in the application.</p> <p>I hereby acknowledge that any willful false statement made in this declaration is punishable under 18 U.S.C. 1001 by fine or imprisonment of not more than five (5) years, or both.</p> <p style="text-align: center;"><b>WARNING:</b></p> <p>Petitioner/applicant is cautioned to avoid submitting personal information in documents filed in a patent application that may contribute to identity theft. Personal information such as social security numbers, bank account numbers, or credit card numbers (other than a check or credit card authorization form PTO-2038 submitted for payment purposes) is never required by the USPTO to support a petition or an application. If this type of personal information is included in documents submitted to the USPTO, petitioners/applicants should consider redacting such personal information from the documents before submitting them to the USPTO. Petitioner/applicant is advised that the record of a patent application is available to the public after publication of the application (unless a non-publication request in compliance with 37 CFR 1.213(a) is made in the application) or issuance of a patent. Furthermore, the record from an abandoned application may also be available to the public if the application is referenced in a published application or an issued patent (see 37 CFR 1.14). Checks and credit card authorization forms PTO-2038 submitted for payment purposes are not retained in the application file and therefore are not publicly available.</p>	
<b>LEGAL NAME OF INVENTOR</b>	
Inventor: <u>Stephen J. MCERLAIN</u> Date (Optional): _____	
Signature: 	
<p>Note: An application data sheet (PTO/SB/14 or equivalent), including naming the entire inventive entity, must accompany this form or must have been previously filed. Use an additional PTO/AIA/01 form for each additional inventor.</p>	

This collection of information is required by 35 U.S.C. 115 and 37 CFR 1.63. The information is required to obtain or retain a benefit by the public which is to file (and by the USPTO to process) an application. Confidentiality is governed by 35 U.S.C. 122 and 37 CFR 1.11 and 1.14. This collection is estimated to take 1 minute to complete, including gathering, preparing, and submitting the completed application form to the USPTO. Time will vary depending upon the individual case. Any comments on the amount of time you require to complete this form and/or suggestions for reducing this burden, should be sent to the Chief Information Officer, U.S. Patent and Trademark Office, U.S. Department of Commerce, P.O. Box 1450, Alexandria, VA 22313-1450. DO NOT SEND FEES OR COMPLETED FORMS TO THIS ADDRESS. **SEND TO: Commissioner for Patents, P.O. Box 1450, Alexandria, VA 22313-1450.**

*If you need assistance in completing the form, call 1-800-PTO-9199 and select option 2.*



UNITED STATES PATENT AND TRADEMARK OFFICE

UNITED STATES DEPARTMENT OF COMMERCE  
United States Patent and Trademark Office  
Address: COMMISSIONER FOR PATENTS  
P.O. Box 1450  
Alexandria, Virginia 22313-1450  
www.uspto.gov

APPLICATION NUMBER	FILING OR 371(C) DATE	FIRST NAMED APPLICANT	ATTY. DOCKET NO./TITLE
14/134,926	12/19/2013	James J. FALLON	2855.0050008

**CONFIRMATION NO. 7069**

**POA ACCEPTANCE LETTER**

26111  
STERNE, KESSLER, GOLDSTEIN & FOX P.L.L.C.  
1100 NEW YORK AVENUE, N.W.  
WASHINGTON, DC 20005



Date Mailed: 01/07/2014

**NOTICE OF ACCEPTANCE OF POWER OF ATTORNEY**

This is in response to the Power of Attorney filed 12/19/2013.

The Power of Attorney in this application is accepted. Correspondence in this application will be mailed to the above address as provided by 37 CFR 1.33.

/kung/

Office of Data Management, Application Assistance Unit (571) 272-4000, or (571) 272-4200, or 1-888-786-0101



UNITED STATES PATENT AND TRADEMARK OFFICE

UNITED STATES DEPARTMENT OF COMMERCE
United States Patent and Trademark Office
Address: COMMISSIONER FOR PATENTS
P.O. Box 1450
Alexandria, Virginia 22313-1450
www.uspto.gov

Table with 7 columns: APPLICATION NUMBER, FILING or 371(c) DATE, GRP ART UNIT, FIL FEE REC'D, ATTY.DOCKET.NO, TOT CLAIMS, IND CLAIMS. Row 1: 14/134,926, 12/19/2013, 3120, 2855.0050008, 30, 4

CONFIRMATION NO. 7069

26111
STERNE, KESSLER, GOLDSTEIN & FOX P.L.L.C.
1100 NEW YORK AVENUE, N.W.
WASHINGTON, DC 20005

FILING RECEIPT



Date Mailed: 01/07/2014

Receipt is acknowledged of this non-provisional patent application. The application will be taken up for examination in due course. Applicant will be notified as to the results of the examination. Any correspondence concerning the application must include the following identification information: the U.S. APPLICATION NUMBER, FILING DATE, NAME OF APPLICANT, and TITLE OF INVENTION. Fees transmitted by check or draft are subject to collection. Please verify the accuracy of the data presented on this receipt. If an error is noted on this Filing Receipt, please submit a written request for a Filing Receipt Correction. Please provide a copy of this Filing Receipt with the changes noted thereon. If you received a "Notice to File Missing Parts" for this application, please submit any corrections to this Filing Receipt with your reply to the Notice. When the USPTO processes the reply to the Notice, the USPTO will generate another Filing Receipt incorporating the requested corrections

Inventor(s)

James J. FALLON, Armonk, NY;
Stephen J. MCERLAIN, Armonk, NY;

Applicant(s)

REALTIME DATA LLC, New York, NY

Assignment For Published Patent Application

REALTIME DATA LLC, New York, NY

Power of Attorney: The patent practitioners associated with Customer Number 26111

Domestic Priority data as claimed by applicant

This application is a CON of 14/033,245 09/20/2013
which is a CON of 13/154,239 06/06/2011 PAT 8553759
which is a CON of 12/123,081 05/19/2008 PAT 8073047
which is a CON of 10/076,013 02/13/2002 PAT 7386046
which claims benefit of 60/268,394 02/13/2001

Foreign Applications for which priority is claimed (You may be eligible to benefit from the Patent Prosecution Highway program at the USPTO. Please see http://www.uspto.gov for more information.) - None.

Foreign application information must be provided in an Application Data Sheet in order to constitute a claim to foreign priority. See 37 CFR 1.55 and 1.76.

Permission to Access - A proper Authorization to Permit Access to Application by Participating Offices (PTO/SB/39 or its equivalent) has been received by the USPTO.

If Required, Foreign Filing License Granted: 12/31/2013

The country code and number of your priority application, to be used for filing abroad under the Paris Convention, is **US 14/134,926**

**Projected Publication Date:** 04/17/2014

**Non-Publication Request:** No

**Early Publication Request:** No

**Title**

SYSTEM AND METHODS FOR VIDEO AND AUDIO DATA DISTRIBUTION

**Preliminary Class**

**Statement under 37 CFR 1.55 or 1.78 for AIA (First Inventor to File) Transition Applications:** No

### **PROTECTING YOUR INVENTION OUTSIDE THE UNITED STATES**

Since the rights granted by a U.S. patent extend only throughout the territory of the United States and have no effect in a foreign country, an inventor who wishes patent protection in another country must apply for a patent in a specific country or in regional patent offices. Applicants may wish to consider the filing of an international application under the Patent Cooperation Treaty (PCT). An international (PCT) application generally has the same effect as a regular national patent application in each PCT-member country. The PCT process **simplifies** the filing of patent applications on the same invention in member countries, but **does not result** in a grant of "an international patent" and does not eliminate the need of applicants to file additional documents and fees in countries where patent protection is desired.

Almost every country has its own patent law, and a person desiring a patent in a particular country must make an application for patent in that country in accordance with its particular laws. Since the laws of many countries differ in various respects from the patent law of the United States, applicants are advised to seek guidance from specific foreign countries to ensure that patent rights are not lost prematurely.

Applicants also are advised that in the case of inventions made in the United States, the Director of the USPTO must issue a license before applicants can apply for a patent in a foreign country. The filing of a U.S. patent application serves as a request for a foreign filing license. The application's filing receipt contains further information and guidance as to the status of applicant's license for foreign filing.

Applicants may wish to consult the USPTO booklet, "General Information Concerning Patents" (specifically, the section entitled "Treaties and Foreign Patents") for more information on timeframes and deadlines for filing foreign patent applications. The guide is available either by contacting the USPTO Contact Center at 800-786-9199, or it can be viewed on the USPTO website at <http://www.uspto.gov/web/offices/pac/doc/general/index.html>.

For information on preventing theft of your intellectual property (patents, trademarks and copyrights), you may wish to consult the U.S. Government website, <http://www.stopfakes.gov>. Part of a Department of Commerce initiative, this website includes self-help "toolkits" giving innovators guidance on how to protect intellectual property in specific countries such as China, Korea and Mexico. For questions regarding patent enforcement issues, applicants may call the U.S. Government hotline at 1-866-999-HALT (1-866-999-4258).



**LICENSE FOR FOREIGN FILING UNDER**  
**Title 35, United States Code, Section 184**  
**Title 37, Code of Federal Regulations, 5.11 & 5.15**

**GRANTED**

The applicant has been granted a license under 35 U.S.C. 184, if the phrase "IF REQUIRED, FOREIGN FILING LICENSE GRANTED" followed by a date appears on this form. Such licenses are issued in all applications where the conditions for issuance of a license have been met, regardless of whether or not a license may be required as set forth in 37 CFR 5.15. The scope and limitations of this license are set forth in 37 CFR 5.15(a) unless an earlier license has been issued under 37 CFR 5.15(b). The license is subject to revocation upon written notification. The date indicated is the effective date of the license, unless an earlier license of similar scope has been granted under 37 CFR 5.13 or 5.14.

This license is to be retained by the licensee and may be used at any time on or after the effective date thereof unless it is revoked. This license is automatically transferred to any related applications(s) filed under 37 CFR 1.53(d). This license is not retroactive.

The grant of a license does not in any way lessen the responsibility of a licensee for the security of the subject matter as imposed by any Government contract or the provisions of existing laws relating to espionage and the national security or the export of technical data. Licensees should apprise themselves of current regulations especially with respect to certain countries, of other agencies, particularly the Office of Defense Trade Controls, Department of State (with respect to Arms, Munitions and Implements of War (22 CFR 121-128)); the Bureau of Industry and Security, Department of Commerce (15 CFR parts 730-774); the Office of Foreign Assets Control, Department of Treasury (31 CFR Parts 500+) and the Department of Energy.

**NOT GRANTED**

No license under 35 U.S.C. 184 has been granted at this time, if the phrase "IF REQUIRED, FOREIGN FILING LICENSE GRANTED" DOES NOT appear on this form. Applicant may still petition for a license under 37 CFR 5.12, if a license is desired before the expiration of 6 months from the filing date of the application. If 6 months has lapsed from the filing date of this application and the licensee has not received any indication of a secrecy order under 35 U.S.C. 181, the licensee may foreign file the application pursuant to 37 CFR 5.15(b).

---

***SelectUSA***

The United States represents the largest, most dynamic marketplace in the world and is an unparalleled location for business investment, innovation, and commercialization of new technologies. The U.S. offers tremendous resources and advantages for those who invest and manufacture goods here. Through SelectUSA, our nation works to promote and facilitate business investment. SelectUSA provides information assistance to the international investor community; serves as an ombudsman for existing and potential investors; advocates on behalf of U.S. cities, states, and regions competing for global investment; and counsels U.S. economic development organizations on investment attraction best practices. To learn more about why the United States is the best country in the world to develop technology, manufacture products, deliver services, and grow your business, visit <http://www.SelectUSA.gov> or call +1-202-482-6800.

**PATENT APPLICATION FEE DETERMINATION RECORD**

Substitute for Form PTO-875

Application or Docket Number  
14/134,926

**APPLICATION AS FILED - PART I**

(Column 1)		(Column 2)	SMALL ENTITY		OR	OTHER THAN SMALL ENTITY	
FOR	NUMBER FILED	NUMBER EXTRA	RATE(\$)	FEE(\$)		RATE(\$)	FEE(\$)
BASIC FEE (37 CFR 1.16(a), (b), or (c))	N/A	N/A	N/A			N/A	280
SEARCH FEE (37 CFR 1.16(k), (l), or (m))	N/A	N/A	N/A			N/A	600
EXAMINATION FEE (37 CFR 1.16(e), (p), or (q))	N/A	N/A	N/A			N/A	720
TOTAL CLAIMS (37 CFR 1.16(j))	30 minus 20 = *	10			OR	x 80 =	800
INDEPENDENT CLAIMS (37 CFR 1.16(h))	4 minus 3 = *	1				x 420 =	420
APPLICATION SIZE FEE (37 CFR 1.16(s))	If the specification and drawings exceed 100 sheets of paper, the application size fee due is \$310 (\$155 for small entity) for each additional 50 sheets or fraction thereof. See 35 U.S.C. 41(a)(1)(G) and 37 CFR 1.16(s).						0.00
MULTIPLE DEPENDENT CLAIM PRESENT (37 CFR 1.16(j))							0.00
* If the difference in column 1 is less than zero, enter "0" in column 2.			TOTAL			TOTAL	2820

**APPLICATION AS AMENDED - PART II**

(Column 1)		(Column 2)	(Column 3)	SMALL ENTITY		OR	OTHER THAN SMALL ENTITY	
AMENDMENT A	CLAIMS REMAINING AFTER AMENDMENT	HIGHEST NUMBER PREVIOUSLY PAID FOR	PRESENT EXTRA	RATE(\$)	ADDITIONAL FEE(\$)		RATE(\$)	ADDITIONAL FEE(\$)
	Total (37 CFR 1.16(i))	* Minus **	=	x	=	OR	x	=
	Independent (37 CFR 1.16(h))	* Minus ***	=	x	=	OR	x	=
	Application Size Fee (37 CFR 1.16(s))					OR		
FIRST PRESENTATION OF MULTIPLE DEPENDENT CLAIM (37 CFR 1.16(j))					OR			
			TOTAL ADD'L FEE		OR	TOTAL ADD'L FEE		
AMENDMENT B	CLAIMS REMAINING AFTER AMENDMENT	HIGHEST NUMBER PREVIOUSLY PAID FOR	PRESENT EXTRA	RATE(\$)	ADDITIONAL FEE(\$)		RATE(\$)	ADDITIONAL FEE(\$)
	Total (37 CFR 1.16(i))	* Minus **	=	x	=	OR	x	=
	Independent (37 CFR 1.16(h))	* Minus ***	=	x	=	OR	x	=
	Application Size Fee (37 CFR 1.16(s))					OR		
FIRST PRESENTATION OF MULTIPLE DEPENDENT CLAIM (37 CFR 1.16(j))					OR			
			TOTAL ADD'L FEE		OR	TOTAL ADD'L FEE		

\* If the entry in column 1 is less than the entry in column 2, write "0" in column 3.  
 \*\* If the "Highest Number Previously Paid For" IN THIS SPACE is less than 20, enter "20".  
 \*\*\* If the "Highest Number Previously Paid For" IN THIS SPACE is less than 3, enter "3".  
 The "Highest Number Previously Paid For" (Total or Independent) is the highest found in the appropriate box in column 1.



UNITED STATES PATENT AND TRADEMARK OFFICE

Commissioner for Patents  
United States Patent and Trademark Office  
P.O. Box 1450  
Alexandria, VA 22313-1450  
www.uspto.gov

STERNE, KESSLER, GOLDSTEIN & FOX P.L.L.C.  
1100 NEW YORK AVENUE, N.W.  
WASHINGTON DC 20005

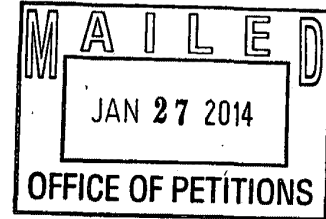

Doc Code: TRACK1.GRANT

<p><b>Decision Granting Request for Prioritized Examination (Track I or After RCE)</b></p>	<p>Application No.: 14/134,926</p>
<p>1. THE REQUEST FILED <u>December 19, 2013</u> IS <b>GRANTED</b>.</p> <p>The above-identified application has met the requirements for prioritized examination</p> <p>A. <input checked="" type="checkbox"/> for an original nonprovisional application (Track I).  B. <input type="checkbox"/> for an application undergoing continued examination (RCE).</p> <p>2. <b>The above-identified application will undergo prioritized examination.</b> The application will be accorded special status throughout its entire course of prosecution until one of the following occurs:</p> <p>A. filing a <b>petition for extension of time</b> to extend the time period for filing a reply;  B. filing an <b>amendment to amend the application to contain more than four independent claims, more than thirty total claims</b>, or a multiple dependent claim;  C. filing a <b>request for continued examination</b>;  D. filing a notice of appeal;  E. filing a request for suspension of action;  F. mailing of a notice of allowance;  G. mailing of a final Office action;  H. completion of examination as defined in 37 CFR 41.102; or  I. abandonment of the application.</p> <p>Telephone inquiries with regard to this decision should be directed to <u>JoAnne Burke</u> at <u>571-272-4584</u>. In his/her absence, calls may be directed to <u>Brian Brown</u>, <u>571-272-5338</u>.</p> <p><u>/JoAnne Burke/</u> [Signature]</p> <p><u>Paralegal Specialist, Office of Petitions</u> (Title)</p>	

MICHAEL V. MESSINGER  
DIRECTOR  
(202) 772-8667  
MIKEM@SKGF.COM



January 28, 2014

Commissioner for Patents  
PO Box 1450  
Alexandria, VA 22313-1450

**Confirmation No. 7069**  
**Art Unit To Be Assigned**

Re: U.S. Utility Patent Application  
Appl. No. 14/134,926; Filing Date: December 19, 2013  
For: **SYSTEM AND METHODS FOR VIDEO AND AUDIO DATA  
DISTRIBUTION**  
Inventors: FALLON *et al.*  
Our Ref: 2855.0050008

Commissioner:

Transmitted herewith for appropriate action are the following documents:

1. Application Data Sheet (PTO/AIA/14);
2. Request for Corrected Official Filing Receipt; and
3. Copy of marked up instant Official Filing Receipt.

The above-listed documents are filed electronically through EFS-Web.

In the event that extensions of time are necessary to prevent abandonment of this patent application, then such extensions of time are hereby petitioned.

The U.S. Patent and Trademark Office is hereby authorized to charge any fee deficiency, or credit any overpayment, to our Deposit Account No. 19-0036.

Respectfully submitted,

STERNE, KESSLER, GOLDSTEIN & FOX P.L.L.C.

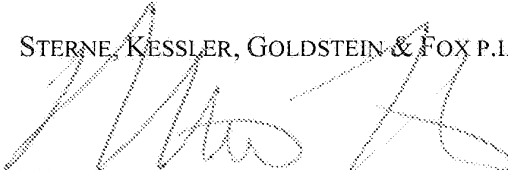

Michael V. Messinger  
Attorney for Applicant  
Registration No. 37,575

MVM/MRM/leh  
Enclosures

1800068\_1

IN THE UNITED STATES PATENT AND TRADEMARK OFFICE

In re application of:

Realtime Data LLC

Appl. No.: 14/134,926

Filed: December 19, 2013

For: **SYSTEM AND METHODS FOR  
VIDEO AND AUDIO DATA  
DISTRIBUTION**

Confirmation No.: 7069

Art Unit: To Be Assigned

Examiner: To Be Assigned

Atty. Docket: 2855.0050008

**Request for Corrected Official Filing Receipt**

Commissioner for Patents  
PO Box 1450  
Alexandria, VA 22313-1450

*Mail Stop Missing Parts*

Commissioner:

Applicant hereby requests that a corrected Official Filing Receipt be issued and sent to the undersigned representative. Specifically, the following corrections to the Official Filing Receipt are requested: **Please see the attached Application Data Sheet (PTO/AIA/14) stating the correct Applicant. Specifically, It is requested that under Applicant(s) "REALTIME DATA LLC, New York, NY" be replaced with -- REALTIME DATA LLC, Armonk, NY--.** In support of the above request, a marked-up copy of the instant Official Filing Receipt is enclosed to show the corrections. It is requested that a corrected Official Filing Receipt be issued, and sent to the undersigned at the earliest possible time.

Respectfully submitted,  
STERNE, KESSLER, GOLDSTEIN & FOX P.L.L.C.

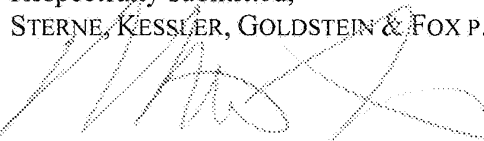

Michael V. Messinger  
Attorney for Applicant  
Registration No. 37,575

Date: January 26, 2014

1100 New York Avenue, N.W.  
Washington, D.C. 20005-3934  
(202) 371-2600



UNITED STATES PATENT AND TRADEMARK OFFICE

RECEIVED  
JAN 10 2014  
M. Malek

UNITED STATES  
United States Patent and Trademark Office  
Address: COMMISSIONER FOR PATENTS P.L.L.C.  
P.O. Box 1450  
Alexandria, Virginia 22313-1450  
www.uspto.gov

APPLICATION NUMBER	FILING or 37(c) DATE	GRP ART UNIT	FIL FEE REC'D	ATTY. DOCKET NO	TOT CLAIMS	IND CLAIMS
14/134,926	12/19/2013		3120	2855.0050008	30	4

CONFIRMATION NO. 7069

26111  
STERNE, KESSLER, GOLDSTEIN & FOX P.L.L.C.  
1100 NEW YORK AVENUE, N.W.  
WASHINGTON, DC 20005

FILING RECEIPT



Date Mailed: 01/07/2014

Receipt is acknowledged of this non-provisional patent application. The application will be taken up for examination in due course. Applicant will be notified as to the results of the examination. Any correspondence concerning the application must include the following identification information: the U.S. APPLICATION NUMBER, FILING DATE, NAME OF APPLICANT, and TITLE OF INVENTION. Fees transmitted by check or draft are subject to collection. Please verify the accuracy of the data presented on this receipt. **If an error is noted on this Filing Receipt, please submit a written request for a Filing Receipt Correction. Please provide a copy of this Filing Receipt with the changes noted thereon. If you received a "Notice to File Missing Parts" for this application, please submit any corrections to this Filing Receipt with your reply to the Notice. When the USPTO processes the reply to the Notice, the USPTO will generate another Filing Receipt incorporating the requested corrections**

Inventor(s)

James J. FALLON, Armonk, NY;  
Stephen J. MCERLAIN, Armonk, NY; Astoria

Applicant(s)

REALTIME DATA LLC, Armonk, New York, NY

Assignment For Published Patent Application

REALTIME DATA LLC, Armonk, New York, NY

Power of Attorney: The patent practitioners associated with Customer Number 26111

Domestic Priority data as claimed by applicant

This application is a CON of 14/033,245 09/20/2013  
which is a CON of 13/154,239 06/06/2011 PAT 8553759  
which is a CON of 12/123,081 05/19/2008 PAT 8073047  
which is a CON of 10/076,013 02/13/2002 PAT 7386046  
which claims benefit of 60/268,394 02/13/2001

Foreign Applications for which priority is claimed (You may be eligible to benefit from the Patent Prosecution Highway program at the USPTO. Please see <http://www.uspto.gov> for more information.) - None.

Foreign application information must be provided in an Application Data Sheet in order to constitute a claim to foreign priority. See 37 CFR 1.55 and 1.76.

Permission to Access - A proper Authorization to Permit Access to Application by Participating Offices (PTO/SB/39 or its equivalent) has been received by the USPTO.

If Required, Foreign Filing License Granted: 12/31/2013

The country code and number of your priority application, to be used for filing abroad under the Paris Convention, is **US 14/134,926**

**Projected Publication Date:** 04/17/2014

**Non-Publication Request:** No

**Early Publication Request:** No  
**Title**

SYSTEM AND METHODS FOR VIDEO AND AUDIO DATA DISTRIBUTION

**Preliminary Class**

**Statement under 37 CFR 1.55 or 1.78 for AIA (First Inventor to File) Transition Applications:** No

### **PROTECTING YOUR INVENTION OUTSIDE THE UNITED STATES**

Since the rights granted by a U.S. patent extend only throughout the territory of the United States and have no effect in a foreign country, an inventor who wishes patent protection in another country must apply for a patent in a specific country or in regional patent offices. Applicants may wish to consider the filing of an international application under the Patent Cooperation Treaty (PCT). An international (PCT) application generally has the same effect as a regular national patent application in each PCT-member country. The PCT process **simplifies** the filing of patent applications on the same invention in member countries, but **does not result** in a grant of "an international patent" and does not eliminate the need of applicants to file additional documents and fees in countries where patent protection is desired.

Almost every country has its own patent law, and a person desiring a patent in a particular country must make an application for patent in that country in accordance with its particular laws. Since the laws of many countries differ in various respects from the patent law of the United States, applicants are advised to seek guidance from specific foreign countries to ensure that patent rights are not lost prematurely.

Applicants also are advised that in the case of inventions made in the United States, the Director of the USPTO must issue a license before applicants can apply for a patent in a foreign country. The filing of a U.S. patent application serves as a request for a foreign filing license. The application's filing receipt contains further information and guidance as to the status of applicant's license for foreign filing.

Applicants may wish to consult the USPTO booklet, "General Information Concerning Patents" (specifically, the section entitled "Treaties and Foreign Patents") for more information on timeframes and deadlines for filing foreign patent applications. The guide is available either by contacting the USPTO Contact Center at 800-786-9199, or it can be viewed on the USPTO website at <http://www.uspto.gov/web/offices/pac/doc/general/index.html>.

For information on preventing theft of your intellectual property (patents, trademarks and copyrights), you may wish to consult the U.S. Government website, <http://www.stopfakes.gov>. Part of a Department of Commerce initiative, this website includes self-help "toolkits" giving innovators guidance on how to protect intellectual property in specific countries such as China, Korea and Mexico. For questions regarding patent enforcement issues, applicants may call the U.S. Government hotline at 1-866-999-HALT (1-866-999-4258).

**LICENSE FOR FOREIGN FILING UNDER  
Title 35, United States Code, Section 184  
Title 37, Code of Federal Regulations, 5.11 & 5.15**

**GRANTED**

The applicant has been granted a license under 35 U.S.C. 184, if the phrase "IF REQUIRED, FOREIGN FILING LICENSE GRANTED" followed by a date appears on this form. Such licenses are issued in all applications where the conditions for issuance of a license have been met, regardless of whether or not a license may be required as set forth in 37 CFR 5.15. The scope and limitations of this license are set forth in 37 CFR 5.15(a) unless an earlier license has been issued under 37 CFR 5.15(b). The license is subject to revocation upon written notification. The date indicated is the effective date of the license, unless an earlier license of similar scope has been granted under 37 CFR 5.13 or 5.14.

This license is to be retained by the licensee and may be used at any time on or after the effective date thereof unless it is revoked. This license is automatically transferred to any related applications(s) filed under 37 CFR 1.53(d). This license is not retroactive.

The grant of a license does not in any way lessen the responsibility of a licensee for the security of the subject matter as imposed by any Government contract or the provisions of existing laws relating to espionage and the national security or the export of technical data. Licensees should apprise themselves of current regulations especially with respect to certain countries, of other agencies, particularly the Office of Defense Trade Controls, Department of State (with respect to Arms, Munitions and Implements of War (22 CFR 121-128)); the Bureau of Industry and Security, Department of Commerce (15 CFR parts 730-774); the Office of Foreign Assets Control, Department of Treasury (31 CFR Parts 500+) and the Department of Energy.

**NOT GRANTED**

No license under 35 U.S.C. 184 has been granted at this time, if the phrase "IF REQUIRED, FOREIGN FILING LICENSE GRANTED" DOES NOT appear on this form. Applicant may still petition for a license under 37 CFR 5.12, if a license is desired before the expiration of 6 months from the filing date of the application. If 6 months has lapsed from the filing date of this application and the licensee has not received any indication of a secrecy order under 35 U.S.C. 181, the licensee may foreign file the application pursuant to 37 CFR 5.15(b).

---

**SelectUSA**

The United States represents the largest, most dynamic marketplace in the world and is an unparalleled location for business investment, innovation, and commercialization of new technologies. The U.S. offers tremendous resources and advantages for those who invest and manufacture goods here. Through SelectUSA, our nation works to promote and facilitate business investment. SelectUSA provides information assistance to the international investor community; serves as an ombudsman for existing and potential investors; advocates on behalf of U.S. cities, states, and regions competing for global investment; and counsels U.S. economic development organizations on investment attraction best practices. To learn more about why the United States is the best country in the world to develop technology, manufacture products, deliver services, and grow your business, visit <http://www.SelectUSA.gov> or call +1-202-482-6800.



Under the Paperwork Reduction Act of 1995, no persons are required to respond to a collection of information unless it contains a valid OMB control number.

<b>Application Data Sheet 37 CFR 1.76</b>		Attorney Docket Number	2855.0050008
		Application Number	
Title of Invention	SYSTEM AND METHODS FOR VIDEO AND AUDIO DATA DISTRIBUTION		
<p>The application data sheet is part of the provisional or nonprovisional application for which it is being submitted. The following form contains the bibliographic data arranged in a format specified by the United States Patent and Trademark Office as outlined in 37 CFR 1.76. This document may be completed electronically and submitted to the Office in electronic format using the Electronic Filing System (EFS) or the document may be printed and included in a paper filed application.</p>			

### Secrecy Order 37 CFR 5.2

<input type="checkbox"/>	Portions or all of the application associated with this Application Data Sheet may fall under a Secrecy Order pursuant to 37 CFR 5.2 (Paper filers only. Applications that fall under Secrecy Order may not be filed electronically.)
--------------------------	---

### Inventor Information:

<b>Inventor 1</b>						<input type="button" value="Remove"/>		
Legal Name								
Prefix	Given Name		Middle Name		Family Name		Suffix	
	James		J.		FALLON			
Residence Information (Select One) <input checked="" type="radio"/> US Residency <input type="radio"/> Non US Residency <input type="radio"/> Active US Military Service								
City	Armonk		State/Province	NY	Country of Residence		US	
Mailing Address of inventor:								
Address 1		11 Wampus Close						
Address 2								
City	<del>New York</del>	Armonk		State/Province	NY			
Postal Code	10504			Country	US			
<b>Inventor 2</b>						<input type="button" value="Remove"/>		
Legal Name								
Prefix	Given Name		Middle Name		Family Name		Suffix	
	Stephen		J.		MCERLAIN			
Residence Information (Select One) <input checked="" type="radio"/> US Residency <input type="radio"/> Non US Residency <input type="radio"/> Active US Military Service								
City	<del>Armonk</del>	Astoria		State/Province	NY	Country of Residence		US
Mailing Address of inventor:								
Address 1		<del>11 Wampus Close</del> 2454 37th Street						
Address 2		#4F						
City	<del>New York</del>	Astoria		State/Province	NY			
Postal Code	<del>10504</del> 11103			Country	US			
All Inventors Must Be Listed - Additional Inventor Information blocks may be generated within this form by selecting the Add button.						<input type="button" value="Add"/>		

### Correspondence Information:

Enter either Customer Number or complete the Correspondence Information section below.  
For further information see 37 CFR 1.33(a).

Under the Paperwork Reduction Act of 1995, no persons are required to respond to a collection of information unless it contains a valid OMB control number.

<b>Application Data Sheet 37 CFR 1.76</b>		Attorney Docket Number	2855.0050008
		Application Number	
Title of Invention	SYSTEM AND METHODS FOR VIDEO AND AUDIO DATA DISTRIBUTION		

An Address is being provided for the correspondence information of this application.

Customer Number	26111		
Email Address		<input type="button" value="Add Email"/>	<input type="button" value="Remove Email"/>

**Application Information:**

Title of the Invention	SYSTEM AND METHODS FOR VIDEO AND AUDIO DATA DISTRIBUTION		
Attorney Docket Number	2855.0050008	Small Entity Status Claimed	<input type="checkbox"/>
Application Type	Nonprovisional		
Subject Matter	Utility		
Total Number of Drawing Sheets (if any)	4	Suggested Figure for Publication (if any)	

**Filing By Reference :**

Only complete this section when filing an application by reference under 35 U.S.C. 111(c) and 37 CFR 1.57(a). Do not complete this section if application papers including a specification and any drawings are being filed. Any domestic benefit or foreign priority information must be provided in the appropriate section(s) below (i.e., "Domestic Benefit/National Stage Information" and "Foreign Priority Information").

For the purposes of a filing date under 37 CFR 1.53(b), the description and any drawings of the present application are replaced by this reference to the previously filed application, subject to conditions and requirements of 37 CFR 1.57(a).

Application number of the previously filed application	Filing date (YYYY-MM-DD)	Intellectual Property Authority or Country

**Publication Information:**

Request Early Publication (Fee required at time of Request 37 CFR 1.219)

**Request Not to Publish.** I hereby request that the attached application not be published under 35 U.S.C. 122(b) and certify that the invention disclosed in the attached application **has not and will not** be the subject of an application filed in another country, or under a multilateral international agreement, that requires publication at eighteen months after filing.

**Representative Information:**

Representative information should be provided for all practitioners having a power of attorney in the application. Providing this information in the Application Data Sheet does not constitute a power of attorney in the application (see 37 CFR 1.32). Either enter Customer Number or complete the Representative Name section below. If both sections are completed the customer number will be used for the Representative Information during processing.

Please Select One:	<input checked="" type="radio"/> Customer Number	<input type="radio"/> US Patent Practitioner	<input type="radio"/> Limited Recognition (37 CFR 11.9)
Customer Number	26111		

Under the Paperwork Reduction Act of 1995, no persons are required to respond to a collection of information unless it contains a valid OMB control number.

<b>Application Data Sheet 37 CFR 1.76</b>		Attorney Docket Number	2855.0050008
		Application Number	
Title of Invention	SYSTEM AND METHODS FOR VIDEO AND AUDIO DATA DISTRIBUTION		

### Domestic Benefit/National Stage Information:

This section allows for the applicant to either claim benefit under 35 U.S.C. 119(e), 120, 121, or 365(c) or indicate National Stage entry from a PCT application. Providing this information in the application data sheet constitutes the specific reference required by 35 U.S.C. 119(e) or 120, and 37 CFR 1.78.

When referring to the current application, please leave the application number blank.

Prior Application Status	Pending		<a href="#">Remove</a>		
Application Number	Continuity Type		Prior Application Number	Filing Date (YYYY-MM-DD)	
	Continuation of		14033245	2013-09-20	
Prior Application Status	Patented		<a href="#">Remove</a>		
Application Number	Continuity Type	Prior Application Number	Filing Date (YYYY-MM-DD)	Patent Number	Issue Date (YYYY-MM-DD)
14033245	Continuation of	13154239	2011-06-06	8553759	2013-10-08
Prior Application Status	Patented		<a href="#">Remove</a>		
Application Number	Continuity Type	Prior Application Number	Filing Date (YYYY-MM-DD)	Patent Number	Issue Date (YYYY-MM-DD)
13154239	Continuation of	12123081	2008-05-19	8073047	2011-12-06
Prior Application Status	Patented		<a href="#">Remove</a>		
Application Number	Continuity Type	Prior Application Number	Filing Date (YYYY-MM-DD)	Patent Number	Issue Date (YYYY-MM-DD)
12123081	Continuation of	10076013	2002-02-13	7386046	2008-06-10
Prior Application Status	Expired		<a href="#">Remove</a>		
Application Number	Continuity Type		Prior Application Number	Filing Date (YYYY-MM-DD)	
10076013	Claims benefit of provisional		60268394	2001-02-13	
Additional Domestic Benefit/National Stage Data may be generated within this form by selecting the <b>Add</b> button.					

### Foreign Priority Information:

This section allows for the applicant to claim priority to a foreign application. Providing this information in the application data sheet constitutes the claim for priority as required by 35 U.S.C. 119(b) and 37 CFR 1.55(d). When priority is claimed to a foreign application that is eligible for retrieval under the priority document exchange program (PDX)<sup>1</sup> the information will be used by the Office to automatically attempt retrieval pursuant to 37 CFR 1.55(h)(1) and (2). Under the PDX program, applicant bears the ultimate responsibility for ensuring that a copy of the foreign application is received by the Office from the participating foreign intellectual property office, or a certified copy of the foreign priority application is filed, within the time period specified in 37 CFR 1.55(g)(1).

<a href="#">Remove</a>			
Application Number	Country <sup>1</sup>	Filing Date (YYYY-MM-DD)	Access Code <sup>1</sup> (if applicable)
Additional Foreign Priority Data may be generated within this form by selecting the <b>Add</b> button.			

<b>Application Data Sheet 37 CFR 1.76</b>	Attorney Docket Number	2855.0050008
	Application Number	
Title of Invention	SYSTEM AND METHODS FOR VIDEO AND AUDIO DATA DISTRIBUTION	

### Statement under 37 CFR 1.55 or 1.78 for AIA (First Inventor to File) Transition Applications

- This application (1) claims priority to or the benefit of an application filed before March 16, 2013 and (2) also contains, or contained at any time, a claim to a claimed invention that has an effective filing date on or after March 16, 2013.
- NOTE: By providing this statement under 37 CFR 1.55 or 1.78, this application, with a filing date on or after March 16, 2013, will be examined under the first inventor to file provisions of the AIA.

### Authorization to Permit Access:

Authorization to Permit Access to the Instant Application by the Participating Offices

If checked, the undersigned hereby grants the USPTO authority to provide the European Patent Office (EPO), the Japan Patent Office (JPO), the Korean Intellectual Property Office (KIPO), the World Intellectual Property Office (WIPO), and any other intellectual property offices in which a foreign application claiming priority to the instant patent application is filed access to the instant patent application. See 37 CFR 1.14(c) and (h). This box should not be checked if the applicant does not wish the EPO, JPO, KIPO, WIPO, or other intellectual property office in which a foreign application claiming priority to the instant patent application is filed to have access to the instant patent application.

In accordance with 37 CFR 1.14(h)(3), access will be provided to a copy of the instant patent application with respect to: 1) the instant patent application-as-filed; 2) any foreign application to which the instant patent application claims priority under 35 U.S.C. 119(a)-(d) if a copy of the foreign application that satisfies the certified copy requirement of 37 CFR 1.55 has been filed in the instant patent application; and 3) any U.S. application-as-filed from which benefit is sought in the instant patent application.

In accordance with 37 CFR 1.14(c), access may be provided to information concerning the date of filing this Authorization.

### Applicant Information:

Providing assignment information in this section does not substitute for compliance with any requirement of part 3 of Title 37 of CFR to have an assignment recorded by the Office.

Under the Paperwork Reduction Act of 1995, no persons are required to respond to a collection of information unless it contains a valid OMB control number.

<b>Application Data Sheet 37 CFR 1.76</b>	Attorney Docket Number	2855.0050008
	Application Number	
Title of Invention	SYSTEM AND METHODS FOR VIDEO AND AUDIO DATA DISTRIBUTION	

<b>Applicant 1</b>			
If the applicant is the inventor (or the remaining joint inventor or inventors under 37 CFR 1.45), this section should not be completed. The information to be provided in this section is the name and address of the legal representative who is the applicant under 37 CFR 1.43; or the name and address of the assignee, person to whom the inventor is under an obligation to assign the invention, or person who otherwise shows sufficient proprietary interest in the matter who is the applicant under 37 CFR 1.46. If the applicant is an applicant under 37 CFR 1.46 (assignee, person to whom the inventor is obligated to assign, or person who otherwise shows sufficient proprietary interest) together with one or more joint inventors, then the joint inventor or inventors who are also the applicant should be identified in this section.			
<input type="button" value="Clear"/>			
<input checked="" type="radio"/> Assignee	<input type="radio"/> Legal Representative under 35 U.S.C. 117	<input type="radio"/> Joint Inventor	
<input type="radio"/> Person to whom the inventor is obligated to assign.		<input type="radio"/> Person who shows sufficient proprietary interest	
If applicant is the legal representative, indicate the authority to file the patent application, the inventor is:			
Name of the Deceased or Legally Incapacitated Inventor : <input type="text"/>			
If the Applicant is an Organization check here. <input checked="" type="checkbox"/>			
Organization Name	Realtime Data LLC		
<b>Mailing Address Information For Applicant:</b>			
Address 1	11 Wampus Close		
Address 2			
City	New York Armonk	State/Province	NY
Country	US	Postal Code	10504
Phone Number		Fax Number	
Email Address			
Additional Applicant Data may be generated within this form by selecting the Add button.			

**Assignee Information including Non-Applicant Assignee Information:**

Providing assignment information in this section does not substitute for compliance with any requirement of part 3 of Title 37 of CFR to have an assignment recorded by the Office.
<b>Assignee 1</b>
Complete this section if assignee information, including non-applicant assignee information, is desired to be included on the patent application publication. An assignee-applicant identified in the "Applicant Information" section will appear on the patent application publication as an applicant. For an assignee-applicant, complete this section only if identification as an assignee is also desired on the patent application publication.
If the Assignee or Non-Applicant Assignee is an Organization check here. <input type="checkbox"/>

Under the Paperwork Reduction Act of 1995, no persons are required to respond to a collection of information unless it contains a valid OMB control number.

<b>Application Data Sheet 37 CFR 1.76</b>		Attorney Docket Number	2855.0050008
		Application Number	
Title of Invention	SYSTEM AND METHODS FOR VIDEO AND AUDIO DATA DISTRIBUTION		

Prefix	Given Name	Middle Name	Family Name	Suffix

**Mailing Address Information For Assignee including Non-Applicant Assignee:**

Address 1			
Address 2			
City		State/Province	
Country		Postal Code	
Phone Number		Fax Number	
Email Address			

Additional Assignee or Non-Applicant Assignee Data may be generated within this form by selecting the Add button.

**Signature:**

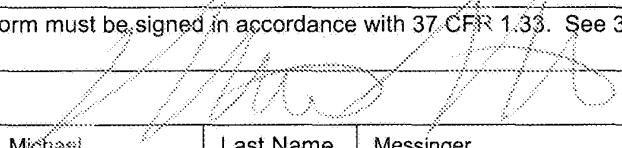
NOTE: This form must be signed in accordance with 37 CFR 1.33. See 37 CFR 1.4 for signature requirements and certifications.					
Signature				Date (YYYY-MM-DD)	2014-01-22
First Name	Michael	Last Name	Messinger	Registration Number	37575
Additional Signature may be generated within this form by selecting the Add button.					

This collection of information is required by 37 CFR 1.76. The information is required to obtain or retain a benefit by the public which is to file (and by the USPTO to process) an application. Confidentiality is governed by 35 U.S.C. 122 and 37 CFR 1.14. This collection is estimated to take 23 minutes to complete, including gathering, preparing, and submitting the completed application data sheet form to the USPTO. Time will vary depending upon the individual case. Any comments on the amount of time you require to complete this form and/or suggestions for reducing this burden, should be sent to the Chief Information Officer, U.S. Patent and Trademark Office, U.S. Department of Commerce, P.O. Box 1450, Alexandria, VA 22313-1450. DO NOT SEND FEES OR COMPLETED FORMS TO THIS ADDRESS. **SEND TO: Commissioner for Patents, P.O. Box 1450, Alexandria, VA 22313-1450.**

## Electronic Acknowledgement Receipt

<b>EFS ID:</b>	18049292
<b>Application Number:</b>	14134926
<b>International Application Number:</b>	
<b>Confirmation Number:</b>	7069
<b>Title of Invention:</b>	SYSTEM AND METHODS FOR VIDEO AND AUDIO DATA DISTRIBUTION
<b>First Named Inventor/Applicant Name:</b>	James J. FALLON
<b>Customer Number:</b>	26111
<b>Filer:</b>	Michael Raymond Malek/Lauren Harrison
<b>Filer Authorized By:</b>	Michael Raymond Malek
<b>Attorney Docket Number:</b>	2855.0050008
<b>Receipt Date:</b>	28-JAN-2014
<b>Filing Date:</b>	19-DEC-2013
<b>Time Stamp:</b>	17:17:20
<b>Application Type:</b>	Utility under 35 USC 111(a)

### Payment information:

Submitted with Payment	no
------------------------	----

### File Listing:

Document Number	Document Description	File Name	File Size(Bytes)/ Message Digest	Multi Part /.zip	Pages (if appl.)
1		28550050008reqcorrofr.pdf	7801692 <small>010c9a9e178b3a814059b211d0cec3d2cb0d4e52</small>	yes	11

Multipart Description/PDF files in .zip description		
Document Description	Start	End
Miscellaneous Incoming Letter	1	1
Request for Corrected Filing Receipt	2	5
Application Data Sheet	6	11

**Warnings:**

**Information:**

<b>Total Files Size (in bytes):</b>	7801692
-------------------------------------	---------

**This Acknowledgement Receipt evidences receipt on the noted date by the USPTO of the indicated documents, characterized by the applicant, and including page counts, where applicable. It serves as evidence of receipt similar to a Post Card, as described in MPEP 503.**

**New Applications Under 35 U.S.C. 111**

**If a new application is being filed and the application includes the necessary components for a filing date (see 37 CFR 1.53(b)-(d) and MPEP 506), a Filing Receipt (37 CFR 1.54) will be issued in due course and the date shown on this Acknowledgement Receipt will establish the filing date of the application.**

**National Stage of an International Application under 35 U.S.C. 371**

**If a timely submission to enter the national stage of an international application is compliant with the conditions of 35 U.S.C. 371 and other applicable requirements a Form PCT/DO/EO/903 indicating acceptance of the application as a national stage submission under 35 U.S.C. 371 will be issued in addition to the Filing Receipt, in due course.**

**New International Application Filed with the USPTO as a Receiving Office**

**If a new international application is being filed and the international application includes the necessary components for an international filing date (see PCT Article 11 and MPEP 1810), a Notification of the International Application Number and of the International Filing Date (Form PCT/RO/105) will be issued in due course, subject to prescriptions concerning national security, and the date shown on this Acknowledgement Receipt will establish the international filing date of the application.**





UNITED STATES PATENT AND TRADEMARK OFFICE

UNITED STATES DEPARTMENT OF COMMERCE
United States Patent and Trademark Office
Address: COMMISSIONER FOR PATENTS
P.O. Box 1450
Alexandria, Virginia 22313-1450
www.uspto.gov

Table with 7 columns: APPLICATION NUMBER, FILING or 371(c) DATE, GRP ART UNIT, FIL FEE REC'D, ATTY.DOCKET.NO, TOT CLAIMS, IND CLAIMS. Row 1: 14/134,926, 12/19/2013, 2634, 3120, 2855.0050008, 30, 4

CONFIRMATION NO. 7069

CORRECTED FILING RECEIPT

26111
STERNE, KESSLER, GOLDSTEIN & FOX P.L.L.C.
1100 NEW YORK AVENUE, N.W.
WASHINGTON, DC 20005



Date Mailed: 02/10/2014

Receipt is acknowledged of this non-provisional patent application. The application will be taken up for examination in due course. Applicant will be notified as to the results of the examination. Any correspondence concerning the application must include the following identification information: the U.S. APPLICATION NUMBER, FILING DATE, NAME OF APPLICANT, and TITLE OF INVENTION. Fees transmitted by check or draft are subject to collection. Please verify the accuracy of the data presented on this receipt. If an error is noted on this Filing Receipt, please submit a written request for a Filing Receipt Correction. Please provide a copy of this Filing Receipt with the changes noted thereon. If you received a "Notice to File Missing Parts" for this application, please submit any corrections to this Filing Receipt with your reply to the Notice. When the USPTO processes the reply to the Notice, the USPTO will generate another Filing Receipt incorporating the requested corrections

Inventor(s)

James J. FALLON, Armonk, NY;
Stephen J. MCERLAIN, Astoria, NY;

Applicant(s)

REALTIME DATA LLC, Armonk, NY

Assignment For Published Patent Application

REALTIME DATA LLC, Armonk, NY

Power of Attorney: The patent practitioners associated with Customer Number 26111

Domestic Priority data as claimed by applicant

This application is a CON of 14/033,245 09/20/2013
which is a CON of 13/154,239 06/06/2011 PAT 8553759
which is a CON of 12/123,081 05/19/2008 PAT 8073047
which is a CON of 10/076,013 02/13/2002 PAT 7386046
which claims benefit of 60/268,394 02/13/2001

Foreign Applications for which priority is claimed (You may be eligible to benefit from the Patent Prosecution Highway program at the USPTO. Please see http://www.uspto.gov for more information.) - None.

Foreign application information must be provided in an Application Data Sheet in order to constitute a claim to foreign priority. See 37 CFR 1.55 and 1.76.

Permission to Access - A proper Authorization to Permit Access to Application by Participating Offices (PTO/SB/39 or its equivalent) has been received by the USPTO.

If Required, Foreign Filing License Granted: 12/31/2013

The country code and number of your priority application, to be used for filing abroad under the Paris Convention, is **US 14/134,926**

**Projected Publication Date:** 04/17/2014

**Non-Publication Request:** No

**Early Publication Request:** No

**Title**

SYSTEM AND METHODS FOR VIDEO AND AUDIO DATA DISTRIBUTION

**Preliminary Class**

375

**Statement under 37 CFR 1.55 or 1.78 for AIA (First Inventor to File) Transition Applications:** No

## **PROTECTING YOUR INVENTION OUTSIDE THE UNITED STATES**

Since the rights granted by a U.S. patent extend only throughout the territory of the United States and have no effect in a foreign country, an inventor who wishes patent protection in another country must apply for a patent in a specific country or in regional patent offices. Applicants may wish to consider the filing of an international application under the Patent Cooperation Treaty (PCT). An international (PCT) application generally has the same effect as a regular national patent application in each PCT-member country. The PCT process **simplifies** the filing of patent applications on the same invention in member countries, but **does not result** in a grant of "an international patent" and does not eliminate the need of applicants to file additional documents and fees in countries where patent protection is desired.

Almost every country has its own patent law, and a person desiring a patent in a particular country must make an application for patent in that country in accordance with its particular laws. Since the laws of many countries differ in various respects from the patent law of the United States, applicants are advised to seek guidance from specific foreign countries to ensure that patent rights are not lost prematurely.

Applicants also are advised that in the case of inventions made in the United States, the Director of the USPTO must issue a license before applicants can apply for a patent in a foreign country. The filing of a U.S. patent application serves as a request for a foreign filing license. The application's filing receipt contains further information and guidance as to the status of applicant's license for foreign filing.

Applicants may wish to consult the USPTO booklet, "General Information Concerning Patents" (specifically, the section entitled "Treaties and Foreign Patents") for more information on timeframes and deadlines for filing foreign patent applications. The guide is available either by contacting the USPTO Contact Center at 800-786-9199, or it can be viewed on the USPTO website at <http://www.uspto.gov/web/offices/pac/doc/general/index.html>.

For information on preventing theft of your intellectual property (patents, trademarks and copyrights), you may wish to consult the U.S. Government website, <http://www.stopfakes.gov>. Part of a Department of Commerce initiative, this website includes self-help "toolkits" giving innovators guidance on how to protect intellectual property in specific countries such as China, Korea and Mexico. For questions regarding patent enforcement issues, applicants may call the U.S. Government hotline at 1-866-999-HALT (1-866-999-4258).

**LICENSE FOR FOREIGN FILING UNDER**  
**Title 35, United States Code, Section 184**  
**Title 37, Code of Federal Regulations, 5.11 & 5.15**

**GRANTED**

The applicant has been granted a license under 35 U.S.C. 184, if the phrase "IF REQUIRED, FOREIGN FILING LICENSE GRANTED" followed by a date appears on this form. Such licenses are issued in all applications where the conditions for issuance of a license have been met, regardless of whether or not a license may be required as set forth in 37 CFR 5.15. The scope and limitations of this license are set forth in 37 CFR 5.15(a) unless an earlier license has been issued under 37 CFR 5.15(b). The license is subject to revocation upon written notification. The date indicated is the effective date of the license, unless an earlier license of similar scope has been granted under 37 CFR 5.13 or 5.14.

This license is to be retained by the licensee and may be used at any time on or after the effective date thereof unless it is revoked. This license is automatically transferred to any related applications(s) filed under 37 CFR 1.53(d). This license is not retroactive.

The grant of a license does not in any way lessen the responsibility of a licensee for the security of the subject matter as imposed by any Government contract or the provisions of existing laws relating to espionage and the national security or the export of technical data. Licensees should apprise themselves of current regulations especially with respect to certain countries, of other agencies, particularly the Office of Defense Trade Controls, Department of State (with respect to Arms, Munitions and Implements of War (22 CFR 121-128)); the Bureau of Industry and Security, Department of Commerce (15 CFR parts 730-774); the Office of Foreign Assets Control, Department of Treasury (31 CFR Parts 500+) and the Department of Energy.

**NOT GRANTED**

No license under 35 U.S.C. 184 has been granted at this time, if the phrase "IF REQUIRED, FOREIGN FILING LICENSE GRANTED" DOES NOT appear on this form. Applicant may still petition for a license under 37 CFR 5.12, if a license is desired before the expiration of 6 months from the filing date of the application. If 6 months has lapsed from the filing date of this application and the licensee has not received any indication of a secrecy order under 35 U.S.C. 181, the licensee may foreign file the application pursuant to 37 CFR 5.15(b).

---

***SelectUSA***

The United States represents the largest, most dynamic marketplace in the world and is an unparalleled location for business investment, innovation, and commercialization of new technologies. The U.S. offers tremendous resources and advantages for those who invest and manufacture goods here. Through SelectUSA, our nation works to promote and facilitate business investment. SelectUSA provides information assistance to the international investor community; serves as an ombudsman for existing and potential investors; advocates on behalf of U.S. cities, states, and regions competing for global investment; and counsels U.S. economic development organizations on investment attraction best practices. To learn more about why the United States is the best country in the world to develop technology, manufacture products, deliver services, and grow your business, visit <http://www.SelectUSA.gov> or call +1-202-482-6800.

Substitute for form 1449/PTO		<b>Complete if Known</b>	
<b>INFORMATION DISCLOSURE STATEMENT BY APPLICANT</b> <i>(Use as many sheets as necessary)</i>		Application Number	14/134,926
		Filing Date	December 19, 2013
		First Named Inventor	James J. FALLON
		Art Unit	2634
		Examiner Name	BOCURE, Tesfaldet
		Attorney Docket Number	2855.0050008
Sheet	1	of	29

**U.S. PATENT DOCUMENTS**

Examiner initials*	Cite No. <sup>1</sup>	Document Number		Publication Date MM-DD-YYYY	Name of Patentee or Applicant of Cited Document	Pages, Columns, Lines, Where Relevant Passages or Relevant Figures Appear
		Number-Kind Code <sup>2</sup> (if known)				
	US1	3,394,352		07-23-1968	Wernikoff et al.	
	US2	3,490,690		01-20-1970	Apple et al.	
	US3	4,021,782		05-03-1977	Hoerning	
	US4	4,032,893		06-28-1977	Moran	
	US5	4,054,951		10-18-1977	Jackson et al.	
	US6	4,127,518		11-28-1978	Coy et al.	
	US7	4,302,775		11-24-1981	Widergren et al.	
	US8	4,325,085		04-13-1982	Gooch	
	US9	4,360,840		11-23-1982	Wolfrun et al.	
	US10	4,386,416		05-31-1983	Giltner et al.	
	US11	4,394,774		07-19-1983	Widergren et al.	
	US12	4,464,650		08-07-1984	Eastman	
	US13	4,494,108		01-15-1985	Langdon, Jr. et al.	
	US14	4,499,499		02-12-1985	Brickman et al.	
	US15	4,574,351		03-04-1986	Dang et al.	
	US16	4,593,324		06-03-1986	Ohkubo et al.	
	US17	4,626,829		12-02-1986	Hauck	
	US18	4,646,061		02-24-1987	Bledsoe	
	US19	4,682,150		07-21-1987	Mathes et al.	
	US20	4,701,745		10-20-1987	Waterworth	

**FOREIGN PATENT DOCUMENTS**

Examiner initials*	Cite No. <sup>1</sup>	Foreign Patent Document		Publication Date MM-DD-YYYY	Name of Patentee or Applicant of Cited Document	Pages, Columns, Lines, Where Relevant Passages or Relevant Figures Appear	T <sup>6</sup>
		Country Code <sup>3</sup> -Number <sup>4</sup> -Kind Code <sup>5</sup> (if known)					
	FP1	DE 4127518		02-27-1992	Tokico Ltd		
	FP2	EP 0 164 677		12-18-1985	Texas Instruments Inc		
	FP3	EP 0 185 098		06-25-1986	Hitachi Ltd		
	FP4	EP 0 283 798		09-28-1988	International Business Machines Corporation		
	FP5	EP 0 405 572		01-02-1991	Fujitsu Limited		
	FP6	EP 0 493 130		07-01-1992	Canon Kabushiki Kaisha		
	FP7	EP 0 587 437		03-16-1994	International Business Machines Corporation		
	FP8	EP 0 595 406		05-04-1994	Philips Electronics		

Examiner Signature		Date Considered	
-----------------------	--	--------------------	--

\*EXAMINER: Initial if reference considered, whether or not citation is in conformance with MPEP 609. Draw line through citation if not in conformance and not considered. Include copy of this form with next communication to applicant. <sup>1</sup> Applicant's unique citation designation number (optional). <sup>2</sup> See Kinds Codes of USPTO Patent Documents at [www.uspto.gov](http://www.uspto.gov) or MPEP 901.04. <sup>3</sup> Enter Office that issued the document, by the two-letter code (WIPO Standard ST.3). <sup>4</sup> For Japanese patent documents, the indication of the year of the reign of the Emperor must precede the serial number of the patent document. <sup>5</sup> Kind of document by the appropriate symbols as indicated on the document under WIPO Standard ST.16 if possible. <sup>6</sup> Applicant is to place a check mark here if English language Translation is attached.

Substitute for form I 449/PTO				<b>Complete if Known</b>	
<b>INFORMATION DISCLOSURE STATEMENT BY APPLICANT</b> <i>(Use as many sheets as necessary)</i>				Application Number	14/134,926
				Filing Date	December 19, 2013
				First Named Inventor	James J. FALLON
				Art Unit	2634
				Examiner Name	BOCURE, Tesfaldet
Sheet	2	of	29	Attorney Docket Number	2855.0050008

**U.S. PATENT DOCUMENTS**

Examiner initials*	Cite No. <sup>1</sup>	Document Number		Publication Date MM-DD-YYYY	Name of Patentee or Applicant of Cited Document	Pages, Columns, Lines, Where Relevant Passages or Relevant Figures Appear
		Number-Kind Code <sup>2</sup> (if known)				
	US21	4,729,020		03-01-1988	Schaphorst et al.	
	US22	4,730,348		03-08-1988	MacCrisken	
	US23	4,745,559		05-17-1988	Willis et al.	
	US24	4,748,638		05-31-1988	Freidman et al.	
	US25	4,750,135		06-07-1988	Boilen	
	US26	4,754,351		06-28-1988	Wright	
	US27	4,804,959		02-14-1989	Makansi et al.	
	US28	4,813,040		03-14-1989	Futato	
	US29	4,814,746		03-21-1989	Miller et al.	
	US30	4,862,167		08-29-1989	Copeland, III	
	US31	4,866,601		09-12-1989	DuLac et al.	
	US32	4,870,415		09-26-1989	Van Maren et al.	
	US33	4,872,009		10-03-1989	Tsukiyama et al.	
	US34	4,876,541		10-24-1989	Storer	
	US35	4,888,812		12-19-1989	Dinan et al.	
	US36	4,890,282		12-26-1989	Lambert et al.	
	US37	4,897,717		01-30-1990	Hamilton et al.	
	US38	4,906,991		03-06-1990	Fiala et al.	
	US39	4,906,995		03-06-1990	Swanson	
	US40	4,929,946		05-29-1990	O'Brien et al.	

**FOREIGN PATENT DOCUMENTS**

Examiner initials*	Cite No. <sup>1</sup>	Foreign Patent Document		Publication Date MM-DD-YYYY	Name of Patentee or Applicant of Cited Document	Pages, Columns, Lines, Where Relevant Passages or Relevant Figures Appear	T <sup>6</sup>
		Country Code <sup>3</sup> -Number <sup>4</sup> -Kind Code <sup>5</sup> (if known)					
	FP9	EP 0 718 751		06-26-1996	International Business Machines Corporation		
	FP10	EP 0 928 070 A2		07-07-1999	Unwired Planet, Inc.		
	FP11	GB 2162025		01-22-1986	King Reginald Alfred		
	FP12	JP 6051989		02-25-1994	NEC Corp		
	FP13	JP 9188009		07-22-1997	Canon Inc		
	FP14	JP 11149376		06-02-1999	Toyo Commun Equip Co. Ltd		
	FP15	WO 9414273		06-23-1994	Voxson International Pty Ltd		
	FP16	WO 9429852		12-22-1994	Maxtor Corp		

Examiner Signature		Date Considered	
--------------------	--	-----------------	--

\*EXAMINER: Initial if reference considered, whether or not citation is in conformance with MPEP 609. Draw line through citation if not in conformance and not considered. Include copy of this form with next communication to applicant. <sup>1</sup> Applicant's unique citation designation number (optional). <sup>2</sup> See Kinds Codes of USPTO Patent Documents at [www.uspto.gov](http://www.uspto.gov) or MPEP 901.04. <sup>3</sup> Enter Office that issued the document, by the two-letter code (WIPO Standard ST.3). <sup>4</sup> For Japanese patent documents, the indication of the year of the reign of the Emperor must precede the serial number of the patent document. <sup>5</sup> Kind of document by the appropriate symbols as indicated on the document under WIPO Standard ST.16 if possible. <sup>6</sup> Applicant is to place a check mark here if English language Translation is attached.

Substitute for form 1449/PTO				<b>Complete if Known</b>	
<b>INFORMATION DISCLOSURE STATEMENT BY APPLICANT</b> <i>(Use as many sheets as necessary)</i>				Application Number	14/134,926
				Filing Date	December 19, 2013
				First Named Inventor	James J. FALLON
				Art Unit	2634
				Examiner Name	BOCURE, Tesfaldet
Sheet	3	of	29	Attorney Docket Number	2855.0050008

**U.S. PATENT DOCUMENTS**

Examiner initials*	Cite No. <sup>1</sup>	Document Number		Publication Date MM-DD-YYYY	Name of Patentee or Applicant of Cited Document	Pages, Columns, Lines, Where Relevant Passages or Relevant Figures Appear
		Number-Kind Code <sup>2</sup> (if known)				
	US41	4,953,324		09-04-1990	Hermann	
	US42	4,956,808		09-11-1990	Aakre et al.	
	US43	4,965,675		10-23-1990	Hori et al.	
	US44	4,988,998		01-29-1991	O'Brien	
	US45	5,003,307		03-26-1991	Whiting et al.	
	US46	5,016,009		05-14-1991	Whiting et al.	
	US47	5,027,376		06-25-1991	Freidman et al.	
	US48	5,028,922		07-02-1991	Huang	
	US49	5,045,848		09-03-1991	Fascenda	
	US50	5,045,852		09-03-1991	Mitchell et al.	
	US51	5,046,027		09-03-1991	Taaffe et al.	
	US52	5,049,881		09-17-1991	Gibson et al.	
	US53	5,091,782		02-25-1992	Krause et al.	
	US54	5,097,261		03-17-1992	Langdon, Jr. et al.	
	US55	5,109,226		04-28-1992	MacLean, Jr. et al.	
	US56	5,109,433		04-28-1992	Notenboom	
	US57	5,113,522		05-12-1992	Dinwiddie, Jr. et al.	
	US58	5,115,309		05-19-1992	Hang	
	US59	5,121,342		06-09-1992	Szymborski	
	US60	5,126,739		06-30-1992	Whiting et al.	

**FOREIGN PATENT DOCUMENTS**

Examiner initials*	Cite No. <sup>1</sup>	Foreign Patent Document		Publication Date MM-DD-YYYY	Name of Patentee or Applicant of Cited Document	Pages, Columns, Lines, Where Relevant Passages or Relevant Figures Appear	T <sup>6</sup>
		Country Code <sup>3</sup> -Number <sup>4</sup> -Kind Code <sup>5</sup> (if known)					
	FP17	WO 9502873		01-26-1995	Philips Electronics		
	FP18	WO 95/29437 A1		11-02-1995	Sony Corp		
	FP19	WO 9748212		12-18-1997	Nokia Telecommunications		
	FP20	WO 9839699 A2		09-11-1998	Intelligent Compression Technologies		
	FP21	WO 9908186		02-18-1999	Macronix International Co, Ltd		
	FP22	WO 0036754 A1		06-22-2000	Microsoft Corporation		
	FP23	WO 01/057642		08-09-2001	Realtime Data LLC		
	FP24	WO 01/057659		08-09-2001	Realtime Data LLC		

Examiner Signature		Date Considered	
-----------------------	--	--------------------	--

\*EXAMINER: Initial if reference considered, whether or not citation is in conformance with MPEP 609. Draw line through citation if not in conformance and not considered. Include copy of this form with next communication to applicant. <sup>1</sup> Applicant's unique citation designation number (optional). <sup>2</sup> See Kinds Codes of USPTO Patent Documents at [www.uspto.gov](http://www.uspto.gov) or MPEP 901.04. <sup>3</sup> Enter Office that issued the document, by the two-letter code (WIPO Standard ST.3). <sup>4</sup> For Japanese patent documents, the indication of the year of the reign of the Emperor must precede the serial number of the patent document. <sup>5</sup> Kind of document by the appropriate symbols as indicated on the document under WIPO Standard ST.16 if possible. <sup>6</sup> Applicant is to place a check mark here if English language Translation is attached.

Substitute for form 1449/PTO		<b>Complete if Known</b>	
<b>INFORMATION DISCLOSURE STATEMENT BY APPLICANT</b> <i>(Use as many sheets as necessary)</i>		Application Number	14/134,926
		Filing Date	December 19, 2013
		First Named Inventor	James J. FALLON
		Art Unit	2634
		Examiner Name	BOCURE, Tesfaldet
		Attorney Docket Number	2855.0050008
Sheet	4	of	29

**U.S. PATENT DOCUMENTS**

Examiner initials*	Cite No. <sup>1</sup>	Document Number	Publication Date MM-DD-YYYY	Name of Patentee or Applicant of Cited Document	Pages, Columns, Lines, Where Relevant Passages or Relevant Figures Appear
		Number-Kind Code <sup>2</sup> (if known)			
	US61	5,128,963	07-07-1992	Akagiri	
	US62	5,132,992	07-21-1992	Yurt et al.	
	US63	5,146,221	09-08-1992	Whiting et al.	
	US64	5,150,430	09-22-1992	Chu	
	US65	5,155,484	10-13-1992	Chambers, IV	
	US66	5,159,336	10-27-1992	Rabin et al.	
	US67	5,167,034	11-24-1992	MacLean, Jr. et al.	
	US68	5,175,543	12-29-1992	Lantz	
	US69	5,179,651	01-12-1993	Taaffe et al.	
	US70	5,187,793	02-16-1993	Keith et al.	
	US71	5,191,431	03-02-1993	Hasegawa et al.	
	US72	5,204,756	04-20-1993	Chevion et al.	
	US73	5,209,220	05-11-1993	Hiyama et al.	
	US74	5,212,742	05-18-1993	Normile et al.	
	US75	5,226,176	07-06-1993	Westaway et al.	
	US76	5,227,893	07-13-1993	Eit	
	US77	5,231,492	07-27-1993	Dangi et al.	
	US78	5,237,460	08-17-1993	Miller et al.	
	US79	5,237,675	08-17-1993	Hannon, Jr.	
	US80	5,243,341	09-07-1993	Seroussi et al.	

**FOREIGN PATENT DOCUMENTS**

Examiner initials*	Cite No. <sup>1</sup>	Foreign Patent Document	Publication Date MM-DD-YYYY	Name of Patentee or Applicant of Cited Document	Pages, Columns, Lines, Where Relevant Passages or Relevant Figures Appear	T <sup>6</sup>
		Country Code <sup>3</sup> -Number <sup>4</sup> -Kind Code <sup>5</sup> (if known)				
	FP25	WO 01/63772	08-30-2001	Physical Optics Corporation		
	FP26	WO 02/39591	05-16-2002	Realtime Data LLC		
	FP27	JP 04-241681	08-28-1992	Fujitsu Limited		

Examiner Signature		Date Considered	
--------------------	--	-----------------	--

\*EXAMINER: Initial if reference considered, whether or not citation is in conformance with MPEP 609. Draw line through citation if not in conformance and not considered. Include copy of this form with next communication to applicant. <sup>1</sup> Applicant's unique citation designation number (optional). <sup>2</sup> See Kinds Codes of USPTO Patent Documents at www.uspto.gov or MPEP 901.04. <sup>3</sup> Enter Office that issued the document, by the two-letter code (WIPO Standard ST.3). <sup>4</sup> For Japanese patent documents, the indication of the year of the reign of the Emperor must precede the serial number of the patent document. <sup>5</sup> Kind of document by the appropriate symbols as indicated on the document under WIPO Standard ST.16 if possible. <sup>6</sup> Applicant is to place a check mark here if English language Translation is attached.

<p>Substitute for form 1449/PTO</p> <p align="center"><b>INFORMATION DISCLOSURE STATEMENT BY APPLICANT</b></p> <p align="center"><i>(Use as many sheets as necessary)</i></p>				<b>Complete if Known</b>	
				Application Number	14/134,926
				Filing Date	December 19, 2013
				First Named Inventor	James J. FALLON
				Art Unit	2634
				Examiner Name	BOCURE, Tesfaldet
Sheet	5	of	29	Attorney Docket Number	2855.0050008

**U.S. PATENT DOCUMENTS**

Examiner initials*	Cite No. <sup>1</sup>	Document Number		Publication Date MM-DD-YYYY	Name of Patentee or Applicant of Cited Document	Pages, Columns, Lines, Where Relevant Passages or Relevant Figures Appear
		Number-Kind Code <sup>2</sup> (if known)				
	US81	5,243,348		09-07-1993	Jackson	
	US82	5,247,638		09-21-1993	O'Brien et al.	
	US83	5,247,646		09-21-1993	Osterlund et al.	
	US84	5,249,053		09-28-1993	Jain	
	US85	5,263,168		11-16-1993	Toms et al.	
	US86	5,267,333		11-30-1993	Aono	
	US87	5,270,832		12-14-1993	Balkanski et al.	
	US88	5,280,600		01-18-1994	Van Maren et al.	
	US89	5,287,420		02-15-1994	Barrett	
	US90	5,289,580		02-22-1994	Latif et al.	
	US91	5,293,379		03-08-1994	Carr	
	US92	5,293,576		03-08-1994	Mihm, Jr. et al.	
	US93	5,307,497		04-26-1994	Feigenbaum et al.	
	US94	5,309,555		05-03-1994	Akins et al.	
	US95	5,319,682		06-07-1994	Clark	
	US96	5,331,425		07-19-1994	Ozaki et al.	
	US97	5,341,440		08-23-1994	Earl et al.	
	US98	5,347,600		09-13-1994	Barnsley et al.	
	US99	5,353,132		10-04-1994	Katsuma	
	US100	5,354,315		10-11-1994	Armstrong	

**FOREIGN PATENT DOCUMENTS**

Examiner initials*	Cite No. <sup>1</sup>	Foreign Patent Document		Publication Date MM-DD-YYYY	Name of Patentee or Applicant of Cited Document	Pages, Columns, Lines, Where Relevant Passages or Relevant Figures Appear	T <sup>6</sup>
		Country Code <sup>3</sup> -Number <sup>4</sup> -Kind Code <sup>5</sup> (if known)					

Examiner Signature		Date Considered	
--------------------	--	-----------------	--

\*EXAMINER: Initial if reference considered, whether or not citation is in conformance with MPEP 609. Draw line through citation if not in conformance and not considered. Include copy of this form with next communication to applicant. <sup>1</sup> Applicant's unique citation designation number (optional). <sup>2</sup> See Kinds Codes of USPTO Patent Documents at www.uspto.gov or MPEP 901.04. <sup>3</sup> Enter Office that issued the document, by the two-letter code (WIPO Standard ST.3). <sup>4</sup> For Japanese patent documents, the indication of the year of the reign of the Emperor must precede the serial number of the patent document. <sup>5</sup> Kind of document by the appropriate symbols as indicated on the document under WIPO Standard ST.16 if possible. <sup>6</sup> Applicant is to place a check mark here if English language Translation is attached.



Substitute for form 1449/PTO				<b>Complete if Known</b>	
				Application Number	14/134,926
<b>INFORMATION DISCLOSURE STATEMENT BY APPLICANT</b> <i>(Use as many sheets as necessary)</i>				Filing Date	December 19, 2013
				First Named Inventor	James J. FALLON
				Art Unit	2634
				Examiner Name	BOCURE, Tesfaldet
				Attorney Docket Number	2855.0050008
Sheet	6	of	29		

**U.S. PATENT DOCUMENTS**

Examiner initials*	Cite No. <sup>1</sup>	Document Number		Publication Date MM-DD-YYYY	Name of Patentee or Applicant of Cited Document	Pages, Columns, Lines, Where Relevant Passages or Relevant Figures Appear
		Number-Kind Code <sup>2</sup> (if known)				
	US101	5,355,498		10-11-1994	Provino et al.	
	US102	5,357,614		10-18-1994	Pattisam et al.	
	US103	5,367,629		11-22-1994	Chu et al.	
	US104	5,373,290		12-13-1994	Lempel et al.	
	US105	5,374,916		12-20-1994	Chu	
	US106	5,379,036		01-03-1995	Storer	
	US107	5,379,757		01-10-1995	Hiyama et al.	
	US108	5,381,145		01-10-1995	Allen et al.	
	US109	5,389,922		02-14-1995	Seroussi et al.	
	US110	5,394,534		02-28-1995	Kulakowski et al.	
	US111	5,396,228		03-07-1995	Garahi	
	US112	5,400,401		03-21-1995	Wasilewski et al.	
	US113	5,403,639		04-04-1995	Belsan et al.	
	US114	5,406,278		04-11-1995	Graybill et al.	
	US115	5,406,279		04-11-1995	Anderson et al.	
	US116	5,410,671		04-25-1995	Elgamal et al.	
	US117	5,412,384		05-02-1995	Chang et al.	
	US118	5,414,850		05-09-1995	Whiting	
	US119	5,420,639		05-30-1995	Perkins	
	US120	5,434,983		07-18-1995	Yaso et al.	

**FOREIGN PATENT DOCUMENTS**

Examiner initials*	Cite No. <sup>1</sup>	Foreign Patent Document		Publication Date MM-DD-YYYY	Name of Patentee or Applicant of Cited Document	Pages, Columns, Lines, Where Relevant Passages or Relevant Figures Appear	T <sup>6</sup>
		Country Code <sup>3</sup> , Number <sup>4</sup> , Kind Code <sup>5</sup> (if known)					

Examiner Signature		Date Considered	
--------------------	--	-----------------	--

\*EXAMINER: Initial if reference considered, whether or not citation is in conformance with MPEP 609. Draw line through citation if not in conformance and not considered. Include copy of this form with next communication to applicant. <sup>1</sup> Applicant's unique citation designation number (optional). <sup>2</sup> See Kinds Codes of USPTO Patent Documents at [www.uspto.gov](http://www.uspto.gov) or MPEP 901.04. <sup>3</sup> Enter Office that issued the document, by the two-letter code (WIPO Standard ST.3). <sup>4</sup> For Japanese patent documents, the indication of the year of the reign of the Emperor must precede the serial number of the patent document. <sup>5</sup> Kind of document by the appropriate symbols as indicated on the document under WIPO Standard ST.16 if possible. <sup>6</sup> Applicant is to place a check mark here if English language Translation is attached.

Substitute for form 1449/PTO		<i>Complete if Known</i>	
<b>INFORMATION DISCLOSURE STATEMENT BY APPLICANT</b> <i>(Use as many sheets as necessary)</i>		Application Number	14/134,926
		Filing Date	December 19, 2013
		First Named Inventor	James J. FALLON
		Art Unit	2634
		Examiner Name	BOCURE, Tesfaldet
		Attorney Docket Number	2855.0050008
Sheet	7	of	29

### U.S. PATENT DOCUMENTS

Examiner initials*	Cite No. <sup>1</sup>	Document Number		Publication Date MM-DD-YYYY	Name of Patentee or Applicant of Cited Document	Pages, Columns, Lines, Where Relevant Passages or Relevant Figures Appear
		Number-Kind Code <sup>2</sup> (if known)				
	US121	5,437,020		07-25-1995	Wells et al.	
	US122	5,452,287		09-19-1995	Dicecco et al.	
	US123	5,454,079		09-26-1995	Roper et al.	
	US124	5,454,107		09-26-1995	Lehman et al.	
	US125	5,455,576		10-03-1995	Clark, II et al.	
	US126	5,455,578		10-03-1995	Bhandari	
	US127	5,455,680		10-03-1995	Shin	
	US128	5,461,679		10-24-1995	Normile et al.	
	US129	5,463,390		10-31-1995	Whiting et al.	
	US130	5,467,087		11-14-1995	Chu	
	US131	5,471,206		11-28-1995	Allen et al.	
	US132	5,475,388		12-12-1995	Gormish et al.	
	US133	5,479,587		12-26-1995	Campbell et al.	
	US134	5,479,633		12-26-1995	Wells et al.	
	US135	5,483,470		01-09-1996	Alur et al.	
	US136	5,486,826		01-23-1996	Remillard	
	US137	5,488,364		01-30-1996	Cole	
	US138	5,488,365		01-30-1996	Seroussi et al.	
	US139	5,495,244		02-27-1996	Jeong et al.	
	US140	5,504,842		04-02-1996	Gentile	

### FOREIGN PATENT DOCUMENTS

Examiner initials*	Cite No. <sup>1</sup>	Foreign Patent Document		Publication Date MM-DD-YYYY	Name of Patentee or Applicant of Cited Document	Pages, Columns, Lines, Where Relevant Passages or Relevant Figures Appear	T <sup>6</sup>
		Country Code <sup>3</sup> -Number <sup>4</sup> -Kind Code <sup>5</sup> (if known)					

Examiner Signature		Date Considered	
--------------------	--	-----------------	--

\*EXAMINER: Initial if reference considered, whether or not citation is in conformance with MPEP 609. Draw line through citation if not in conformance and not considered. Include copy of this form with next communication to applicant. <sup>1</sup> Applicant's unique citation designation number (optional). <sup>2</sup> See Kinds Codes of USPTO Patent Documents at [www.uspto.gov](http://www.uspto.gov) or MPEP 901.04. <sup>3</sup> Enter Office that issued the document, by the two-letter code (WIPO Standard ST.3). <sup>4</sup> For Japanese patent documents, the indication of the year of the reign of the Emperor must precede the serial number of the patent document. <sup>5</sup> Kind of document by the appropriate symbols as indicated on the document under WIPO Standard ST.16 if possible. <sup>6</sup> Applicant is to place a check mark here if English language Translation is attached.

<b>INFORMATION DISCLOSURE STATEMENT BY APPLICANT</b> <i>(Use as many sheets as necessary)</i>			<i>Complete if Known</i>			
			Application Number		14/134,926	
			Filing Date		December 19, 2013	
			First Named Inventor		James J. FALLON	
			Art Unit		2634	
			Examiner Name		BOCURE, Tesfaldet	
Sheet	8	of	29	Attorney Docket Number	2855.0050008	

U.S. PATENT DOCUMENTS						
Examiner initials*	Cite No. <sup>1</sup>	Document Number		Publication Date MM-DD-YYYY	Name of Patentee or Applicant of Cited Document	Pages, Columns, Lines, Where Relevant Passages or Relevant Figures Appear
		Number-Kind Code <sup>2</sup> (if known)				
	US141	5,506,844		04-09-1996	Rao	
	US142	5,506,872		04-09-1996	Mohler	
	US143	5,506,944		04-09-1996	Gentile	
	US144	5,521,940		05-28-1996	Lane et al.	
	US145	5,528,628		06-18-1996	Park et al.	
	US146	5,530,845		06-25-1996	Hiatt et al.	
	US147	5,533,051		07-02-1996	James	
	US148	5,535,311		07-09-1996	Zimmerman	
	US149	5,535,356		07-09-1996	Kim et al.	
	US150	5,535,369		07-09-1996	Wells et al.	
	US151	5,537,658		07-16-1996	Bakke et al.	
	US152	5,539,865		07-23-1996	Gentile	
	US153	5,542,031		07-30-1996	Douglass et al.	
	US154	5,544,290		08-06-1996	Gentile	
	US155	5,546,395		08-13-1996	Sharma et al.	
	US156	5,546,475		08-13-1996	Bolle et al.	
	US157	5,553,160		09-03-1996	Dawson	
	US158	5,557,551		09-17-1996	Craft	
	US159	5,557,668		09-17-1996	Brady	
	US160	5,557,749		09-17-1996	Norris	

FOREIGN PATENT DOCUMENTS							
Examiner initials*	Cite No. <sup>1</sup>	Foreign Patent Document		Publication Date MM-DD-YYYY	Name of Patentee or Applicant of Cited Document	Pages, Columns, Lines, Where Relevant Passages or Relevant Figures Appear	T <sup>6</sup>
		Country Code <sup>3</sup>	Number-Kind Code <sup>4</sup> (if known)				

Examiner Signature		Date Considered	
--------------------	--	-----------------	--

\*EXAMINER: Initial if reference considered, whether or not citation is in conformance with MPEP 609. Draw line through citation if not in conformance and not considered. Include copy of this form with next communication to applicant. <sup>1</sup> Applicant's unique citation designation number (optional). <sup>2</sup> See Kinds Codes of USPTO Patent Documents at www.uspto.gov or MPEP 901.04. <sup>3</sup> Enter Office that issued the document, by the two-letter code (WIPO Standard ST.3). <sup>4</sup> For Japanese patent documents, the indication of the year of the reign of the Emperor must precede the serial number of the patent document. <sup>5</sup> Kind of document by the appropriate symbols as indicated on the document under WIPO Standard ST.16 if possible. <sup>6</sup> Applicant is to place a check mark here if English language Translation is attached.

Substitute for form 1449/PTO			<b>Complete if Known</b>	
<b>INFORMATION DISCLOSURE STATEMENT BY APPLICANT</b> <i>(Use as many sheets as necessary)</i>			Application Number	14/134,926
			Filing Date	December 19, 2013
			First Named Inventor	James J. FALLON
			Art Unit	2634
			Examiner Name	BOCURE, Tesfaldet
			Attorney Docket Number	2855.0050008
Sheet	9	of	29	

U.S. PATENT DOCUMENTS						
Examiner initials*	Cite No. <sup>1</sup>	Document Number		Publication Date MM-DD-YYYY	Name of Patentee or Applicant of Cited Document	Pages, Columns, Lines, Where Relevant Passages or Relevant Figures Appear
		Number-Kind Code <sup>2</sup> (if known)				
	US161	5,561,421		10-01-1996	Smith et al.	
	US162	5,561,824		10-01-1996	Carreiro et al.	
	US163	5,563,961		10-08-1996	Rynderman et al.	
	US164	5,574,952		11-12-1996	Brady et al.	
	US165	5,574,953		11-12-1996	Rust et al.	
	US166	5,576,953		11-19-1996	Hugentobler	
	US167	5,577,248		11-19-1996	Chambers, IV	
	US168	5,581,715		12-03-1996	Verinsky et al.	
	US169	5,583,500		12-10-1996	Allen et al.	
	US170	5,586,264		12-17-1996	Belknap et al.	
	US171	5,586,285		12-17-1996	Hasbun et al.	
	US172	5,590,306		12-31-1996	Watanabe et al.	
	US173	5,596,674		01-21-1997	Bhandari et al.	
	US174	5,598,388		01-28-1997	Van Maren et al.	
	US175	5,604,824		02-18-1997	Chui et al.	
	US176	5,606,706		02-25-1997	Takamoto et al.	
	US177	5,610,657		03-11-1997	Zhang	
	US178	5,611,024		03-11-1997	Campbell et al.	
	US179	5,612,788		03-18-1997	Stone	
	US180	5,613,069		03-18-1997	Walker	

FOREIGN PATENT DOCUMENTS							
Examiner initials*	Cite No. <sup>1</sup>	Foreign Patent Document		Publication Date MM-DD-YYYY	Name of Patentee or Applicant of Cited Document	Pages, Columns, Lines, Where Relevant Passages or Relevant Figures Appear	T <sup>6</sup>
		Country Code <sup>3</sup>	Number <sup>4</sup> -Kind Code <sup>5</sup> (if known)				

Examiner Signature		Date Considered	
--------------------	--	-----------------	--

\*EXAMINER: Initial if reference considered, whether or not citation is in conformance with MPEP 609. Draw line through citation if not in conformance and not considered. Include copy of this form with next communication to applicant. <sup>1</sup> Applicant's unique citation designation number (optional). <sup>2</sup> See Kinds Codes of USPTO Patent Documents at www.uspto.gov or MPEP 901.04. <sup>3</sup> Enter Office that issued the document, by the two-letter code (WIPO Standard ST.3). <sup>4</sup> For Japanese patent documents, the indication of the year of the reign of the Emperor must precede the serial number of the patent document. <sup>5</sup> Kind of document by the appropriate symbols as indicated on the document under WIPO Standard ST.16 if possible. <sup>6</sup> Applicant is to place a check mark here if English language Translation is attached.

Substitute for form 1449/PTO		<i>Complete if Known</i>	
<b>INFORMATION DISCLOSURE STATEMENT BY APPLICANT</b> <i>(Use as many sheets as necessary)</i>		Application Number	14/134,926
		Filing Date	December 19, 2013
		First Named Inventor	James J. FALLON
		Art Unit	2634
		Examiner Name	BOCURE, Tesfaldet
		Attorney Docket Number	2855.0050008
Sheet	10	of	29

<b>U.S. PATENT DOCUMENTS</b>						
Examiner initials*	Cite No. <sup>1</sup>	Document Number		Publication Date MM-DD-YYYY	Name of Patentee or Applicant of Cited Document	Pages, Columns, Lines, Where Relevant Passages or Relevant Figures Appear
		Number	Kind Code <sup>2</sup> (if known)			
	US181	5,615,017		03-25-1997	Choi	
	US182	5,615,287		03-25-1997	Fu et al.	
	US183	5,619,995		04-15-1997	Lobodzinski	
	US184	5,621,820		04-15-1997	Rynderman et al.	
	US185	5,623,623		04-22-1997	Kim et al.	
	US186	5,623,701		04-22-1997	Bakke et al.	
	US187	5,627,534		05-06-1997	Craft	
	US188	5,627,995		05-06-1997	Miller et al.	
	US189	5,629,732		05-13-1997	Moskowitz et al.	
	US190	5,630,092		05-13-1997	Carreiro et al.	
	US191	5,635,632		06-03-1997	Fay et al.	
	US192	5,635,932		06-03-1997	Shinagawa et al.	
	US193	5,638,498		06-10-1997	Tyler et al.	
	US194	5,640,158		06-17-1997	Okayama et al.	
	US195	5,642,506		06-24-1997	Lee	
	US196	5,649,032		07-15-1997	Burt et al.	
	US197	5,652,795		07-29-1997	Dillon et al.	
	US198	5,652,857		07-29-1997	Shimoi et al.	
	US199	5,652,917		07-29-1997	Maupin et al.	
	US200	5,654,703		08-05-1997	Clark, II	

<b>FOREIGN PATENT DOCUMENTS</b>							
Examiner initials*	Cite No. <sup>1</sup>	Foreign Patent Document		Publication Date MM-DD-YYYY	Name of Patentee or Applicant of Cited Document	Pages, Columns, Lines, Where Relevant Passages or Relevant Figures Appear	T <sup>6</sup>
		Country Code <sup>3</sup>	Number <sup>4</sup> -Kind Code <sup>5</sup> (if known)				

Examiner Signature		Date Considered	
--------------------	--	-----------------	--

\*EXAMINER: Initial if reference considered, whether or not citation is in conformance with MPEP 609. Draw line through citation if not in conformance and not considered. Include copy of this form with next communication to applicant. <sup>1</sup> Applicant's unique citation designation number (optional). <sup>2</sup> See Kinds Codes of USPTO Patent Documents at www.uspto.gov or MPEP 901.04. <sup>3</sup> Enter Office that issued the document, by the two-letter code (WIPO Standard ST.3). <sup>4</sup> For Japanese patent documents, the indication of the year of the reign of the Emperor must precede the serial number of the patent document. <sup>5</sup> Kind of document by the appropriate symbols as indicated on the document under WIPO Standard ST.16 if possible. <sup>6</sup> Applicant is to place a check mark here if English language Translation is attached.

Substitute for form 1449/PTO  <h2 style="text-align: center;">INFORMATION DISCLOSURE STATEMENT BY APPLICANT</h2> <p style="text-align: center;"><i>(Use as many sheets as necessary)</i></p>		<h3 style="text-align: center;">Complete if Known</h3> <table border="1" style="width:100%; border-collapse: collapse;"> <tr> <td style="width:50%;">Application Number</td> <td>14/134,926</td> </tr> <tr> <td>Filing Date</td> <td>December 19, 2013</td> </tr> <tr> <td>First Named Inventor</td> <td>James J. FALLON</td> </tr> <tr> <td>Art Unit</td> <td>2634</td> </tr> <tr> <td>Examiner Name</td> <td>BOCURE, Testaldet</td> </tr> <tr> <td>Attorney Docket Number</td> <td>2855.0050008</td> </tr> </table>		Application Number	14/134,926	Filing Date	December 19, 2013	First Named Inventor	James J. FALLON	Art Unit	2634	Examiner Name	BOCURE, Testaldet	Attorney Docket Number	2855.0050008
Application Number	14/134,926														
Filing Date	December 19, 2013														
First Named Inventor	James J. FALLON														
Art Unit	2634														
Examiner Name	BOCURE, Testaldet														
Attorney Docket Number	2855.0050008														
Sheet	11 of 29														

U.S. PATENT DOCUMENTS						
Examiner initials*	Cite No. <sup>1</sup>	Document Number		Publication Date MM-DD-YYYY	Name of Patentee or Applicant of Cited Document	Pages, Columns, Lines, Where Relevant Passages or Relevant Figures Appear
		Number-Kind Code <sup>2</sup> (if known)				
	US201	5,655,138		08-05-1997	Kikinis	
	US202	5,666,560		09-09-1997	Moertl et al.	
	US203	5,668,737		09-16-1997	Iler	
	US204	5,671,355		09-23-1997	Collins	
	US205	5,671,389		09-23-1997	Saliba	
	US206	5,671,413		09-23-1997	Shipman et al.	
	US207	5,675,333		10-07-1997	Boursier et al.	
	US208	5,675,789		10-07-1997	Ishii et al.	
	US209	5,686,916		11-11-1997	Bakhtmutsky	
	US210	5,692,159		11-25-1997	Shand	
	US211	5,694,619		12-02-1997	Konno	
	US212	5,696,927		12-09-1997	MacDonald et al.	
	US213	5,703,793		12-30-1997	Wise et al.	
	US214	5,708,511		01-13-1998	Gandhi et al.	
	US215	5,715,477		02-03-1998	Kikinis	
	US216	5,717,393		02-10-1998	Nakano et al.	
	US217	5,717,394		02-10-1998	Schwartz et al.	
	US218	5,719,862		02-17-1998	Lee et al.	
	US219	5,721,958		02-24-1998	Kikinis	
	US220	5,724,475		03-03-1998	Kirsten	

FOREIGN PATENT DOCUMENTS							
Examiner initials*	Cite No. <sup>1</sup>	Foreign Patent Document		Publication Date MM-DD-YYYY	Name of Patentee or Applicant of Cited Document	Pages, Columns, Lines, Where Relevant Passages or Relevant Figures Appear	T <sup>6</sup>
		Country Code <sup>3</sup> -Number <sup>4</sup> -Kind Code <sup>5</sup> (if known)					

Examiner Signature		Date Considered	
-----------------------	--	--------------------	--

\*EXAMINER: Initial if reference considered, whether or not citation is in conformance with MPEP 609. Draw line through citation if not in conformance and not considered. Include copy of this form with next communication to applicant. <sup>1</sup> Applicant's unique citation designation number (optional). <sup>2</sup> See Kinds Codes of USPTO Patent Documents at www.uspto.gov or MPEP 901.04. <sup>3</sup> Enter Office that issued the document, by the two-letter code (WIPO Standard ST.3). <sup>4</sup> For Japanese patent documents, the indication of the year of the reign of the Emperor must precede the serial number of the patent document. <sup>5</sup> Kind of document by the appropriate symbols as indicated on the document under WIPO Standard ST.16 if possible. <sup>6</sup> Applicant is to place a check mark here if English language Translation is attached.

Substitute for form 1449/PTO		<i>Complete if Known</i>	
<b>INFORMATION DISCLOSURE STATEMENT BY APPLICANT</b> <i>(Use as many sheets as necessary)</i>		Application Number	14/134,926
		Filing Date	December 19, 2013
		First Named Inventor	James J. FALLON
		Art Unit	2634
		Examiner Name	BOCURE, Tesfaldet
		Attorney Docket Number	2855.0050008
Sheet	12 of 29		

U.S. PATENT DOCUMENTS						
Examiner initials*	Cite No. <sup>1</sup>	Document Number		Publication Date MM-DD-YYYY	Name of Patentee or Applicant of Cited Document	Pages, Columns, Lines, Where Relevant Passages or Relevant Figures Appear
		Number-Kind Code <sup>2</sup> (if known)				
	US221	5,729,228		03-17-1998	Franaszek et al.	
	US222	5,740,395		04-14-1998	Wells et al.	
	US223	5,742,773		04-21-1998	Blomfield-Brown et al.	
	US224	5,748,904		05-05-1998	Huang et al.	
	US225	5,757,852		05-26-1998	Jericevic et al.	
	US226	5,765,027		06-09-1998	Wang et al.	
	US227	5,767,898		06-16-1998	Urano et al.	
	US228	5,768,445		06-16-1998	Troeller et al.	
	US229	5,768,525		06-16-1998	Kralowetz et al.	
	US230	5,771,340		06-23-1998	Nakazato et al.	
	US231	5,774,715		06-30-1998	Madany et al.	
	US232	5,778,411		07-07-1998	DeMoss et al.	
	US233	5,781,767		07-14-1998	Inoue et al.	
	US234	5,784,572		07-21-1998	Rostoker et al.	
	US235	5,784,631		07-21-1998	Wise	
	US236	5,787,487		07-28-1998	Hashimoto et al.	
	US237	5,794,229		08-11-1998	French et al.	
	US238	5,796,864		08-18-1998	Callahan	
	US239	5,799,110		08-25-1998	Israelsen et al.	
	US240	5,805,834		09-08-1998	McKinley et al.	

FOREIGN PATENT DOCUMENTS							
Examiner initials*	Cite No. <sup>1</sup>	Foreign Patent Document		Publication Date MM-DD-YYYY	Name of Patentee or Applicant of Cited Document	Pages, Columns, Lines, Where Relevant Passages or Relevant Figures Appear	T <sup>6</sup>
		Country Code <sup>3</sup> -Number <sup>4</sup> -Kind Code <sup>5</sup> (if known)					

Examiner Signature		Date Considered	
-----------------------	--	--------------------	--

\*EXAMINER: Initial if reference considered, whether or not citation is in conformance with MPEP 609. Draw line through citation if not in conformance and not considered. Include copy of this form with next communication to applicant. <sup>1</sup> Applicant's unique citation designation number (optional). <sup>2</sup> See Kinds Codes of USPTO Patent Documents at [www.uspto.gov](http://www.uspto.gov) or MPEP 901.04. <sup>3</sup> Enter Office that issued the document, by the two-letter code (WIPO Standard ST.3). <sup>4</sup> For Japanese patent documents, the indication of the year of the reign of the Emperor must precede the serial number of the patent document. <sup>5</sup> Kind of document by the appropriate symbols as indicated on the document under WIPO Standard ST.16 if possible. <sup>6</sup> Applicant is to place a check mark here if English language Translation is attached.

Substitute for form 1449/PTO				<b>Complete if Known</b>	
<b>INFORMATION DISCLOSURE STATEMENT BY APPLICANT</b> <i>(Use as many sheets as necessary)</i>				Application Number	14/134,926
				Filing Date	December 19, 2013
				First Named Inventor	James J. FALLON
				Art Unit	2634
				Examiner Name	BOCURE, Tesfaldet
Sheet	13	of	29	Attorney Docket Number	2855.0050008

**U.S. PATENT DOCUMENTS**

Examiner initials*	Cite No. <sup>1</sup>	Document Number		Publication Date MM-DD-YYYY	Name of Patentee or Applicant of Cited Document	Pages, Columns, Lines, Where Relevant Passages or Relevant Figures Appear
		Number-Kind Code <sup>2</sup> (if known)				
	US241	5,805,932		09-08-1998	Kawashima et al.	
	US242	5,807,036		09-15-1998	Lostlen	
	US243	5,808,660		09-15-1998	Sekine et al.	
	US244	5,809,176		09-15-1998	Yajima	
	US245	5,809,299		09-15-1998	Cloutier et al.	
	US246	5,809,337		09-15-1998	Hannah et al.	
	US247	5,812,195		09-22-1998	Zhang	
	US248	5,812,789		09-22-1998	Diaz et al.	
	US249	5,818,368		10-06-1998	Langley	
	US250	5,818,369		10-06-1998	Withers	
	US251	5,818,530		10-06-1998	Canfield et al.	
	US252	5,819,215		10-06-1998	Dobson et al.	
	US253	5,822,781		10-13-1998	Wells et al.	
	US254	5,825,424		10-20-1998	Canfield et al.	
	US255	5,825,830		10-20-1998	Kopf	
	US256	5,832,037		11-03-1998	Park	
	US257	5,832,126		11-03-1998	Tanaka	
	US258	5,832,443		11-03-1998	Kolesnik et al.	
	US259	5,835,788		11-10-1998	Blumer et al.	
	US260	5,836,003		11-10-1998	Sadeh	

**FOREIGN PATENT DOCUMENTS**

Examiner initials*	Cite No. <sup>1</sup>	Foreign Patent Document		Publication Date MM-DD-YYYY	Name of Patentee or Applicant of Cited Document	Pages, Columns, Lines, Where Relevant Passages or Relevant Figures Appear	7 <sup>6</sup>
		Country Code <sup>3</sup> -Number <sup>4</sup> -Kind Code <sup>5</sup> (if known)					

Examiner Signature		Date Considered	
-----------------------	--	--------------------	--

\*EXAMINER: Initial if reference considered, whether or not citation is in conformance with MPEP 609. Draw line through citation if not in conformance and not considered. Include copy of this form with next communication to applicant. <sup>1</sup> Applicant's unique citation designation number (optional). <sup>2</sup> See Kinds Codes of USPTO Patent Documents at [www.uspto.gov](http://www.uspto.gov) or MPEP 901.04. <sup>3</sup> Enter Office that issued the document, by the two-letter code (WIPO Standard ST.3). <sup>4</sup> For Japanese patent documents, the indication of the year of the reign of the Emperor must precede the serial number of the patent document. <sup>5</sup> Kind of document by the appropriate symbols as indicated on the document under WIPO Standard ST.16 if possible. <sup>6</sup> Applicant is to place a check mark here if English language Translation is attached.



Substitute for form 1449/PTO			<b>Complete if Known</b>	
<b>INFORMATION DISCLOSURE STATEMENT BY APPLICANT</b> <i>(Use as many sheets as necessary)</i>			Application Number	14/134,926
			Filing Date	December 19, 2013
			First Named Inventor	James J. FALLON
			Art Unit	2634
			Examiner Name	BOCURE, Tesfaldet
			Attorney Docket Number	2855.0050008
Sheet	14	of	29	

<b>U.S. PATENT DOCUMENTS</b>						
Examiner initials*	Cite No. <sup>1</sup>	Document Number		Publication Date MM-DD-YYYY	Name of Patentee or Applicant of Cited Document	Pages, Columns, Lines, Where Relevant Passages or Relevant Figures Appear
		Number	Kind Code <sup>2</sup> (if known)			
	US261	5,838,821		11-17-1998	Matsubara et al.	
	US262	5,838,927		11-17-1998	Gillon	
	US263	5,838,996		11-17-1998	deCarmo	
	US264	5,839,100		11-17-1998	Wegener	
	US265	5,841,979		11-24-1998	Schulhof et al.	
	US266	5,847,762		12-08-1998	Canfield et al.	
	US267	5,850,565		12-15-1998	Wightman	
	US268	5,856,797		01-05-1999	Kawauchi	
	US269	5,861,824		01-19-1999	Ryu et al.	
	US270	5,861,920		01-19-1999	Mead et al.	
	US271	5,864,342		01-26-1999	Kajiya et al.	
	US272	5,864,678		01-26-1999	Riddle	
	US273	5,867,167		02-02-1999	Deering	
	US274	5,867,602		02-02-1999	Zandi et al.	
	US275	5,870,036		02-09-1999	Franaszek et al.	
	US276	5,870,087		02-09-1999	Chau	
	US277	5,872,530		02-16-1999	Domyo et al.	
	US278	5,874,907		02-23-1999	Craft	
	US279	5,883,975		03-16-1999	Narita et al.	
	US280	5,884,269		03-16-1999	Cellier et al.	

<b>FOREIGN PATENT DOCUMENTS</b>							
Examiner initials*	Cite No. <sup>1</sup>	Foreign Patent Document		Publication Date MM-DD-YYYY	Name of Patentee or Applicant of Cited Document	Pages, Columns, Lines, Where Relevant Passages or Relevant Figures Appear	T <sup>6</sup>
		Country Code <sup>3</sup>	Number <sup>4</sup> Kind Code <sup>5</sup> (if known)				

Examiner Signature		Date Considered	
--------------------	--	-----------------	--

\*EXAMINER: Initial if reference considered, whether or not citation is in conformance with MPEP 609. Draw line through citation if not in conformance and not considered. Include copy of this form with next communication to applicant. <sup>1</sup> Applicant's unique citation designation number (optional). <sup>2</sup> See Kinds Codes of USPTO Patent Documents at www.uspto.gov or MPEP 901.04. <sup>3</sup> Enter Office that issued the document, by the two-letter code (WIPO Standard ST.3). <sup>4</sup> For Japanese patent documents, the indication of the year of the reign of the Emperor must precede the serial number of the patent document. <sup>5</sup> Kind of document by the appropriate symbols as indicated on the document under WIPO Standard ST.16 if possible. <sup>6</sup> Applicant is to place a check mark here if English language Translation is attached.

Substitute for form 1449/PTO  <b>INFORMATION DISCLOSURE STATEMENT BY APPLICANT</b> <i>(Use as many sheets as necessary)</i>				<i>Complete if Known</i>		
				Application Number	14/134,926	
Sheet		15	of	29	Examiner Name	BOCURE, Tesfaldet
				Attorney Docket Number	2855.0050008	

**U.S. PATENT DOCUMENTS**

Examiner initials*	Cite No. <sup>1</sup>	Document Number		Publication Date MM-DD-YYYY	Name of Patentee or Applicant of Cited Document	Pages, Columns, Lines, Where Relevant Passages or Relevant Figures Appear
		Number	Kind Code <sup>2</sup> (if known)			
	US281	5,886,655		03-23-1999	Rust	
	US282	5,887,165		03-23-1999	Martel et al.	
	US283	5,889,961		03-30-1999	Dobbek	
	US284	5,892,847		04-06-1999	Johnson	
	US285	5,907,801		05-15-1999	Albert et al.	
	US286	5,909,557		06-01-1999	Beiker et al.	
	US287	5,909,559		06-01-1999	So	
	US288	5,915,079		06-22-1999	Vondran, Jr. et al.	
	US289	5,917,438		06-29-1999	Ando	
	US290	5,918,068		06-29-1999	Shafe	
	US291	5,918,225		06-29-1999	White et al.	
	US292	5,920,326		07-06-1999	Rentschler et al.	
	US293	5,923,860		07-13-1999	Olarig	
	US294	5,930,358		07-27-1999	Rao	
	US295	5,936,616		08-10-1999	Torberg, Jr. et al.	
	US296	5,938,737		08-17-1999	Smallcomb et al.	
	US297	5,943,692		08-24-1999	Marberg	
	US298	5,945,933		08-31-1999	Kalkstein	
	US299	5,949,355		09-07-1999	Panaoussis	
	US300	5,949,968		09-07-1999	Gentile	

**FOREIGN PATENT DOCUMENTS**

Examiner initials*	Cite No. <sup>1</sup>	Foreign Patent Document		Publication Date MM-DD-YYYY	Name of Patentee or Applicant of Cited Document	Pages, Columns, Lines, Where Relevant Passages or Relevant Figures Appear	T <sup>6</sup>
		Country Code <sup>3</sup>	Number <sup>4</sup> -Kind Code <sup>5</sup> (if known)				

Examiner Signature		Date Considered	
--------------------	--	-----------------	--

\*EXAMINER: Initial if reference considered, whether or not citation is in conformance with MPEP 609. Draw line through citation if not in conformance and not considered. Include copy of this form with next communication to applicant. <sup>1</sup> Applicant's unique citation designation number (optional). <sup>2</sup> See Kinds Codes of USPTO Patent Documents at [www.uspto.gov](http://www.uspto.gov) or MPEP 901.04. <sup>3</sup> Enter Office that issued the document, by the two-letter code (WIPO Standard ST.3). <sup>4</sup> For Japanese patent documents, the indication of the year of the reign of the Emperor must precede the serial number of the patent document. <sup>5</sup> Kind of document by the appropriate symbols as indicated on the document under WIPO Standard ST.16 if possible. <sup>6</sup> Applicant is to place a check mark here if English language Translation is attached.

Substitute for form 1449/PTO  <div style="text-align: center;"><b>INFORMATION DISCLOSURE STATEMENT BY APPLICANT</b></div> (Use as many sheets as necessary)				<b>Complete if Known</b>	
		Application Number	14/134,926		
		Filing Date	December 19, 2013		
		First Named Inventor	James J. FALLON		
		Art Unit	2634		
		Examiner Name	BOCURE, Tesfaldet		
		Attorney Docket Number	2855.0050008		
Sheet	16	of	29		

U.S. PATENT DOCUMENTS						
Examiner initials*	Cite No. <sup>1</sup>	Document Number		Publication Date MM-DD-YYYY	Name of Patentee or Applicant of Cited Document	Pages, Columns, Lines, Where Relevant Passages or Relevant Figures Appear
		Number-Kind Code <sup>2</sup> (if known)				
	US301	5,951,623		09-14-1999	Reynar et al.	
	US302	5,955,976		09-21-1999	Heath	
	US303	5,956,490		09-21-1999	Buchholz et al.	
	US304	5,960,465		09-28-1999	Adams	
	US305	5,964,842		10-12-1999	Packard	
	US306	5,968,149		10-19-1999	Jaquette et al.	
	US307	5,969,927		10-19-1999	Schirmer et al.	
	US308	5,973,630		10-26-1999	Heath	
	US309	5,974,235		10-26-1999	Nunally et al.	
	US310	5,974,387		10-26-1999	Kageyama	
	US311	5,974,471		10-26-1999	Belt	
	US312	5,978,483		11-02-1999	Thompson, Jr. et al.	
	US313	5,982,360		11-09-1999	Wu et al.	
	US314	5,982,723		11-09-1999	Kamatani	
	US315	5,987,022		11-16-1999	Geiger et al.	
	US316	5,987,432		11-16-1999	Zusman et al.	
	US317	5,987,590		11-16-1999	Wing So	
	US318	5,990,884		11-23-1999	Douma et al.	
	US319	5,991,515		11-23-1999	Fall et al.	
	US320	5,996,033		11-30-1999	Chiu-Hao	

FOREIGN PATENT DOCUMENTS							
Examiner initials*	Cite No. <sup>1</sup>	Foreign Patent Document		Publication Date MM-DD-YYYY	Name of Patentee or Applicant of Cited Document	Pages, Columns, Lines, Where Relevant Passages or Relevant Figures Appear	T <sup>6</sup>
		Country Code <sup>3</sup> -Number <sup>4</sup> -Kind Code <sup>5</sup> (if known)					

Examiner Signature		Date Considered	
-----------------------	--	--------------------	--

\*EXAMINER: Initial if reference considered, whether or not citation is in conformance with MPEP 609. Draw line through citation if not in conformance and not considered. Include copy of this form with next communication to applicant. <sup>1</sup> Applicant's unique citation designation number (optional). <sup>2</sup> See Kinds Codes of USPTO Patent Documents at [www.uspto.gov](http://www.uspto.gov) or MPEP 901.04. <sup>3</sup> Enter Office that issued the document, by the two-letter code (WIPO Standard ST.3). <sup>4</sup> For Japanese patent documents, the indication of the year of the reign of the Emperor must precede the serial number of the patent document. <sup>5</sup> Kind of document by the appropriate symbols as indicated on the document under WIPO Standard ST.16 if possible. <sup>6</sup> Applicant is to place a check mark here if English language Translation is attached.

Substitute for form 1449/PTO		<b>Complete if Known</b>	
<b>INFORMATION DISCLOSURE STATEMENT BY APPLICANT</b> <i>(Use as many sheets as necessary)</i>		Application Number	14/134,926
		Filing Date	December 19, 2013
		First Named Inventor	James J. FALLON
		Art Unit	2634
		Examiner Name	BOCURE, Testaldet
		Attorney Docket Number	2855.0050008
Sheet	17	of	29

**U.S. PATENT DOCUMENTS**

Examiner initials*	Cite No. <sup>1</sup>	Document Number		Publication Date MM-DD-YYYY	Name of Patentee or Applicant of Cited Document	Pages, Columns, Lines, Where Relevant Passages or Relevant Figures Appear
		Number-Kind Code <sup>2</sup> (if known)				
	US321	6,000,009		12-07-1999	Brady	
	US322	6,002,411		12-14-1999	Dye	
	US323	6,003,115		12-14-1999	Spear et al.	
	US324	6,008,743		12-28-1999	Jaquette	
	US325	6,009,491		12-28-1999	Roppel et al.	
	US326	6,011,901		01-04-2000	Kirsten	
	US327	6,014,694		01-11-2000	Aharoni et al.	
	US328	6,021,433		02-01-2000	Payne	
	US329	6,023,755		02-08-2000	Casselman	
	US330	6,026,217		02-15-2000	Adiletta	
	US331	6,028,725		02-22-2000	Blumenau	
	US332	6,031,939		02-29-2000	Gilbert et al.	
	US333	6,032,148		02-29-2000	Wilkes	
	US334	6,032,197		02-29-2000	Birdwell et al.	
	US335	6,038,346		03-14-2000	Ratnakar	
	US336	6,058,459		05-02-2000	Owen et al.	
	US337	6,061,398		05-09-2000	Satoh et al.	
	US338	6,061,473		05-09-2000	Chen et al.	
	US339	6,070,179		05-30-2000	Craft	
	US340	6,073,232		06-06-2000	Kroeker et al.	

**FOREIGN PATENT DOCUMENTS**

Examiner initials*	Cite No. <sup>1</sup>	Foreign Patent Document		Publication Date MM-DD-YYYY	Name of Patentee or Applicant of Cited Document	Pages, Columns, Lines, Where Relevant Passages or Relevant Figures Appear	T <sup>6</sup>
		Country Code <sup>3</sup> -Number <sup>4</sup> -Kind Code <sup>5</sup> (if known)					

Examiner Signature		Date Considered	
--------------------	--	-----------------	--

\*EXAMINER: Initial if reference considered, whether or not citation is in conformance with MPEP 609. Draw line through citation if not in conformance and not considered. Include copy of this form with next communication to applicant. <sup>1</sup> Applicant's unique citation designation number (optional). <sup>2</sup> See Kinds Codes of USPTO Patent Documents at [www.uspto.gov](http://www.uspto.gov) or MPEP 901.04. <sup>3</sup> Enter Office that issued the document, by the two-letter code (WIPO Standard ST.3). <sup>4</sup> For Japanese patent documents, the indication of the year of the reign of the Emperor must precede the serial number of the patent document. <sup>5</sup> Kind of document by the appropriate symbols as indicated on the document under WIPO Standard ST.16 if possible. <sup>6</sup> Applicant is to place a check mark here if English language Translation is attached.

Substitute for form 1449/PTO				<b>Complete if Known</b>	
<b>INFORMATION DISCLOSURE STATEMENT BY APPLICANT</b> <i>(Use as many sheets as necessary)</i>				Application Number	14/134,926
				Filing Date	December 19, 2013
				First Named Inventor	James J. FALLON
				Art Unit	2634
				Examiner Name	BOCURE, Tesfaldet
				Attorney Docket Number	2855.0050008
Sheet	18	of	29		

**U.S. PATENT DOCUMENTS**

Examiner initials*	Cite No. <sup>1</sup>	Document Number	Publication Date MM-DD-YYYY	Name of Patentee or Applicant of Cited Document	Pages, Columns, Lines, Where Relevant Passages or Relevant Figures Appear
		Number-Kind Code <sup>2</sup> (if known)			
	US341	6,075,470	06-13-2000	Little et al.	
	US342	6,078,958	06-20-2000	Echeita et al.	
	US343	6,091,777	07-18-2000	Guetz et al.	
	US344	6,092,123	07-18-2000	Steffan et al.	
	US345	6,094,634	07-25-2000	Yahagi et al.	
	US346	6,097,520	08-01-2000	Kadnier	
	US347	6,097,845	08-01-2000	Ng et al.	
	US348	6,098,114	08-01-2000	McDonald et al.	
	US349	6,104,389	08-15-2000	Ando	
	US350	6,105,130	08-15-2000	Wu et al.	
	US351	6,115,384	09-05-2000	Parzych	
	US352	6,128,412	10-03-2000	Satoh	
	US353	6,134,631	10-17-2000	Jennings, III	
	US354	6,141,053	10-31-2000	Saukkonen	
	US355	6,145,020	11-07-2000	Barnett	
	US356	6,145,069	11-07-2000	Dye	
	US357	6,169,241	01-02-2001	Shimizu	
	US358	6,170,007	01-02-2001	Venkatraman et al.	
	US359	6,170,047	01-02-2001	Dye	
	US360	6,170,049	01-02-2001	So	

**FOREIGN PATENT DOCUMENTS**

Examiner initials*	Cite No. <sup>1</sup>	Foreign Patent Document	Publication Date MM-DD-YYYY	Name of Patentee or Applicant of Cited Document	Pages, Columns, Lines, Where Relevant Passages or Relevant Figures Appear	T <sup>6</sup>
		Country Code <sup>3</sup> -Number <sup>4</sup> -Kind Code <sup>5</sup> (if known)				

Examiner Signature		Date Considered	
--------------------	--	-----------------	--

\*EXAMINER: Initial if reference considered, whether or not citation is in conformance with MPEP 609. Draw line through citation if not in conformance and not considered. Include copy of this form with next communication to applicant. <sup>1</sup> Applicant's unique citation designation number (optional). <sup>2</sup> See Kinds Codes of USPTO Patent Documents at [www.uspto.gov](http://www.uspto.gov) or MPEP 901.04. <sup>3</sup> Enter Office that issued the document, by the two-letter code (WIPO Standard ST.3). <sup>4</sup> For Japanese patent documents, the indication of the year of the reign of the Emperor must precede the serial number of the patent document. <sup>5</sup> Kind of document by the appropriate symbols as indicated on the document under WIPO Standard ST.16 if possible. <sup>6</sup> Applicant is to place a check mark here if English language Translation is attached.

Substitute for form 1449/PTO				<i>Complete if Known</i>	
<b>INFORMATION DISCLOSURE STATEMENT BY APPLICANT</b> <i>(Use as many sheets as necessary)</i>				Application Number	14/134,926
				Filing Date	December 19, 2013
				First Named Inventor	James J. FALLON
				Art Unit	2634
				Examiner Name	BOCURE, Tesfaldet
				Attorney Docket Number	2855.0050008
Sheet	19	of	29		

U.S. PATENT DOCUMENTS						
Examiner Initials*	Cite No. <sup>1</sup>	Document Number		Publication Date MM-DD-YYYY	Name of Patentee or Applicant of Cited Document	Pages, Columns, Lines, Where Relevant Passages or Relevant Figures Appear
		Number-Kind Code <sup>2</sup> (if known)				
	US361	6,172,936		01-09-2001	Kitazaki	
	US362	6,173,381		01-09-2001	Dye	
	US363	6,175,650		01-16-2001	Sindhu et al.	
	US364	6,175,856		01-16-2001	Riddle	
	US365	6,182,125		01-30-2001	Borelia et al.	
	US366	6,185,625		02-06-2001	Tso et al.	
	US367	6,185,659		02-06-2001	Milillo et al.	
	US368	6,192,082		02-20-2001	Moriarty et al.	
	US369	6,192,155		02-20-2001	Fan	
	US370	6,195,024		02-27-2001	Fallon	
	US371	6,195,125		02-27-2001	Udagawa et al.	
	US372	6,195,391		02-27-2001	Hancock et al.	
	US373	6,195,465		02-27-2001	Zandi et al.	
	US374	6,198,850		03-06-2001	Banton	
	US375	6,208,273		03-27-2001	Dye et al.	
	US376	6,215,904		04-10-2001	Lavellee	
	US377	6,219,754		04-17-2001	Belt et al.	
	US378	6,222,886		04-24-2001	Yogeshwar	
	US379	6,225,922		05-01-2001	Norton	
	US380	6,226,667		05-01-2001	Matthews et al.	

FOREIGN PATENT DOCUMENTS							
Examiner Initials*	Cite No. <sup>1</sup>	Foreign Patent Document		Publication Date MM-DD-YYYY	Name of Patentee or Applicant of Cited Document	Pages, Columns, Lines, Where Relevant Passages or Relevant Figures Appear	T <sup>6</sup>
		Country Code <sup>3</sup> -Number <sup>4</sup> -Kind Code <sup>5</sup> (if known)					

Examiner Signature		Date Considered	
--------------------	--	-----------------	--

\*EXAMINER: Initial if reference considered, whether or not citation is in conformance with MPEP 609. Draw line through citation if not in conformance and not considered. Include copy of this form with next communication to applicant. <sup>1</sup> Applicant's unique citation designation number (optional). <sup>2</sup> See Kinds Codes of USPTO Patent Documents at [www.uspto.gov](http://www.uspto.gov) or MPEP 901.04. <sup>3</sup> Enter Office that issued the document, by the two-letter code (WIPO Standard ST.3). <sup>4</sup> For Japanese patent documents, the indication of the year of the reign of the Emperor must precede the serial number of the patent document. <sup>5</sup> Kind of document by the appropriate symbols as indicated on the document under WIPO Standard ST.16 if possible. <sup>6</sup> Applicant is to place a check mark here if English language Translation is attached.

Substitute for form 1449/PTO		<b>Complete if Known</b>	
<b>INFORMATION DISCLOSURE STATEMENT BY APPLICANT</b> <i>(Use as many sheets as necessary)</i>		Filing Date	December 19, 2013
		First Named Inventor	James J. FALLON
		Art Unit	2634
		Examiner Name	BOCURE, Tesfaldet
		Attorney Docket Number	2855.0050008
		Sheet	20 of 29

**U.S. PATENT DOCUMENTS**

Examiner Initials*	Cite No. <sup>1</sup>	Document Number		Publication Date MM-DD-YYYY	Name of Patentee or Applicant of Cited Document	Pages, Columns, Lines, Where Relevant Passages or Relevant Figures Appear
		Number	Kind Code <sup>2</sup> (if known)			
	US381	6,226,740		05-01-2001	Iga	
	US382	6,230,223		05-08-2001	Olarig	
	US383	6,237,054		05-22-2001	Freitag, Jr.	
	US384	6,243,829		06-05-2001	Chan	
	US385	6,253,264		06-26-2001	Sebastian	
	US386	6,272,178		08-07-2001	Nieweglowski et al.	
	US387	6,272,627		08-07-2001	Mann	
	US388	6,272,628		08-07-2001	Aguilar et al.	
	US389	6,282,641		08-28-2001	Christensen	
	US390	6,285,458		09-04-2001	Yada	
	US391	6,298,408		10-02-2001	Park	
	US392	6,308,311		10-23-2001	Carmichael et al.	
	US393	6,309,424		10-30-2001	Fallon	
	US394	6,310,563		10-30-2001	Har et al.	
	US395	6,317,714		11-13-2001	Del Castillo et al.	
	US396	6,317,818		11-13-2001	Zwiegincew et al.	
	US397	6,330,622		12-11-2001	Shaefer	
	US398	6,333,745		12-25-2001	Shimomura et al.	
	US399	6,336,153		01-01-2002	Izumida et al.	
	US400	6,345,307		02-05-2002	Booth	

**FOREIGN PATENT DOCUMENTS**

Examiner Initials*	Cite No. <sup>1</sup>	Foreign Patent Document		Publication Date MM-DD-YYYY	Name of Patentee or Applicant of Cited Document	Pages, Columns, Lines, Where Relevant Passages or Relevant Figures Appear	1 <sup>6</sup>
		Country Code <sup>3</sup> -Number <sup>4</sup> -Kind Code <sup>5</sup> (if known)					

Examiner Signature		Date Considered	
--------------------	--	-----------------	--

**\*EXAMINER:** Initial if reference considered, whether or not citation is in conformance with MPEP 609. Draw line through citation if not in conformance and not considered. Include copy of this form with next communication to applicant. <sup>1</sup> Applicant's unique citation designation number (optional). <sup>2</sup> See Kinds Codes of USPTO Patent Documents at www.uspto.gov or MPEP 901.04. <sup>3</sup> Enter Office that issued the document, by the two-letter code (WIPO Standard ST.3). <sup>4</sup> For Japanese patent documents, the indication of the year of the reign of the Emperor must precede the serial number of the patent document. <sup>5</sup> Kind of document by the appropriate symbols as indicated on the document under WIPO Standard ST.16 if possible. <sup>6</sup> Applicant is to place a check mark here if English language Translation is attached.

Substitute for form 1449/PTO				<b>Complete if Known</b>	
				Application Number	14/134,926
<b>INFORMATION DISCLOSURE STATEMENT BY APPLICANT</b> <i>(Use as many sheets as necessary)</i>				Filing Date	December 19, 2013
				First Named Inventor	James J. FALLON
				Art Unit	2634
				Examiner Name	BOCURE, Tesfaldet
Sheet	21	of	29	Attorney Docket Number	2855.0050008

**U.S. PATENT DOCUMENTS**

Examiner initials*	Cite No. <sup>1</sup>	Document Number		Publication Date MM-DD-YYYY	Name of Patentee or Applicant of Cited Document	Pages, Columns, Lines, Where Relevant Passages or Relevant Figures Appear
		Number-Kind Code <sup>2</sup> (if known)				
	US401	6,356,589		03-12-2002	Gebler et al.	
	US402	6,374,353		04-16-2002	Settsu et al.	
	US403	6,356,937		03-12-2002	Montville et al.	
	US404	6,388,584		05-14-2002	Dorward et al.	
	US405	6,392,567		05-21-2002	Satoh	
	US406	6,404,931		06-11-2002	Chen et al.	
	US407	6,421,387		07-16-2002	Rhee	
	US408	6,434,168		08-13-2002	Kari	
	US409	6,434,695		08-13-2002	Esfahani et al.	
	US410	6,442,659		08-27-2002	Blumenau	
	US411	6,449,658		09-10-2002	Lafe et al.	
	US412	6,449,682		09-10-2002	Toorians	
	US413	6,452,602		09-17-2002	Morein	
	US414	6,452,933		09-17-2002	Duffield et al.	
	US415	6,459,429		10-01-2002	Deering	
	US416	6,463,509		10-08-2002	Teoman et al.	
	US417	6,487,640		11-26-2002	Lipasti	
	US418	6,489,902		12-03-2002	Heath	
	US419	6,513,113		01-28-2003	Kobayashi	
	US420	6,523,102		02-18-2003	Dye et al.	

**FOREIGN PATENT DOCUMENTS**

Examiner initials*	Cite No. <sup>1</sup>	Foreign Patent Document		Publication Date MM-DD-YYYY	Name of Patentee or Applicant of Cited Document	Pages, Columns, Lines, Where Relevant Passages or Relevant Figures Appear	T <sup>6</sup>
		Country Code <sup>3</sup> -Number <sup>4</sup> -Kind Code <sup>5</sup> (if known)					

Examiner Signature		Date Considered	
--------------------	--	-----------------	--

\*EXAMINER: Initial if reference considered, whether or not citation is in conformance with MPEP 609. Draw line through citation if not in conformance and not considered. Include copy of this form with next communication to applicant. <sup>1</sup> Applicant's unique citation designation number (optional). <sup>2</sup> See Kinds Codes of USPTO Patent Documents at www.uspto.gov or MPEP 901.04. <sup>3</sup> Enter Office that issued the document, by the two-letter code (WIPO Standard ST.3). <sup>4</sup> For Japanese patent documents, the indication of the year of the reign of the Emperor must precede the serial number of the patent document. <sup>5</sup> Kind of document by the appropriate symbols as indicated on the document under WIPO Standard ST.16 if possible. <sup>6</sup> Applicant is to place a check mark here if English language Translation is attached.



<p>Substitute for form 1449/PTO</p> <p style="text-align: center;"><b>INFORMATION DISCLOSURE STATEMENT BY APPLICANT</b></p> <p style="text-align: center;"><i>(Use as many sheets as necessary)</i></p>	<p><b>Complete if Known</b></p> <table border="1" style="width:100%; border-collapse: collapse;"> <tr><td>Application Number</td><td>14/134,926</td></tr> <tr><td>Filing Date</td><td>December 19, 2013</td></tr> <tr><td>First Named Inventor</td><td>James J. FALLON</td></tr> <tr><td>Art Unit</td><td>2634</td></tr> <tr><td>Examiner Name</td><td>BOCURE, Tesfaldet</td></tr> <tr><td>Attorney Docket Number</td><td>2855.0050008</td></tr> </table>	Application Number	14/134,926	Filing Date	December 19, 2013	First Named Inventor	James J. FALLON	Art Unit	2634	Examiner Name	BOCURE, Tesfaldet	Attorney Docket Number	2855.0050008
Application Number	14/134,926												
Filing Date	December 19, 2013												
First Named Inventor	James J. FALLON												
Art Unit	2634												
Examiner Name	BOCURE, Tesfaldet												
Attorney Docket Number	2855.0050008												
Sheet 22 of 29													

U.S. PATENT DOCUMENTS						
Examiner initials*	Cite No. <sup>1</sup>	Document Number		Publication Date MM-DD-YYYY	Name of Patentee or Applicant of Cited Document	Pages, Columns, Lines, Where Relevant Passages or Relevant Figures Appear
		Number-Kind Code <sup>2</sup> (if known)				
	US421	6,526,174		02-25-2003	Graffagnino	
	US422	6,529,633		03-04-2003	Easwar et al.	
	US423	6,532,121		03-11-2003	Rust et al.	
	US424	6,539,438		03-25-2003	Ledzius et al.	
	US425	6,539,456		03-25-2003	Stewart	
	US426	6,542,644		04-01-2003	Satoh	
	US427	6,577,254		06-10-2003	Rasmussen	
	US428	6,590,609		07-08-2003	Kitade et al.	
	US429	6,597,812		07-22-2003	Fallon et al.	
	US430	6,601,104		07-29-2003	Fallon	
	US431	6,604,040		08-05-2003	Kawasaki et al.	
	US432	6,604,158		08-05-2003	Fallon	
	US433	6,606,040		08-12-2003	Abdat	
	US434	6,606,413		08-12-2003	Zeineh	
	US435	6,609,223		08-19-2003	Wolfgang	
	US436	6,618,728		09-09-2003	Rail	
	US437	6,624,761		09-23-2003	Fallon	
	US438	6,633,244		10-14-2003	Avery	
	US439	6,633,968		10-14-2003	Zwieginzew et al.	
	US440	6,650,261		11-18-2003	Nelson et al.	

FOREIGN PATENT DOCUMENTS							
Examiner initials*	Cite No. <sup>1</sup>	Foreign Patent Document		Publication Date MM-DD-YYYY	Name of Patentee or Applicant of Cited Document	Pages, Columns, Lines, Where Relevant Passages or Relevant Figures Appear	T <sup>6</sup>
		Country Code <sup>3</sup> -Number <sup>4</sup> -Kind Code <sup>5</sup> (if known)					

Examiner Signature		Date Considered	
--------------------	--	-----------------	--

\*EXAMINER: Initial if reference considered, whether or not citation is in conformance with MPEP 609. Draw line through citation if not in conformance and not considered. Include copy of this form with next communication to applicant. <sup>1</sup> Applicant's unique citation designation number (optional). <sup>2</sup> See Kinds Codes of USPTO Patent Documents at [www.uspto.gov](http://www.uspto.gov) or MPEP 901.04. <sup>3</sup> Enter Office that issued the document, by the two-letter code (WIPO Standard ST.3). <sup>4</sup> For Japanese patent documents, the indication of the year of the reign of the Emperor must precede the serial number of the patent document. <sup>5</sup> Kind of document by the appropriate symbols as indicated on the document under WIPO Standard ST.16 if possible. <sup>6</sup> Applicant is to place a check mark here if English language Translation is attached.

Substitute for form 1449/PTO			<b>Complete if Known</b>	
<b>INFORMATION DISCLOSURE STATEMENT BY APPLICANT</b> <i>(Use as many sheets as necessary)</i>			Application Number	14/134,926
			Filing Date	December 19, 2013
			First Named Inventor	James J. FALLON
			Art Unit	2634
			Examiner Name	BOCURE, Tesfaldet
Sheet 23 of 29	Attorney Docket Number		2855.0050008	

U.S. PATENT DOCUMENTS						
Examiner initials*	Cite No. <sup>1</sup>	Document Number		Publication Date MM-DD-YYYY	Name of Patentee or Applicant of Cited Document	Pages, Columns, Lines, Where Relevant Passages or Relevant Figures Appear
		Number	Kind Code <sup>2</sup> (if known)			
	US441	6,661,839		12-09-2003	Ishida et al.	
	US442	6,661,845		12-09-2003	Herath	
	US443	6,704,840		03-09-2004	Nalawadi et al.	
	US444	6,708,220		03-16-2004	Olin	
	US445	6,711,709		03-23-2004	York	
	US446	6,717,534		04-06-2004	Yokose	
	US447	6,731,814		05-04-2004	Zeck et al.	
	US448	6,745,282		06-01-2004	Okada et al.	
	US449	6,748,457		06-08-2004	Fallon et al.	
	US450	6,756,922		06-29-2004	Ossia	
	US451	6,768,749		07-27-2004	Osler et al.	
	US452	6,792,151		09-14-2004	Barnes et al.	
	US453	6,810,434		10-26-2004	Muthujumaraswathy et al.	
	US454	6,813,689		11-02-2004	Baxter, III	
	US455	6,819,271		11-16-2004	Geiger et al.	
	US456	6,822,589		11-23-2004	Dye et al.	
	US457	6,856,651		02-15-2005	Singh	
	US458	6,862,278		03-01-2005	Chang et al.	
	US459	6,879,266		04-12-2005	Dye et al.	
	US460	6,885,316		04-26-2005	Mehring	

FOREIGN PATENT DOCUMENTS							
Examiner initials*	Cite No. <sup>1</sup>	Foreign Patent Document		Publication Date MM-DD-YYYY	Name of Patentee or Applicant of Cited Document	Pages, Columns, Lines, Where Relevant Passages or Relevant Figures Appear	T <sup>6</sup>
		Country Code <sup>3</sup>	Number <sup>4</sup> -Kind Code <sup>5</sup> (if known)				

Examiner Signature		Date Considered	
--------------------	--	-----------------	--

\*EXAMINER: Initial if reference considered, whether or not citation is in conformance with MPEP 609. Draw line through citation if not in conformance and not considered. Include copy of this form with next communication to applicant. <sup>1</sup> Applicant's unique citation designation number (optional). <sup>2</sup> See Kinds Codes of USPTO Patent Documents at www.uspto.gov or MPEP 901.04. <sup>3</sup> Enter Office that issued the document, by the two-letter code (WIPO Standard ST.3). <sup>4</sup> For Japanese patent documents, the indication of the year of the reign of the Emperor must precede the serial number of the patent document. <sup>5</sup> Kind of document by the appropriate symbols as indicated on the document under WIPO Standard ST.16 if possible. <sup>6</sup> Applicant is to place a check mark here if English language Translation is attached.

Substitute for form 1449/PTO		<i>Complete if Known</i>	
<b>INFORMATION DISCLOSURE STATEMENT BY APPLICANT</b> <i>(Use as many sheets as necessary)</i>		Application Number	14/134,926
		Filing Date	December 19, 2013
		First Named Inventor	James J. FALLON
		Art Unit	2634
		Examiner Name	BOCURE, Tesfaldet
		Attorney Docket Number	2855.0050008
Sheet	24	of	29

<b>U.S. PATENT DOCUMENTS</b>						
Examiner initials*	Cite No. <sup>1</sup>	Document Number		Publication Date MM-DD-YYYY	Name of Patentee or Applicant of Cited Document	Pages, Columns, Lines, Where Relevant Passages or Relevant Figures Appear
		Number-Kind Code <sup>2</sup> (if known)				
	US461	6,885,319		04-26-2005	Geiger et al.	
	US462	6,888,893		05-03-2005	Li et al.	
	US463	6,909,383		06-21-2005	Shokrollahi et al.	
	US464	6,909,745		06-21-2005	Puri et al.	
	US465	6,944,740		09-13-2005	Abali et al.	
	US466	6,952,409		10-04-2002	Jolitz	
	US467	6,959,359		10-25-2005	Suzuki et al.	
	US468	6,963,608		11-08-2005	Wu	
	US469	6,990,247		01-24-2006	Schwartz	
	US470	6,993,597		01-31-2006	Nakagawa et al.	
	US471	7,007,099		02-28-2006	Donati et al.	
	US472	7,024,460		04-04-2006	Koopmas	
	US473	7,054,493		05-30-2006	Schwartz	
	US474	7,069,342		06-27-2006	Biederman	
	US475	7,089,391		08-08-2006	Geiger et al.	
	US476	7,102,544		09-05-2006	Liu	
	US477	7,127,518		10-24-2006	Vange et al.	
	US478	7,129,860		10-31-2006	Alvarez, II	
	US479	7,130,913		10-31-2006	Fallon	
	US480	7,161,506		01-09-2007	Fallon	

<b>FOREIGN PATENT DOCUMENTS</b>							
Examiner initials*	Cite No. <sup>1</sup>	Foreign Patent Document		Publication Date MM-DD-YYYY	Name of Patentee or Applicant of Cited Document	Pages, Columns, Lines, Where Relevant Passages or Relevant Figures Appear	T <sup>6</sup>
		Country Code <sup>3</sup> -Number <sup>4</sup> -Kind Code <sup>5</sup> (if known)					

Examiner Signature		Date Considered	
--------------------	--	-----------------	--

\*EXAMINER: Initial if reference considered, whether or not citation is in conformance with MPEP 609. Draw line through citation if not in conformance and not considered. Include copy of this form with next communication to applicant. <sup>1</sup> Applicant's unique citation designation number (optional). <sup>2</sup> See Kinds Codes of USPTO Patent Documents at [www.uspto.gov](http://www.uspto.gov) or MPEP 901.04. <sup>3</sup> Enter Office that issued the document, by the two-letter code (WIPO Standard ST.3). <sup>4</sup> For Japanese patent documents, the indication of the year of the reign of the Emperor must precede the serial number of the patent document. <sup>5</sup> Kind of document by the appropriate symbols as indicated on the document under WIPO Standard ST.16 if possible. <sup>6</sup> Applicant is to place a check mark here if English language Translation is attached.

Substitute for form 1449/PTO  <b>INFORMATION DISCLOSURE STATEMENT BY APPLICANT</b> <i>(Use as many sheets as necessary)</i>				<i>Complete if Known</i>		
				Application Number	14/134,926	
				Filing Date	December 19, 2013	
				First Named Inventor	James J. FALLON	
				Art Unit	2634	
				Examiner Name	BOCURE, Tesfaldet	
Sheet	25	of	29	Attorney Docket Number	2855.0050008	

U.S. PATENT DOCUMENTS						
Examiner initials*	Cite No. <sup>1</sup>	Document Number		Publication Date MM-DD-YYYY	Name of Patentee or Applicant of Cited Document	Pages, Columns, Lines, Where Relevant Passages or Relevant Figures Appear
		Number	Kind Code <sup>2</sup> (if known)			
	US481	7,181,608		02-20-2007	Fallon et al.	
	US482	7,190,284		03-13-2007	Dye et al.	
	US483	7,319,667		01-15-2008	Biederman	
	US484	7,321,937		01-22-2008	Fallon	
	US485	7,327,287		02-05-2008	Martinian et al.	
	US486	7,330,912		02-12-2008	Fox et al.	
	US487	RE40,092		02-19-2008	Kang	
	US488	7,352,300		04-01-2008	Fallon	
	US489	7,358,867		04-15-2008	Fallon	
	US490	7,376,772		05-20-2008	Fallon	
	US491	7,378,992		05-27-2008	Fallon	
	US492	7,386,046		06-10-2008	Fallon et al.	
	US493	7,395,345		07-01-2008	Fallon	
	US494	7,400,274		07-15-2008	Fallon et al.	
	US495	7,415,530		08-19-2008	Fallon	
	US496	7,417,568		08-26-2008	Fallon et al.	
	US497	7,552,069		06-23-2009	Kepecs	
	US498	7,565,441		07-21-2009	Romanik et al.	
	US499	7,711,938		05-04-2010	Wise et al.	
	US500	7,714,747		05-11-2010	Fallon	

FOREIGN PATENT DOCUMENTS							
Examiner initials*	Cite No. <sup>1</sup>	Foreign Patent Document		Publication Date MM-DD-YYYY	Name of Patentee or Applicant of Cited Document	Pages, Columns, Lines, Where Relevant Passages or Relevant Figures Appear	T <sup>6</sup>
		Country Code <sup>3</sup>	Number <sup>4</sup> -Kind Code <sup>5</sup> (if known)				

Examiner Signature		Date Considered	
--------------------	--	-----------------	--

\*EXAMINER: Initial if reference considered, whether or not citation is in conformance with MPEP 609. Draw line through citation if not in conformance and not considered. Include copy of this form with next communication to applicant. <sup>1</sup> Applicant's unique citation designation number (optional). <sup>2</sup> See Kinds Codes of USPTO Patent Documents at www.uspto.gov or MPEP 901.04. <sup>3</sup> Enter Office that issued the document, by the two-letter code (WIPO Standard ST.3). <sup>4</sup> For Japanese patent documents, the indication of the year of the reign of the Emperor must precede the serial number of the patent document. <sup>5</sup> Kind of document by the appropriate symbols as indicated on the document under WIPO Standard ST.16 if possible. <sup>6</sup> Applicant is to place a check mark here if English language Translation is attached.

Substitute for form 1449/PTO				<b>Complete if Known</b>	
				Application Number	14/134,926
<b>INFORMATION DISCLOSURE STATEMENT BY APPLICANT</b> <i>(Use as many sheets as necessary)</i>				Filing Date	December 19, 2013
				First Named Inventor	James J. FALLON
				Art Unit	2634
				Examiner Name	BOCURE, Tesfaldet
				Attorney Docket Number	2855.0050008
Sheet	26	of	29		

<b>U.S. PATENT DOCUMENTS</b>						
Examiner initials*	Cite No. <sup>1</sup>	Document Number		Publication Date MM-DD-YYYY	Name of Patentee or Applicant of Cited Document	Pages, Columns, Lines, Where Relevant Passages or Relevant Figures Appear
		Number	Kind Code <sup>2</sup> (if known)			
	US501	7,777,651		08-17-2010	Fallon et al.	
	US502	8,004,431		08-23-2011	Reznik	
	US503	8,054,879		11-08-2011	Fallon et al.	
	US504	8,073,047		12-06-2011	Fallon et al.	
	US505	8,090,936		01-03-2012	Fallon et al.	
	US506	8,112,619		02-07-2012	Fallon et al.	
	US507	8,275,897		09-25-2012	Fallon	
	US508	8,502,707		08-06-2013	Fallon	
	US509	8,504,710		08-06-2013	Fallon	
	US510	8,553,759		10-08-2013	Fallon et al.	
	US511	5,103,306		04-07-1992	Weiman	
	US512	5,764,774		06-09-1998	Liu	
	US513	5,673,370		09-30-1997	Laney	
	US514	6,505,239		01-07-2003	Kobata	
	US515	5,982,937		11-09-1999	Accad	
	US516	5,079,630		01-07-1992	Golin	
	US517	6,198,850		03-06-2001	Banton	
	US518	6,198,842		03-06-2001	Yeo	
	US519	2001/0019630		09-06-2001	Johnson	
	US520	2001/0031092 A1		10-18-2001	Zeck et al.	

<b>FOREIGN PATENT DOCUMENTS</b>							
Examiner initials*	Cite No. <sup>1</sup>	Foreign Patent Document		Publication Date MM-DD-YYYY	Name of Patentee or Applicant of Cited Document	Pages, Columns, Lines, Where Relevant Passages or Relevant Figures Appear	T <sup>6</sup>
		Country Code <sup>3</sup>	Number <sup>4</sup> -Kind Code <sup>5</sup> (if known)				

Examiner Signature		Date Considered	
--------------------	--	-----------------	--

\*EXAMINER: Initial if reference considered, whether or not citation is in conformance with MPEP 609. Draw line through citation if not in conformance and not considered. Include copy of this form with next communication to applicant. <sup>1</sup> Applicant's unique citation designation number (optional). <sup>2</sup> See Kinds Codes of USPTO Patent Documents at www.uspto.gov or MPEP 901.04. <sup>3</sup> Enter Office that issued the document, by the two-letter code (WIPO Standard ST.3). <sup>4</sup> For Japanese patent documents, the indication of the year of the reign of the Emperor must precede the serial number of the patent document. <sup>5</sup> Kind of document by the appropriate symbols as indicated on the document under WIPO Standard ST.16 if possible. <sup>6</sup> Applicant is to place a check mark here if English language Translation is attached.

Substitute for form 1449/PTO				<i>Complete if Known</i>	
<b>INFORMATION DISCLOSURE STATEMENT BY APPLICANT</b> <i>(Use as many sheets as necessary)</i>				Application Number	14/134,926
				Filing Date	December 19, 2013
				First Named Inventor	James J. FALLON
				Art Unit	2634
				Examiner Name	BOCURE, Tesfaldet
Sheet	27	of	29	Attorney Docket Number	2855.0050008

**U.S. PATENT DOCUMENTS**

Examiner initials*	Cite No. <sup>1</sup>	Document Number		Publication Date MM-DD-YYYY	Name of Patentee or Applicant of Cited Document	Pages, Columns, Lines, Where Relevant Passages or Relevant Figures Appear
		Number-Kind Code <sup>2</sup> (if known)				
	US521	2001/0032128	A1	10-18-2001	Kepecs	
	US522	2001/0047473	A1	11-29-2001	Fallon	
	US523	2001/0052038	A1	12-13-2001	Fallon et al.	
	US524	2001/0054131	A1	12-20-2001	Alvarez, II et al.	
	US525	2002/0037035	A1	03-28-2002	Singh	
	US526	2002/0069354	A1	06-06-2002	Fallon et al.	
	US527	2002/0080871	A1	06-27-2002	Fallon et al.	
	US528	2002/0097172	A1	07-25-2002	Fallon	
	US529	2002/0101367	A1	08-01-2002	Geiger et al.	
	US530	2002/0104891	A1	08-08-2002	Otto	
	US531	2002/0126755	A1	09-12-2002	Li et al.	
	US532	2002/0169950	A1	11-14-2002	Esfahani et al.	
	US533	2002/0191692	A1	12-19-2002	Fallon et al.	
	US534	2003/0034905	A1	02-20-2003	Anton et al.	
	US535	2003/0084238	A1	05-01-2003	Okada et al.	
	US536	2003/0030575	A1	02-13-2003	Frachtenberg et al.	
	US537	2003/0090397	A1	05-15-2003	Rasmussen	
	US538	2003/0142874	A1	07-31-2003	Schwartz	
	US539	2003/0191876	A1	10-09-2003	Fallon	
	US540	2004/0042506	A1	03-04-2004	Fallon et al.	

**FOREIGN PATENT DOCUMENTS**

Examiner initials*	Cite No. <sup>1</sup>	Foreign Patent Document		Publication Date MM-DD-YYYY	Name of Patentee or Applicant of Cited Document	Pages, Columns, Lines, Where Relevant Passages or Relevant Figures Appear	<sup>6</sup>
		Country Code <sup>3</sup>	Number-Kind Code <sup>4</sup> (if known)				

Examiner Signature		Date Considered	
--------------------	--	-----------------	--

\*EXAMINER: Initial if reference considered, whether or not citation is in conformance with MPEP 609. Draw line through citation if not in conformance and not considered. Include copy of this form with next communication to applicant. <sup>1</sup> Applicant's unique citation designation number (optional). <sup>2</sup> See Kinds Codes of USPTO Patent Documents at www.uspto.gov or MPEP 901.04. <sup>3</sup> Enter Office that issued the document, by the two-letter code (WIPO Standard ST.3). <sup>4</sup> For Japanese patent documents, the indication of the year of the reign of the Emperor must precede the serial number of the patent document. <sup>5</sup> Kind of document by the appropriate symbols as indicated on the document under WIPO Standard ST.16 if possible. <sup>6</sup> Applicant is to place a check mark here if English language Translation is attached.

Substitute for form 1449/PTO  <h2 style="text-align: center;">INFORMATION DISCLOSURE STATEMENT BY APPLICANT</h2> <p style="text-align: center;"><i>(Use as many sheets as necessary)</i></p>		<b>Complete if Known</b>	
		Application Number	14/134,926
		Filing Date	December 19, 2013
		First Named Inventor	James J. FALLON
		Art Unit	2634
		Examiner Name	BOCURE, Tesfaldet
		Attorney Docket Number	2855.0050008
Sheet	28	of	29

U.S. PATENT DOCUMENTS						
Examiner Initials*	Cite No. <sup>1</sup>	Document Number		Publication Date MM-DD-YYYY	Name of Patentee or Applicant of Cited Document	Pages, Columns, Lines, Where Relevant Passages or Relevant Figures Appear
		Number-Kind Code <sup>2</sup> (if known)				
	US541	2004/0056783	A1	03-25-2004	Fallon	
	US542	2004/0073710	A1	04-15-2004	Fallon	
	US543	2004/0073746	A1	04-15-2004	Fallon	
	US544	2006/0015650	A1	01-19-2006	Fallon	
	US545	2006/0181441	A1	08-17-2006	Fallon	
	US546	2006/0181442	A1	08-17-2006	Fallon	
	US547	2006/0184687	A1	08-17-2006	Fallon	
	US548	2006/0184696	A1	08-17-2006	Fallon	
	US549	2006/0190644	A1	08-24-2006	Fallon	
	US550	2006/0195601	A1	08-31-2006	Fallon	
	US551	2007/0043939	A1	02-22-2007	Fallon et al.	
	US552	2007/0050514	A1	03-01-2007	Fallon	
	US553	2007/0050515	A1	03-01-2007	Fallon	
	US554	2007/0067483	A1	03-22-2007	Fallon	
	US555	2007/0083746	A1	04-12-2007	Fallon et al.	
	US556	2007/0109154	A1	05-17-2007	Fallon	
	US557	2007/0109155	A1	05-17-2007	Fallon	
	US558	2007/0109156	A1	05-17-2007	Fallon	
	US559	2007/0174209	A1	07-26-2007	Fallon	
	US560	2008/0232457	A1	09-25-2008	Fallon et al.	

FOREIGN PATENT DOCUMENTS							
Examiner Initials*	Cite No. <sup>1</sup>	Foreign Patent Document		Publication Date MM-DD-YYYY	Name of Patentee or Applicant of Cited Document	Pages, Columns, Lines, Where Relevant Passages or Relevant Figures Appear	76
		Country Code <sup>3</sup>	Number <sup>4</sup> -Kind Code <sup>5</sup> (if known)				

Examiner Signature		Date Considered	
--------------------	--	-----------------	--

\*EXAMINER: Initial if reference considered, whether or not citation is in conformance with MPEP 609. Draw line through citation if not in conformance and not considered. Include copy of this form with next communication to applicant. <sup>1</sup> Applicant's unique citation designation number (optional). <sup>2</sup> See Kinds Codes of USPTO Patent Documents at [www.uspto.gov](http://www.uspto.gov) or MPEP 901.04. <sup>3</sup> Enter Office that issued the document, by the two-letter code (WIPO Standard ST.3). <sup>4</sup> For Japanese patent documents, the indication of the year of the reign of the Emperor must precede the serial number of the patent document. <sup>5</sup> Kind of document by the appropriate symbols as indicated on the document under WIPO Standard ST.16 if possible. <sup>6</sup> Applicant is to place a check mark here if English language Translation is attached.

Substitute for form 1449/PTO		<i>Complete if Known</i>	
<b>INFORMATION DISCLOSURE STATEMENT BY APPLICANT</b> <i>(Use as many sheets as necessary)</i>		Application Number	14/134,926
		Filing Date	December 19, 2013
		First Named Inventor	James J. FALLON
		Art Unit	2634
		Examiner Name	BOCURE, Tesfaldet
		Attorney Docket Number	2855.0050008
Sheet	29	of	29

**U.S. PATENT DOCUMENTS**

Examiner initials*	Cite No. 1	Document Number		Publication Date MM-DD-YYYY	Name of Patentee or Applicant of Cited Document	Pages, Columns, Lines, Where Relevant Passages or Relevant Figures Appear
		Number-Kind Code 2 (if known)				
	US561	2009/0125698 A1		05-14-2009	Dye	
	US562	2009/0154545 A1		06-18-2009	Fallon et al.	
	US563	2009/0287839 A1		11-19-2009	Fallon et al.	
	US564	2010/0316114 A1		12-16-2010	Fallon et al.	
	US565	2010/0318684 A1		12-16-2010	Fallon	
	US566	2010/0332700 A1		12-30-2010	Fallon	
	US567	2011/0037626 A1		02-17-2011	Fallon	
	US568	2011/0199243 A1		08-18-2011	Fallon et al.	
	US569	2011/0208833 A1		08-25-2011	Fallon	
	US570	2011/0231642 A1		09-22-2011	Fallon et al.	
	US571	2011/0235697 A1		09-29-2011	Fallon et al.	
	US572	2011/0285559 A1		11-24-2011	Fallon	
	US573	2012/0194362 A1		08-02-2012	Fallon et al.	
	US574	2012/0239921 A1		09-20-2012	Fallon	
	US575	2014/0022098 A1		01-23-2014	Fallon	
	US576	2014/0022099 A1		01-23-2014	Fallon et al.	
	US577	2014/0022100 A1		01-23-2014	Fallon et al.	
	US578	2014/0023135 A1		01-23-2014	Fallon et al.	
	US579	2014/0028480 A1		01-30-2014	Fallon et al.	

**FOREIGN PATENT DOCUMENTS**

Examiner initials*	Cite No. 1	Foreign Patent Document		Publication Date MM-DD-YYYY	Name of Patentee or Applicant of Cited Document	Pages, Columns, Lines, Where Relevant Passages or Relevant Figures Appear	76
		Country Code 3-Number 4-Kind Code 5 (if known)					

1801958\_1

Examiner Signature		Date Considered	
--------------------	--	-----------------	--

\*EXAMINER: Initial if reference considered, whether or not citation is in conformance with MPEP 609. Draw line through citation if not in conformance and not considered. Include copy of this form with next communication to applicant. 1 Applicant's unique citation designation number (optional). 2 See Kinds Codes of USPTO Patent Documents at www.uspto.gov or MPEP 901.04. 3 Enter Office that issued the document, by the two-letter code (WIPO Standard ST.3). 4 For Japanese patent documents, the indication of the year of the reign of the Emperor must precede the serial number of the patent document. 5 Kind of document by the appropriate symbols as indicated on the document under WIPO Standard ST.16 if possible. 6 Applicant is to place a check mark here if English language Translation is attached.



Substitute for form 1449/PTO			<b>Complete if Known</b>	
<b>INFORMATION DISCLOSURE STATEMENT BY APPLICANT</b> <i>(Use as many sheets as necessary)</i>			Application Number	14/135,926
			Filing Date	December 19, 2013
			First Named Inventor	FALLON et al.
			Art Unit	2634
			Examiner Name	BOCURE, Tesfaldet
			Attorney Docket Number	2855.0050008
Sheet	1	of	97	

NON PATENT LITERATURE DOCUMENTS			
Examiner Initials*	Cite No. <sup>1</sup>	Include name of the author (in CAPITAL LETTERS), title of the article (when appropriate), title of the item (book, magazine, journal, serial, symposium, catalog, etc.), date, page(s), volume-issue number(s), publisher, city and/or country where published	T <sup>2</sup>
	NPL1	Realtime's Response in Opposition to the Defendants' Joint Objections to Report and Recommendation of Magistrate Regarding Motion for Partial Summary Judgment of Invalidity for Indefiniteness, in Realtime Data, LLC d/b/a/IXO v. Packeteer, Inc. et al., Civil Action No. 6:08-cv-00144-LED; U.S. District Court for the Eastern District of Texas, dated July 27, 2009, 15 pages.	
	NPL2	Reply to Realtime's Response to Blue Coat Defendants' Objections to Report and Recommendation of United States Magistrate Judge Regarding Motion for Partial Summary Judgment of Invalidity for Indefiniteness Entered June 23, 2009, in Realtime Data, LLC d/b/a/IXO v. Packeteer, Inc. et al., Civil Action No. 6:08-cv-00144-LED; U.S. District Court for the Eastern District of Texas, July 31, 2009, 3 pgs.	
	NPL3	Realtime Data's Sur-Reply in Opposition to the Defendants' Joint Objections to Report and Recommendation of Magistrate Regarding Motion for Partial Summary Judgment of Invalidity for Indefiniteness, in Realtime Data, LLC d/b/a/IXO v. Packeteer, Inc. et al., Civil Action No. 6:08-cv-00144-LED; U.S. District Court for the Eastern District of Texas, dated August 3, 2009, 3 pages.	
	NPL4	"A-T Financial Offers Manipulation, Redistribution of Ticker III", Inside Market Data, Vol. 4 No. 14, September 5, 1989, 1 page.	
	NPL5	"Add-on Options for the XpressFiles", Intelligent Compression Technologies, <a href="http://web.archive.org/web/19980518053418/ictcompress.com/options_X.html">http://web.archive.org/web/19980518053418/ictcompress.com/options_X.html</a> , 1998, 2 pages.	
	NPL6	ANDREWS et al., "A Mean-Removed Variation of Weighted Universal Vector Quantization for Image Coding", IEEE, 1993, pages 302-309.	
	NPL7	Asserted Claims Chart for U.S. Patent No. 6,624,761, Realtime Data, LLC D/B/A IXO v. CME Group Inc., et al., 6:09-cv-327-LED-JDL, 6:10-cv-246-LED-JDL, United States District Court for the Eastern District of Texas Tyler Division, October 19, 2010, 4 pages.	
	NPL8	Asserted Claims Chart for U.S. Patent No. 7,161,506, Realtime Data, LLC D/B/A IXO v. CME Group Inc., et al., 6:09-cv-327-LED-JDL, 6:10-cv-246-LED-JDL, United States District Court for the Eastern District of Texas Tyler Division, October 19, 2010, 5 pages	
	NPL9	Asserted Claims Chart for U.S. Patent No. 7,400,274, Realtime Data, LLC D/B/A IXO v. CME Group Inc., et al., 6:09-cv-327-LED-JDL, 6:10-cv-246-LED-JDL, United States District Court for the Eastern District of Texas Tyler Division, October 19, 2010, 6 pages.	
	NPL10	Asserted Claims Chart for U.S. Patent No. 7,417,568, Realtime Data, LLC D/B/A IXO v. CME Group Inc., et al., 6:09-cv-327-LED-JDL, 6:10-cv-246-LED-JDL, United States District Court for the Eastern District of Texas Tyler Division, October 19, 2010, 13 pages.	

Examiner Signature		Date Considered	
--------------------	--	-----------------	--

\*EXAMINER: Initial if reference considered, whether or not citation is in conformance with MPEP 609. Draw line through citation if not in conformance and not considered. Include copy of this form with next communication to applicant.

<sup>1</sup> Applicant's unique citation designation number (optional). <sup>2</sup> Applicant is to place a check mark here if English language Translation is attached.

Substitute for form 1449/PTO		<b>Complete if Known</b>	
<b>INFORMATION DISCLOSURE STATEMENT BY APPLICANT</b> <i>(Use as many sheets as necessary)</i>		Application Number	14/135,926
		Filing Date	December 19, 2013
		First Named Inventor	FALLON et al.
		Art Unit	2634
		Examiner Name	BOCURE, Tesfaldet
		Attorney Docket Number	2855.0050008
Sheet	2	of	97

NON PATENT LITERATURE DOCUMENTS			
Examiner Initials*	Cite No. <sup>1</sup>	Include name of the author (in CAPITAL LETTERS), title of the article (when appropriate), title of the item (book, magazine, journal, serial, symposium, catalog, etc.), date, page(s), volume number, publisher, city and/or country where published	T <sup>2</sup>
	NPL11	Asserted Claims Chart for U.S. Patent No. 7,714,747, Realtime Data, LLC D/B/A IXO v. CME Group Inc., et al. , 6:09-cv-327-LED-JDL, 6:10-cv-246-LED-JDL, United States District Court for the Eastern District of Texas Tyler Division, October 19, 2010, 19 pages.	
	NPL12	BARTON, Rich, S&P ComStock Network Character Set Definition, 19.2 KB Network, Version 1.7.0, February 10, 1995, 29 pages.	
	NPL13	BEECH, W. A., et al., "AX.25 Link Access Protocol for Amateur Packet Radio," Version 2.2, Revision: July 1998, 143 pages.	
	NPL14	BORMANN, Carsten, "Providing Integrated Services over Low-bitrate Links," Network Working Group Request for Comments: 2689, Category: Informational, September 1999, 14 pages.	
	NPL15	ComStock Services Pamphlet, McGraw-Hill Financial Services Company, purportedly published by July 19, 1995, 6 pages.	
	NPL16	CORMACK, Gordon V., "Data Compression on a Database System", Communications of the ACM, Volume 28, Number 12, December, 1985, pages 1336-1342.	
	NPL17	DANSKIN, John Moffatt, "Compressing the X Graphics Protocol: A Dissertation Presented to the Facult of Princeton University in Candidacy for the Degree of Doctor of Philosophy," January 1995, 147 pages.	
	NPL18	"Data Networks and Open System Communications," Information Technology - Abstract Syntax Notation One (ASN. 1) Specification of Basic Notation, International Telecommunication Union, ITU-T Telecommunication Standardization Sector of ITU X.680, July 1994,	
	NPL19	Defendants' Invalidity Contentions, Realtime Data, LLC D/B/A IXO v. CME Group Inc., et al. , 6:09-cv-327-LED-JDL, 6:10-cv-246-LED-JDL, United States District Court for the Eastern District of Texas Tyler Division, October 19, 2010, 19 pages.	
	NPL20	DEGERMARK, Mikael, "IP Header Compression", Network Working Group Request for Comments: 2507, Category: Standards Track, February 1999, 47 pages.	

Examiner Signature		Date Considered	
--------------------	--	-----------------	--

\*EXAMINER: Initial if reference considered, whether or not citation is in conformance with MPEP 609. Draw line through citation if not in conformance and not considered. Include copy of this form with next communication to applicant.  
<sup>1</sup> Applicant's unique citation designation number (optional). <sup>2</sup> Applicant is to place a check mark here if English language Translation is attached.

Substitute for form 1449/PTO		<b>Complete if Known</b>	
<b>INFORMATION DISCLOSURE STATEMENT BY APPLICANT</b> <i>(Use as many sheets as necessary)</i>		Application Number	14/135,926
		Filing Date	December 19, 2013
		First Named Inventor	FALLON et al.
		Art Unit	2634
		Examiner Name	BOCURE, Tesfaldet
		Attorney Docket Number	2855.0050008
Sheet	3	of	97

NON PATENT LITERATURE DOCUMENTS			
Examiner Initials*	Cite No. <sup>1</sup>	Include name of the author (in CAPITAL LETTERS), title of the article (when appropriate), title of the item (book, magazine, journal, serial, symposium, catalog, etc.), date, page(s), volume number, publisher, city and/or country where published	T <sup>2</sup>
	NPL21	Developer's Guide, Version 1.0.2, S&P ComStock, February 15, 1994, 186 pages.	
	NPL22	DOMANSKI, Dr. Bernie, "All the news you can eat, Department: Dr. Bernie's Digestions and Digressions", Demand Technology's Capacity Management Review, Volume 25, No. 7, July 1997, pages 24, 18-22.	
	NPL23	EFFROS, Michelle and Philip A. Chou, "Weighted Universal Transform Coding: Universal Image Compression with the Karhunen-Loeve Transform", IEEE, 1995, pages 61-64.	
	NPL24	ENGAN, Mathias, "IP Header Compression over PPP", Network Working Group Request for Comments: 2509, Category: 2509, February 1999, 10 pages.	
	NPL25	Exhibit A, Invalidity Claim Charts A1-A45 for U.S. Patent 6,624,761, Realtime Data, LLC D/B/A IXO v. CME Group Inc., et al. , 6:09-cv-327-LED-JDL, 6:10-cv-246-LED-JDL, United States District Court for the Eastern District of Texas Tyler Division, October 19, 2010, 616 pages.	
	NPL26	Exhibit B, Invalidity Claim Charts B1-B45 for U.S. Patent 7,161,506, Realtime Data, LLC D/B/A IXO v. CME Group Inc., et al. , 6:09-cv-327-LED-JDL, 6:10-cv-246-LED-JDL, United States District Court for the Eastern District of Texas Tyler Division, October 19, 2010, 1513 pages.	
	NPL27	Exhibit C, Invalidity Claim Charts C1-C7, C9-C31, C33-C45 for U.S. Patent 7,400,274, Realtime Data, LLC D/B/A IXO v. CME Group Inc., et al. , 6:09-cv-327-LED-JDL, 6:10-cv-246-LED-JDL, United States District Court for the Eastern District of Texas Tyler Division, October 19, 2010, 1528 pages.	
	NPL28	Exhibit D, Invalidity Claim Charts D1-D7, D9-D45 for U.S. Patent 7,417,568, Realtime Data, LLC D/B/A IXO v. CME Group Inc., et al. , 6:09-cv-327-LED-JDL, 6:10-cv-246-LED-JDL, United States District Court for the Eastern District of Texas Tyler Division, October 19, 2010, 2458 pages.	
	NPL29	Exhibit E, Invalidity Claim Charts E1-E7, E9, E11, E13-E15, E17-E30, E32-E45 for U.S. Patent 7,714,747, Realtime Data, LLC D/B/A IXO v. CME Group Inc., et al. , 6:09-cv-327-LED-JDL, 6:10-cv-246-LED-JDL, United States District Court for the Eastern District of Texas Tyler Division, October 19, 2010, 3312 pages.	
	NPL30	GREENE, Tim, "Squeeze your 'Net links", NetworkWorld, Volume 14, Number 28, July 14, 1997, pages 1 and 56.	

Examiner Signature		Date Considered	
-----------------------	--	--------------------	--

\*EXAMINER: Initial if reference considered, whether or not citation is in conformance with MPEP 609. Draw line through citation if not in conformance and not considered. Include copy of this form with next communication to applicant.

<sup>1</sup> Applicant's unique citation designation number (optional). <sup>2</sup> Applicant is to place a check mark here if English language Translation is attached.

Substitute for form 1449/PTO		<b>Complete if Known</b>	
<b>INFORMATION DISCLOSURE STATEMENT BY APPLICANT</b> <i>(Use as many sheets as necessary)</i>		Application Number	14/135,926
		Filing Date	December 19, 2013
		First Named Inventor	FALLON et al.
		Art Unit	2634
		Examiner Name	BOCURE, Tesfaldet
		Attorney Docket Number	2855.0050008
Sheet	4	of	97

NON PATENT LITERATURE DOCUMENTS			
Examiner Initials*	Cite No. <sup>1</sup>	Include name of the author (in CAPITAL LETTERS), title of the article (when appropriate), title of the item (book, magazine, journal, serial, symposium, catalog, etc.), date, page(s), volume number, publisher, city and/or country where published	T <sup>2</sup>
	NPL31	HELCK, Christopher J., "Encapsulated Ticker: Ver 1.0," July 14, 1993, 22 pages.	
	NPL32	"High-performance schema-specific compression for XML data formats," XML-Xpress: Product Overview, Intelligent Compression Technologies, <a href="http://web.archive.org/web/20020818002535/www.ictcompress.com/products_xmlxpress">http://web.archive.org/web/20020818002535/www.ictcompress.com/products_xmlxpress</a> , 2001, 2 pages.	
	NPL33	HSU, William H. and Amy E. Zwarico, "Automatic Synthesis of Compression Techniques for Heterogeneous Files," Software - Practice and Experience, Volume 25 (10), October 1995, pages 1097-1116.	
	NPL34	"ICT's XML-Xpress", Intelligent Compression Technologies, December, 2000, 6 pages.	
	NPL35	"Information processing systems - Data communication - High-level data link control procedures - Frame structure", UNI ISO 3309, 1984, 11 pages.	
	NPL36	Installing and Administering PPP, Edition 1, Hewlett-Packard Company, 1997, 169 pages.	
	NPL37	"Introducing XpressFiles", Intelligent Compression Technologies, <a href="http://web.archive.org/web/19980518053310/ictcompress.com/xpressfiles.html">http://web.archive.org/web/19980518053310/ictcompress.com/xpressfiles.html</a> , 1998, 1 page.	
	NPL38	"Ion's RemoteScript speeds transmission", Seybold Report on Publishing Systems, Volume 22 Number 5, November 9, 1992, pages 21-23.	
	NPL39	JACOBSON, V., "Compressing TCP/IP Headers for Low-Speed Serial Links," February 1990, 45 pages.	
	NPL40	KULKOSKY, Victor, "Upping the Ante", Wall Street & Technology, Volume 11 Number 5, October 1993, pages 8-11.	

Examiner Signature		Date Considered	
-----------------------	--	--------------------	--

\*EXAMINER: Initial if reference considered, whether or not citation is in conformance with MPEP 609. Draw line through citation if not in conformance and not considered. Include copy of this form with next communication to applicant.

<sup>1</sup> Applicant's unique citation designation number (optional). <sup>2</sup> Applicant is to place a check mark here if English language Translation is attached.

Substitute for form 1449/PTO				<i>Complete if Known</i>	
<b>INFORMATION DISCLOSURE STATEMENT BY APPLICANT</b> <i>(Use as many sheets as necessary)</i>				Application Number	14/135,926
				Filing Date	December 19, 2013
				First Named Inventor	FALLON et al.
				Art Unit	2634
				Examiner Name	BOCURE, Tesfaldet
Sheet	5	of	97	Attorney Docket Number	2855.0050008

NON PATENT LITERATURE DOCUMENTS			
Examiner Initials*	Cite No. <sup>1</sup>	Include name of the author (in CAPITAL LETTERS), title of the article (when appropriate), title of the item (book, magazine, journal, serial, symposium, catalog, etc.), date, page(s), volume number, publisher, city and/or country where published	T <sup>2</sup>
	NPL41	LIEFKE, Hartmut and Dan Suci, "An Extensible Compressor for XML Data," SIGMOD Record, Vol. 29, No. 1, March 2000, pages 57-62.	
	NPL42	LIEFKE, Hartmut and Dan Suci, "XMill: an Efficient Compressor for XML Data," 2000, pages 153-164.	
	NPL43	LIEFKE, Hartmut and Dan Suci, Xmill: an Efficient Compressor for XML Data, October 18, 1999, 25 pages.	
	NPL44	McGREGOR, Glenn, "The PPP Internet Protocol Control Protocol (IPCP)", Network Working Group Request for Comments: 1332, Obsoletes: RFC 1172, May 1992, 14 pages.	
	NPL45	Obviousness Chart for U.S. Pat. No. 6,624,761, Realtime Data, LLC D/B/A IXO v. CME Group Inc., et al. , 6:09-cv-327-LED-JDL, 6:10-cv-246-LED-JDL, United States District Court for the Eastern District of Texas Tyler Division, October 19, 2010, 19 pages.	
	NPL46	Obviousness Chart for U.S. Pat. No. 7,161,506, Realtime Data, LLC D/B/A IXO v. CME Group Inc., et al. , 6:09-cv-327-LED-JDL, 6:10-cv-246-LED-JDL, United States District Court for the Eastern District of Texas Tyler Division, October 19, 2010, 49 pages.	
	NPL47	Obviousness Chart for U.S. Pat. No. 7,400,274, Realtime Data, LLC D/B/A IXO v. CME Group Inc., et al. , 6:09-cv-327-LED-JDL, 6:10-cv-246-LED-JDL, United States District Court for the Eastern District of Texas Tyler Division, October 19, 2010, 41 pages.	
	NPL48	Obviousness Chart for U.S. Pat. No. 7,417,568, Realtime Data, LLC D/B/A IXO v. CME Group Inc., et al. , 6:09-cv-327-LED-JDL, 6:10-cv-246-LED-JDL, United States District Court for the Eastern District of Texas Tyler Division, October 19, 2010, 75 pages.	
	NPL49	Obviousness Chart for U.S. Pat. No. 7,714,747, Realtime Data, LLC D/B/A IXO v. CME Group Inc., et al. , 6:09-cv-327-LED-JDL, 6:10-cv-246-LED-JDL, United States District Court for the Eastern District of Texas Tyler Division, October 19, 2010, 97 pages.	
	NPL50	Open Financial Exchange Specification 2.0, Intuit Inc., Microsoft Corp., April 28, 2000, 537 pages.	

Examiner Signature	Date Considered	
--------------------	-----------------	--

\*EXAMINER: Initial if reference considered, whether or not citation is in conformance with MPEP 609. Draw line through citation if not in conformance and not considered. Include copy of this form with next communication to applicant.  
<sup>1</sup> Applicant's unique citation designation number (optional). <sup>2</sup> Applicant is to place a check mark here if English language Translation is attached.

Substitute for form 1449/PTO				<b>Complete if Known</b>	
<b>INFORMATION DISCLOSURE STATEMENT BY APPLICANT</b> <i>(Use as many sheets as necessary)</i>				Application Number	14/135,926
				Filing Date	December 19, 2013
				First Named Inventor	FALLON et al.
				Art Unit	2634
				Examiner Name	BOCURE, Tesfaldet
Sheet	6	of	97	Attorney Docket Number	2855.0050008

NON PATENT LITERATURE DOCUMENTS			
Examiner Initials*	Cite No. <sup>1</sup>	Include name of the author (in CAPITAL LETTERS), title of the article (when appropriate), title of the item (book, magazine, journal, serial, symposium, catalog, etc.), date, page(s), volume number, publisher, city and/or country where published	T <sup>2</sup>
	NPL51	RAND, Dave, "The PPP Compression Control Protocol (CCP)", Network Working Group Request for Comments: 1962, Category: Standards Track, June 1996, 9 pages.	
	NPL52	ROGERS, Amy, "Bandwidth Bargain IT hot on products that squeeze more out of the pipe", Number 673, July 21, 1997, pages 1 and 65.	
	NPL53	ROTH, Mark A. and Scott J. Van Horn, "Database Compression", SIGMOD Record, Vol. 22, No. 3, September 1993, pages 31-39.	
	NPL54	SCHMERKEN, Ivy, "Time Running Out for Old Technologies", Wall Street Computer Review, April 1990, pages 14-16, 23-24, 28, 56.	
	NPL55	"Scrolling News", Inside Market Data, February 27, 1995, 2 pages.	
	NPL56	SIMPSON, W., "PPP in HDLC-like Framing", Network Working Group Request for Comments: 1662, STD 51, Obsoletes 1549, Category: Standards Track, July 1994, 26 pages.	
	NPL57	SUCIU, Dan, Data Management on the Web, AT&T Labs, April 4, 2000, 52 slides.	
	NPL58	SUCIU, Dan, "Data Management on the Web: Abstract," University of Washington Computer Science & Engineering, April 4, 2000, 1 page.	
	NPL59	"Telekurs Buys S&P Trading Systems And Its Ticker III Feed", Inside Market Data, Vol. 4, No. 11, July 10, 1989, 1 page.	
	NPL60	"Telekurs May Debut 128 KPS Ticker By Year's End", Inside Market Data, July 18, 1994, 2 pages.	

Examiner Signature		Date Considered	
-----------------------	--	--------------------	--

\*EXAMINER: Initial if reference considered, whether or not citation is in conformance with MPEP 609. Draw line through citation if not in conformance and not considered. Include copy of this form with next communication to applicant.

<sup>1</sup> Applicant's unique citation designation number (optional). <sup>2</sup> Applicant is to place a check mark here if English language Translation is attached.

Substitute for form 1449/PTO			<b>Complete if Known</b>	
<b>INFORMATION DISCLOSURE STATEMENT BY APPLICANT</b> <i>(Use as many sheets as necessary)</i>			Application Number	14/135,926
			Filing Date	December 19, 2013
			First Named Inventor	FALLON et al.
			Art Unit	2634
			Examiner Name	BOCURE, Tesfaldet
			Attorney Docket Number	2855.0050008
Sheet	7	of	97	

NON PATENT LITERATURE DOCUMENTS			
Examiner Initials*	Cite No. <sup>1</sup>	Include name of the author (in CAPITAL LETTERS), title of the article (when appropriate), title of the item (book, magazine, journal, serial, symposium, catalog, etc.), date, page(s), volume number, publisher, city and/or country where published	T <sup>2</sup>
	NPL61	"Telekurs Now Carries All Dow Jones' News on 56-Kbps Ticker," Inside Market Data, December 20, 1993, 2 pages.	
	NPL62	"Telekurs Sells No. American Division in Mgmt. Buyout", Inside Market Data, October 23, 1995, 2 pages.	
	NPL63	"Telekurs to Launch New Int'l Feed/Internet Server", Wall Street & Technology, Volume 15, No. 1, January 1997, page 14.	
	NPL64	"The Technology Behind XpressFiles", Intelligent Compression Technologies, <a href="http://web.archive.org/web/19980518053634/ictcompress.com/technical_X.html">http://web.archive.org/web/19980518053634/ictcompress.com/technical_X.html</a> , 1998, 1 page.	
	NPL65	TID Information: Revisions to TID Program Since the Dawn of Time!!! Version 1.0, 23 pages; TID Codes 1, 1 page; TID Codes 2, 1 page, purportedly by July 19, 1995.	
	NPL66	TypeWorld: The First and Only Newspaper for Electronic Publishing, Volume 16 Number 9, June 17, 1992, 3 pages.	
	NPL67	"XpressFiles White Paper", Intelligent Compression Technologies, 1999-2001, 3 pages.	
	NPL68	United States Provisional Patent Application No. 60/309,218, filed July 31, 2001.	
	NPL69	Telekurs Manual, January 11, 1993, 184 pages.	
	NPL70	DANSKIN, et al., "Fast Higher Bandwidth X," Dartmouth College, Hanover, NH, 1995, 8 pages.	

Examiner Signature	Date Considered	
-----------------------	--------------------	--

\*EXAMINER: Initial if reference considered, whether or not citation is in conformance with MPEP 609. Draw line through citation if not in conformance and not considered. Include copy of this form with next communication to applicant.

<sup>1</sup> Applicant's unique citation designation number (optional). <sup>2</sup> Applicant is to place a check mark here if English language Translation is attached.

Substitute for form 1449/PTO				<b>Complete if Known</b>	
<b>INFORMATION DISCLOSURE STATEMENT BY APPLICANT</b> <i>(Use as many sheets as necessary)</i>				Application Number	14/135,926
				Filing Date	December 19, 2013
				First Named Inventor	FALLON et al.
				Art Unit	2634
				Examiner Name	BOCURE, Tesfaldet
Sheet	8	of	97	Attorney Docket Number	2855.0050008

NON PATENT LITERATURE DOCUMENTS			
Examiner Initials*	Cite No. <sup>1</sup>	Include name of the author (in CAPITAL LETTERS), title of the article (when appropriate), title of the item (book, magazine, journal, serial, symposium, catalog, etc.), date, page(s), volume number, publisher, city and/or country where published	T <sup>2</sup>
	NPL71	HOFFMAN, Roy, "Data Compression in Digital Systems," Digital Multimedia Standards Series, Chapman & Hall, 1997, 426 pages.	
	NPL72	Defendants' Invalidation Contentions, Realtime Data, LLC D/B/A IXO v. Morgan Stanley, et al., 6:09-cv-326-LED-JDL, 6:10-cv-248-LED-JDL, 6:10-cv-426-LED-JDL, Realtime Data, LLC D/B/A IXO v. CME Group Inc., et al., 6:09-cv-327-LED-JDL, 6:10-cv-246-LED-JDL, 6:10-cv-424-LED-JDL, Realtime Data, LLC D/B/A IXO v. Thomson Reuters Corp., et al., 6:09-cv-333-LED-JDL, 6:10-cv-247-LED-JDL, 6:10-cv-425-LED-JDL, United States District Court for the Eastern District of Texas Tyler Division, February 4, 2011, 34 pages.	
	NPL73	Appendix A, Obviousness Chart for U.S. Patent No. 7,777,651, not dated, Realtime Data, LLC D/B/A IXO v. Morgan Stanley, et al., 6:09-cv-326-LED-JDL, 6:10-cv-248-LED-JDL, 6:10-cv-426-LED-JDL, Realtime Data, LLC D/B/A IXO v. CME Group Inc., et al., 6:09-cv-327-LED-JDL, 6:10-cv-246-LED-JDL, 6:10-cv-424-LED-JDL, Realtime Data, LLC D/B/A IXO v. Thomson Reuters Corp., et al., 6:09-cv-333-LED-JDL, 6:10-cv-247-LED-JDL, 6:10-cv-425-LED-JDL, United States District Court for the Eastern District of Texas Tyler Division, February 4, 2011, 466 pages.	
	NPL74	Appendix B, § 112 Invalidation Arguments for U.S. Pat. No. 7,777,651, Realtime Data, LLC D/B/A IXO v. Morgan Stanley, et al., 6:09-cv-326-LED-JDL, 6:10-cv-248-LED-JDL, 6:10-cv-426-LED-JDL, Realtime Data, LLC D/B/A IXO v. CME Group Inc., et al., 6:09-cv-327-LED-JDL, 6:10-cv-246-LED-JDL, 6:10-cv-424-LED-JDL, Realtime Data, LLC D/B/A IXO v. Thomson Reuters Corp., et al., 6:09-cv-333-LED-JDL, 6:10-cv-247-LED-JDL, 6:10-cv-425-LED-JDL, United States District Court for the Eastern District of Texas Tyler Division, February 4, 2011, 75 pages.	
	NPL75	Exhibit 1, Prior Art Chart for U.S. Pat. No. 7,777,651, Realtime Data, LLC D/B/A IXO v. Morgan Stanley, et al., 6:09-cv-326-LED-JDL, 6:10-cv-248-LED-JDL, 6:10-cv-426-LED-JDL, Realtime Data, LLC D/B/A IXO v. CME Group Inc., et al., 6:09-cv-327-LED-JDL, 6:10-cv-246-LED-JDL, 6:10-cv-424-LED-JDL, Realtime Data, LLC D/B/A IXO v. Thomson Reuters Corp., et al., 6:09-cv-333-LED-JDL, 6:10-cv-247-LED-JDL, 6:10-cv-425-LED-JDL, United States District Court for the Eastern District of Texas Tyler Division, February 4, 2011, 161 pages, citing Aakre et al., U.S. Patent No. 4,956,808.	
	NPL76	Exhibit 2, Prior Art Chart for U.S. Pat. No. 7,777,651, Realtime Data, LLC D/B/A IXO v. Morgan Stanley, et al., 6:09-cv-326-LED-JDL, 6:10-cv-248-LED-JDL, 6:10-cv-426-LED-JDL, Realtime Data, LLC D/B/A IXO v. CME Group Inc., et al., 6:09-cv-327-LED-JDL, 6:10-cv-246-LED-JDL, 6:10-cv-424-LED-JDL, Realtime Data, LLC D/B/A IXO v. Thomson Reuters Corp., et al., 6:09-cv-333-LED-JDL, 6:10-cv-247-LED-JDL, 6:10-cv-425-LED-JDL, United States District Court for the Eastern District of Texas Tyler Division, February 4, 2011, 206 pages, citing Albert et al., U.S. Patent No. 5,907,801.	
Examiner Signature		Date Considered	

\*EXAMINER: Initial if reference considered, whether or not citation is in conformance with MPEP 609. Draw line through citation if not in conformance and not considered. Include copy of this form with next communication to applicant.  
<sup>1</sup> Applicant's unique citation designation number (optional). <sup>2</sup> Applicant is to place a check mark here if English language Translation is attached.



Substitute for form 1449/PTO				<b>Complete if Known</b>	
<b>INFORMATION DISCLOSURE STATEMENT BY APPLICANT</b> <i>(Use as many sheets as necessary)</i>				Application Number	14/135,926
				Filing Date	December 19, 2013
				First Named Inventor	FALLON et al.
				Art Unit	2634
				Examiner Name	BOCURE, Tesfaldet
Sheet	9	of	97	Attorney Docket Number	2855.0050008

NON PATENT LITERATURE DOCUMENTS			
Examiner Initials*	Cite No. <sup>1</sup>	Include name of the author (in CAPITAL LETTERS), title of the article (when appropriate), title of the item (book, magazine, journal, serial, symposium, catalog, etc.), date, page(s), volume number, publisher, city and/or country where published	T <sup>2</sup>
	NPL77	Exhibit 3, Prior Art Chart for U.S. Pat. No. 7,777,651, Realtime Data, LLC D/B/A IXO v. Morgan Stanley, et al., 6:09-cv-326-LED-JDL, 6:10-cv-248-LED-JDL, 6:10-cv-426-LED-JDL, Realtime Data, LLC D/B/A IXO v. CME Group Inc., et al., 6:09-cv-327-LED-JDL, 6:10-cv-246-LED-JDL, 6:10-cv-424-LED-JDL, Realtime Data, LLC D/B/A IXO v. Thomson Reuters Corp., et al., 6:09-cv-333-LED-JDL, 6:10-cv-247-LED-JDL, 6:10-cv-425-LED-JDL, United States District Court for the Eastern District of Texas Tyler Division, February 4, 2011, 95 pages, citing B. Andrews, P. Chou, M. Effros and R. Gray "A Mean-Removed Variation of Weighted Universal Vector Quantization for Image Coding," IEEE 0-8186-3392-1/93, 302-309 (1993).	
	NPL78	Exhibit 4, Prior Art Chart for U.S. Pat. No. 7,777,651, 144 pages, Realtime Data, LLC D/B/A IXO v. Morgan Stanley, et al., 6:09-cv-326-LED-JDL, 6:10-cv-248-LED-JDL, 6:10-cv-426-LED-JDL, Realtime Data, LLC D/B/A IXO v. CME Group Inc., et al., 6:09-cv-327-LED-JDL, 6:10-cv-246-LED-JDL, 6:10-cv-424-LED-JDL, Realtime Data, LLC D/B/A IXO v. Thomson Reuters Corp., et al., 6:09-cv-333-LED-JDL, 6:10-cv-247-LED-JDL, 6:10-cv-425-LED-JDL, United States District Court for the Eastern District of Texas Tyler Division, February 4, 2011, citing Barnes et al., U.S. Patent No. 6,792,151.	
	NPL79	Exhibit 5, Prior Art Chart for U.S. Pat. No. 7,777,651, 216 pages, Realtime Data, LLC D/B/A IXO v. Morgan Stanley, et al., 6:09-cv-326-LED-JDL, 6:10-cv-248-LED-JDL, 6:10-cv-426-LED-JDL, Realtime Data, LLC D/B/A IXO v. CME Group Inc., et al., 6:09-cv-327-LED-JDL, 6:10-cv-246-LED-JDL, 6:10-cv-424-LED-JDL, Realtime Data, LLC D/B/A IXO v. Thomson Reuters Corp., et al., 6:09-cv-333-LED-JDL, 6:10-cv-247-LED-JDL, 6:10-cv-425-LED-JDL, United States District Court for the Eastern District of Texas Tyler Division, February 4, 2011, citing Birdwell et al., U.S. Patent No. 6,032,197.	
	NPL80	Exhibit 6, Prior Art Chart for U.S. Pat. No. 7,777,651, 257 pages, Realtime Data, LLC D/B/A IXO v. Morgan Stanley, et al., 6:09-cv-326-LED-JDL, 6:10-cv-248-LED-JDL, 6:10-cv-426-LED-JDL, Realtime Data, LLC D/B/A IXO v. CME Group Inc., et al., 6:09-cv-327-LED-JDL, 6:10-cv-246-LED-JDL, 6:10-cv-424-LED-JDL, Realtime Data, LLC D/B/A IXO v. Thomson Reuters Corp., et al., 6:09-cv-333-LED-JDL, 6:10-cv-247-LED-JDL, 6:10-cv-425-LED-JDL, United States District Court for the Eastern District of Texas Tyler Division, February 4, 2011, citing Bledsoe, U.S. Patent No. 4,646,061.	
	NPL81	Exhibit 7, Prior Art Chart for U.S. Pat. No. 7,777,651, 169 pages, Realtime Data, LLC D/B/A IXO v. Morgan Stanley, et al., 6:09-cv-326-LED-JDL, 6:10-cv-248-LED-JDL, 6:10-cv-426-LED-JDL, Realtime Data, LLC D/B/A IXO v. CME Group Inc., et al., 6:09-cv-327-LED-JDL, 6:10-cv-246-LED-JDL, 6:10-cv-424-LED-JDL, Realtime Data, LLC D/B/A IXO v. Thomson Reuters Corp., et al., 6:09-cv-333-LED-JDL, 6:10-cv-247-LED-JDL, 6:10-cv-425-LED-JDL, United States District Court for the Eastern District of Texas Tyler Division, February 4, 2011, citing Brickman et al., U.S. Patent No. 4,499,499.	
Examiner Signature		Date Considered	

\*EXAMINER: Initial if reference considered, whether or not citation is in conformance with MPEP 609. Draw line through citation if not in conformance and not considered. Include copy of this form with next communication to applicant.  
<sup>1</sup> Applicant's unique citation designation number (optional). <sup>2</sup> Applicant is to place a check mark here if English language Translation is attached.

Substitute for form 1449/PTO			<b>Complete if Known</b>	
<b>INFORMATION DISCLOSURE STATEMENT BY APPLICANT</b> <i>(Use as many sheets as necessary)</i>			Application Number	14/135,926
			Filing Date	December 19, 2013
			First Named Inventor	FALLON et al.
			Art Unit	2634
			Examiner Name	BOCURE, Tesfaldet
			Attorney Docket Number	2855.0050008
Sheet	10	of	97	

NON PATENT LITERATURE DOCUMENTS			
Examiner Initials*	Cite No. <sup>1</sup>	Include name of the author (in CAPITAL LETTERS), title of the article (when appropriate), title of the item (book, magazine, journal, serial, symposium, catalog, etc.), date, page(s), volume number, publisher, city and/or country where published	T <sup>2</sup>
	NPL82	Exhibit 8, Prior Art Chart for U.S. Pat. No. 7,777,651, 396 pages, Realtime Data, LLC D/B/A IXO v. Morgan Stanley, et al., 6:09-cv-326-LED-JDL, 6:10-cv-248-LED-JDL, 6:10-cv-426-LED-JDL, Realtime Data, LLC D/B/A IXO v. CME Group Inc., et al., 6:09-cv-327-LED-JDL, 6:10-cv-246-LED-JDL, 6:10-cv-424-LED-JDL, Realtime Data, LLC D/B/A IXO v. Thomson Reuters Corp., et al., 6:09-cv-333-LED-JDL, 6:10-cv-247-LED-JDL, 6:10-cv-425-LED-JDL, United States District Court for the Eastern District of Texas Tyler Division, February 4, 2011, citing C. Bormann et al., "Robust Header Compression (ROHC)," Network Working Group Internet-Draft Sept. 18, 2000.	
	NPL83	Exhibit 9, Prior Art Chart for U.S. Pat. No. 7,777,651, 253 pages, Realtime Data, LLC D/B/A IXO v. Morgan Stanley, et al., 6:09-cv-326-LED-JDL, 6:10-cv-248-LED-JDL, 6:10-cv-426-LED-JDL, Realtime Data, LLC D/B/A IXO v. CME Group Inc., et al., 6:09-cv-327-LED-JDL, 6:10-cv-246-LED-JDL, 6:10-cv-424-LED-JDL, Realtime Data, LLC D/B/A IXO v. Thomson Reuters Corp., et al., 6:09-cv-333-LED-JDL, 6:10-cv-247-LED-JDL, 6:10-cv-425-LED-JDL, United States District Court for the Eastern District of Texas Tyler Division, February 4, 2011, citing Carr, U.S. Patent No. 5,293,379.	
	NPL84	Exhibit 10, Prior Art Chart for U.S. Pat. No. 7,777,651, 205 pages, Realtime Data, LLC D/B/A IXO v. Morgan Stanley, et al., 6:09-cv-326-LED-JDL, 6:10-cv-248-LED-JDL, 6:10-cv-426-LED-JDL, Realtime Data, LLC D/B/A IXO v. CME Group Inc., et al., 6:09-cv-327-LED-JDL, 6:10-cv-246-LED-JDL, 6:10-cv-424-LED-JDL, Realtime Data, LLC D/B/A IXO v. Thomson Reuters Corp., et al., 6:09-cv-333-LED-JDL, 6:10-cv-247-LED-JDL, 6:10-cv-425-LED-JDL, United States District Court for the Eastern District of Texas Tyler Division, February 4, 2011, citing Cellier et al., U.S. Patent No. 5,884,269.	
	NPL85	Exhibit 11, Prior Art Chart for U.S. Pat. No. 7,777,651, 181 pages, Realtime Data, LLC D/B/A IXO v. Morgan Stanley, et al., 6:09-cv-326-LED-JDL, 6:10-cv-248-LED-JDL, 6:10-cv-426-LED-JDL, Realtime Data, LLC D/B/A IXO v. CME Group Inc., et al., 6:09-cv-327-LED-JDL, 6:10-cv-246-LED-JDL, 6:10-cv-424-LED-JDL, Realtime Data, LLC D/B/A IXO v. Thomson Reuters Corp., et al., 6:09-cv-333-LED-JDL, 6:10-cv-247-LED-JDL, 6:10-cv-425-LED-JDL, United States District Court for the Eastern District of Texas Tyler Division, February 4, 2011, citing Chu, U.S. Patent Nos. 5,374,916 & 5,467,087.	
	NPL86	Exhibit 12, Prior Art Chart for U.S. Pat. No. 7,777,651, 175 pages, Realtime Data, LLC D/B/A IXO v. Morgan Stanley, et al., 6:09-cv-326-LED-JDL, 6:10-cv-248-LED-JDL, 6:10-cv-426-LED-JDL, Realtime Data, LLC D/B/A IXO v. CME Group Inc., et al., 6:09-cv-327-LED-JDL, 6:10-cv-246-LED-JDL, 6:10-cv-424-LED-JDL, Realtime Data, LLC D/B/A IXO v. Thomson Reuters Corp., et al., 6:09-cv-333-LED-JDL, 6:10-cv-247-LED-JDL, 6:10-cv-425-LED-JDL, United States District Court for the Eastern District of Texas Tyler Division, February 4, 2011, citing Cisco IOS Data Compression White Paper (Cisco Systems Inc., 1997).	

Examiner Signature		Date Considered	
-----------------------	--	--------------------	--

\*EXAMINER: Initial if reference considered, whether or not citation is in conformance with MPEP 609. Draw line through citation if not in conformance and not considered. Include copy of this form with next communication to applicant.

<sup>1</sup> Applicant's unique citation designation number (optional). <sup>2</sup> Applicant is to place a check mark here if English language Translation is attached.

Substitute for form 1449/PTO				<b>Complete if Known</b>	
<b>INFORMATION DISCLOSURE STATEMENT BY APPLICANT</b> <i>(Use as many sheets as necessary)</i>				Application Number	14/135,926
				Filing Date	December 19, 2013
				First Named Inventor	FALLON et al.
				Art Unit	2634
				Examiner Name	BOCURE, Tesfaldet
Sheet	11	of	97	Attorney Docket Number	2855.0050008

NON PATENT LITERATURE DOCUMENTS			
Examiner Initials*	Cite No. <sup>1</sup>	Include name of the author (in CAPITAL LETTERS), title of the article (when appropriate), title of the item (book, magazine, journal, serial, symposium, catalog, etc.), date, page(s), volume number, publisher, city and/or country where published	T <sup>2</sup>
	NPL87	Exhibit 13, Prior Art Chart for U.S. Pat. No. 7,777,651, 590 pages, Realtime Data, LLC D/B/A IXO v. Morgan Stanley, et al., 6:09-cv-326-LED-JDL, 6:10-cv-248-LED-JDL, 6:10-cv-426-LED-JDL, Realtime Data, LLC D/B/A IXO v. CME Group Inc., et al., 6:09-cv-327-LED-JDL, 6:10-cv-246-LED-JDL, 6:10-cv-424-LED-JDL, Realtime Data, LLC D/B/A IXO v. Thomson Reuters Corp., et al., 6:09-cv-333-LED-JDL, 6:10-cv-247-LED-JDL, 6:10-cv-425-LED-JDL, United States District Court for the Eastern District of Texas Tyler Division, February 4, 2011, citing Comstock - S&P ComStock Developers Guides (McGraw-Hill, 1994); Rich Barton, "S&P ComStock Network Character Set Definition" (February 10, 1995).	
	NPL88	Exhibit 14, Prior Art Chart for U.S. Pat. No. 7,777,651, 186 pages, Realtime Data, LLC D/B/A IXO v. Morgan Stanley, et al., 6:09-cv-326-LED-JDL, 6:10-cv-248-LED-JDL, 6:10-cv-426-LED-JDL, Realtime Data, LLC D/B/A IXO v. CME Group Inc., et al., 6:09-cv-327-LED-JDL, 6:10-cv-246-LED-JDL, 6:10-cv-424-LED-JDL, Realtime Data, LLC D/B/A IXO v. Thomson Reuters Corp., et al., 6:09-cv-333-LED-JDL, 6:10-cv-247-LED-JDL, 6:10-cv-425-LED-JDL, United States District Court for the Eastern District of Texas Tyler Division, February 4, 2011, citing D.J. Craft. "A fast hardware data compression algorithm and some algorithmic extensions," IBM J. Res. Develop. Vol. 42, No. 6 (November 1998).	
	NPL89	Exhibit 15, Prior Art Chart for U.S. Pat. No. 7,777,651, 142 pages, Realtime Data, LLC D/B/A IXO v. Morgan Stanley, et al., 6:09-cv-326-LED-JDL, 6:10-cv-248-LED-JDL, 6:10-cv-426-LED-JDL, Realtime Data, LLC D/B/A IXO v. CME Group Inc., et al., 6:09-cv-327-LED-JDL, 6:10-cv-246-LED-JDL, 6:10-cv-424-LED-JDL, Realtime Data, LLC D/B/A IXO v. Thomson Reuters Corp., et al., 6:09-cv-333-LED-JDL, 6:10-cv-247-LED-JDL, 6:10-cv-425-LED-JDL, United States District Court for the Eastern District of Texas Tyler Division, February 4, 2011, citing Deering, U.S. Patent No. 6,459,429.	
	NPL90	Exhibit 16, Prior Art Chart for U.S. Pat. No. 7,777,651, 284 pages, Realtime Data, LLC D/B/A IXO v. Morgan Stanley, et al., 6:09-cv-326-LED-JDL, 6:10-cv-248-LED-JDL, 6:10-cv-426-LED-JDL, Realtime Data, LLC D/B/A IXO v. CME Group Inc., et al., 6:09-cv-327-LED-JDL, 6:10-cv-246-LED-JDL, 6:10-cv-424-LED-JDL, Realtime Data, LLC D/B/A IXO v. Thomson Reuters Corp., et al., 6:09-cv-333-LED-JDL, 6:10-cv-247-LED-JDL, 6:10-cv-425-LED-JDL, United States District Court for the Eastern District of Texas Tyler Division, February 4, 2011, citing Dye et al., U.S. Patent No. 7,190,284 and International Publication No. WO 00/45516.	
	NPL91	Exhibit 17, Prior Art Chart for U.S. Pat. No. 7,777,651, 269 pages, Realtime Data, LLC D/B/A IXO v. Morgan Stanley, et al., 6:09-cv-326-LED-JDL, 6:10-cv-248-LED-JDL, 6:10-cv-426-LED-JDL, Realtime Data, LLC D/B/A IXO v. CME Group Inc., et al., 6:09-cv-327-LED-JDL, 6:10-cv-246-LED-JDL, 6:10-cv-424-LED-JDL, Realtime Data, LLC D/B/A IXO v. Thomson Reuters Corp., et al., 6:09-cv-333-LED-JDL, 6:10-cv-247-LED-JDL, 6:10-cv-425-LED-JDL, United States District Court for the Eastern District of Texas Tyler Division, February 4, 2011, citing Earl et al., U.S. Patent No. 5,341,440.	

Examiner Signature		Date Considered	
-----------------------	--	--------------------	--

\*EXAMINER: Initial if reference considered, whether or not citation is in conformance with MPEP 609. Draw line through citation if not in conformance and not considered. Include copy of this form with next communication to applicant.

<sup>1</sup> Applicant's unique citation designation number (optional). <sup>2</sup> Applicant is to place a check mark here if English language Translation is attached.

Substitute for form 1449/PTO			<b>Complete if Known</b>	
<b>INFORMATION DISCLOSURE STATEMENT BY APPLICANT</b> <i>(Use as many sheets as necessary)</i>			Application Number	14/135,926
			Filing Date	December 19, 2013
			First Named Inventor	FALLON et al.
			Art Unit	2634
			Examiner Name	BOCURE, Tesfaldet
			Attorney Docket Number	2855.0050008
Sheet	12	of	97	

NON PATENT LITERATURE DOCUMENTS			
Examiner Initials*	Cite No. <sup>1</sup>	Include name of the author (in CAPITAL LETTERS), title of the article (when appropriate), title of the item (book, magazine, journal, serial, symposium, catalog, etc.), date, page(s), volume number, publisher, city and/or country where published	T <sup>2</sup>
	NPL92	Exhibit 18, Prior Art Chart for U.S. Pat. No. 7,777,651, 132 pages, Realtime Data, LLC D/B/A IXO v. Morgan Stanley, et al., 6:09-cv-326-LED-JDL, 6:10-cv-248-LED-JDL, 6:10-cv-426-LED-JDL, Realtime Data, LLC D/B/A IXO v. CME Group Inc., et al., 6:09-cv-327-LED-JDL, 6:10-cv-246-LED-JDL, 6:10-cv-424-LED-JDL, Realtime Data, LLC D/B/A IXO v. Thomson Reuters Corp., et al., 6:09-cv-333-LED-JDL, 6:10-cv-247-LED-JDL, 6:10-cv-425-LED-JDL, United States District Court for the Eastern District of Texas Tyler Division, February 4, 2011, citing Eastman et al., U.S. Patent No. 4,464,650.	
	NPL93	Exhibit 19, Prior Art Chart for U.S. Pat. No. 7,777,651, 125 pages, Realtime Data, LLC D/B/A IXO v. Morgan Stanley, et al., 6:09-cv-326-LED-JDL, 6:10-cv-248-LED-JDL, 6:10-cv-426-LED-JDL, Realtime Data, LLC D/B/A IXO v. CME Group Inc., et al., 6:09-cv-327-LED-JDL, 6:10-cv-246-LED-JDL, 6:10-cv-424-LED-JDL, Realtime Data, LLC D/B/A IXO v. Thomson Reuters Corp., et al., 6:09-cv-333-LED-JDL, 6:10-cv-247-LED-JDL, 6:10-cv-425-LED-JDL, United States District Court for the Eastern District of Texas Tyler Division, February 4, 2011, citing Elgamal et al., U.S. Patent No. 5,410,671.	
	NPL94	Exhibit 20, Prior Art Chart for U.S. Pat. No. 7,777,651, 122 pages, Realtime Data, LLC D/B/A IXO v. Morgan Stanley, et al., 6:09-cv-326-LED-JDL, 6:10-cv-248-LED-JDL, 6:10-cv-426-LED-JDL, Realtime Data, LLC D/B/A IXO v. CME Group Inc., et al., 6:09-cv-327-LED-JDL, 6:10-cv-246-LED-JDL, 6:10-cv-424-LED-JDL, Realtime Data, LLC D/B/A IXO v. Thomson Reuters Corp., et al., 6:09-cv-333-LED-JDL, 6:10-cv-247-LED-JDL, 6:10-cv-425-LED-JDL, United States District Court for the Eastern District of Texas Tyler Division, February 4, 2011, citing Enari et al., EP 0493103.	
	NPL95	Exhibit 21, Prior Art Chart for U.S. Pat. No. 7,777,651, 379 pages, Realtime Data, LLC D/B/A IXO v. Morgan Stanley, et al., 6:09-cv-326-LED-JDL, 6:10-cv-248-LED-JDL, 6:10-cv-426-LED-JDL, Realtime Data, LLC D/B/A IXO v. CME Group Inc., et al., 6:09-cv-327-LED-JDL, 6:10-cv-246-LED-JDL, 6:10-cv-424-LED-JDL, Realtime Data, LLC D/B/A IXO v. Thomson Reuters Corp., et al., 6:09-cv-333-LED-JDL, 6:10-cv-247-LED-JDL, 6:10-cv-425-LED-JDL, United States District Court for the Eastern District of Texas Tyler Division, February 4, 2011, citing Fascenda, U.S. Patent No. 5,045,848.	
	NPL96	Exhibit 22, Prior Art Chart for U.S. Pat. No. 7,777,651, 218 pages, Realtime Data, LLC D/B/A IXO v. Morgan Stanley, et al., 6:09-cv-326-LED-JDL, 6:10-cv-248-LED-JDL, 6:10-cv-426-LED-JDL, Realtime Data, LLC D/B/A IXO v. CME Group Inc., et al., 6:09-cv-327-LED-JDL, 6:10-cv-246-LED-JDL, 6:10-cv-424-LED-JDL, Realtime Data, LLC D/B/A IXO v. Thomson Reuters Corp., et al., 6:09-cv-333-LED-JDL, 6:10-cv-247-LED-JDL, 6:10-cv-425-LED-JDL, United States District Court for the Eastern District of Texas Tyler Division, February 4, 2011, citing Frachtenberg et al., U.S. Patent. Pub. 2003/0030575.	

Examiner Signature		Date Considered	
-----------------------	--	--------------------	--

\*EXAMINER: Initial if reference considered, whether or not citation is in conformance with MPEP 609. Draw line through citation if not in conformance and not considered. Include copy of this form with next communication to applicant.

<sup>1</sup> Applicant's unique citation designation number (optional). <sup>2</sup> Applicant is to place a check mark here if English language Translation is attached.

Substitute for form 1449/PTO			<b>Complete if Known</b>	
<b>INFORMATION DISCLOSURE STATEMENT BY APPLICANT</b> <i>(Use as many sheets as necessary)</i>			Application Number	14/135,926
			Filing Date	December 19, 2013
			First Named Inventor	FALLON et al.
			Art Unit	2634
			Examiner Name	BOCURE, Tesfaldet
			Attorney Docket Number	2855.0050008
Sheet	13	of	97	

NON PATENT LITERATURE DOCUMENTS			
Examiner Initials*	Cite No. <sup>1</sup>	Include name of the author (in CAPITAL LETTERS), title of the article (when appropriate), title of the item (book, magazine, journal, serial, symposium, catalog, etc.), date, page(s), volume number, publisher, city and/or country where published	T <sup>2</sup>
	NPL97	Exhibit 23, Prior Art Chart for U.S. Pat. No. 7,777,651, 247 pages, Realtime Data, LLC D/B/A IXO v. Morgan Stanley, et al., 6:09-cv-326-LED-JDL, 6:10-cv-248-LED-JDL, 6:10-cv-426-LED-JDL, Realtime Data, LLC D/B/A IXO v. CME Group Inc., et al., 6:09-cv-327-LED-JDL, 6:10-cv-246-LED-JDL, 6:10-cv-424-LED-JDL, Realtime Data, LLC D/B/A IXO v. Thomson Reuters Corp., et al., 6:09-cv-333-LED-JDL, 6:10-cv-247-LED-JDL, 6:10-cv-425-LED-JDL, United States District Court for the Eastern District of Texas Tyler Division, February 4, 2011, citing Franaszek et al., U. S. Patent No. 5,870,036.	
	NPL98	Exhibit 24, Prior Art Chart for U.S. Pat. No. 7,777,651, 327 pages, Realtime Data, LLC D/B/A IXO v. Morgan Stanley, et al., 6:09-cv-326-LED-JDL, 6:10-cv-248-LED-JDL, 6:10-cv-426-LED-JDL, Realtime Data, LLC D/B/A IXO v. CME Group Inc., et al., 6:09-cv-327-LED-JDL, 6:10-cv-246-LED-JDL, 6:10-cv-424-LED-JDL, Realtime Data, LLC D/B/A IXO v. Thomson Reuters Corp., et al., 6:09-cv-333-LED-JDL, 6:10-cv-247-LED-JDL, 6:10-cv-425-LED-JDL, United States District Court for the Eastern District of Texas Tyler Division, February 4, 2011, citing French et al., U.S. Patent No. 5,794,229.	
	NPL99	Exhibit 25, Prior Art Chart for U.S. Pat. No. 7,777,651, 225 pages, Exhibit 24, Prior Art Chart for U.S. Pat. No. 7,777,651, 327 pages, Realtime Data, LLC D/B/A IXO v. Morgan Stanley, et al., 6:09-cv-326-LED-JDL, 6:10-cv-248-LED-JDL, 6:10-cv-426-LED-JDL, Realtime Data, LLC D/B/A IXO v. CME Group Inc., et al., 6:09-cv-327-LED-JDL, 6:10-cv-246-LED-JDL, 6:10-cv-424-LED-JDL, Realtime Data, LLC D/B/A IXO v. Thomson Reuters Corp., et al., 6:09-cv-333-LED-JDL, 6:10-cv-247-LED-JDL, 6:10-cv-425-LED-JDL, United States District Court for the Eastern District of Texas Tyler Division, February 4, 2011, citing Geiger et al., U.S. Patent No. 5,987,022.	
	NPL100	Exhibit 26, Prior Art Chart for U.S. Pat. No. 7,777,651, 219 pages, Realtime Data, LLC D/B/A IXO v. Morgan Stanley, et al., 6:09-cv-326-LED-JDL, 6:10-cv-248-LED-JDL, 6:10-cv-426-LED-JDL, Realtime Data, LLC D/B/A IXO v. CME Group Inc., et al., 6:09-cv-327-LED-JDL, 6:10-cv-246-LED-JDL, 6:10-cv-424-LED-JDL, Realtime Data, LLC D/B/A IXO v. Thomson Reuters Corp., et al., 6:09-cv-333-LED-JDL, 6:10-cv-247-LED-JDL, 6:10-cv-425-LED-JDL, United States District Court for the Eastern District of Texas Tyler Division, February 4, 2011, citing Gentile, U.S. Patent No. 5,504,842.	
	NPL101	Exhibit 27, Prior Art Chart for U.S. Pat. No. 7,777,651, Realtime Data, LLC D/B/A IXO v. Morgan Stanley, et al., 6:09-cv-326-LED-JDL, 6:10-cv-248-LED-JDL, 6:10-cv-426-LED-JDL, Realtime Data, LLC D/B/A IXO v. CME Group Inc., et al., 6:09-cv-327-LED-JDL, 6:10-cv-246-LED-JDL, 6:10-cv-424-LED-JDL, Realtime Data, LLC D/B/A IXO v. Thomson Reuters Corp., et al., 6:09-cv-333-LED-JDL, 6:10-cv-247-LED-JDL, 6:10-cv-425-LED-JDL, United States District Court for the Eastern District of Texas Tyler Division, February 4, 2011, 167 pages, citing Giltner et al., U.S. Patent No. 4,386,416.	

Examiner Signature	Date Considered	
--------------------	-----------------	--

\*EXAMINER: Initial if reference considered, whether or not citation is in conformance with MPEP 609. Draw line through citation if not in conformance and not considered. Include copy of this form with next communication to applicant.

<sup>1</sup> Applicant's unique citation designation number (optional). <sup>2</sup> Applicant is to place a check mark here if English language Translation is attached.

Substitute for form 1449/PTO			<b>Complete if Known</b>	
<b>INFORMATION DISCLOSURE STATEMENT BY APPLICANT</b> <i>(Use as many sheets as necessary)</i>			Application Number	14/135,926
			Filing Date	December 19, 2013
			First Named Inventor	FALLON et al.
			Art Unit	2634
			Examiner Name	BOCURE, Tesfaldet
			Attorney Docket Number	2855.0050008
Sheet	14	of	97	

NON PATENT LITERATURE DOCUMENTS			
Examiner Initials*	Cite No. <sup>1</sup>	Include name of the author (in CAPITAL LETTERS), title of the article (when appropriate), title of the item (book, magazine, journal, serial, symposium, catalog, etc.), date, page(s), volume number, publisher, city and/or country where published	T <sup>2</sup>
	NPL102	Exhibit 28, Prior Art Chart for U.S. Pat. No. 7,777,651, 156 pages, Realtime Data, LLC D/B/A IXO v. Morgan Stanley, et al., 6:09-cv-326-LED-JDL, 6:10-cv-248-LED-JDL, 6:10-cv-426-LED-JDL, Realtime Data, LLC D/B/A IXO v. CME Group Inc., et al., 6:09-cv-327-LED-JDL, 6:10-cv-246-LED-JDL, 6:10-cv-424-LED-JDL, Realtime Data, LLC D/B/A IXO v. Thomson Reuters Corp., et al., 6:09-cv-333-LED-JDL, 6:10-cv-247-LED-JDL, 6:10-cv-425-LED-JDL, United States District Court for the Eastern District of Texas Tyler Division, February 4, 2011, citing Gooch, U.S. Patent No. 4,325,085.	
	NPL103	Exhibit 29, Prior Art Chart for U.S. Pat. No. 7,777,651, 132 pages, Realtime Data, LLC D/B/A IXO v. Morgan Stanley, et al., 6:09-cv-326-LED-JDL, 6:10-cv-248-LED-JDL, 6:10-cv-426-LED-JDL, Realtime Data, LLC D/B/A IXO v. CME Group Inc., et al., 6:09-cv-327-LED-JDL, 6:10-cv-246-LED-JDL, 6:10-cv-424-LED-JDL, Realtime Data, LLC D/B/A IXO v. Thomson Reuters Corp., et al., 6:09-cv-333-LED-JDL, 6:10-cv-247-LED-JDL, 6:10-cv-425-LED-JDL, United States District Court for the Eastern District of Texas Tyler Division, February 4, 2011, citing Hauck, U.S. Patent No. 4,626,829.	
	NPL104	Exhibit 30, Prior Art Chart for U.S. Pat. No. 7,777,651, 161 pages, Realtime Data, LLC D/B/A IXO v. Morgan Stanley, et al., 6:09-cv-326-LED-JDL, 6:10-cv-248-LED-JDL, 6:10-cv-426-LED-JDL, Realtime Data, LLC D/B/A IXO v. CME Group Inc., et al., 6:09-cv-327-LED-JDL, 6:10-cv-246-LED-JDL, 6:10-cv-424-LED-JDL, Realtime Data, LLC D/B/A IXO v. Thomson Reuters Corp., et al., 6:09-cv-333-LED-JDL, 6:10-cv-247-LED-JDL, 6:10-cv-425-LED-JDL, United States District Court for the Eastern District of Texas Tyler Division, February 4, 2011, citing Heath, U.S. Patent No. 5,955,976.	
	NPL105	Exhibit 31, Prior Art Chart for U.S. Pat. No. 7,777,651, 359 pages, Realtime Data, LLC D/B/A IXO v. Morgan Stanley, et al., 6:09-cv-326-LED-JDL, 6:10-cv-248-LED-JDL, 6:10-cv-426-LED-JDL, Realtime Data, LLC D/B/A IXO v. CME Group Inc., et al., 6:09-cv-327-LED-JDL, 6:10-cv-246-LED-JDL, 6:10-cv-424-LED-JDL, Realtime Data, LLC D/B/A IXO v. Thomson Reuters Corp., et al., 6:09-cv-333-LED-JDL, 6:10-cv-247-LED-JDL, 6:10-cv-425-LED-JDL, United States District Court for the Eastern District of Texas Tyler Division, February 4, 2011, citing Hewlett-Packard Company, "Installing and Administering PPP," B2355-90137, HP 9000 Networking, E0948 (1st Ed. 1997).	
	NPL106	Exhibit 32, Prior Art Chart for U.S. Pat. No. 7,777,651, 229 pages, Realtime Data, LLC D/B/A IXO v. Morgan Stanley, et al., 6:09-cv-326-LED-JDL, 6:10-cv-248-LED-JDL, 6:10-cv-426-LED-JDL, Realtime Data, LLC D/B/A IXO v. CME Group Inc., et al., 6:09-cv-327-LED-JDL, 6:10-cv-246-LED-JDL, 6:10-cv-424-LED-JDL, Realtime Data, LLC D/B/A IXO v. Thomson Reuters Corp., et al., 6:09-cv-333-LED-JDL, 6:10-cv-247-LED-JDL, 6:10-cv-425-LED-JDL, United States District Court for the Eastern District of Texas Tyler Division, February 4, 2011, citing Hsu & Zwarico, Automatic Synthesis of Compression Techniques for Heterogeneous Files, Software-Practice & Experience, vol. 25(10), pp.1097-1116 (October 1995).	

Examiner Signature		Date Considered	
-----------------------	--	--------------------	--

\*EXAMINER: Initial if reference considered, whether or not citation is in conformance with MPEP 609. Draw line through citation if not in conformance and not considered. Include copy of this form with next communication to applicant.

<sup>1</sup> Applicant's unique citation designation number (optional). <sup>2</sup> Applicant is to place a check mark here if English language Translation is attached.

Substitute for form 1449/PTO			<i>Complete if Known</i>		
<b>INFORMATION DISCLOSURE STATEMENT BY APPLICANT</b> <i>(Use as many sheets as necessary)</i>			Application Number	14/135,926	
			Filing Date	December 19, 2013	
			First Named Inventor	FALLON et al.	
			Art Unit	2634	
			Examiner Name	BOCURE, Tesfaldet	
Sheet	15	of	97	Attorney Docket Number	2855.0050008

NON PATENT LITERATURE DOCUMENTS			
Examiner Initials*	Cite No. <sup>1</sup>	Include name of the author (in CAPITAL LETTERS), title of the article (when appropriate), title of the item (book, magazine, journal, serial, symposium, catalog, etc.), date, page(s), volume number, publisher, city and/or country where published	T <sup>2</sup>
	NPL107	Exhibit 33, Prior Art Chart for U.S. Pat. No. 7,777,651, 206 pages, Realtime Data, LLC D/B/A IXO v. Morgan Stanley, et al., 6:09-cv-326-LED-JDL, 6:10-cv-248-LED-JDL, 6:10-cv-426-LED-JDL, Realtime Data, LLC D/B/A IXO v. CME Group Inc., et al., 6:09-cv-327-LED-JDL, 6:10-cv-246-LED-JDL, 6:10-cv-424-LED-JDL, Realtime Data, LLC D/B/A IXO v. Thomson Reuters Corp., et al., 6:09-cv-333-LED-JDL, 6:10-cv-247-LED-JDL, 6:10-cv-425-LED-JDL, United States District Court for the Eastern District of Texas Tyler Division, February 4, 2011, citing ICT XML-Xpress White Paper (Intelligent Compression Technologies Inc., 2000) & website.	
	NPL108	Exhibit 34, Prior Art Chart for U.S. Pat. No. 7,777,651, 138 pages, Realtime Data, LLC D/B/A IXO v. Morgan Stanley, et al., 6:09-cv-326-LED-JDL, 6:10-cv-248-LED-JDL, 6:10-cv-426-LED-JDL, Realtime Data, LLC D/B/A IXO v. CME Group Inc., et al., 6:09-cv-327-LED-JDL, 6:10-cv-246-LED-JDL, 6:10-cv-424-LED-JDL, Realtime Data, LLC D/B/A IXO v. Thomson Reuters Corp., et al., 6:09-cv-333-LED-JDL, 6:10-cv-247-LED-JDL, 6:10-cv-425-LED-JDL, United States District Court for the Eastern District of Texas Tyler Division, February 4, 2011, citing ICT XpressFiles White Paper (Intelligent Compression Technologies Inc., 1999) & website.	
	NPL109	Exhibit 35, Prior Art Chart for U.S. Pat. No. 7,777,651, 128 pages, Realtime Data, LLC D/B/A IXO v. Morgan Stanley, et al., 6:09-cv-326-LED-JDL, 6:10-cv-248-LED-JDL, 6:10-cv-426-LED-JDL, Realtime Data, LLC D/B/A IXO v. CME Group Inc., et al., 6:09-cv-327-LED-JDL, 6:10-cv-246-LED-JDL, 6:10-cv-424-LED-JDL, Realtime Data, LLC D/B/A IXO v. Thomson Reuters Corp., et al., 6:09-cv-333-LED-JDL, 6:10-cv-247-LED-JDL, 6:10-cv-425-LED-JDL, United States District Court for the Eastern District of Texas Tyler Division, February 4, 2011, citing Iseda et al., E.P. 0405572 A2.	
	NPL110	Exhibit 36, Prior Art Chart for U.S. Pat. No. 7,777,651, 205 pages, Realtime Data, LLC D/B/A IXO v. Morgan Stanley, et al., 6:09-cv-326-LED-JDL, 6:10-cv-248-LED-JDL, 6:10-cv-426-LED-JDL, Realtime Data, LLC D/B/A IXO v. CME Group Inc., et al., 6:09-cv-327-LED-JDL, 6:10-cv-246-LED-JDL, 6:10-cv-424-LED-JDL, Realtime Data, LLC D/B/A IXO v. Thomson Reuters Corp., et al., 6:09-cv-333-LED-JDL, 6:10-cv-247-LED-JDL, 6:10-cv-425-LED-JDL, United States District Court for the Eastern District of Texas Tyler Division, February 4, 2011, citing J. Danskin, "Compressing the X Graphics Protocol," Princeton University (Jan. 1995).	
	NPL111	Exhibit 37, Prior Art Chart for U.S. Pat. No. 7,777,651, 159 pages, Realtime Data, LLC D/B/A IXO v. Morgan Stanley, et al., 6:09-cv-326-LED-JDL, 6:10-cv-248-LED-JDL, 6:10-cv-426-LED-JDL, Realtime Data, LLC D/B/A IXO v. CME Group Inc., et al., 6:09-cv-327-LED-JDL, 6:10-cv-246-LED-JDL, 6:10-cv-424-LED-JDL, Realtime Data, LLC D/B/A IXO v. Thomson Reuters Corp., et al., 6:09-cv-333-LED-JDL, 6:10-cv-247-LED-JDL, 6:10-cv-425-LED-JDL, United States District Court for the Eastern District of Texas Tyler Division, February 4, 2011, citing Kalkstein, U.S. Patent No. 5,945,933.	

Examiner Signature	Date Considered	
-----------------------	--------------------	--

\*EXAMINER: Initial if reference considered, whether or not citation is in conformance with MPEP 609. Draw line through citation if not in conformance and not considered. Include copy of this form with next communication to applicant.

<sup>1</sup> Applicant's unique citation designation number (optional). <sup>2</sup> Applicant is to place a check mark here if English language Translation is attached.

Substitute for form 1449/PTO				<b>Complete if Known</b>	
<b>INFORMATION DISCLOSURE STATEMENT BY APPLICANT</b> <i>(Use as many sheets as necessary)</i>				Application Number	14/135,926
				Filing Date	December 19, 2013
				First Named Inventor	FALLON et al.
				Art Unit	2634
				Examiner Name	BOCURE, Tesfaldet
				Attorney Docket Number	2855.0050008
Sheet	16	of	97		

NON PATENT LITERATURE DOCUMENTS			
Examiner Initials*	Cite No. <sup>1</sup>	Include name of the author (in CAPITAL LETTERS), title of the article (when appropriate), title of the item (book, magazine, journal, serial, symposium, catalog, etc.), date, page(s), volume number, publisher, city and/or country where published	T <sup>2</sup>
	NPL112	Exhibit 38, Prior Art Chart for U.S. Pat. No. 7,777,651, 402 pages, Realtime Data, LLC D/B/A IXO v. Morgan Stanley, et al., 6:09-cv-326-LED-JDL, 6:10-cv-248-LED-JDL, 6:10-cv-426-LED-JDL, Realtime Data, LLC D/B/A IXO v. CME Group Inc., et al., 6:09-cv-327-LED-JDL, 6:10-cv-246-LED-JDL, 6:10-cv-424-LED-JDL, Realtime Data, LLC D/B/A IXO v. Thomson Reuters Corp., et al., 6:09-cv-333-LED-JDL, 6:10-cv-247-LED-JDL, 6:10-cv-425-LED-JDL, United States District Court for the Eastern District of Texas Tyler Division, February 4, 2011, citing Kari, U.S. Patent No. 6,434,168; International Publication No. WO97/48212 A1.	
	NPL113	Exhibit 39, Prior Art Chart for U.S. Pat. No. 7,777,651, 209 pages, Realtime Data, LLC D/B/A IXO v. Morgan Stanley, et al., 6:09-cv-326-LED-JDL, 6:10-cv-248-LED-JDL, 6:10-cv-426-LED-JDL, Realtime Data, LLC D/B/A IXO v. CME Group Inc., et al., 6:09-cv-327-LED-JDL, 6:10-cv-246-LED-JDL, 6:10-cv-424-LED-JDL, Realtime Data, LLC D/B/A IXO v. Thomson Reuters Corp., et al., 6:09-cv-333-LED-JDL, 6:10-cv-247-LED-JDL, 6:10-cv-425-LED-JDL, United States District Court for the Eastern District of Texas Tyler Division, February 4, 2011, citing Koopmas et al., U.S. Patent No. 7,024,460.	
	NPL114	Exhibit 40, Prior Art Chart for U.S. Pat. No. 7,777,651, 214 pages, Realtime Data, LLC D/B/A IXO v. Morgan Stanley, et al., 6:09-cv-326-LED-JDL, 6:10-cv-248-LED-JDL, 6:10-cv-426-LED-JDL, Realtime Data, LLC D/B/A IXO v. CME Group Inc., et al., 6:09-cv-327-LED-JDL, 6:10-cv-246-LED-JDL, 6:10-cv-424-LED-JDL, Realtime Data, LLC D/B/A IXO v. Thomson Reuters Corp., et al., 6:09-cv-333-LED-JDL, 6:10-cv-247-LED-JDL, 6:10-cv-425-LED-JDL, United States District Court for the Eastern District of Texas Tyler Division, February 4, 2011, citing Kopf, U.S. Patent No. 5,825,830.	
	NPL115	Exhibit 41, Prior Art Chart for U.S. Pat. No. 7,777,651, 281 pages, Realtime Data, LLC D/B/A IXO v. Morgan Stanley, et al., 6:09-cv-326-LED-JDL, 6:10-cv-248-LED-JDL, 6:10-cv-426-LED-JDL, Realtime Data, LLC D/B/A IXO v. CME Group Inc., et al., 6:09-cv-327-LED-JDL, 6:10-cv-246-LED-JDL, 6:10-cv-424-LED-JDL, Realtime Data, LLC D/B/A IXO v. Thomson Reuters Corp., et al., 6:09-cv-333-LED-JDL, 6:10-cv-247-LED-JDL, 6:10-cv-425-LED-JDL, United States District Court for the Eastern District of Texas Tyler Division, February 4, 2011, citing Kopf, U.S. Patent No. 5,825,830.	
	NPL116	Exhibit 42, Prior Art Chart for U.S. Pat. No. 7,777,651, 340 pages, Realtime Data, LLC D/B/A IXO v. Morgan Stanley, et al., 6:09-cv-326-LED-JDL, 6:10-cv-248-LED-JDL, 6:10-cv-426-LED-JDL, Realtime Data, LLC D/B/A IXO v. CME Group Inc., et al., 6:09-cv-327-LED-JDL, 6:10-cv-246-LED-JDL, 6:10-cv-424-LED-JDL, Realtime Data, LLC D/B/A IXO v. Thomson Reuters Corp., et al., 6:09-cv-333-LED-JDL, 6:10-cv-247-LED-JDL, 6:10-cv-425-LED-JDL, United States District Court for the Eastern District of Texas Tyler Division, February 4, 2011, citing Lane et al., U.S. Patent No. 5,521,940.	

Examiner Signature	Date Considered
--------------------	-----------------

\*EXAMINER: Initial if reference considered, whether or not citation is in conformance with MPEP 609. Draw line through citation if not in conformance and not considered. Include copy of this form with next communication to applicant.

<sup>1</sup> Applicant's unique citation designation number (optional). <sup>2</sup> Applicant is to place a check mark here if English language Translation is attached.



Substitute for form 1449/PTO				<b>Complete if Known</b>	
<b>INFORMATION DISCLOSURE STATEMENT BY APPLICANT</b> <i>(Use as many sheets as necessary)</i>				Application Number	14/135,926
				Filing Date	December 19, 2013
				First Named Inventor	FALLON et al.
				Art Unit	2634
				Examiner Name	BOCURE, Tesfaldet
				Attorney Docket Number	2855.0050008
Sheet	17	of	97		

NON PATENT LITERATURE DOCUMENTS			
Examiner Initials*	Cite No. <sup>1</sup>	Include name of the author (in CAPITAL LETTERS), title of the article (when appropriate), title of the item (book, magazine, journal, serial, symposium, catalog, etc.), date, page(s), volume number, publisher, city and/or country where published	T <sup>2</sup>
	NPL117	Exhibit 43, Prior Art Chart for U.S. Pat. No. 7,777,651, 164 pages, Realtime Data, LLC D/B/A IXO v. Morgan Stanley, et al., 6:09-cv-326-LED-JDL, 6:10-cv-248-LED-JDL, 6:10-cv-426-LED-JDL, Realtime Data, LLC D/B/A IXO v. CME Group Inc., et al., 6:09-cv-327-LED-JDL, 6:10-cv-246-LED-JDL, 6:10-cv-424-LED-JDL, Realtime Data, LLC D/B/A IXO v. Thomson Reuters Corp., et al., 6:09-cv-333-LED-JDL, 6:10-cv-247-LED-JDL, 6:10-cv-425-LED-JDL, United States District Court for the Eastern District of Texas Tyler Division, February 4, 2011, citing Langdon, Jr. et al., U.S. Patent No. 4,494,108.	
	NPL118	Exhibit 44, Prior Art Chart for U.S. Pat. No. 7,777,651, 211 pages, Realtime Data, LLC D/B/A IXO v. Morgan Stanley, et al., 6:09-cv-326-LED-JDL, 6:10-cv-248-LED-JDL, 6:10-cv-426-LED-JDL, Realtime Data, LLC D/B/A IXO v. CME Group Inc., et al., 6:09-cv-327-LED-JDL, 6:10-cv-246-LED-JDL, 6:10-cv-424-LED-JDL, Realtime Data, LLC D/B/A IXO v. Thomson Reuters Corp., et al., 6:09-cv-333-LED-JDL, 6:10-cv-247-LED-JDL, 6:10-cv-425-LED-JDL, United States District Court for the Eastern District of Texas Tyler Division, February 4, 2011, citing Lavallee, U.S. Patent No. 6,215,904.	
	NPL119	Exhibit 45, Prior Art Chart for U.S. Pat. No. 7,777,651, 103 pages, Realtime Data, LLC D/B/A IXO v. Morgan Stanley, et al., 6:09-cv-326-LED-JDL, 6:10-cv-248-LED-JDL, 6:10-cv-426-LED-JDL, Realtime Data, LLC D/B/A IXO v. CME Group Inc., et al., 6:09-cv-327-LED-JDL, 6:10-cv-246-LED-JDL, 6:10-cv-424-LED-JDL, Realtime Data, LLC D/B/A IXO v. Thomson Reuters Corp., et al., 6:09-cv-333-LED-JDL, 6:10-cv-247-LED-JDL, 6:10-cv-425-LED-JDL, United States District Court for the Eastern District of Texas Tyler Division, February 4, 2011, citing M. Effros, P. Chou & R.M. Gray. "Variable Dimension Weighted Universal Vector Quantization and Noiseless Coding," IEEE 1068-0314/94 (1994).	
	NPL120	Exhibit 46, Prior Art Chart for U.S. Pat. No. 7,777,651, 414 pages, Realtime Data, LLC D/B/A IXO v. Morgan Stanley, et al., 6:09-cv-326-LED-JDL, 6:10-cv-248-LED-JDL, 6:10-cv-426-LED-JDL, Realtime Data, LLC D/B/A IXO v. CME Group Inc., et al., 6:09-cv-327-LED-JDL, 6:10-cv-246-LED-JDL, 6:10-cv-424-LED-JDL, Realtime Data, LLC D/B/A IXO v. Thomson Reuters Corp., et al., 6:09-cv-333-LED-JDL, 6:10-cv-247-LED-JDL, 6:10-cv-425-LED-JDL, United States District Court for the Eastern District of Texas Tyler Division, February 4, 2011, citing MacCrisken, U.S. Patent No. 4,730,348.	
	NPL121	Exhibit 47, Prior Art Chart for U.S. Pat. No. 7,777,651, 319 pages, Realtime Data, LLC D/B/A IXO v. Morgan Stanley, et al., 6:09-cv-326-LED-JDL, 6:10-cv-248-LED-JDL, 6:10-cv-426-LED-JDL, Realtime Data, LLC D/B/A IXO v. CME Group Inc., et al., 6:09-cv-327-LED-JDL, 6:10-cv-246-LED-JDL, 6:10-cv-424-LED-JDL, Realtime Data, LLC D/B/A IXO v. Thomson Reuters Corp., et al., 6:09-cv-333-LED-JDL, 6:10-cv-247-LED-JDL, 6:10-cv-425-LED-JDL, United States District Court for the Eastern District of Texas Tyler Division, February 4, 2011, citing Madany et al., U.S. Patent No. 5,774,715.	
Examiner Signature		Date Considered	

\*EXAMINER: Initial if reference considered, whether or not citation is in conformance with MPEP 609. Draw line through citation if not in conformance and not considered. Include copy of this form with next communication to applicant.

<sup>1</sup> Applicant's unique citation designation number (optional). <sup>2</sup> Applicant is to place a check mark here if English language Translation is attached.

Substitute for form 1449/PTO			<b>Complete if Known</b>	
<b>INFORMATION DISCLOSURE STATEMENT BY APPLICANT</b> <i>(Use as many sheets as necessary)</i>			Application Number	14/135,926
			Filing Date	December 19, 2013
			First Named Inventor	FALLON et al.
			Art Unit	2634
			Examiner Name	BOCURE, Tesfaldet
			Attorney Docket Number	2855.0050008
Sheet	18	of	97	

NON PATENT LITERATURE DOCUMENTS			
Examiner Initials*	Cite No. <sup>1</sup>	Include name of the author (in CAPITAL LETTERS), title of the article (when appropriate), title of the item (book, magazine, journal, serial, symposium, catalog, etc.), date, page(s), volume number, publisher, city and/or country where published	T <sup>2</sup>
	NPL122	Exhibit 48, Prior Art Chart for U.S. Pat. No. 7,777,651, 228 pages, Realtime Data, LLC D/B/A IXO v. Morgan Stanley, et al., 6:09-cv-326-LED-JDL, 6:10-cv-248-LED-JDL, 6:10-cv-426-LED-JDL, Realtime Data, LLC D/B/A IXO v. CME Group Inc., et al., 6:09-cv-327-LED-JDL, 6:10-cv-246-LED-JDL, 6:10-cv-424-LED-JDL, Realtime Data, LLC D/B/A IXO v. Thomson Reuters Corp., et al., 6:09-cv-333-LED-JDL, 6:10-cv-247-LED-JDL, 6:10-cv-425-LED-JDL, United States District Court for the Eastern District of Texas Tyler Division, February 4, 2011, citing Mark A. Roth and Scott J. Van Horn, "Database Compression" SIGMOD Record, Vol. 22, No. 3 (1993).	
	NPL123	Exhibit 49, Prior Art Chart for U.S. Pat. No. 7,777,651, 235 pages, Realtime Data, LLC D/B/A IXO v. Morgan Stanley, et al., 6:09-cv-326-LED-JDL, 6:10-cv-248-LED-JDL, 6:10-cv-426-LED-JDL, Realtime Data, LLC D/B/A IXO v. CME Group Inc., et al., 6:09-cv-327-LED-JDL, 6:10-cv-246-LED-JDL, 6:10-cv-424-LED-JDL, Realtime Data, LLC D/B/A IXO v. Thomson Reuters Corp., et al., 6:09-cv-333-LED-JDL, 6:10-cv-247-LED-JDL, 6:10-cv-425-LED-JDL, United States District Court for the Eastern District of Texas Tyler Division, February 4, 2011, citing Miller et al., U.S. Patent No. 4,814,746.	
	NPL124	Exhibit 50, Prior Art Chart for U.S. Pat. No. 7,777,651, 172 pages, Realtime Data, LLC D/B/A IXO v. Morgan Stanley, et al., 6:09-cv-326-LED-JDL, 6:10-cv-248-LED-JDL, 6:10-cv-426-LED-JDL, Realtime Data, LLC D/B/A IXO v. CME Group Inc., et al., 6:09-cv-327-LED-JDL, 6:10-cv-246-LED-JDL, 6:10-cv-424-LED-JDL, Realtime Data, LLC D/B/A IXO v. Thomson Reuters Corp., et al., 6:09-cv-333-LED-JDL, 6:10-cv-247-LED-JDL, 6:10-cv-425-LED-JDL, United States District Court for the Eastern District of Texas Tyler Division, February 4, 2011, citing O'Brien et al., U.S. Patent No. 4,929,946.	
	NPL125	Exhibit 51, Prior Art Chart for U.S. Pat. No. 7,777,651, 30 pages, Realtime Data, LLC D/B/A IXO v. Morgan Stanley, et al., 6:09-cv-326-LED-JDL, 6:10-cv-248-LED-JDL, 6:10-cv-426-LED-JDL, Realtime Data, LLC D/B/A IXO v. CME Group Inc., et al., 6:09-cv-327-LED-JDL, 6:10-cv-246-LED-JDL, 6:10-cv-424-LED-JDL, Realtime Data, LLC D/B/A IXO v. Thomson Reuters Corp., et al., 6:09-cv-333-LED-JDL, 6:10-cv-247-LED-JDL, 6:10-cv-425-LED-JDL, United States District Court for the Eastern District of Texas Tyler Division, February 4, 2011, citing Osler et al., U.S. Patent No. 6,768,749.	
	NPL126	Exhibit 52, Prior Art Chart for U.S. Pat. No. 7,777,651, 103 pages, Realtime Data, LLC D/B/A IXO v. Morgan Stanley, et al., 6:09-cv-326-LED-JDL, 6:10-cv-248-LED-JDL, 6:10-cv-426-LED-JDL, Realtime Data, LLC D/B/A IXO v. CME Group Inc., et al., 6:09-cv-327-LED-JDL, 6:10-cv-246-LED-JDL, 6:10-cv-424-LED-JDL, Realtime Data, LLC D/B/A IXO v. Thomson Reuters Corp., et al., 6:09-cv-333-LED-JDL, 6:10-cv-247-LED-JDL, 6:10-cv-425-LED-JDL, United States District Court for the Eastern District of Texas Tyler Division, February 4, 2011, citing P. G. Howard, F. Kossenti, S. Forchammer, and W. J. Rucklidge [1998]. "The Emerging JBIG2 Standard", IEEE Transactions On Circuits And Systems For Video Technology 8:7, 838-848.	
Examiner Signature		Date Considered	

\*EXAMINER: Initial if reference considered, whether or not citation is in conformance with MPEP 609. Draw line through citation if not in conformance and not considered. Include copy of this form with next communication to applicant.

<sup>1</sup> Applicant's unique citation designation number (optional). <sup>2</sup> Applicant is to place a check mark here if English language Translation is attached.

Substitute for form 1449/PTO			<b>Complete if Known</b>	
<b>INFORMATION DISCLOSURE STATEMENT BY APPLICANT</b> <i>(Use as many sheets as necessary)</i>			Application Number	14/135,926
			Filing Date	December 19, 2013
			First Named Inventor	FALLON et al.
			Art Unit	2634
			Examiner Name	BOCURE, Tesfaldet
			Attorney Docket Number	2855.0050008
Sheet	19	of	97	

NON PATENT LITERATURE DOCUMENTS			
Examiner Initials*	Cite No. <sup>1</sup>	Include name of the author (in CAPITAL LETTERS), title of the article (when appropriate), title of the item (book, magazine, journal, serial, symposium, catalog, etc.), date, page(s), volume number, publisher, city and/or country where published	T <sup>2</sup>
	NPL127	Exhibit 53, Prior Art Chart for U.S. Pat. No. 7,777,651, 218 pages, Realtime Data, LLC D/B/A IXO v. Morgan Stanley, et al., 6:09-cv-326-LED-JDL, 6:10-cv-248-LED-JDL, 6:10-cv-426-LED-JDL, Realtime Data, LLC D/B/A IXO v. CME Group Inc., et al., 6:09-cv-327-LED-JDL, 6:10-cv-246-LED-JDL, 6:10-cv-424-LED-JDL, Realtime Data, LLC D/B/A IXO v. Thomson Reuters Corp., et al., 6:09-cv-333-LED-JDL, 6:10-cv-247-LED-JDL, 6:10-cv-425-LED-JDL, United States District Court for the Eastern District of Texas Tyler Division, February 4, 2011, citing Panaoussis, U.S. Patent No. 5,949,355.	
	NPL128	Exhibit 54, Prior Art Chart for U.S. Pat. No. 7,777,651, 335 pages, Realtime Data, LLC D/B/A IXO v. Morgan Stanley, et al., 6:09-cv-326-LED-JDL, 6:10-cv-248-LED-JDL, 6:10-cv-426-LED-JDL, Realtime Data, LLC D/B/A IXO v. CME Group Inc., et al., 6:09-cv-327-LED-JDL, 6:10-cv-246-LED-JDL, 6:10-cv-424-LED-JDL, Realtime Data, LLC D/B/A IXO v. Thomson Reuters Corp., et al., 6:09-cv-333-LED-JDL, 6:10-cv-247-LED-JDL, 6:10-cv-425-LED-JDL, United States District Court for the Eastern District of Texas Tyler Division, February 4, 2011, citing Payne et al, U.S. Patent No. 6,021,433.	
	NPL129	Exhibit 55, Prior Art Chart for U.S. Pat. No. 7,777,651, 273 pages, Realtime Data, LLC D/B/A IXO v. Morgan Stanley, et al., 6:09-cv-326-LED-JDL, 6:10-cv-248-LED-JDL, 6:10-cv-426-LED-JDL, Realtime Data, LLC D/B/A IXO v. CME Group Inc., et al., 6:09-cv-327-LED-JDL, 6:10-cv-246-LED-JDL, 6:10-cv-424-LED-JDL, Realtime Data, LLC D/B/A IXO v. Thomson Reuters Corp., et al., 6:09-cv-333-LED-JDL, 6:10-cv-247-LED-JDL, 6:10-cv-425-LED-JDL, United States District Court for the Eastern District of Texas Tyler Division, February 4, 2011, citing Reynar et al, U. S. Patent No. 5,951,623.	
	NPL130	Exhibit 56, Prior Art Chart for U.S. Pat. No. 7,777,651, 399 pages, Realtime Data, LLC D/B/A IXO v. Morgan Stanley, et al., 6:09-cv-326-LED-JDL, 6:10-cv-248-LED-JDL, 6:10-cv-426-LED-JDL, Realtime Data, LLC D/B/A IXO v. CME Group Inc., et al., 6:09-cv-327-LED-JDL, 6:10-cv-246-LED-JDL, 6:10-cv-424-LED-JDL, Realtime Data, LLC D/B/A IXO v. Thomson Reuters Corp., et al., 6:09-cv-333-LED-JDL, 6:10-cv-247-LED-JDL, 6:10-cv-425-LED-JDL, United States District Court for the Eastern District of Texas Tyler Division, February 4, 2011, citing RFC 1144: V. Jacobson, "Compressing TCP/IP Headers for Low-Speed Serial Links," Network Working Group, Request for Comments: 1144 (February 1990).	
	NPL131	Exhibit 57, Prior Art Chart for U.S. Pat. No. 7,777,651, 103 pages, Realtime Data, LLC D/B/A IXO v. Morgan Stanley, et al., 6:09-cv-326-LED-JDL, 6:10-cv-248-LED-JDL, 6:10-cv-426-LED-JDL, Realtime Data, LLC D/B/A IXO v. CME Group Inc., et al., 6:09-cv-327-LED-JDL, 6:10-cv-246-LED-JDL, 6:10-cv-424-LED-JDL, Realtime Data, LLC D/B/A IXO v. Thomson Reuters Corp., et al., 6:09-cv-333-LED-JDL, 6:10-cv-247-LED-JDL, 6:10-cv-425-LED-JDL, United States District Court for the Eastern District of Texas Tyler Division, February 4, 2011, citing RFC 1661: Point-to-Point Protocol Working Group, "The Point-to-Point Protocol," RFC 1661 (William Simpson ed., Internet Engineering Task Force 1994); RFC 1662: Point-to-Point Protocol Working Group, "PPP in HDLC-like Framing," RFC 1662 (William Simpson ed., Internet Engineering Task Force 1994); RFC 1962: Dave Rand, "The PPP compression Control Protocol (CCP)," RFC 1962 (Internet Engineering Task Force 1996); RFC 1332: Glenn McGregor, "The PPP Internet Protocol Control Protocol (IPCP)," RFC 1332 (Internet Engineering Task Force 1992); RFC 2509: Mathias Engan et al., "IP Header Compression over IP," RFC 2509 (Internet Society 1999).	
Examiner Signature		Date Considered	

\*EXAMINER: Initial if reference considered, whether or not citation is in conformance with MPEP 609. Draw line through citation if not in conformance and not considered. Include copy of this form with next communication to applicant.  
<sup>1</sup> Applicant's unique citation designation number (optional). <sup>2</sup> Applicant is to place a check mark here if English language Translation is attached.

Substitute for form 1449/PTO				<b>Complete if Known</b>	
<b>INFORMATION DISCLOSURE STATEMENT BY APPLICANT</b> <i>(Use as many sheets as necessary)</i>				Application Number	14/135,926
				Filing Date	December 19, 2013
				First Named Inventor	FALLON et al.
				Art Unit	2634
				Examiner Name	BOCURE, Tesfaldet
Sheet	20	of	97	Attorney Docket Number	2855.0050008

NON PATENT LITERATURE DOCUMENTS			
Examiner Initials*	Cite No. <sup>1</sup>	Include name of the author (in CAPITAL LETTERS), title of the article (when appropriate), title of the item (book, magazine, journal, serial, symposium, catalog, etc.), date, page(s), volume number, publisher, city and/or country where published	T <sup>2</sup>
	NPL132	Exhibit 58, Prior Art Chart for U.S. Pat. No. 7,777,651, 218 pages, Realtime Data, LLC D/B/A IXO v. Morgan Stanley, et al., 6:09-cv-326-LED-JDL, 6:10-cv-248-LED-JDL, 6:10-cv-426-LED-JDL, Realtime Data, LLC D/B/A IXO v. CME Group Inc., et al., 6:09-cv-327-LED-JDL, 6:10-cv-246-LED-JDL, 6:10-cv-424-LED-JDL, Realtime Data, LLC D/B/A IXO v. Thomson Reuters Corp., et al., 6:09-cv-333-LED-JDL, 6:10-cv-247-LED-JDL, 6:10-cv-425-LED-JDL, United States District Court for the Eastern District of Texas Tyler Division, February 4, 2011, citing RFC 2507: Mikael Degermark et al., "IP Header Compression," RFC 2507 (Internet Society 1999).	
	NPL133	Exhibit 59, Prior Art Chart for U.S. Pat. No. 7,777,651, 335 pages, Realtime Data, LLC D/B/A IXO v. Morgan Stanley, et al., 6:09-cv-326-LED-JDL, 6:10-cv-248-LED-JDL, 6:10-cv-426-LED-JDL, Realtime Data, LLC D/B/A IXO v. CME Group Inc., et al., 6:09-cv-327-LED-JDL, 6:10-cv-246-LED-JDL, 6:10-cv-424-LED-JDL, Realtime Data, LLC D/B/A IXO v. Thomson Reuters Corp., et al., 6:09-cv-333-LED-JDL, 6:10-cv-247-LED-JDL, 6:10-cv-425-LED-JDL, United States District Court for the Eastern District of Texas Tyler Division, February 4, 2011, citing Roper et al., U.S. Patent No. 5,454,079.	
	NPL134	Exhibit 60, Prior Art Chart for U.S. Pat. No. 7,777,651, 273 pages, Realtime Data, LLC D/B/A IXO v. Morgan Stanley, et al., 6:09-cv-326-LED-JDL, 6:10-cv-248-LED-JDL, 6:10-cv-426-LED-JDL, Realtime Data, LLC D/B/A IXO v. CME Group Inc., et al., 6:09-cv-327-LED-JDL, 6:10-cv-246-LED-JDL, 6:10-cv-424-LED-JDL, Realtime Data, LLC D/B/A IXO v. Thomson Reuters Corp., et al., 6:09-cv-333-LED-JDL, 6:10-cv-247-LED-JDL, 6:10-cv-425-LED-JDL, United States District Court for the Eastern District of Texas Tyler Division, February 4, 2011, citing Sebastian, U.S. Patent No. 6,253,264 and International Publication No. WO/1998/039699.	
	NPL135	Exhibit 61, Prior Art Chart for U.S. Pat. No. 7,777,651, 399 pages, Realtime Data, LLC D/B/A IXO v. Morgan Stanley, et al., 6:09-cv-326-LED-JDL, 6:10-cv-248-LED-JDL, 6:10-cv-426-LED-JDL, Realtime Data, LLC D/B/A IXO v. CME Group Inc., et al., 6:09-cv-327-LED-JDL, 6:10-cv-246-LED-JDL, 6:10-cv-424-LED-JDL, Realtime Data, LLC D/B/A IXO v. Thomson Reuters Corp., et al., 6:09-cv-333-LED-JDL, 6:10-cv-247-LED-JDL, 6:10-cv-425-LED-JDL, United States District Court for the Eastern District of Texas Tyler Division, February 4, 2011, citing Seroussi et al., U.S. Patent No. 5,243,341.	
	NPL136	Exhibit 62, Prior Art Chart for U.S. Pat. No. 7,777,651, 322 pages, Realtime Data, LLC D/B/A IXO v. Morgan Stanley, et al., 6:09-cv-326-LED-JDL, 6:10-cv-248-LED-JDL, 6:10-cv-426-LED-JDL, Realtime Data, LLC D/B/A IXO v. CME Group Inc., et al., 6:09-cv-327-LED-JDL, 6:10-cv-246-LED-JDL, 6:10-cv-424-LED-JDL, Realtime Data, LLC D/B/A IXO v. Thomson Reuters Corp., et al., 6:09-cv-333-LED-JDL, 6:10-cv-247-LED-JDL, 6:10-cv-425-LED-JDL, United States District Court for the Eastern District of Texas Tyler Division, February 4, 2011, citing Seroussi et al., U.S. Patent No. 5,389,922.	

Examiner Signature	Date Considered	
--------------------	-----------------	--

\*EXAMINER: Initial if reference considered, whether or not citation is in conformance with MPEP 609. Draw line through citation if not in conformance and not considered. Include copy of this form with next communication to applicant.

<sup>1</sup> Applicant's unique citation designation number (optional). <sup>2</sup> Applicant is to place a check mark here if English language Translation is attached.

Substitute for form 1449/PTO				<b>Complete if Known</b>	
<b>INFORMATION DISCLOSURE STATEMENT BY APPLICANT</b> <i>(Use as many sheets as necessary)</i>				Application Number	14/135,926
				Filing Date	December 19, 2013
				First Named Inventor	FALLON et al.
				Art Unit	2634
				Examiner Name	BOCURE, Tesfaldet
Sheet	21	of	97	Attorney Docket Number	2855.0050008

NON PATENT LITERATURE DOCUMENTS			
Examiner Initials*	Cite No. <sup>1</sup>	Include name of the author (in CAPITAL LETTERS), title of the article (when appropriate), title of the item (book, magazine, journal, serial, symposium, catalog, etc.), date, page(s), volume number, publisher, city and/or country where published	T <sup>2</sup>
	NPL137	Exhibit 63, Prior Art Chart for U.S. Pat. No. 7,777,651, 102 pages, Realtime Data, LLC D/B/A IXO v. Morgan Stanley, et al., 6:09-cv-326-LED-JDL, 6:10-cv-248-LED-JDL, 6:10-cv-426-LED-JDL, Realtime Data, LLC D/B/A IXO v. CME Group Inc., et al., 6:09-cv-327-LED-JDL, 6:10-cv-246-LED-JDL, 6:10-cv-424-LED-JDL, Realtime Data, LLC D/B/A IXO v. Thomson Reuters Corp., et al., 6:09-cv-333-LED-JDL, 6:10-cv-247-LED-JDL, 6:10-cv-425-LED-JDL, United States District Court for the Eastern District of Texas Tyler Division, February 4, 2011, citing Shin, U.S. Patent No. 5,455,680.	
	NPL138	Exhibit 64, Prior Art Chart for U.S. Pat. No. 7,777,651, 126 pages, Realtime Data, LLC D/B/A IXO v. Morgan Stanley, et al., 6:09-cv-326-LED-JDL, 6:10-cv-248-LED-JDL, 6:10-cv-426-LED-JDL, Realtime Data, LLC D/B/A IXO v. CME Group Inc., et al., 6:09-cv-327-LED-JDL, 6:10-cv-246-LED-JDL, 6:10-cv-424-LED-JDL, Realtime Data, LLC D/B/A IXO v. Thomson Reuters Corp., et al., 6:09-cv-333-LED-JDL, 6:10-cv-247-LED-JDL, 6:10-cv-425-LED-JDL, United States District Court for the Eastern District of Texas Tyler Division, February 4, 2011, citing Taaffe et al., U.S. Patent No. 5,179,651.	
	NPL139	Exhibit 65, Prior Art Chart for U.S. Pat. No. 7,777,651, 313 pages, Realtime Data, LLC D/B/A IXO v. Morgan Stanley, et al., 6:09-cv-326-LED-JDL, 6:10-cv-248-LED-JDL, 6:10-cv-426-LED-JDL, Realtime Data, LLC D/B/A IXO v. CME Group Inc., et al., 6:09-cv-327-LED-JDL, 6:10-cv-246-LED-JDL, 6:10-cv-424-LED-JDL, Realtime Data, LLC D/B/A IXO v. Thomson Reuters Corp., et al., 6:09-cv-333-LED-JDL, 6:10-cv-247-LED-JDL, 6:10-cv-425-LED-JDL, United States District Court for the Eastern District of Texas Tyler Division, February 4, 2011, citing Telekurs Ticker - "Telekurs Ticker Service: Programmer's Reference," Telekurs (North America), Inc. (January 11, 1993); C. Helck. "Encapsulated Ticker: Ver. 1.0," Telekurs NA, 1-22 (July 14, 1993); A-T FINANCIAL OFFERS MANIPULATION, REDISTRIBUTION OF TICKER III, Micro Ticker Report, v 4, n 14 (Sept 5, 1989); V. Kulkosky, "Upping the Ante" Wall Street & Technology, v11 n5 pp: 8-11 (Oct 1993); "Telekurs to Launch New Int'l Feed/Internet Server," Wall Street & Technology, v15 n1 pp: 14 (Jan 1997); I. Schmerken, "Time running out for old technologies", Wall Street Computer Review, v7 n7 p14(7) (April, 1990); SCROLLING NEWS, Inside Market Data, v 10, n 11 (Feb 27, 1995); TELEKURS BUYS S&P TRADING SYSTEMS AND ITS TICKER III FEED, Micro Ticker Report, v 4, n 11 (July 10, 1989); TELEKURS MAY DEBUT 128 KPS TICKER BY YEAR'S END, Inside Market Data, v 9, n 21 (July 18, 1994); TELEKURS NOW CARRIES ALL DOW JONES' NEWS ON 56-KBPS TICKER, Inside Market Data, v9, n7 (Dec 20, 1993); TELEKURS SELLS NO. AMERICAN DIVISION IN MGMT. BUYOUT, Inside Market Data, v11, n3 (Oct 23, 1995).	
	NPL140	Exhibit 66, Prior Art Chart for U.S. Pat. No. 7,777,651, 265 pages, Realtime Data, LLC D/B/A IXO v. Morgan Stanley, et al., 6:09-cv-326-LED-JDL, 6:10-cv-248-LED-JDL, 6:10-cv-426-LED-JDL, Realtime Data, LLC D/B/A IXO v. CME Group Inc., et al., 6:09-cv-327-LED-JDL, 6:10-cv-246-LED-JDL, 6:10-cv-424-LED-JDL, Realtime Data, LLC D/B/A IXO v. Thomson Reuters Corp., et al., 6:09-cv-333-LED-JDL, 6:10-cv-247-LED-JDL, 6:10-cv-425-LED-JDL, United States District Court for the Eastern District of Texas Tyler Division, February 4, 2011, citing Tyler et al., U.S. Patent No. 5,638,498.	

Examiner Signature		Date Considered	
-----------------------	--	--------------------	--

\*EXAMINER: Initial if reference considered, whether or not citation is in conformance with MPEP 609. Draw line through citation if not in conformance and not considered. Include copy of this form with next communication to applicant.

<sup>1</sup> Applicant's unique citation designation number (optional). <sup>2</sup> Applicant is to place a check mark here if English language Translation is attached.

Substitute for form 1449/PTO				<b>Complete if Known</b>	
<b>INFORMATION DISCLOSURE STATEMENT BY APPLICANT</b> <i>(Use as many sheets as necessary)</i>				Application Number	14/135,926
				Filing Date	December 19, 2013
				First Named Inventor	FALLON et al.
				Art Unit	2634
				Examiner Name	BOCURE, Tesfaldet
				Attorney Docket Number	2855.0050008
Sheet	22	of	97		

NON PATENT LITERATURE DOCUMENTS			
Examiner Initials*	Cite No. <sup>1</sup>	Include name of the author (in CAPITAL LETTERS), title of the article (when appropriate), title of the item (book, magazine, journal, serial, symposium, catalog, etc.), date, page(s), volume number, publisher, city and/or country where published	T <sup>2</sup>
	NPL141	Exhibit 67, Prior Art Chart for U.S. Pat. No. 7,777,651, 86 pages, Realtime Data, LLC D/B/A IXO v. Morgan Stanley, et al., 6:09-cv-326-LED-JDL, 6:10-cv-248-LED-JDL, 6:10-cv-426-LED-JDL, Realtime Data, LLC D/B/A IXO v. CME Group Inc., et al., 6:09-cv-327-LED-JDL, 6:10-cv-246-LED-JDL, 6:10-cv-424-LED-JDL, Realtime Data, LLC D/B/A IXO v. Thomson Reuters Corp., et al., 6:09-cv-333-LED-JDL, 6:10-cv-247-LED-JDL, 6:10-cv-425-LED-JDL, United States District Court for the Eastern District of Texas Tyler Division, February 4, 2011, citing UNI International Standard ISO 3309-1984 (E) [1984]. "Information Processing Systems -- Data Communication -- High-level Data Link Control Procedures --Frame Structure," 1-6 (1984).	
	NPL142	Exhibit 68, Prior Art Chart for U.S. Pat. No. 7,777,651, 236 pages, Realtime Data, LLC D/B/A IXO v. Morgan Stanley, et al., 6:09-cv-326-LED-JDL, 6:10-cv-248-LED-JDL, 6:10-cv-426-LED-JDL, Realtime Data, LLC D/B/A IXO v. CME Group Inc., et al., 6:09-cv-327-LED-JDL, 6:10-cv-246-LED-JDL, 6:10-cv-424-LED-JDL, Realtime Data, LLC D/B/A IXO v. Thomson Reuters Corp., et al., 6:09-cv-333-LED-JDL, 6:10-cv-247-LED-JDL, 6:10-cv-425-LED-JDL, United States District Court for the Eastern District of Texas Tyler Division, February 4, 2011, citing Unwired Planet, EP 0928070 A2.	
	NPL143	Exhibit 69, Prior Art Chart for U.S. Pat. No. 7,777,651, 80 pages, Realtime Data, LLC D/B/A IXO v. Morgan Stanley, et al., 6:09-cv-326-LED-JDL, 6:10-cv-248-LED-JDL, 6:10-cv-426-LED-JDL, Realtime Data, LLC D/B/A IXO v. CME Group Inc., et al., 6:09-cv-327-LED-JDL, 6:10-cv-246-LED-JDL, 6:10-cv-424-LED-JDL, Realtime Data, LLC D/B/A IXO v. Thomson Reuters Corp., et al., 6:09-cv-333-LED-JDL, 6:10-cv-247-LED-JDL, 6:10-cv-425-LED-JDL, United States District Court for the Eastern District of Texas Tyler Division, February 4, 2011, citing Vange et al., U.S. Patent No. 7,127,518.	
	NPL144	Exhibit 70, Prior Art Chart for U.S. Pat. No. 7,777,651, 197 pages, Realtime Data, LLC D/B/A IXO v. Morgan Stanley, et al., 6:09-cv-326-LED-JDL, 6:10-cv-248-LED-JDL, 6:10-cv-426-LED-JDL, Realtime Data, LLC D/B/A IXO v. CME Group Inc., et al., 6:09-cv-327-LED-JDL, 6:10-cv-246-LED-JDL, 6:10-cv-424-LED-JDL, Realtime Data, LLC D/B/A IXO v. Thomson Reuters Corp., et al., 6:09-cv-333-LED-JDL, 6:10-cv-247-LED-JDL, 6:10-cv-425-LED-JDL, United States District Court for the Eastern District of Texas Tyler Division, February 4, 2011, citing Wernikoff et al., U.S. Patent No. 3,394,352.	
	NPL145	Exhibit 71, Prior Art Chart for U.S. Pat. No. 7,777,651, 253 pages, Exhibit 70, Prior Art Chart for U.S. Pat. No. 7,777,651, 197 pages, Realtime Data, LLC D/B/A IXO v. Morgan Stanley, et al., 6:09-cv-326-LED-JDL, 6:10-cv-248-LED-JDL, 6:10-cv-426-LED-JDL, Realtime Data, LLC D/B/A IXO v. CME Group Inc., et al., 6:09-cv-327-LED-JDL, 6:10-cv-246-LED-JDL, 6:10-cv-424-LED-JDL, Realtime Data, LLC D/B/A IXO v. Thomson Reuters Corp., et al., 6:09-cv-333-LED-JDL, 6:10-cv-247-LED-JDL, 6:10-cv-425-LED-JDL, United States District Court for the Eastern District of Texas Tyler Division, February 4, 2011, citing Willis et al., U.S. Patent No. 4,745,559; Boilen, U.S. Patent No. 4,750,135.	

Examiner Signature	Date Considered
--------------------	-----------------

\*EXAMINER: Initial if reference considered, whether or not citation is in conformance with MPEP 609. Draw line through citation if not in conformance and not considered. Include copy of this form with next communication to applicant.

<sup>1</sup> Applicant's unique citation designation number (optional). <sup>2</sup> Applicant is to place a check mark here if English language Translation is attached.

Substitute for form 1449/PTO				<b>Complete if Known</b>	
<b>INFORMATION DISCLOSURE STATEMENT BY APPLICANT</b> <i>(Use as many sheets as necessary)</i>				Application Number	14/135,926
				Filing Date	December 19, 2013
				First Named Inventor	FALLON et al.
				Art Unit	2634
				Examiner Name	BOCURE, Tesfaldet
Sheet	23	of	97	Attorney Docket Number	2855.0050008

NON PATENT LITERATURE DOCUMENTS			
Examiner Initials*	Cite No. <sup>1</sup>	Include name of the author (in CAPITAL LETTERS), title of the article (when appropriate), title of the item (book, magazine, journal, serial, symposium, catalog, etc.), date, page(s), volume number, publisher, city and/or country where published	T <sup>2</sup>
	NPL146	Exhibit 72, Prior Art Chart for U.S. Pat. No. 7,777,651, 277 pages, Exhibit 71, Prior Art Chart for U.S. Pat. No. 7,777,651, 253 pages, Exhibit 70, Prior Art Chart for U.S. Pat. No. 7,777,651, 197 pages, Realtime Data, LLC D/B/A IXO v. Morgan Stanley, et al., 6:09-cv-326-LED-JDL, 6:10-cv-248-LED-JDL, 6:10-cv-426-LED-JDL, Realtime Data, LLC D/B/A IXO v. CME Group Inc., et al., 6:09-cv-327-LED-JDL, 6:10-cv-246-LED-JDL, 6:10-cv-424-LED-JDL, Realtime Data, LLC D/B/A IXO v. Thomson Reuters Corp., et al., 6:09-cv-333-LED-JDL, 6:10-cv-247-LED-JDL, 6:10-cv-425-LED-JDL, United States District Court for the Eastern District of Texas Tyler Division, February 4, 2011, citing XMill - Hartmut Liefke & Dan Suci, "XMill: an Efficient Compressor for XML Data," University of Pennsylvania, Philadelphia, Pennsylvania, MS-CIS-99-26 (October 18, 1999); Hartmut Liefke & Dan Suci, "XMill: an Efficient Compressor for XML Data," Proceedings of SIGMOD, 2000; Hartmut Liefke & Dan Suci, "An Extensible Compressor for XML Data," SIGMOD Record, Vol. 29, No. 1 (March 2000); Dan Suci, "Data Management on the Web," Presentation at University of Washington College of Computer Science & Engineering, Seattle, WA (April 4, 2000).	
	NPL147	BORMANN et al., "Robust Header Compression (ROHC)," Network Working Group Internet-Draft, September 18, 2000, 111 pages.	
	NPL148	EFFROS, M., P.A. CHOU and R.M. GRAY, "Variable Dimension Weighted Universal Vector Quantization and Noiseless Coding," IEEE 1068-0314/94, 1994, pages 2-11.	
	NPL149	Defendant Bloomberg L.P.'s Invalidity Contentions Pursuant to Patent Local Rule 3-3, Realtime Data, LLC d/b/a IXO vs. Thomson Reuters Corp., et al., 6:2009-cv-00333 LED-JDL, 6:2010-cv-00247 LED-JDL, 6:2010-cv-00425 LED-JDL, October 29, 2010, 17 pages.	
	NPL150	Appendix A: U.S. Patent No. 6,624,761 (The "761 Patent"), from Defendant Bloomberg L.P.'s Invalidity Contentions Pursuant to Patent Local Rule 3-3, Realtime Data, LLC d/b/a IXO vs. Thomson Reuters Corp., et al., 6:2009-cv-00333 LED-JDL, 6:2010-cv-00247 LED-JDL, 6:2010-cv-00425 LED-JDL, October 29, 2010, 37 pages.	
	NPL151	Appendix B: U.S. Patent No. 7,161,506 (The "506 Patent"), from Defendant Bloomberg L.P.'s Invalidity Contentions Pursuant to Patent Local Rule 3-3, Realtime Data, LLC d/b/a IXO vs. Thomson Reuters Corp., et al., 6:2009-cv-00333 LED-JDL, 6:2010-cv-00247 LED-JDL, 6:2010-cv-00425 LED-JDL, October 29, 2010, 63 pages.	
	NPL152	Appendix C: U.S. Patent No. 7,400,274 (The 274 Patent), from Defendant Bloomberg L.P.'s Invalidity Contentions Pursuant to Patent Local Rule 3-3, Realtime Data, LLC d/b/a IXO vs. Thomson Reuters Corp., et al., 6:2009-cv-00333 LED-JDL, 6:2010-cv-00247 LED-JDL, 6:2010-cv-00425 LED-JDL, October 29, 2010, 95 pages.	

Examiner Signature	Date Considered	
-----------------------	--------------------	--

\*EXAMINER: Initial if reference considered, whether or not citation is in conformance with MPEP 609. Draw line through citation if not in conformance and not considered. Include copy of this form with next communication to applicant.

<sup>1</sup> Applicant's unique citation designation number (optional). <sup>2</sup> Applicant is to place a check mark here if English language Translation is attached.

Substitute for form 1449/PTO				<b>Complete if Known</b>	
<b>INFORMATION DISCLOSURE STATEMENT BY APPLICANT</b> <i>(Use as many sheets as necessary)</i>				Application Number	14/135,926
				Filing Date	December 19, 2013
				First Named Inventor	FALLON et al.
				Art Unit	2634
				Examiner Name	BOCURE, Tesfaldet
Sheet	24	of	97	Attorney Docket Number	2855.0050008

NON PATENT LITERATURE DOCUMENTS			
Examiner Initials*	Cite No. <sup>1</sup>	Include name of the author (in CAPITAL LETTERS), title of the article (when appropriate), title of the item (book, magazine, journal, serial, symposium, catalog, etc.), date, page(s), volume number, publisher, city and/or country where published	T <sup>2</sup>
	NPL153	Appendix D: U.S. Patent No. 7,417,568 (The 568 Patent), from Defendant Bloomberg L.P.'s Invalidation Contentions Pursuant to Patent Local Rule 3-3, Realtime Data, LLC d/b/a IXO vs. Thomson Reuters Corp., et al., 6:2009-cv-00333 LED-JDL, 6:2010-cv-00247 LED-JDL, 6:2010-cv-00425 LED-JDL, October 29, 2010, 147 pages.	
	NPL154	Appendix E: U.S. Patent No. 7,714,747 (The "747 Patent"), from Defendant Bloomberg L.P.'s Invalidation Contentions Pursuant to Patent Local Rule 3-3, Realtime Data, LLC d/b/a IXO vs. Thomson Reuters Corp., et al., 6:2009-cv-00333 LED-JDL, 6:2010-cv-00247 LED-JDL, 6:2010-cv-00425 LED-JDL, October 29, 2010, 137 pages.	
	NPL155	Appendix F: Comparison of FAST to the Prior Art, from Defendant Bloomberg L.P.'s Invalidation Contentions Pursuant to Patent Local Rule 3-3, Realtime Data, LLC d/b/a IXO vs. Thomson Reuters Corp., et al., 6:2009-cv-00333 LED-JDL, 6:2010-cv-00247 LED-JDL, 6:2010-cv-00425 LED-JDL, October 29, 2010, 7 pages.	
	NPL156	Defendant Bloomberg L.P.'s Invalidation Contentions Pursuant to Patent Local Rule 3-3 Regarding U.S. Patent No. 7,777,651, Realtime Data, LLC d/b/a IXO vs. Thomson Reuters Corp., et al., 6:2009-cv-00333 LED-JDL, 6:2010-cv-00247 LED-JDL, 6:2010-cv-00425 LED-JDL, February 4, 2011, 21 pages.	
	NPL157	Appendix G: U.S. Patent No. 7,777,651 (The 651 Patent), Defendant Bloomberg L.P.'s Invalidation Contentions Pursuant to Patent Local Rule 3-3 Regarding U.S. Patent No. 7,777,651, Realtime Data, LLC d/b/a IXO vs. Thomson Reuters Corp., et al., 6:2009-cv-00333 LED-JDL, 6:2010-cv-00247 LED-JDL, 6:2010-cv-00425 LED-JDL, February 4, 2011, 480 pages.	
	NPL158	RICE, ROBERT F., "Some Practical Universal Noiseless Coding Techniques", Jet Propulsion Laboratory, Pasadena, California, JPL Publication 79-22, March 15, 1979; 140 pgs.	
	NPL159	ANDERSON, J., et al. "Codec squeezes color teleconferencing through digital telephone lines," Electronics 1984, pp. 13-15.	
	NPL160	VENBRUX, JACK, "A VLSI Chip Set for High-Speed Lossless Data Compression", IEEE Trans. On Circuits and Systems for Video Technology, Vol. 2, No. 4, December 1992, pp. 381-391.	
	NPL161	"Fast Dos Soft Boot", IBM Technical Disclosure Bulletin, Feb. 1994, Vol. 37, Issue No. 2B, pp. 185-186.	
	NPL162	"Operating System Platform Abstraction Method", IBM Technical Disclosure Bulletin, Feb. 1995, Vol. 38, Issue No. 2, pp 343-344.	

Examiner Signature	Date Considered
--------------------	-----------------

\*EXAMINER: Initial if reference considered, whether or not citation is in conformance with MPEP 609. Draw line through citation if not in conformance and not considered. Include copy of this form with next communication to applicant.

<sup>1</sup> Applicant's unique citation designation number (optional). <sup>2</sup> Applicant is to place a check mark here if English language Translation is attached.



Substitute for form 1449/PTO				<b>Complete if Known</b>	
<b>INFORMATION DISCLOSURE STATEMENT BY APPLICANT</b> <i>(Use as many sheets as necessary)</i>				Application Number	14/135,926
				Filing Date	December 19, 2013
				First Named Inventor	FALLON et al.
				Art Unit	2634
				Examiner Name	BOCURE, Tesfaldet
				Attorney Docket Number	2855.0050008
Sheet	25	of	97		

NON PATENT LITERATURE DOCUMENTS			
Examiner Initials*	Cite No. <sup>1</sup>	Include name of the author (in CAPITAL LETTERS), title of the article (when appropriate), title of the item (book, magazine, journal, serial, symposium, catalog, etc.), date, page(s), volume number, publisher, city and/or country where published	T <sup>2</sup>
	NPL163	MURASHITA, K., et al., "High-Speed Statistical Compression using Self-Organized Rules and Predetermined Code Tables", IEEE, 1996 Data Compression Conference.	
	NPL164	COENE, W., et al. "A Fast Route For Application of Rate-distortion Optimal Quantization in an MPEG Video Encoder" Proceedings of the International Conference on Image Processing, US., New York, IEEE, 16 September 1996, pp. 825-828.	
	NPL165	RICE, ROBERT, "Lossless Coding Standards for Space Data Systems", IEEE 1058-6393197, Nov. 3-6, 1996, pp. 577-585.	
	NPL166	MILLMAN, HOWARD, "Image and video compression", Computerworld, Vol. 33, Issue No. 3, January 18, 1999, pp. 78.	
	NPL167	"IBM boosts your memory", Geek.com [online], June 26, 2000 [retrieved on July 6, 2007, www.geek.com/ibm-boosts-your-memory/, 7 pages.	
	NPL168	"IBM Research Breakthrough Doubles Computer Memory Capacity", IBM Press Release [online], June 26, 2000 [retrieved on July 6, 2007, www-03.ibm.com/press/us/en/pressrelease/1653.wss, 3 pages.	
	NPL169	"ServerWorks To Deliver IBM's Memory expansion Technology in Next-Generation Core Logic for Servers", ServerWorks Press Release [online], June 27, 2000 [retrieved on July 14, 2000, http://www.serverworks.com/news/press/000627.html, 1 page.	
	NPL170	ABALI, B., et al., "Memory Expansion Technology (MXT) Software support and performance", IBM Journal of Research and Development, Vol. 45, Issue No. 2, March 2001, pp. 287-301.	
	NPL171	FRANASZEK, P. A., et al., "Algorithms and data structures for compressed-memory machines", IBM Journal of Research and Development, Vol. 45, Issue No. 2, March 2001, pp. 245-258.	
	NPL172	FRANASZEK, P. A., et al., "On internal organization in compressed random-access memories", IBM Journal of Research and Development, Vol. 45, Issue No. 2, March 2001, pp. 259-270.	

Examiner Signature		Date Considered	
-----------------------	--	--------------------	--

\*EXAMINER: Initial if reference considered, whether or not citation is in conformance with MPEP 609. Draw line through citation if not in conformance and not considered. Include copy of this form with next communication to applicant.

<sup>1</sup> Applicant's unique citation designation number (optional). <sup>2</sup> Applicant is to place a check mark here if English language Translation is attached.

Substitute for form 1449/PTO			<b>Complete if Known</b>	
<b>INFORMATION DISCLOSURE STATEMENT BY APPLICANT</b> <i>(Use as many sheets as necessary)</i>			Application Number	14/135,926
			Filing Date	December 19, 2013
			First Named Inventor	FALLON et al.
			Art Unit	2634
			Examiner Name	BOCURE, Tesfaldet
			Attorney Docket Number	2855.0050008
Sheet	26	of	97	

NON PATENT LITERATURE DOCUMENTS			
Examiner Initials*	Cite No. <sup>1</sup>	Include name of the author (in CAPITAL LETTERS), title of the article (when appropriate), title of the item (book, magazine, journal, serial, symposium, catalog, etc.), date, page(s), volume number, publisher, city and/or country where published	T <sup>2</sup>
	NPL173	SMITH, T.B., et al., "Memory Expansion Technology (MXT) Competitive impact", IBM Journal of Research and Development, Vol. 45, Issue No. 2, March 2001, pp. 303-309.	
	NPL174	TREMAINE, R. B., et al., "IBM Memory Expansion Technology (MXT)", IBM Journal of Research and Development, Vol. 45, Issue No. 2, March 2001, pp. 271-285.	
	NPL175	YEH, PEN-SHU, "The CCSDS Lossless Data Compression Recommendation for Space Applications", Chapter 16, Lossless Compression Handbook, Elsevier Science (USA), 2003, PP. 311-326.	
	NPL176	Expand Networks Accelerator 4000 Series User's Guide, 1999, 101 pgs.	
	NPL177	Tridgell, Andrew; "Efficient Algorithms for Sorting and Synchronization"; A thesis submitted for the degree of Doctor of Philosophy at The Australian National University; February 1999; pages iii-106	
	NPL178	Jung, et al.; "Performance optimization of wireless local area networks through VLSI data compression"; Wireless Networks, Volume 4, 1998; pages 27-39.	
	NPL179	Baker, K. et al., "Lossless Data Compression for Short Duration 3D Frames in Positron Emission Tomography," 0-7803-1487, May 1994, pages 1831-1834.	
	NPL180	Maier, Mark W.; "Algorithm Evaluation for the Synchronous Data Compression Standard"; University of Alabama: 1995, pages 1-10.	
	NPL181	Bassiouni, et al.; "A Scheme for Data Compression in Supercomputers"; IEEE; 1988; pages 272-278.	
	NPL182	Welch, Terry A.; "A Technique for High-Performance Data Compression"; IEEE; June 1984; pages 8-19.	

Examiner Signature		Date Considered	
-----------------------	--	--------------------	--

\*EXAMINER: Initial if reference considered, whether or not citation is in conformance with MPEP 609. Draw line through citation if not in conformance and not considered. Include copy of this form with next communication to applicant.

<sup>1</sup> Applicant's unique citation designation number (optional). <sup>2</sup> Applicant is to place a check mark here if English language Translation is attached.

Substitute for form 1449/PTO				<b>Complete if Known</b>	
<b>INFORMATION DISCLOSURE STATEMENT BY APPLICANT</b> <i>(Use as many sheets as necessary)</i>				Application Number	14/135,926
				Filing Date	December 19, 2013
				First Named Inventor	FALLON et al.
				Art Unit	2634
				Examiner Name	BOCURE, Tesfaldet
				Attorney Docket Number	2855.0050008
Sheet	27	of	97		

NON PATENT LITERATURE DOCUMENTS			
Examiner Initials*	Cite No. <sup>1</sup>	Include name of the author (in CAPITAL LETTERS), title of the article (when appropriate), title of the item (book, magazine, journal, serial, symposium, catalog, etc.), date, page(s), volume number, publisher, city and/or country where published	T <sup>2</sup>
	NPL183	ALDC: Adaptive Lossless Data Compression; IBM; 1994, 2 pgs.	
	NPL184	ALDC-Macro: Adaptive Lossless Data Compression; IBM Corporation; 1994, 2 pgs.	
	NPL185	ALDC1-20S: Adaptive Lossless Data Compression; IBM Corporation; 1994, 2 pgs.	
	NPL186	ALDC1-40S: Adaptive Lossless Data Compression; IBM Corporation; 1994, 2 pgs.	
	NPL187	ALDC1-5S: Adaptive Lossless Data Compression; IBM Corporation; 1994, 2 pgs.	
	NPL188	Craft, David J.; "Data Compression Choice No Easy Call"; Computer Technology Review; Volume XIV, Number 1; January 1994, 2 pgs.	
	NPL189	Costlow, Terry; "Sony designs faster, denser tape drive"; Electronic Engineering Times; May 20, 1996, pages 86-87.	
	NPL190	Wilson, Ron; "IBM ups compression ante"; Electronic Engineering Times; August 16, 1993; pages 1-94.	
	NPL191	"IBM Announces New Feature for 3480 Subsystem"; Tucson Today; Volume 12, Number 337, July 25, 1989, 1 pg.	
	NPL192	Syngress Media, Inc.; "CCA Citrix Certified Administrator for MetaFrame 1.8 Study Guide"; 2000, 568 pgs.	

Examiner Signature		Date Considered	
-----------------------	--	--------------------	--

\*EXAMINER: Initial if reference considered, whether or not citation is in conformance with MPEP 609. Draw line through citation if not in conformance and not considered. Include copy of this form with next communication to applicant.

<sup>1</sup> Applicant's unique citation designation number (optional). <sup>2</sup> Applicant is to place a check mark here if English language Translation is attached.

Substitute for form 1449/PTO				<b>Complete if Known</b>	
<b>INFORMATION DISCLOSURE STATEMENT BY APPLICANT</b> <i>(Use as many sheets as necessary)</i>				Application Number	14/135,926
				Filing Date	December 19, 2013
				First Named Inventor	FALLON et al.
				Art Unit	2634
				Examiner Name	BOCURE, Tesfaldet
Sheet	28	of	97	Attorney Docket Number	2855.0050008

NON PATENT LITERATURE DOCUMENTS			
Examiner Initials*	Cite No. <sup>1</sup>	Include name of the author (in CAPITAL LETTERS), title of the article (when appropriate), title of the item (book, magazine, journal, serial, symposium, catalog, etc.), date, page(s), volume number, publisher, city and/or country where published	T <sup>2</sup>
	NPL193	International Telecommunication Union; "Data Compression Procedures for Data Circuit Terminating Equipment (DCE) Using Error Correction Procedures"; Geneva, 1990, 29 pgs.	
	NPL194	Cheng, et al.; "A fast, highly reliable data compression chip and algorithm for storage systems"; IBM J. Res. Develop.; Vol. 40, No. 6, November 1996; pages 603-613.	
	NPL195	Cisco Systems; "Cisco IOS Data Compression"; 1997; pages 1-10.	
	NPL196	Craft, D. J.; "A fast hardware data compression algorithm and some algorithmic extensions"; IBM J. Res. Develop.; Vol. 42; No. 6; November 6, 1998; pages 733-746.	
	NPL197	Rustici, Robert; "Enhanced CU-SeeMe" 1995, Zero In Technologies, Inc., 308 pgs.	
	NPL198	White Pine Software; "CU-SeeMe Pro: Quick Start Guide"; Version 4.0 for Windows; 1999, 86 pgs.	
	NPL199	"CU-SeeMe Reflector"; <a href="http://www.geektimes.com/michael/CU-SeeMe/faqs/reflectors.html">www.geektimes.com/michael/CU-SeeMe/faqs/reflectors.html</a> ; accessed on December 2, 2008, 5 pgs.	
	NPL200	Daniels, et al.; "Citrix WinFrame 1.6 Beta"; May 1 1996; <a href="http://license.icopyright.net/user/downloadLicense.act?lic=3.7009-9123">license.icopyright.net/user/downloadLicense.act?lic=3.7009-9123</a> ; accessed December 2, 2008, 4 pgs.	
	NPL201	Held, et al.; "Data Compression"; Third Edition; John Wiley & Sons Ltd.; 1991, 150 pgs.	
	NPL202	Data Compression Applications and Innovations Workshop; Proceedings of a Workshop held in Conjunction with the IEEE Data Compression Conference; Snowbird, Utah; March 31, 1995, 64 pgs.	

Examiner Signature		Date Considered	
-----------------------	--	--------------------	--

\*EXAMINER: Initial if reference considered, whether or not citation is in conformance with MPEP 609. Draw line through citation if not in conformance and not considered. Include copy of this form with next communication to applicant.

<sup>1</sup> Applicant's unique citation designation number (optional). <sup>2</sup> Applicant is to place a check mark here if English language Translation is attached.

Substitute for form 1449/PTO				<b>Complete if Known</b>	
<b>INFORMATION DISCLOSURE STATEMENT BY APPLICANT</b> <i>(Use as many sheets as necessary)</i>				Application Number	14/135,926
				Filing Date	December 19, 2013
				First Named Inventor	FALLON et al.
				Art Unit	2634
				Examiner Name	BOCURE, Tesfaldet
				Attorney Docket Number	2855.0050008
Sheet	29	of	97		

NON PATENT LITERATURE DOCUMENTS			
Examiner Initials*	Cite No. <sup>1</sup>	Include name of the author (in CAPITAL LETTERS), title of the article (when appropriate), title of the item (book, magazine, journal, serial, symposium, catalog, etc.), date, page(s), volume number, publisher, city and/or country where published	T <sup>2</sup>
	NPL203	Britton, et al.; "Discovery Desktop Conferencing with NetMeeting 2.0"; IDG Books Worldwide, inc.; 1997, 244 pgs.	
	NPL204	Sattler, Michael; "Internet TV with CU-SeeMe"; Sams.Net Publishing; 1995; First Edition, 80 pgs.	
	NPL205	IBM Microelectronics Comdex Fall '93 Booth Location, 1 pg.	
	NPL206	Disz, et al.; "Performance Model of the Argonne Voyager Multimedia Server"; IEEE; 1997; pages 316-327.	
	NPL207	"Downloading and Installing NetMeeting"; www.w4mq.com/helph3.htm; accessed on December 2, 2008; 6 pgs.	
	NPL208	Fox, et al.; "Adapting to Network and Client Variability via On-Demand Dynamic Distillation"; ASPLOS VII; October 1996; pages 160-170.	
	NPL209	Fox, et al.; "Adapting to Network and Client Variation Using Infrastructural Proxies: Lessons and Perspectives"; IEEE Personal Communications, August 1998; pages 10-19.	
	NPL210	Han, et al.; "CU-SeeMe VR Immersive Desktop Teleconferencing"; Department of Computer Science; Cornell University; To appear in ACM Multimedia 1996, 9 pgs.	
	NPL211	Howard, et al.; "Parallel Lossless Image Compression Using Huffman and Arithmetic Coding"; 1992; pages 1-9.	
	NPL212	Howard, Paul G.; "Text Image Compression Using Soft Pattern Matching"; The Computer Journal; Vol. 40, No. 213; 1997; pages 146-156.	

Examiner Signature		Date Considered	
--------------------	--	-----------------	--

\*EXAMINER: Initial if reference considered, whether or not citation is in conformance with MPEP 609. Draw line through citation if not in conformance and not considered. Include copy of this form with next communication to applicant.

<sup>1</sup> Applicant's unique citation designation number (optional). <sup>2</sup> Applicant is to place a check mark here if English language Translation is attached.

Substitute for form 1449/PTO		<b>Complete if Known</b>	
<b>INFORMATION DISCLOSURE STATEMENT BY APPLICANT</b> <i>(Use as many sheets as necessary)</i>		Application Number	14/135,926
		Filing Date	December 19, 2013
		First Named Inventor	FALLON et al.
		Art Unit	2634
		Examiner Name	BOCURE, Tesfaldet
		Attorney Docket Number	2855.0050008
Sheet	30	of	97

NON PATENT LITERATURE DOCUMENTS			
Examiner Initials*	Cite No. <sup>1</sup>	Include name of the author (in CAPITAL LETTERS), title of the article (when appropriate), title of the item (book, magazine, journal, serial, symposium, catalog, etc.), date, page(s), volume number, publisher, city and/or country where published	T <sup>2</sup>
	NPL213	Howard, et al.; "The Emerging JBIG2 Standard"; IEEE Transactions on Circuits and Systems for Video Technology, Vol. 8, No. 7, November 1998; pages 838-848.	
	NPL214	Craft, D. J.; "A fast hardware data compression algorithm and some algorithmic extensions"; Journal of Research and Development; Vol. 42, No. 6, November 1998; pages 733-745.	
	NPL215	"Direct Access Storage Device Compression and Decompression Data Flow"; IBM Technical Disclosure Bulletin; Vol. 38, No. 11; November 1995; pages 291-295.	
	NPL216	ICA Timeline, September 24, 2007, 3 pgs.	
	NPL217	Converse, et al.; "Low Bandwidth X Extension"; Protocol Version 1 .O; X Consortium; December 21, 1996, 55 pgs.	
	NPL218	Magstar and IBM 3590 High Performance Tape Subsystem Technical Guide; November 1996; IBM International Technical Support Organization, 288 pgs.	
	NPL219	MetaFrame Administration Student Workbook; June 1998; Citrix Professional Courseware; Citrix Systems, Inc, 113 pgs.	
	NPL220	NCD Wincenter 3.1 : Bringing Windows to Every Desktop, 1998; 2 pgs.	
	NPL221	Overview NetMeeting 2.1; Microsoft TechNet; technet.microsoft.com/en-us/library/cc767141(printer).aspx; accessed December 2, 2008; 7 pgs.	
	NPL222	NetMeeting 2.1 Resource Kit; Microsoft TechNet; technet.microsoft.com/en-us/library/cc767142(printer).aspx; accessed on December 2, 2008, 34 pgs.	

Examiner Signature		Date Considered	
-----------------------	--	--------------------	--

\*EXAMINER: Initial if reference considered, whether or not citation is in conformance with MPEP 609. Draw line through citation if not in conformance and not considered. Include copy of this form with next communication to applicant.

<sup>1</sup> Applicant's unique citation designation number (optional). <sup>2</sup> Applicant is to place a check mark here if English language Translation is attached.

Substitute for form 1449/PTO				<b>Complete if Known</b>	
<b>INFORMATION DISCLOSURE STATEMENT BY APPLICANT</b> <i>(Use as many sheets as necessary)</i>				Application Number	14/135,926
				Filing Date	December 19, 2013
				First Named Inventor	FALLON et al.
				Art Unit	2634
				Examiner Name	BOCURE, Tesfaldet
				Attorney Docket Number	2855.0050008
Sheet	31	of	97		

NON PATENT LITERATURE DOCUMENTS			
Examiner Initials*	Cite No. <sup>1</sup>	Include name of the author (in CAPITAL LETTERS), title of the article (when appropriate), title of the item (book, magazine, journal, serial, symposium, catalog, etc.), date, page(s), volume number, publisher, city and/or country where published	T <sup>2</sup>
	NPL223	Conferencing Standards: NetMeeting 2.1 Resource Kit: Microsoft TechNet; <a href="http://technet.microsoft.com/us/library/cc767150(printer).aspx">technet.microsoft.com/us/library/cc767150(printer).aspx</a> ; accessed December 2, 2008, 14 pgs.	
	NPL224	Summers, Bob; "Official Microsoft NetMeeting Book," Microsoft Press, 1998, 374 pgs.	
	NPL225	Zebroze, Katherine L.; "Integrating Hardware Accelerators into Internetworking Switches"; Telco Systems, 1995, 10 pages.	
	NPL226	Simpson, et al.; "A Multiple Processor Approach to Data Compression"; ACM; 1998; pages 641-649, 9 pgs.	
	NPL227	"IBM Technology Products Introduces New Family of High-Performance Data Compression Products"; IBM; August 16, 1993, 6 pgs.	
	NPL228	ReadMe; PowerQuest Drive Image Pro; Version 3.00; 1994-1999; PowerQuest Corporation; page 1-6.	
	NPL229	Schulzrinne, et al., "RTP Profile for Audio and Video Conferences with Minimal Control," January 1996, <a href="http://www.ietf.org/rfc/rfc1890.txt">www.ietf.org/rfc/rfc1890.txt</a> , accessed on December 3, 2008; 17 pgs.	
	NPL230	Zhu, C., "RTP Payload Format for H.263 Video Streams," Standards Track, September 1997, pages 1-12.	
	NPL231	Simpson, W., "The Point-To-Point Protocol (PPP)," Standards Track, July 1994, pages i-52.	
	NPL232	Reynolds, et al., "Assigned Numbers," Standards Track, October 1994, pages 1-230.	

Examiner Signature		Date Considered	
-----------------------	--	--------------------	--

\*EXAMINER: Initial if reference considered, whether or not citation is in conformance with MPEP 609. Draw line through citation if not in conformance and not considered. Include copy of this form with next communication to applicant.

<sup>1</sup> Applicant's unique citation designation number (optional). <sup>2</sup> Applicant is to place a check mark here if English language Translation is attached.

Substitute for form 1449/PTO				<b>Complete if Known</b>	
<b>INFORMATION DISCLOSURE STATEMENT BY APPLICANT</b> <i>(Use as many sheets as necessary)</i>				Application Number	14/135,926
				Filing Date	December 19, 2013
				First Named Inventor	FALLON et al.
				Art Unit	2634
				Examiner Name	BOCURE, Tesfaldet
Sheet	32	of	97	Attorney Docket Number	2855.0050008

NON PATENT LITERATURE DOCUMENTS			
Examiner Initials*	Cite No. <sup>1</sup>	Include name of the author (in CAPITAL LETTERS), title of the article (when appropriate), title of the item (book, magazine, journal, serial, symposium, catalog, etc.), date, page(s), volume number, publisher, city and/or country where published	T <sup>2</sup>
	NPL233	Deutsch, et al., "ZLIB Compressed Data Format Specification version 3.3," Informational, May 1996, pages 1-10.	
	NPL234	Deutsch, P., "DEFLATE Compressed Data Format Specification version 1.3," Informational, May 1996, pages 1-15.	
	NPL235	Rand, D., "The PPP Compression Control Protocol (CCP)," Standards Track, June 1996, pages 1-9.	
	NPL236	Schneider, et al., "PPP LZS-DCP Compression Protocol (LZS-DCP)," Informational, August 1996, pages 1-18.	
	NPL237	Friend, et al., "PPP Stac LZS Compression Protocol," Informational, August 1996; pages 1-20.	
	NPL238	Schneider, et al., "PPP for Data Compression in Data Circuit-Terminating Equipment (DCE)," Informational, August 1996, pages 1-10.	
	NPL239	Atkins, et al., "PGP Message Exchange Formats," Informational, August 1996, pages 1-21.	
	NPL240	Castineyra, et al., "The Nimrod Routing Architecture," Informational, August 1996, pages 1-27.	
	NPL241	Freed, et al., "Multipurpose Internet Mail Extensions (MIME) Part Four: Registration Procedures," Best Current Practice, November 1996, pages 1-21.	
	NPL242	Shacham, et al., "IP Payload Compression Protocol (IPComp)," Standards Track, December 1998, pages 1-10.	

Examiner Signature	Date Considered	
-----------------------	--------------------	--

\*EXAMINER: Initial if reference considered, whether or not citation is in conformance with MPEP 609. Draw line through citation if not in conformance and not considered. Include copy of this form with next communication to applicant.

<sup>1</sup> Applicant's unique citation designation number (optional). <sup>2</sup> Applicant is to place a check mark here if English language Translation is attached.



Substitute for form 1449/PTO			<b>Complete if Known</b>	
<b>INFORMATION DISCLOSURE STATEMENT BY APPLICANT</b> <i>(Use as many sheets as necessary)</i>			Application Number	14/135,926
			Filing Date	December 19, 2013
			First Named Inventor	FALLON et al.
			Art Unit	2634
			Examiner Name	BOCURE, Tesfaldet
			Attorney Docket Number	2855.0050008
			Sheet	33

<b>NON PATENT LITERATURE DOCUMENTS</b>			
Examiner Initials*	Cite No. <sup>1</sup>	Include name of the author (in CAPITAL LETTERS), title of the article (when appropriate), title of the item (book, magazine, journal, serial, symposium, catalog, etc.), date, page(s), volume number, publisher, city and/or country where published	T <sup>2</sup>
	NPL243	Sidewinder 50 Product Manual, Seagate Technology, Inc., 1997, 189 pgs.	
	NPL244	IBM RAMAC Virtual Array, IBM, July 1997, 490 pgs.	
	NPL245	Bruni, et al., "DB2 for OS/390 and Data Compression" IBM Corporation, November 1998, 172 pgs.	
	NPL246	Smith, Mark, "Thin Client/Server Computing Works," WindowsITPro, November 1, 1998, pages 1-13, license.icopyright.net/user/downloadLicense.act?lic=3.7009-8355, accessed December 2, 2008.	
	NPL247	International Telecommunication Union, "Information Technology - Digital Compression and Coding of Continuous-Tone Still Images-Requirements and Guidelines," 1993, 186 pgs.	
	NPL248	International Telecommunications Union, "Information technology - Lossless and near-lossless compression of continuous-tone still images - Baseline," 1999, 75 pgs.	
	NPL249	Davis, Andrew W., "The Video Answering Machine: Intel Proshare's Next Step," Advanced Imaging, Vol. 12, No. 3, March 1997, pages 28, 30.	
	NPL250	Abbott, III, Walter D., "A Simple, Low Overhead Data Compression Algorithm for Converting Lossy Compression Processes to Lossless," Naval Postgraduate School Thesis; December 1993, 93 pgs.	
	NPL251	Thomborson, Clark, "V.42bis and Other Ziv-Lemoel Variants," IEEE, 1991, page 460.	
	NPL252	Thomborson, Clark, "The V.42bis Standard for Data-Compressing Modems," IEEE, October 1992, pages 41-53.	

Examiner Signature		Date Considered	
-----------------------	--	--------------------	--

\*EXAMINER: Initial if reference considered, whether or not citation is in conformance with MPEP 609. Draw line through citation if not in conformance and not considered. Include copy of this form with next communication to applicant.

<sup>1</sup> Applicant's unique citation designation number (optional). <sup>2</sup> Applicant is to place a check mark here if English language Translation is attached.

Substitute for form 1449/PTO			<b>Complete if Known</b>	
<b>INFORMATION DISCLOSURE STATEMENT BY APPLICANT</b> <i>(Use as many sheets as necessary)</i>			Application Number	14/135,926
			Filing Date	December 19, 2013
			First Named Inventor	FALLON et al.
			Art Unit	2634
			Examiner Name	BOCURE, Tesfaldet
			Attorney Docket Number	2855.0050008
Sheet	34	of	97	

NON PATENT LITERATURE DOCUMENTS			
Examiner Initials*	Cite No. <sup>1</sup>	Include name of the author (in CAPITAL LETTERS), title of the article (when appropriate), title of the item (book, magazine, journal, serial, symposium, catalog, etc.), date, page(s), volume number, publisher, city and/or country where published	T <sup>2</sup>
	NPL253	Sun, Andrew, "Using and Managing PPP," O'Reilly & Associates, Inc., 1999, 89 pgs.	
	NPL254	"What is the V42bis Standard?," www.faqs.org/faqs/compression-faq/part1/section-10.html, accessed on December 2, 2008, 2 pgs.	
	NPL255	"The WSDC Download Guide: Drive Image Professional for DOS, OS/2, and Windows," wsdc01.watson.ibm.com/WSDC.nsf/Guides/Download/Applications-DriveImage.htm, Accessed November 22, 1999, 4 pgs.	
	NPL256	"The WSDC Download Guide: Drive Image Professional," wsdc01.watson.ibm.com/wsdc.nsf/Guides/Download/Applications-DriveImage.htm, accessed on May 3, 2001, 5 pgs.	
	NPL257	APPNOTE-TXT from pkware.txt, Version 6.3.2, PKWARE Inc., 1989, 52 pgs.	
	NPL258	CU-SeeMe readme.txt, December 2, 1995, 9 pgs.	
	NPL259	CU-seeme txt from indstate.txt, README.TXT for CU-SeeMe version 0.90bl, March 23, 1997, 5 pgs.	
	NPL260	Cuseeme txt 19960221 .txt; CUSEEME.TXT, February 21, 1996, 9 pgs.	
	NPL261	Citrix Technology Guide, 1997, 413 pgs.	
	NPL262	Lettieri, et al., "Data Compression in the V.42bis Modems," 1992, pages 398-403.	

Examiner Signature	Date Considered	
-----------------------	--------------------	--

\*EXAMINER: Initial if reference considered, whether or not citation is in conformance with MPEP 609. Draw line through citation if not in conformance and not considered. Include copy of this form with next communication to applicant.

<sup>1</sup> Applicant's unique citation designation number (optional). <sup>2</sup> Applicant is to place a check mark here if English language Translation is attached.

Substitute for form 1449/PTO				<b>Complete if Known</b>	
<b>INFORMATION DISCLOSURE STATEMENT BY APPLICANT</b> <i>(Use as many sheets as necessary)</i>				Application Number	14/135,926
				Filing Date	December 19, 2013
				First Named Inventor	FALLON et al.
				Art Unit	2634
				Examiner Name	BOCURE, Tesfaldet
				Attorney Docket Number	2855.0050008
Sheet	35	of	97		

NON PATENT LITERATURE DOCUMENTS			
Examiner Initials*	Cite No. <sup>1</sup>	Include name of the author (in CAPITAL LETTERS), title of the article (when appropriate), title of the item (book, magazine, journal, serial, symposium, catalog, etc.), date, page(s), volume number, publisher, city and/or country where published	T <sup>2</sup>
	NPL263	High Performance x2/V.34+N.42bis 56K BPS Plug & Play External Voice/FAX/Data Modem User's Manual, 1997, 27 pgs.	
	NPL264	H.323 Protocols Suite, www.protocols.com/pbook-h323.htm, 26 pages (referenced in Expert Report of Dr. James A. Storer on Invalidity filed on behalf of some of the defendants, filed in Realtime Data, LLC d/b/a IXO v. Packeteer, Inc. et al., Civil Action No. 6:08-cv-00144-LED, U.S. District Court for the Eastern District of Texas, June 10, 2009, and indicated as being last accessed in 2008, see e.g., Exhibit E, page 12).	
	NPL265	LBX X Consortium Algorithms; rzdocs.uni-hohenheim.de/aix-4.33/ext-doc/usr/share/man/info/en-US/a-doc-lib/.x."l;1 X I 1R 6 Technical Specifications, December 1996, 3 pgs.	
	NPL266	Basics of Images; www.geom.uiuc.edu/events/courses/1996/cmwh/Still/basics.html, 1996, 5 pgs.	
	NPL267	Parties' Joint Claim Construction and Prehearing Statement Pursuant to P.R. 4-3, filed in Realtime Data, LLC d/b/a IXO v. Packeteer, Inc. et al., Civil Action No. 6:08-cv-00144-LED; U.S. District Court for the Eastern District of Texas, February 18, 2009, 168 pages.	
	NPL268	Declaration of Professor James A. Storer, Ph.D., relating to U.S. Patent No. 6,604,158, March 18, 2009, 10 pgs.	
	NPL269	Declaration of Professor James A. Storer, Ph.D., relating to U.S. Patent No. 6,601,104, March 18, 2009, 8 pgs.	
	NPL270	Declaration of Professor James A. Storer, Ph.D., relating to U.S. Patent No. 7,321,937, May 4, 2009, 15 pgs.	
	NPL271	Declaration of Professor James A. Storer, Ph.D., relating to U.S. Patent No. 6,624,761, May 4, 2009, 6 pgs.	
	NPL272	Declaration of Professor James A. Storer, Ph.D., relating to U.S. Patent No. 7,378,992, May 20, 2009, 6 pgs.	

Examiner Signature	Date Considered	
-----------------------	--------------------	--

\*EXAMINER: Initial if reference considered, whether or not citation is in conformance with MPEP 609. Draw line through citation if not in conformance and not considered. Include copy of this form with next communication to applicant.

<sup>1</sup> Applicant's unique citation designation number (optional). <sup>2</sup> Applicant is to place a check mark here if English language Translation is attached.

Substitute for form 1449/PTO			<i>Complete if Known</i>	
<b>INFORMATION DISCLOSURE STATEMENT BY APPLICANT</b> <i>(Use as many sheets as necessary)</i>			Application Number	14/135,926
			Filing Date	December 19, 2013
			First Named Inventor	FALLON et al.
			Art Unit	2634
			Examiner Name	BOCURE, Tesfaldet
			Attorney Docket Number	2855.0050008
Sheet	36	of	97	

NON PATENT LITERATURE DOCUMENTS			
Examiner Initials*	Cite No. <sup>1</sup>	Include name of the author (in CAPITAL LETTERS), title of the article (when appropriate), title of the item (book, magazine, journal, serial, symposium, catalog, etc.), date, page(s), volume number, publisher, city and/or country where published	T <sup>2</sup>
	NPL273	Declaration of Professor James A. Storer, Ph.D., relating to U.S. Patent No. 7,161,506, May 26, 2009, 5 pgs.	
	NPL274	"Video Coding for Low Bit Rate Communication", International Telecommunication Union (ITU), Recommendation H.263, §3.4 (March 1996) ("ITU H.263"), 52 pgs.	
	NPL275	Order Adopting Report and Recommendation of United States Magistrate Judge, Realtime Data, LLC D/B/A Ixo v. Packeteer, Inc., et al., District Court for the Eastern District of Texas, No. 6:08cv144, August 24, 2009, 2 pgs.	
	NPL276	Second Amended Answer filed on behalf of Citrix Systems, Inc. (includes allegations of inequitable conduct on at least pages 24-43) filed in Realtime Data, LLC d/b/a/IXO v. Packeteer, Inc. et al., Civil Action No. 6:08-cv-00144-LED; U.S. District Court for the Eastern District of Texas, February 10, 2009, 45 pgs.	
	NPL277	Expert Report of James B. Gambrell on Inequitable Conduct filed on behalf of some of the defendants [Includes Appendices - Exhibits A-I] filed in Realtime Data, LLC d/b/a/IXO v. Packeteer, Inc. et al., Civil Action No. 6:08-cv-00144-LED; U.S. District Court for the Eastern District of Texas, June 10, 2009, 199 pgs.	
	NPL278	Expert Report of Dr. James A. Storer on Invalidity filed on behalf of some of the defendants [Includes Appendices - Exhibits A-K (Exhibit A has been redacted pursuant to a protective order)] filed in Realtime Data, LLC d/b/a IXO v. Packeteer, Inc. et al., Civil Action No. 6:08-cv-00144-LED; U.S. District Court for the Eastern District of Texas, June 10, 2009, 1090 pgs.	
	NPL279	Supplemental Expert Report of Dr. James A. Storer on Invalidity filed on behalf of some of the defendants [Includes Appendices - Exhibits 1-8] filed in Realtime Data, LLC d/b/a/IXO v. Packeteer, Inc. et al., Civil Action No. 6:08-cv-00144-LED; U.S. District Court for the Eastern District of Texas, June 19, 2009, 301 pgs.	
	NPL280	Deposition of Dr. James A. Storer conducted on behalf of the plaintiffs filed in Realtime Data, LLC d/b/a/IXO v. Packeteer, Inc. et al., Civil Action No. 6:08-cv-00144-LED; U.S. District Court for the Eastern District of Texas, February 27, 2009, 242 pgs.	
	NPL281	Deposition of Brian Von Herzen conducted on behalf of the plaintiffs filed in Realtime Data, LLC d/b/a/IXO v. Packeteer, Inc. et al., Civil Action No. 6:08-cv-00144-LED; U.S. District Court for the Eastern District of Texas, February 26, 2009, 241 pgs.	
	NPL282	Second Amended Complaint filed on behalf of the Plaintiff in Realtime Data, LLC d/b/a/IXO v. Packeteer, Inc. et al., Civil Action No. 6:08-cv-00144-LED; U.S. District Court for the Eastern District of Texas, February 10, 2009, 28 pgs.	

Examiner Signature	Date Considered	
-----------------------	--------------------	--

\*EXAMINER: Initial if reference considered, whether or not citation is in conformance with MPEP 609. Draw line through citation if not in conformance and not considered. Include copy of this form with next communication to applicant.

<sup>1</sup> Applicant's unique citation designation number (optional). <sup>2</sup> Applicant is to place a check mark here if English language Translation is attached.

Substitute for form 1449/PTO			<b>Complete if Known</b>	
<b>INFORMATION DISCLOSURE STATEMENT BY APPLICANT</b> <i>(Use as many sheets as necessary)</i>			Application Number	14/135,926
			Filing Date	December 19, 2013
			First Named Inventor	FALLON et al.
			Art Unit	2634
			Examiner Name	BOCURE, Tesfaldet
			Attorney Docket Number	2855.0050008
Sheet	37	of	97	

NON PATENT LITERATURE DOCUMENTS			
Examiner Initials*	Cite No. <sup>1</sup>	Include name of the author (in CAPITAL LETTERS), title of the article (when appropriate), title of the item (book, magazine, journal, serial, symposium, catalog, etc.), date, page(s), volume number, publisher, city and/or country where published	T <sup>2</sup>
	NPL283	Answers to the Second Amended Complaint and Counterclaims filed by Citrix Systems, Inc, in Realtime Data, LLC d/b/a/IXO v. Packeteer, Inc. et al., Civil Action No. 6:08-cv-00144-LED; U.S. District Court for the Eastern District of Texas, February 17, 2009, 46 pgs.	
	NPL284	Answers to the Second Amended Complaint and Counterclaims filed by F5 Networks, Inc, in Realtime Data, LLC d/b/a/IXO v. Packeteer, Inc. et al., Civil Action No. 6:08-cv-00144-LED; U.S. District Court for the Eastern District of Texas, February 17, 2009, 17 pgs.	
	NPL285	Answers to the Second Amended Complaint and Counterclaims filed by Averitt Express, Inc, in Realtime Data, LLC d/b/a/IXO v. Packeteer, Inc. et al., Civil Action No. 6:08-cv-00144-LED; U.S. District Court for the Eastern District of Texas, February 17, 2009, 17 pgs.	
	NPL286	Answers to the Second Amended Complaint and Counterclaims filed by DHL Express, Inc, in Realtime Data, LLC d/b/a/IXO v. Packeteer, Inc. et al., Civil Action No. 6:08-cv-00144-LED; U.S. District Court for the Eastern District of Texas, February 17, 2009, 37 pgs.	
	NPL287	Answers to the Second Amended Complaint and Counterclaims filed by Expand Networks, Inc, Interstate Battery System of America, Inc., and O'Reilly Automotive, Inc. in Realtime Data, LLC d/b/a/IXO v. Packeteer, Inc. et al., Civil Action No. 6:08-cv-00144-LED; U.S. District Court for the Eastern District of Texas, February 17, 2009, 21 pgs.	
	NPL288	Answers to the Second Amended Complaint and Counterclaims filed by Blue Coat Systems, Inc., Packeteer, Inc., 7-Eleven, Inc., ABM Industries, Inc., ABM Janitorial Services-South Central, Inc., and Build -A-Bear Workshop, Inc. in Realtime Data, LLC d/b/a/IXO v. Packeteer, Inc. et al., Civil Action No. 6:08-cv-00144-LED; U.S. District Court for the Eastern District of Texas, February 18, 2009, 84 pgs.	
	NPL289	Plaintiff's Response to the Answers to the Second Amended Complaint and Counterclaims filed by Citrix Systems, Inc, in Realtime Data, LLC d/b/a/IXO v. Packeteer, Inc. et al., Civil Action No. 6:08-cv-00144-LED; U.S. District Court for the Eastern District of Texas, March 4, 2009, 24 pgs.	
	NPL290	Plaintiff's Responses to the Answers to the Second Amended Complaint and Counterclaims filed by F5 Networks, Inc, in Realtime Data, LLC d/b/a/IXO v. Packeteer, Inc. et al., Civil Action No. 6:08-cv-00144-LED; U.S. District Court for the Eastern District of Texas, March 4, 2009, 5 pgs.	
	NPL291	Plaintiff's Responses to the Answers to the Second Amended Complaint and Counterclaims filed by Averitt Express, Inc, in Realtime Data, LLC d/b/a/IXO v. Packeteer, Inc. et al., Civil Action No. 6:08-cv-00144-LED; U.S. District Court for the Eastern District of Texas, March 4, 2009, 5 pgs.	
	NPL292	Plaintiff's Responses to the Answers to the Second Amended Complaint and Counterclaims filed by DHL Express, Inc, in Realtime Data, LLC d/b/a/IXO v. Packeteer, Inc. et al., Civil Action No. 6:08-cv-00144-LED; U.S. District Court for the Eastern District of Texas, March 4, 2009, 17 pgs.	

Examiner Signature		Date Considered	
-----------------------	--	--------------------	--

\*EXAMINER: Initial if reference considered, whether or not citation is in conformance with MPEP 609. Draw line through citation if not in conformance and not considered. Include copy of this form with next communication to applicant.

<sup>1</sup> Applicant's unique citation designation number (optional). <sup>2</sup> Applicant is to place a check mark here if English language Translation is attached.

Substitute for form 1449/PTO			<b>Complete if Known</b>	
<b>INFORMATION DISCLOSURE STATEMENT BY APPLICANT</b> <i>(Use as many sheets as necessary)</i>			Application Number	14/135,926
			Filing Date	December 19, 2013
			First Named Inventor	FALLON et al.
			Art Unit	2634
			Examiner Name	BOCURE, Tesfaldet
			Attorney Docket Number	2855.0050008
Sheet	38	of	97	

NON PATENT LITERATURE DOCUMENTS			
Examiner Initials*	Cite No. <sup>1</sup>	Include name of the author (in CAPITAL LETTERS), title of the article (when appropriate), title of the item (book, magazine, journal, serial, symposium, catalog, etc.), date, page(s), volume number, publisher, city and/or country where published	T <sup>2</sup>
	NPL293	Plaintiff's Responses to the Answers to the Second Amended Complaint and Counterclaims filed by Expand Networks, Inc, Interstate Battery System of America, Inc., and O'Reilly Automotive, Inc. in Realtime Data, LLC d/b/a/IXO v. Packeteer, Inc. et al., Civil Action No. 6:08-cv-00144-LED; U.S. District Court for the Eastern District of Texas, March 4, 2009, 15 pgs.	
	NPL294	Plaintiff's Responses to the Answers to the Second Amended Complaint and Counterclaims filed by Blue Coat Systems, Inc., Packeteer, Inc., 7-Eleven, Inc., ABM Industries, Inc., ABM Janitorial Services-South Central, Inc., and Build -A-Bear Workshop, Inc. in Realtime Data, LLC d/b/a/IXO v. Packeteer, Inc. et al., Civil Action No. 6:08-cv-00144-LED; U.S. District Court for the Eastern District of Texas, March 4, 2009, 34 pgs.	
	NPL295	Opening Claim Construction Brief filed in Realtime Data, LLC d/b/a/IXO v. Packeteer, Inc. et al., Civil Action No. 6:08-cv-00144-LED; U.S. District Court for the Eastern District of Texas, March 5, 2009, 36 pgs.	
	NPL296	Declaration of Jordan Adler in support of the Opening Claim Construction Brief filed in Realtime Data, LLC d/b/a/IXO v. Packeteer, Inc. et al., Civil Action No. 6:08-cv-00144-LED; U.S. District Court for the Eastern District of Texas, March 5, 2009, 214 pgs.	
	NPL297	Motion for Partial Summary Judgment for Invalidity of some of the Patents in Suit for Indefiniteness, including the '104 patent, filed on behalf of the defendants in Realtime Data, LLC d/b/a/IXO v. Packeteer, Inc. et al., Civil Action No. 6:08-cv-00144-LED; U.S. District Court for the Eastern District of Texas, March 16, 2009, 22 pgs.	
	NPL298	Declaration of Michele E. Moreland in support Motion for Partial Summary Judgment for Invalidity of some of the Patents in Suit for Indefiniteness, including the '104 patent, filed on behalf of the defendants in Realtime Data, LLC d/b/a/IXO v. Packeteer, Inc. et al., Civil Action No. 6:08-cv-00144-LE, March 16, 2009, 168 pgs.	
	NPL299	Declaration of James A. Storer in support Motion for Partial Summary Judgment for Invalidity of some of the Patents in Suit for Indefiniteness, including the '104 patent, filed on behalf of the defendants in Realtime Data, LLC d/b/a/IXO v. Packeteer, Inc. et al., Civil Action No. 6:08-cv-00144-LE, March 16, 2009, 27 pgs.	
	NPL300	Joint Defendants Reply regarding Motion for Partial Summary Judgment for Invalidity of some of the Patents in Suit for Indefiniteness, including the '104 patent, filed on behalf of the defendants in Realtime Data, LLC d/b/a/IXO v. Packeteer, Inc. et al., Civil Action No. 6:08-cv-00144-LE, April 2, 2009, 20 pgs.	
	NPL301	Responsive Briefs in Support of Claim Construction filed by Blue Coats Systems, Inc., Packeteer, Inc., 7-Eleven, Inc., ABM Industries, Inc., ABM Janitorial Services-South Central, Inc. and Build-A-Bear Workshop, Inc. in Realtime Data, LLC d/b/a/IXO v. Packeteer, Inc. et al., Civil Action No. 6:08-cv-00144-LED; U.S. District Court for the Eastern District of Texas, March 19, 2009, 451 pgs.	
	NPL302	Responsive Briefs in Support of Claim Construction filed by F5 Networks, Inc. and Averitt Express, Inc. in Realtime Data, LLC d/b/a/IXO v. Packeteer, Inc. et al., Civil Action No. 6:08-cv-00144-LED; U.S. District Court for the Eastern District of Texas, March 19, 2009, 20 pgs.	
Examiner Signature		Date Considered	

\*EXAMINER: Initial if reference considered, whether or not citation is in conformance with MPEP 609. Draw line through citation if not in conformance and not considered. Include copy of this form with next communication to applicant.

<sup>1</sup> Applicant's unique citation designation number (optional). <sup>2</sup> Applicant is to place a check mark here if English language Translation is attached.

Substitute for form 1449/PTO				<b>Complete if Known</b>	
<b>INFORMATION DISCLOSURE STATEMENT BY APPLICANT</b> <i>(Use as many sheets as necessary)</i>				Application Number	14/135,926
				Filing Date	December 19, 2013
				First Named Inventor	FALLON et al.
				Art Unit	2634
				Examiner Name	BOCURE, Tesfaldet
				Attorney Docket Number	2855.0050008
Sheet	39	of	97		

NON PATENT LITERATURE DOCUMENTS			
Examiner Initials*	Cite No. <sup>1</sup>	Include name of the author (in CAPITAL LETTERS), title of the article (when appropriate), title of the item (book, magazine, journal, serial, symposium, catalog, etc.), date, page(s), volume number, publisher, city and/or country where published	T <sup>2</sup>
	NPL303	Responsive Briefs in Support of Claim Construction filed by Citrix Systems, Inc., Expand Networks, Inc., DHL Express (USA), Inc., Interstate Battery System of America, Inc., and O'Reilly Automotive Inc. in Realtime Data, LLC d/b/a/IXO v. Packeteer, Inc. et al., Civil Action No. 6:08-cv-00144-LED; U.S. District Court for the Eastern District of Texas, March 19, 2009, 377 pgs.	
	NPL304	Declaration of Dr. James A. Storer filed in Support of the Brief in Support of Claim Construction filed on behalf of F5 Networks, Inc. in Realtime Data, LLC d/b/a/IXO v. Packeteer, Inc. et al., Civil Action No. 6:08-cv-00144-LED; U.S. District Court for the Eastern District of Texas, March 19, 2009, 778 pgs.	
	NPL305	Defendant Citrix Systems, Inc.'s Motion to Exclude Dr. Brian Von Herzen's Opinions Regarding Claim Construction filed in Realtime Data, LLC d/b/a/IXO v. Packeteer, Inc. et al., Civil Action No. 6:08-cv-00144-LED; U.S. District Court for the Eastern District of Texas, March 20, 2009, 244 pgs.	
	NPL306	Plaintiff's Opposition to Defendant Citrix Systems, Inc.'s Motion to Exclude Dr. Brian Von Herzen's Opinions Regarding Claim Construction filed in Realtime Data, LLC d/b/a/IXO v. Packeteer, Inc. et al., Civil Action No. 6:08-cv-00144-LED; U.S. District Court for the Eastern District of Texas, April 6, 2009, 20 pgs.	
	NPL307	Declaration of Karim Oussayef submitted in support of the Opposition of Plaintiff's Opposition to Defendant Citrix Systems, Inc.'s Motion to Exclude Dr. Brian Von Herzen's Opinions Regarding Claim Construction filed in Realtime Data, LLC d/b/a/IXO v. Packeteer, Inc. et al., Civil Action No. 6:08-cv-00144-LED; U.S. District Court for the Eastern District of Texas, April 6, 2009, 119 pgs.	
	NPL308	Order of the Court Denying Defendant Citrix Systems, Inc.'s Motion to Exclude Dr. Brian Von Herzen's Opinions Regarding Claim Construction, Realtime Data, LLC D/B/A Ixo v. Packeteer, Inc., et al., District Court for the Eastern District of Texas, No. 6:08cv144, April 6, 2009, 1 pg.	
	NPL309	Parties Joint Submission of Terms to be Heard at the Markman Hearing filed in Realtime Data, LLC d/b/a/IXO v. Packeteer, Inc. et al., Civil Action No. 6:08-cv-00144-LED; U.S. District Court for the Eastern District of Texas, March 24, 2009, 5 pgs.	
	NPL310	Order of the Court Regarding the terms to be heard at the Markman Hearing in Realtime Data, LLC d/b/a/IXO v. Packeteer, Inc. et al., Civil Action No. 6:08-cv-00144-LED; U.S. District Court for the Eastern District of Texas, March 24, 2009, 2 pgs.	
	NPL311	Transcript of the Markman Hearing held on April 9, 2009 in Realtime Data, LLC d/b/a/IXO v. Packeteer, Inc. et al., Civil Action No. 6:08-cv-00144-LED; U.S. District Court for the Eastern District of Texas, 174 pgs.	
	NPL312	Plaintiff's Reply Claim Construction Brief filed in Realtime Data, LLC d/b/a/IXO v. Packeteer, Inc. et al., Civil Action No. 6:08-cv-00144-LED; U.S. District Court for the Eastern District of Texas, March 30, 2009, 30 pgs.	

Examiner Signature	Date Considered
--------------------	-----------------

\*EXAMINER: Initial if reference considered, whether or not citation is in conformance with MPEP 609. Draw line through citation if not in conformance and not considered. Include copy of this form with next communication to applicant.

<sup>1</sup> Applicant's unique citation designation number (optional). <sup>2</sup> Applicant is to place a check mark here if English language Translation is attached.

Substitute for form 1449/PTO			<b>Complete if Known</b>	
<b>INFORMATION DISCLOSURE STATEMENT BY APPLICANT</b> <i>(Use as many sheets as necessary)</i>			Application Number	14/135,926
			Filing Date	December 19, 2013
			First Named Inventor	FALLON et al.
			Art Unit	2634
			Examiner Name	BOCURE, Tesfaldet
			Attorney Docket Number	2855.0050008
Sheet	40	of	97	

NON PATENT LITERATURE DOCUMENTS			
Examiner Initials*	Cite No. <sup>1</sup>	Include name of the author (in CAPITAL LETTERS), title of the article (when appropriate), title of the item (book, magazine, journal, serial, symposium, catalog, etc.), date, page(s), volume number, publisher, city and/or country where published	T <sup>2</sup>
	NPL313	Declaration of Brian von Herzen in Support of the Plaintiff's Reply Claim Construction Brief filed in Realtime Data, LLC d/b/a/IXO v. Packeteer, Inc. et al., Civil Action No. 6:08-cv-00144-LED; U.S. District Court for the Eastern District of Texas, March 30, 2009, 25 pgs.	
	NPL314	F5 Sur-Reply to Plaintiff's Claim Construction Brief filed by some of the defendants in Realtime Data, LLC d/b/a/IXO v. Packeteer, Inc. et al., Civil Action No. 6:08-cv-00144-LED; U.S. District Court for the Eastern District of Texas, April 3, 2009, 12 pg	
	NPL315	Citrix Sur-Reply to Plaintiff's Claim Construction Brief filed by some of the defendants in Realtime Data, LLC d/b/a/IXO v. Packeteer, Inc. et al., Civil Action No. 6:08-cv-00144-LED; U.S. District Court for the Eastern District of Texas, April 3, 2009, 13 pgs.	
	NPL316	Blue Coat Sur-Reply to Plaintiff's Claim Construction Brief filed by some of the defendants in Realtime Data, LLC d/b/a/IXO v. Packeteer, Inc. et al., Civil Action No. 6:08-cv-00144-LED; U.S. District Court for the Eastern District of Texas, April 3, 2009, 12 pgs.	
	NPL317	Declaration of Michele Moreland in Support of Sur-Replies to Plaintiff's Claim Construction Brief filed by some of the defendants in Realtime Data, LLC d/b/a/IXO v. Packeteer, Inc. et al., Civil Action No. 6:08-cv-00144-LED; U.S. District Court for the Eastern District of Texas, April 3, 2009, 8 pgs.	
	NPL318	Declaration of James Storer in Support of Sur-Replies to Plaintiff's Claim Construction Brief filed by some of the defendants in Realtime Data, LLC d/b/a/IXO v. Packeteer, Inc. et al., Civil Action No. 6:08-cv-00144-LED; U.S. District Court for the Eastern District of Texas, April 7, 2009, 6 pgs.	
	NPL319	Plaintiff's Motion for Leave to Supplement the Parties' Joint Claim Construction and Prehearing Statement filed in Realtime Data, LLC d/b/a/IXO v. Packeteer, Inc. et al., Civil Action No. 6:08-cv-00144-LED; U.S. District Court for the Eastern District of Texas, April 8, 2009, 123 pgs.	
	NPL320	Motion for Reconsideration of the Court's Order Denying Plaintiff's Motion for Leave to Supplement the Parties' Joint Claim Construction and Prehearing Statement filed in Realtime Data, LLC d/b/a/IXO v. Packeteer, Inc. et al., Civil Action No. 6:08-cv-00144-LED; U.S. District Court for the Eastern District of Texas, July 13, 2009, 3 pgs.	
	NPL321	Citrix Systems' Opposition to Realtime Data's Motion for Reconsideration of Realtime's Motion for Leave to Supplement the Parties' Joint Claim Construction, filed in Realtime Data, LLC d/b/a/IXO v. Packeteer, Inc. et al., Civil Action No. 6:08-cv-00144-LED; U.S. District Court for the Eastern District of Texas, July 27, 2009, 6 pgs.	
	NPL322	Notice of Agreement to Claim Term between Plaintiff and Defendant filed in Realtime Data, LLC d/b/a/IXO v. Packeteer, Inc. et al., Civil Action No. 6:08-cv-00144-LED; U.S. District Court for the Eastern District of Texas, April 22, 2009, 3 pgs.	

Examiner Signature	Date Considered
--------------------	-----------------

\*EXAMINER: Initial if reference considered, whether or not citation is in conformance with MPEP 609. Draw line through citation if not in conformance and not considered. Include copy of this form with next communication to applicant.

<sup>1</sup> Applicant's unique citation designation number (optional). <sup>2</sup> Applicant is to place a check mark here if English language Translation is attached.



Substitute for form 1449/PTO			<b>Complete if Known</b>	
<b>INFORMATION DISCLOSURE STATEMENT BY APPLICANT</b> <i>(Use as many sheets as necessary)</i>			Application Number	14/135,926
			Filing Date	December 19, 2013
			First Named Inventor	FALLON et al.
			Art Unit	2634
			Examiner Name	BOCURE, Tesfaldet
			Attorney Docket Number	2855.0050008
Sheet	41	of	97	

NON PATENT LITERATURE DOCUMENTS			
Examiner Initials*	Cite No. <sup>1</sup>	Include name of the author (in CAPITAL LETTERS), title of the article (when appropriate), title of the item (book, magazine, journal, serial, symposium, catalog, etc.), date, page(s), volume number, publisher, city and/or country where published	T <sup>2</sup>
	NPL323	Provisional Claim Construction Order issued by the Court on June 2, 2009 in Realtime Data, LLC d/b/a/IXO v. Packeteer, Inc. et al., Civil Action No. 6:08-cv-00144-LED; U.S. District Court for the Eastern District of Texas, 28 pgs.	
	NPL324	Citrix Request for Consideration and Objections to the Provisional Claim Construction Order issued by the Court on June 22, 2009 filed on behalf of some of the defendants in Realtime Data, LLC d/b/a/IXO v. Packeteer, Inc. et al., Civil Action No. 6:08-cv-00144-LED; U.S. District Court for the Eastern District of Texas, July 9, 2009, 22 pgs.	
	NPL325	Blue Coat Request for Consideration and Objections to the Provisional Claim Construction Order issued by the Court on June 22, 2009 filed on behalf of some of the defendants in Realtime Data, LLC d/b/a/IXO v. Packeteer, Inc. et al., Civil Action No. 6:08-cv-00144-LED, U.S. District Court for the Eastern District of Texas, July 10, 2009, 9 pgs.	
	NPL326	F5 Request for Consideration and Objections to the Provisional Claim Construction Order issued by the Court on June 22, 2009 filed on behalf of some of the defendants in Realtime Data, LLC d/b/a/IXO v. Packeteer, Inc. et al., Civil Action No. 6:08-cv-00144-LED; U.S. District Court for the Eastern District of Texas, July 10, 2009, 15 pgs.	
	NPL327	Comtech AHA Corporation's Complaint in Intervention against the Plaintiff filed in Realtime Data, LLC d/b/a/IXO v. Packeteer, Inc. et al., Civil Action No. 6:08-cv-00144-LED; U.S. District Court for the Eastern District of Texas, April 6, 2009, 8 pgs.	
	NPL328	Report and Recommendation of United States Magistrate Judge on Motion for Partial Summary Judgment issued on June 23, 2009, in Realtime Data, LLC d/b/a/IXO v. Packeteer, Inc. et al., Civil Action No. 6:08-cv-00144-LED; U.S. District Court for the Eastern District of Texas, 22 pgs.	
	NPL329	Blue Coat Defendants' Report and Recommendations Regarding Motion for Partial Summary Judgment of Invalidity for Indefiniteness in Realtime Data, LLC d/b/a/IXO v. Packeteer, Inc. et al., Civil Action No. 6:08-cv-00144-LED; U.S. District Court for the Eastern District of Texas, July 8, 2009, 18 pgs.	
	NPL330	Plaintiff's Objections To and Partially Unopposed Motion for Reconsideration of United States Magistrate Judge's Claim Construction Memorandum and Order, in Realtime Data, LLC d/b/a/IXO v. Packeteer, Inc. et al., Civil Action No. 6:08-cv-00144-LED; U.S. District Court for the Eastern District of Texas, July 13, 2009, 11 pgs.	
	NPL331	Defendant Citrix Opposition to Realtime's Objections to and Partially Unopposed Motion for Reconsideration of Magistrate Love's Claim Construction Memorandum and Order filed by Citrix Systems, Inc., filed on behalf of some of the defendants in Realtime Data, LLC d/b/a/IXO v. Packeteer, Inc. et al., Civil Action No. 6:08-cv-00144-LED; U.S. District Court for the Eastern District of Texas, July 27, 2009, 8 pgs.	

Examiner Signature		Date Considered	
-----------------------	--	--------------------	--

\*EXAMINER: Initial if reference considered, whether or not citation is in conformance with MPEP 609. Draw line through citation if not in conformance and not considered. Include copy of this form with next communication to applicant.

<sup>1</sup> Applicant's unique citation designation number (optional). <sup>2</sup> Applicant is to place a check mark here if English language Translation is attached.

Substitute for form 1449/PTO				<b>Complete if Known</b>	
<b>INFORMATION DISCLOSURE STATEMENT BY APPLICANT</b> <i>(Use as many sheets as necessary)</i>				Application Number	14/135,926
				Filing Date	December 19, 2013
				First Named Inventor	FALLON et al.
				Art Unit	2634
				Examiner Name	BOCURE, Tesfaldet
				Attorney Docket Number	2855.0050008
Sheet	42	of	97		

NON PATENT LITERATURE DOCUMENTS			
Examiner Initials*	Cite No. <sup>1</sup>	Include name of the author (in CAPITAL LETTERS), title of the article (when appropriate), title of the item (book, magazine, journal, serial, symposium, catalog, etc.), date, page(s), volume number, publisher, city and/or country where published	T <sup>2</sup>
	NPL332	Defendant F5 Networks, Inc.'s Opposition to Plaintiff's Objections and Partially Unopposed Motion for Reconsideration of Magistrate Judge Love's Claim Construction and Order, filed on behalf of some of the defendants in Realtime Data, LLC d/b/a/IXO v. Packeteer, Inc. et al., Civil Action No. 6:08-cv-00144-LED; U.S. District Court for the Eastern District of Texas, July 27, 2009, 4 pgs.	
	NPL333	Defendants' Response in Opposition to Realtime Data's Objections to and Partially Unopposed Motion for Reconsideration of Magistrate Judge Love's Claim Construction Memorandum and Order, filed on behalf of some of the defendants in Realtime Data, LLC d/b/a/IXO v. Packeteer, Inc. et al., Civil Action No. 6:08-cv-00144-LED; U.S. District Court for the Eastern District of Texas, July 27, 2009, 9 pgs.	
	NPL334	Realtime Data's Response in Opposition to Defendant Citrix Systems Objections to and Request for Reconsideration of Magistrate's Order Regarding Claim Construction, in Realtime Data, LLC d/b/a/IXO v. Packeteer, Inc. et al., Civil Action No. 6:08-cv-00144-LED; U.S. District Court for the Eastern District of Texas, July 27, 2009, 13 pgs.	
	NPL335	Plaintiff Realtime Data's Response in Opposition to Blue Coat Defendants' Objection to Magistrate's Memorandum Opinion and Order Regarding Claim Construction, in Realtime Data, LLC d/b/a/IXO v. Packeteer, Inc. et al., Civil Action No. 6:08-cv-00144-LED; U.S. District Court for the Eastern District of Texas, July 27, 2009, 9 pgs.	
	NPL336	Plaintiff's selected Responses to Defendant Citrix System's Interrogatories and First Set of Requests for Admission filed in Realtime Data, LLC d/b/a/IXO v. Packeteer, Inc. et al., Civil Action No. 6:08-cv-00144-LED; U.S. District Court for the Eastern District of Texas, July 15, 2009, 151 pgs.	
	NPL337	Script for Defendants' Joint Claim Construction Technology Tutorial Presented to the Magistrate Judge in Realtime Data, LLC d/b/a/IXO v. Packeteer, Inc. et al., Civil Action No. 6:08-cv-00144-LED; U.S. District Court for the Eastern District of Texas, filed on April 18, 2008 and terminated February 2, 95 pgs.	
	NPL338	Preliminary Data Sheet, 9600 Data Compressor Processor, Hi/fn, 1997-99, HIFN 000001-68, 68 pgs.	
	NPL339	Data Sheet, 9751 Data Compression Processor, 1997-99, HIFN 000069-187, 119 pgs.	
	NPL340	Signal Termination Guide, Application Note, Hi/fn, 1997-98, HIFN 000188-194, 7 pgs.	
	NPL341	How LZS Data Compression Works, Application Note, Hi/fn, 1997-99, HIFN 000195-207, 13 pgs.	

Examiner Signature		Date Considered	
--------------------	--	-----------------	--

\*EXAMINER: Initial if reference considered, whether or not citation is in conformance with MPEP 609. Draw line through citation if not in conformance and not considered. Include copy of this form with next communication to applicant.

<sup>1</sup> Applicant's unique citation designation number (optional). <sup>2</sup> Applicant is to place a check mark here if English language Translation is attached.

Substitute for form 1449/PTO			<b>Complete if Known</b>	
<b>INFORMATION DISCLOSURE STATEMENT BY APPLICANT</b> <i>(Use as many sheets as necessary)</i>			Application Number	14/135,926
			Filing Date	December 19, 2013
			First Named Inventor	FALLON et al.
			Art Unit	2634
			Examiner Name	BOCURE, Testaldet
			Attorney Docket Number	2855.0050008
Sheet	43	of	97	

NON PATENT LITERATURE DOCUMENTS			
Examiner Initials*	Cite No. <sup>1</sup>	Include name of the author (in CAPITAL LETTERS), title of the article (when appropriate), title of the item (book, magazine, journal, serial, symposium, catalog, etc.), date, page(s), volume number, publisher, city and/or country where published	T <sup>2</sup>
	NPL342	Reference Hardware, 9751 Compression Processor, Hi/fn, 1997-99, HIFN 000208-221, 14 pgs.	
	NPL343	Using 9751 in Big Endian Systems, Application Note, Hi/fn, 1997-99, HIFN 000222-234, 13 pgs.	
	NPL344	Specification Update, 9751 Compression Processor, Hi/fn, 1997-2000, HIFN 000235-245, 11 pgs.	
	NPL345	9732AM Product Release, Hi/fn, 1994-99, HIFN 000246-302, 57 pgs.	
	NPL346	Data Sheet, 9732A Data Compression Processor, Hi/fn, 1997-99, HIFN 000303-353, 51 pgs.	
	NPL347	9711 to 7711 Migration, Application Note, Hi/fn, 1997-99, HIFN 000354-361, 8 pgs.	
	NPL348	Specification Update, 9711 Data Compression Processor, Hi/fn, 1997-99, HIFN 000362-370, 9 pgs.	
	NPL349	Differences Between the 9710 & 9711 Processors, Application Note, Hi/fn, 1997-99, HIFN 000371-77, 7 pgs.	
	NPL350	Specification Update, 9710 Data Compression Processor, Hi/fn, 1997-99, HIFN 000378-388, 11 pgs.	
	NPL351	9706/9706A Data Compression Coprocessor Data Sheet, Stac Electronics, 1991-97, HIFN 000389-473, 85 pgs.	

Examiner Signature	Date Considered	
--------------------	-----------------	--

\*EXAMINER: Initial if reference considered, whether or not citation is in conformance with MPEP 609. Draw line through citation if not in conformance and not considered. Include copy of this form with next communication to applicant.  
<sup>1</sup> Applicant's unique citation designation number (optional). <sup>2</sup> Applicant is to place a check mark here if English language Translation is attached.

Substitute for form 1449/PTO			<b>Complete if Known</b>	
<b>INFORMATION DISCLOSURE STATEMENT BY APPLICANT</b> <i>(Use as many sheets as necessary)</i>			Application Number	14/135,926
			Filing Date	December 19, 2013
			First Named Inventor	FALLON et al.
			Art Unit	2634
			Examiner Name	BOCURE, Tesfaldet
			Attorney Docket Number	2855.0050008
Sheet	44	of	97	

NON PATENT LITERATURE DOCUMENTS			
Examiner Initials*	Cite No. <sup>1</sup>	Include name of the author (in CAPITAL LETTERS), title of the article (when appropriate), title of the item (book, magazine, journal, serial, symposium, catalog, etc.), date, page(s), volume number, publisher, city and/or country where published	T <sup>2</sup>
	NPL352	9705/9705A Data Compression Coprocessor, Stac Electronics, 1988-96, HIFN 000474-562, 88 pgs.	
	NPL353	9705/9705A Data Compression Coprocessor Data Sheet, Stac Electronics, 1988-96, HIFN 000563-649, 87 pgs.	
	NPL354	9700/9701 Compression Coprocessors, Hi/fn, 1997, HIFN 000650-702, 53 pgs.	
	NPL355	Data Sheet 9610 Data Compression Processor, Hi/fn, 1997-98, HIFN 000703-744, 42 pgs.	
	NPL356	Specification Update 9610 Data Compression Processor, Hi/fn, 1997-99, HIFN 000745-751, 7 pgs.	
	NPL357	9705 Data Compression Coprocessor, Stac Electronics, 1988-92, HIFN 000752-831, 80 pgs.	
	NPL358	9705 Network Software Design Guide, Application Note, Stac Electronics, 1990-91, HIFN 000832-861, 30 pgs.	
	NPL359	Data Sheet 9601 Data Compression Processor, Hi/fn, May 21, 1998, HIFN 000862-920, 59 pgs.	
	NPL360	7751 Encryption Processor Reference Kit, Hi/fn, April 1999, HIFN 000921-1114, 194 pgs.	
	NPL361	Hardware Data Book, Hi/fn, November 1998, HIFN 001115-1430, 316 pgs.	

Examiner Signature	Date Considered	
-----------------------	--------------------	--

\*EXAMINER: Initial if reference considered, whether or not citation is in conformance with MPEP 609. Draw line through citation if not in conformance and not considered. Include copy of this form with next communication to applicant.

<sup>1</sup> Applicant's unique citation designation number (optional). <sup>2</sup> Applicant is to place a check mark here if English language Translation is attached.

Substitute for form 1449/PTO				<b>Complete if Known</b>	
<b>INFORMATION DISCLOSURE STATEMENT BY APPLICANT</b> <i>(Use as many sheets as necessary)</i>				Application Number	14/135,926
				Filing Date	December 19, 2013
				First Named Inventor	FALLON et al.
				Art Unit	2634
				Examiner Name	BOCURE, Tesfaldet
				Attorney Docket Number	2855.0050008
Sheet	45	of	97		

NON PATENT LITERATURE DOCUMENTS			
Examiner Initials*	Cite No. <sup>1</sup>	Include name of the author (in CAPITAL LETTERS), title of the article (when appropriate), title of the item (book, magazine, journal, serial, symposium, catalog, etc.), date, page(s), volume number, publisher, city and/or country where published	T <sup>2</sup>
	NPL362	Data Compression Data Book, Hi/fn, January 1999, HIFN 001431-1889, 459 pgs.	
	NPL363	Reference Software 7751 Encryption Processor, Hi/fn, November 1998, HIFN 002164-2201, 38 pgs.	
	NPL364	Interface Specification for Synergize Encoding/Decoding Program, JPB, October 10, 1997, HIFN 002215-2216, 2 pgs.	
	NPL365	Anderson, Chip, Extended Memory Specification Driver, 1998, HIFN 002217-2264, 48 pgs.	
	NPL366	Whiting, Doug, LZS Hardware API, March 12, 1993, HIFN 002265-68, 4 pgs.	
	NPL367	Whiting, Doug, Encryption in Sequoia, April 28, 1997, HIFN 002309-2313, 5 pgs.	
	NPL368	LZS221-C Version 4 Data Compression Software, Data Sheet, Hi/fn, 1994-97, HIFN 002508-2525, 18 pgs.	
	NPL369	eXtended Memory Specification (XMS), ver. 2.0, Microsoft, July 19, 1988, HIFN 002670-2683, 14 pgs.	
	NPL370	King, Stanley, Just for Your Info – From Microsoft 2, May 4, 1992, HIFN 002684-2710, 27 pgs.	
	NPL371	eXtended Memory Specification (XMS), ver. 2.0, Microsoft, July 19, 1988, HIFN 002711-2724, 14 pgs.	

Examiner Signature		Date Considered	
--------------------	--	-----------------	--

\*EXAMINER: Initial if reference considered, whether or not citation is in conformance with MPEP 609. Draw line through citation if not in conformance and not considered. Include copy of this form with next communication to applicant.  
<sup>1</sup> Applicant's unique citation designation number (optional). <sup>2</sup> Applicant is to place a check mark here if English language Translation is attached.

Substitute for form 1449/PTO				<b>Complete if Known</b>	
<b>INFORMATION DISCLOSURE STATEMENT BY APPLICANT</b> <i>(Use as many sheets as necessary)</i>				Application Number	14/135,926
				Filing Date	December 19, 2013
				First Named Inventor	FALLON et al.
				Art Unit	2634
				Examiner Name	BOCURE, Tesfaldet
				Attorney Docket Number	2855.0050008
Sheet	46	of	97		

NON PATENT LITERATURE DOCUMENTS			
Examiner Initials*	Cite No. <sup>1</sup>	Include name of the author (in CAPITAL LETTERS), title of the article (when appropriate), title of the item (book, magazine, journal, serial, symposium, catalog, etc.), date, page(s), volume number, publisher, city and/or country where published	T <sup>2</sup>
	NPL372	Advanced LZS Technology (ALZS), Whitepaper, Hi/fn, June 1, 1998, HIFN 002725-2727, 3 pgs.	
	NPL373	Secure Tape Technology (STT) Whitepaper, Hi/fn, June 1, 1998, HIFN 002728-2733, 6 pgs.	
	NPL374	SSLRef 3.0 API Details, Netscape, November 19, 1996, HIFN 002734-2778, 45 pgs.	
	NPL375	LZS221-C Version 4 Data Compression Software Data Sheet , Hi/fn, 1994-97, HIFN 002779-2796, 18 pgs.	
	NPL376	MPPC-C Version 4 Data Compression Software Data Sheet, Hi/fn, 1994-1997, HIFN 002797-2810, 14 pgs.	
	NPL377	Magstar MP Hardware Reference B Series Models Document GA32-0365-01, 1996-1997, [IBM_1_601 pages 1-338], 338 pages.	
	NPL378	Magstar MP 3570 Tape Subsystem, Operator Guide, B-Series Models, 1998-1999, [IBM_1_601 pages 339-525], 188 pages.	
	NPL379	Preview, IBM Magstar 3590 Tape System Enhancements, Hardware Announcement, February 16, 1999, [IBM_1_601 pages 526-527], 2 pgs.	
	NPL380	New IBM Magstar 3590 Models E11 and E1A Enhance Tape Drive Performance, Hardware Announcement, April 20, 1999, [IBM_1_601 pages 528-540] 13 pgs.	
	NPL381	NEW IBM Magstar 3590 Model A60 Dramatically Enhances Tape Drive Performance, Hardware Announcement July 27, 1999, [IBM_1_601 pages 541-550] 10 pgs.	

Examiner Signature		Date Considered	
-----------------------	--	--------------------	--

\*EXAMINER: Initial if reference considered, whether or not citation is in conformance with MPEP 609. Draw line through citation if not in conformance and not considered. Include copy of this form with next communication to applicant.

<sup>1</sup> Applicant's unique citation designation number (optional). <sup>2</sup> Applicant is to place a check mark here if English language Translation is attached.

Substitute for form 1449/PTO				<b>Complete if Known</b>	
<b>INFORMATION DISCLOSURE STATEMENT BY APPLICANT</b> <i>(Use as many sheets as necessary)</i>				Application Number	14/135,926
				Filing Date	December 19, 2013
				First Named Inventor	FALLON et al.
				Art Unit	2634
				Examiner Name	BOCURE, Tesfaldet
				Attorney Docket Number	2855.0050008
Sheet	47	of	97		

NON PATENT LITERATURE DOCUMENTS			
Examiner Initials*	Cite No. <sup>1</sup>	Include name of the author (in CAPITAL LETTERS), title of the article (when appropriate), title of the item (book, magazine, journal, serial, symposium, catalog, etc.), date, page(s), volume number, publisher, city and/or country where published	T <sup>2</sup>
	NPL382	The IBM Magstar MP Tape Subsystem Provides Fast Access to Data, September 3, 1996, Announcement No. 196-176, [IBM_1_601 pages 551-563] 13 pgs.	
	NPL383	IBM 3590 High Performance Tape Subsystem, April 10, 1995, Announcement 195-106, [IBM_1_601 pages 564-581] 18 pgs.	
	NPL384	Standard ECMA-222 (June 1995): ECMA – Standardizing Information and Communications Systems, Adaptive Lossless Data Compression Algorithm, [IBM_1_601 pages 582-601] 20 pgs.	
	NPL385	IBM 3590 and 3494 Revised Availability, Hardware Announcement August 8, 1995, [IBM_743_1241 page 1] 1 pg.	
	NPL386	Direct Delivery of IBM 3494, 3466, and 3590 Storage Products, Hardware Announcement, September 30, 1997, Announcement 197-297, [IBM_743_1241 pages 2-3] 2 pgs.	
	NPL387	IBM Magstar 3590 Enhances Open Systems, Hardware Announcement February 9, 1996, Announcement 198-014, [IBM_743_1241 pages 4-7] 4 pgs.	
	NPL388	Hardware Withdrawal: IBM Magstar 3590 A00 Controller -- Replacement Available, Announcement Number 197-267, Withdrawal Announcement, December 9, 1997, [IBM_743_1241 page 9] 1 pg.	
	NPL389	IBM Magstar 3590 Tape Subsystem, Introduction and Planning Guide, Document No. GA32-0329007, [IBM_743_1241 pages 10-499] 490 pgs.	
	NPL390	NetMeeting 2.0 Reviewers Guide, April 1997, [MSCS_298_339] 42 pgs.	
	NPL391	Microsoft NetMeeting Compatible Products and Services Directory, April 1997, [MSCS_242_297] 56 pgs.	

Examiner Signature		Date Considered	
--------------------	--	-----------------	--

\*EXAMINER: Initial if reference considered, whether or not citation is in conformance with MPEP 609. Draw line through citation if not in conformance and not considered. Include copy of this form with next communication to applicant.

<sup>1</sup> Applicant's unique citation designation number (optional). <sup>2</sup> Applicant is to place a check mark here if English language Translation is attached.

Substitute for form 1449/PTO			<b>Complete if Known</b>	
<b>INFORMATION DISCLOSURE STATEMENT BY APPLICANT</b> <i>(Use as many sheets as necessary)</i>			Application Number	14/135,926
			Filing Date	December 19, 2013
			First Named Inventor	FALLON et al.
			Art Unit	2634
			Examiner Name	BOCURE, Tesfaldet
			Attorney Docket Number	2855.0050008
			Sheet	48

NON PATENT LITERATURE DOCUMENTS			
Examiner Initials*	Cite No. <sup>1</sup>	Include name of the author (in CAPITAL LETTERS), title of the article (when appropriate), title of the item (book, magazine, journal, serial, symposium, catalog, etc.), date, page(s), volume number, publisher, city and/or country where published	T <sup>2</sup>
	NPL392	Microsoft NetMeeting "Try This!" Guide, 1997, [MSCS_340_345] 6 pgs.	
	NPL393	The Professional Companion to NetMeeting 2 – The Technical Guide to Installing, Configuring, and Supporting NetMeeting 2.0 in Your Organization -Microsoft NetMeeting 2.0, 1996-97, [MSCS_2_241] 240 pgs.	
	NPL394	CUSEE Me 3.1.2 User Guide, November 1998, [RAD_1_220] 220 pgs.	
	NPL395	MeetingPoint Conference Server Users Guide 3.0, November 1997, [RAD_221_548] 328 pgs.	
	NPL396	MeetingPoint Conference Server Users Guide 4.0.2, December 1999, [RAD_549_818] 270 pgs.	
	NPL397	MeetingPoint Conference Service Users Guide 3.5.1, December 1998, [RAD_819_1062] 244 pgs.	
	NPL398	Enhanced CUSEE Me – Authorized Guide, 1995-1996, [RAD_1063_1372] 310 pgs.	
	NPL399	Meeting Point Reader File, June 1999, [RAD_1437_1445] 9 pgs.	
	NPL400	Press Release - White Pine Announces Launch of MeetingPoint Conferences Server, October 9, 1997, [RAD_1738_1739] 2 pgs.	
	NPL401	Press Release - Leading Network Service Providers Line Up to Support White Pine's MeetingPoint Conference Server Technology, October 9, 1997, [RAD_1740_1743] 4 pgs.	

Examiner Signature		Date Considered	
--------------------	--	-----------------	--

\*EXAMINER: Initial if reference considered, whether or not citation is in conformance with MPEP 609. Draw line through citation if not in conformance and not considered. Include copy of this form with next communication to applicant.

<sup>1</sup> Applicant's unique citation designation number (optional). <sup>2</sup> Applicant is to place a check mark here if English language Translation is attached.



Substitute for form 1449/PTO			<b>Complete if Known</b>	
<b>INFORMATION DISCLOSURE STATEMENT BY APPLICANT</b> <i>(Use as many sheets as necessary)</i>			Application Number	14/135,926
			Filing Date	December 19, 2013
			First Named Inventor	FALLON et al.
			Art Unit	2634
			Examiner Name	BOCURE, Tesfaldet
			Attorney Docket Number	2855.0050008
			Sheet	49

NON PATENT LITERATURE DOCUMENTS			
Examiner Initials*	Cite No. <sup>1</sup>	Include name of the author (in CAPITAL LETTERS), title of the article (when appropriate), title of the item (book, magazine, journal, serial, symposium, catalog, etc.), date, page(s), volume number, publisher, city and/or country where published	T <sup>2</sup>
	NPL402	BYTE - A New MeetingPoint for Videoconferencing, October 9, 1997, [RAD_1744 1750] 7 pgs.	
	NPL403	Declaration of Patrick Gogerty, Realtime Data, LLC D/B/A Ixo v. Packeteer, Inc., et al., District Court for the Eastern District of Texas, No. 6:08cv144, executed May 8, 2009, 3 pgs.	
	NPL404	Other Responses to Interrogatories, Requests for Admission, and Objections to Requests for Admission filed in Realtime Data, LLC d/b/a/IXO v. Packeteer, Inc. et al., Civil Action No. 6:08-cv-00144-LED; U.S. District Court for the Eastern District of Texas, filed April 18, 2008 and terminated February 2, 2010. (PTO Notified -- Document NOT submitted)	
	NPL405	Deposition Transcript of persons involved in litigation, including inventor James Fallon, and third-party witnesses Jim Karp, Ke-Chiang Chu, and Frank V. DeRosa filed in Realtime Data, LLC d/b/a/IXO v. Packeteer, Inc. et al., Civil Action No. 6:08-cv-00144-LED; U.S. District Court for the Eastern District of Texas, filed April 18, 2008 and terminated February 2, 2010. (PTO Notified -- Document NOT submitted)	
	NPL406	Office of Rebuttal Expert Reports of Dr. Brian Von Herzen, Lester L. Hewitt and Dr. James A. Storer, and Expert Reports of Dr. James A. Storer and Dr. Nathaniel Polish filed in Realtime Data, LLC d/b/a/IXO v. Packeteer, Inc. et al., Civil Action No. 6:08-cv-00144-LED; U.S. District Court for the Eastern District of Texas, filed April 18, 2008 and terminated February 2, 2010. (PTO Notified -- Document NOT submitted)	
	NPL407	Proposed Amended Infringement Contentions filed in Realtime Data, LLC d/b/a/IXO v. Packeteer, Inc. et al., Civil Action No. 6:08-cv-00144-LED; U.S. District Court for the Eastern District of Texas, filed April 18, 2008 and terminated February 2, 2010. (PTO Notified -- Document NOT submitted)	
	NPL408	Documents Concerning Agreements for Mediations and Mediation Proceedings Between Plaintiffs and Some of the Defendants filed in Realtime Data, LLC d/b/a/IXO v. Packeteer, Inc. et al., Civil Action No. 6:08-cv-00144-LED; U.S. District Court for the Eastern District of Texas, filed April 18, 2008 and terminated February 2, 2010. (PTO Notified -- Document NOT submitted)	
	NPL409	Plaintiff's Opposition to Joint Defendants' Motion for Partial Summary Judgment of Invalidity of some of the patents in Suit for indefiniteness, including the '104 patent, Blue Coat's response to this objection, Blue Coat's Reply to Plaintiff's response and Plaintiff's Sur-Reply to Blue Coat's Reply filed in Realtime Data, LLC d/b/a/IXO v. Packeteer, Inc. et al., Civil Action No. 6:08-cv-00144-LED; U.S. District Court for the Eastern District of Texas, filed April 18, 2008 and terminated February 2, 2010. (PTO Notified -- Document NOT submitted)	

Examiner Signature		Date Considered	
-----------------------	--	--------------------	--

\*EXAMINER: Initial if reference considered, whether or not citation is in conformance with MPEP 609. Draw line through citation if not in conformance and not considered. Include copy of this form with next communication to applicant.

<sup>1</sup> Applicant's unique citation designation number (optional). <sup>2</sup> Applicant is to place a check mark here if English language Translation is attached.

Substitute for form 1449/PTO			<b>Complete if Known</b>	
<b>INFORMATION DISCLOSURE STATEMENT BY APPLICANT</b> <i>(Use as many sheets as necessary)</i>			Application Number	14/135,926
			Filing Date	December 19, 2013
			First Named Inventor	FALLON et al.
			Art Unit	2634
			Examiner Name	BOCURE, Tesfaldet
			Attorney Docket Number	2855.0050008
Sheet	50	of	97	

NON PATENT LITERATURE DOCUMENTS			
Examiner Initials*	Cite No. <sup>1</sup>	Include name of the author (in CAPITAL LETTERS), title of the article (when appropriate), title of the item (book, magazine, journal, serial, symposium, catalog, etc.), date, page(s), volume number, publisher, city and/or country where published	T <sup>2</sup>
	NPL410	Plaintiff's Amended P.R. 3-1 Disclosures and Infringement Contentions, Defendants' Motions to Strick unauthorized portions of these disclosures, and Sur-Replies to these Motions filed in Realtime Data, LLC d/b/a/IXO v. Packeteer, Inc. et al., Civil Action No. 6:08-cv-00144-LED; U.S. District Court for the Eastern District of Texas, filed April 18, 2008 and terminated February 2, 2010. (PTO Notified -- Document NOT submitted)	
	NPL411	Expert Report of Dr. James A. Storer Regarding Non-Infringement that contains positions related to the validity of the patents in suit filed in Realtime Data, LLC d/b/a/IXO v. Packeteer, Inc. et al., Civil Action No. 6:08-cv-00144-LED; U.S. District Court for the Eastern District of Texas, filed April 18, 2008 and terminated February 2, 2010. (PTO Notified -- Document NOT submitted)	
	NPL412	Thomson Reuters Corporation v. Realtime Data, LLC D/B/A IXO, No. 09 CV 7868 (S.D.N.Y.) 2009.09.23 Order Dismissing Case in Favor of Texas Action, 1 pg.	
	NPL413	Thomson Reuters Corporation v. Realtime Data, LLC D/B/A IXO, No. 09 CV 7868 (S.D.N.Y.) 2009.09.30 Response to Order re Transfer, 103 pgs.	
	NPL414	Thomson Reuters Corporation v. Realtime Data, LLC D/B/A IXO, No. 09 CV 7868 (S.D.N.Y.) 2009.10.07 Reply Letter regarding Judge Berman 2009.09.23 Order re Transfer, 182 pgs.	
	NPL415	Thomson Reuters Corporation v. Realtime Data, LLC D/B/A IXO, No. 09 CV 7868 (S.D.N.Y.) 2009.10.15 Order Staying Case Until TX Action Decided, 3 pgs.	
	NPL416	Thomson Reuters Corporation v. Realtime Data, LLC D/B/A IXO, No. 09 CV 7868 (S.D.N.Y.) 2009.09.11 Complaint - DJ SD NY, 41 pgs.	
	NPL417	Thomson Reuters Corporation v. Realtime Data, LLC D/B/A IXO, No. 09 CV 7868 (S.D.N.Y.) 2009.09.11 Rule 7.1 Disclosure Statement for Thomson Reuters, 1 pg.	
	NPL418	Thomson Reuters Corporation v. Realtime Data, LLC D/B/A IXO, No. 09 CV 7868 (S.D.N.Y.) Order- Stay Pending Transfer Motion Confirmed 10_15_09, 3 pgs.	
	NPL419	Opinion and Order of United States Magistrate Judge regarding Claim Construction, Realtime Data, LLC D/B/A Ixo v. Packeteer, Inc., et al., District Court for the Eastern District of Texas, No. 6:08cv144, issued June 22, 2009, 75 pgs.	

Examiner Signature		Date Considered	
-----------------------	--	--------------------	--

\*EXAMINER: Initial if reference considered, whether or not citation is in conformance with MPEP 609. Draw line through citation if not in conformance and not considered. Include copy of this form with next communication to applicant.

<sup>1</sup> Applicant's unique citation designation number (optional). <sup>2</sup> Applicant is to place a check mark here if English language Translation is attached.

Substitute for form 1449/PTO				<b>Complete if Known</b>	
<b>INFORMATION DISCLOSURE STATEMENT BY APPLICANT</b> <i>(Use as many sheets as necessary)</i>				Application Number	14/135,926
				Filing Date	December 19, 2013
				First Named Inventor	FALLON et al.
				Art Unit	2634
				Examiner Name	BOCURE, Tesfaldet
				Attorney Docket Number	2855.0050008
Sheet	51	of	97		

NON PATENT LITERATURE DOCUMENTS			
Examiner Initials*	Cite No. <sup>1</sup>	Include name of the author (in CAPITAL LETTERS), title of the article (when appropriate), title of the item (book, magazine, journal, serial, symposium, catalog, etc.), date, page(s), volume number, publisher, city and/or country where published	T <sup>2</sup>
	NPL420	Script for Realties' Technology Tutorial Presented to the Magistrate Judge in Realtime Data, LLC d/b/a/IXO v. Packeteer, Inc. et al., Civil Action No. 6:08-cv-00144-LED; U.S. District Court for the Eastern District of Texas, March 16, 2009, 69 pgs.	
	NPL421	Opinion and Order of United States Magistrate Judge regarding Plaintiff's Motion to Strike Unauthorized New Invalidity Theories from Defendant Citrix's Opening and Reply Briefs in Support of its Motion for Summary Judgment of Invalidity, Realtime Data, LLD/B/A Ixo v. Packeteer, Inc., et al., District Court for the Eastern District of Texas, No. 6:08cv144, issued Dec. 8, 2009, 10 pgs	
	NPL422	Defendant Citrix Systems, Inc.'s Notice Pursuant to 35 U.S.C. Section 282 Disclosures, Realtime Data, LLC D/B/A Ixo v. Packeteer, Inc., et al., District Court for the Eastern District of Texas, No. 6:08cv144, filed December 11, 2009, 7 pgs.	
	NPL423	Blue Coat Defendants' Notice Pursuant to 35 U.S.C. Section 282 Disclosures, Realtime Data, LLC D/B/A Ixo v. Packeteer, Inc., et al., District Court for the Eastern District of Texas, No. 6:08cv144, filed December 11, 2009, 7 pgs.	
	NPL424	Expand Networks' 35 U.S.C. Section 282 Disclosures, Realtime Data, LLC D/B/A Ixo v. Packeteer, Inc., et al., District Court for the Eastern District of Texas, No. 6:08cv144, filed December 11, 2009, 4 pgs.	
	NPL425	Expand Networks' 35 U.S.C. Section 282 Disclosures (Amended), Realtime Data, LLC D/B/A Ixo v. Packeteer, Inc., et al., District Court for the Eastern District of Texas, No. 6:08cv144, filed December 11, 2009, 5 pgs.	
	NPL426	Defendant Citrix Systems, Inc.'s Notice of Obviousness Combinations Pursuant to Court Order, Realtime Data, LLC D/B/A Ixo v. Packeteer, Inc., et al., District Court for the Eastern District of Texas, No. 6:08cv144, filed December 11, 2009, 3 pgs.	
	NPL427	Order of United States Magistrate Judge regarding Motion to Limit the Number of Prior Art References to be Asserted at Trial, Realtime Data, LLC D/B/A Ixo v. Packeteer, Inc., et al., District Court for the Eastern District of Texas, No. 6:08cv144, filed December 21, 2009, 6 pgs.	
	NPL428	Expand Defendants' Notice of Obviousness Combinations Pursuant to Court Order, Realtime Data, LLC D/B/A Ixo v. Packeteer, Inc., et al., District Court for the Eastern District of Texas, No. 6:08cv144, filed December 22, 2009, 3 pgs.	
	NPL429	Blue Coat Systems, Inc. and 7-Eleven, Inc.'s Notice of Obviousness Combinations to be Used at Trial, Realtime Data, LLC D/B/A Ixo v. Packeteer, Inc., et al., District Court for the Eastern District of Texas, No. 6:08cv144, filed December 22, 2009, 38 pgs.	

Examiner Signature	Date Considered	
--------------------	-----------------	--

\*EXAMINER: Initial if reference considered, whether or not citation is in conformance with MPEP 609. Draw line through citation if not in conformance and not considered. Include copy of this form with next communication to applicant.  
<sup>1</sup> Applicant's unique citation designation number (optional). <sup>2</sup> Applicant is to place a check mark here if English language Translation is attached.

Substitute for form 1449/PTO				<b>Complete if Known</b>	
<b>INFORMATION DISCLOSURE STATEMENT BY APPLICANT</b> <i>(Use as many sheets as necessary)</i>				Application Number	14/135,926
				Filing Date	December 19, 2013
				First Named Inventor	FALLON et al.
				Art Unit	2634
				Examiner Name	BOCURE, Tesfaldet
				Attorney Docket Number	2855.0050008
Sheet	52	of	97		

NON PATENT LITERATURE DOCUMENTS			
Examiner Initials*	Cite No. <sup>1</sup>	Include name of the author (in CAPITAL LETTERS), title of the article (when appropriate), title of the item (book, magazine, journal, serial, symposium, catalog, etc.), date, page(s), volume number, publisher, city and/or country where published	T <sup>2</sup>
	NPL430	Defendant Citrix Systems, Inc's Notice of Other Prior Art References Within the Scope of the References Discussed at the Dec. 17, 2009 Hearing, Realtime Data, LLC D/B/A Ixo v. Packeteer, Inc., et al., District Court for the Eastern District of Texas, No. 6:08cv144, filed December 29, 2009, 6 pgs.	
	NPL431	Docket Listing downloaded March 10, 2010 for Realtime Data, LLC D/B/A Ixo v. Packeteer, Inc., et al., District Court for the Eastern District of Texas, No. 6:08cv144, filed April 18, 2008, 165 pgs.	
	NPL432	CCITT Draft Recommendation T.4, RFC 804, January 1981, 12 pgs.	
	NPL433	SNA Formats, IBM Corporation, 14th Ed., November 1993, 3 pgs.	
	NPL434	Munteanu et al, "Wavelet-Based Lossless Compression Scheme with Progressive Transmission Capability," John Wiley & Sons, Inc., Int'l J. Imaging Sys. Tech., vol. 10, (1999) pgs 76-85.	
	NPL435	Forchhammer and Jensen, "Data Compression of Scanned Halftone Images," IEEE Trans. Commun., vol. 42, Feb.-Apr. 1994, pgs 1881-1893.	
	NPL436	Christopher Eoyang et al., "The Birth of the Second Generation: The Hitachi S-820/80," Proceedings of the 1998 ACM/IEEE Conference on Supercomputing, pgs 296-303 (1998)	
	NPL437	Transcript for Hearing on Motions for Summary Judgment, Realtime Data, LLC d/b/a IXO v. Packeteer, Inc. et al, Civil Action No. 6:08-cv-00144-LED; U.S. District Court for the Eastern District of Texas, 133 pgs, November 8, 2009.	
	NPL438	Transcript for Motions Hearing (Including Supplemental Claim Construction Hearing), Realtime Data, LLC d/b/a IXO v. Packeteer, Inc. et al, Civil Action No. 6:08-cv-00144-LED; U.S. District Court for the Eastern District of Texas, 88 pgs, November 10, 2009	
	NPL439	Nelson, "The Data Compression Book," M&T Books (2nd Ed. 1996), 283 pgs.	

Examiner Signature	Date Considered
--------------------	-----------------

\*EXAMINER: Initial if reference considered, whether or not citation is in conformance with MPEP 609. Draw line through citation if not in conformance and not considered. Include copy of this form with next communication to applicant.

<sup>1</sup> Applicant's unique citation designation number (optional). <sup>2</sup> Applicant is to place a check mark here if English language Translation is attached.

Substitute for form 1449/PTO			<b>Complete if Known</b>	
<b>INFORMATION DISCLOSURE STATEMENT BY APPLICANT</b> <i>(Use as many sheets as necessary)</i>			Application Number	14/135,926
			Filing Date	December 19, 2013
			First Named Inventor	FALLON et al.
			Art Unit	2634
			Examiner Name	BOCURE, Tesfaldet
			Attorney Docket Number	2855.0050008
Sheet	53	of	97	

NON PATENT LITERATURE DOCUMENTS			
Examiner Initials*	Cite No. <sup>1</sup>	Include name of the author (in CAPITAL LETTERS), title of the article (when appropriate), title of the item (book, magazine, journal, serial, symposium, catalog, etc.), date, page(s), volume number, publisher, city and/or country where published	T <sup>2</sup>
	NPL440	"The Authoritative Dictionary of IEEE Standards Terms," 7th Ed. 2000, pg. 273.	
	NPL441	Larousse Dictionary of Science and Technology, 1st Ed., 1995, pg. 916.	
	NPL442	Plaintiff Realtime Data's Motion to Strike Unauthorized New Invalidity Theories from Defendant Citrix's Opening and Reply Briefs in Support Its Motion for Summary Judgment of Invalidity of U.S. Patent No. 7,352,300 (September 22, 2009), 14 pgs.	
	NPL443	Realtime Data's Reply in Support of Its Motion to Strike Unauthorized New Invalidity Theories from Defendant Citrix's Opening and Reply Briefs in Support of Its Motion for Summary Judgment of Invalidity of U.S. Patent No. 7,352,300 (October 19, 2009), 17 pgs.	
	NPL444	Defendant Citrix Systems, Inc.'s Sur-Reply in Opposition to Realtime Data LLC's Motion to Strike Unauthorized New Invalidity Theories from Citrix's Opening and Reply Briefs in Support of Its Motion for Summary Judgment of Invalidity of U.S. Patent No. 7,352,300 (October 30, 2009), 9 pgs.	
	NPL445	Blue Coat Defendants' Response to Realtime Data, LLC's Notice Re Proposed Construction of "Data Storage Rate" (November 11, 2009), 3 pgs.	
	NPL446	Order for Supplemental Briefing on Blue Coat 7-11 Motion for Partial SJ on Non-infringement of Pat 6,601,104 (November 13, 2009), 6 pgs.	
	NPL447	Memorandum Opinion and Order (November 23, 2009), 15 pgs.	
	NPL448	Memorandum Opinion and Order (December 8, 2009), 10 pgs.	
	NPL449	Expand's Conclusions of Fact and Law Regarding Defense of Inequitable Conduct Concerning the Unenforceability of U.S. Patent No. 7,321,937 (November 12, 2009), 3 pgs.	

Examiner Signature		Date Considered	
-----------------------	--	--------------------	--

\*EXAMINER: Initial if reference considered, whether or not citation is in conformance with MPEP 609. Draw line through citation if not in conformance and not considered. Include copy of this form with next communication to applicant.

<sup>1</sup> Applicant's unique citation designation number (optional). <sup>2</sup> Applicant is to place a check mark here if English language Translation is attached.

Substitute for form 1449/PTO			<b>Complete if Known</b>	
<b>INFORMATION DISCLOSURE STATEMENT BY APPLICANT</b> <i>(Use as many sheets as necessary)</i>			Application Number	14/135,926
			Filing Date	December 19, 2013
			First Named Inventor	FALLON et al.
			Art Unit	2634
			Examiner Name	BOCURE, Tesfaldet
			Attorney Docket Number	2855.0050008
Sheet	54	of	97	

NON PATENT LITERATURE DOCUMENTS			
Examiner Initials*	Cite No. <sup>1</sup>	Include name of the author (in CAPITAL LETTERS), title of the article (when appropriate), title of the item (book, magazine, journal, serial, symposium, catalog, etc.), date, page(s), volume number, publisher, city and/or country where published	T <sup>2</sup>
	NPL450	Realtime Data's Sur-reply Supplemental Claim Construction Brief Concerning Whether the Asserted Claims of the '104 Patent are Product Claims (December 23, 2009), 6 pgs.	
	NPL451	Order regarding Defendant Citrix Systems, Inc's Notice of Other Prior Art References Within the Scope of the References Discussed at the December 17, 2009 Hearing (December 30, 2009), 3 pgs.	
	NPL452	Network Working group RFC 2068 (Jan. 1997), 163 pgs.	
	NPL453	Network Working group RFC 2616 (Jun. 1999), 114 pgs.	
	NPL454	Network Working group RFC 1945 (May 1996), 61 pgs.	
	NPL455	Network Working group RFC 1950 (May 1996), 10 pgs.	
	NPL456	Network Working group RFC 1951 (May 1996), 15 pgs.	
	NPL457	Network Working group RFC 1952 (May 1996), 12 pgs.	
	NPL458	Notice of Plaintiff Realtime Data LLC's Proposed Supplemental Construction of "Data Storage Rate" In Response to the Court's Comments During the November 10, 2009 Supplemental Claim Construction Hearing (November 10, 2009), 4 pgs.	
	NPL459	Citrix's Amended Invalidity Contentions, Including Appendices G2-G8 (December 15, 2009), 509 pgs.	

Examiner Signature		Date Considered	
--------------------	--	-----------------	--

\*EXAMINER: Initial if reference considered, whether or not citation is in conformance with MPEP 609. Draw line through citation if not in conformance and not considered. Include copy of this form with next communication to applicant.

<sup>1</sup> Applicant's unique citation designation number (optional). <sup>2</sup> Applicant is to place a check mark here if English language Translation is attached.

Substitute for form 1449/PTO			<b>Complete if Known</b>	
<b>INFORMATION DISCLOSURE STATEMENT BY APPLICANT</b> <i>(Use as many sheets as necessary)</i>			Application Number	14/135,926
			Filing Date	December 19, 2013
			First Named Inventor	FALLON et al.
			Art Unit	2634
			Examiner Name	BOCURE, Tesfaldet
			Attorney Docket Number	2855.0050008
Sheet	55	of	97	

NON PATENT LITERATURE DOCUMENTS			
Examiner Initials*	Cite No. <sup>1</sup>	Include name of the author (in CAPITAL LETTERS), title of the article (when appropriate), title of the item (book, magazine, journal, serial, symposium, catalog, etc.), date, page(s), volume number, publisher, city and/or country where published	T <sup>2</sup>
	NPL460	"Plaintiff Realtime Data's Opposition to Defendant F5 Networks' Motion for Summary Judgment that Claims 18-20 of U.S. Patent No. 7,321,937 are Invalid (August 25, 2009)" Civil Action No. 6:08-cv-00144-LED Jury Trial Demanded Filed Under Seal; In the United States District Court for the Eastern District of Texas Tyler Division. [Under Seal - Document NOT Submitted]	
	NPL461	Declaration of Dr. James W. Modestino relating to U.S. Patent No. 7,161,506, March 15, 2010, 49 pgs.	
	NPL462	Second Declaration of Dr. George T. Ligler under 37 C.F.R. §1.132 relating to U.S. Patent No. 6,601,104, executed May 5, 2010, 3 pgs.	
	NPL463	Realtime Data, LLC Complaint for Patent Infringement, Realtime Data, LLC D/B/A IXO v. CME Group Inc., et al. (II), District Court for the Eastern District of Texas, No. 6:10-cv-246, filed May 11, 2010, 24 pages.	
	NPL464	Realtime Data, LLC Complaint for Patent Infringement, Realtime Data, LLC D/B/A IXO v. Thomson Reuters Corporation, et al. (II), District Court for the Eastern District of Texas, No. 6:10-cv-247, filed May 11, 2010, 15 pages.	
	NPL465	Realtime Data, LLC Complaint for Patent Infringement, Realtime Data, LLC D/B/A IXO v. Morgan Stanley, et al. (II), District Court for the Eastern District of Texas, No. 6:10-cv-248, filed May 11, 2010, 27 pages.	
	NPL466	Declaration of Padmaja Chinta In Support of Realtime Data's Reply Claim Construction Brief (including Exhibits A-S), Realtime Data, LLC D/B/A IXO v. Packeteer, Inc., et al., District Court for the Eastern District of Texas, No. 6:08-cv-00144-LED, dated March 30, 2009, 217 pgs.	
	NPL467	Extended European search report issuing from European Patent Application 09150508.1, August 3, 2010, 5 pgs.	
	NPL468	Complaint, Thomson Reuters Corporation v. Realtime Data, LLC D/B/A IXO, Southern District of New York, No. 2:09-cv-7868-RMB, filed September 11, 2009, 6 pages.	
	NPL469	Realtime Data, LLC Complaint for Patent Infringement, Realtime Data, LLC D/B/A IXO v. MetroPCS Texas, LLC et al., District Court for the Eastern District of Texas, No. 6:10-cv-00493, filed September 23, 2010, 14 pages.	

Examiner Signature		Date Considered	
-----------------------	--	--------------------	--

\*EXAMINER: Initial if reference considered, whether or not citation is in conformance with MPEP 609. Draw line through citation if not in conformance and not considered. Include copy of this form with next communication to applicant.

<sup>1</sup> Applicant's unique citation designation number (optional). <sup>2</sup> Applicant is to place a check mark here if English language Translation is attached.

Substitute for form 1449/PTO				<b>Complete if Known</b>	
<b>INFORMATION DISCLOSURE STATEMENT BY APPLICANT</b> <i>(Use as many sheets as necessary)</i>				Application Number	14/135,926
				Filing Date	December 19, 2013
				First Named Inventor	FALLON et al.
				Art Unit	2634
				Examiner Name	BOCURE, Tesfaldet
				Attorney Docket Number	2855.0050008
Sheet	56	of	97		

NON PATENT LITERATURE DOCUMENTS			
Examiner Initials*	Cite No. <sup>1</sup>	Include name of the author (in CAPITAL LETTERS), title of the article (when appropriate), title of the item (book, magazine, journal, serial, symposium, catalog, etc.), date, page(s), volume number, publisher, city and/or country where published	T <sup>2</sup>
	NPL470	Complaint and Demand for Jury Trial, Chicago Board Options Exchange, Incorporated v. Realtime Data, LLC D/B/A IXO, United States District Court for the Northern District of Illinois, No. 09 CV 4486, filed July 24, 2009, 6 pages.	
	NPL471	Realtime's Response in Opposition to the Defendants' Joint Objections to Report and Recommendation of Magistrate Regarding Motion for Partial Summary Judgment of Invalidity for Indefiniteness, in Realtime Data, LLC d/b/a/IXO v. Packeteer, Inc. et al., Civil Action No. 6:08-cv-00144-LED; U.S. District Court for the Eastern District of Texas, July 27, 2009, 15 pgs.	
	NPL472	Reply to Realtime's Response to Blue Coat Defendants' Objections to Report and Recommendation of United States Magistrate Judge Regarding Motion for Partial Summary Judgment of Invalidity for Indefiniteness Entered June 23, 2009, in Realtime Data, LLC d/b/a/IXO v. Packeteer, Inc. et al., Civil Action No. 6:08-cv-00144-LED; U.S. District Court for the Eastern District of Texas, July 31, 2009, 3 pgs.	
	NPL473	Realtime Data's Sur-Reply in Opposition to the Defendants' Joint Objections to Report and Recommendation of Magistrate Regarding Motion for Partial Summary Judgment of Invalidity for Indefiniteness, in Realtime Data, LLC d/b/a/IXO v. Packeteer, Inc. et al., Civil Action No. 6:08-cv-00144-LED; U.S. District Court for the Eastern District of Texas, August 3, 2009, 3 pgs.	
	NPL474	Defendants' Invalidity Contentions, Realtime Data, LLC d/b/a IXO, vs. MetroPCS Texas, LLC, et al., Case No. 6:10-CV-00493-LED, In the United States District Court Eastern District of Texas Tyler Division, June 17, 2011, 138 pages.	
	NPL475	Appendix A, Claim Charts A-1 to A-25, from Invalidity Contentions, Realtime Data LLC v. MetroPCS Texas, LLC, et al., Case No. 6:10-CV-00493-LED, June 17, 2011, 173 pages.	
	NPL476	Appendix B, Claim Charts B-1 to B-23, from Realtime Data LLC v. MetroPCS Texas, LLC et al., Case No. 6:10-CV-00493-LED, June 17, 2011, 809 pages.	
	NPL477	Appendix C, Claim Charts C-1 to C-22, from Realtime Data LLC v. MetroPCS Texas, LLC et al., Case No. 6:10-CV-00493-LED, June 17, 2011, 530 pages.	
	NPL478	Appendix D, Claim Charts D-1 to D-16, from Realtime Data LLC v. MetroPCS Texas, LLC et al., Case No. 6:10-CV-00493-LED, June 17, 2011, 253 pages.	
	NPL479	Appendix E, Claim Charts E-1 to E-20, from Realtime Data LLC v. MetroPCS Texas, LLC et al., Case No. 6:10-CV-00493-LED, June 17, 2011, 397 pages.	

Examiner Signature		Date Considered	
-----------------------	--	--------------------	--

\*EXAMINER: Initial if reference considered, whether or not citation is in conformance with MPEP 609. Draw line through citation if not in conformance and not considered. Include copy of this form with next communication to applicant.

<sup>1</sup> Applicant's unique citation designation number (optional). <sup>2</sup> Applicant is to place a check mark here if English language Translation is attached.



Substitute for form 1449/PTO			<b>Complete if Known</b>	
<b>INFORMATION DISCLOSURE STATEMENT BY APPLICANT</b> <i>(Use as many sheets as necessary)</i>			Application Number	14/135,926
			Filing Date	December 19, 2013
			First Named Inventor	FALLON et al.
			Art Unit	2634
			Examiner Name	BOCURE, Tesfaldet
			Attorney Docket Number	2855.0050008
Sheet	57	of	97	

NON PATENT LITERATURE DOCUMENTS			
Examiner Initials*	Cite No. <sup>1</sup>	Include name of the author (in CAPITAL LETTERS), title of the article (when appropriate), title of the item (book, magazine, journal, serial, symposium, catalog, etc.), date, page(s), volume number, publisher, city and/or country where published	T <sup>2</sup>
	NPL480	Appendix F, Claim Charts F-1 to F-19, from Realtime Data LLC v. MetroPCS Texas, LLC et al., Case No. 6:10-CV-00493-LED, June 17, 2011, 462 pages.	
	NPL481	Appendix G, Claim Charts G-1 to G-18, from Realtime Data LLC v. MetroPCS Texas, LLC et al., Case No. 6:10-CV-00493-LED, June 17, 2011, 548 pages.	
	NPL482	Appendix H, Claim Charts H-1 to H-22, from Realtime Data LLC v. MetroPCS Texas, LLC et al., Case No. 6:10-CV-00493-LED, June 17, 2011, 151 pages.	
	NPL483	AMIR et al., "An Application Level Video Gateway," 1995, 11 pages.	
	NPL484	KATZ, Randy H. and Eric A. Brewer, "The Bay Area Research Wireless Access Network: Towards a Wireless Overlay Internetworking Architecture," Computer Science Division, EECS Department, U.C. Berkeley, 1995, 56 pages.	
	NPL485	KATZ, R.H. and E.A. Brewer, "The Bay Area Research Wireless Access Network (BARWAN)," UC Berkeley, 1995, 68 pages.	
	NPL486	BRUCKMAN, Alfred and Andreas UHL, "Selective Medical Image Compression Using Wavelet Techniques," June 1998, 23 pages.	
	NPL487	CROWLEY et al., "Dynamic Compression During System Save Operations," May 1, 1984, 3 pages.	
	NPL488	HERSHKOVITS, "Universal Data Compression with Finite-Memory," February 1995, 99 pages.	
	NPL489	KATZ et al., "The Bay Area Research Wireless Access Networks (BARWAN)," 1996, 6 pages.	

Examiner Signature	Date Considered	
--------------------	-----------------	--

\*EXAMINER: Initial if reference considered, whether or not citation is in conformance with MPEP 609. Draw line through citation if not in conformance and not considered. Include copy of this form with next communication to applicant.

<sup>1</sup> Applicant's unique citation designation number (optional). <sup>2</sup> Applicant is to place a check mark here if English language Translation is attached.

Substitute for form 1449/PTO			<b>Complete if Known</b>	
<b>INFORMATION DISCLOSURE STATEMENT BY APPLICANT</b> <i>(Use as many sheets as necessary)</i>			Application Number	14/135,926
			Filing Date	December 19, 2013
			First Named Inventor	FALLON et al.
			Art Unit	2634
			Examiner Name	BOCURE, Tesfaldet
			Attorney Docket Number	2855.0050008
			Sheet	58

NON PATENT LITERATURE DOCUMENTS			
Examiner Initials*	Cite No. <sup>1</sup>	Include name of the author (in CAPITAL LETTERS), title of the article (when appropriate), title of the item (book, magazine, journal, serial, symposium, catalog, etc.), date, page(s), volume number, publisher, city and/or country where published	T <sup>2</sup>
	NPL490	KLEIN, "Compression and Coding in Information Retrieval Systems," June 1987, pages vii-viii, 1-4, 10-15, 22-30, 43-48, 62-66, 86-89, 108-111.	
	NPL491	REGHBATI, "An Overview of Data Compression Techniques," April 1981, pages 71-75.	
	NPL492	Defendants' Joint Preliminary Invalidation Contentions filed in Realtime Data, LLC D/B/A IXO v. Packeteer, Inc., et al., Civil Action No. 6:08-cv-144-LED, United States District Court for the Eastern District of Texas Tyler Division, December 8, 2008, 19 pages.	
	NPL493	Appendix A, Claim Charts A-1 to A-46, from Realtime Data, LLC v. Packeteer, Inc., et al., Civil Action No. 6:08-cv-144-LED, December 8, 2008, 345 pages.	
	NPL494	Appendix B, Claim Charts B-1 to B-17, from Realtime Data, LLC v. Packeteer, Inc., et al., Civil Action No. 6:08-cv-144-LED, December 8, 2008, 1893 pages.	
	NPL495	Appendix C, Claim Charts C-1 to C-34, from Realtime Data, LLC v. Packeteer, Inc., et al., Civil Action No. 6:08-cv-144-LED, December 8, 2008, 1,055 pages.	
	NPL496	Appendix D, Claim Charts D-1 to D-14, from Realtime Data, LLC v. Packeteer, Inc., et al., Civil Action No. 6:08-cv-144-LED, December 8, 2008, 197 pages.	
	NPL497	Appendix E, Claim Charts E-1 to E-11, from Realtime Data, LLC v. Packeteer, Inc., et al., Civil Action No. 6:08-cv-144-LED, December 8, 2008, 735 pages.	
	NPL498	Appendix F, Claim Charts F-1 to F-11, from Realtime Data, LLC v. Packeteer, Inc., et al., Civil Action No. 6:08-cv-144-LED, December 8, 2008, 775 pages.	
	NPL499	Appendix G Claim Charts G-1 to G-8 from Realtime Data, LLC v. Packeteer, Inc., et al., Civil Action No. 6:08-cv-144-LED, December 8, 2008, 567 pages.	

Examiner Signature	Date Considered	
--------------------	-----------------	--

\*EXAMINER: Initial if reference considered, whether or not citation is in conformance with MPEP 609. Draw line through citation if not in conformance and not considered. Include copy of this form with next communication to applicant.

<sup>1</sup> Applicant's unique citation designation number (optional). <sup>2</sup> Applicant is to place a check mark here if English language Translation is attached.

Substitute for form 1449/PTO			<b>Complete if Known</b>	
<b>INFORMATION DISCLOSURE STATEMENT BY APPLICANT</b> <i>(Use as many sheets as necessary)</i>			Application Number	14/135,926
			Filing Date	December 19, 2013
			First Named Inventor	FALLON et al.
			Art Unit	2634
			Examiner Name	BOCURE, Tesfaldet
			Attorney Docket Number	2855.0050008
Sheet	59	of	97	

NON PATENT LITERATURE DOCUMENTS			
Examiner Initials*	Cite No. <sup>1</sup>	Include name of the author (in CAPITAL LETTERS), title of the article (when appropriate), title of the item (book, magazine, journal, serial, symposium, catalog, etc.), date, page(s), volume number, publisher, city and/or country where published	T <sup>2</sup>
	NPL500	Appendix H, Claim Charts H-1 to H-18, from Realtime Data, LLC v. Packeteer, Inc., et al., Civil Action No. 6:08-cv-144-LED, December 8, 2008, 97 pages.	
	NPL501	Appendix I, Claim Charts I-1 to I-18, from Realtime Data, LLC v. Packeteer, Inc., et al., Civil Action No. 6:08-cv-144-LED, December 8, 2008, 146 pages.	
	NPL502	Appendix J, Prior Art Chart, from Realtime Data, LLC v. Packeteer, Inc., et al., Civil Action No. 6:08-cv-144-LED, December 8, 2008, 25 pages.	
	NPL503	Realtime Data, LLC's [Corrected] P.R. 3-1 Disclosures and Preliminary Infringement Contentions filed in Realtime Data, LLC D/B/A/IXO v. Packeteer, Inc., et al., Civil Action No. 6:08-cv-00144-LED, United States District Court for the Eastern District of Texas Tyler Division, October 8, 2008, 591 pages.	
	NPL504	Amended Answer and Counterclaims of Defendants Blue Coat Systems, Inc., Packeteer, Inc., 7-Eleven, Inc., ABM Industries, Inc., ABM Janitorial Services-South Central, Inc., and Build-A-Bear Workshop, Inc. to Plaintiff's First Amended Complaint for Patent Infringement filed in Realtime Data, LLC d/b/a/IXO v. Packeteer, Inc., et al., Civil Action No. 6:08cv144-LED, United States District Court for the Eastern District of Texas Tyler Division, October 28, 2008, 81 pages.	
	NPL505	"Packeteer iShaper, PacketShaper and iShared Appliances Drive Intelligent Application Acceleration Across Coogee Resources Wide Area Network", Business Wire, accessed on August 25, 2008, 2 pages.	
	NPL506	WHITING, Doug, "Deflate vs. LZS", November, 2000, 2 pages.	
	NPL507	"The Packeteer Q4 2005 Financial Conference Call", January 26, 2006, 9 pages.	
	NPL508	"Data Compression Ratio", Wikipedia, the free encyclopedia, accessed on August 10, 2011 from <a href="http://en.wikipedia.org/wiki/Data_compression_ratio">http://en.wikipedia.org/wiki/Data_compression_ratio</a> , 2 pages.	
	NPL509	"Hard Disk Data Control Method", IBM Technical Disclosure Bulletin NN9302301, Vol. 36, No. 2, February 1993, pages 301-302.	

Examiner Signature		Date Considered	
-----------------------	--	--------------------	--

\*EXAMINER: Initial if reference considered, whether or not citation is in conformance with MPEP 609. Draw line through citation if not in conformance and not considered. Include copy of this form with next communication to applicant.

<sup>1</sup> Applicant's unique citation designation number (optional). <sup>2</sup> Applicant is to place a check mark here if English language Translation is attached.

Substitute for form 1449/PTO			<b>Complete if Known</b>	
<b>INFORMATION DISCLOSURE STATEMENT BY APPLICANT</b> <i>(Use as many sheets as necessary)</i>			Application Number	14/135,926
			Filing Date	December 19, 2013
			First Named Inventor	FALLON et al.
			Art Unit	2634
			Examiner Name	BOCURE, Tesfaldet
			Attorney Docket Number	2855.0050008
Sheet	60	of	97	

NON PATENT LITERATURE DOCUMENTS			
Examiner Initials*	Cite No. <sup>1</sup>	Include name of the author (in CAPITAL LETTERS), title of the article (when appropriate), title of the item (book, magazine, journal, serial, symposium, catalog, etc.), date, page(s), volume number, publisher, city and/or country where published	T <sup>2</sup>
	NPL510	Defendants' Supplemental Invalidity Contentions, filed in Realtime Data, LLC d/b/a IXO v. Morgan Stanley, et al., Civil Action No. 1:11-cv-6696, Realtime Data, LLC d/b/a IXO v. CME Group Inc., et al., Civil Action No. 1:11-cv-6697, and Realtime Data, LLC d/b/a IXO v. Thomson Reuters, et al., Civil Action No. 1:11-cv-6698, United States District Court Southern District of New York, filed May 17, 2012, 54 pages.	
	NPL511	Expert Report of Michael Brogioli Regarding Asserted Claims of U.S. Patent Nos. 7,417,568 and 7,777,651, with Exhibit A: List of Materials Reviewed, filed in Realtime Data, LLC d/b/a IXO v. Morgan Stanley, et al., Civil Action No. 1:11-cv-6696, Realtime Data, LLC d/b/a IXO v. CME Group Inc., et al., Civil Action No. 1:11-cv-6697, and Realtime Data, LLC d/b/a IXO v. Thomson Reuters, et al., Civil Action No. 1:11-cv-6698, United States District Court Southern District of New York, filed June 15, 2012, 26 pages.	
	NPL512	Exhibit 1, Curriculum Vitae of Michael C. Brogioli, from Expert Report, filed in Realtime Data, LLC d/b/a IXO v. Morgan Stanley, et al., Civil Action No. 1:11-cv-6696, Realtime Data, LLC d/b/a IXO v. CME Group Inc., et al., Civil Action No. 1:11-cv-6697, and Realtime Data, LLC d/b/a IXO v. Thomson Reuters, et al., Civil Action No. 1:11-cv-6698, United States District Court Southern District of New York, filed June 15, 2012, 9 pages.	
	NPL513	Exhibit 2, [Proposed] Order Adopting the Parties' Agreed Claim Constructions, from Expert Report, filed in Realtime Data, LLC d/b/a IXO v. Morgan Stanley, et al., Civil Action No. 1:11-cv-6696, Realtime Data, LLC d/b/a IXO v. CME Group Inc., et al., Civil Action No. 1:11-cv-6697, and Realtime Data, LLC d/b/a IXO v. Thomson Reuters, et al., Civil Action No. 1:11-cv-6698, United States District Court Southern District of New York, filed June 15, 2012, 6 pages.	
	NPL514	Exhibit 3, The Parties' Disputed Claim Constructions, revised May 3, 2012, from Expert Report, filed in Realtime Data, LLC d/b/a IXO v. Morgan Stanley, et al., Civil Action No. 1:11-cv-6696, Realtime Data, LLC d/b/a IXO v. CME Group Inc., et al., Civil Action No. 1:11-cv-6697, and Realtime Data, LLC d/b/a IXO v. Thomson Reuters, et al., Civil Action No. 1:11-cv-6698, United States District Court Southern District of New York, filed June 15, 2012, 6 pages.	
	NPL515	Exhibit 4, E-Mail Correspondence between James Shalek and Brett Cooper, dated May 17 and 18, 2012, from Expert Report, filed in Realtime Data, LLC d/b/a IXO v. Morgan Stanley, et al., Civil Action No. 1:11-cv-6696, Realtime Data, LLC d/b/a IXO v. CME Group Inc., et al., Civil Action No. 1:11-cv-6697, and Realtime Data, LLC d/b/a IXO v. Thomson Reuters, et al., Civil Action No. 1:11-cv-6698, United States District Court Southern District of New York, filed June 15, 2012, 3 pages.	
	NPL516	Exhibit 5, Source Code Chart for U.S. Pat. No. 7,417,568 comparing representative elements of the NQDSLIB source code (April 29, 2002 or earlier), from Expert Report, filed in Realtime Data, LLC d/b/a IXO v. Morgan Stanley, et al., Civil Action No. 1:11-cv-6696, Realtime Data, LLC d/b/a IXO v. CME Group Inc., et al., Civil Action No. 1:11-cv-6697, and Realtime Data, LLC d/b/a IXO v. Thomson Reuters, et al., Civil Action No. 1:11-cv-6698, United States District Court Southern District of New York, filed June 15, 2012, 3 pages.	

Examiner Signature		Date Considered	
--------------------	--	-----------------	--

\*EXAMINER: Initial if reference considered, whether or not citation is in conformance with MPEP 609. Draw line through citation if not in conformance and not considered. Include copy of this form with next communication to applicant.

<sup>1</sup> Applicant's unique citation designation number (optional). <sup>2</sup> Applicant is to place a check mark here if English language Translation is attached.

Substitute for form 1449/PTO				<b>Complete if Known</b>	
<b>INFORMATION DISCLOSURE STATEMENT BY APPLICANT</b> <i>(Use as many sheets as necessary)</i>				Application Number	14/135,926
				Filing Date	December 19, 2013
				First Named Inventor	FALLON et al.
				Art Unit	2634
				Examiner Name	BOCURE, Tesfaldet
				Attorney Docket Number	2855.0050008
Sheet	61	of	97		

NON PATENT LITERATURE DOCUMENTS			
Examiner Initials*	Cite No. <sup>1</sup>	Include name of the author (in CAPITAL LETTERS), title of the article (when appropriate), title of the item (book, magazine, journal, serial, symposium, catalog, etc.), date, page(s), volume number, publisher, city and/or country where published	T <sup>2</sup>
	NPL517	Exhibit 6, Source Code Chart for U.S. Pat. No. 7,417,568 comparing representative elements of the NQDSLIB source code (May 02, 2002 or earlier), from Expert Report, filed in Realtime Data, LLC d/b/a IXO v. Morgan Stanley, et al., Civil Action No. 1:11-cv-6696, Realtime Data, LLC d/b/a IXO v. CME Group Inc., et al., Civil Action No. 1:11-cv-6697, and Realtime Data, LLC d/b/a IXO v. Thomson Reuters, et al., Civil Action No. 1:11-cv-6698, United States District Court Southern District of New York, filed June 15, 2012, 3 pages.	
	NPL518	Exhibit 7, Source Code Chart for U.S. Pat. No. 7,777,651 comparing representative elements of the NQDSLIB source code (April 29, 2002 or earlier), from Expert Report, filed in Realtime Data, LLC d/b/a IXO v. Morgan Stanley, et al., Civil Action No. 1:11-cv-6696, Realtime Data, LLC d/b/a IXO v. CME Group Inc., et al., Civil Action No. 1:11-cv-6697, and Realtime Data, LLC d/b/a IXO v. Thomson Reuters, et al., Civil Action No. 1:11-cv-6698, United States District Court Southern District of New York, filed June 15, 2012, 21 pages.	
	NPL519	Exhibit 8, Source Code Chart for U.S. Pat. No. 7,777,651 comparing representative elements of the NQDSLIB source code (May 02, 2002 or earlier), from Expert Report, filed in Realtime Data, LLC d/b/a IXO v. Morgan Stanley, et al., Civil Action No. 1:11-cv-6696, Realtime Data, LLC d/b/a IXO v. CME Group Inc., et al., Civil Action No. 1:11-cv-6697, and Realtime Data, LLC d/b/a IXO v. Thomson Reuters, et al., Civil Action No. 1:11-cv-6698, United States District Court Southern District of New York, filed June 15, 2012, 21 pages.	
	NPL520	Invalidity Expert Report of Dr. James A. Storer (Redacted), filed in Realtime Data, LLC d/b/a IXO v. Morgan Stanley, et al., Civil Action No. 1:11-cv-6696, Realtime Data, LLC d/b/a IXO v. CME Group Inc., et al., Civil Action No. 1:11-cv-6697, and Realtime Data, LLC d/b/a IXO v. Thomson Reuters, et al., Civil Action No. 1:11-cv-6698, United States District Court Southern District of New York, filed June 15, 2012, 227 pages.	
	NPL521	Defendants' Claim Construction Tutorial, filed in Realtime Data, LLC d/b/a IXO v. Morgan Stanley, et al., Civil Action No. 1:11-cv-6696, Realtime Data, LLC d/b/a IXO v. CME Group Inc., et al., Civil Action No. 1:11-cv-6697, and Realtime Data, LLC d/b/a IXO v. Thomson Reuters, et al., Civil Action No. 1:11-cv-6698, United States District Court Southern District of New York, filed June 15, 2012, 54 pages.	
	NPL522	Opinion and Order (Markman), filed in Realtime Data, LLC d/b/a IXO v. Morgan Stanley, et al., Civil Action No. 1:11-cv-6696, Realtime Data, LLC d/b/a IXO v. CME Group Inc., et al., Civil Action No. 1:11-cv-6697, and Realtime Data, LLC d/b/a IXO v. Thomson Reuters, et al., Civil Action No. 1:11-cv-6698, United States District Court Southern District of New York, filed June 22, 2012, 41 pages.	
	NPL523	Opinion and Order (Partial Motion for Summary Judgment re Written Description: "Data Packets"), filed in Realtime Data, LLC d/b/a IXO v. Morgan Stanley, et al., Civil Action No. 1:11-cv-6696, Realtime Data, LLC d/b/a IXO v. CME Group Inc., et al., Civil Action No. 1:11-cv-6697, and Realtime Data, LLC d/b/a IXO v. Thomson Reuters, et al., Civil Action No. 1:11-cv-6698, United States District Court Southern District of New York, filed June 26, 2012, 8 pages.	

Examiner Signature		Date Considered	
--------------------	--	-----------------	--

\*EXAMINER: Initial if reference considered, whether or not citation is in conformance with MPEP 609. Draw line through citation if not in conformance and not considered. Include copy of this form with next communication to applicant.

<sup>1</sup> Applicant's unique citation designation number (optional). <sup>2</sup> Applicant is to place a check mark here if English language Translation is attached.

Substitute for form 1449/PTO			<b>Complete if Known</b>	
<b>INFORMATION DISCLOSURE STATEMENT BY APPLICANT</b> <i>(Use as many sheets as necessary)</i>			Application Number	14/135,926
			Filing Date	December 19, 2013
			First Named Inventor	FALLON et al.
			Art Unit	2634
			Examiner Name	BOCURE, Tesfaldet
			Attorney Docket Number	2855.0050008
			Sheet	62

NON PATENT LITERATURE DOCUMENTS			
Examiner Initials*	Cite No. <sup>1</sup>	Include name of the author (in CAPITAL LETTERS), title of the article (when appropriate), title of the item (book, magazine, journal, serial, symposium, catalog, etc.), date, page(s), volume number, publisher, city and/or country where published	T <sup>2</sup>
	NPL524	Opinion and Order (Partial Motion for Summary Judgment re Data Decompression) filed in Realtime Data, LLC d/b/a IXO v. Morgan Stanley, et al., Civil Action No. 1:11-cv-6696, Realtime Data, LLC d/b/a IXO v. CME Group Inc., et al., Civil Action No. 1:11-cv-6697, and Realtime Data, LLC d/b/a IXO v. Thomson Reuters, et al., Civil Action No. 1:11-cv-6698, United States District Court Southern District of New York, filed June 27, 2012, 21 pages.	
	NPL525	Technology Tutorial (.exe file), presentation filed in Realtime Data, LLC d/b/a IXO v. Morgan Stanley, et al., Civil Action No. 1:11-cv-6696, Realtime Data, LLC d/b/a IXO v. CME Group Inc., et al., Civil Action No. 1:11-cv-6697, and Realtime Data, LLC d/b/a IXO v. Thomson Reuters, et al., Civil Action No. 1:11-cv-6698, United States District Court Southern District of New York, filed June 2012 (submitted on accompanying CD-ROM).	
	NPL526	Lilley, J., et al., "A Unified Header Compression Framework for Low-Bandwidth Links," MobiCom 2000, August 6-11, 2000. Boston, MA, 12 pages.	
	NPL527	"WAN Link Compression on HP Routers," Hewlett Packard Application Note, May 1995, 7 pages.	
	NPL528	"User Manual for XMill," 2001, 21 pages.	
	NPL529	"High Speed Network, Developer's Guide," Standard & Poor's Comstock, Version 1.1, 1994, pages 1-42, and 53-124.	
	NPL530	Larmouth, J., "ASN.1 Complete", Academic Press, 2000, pages xxi-xxvii, 1-45, 115-130, 168-172, 174, 270-276, and 443-472.	
	NPL531	Petty, J., "PPP Hewlett-Packard Packet-by-Packet Compression (HP PPC) Protocol," draft-ietf-ppext-hppcc-00.txt., October 1993, 7 pages.	
	NPL532	Friend, R., et al., "IP Payload Compression Using LZS," Network Working Group, Request for Comments: 2395, Category: Informational, December 1998; 9 pages.	
	NPL533	"Information technology - Abstract Syntax Notation One (ASN.1): Specification of basic notation," Series X: Data Networks and Open System Communications, OSI networking and system aspects - Abstract Syntax Notation One (ASN.1), International Telecommunication Union, ITU-T Recommendation X.680, December 1997, 109 pages.	

Examiner Signature	Date Considered	
-----------------------	--------------------	--

\*EXAMINER: Initial if reference considered, whether or not citation is in conformance with MPEP 609. Draw line through citation if not in conformance and not considered. Include copy of this form with next communication to applicant.

<sup>1</sup> Applicant's unique citation designation number (optional). <sup>2</sup> Applicant is to place a check mark here if English language Translation is attached.

Substitute for form 1449/PTO			<b>Complete if Known</b>	
<b>INFORMATION DISCLOSURE STATEMENT BY APPLICANT</b> <i>(Use as many sheets as necessary)</i>			Application Number	14/135,926
			Filing Date	December 19, 2013
			First Named Inventor	FALLON et al.
			Art Unit	2634
			Examiner Name	BOCURE, Tesfaldet
			Attorney Docket Number	2855.0050008
Sheet	63	of	97	

<b>NON PATENT LITERATURE DOCUMENTS</b>			
Examiner Initials*	Cite No. <sup>1</sup>	Include name of the author (in CAPITAL LETTERS), title of the article (when appropriate), title of the item (book, magazine, journal, serial, symposium, catalog, etc.), date, page(s), volume number, publisher, city and/or country where published	T <sup>2</sup>
	NPL534	"Information technology - ASN.1 encoding rules - Specification of Packed Encoding Rules (PER), Series X: Data Networks and Open System Communications, OSI networking and system aspects - Abstract Syntax Notation One (ASN.1), International Telecommunication Union, ITU-T Recommendation X.691, December 1997, 51 pages.	
	NPL535	Opinion and Order, filed in Realtime Data, LLC d/b/a IXO v. Morgan Stanley, et al., Civil Action No. 1:11-cv-6696, Realtime Data, LLC d/b/a IXO v. CME Group Inc., et al., Civil Action No. 1:11-cv-6697, and Realtime Data, LLC d/b/a IXO v. Thomson Reuters, et al., Civil Action No. 1:11-cv-6698, United States District Court Southern District of New York, filed September 24, 2012, 48 pages.	
	NPL536	Memorandum Opinion and Order, filed in Realtime Data, LLC d/b/a IXO, v. MetroPCS Texas, LLC, et al., Civil Action No. 6:10-cv-00493, United States District Court for the Eastern District of Texas, filed October 1, 2012, 22 pages.	
	NPL537	T-Mobile's Motion for Leave to Supplement Trial Witness List & Invalidation Contentions, filed in Realtime Data, LLC d/b/a IXO, v. MetroPCS Texas, LLC, et al., Civil Action No. 6:10-cv-00493, United States District Court for the Eastern District of Texas, filed December 17, 2012, 16 pages.	
	NPL538	Exhibit 2, Defendant T-Mobile's Supplemental Invalidation Contentions, filed in Realtime Data, LLC d/b/a IXO, v. MetroPCS Texas, LLC, et al., Civil Action No. 6:10-cv-00493, United States District Court for the Eastern District of Texas, filed December 17, 2012, 13 pages.	
	NPL539	Exhibit 3, FNLTD-74478, Flash Networks: Commercial Part Written by Flash Networks for Cegetel, filed in Realtime Data, LLC d/b/a IXO, v. MetroPCS Texas, LLC, et al., Civil Action No. 6:10-cv-00493, United States District Court for the Eastern District of Texas, filed December 17, 2012, 6 pages.	
	NPL540	Exhibit 4, FNLTD-74444, Response to Cegetel RFP: Technical Section, filed in Realtime Data, LLC d/b/a IXO, v. MetroPCS Texas, LLC, et al., Civil Action No. 6:10-cv-00493, United States District Court for the Eastern District of Texas, filed December 17, 2012, 5 pages.	
	NPL541	Exhibit 5, FNLTD-74926, Flash Networks Optimization Products Selected by AT&T Wireless, Flash Networks, Inc. Press Release, filed in Realtime Data, LLC d/b/a IXO, v. MetroPCS Texas, LLC, et al., Civil Action No. 6:10-cv-00493, United States District Court for the Eastern District of Texas, filed December 17, 2012, 3 pages.	
	NPL542	Exhibit 6, Flash Networks: Harmony, filed in Realtime Data, LLC d/b/a IXO, v. MetroPCS Texas, LLC, et al., Civil Action No. 6:10-cv-00493, United States District Court for the Eastern District of Texas, filed December 17, 2012, 6 pages.	
	NPL543	Exhibit 7, Declaration of Adi Weiser, filed in Realtime Data, LLC d/b/a IXO, v. MetroPCS Texas, LLC, et al., Civil Action No. 6:10-cv-00493, United States District Court for the Eastern District of Texas, filed December 17, 2012, 4 pages.	
Examiner Signature		Date Considered	

\*EXAMINER: Initial if reference considered, whether or not citation is in conformance with MPEP 609. Draw line through citation if not in conformance and not considered. Include copy of this form with next communication to applicant.

<sup>1</sup> Applicant's unique citation designation number (optional). <sup>2</sup> Applicant is to place a check mark here if English language Translation is attached.

Substitute for form 1449/PTO				<b>Complete if Known</b>	
<b>INFORMATION DISCLOSURE STATEMENT BY APPLICANT</b> <i>(Use as many sheets as necessary)</i>				Application Number	14/135,926
				Filing Date	December 19, 2013
				First Named Inventor	FALLON et al.
				Art Unit	2634
				Examiner Name	BOCURE, Tesfaldet
				Attorney Docket Number	2855.0050008
Sheet	64	of	97		

NON PATENT LITERATURE DOCUMENTS			
Examiner Initials*	Cite No. <sup>1</sup>	Include name of the author (in CAPITAL LETTERS), title of the article (when appropriate), title of the item (book, magazine, journal, serial, symposium, catalog, etc.), date, page(s), volume number, publisher, city and/or country where published	T <sup>2</sup>
	NPL544	Exhibit 8, Declaration of Yoav Weiss, filed in Realtime Data, LLC d/b/a IXO, v. MetroPCS Texas, LLC, et al., Civil Action No. 6:10-cv-00493, United States District Court for the Eastern District of Texas, filed December 17, 2012, 4 pages.	
	NPL545	Exhibit 9, Declaration of Richard Luthi, filed in Realtime Data, LLC d/b/a IXO, v. MetroPCS Texas, LLC, et al., Civil Action No. 6:10-cv-00493, United States District Court for the Eastern District of Texas, filed December 17, 2012, 4 pages.	
	NPL546	Exhibit 13, Declaration of Gali Weiss, filed in Realtime Data, LLC d/b/a IXO, v. MetroPCS Texas, LLC, et al., Civil Action No. 6:10-cv-00493, United States District Court for the Eastern District of Texas, filed December 17, 2012, 4 pages.	
	NPL547	Exhibit 17, P.R. 3-1 Claim Chart for T-Mobile, U.S. Patent No. 7,161,506, filed in Realtime Data, LLC d/b/a IXO, v. MetroPCS Texas, LLC, et al., Civil Action No. 6:10-cv-00493, United States District Court for the Eastern District of Texas, filed December 17, 2012, 33 pages.	
	NPL548	"Flash Networks Introduces NettGain 1100, New Products for Carriers & Enterprises that Enables Immediate Deployment of Wireless Data Solutions," Press Release, dated March 20, 2001, 2 pages.	
	NPL549	Amended Expert Report of Dr. Cliff Reader, filed in Realtime Data, LLC d/b/a IXO, v. MetroPCS Texas, LLC, et al., Civil Action No. 6:10-cv-00493, United States District Court for the Eastern District of Texas, filed July 30, 2012, 205 pages.	
	NPL550	Final Judgment, filed in Realtime Data, LLC, d/b/a IXO, v. T-Mobile USA, Inc., Civil Action No. 6:10-cv-00493, United States District Court for the Eastern District of Texas, filed March 28, 2013, 1 page.	
	NPL551	Final Judgment Pursuant to Fed. R. Civ. P. 45(b), filed in Realtime Data LLC, d/b/a IXO, v. CME Group Inc., et al., Civil Action No. 1:11-cv-06697, United States District Court Southern District of New York, dated November 9, 2012, 10 pages.	
	NPL552	Final Judgment Pursuant to Fed. R. Civ. P. 45(b), filed in Realtime Data LLC, d/b/a IXO, v. Morgan Stanley, et al., Civil Action No. 1:11-cv-06696, United States District Court Southern District of New York, dated November 9, 2012, 10 pages.	
	NPL553	Final Judgment Pursuant to Fed. R. Civ. P. 45(b), filed in Realtime Data LLC, d/b/a IXO, v. Thomson Reuters Corporation, et al., Civil Action No. 1:11-cv-06698, United States District Court Southern District of New York, dated November 9, 2012, 6 pages.	

Examiner Signature		Date Considered	
--------------------	--	-----------------	--

\*EXAMINER: Initial if reference considered, whether or not citation is in conformance with MPEP 609. Draw line through citation if not in conformance and not considered. Include copy of this form with next communication to applicant.

<sup>1</sup> Applicant's unique citation designation number (optional). <sup>2</sup> Applicant is to place a check mark here if English language Translation is attached.



Substitute for form 1449/PTO				<b>Complete if Known</b>	
<b>INFORMATION DISCLOSURE STATEMENT BY APPLICANT</b> <i>(Use as many sheets as necessary)</i>				Application Number	14/135,926
				Filing Date	December 19, 2013
				First Named Inventor	FALLON et al.
				Art Unit	2634
				Examiner Name	BOCURE, Tesfaldet
				Attorney Docket Number	2855.0050008
Sheet	65	of	97		

NON PATENT LITERATURE DOCUMENTS			
Examiner Initials*	Cite No. <sup>1</sup>	Include name of the author (in CAPITAL LETTERS), title of the article (when appropriate), title of the item (book, magazine, journal, serial, symposium, catalog, etc.), date, page(s), volume number, publisher, city and/or country where published	T <sup>2</sup>
	NPL554	Opinion and Order (Motion 10), filed in Realtime Data, LLC d/b/a IXO v. Morgan Stanley, et al., Civil Action No. 1:11-cv-6696, Realtime Data, LLC d/b/a IXO v. CME Group Inc., et al., Civil Action No. 1:11-cv-6697, and Realtime Data, LLC d/b/a IXO v. Thomson Reuters, et al., Civil Action No. 1:11-cv-6698, United States District Court Southern District of New York, filed August 2, 2012, 13 pages.	
	NPL555	Supplemental Order, filed in Realtime Data, LLC d/b/a IXO v. Morgan Stanley, et al., Civil Action No. 1:11-cv-6696, Realtime Data, LLC d/b/a IXO v. CME Group Inc., et al., Civil Action No. 1:11-cv-6697, and Realtime Data, LLC d/b/a IXO v. Thomson Reuters, et al., Civil Action No. 1:11-cv-6698, United States District Court Southern District of New York, filed November 9, 2012, 5 pages.	
	NPL556	Memorandum & Order, filed in Realtime Data, LLC d/b/a IXO v. Morgan Stanley, et al., Civil Action No. 1:11-cv-6696, Realtime Data, LLC d/b/a IXO v. CME Group Inc., et al., Civil Action No. 1:11-cv-6697, and Realtime Data, LLC d/b/a IXO v. Thomson Reuters, et al., Civil Action No. 1:11-cv-6698, United States District Court Southern District of New York, filed August 2, 2012, 13 pages.	
	NPL557	Amended Opinion & Order, filed in Realtime Data, LLC d/b/a IXO v. Morgan Stanley, et al., Civil Action No. 1:11-cv-6696, Realtime Data, LLC d/b/a IXO v. CME Group Inc., et al., Civil Action No. 1:11-cv-6697, and Realtime Data, LLC d/b/a IXO v. Thomson Reuters, et al., Civil Action No. 1:11-cv-6698, United States District Court Southern District of New York, filed August 15, 2012, 48 pages.	
	NPL558	Non-Confidential Brief for Plaintiff-Appellant Realtime Data, LLC d/b/a IXO, filed in Realtime Data, LLC d/b/a IXO v. Morgan Stanley et al., Case Nos. 2013-1092, -1093, -1095, -1097, -1098, -1099, -1100, -1101, and -1103, United States Court of Appeals for the Federal Circuit, filed March 6, 2013, 80 pages.	
	NPL559	Non-Confidential Brief for Defendants - Appellees CME Group, Inc., Board of Trade of the City of Chicago, Inc., The New York Mercantile Exchange, Inc., BATS Trading, Inc., and NASDAQ OMX Group, Inc. and NASDAQ OMX PHLX, Inc., filed in Realtime Data, LLC d/b/a IXO v. CME Group, Inc., et al., Case Nos. 13-1093, -1097, and -1100, United States Court of Appeals for the Federal Circuit, filed May 20, 2013, 74 pages.	
	NPL560	Non-Confidential Reply Brief for Plaintiff-Appellant Realtime Data, LLC d/b/a IXO, filed in Realtime Data, LLC d/b/a IXO v. Morgan Stanley, et al., Case Nos. 13-1092, -1093, -1095, -1097, -1098, -1099, -1100, -1101, and -1103, United States Court of Appeals for the Federal Circuit, filed June 19, 2013, 53 pages.	
	NPL561	ChangeLog file for zlib, zlib.net/ChangeLog.txt file, accessed on May 23, 2013, with date references April 11, 1995 - April 28, 2013, 26 pages.	
	NPL562	2.0.39 Kernel Release History, accessed at lwn.net/2001/1018/a/hist-2.0.39.php3, dated October 14, 2001, 8 pages.	

Examiner Signature	Date Considered	
--------------------	-----------------	--

\*EXAMINER: Initial if reference considered, whether or not citation is in conformance with MPEP 609. Draw line through citation if not in conformance and not considered. Include copy of this form with next communication to applicant.  
<sup>1</sup> Applicant's unique citation designation number (optional). <sup>2</sup> Applicant is to place a check mark here if English language Translation is attached.

Substitute for form 1449/PTO				<b>Complete if Known</b>	
<b>INFORMATION DISCLOSURE STATEMENT BY APPLICANT</b> <i>(Use as many sheets as necessary)</i>				Application Number	14/135,926
				Filing Date	December 19, 2013
				First Named Inventor	FALLON et al.
				Art Unit	2634
				Examiner Name	BOCURE, Tesfaldet
				Attorney Docket Number	2855.0050008
Sheet	66	of	97		

NON PATENT LITERATURE DOCUMENTS			
Examiner Initials*	Cite No. <sup>1</sup>	Include name of the author (in CAPITAL LETTERS), title of the article (when appropriate), title of the item (book, magazine, journal, serial, symposium, catalog, etc.), date, page(s), volume number, publisher, city and/or country where published	T <sup>2</sup>
	NPL563	"Linux Kernel," Wikipedia - the Free Encyclopedia, accessed at en.wikipedia.org/wiki/Linux_kernel, accessed on May 9, 2013, 20 pages.	
	NPL564	RUBINI, A., "Booting the Kernel," accessed at www.linux.it/~rubini/docs/boot/, June 1997, 6 pages.	
	NPL565	ZADOK, E., et al., "Fast Indexing: Support for Size-Changing Algorithms in Stackable File Systems," Proceedings of the 2001 Annual USENIX Technical Conference, June 2001, 16 pages.	
	NPL566	Court Docket History for 6:10-cv-00493-LED Realtime Data, LLC d/b/a IXO, v. MetroPCS Texas, LLC et al., downloaded August 9, 2013, 78 pages.	
	NPL567	Court Docket History for 1:09-cv-04486 Chicago Board Options Exchange, Incorporated v. Realtime Data, LLC, downloaded August 9, 2013, 7 pages.	
	NPL568	Court Docket History for 6:08-cv-00144-LED-JDL Realtime Data, LLC d/b/a IXO v. Packeteer, Inc. et al., downloaded August 9, 2013, 119 pages.	
	NPL569	Court Docket History for 6:09-cv-00326-LED-JDL Realtime Data, LLC d/b/a IXO, v. Morgan Stanley et al., downloaded August 9, 2013, 45 pages.	
	NPL570	Court Docket History for 6:09-cv-00327-LED-JDL Realtime Data, LLC d/b/a IXO, v. CME Group Inc. et al., downloaded August 9, 2013, 56 pages.	
	NPL571	Court Docket History for 6:09-cv-00333-LED-JDL Realtime Data, LLC d/b/a IXO v. Thomson Reuters et al., downloaded August 9, 2013, 30 pages.	
	NPL572	Court Docket History for 1:09-cv-07868-RMB Thomson Reuters Corporation v. Realtime Data, LLC, downloaded August 9, 2013, 3 pages.	
	NPL573	Notice of Allowance in Commonly-Assigned U.S. Application. No. 11/651,366, issued April 10, 2009, 7 pgs.	

Examiner Signature	Date Considered	
-----------------------	--------------------	--

\*EXAMINER: Initial if reference considered, whether or not citation is in conformance with MPEP 609. Draw line through citation if not in conformance and not considered. Include copy of this form with next communication to applicant.

<sup>1</sup> Applicant's unique citation designation number (optional). <sup>2</sup> Applicant is to place a check mark here if English language Translation is attached.

Substitute for form 1449/PTO				<b>Complete if Known</b>	
<b>INFORMATION DISCLOSURE STATEMENT BY APPLICANT</b> <i>(Use as many sheets as necessary)</i>				Application Number	14/135,926
				Filing Date	December 19, 2013
				First Named Inventor	FALLON et al.
				Art Unit	2634
				Examiner Name	BOCURE, Tesfaldet
				Attorney Docket Number	2855.0050008
Sheet	67	of	97		

NON PATENT LITERATURE DOCUMENTS			
Examiner Initials*	Cite No. <sup>1</sup>	Include name of the author (in CAPITAL LETTERS), title of the article (when appropriate), title of the item (book, magazine, journal, serial, symposium, catalog, etc.), date, page(s), volume number, publisher, city and/or country where published	T <sup>2</sup>
	NPL574	Copy of Non-Final Office Action for U.S. Appl. No. 12/684,624, mailed November 10, 2010, 5 pgs.	
	NPL575	Copy of Notice of Allowance for U.S. Appl. No. 12/123,081, mailed February 17, 2011, 7 pgs.	
	NPL576	Copy of Non-Final Office Action for U.S. Appl. No. 12/688,413, mailed September 27, 2010, 13 pgs.	
	NPL577	Copy of Notice of Allowance for U.S. Appl. No. 11/551,211, mailed January 31, 2011, 4 pgs.	
	NPL578	Copy of Notice of Allowance for U.S. Appl. No. 11/551,211, mailed September 22, 2010, 4 pgs.	
	NPL579	Copy of Notice of Allowance for U.S. Appl. No. 11/551,204, mailed January 11, 2011, 4 pgs.	
	NPL580	Copy of Notice of Allowance for U.S. Appl. No. 11/553,419, mailed September 22, 2010, 4 pgs.	
	NPL581	Copy of Non-Final Office Action for U.S. Appl. No. 11/400,008, mailed November 23, 2010, 7 pgs.	
	NPL582	Copy of Notice of Allowance for U.S. Appl. No. 11/651,365, mailed February 4, 2010, 8 pgs.	
	NPL583	Copy of Notice of Allowance for U.S. Appl. No. 11/651,365, mailed November 19, 2009, 8 pgs.	

Examiner Signature		Date Considered	
-----------------------	--	--------------------	--

\*EXAMINER: Initial if reference considered, whether or not citation is in conformance with MPEP 609. Draw line through citation if not in conformance and not considered. Include copy of this form with next communication to applicant.

<sup>1</sup> Applicant's unique citation designation number (optional). <sup>2</sup> Applicant is to place a check mark here if English language Translation is attached.

Substitute for form 1449/PTO			<b>Complete if Known</b>	
<b>INFORMATION DISCLOSURE STATEMENT BY APPLICANT</b> <i>(Use as many sheets as necessary)</i>			Application Number	14/135,926
			Filing Date	December 19, 2013
			First Named Inventor	FALLON et al.
			Art Unit	2634
			Examiner Name	BOCURE, Tesfaldet
			Attorney Docket Number	2855.0050008
Sheet	68	of	97	

NON PATENT LITERATURE DOCUMENTS			
Examiner Initials*	Cite No. <sup>1</sup>	Include name of the author (in CAPITAL LETTERS), title of the article (when appropriate), title of the item (book, magazine, journal, serial, symposium, catalog, etc.), date, page(s), volume number, publisher, city and/or country where published	T <sup>2</sup>
	NPL584	Copy of Non-Final Office Action for U.S. Appl. No. 09/969,987, mailed August 27, 2010, 13 pgs.	
	NPL585	Copy of Final Office Action for U.S. Appl. No. 09/969,987, mailed January 28, 2010, 11 pgs.	
	NPL586	Copy of Notice of Allowance for U.S. Appl. No. 12/131,631, mailed June 22, 2010, 5 pgs.	
	NPL587	Copy of Final Office Action for U.S. Appl. No. 11/400,008, mailed October 30, 2009, 7 pgs.	
	NPL588	Copy of Final Office Action for U.S. Appl. No. 11/400,008, mailed May 11, 2010, 7 pgs.	
	NPL589	Copy of Notice of Allowance for U.S. Appl. No 11/551,204, mailed September 30, 2010; 4 pages	
	NPL590	Copy of Non-Final Office Action for U.S. Appl. No.11/551,204, mailed June 16, 2009, 5 pgs.	
	NPL591	Copy of Notice of Allowance for U.S. Appl. No. 11/551,204, mailed June 21, 2010, 4 pgs.	
	NPL592	Copy of Non-Final Office Action for U.S. Appl. No.11/551,204, mailed September 22, 2008, 9 pgs.	
	NPL593	Copy of Notice of Allowance for U.S. Appl. No. 11/551,204, mailed January 27, 2010, 4 pgs.	

Examiner Signature		Date Considered	
--------------------	--	-----------------	--

\*EXAMINER: Initial if reference considered, whether or not citation is in conformance with MPEP 609. Draw line through citation if not in conformance and not considered. Include copy of this form with next communication to applicant.

<sup>1</sup> Applicant's unique citation designation number (optional). <sup>2</sup> Applicant is to place a check mark here if English language Translation is attached.

Substitute for form 1449/PTO				<b>Complete if Known</b>	
<b>INFORMATION DISCLOSURE STATEMENT BY APPLICANT</b> <i>(Use as many sheets as necessary)</i>				Application Number	14/135,926
				Filing Date	December 19, 2013
				First Named Inventor	FALLON et al.
				Art Unit	2634
				Examiner Name	BOCURE, Tesfaldet
Sheet	69	of	97	Attorney Docket Number	2855.0050008

NON PATENT LITERATURE DOCUMENTS			
Examiner Initials*	Cite No. <sup>1</sup>	Include name of the author (in CAPITAL LETTERS), title of the article (when appropriate), title of the item (book, magazine, journal, serial, symposium, catalog, etc.), date, page(s), volume number, publisher, city and/or country where published	T <sup>2</sup>
	NPL594	Copy of Non-Final Office Action for U.S. Appl. No.12/690,125, mailed September 21, 2010, 12 pgs.	
	NPL595	Copy of Notice of Allowance for U.S. Appl. No 11/553,427, mailed March 24, 2011, 5 pages	
	NPL596	Copy of Notice of Allowance for U.S. Appl. No 12/703,042, mailed May 5, 2011, 8 pages.	
	NPL597	Copy of Notice of Allowance for U.S. Appl. No 11/551,211, mailed May 6, 2011, 5 pages	
	NPL598	Copy of Notice of Allowance for U.S. Appl. No 11/553,419, mailed May 20, 2011, 5 pages	
	NPL599	Copy of Final Office Action for U.S. Appl. No. 09/969,987, mailed May 24, 2011, 17 pgs.	
	NPL600	Copy of Notice of Allowance for U.S. Appl. No. 11/553,427, mailed May 31, 2011, 5 pages.	
	NPL601	Copy of Final Office Action for U.S. Appl. No. 12/690,125, mailed June 7, 2011, 11 pages.	
	NPL602	Copy of Final Office Action for U.S. Appl. No. 12/688,413, mailed June 7, 2011, 15 pages.	
	NPL603	Copy of Final Office Action for U.S. Appl. No. 11/400,008, mailed June 27, 2011, 6 pages.	

Examiner Signature	Date Considered	
-----------------------	--------------------	--

\*EXAMINER: Initial if reference considered, whether or not citation is in conformance with MPEP 609. Draw line through citation if not in conformance and not considered. Include copy of this form with next communication to applicant.

<sup>1</sup> Applicant's unique citation designation number (optional). <sup>2</sup> Applicant is to place a check mark here if English language Translation is attached.

Substitute for form 1449/PTO				<b>Complete if Known</b>	
<b>INFORMATION DISCLOSURE STATEMENT BY APPLICANT</b> <i>(Use as many sheets as necessary)</i>				Application Number	14/135,926
				Filing Date	December 19, 2013
				First Named Inventor	FALLON et al.
				Art Unit	2634
				Examiner Name	BOCURE, Tesfaldet
				Attorney Docket Number	2855.0050008
Sheet	70	of	97		

NON PATENT LITERATURE DOCUMENTS			
Examiner Initials*	Cite No. <sup>1</sup>	Include name of the author (in CAPITAL LETTERS), title of the article (when appropriate), title of the item (book, magazine, journal, serial, symposium, catalog, etc.), date, page(s), volume number, publisher, city and/or country where published	T <sup>2</sup>
	NPL604	Copy of Notice of Allowance for U.S. Appl. No. 11/551,204, mailed July 11, 2011, 5 pages.	
	NPL605	Copy of Notice of Allowance for U.S. Appl. No. 12/684,624, mailed July 25, 2011, 5 pages.	
	NPL606	Copy of Non-Final Office Action for U.S. Appl. No. 12/703,042, mailed July 28, 2011, 5 pages.	
	NPL607	Copy of Non-Final Office Action for U.S. Appl. No. 12/857,238, mailed August 10, 2011, 6 pages.	
	NPL608	Copy of Non-Final Office Action for U.S. Appl. No. 13/101,994, mailed August 16, 2011, 10 pages.	
	NPL609	Copy of Notice of Allowance for U.S. Appl. No. 11/551,211, mailed August 24, 2011, 5 pages.	
	NPL610	Copy of Notice of Allowance for U.S. Appl. No. 12/684,624, mailed September 1, 2011, 9 pages.	
	NPL611	Copy of Notice of Allowance for U.S. Appl. No. 12/123,081, mailed September 26, 2011, 9 pages.	
	NPL612	Copy of Notice of Allowance for U.S. Appl. No. 11/551,204, mailed September 28, 2011, 5 pages.	
	NPL613	Copy of Notice of Allowance for U.S. Appl. No. 11/551,211, mailed October 18, 2011, 5 pages.	

Examiner Signature	Date Considered	
-----------------------	--------------------	--

\*EXAMINER: Initial if reference considered, whether or not citation is in conformance with MPEP 609. Draw line through citation if not in conformance and not considered. Include copy of this form with next communication to applicant.  
<sup>1</sup> Applicant's unique citation designation number (optional). <sup>2</sup> Applicant is to place a check mark here if English language Translation is attached.

Substitute for form 1449/PTO		<b>Complete if Known</b>	
<b>INFORMATION DISCLOSURE STATEMENT BY APPLICANT</b> <i>(Use as many sheets as necessary)</i>		Application Number	14/135,926
		Filing Date	December 19, 2013
		First Named Inventor	FALLON et al.
		Art Unit	2634
		Examiner Name	BOCURE, Tesfaldet
		Attorney Docket Number	2855.0050008
Sheet	71	of	97

NON PATENT LITERATURE DOCUMENTS			
Examiner Initials*	Cite No. <sup>1</sup>	Include name of the author (in CAPITAL LETTERS), title of the article (when appropriate), title of the item (book, magazine, journal, serial, symposium, catalog, etc.), date, page(s), volume number, publisher, city and/or country where published	T <sup>2</sup>
	NPL614	Copy of Non-Final Office Action for U.S. Appl. No. 13/154,239, mailed November 2, 2011, 6 pages.	
	NPL615	Copy of Notice of Allowance for U.S. Appl. No. 12/703,042, mailed November 15, 2011, 8 pages.	
	NPL616	Copy of Non-Final Office Action for U.S. Appl. No. 12/688,413, mailed November 28, 2011, 14 pages.	
	NPL617	Copy of Notice of Allowance for U.S. Appl. No. 12/857,238, mailed December 30, 2011, 5 pages.	
	NPL618	Copy of Notice of Allowance for U.S. Appl. No. 11/400,008, mailed February 6, 2012, 8 pages.	
	NPL619	Copy of Non-Final Office Action for U.S. Appl. No. 12/690,125, mailed March 8, 2012, 7 pages.	
	NPL620	Copy of Notice of Allowance for U.S. Patent Appl. No. 12/703,042, mailed March 30, 2012, 8 pages.	
	NPL621	Copy of Non-Final Office Action for U.S. Appl. No. 09/969,987, mailed April 11, 2012, 6 pages.	
	NPL622	Copy of Notice of Allowance for U.S. Appl. No. 11/553,419, mailed April 23, 2012, 6 pages.	
	NPL623	Copy of Notice of Allowance for U.S. Appl. No. 11/553,427, mailed May 7, 2012, 7 pages.	

Examiner Signature	Date Considered	
-----------------------	--------------------	--

\*EXAMINER: Initial if reference considered, whether or not citation is in conformance with MPEP 609. Draw line through citation if not in conformance and not considered. Include copy of this form with next communication to applicant.

<sup>1</sup> Applicant's unique citation designation number (optional). <sup>2</sup> Applicant is to place a check mark here if English language Translation is attached.

Substitute for form 1449/PTO			<b>Complete if Known</b>	
<b>INFORMATION DISCLOSURE STATEMENT BY APPLICANT</b> <i>(Use as many sheets as necessary)</i>			Application Number	14/135,926
			Filing Date	December 19, 2013
			First Named Inventor	FALLON et al.
			Art Unit	2634
			Examiner Name	BOCURE, Tesfaldet
			Attorney Docket Number	2855.0050008
Sheet	72	of	97	

NON PATENT LITERATURE DOCUMENTS			
Examiner Initials*	Cite No. <sup>1</sup>	Include name of the author (in CAPITAL LETTERS), title of the article (when appropriate), title of the item (book, magazine, journal, serial, symposium, catalog, etc.), date, page(s), volume number, publisher, city and/or country where published	T <sup>2</sup>
	NPL624	Copy of Non-Final Office Action for U.S. Appl. No. 13/118,122, mailed May 16, 2012, 9 pages.	
	NPL625	Copy of Non-Final Office Action for U.S. Appl. No. 13/101,994, mailed May 23, 2012, 12 pages.	
	NPL626	Copy of Notice of Allowance for U.S. Appl. No. 12/857,238, mailed May 29, 2012, 5 pages.	
	NPL627	Copy of Notice of Allowance for U.S. Appl. No. 11/400,008, mailed June 21, 2012, 8 pages.	
	NPL628	Copy of Final Office Action for U.S. Appl. No. 13/154,239, mailed June 26, 2012, 14 pages.	
	NPL629	Copy of Notice of Allowance for U.S. Appl. No. 12/857,238, mailed July 12, 2012, 5 pages.	
	NPL630	Copy of Notice of Allowance for U.S. Appl. No. 12/703,042, mailed July 16, 2012, 8 pages.	
	NPL631	Copy of Non-Final Office Action for U.S. Appl. No. 13/482,800, mailed July 20, 2012, 14 pages.	
	NPL632	Copy of Notice of Allowance for U.S. Appl. No. 11/553,427, mailed November 6, 2012, 5 pages.	
	NPL633	Copy of Notice of Allowance for U.S. Appl. No. 12/703,042, mailed November 15, 2012, 9 pages.	

Examiner Signature	Date Considered	
-----------------------	--------------------	--

\*EXAMINER: Initial if reference considered, whether or not citation is in conformance with MPEP 609. Draw line through citation if not in conformance and not considered. Include copy of this form with next communication to applicant.

<sup>1</sup> Applicant's unique citation designation number (optional). <sup>2</sup> Applicant is to place a check mark here if English language Translation is attached.



Substitute for form 1449/PTO				<b>Complete if Known</b>	
<b>INFORMATION DISCLOSURE STATEMENT BY APPLICANT</b> <i>(Use as many sheets as necessary)</i>				Application Number	14/135,926
				Filing Date	December 19, 2013
				First Named Inventor	FALLON et al.
				Art Unit	2634
				Examiner Name	BOCURE, Tesfaldet
				Attorney Docket Number	2855.0050008
Sheet	73	of	97		

NON PATENT LITERATURE DOCUMENTS			
Examiner Initials*	Cite No. <sup>1</sup>	Include name of the author (in CAPITAL LETTERS), title of the article (when appropriate), title of the item (book, magazine, journal, serial, symposium, catalog, etc.), date, page(s), volume number, publisher, city and/or country where published	T <sup>2</sup>
	NPL634	Copy of Non-Final Office Action for U.S. Appl. No. 12/857,238, mailed November 29, 2012, 17 pages.	
	NPL635	Copy of Final Office Action for U.S. Appl. No. 09/969,987, mailed December 4, 2012, 7 pages.	
	NPL636	Copy of Final Office Action for U.S. Appl. No. 13/101,994, mailed December 13, 2012, 5 pages.	
	NPL637	Copy of Supplemental Notice of Allowability for U.S. Appl. No. 12/703,042, mailed December 18, 2012, 6 pages.	
	NPL638	Copy of Notice of Allowance for U.S. Appl. No. 12/690,125, mailed December 28, 2012, 5 pages.	
	NPL639	Copy of Final Office Action for U.S. Appl. No. 13/118,122, mailed January 9, 2013, 11 pages.	
	NPL640	Copy of Non-Final Office Action for U.S. Appl. No. 11/553,419, mailed January 15, 2013, 4 pages.	
	NPL641	Copy of Non-Final Office Action for U.S. Appl. No. 13/482,800, mailed February 19, 2013, 15 pages.	
	NPL642	Copy of Notice of Allowance for U.S. Appl. No. 12/703,042, mailed March 4, 2013, 9 pages.	
	NPL643	Copy of Non-Final Office Action for U.S. Appl. No. 12/690,125, mailed April 15, 2013, 11 pages.	

Examiner Signature	Date Considered
--------------------	-----------------

\*EXAMINER: Initial if reference considered, whether or not citation is in conformance with MPEP 609. Draw line through citation if not in conformance and not considered. Include copy of this form with next communication to applicant.

<sup>1</sup> Applicant's unique citation designation number (optional). <sup>2</sup> Applicant is to place a check mark here if English language Translation is attached.

Substitute for form 1449/PTO			<b>Complete if Known</b>	
<b>INFORMATION DISCLOSURE STATEMENT BY APPLICANT</b> <i>(Use as many sheets as necessary)</i>			Application Number	14/135,926
			Filing Date	December 19, 2013
			First Named Inventor	FALLON et al.
			Art Unit	2634
			Examiner Name	BOCURE, Tesfaldet
			Attorney Docket Number	2855.0050008
Sheet	74	of	97	

NON PATENT LITERATURE DOCUMENTS			
Examiner Initials*	Cite No. <sup>1</sup>	Include name of the author (in CAPITAL LETTERS), title of the article (when appropriate), title of the item (book, magazine, journal, serial, symposium, catalog, etc.), date, page(s), volume number, publisher, city and/or country where published	T <sup>2</sup>
	NPL644	Copy of Notice of Allowance for U.S. Appl. No. 13/154,239, mailed April 24, 2013, 10 pages.	
	NPL645	Copy of Notice of Allowance for U.S. Appl. No. 11/553,427, mailed May 14, 2013, 6 pages.	
	NPL646	Copy of Supplemental Notice of Allowance for U.S. Appl. No. 11/553,427, mailed May 15, 2013, 6 pages.	
	NPL647	Copy of Notice of Allowance for U.S. Appl. No. 12/857,238, mailed June 17, 2013, 6 pages.	
	NPL648	Copy of Supplemental Notice of Allowance for U.S. Appl. No. 12/703,042, mailed June 18, 2013, 6 pages.	
	NPL649	Copy of Supplemental Notice of Allowance for U.S. Appl. No. 11/553,427, mailed July 2, 2013, 2 pages.	
	NPL650	Copy of Non-Final Office Action for U.S. Appl. No. 09/969,987, mailed July 3, 2013, 8 pages.	
	NPL651	Copy of Notice of Allowance for U.S. Appl. No. 13/154,211, mailed July 11, 2013, 10 pages.	
	NPL652	Copy of Non-Final Office Action for U.S. Appl. No. 13/118,122, mailed July 19, 2013, 12 pages.	
	NPL653	Copy of Notice of Allowance for U.S. Appl. No. 13/154,239, mailed August 2, 2013, 9 pages.	

Examiner Signature		Date Considered	
--------------------	--	-----------------	--

\*EXAMINER: Initial if reference considered, whether or not citation is in conformance with MPEP 609. Draw line through citation if not in conformance and not considered. Include copy of this form with next communication to applicant.  
<sup>1</sup> Applicant's unique citation designation number (optional). <sup>2</sup> Applicant is to place a check mark here if English language Translation is attached.

Substitute for form 1449/PTO			<b>Complete if Known</b>	
<b>INFORMATION DISCLOSURE STATEMENT BY APPLICANT</b> <i>(Use as many sheets as necessary)</i>			Application Number	14/135,926
			Filing Date	December 19, 2013
			First Named Inventor	FALLON et al.
			Art Unit	2634
			Examiner Name	BOCURE, Tesfaldet
			Attorney Docket Number	2855.0050008
Sheet	75	of	97	

NON PATENT LITERATURE DOCUMENTS			
Examiner Initials*	Cite No. <sup>1</sup>	Include name of the author (in CAPITAL LETTERS), title of the article (when appropriate), title of the item (book, magazine, journal, serial, symposium, catalog, etc.), date, page(s), volume number, publisher, city and/or country where published	T <sup>2</sup>
	NPL654	Copy of Notice of Allowance for U.S. Appl. No. 13/118,122, mailed September 19, 2013, 6 pages.	
	NPL655	Copy of Notice of Allowance for U.S. Appl. No. 11/553,419, mailed October 17, 2013, 7 pages.	
	NPL656	Copy of Notice of Allowance for U.S. Appl. No. 12/857,238, mailed October 23, 2013, 7 pages.	
	NPL657	Copy of Notice of Allowance for U.S. Appl. No. 13/154,211, mailed October 24, 2013, 9 pages.	
	NPL658	Copy of Final Office Action for U.S. Appl. No. 13/482,800, mailed October 25, 2013, 21 pages.	
	NPL659	International Search Report for PCT/US00/42018, mailed July 31, 2001, 3 pages.	
	NPL660	International Search Report for PCT/US01/03712, mailed May 10, 2002, 2 pages.	
	NPL661	International Search Report for PCT/US01/03711, mailed January 28, 2001, 5 pages.	
	NPL662	Copy of submission of prior art under 37 CFR 1.501, for U.S. Pat. No. 6,604,158, March 3, 2011, 5 pgs.	
	NPL663	Copy of submission of prior art under 37 CFR 1.501, for U.S. Pat. No. 7,415,530, March 3, 2011, 14 pgs.	

Examiner Signature		Date Considered	
-----------------------	--	--------------------	--

\*EXAMINER: Initial if reference considered, whether or not citation is in conformance with MPEP 609. Draw line through citation if not in conformance and not considered. Include copy of this form with next communication to applicant.

<sup>1</sup> Applicant's unique citation designation number (optional). <sup>2</sup> Applicant is to place a check mark here if English language Translation is attached.

Substitute for form 1449/PTO				<b>Complete if Known</b>	
<b>INFORMATION DISCLOSURE STATEMENT BY APPLICANT</b> <i>(Use as many sheets as necessary)</i>				Application Number	14/135,926
				Filing Date	December 19, 2013
				First Named Inventor	FALLON et al.
				Art Unit	2634
				Examiner Name	BOCURE, Tesfaldet
Sheet	76	of	97	Attorney Docket Number	2855.0050008

NON PATENT LITERATURE DOCUMENTS			
Examiner Initials*	Cite No. <sup>1</sup>	Include name of the author (in CAPITAL LETTERS), title of the article (when appropriate), title of the item (book, magazine, journal, serial, symposium, catalog, etc.), date, page(s), volume number, publisher, city and/or country where published	T <sup>2</sup>
	NPL664	Copy of submission of prior art under 37 CFR 1.501, for U.S. Pat. No. 6,601,104, March 3, 2011, 5 pgs.	
	NPL665	Copy of submission of prior art under 37 CFR 1.501, for U.S. Pat. No. 7,161,506, March 3, 2011, 12 pgs.	
	NPL666	Copy of submission of prior art under 37 CFR 1.501, for U.S. Pat. No. 7,395,345, March 3, 2011, 14 pgs.	
	NPL667	Copy of submission of prior art under 37 CFR 1.501, for U.S. Pat. No. 7,321,937, March 3, 2011, 14 pgs.	
	NPL668	Copy of submission of prior art under 37 CFR 1.501, for U.S. Pat. No. 7,352,300, March 3, 2011, 14 pgs.	
	NPL669	Copy of submission of prior art under 37 CFR 1.501, for U.S. Pat. No. 7,378,992, March 3, 2011, 14 pgs.	
	NPL670	Ex Parte Reexamination Interview Summary, mailed December 3, 2009, for U.S. Reexam App. No. 90/009,428, 4 pgs.	
	NPL671	Request for Inter Partes Reexamination of U.S. Patent No. 7,714,747, Control No. 95/001,517, filed December 30, 2010, 696 pages.	
	NPL672	Replacement Request for Inter Partes Reexamination of U.S. Patent No. 7,417,568, Control No. 95/001,533, filed March 1, 2011, 357 pages.	
	NPL673	L. Gannoun, "RTP Payload Format for X Protocol Media Streams," Audio-Visual Transport WG Internet Draft, Internet Engineering Task Force, March 11, 1998, 15 pgs.	

Examiner Signature		Date Considered	
-----------------------	--	--------------------	--

\*EXAMINER: Initial if reference considered, whether or not citation is in conformance with MPEP 609. Draw line through citation if not in conformance and not considered. Include copy of this form with next communication to applicant.

<sup>1</sup> Applicant's unique citation designation number (optional). <sup>2</sup> Applicant is to place a check mark here if English language Translation is attached.

Substitute for form 1449/PTO				<b>Complete if Known</b>	
<b>INFORMATION DISCLOSURE STATEMENT BY APPLICANT</b> <i>(Use as many sheets as necessary)</i>				Application Number	14/135,926
				Filing Date	December 19, 2013
				First Named Inventor	FALLON et al.
				Art Unit	2634
				Examiner Name	BOCURE, Tesfaldet
				Attorney Docket Number	2855.0050008
Sheet	77	of	97		

NON PATENT LITERATURE DOCUMENTS			
Examiner Initials*	Cite No. <sup>1</sup>	Include name of the author (in CAPITAL LETTERS), title of the article (when appropriate), title of the item (book, magazine, journal, serial, symposium, catalog, etc.), date, page(s), volume number, publisher, city and/or country where published	T <sup>2</sup>
	NPL674	Official Order Granting Request for Inter Partes Reexamination of U.S. Pat. No. 6,624,761, Control No. 95/000,464, issued July 24, 2009, 29 pgs.	
	NPL675	Non-Final Office Action in Inter Partes Reexamination of U.S. Pat. No. 6,624,761, Control No. 95/000,464, issued December 15, 2009, 20 pgs.	
	NPL676	Non-Final Office Action in Inter Partes Reexamination of U.S. Pat. No. 7,321,937, Control No. 95/000,466, issued June 22, 2009, 11 pgs.	
	NPL677	Official Order Granting Request for Inter Partes Reexamination of U.S. Pat. No. 7,321,937, Control No. 95/000,466, issued June 22, 2009, 16 pgs.	
	NPL678	Official Action Closing Prosecution for Inter Partes Reexamination of U.S. Pat. No. 7,321,937, Control No. 95/000,466, issued December 22, 2009, 20 pgs.	
	NPL679	Comments by Third Party Requester to Patent Owner's Response Inter Partes Reexamination of U.S. Patent No. 7,321,937, Control No. 95/000,466, filed November 10, 2009, 30 pgs.	
	NPL680	Supplemental Declaration of Professor James A. Storer, Ph.D. under 37 C.F.R. §1.132 in Inter Partes Reexamination of U.S. Patent No. 7,321,937, Control No. 95/000,466, executed on November 10, 2009, 16 pgs.	
	NPL681	Examiner Interview Summary in Ex Parte Reexamination of U.S. Pat. No. 6,601,104, Control No. 90/009,428, issued December 3, 2009, 3 pgs.	
	NPL682	Non-Final Office Action in Ex Parte Reexamination of U.S. Pat. No. 6,601,104, Control No. 90/009,428, issued November 2, 2009, 13 pgs.	
	NPL683	Official Order Granting Request for Ex Parte Reexamination of U.S. Pat. No. 6,601,104, Control No. 90/009,428, issued June 1, 2009, 12 pgs.	

Examiner Signature		Date Considered	
-----------------------	--	--------------------	--

\*EXAMINER: Initial if reference considered, whether or not citation is in conformance with MPEP 609. Draw line through citation if not in conformance and not considered. Include copy of this form with next communication to applicant.

<sup>1</sup> Applicant's unique citation designation number (optional). <sup>2</sup> Applicant is to place a check mark here if English language Translation is attached.

Substitute for form 1449/PTO				<b>Complete if Known</b>	
<b>INFORMATION DISCLOSURE STATEMENT BY APPLICANT</b> <i>(Use as many sheets as necessary)</i>				Application Number	14/135,926
				Filing Date	December 19, 2013
				First Named Inventor	FALLON et al.
				Art Unit	2634
				Examiner Name	BOCURE, Tesfaldet
Sheet	78	of	97	Attorney Docket Number	2855.0050008

NON PATENT LITERATURE DOCUMENTS			
Examiner Initials*	Cite No. <sup>1</sup>	Include name of the author (in CAPITAL LETTERS), title of the article (when appropriate), title of the item (book, magazine, journal, serial, symposium, catalog, etc.), date, page(s), volume number, publisher, city and/or country where published	T <sup>2</sup>
	NPL684	Declaration of Dr. George T. Ligler under 37 C.F.R. §1.132 in Ex Parte Reexamination of U.S. Pat. No. 6,601,104, Control No. 90/009,428, executed December 28, 2009 16 pgs.	
	NPL685	Supplementary Declaration of Dr. George T. Ligler under 37 C.F.R. §1.132 in Ex Parte Reexamination of U.S. Pat. No. 6,601,104, Control No. 90/009,428, executed December 30, 2009 1 pg.	
	NPL686	Declaration of Dr. George T. Ligler under 37 C.F.R. §1.132 in Inter Partes Reexamination of U.S. Pat. No. 7,321,937, Control No. 95/000,466, executed August 24, 2009, 30 pgs.	
	NPL687	Official Order Granting Request for Inter Partes Reexamination of U.S. Pat. No. 7,161,506, Control No. 95/000,479, issued August 14, 2009, 41 pgs.	
	NPL688	Non-Final Office Action in Inter Partes Reexamination of U.S. Pat. No. 7,161,506, Control No. 95/000,479, issued December 15, 2009, 37 pgs.	
	NPL689	Official Order Granting Request for Inter Partes Reexamination of U.S. Pat. No. 7,378,992, Control No. 95/000,478, issued August 13, 2009, 60 pgs.	
	NPL690	Non-Final Office Action in Inter Partes Reexamination of U.S. Pat. No. 7,378,992, Control No. 95/000,478, issued December 15, 2009, 27 pgs.	
	NPL691	Official Order Granting Request for Inter Partes Reexamination of U.S. Pat. No. 6,604,158 Control No. 95/000,486, issued August 14, 2009, 35 pgs.	
	NPL692	Non-Final Office Action in Inter Partes Reexamination of U.S. Pat. No. 6,604,158, Control No. 95/000,486, issued November 12, 2009, 199 pgs.	
	NPL693	Right of Appeal Notice in Inter Partes Reexamination of U.S. Pat. No. 6,624,761, Control No. 95/000,464, issued January 6, 2011, 15 pgs.	

Examiner Signature	Date Considered	
-----------------------	--------------------	--

\*EXAMINER: Initial if reference considered, whether or not citation is in conformance with MPEP 609. Draw line through citation if not in conformance and not considered. Include copy of this form with next communication to applicant.

<sup>1</sup> Applicant's unique citation designation number (optional). <sup>2</sup> Applicant is to place a check mark here if English language Translation is attached.

Substitute for form 1449/PTO				<b>Complete if Known</b>	
<b>INFORMATION DISCLOSURE STATEMENT BY APPLICANT</b> <i>(Use as many sheets as necessary)</i>				Application Number	14/135,926
				Filing Date	December 19, 2013
				First Named Inventor	FALLON et al.
				Art Unit	2634
				Examiner Name	BOCURE, Tesfaldet
Sheet	79	of	97	Attorney Docket Number	2855.0050008

NON PATENT LITERATURE DOCUMENTS			
Examiner Initials*	Cite No. <sup>1</sup>	Include name of the author (in CAPITAL LETTERS), title of the article (when appropriate), title of the item (book, magazine, journal, serial, symposium, catalog, etc.), date, page(s), volume number, publisher, city and/or country where published	T <sup>2</sup>
	NPL694	Action Closing Prosecution in Inter Partes Reexamination of U.S. Pat. No. 6,624,761, Control No. 95/000,464, issued August 27, 2010, 25 pgs.	
	NPL695	Right of Appeal Notice in Inter Partes Reexamination of U.S. Pat. No. 7,321,937, Control No. 95/000,466, issued May 24, 2010, 23 pgs.	
	NPL696	Final Office Action in Ex Parte Reexamination of U.S. Pat. No. 6,601,104, Control No. 90/009,428, issued February 5, 2010, 16 pgs.	
	NPL697	Right of Appeal Notice for Inter Partes Reexamination of U.S. Pat. No. 7,161,506, Control No. 95/000,479, issued January 6, 2011, 18 pgs.	
	NPL698	Action Closing Prosecution in Inter Partes Reexamination of U.S. Pat. No. 7,161,506, Control No. 95/000,479, issued August 27, 2010, 34 pgs.	
	NPL699	Right of Appeal Notice for Inter Partes Reexamination of U.S. Pat. No. 7,378,992, Control No. 95/000,478, issued January 6, 2011, 15 pgs.	
	NPL700	Action Closing Prosecution in Inter Partes Reexamination of U.S. Pat. No. 7,378,992, Control No. 95/000,478, issued August 23, 2010, 31 pgs.	
	NPL701	Action Closing Prosecution in Inter Partes Reexamination of U.S. Pat. No. 6,604,158 Control No. 95/000,486, issued March 7, 2011, 257 pgs.	
	NPL702	Patent Owner's reply to Office Action in Inter Partes Reexamination of U.S. Patent No. 7,378,992, mailed March 15, 2010, 23 pages.	
	NPL703	Patent Owner's Reply to Office Action in Inter Partes Reexamination of U.S. Patent No. 7,161,506, mailed March 15, 2010, 23 pages.	

Examiner Signature		Date Considered	
-----------------------	--	--------------------	--

\*EXAMINER: Initial if reference considered, whether or not citation is in conformance with MPEP 609. Draw line through citation if not in conformance and not considered. Include copy of this form with next communication to applicant.

<sup>1</sup> Applicant's unique citation designation number (optional). <sup>2</sup> Applicant is to place a check mark here if English language Translation is attached.

Substitute for form 1449/PTO				<b>Complete if Known</b>	
<b>INFORMATION DISCLOSURE STATEMENT BY APPLICANT</b> <i>(Use as many sheets as necessary)</i>				Application Number	14/135,926
				Filing Date	December 19, 2013
				First Named Inventor	FALLON et al.
				Art Unit	2634
				Examiner Name	BOCURE, Tesfaldet
				Attorney Docket Number	2855.0050008
Sheet	80	of	97		

NON PATENT LITERATURE DOCUMENTS			
Examiner Initials*	Cite No. <sup>1</sup>	Include name of the author (in CAPITAL LETTERS), title of the article (when appropriate), title of the item (book, magazine, journal, serial, symposium, catalog, etc.), date, page(s), volume number, publisher, city and/or country where published	T <sup>2</sup>
	NPL704	Patent Owner's Reply to Action Closing Prosecution of August 23, 2010 in Inter Partes Reexamination of U.S. Patent 7,378,992, mailed September 23, 2010, 23 pages.	
	NPL705	Patent Owner's Reply to Action Closing Prosecution of August 27, 2010 in Inter Partes Reexamination of U.S. Patent No. 7,161,506, mailed September 27, 2010, 26 pages.	
	NPL706	Patent Owner's reply to Action Closing Prosecution of August 27, 2010 in Inter Partes Reexamination of U.S. Patent No. 6,624,761, mailed September 27, 2010, 20 pages.	
	NPL707	Corrected Request for Inter Partes Reexamination of U.S. Patent No. 6,624,761, filed June 15, 2009, 241 pages.	
	NPL708	Request for Inter Partes Reexamination of U.S. Patent No. 7,378,992, filed May 21, 2009, 255 pages.	
	NPL709	Request for Inter Partes Reexamination of U.S. Patent No. 7,161,506, filed May 28, 2009, 455 pages.	
	NPL710	Request for Inter Partes Reexamination of U.S. Patent No. 7,777,651, Control No. 95/001,581, filed March 21, 2011, 2,136 pages.	
	NPL711	Request for Inter Partes Reexamination of U.S. Patent No. 7,400,274, Control No. 95/001,544, filed February 14, 2011, 420 pages.	
	NPL712	Action Closing Prosecution in Inter Partes Reexamination of U.S. Pat. No. 7,321,937, Control No. 95/000,466 issued December 22, 2009, 20 pages.	
	NPL713	Order Granting request for inter partes reexamination of U.S. Patent No. 7,400,274 and Non-Final Office Action in Inter Partes reexam of U.S. Patent No. 7,400,274, Control No. 95/001,544, issued March 25, 2011, 47 pages.	

Examiner Signature	Date Considered	
-----------------------	--------------------	--

\*EXAMINER: Initial if reference considered, whether or not citation is in conformance with MPEP 609. Draw line through citation if not in conformance and not considered. Include copy of this form with next communication to applicant.

<sup>1</sup> Applicant's unique citation designation number (optional). <sup>2</sup> Applicant is to place a check mark here if English language Translation is attached.



Substitute for form 1449/PTO				<b>Complete if Known</b>	
<b>INFORMATION DISCLOSURE STATEMENT BY APPLICANT</b> <i>(Use as many sheets as necessary)</i>				Application Number	14/135,926
				Filing Date	December 19, 2013
				First Named Inventor	FALLON et al.
				Art Unit	2634
				Examiner Name	BOCURE, Tesfaldet
				Attorney Docket Number	2855.0050008
Sheet	81	of	97		

NON PATENT LITERATURE DOCUMENTS			
Examiner Initials*	Cite No. <sup>1</sup>	Include name of the author (in CAPITAL LETTERS), title of the article (when appropriate), title of the item (book, magazine, journal, serial, symposium, catalog, etc.), date, page(s), volume number, publisher, city and/or country where published	T <sup>2</sup>
	NPL714	Non-Final Office Action in Inter Partes Reexamination of U.S. Patent No. 7,400,274, Control No. 95/001,544, mailed May 20, 2011, 47 pages.	
	NPL715	Order Granting Request for Inter Partes Reexamination of U.S. Patent No. 7,777,651, Control No. 95/001,581, mailed June 15, 2011, 22 pages.	
	NPL716	Non-Final Office Action in Inter Partes Reexamination of U.S. Patent No. 7,417,568, Control No. 95/001,553, mailed May 6, 2011, 105 pages.	
	NPL717	Order Granting Reexamination of U.S. Patent No. 7,714,747, Control No. 95/001,517, mailed March 9, 2011, 21 pages.	
	NPL718	Appeal Brief filed in Inter Partes Reexamination of U.S. Patent No. 6,601,104, Control no. 90/009,428, mailed September 2, 2010, 28 pages	
	NPL719	Examiner's Answer to Appeal Brief in Inter Partes Reexamination of U.S. Patent No. 7,321,937, Control No. 95/000,466, mailed July 18, 2011, 33 pages.	
	NPL720	Non-Final Office Action in Inter Partes Reexamination of U.S. Patent No. 7,777,651, Control No. 95/001,581, mailed July 25, 2011, 274 pages.	
	NPL721	Non-Final Action Closing Prosecution in Inter Partes Reexamination of U.S. Patent No. 7,714,747, Control No. 95/001,517, mailed September 21, 2011, 29 pages.	
	NPL722	Definition of "data packet", Academic Press Dictionary of Science and Technology, Copyright 1992, 1996, cited by Examiner in Inter Partes Reexamination of U.S. Patent No. 7,714,747, Control No. 95/001,517, mailed September 21, 2011, 2 pages.	
	NPL723	Patent Owner's Reply to Office Action in Inter Partes Reexamination of U.S. Patent No. 7,777,651, Control No. 95/001,581, mailed September 26, 2011, 44 pages.	

Examiner Signature		Date Considered	
-----------------------	--	--------------------	--

\*EXAMINER: Initial if reference considered, whether or not citation is in conformance with MPEP 609. Draw line through citation if not in conformance and not considered. Include copy of this form with next communication to applicant.

<sup>1</sup> Applicant's unique citation designation number (optional). <sup>2</sup> Applicant is to place a check mark here if English language Translation is attached.

Substitute for form 1449/PTO			<b>Complete if Known</b>	
<b>INFORMATION DISCLOSURE STATEMENT BY APPLICANT</b> <i>(Use as many sheets as necessary)</i>			Application Number	14/135,926
			Filing Date	December 19, 2013
			First Named Inventor	FALLON et al.
			Art Unit	2634
			Examiner Name	BOCURE, Tesfaldet
			Attorney Docket Number	2855.0050008
Sheet	82	of	97	

<b>NON PATENT LITERATURE DOCUMENTS</b>			
Examiner Initials*	Cite No. <sup>1</sup>	Include name of the author (in CAPITAL LETTERS), title of the article (when appropriate), title of the item (book, magazine, journal, serial, symposium, catalog, etc.), date, page(s), volume number, publisher, city and/or country where published	T <sup>2</sup>
	NPL724	Examiner's Answer to Appeal Brief in Inter Partes Reexamination of U.S. Patent No. 6,624,761, Control No. 95/000,464, mailed September 28, 2011, 20 pages.	
	NPL725	Examiner's Answer to Appeal Brief in Inter Partes Reexamination of U.S. Patent No. 7,161,506, Control no. 95/000,479, mailed September 28, 2011, 25 pages.	
	NPL726	Examiner's Answer to Appeal Brief in Inter Partes Reexamination of U.S. Patent No. 7,378,992, Control No. 95/000,478, mailed September 29, 2011, 27 pages.	
	NPL727	Decision on Appeal in Ex parte Reexamination of U.S. Patent No. 6,601,104 B1, Control No. 90/009,428, dated March 18, 2011, 14 pages.	
	NPL728	Patent Owner's Rebuttal Brief Under 37 C.F.R § 41.71 Retracting the Arguments Made to Overcome the Claim Rejections and Thereby Eliminating the Issues on Appeal in Inter Partes Reexamination of U.S. Patent No, 6,624,761, Control No. 95/000,464, dated October 28, 2011, 9 pages.	
	NPL729	Patent Owner's Rebuttal Brief Under 37 C.F.R § 41.71 Retracting the Arguments Made to Overcome the Claim Rejections and Thereby Eliminating the Issues on Appeal in Inter Partes Reexamination of U.S. Patent No, 7,378,992, Control No. 95/000,478, dated October 28, 2011, 10 pages.	
	NPL730	Patent Owner's Rebuttal Brief Under 37 C.F.R § 41.71 Retracting the Arguments Made to Overcome the Claim Rejections and Thereby Eliminating the Issues on Appeal in Inter Partes Reexamination of U.S. Patent No, 7,161,506, Control No. 95/000,479, dated October 28, 2011, 9 pages.	
	NPL731	Non-Final Action Closing Prosecution in Inter Partes Reexamination of U.S. Patent No. 7,400,274, Control No. 95/001,544, mailed November 18, 2011, 39 pages.	
	NPL732	Non-Final Action Closing Prosecution in Inter Partes Reexamination of U.S. Patent No. 7,417,568, Control No. 95/001,533, mailed December 9, 2011, 42 pages.	
	NPL733	Patent Owner's Reply to Action Closing Prosecution of November 18, 2011 in Inter Partes Reexamination of U.S. Patent No. 7,400,274, Control No. 95/001,544, mailed December 19, 2011, 9 pages.	

Examiner Signature	Date Considered	
-----------------------	--------------------	--

\*EXAMINER: Initial if reference considered, whether or not citation is in conformance with MPEP 609. Draw line through citation if not in conformance and not considered. Include copy of this form with next communication to applicant.

<sup>1</sup> Applicant's unique citation designation number (optional). <sup>2</sup> Applicant is to place a check mark here if English language Translation is attached.

Substitute for form 1449/PTO				<b>Complete if Known</b>	
<b>INFORMATION DISCLOSURE STATEMENT BY APPLICANT</b> <i>(Use as many sheets as necessary)</i>				Application Number	14/135,926
				Filing Date	December 19, 2013
				First Named Inventor	FALLON et al.
				Art Unit	2634
				Examiner Name	BOCURE, Tesfaldet
				Attorney Docket Number	2855.0050008
Sheet	83	of	97		

NON PATENT LITERATURE DOCUMENTS			
Examiner Initials*	Cite No. <sup>1</sup>	Include name of the author (in CAPITAL LETTERS), title of the article (when appropriate), title of the item (book, magazine, journal, serial, symposium, catalog, etc.), date, page(s), volume number, publisher, city and/or country where published	T <sup>2</sup>
	NPL734	Patent Owner's Reply to Action Closing Prosecution of December 9, 2011 in Inter Partes Reexamination of U.S. Patent No. 7,417,568, Control No. 95/001,533, mailed December 29, 2011, 14 pages.	
	NPL735	Notice of Intent to Issue Ex Parte Reexamination Certificate in Ex Parte Reexamination of U.S. Patent No. 6,601,104, Control No. 90/009,428, mailed January 13, 2012, 5 pages.	
	NPL736	Decision on Appeal in Inter Partes Reexamination of U.S. Patent No. 6,624,761, Control No. 95/000,464, mailed January 18, 2012, 5 pages.	
	NPL737	Decision on Appeal in Inter Partes Reexamination of U.S. Patent No. 7,321,937, Control No. 95/000,466, mailed January 18, 2012, 8 pages.	
	NPL738	Decision on Appeal in Inter Partes Reexamination of U.S. Patent No. 7,378,992, Control No. 95/000,478, mailed January 18, 2012, 5 pages.	
	NPL739	Decision on Appeal in Inter Partes Reexamination of U.S. Patent No. 7,161,506, Control No. 95/000,479, mailed January 18, 2012, 6 pages.	
	NPL740	Non-Final Office Action in Inter Partes Reexamination of U.S. Patent No. 7,777,651, Control No. 95/001,581, mailed January 27, 2012, 152 pages.	
	NPL741	Patent Owner's Respondent Brief on Appeal Under 37 C.F.R. § 41.68 in Inter Partes Reexamination of U.S. Patent No. 7,714,747, Control No. 95/001,517, filed February 17, 2012, 20 pages.	
	NPL742	Patent Owner's Reply to Second Non-Final Office Action of January 27, 2012 in Inter Partes Reexamination of U.S. Patent No. 7,777,651, Control No. 95/001,581, filed February 24, 2012, 30 pages.	
	NPL743	Ex Parte Reexamination Certificate in Ex Parte Reexamination of U.S. Patent No. 6,601,104, Control No. 90/009,428, issued February 28, 2012, 2 pages.	

Examiner Signature		Date Considered	
-----------------------	--	--------------------	--

\*EXAMINER: Initial if reference considered, whether or not citation is in conformance with MPEP 609. Draw line through citation if not in conformance and not considered. Include copy of this form with next communication to applicant.

<sup>1</sup> Applicant's unique citation designation number (optional). <sup>2</sup> Applicant is to place a check mark here if English language Translation is attached.

Substitute for form 1449/PTO			<b>Complete if Known</b>	
<b>INFORMATION DISCLOSURE STATEMENT BY APPLICANT</b> <i>(Use as many sheets as necessary)</i>			Application Number	14/135,926
			Filing Date	December 19, 2013
			First Named Inventor	FALLON et al.
			Art Unit	2634
			Examiner Name	BOCURE, Tesfaldet
			Attorney Docket Number	2855.0050008
Sheet	84	of	97	

NON PATENT LITERATURE DOCUMENTS			
Examiner Initials*	Cite No. <sup>1</sup>	Include name of the author (in CAPITAL LETTERS), title of the article (when appropriate), title of the item (book, magazine, journal, serial, symposium, catalog, etc.), date, page(s), volume number, publisher, city and/or country where published	T <sup>2</sup>
	NPL744	Examiner's Answer to Appeal Brief in Inter Partes Reexamination of U.S. Patent No. 7,714,747, Control No. 95/001,517, mailed March 1, 2012, 4 pages.	
	NPL745	Right of Appeal Notice in Inter Partes Reexamination of U.S. Patent No. 7,417,568, Control No. 95/001,533, mailed March 1, 2012, 8 pages.	
	NPL746	Right of Appeal Notice in Inter Partes Reexamination of U.S. Patent No. 7,400,274, Control No. 95/001,544, mailed March 6, 2012, 7 pages.	
	NPL747	Request for Inter Partes Reexamination of U.S. Patent No. 7,321,937, Control No. 95/001,922, filed March 2, 2012, including accompanying Exhibits PA-A to PA-D, PAT-A to PAT-C, CC-A to CC-D, Oth-A, and Form PTO/SB/08a, 2865 pages.	
	NPL748	Request for Inter Partes Reexamination of U.S. Patent No. 6,604,158, Control No. 95/001,923, filed March 2, 2012, including accompanying Exhibits PA-A to PA-D, PAT-A to PAT-B, CC-A to CC-F, Oth-A, and Form PTO/SB/08a, 560 pages.	
	NPL749	Request for Inter Partes Reexamination of U.S. Patent No. 7,352,300, Control No. 95/001,924, filed March 2, 2012, including accompanying Exhibits PA-A to PA-H, PAT-A to PAT-B, CC-A to CC-F, Oth-A, and Form PTO/SB/08a, 1012 pages.	
	NPL750	Request for Inter Partes Reexamination of U.S. Patent No. 7,395,345, Control No. 95/001,925, filed March 2, 2012, including accompanying Exhibits PA-A to PA-C, PAT-A, CC-A to CC-C, Oth-A, and Form PTO/SB/08a, 204 pages.	
	NPL751	Request for Inter Partes Reexamination of U.S. Patent No. 7,161,506, Control No. 95/001,926, filed March 2, 2012, with accompanying Exhibits PA-A to PA-C, PAT-A to PAT-C, CC-A to CC-B, Oth-A to Oth-B, and Form PTO/SB/08a, 2651 pages.	
	NPL752	Request for Inter Partes Reexamination of U.S. Patent No. 7,415,530, Control No. 95/001,927, filed March 2, 2012, including accompanying Exhibits PA-A to PA-F, PAT-A to PAT-B, CC-A to CC-O, Oth-A, and Form PTO/SB/08a, 700 pages.	
	NPL753	Request for Inter Partes Reexamination of U.S. Patent No. 7,378,992, Control No. 95/001,928, filed March 2, 2012, including Exhibits PA-A to PA-D, PAT-A to PAT-C, CC-A to CC-B, Oth-A, and Form PTO/SB/08a, 2316 pages.	

Examiner Signature		Date Considered	
-----------------------	--	--------------------	--

\*EXAMINER: Initial if reference considered, whether or not citation is in conformance with MPEP 609. Draw line through citation if not in conformance and not considered. Include copy of this form with next communication to applicant.

<sup>1</sup> Applicant's unique citation designation number (optional). <sup>2</sup> Applicant is to place a check mark here if English language Translation is attached.

Substitute for form 1449/PTO			<b>Complete if Known</b>	
<b>INFORMATION DISCLOSURE STATEMENT BY APPLICANT</b> <i>(Use as many sheets as necessary)</i>			Application Number	14/135,926
			Filing Date	December 19, 2013
			First Named Inventor	FALLON et al.
			Art Unit	2634
			Examiner Name	BOCURE, Tesfaldet
			Attorney Docket Number	2855.0050008
Sheet	85	of	97	

NON PATENT LITERATURE DOCUMENTS			
Examiner Initials*	Cite No. <sup>1</sup>	Include name of the author (in CAPITAL LETTERS), title of the article (when appropriate), title of the item (book, magazine, journal, serial, symposium, catalog, etc.), date, page(s), volume number, publisher, city and/or country where published	T <sup>2</sup>
	NPL754	Official Order Granting Request for Inter Partes Reexamination of U.S. Patent No. 7,395,345, Control No. 95/001,925, mailed March 19, 2012, 11 pages.	
	NPL755	Non-Final Office Action in Inter Partes Reexamination of U.S. Patent No. 7,395,345, Control No. 95/001,925, mailed March 19, 2012, 20 pages.	
	NPL756	Notice of Intent to Issue Inter Partes Reexamination Certificate in Inter Partes Reexamination of U.S. Patent No. 7,321,937, Control No. 95/000,466, mailed March 21, 2012, 7 pages.	
	NPL757	Right of Appeal Notice for Inter Partes Reexamination of U.S. Patent No. 6,604,158, Control No. 95/000,486, mailed March 26, 2012, 253 pages.	
	NPL758	Notice of Intent to Issue Inter Partes Reexamination Certificate in Inter Partes Reexamination of U.S. Patent No. 6,624,761, Control No. 95/000,464, mailed April 3, 2012, 7 pages.	
	NPL759	Notice of Intent to Issue Inter Partes Reexamination Certificate in Inter Partes Reexamination of U.S. Patent No. 7,161,506, Control No. 95/000,479, mailed April 4, 2012, 15 pages.	
	NPL760	Notice of Intent to Issue Inter Partes Reexamination Certificate in Inter Partes Reexamination of U.S. Patent No. 7,378,992, Control No. 95/000,478, mailed April 6, 2012, 5 pages.	
	NPL761	Official Order Granting Request for Inter Partes Reexamination of U.S. Patent No. 7,321,937, Control no. 95/001,922, mailed April 20, 2012, 17 pages.	
	NPL762	Non-Final Office Action in Inter Partes Reexamination of U.S. Patent No. 7,321,937, Control No. 95/001,922, mailed April 20, 2012, 8 pages.	
	NPL763	Official Order Granting Request for Inter Partes Reexamination of U.S. Patent No. 7,161,506, Control No. 95/001,926, mailed April 25, 2012, 9 pages.	

Examiner Signature		Date Considered	
-----------------------	--	--------------------	--

\*EXAMINER: Initial if reference considered, whether or not citation is in conformance with MPEP 609. Draw line through citation if not in conformance and not considered. Include copy of this form with next communication to applicant.

<sup>1</sup> Applicant's unique citation designation number (optional). <sup>2</sup> Applicant is to place a check mark here if English language Translation is attached.

Substitute for form 1449/PTO			<b>Complete if Known</b>	
<b>INFORMATION DISCLOSURE STATEMENT BY APPLICANT</b> <i>(Use as many sheets as necessary)</i>			Application Number	14/135,926
			Filing Date	December 19, 2013
			First Named Inventor	FALLON et al.
			Art Unit	2634
			Examiner Name	BOCURE, Tesfaldet
			Attorney Docket Number	2855.0050008
Sheet	86	of	97	

NON PATENT LITERATURE DOCUMENTS			
Examiner Initials*	Cite No. <sup>1</sup>	Include name of the author (in CAPITAL LETTERS), title of the article (when appropriate), title of the item (book, magazine, journal, serial, symposium, catalog, etc.), date, page(s), volume number, publisher, city and/or country where published	T <sup>2</sup>
	NPL764	Non-Final Office Action in Inter Partes Reexamination of U.S. Patent No. 7,161,506, Control No. 95/001,926, mailed April 25, 2012, 7 pages.	
	NPL765	Official Order Granting Request for Inter Partes Reexamination of U.S. Patent No. 7,378,992, Control No. 95/001,928, mailed April 25, 2012, 8 pages.	
	NPL766	Non-Final Office Action in Inter Partes Reexamination of U.S. Patent No. 7,378,992, Control No. 95/001,928, mailed April 25, 2012, 8 pages.	
	NPL767	Official Order Denying Request for Inter Partes Reexamination of U.S. Patent No. 7,415,530, Control No. 95/001,927, mailed April 27, 2012, 52 pages.	
	NPL768	Official Order Granting Request for Inter Partes Reexamination of U.S. Patent No. 6,604,158, Control No. 95/001,923, mailed May 7, 2012, 14 pages.	
	NPL769	Non-Final Office Action in Inter Partes Reexamination of U.S. Patent No. 6,604,158, Control No. 95/001,923, mailed May 7, 2012, 8 pages.	
	NPL770	Petition Under 37 C.F.R. §§ 1.181 and 1.182 for Correction of Notice of Intent to Issue Reexamination Certificate in Inter Partes Reexamination of U.S. Patent No. 7,378,992, Control No. 95/000,478, filed May 9, 2012, 8 pages.	
	NPL771	Inter Partes Reexamination Certificate in Inter Partes Reexamination of U.S. Patent No. 7,321,937, Control No. 95/000,466, issued May 15, 2012, 2 pages.	
	NPL772	Official Order Granting Request for Inter Partes Reexamination of U.S. Patent No. 7,352,300, Control No. 95/001,924, mailed May 17, 2012, 12 pages.	
	NPL773	Non-Final Office Action in Inter Partes Reexamination of U.S. Patent No. 7,352,300, Control No. 95/001,924, mailed May 17, 2012, 18 pages.	

Examiner Signature	Date Considered	
--------------------	-----------------	--

\*EXAMINER: Initial if reference considered, whether or not citation is in conformance with MPEP 609. Draw line through citation if not in conformance and not considered. Include copy of this form with next communication to applicant.  
<sup>1</sup> Applicant's unique citation designation number (optional). <sup>2</sup> Applicant is to place a check mark here if English language Translation is attached.

Substitute for form 1449/PTO		<b>Complete if Known</b>	
<b>INFORMATION DISCLOSURE STATEMENT BY APPLICANT</b> <i>(Use as many sheets as necessary)</i>		Application Number	14/135,926
		Filing Date	December 19, 2013
		First Named Inventor	FALLON et al.
		Art Unit	2634
		Examiner Name	BOCURE, Tesfaldet
		Attorney Docket Number	2855.0050008
Sheet	87	of	97

NON PATENT LITERATURE DOCUMENTS			
Examiner Initials*	Cite No. <sup>1</sup>	Include name of the author (in CAPITAL LETTERS), title of the article (when appropriate), title of the item (book, magazine, journal, serial, symposium, catalog, etc.), date, page(s), volume number, publisher, city and/or country where published	T <sup>2</sup>
	NPL774	Patent Owner's Response to Office Action of March 19, 2012 in Inter Partes Reexamination of U.S. Patent No. 7,395,345, Control No. 95/001,925, filed May 21, 2012, 21 pages.	
	NPL775	Inter Partes Reexamination Certificate in Inter Partes Reexamination of U.S. Patent No. 7,161,506, Control No. 95/000,479, issued May 22, 2012, 2 pages.	
	NPL776	Inter Partes Reexamination Certificate in Inter Partes Reexamination of U.S. Patent No. 6,624,761, Control No. 95/000,464, issued June 12, 2012, 2 pages.	
	NPL777	Action Closing Prosecution in Inter Partes Reexamination of U.S. Patent No. 7,777,651, Control No. 95/001,581, mailed June 18, 2012, 45 pages.	
	NPL778	Patent Owner's Response to Office Action of April 20, 2012 in Inter Partes Reexamination of U.S. Patent No. 7,321,937, Control No. 95/001,922, filed June 20, 2012, 11 pages.	
	NPL779	Patent Owner's Response to Office Action of April 25, 2012 in Inter Partes Reexamination of U.S. Patent No. 7,161,506, Control No. 95/001,926, filed June 25, 2012, 20 pages.	
	NPL780	Patent Owner's Response to Office Action of April 25, 2012 in Inter Partes Reexamination of U.S. Patent No. 7,378,992, Control No. 95/001,928, filed June 25, 2012, 20 pages.	
	NPL781	Patent Owner's Response to Office Action of May 7, 2012 in Inter Partes Reexamination of U.S. Patent No. 6,604,158, Control No. 95/001,923, filed July 9, 2012, 19 pages.	
	NPL782	Patent Owner's Response to Office Action of May 17, 2012 in Inter Partes Reexamination of U.S. Patent No. 7,352,300, Control No. 95/001,924, filed July 17, 2012, 31 pages.	
	NPL783	New Decision on Appeal after Board Decision in Inter Partes Reexamination of U.S. Patent No. 7,714,747, Control No. 95/001,517, mailed July 24, 2012, 24 pages.	

Examiner Signature		Date Considered	
-----------------------	--	--------------------	--

\*EXAMINER: Initial if reference considered, whether or not citation is in conformance with MPEP 609. Draw line through citation if not in conformance and not considered. Include copy of this form with next communication to applicant.

<sup>1</sup> Applicant's unique citation designation number (optional). <sup>2</sup> Applicant is to place a check mark here if English language Translation is attached.

Substitute for form 1449/PTO			<b>Complete if Known</b>	
<b>INFORMATION DISCLOSURE STATEMENT BY APPLICANT</b> <i>(Use as many sheets as necessary)</i>			Application Number	14/135,926
			Filing Date	December 19, 2013
			First Named Inventor	FALLON et al.
			Art Unit	2634
			Examiner Name	BOCURE, Tesfaldet
			Attorney Docket Number	2855.0050008
Sheet	88	of	97	

NON PATENT LITERATURE DOCUMENTS			
Examiner Initials*	Cite No. <sup>1</sup>	Include name of the author (in CAPITAL LETTERS), title of the article (when appropriate), title of the item (book, magazine, journal, serial, symposium, catalog, etc.), date, page(s), volume number, publisher, city and/or country where published	T <sup>2</sup>
	NPL784	Right of Appeal Notice for Inter Partes Reexamination of U.S. Patent No. 7,777,651, Control No. 95/001,581, mailed August 3, 2012, 7 pages.	
	NPL785	Notice of Intent to Issue Inter Partes Reexamination Certificate in Inter Partes Reexamination of U.S. Patent No. 6,604,158, Control No. 95/000,486, mailed August 30, 2012, 5 pages.	
	NPL786	Notice of Intent to Issue Inter Partes Reexamination Certificate in Inter Partes Reexamination of U.S. Patent No. 7,378,992, Control No. 95/000,478, mailed August 31, 2012, 6 pages.	
	NPL787	Decision on Petition for Supervisory Review of Refusal to Order Reexamination for Claims 1-2, 16-21, and 23 (37 CFR §§ 1.927 and 1.181) in Inter Partes Reexamination of U.S. Patent No. 7,415,530, Control No. 95/001,927, mailed August 31, 2012, 10 pages.	
	NPL788	Decision on Petition Under 37 C.F.R. §§ 1.181 and 1.182 for Correction of Notice of Intent to Issue Reexamination Certificate in Inter Partes Reexamination of U.S. Patent No. 7,378,992, Control No. 95/000,478, mailed September 10, 2012, 6 pages.	
	NPL789	Decision on Petition for Supervisory Review of Refusal to Order Reexamination of Claims 5-7, 14-16, and 18-19 (37 CFR §§ 1.927 and 1.181) in Inter Partes Reexamination of U.S. Patent No. 7,321,937, Control No. 95/001,922, mailed September 10, 2012, 12 pages.	
	NPL790	Decision on Petition for Supervisory Review of Refusal to Order Reexamination for Claims 86, 89, 90, 92-96, and 98 (37 CFR §§ 1.927 and 1.181) in Inter Partes Reexamination of U.S. Patent No. 7,161,506, Control No. 95/001,926, mailed September 21, 2012, 10 pages.	
	NPL791	Non-Final Office Action in Inter Partes Reexamination of U.S. Patent No. 7,415,530, Control No. 95/001,927, mailed September 21, 2012, 15 pages.	
	NPL792	Patent Owner's Request to Reopen Prosecution Before the Examiner Under 37 C.F.R. § 41.77(b) in Inter Partes Reexamination of U.S. Patent No. 7,714,747, Control No. 95/001,517, filed September 24, 2012, 29 pages.	
	NPL793	Examiner's Answer to Appeal Brief in Ex Parte Reexamination of U.S. Patent No. 7,400,274, Control No. 95/001,544, mailed October 1, 2012, 17 pages.	

Examiner Signature	Date Considered	
-----------------------	--------------------	--

\*EXAMINER: Initial if reference considered, whether or not citation is in conformance with MPEP 609. Draw line through citation if not in conformance and not considered. Include copy of this form with next communication to applicant.

<sup>1</sup> Applicant's unique citation designation number (optional). <sup>2</sup> Applicant is to place a check mark here if English language Translation is attached.



Substitute for form 1449/PTO			<b>Complete if Known</b>	
<b>INFORMATION DISCLOSURE STATEMENT BY APPLICANT</b> <i>(Use as many sheets as necessary)</i>			Application Number	14/135,926
			Filing Date	December 19, 2013
			First Named Inventor	FALLON et al.
			Art Unit	2634
			Examiner Name	BOCURE, Tesfaldet
			Attorney Docket Number	2855.0050008
Sheet	89	of	97	

NON PATENT LITERATURE DOCUMENTS			
Examiner Initials*	Cite No. <sup>1</sup>	Include name of the author (in CAPITAL LETTERS), title of the article (when appropriate), title of the item (book, magazine, journal, serial, symposium, catalog, etc.), date, page(s), volume number, publisher, city and/or country where published	T <sup>2</sup>
	NPL794	Inter Partes Reexam Certificate in Inter Partes Reexamination of U.S. Patent No. 7,378,992, Control No. 95/000,478, issued October 4, 2012, 2 pages.	
	NPL795	Inter Partes Reexam Certificate in Inter Partes Reexamination of U.S. Patent No. 6,604,158, Control No. 95/000,486, issued October 10, 2012, 2 pages.	
	NPL796	Examiner's Answer to Appeal Brief in Inter Partes Reexamination of U.S. Patent No. 7,417,568, Control No. 95/001,533, mailed October 15, 2012, 44 pages.	
	NPL797	Non-Final Office Action in Inter Partes Reexamination of U.S. Patent No. 7,321,937, Control No. 95/001,922, mailed October 18, 2012, 10 pages.	
	NPL798	Patent Owner's Rebuttal Brief Under 37 C.F.R § 41.71 in Inter Partes Reexamination of U.S. Patent No. 7,417,568, Control No. 95/001,533, filed November 15, 2012, 15 pages.	
	NPL799	Patent Owner's Response to Office Action of October 18, 2012 in Inter Partes Reexamination of U.S. Patent No. 7,321,937, Control No. 95/001,922, filed November 19, 2012, 30 pages.	
	NPL800	Patent Owner's Supplemental Amendment Subsequent to Timely Submission of Response to Office Action of October 18, 2012 in Inter Partes Reexamination of U.S. Patent No. 7,321,937, Control No. 95/001,922, filed November 27, 2012, 6 pages.	
	NPL801	Patent Owner's Response to Office Action of September 21, 2012 in Inter Partes Reexamination of U.S. Patent No. 7,415,530, Control No. 95/001,927, filed December 21, 2012, 51 pages.	
	NPL802	Action Closing Prosecution in Inter Partes Reexamination of U.S. Patent No. 7,161,506, Control No. 95/001,926, mailed March 5, 2013, 23 pages.	
	NPL803	Action Closing Prosecution in Inter Partes Reexamination of U.S. Patent No. 7,378,992, Control No. 95/001,928, mailed March 5, 2013, 29 pages.	

Examiner Signature		Date Considered	
-----------------------	--	--------------------	--

\*EXAMINER: Initial if reference considered, whether or not citation is in conformance with MPEP 609. Draw line through citation if not in conformance and not considered. Include copy of this form with next communication to applicant.

<sup>1</sup> Applicant's unique citation designation number (optional). <sup>2</sup> Applicant is to place a check mark here if English language Translation is attached.

Substitute for form 1449/PTO			<b>Complete if Known</b>	
<b>INFORMATION DISCLOSURE STATEMENT BY APPLICANT</b> <i>(Use as many sheets as necessary)</i>			Application Number	14/135,926
			Filing Date	December 19, 2013
			First Named Inventor	FALLON et al.
			Art Unit	2634
			Examiner Name	BOCURE, Tesfaldet
			Attorney Docket Number	2855.0050008
Sheet	90	of	97	

NON PATENT LITERATURE DOCUMENTS			
Examiner Initials*	Cite No. <sup>1</sup>	Include name of the author (in CAPITAL LETTERS), title of the article (when appropriate), title of the item (book, magazine, journal, serial, symposium, catalog, etc.), date, page(s), volume number, publisher, city and/or country where published	T <sup>2</sup>
	NPL804	Examiner's Answer to Appeal Brief in Inter Partes Reexamination of U.S. Patent No. 7,777,651, Control No. 95/001,581, mailed March 14, 2013, 21 pages.	
	NPL805	Decision on Petition to Strike Patent Owner's Rebuttal Brief in Inter Partes Reexamination of U.S. Patent No. 7,417,568, Control No. 95/001,533, mailed March 15, 2013, 7 pages.	
	NPL806	Order Remanding Inter Partes Reexamination Under 37 C.F.R § 41.77(d) to the Examiner in Inter Partes Reexamination of U.S. Patent No. 7,714,747, Control No. 95/001,517, mailed March 18, 2013, 3 pages.	
	NPL807	Decision on Petition Under 37 C.F.R. § 1.183 to Request Examiner Enter Evidence in Inter Partes Reexamination of U.S. Patent No. 7,417,568, Control No. 95/001,533, mailed March 20, 2013, 7 pages.	
	NPL808	Action Closing Prosecution in Inter Partes Reexamination of U.S. Patent No. 7,415,530, Control No. 95/001,927, mailed April 3, 2013, 24 pages.	
	NPL809	Patent Owner's Reply to Action Closing Prosecution of March 5, 2013 in Inter Partes Reexamination of U.S. Patent No. 7,161,506, Control No. 95/001,926, filed April 5, 2013, 19 pages.	
	NPL810	Patent Owner's Reply to Action Closing Prosecution of March 5, 2013 in Inter Partes Reexamination of U.S. Patent No. 7,378,992, Control No. 95/001,928, filed April 5, 2013, 23 pages.	
	NPL811	Action Closing Prosecution in Inter Partes Reexamination of U.S. Patent No. 7,321,937, Control No. 95/001,922, mailed April 9, 2013, 59 pages.	
	NPL812	"Data Transfer Rate (DTR)," accessed at <a href="http://searchunifiedcommunications.techtarget.com/definition/data-transfer-rate">http://searchunifiedcommunications.techtarget.com/definition/data-transfer-rate</a> , published May 18, 2011, 1 page.	
	NPL813	"Bandwidth - technical definition," accessed at <a href="http://computer.yourdictionary.com/bandwidth">http://computer.yourdictionary.com/bandwidth</a> , accessed on March 7, 2013, 4 pages.	

Examiner Signature		Date Considered	
-----------------------	--	--------------------	--

\*EXAMINER: Initial if reference considered, whether or not citation is in conformance with MPEP 609. Draw line through citation if not in conformance and not considered. Include copy of this form with next communication to applicant.

<sup>1</sup> Applicant's unique citation designation number (optional). <sup>2</sup> Applicant is to place a check mark here if English language Translation is attached.

Substitute for form 1449/PTO			<b>Complete if Known</b>	
<b>INFORMATION DISCLOSURE STATEMENT BY APPLICANT</b> <i>(Use as many sheets as necessary)</i>			Application Number	14/135,926
			Filing Date	December 19, 2013
			First Named Inventor	FALLON et al.
			Art Unit	2634
			Examiner Name	BOCURE, Tesfaldet
			Attorney Docket Number	2855.0050008
Sheet	91	of	97	

NON PATENT LITERATURE DOCUMENTS			
Examiner Initials*	Cite No. <sup>1</sup>	Include name of the author (in CAPITAL LETTERS), title of the article (when appropriate), title of the item (book, magazine, journal, serial, symposium, catalog, etc.), date, page(s), volume number, publisher, city and/or country where published	T <sup>2</sup>
	NPL814	"Bandwidth - Definition," accessed at <a href="http://www.yourdictionary.com/bandwidth">http://www.yourdictionary.com/bandwidth</a> , accessed on March 7, 2013, 2 pages.	
	NPL815	"Bandwidth," accessed at <a href="http://searchenterprise.wan.techtarg.com/definitions/bandwidth">http://searchenterprise.wan.techtarg.com/definitions/bandwidth</a> , published March 24, 2010, 1 page.	
	NPL816	Action Closing Prosecution in Inter Partes Reexamination of U.S. Patent No. 7,352,300, Control No. 95/001,924, mailed April 9, 2013, 30 pages.	
	NPL817	Examiner's Determination Under 37 C.F.R. § 41.77(d) in Inter Partes Reexamination of U.S. Patent No. 7,714,747, Control No. 95/001,517, mailed April 10, 2013, 7 pages.	
	NPL818	Patent Owner's Supplemental Response to Office Action of May 7, 2012 in Inter Partes Reexamination of U.S. Patent No. 6,604,158, Control No. 95/001,923, filed April 29, 2013, 20 pages.	
	NPL819	Patent Owner's Supplemental Response to Office Action of March 19, 2012 in Inter Partes Reexamination of U.S. Patent No. 7,395,345, Control No. 95/001,925, filed May 6, 2013, 24 pages.	
	NPL820	Patent Owner's Response to Action Closing Prosecution of April 9, 2013 in Inter Partes Reexamination of U.S. Patent No. 7,321,937, Control No. 95/001,922, filed May 9, 2013, 13 pages.	
	NPL821	Patent Owner's Response to Action Closing Prosecution of April 9, 2013 in Inter Partes Reexamination of U.S. Patent No. 7,352,300, Control No. 95/001,924, filed May 9, 2013, 29 pages.	
	NPL822	Patent Owner's Comments in Response to Examiner's Determination Under 37 C.F.R. § 41.77(e) in Inter Partes Reexamination of U.S. Patent No. 7,714,747, Control No. 95/001,517, filed May 10, 2013, 20 pages.	
	NPL823	Patent Owner's Supplemental Response to Action Closing Prosecution of April 9, 2013 in Inter Partes Reexamination of U.S. Patent No. 7,321,937, Control No. 95/001,922, filed May 15, 2013, 13 pages.	

Examiner Signature		Date Considered	
-----------------------	--	--------------------	--

\*EXAMINER: Initial if reference considered, whether or not citation is in conformance with MPEP 609. Draw line through citation if not in conformance and not considered. Include copy of this form with next communication to applicant.

<sup>1</sup> Applicant's unique citation designation number (optional). <sup>2</sup> Applicant is to place a check mark here if English language Translation is attached.

Substitute for form 1449/PTO			<b>Complete if Known</b>	
<b>INFORMATION DISCLOSURE STATEMENT BY APPLICANT</b> <i>(Use as many sheets as necessary)</i>			Application Number	14/135,926
			Filing Date	December 19, 2013
			First Named Inventor	FALLON et al.
			Art Unit	2634
			Examiner Name	BOCURE, Tesfaldet
			Attorney Docket Number	2855.0050008
Sheet	92	of	97	

NON PATENT LITERATURE DOCUMENTS			
Examiner Initials*	Cite No. <sup>1</sup>	Include name of the author (in CAPITAL LETTERS), title of the article (when appropriate), title of the item (book, magazine, journal, serial, symposium, catalog, etc.), date, page(s), volume number, publisher, city and/or country where published	T <sup>2</sup>
	NPL824	Right of Appeal Notice in Inter Partes Reexamination of U.S. Patent No. 7,415,530, Control No. 95/001,927, mailed May 31, 2013, 26 pages.	
	NPL825	Petition Under 37 C.F.R. § 1.181 to Expunge Third Party Requester's Improper Submission of Declarations Under 37 C.F.R. § 1.132 and Strike Comments Directed to Examiner's Determination in Inter Partes Reexamination of U.S. Patent No. 7,714,747, Control No. 95/001,517, filed June 26, 2013, 6 pages.	
	NPL826	Notice of Intent to Issue A Reexam Certificate in Inter Partes Reexamination of U.S. Patent No. 7,415,530, Control No. 95/001,927, mailed July 19, 2013, 5 pages.	
	NPL827	Right of Appeal Notice in Inter Partes Reexamination of U.S. Patent No. 7,321,937, Control No. 95/001,922, mailed August 15, 2013, 12 pages.	
	NPL828	Right of Appeal Notice in Inter Partes Reexamination of U.S. Patent No. 7,161,506, Control No. 95/001,926, mailed August 16, 2013, 11 pages.	
	NPL829	Inter Partes Reexamination Certificate in Inter Partes Reexamination of U.S. Patent No. 7,415,530, Control No. 95/001,927, issued August 16, 2013, 2 pages.	
	NPL830	Right of Appeal Notice in Inter Partes Reexamination of U.S. Patent No. 7,378,992, Control No. 95/001,928, mailed August 16, 2013, 11 pages.	
	NPL831	Right of Appeal Notice in Inter Partes Reexamination of U.S. Patent No. 7,352,300, Control No. 95/001,925, mailed August 29, 2013, 23 pages.	
	NPL832	Action Closing Prosecution in Inter Partes Reexamination of U.S. Patent No. 7,395,345, Control No. 95/001,925, mailed September 20, 2013, 47 pages.	
	NPL833	Decision on Petition(s) Decided Under 37 C.F.R. 1.181 in Inter Partes Reexamination of U.S. Patent No. 7,714,747, Control No. 95/001,517, mailed September 23, 2013, 3 pages.	

Examiner Signature		Date Considered	
-----------------------	--	--------------------	--

\*EXAMINER: Initial if reference considered, whether or not citation is in conformance with MPEP 609. Draw line through citation if not in conformance and not considered. Include copy of this form with next communication to applicant.

<sup>1</sup> Applicant's unique citation designation number (optional). <sup>2</sup> Applicant is to place a check mark here if English language Translation is attached.

Substitute for form 1449/PTO			<b>Complete if Known</b>	
<b>INFORMATION DISCLOSURE STATEMENT BY APPLICANT</b> <i>(Use as many sheets as necessary)</i>			Application Number	14/135,926
			Filing Date	December 19, 2013
			First Named Inventor	FALLON et al.
			Art Unit	2634
			Examiner Name	BOCURE, Tesfaldet
			Attorney Docket Number	2855.0050008
Sheet	93	of	97	

NON PATENT LITERATURE DOCUMENTS			
Examiner Initials*	Cite No. <sup>1</sup>	Include name of the author (in CAPITAL LETTERS), title of the article (when appropriate), title of the item (book, magazine, journal, serial, symposium, catalog, etc.), date, page(s), volume number, publisher, city and/or country where published	T <sup>2</sup>
	NPL834	Action Closing Prosecution in Inter Partes Reexamination of U.S. Patent No. 6,604,158, Control No. 95/001,923, mailed October 2, 2013, 18 pages.	
	NPL835	Patent Owner's Reply to Action Closing Prosecution of September 20, 2013 in Inter Partes Reexamination of U.S. Patent No. 7,395,345, Control No. 95/001,925, filed October 21, 2013, 9 pages.	
	NPL836	Decision on Appeal in Inter Partes Reexamination of U.S. Patent No. 7,417,568, Control No. 95/001,533, mailed November 1, 2013, 18 pages.	
	NPL837	Decision on Appeal in Inter Partes Reexamination of U.S. Patent No. 7,400,274, Control No. 95/001,544, mailed November 1, 2013, 12 pages.	
	NPL838	Decision on Appeal in Inter Partes Reexamination of U.S. Patent No. 7,777,651, Control No. 95/001,581, mailed November 1, 2013, 15 pages.	
	NPL839	Patent Owner's Reply to Action Closing Prosecution of October 2, 2013 in Inter Partes Reexamination of U.S. Patent No. 6,604,158, Control No. 95/001,923, filed November 4, 2013, 9 pages.	
	NPL840	Notice of Intent to Issue A Reexam Certificate in Inter Partes Reexamination of U.S. Patent No. 7,321,937, Control No. 95/001,922, mailed November 13, 2013, 8 pages.	
	NPL841	Copy of Supplemental Notice of Allowability for U.S. Appl. No. 13/154,211, mailed November 26, 2013, 4 pages.	
	NPL842	Copy of Notice of Allowance for U.S. Appl. No. 13/101,994, mailed December 2, 2013, 7 pages.	
	NPL843	Copy of Notice of Allowance for U.S. Appl. No. 11/553,419, mailed December 18, 2013, 6 pages.	

Examiner Signature		Date Considered	
-----------------------	--	--------------------	--

\*EXAMINER: Initial if reference considered, whether or not citation is in conformance with MPEP 609. Draw line through citation if not in conformance and not considered. Include copy of this form with next communication to applicant.

<sup>1</sup> Applicant's unique citation designation number (optional). <sup>2</sup> Applicant is to place a check mark here if English language Translation is attached.

Substitute for form 1449/PTO			<b>Complete if Known</b>	
<b>INFORMATION DISCLOSURE STATEMENT BY APPLICANT</b> <i>(Use as many sheets as necessary)</i>			Application Number	14/135,926
			Filing Date	December 19, 2013
			First Named Inventor	FALLON et al.
			Art Unit	2634
			Examiner Name	BOCURE, Tesfaldet
			Attorney Docket Number	2855.0050008
			Sheet	94

NON PATENT LITERATURE DOCUMENTS			
Examiner Initials*	Cite No. <sup>1</sup>	Include name of the author (in CAPITAL LETTERS), title of the article (when appropriate), title of the item (book, magazine, journal, serial, symposium, catalog, etc.), date, page(s), volume number, publisher, city and/or country where published	T <sup>2</sup>
	NPL844	Copy of Supplemental Notice of Allowability for U.S. Appl. No. 13/154,211, mailed December 19, 2013, 4 pages.	
	NPL845	Copy of Non-Final Office Action for U.S. Appl. No. 14/035,716, mailed December 20, 2013, 12 pages.	
	NPL846	Copy of Notice of Allowance for U.S. Appl. No. 14/035,712, mailed December 20, 2013, 8 pages.	
	NPL847	Copy of Non-Final Office Action for U.S. Appl. No. 14/035,719, mailed December 20, 2013, 11 pages.	
	NPL848	Copy of Final Office Action for U.S. Appl. No. 12/690,125, mailed December 27, 2013, 12 pages.	
	NPL849	Copy of Corrected Notice of Allowability for U.S. Appl. No. 11/553,419, mailed January 14, 2014, 2 pages.	
	NPL850	Copy of Notice of Allowance for U.S. Appl. No. 14/035,561, mailed January 16, 2014, 9 pages.	
	NPL851	Notice of Intent to Issue an Inter Partes Reexamination Certificate in Inter Partes Reexamination of U.S. Patent No. 7,378,992, Control No. 95/001,928, mailed November 21, 2013, 10 pages.	
	NPL852	Notice of Intent to Issue an Inter Partes Reexamination Certificate in Inter Partes Reexamination of U.S. Patent No. 7,161,506, Control No. 95/001,926, mailed November 27, 2013, 10 pages.	
	NPL853	Patent Owner's Request to Reopen Prosecution Before the Examiner under 37 C.F.R. § 41.77(b) in Inter Partes Reexamination of U.S. Patent No. 7,417,568, Control No. 95/001,533, filed December 2, 2013, 41 pages.	

Examiner Signature		Date Considered	
-----------------------	--	--------------------	--

\*EXAMINER: Initial if reference considered, whether or not citation is in conformance with MPEP 609. Draw line through citation if not in conformance and not considered. Include copy of this form with next communication to applicant.

<sup>1</sup> Applicant's unique citation designation number (optional). <sup>2</sup> Applicant is to place a check mark here if English language Translation is attached.

Substitute for form 1449/PTO			<b>Complete if Known</b>	
<b>INFORMATION DISCLOSURE STATEMENT BY APPLICANT</b> <i>(Use as many sheets as necessary)</i>			Application Number	14/135,926
			Filing Date	December 19, 2013
			First Named Inventor	FALLON et al.
			Art Unit	2634
			Examiner Name	BOCURE, Tesfaldet
			Attorney Docket Number	2855.0050008
Sheet	95	of	97	

NON PATENT LITERATURE DOCUMENTS			
Examiner Initials*	Cite No. <sup>1</sup>	Include name of the author (in CAPITAL LETTERS), title of the article (when appropriate), title of the item (book, magazine, journal, serial, symposium, catalog, etc.), date, page(s), volume number, publisher, city and/or country where published	T <sup>2</sup>
	NPL854	Patent Owner's Request to Reopen Prosecution Before the Examiner under 37 C.F.R. § 41.77(b) in Inter Partes Reexamination of U.S. Patent No. 7,777,651, Control No. 95/001,581, filed December 2, 2013, 57 pages.	
	NPL855	Patent Owner's Request to Reopen Prosecution Before the Examiner under 37 C.F.R. § 41.77(b) in Inter Partes Reexamination of U.S. Patent No. 7,400,274, Control No. 95/001,544, filed December 2, 2013, 33 pages.	
	NPL856	Inter Partes Reexamination Certificate in Inter Partes Reexamination of U.S. Patent No. 7,321,937, Control No. 95/001,922, mailed December 5, 2013, 2 pages.	
	NPL857	Patent Owner's Petition Under 37 C.F.R. § 1.182 in Opposition to CME Group's Petition to Strike Patent Owner's Proposed New Claims, in Inter Partes Reexamination of U.S. Patent No. 7,417,568, Control No. 95/001,533, mailed January 2, 2014, 8 pages.	
	NPL858	Patent Owner's Petition Under 37 C.F.R. § 1.182 in Opposition to CME Group's Petition to Strike Patent Owner's Proposed New Claims, in Inter Partes Reexamination of U.S. Patent No. 7,400,274, Control No. 95/001,544, mailed January 2, 2014, 8 pages.	
	NPL859	Patent Owner's Petition Under 37 C.F.R. § 1.182 in Opposition to CME Group's Petition to Strike Patent Owner's Proposed New Claims, in Inter Partes Reexamination of U.S. Patent No. 7,777,651, Control No. 95/001,581, mailed January 2, 2014, 10 pages.	
	NPL860	Inter Partes Reexamination Certificate in Inter Partes Reexamination of U.S. Patent No. 7,161,506, Control No. 95/001,926, mailed January 8, 2014, 2 pages.	
	NPL861	Inter Partes Reexamination Certificate in Inter Partes Reexamination of U.S. Patent No. 7,378,992, Control No. 95/001,928, mailed January 8, 2014, 3 pages.	
	NPL862	Examiner's Determination Under 37 C.F.R. § 41.77(d) in Inter Partes Reexamination of U.S. Patent No. 7,714,747, Control No. 95/001,517, mailed January 14, 2014, 11 pages.	
	NPL863	Patent Owner's Petition Under 37 C.F.R. § 1.181 to Strike Third Party Requester's Improper Response Under 37 C.F.R. § 41.77(c), in Inter Partes Reexamination of U.S. Patent No. 7,417,568, Control No. 95/001,533, mailed January 22, 2014, 3 pages.	

Examiner Signature	Date Considered	
--------------------	-----------------	--

\*EXAMINER: Initial if reference considered, whether or not citation is in conformance with MPEP 609. Draw line through citation if not in conformance and not considered. Include copy of this form with next communication to applicant.  
<sup>1</sup> Applicant's unique citation designation number (optional). <sup>2</sup> Applicant is to place a check mark here if English language Translation is attached.

Substitute for form 1449/PTO				<b>Complete if Known</b>	
<b>INFORMATION DISCLOSURE STATEMENT BY APPLICANT</b> <i>(Use as many sheets as necessary)</i>				Application Number	14/135,926
				Filing Date	December 19, 2013
				First Named Inventor	FALLON et al.
				Art Unit	2634
				Examiner Name	BOCURE, Tesfaldet
				Attorney Docket Number	2855.0050008
Sheet	96	of	97		

NON PATENT LITERATURE DOCUMENTS			
Examiner Initials*	Cite No. <sup>1</sup>	Include name of the author (in CAPITAL LETTERS), title of the article (when appropriate), title of the item (book, magazine, journal, serial, symposium, catalog, etc.), date, page(s), volume number, publisher, city and/or country where published	T <sup>2</sup>
	NPL864	Patent Owner's Petition Under 37 C.F.R. § 1.181 to Strike Third Party Requester's Improper Response Under 37 C.F.R. § 41.77(c), in Inter Partes Reexamination of U.S. Patent No. 7,400,274, Control No. 95/001,544, mailed January 22, 2014, 3 pages.	
	NPL865	Patent Owner's Petition Under 37 C.F.R. § 1.181 to Strike Third Party Requester's Improper Response Under 37 C.F.R. § 41.77(c), in Inter Partes Reexamination of U.S. Patent No. 7,777,651, Control No. 95/001,581, mailed January 22, 2014, 3 pages.	
	NPL866	Patent Owner's Petition Under 37 C.F.R. § 1.181 to Strike Third Party Requester's Improper Response Under 37 C.F.R. § 1.132, in Inter Partes Reexamination of U.S. Patent No. 7,417,568, Control No. 95/001,533, mailed January 22, 2014, 3 pages.	
	NPL867	Patent Owner's Petition Under 37 C.F.R. § 1.181 to Strike Third Party Requester's Improper Response Under 37 C.F.R. § 1.132, in Inter Partes Reexamination of U.S. Patent No. 7,400,274, Control No. 95/001,544, mailed January 22, 2014, 3 pages.	
	NPL868	Patent Owner's Petition Under 37 C.F.R. § 1.181 to Strike Third Party Requester's Improper Response Under 37 C.F.R. § 1.132, in Inter Partes Reexamination of U.S. Patent No. 7,777,651, Control No. 95/001,581, mailed January 22, 2014, 3 pages.	
	NPL869	Court Docket History for 6:10-cv-00493-LED-JDL, Realtime Data, LLC d/b/a IXO, v. T-Mobile, USA Inc., downloaded January 30, 2014, 78 pages.	
	NPL870	Court Docket History for 1:11-cv-06696-RJH, Realtime Data, LLC d/b/a IXO, v. Morgan Stanley et al., downloaded January 30, 2014, 80 pages.	
	NPL871	Court Docket History for 1:11-cv-06697-UA, Realtime Data, LLC d/b/a IXO, v. CME Group Inc. et al., downloaded January 30, 2014, 105 pages.	
	NPL872	Court Docket History for 1:11-cv-06698-UA, Realtime Data, LLC d/b/a IXO, v. Thomson Reuters et al., downloaded January 30, 2014, 59 pages.	
	NPL873	Opinion, with Errata, filed in Realtime Data, LLC d/b/a IXO v. Morgan Stanley, et al., Case Nos. 13-1092, -1093, -1095, -1097, -1098, -1099, -1100, -1101, and -1103, United States Court of Appeals for the Federal Circuit, filed January 27, 2014, 41 pages.	

Examiner Signature		Date Considered	
-----------------------	--	--------------------	--

\*EXAMINER: Initial if reference considered, whether or not citation is in conformance with MPEP 609. Draw line through citation if not in conformance and not considered. Include copy of this form with next communication to applicant.  
<sup>1</sup> Applicant's unique citation designation number (optional). <sup>2</sup> Applicant is to place a check mark here if English language Translation is attached.







US007161506C2

(12) **INTER PARTES REEXAMINATION CERTIFICATE (784th)**

**United States Patent**

**Fallon**

(10) **Number:** **US 7,161,506 C2**

(45) **Certificate Issued:** **\*Jan. 8, 2014**

(54) **SYSTEM AND METHODS FOR DATA COMPRESSION SUCH AS CONTENT DEPENDENT DATA COMPRESSION**

(75) Inventor: **James J. Fallon**, Armonk, NY (US)

(73) Assignee: **Realtime Data, LLC**, New York, NY (US)

(51) **Int. Cl.**  
**H03M 7/34** (2006.01)

(52) **U.S. Cl.**  
USPC ..... **341/51; 341/79**

(58) **Field of Classification Search**  
None  
See application file for complete search history.

**Reexamination Request:**  
No. 95/001,926, Mar. 2, 2012

**Reexamination Certificate for:**  
Patent No.: **7,161,506**  
Issued: **Jan. 9, 2007**  
Appl. No.: **10/668,768**  
Filed: **Sep. 22, 2003**

Reexamination Certificate C1 7,161,506 issued May 22, 2012

(\* ) Notice: This patent is subject to a terminal disclaimer.

**Related U.S. Application Data**

(63) Continuation of application No. 10/016,355, filed on Oct. 29, 2010, now Pat. No. 6,624,761, which is a continuation-in-part of application No. 09/705,446, filed on Nov. 3, 2000, now Pat. No. 6,309,424, which is a continuation of application No. 09/210,491, filed on Dec. 11, 1998, now Pat. No. 6,195,024.

(56) **References Cited**

To view the complete listing of prior art documents cited during the proceeding for Reexamination Control Number 95/001,926, please refer to the USPTO's public Patent Application Information Retrieval (PAIR) system under the Display References tab.

*Primary Examiner* — Christina Y Leung

(57) **ABSTRACT**

Systems and methods for providing fast and efficient data compression using a combination of content independent data compression and content dependent data compression. In one aspect, a method for compressing data comprises the steps of: analyzing a data block of an input data stream to identify a data type of the data block, the input data stream comprising a plurality of disparate data types; performing content dependent data compression on the data block; if the data type of the data block is identified; performing content independent data compression on the data block, if the data type of the data block is not identified.

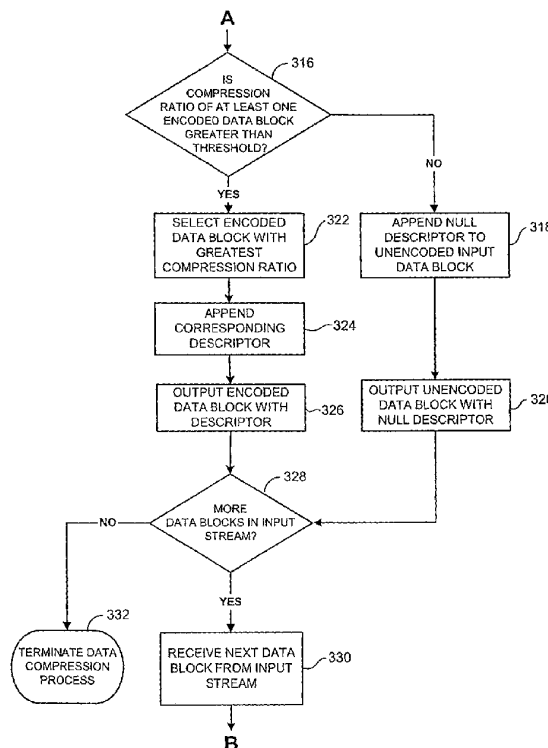

**INTER PARTES  
REEXAMINATION CERTIFICATE  
ISSUED UNDER 35 U.S.C. 316**

THE PATENT IS HEREBY AMENDED AS  
INDICATED BELOW.

**Matter enclosed in heavy brackets [ ] appeared in the patent, but has been deleted and is no longer a part of the patent; matter printed in italics indicates additions made to the patent.**

AS A RESULT OF REEXAMINATION, IT HAS BEEN DETERMINED THAT:

Claims 1-5, 8, 9, 11, 17, 20-23, 27, 39, 43, 69-73, 79, 81, 82, 84-90, 96 and 98 were previously cancelled.

Claims 91, 97 and 99 are determined to be patentable as amended.

New claims 100-105 are added and determined to be patentable.

Claims 6, 7, 10, 12-16, 18, 19, 24-26, 28-38, 40-42, 44-68, 74-78, 80, 83 and 92-95 were not reexamined.

91. The method of claim 86, further comprising:  
compressing said data block to provide said data block in said compressed form in accordance with said determination whether to compress said data block with content dependent data compression or said single data compression encoder, wherein said data block in said compressed form is provided by a lossy compression technique; and

*analyzing data within the data block to identify one or more data types of the data within the data block, wherein the analyzing of the data within the data block to identify one or more data types excludes analyzing based only on a descriptor that is indicative of the data type of the data within the data block.*

97. The method of claim 86, further comprising:  
*analyzing data within the data block to identify one or more data types of the data within the data block, wherein the analyzing of the data within the data block to identify one or more data types excludes analyzing based only on a descriptor that is indicative of the data type of the data within the data block, and wherein said single data compression encoder is lossless and at least one encoder associated with said content dependent data compression is lossy.*

99. The method of claim 86, further comprising:  
*analyzing within the data block to identify one or more data types of the data within the data block, wherein the analyzing of the data within the data block to identify one or more data types excludes analyzing based only on a descriptor that is indicative of the data type of the data within the data block, and wherein said single data compression encoder is lossless, at least one encoder associated with said content dependent data compression is lossless, and at least another one encoder associated with said content dependent data compression is lossy.*

100. A computer implemented method comprising:  
*receiving, a data block, wherein the data block is included in a data stream;  
analyzing data within the data block to identify one or more data types of the data within the data block;*

*determining whether to output said data block in received form or in a compressed form; and  
outputting the data block in received form or the compressed form based on the determination,*

5 *wherein outputting the data block in the compressed form comprises determining whether to compress the data block with a content dependent data compression encoder based on the type of the data block or to compress the data block with a single data compression encoder; and*

10 *wherein the analyzing of the data within the data block to identify one or more data types excludes analyzing based only on a descriptor that is indicative of the data type of the data within the data block.*

15 *101. The computer implemented method of claim 100, further comprising:*

*compressing the data block to provide the data block in the compressed form in accordance with the determination whether to compress the data block with a content dependent data compression encoder or the single data compression encoder, wherein the data block is compressed using a lossy compression encoder.*

20 *102. The computer implemented method of claim 100, wherein the single data compression encoder is lossless and at least one encoder associated with the content dependent data compression is lossy.*

25 *103. The computer implemented method of claim 100, wherein the single data compression encoder is lossless, at least one encoder associated with the content dependent data compression is lossless, and at least another one encoder associated with the content dependent data compression is lossy.*

30 *104. A computer implemented method for compressing data, comprising:*

*analyzing data within a data block of an input data stream to identify one or more data types of the data block, the input data stream comprising a plurality of disparate data types;*

35 *performing content dependent data compression with a content dependent data compression encoder if a data type of the data block is identified; and  
performing data compression with a single data compression encoder, if a data type of the data block is not identified,*

40 *wherein the analyzing of the data within the data block to identify one or more data types excludes analyzing based only on a descriptor that is indicative of the data type of the data within the data block.*

45 *105. A computer implemented method comprising:  
receiving a data block in an uncompressed form, said data block being included in a data stream;  
analyzing data within the data block to determine a type of said data block; and*

50 *compressing said data block to provide a compressed data block,  
wherein if one or more encoders are associated to said type, compressing said data block with at least one of said one or more encoders, otherwise compressing said data block with a default data compression encoder, and  
wherein the analyzing of the data within the data block to identify one or more data types excludes analyzing based only on a descriptor that is indicative of the data type of the data within the data block.*

\* \* \* \* \*



US007378992C2

(12) **INTER PARTES REEXAMINATION CERTIFICATE (785th)**

**United States Patent**

**Fallon**

(10) **Number:** **US 7,378,992 C2**

(45) **Certificate Issued:** **\*Jan. 8, 2014**

(54) **CONTENT INDEPENDENT DATA  
COMPRESSION METHOD AND SYSTEM**

(75) Inventor: **James J. Fallon**, Armonk, NY (US)

(73) Assignee: **Realtime Data, LLC**, New York, NY (US)

(51) **Int. Cl.**  
**H03M 7/34** (2006.01)

(52) **U.S. Cl.**  
USPC ..... **341/51; 341/65; 341/67; 341/87**

(58) **Field of Classification Search**  
None  
See application file for complete search history.

**Reexamination Request:**  
No. 95/001,928, Mar. 2, 2012

**Reexamination Certificate for:**  
Patent No.: **7,378,992**  
Issued: **May 27, 2008**  
Appl. No.: **11/400,533**  
Filed: **Apr. 8, 2006**

Reexamination Certificate C1 7,378,992 issued Oct. 4, 2012

(\*) Notice: This patent is subject to a terminal disclaimer.

**Related U.S. Application Data**

(63) Continuation of application No. 10/668,768, filed on Sep. 22, 2003, now Pat. No. 7,161,506, which is a continuation of application No. 10/016,355, filed on Oct. 29, 2001, now Pat. No. 6,624,761, which is a continuation-in-part of application No. 09/705,446, filed on Nov. 3, 2000, now Pat. No. 6,309,424, which is a continuation of application No. 09/210,491, filed on Dec. 11, 1998, now Pat. No. 6,195,024.

(56) **References Cited**

To view the complete listing of prior art documents cited during the proceeding for Reexamination Control Number 95/001,928, please refer to the USPTO's public Patent Application Information Retrieval (PAIR) system under the Display References tab.

*Primary Examiner* — Christina Y Leung

(57) **ABSTRACT**

Systems and methods for providing fast and efficient data compression using a combination of content independent data compression and content dependent data compression. In one aspect, a method for compressing data comprises the steps of: analyzing a data block of an input data stream to identify a data type of the data block, the input data stream comprising a plurality of disparate data types; performing content dependent data compression on the data block, if the data type of the data block is identified, performing content independent data compression on the data block, if the data type of the data block is not identified.

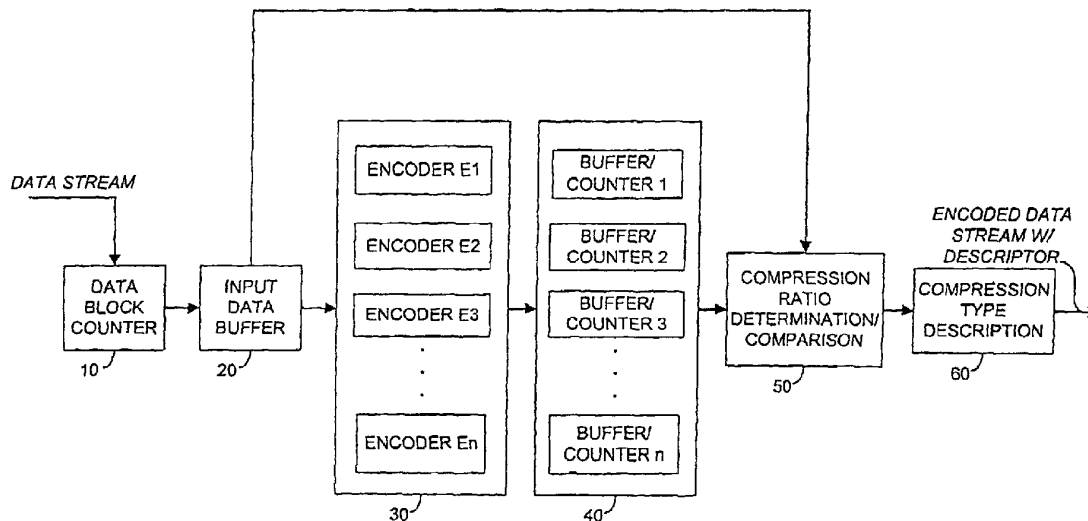

**1**  
**INTER PARTES**  
**REEXAMINATION CERTIFICATE**  
**ISSUED UNDER 35 U.S.C. 316**

THE PATENT IS HEREBY AMENDED AS  
INDICATED BELOW.

**Matter enclosed in heavy brackets [ ] appeared in the patent, but has been deleted and is no longer a part of the patent; matter printed in italics indicates additions made to the patent.**

AS A RESULT OF REEXAMINATION, IT HAS BEEN DETERMINED THAT:

Claims 1, 3, 7, 9-15, 18-21, 26-29, 32, 33 and 36 were previously cancelled.

Claim 35 is determined to be patentable as amended.

New claims 46-51 are added and determined to be patentable.

Claims 2, 4, 5, 6, 8, 16, 17, 22-25, 30, 31, 34 and 37-45 were not reexamined.

35. The method of claim 33, [wherein the size of said data block is variable] further comprising:

*analyzing data within the data block to identify one or more data types of the data within the data block, wherein the analyzing of the data within the data block to identify one or more data types excludes analyzing based only on a descriptor that is indicative of the data type of the data within the data block.*

46. A computer implemented method comprising: receiving a data block; analyzing data within the data block to determine whether or not a data type is identified for the data within the data block;

*compressing, if said data type is identified, said data block with at least one encoder associated with said data type to provide a compressed data block;*

*compressing, if said data type is not identified, said data block with at least one encoder associated with a non-identifiable data type to provide said compressed data block; and*

*storing said compressed data block; wherein the analyzing of the data within the data block to identify one or more data types excludes analyzing based only on a descriptor that is indicative of the data type of the data within the data block.*

47. A computer implemented method comprising: receiving a data block; analyzing data within the data block to determine whether or not a data type is identified for the data within the data block;

*compressing, if said data type is identified, said data block with at least one encoder associated with said data type to provide a compressed data block;*

*compressing, if said data type is not identified, said data block with at least one encoder associated with a non-identifiable data type to provide said compressed data block;*

*storing said compressed data block; transmitting a data compression type descriptor, indicative of the compression utilized to provide said compressed data block, with said compressed data block;*

*receiving said compressed data block and said data compression type descriptor; and*

**2**

*decompressing said compressed data block based on said data compression type descriptor;*

*wherein the analyzing of the data within the data block to identify one or more data types excludes analyzing based only on a descriptor that is indicative of the data type of the data within the data block.*

48. A computer implemented method comprising: receiving a data block;

*associating at least one encoder to each one of several data types;*

*analyzing data within the data block to identify a first data type of the data within the data block;*

*compressing, if said first data type is the same as one of said several data types, said data block with said at least one encoder associated with said one of said several data types that is the same as said first data type to provide a compressed data block; and*

*compressing, if said first data type is not the same as one of said several data types, said data block with a default encoder to provide said compressed data block,*

*wherein the analyzing of the data within the data block to identify one or more data types excludes analyzing based only on a descriptor that is indicative of the data type of the data within the data block.*

49. A computer implemented method comprising: receiving a data block;

*associating at least one encoder to each one of several data types;*

*analyzing data within the data block to identify a first data type of the data within the data block;*

*compressing, if said first data type is the same as one of said several data types, said data block with said at least one encoder associated with said one of said several data types that is the same as said first data type to provide a compressed data block;*

*compressing, if said first data type is not the same as one of said several data types, said data block with a default encoder to provide said compressed data block;*

*transmitting a data compression type descriptor, indicative of the compression utilized to provide said compressed data block, with said compressed data block;*

*receiving said compressed data block and said data compression type descriptor; and*

*decompressing said compressed data block based on said data compression type descriptor;*

*wherein the analyzing of the data within the data block to identify one or more data types excludes analyzing based only on a descriptor that is indicative of the data type of the data within the data block.*

50. A computer implemented method comprising:

*associating a first encoder to a first data type;*

*associating a second encoder to a second data type;*

*receiving a data block;*

*analyzing data within the data block to determine a data type of the data within the data block;*

*compressing said data block with said first encoder if said data type is the same as said first data type;*

*compressing said data block with said second encoder if said data type is the same as said second data type; and compressing said data block with a third encoder if said data type cannot be identified,*

*wherein the analyzing of the data within the data block to identify one or more data types excludes analyzing based only on a descriptor that is indicative of the data type of the data within the data block.*

51. A computer implemented method comprising:  
 associating at least one of several first encoders to each  
 one of several data types;  
 associating at least one second encoder to a non-identifi-  
 cable data type; 5  
 receiving a data block from an input stream of data;  
 analyzing data within the data block to determine whether  
 a data type is identified for the data within the data  
 block;  
 compressing, if a data type is identified as being associated 10  
 with said at least one of several first encoders, said data  
 block with said at least one of several first encoders  
 associated with said data type to provide a compressed  
 data block;  
 compressing, if a data type is not identified, said data block 15  
 with said at least one second encoder to provide said  
 compressed data block; and  
 transmitting said compressed data block with a data com-  
 pression type descriptor indicative of the compression  
 utilized to provide said compressed data block, 20  
 wherein the analyzing of the data within the data block to  
 identify one or more data types excludes analyzing  
 based only on a descriptor that is indicative of the data  
 type of the data within the data block.

\* \* \* \* \*

25

## Electronic Acknowledgement Receipt

<b>EFS ID:</b>	18190605
<b>Application Number:</b>	14134926
<b>International Application Number:</b>	
<b>Confirmation Number:</b>	7069
<b>Title of Invention:</b>	SYSTEM AND METHODS FOR VIDEO AND AUDIO DATA DISTRIBUTION
<b>First Named Inventor/Applicant Name:</b>	James J. FALLON
<b>Customer Number:</b>	26111
<b>Filer:</b>	Michael V. Messinger/William Flanigen
<b>Filer Authorized By:</b>	Michael V. Messinger
<b>Attorney Docket Number:</b>	2855.0050008
<b>Receipt Date:</b>	12-FEB-2014
<b>Filing Date:</b>	19-DEC-2013
<b>Time Stamp:</b>	17:38:19
<b>Application Type:</b>	Utility under 35 USC 111(a)

### Payment information:

Submitted with Payment	no
------------------------	----

### File Listing:

Document Number	Document Description	File Name	File Size(Bytes)/ Message Digest	Multi Part /.zip	Pages (if appl.)
1		28550050008_IDS.pdf	25154119 <small>e054623291f9fc816335a5576885a24b5781b5a4</small>	yes	139

Multipart Description/PDF files in .zip description					
Document Description			Start	End	
Miscellaneous Incoming Letter			1	2	
Transmittal Letter			3	13	
Information Disclosure Statement (IDS) Form (SB08)			14	139	
<b>Warnings:</b>					
<b>Information:</b>					
2	Non Patent Literature	NPL841_Suppl_NOA_13154211_11262013.pdf	144975 45bba208cf2aaf779c49de5b4860ff0aac4c8a63	no	4
<b>Warnings:</b>					
<b>Information:</b>					
3	Non Patent Literature	NPL842_NOA_13101994_12022013.pdf	353951 2bc183acb7b13bf167b552efdb15d39a20dde672	no	7
<b>Warnings:</b>					
<b>Information:</b>					
4	Non Patent Literature	NPL843_NOA_11553419_12182013.pdf	367164 03d842fe7f63293c025a9f2d4e2ed42d3eb93a63	no	6
<b>Warnings:</b>					
<b>Information:</b>					
5	Non Patent Literature	NPL844_SNOA_13154211_12192013.pdf	142681 19b97720028a74102177c811657906d98ff6313e	no	4
<b>Warnings:</b>					
<b>Information:</b>					
6	Non Patent Literature	NPL845_NFOA_14035716_12202013.pdf	467371 8edd163a56abc0425585c8eeea01ef8e37ac18b1	no	12
<b>Warnings:</b>					
<b>Information:</b>					
7	Non Patent Literature	NPL846_NOA_14035712_12202013.pdf	420186 d524fb01979039f93c7728b0ae7bb8ebffbf51fef	no	8
<b>Warnings:</b>					
<b>Information:</b>					
8	Non Patent Literature	NPL847_NFOA_14035719_12202013.pdf	421462 5214663838ea435d1b170cda2fe21c167b7103af	no	11
<b>Warnings:</b>					



<b>Information:</b>					
9	Non Patent Literature	NPL848_FOA_12690125_12272013.pdf	473761 13fbc242e28286e060a94a64ba9fce0231fd836f	no	12
<b>Warnings:</b>					
<b>Information:</b>					
10	Non Patent Literature	NPL849_Corrected_Notice_of_Allowability_11553419_01142014.pdf	81773 5f298ada6e96a054614761f32074273c8dadad65	no	2
<b>Warnings:</b>					
<b>Information:</b>					
11	Non Patent Literature	NPL850_NOA_14035561_01162014.pdf	472710 04b935a329b9cd72295d4b56aee8078d7f9e9e65	no	9
<b>Warnings:</b>					
<b>Information:</b>					
12	Non Patent Literature	NPL851_NIIRC_95001928_11212013.pdf	433755 85016735b146496754f31a9c141f4ef483eb5b06	no	10
<b>Warnings:</b>					
<b>Information:</b>					
13	Non Patent Literature	NPL852_NIIRC_95001926_11272013.pdf	369893 b60d355a717feb7aca6c8efdeff9a0e8828f6c26	no	10
<b>Warnings:</b>					
<b>Information:</b>					
14	Non Patent Literature	NPL853_PO_Request_to_Reopen_Prosecution_95001533_12022013.pdf	2635287 b4a7fe67db7bb764354ad091c3039421edadb1	no	41
<b>Warnings:</b>					
<b>Information:</b>					
15	Non Patent Literature	NPL854_PO_Request_to_Reopen_Prosecution_95001581_12022013.pdf	3818680 ae37e0f11dcae17bb3f9038a85bcde04f6580454	no	57
<b>Warnings:</b>					
<b>Information:</b>					
16	Non Patent Literature	NPL855_PO_Request_to_Reopen_Prosecution_95001544_12022013.pdf	2020684 3d2ebacd0749ea09a6e32bc7efa004470fa12d0	no	33
<b>Warnings:</b>					
<b>Information:</b>					
17	Non Patent Literature	NPL856_Reexam_Certificate_95001922_12052013.pdf	67289 f38744efe2a88f20a745f902c5ea6726d972c57a	no	2
<b>Warnings:</b>					

<b>Information:</b>					
18	Non Patent Literature	NPL857_PO_Petition_9500153_3_01022014.pdf	413963 69d97556181aa7a7771f131246c9f8f98c42920d	no	8
<b>Warnings:</b>					
<b>Information:</b>					
19	Non Patent Literature	NPL858_PO_Petition_9500154_4_01022014.pdf	489952 e0ecf85b4ec041c9372d2146ecf43802158ffc58	no	8
<b>Warnings:</b>					
<b>Information:</b>					
20	Non Patent Literature	NPL859_PO_Petition_9500158_1_01022014.pdf	602107 4762c199c04d7016fe13e0166520b71bb7a174bc	no	10
<b>Warnings:</b>					
<b>Information:</b>					
21	Non Patent Literature	NPL860_Reexam_Certificate_95001926_01082014.pdf	161501 da796f2645c268f2e48995515f84ad0295dc7792	no	2
<b>Warnings:</b>					
<b>Information:</b>					
22	Non Patent Literature	NPL861_Reexam_Certificate_95001928_01082014.pdf	186439 9dc3f5e7a4589d8d5349d9a59ac0badf5bac9b86	no	3
<b>Warnings:</b>					
<b>Information:</b>					
23	Non Patent Literature	NPL862_Examiners_Determination_95001517_01142014.pdf	430915 4e90804f15bb2f36ca8354bc75c7f22af0e533eb	no	11
<b>Warnings:</b>					
<b>Information:</b>					
24	Non Patent Literature	NPL863_PO_Petition_1_95001533_01222014.pdf	180700 64dea460e6a026800900e78d8740ab3504905a84	no	3
<b>Warnings:</b>					
<b>Information:</b>					
25	Non Patent Literature	NPL864_PO_Petition_1_95001544_01222014.pdf	168213 70351bce1472f47e7c4f3cc8468cf49b71f953f9	no	3
<b>Warnings:</b>					
<b>Information:</b>					
26	Non Patent Literature	NPL865_PO_Petition_1_95001581_01222014.pdf	139339 fb0203c32a43ccdb85be279c7a478a9f1a8bf664	no	3
<b>Warnings:</b>					

<b>Information:</b>					
27	Non Patent Literature	NPL866_PO_Petition_2_95001 533_01222014.pdf	165413 174419facd0ccc5908e03d9ce9649a81408e2a5	no	3
<b>Warnings:</b>					
<b>Information:</b>					
28	Non Patent Literature	NPL867_PO_Petition_2_95001 544_01222014.pdf	146892 8fb4c97282863132a65885fc96bc8a183ccb8e8a5	no	3
<b>Warnings:</b>					
<b>Information:</b>					
29	Non Patent Literature	NPL868_PO_Petition_2_95001 581_01222014.pdf	126169 80e1c8842bfcaaf1e673d628094778edccdd0acab	no	3
<b>Warnings:</b>					
<b>Information:</b>					
30	Non Patent Literature	NPL869_MetroPCS_Court_Docket_Listing_01302014.pdf	614866 9c803dca7ad3d225e6f1045a23c4db047ceafc3c	no	78
<b>Warnings:</b>					
<b>Information:</b>					
31	Non Patent Literature	NPL870_Morgan_Stanley_Court_Docket_Listing_01302014.pdf	976198 1f3f5f9484e03f7995dc3655863a7b173687e6d5	no	80
<b>Warnings:</b>					
<b>Information:</b>					
32	Non Patent Literature	NPL871_CME_Court_Docket_Listing_01302014.pdf	783350 c1ffa6fc6df0d16686ae07a9f4c71212413fefed	no	105
<b>Warnings:</b>					
<b>Information:</b>					
33	Non Patent Literature	NPL872_Thompson_Reuters_Court_Docket_Listing_01302014.pdf	772832 5769c695e5531cda945fd4c13f0ebc6e669b4368	no	59
<b>Warnings:</b>					
<b>Information:</b>					
34	Non Patent Literature	NPL873_CAF_C_Opinion_with_Errata_01272014.pdf	280049 9cecff362f26c5d3e56c906207acc4687c95094	no	41
<b>Warnings:</b>					
<b>Information:</b>					
35	Non Patent Literature	NPL874_Corrected_Notice_of-Allowability_11553419_01312014.pdf	81748 199f74a63cd124d861144130eff61d98d68b6d3a	no	2
<b>Warnings:</b>					

<b>Information:</b>	
<b>Total Files Size (in bytes):</b>	44566387
<p><b>This Acknowledgement Receipt evidences receipt on the noted date by the USPTO of the indicated documents, characterized by the applicant, and including page counts, where applicable. It serves as evidence of receipt similar to a Post Card, as described in MPEP 503.</b></p> <p><b><u>New Applications Under 35 U.S.C. 111</u></b>  <b>If a new application is being filed and the application includes the necessary components for a filing date (see 37 CFR 1.53(b)-(d) and MPEP 506), a Filing Receipt (37 CFR 1.54) will be issued in due course and the date shown on this Acknowledgement Receipt will establish the filing date of the application.</b></p> <p><b><u>National Stage of an International Application under 35 U.S.C. 371</u></b>  <b>If a timely submission to enter the national stage of an international application is compliant with the conditions of 35 U.S.C. 371 and other applicable requirements a Form PCT/DO/EO/903 indicating acceptance of the application as a national stage submission under 35 U.S.C. 371 will be issued in addition to the Filing Receipt, in due course.</b></p> <p><b><u>New International Application Filed with the USPTO as a Receiving Office</u></b>  <b>If a new international application is being filed and the international application includes the necessary components for an international filing date (see PCT Article 11 and MPEP 1810), a Notification of the International Application Number and of the International Filing Date (Form PCT/RO/105) will be issued in due course, subject to prescriptions concerning national security, and the date shown on this Acknowledgement Receipt will establish the international filing date of the application.</b></p>	

MICHAEL V. MESSINGER  
DIRECTOR  
(202) 772-8667  
MIKEM@SKGF.COM



February 12, 2014

Commissioner for Patents  
PO Box 1450  
Alexandria, VA 22313-1450

Confirmation No. 7069  
Art Unit 2634  
**Attn: Mail Stop Amendment**

Re: U.S. Utility Patent Application  
Application No. 14/134,926; Filing Date: December 19, 2013  
For: **SYSTEM AND METHODS FOR VIDEO AND AUDIO DATA  
DISTRIBUTION**  
Inventors: FALLON *et al.*  
Our Ref: 2855.0050008

Commissioner:

Transmitted herewith for appropriate action are the following documents:

1. Information Disclosure Statement;
2. Form PTO/SB/08a (29 sheets) listing 606 documents (**US1-US579** and **FP1-FP27**);
3. Form PTO/SB/08b (97 sheets) listing 875 documents (**NPL1-NPL875**); and
4. Copies of cited documents (**NPL841-NPL874**).

***The above-listed documents are filed electronically through EFS-Web.***

In the event that extensions of time are necessary to prevent abandonment of this patent application, then such extensions of time are hereby petitioned.

Commissioner for Patents  
February 12, 2014  
Page 2

The U.S. Patent and Trademark Office is hereby authorized to charge any fee deficiency, or credit any overpayment, to our Deposit Account No. 19-0036.

Respectfully submitted,

STERNE, KESSLER, GOLDSTEIN & FOX P.L.L.C.

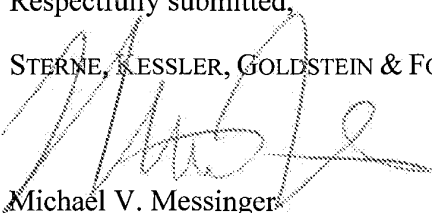

Michael V. Messinger  
Attorney for Applicants  
Registration No. 37,575

MVM/MRM/wcf  
Enclosures

1802104\_\_1

IN THE UNITED STATES PATENT AND TRADEMARK OFFICE

In re application of:

FALLON *et al.*

Appl. No.: 14/134,926

Filed: December 19, 2013

For: **System and Methods for Video and Audio Data Distribution**

Confirmation No.: 7069

Art Unit: 2634

Examiner: BOCURE, Tesfaldet

Atty. Docket: 2855.0050008

**Information Disclosure Statement**

*Mail Stop Amendment*

Commissioner for Patents  
PO Box 1450  
Alexandria, VA 22313-1450

Commissioner:

Notice of Prior and Concurrent Proceedings

Applicants hereby call to the attention of the Patent and Trademark Office the following reexamination proceedings involving patents that are commonly-assigned with the patent in the above-identified patent application:

<b>Proceeding</b>	<b>Status</b>
<i>Inter Partes</i> Reexamination of U.S. Patent No. 6,604,158 (Control No. 95/000,486)	<i>Inter Partes</i> Reexamination Certificate issued 10/10/2012
<i>Inter Partes</i> Reexamination of U.S. Patent No. 7,321,937 (Control No. 95/000,466)	<i>Inter Partes</i> Reexamination Certificate issued 05/15/2012
<i>Inter Partes</i> Reexamination of U.S. Patent No. 6,604,158 (Control No. 95/000,453)	Terminated
<i>Ex Parte</i> Reexamination of U.S. Patent No. 6,601,104 (Control No. 90/009,428)	<i>Ex Parte</i> Reexamination Certificate issued 02/28/2012
<i>Inter Partes</i> Reexamination of U.S. Patent No. 7,378,992 (Control No. 95/000,478)	<i>Inter Partes</i> Reexamination Certificate issued 10/04/2012
<i>Inter Partes</i> Reexamination of U.S. Patent No. 6,624,761 (Control No. 95/000,464)	<i>Inter Partes</i> Reexamination Certificate issued 06/12/2012
<i>Inter Partes</i> Reexamination of U.S. Patent No. 7,161,506 (Control No. 95/000,479)	<i>Inter Partes</i> Reexamination Certificate issued 05/22/2012
<i>Inter Partes</i> Reexamination of U.S. Patent No. 7,714,747 (Control No. 95/001,517)	Examiner's Determination under 37 C.F.R. § 41.77(d) mailed 01/14/2014

<b>Proceeding</b>	<b>Status</b>
<i>Inter Partes</i> Reexamination of U.S. Patent No. 7,417,568 (Control No. 95/001,533)	Patent Owner's Request to Reopen Prosecution filed 12/02/2013; Decision on Appeal mailed 11/01/2013
<i>Inter Partes</i> Reexamination of U.S. Patent No. 7,777,651 (Control No. 95/001,581)	Patent Owner's Request to Reopen Prosecution filed 12/02/2013; Decision on Appeal mailed 11/01/2013
<i>Inter Partes</i> Reexamination of U.S. Patent No. 7,400,274 (Control No. 95/001,544)	Patent Owner's Request to Reopen Prosecution filed 12/02/2013; Decision on Appeal mailed 11/01/2013

Applicants hereby call to the attention of the Patent and Trademark Office the following reexamination proceedings filed by Celco Partnership d/b/a Verizon Wireless, involving patents that are commonly-assigned with the patent in the above-identified patent application:

<b>Proceeding</b>	<b>Status</b>
<i>Inter Partes</i> Reexamination of U.S. Patent No. 7,321,937 (Control No. 95/001,922)	Inter Partes Reexamination Certificate issued 12/05/2013
<i>Inter Partes</i> Reexamination of U.S. Patent No. 6,604,158 (Control No. 95/001,923)	Patent Owner's Reply to Action Closing Prosecution filed 11/04/2013
<i>Inter Partes</i> Reexamination of U.S. Patent No. 7,352,300 (Control No. 95/001,924)	Right of Appeal Notice mailed 08/29/2013
<i>Inter Partes</i> Reexamination of U.S. Patent No. 7,395,345 (Control No. 95/001,925)	Patent Owner's Reply to Action Closing Prosecution filed 10/21/2013; Action Closing Prosecution mailed 09/20/2013
<i>Inter Partes</i> Reexamination of U.S. Patent No. 7,161,506 (Control No. 95/001,926)	Inter Partes Reexamination Certificate issued 01/08/2014
<i>Inter Partes</i> Reexamination of U.S. Patent No. 7,415,530 (Control No. 95/001,927)	Inter Partes Reexamination Certificate issued 08/16/2013
<i>Inter Partes</i> Reexamination of U.S. Patent No. 7,378,992 (Control No. 95/001,928)	Inter Partes Reexamination Certificate issued 01/08/2014



Applicants invite the Examiner to review the Requests for Reexamination, issued Office Actions, replies, and any other papers in the above-identified reexamination proceedings. If the Examiner is unable to obtain copies of papers in any reexamination proceeding, copies can be provided to the Examiner upon request. Those documents which may be material that are not already of record in this patent application are listed on the accompanying Form PTO/SB/08. For example, documents related to the reexaminations are listed as **NPL670-NPL840** and **NPL851-NPL868**.

Notice of Related Litigation

Applicants notify the Patent and Trademark Office of the following litigation involving U.S. Patents commonly-owned with the current patent application, the subject matter of which may be related to the present patent application:

No.	Case	Status
1	<i>Realtime Data LLC d/b/a IXO v. Packeteer, Inc. et al.</i> , No. 6:08-cv-00144-LED (E.D. Texas)	Dismissed

Applicants also notify the Patent and Trademark Office of the following additional litigation involving U.S. Patents commonly-owned with the current patent application, the subject matter of which may be related to the present patent application:

No.	Case	Status
2	<i>Realtime Data LLC d/b/a IXO v. Thomson Reuters Corporation et al.</i> No. 1:11-cv-06698-RJH (S.D. New York) (transferred from E.D. Texas; 6:09-cv-00333-LED)	Opinion of the Court of Appeals for the Federal Circuit received 01/27/2014
3	<i>Realtime Data LLC d/b/a IXO v. Morgan Stanley et al.</i> , No. 1:11-cv-06696-RJH (S.D. New York) (transferred from E.D. Texas; 6:09-cv-00326-LED)	Opinion of the Court of Appeals for the Federal Circuit received

		01/27/2014
4	<i>Realtime Data LLC d/b/a IXO v. CME Group Inc., et al.</i> , No. 1:11-cv-06697-RJH (S.D. New York) (transferred from E.D. Texas; No. 6:09-cv-00327-LED)	Opinion of the Court of Appeals for the Federal Circuit received 01/27/2014
5	<i>Chicago Board Options Exchange, Inc., v. Realtime Data LLC d/b/a IXO</i> , No. 09-cv-4486 (N.D. Ill.)	Dismissed
6	<i>Thomson Reuters Corporation v. Realtime Data, LLC d/b/a IXO</i> , No. 1:09-cv-07868-RMB (S.D.N.Y)	Consolidated with Case No. 2
7	<i>Realtime Data, LLC d/b/a IXO v. CME Group Inc., et al. (II)</i> , No. 6:10-cv-246 (E.D. Texas)	Consolidated with Case No. 4
8	<i>Realtime Data LLC d/b/a IXO v. Thomson Reuters Corporation et al. (II)</i> , No. 6:10-cv-247 (E.D. Texas)	Consolidated with Case No. 2
9	<i>Realtime Data, LLC d/b/a IXO v. Morgan Stanley, et al. (II)</i> , No. 6:10-cv-248 (E.D. Texas)	Consolidated with Case No. 3
10	<i>Realtime Data, LLC d/b/a IXO v. MetroPCS Texas, LLC et al.</i> , No. 6:10-cv-00493 (E.D. Texas)	Notice of Appeal Filed

Updated court docket listings for litigations previously disclosed and pending are submitted herewith as **NPL566-NPL572** and **NPL869-NPL872**.

Information Disclosure Statement

Listed on accompanying IDS Forms PTO/SB/08a equivalent and PTO/SB/08b equivalent are documents that may be considered material to the patentability of this application as defined in 37 C.F.R. §1.56, and in compliance with the duty of disclosure requirements of 37 C.F.R. §§ 1.97 and 1.98.

Applicants have listed publication dates on the attached IDS Forms based on information presently available to the undersigned. However, the listed publication dates should not be construed as an admission that the information was actually published on the date indicated.

Applicants reserve the right to establish the patentability of the claimed invention over any of the information provided herewith, and/or to prove that this information may not be prior art, and/or to prove that this information may not be enabling for the teachings purportedly offered.

This statement should not be construed as a representation that a search has been made, or that information more material to the examination of the present patent application does not exist. The Examiner is specifically requested not to rely solely on the material submitted herewith.

Filing under 37 C.F.R. § 1.97(b). This Information Disclosure Statement is being filed before the mailing of a first Office Action and after the filing of a request for continued examination under 37 C.F.R. § 1.114. No statement or fee is required.

Documents **US1-US579** and **FP1-FP27** are cited on the attached form PTO/SB/08A. Documents **NPL1-NPL875** are cited on the attached form PTO/SB/08B. Copies of documents **NPL841-NPL874** are submitted. However, in accordance with 37 C.F.R. § 1.98(a)(2), no copies of U.S. patents and patent application publications cited as **US1-US579** on the attached IDS Forms are submitted.

Copies of documents **FP1-FP27** and **NPL1-NPL840** were cited by or submitted to the Office in an IDS that complies with 37 C.F.R. § 1.98(a)-(c) in Application No. 13/154,239, filed June 6, 2011 (now U.S. Patent No. 8,553,759), and 14/033,245, filed September 20, 2013 (now pending), which are relied upon for an earlier filing date under 35 U.S.C. § 120. Thus, copies of these documents are not attached. 37 C.F.R. § 1.98(d).

Additionally, a copy of document **NPL875**, cited on the attached IDS Form, is not provided in accordance with the U.S. Patent and Trademark Office Official Gazette notice of October 19, 2004, which states: "the requirement in 37 C.F.R. § 1.98(a)(2)(iii) for a legible copy of the specification, including the claims, and drawings of each cited pending U.S. patent application (or portion of the application which caused it to be listed) is *sua sponte* waived where the cited pending application is stored in the USPTO's IFW system."

A concise explanation of the relevance of the non-English language documents appears below in accordance with 37 C.F.R. § 1.98(a)(3).

Document **FP1** (DE 4127518) is in the German language. An English-language abstract is as follows:

The magnetic disc storage device is connected to a host processor (5) and contains at least one magnetic disc for the storage of data with system startup data in a startup data region, a buffer memory (2) for data to be transferred from the disc/host computer and a data communication device (1). The data communication device transfers the startup data from the startup data region into the buffer memory at the time of system startup. The storage device can be used as an external memory device. **ADVANTAGE** - Enables very short startup times to be achieved for memory systems.

Document **FP12** (JP 6051989) is in the Japanese language. An English-language abstract is as follows:

PURPOSE: To perform the fast load processing of an operating system without performing the read processing of volume information for the whole device in spite of the presence/absence of a restore command in the initial load processing of the operating system.

CONSTITUTION: This system is provided with the device name instruction means 2 of a system storage file volume which instructs a volume in which a system storage file is stored in a device name by a REST command to instruct the generation of a system residence volume, the acquiring means 3 of the correspondence table of the device name with a channel number, a channel number acquiring means 4 to acquire the channel number from the device name of the volume, a restore processing means 5 which performs the generation processing of the system residence volume based on the device name and the channel number, and a device name/channel number correspondence table 6.

Document **FP13** (JP 9188009) is in the Japanese language. An English-language abstract is as follows:

PROBLEM TO BE SOLVED: To provide a printer capable of enhancing a compression ratio by electing a compression method fitted to data from a plurality of compression methods to perform compression and the data compressing method in the printer.

SOLUTION: A laser beam printer is equipped with an ROM 4 storing a plurality of preset compression methods and a CPU 3 having a data kind discriminating

function analyzing the command of received data and discriminating the kind of data on the basis of the analytical result, a compression method selecting function selecting the compression method fitted to the kind of the discriminated data from a plurality of the compression methods stored in the ROM 4 and data compressing function compressing the data on the basis of the selected compression method.

Document **FP14** (JP 11149376) is in the Japanese language. An English-language abstract is as follows:

**PROBLEM TO BE SOLVED:** To provide a more flexible software development environment by realizing the same function with a circuit mounting an Initial Program Loader ROM in circuit constitution of a smaller scale.

**SOLUTION:** A BOOT loader circuit is provided with a BOOT detection part 4 for detecting whether a system becomes a BOOT mode or not, an address decoder 5 for generating a selection signal for each device, switch parts 6 and 7 for selecting ROM and the external input interface and a CPU stop control part 8 for instructing the stop of CPU various conditions.

Document **FP18** (WO 95/29437 A1) is in the Japanese language. An English-language abstract is as follows:

A differential value and compressibility calculating means (76) of a data processing means (71) of a data transmitter calculates the actual differential value and the actual compressibility based on the data length of uncompressed data

received from a data outputting source (2) through an uncompressed data receiving means (74) and the data length of compressed data from a data compressing circuit (67). When the actual differential value is equal to or larger than a set differential value alpha, at the same time, the actual compressibility is equal to or larger than a set compressibility beta, the means (76) transmits the compressed data to a destination (3) through a transfert-requested data outputting means (79), and, in the other cases, transmits the uncompressed data to the destination (3). Therefore, such a phenomenon that the area occupied by compressed data in the memory area in the destination (3) is almost equal to the area occupied by uncompressed data in the memory area can be prevented, and useless data expansion can be avoided at the destination (3).

Document **FP27** (JP 04-241681) is in the Japanese language. An English-language abstract is as follows:

**PURPOSE:** To provide a means which can make optimum compression on data of any kinds of data pattern and can improve the data compressing efficiency.

**CONSTITUTION:** At the time of storing data, the data are compressed by means of compression circuits 11 and 12 of plural data compressing systems and counted results of the byte numbers of the compressed data are compared with each other after the byte numbers are counted. Then the compressed data of the smallest amount are selected and stored in a storing section 2 after adding a code indicating the compressing system. At the time of reading out the recorded data, the data are restored to the original data by selecting the corresponding

restoration circuit 31 or 32 in accordance with the added code indicating the compressing system.

Applicants submit herewith actions from co-pending, commonly assigned U.S. Patent Applications as documents **NPL573-NPL658**, **NPL841-NPL850**, and **NPL874**. The identification of these actions is not to be construed as a waiver of secrecy as to those applications now or upon issuance of the present application as a patent. The Examiner is respectfully requested to consider the cited applications and the art cited therein during examination.

It is expected that the examiner will review the prosecution and cited art in the parent application nos. 10/076,013, filed February 13, 2002 (now U.S. Patent No. 7,386,046); 12/123,081, filed May 19, 2008 (now U.S. Patent No. 8,073,047); 13/154,239, filed June 6, 2011 (now U.S. Patent No. 8,553,759); and 14/033,245, filed September 20, 2013 (now pending), in accordance with MPEP 2001.06(b), and indicate in the next communication from the office that the art cited in the earlier prosecution history has been reviewed in connection with the present application.

It is respectfully requested that the Examiner initial and return a copy of the enclosed IDS Forms, and indicate in the official file wrapper of this patent application that the documents have been considered.



The U.S. Patent and Trademark Office is hereby authorized to charge any fee deficiency, or credit any overpayment, to our Deposit Account No. 19-0036.

Respectfully submitted,

STERNE, KESSLER, GOLDSTEIN & FOX P.L.L.C.

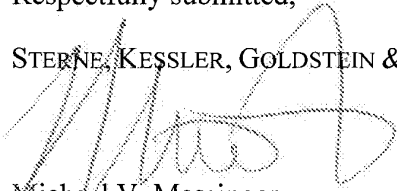

Michael V. Messinger  
Attorney for Applicants  
Registration No. 37,575

Date:

February 12, 2018

1100 New York Avenue, N.W.  
Washington, D.C. 20005-3934  
(202) 371-2600

1802087\_1



UNITED STATES PATENT AND TRADEMARK OFFICE

UNITED STATES DEPARTMENT OF COMMERCE  
United States Patent and Trademark Office  
Address: COMMISSIONER FOR PATENTS  
P.O. Box 1450  
Alexandria, Virginia 22313-1450  
www.uspto.gov

APPLICATION NO.	FILING DATE	FIRST NAMED INVENTOR	ATTORNEY DOCKET NO.	CONFIRMATION NO.
14/134,926	12/19/2013	James J. FALLON	2855.0050008	7069

26111 7590 02/27/2014  
STERNE, KESSLER, GOLDSTEIN & FOX P.L.L.C.  
1100 NEW YORK AVENUE, N.W.  
WASHINGTON, DC 20005

EXAMINER

BOCURE, TESFALDET

ART UNIT	PAPER NUMBER
2634	

MAIL DATE	DELIVERY MODE
02/27/2014	PAPER

**Please find below and/or attached an Office communication concerning this application or proceeding.**

The time period for reply, if any, is set in the attached communication.

<b>Office Action Summary</b>	<b>Application No.</b> 14/134,926	<b>Applicant(s)</b> FALLON ET AL.	
	<b>Examiner</b> TESFALDET BOCURE	<b>Art Unit</b> 2634	<b>AIA (First Inventor to File) Status</b> No

**-- The MAILING DATE of this communication appears on the cover sheet with the correspondence address --**

**Period for Reply**

A SHORTENED STATUTORY PERIOD FOR REPLY IS SET TO EXPIRE 3 MONTHS FROM THE MAILING DATE OF THIS COMMUNICATION.

- Extensions of time may be available under the provisions of 37 CFR 1.136(a). In no event, however, may a reply be timely filed after SIX (6) MONTHS from the mailing date of this communication.
- If NO period for reply is specified above, the maximum statutory period will apply and will expire SIX (6) MONTHS from the mailing date of this communication.
- Failure to reply within the set or extended period for reply will, by statute, cause the application to become ABANDONED (35 U.S.C. § 133). Any reply received by the Office later than three months after the mailing date of this communication, even if timely filed, may reduce any earned patent term adjustment. See 37 CFR 1.704(b).

**Status**

- 1)  Responsive to communication(s) filed on 12/19/2013.  
 A declaration(s)/affidavit(s) under **37 CFR 1.130(b)** was/were filed on \_\_\_\_\_.
- 2a)  This action is **FINAL**.
- 2b)  This action is non-final.
- 3)  An election was made by the applicant in response to a restriction requirement set forth during the interview on \_\_\_\_\_; the restriction requirement and election have been incorporated into this action.
- 4)  Since this application is in condition for allowance except for formal matters, prosecution as to the merits is closed in accordance with the practice under *Ex parte Quayle*, 1935 C.D. 11, 453 O.G. 213.

**Disposition of Claims\***

- 5)  Claim(s) 1-30 is/are pending in the application.  
5a) Of the above claim(s) \_\_\_\_\_ is/are withdrawn from consideration.
- 6)  Claim(s) \_\_\_\_\_ is/are allowed.
- 7)  Claim(s) 1-3,5-11,13-25,27,28 and 30 is/are rejected.
- 8)  Claim(s) 4,12,26 and 29 is/are objected to.
- 9)  Claim(s) \_\_\_\_\_ are subject to restriction and/or election requirement.

\* If any claims have been determined allowable, you may be eligible to benefit from the **Patent Prosecution Highway** program at a participating intellectual property office for the corresponding application. For more information, please see [http://www.uspto.gov/patents/init\\_events/pph/index.jsp](http://www.uspto.gov/patents/init_events/pph/index.jsp) or send an inquiry to [PPHfeedback@uspto.gov](mailto:PPHfeedback@uspto.gov).

**Application Papers**

- 10)  The specification is objected to by the Examiner.
- 11)  The drawing(s) filed on 12/19/2013 is/are: a)  accepted or b)  objected to by the Examiner.  
Applicant may not request that any objection to the drawing(s) be held in abeyance. See 37 CFR 1.85(a).  
Replacement drawing sheet(s) including the correction is required if the drawing(s) is objected to. See 37 CFR 1.121(d).

**Priority under 35 U.S.C. § 119**

- 12)  Acknowledgment is made of a claim for foreign priority under 35 U.S.C. § 119(a)-(d) or (f).

**Certified copies:**

- a)  All    b)  Some\*\*    c)  None of the:
  - 1.  Certified copies of the priority documents have been received.
  - 2.  Certified copies of the priority documents have been received in Application No. \_\_\_\_\_.
  - 3.  Copies of the certified copies of the priority documents have been received in this National Stage application from the International Bureau (PCT Rule 17.2(a)).

\*\* See the attached detailed Office action for a list of the certified copies not received.

**Attachment(s)**

- 1)  Notice of References Cited (PTO-892)
- 2)  Information Disclosure Statement(s) (PTO/SB/08a and/or PTO/SB/08b)  
Paper No(s)/Mail Date \_\_\_\_\_.
- 3)  Interview Summary (PTO-413)  
Paper No(s)/Mail Date. \_\_\_\_\_.
- 4)  Other: \_\_\_\_\_.

### **DETAILED ACTION**

1. The present application is being examined under the pre-AIA first to invent provisions.
2. This office action is in response to the application as originally filed on 12/19/2013; claims 1-30 are pending in this application.

### ***Information Disclosure Statement***

3. The information disclosure statements (IDSs) submitted on 2/12/2014 (two IDSs submitted on the same date) are in compliance with the provisions of 37 CFR 1.97. Accordingly, the information disclosure statement is being considered by the examiner. Attached with this correspondence are the initialed copies of the IDSs.

### ***Drawings***

4. The drawings were received on 12/19/2013. These drawings are accepted by the Examiner.

### ***Specification***

5. The disclosure is objected to because of the following informalities:
  - a. The incorporated by reference to US patent application S/Ns 09/266,394 and 09/481,243 in ¶ [0054] and S/N 09/775,905 in ¶ [0079] and ¶ [0083] should be updated by their corresponding US patent numbers.

Examiner would like to bring to the attention of the applicant that the incorporation of essential material in the specification by reference to an unpublished U.S. application, foreign application or patent, or to a publication is improper. Applicant is required to amend the disclosure to include the material incorporated by reference, if the material is relied upon to overcome any objection, rejection, or other requirement imposed by the Office. The amendment must be accompanied by a statement executed by the applicant, or a practitioner representing the applicant, stating that the material being inserted is the material previously incorporated by reference and that the amendment contains no new matter. 37 CFR 1.57(g).

***Claim Rejections - 35 USC § 112***

8. The following is a quotation of the first paragraph of 35 U.S.C. 112(a):

(a) IN GENERAL.—The specification shall contain a written description of the invention, and of the manner and process of making and using it, in such full, clear, concise, and exact terms as to enable any person skilled in the art to which it pertains, or with which it is most nearly connected, to make and use the same, and shall set forth the best mode contemplated by the inventor or joint inventor of carrying out the invention.

The following is a quotation of the first paragraph of pre-AIA 35 U.S.C. 112:

The specification shall contain a written description of the invention, and of the manner and process of making and using it, in such full, clear, concise, and exact terms as to enable any person skilled in the art to which it pertains, or with which it is most nearly connected, to make and use the same, and shall set forth the best mode contemplated by the inventor of carrying out his invention.

9. Claims 1-16 and 21, and 28 are rejected under 35 U.S.C. 112(a) or 35 U.S.C. 112 (pre-AIA), first paragraph, as failing to comply with the written description requirement. The claim(s) contains subject matter which was not described in the

specification in such a way as to reasonably convey to one skilled in the relevant art that the inventor or a joint inventor, or for pre-AIA the inventor(s), at the time the application was filed, had possession of the claimed invention.

The claimed “---selecting a compression algorithm selected from among a plurality of compression algorithms based upon a bandwidth of a communication channel or a bandwidth of a transmission line and a parameter or an attribute of the data block” in claims 1,3,6,8,11,14,15, 21, and 28 is not disclosed as to how the selection of the algorithm is done based on the transmission line or the communication channel. The disclosure mentions the transmission line or the communication channel in ¶[0061] with respect to the input/output port 16 but not how it is used to select the compression algorithm. If Applicant believe that there is a disclosure to support the above mentioned limitation, Examiner is kindly asking you to point where such a support is found in the specification.

The claimed “--- decompressing prior to compressing the data block with the selected compression algorithm” in claims 5,13,20 and 27 is not found in the disclosure.

10. Claims 2,4,7,9,10,12 and 16 are inherently rejected as being dependent on the rejected base claims.

***Claim Rejections - 35 USC § 102***

11. In the event the determination of the status of the application as subject to AIA 35 U.S.C. 102 and 103 (or as subject to pre-AIA 35 U.S.C. 102 and 103) is incorrect, any correction of the statutory basis for the rejection will not be considered a new ground of rejection if the prior art relied upon, and the rationale supporting the rejection, would be the same under either status.

The following is a quotation of the appropriate paragraphs of pre-AIA 35 U.S.C. 102 that form the basis for the rejections under this section made in this Office action:

A person shall be entitled to a patent unless –

(e) the invention was described in a patent granted on an application for patent by another filed in the United States before the invention thereof by the applicant for patent, or on an international application by another who has fulfilled the requirements of paragraphs (1), (2), and (4) of section 371(c) of this title before the invention thereof by the applicant for patent.

The changes made to 35 U.S.C. 102(e) by the American Inventors Protection Act of 1999 (AIPA) and the Intellectual Property and High Technology Technical Amendments Act of 2002 do not apply when the reference is a U.S. patent resulting directly or indirectly from an international application filed before November 29, 2000. Therefore, the prior art date of the reference is determined under 35 U.S.C. 102(e) prior to the amendment by the AIPA (**pre-AIPA** 35 U.S.C. 102(e)).

12. Claims 1-3, 6-10, 14-18, 21-25 and 28-30 are rejected under pre-AIA 35 U.S.C. 102(e) as being anticipated by Vishwanath et al., Vishwanath hereinafter (US patent number 6,216,157).

Vishwanath teaches a method comprising:

A method, comprising:

determining a parameter or an attribute of a data block having video or audio data;

selecting a compression algorithm from among a plurality of compression algorithms to apply to the data block based upon the determined parameter or attribute and a bandwidth of a transmission line or of a communication channel (see types of data, text, graphics, image, audio or video disclosed in col. 2 and the disclosed subject matter with respect to different types of data and shown in fig. 7); and  
compressing the data block with the selected compression algorithm after selecting the compression algorithm (compressing the type according to the data type disclosed in col. 6, lines 15-66 and as shown in figures 6, 9A and 9B), as in claim 1.

An apparatus, comprising:

a controller configured to:

determine a parameter or an attribute of a data block having video or audio data,  
and select a compression algorithm from among the determine plurality of  
compression algorithms to apply to the data block based upon the determined  
parameter or attribute and a bandwidth of a transmission line or of a communication  
channel (see types of data, text, graphics, image, audio or video disclosed in col. 2 and  
the disclosed subject matter with respect to different types of data and shown in fig. 7);  
and a data compression system configured to compress the data block with the  
selected compression algorithm, as in claim 8.

A method, comprising:

determining a plurality of compression algorithms (see types of data, text, graphics,



image, audio or video disclosed in col. 2 and the disclosed subject matter with respect to different types of data and shown in fig. 7);

selecting a compression algorithm from among the determined plurality of compression algorithms based upon a frequency of access of a data block; and

compressing the data block with the selected compression algorithm (see types of data, text, graphics, image, audio or video disclosed in col. 2 and the disclosed subject matter with respect to different types of data and shown in fig. 7 and the client request, claimed frequency of access, to determine which data type to be compressed; the video, audio or any of the disclosed data types having a corresponding compression and the compression according to the medium of transmission and bandwidth disclosed in col. 6, lines 35-68), as in claim 17

An apparatus, comprising:

a controller configured to (see types of data, text, graphics, image, audio or video disclosed in col. 2 and the disclosed subject matter with respect to different types of data and shown in fig. 7):

determine a plurality of compression algorithms, and

select a compression algorithm from among the determined plurality of compression algorithms based upon a frequency of access of a data block; and

a data compression system configured to compress the data block with the selected compression algorithm (see types of data, text, graphics, image, audio or video disclosed in col. 2 and the disclosed subject matter with respect to different types of data and shown in fig. 7 and the client request, claimed frequency of access, to determine which data type to be compressed; the video, audio or any of the disclosed data types having a corresponding compression and the compression according to the medium of transmission and bandwidth disclosed in col. 6, lines 35-68), as in claim 24.

Further to the dependent claims 2-3,6,7,9,10,14,15,16,18,21,22,23,25 and 28-30,  
Vishwanath teaches:

The method of claim 1, further comprising:  
storing the compressed data block (see data to be transmitted to the client in future time according to the profile of the end-user disclosed in col. 2, lines 42-53 are inherently stored at the server which performs the compression and transmission), as in claim 2.

The method of claim 2, further comprising:  
retrieving at least some of the compressed data block based upon the bandwidth of the transmission line or of the communication channel or a user command (See disclosed server transmitting the data to user over the medium in col. 4 and the client receiving and decoding the transmitted data in col. 2, lines 54-59), as in claim 3.

The method of claim 1, wherein selecting comprises:  
selecting the compression algorithm to apply to the data block based upon the determined parameter or attribute, the bandwidth of the transmission line or of the communication channel, and a frequency of access of the data block (see types of data, text, graphics, image, audio or video disclosed in col. 2 and the disclosed subject matter with respect to different types of data and shown in fig. 7 and the client request, claimed frequency of access, to determine which data type to be compressed; the video, audio or any of the disclosed data types having a corresponding compression and the compression according to the medium of transmission and bandwidth disclosed in col. 6, lines 35-68), as in claim 6.

The method of claim 1, wherein compressing comprises:  
compressing the data block with the selected compression algorithm based upon a user command (see the disclosed server compressing the video, audio or any other disclosed data according to the client request, claimed user command), as in claim 7.

The apparatus of claim 8, further comprising:  
a storage medium configured to store the compressed data block (see data to be transmitted to the client in future time according to the profile of the end-user disclosed in col. 2, lines 42-53 are inherently stored at the server which performs the compression and transmission), as in claim 9.

The apparatus of claim 9, wherein the data compression system is further configured to retrieve at least some of the compressed data block from the storage medium based upon the bandwidth of the transmission line or of the communication

channel or a user command (See disclosed server transmitting the data to user over the medium in col. 4 and the client receiving and decoding the transmitted data in col. 2, lines 54-59), as in claim 10.

The apparatus of claim 8, wherein the controller is further configured to select a second compression algorithm from among the plurality compression algorithms to apply to the compressed data block based upon a second bandwidth of the transmission line or of communication channel, the second bandwidth of the transmission line or of communication channel differing from the bandwidth of the transmission line or of communication channel (see for the plurality of data, video, audio or any other disclosed data having inherent respective and different bandwidth and compression algorithm, claimed second compression), as in claim 14.

The apparatus of claim 8, wherein the controller is configured to select the compression algorithm to apply to the data block based upon the determined parameter or attribute, the bandwidth of the transmission line or of the communication channel, and a frequency of access of the data block (see types of data, text, graphics, image, audio or video disclosed in col. 2 and the disclosed subject matter with respect to different types of data and shown in fig. 7 and the client request, claimed frequency of access, to determine which data type to be compressed; the video, audio or any of the disclosed data types having a corresponding compression and the compression according to the medium of transmission and bandwidth disclosed in col. 6, lines 35-68), as in claim 15.

The apparatus of claim 8, wherein the data compression system is configured to compress the data block with the selected compression algorithm based upon a user command (see the disclosed server compressing the video, audio or any other disclosed data according to the client request, claimed user command), as in claim 16.

The method of claim 17, further comprising:  
storing the compressed data block (see data to be transmitted to the client in future time according to the profile of the end-user disclosed in col. 2, lines 42-53 are inherently stored at the server which performs the compression and transmission), as in claim 18.

The method of claim 17, further comprising:  
selecting a second compression algorithm from among the determined plurality compression algorithms to apply to the compressed data block based upon a bandwidth of a transmission line or of a communication channel, (see for the plurality of data, video, audio or any other disclosed data having inherent respective and different bandwidth and compression algorithm, claimed second compression), as in claim 21.

The method of claim 18, further comprising:  
retrieving at least some of the compressed data block based upon a bandwidth of a transmission line or of a communication channel or a user command (see the disclosed server compressing the video, audio or any other disclosed data according to the client request, claimed user command, and the client receiving and decoding the data), as in claim 22.

The method of claim 17, wherein compressing comprises:

compressing the data block with the selected compression algorithm based upon a user command (see the disclosed server compressing the video, audio or any other disclosed data according to the client request, claimed user command), as in claim 23.

The apparatus of claim 24, further comprising:

a storage medium configured to store the compressed data block (see data to be transmitted to the client in future time according to the profile of the end-user disclosed in col. 2, lines 42-53 are inherently stored at the server which performs the compression), in claim 25.

The apparatus of claim 24, wherein the controller is further configured to select a second compression algorithm from among the determined plurality compression of algorithms to apply to the compressed data block based upon a bandwidth of a transmission line or of a communication channel (see for the plurality of data, video, audio or any other disclosed data having inherent compression algorithm, claimed second compression), as in claim 28.

The apparatus of claim 25, wherein the data compression system is further configured to retrieve at least some of the compressed data block from the storage medium based upon a bandwidth of a transmission line or of a communication channel or a user command (See disclosed server transmitting the data to user over the medium

in col. 4 and the client receiving and decoding the transmitted data in col. 2, lines 54-59), as in claim 29.

The apparatus of claim 23, wherein the data compression system is configured to compress the data block with the selected compression algorithm based upon a user command (see the disclosed server compressing the video, audio or any other disclosed data according to the client request, claimed user command), as in claim 30.

#### ***Allowable Subject Matter***

13. Claims 4,12,19, and 26 are objected to as being dependent upon a rejected base claim, but would be allowable if rewritten in independent form including all of the limitations of the base claim and any intervening claims.

#### ***Conclusion***

14. The prior art made of record and not relied upon is considered pertinent to applicant's disclosure.

- a. US patent numbers 5,812,883 (see also 5,930,358 by the same inventive entity), 5,901,278, 6,257,693, 6,792,151, 6,938,073 and 7,245,636 issued to Rao, Kurihara et al., Miller et al., Barnes et al., Mendhekar et al and Hans et al. respectively disclose selection of compression method according to the data type (claimed attribute and parameter) .
- b. US patent numbers 5,881,104 and 7,050,639 issued to Akahane and Barnes et al. respectively and US patent publication number 2002/0078241

issued to Vidal et al. disclose selection of compression/decompression algorithm which maximize the ratio.

c. US patent publication number 2003/0058873 issued to Geiger et al. discloses a system having means for storing the compressed data.

### ***Conclusion***

15. Any inquiry concerning this communication or earlier communications from the examiner should be directed to TESHALDET BOCURE whose telephone number is (571)272-3015. The examiner can normally be reached on Mon-Th, 8:30-6:00 and 8:30-5:00 2nd Friday.

If attempts to reach the examiner by telephone are unsuccessful, the examiner's supervisor, DANIEL C. WASHBURN can be reached on (571)272-5551. The fax phone number for the organization where this application or proceeding is assigned is 571-273-8300.



Information regarding the status of an application may be obtained from the Patent Application Information Retrieval (PAIR) system. Status information for published applications may be obtained from either Private PAIR or Public PAIR. Status information for unpublished applications is available through Private PAIR only. For more information about the PAIR system, see <http://pair-direct.uspto.gov>. Should you have questions on access to the Private PAIR system, contact the Electronic Business Center (EBC) at 866-217-9197 (toll-free). If you would like assistance from a USPTO Customer Service Representative or access to the automated information system, call 800-786-9199 (IN USA OR CANADA) or 571-272-1000.

/TESFALDET BOCURE/  
Primary Examiner, Art Unit 2634

/T. B./  
Primary Examiner, Art Unit 2634

<b>Notice of References Cited</b>	Application/Control No. 14/134,926	Applicant(s)/Patent Under Reexamination FALLON ET AL.	
	Examiner TESFALDET BOCURE	Art Unit 2634	Page 1 of 1

**U.S. PATENT DOCUMENTS**

*	Document Number Country Code-Number-Kind Code	Date MM-YYYY	Name	Classification
*	A US-5,812,883	09-1998	Rao, Mahesh Chandra	710/74
*	B US-5,881,104	03-1999	Akahane, Masaaki	375/240
*	C US-5,901,278	05-1999	Kurihara et al.	358/1.15
*	D US-6,216,157	04-2001	Vishwanath et al.	709/208
*	E US-6,257,693	07-2001	Miller et al.	347/19
*	F US-6,792,151	09-2004	Barnes et al.	382/239
*	G US-6,938,073	08-2005	Mendhekar et al.	709/217
*	H US-7,050,639	05-2006	Barnes et al.	382/239
*	I US-7,245,636	07-2007	Hans et al.	370/474
*	J US-2003/0058873	03-2003	Geiger et al.	370/401
	K US-			
	L US-			
	M US-			

**FOREIGN PATENT DOCUMENTS**

*	Document Number Country Code-Number-Kind Code	Date MM-YYYY	Country	Name	Classification
	N				
	O				
	P				
	Q				
	R				
	S				
	T				

**NON-PATENT DOCUMENTS**

*	Document Number Country Code-Number-Kind Code	Date MM-YYYY	Country	Name	Classification
	Include as applicable: Author, Title Date, Publisher, Edition or Volume, Pertinent Pages)				
	U				
	V				
	W				
	X				

\*A copy of this reference is not being furnished with this Office action. (See MPEP § 707.05(a).)  
Dates in MM-YYYY format are publication dates. Classifications may be US or foreign.

**EAST Search History**

**EAST Search History (Prior Art)**

Ref #	Hits	Search Query	DBs	Default Operator	Plurals	Time Stamp
L1	56706327	@ad<="20010213"	US-PGPUB; USPAT; USOCR; FPRS; EPO; JPO; DERWENT; IBM_TDB	OR	OFF	2014/02/24 12:55
L2	2807	Fallon.inv. or mcerlain.inv.	US-PGPUB; USPAT; USOCR; FPRS; EPO; JPO; DERWENT; IBM_TDB	OR	OFF	2014/02/24 12:55
L3	227	(Selecting or select or choose or choosing) near4 ((compress or compression or compressing) near4 (algorithm or algorithms or mode or modes)) same (parameter or parameters or attribute or attributes)	US-PGPUB; USPAT; USOCR; FPRS; EPO; JPO; DERWENT; IBM_TDB	OR	OFF	2014/02/24 12:55
L4	48	L1 and L3	US-PGPUB; USPAT; USOCR; FPRS; EPO; JPO; DERWENT; IBM_TDB	OR	OFF	2014/02/24 12:55
L5	28	L2 and L3	US-PGPUB; USPAT; USOCR; FPRS; EPO; JPO; DERWENT; IBM_TDB	OR	OFF	2014/02/24 12:55
L6	138	(selecting or select or choose or choosing) near4 ((compress or compression or compressing) near4 (algorithm or algorithms or mode or modes)) same (read or reading or write or writing or retrieve or retrieving or throughput or throughputs)	US-PGPUB; USPAT; USOCR; FPRS; EPO; JPO; DERWENT; IBM_TDB	OR	OFF	2014/02/24 12:55
L7	50	L6 and L1	US-PGPUB; USPAT; USOCR; FPRS; EPO; JPO; DERWENT; IBM_TDB	OR	OFF	2014/02/24 12:55

EAST Search History

L8	10	L6 and L2	US-PGPUB; USPAT; USOCR; FPRS; EPO; JPO; DERWENT; IBM_TDB	OR	OFF	2014/02/24 12:55
L9	345	L3 or L6	US-PGPUB; USPAT; USOCR; FPRS; EPO; JPO; DERWENT; IBM_TDB	OR	OFF	2014/02/24 12:55
L10	149	L9 AND ( (H03M7/30 OR H03M7/3084 OR H03M7/3059 OR G06F17/30153 OR G06F2212/401 OR G06F12/0246 OR G06F17/30501 OR G06F3/0679 OR G06F3/0688 OR H04L69/04 OR Y10S707/99931 OR Y10S707/99942 OR H04W28/06 OR H04N1/00236 OR H04N2201/3283 OR G11C29/40 OR Y02B60/1225).CPC. OR (707/E17.001 OR 375/240 OR 375/E7.094 OR 370/477 OR 711/E12.008 OR 711/154 OR 709/247 OR 708/203).OCLS. OR (G06F17/30 OR G06F12/00 OR G06F12/02 OR H03M7/30 OR H04B1/66 OR H04N7/26 OR H04N11/02 OR H04J3/18).IPCR. )	US-PGPUB; USPAT; USOCR; FPRS; EPO; JPO; DERWENT; IBM_TDB	OR	OFF	2014/02/24 12:55
L11	2807	Fallon.inv. or mcerlain.inv.	US-PGPUB; USPAT; USOCR; FPRS; EPO; JPO; DERWENT; IBM_TDB	OR	OFF	2014/02/24 12:55
L12	227	(Selecting or select or choose or choosing) near4 ((compress or compression or compressing) near4 (algorithm or algorithms or mode or modes)) same (parameter or parameters or attribute or attributes)	US-PGPUB; USPAT; USOCR; FPRS; EPO; JPO; DERWENT; IBM_TDB	OR	OFF	2014/02/24 12:55
L13	28	L11 and L12	US-PGPUB; USPAT; USOCR; FPRS; EPO; JPO; DERWENT; IBM_TDB	OR	OFF	2014/02/24 12:55
L14	138	(selecting or select or choose or choosing) near4 ((compress or compression or compressing) near4 (algorithm or algorithms or mode or modes)) same (read or reading or write or writing or retrieve or retrieving or throughput or throughputs)	US-PGPUB; USPAT; USOCR; FPRS; EPO; JPO; DERWENT; IBM_TDB	OR	OFF	2014/02/24 12:55
L15	10	L14 and L11	US-PGPUB; USPAT; USOCR;	OR	OFF	2014/02/24 12:55

			FPRS; EPO; JPO; DERWENT; IBM_TDB			
L16	345	L12 or L14	US-PGPUB; USPAT; USOCR; FPRS; EPO; JPO; DERWENT; IBM_TDB	OR	OFF	2014/02/24 12:55
L17	149	L16 AND ( (H03M7/30 OR H03M7/3084 OR H03M7/3059 OR G06F17/30153 OR G06F2212/401 OR G06F12/0246 OR G06F17/30501 OR G06F3/0679 OR G06F3/0688 OR H04L69/04 OR Y10S707/99931 OR Y10S707/99942 OR H04W28/06 OR H04N1/00236 OR H04N2201/3283 OR G11C29/40 OR Y02B60/1225).CPC. OR (707/E17.001 OR 375/240 OR 375/E7.094 OR 370/477 OR 711/E12.008 OR 711/154 OR 709/247 OR 708/203).OCLS. OR (G06F17/30 OR G06F12/00 OR G06F12/02 OR H03M7/30 OR H04B1/66 OR H04N7/26 OR H04N11/02 OR H04J3/18).IPCR. )	US-PGPUB; USPAT; USOCR; FPRS; EPO; JPO; DERWENT; IBM_TDB	OR	OFF	2014/02/24 12:55
L18	109	("5354315" "5488365" "6990247" "7714747" "7777651").PN. or ("4127518" "5598388" "5864678" "6285458" "7552069").PN. or ("4464650" "4646061" "4745559" "4750135" "4814746" "5027376" "5132992" "5267333" "5353132" "5374916" "5521940" "5577248" "5838821" "5838927" "5907801" "5938737" "5949968" "6021433" "6032197" "6115384").PN. or ("20020169950" "20090125698" "20120194362" "20120239921" "5475388" "6909745" "8275897").PN.	US-PGPUB; USPAT; USOCR; FPRS; EPO; JPO; DERWENT; IBM_TDB	OR	OFF	2014/02/24 12:55
L19	77	"5454079".pn. or "5455680".pn. or "5610657".pn. or "5809299".pn. or "5812195".pn. or "5974387".pn. or "5987022".pn. or "6175650".pn. or "6192155".pn. or "6208273".pn. or "6963608".pn. or "6526174".pn. or "7565441".pn. or "20010047473" or "20090287839" or "20090154545" or "7386046".pn. or "5331425".pn. or "5987432".pn. or "6038346".pn. or "6097845".pn. or "6195125".pn. or "6195391".pn. or "6198850".pn. or "8054879".pn. or "8073047".pn. or "8090936".pn. or "8112619".pn. or "20110199243" or "20110208833" or "20110231642" or "20110285559"	US-PGPUB; USPAT; USOCR; FPRS; EPO; JPO; DERWENT; IBM_TDB	OR	OFF	2014/02/24 12:55
L20	395	("20010054131" "20030034905" "3394352" "3490690" "4021782" "4032893" "4054951" "4325085"	US-PGPUB; USPAT; USOCR;	OR	OFF	2014/02/24 12:55

		"4360840"   "4386416"   "4499499" "4626829"   "4701745"   "4729020" "4748638"   "4813040"   "4862167" "4866601"   "4890282"   "4897717" "4906991"   "4956808"   "5003307" "5016009"   "5109226"   "5109433" "5115309"   "5126739"   "5146221" "5155484"   "5167034"   "5249053" "5280600"   "5289580"   "5341440" "5347600"   "5367629"   "5410671" "5437020"   "5454107"   "5463390" "5479633"   "5488364"   "5504842" "5506944"   "5535311"   "5535369" "5539865"   "5542031"   "5544290" "5546395"   "5546475"   "5553160" "5561421"   "5576953"   "5581715" "5586264"   "5586285"   "5615287" "5619995"   "5671355"   "5671413" "5675789"   "5692159"   "5708511" "5740395"   "5742773"   "5765027" "5768445"   "5768525"   "5774715" "5794229"   "5805834"   "5808660" "5822781"   "5835788"   "5850565" "5874907"   "5884269"   "5887165" "5892847"   "5909557"   "5909559" "5918068"   "5918225"   "5923860" "5930358"   "5943692"   "5945933" "5951623"   "5956490"   "5969927" "5982360"   "5987590"   "5990884" "6023755"   "6058459"   "6070179" "6078958"   "6092123"   "6098114" "6134631"   "6145020"   "6170007" "6170047"   "6170049"   "6175856" "6185625"   "6185659"   "6208273" "6215904"   "6219754"   "6230223" "6237054"   "6243829"   "6298408" "6310563"   "6356589"   "6356937" "6449658"   "6452933"   "6523102" "6539438"   "6768749"   "6792151" "6813689"   "6819271"   "6822589" "6862278"   "6879266"   "6959359" "6993597"   "7007099"   "7069342" "7089391"   "7129860"   "7319667" "7330912").FN.	FPRS; EPO; JPO; DERWENT; IBM_TDB			
L21	320	("5819215"   "5825424"   "5825830" "5832037"   "5832126"   "5836003" "5838996"   "5839100"   "5841979" "5847762"   "5861824"   "5861920" "5864342"   "5867167"   "5867602" "5870036"   "5870087"   "5872530" "5883975"   "5886655"   "5889961" "5915079"   "5917438"   "5920326" "5936616"   "5949355"   "5960465" "5964842"   "5968149"   "5973630" "5974235"   "5974471"   "5978483" "5982723"   "5991515"   "5996033" "0522742"   "6000009"   "6002411" "6003115"   "6008743"   "6011901" "6026217"   "6028725"   "6031939" "6032148"   "6061398"   "6073232" "6075470"   "6091777"   "6094634" "6097520"   "6104389"   "6105130" "6128412"   "6141053"   "6145069" "6169241"   "6172936"   "6173381"	US-PGPUB; OR USPAT; USOCR; FPRS; EPO; JPO; DERWENT; IBM_TDB	OFF	2014/02/24 12:55	

		"6182125"   "6192082"   "6195024" "6195465"   "6222886"   "6225922" "6226667"   "6226740"   "6253264" "6272178"   "6272627"   "6272628" "6282641"   "6308311"   "6309424" "6317714"   "6330622"   "6345307" "6392567"   "6404931"   "6421387" "6434168"   "6434695"   "6442659" "6449682"   "6452602"   "6459429" "6463509"   "6487640"   "6489902" "6513113"   "6529633"   "6532121" "6539456"   "6542644"   "6577254" "6590609"   "6597812"   "6601104" "6604040"   "6604158"   "6606413" "6609223"   "6618728"   "6624761" "6661839"   "6661845"   "6704840" "6717534"   "6745282"   "6748457" "6756922"   "6810434"   "6856651" "6885316"   "6885319"   "6888893" "6909383"   "6944740"   "0601694" "7054493"   "7102544"   "7130913" "7161506").PN.				
L22	480	("20040056783"   "20040073710" "20040073746"   "20060015650" "20060181441"   "20060181442" "20060184687"   "20060184696" "20060190644"   "20060195601" "20070043939"   "20070050514" "20070050515"   "20070067483" "20070083746"   "20070109154" "20070109155"   "20070109156" "20070174209"   "20080232457" "4302775"   "4394774"   "4494108" "4574351"   "4593324"   "4682150" "4730348"   "4754351"   "4804959" "4870415"   "4872009"   "4876541" "4888812"   "4906995"   "4929946" "4953324"   "4965675"   "4988998" "5028922"   "5045848"   "5045852" "5046027"   "5049881"   "5091782" "5097261"   "5113522"   "5121342" "5128963"   "5150430"   "5159336" "5175543"   "5179651"   "5187793" "5191431"   "5204756"   "5209220" "5226176"   "5227893"   "5231492" "5237460"   "5237675"   "5243341" "5243348"   "5247638"   "5247646" "5263168"   "5270832"   "5287420" "5293379"   "5293576"   "5307497" "5309555"   "5355498"   "5357614" "5373290"   "5379036"   "5379757" "5381145"   "5394534"   "5396228" "5400401"   "5403639"   "5406278" "5406279"   "5412384"   "5414850" "5420639"   "5434983"   "5452287" "5455576"   "5461679"   "5467087" "5471206"   "5479587"   "5483470" "5486826"   "5495244"   "5506844" "5506872"   "5530845"   "5533051" "5535356"   "5537658"   "5557551" "5557668"   "5557749"   "5561824" "5563961"   "5574952"   "5574953" "5583500"   "5590306"   "5596674" "5604824"   "5606706"   "5611024"	US-PGPUB; USPAT; USOCR; FPRS; EPO; JPO; DERWENT; IBM_TDB	OR	OFF	2014/02/24 12:55

		"5612788"   "5613069"   "5615017" "5621820"   "5623623"   "5623701" "5627534"   "5627995"   "5629732" "5630092"   "5635632"   "5635932" "5638498"   "5640158"   "5642506" "5649032"   "5652795"   "5652857" "5652917"   "5654703"   "5655138" "5666560"   "5668737"   "5671389" "5675333"   "5686916"   "5694619" "5696927"   "5703793"   "5715477" "5717393"   "5717394"   "5719862" "5721958"   "5724475"   "5729228" "5748904"   "5757852"   "5771340" "5778411"   "5781767"   "5784572" "5787487"   "5796864"   "5799110" "5805932"   "5808660"   "5809176" "5809337"   "5812789"   "5818368" "5818369"   "5818530").pn.				
L23	24	L16 and (L18 or L19 or L20 or L21 or L22)	US-PGPUB; USPAT; USOCR; FPRS; EPO; JPO; DERWENT; IBM_TDB	OR	OFF	2014/02/24 12:55
L24	0	L16 and (assymetric near4 (compressing or compression))	US-PGPUB; USPAT; USOCR; FPRS; EPO; JPO; DERWENT; IBM_TDB	OR	OFF	2014/02/24 12:55
L25	0	L16 and (((fast or slow) near (read or reading or retrieving or retrieve)) same ((fast or slow) near (write or writing)))	US-PGPUB; USPAT; USOCR; FPRS; EPO; JPO; DERWENT; IBM_TDB	OR	OFF	2014/02/24 12:55
L26	0	(Selecting or select or choose or choosing) near4 ((compress or compression or compressing) near4 (algorithm or algorithms or mode or modes)) same (assymetric near4 (compressing or compression))	US-PGPUB; USPAT; USOCR; FPRS; EPO; JPO; DERWENT; IBM_TDB	OR	OFF	2014/02/24 12:55
L27	0	((compress or compression or compressing) near4 (algorithm or algorithms or mode or modes)) same (parameter or parameters or attribute or attributes) same (assymetric near4 (compressing or compression))	US-PGPUB; USPAT; USOCR; FPRS; EPO; JPO; DERWENT; IBM_TDB	OR	OFF	2014/02/24 12:55
L28	0	((compress or compression or compressing) near4 (algorithm or algorithms or mode or modes)) same (((fast or slow) near (read or reading or retrieving or retrieve)) same ((fast or slow) near (write or writing)))	US-PGPUB; USPAT; USOCR; FPRS; EPO; JPO; DERWENT; IBM_TDB	OR	OFF	2014/02/24 12:55
L29	0	((compress or compression or compressing) near4 (algorithm or	US-PGPUB; USPAT;	OR	OFF	2014/02/24 12:55



EAST Search History

algorithms or mode or modes)) same (((fast or slow) near (read or reading or retrieving or retrieve)) same ((fast or slow) near (storing or store or write or writing)))	USOCR; FPRS; EPO; JPO; DERWENT; IBM_TDB
--	---

**2/ 24/ 2014 12:59:12 PM**

**C:\Users\tbocure\Documents\EAST\Workspaces\14134926.wsp**

<b>Index of Claims</b>  	<b>Application/Control No.</b> 14134926	<b>Applicant(s)/Patent Under Reexamination</b> FALLON ET AL.
	<b>Examiner</b> TESFALDET BOCURE	<b>Art Unit</b> 2634

✓	<b>Rejected</b>
=	<b>Allowed</b>

-	<b>Cancelled</b>
÷	<b>Restricted</b>

N	<b>Non-Elected</b>
I	<b>Interference</b>

A	<b>Appeal</b>
O	<b>Objected</b>

Claims renumbered in the same order as presented by applicant
  CPA
  T.D.
  R.1.47

CLAIM		DATE									
Final	Original	02/24/2014									
	1	✓									
	2	✓									
	3	✓									
	4	O									
	5	✓									
	6	✓									
	7	✓									
	8	✓									
	9	✓									
	10	✓									
	11	✓									
	12	O									
	13	✓									
	14	✓									
	15	✓									
	16	✓									
	17	✓									
	18	✓									
	19	O									
	20	✓									
	21	✓									
	22	✓									
	23	✓									
	24	✓									
	25	✓									
	26	O									
	27	✓									
	28	✓									
	29	✓									
	30	✓									

<b>Search Notes</b>  	<b>Application/Control No.</b>  14134926	<b>Applicant(s)/Patent Under Reexamination</b>  FALLON ET AL.
	<b>Examiner</b>  TESFALDET BOCURE	<b>Art Unit</b>  2634

CPC- SEARCHED		
Symbol	Date	Examiner
((H03M7/30 H03M7 H03M7/3059 G06F17/30153 G06F2212/401 G06F12/0246 G06F17/30501 G06F3/0679 G06F3/0688 H04L69/04 Y10S707/99931 Y10S707/99942 H04W28/06 H04N1/00236 H04N2201/3283 G11C29/40 Y02B60/1225).C	2/2 4/2 014	TB

CPC COMBINATION SETS - SEARCHED		
Symbol	Date	Examiner

US CLASSIFICATION SEARCHED			
Class	Subclass	Date	Examiner
USPC Search in CPC	(707/E17.001 375/240 375/E7.094 370/477 711/E12.008 711/154 709/247 708/203).CCLS.	2/24/2014	TB
IPC Search in CPC		2/24/2014	TB
375, 348, 370, 341, 709, 711, 382	Search ALL (\$.8.ccls.)	2/24/2014	TB

SEARCH NOTES		
Search Notes	Date	Examiner
WEST and Inventor's Name Searched	2/24/2014	TB

INTERFERENCE SEARCH			
US Class/ CPC Symbol	US Subclass / CPC Group	Date	Examiner

	/TESFALDET BOCURE/ Primary Examiner.Art Unit 2634
--	--



UNITED STATES PATENT AND TRADEMARK OFFICE

UNITED STATES DEPARTMENT OF COMMERCE  
 United States Patent and Trademark Office  
 Address: COMMISSIONER FOR PATENTS  
 P.O. Box 1450  
 Alexandria, Virginia 22313-1450  
 www.uspto.gov

BIB DATA SHEET

CONFIRMATION NO. 7069

<b>SERIAL NUMBER</b> 14/134,926	<b>FILING or 371(c) DATE</b> 12/19/2013	<b>CLASS</b> 375	<b>GROUP ART UNIT</b> 2634	<b>ATTORNEY DOCKET NO.</b> 2855.0050008		
<b>APPLICANTS</b> REALTIME DATA LLC, Armonk, NY, Assignee (with 37 CFR 1.172 Interest);						
<b>INVENTORS</b> James J. FALLON, Armonk, NY; Stephen J. MCERLAIN, Astoria, NY;						
<b>** CONTINUING DATA *****</b> This application is a CON of 14/033,245 09/20/2013 which is a CON of 13/154,239 06/06/2011 PAT 8553759 which is a CON of 12/123,081 05/19/2008 PAT 8073047 which is a CON of 10/076,013 02/13/2002 PAT 7386046 which claims benefit of 60/268,394 02/13/2001						
<b>** FOREIGN APPLICATIONS *****</b>						
<b>** IF REQUIRED, FOREIGN FILING LICENSE GRANTED **</b> 12/31/2013						
Foreign Priority claimed <input type="checkbox"/> Yes <input checked="" type="checkbox"/> No	35 USC 119(a-d) conditions met <input type="checkbox"/> Yes <input checked="" type="checkbox"/> No	<input type="checkbox"/> Met after Allowance	<b>STATE OR COUNTRY</b> NY	<b>SHEETS DRAWINGS</b> 4	<b>TOTAL CLAIMS</b> 30	<b>INDEPENDENT CLAIMS</b> 4
Verified and Acknowledged	/TESFALDET BOCURE/ Examiner's Signature	Initials				
<b>ADDRESS</b> STERNE, KESSLER, GOLDSTEIN & FOX P.L.L.C. 1100 NEW YORK AVENUE, N.W. WASHINGTON, DC 20005 UNITED STATES						
<b>TITLE</b> SYSTEM AND METHODS FOR VIDEO AND AUDIO DATA DISTRIBUTION						
<b>FILING FEE RECEIVED</b> 3120	FEES: Authority has been given in Paper No. _____ to charge/credit DEPOSIT ACCOUNT No. _____ for following:		<input type="checkbox"/> All Fees <input type="checkbox"/> 1.16 Fees (Filing) <input type="checkbox"/> 1.17 Fees (Processing Ext. of time) <input type="checkbox"/> 1.18 Fees (Issue) <input type="checkbox"/> Other _____ <input type="checkbox"/> Credit			

IN THE UNITED STATES PATENT AND TRADEMARK OFFICE

In re application of:

FALLON *et al.*

Appl. No.: 14/134,926

Filed: December 19, 2013

For: **System and Methods for Video and Audio Data Distribution**

Confirmation No.: 7069

Art Unit: 2634

Examiner: BOCURE, Tesfaldet

Atty. Docket: 2855.0050008

**Information Disclosure Statement**

*Mail Stop Amendment*

Commissioner for Patents  
PO Box 1450  
Alexandria, VA 22313-1450

Commissioner:

Notice of Prior and Concurrent Proceedings

Applicants hereby call to the attention of the Patent and Trademark Office the following reexamination proceedings involving patents that are commonly-assigned with the patent in the above-identified patent application:

<b>Proceeding</b>	<b>Status</b>
<i>Inter Partes</i> Reexamination of U.S. Patent No. 6,604,158 (Control No. 95/000,486)	<i>Inter Partes</i> Reexamination Certificate issued 10/10/2012
<i>Inter Partes</i> Reexamination of U.S. Patent No. 7,321,937 (Control No. 95/000,466)	<i>Inter Partes</i> Reexamination Certificate issued 05/15/2012
<i>Inter Partes</i> Reexamination of U.S. Patent No. 6,604,158 (Control No. 95/000,453)	Terminated
<i>Ex Parte</i> Reexamination of U.S. Patent No. 6,601,104 (Control No. 90/009,428)	<i>Ex Parte</i> Reexamination Certificate issued 02/28/2012
<i>Inter Partes</i> Reexamination of U.S. Patent No. 7,378,992 (Control No. 95/000,478)	<i>Inter Partes</i> Reexamination Certificate issued 10/04/2012
<i>Inter Partes</i> Reexamination of U.S. Patent No. 6,624,761 (Control No. 95/000,464)	<i>Inter Partes</i> Reexamination Certificate issued 06/12/2012
<i>Inter Partes</i> Reexamination of U.S. Patent No. 7,161,506 (Control No. 95/000,479)	<i>Inter Partes</i> Reexamination Certificate issued 05/22/2012
<i>Inter Partes</i> Reexamination of U.S. Patent No. 7,714,747 (Control No. 95/001,517)	Examiner's Determination under 37 C.F.R. § 41.77(d) mailed 01/14/2014

/Tefaldet Bocure/

02/19/2014

ALL REFERENCES CONSIDERED EXCEPT WHERE LINED THROUGH. /T.B./

<b>Proceeding</b>	<b>Status</b>
<i>Inter Partes</i> Reexamination of U.S. Patent No. 7,417,568 (Control No. 95/001,533)	Patent Owner's Request to Reopen Prosecution filed 12/02/2013; Decision on Appeal mailed 11/01/2013
<i>Inter Partes</i> Reexamination of U.S. Patent No. 7,777,651 (Control No. 95/001,581)	Patent Owner's Request to Reopen Prosecution filed 12/02/2013; Decision on Appeal mailed 11/01/2013
<i>Inter Partes</i> Reexamination of U.S. Patent No. 7,400,274 (Control No. 95/001,544)	Patent Owner's Request to Reopen Prosecution filed 12/02/2013; Decision on Appeal mailed 11/01/2013

Applicants hereby call to the attention of the Patent and Trademark Office the following reexamination proceedings filed by Celco Partnership d/b/a Verizon Wireless, involving patents that are commonly-assigned with the patent in the above-identified patent application:

<b>Proceeding</b>	<b>Status</b>
<i>Inter Partes</i> Reexamination of U.S. Patent No. 7,321,937 (Control No. 95/001,922)	<i>Inter Partes</i> Reexamination Certificate issued 12/05/2013
<i>Inter Partes</i> Reexamination of U.S. Patent No. 6,604,158 (Control No. 95/001,923)	Patent Owner's Reply to Action Closing Prosecution filed 11/04/2013
<i>Inter Partes</i> Reexamination of U.S. Patent No. 7,352,300 (Control No. 95/001,924)	Right of Appeal Notice mailed 08/29/2013
<i>Inter Partes</i> Reexamination of U.S. Patent No. 7,395,345 (Control No. 95/001,925)	Patent Owner's Reply to Action Closing Prosecution filed 10/21/2013; Action Closing Prosecution mailed 09/20/2013
<i>Inter Partes</i> Reexamination of U.S. Patent No. 7,161,506 (Control No. 95/001,926)	<i>Inter Partes</i> Reexamination Certificate issued 01/08/2014
<i>Inter Partes</i> Reexamination of U.S. Patent No. 7,415,530 (Control No. 95/001,927)	<i>Inter Partes</i> Reexamination Certificate issued 08/16/2013
<i>Inter Partes</i> Reexamination of U.S. Patent No. 7,378,992 (Control No. 95/001,928)	<i>Inter Partes</i> Reexamination Certificate issued 01/08/2014

/Tsfaldet Bocure/

02/19/2014

ALL REFERENCES CONSIDERED EXCEPT WHERE LINED THROUGH. /T.B./

Applicants invite the Examiner to review the Requests for Reexamination, issued Office Actions, replies, and any other papers in the above-identified reexamination proceedings. If the Examiner is unable to obtain copies of papers in any reexamination proceeding, copies can be provided to the Examiner upon request. Those documents which may be material that are not already of record in this patent application are listed on the accompanying Form PTO/SB/08. For example, documents related to the reexaminations are listed as **NPL670-NPL840** and **NPL851-NPL868**.

Notice of Related Litigation

Applicants notify the Patent and Trademark Office of the following litigation involving U.S. Patents commonly-owned with the current patent application, the subject matter of which may be related to the present patent application:

No.	Case	Status
1	<i>Realtime Data LLC d/b/a IXO v. Packeteer, Inc. et al.</i> , No. 6:08-cv-00144-LED (E.D. Texas)	Dismissed

Applicants also notify the Patent and Trademark Office of the following additional litigation involving U.S. Patents commonly-owned with the current patent application, the subject matter of which may be related to the present patent application:

No.	Case	Status
2	<i>Realtime Data LLC d/b/a IXO v. Thomson Reuters Corporation et al.</i> No. 1:11-cv-06698-RJH (S.D. New York) (transferred from E.D. Texas; 6:09-cv-00333-LED)	Opinion of the Court of Appeals for the Federal Circuit received 01/27/2014
3	<i>Realtime Data LLC d/b/a IXO v. Morgan Stanley et al.</i> , No. 1:11-cv-06696-RJH (S.D. New York) (transferred from E.D. Texas; 6:09-cv-00326-LED)	Opinion of the Court of Appeals for the Federal Circuit received

/Tsfaldet Bocure/

02/19/2014

Atty. Dkt. No. 2855.0050008

ALL REFERENCES CONSIDERED EXCEPT WHERE LINED THROUGH. /T.B./

		01/27/2014
4	<i>Realtime Data LLC d/b/a IXO v. CME Group Inc., et al.</i> , No. 1:11-cv-06697-RJH (S.D. New York) (transferred from E.D. Texas; No. 6:09-cv-00327-LED)	Opinion of the Court of Appeals for the Federal Circuit received 01/27/2014
5	<i>Chicago Board Options Exchange, Inc., v. Realtime Data LLC d/b/a IXO</i> , No. 09-cv-4486 (N.D. Ill.)	Dismissed
6	<i>Thomson Reuters Corporation v. Realtime Data, LLC d/b/a IXO</i> , No. 1:09-cv-07868-RMB (S.D.N.Y)	Consolidated with Case No. 2
7	<i>Realtime Data, LLC d/b/a IXO v. CME Group Inc., et al. (II)</i> , No. 6:10-cv-246 (E.D. Texas)	Consolidated with Case No. 4
8	<i>Realtime Data LLC d/b/a IXO v. Thomson Reuters Corporation et al. (II)</i> , No. 6:10-cv-247 (E.D. Texas)	Consolidated with Case No. 2
9	<i>Realtime Data, LLC d/b/a IXO v. Morgan Stanley, et al. (II)</i> , No. 6:10-cv-248 (E.D. Texas)	Consolidated with Case No. 3
10	<i>Realtime Data, LLC d/b/a IXO v. MetroPCS Texas, LLC et al.</i> , No. 6:10-cv-00493 (E.D. Texas)	Notice of Appeal Filed

Updated court docket listings for litigations previously disclosed and pending are submitted herewith as **NPL566-NPL572** and **NPL869-NPL872**.

Information Disclosure Statement

Listed on accompanying IDS Forms PTO/SB/08a equivalent and PTO/SB/08b equivalent are documents that may be considered material to the patentability of this application as defined in 37 C.F.R. §1.56, and in compliance with the duty of disclosure requirements of 37 C.F.R. §§ 1.97 and 1.98.

Applicants have listed publication dates on the attached IDS Forms based on information presently available to the undersigned. However, the listed publication dates should not be construed as an admission that the information was actually published on the date indicated.

/Tsfaldet Bocure/

02/19/2014

ALL REFERENCES CONSIDERED EXCEPT WHERE LINED THROUGH. /T.B./



Applicants reserve the right to establish the patentability of the claimed invention over any of the information provided herewith, and/or to prove that this information may not be prior art, and/or to prove that this information may not be enabling for the teachings purportedly offered.

This statement should not be construed as a representation that a search has been made, or that information more material to the examination of the present patent application does not exist. The Examiner is specifically requested not to rely solely on the material submitted herewith.

Filing under 37 C.F.R. § 1.97(b). This Information Disclosure Statement is being filed before the mailing of a first Office Action and after the filing of a request for continued examination under 37 C.F.R. § 1.114. No statement or fee is required.

Documents **US1-US579** and **FP1-FP27** are cited on the attached form PTO/SB/08A. Documents **NPL1-NPL875** are cited on the attached form PTO/SB/08B. Copies of documents **NPL841-NPL874** are submitted. However, in accordance with 37 C.F.R. § 1.98(a)(2), no copies of U.S. patents and patent application publications cited as **US1-US579** on the attached IDS Forms are submitted.

Copies of documents **FP1-FP27** and **NPL1-NPL840** were cited by or submitted to the Office in an IDS that complies with 37 C.F.R. § 1.98(a)-(c) in Application No. 13/154,239, filed June 6, 2011 (now U.S. Patent No. 8,553,759), and 14/033,245, filed September 20, 2013 (now pending), which are relied upon for an earlier filing date under 35 U.S.C. § 120. Thus, copies of these documents are not attached. 37 C.F.R. § 1.98(d).

/Tsfaldet Bocure/

02/19/2014

Additionally, a copy of document **NPL875**, cited on the attached IDS Form, is not provided in accordance with the U.S. Patent and Trademark Office Official Gazette notice of October 19, 2004, which states: "the requirement in 37 C.F.R. § 1.98(a)(2)(iii) for a legible copy of the specification, including the claims, and drawings of each cited pending U.S. patent application (or portion of the application which caused it to be listed) is *sua sponte* waived where the cited pending application is stored in the USPTO's IFW system."

A concise explanation of the relevance of the non-English language documents appears below in accordance with 37 C.F.R. § 1.98(a)(3).

Document **FP1** (DE 4127518) is in the German language. An English-language abstract is as follows:

The magnetic disc storage device is connected to a host processor (5) and contains at least one magnetic disc for the storage of data with system startup data in a startup data region, a buffer memory (2) for data to be transferred from the disc/host computer and a data communication device (1). The data communication device transfers the startup data from the startup data region into the buffer memory at the time of system startup. The storage device can be used as an external memory device. **ADVANTAGE** - Enables very short startup times to be achieved for memory systems.

Document **FP12** (JP 6051989) is in the Japanese language. An English-language abstract is as follows:

/Tsfaldet Bocure/

02/19/2014

PURPOSE: To perform the fast load processing of an operating system without performing the read processing of volume information for the whole device in spite of the presence/absence of a restore command in the initial load processing of the operating system.

CONSTITUTION: This system is provided with the device name instruction means 2 of a system storage file volume which instructs a volume in which a system storage file is stored in a device name by a REST command to instruct the generation of a system residence volume, the acquiring means 3 of the correspondence table of the device name with a channel number, a channel number acquiring means 4 to acquire the channel number from the device name of the volume, a restore processing means 5 which performs the generation processing of the system residence volume based on the device name and the channel number, and a device name/channel number correspondence table 6.

Document **FP13** (JP 9188009) is in the Japanese language. An English-language abstract is as follows:

PROBLEM TO BE SOLVED: To provide a printer capable of enhancing a compression ratio by electing a compression method fitted to data from a plurality of compression methods to perform compression and the data compressing method in the printer.

SOLUTION: A laser beam printer is equipped with an ROM 4 storing a plurality of preset compression methods and a CPU 3 having a data kind discriminating

/Tsfaldet Bocure/

02/19/2014

ALL REFERENCES CONSIDERED EXCEPT WHERE LINED THROUGH. /T.B./

function analyzing the command of received data and discriminating the kind of data on the basis of the analytical result, a compression method selecting function selecting the compression method fitted to the kind of the discriminated data from a plurality of the compression methods stored in the ROM 4 and data compressing function compressing the data on the basis of the selected compression method.

Document **FP14** (JP 11149376) is in the Japanese language. An English-language abstract is as follows:

**PROBLEM TO BE SOLVED:** To provide a more flexible software development environment by realizing the same function with a circuit mounting an Initial Program Loader ROM in circuit constitution of a smaller scale.

**SOLUTION:** A BOOT loader circuit is provided with a BOOT detection part 4 for detecting whether a system becomes a BOOT mode or not, an address decoder 5 for generating a selection signal for each device, switch parts 6 and 7 for selecting ROM and the external input interface and a CPU stop control part 8 for instructing the stop of CPU various conditions.

Document **FP18** (WO 95/29437 A1) is in the Japanese language. An English-language abstract is as follows:

A differential value and compressibility calculating means (76) of a data processing means (71) of a data transmitter calculates the actual differential value and the actual compressibility based on the data length of uncompressed data

/Tesfaldet Bocure/

02/19/2014

ALL REFERENCES CONSIDERED EXCEPT WHERE LINED THROUGH. /T.B./

received from a data outputting source (2) through an uncompressed data receiving means (74) and the data length of compressed data from a data compressing circuit (67). When the actual differential value is equal to or larger than a set differential value alpha, at the same time, the actual compressibility is equal to or larger than a set compressibility beta, the means (76) transmits the compressed data to a destination (3) through a transfer-requested data outputting means (79), and, in the other cases, transmits the uncompressed data to the destination (3). Therefore, such a phenomenon that the area occupied by compressed data in the memory area in the destination (3) is almost equal to the area occupied by uncompressed data in the memory area can be prevented, and useless data expansion can be avoided at the destination (3).

Document **FP27** (JP 04-241681) is in the Japanese language. An English-language abstract is as follows:

**PURPOSE:** To provide a means which can make optimum compression on data of any kinds of data pattern and can improve the data compressing efficiency.

**CONSTITUTION:** At the time of storing data, the data are compressed by means of compression circuits 11 and 12 of plural data compressing systems and counted results of the byte numbers of the compressed data are compared with each other after the byte numbers are counted. Then the compressed data of the smallest amount are selected and stored in a storing section 2 after adding a code indicating the compressing system. At the time of reading out the recorded data, the data are restored to the original data by selecting the corresponding

/Tesfaldet Bocure/

02/19/2014

Atty. Dkt. No. 2855.0050008  
ALL REFERENCES CONSIDERED EXCEPT WHERE LINED THROUGH. /T.B./

restoration circuit 31 or 32 in accordance with the added code indicating the compressing system.

Applicants submit herewith actions from co-pending, commonly assigned U.S. Patent Applications as documents **NPL573-NPL658**, **NPL841-NPL850**, and **NPL874**. The identification of these actions is not to be construed as a waiver of secrecy as to those applications now or upon issuance of the present application as a patent. The Examiner is respectfully requested to consider the cited applications and the art cited therein during examination.

It is expected that the examiner will review the prosecution and cited art in the parent application nos. 10/076,013, filed February 13, 2002 (now U.S. Patent No. 7,386,046); 12/123,081, filed May 19, 2008 (now U.S. Patent No. 8,073,047); 13/154,239, filed June 6, 2011 (now U.S. Patent No. 8,553,759); and 14/033,245, filed September 20, 2013 (now pending), in accordance with MPEP 2001.06(b), and indicate in the next communication from the office that the art cited in the earlier prosecution history has been reviewed in connection with the present application.

It is respectfully requested that the Examiner initial and return a copy of the enclosed IDS Forms, and indicate in the official file wrapper of this patent application that the documents have been considered.

/Tsfaldet Bocure/

02/19/2014

The U.S. Patent and Trademark Office is hereby authorized to charge any fee deficiency, or credit any overpayment, to our Deposit Account No. 19-0036.

Respectfully submitted,

STERNE, KESSLER, GOLDSTEIN & FOX P.L.L.C.

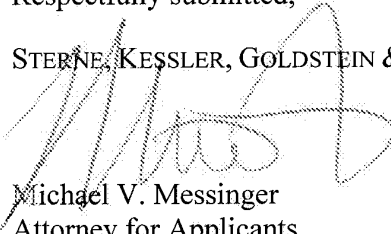

Michael V. Messinger  
Attorney for Applicants  
Registration No. 37,575

Date:

February 12, 2018

1100 New York Avenue, N.W.  
Washington, D.C. 20005-3934  
(202) 371-2600

1802087\_1

Substitute for form 1449/PTO		<b>Complete if Known</b>	
<b>INFORMATION DISCLOSURE STATEMENT BY APPLICANT</b> <i>(Use as many sheets as necessary)</i>		Application Number	14/134,926
		Filing Date	December 19, 2013
		First Named Inventor	James J. FALLON
		Art Unit	2634
		Examiner Name	BOCURE, Tesfaldet
		Attorney Docket Number	2855.0050008
Sheet	1	of	29

<b>U.S. PATENT DOCUMENTS</b>						
Examiner initials*	Cite No. <sup>1</sup>	Document Number		Publication Date MM-DD-YYYY	Name of Patentee or Applicant of Cited Document	Pages, Columns, Lines, Where Relevant Passages or Relevant Figures Appear
		Number-Kind Code <sup>2</sup> (if known)				
	US1	3,394,352		07-23-1968	Wernikoff et al.	
	US2	3,490,690		01-20-1970	Apple et al.	
	US3	4,021,782		05-03-1977	Hoerning	
	US4	4,032,893		06-28-1977	Moran	
	US5	4,054,951		10-18-1977	Jackson et al.	
	US6	4,127,518		11-28-1978	Coy et al.	
	US7	4,302,775		11-24-1981	Widergren et al.	
	US8	4,325,085		04-13-1982	Gooch	
	US9	4,360,840		11-23-1982	Wolfrun et al.	
	US10	4,386,416		05-31-1983	Giltner et al.	
	US11	4,394,774		07-19-1983	Widergren et al.	
	US12	4,464,650		08-07-1984	Eastman	
	US13	4,494,108		01-15-1985	Langdon, Jr. et al.	
	US14	4,499,499		02-12-1985	Brickman et al.	
	US15	4,574,351		03-04-1986	Dang et al.	
	US16	4,593,324		06-03-1986	Ohkubo et al.	
	US17	4,626,829		12-02-1986	Hauck	
	US18	4,646,061		02-24-1987	Bledsoe	
	US19	4,682,150		07-21-1987	Mathes et al.	
	US20	4,701,745		10-20-1987	Waterworth	

<b>FOREIGN PATENT DOCUMENTS</b>							
Examiner initials*	Cite No. <sup>1</sup>	Foreign Patent Document		Publication Date MM-DD-YYYY	Name of Patentee or Applicant of Cited Document	Pages, Columns, Lines, Where Relevant Passages or Relevant Figures Appear	T <sup>6</sup>
		Country Code <sup>3</sup> -Number <sup>4</sup> -Kind Code <sup>5</sup> (if known)					
	FP1	DE	4127518	02-27-1992	Tokico Ltd		
	FP2	EP	0 164 677	12-18-1985	Texas Instruments Inc		
	FP3	EP	0 185 098	06-25-1986	Hitachi Ltd		
	FP4	EP	0 283 798	09-28-1988	International Business Machines Corporation		
	FP5	EP	0 405 572	01-02-1991	Fujitsu Limited		
	FP6	EP	0 493 130	07-01-1992	Canon Kabushiki Kaisha		
	FP7	EP	0 587 437	03-16-1994	International Business Machines Corporation		
	FP8	EP	0 595 406	05-04-1994	Philips Electronics		

Examiner Signature	/Tefaldet Bocure/	Date Considered	02/19/2014
--------------------	-------------------	-----------------	------------

\*EXAMINER: Initial if reference considered, whether or not citation is in conformance with MPEP 609. Draw line through citation if not in conformance and not considered. Include copy of this form with next communication to applicant. <sup>1</sup> Applicant's unique citation designation number (optional). <sup>2</sup> See Kinds Codes of USPTO Patent Documents at www.uspto.gov or MPEP 901.04. <sup>3</sup> Enter Office that issued the document, by the two-letter code (WIPO Standard ST.3). <sup>4</sup> For Japanese patent documents, the indication of the year of the reign of the Emperor must precede the serial number of the patent document. <sup>5</sup> Kind of document by the appropriate symbols as indicated on the document under WIPO Standard ST.3. If possible, Applicant is to check or checkmark if English language translation is attached.



Substitute for form I449/PTO				<b>Complete if Known</b>	
<b>INFORMATION DISCLOSURE STATEMENT BY APPLICANT</b> <i>(Use as many sheets as necessary)</i>				Application Number	14/134,926
				Filing Date	December 19, 2013
				First Named Inventor	James J. FALLON
				Art Unit	2634
				Examiner Name	BOCURE, Tesfaldet
Sheet	2	of	29	Attorney Docket Number	2855.0050008

U.S. PATENT DOCUMENTS						
Examiner initials*	Cite No. <sup>1</sup>	Document Number		Publication Date MM-DD-YYYY	Name of Patentee or Applicant of Cited Document	Pages, Columns, Lines, Where Relevant Passages or Relevant Figures Appear
		Number-Kind Code <sup>2</sup> (if known)				
	US21	4,729,020		03-01-1988	Schaphorst et al.	
	US22	4,730,348		03-08-1988	MacCrisken	
	US23	4,745,559		05-17-1988	Willis et al.	
	US24	4,748,638		05-31-1988	Freidman et al.	
	US25	4,750,135		06-07-1988	Boilen	
	US26	4,754,351		06-28-1988	Wright	
	US27	4,804,959		02-14-1989	Makansi et al.	
	US28	4,813,040		03-14-1989	Futato	
	US29	4,814,746		03-21-1989	Miller et al.	
	US30	4,862,167		08-29-1989	Copeland, III	
	US31	4,866,601		09-12-1989	DuLac et al.	
	US32	4,870,415		09-26-1989	Van Maren et al.	
	US33	4,872,009		10-03-1989	Tsukiyama et al.	
	US34	4,876,541		10-24-1989	Storer	
	US35	4,888,812		12-19-1989	Dinan et al.	
	US36	4,890,282		12-26-1989	Lambert et al.	
	US37	4,897,717		01-30-1990	Hamilton et al.	
	US38	4,906,991		03-06-1990	Fiala et al.	
	US39	4,906,995		03-06-1990	Swanson	
	US40	4,929,946		05-29-1990	O'Brien et al.	

FOREIGN PATENT DOCUMENTS							
Examiner initials*	Cite No. <sup>1</sup>	Foreign Patent Document		Publication Date MM-DD-YYYY	Name of Patentee or Applicant of Cited Document	Pages, Columns, Lines, Where Relevant Passages or Relevant Figures Appear	T6
		Country Code <sup>3</sup>	Number <sup>4</sup> -Kind Code <sup>5</sup> (if known)				
	FP9	EP	0 718 751	06-26-1996	International Business Machines Corporation		
	FP10	EP	0 928 070 A2	07-07-1999	Unwired Planet, Inc.		
	FP11	GB	2162025	01-22-1986	King Reginald Alfred		
	FP12	JP	6051989	02-25-1994	NEC Corp		
	FP13	JP	9188009	07-22-1997	Canon Inc		
	FP14	JP	11149376	06-02-1999	Toyo Commun Equip Co. Ltd		
	FP15	WO	9414273	06-23-1994	Voxson International Pty Ltd		
	FP16	WO	9429852	12-22-1994	Maxtor Corp		

Examiner Signature	/Tefaldet Bocure/	Date Considered	02/19/2014
--------------------	-------------------	-----------------	------------

\*EXAMINER: Initial if reference considered, whether or not citation is in conformance with MPEP 609. Draw line through citation if not in conformance and not considered. Include copy of this form with next communication to applicant. <sup>1</sup> Applicant's unique citation designation number (optional). <sup>2</sup> See Kinds Codes of USPTO Patent Documents at www.uspto.gov or MPEP 901.04. <sup>3</sup> Enter Office that issued the document, by the two-letter code (WIPO Standard ST.3). <sup>4</sup> For Japanese patent documents, the indication of the year of the reign of the Emperor must precede the serial number of the patent document. <sup>5</sup> Kind of document by the appropriate symbols as indicated on the document under WIPO Standard ST.3. If possible, Applicant is to check a checkmark in the English language Translation is attached.

Substitute for form 1449/PTO				<i>Complete if Known</i>	
<b>INFORMATION DISCLOSURE STATEMENT BY APPLICANT</b> <i>(Use as many sheets as necessary)</i>				Application Number	14/134,926
				Filing Date	December 19, 2013
				First Named Inventor	James J. FALLON
				Art Unit	2634
				Examiner Name	BOCURE, Tesfaldet
Sheet	3	of	29	Attorney Docket Number	2855.0050008

U.S. PATENT DOCUMENTS						
Examiner initials*	Cite No. <sup>1</sup>	Document Number		Publication Date MM-DD-YYYY	Name of Patentee or Applicant of Cited Document	Pages, Columns, Lines, Where Relevant Passages or Relevant Figures Appear
		Number-Kind Code <sup>2</sup> (if known)				
	US41	4,953,324		09-04-1990	Hermann	
	US42	4,956,808		09-11-1990	Aakre et al.	
	US43	4,965,675		10-23-1990	Hori et al.	
	US44	4,988,998		01-29-1991	O'Brien	
	US45	5,003,307		03-26-1991	Whiting et al.	
	US46	5,016,009		05-14-1991	Whiting et al.	
	US47	5,027,376		06-25-1991	Freidman et al.	
	US48	5,028,922		07-02-1991	Huang	
	US49	5,045,848		09-03-1991	Fascenda	
	US50	5,045,852		09-03-1991	Mitchell et al.	
	US51	5,046,027		09-03-1991	Taaffe et al.	
	US52	5,049,881		09-17-1991	Gibson et al.	
	US53	5,091,782		02-25-1992	Krause et al.	
	US54	5,097,261		03-17-1992	Langdon, Jr. et al.	
	US55	5,109,226		04-28-1992	MacLean, Jr. et al.	
	US56	5,109,433		04-28-1992	Notenboom	
	US57	5,113,522		05-12-1992	Dinwiddie, Jr. et al.	
	US58	5,115,309		05-19-1992	Hang	
	US59	5,121,342		06-09-1992	Szymborski	
	US60	5,126,739		06-30-1992	Whiting et al.	

FOREIGN PATENT DOCUMENTS							
Examiner initials*	Cite No. <sup>1</sup>	Foreign Patent Document		Publication Date MM-DD-YYYY	Name of Patentee or Applicant of Cited Document	Pages, Columns, Lines, Where Relevant Passages or Relevant Figures Appear	T <sup>6</sup>
		Country Code <sup>3</sup> -Number <sup>4</sup> -Kind Code <sup>5</sup> (if known)					
	FP17	WO	9502873	01-26-1995	Philips Electronics		
	FP18	WO	95/29437 A1	11-02-1995	Sony Corp		
	FP19	WO	9748212	12-18-1997	Nokia Telecommunications		
	FP20	WO	9839699 A2	09-11-1998	Intelligent Compression Technologies		
	FP21	WO	9908186	02-18-1999	Macronix International Co, Ltd		
	FP22	WO	0036754 A1	06-22-2000	Microsoft Corporation		
	FP23	WO	01/057642	08-09-2001	Realtime Data LLC		
	FP24	WO	01/057659	08-09-2001	Realtime Data LLC		

Examiner Signature	/Tefaldet Bocure/	Date Considered	02/19/2014
--------------------	-------------------	-----------------	------------

\*EXAMINER: Initial if reference considered, whether or not citation is in conformance with MPEP 609. Draw line through citation if not in conformance and not considered. Include copy of this form with next communication to applicant. <sup>1</sup> Applicant's unique citation designation number (optional). <sup>2</sup> See Kinds Codes of USPTO Patent Documents at www.uspto.gov or MPEP 901.04. <sup>3</sup> Enter Office that issued the document, by the two-letter code (WIPO Standard ST.3). <sup>4</sup> For Japanese patent documents, the indication of the year of the reign of the Emperor must precede the serial number of the patent document. <sup>5</sup> Kind of document by the appropriate initials as indicated on the document under WIPO Standard ST.3. If possible, Applicant is to place a check mark in the English language Translation is attached.

Substitute for form 1449/PTO		<i>Complete if Known</i>	
<b>INFORMATION DISCLOSURE STATEMENT BY APPLICANT</b> <i>(Use as many sheets as necessary)</i>		Application Number	14/134,926
		Filing Date	December 19, 2013
		First Named Inventor	James J. FALLON
		Art Unit	2634
		Examiner Name	BOCURE, Tesfaldet
		Attorney Docket Number	2855.0050008
Sheet	4	of	29

**U.S. PATENT DOCUMENTS**

Examiner initials*	Cite No. <sup>1</sup>	Document Number	Publication Date MM-DD-YYYY	Name of Patentee or Applicant of Cited Document	Pages, Columns, Lines, Where Relevant Passages or Relevant Figures Appear
		Number-Kind Code <sup>2</sup> (if known)			
	US61	5,128,963	07-07-1992	Akagiri	
	US62	5,132,992	07-21-1992	Yurt et al.	
	US63	5,146,221	09-08-1992	Whiting et al.	
	US64	5,150,430	09-22-1992	Chu	
	US65	5,155,484	10-13-1992	Chambers, IV	
	US66	5,159,336	10-27-1992	Rabin et al.	
	US67	5,167,034	11-24-1992	MacLean, Jr. et al.	
	US68	5,175,543	12-29-1992	Lantz	
	US69	5,179,651	01-12-1993	Taaffe et al.	
	US70	5,187,793	02-16-1993	Keith et al.	
	US71	5,191,431	03-02-1993	Hasegawa et al.	
	US72	5,204,756	04-20-1993	Chevion et al.	
	US73	5,209,220	05-11-1993	Hiyama et al.	
	US74	5,212,742	05-18-1993	Normile et al.	
	US75	5,226,176	07-06-1993	Westaway et al.	
	US76	5,227,893	07-13-1993	Ett	
	US77	5,231,492	07-27-1993	Dangi et al.	
	US78	5,237,460	08-17-1993	Miller et al.	
	US79	5,237,675	08-17-1993	Hannon, Jr.	
	US80	5,243,341	09-07-1993	Seroussi et al.	

**FOREIGN PATENT DOCUMENTS**

Examiner initials*	Cite No. <sup>1</sup>	Foreign Patent Document	Publication Date MM-DD-YYYY	Name of Patentee or Applicant of Cited Document	Pages, Columns, Lines, Where Relevant Passages or Relevant Figures Appear	T <sup>6</sup>
		Country Code <sup>3</sup> -Number <sup>4</sup> -Kind Code <sup>5</sup> (if known)				
	FP25	WO 01/63772	08-30-2001	Physical Optics Corporation		
	FP26	WO 02/39591	05-16-2002	Realtime Data LLC		
	FP27	JP 04-241681	08-28-1992	Fujitsu Limited		

Examiner Signature	/Tesfaldet Bocure/	Date Considered	02/19/2014
--------------------	--------------------	-----------------	------------

\*EXAMINER: Initial if reference considered, whether or not citation is in conformance with MPEP 609. Draw line through citation if not in conformance and not considered. Include copy of this form with next communication to applicant. <sup>1</sup> Applicant's unique citation designation number (optional). <sup>2</sup> See Kinds Codes of USPTO Patent Documents at www.uspto.gov or MPEP 901.04. <sup>3</sup> Enter Office that issued the document, by the two-letter code (WIPO Standard ST.3). <sup>4</sup> For Japanese patent documents, the indication of the year of the reign of the Emperor must precede the serial number of the patent document. <sup>5</sup> Kind of document by the appropriate symbols in the table of symbols in the Manual of Patent Examining Procedure. <sup>6</sup> If appropriate, the applicant is directed to file a copy of the English language Translation is attached.

<b>INFORMATION DISCLOSURE STATEMENT BY APPLICANT</b> <i>(Use as many sheets as necessary)</i>				<b>Complete if Known</b>	
				Application Number	14/134,926
				Filing Date	December 19, 2013
				First Named Inventor	James J. FALLON
				Art Unit	2634
				Examiner Name	BOCURE, Tesfaldet
Sheet	5	of	29	Attorney Docket Number	2855.0050008

U.S. PATENT DOCUMENTS						
Examiner initials*	Cite No. <sup>1</sup>	Document Number		Publication Date MM-DD-YYYY	Name of Patentee or Applicant of Cited Document	Pages, Columns, Lines, Where Relevant Passages or Relevant Figures Appear
		Number-Kind Code <sup>2</sup> (if known)				
	US81	5,243,348		09-07-1993	Jackson	
	US82	5,247,638		09-21-1993	O'Brien et al.	
	US83	5,247,646		09-21-1993	Osterlund et al.	
	US84	5,249,053		09-28-1993	Jain	
	US85	5,263,168		11-16-1993	Toms et al.	
	US86	5,267,333		11-30-1993	Aono	
	US87	5,270,832		12-14-1993	Balkanski et al.	
	US88	5,280,600		01-18-1994	Van Maren et al.	
	US89	5,287,420		02-15-1994	Barrett	
	US90	5,289,580		02-22-1994	Latif et al.	
	US91	5,293,379		03-08-1994	Carr	
	US92	5,293,576		03-08-1994	Mihm, Jr. et al.	
	US93	5,307,497		04-26-1994	Feigenbaum et al.	
	US94	5,309,555		05-03-1994	Akins et al.	
	US95	5,319,682		06-07-1994	Clark	
	US96	5,331,425		07-19-1994	Ozaki et al.	
	US97	5,341,440		08-23-1994	Earl et al.	
	US98	5,347,600		09-13-1994	Barnsley et al.	
	US99	5,353,132		10-04-1994	Katsuma	
	US100	5,354,315		10-11-1994	Armstrong	

FOREIGN PATENT DOCUMENTS							
Examiner initials*	Cite No. <sup>1</sup>	Foreign Patent Document		Publication Date MM-DD-YYYY	Name of Patentee or Applicant of Cited Document	Pages, Columns, Lines, Where Relevant Passages or Relevant Figures Appear	T <sup>6</sup>
		Country Code <sup>3</sup> -Number <sup>4</sup> -Kind Code <sup>5</sup> (if known)					

Examiner Signature	/Tefaldet Bocure/	Date Considered	02/19/2014
--------------------	-------------------	-----------------	------------

\*EXAMINER: Initial if reference considered, whether or not citation is in conformance with MPEP 609. Draw line through citation if not in conformance and not considered. Include copy of this form with next communication to applicant. <sup>1</sup> Applicant's unique citation designation number (optional). <sup>2</sup> See Kinds Codes of USPTO Patent Documents at www.uspto.gov or MPEP 901.04. <sup>3</sup> Enter Office that issued the document, by the two-letter code (WIPO Standard ST.3). <sup>4</sup> For Japanese patent documents, the indication of the year of the reign of the Emperor must precede the serial number of the patent document. <sup>5</sup> Kind of document by the appropriate symbols as indicated on the document under WIPO Standard ST.3. If possible, Applicant is to attach a copy of the English language Translation is attached. **ALL REFERENCES CONSIDERED EXCEPT WHERE LINED THROUGH. /T.B./**

Substitute for form 1449/PTO				<b>Complete if Known</b>	
				Application Number	14/134,926
<b>INFORMATION DISCLOSURE STATEMENT BY APPLICANT</b> <i>(Use as many sheets as necessary)</i>				Filing Date	December 19, 2013
				First Named Inventor	James J. FALLON
				Art Unit	2634
				Examiner Name	BOCURE, Tesfaldet
				Attorney Docket Number	2855.0050008
Sheet	6	of	29		

**U.S. PATENT DOCUMENTS**

Examiner initials*	Cite No. <sup>1</sup>	Document Number		Publication Date MM-DD-YYYY	Name of Patentee or Applicant of Cited Document	Pages, Columns, Lines, Where Relevant Passages or Relevant Figures Appear
		Number-Kind Code <sup>2</sup> (if known)				
	US101	5,355,498		10-11-1994	Provino et al.	
	US102	5,357,614		10-18-1994	Pattisam et al.	
	US103	5,367,629		11-22-1994	Chu et al.	
	US104	5,373,290		12-13-1994	Lempel et al.	
	US105	5,374,916		12-20-1994	Chu	
	US106	5,379,036		01-03-1995	Storer	
	US107	5,379,757		01-10-1995	Hiyama et al.	
	US108	5,381,145		01-10-1995	Allen et al.	
	US109	5,389,922		02-14-1995	Seroussi et al.	
	US110	5,394,534		02-28-1995	Kulakowski et al.	
	US111	5,396,228		03-07-1995	Garahi	
	US112	5,400,401		03-21-1995	Wasilewski et al.	
	US113	5,403,639		04-04-1995	Belsan et al.	
	US114	5,406,278		04-11-1995	Graybill et al.	
	US115	5,406,279		04-11-1995	Anderson et al.	
	US116	5,410,671		04-25-1995	Elgamal et al.	
	US117	5,412,384		05-02-1995	Chang et al.	
	US118	5,414,850		05-09-1995	Whiting	
	US119	5,420,639		05-30-1995	Perkins	
	US120	5,434,983		07-18-1995	Yaso et al.	

**FOREIGN PATENT DOCUMENTS**

Examiner initials*	Cite No. <sup>1</sup>	Foreign Patent Document		Publication Date MM-DD-YYYY	Name of Patentee or Applicant of Cited Document	Pages, Columns, Lines, Where Relevant Passages or Relevant Figures Appear	T <sup>6</sup>
		Country Code <sup>3</sup> , Number <sup>4</sup> , Kind Code <sup>5</sup> (if known)					

Examiner Signature	/Tsfaldet Bcure/	Date Considered	02/19/2014
--------------------	------------------	-----------------	------------

\*EXAMINER: Initial if reference considered, whether or not citation is in conformance with MPEP 609. Draw line through citation if not in conformance and not considered. Include copy of this form with next communication to applicant. <sup>1</sup> Applicant's unique citation designation number (optional). <sup>2</sup> See Kinds Codes of USPTO Patent Documents at [www.uspto.gov](http://www.uspto.gov) or MPEP 901.04. <sup>3</sup> Enter Office that issued the document, by the two-letter code (WIPO Standard ST.3). <sup>4</sup> For Japanese patent documents, the indication of the year of the reign of the Emperor must precede the serial number of the patent document. <sup>5</sup> Kind of document by the appropriate symbols as indicated on the document under WIPO Standard ST.3. If possible, Applicant is to check a checked item if an English language Translation is attached. **ALL REFERENCES CONSIDERED EXCEPT WHERE LINED THROUGH. /T.B./**

Substitute for form 1449/PTO		<b>Complete if Known</b>	
<b>INFORMATION DISCLOSURE STATEMENT BY APPLICANT</b> <i>(Use as many sheets as necessary)</i>		Application Number	14/134,926
		Filing Date	December 19, 2013
		First Named Inventor	James J. FALLON
		Art Unit	2634
		Examiner Name	BOCURE, Tesfaldet
		Attorney Docket Number	2855.0050008
Sheet	7	of	29

**U.S. PATENT DOCUMENTS**

Examiner initials*	Cite No. <sup>1</sup>	Document Number		Publication Date MM-DD-YYYY	Name of Patentee or Applicant of Cited Document	Pages, Columns, Lines, Where Relevant Passages or Relevant Figures Appear
		Number-Kind Code <sup>2</sup> (if known)				
	US121	5,437,020		07-25-1995	Wells et al.	
	US122	5,452,287		09-19-1995	Dicecco et al.	
	US123	5,454,079		09-26-1995	Roper et al.	
	US124	5,454,107		09-26-1995	Lehman et al.	
	US125	5,455,576		10-03-1995	Clark, II et al.	
	US126	5,455,578		10-03-1995	Bhandari	
	US127	5,455,680		10-03-1995	Shin	
	US128	5,461,679		10-24-1995	Normile et al.	
	US129	5,463,390		10-31-1995	Whiting et al.	
	US130	5,467,087		11-14-1995	Chu	
	US131	5,471,206		11-28-1995	Allen et al.	
	US132	5,475,388		12-12-1995	Gormish et al.	
	US133	5,479,587		12-26-1995	Campbell et al.	
	US134	5,479,633		12-26-1995	Wells et al.	
	US135	5,483,470		01-09-1996	Alur et al.	
	US136	5,486,826		01-23-1996	Remillard	
	US137	5,488,364		01-30-1996	Cole	
	US138	5,488,365		01-30-1996	Seroussi et al.	
	US139	5,495,244		02-27-1996	Jeong et al.	
	US140	5,504,842		04-02-1996	Gentile	

**FOREIGN PATENT DOCUMENTS**

Examiner initials*	Cite No. <sup>1</sup>	Foreign Patent Document		Publication Date MM-DD-YYYY	Name of Patentee or Applicant of Cited Document	Pages, Columns, Lines, Where Relevant Passages or Relevant Figures Appear	T <sup>6</sup>
		Country Code <sup>3</sup> -Number <sup>4</sup> -Kind Code <sup>5</sup> (if known)					

Examiner Signature	/Tefaldet Bocure/	Date Considered	02/19/2014
--------------------	-------------------	-----------------	------------

\*EXAMINER: Initial if reference considered, whether or not citation is in conformance with MPEP 609. Draw line through citation if not in conformance and not considered. Include copy of this form with next communication to applicant. <sup>1</sup> Applicant's unique citation designation number (optional). <sup>2</sup> See Kinds Codes of USPTO Patent Documents at [www.uspto.gov](http://www.uspto.gov) or MPEP 901.04. <sup>3</sup> Enter Office that issued the document, by the two-letter code (WIPO Standard ST.3). <sup>4</sup> For Japanese patent documents, the indication of the year of the reign of the Emperor must precede the serial number of the patent document. <sup>5</sup> Kind of document by the appropriate initials as indicated on the document under the Standard ST.60 if possible. Applicant's language must be indicated. If the English language Translation is attached.

**ALL REFERENCES CONSIDERED EXCEPT WHERE LINED THROUGH. /T.B./**

Substitute for form 1449/PTO			<i>Complete if Known</i>	
			Application Number	14/134,926
<b>INFORMATION DISCLOSURE STATEMENT BY APPLICANT</b> <i>(Use as many sheets as necessary)</i>			Filing Date	December 19, 2013
			First Named Inventor	James J. FALLON
			Art Unit	2634
			Examiner Name	BOCURE, Tesfaldet
			Attorney Docket Number	2855.0050008
Sheet	8	of	29	

<b>U.S. PATENT DOCUMENTS</b>						
Examiner initials*	Cite No. <sup>1</sup>	Document Number		Publication Date MM-DD-YYYY	Name of Patentee or Applicant of Cited Document	Pages, Columns, Lines, Where Relevant Passages or Relevant Figures Appear
		Number-Kind Code <sup>2</sup> (if known)				
	US141	5,506,844		04-09-1996	Rao	
	US142	5,506,872		04-09-1996	Mohler	
	US143	5,506,944		04-09-1996	Gentile	
	US144	5,521,940		05-28-1996	Lane et al.	
	US145	5,528,628		06-18-1996	Park et al.	
	US146	5,530,845		06-25-1996	Hiatt et al.	
	US147	5,533,051		07-02-1996	James	
	US148	5,535,311		07-09-1996	Zimmerman	
	US149	5,535,356		07-09-1996	Kim et al.	
	US150	5,535,369		07-09-1996	Wells et al.	
	US151	5,537,658		07-16-1996	Bakke et al.	
	US152	5,539,865		07-23-1996	Gentile	
	US153	5,542,031		07-30-1996	Douglass et al.	
	US154	5,544,290		08-06-1996	Gentile	
	US155	5,546,395		08-13-1996	Sharma et al.	
	US156	5,546,475		08-13-1996	Bolle et al.	
	US157	5,553,160		09-03-1996	Dawson	
	US158	5,557,551		09-17-1996	Craft	
	US159	5,557,668		09-17-1996	Brady	
	US160	5,557,749		09-17-1996	Norris	

<b>FOREIGN PATENT DOCUMENTS</b>							
Examiner initials*	Cite No. <sup>1</sup>	Foreign Patent Document		Publication Date MM-DD-YYYY	Name of Patentee or Applicant of Cited Document	Pages, Columns, Lines, Where Relevant Passages or Relevant Figures Appear	T6
		Country Code <sup>3</sup>	Number <sup>4</sup> -Kind Code <sup>5</sup> (if known)				

Examiner Signature	/Tefaldet Bocure/	Date Considered	02/19/2014
--------------------	-------------------	-----------------	------------

\*EXAMINER: Initial if reference considered, whether or not citation is in conformance with MPEP 609. Draw line through citation if not in conformance and not considered. Include copy of this form with next communication to applicant. <sup>1</sup> Applicant's unique citation designation number (optional). <sup>2</sup> See Kinds Codes of USPTO Patent Documents at www.uspto.gov or MPEP 901.04. <sup>3</sup> Enter Office that issued the document, by the two-letter code (WIPO Standard ST.3). <sup>4</sup> For Japanese patent documents, the indication of the year of the reign of the Emperor must precede the serial number of the patent document. <sup>5</sup> Kind of document by the appropriate symbols as indicated on the document under WIPO Standard ST.3. If possible, Applicant is to check a citation in the English language Translation is attached.

Substitute for form 1449/PTO		<b>Complete if Known</b>	
<b>INFORMATION DISCLOSURE STATEMENT BY APPLICANT</b> <i>(Use as many sheets as necessary)</i>		Application Number	14/134,926
		Filing Date	December 19, 2013
		First Named Inventor	James J. FALLON
		Art Unit	2634
		Examiner Name	BOCURE, Tesfaldet
		Attorney Docket Number	2855.0050008
Sheet	9 of 29		

**U.S. PATENT DOCUMENTS**

Examiner initials*	Cite No. <sup>1</sup>	Document Number		Publication Date MM-DD-YYYY	Name of Patentee or Applicant of Cited Document	Pages, Columns, Lines, Where Relevant Passages or Relevant Figures Appear
		Number-Kind Code <sup>2</sup> (if known)				
	US161	5,561,421		10-01-1996	Smith et al.	
	US162	5,561,824		10-01-1996	Carreiro et al.	
	US163	5,563,961		10-08-1996	Rynderman et al.	
	US164	5,574,952		11-12-1996	Brady et al.	
	US165	5,574,953		11-12-1996	Rust et al.	
	US166	5,576,953		11-19-1996	Hugentobler	
	US167	5,577,248		11-19-1996	Chambers, IV	
	US168	5,581,715		12-03-1996	Verinsky et al.	
	US169	5,583,500		12-10-1996	Allen et al.	
	US170	5,586,264		12-17-1996	Belknap et al.	
	US171	5,586,285		12-17-1996	Hasbun et al.	
	US172	5,590,306		12-31-1996	Watanabe et al.	
	US173	5,596,674		01-21-1997	Bhandari et al.	
	US174	5,598,388		01-28-1997	Van Maren et al.	
	US175	5,604,824		02-18-1997	Chui et al.	
	US176	5,606,706		02-25-1997	Takamoto et al.	
	US177	5,610,657		03-11-1997	Zhang	
	US178	5,611,024		03-11-1997	Campbell et al.	
	US179	5,612,788		03-18-1997	Stone	
	US180	5,613,069		03-18-1997	Walker	

**FOREIGN PATENT DOCUMENTS**

Examiner initials*	Cite No. <sup>1</sup>	Foreign Patent Document		Publication Date MM-DD-YYYY	Name of Patentee or Applicant of Cited Document	Pages, Columns, Lines, Where Relevant Passages or Relevant Figures Appear	T <sup>6</sup>
		Country Code <sup>3</sup> -Number <sup>4</sup> -Kind Code <sup>5</sup> (if known)					

Examiner Signature	/Tefaldet Bocre/	Date Considered	02/19/2014
--------------------	------------------	-----------------	------------

\*EXAMINER: Initial if reference considered, whether or not citation is in conformance with MPEP 609. Draw line through citation if not in conformance and not considered. Include copy of this form with next communication to applicant. <sup>1</sup> Applicant's unique citation designation number (optional). <sup>2</sup> See Kinds Codes of USPTO Patent Documents at www.uspto.gov or MPEP 901.04. <sup>3</sup> Enter Office that issued the document, by the two-letter code (WIPO Standard ST.3). <sup>4</sup> For Japanese patent documents, the indication of the year of the reign of the Emperor must precede the serial number of the patent document. <sup>5</sup> Kind of document by the appropriate symbols as indicated on the document under WIPO Standard ST.3 if possible. <sup>6</sup> Applicant is required to check a corresponding box if English language Translation is attached. **ALL REFERENCES CONSIDERED EXCEPT WHERE LINED THROUGH. /T.B./**



Substitute for form 1449/PTO		<i>Complete if Known</i>	
<b>INFORMATION DISCLOSURE STATEMENT BY APPLICANT</b> <i>(Use as many sheets as necessary)</i>		Application Number	14/134,926
		Filing Date	December 19, 2013
		First Named Inventor	James J. FALLON
		Art Unit	2634
		Examiner Name	BOCURE, Tesfaldet
		Attorney Docket Number	2855.0050008
Sheet	10	of	29

U.S. PATENT DOCUMENTS						
Examiner initials*	Cite No. <sup>1</sup>	Document Number		Publication Date MM-DD-YYYY	Name of Patentee or Applicant of Cited Document	Pages, Columns, Lines, Where Relevant Passages or Relevant Figures Appear
		Number	Kind Code <sup>2</sup> (if known)			
	US181	5,615,017		03-25-1997	Choi	
	US182	5,615,287		03-25-1997	Fu et al.	
	US183	5,619,995		04-15-1997	Lobodzinski	
	US184	5,621,820		04-15-1997	Rynderman et al.	
	US185	5,623,623		04-22-1997	Kim et al.	
	US186	5,623,701		04-22-1997	Bakke et al.	
	US187	5,627,534		05-06-1997	Craft	
	US188	5,627,995		05-06-1997	Miller et al.	
	US189	5,629,732		05-13-1997	Moskowitz et al.	
	US190	5,630,092		05-13-1997	Carreiro et al.	
	US191	5,635,632		06-03-1997	Fay et al.	
	US192	5,635,932		06-03-1997	Shinagawa et al.	
	US193	5,638,498		06-10-1997	Tyler et al.	
	US194	5,640,158		06-17-1997	Okayama et al.	
	US195	5,642,506		06-24-1997	Lee	
	US196	5,649,032		07-15-1997	Burt et al.	
	US197	5,652,795		07-29-1997	Dillon et al.	
	US198	5,652,857		07-29-1997	Shimoi et al.	
	US199	5,652,917		07-29-1997	Maupin et al.	
	US200	5,654,703		08-05-1997	Clark, II	

FOREIGN PATENT DOCUMENTS							
Examiner initials*	Cite No. <sup>1</sup>	Foreign Patent Document		Publication Date MM-DD-YYYY	Name of Patentee or Applicant of Cited Document	Pages, Columns, Lines, Where Relevant Passages or Relevant Figures Appear	T <sup>6</sup>
		Country Code <sup>3</sup>	Number <sup>4</sup> -Kind Code <sup>5</sup> (if known)				

Examiner Signature	/Tesfaldet Bocure/	Date Considered	02/19/2014
--------------------	--------------------	-----------------	------------

\*EXAMINER: Initial if reference considered, whether or not citation is in conformance with MPEP 609. Draw line through citation if not in conformance and not considered. Include copy of this form with next communication to applicant. <sup>1</sup> Applicant's unique citation designation number (optional). <sup>2</sup> See Kinds Codes of USPTO Patent Documents at www.uspto.gov or MPEP 901.04. <sup>3</sup> Enter Office that issued the document, by the two-letter code (WIPO Standard ST.3). <sup>4</sup> For Japanese patent documents, the indication of the year of the reign of the Emperor must precede the serial number of the patent document. <sup>5</sup> Kind of document by the appropriate symbols as indicated in the Classification of Patent Documents. <sup>6</sup> If the patent is in a language other than English, and an English language Translation is attached.

Substitute for form 1449/PTO		<i>Complete if Known</i>	
<b>INFORMATION DISCLOSURE STATEMENT BY APPLICANT</b> <i>(Use as many sheets as necessary)</i>		Application Number	14/134,926
		Filing Date	December 19, 2013
		First Named Inventor	James J. FALLON
		Art Unit	2634
		Examiner Name	BOCURE, Testaldet
		Attorney Docket Number	2855.0050008
Sheet	11	of	29

**U.S. PATENT DOCUMENTS**

Examiner initials*	Cite No. <sup>1</sup>	Document Number		Publication Date MM-DD-YYYY	Name of Patentee or Applicant of Cited Document	Pages, Columns, Lines, Where Relevant Passages or Relevant Figures Appear
		Number-Kind Code <sup>2</sup> (if known)				
	US201	5,655,138		08-05-1997	Kikinis	
	US202	5,666,560		09-09-1997	Moertl et al.	
	US203	5,668,737		09-16-1997	Iler	
	US204	5,671,355		09-23-1997	Collins	
	US205	5,671,389		09-23-1997	Saliba	
	US206	5,671,413		09-23-1997	Shipman et al.	
	US207	5,675,333		10-07-1997	Boursier et al.	
	US208	5,675,789		10-07-1997	Ishii et al.	
	US209	5,686,916		11-11-1997	Bakhtmutsky	
	US210	5,692,159		11-25-1997	Shand	
	US211	5,694,619		12-02-1997	Konno	
	US212	5,696,927		12-09-1997	MacDonald et al.	
	US213	5,703,793		12-30-1997	Wise et al.	
	US214	5,708,511		01-13-1998	Gandhi et al.	
	US215	5,715,477		02-03-1998	Kikinis	
	US216	5,717,393		02-10-1998	Nakano et al.	
	US217	5,717,394		02-10-1998	Schwartz et al.	
	US218	5,719,862		02-17-1998	Lee et al.	
	US219	5,721,958		02-24-1998	Kikinis	
	US220	5,724,475		03-03-1998	Kirsten	

**FOREIGN PATENT DOCUMENTS**

Examiner initials*	Cite No. <sup>1</sup>	Foreign Patent Document		Publication Date MM-DD-YYYY	Name of Patentee or Applicant of Cited Document	Pages, Columns, Lines, Where Relevant Passages or Relevant Figures Appear	T <sup>6</sup>
		Country Code <sup>3</sup> -Number <sup>4</sup> -Kind Code <sup>5</sup> (if known)					

Examiner Signature	/Tesfaldet Bocure/	Date Considered	02/19/2014
--------------------	--------------------	-----------------	------------

\*EXAMINER: Initial if reference considered, whether or not citation is in conformance with MPEP 609. Draw line through citation if not in conformance and not considered. Include copy of this form with next communication to applicant. <sup>1</sup> Applicant's unique citation designation number (optional). <sup>2</sup> See Kinds Codes of USPTO Patent Documents at www.uspto.gov or MPEP 901.04. <sup>3</sup> Enter Office that issued the document, by the two-letter code (WIPO Standard ST.3). <sup>4</sup> For Japanese patent documents, the indication of the year of the reign of the Emperor must precede the serial number of the patent document. <sup>5</sup> Kind of document by the appropriate symbols from the following: (a) original document, (b) translation, (c) abstract, (d) summary, (e) other. <sup>6</sup> Possible where applicant is not the inventor. If English language Translation is attached.

Substitute for form 1449/PTO		<b>Complete if Known</b>	
<b>INFORMATION DISCLOSURE STATEMENT BY APPLICANT</b> <i>(Use as many sheets as necessary)</i>		Application Number	14/134,926
		Filing Date	December 19, 2013
		First Named Inventor	James J. FALLON
		Art Unit	2634
		Examiner Name	BOCURE, Tesfaldet
		Attorney Docket Number	2855.0050008
Sheet	12	of	29

U.S. PATENT DOCUMENTS						
Examiner initials*	Cite No. <sup>1</sup>	Document Number		Publication Date MM-DD-YYYY	Name of Patentee or Applicant of Cited Document	Pages, Columns, Lines, Where Relevant Passages or Relevant Figures Appear
		Number-Kind Code <sup>2</sup> (if known)				
	US221	5,729,228		03-17-1998	Franaszek et al.	
	US222	5,740,395		04-14-1998	Wells et al.	
	US223	5,742,773		04-21-1998	Blomfield-Brown et al.	
	US224	5,748,904		05-05-1998	Huang et al.	
	US225	5,757,852		05-26-1998	Jericevic et al.	
	US226	5,765,027		06-09-1998	Wang et al.	
	US227	5,767,898		06-16-1998	Urano et al.	
	US228	5,768,445		06-16-1998	Troeller et al.	
	US229	5,768,525		06-16-1998	Kralowetz et al.	
	US230	5,771,340		06-23-1998	Nakazato et al.	
	US231	5,774,715		06-30-1998	Madany et al.	
	US232	5,778,411		07-07-1998	DeMoss et al.	
	US233	5,781,767		07-14-1998	Inoue et al.	
	US234	5,784,572		07-21-1998	Rostoker et al.	
	US235	5,784,631		07-21-1998	Wise	
	US236	5,787,487		07-28-1998	Hashimoto et al.	
	US237	5,794,229		08-11-1998	French et al.	
	US238	5,796,864		08-18-1998	Callahan	
	US239	5,799,110		08-25-1998	Israelsen et al.	
	US240	5,805,834		09-08-1998	McKinley et al.	

FOREIGN PATENT DOCUMENTS							
Examiner initials*	Cite No. <sup>1</sup>	Foreign Patent Document		Publication Date MM-DD-YYYY	Name of Patentee or Applicant of Cited Document	Pages, Columns, Lines, Where Relevant Passages or Relevant Figures Appear	T <sup>6</sup>
		Country Code <sup>3</sup> -Number <sup>4</sup> -Kind Code <sup>5</sup> (if known)					

Examiner Signature	/Tefaldet Bocure/	Date Considered	02/19/2014
-----------------------	-------------------	--------------------	------------

\*EXAMINER: Initial if reference considered, whether or not citation is in conformance with MPEP 609. Draw line through citation if not in conformance and not considered. Include copy of this form with next communication to applicant. <sup>1</sup> Applicant's unique citation designation number (optional). <sup>2</sup> See Kinds Codes of USPTO Patent Documents at www.uspto.gov or MPEP 901.04. <sup>3</sup> Enter Office that issued the document, by the two-letter code (WIPO Standard ST.3). <sup>4</sup> For Japanese patent documents, the indication of the year of the reign of the Emperor must precede the serial number of the patent document. <sup>5</sup> Kind of document by the appropriate symbol as indicated on the front cover of the document. <sup>6</sup> If possible, applicant is to place a checkmark in the appropriate box if an English language Translation is attached.

Substitute for form 1449/PTO		<i>Complete if Known</i>	
<b>INFORMATION DISCLOSURE STATEMENT BY APPLICANT</b> <i>(Use as many sheets as necessary)</i>		Application Number	14/134,926
		Filing Date	December 19, 2013
		First Named Inventor	James J. FALLON
		Art Unit	2634
		Examiner Name	BOCURE, Tesfaldet
		Attorney Docket Number	2855.0050008
Sheet	13	of	29

U.S. PATENT DOCUMENTS						
Examiner initials*	Cite No. <sup>1</sup>	Document Number		Publication Date MM-DD-YYYY	Name of Patentee or Applicant of Cited Document	Pages, Columns, Lines, Where Relevant Passages or Relevant Figures Appear
		Number-Kind Code <sup>2</sup> (if known)				
	US241	5,805,932		09-08-1998	Kawashima et al.	
	US242	5,807,036		09-15-1998	Lostlen	
	US243	5,808,660		09-15-1998	Sekine et al.	
	US244	5,809,176		09-15-1998	Yajima	
	US245	5,809,299		09-15-1998	Cloutier et al.	
	US246	5,809,337		09-15-1998	Hannah et al.	
	US247	5,812,195		09-22-1998	Zhang	
	US248	5,812,789		09-22-1998	Diaz et al.	
	US249	5,818,368		10-06-1998	Langley	
	US250	5,818,369		10-06-1998	Withers	
	US251	5,818,530		10-06-1998	Canfield et al.	
	US252	5,819,215		10-06-1998	Dobson et al.	
	US253	5,822,781		10-13-1998	Wells et al.	
	US254	5,825,424		10-20-1998	Canfield et al.	
	US255	5,825,830		10-20-1998	Kopf	
	US256	5,832,037		11-03-1998	Park	
	US257	5,832,126		11-03-1998	Tanaka	
	US258	5,832,443		11-03-1998	Kolesnik et al.	
	US259	5,835,788		11-10-1998	Blumer et al.	
	US260	5,836,003		11-10-1998	Sadeh	

FOREIGN PATENT DOCUMENTS						
Examiner initials*	Cite No. <sup>1</sup>	Foreign Patent Document		Publication Date MM-DD-YYYY	Name of Patentee or Applicant of Cited Document	Pages, Columns, Lines, Where Relevant Passages or Relevant Figures Appear
		Country Code <sup>3</sup> -Number <sup>4</sup> -Kind Code <sup>5</sup> (if known)				

Examiner Signature	/Tefaldet Bocure/	Date Considered	02/19/2014
--------------------	-------------------	-----------------	------------

\*EXAMINER: Initial if reference considered, whether or not citation is in conformance with MPEP 609. Draw line through citation if not in conformance and not considered. Include copy of this form with next communication to applicant. <sup>1</sup> Applicant's unique citation designation number (optional). <sup>2</sup> See Kinds Codes of USPTO Patent Documents at [www.uspto.gov](http://www.uspto.gov) or MPEP 901.04. <sup>3</sup> Enter Office that issued the document, by the two-letter code (WIPO Standard ST.3). <sup>4</sup> For Japanese patent documents, the indication of the year of the reign of the Emperor must precede the serial number of the patent document. <sup>5</sup> Kind of document by the appropriate symbol. **ALL REFERENCES CONSIDERED EXCEPT WHERE LINED THROUGH. /T.B./**

Substitute for form 1449/PTO				<i>Complete if Known</i>	
<b>INFORMATION DISCLOSURE STATEMENT BY APPLICANT</b> <i>(Use as many sheets as necessary)</i>				Application Number	14/134,926
				Filing Date	December 19, 2013
				First Named Inventor	James J. FALLON
				Art Unit	2634
				Examiner Name	BOCURE, Tesfaldet
Sheet	14	of	29	Attorney Docket Number	2855.0050008

U.S. PATENT DOCUMENTS						
Examiner initials*	Cite No. <sup>1</sup>	Document Number		Publication Date MM-DD-YYYY	Name of Patentee or Applicant of Cited Document	Pages, Columns, Lines, Where Relevant Passages or Relevant Figures Appear
		Number-Kind Code <sup>2</sup> (if known)				
	US261	5,838,821		11-17-1998	Matsubara et al.	
	US262	5,838,927		11-17-1998	Gillon	
	US263	5,838,996		11-17-1998	deCarmo	
	US264	5,839,100		11-17-1998	Wegener	
	US265	5,841,979		11-24-1998	Schulhof et al.	
	US266	5,847,762		12-08-1998	Canfield et al.	
	US267	5,850,565		12-15-1998	Wightman	
	US268	5,856,797		01-05-1999	Kawauchi	
	US269	5,861,824		01-19-1999	Ryu et al.	
	US270	5,861,920		01-19-1999	Mead et al.	
	US271	5,864,342		01-26-1999	Kajiya et al.	
	US272	5,864,678		01-26-1999	Riddle	
	US273	5,867,167		02-02-1999	Deering	
	US274	5,867,602		02-02-1999	Zandi et al.	
	US275	5,870,036		02-09-1999	Franaszek et al.	
	US276	5,870,087		02-09-1999	Chau	
	US277	5,872,530		02-16-1999	Domyo et al.	
	US278	5,874,907		02-23-1999	Craft	
	US279	5,883,975		03-16-1999	Narita et al.	
	US280	5,884,269		03-16-1999	Cellier et al.	

FOREIGN PATENT DOCUMENTS							
Examiner initials*	Cite No. <sup>1</sup>	Foreign Patent Document		Publication Date MM-DD-YYYY	Name of Patentee or Applicant of Cited Document	Pages, Columns, Lines, Where Relevant Passages or Relevant Figures Appear	T <sup>6</sup>
		Country Code <sup>3</sup>	Number <sup>4</sup> Kind Code <sup>5</sup> (if known)				

Examiner Signature	/Tefaldet Bocure/	Date Considered	02/19/2014
--------------------	-------------------	-----------------	------------

\*EXAMINER: Initial if reference considered, whether or not citation is in conformance with MPEP 609. Draw line through citation if not in conformance and not considered. Include copy of this form with next communication to applicant. <sup>1</sup> Applicant's unique citation designation number (optional). <sup>2</sup> See Kinds Codes of USPTO Patent Documents at www.uspto.gov or MPEP 901.04. <sup>3</sup> Enter Office that issued the document, by the two-letter code (WIPO Standard ST.3). <sup>4</sup> For Japanese patent documents, the indication of the year of the reign of the Emperor must precede the serial number of the patent document. <sup>5</sup> Kind of document by the appropriate symbols as indicated on the document under WIPO Standard ST.3 if possible. If applicant is required to cite in a language other than English language Translation is attached. **ALL REFERENCES CONSIDERED EXCEPT WHERE LINED THROUGH. /T.B./**

<b>INFORMATION DISCLOSURE STATEMENT BY APPLICANT</b> <i>(Use as many sheets as necessary)</i>		<i>Complete if Known</i>	
		Application Number	14/134,926
		Filing Date	December 19, 2013
		First Named Inventor	James J. FALLON
		Art Unit	2634
		Examiner Name	BOCURE, Tesfaldet
Sheet	15	of	29
		Attorney Docket Number	2855.0050008

U.S. PATENT DOCUMENTS						
Examiner initials*	Cite No. <sup>1</sup>	Document Number		Publication Date MM-DD-YYYY	Name of Patentee or Applicant of Cited Document	Pages, Columns, Lines, Where Relevant Passages or Relevant Figures Appear
		Number	Kind Code <sup>2</sup> (if known)			
	US281	5,886,655		03-23-1999	Rust	
	US282	5,887,165		03-23-1999	Martel et al.	
	US283	5,889,961		03-30-1999	Dobbek	
	US284	5,892,847		04-06-1999	Johnson	
	US285	5,907,801		05-15-1999	Albert et al.	
	US286	5,909,557		06-01-1999	Beiker et al.	
	US287	5,909,559		06-01-1999	So	
	US288	5,915,079		06-22-1999	Vondran, Jr. et al.	
	US289	5,917,438		06-29-1999	Ando	
	US290	5,918,068		06-29-1999	Shafe	
	US291	5,918,225		06-29-1999	White et al.	
	US292	5,920,326		07-06-1999	Rentschler et al.	
	US293	5,923,860		07-13-1999	Olarig	
	US294	5,930,358		07-27-1999	Rao	
	US295	5,936,616		08-10-1999	Torberg, Jr. et al.	
	US296	5,938,737		08-17-1999	Smallcomb et al.	
	US297	5,943,692		08-24-1999	Marberg	
	US298	5,945,933		08-31-1999	Kalkstein	
	US299	5,949,355		09-07-1999	Panaoussis	
	US300	5,949,968		09-07-1999	Gentile	

FOREIGN PATENT DOCUMENTS							
Examiner initials*	Cite No. <sup>1</sup>	Foreign Patent Document		Publication Date MM-DD-YYYY	Name of Patentee or Applicant of Cited Document	Pages, Columns, Lines, Where Relevant Passages or Relevant Figures Appear	T <sup>6</sup>
		Country Code <sup>3</sup>	Number <sup>4</sup> -Kind Code <sup>5</sup> (if known)				

Examiner Signature	/Tefaldet Bocure/	Date Considered	02/19/2014
--------------------	-------------------	-----------------	------------

\*EXAMINER: Initial if reference considered, whether or not citation is in conformance with MPEP 609. Draw line through citation if not in conformance and not considered. Include copy of this form with next communication to applicant. <sup>1</sup> Applicant's unique citation designation number (optional). <sup>2</sup> See Kinds Codes of USPTO Patent Documents at www.uspto.gov or MPEP 901.04. <sup>3</sup> Enter Office that issued the document, by the two-letter code (WIPO Standard ST.3). <sup>4</sup> For Japanese patent documents, the indication of the year of the reign of the Emperor must precede the serial number of the patent document. <sup>5</sup> Kind of document by the appropriate symbols as indicated on the document under WIPO Standard ST.16 if possible. Applicant is to place a check mark in the English language Translation is attached. **ALL REFERENCES CONSIDERED EXCEPT WHERE LINED THROUGH. /T.B./**

Substitute for form 1449/PTO		<b>Complete if Known</b>	
<b>INFORMATION DISCLOSURE STATEMENT BY APPLICANT</b> <i>(Use as many sheets as necessary)</i>		Application Number	14/134,926
		Filing Date	December 19, 2013
		First Named Inventor	James J. FALLON
		Art Unit	2634
		Examiner Name	BOCURE, Tesfaldet
		Attorney Docket Number	2855.0050008
Sheet	16	of	29

U.S. PATENT DOCUMENTS						
Examiner initials*	Cite No. <sup>1</sup>	Document Number		Publication Date MM-DD-YYYY	Name of Patentee or Applicant of Cited Document	Pages, Columns, Lines, Where Relevant Passages or Relevant Figures Appear
		Number-Kind Code <sup>2</sup> (if known)				
	US301	5,951,623		09-14-1999	Reynar et al.	
	US302	5,955,976		09-21-1999	Heath	
	US303	5,956,490		09-21-1999	Buchholz et al.	
	US304	5,960,465		09-28-1999	Adams	
	US305	5,964,842		10-12-1999	Packard	
	US306	5,968,149		10-19-1999	Jaquette et al.	
	US307	5,969,927		10-19-1999	Schirmer et al.	
	US308	5,973,630		10-26-1999	Heath	
	US309	5,974,235		10-26-1999	Nunally et al.	
	US310	5,974,387		10-26-1999	Kageyama	
	US311	5,974,471		10-26-1999	Belt	
	US312	5,978,483		11-02-1999	Thompson, Jr. et al.	
	US313	5,982,360		11-09-1999	Wu et al.	
	US314	5,982,723		11-09-1999	Kamatani	
	US315	5,987,022		11-16-1999	Geiger et al.	
	US316	5,987,432		11-16-1999	Zusman et al.	
	US317	5,987,590		11-16-1999	Wing So	
	US318	5,990,884		11-23-1999	Douma et al.	
	US319	5,991,515		11-23-1999	Fall et al.	
	US320	5,996,033		11-30-1999	Chiu-Hao	

FOREIGN PATENT DOCUMENTS							
Examiner initials*	Cite No. <sup>1</sup>	Foreign Patent Document		Publication Date MM-DD-YYYY	Name of Patentee or Applicant of Cited Document	Pages, Columns, Lines, Where Relevant Passages or Relevant Figures Appear	T <sup>6</sup>
		Country Code <sup>3</sup> -Number <sup>4</sup> -Kind Code <sup>5</sup> (if known)					

Examiner Signature	/Tefaldet Bocure/	Date Considered	02/19/2014
--------------------	-------------------	-----------------	------------

\*EXAMINER: Initial if reference considered, whether or not citation is in conformance with MPEP 609. Draw line through citation if not in conformance and not considered. Include copy of this form with next communication to applicant. <sup>1</sup> Applicant's unique citation designation number (optional). <sup>2</sup> See Kinds Codes of USPTO Patent Documents at [www.uspto.gov](http://www.uspto.gov) or MPEP 901.04. <sup>3</sup> Enter Office that issued the document, by the two-letter code (WIPO Standard ST.3). <sup>4</sup> For Japanese patent documents, the indication of the year of the reign of the Emperor must precede the serial number of the patent document. <sup>5</sup> Kind of document by the appropriate kind code. <sup>6</sup> If the document is in a language other than English, the language of the document must be indicated. If the document is in a language other than English, an English language translation is attached.

**ALL REFERENCES CONSIDERED EXCEPT WHERE LINED THROUGH. /T.B./**





Substitute for form 1449/PTO				<b>Complete if Known</b>	
<b>INFORMATION DISCLOSURE STATEMENT BY APPLICANT</b> <i>(Use as many sheets as necessary)</i>				Filing Date	December 19, 2013
				First Named Inventor	James J. FALLON
				Art Unit	2634
				Examiner Name	BOCURE, Tesfaldet
				Attorney Docket Number	2855.0050008
Sheet	18	of	29		

U.S. PATENT DOCUMENTS						
Examiner initials*	Cite No. <sup>1</sup>	Document Number		Publication Date MM-DD-YYYY	Name of Patentee or Applicant of Cited Document	Pages, Columns, Lines, Where Relevant Passages or Relevant Figures Appear
		Number-Kind Code <sup>2</sup> (if known)				
	US341	6,075,470		06-13-2000	Little et al.	
	US342	6,078,958		06-20-2000	Echeita et al.	
	US343	6,091,777		07-18-2000	Guetz et al.	
	US344	6,092,123		07-18-2000	Steffan et al.	
	US345	6,094,634		07-25-2000	Yahagi et al.	
	US346	6,097,520		08-01-2000	Kadnier	
	US347	6,097,845		08-01-2000	Ng et al.	
	US348	6,098,114		08-01-2000	McDonald et al.	
	US349	6,104,389		08-15-2000	Ando	
	US350	6,105,130		08-15-2000	Wu et al.	
	US351	6,115,384		09-05-2000	Parzych	
	US352	6,128,412		10-03-2000	Satoh	
	US353	6,134,631		10-17-2000	Jennings, III	
	US354	6,141,053		10-31-2000	Saukkonen	
	US355	6,145,020		11-07-2000	Barnett	
	US356	6,145,069		11-07-2000	Dye	
	US357	6,169,241		01-02-2001	Shimizu	
	US358	6,170,007		01-02-2001	Venkatraman et al.	
	US359	6,170,047		01-02-2001	Dye	
	US360	6,170,049		01-02-2001	So	

FOREIGN PATENT DOCUMENTS							
Examiner initials*	Cite No. <sup>1</sup>	Foreign Patent Document		Publication Date MM-DD-YYYY	Name of Patentee or Applicant of Cited Document	Pages, Columns, Lines, Where Relevant Passages or Relevant Figures Appear	T <sup>6</sup>
		Country Code <sup>3</sup> -Number <sup>4</sup> -Kind Code <sup>5</sup> (if known)					

Examiner Signature	/Tefaldet Bocure/	Date Considered	02/19/2014
--------------------	-------------------	-----------------	------------

\*EXAMINER: Initial if reference considered, whether or not citation is in conformance with MPEP 609. Draw line through citation if not in conformance and not considered. Include copy of this form with next communication to applicant. <sup>1</sup> Applicant's unique citation designation number (optional). <sup>2</sup> See Kinds Codes of USPTO Patent Documents at www.uspto.gov or MPEP 901.04. <sup>3</sup> Enter Office that issued the document, by the two-letter code (WIPO Standard ST.3). <sup>4</sup> For Japanese patent documents, the indication of the year of the reign of the Emperor must precede the serial number of the patent document. <sup>5</sup> Kind of document by the appropriate symbol as indicated in the Manual of Patent Examining Procedure. <sup>6</sup> If applicant is the inventor, the date of filing of the application in the English language Translation is attached.

Substitute for form 1449/PTO  <h2 style="text-align: center;">INFORMATION DISCLOSURE STATEMENT BY APPLICANT</h2> <p style="text-align: center;"><i>(Use as many sheets as necessary)</i></p>		<p style="text-align: right;"><i>Complete if Known</i></p> Application Number: 14/134,926 Filing Date: December 19, 2013 First Named Inventor: James J. FALLON Art Unit: 2634 Examiner Name: BOCURE, Tesfaldet Attorney Docket Number: 2855.0050008	
Sheet	19	of	29

**U.S. PATENT DOCUMENTS**

Examiner Initials*	Cite No. <sup>1</sup>	Document Number		Publication Date MM-DD-YYYY	Name of Patentee or Applicant of Cited Document	Pages, Columns, Lines, Where Relevant Passages or Relevant Figures Appear
		Number	Kind Code <sup>2</sup> (if known)			
	US361	6,172,936		01-09-2001	Kitazaki	
	US362	6,173,381		01-09-2001	Dye	
	US363	6,175,650		01-16-2001	Sindhu et al.	
	US364	6,175,856		01-16-2001	Riddle	
	US365	6,182,125		01-30-2001	Borelia et al.	
	US366	6,185,625		02-06-2001	Tso et al.	
	US367	6,185,659		02-06-2001	Milillo et al.	
	US368	6,192,082		02-20-2001	Moriarty et al.	
	US369	6,192,155		02-20-2001	Fan	
	US370	6,195,024		02-27-2001	Fallon	
	US371	6,195,125		02-27-2001	Udagawa et al.	
	US372	6,195,391		02-27-2001	Hancock et al.	
	US373	6,195,465		02-27-2001	Zandi et al.	
	US374	6,198,850		03-06-2001	Banton	
	US375	6,208,273		03-27-2001	Dye et al.	
	US376	6,215,904		04-10-2001	Lavellee	
	US377	6,219,754		04-17-2001	Belt et al.	
	US378	6,222,886		04-24-2001	Yogeshwar	
	US379	6,225,922		05-01-2001	Norton	
	US380	6,226,667		05-01-2001	Matthews et al.	

**FOREIGN PATENT DOCUMENTS**

Examiner Initials*	Cite No. <sup>1</sup>	Foreign Patent Document		Publication Date MM-DD-YYYY	Name of Patentee or Applicant of Cited Document	Pages, Columns, Lines, Where Relevant Passages or Relevant Figures Appear	T <sup>6</sup>
		Country Code <sup>3</sup>	Number <sup>4</sup> -Kind Code <sup>5</sup> (if known)				

Examiner Signature	/Tefaldet Bocure/	Date Considered	02/19/2014
--------------------	-------------------	-----------------	------------

\*EXAMINER: Initial if reference considered, whether or not citation is in conformance with MPEP 609. Draw line through citation if not in conformance and not considered. Include copy of this form with next communication to applicant. <sup>1</sup> Applicant's unique citation designation number (optional). <sup>2</sup> See Kinds Codes of USPTO Patent Documents at www.uspto.gov or MPEP 901.04. <sup>3</sup> Enter Office that issued the document, by the two-letter code (WIPO Standard ST.3). <sup>4</sup> For Japanese patent documents, the indication of the year of the reign of the Emperor must precede the serial number of the patent document. <sup>5</sup> Kind of document by the appropriate symbols in the table of the document kind. <sup>6</sup> If possible, applicant is to check if the document is in the original language or if an English language translation is attached.





Substitute for form 1449/PTO				<i>Complete if Known</i>	
<b>INFORMATION DISCLOSURE STATEMENT BY APPLICANT</b> <i>(Use as many sheets as necessary)</i>				Application Number	14/134,926
				Filing Date	December 19, 2013
				First Named Inventor	James J. FALLON
				Art Unit	2634
				Examiner Name	BOCURE, Tesfaldet
				Attorney Docket Number	2855.0050008
Sheet	22	of	29		

U.S. PATENT DOCUMENTS						
Examiner initials*	Cite No. <sup>1</sup>	Document Number		Publication Date MM-DD-YYYY	Name of Patentee or Applicant of Cited Document	Pages, Columns, Lines, Where Relevant Passages or Relevant Figures Appear
		Number-Kind Code <sup>2</sup> (if known)				
	US421	6,526,174		02-25-2003	Graffagnino	
	US422	6,529,633		03-04-2003	Easwar et al.	
	US423	6,532,121		03-11-2003	Rust et al.	
	US424	6,539,438		03-25-2003	Ledzius et al.	
	US425	6,539,456		03-25-2003	Stewart	
	US426	6,542,644		04-01-2003	Satoh	
	US427	6,577,254		06-10-2003	Rasmussen	
	US428	6,590,609		07-08-2003	Kitade et al.	
	US429	6,597,812		07-22-2003	Fallon et al.	
	US430	6,601,104		07-29-2003	Fallon	
	US431	6,604,040		08-05-2003	Kawasaki et al.	
	US432	6,604,158		08-05-2003	Fallon	
	US433	6,606,040		08-12-2003	Abdat	
	US434	6,606,413		08-12-2003	Zeineh	
	US435	6,609,223		08-19-2003	Wolfgang	
	US436	6,618,728		09-09-2003	Rail	
	US437	6,624,761		09-23-2003	Fallon	
	US438	6,633,244		10-14-2003	Avery	
	US439	6,633,968		10-14-2003	Zwieginzew et al.	
	US440	6,650,261		11-18-2003	Nelson et al.	

FOREIGN PATENT DOCUMENTS							
Examiner initials*	Cite No. <sup>1</sup>	Foreign Patent Document		Publication Date MM-DD-YYYY	Name of Patentee or Applicant of Cited Document	Pages, Columns, Lines, Where Relevant Passages or Relevant Figures Appear	T <sup>6</sup>
		Country Code <sup>3</sup> -Number <sup>4</sup> -Kind Code <sup>5</sup> (if known)					

Examiner Signature	/Tefaldet Bocure/	Date Considered	02/19/2014
--------------------	-------------------	-----------------	------------

\*EXAMINER: Initial if reference considered, whether or not citation is in conformance with MPEP 609. Draw line through citation if not in conformance and not considered. Include copy of this form with next communication to applicant. <sup>1</sup> Applicant's unique citation designation number (optional). <sup>2</sup> See Kinds Codes of USPTO Patent Documents at [www.uspto.gov](http://www.uspto.gov) or MPEP 901.04. <sup>3</sup> Enter Office that issued the document, by the two-letter code (WIPO Standard ST.3). <sup>4</sup> For Japanese patent documents, the indication of the year of the reign of the Emperor must precede the serial number of the patent document. <sup>5</sup> Kind of document by the appropriate symbols as indicated on the document. <sup>6</sup> If possible, applicant is to file a claim in the original language. Translation is attached.

**ALL REFERENCES CONSIDERED EXCEPT WHERE LINED THROUGH. /T.B./**

