



US005806017A

United States Patent [19] Hancock

[11] Patent Number: **5,806,017**
[45] Date of Patent: **Sep. 8, 1998**

[54] **ELECTRONIC AUTOROUTING NAVIGATION SYSTEM FOR VISUALLY IMPAIRED PERSONS**

2 661 607 11/1991 France .
WO 95/04440 2/1995 WIPO .

OTHER PUBLICATIONS

[75] Inventor: **Michael B. Hancock**, Galveston, Tex.

Yewman, "The Seeing-Eye Box," *Biomedical Inquiry*, The University of Texas Medical Branch at Galveston, Spring 1996.

[73] Assignee: **Board of Regents The University of Texas System**, Austin, Tex.

[21] Appl. No.: **699,580**

Primary Examiner—Michael Zanelli
Assistant Examiner—Edward Pipala
Attorney, Agent, or Firm—Arnold, White & Durkee

[22] Filed: **Aug. 19, 1996**

[51] **Int. Cl.⁶** **G01C 21/00; G06F 165/00**

[52] **U.S. Cl.** **701/209; 701/211**

[58] **Field of Search** 364/443, 444.1,
364/444.2, 448, 449.2, 449.3, 449.5; 701/200,
201, 202, 206, 208, 209, 211

[57] ABSTRACT

[56] References Cited

U.S. PATENT DOCUMENTS

3,104,478	9/1963	Strauss et al.	35/25
3,718,896	2/1973	Mowat	340/1 R
4,025,922	5/1977	Trawick, III	343/6.5 LC
4,045,799	8/1977	Dapiran	343/113 PT
4,119,811	10/1978	Moricca et al.	340/407
4,193,689	3/1980	Reymond et al.	356/152
4,648,710	3/1987	Ban et al.	356/4
4,660,022	4/1987	Osaka	340/407
4,904,993	2/1990	Sato	340/825.57
4,935,907	6/1990	Friedman	367/118
5,032,083	7/1991	Friedman	434/112
5,032,836	7/1991	Ono et al.	340/325.71
5,067,081	11/1991	Person	364/444
5,144,294	9/1992	Alonzi et al.	340/825.49
5,214,410	5/1993	Verster	340/572
5,406,491	4/1995	Lima	364/449
5,487,669	1/1996	Kelk	434/112
5,508,699	4/1996	Silverman	340/944
5,600,706	2/1997	Dunn et al.	379/59

FOREIGN PATENT DOCUMENTS

0 338 997 10/1989 European Pat. Off. .

The present invention is an autorouting navigation system for directing one or more visually impaired persons to a physical location. The present invention includes a portable autorouting navigation unit that includes an input device for selecting a target location corresponding to a physical location of a plurality of location beacons, a receiver configured to receive signals from the location beacons, a memory storing information correlating the locations of the location beacons, and an output device for communicating with the user. A microcontroller or microprocessor under program control processes the signals received from the location beacons, analyzes those signals and correlation data, and determines a routing path from the user's present position to the target location. The microcontroller may also provide an indication, such as an audible sound, to the user of whether or not the user is following the routing path to the target location. Significantly, the present invention relies upon beacons that send out location and direction information without being polled by the portable unit determines a routing path that allows for autorouting. Beacons may also be organized in groups of beacons that can correlate to geographical landmarks such as hallways in a building to reduce the size of the correlating data stored in the memory of the portable unit and thereby reduce processing time.

15 Claims, 10 Drawing Sheets

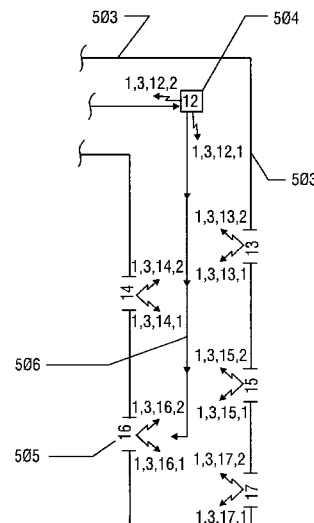
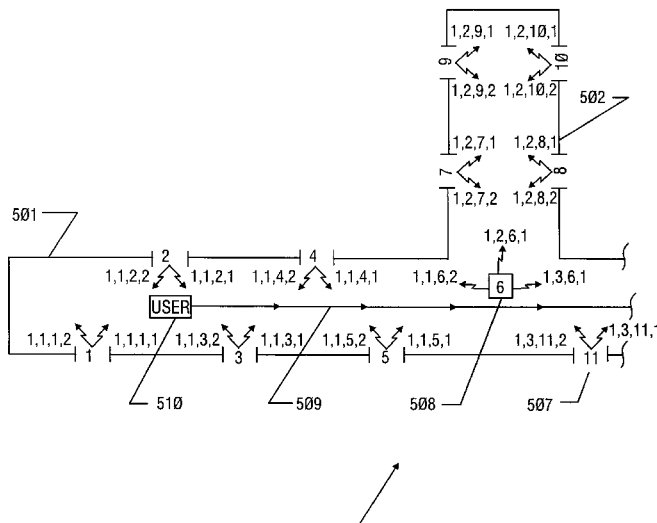

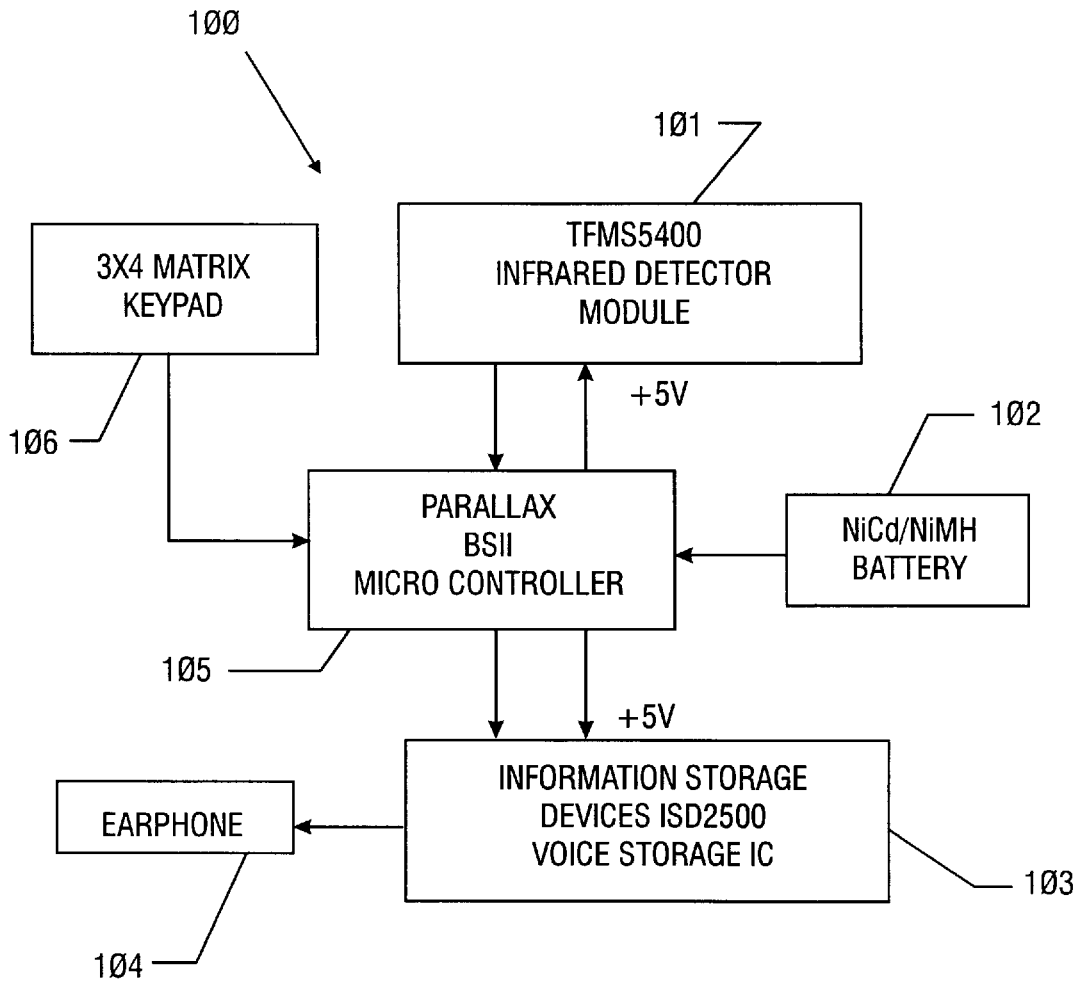

FIG. 1A

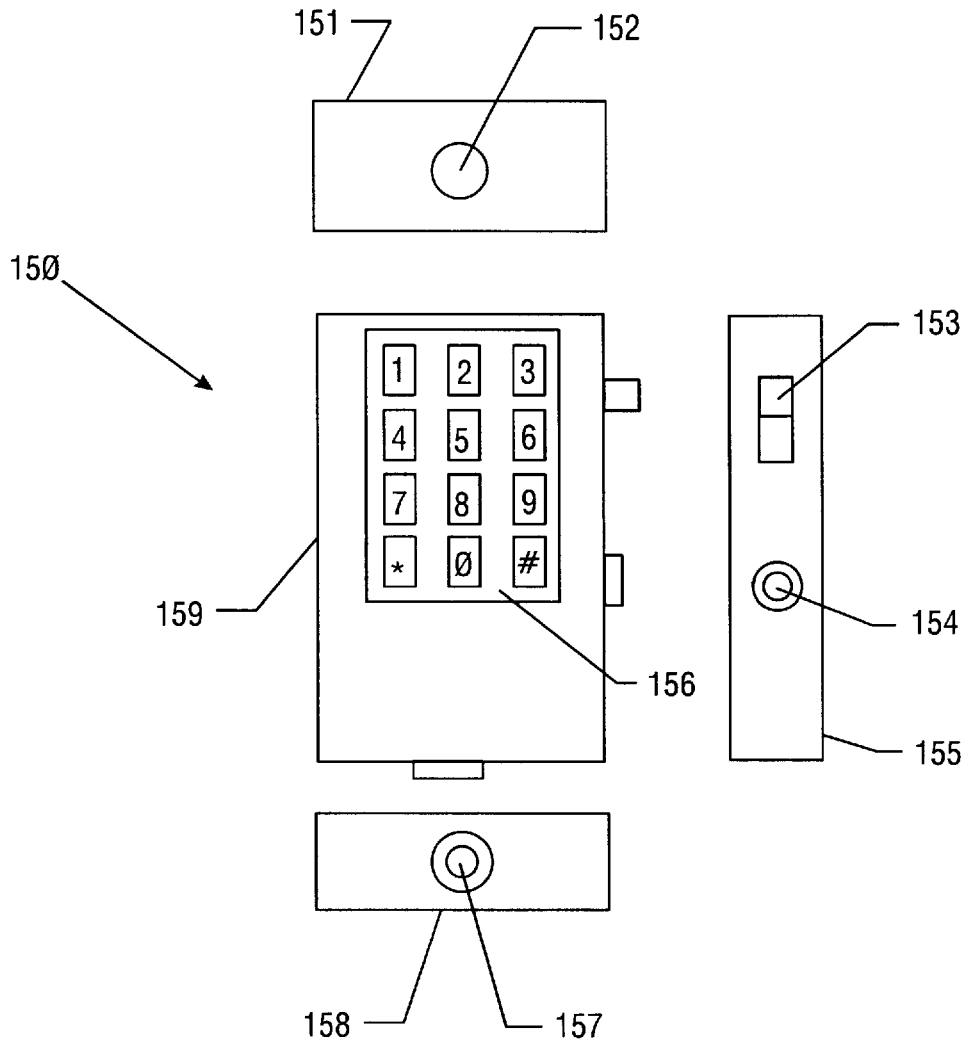

FIG. 1B

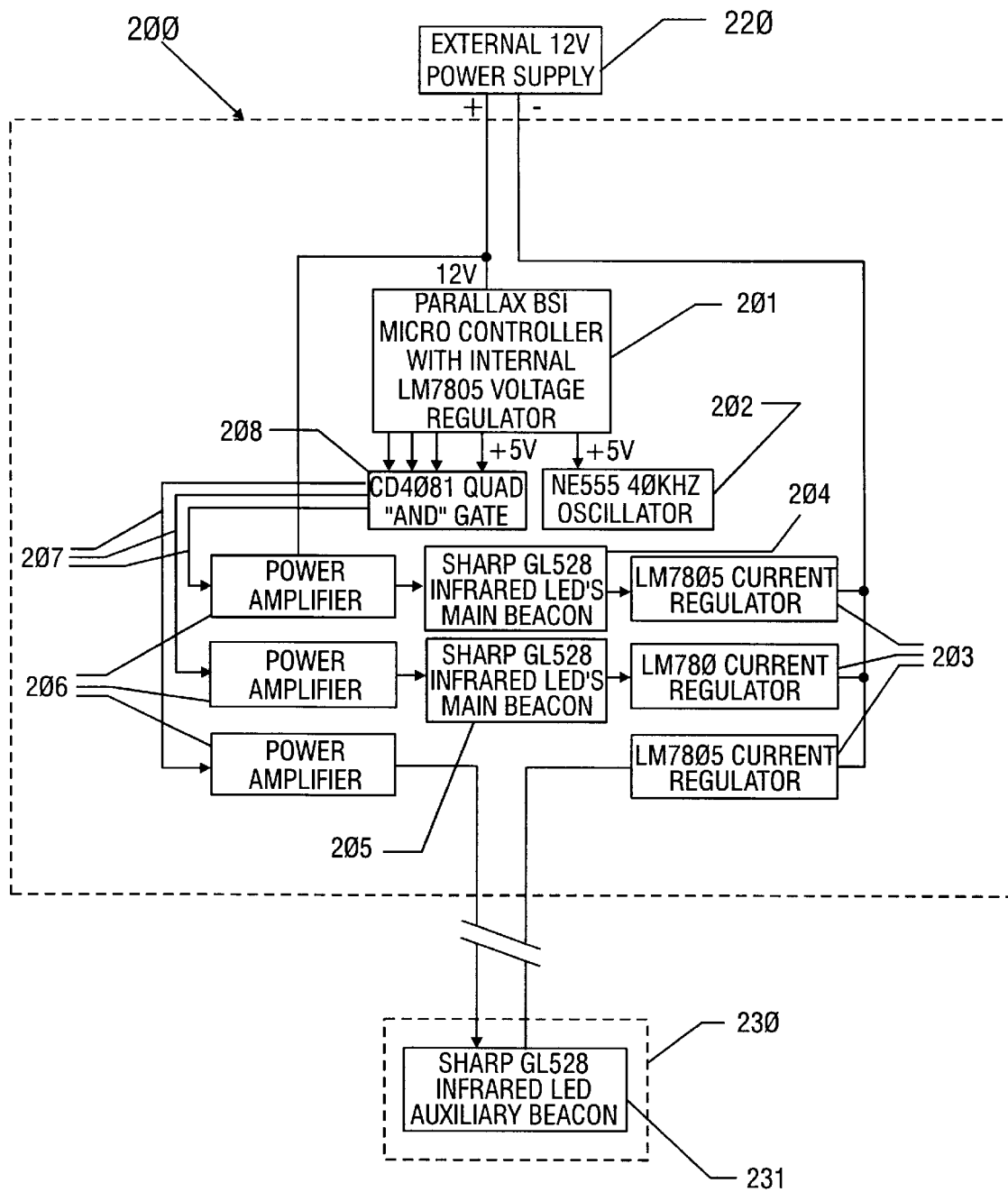

FIG. 2A

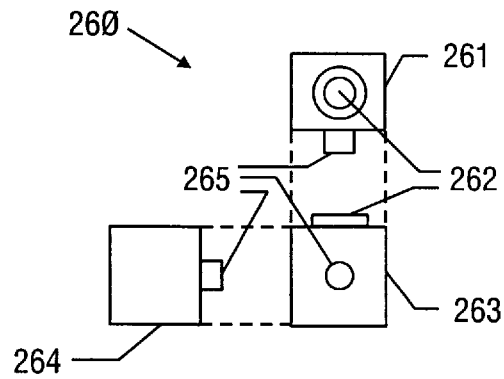
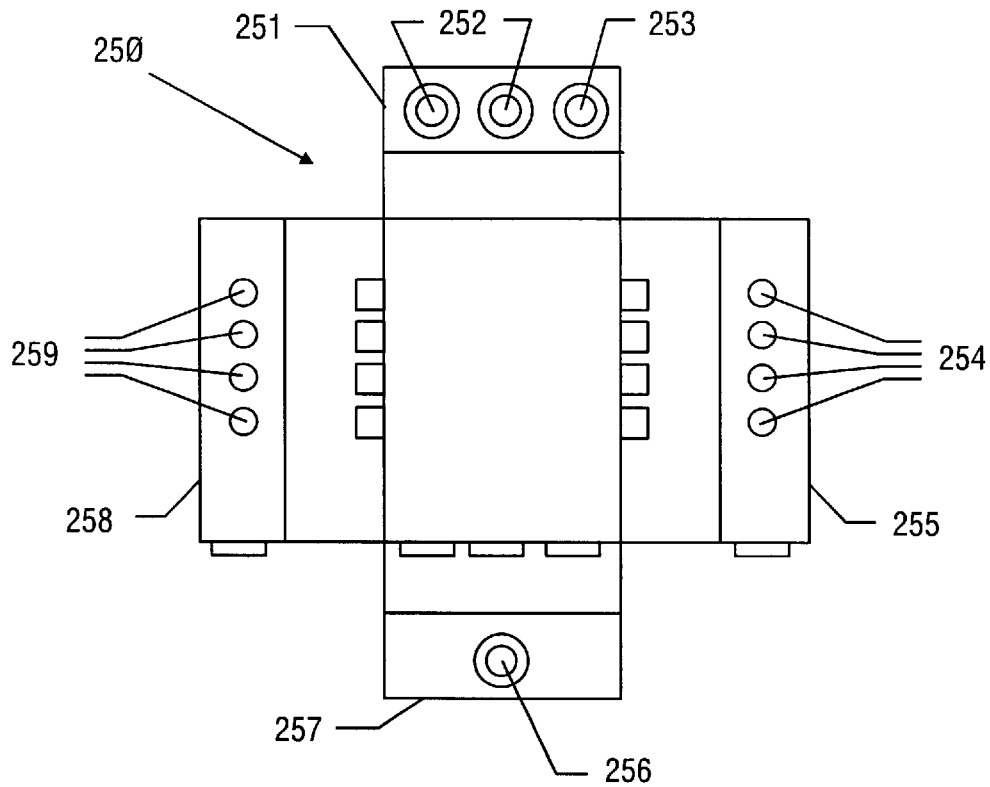

FIG. 2B

Explore Litigation Insights

Docket Alarm provides insights to develop a more informed litigation strategy and the peace of mind of knowing you're on top of things.

Real-Time Litigation Alerts



Keep your litigation team up-to-date with **real-time alerts** and advanced team management tools built for the enterprise, all while greatly reducing PACER spend.

Our comprehensive service means we can handle Federal, State, and Administrative courts across the country.

Advanced Docket Research



With over 230 million records, Docket Alarm's cloud-native docket research platform finds what other services can't. Coverage includes Federal, State, plus PTAB, TTAB, ITC and NLRB decisions, all in one place.

Identify arguments that have been successful in the past with full text, pinpoint searching. Link to case law cited within any court document via Fastcase.

Analytics At Your Fingertips



Learn what happened the last time a particular judge, opposing counsel or company faced cases similar to yours.

Advanced out-of-the-box PTAB and TTAB analytics are always at your fingertips.

API

Docket Alarm offers a powerful API (application programming interface) to developers that want to integrate case filings into their apps.

LAW FIRMS

Build custom dashboards for your attorneys and clients with live data direct from the court.

Automate many repetitive legal tasks like conflict checks, document management, and marketing.

FINANCIAL INSTITUTIONS

Litigation and bankruptcy checks for companies and debtors.

E-DISCOVERY AND LEGAL VENDORS

Sync your system to PACER to automate legal marketing.