



RESEARCH ARTICLES

Effects of Surfactants on the Aqueous Stability and Solubility of β -Lactam Antibiotics

AKIRA TSUJI **, ETSUKO MIYAMOTO †, MUNEAKI MATSUDA *,
KEIKO NISHIMURA *, and TSUKINAKA YAMANA §

Received June 8, 1981, from the *Faculty of Pharmaceutical Sciences and †Hospital Pharmacy, Kanazawa University, Takara-machi, Kanazawa 920, Japan, and the ‡School of Pharmacy, Hokuriku University, Kanagawa-machi, Kanazawa 920-11, Japan. Accepted for publication February 4, 1982.

Abstract □ Studies were undertaken to elucidate the interaction between β -lactam antibiotics and surfactant micelles and to examine the effects of surfactants on their aqueous stability and solubility. The apparent binding constant of the micelle-antibiotic complex was determined as a function of the solution pH at 37° and $\mu = 0.15$ by the dynamic dialysis method and hydrolysis study. In the interaction with nonionic and anionic micelles of polyoxyethylene-23-lauryl ether (I) and sodium lauryl sulfate (II), large differences were noted in the binding constants between the undissociated and ionized species of penicillins. However, the cationic surfactants, cetyltrimethylammonium bromide (III), showed no significant difference in the binding constants for both species. Acid degradation of penicillins was protected in micellar solutions of I and III but was facilitated in micelles of II. The surfactants exerted no influence on the neutral degradation of the antibiotics used. The solubilization of penicillin V acid by micelles of I was studied at pH 2.0 and 35°. The solubility increased threefold in the presence of 10 mM I.

Keyphrases □ Antibiotics, β -lactam—effects of surfactants on the aqueous stability and solubility, interactions with surfactant micelles □ Surfactant micelles—effects on the aqueous stability and solubility of β -lactam antibiotics □ Binding constant—interaction between β -lactam antibiotics and surfactant micelles, aqueous stability and solubility

The interaction of surface-active agents with drugs is of theoretical and practical importance, since such surfactants represent one of the most important groups of adjuvants in pharmaceutical preparations. Surfactants incorporated in the drug dosage form are able to influence the drug stability and dissolution as a result of drug-surfactant micellar interactions.

So far there have been only a few reports on the interaction (1-3) between β -lactam antibiotics and surfactant micelles. Recently, a catalytic effect of cationic surfactants on the degradation of cephalexin at neutral pH by entrapment of the antibiotic micelles was described. No effects on the cephalexin stability, however, were observed in anionic micelles (2).

The aims of the present study were to elucidate the entrapment of penicillin and cephalosporin antibiotics into the micelle of various types of surfactants as a function of the solution pH, and to investigate the effects of the antibiotic-micelle interaction on the stability and solubility of these antibiotics under a gastric pH environment. A preliminary report has already been published (3).

EXPERIMENTAL

Materials—Antibiotics—The following β -lactam antibiotics were used as supplied: propicillin potassium¹ (993 $\mu\text{g}/\text{mg}$), penicillin V potassium² (1490 U/mg), and cefazolin sodium³ (966 $\mu\text{g}/\text{mg}$). Free acid of penicillin V was obtained from a commercial source⁴.

Surfactants—Polyoxyethylene-23-lauryl ether (I), sodium lauryl sulfate (II), and cetyltrimethylammonium bromide (III) were obtained from commercial sources and used without further purification except II. Compound II was recrystallized according to the literature (4).

Chemicals—All other chemicals employed were of reagent grade and used without further purification except imidazole. Imidazole was recrystallized from benzene followed by a thorough washing with ether.

Analytical Procedures—Propicillin and penicillin V were determined by the spectrophotometric method developed previously (5). No influence of surfactants in this assay was observed. The concentration of the antibiotic in the samples was calculated from a calibration curve prepared daily. Cefazolin was analyzed in the stability experiment by reversed-phase high-performance liquid chromatography (HPLC). The liquid chromatograph⁵ was equipped with a UV detector⁶ set at 254 nm. The stationary phase was octadecylsilane chemically bonded on totally porous silica gel, prepacked into a 125-mm stainless steel column⁷ (4.6-mm i.d.). The mobile phase was 10% (v/v) acetonitrile-0.01 M ammonium acetate. The instrument was operated at ambient temperature and at a flow rate

¹ Takeda Chemical Industries, Osaka, Japan.

² Banyu Pharmaceutical Co., Osaka, Japan.

³ Fujisawa Pharmaceutical Co., Osaka, Japan.

⁴ Sigma Chemical Co., St. Louis, Mo.

⁵ Model FLC-A700, Japan Spectroscopic Co., Tokyo, Japan.

⁶ Model UVIDEC-100, Japan Spectroscopic Co., Tokyo, Japan.

⁷ SC-01, Japan Spectroscopic Co., Tokyo, Japan.

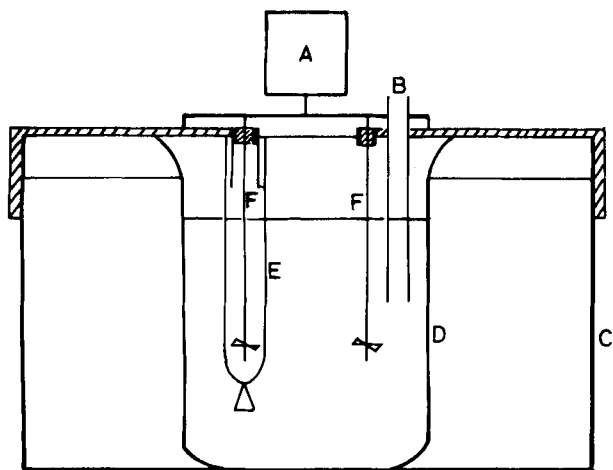

Figure 1—Apparatus for the dynamic dialysis experiment. Key: (A) control motor; (B) sampling hole; (C) thermostated water bath; (D) jacketed beaker; (E) dialysis membrane; and (F) stirring shaft.

of 1.0 ml/min, and then samples were injected through a 100- μ l injector⁸. The peak heights were used for quantification.

Procedure—Dynamic Dialysis—The method employed was essentially the same as that described previously (6). The apparatus used in this study is illustrated in Fig. 1. The system consisted of a jacketed beaker (500 ml) set in a thermostated water bath. Three hundred milliliters of buffer solution (ionic strength 0.15) was placed in the beaker. A cellulose tube⁹ was knotted at one end to form a bag (length 10 cm) and attached with a rubber band to the glass tubing with a stirring shaft. Eight milliliters of antibiotic buffer solution with or without surfactants was placed into the bag. The bag attached with a stopper was fitted on the beaker. Both the inner and outer solutions were stirred. All experiments were carried out at $37 \pm 0.1^\circ$ and at various pHs with phosphate, acetate, and citrate buffer systems maintained at an ionic strength of 0.15. At appropriate time intervals, aliquots (10 ml) of the outer solution were withdrawn and 10 ml of drug-free buffer solution preheated at 37° was added. The samples were analyzed by the spectrophotometric method or HPLC described in the previous section. The concentration of the outer solution samples was corrected as follows:

$$(C_{II})_n = (C_{II})_n^{\text{obs}} + (V_s/V_{II}) \sum_{i=1}^n (C_{II})_{i-1} \quad (\text{Eq. 1})$$

where $(C_{II})_n$ and $(C_{II})_n^{\text{obs}}$ represent the true and observed concentrations of the n th sample from the outer solution, respectively, and V_s and V_{II} represent the sampling volume and volume of the outer solution, respectively.

Degradation Kinetics—Unless otherwise stated, kinetic studies were carried out at $37 \pm 0.1^\circ$ and an ionic strength of 0.15. Each antibiotic was dissolved in hydrochloric acid–potassium chloride aqueous solution with or without surfactant to give a final antibiotic concentration of 6×10^{-4} M. A saturated solution of the antibiotic was sometimes used because of limited solubility. At appropriate time intervals, aliquots were withdrawn, cooled, and analyzed. The pseudo first-order rate constants, k_{deg} , were calculated by least-squares analysis of the slopes of plots between the logarithm of the antibiotic concentration and time.

Solubility Measurement—An excess of penicillin V (acid form) was added to the hydrochloric acid–potassium chloride solution (pH 2.0 and ionic strength 0.5) in a glass-stoppered flask. The flask was placed in a thermostated water bath at $35 \pm 0.1^\circ$ and shaken mechanically until the antibiotic concentration in the solution showed an equilibrium value. A sample was taken through a 0.45- μ m membrane filter¹⁰ and, if necessary, assayed after appropriate dilution with distilled water. The pH of the sample solution was measured¹¹ before use and at the end of the experiment; no significant change was observed.

Determination of Critical Micelle Concentration—The determination of the critical micelle concentration (CMC) was accomplished by deter-

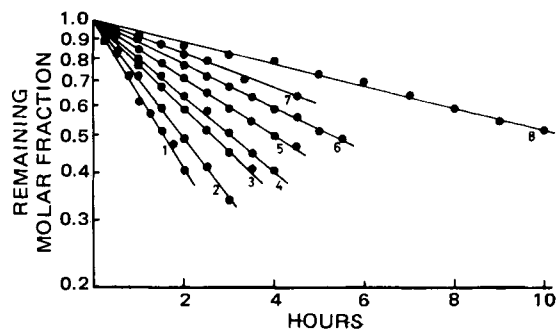

Figure 2—First-order plots for the dialysis of propicillin in the presence of surfactants of various pH values at 37° and $\mu = 0.15$. Key: 1 (control, pH 6.50); 2 (4×10^{-2} M II, pH 6.50); 3 (2×10^{-2} M I, pH 6.50); 4 (3×10^{-2} M II, pH 4.00); 5 (2.4×10^{-3} M III, pH 4.00); 6 (4×10^{-2} M I, pH 4.00); 7 (1.5×10^{-2} M I, pH 3.00); 8 (6.9×10^{-2} M III, pH 6.50).

mining the concentration at which the break in the log concentration versus surface tension plot occurs. The surface tension of surfactant solutions of ionic strength of 0.15 containing various concentrations of I, II, or III and the antibiotic at the concentration used for dialysis and degradation studies was determined at 37° by a Du Nöuy tensiometer¹².

RESULTS

Kinetics of Dynamic Dialysis—For quantification of the interaction between a drug molecule and surfactant micelles, various methods are available such as equilibrium dialysis (7), dynamic dialysis (8), micellar solubilization (9), the potentiometric titration method (10), molecular sieve (11), and micellar catalysis kinetics in the drug degradation (9). Among these, the dynamic dialysis method provides quick information for the existence of the interaction with macromolecules by utilization of marked difference of the permeation rate through a dialysis membrane.

According to Fick's first law of diffusion, the rate of drug dialysis can be expressed by:

$$\frac{d(C_I)_T}{dt} = -k_{\text{dia}} [(C_I)_T - (C_{II})_T] \quad (\text{Eq. 2})$$

where $(C_I)_T$ and $(C_{II})_T$ represent the total concentration of the drug in the inner and outer solutions of the dialysis bag, respectively. Since the present experiments were carried out under the sink condition, $(C_I)_T - (C_{II})_T$ was assumed to be equal to $(C_I)_T$. The apparent first-order dialysis rate constant, k_{dia} , therefore, was calculated from:

$$\ln(C_I)_T/C_0 = -k_{\text{dia}}t \quad (\text{Eq. 3})$$

where C_0 represents the initial concentration of the drug solution in the dialysis bag. The value for $(C_I)_T$ was calculated from the mass balance equation as follows:

$$(C_I)_T = \frac{C_0 V_I - (C_{II})_T V_{II}}{V_I} \quad (\text{Eq. 4})$$

where V_I and V_{II} represent the volume of the inner and outer solutions, respectively. Figure 2 shows typical semilogarithmic plots of the molar fraction of propicillin remaining in various surfactant solutions in the bag versus time, and it indicates that the dialysis rates follow first-order kinetics in conformity with Eq. 3. Plots of the k_{dia} for propicillin versus the concentration of surfactants are given in Fig. 3 and show a marked decrease of k_{dia} with increase in the surfactant concentration and a tendency to reach constant rate constants. The results apparently indicate the occurrence of entrapment of propicillin in the micelles, which are difficult to be dialyzed.

If the drug is incorporated into the micelle, there then will be an equilibrium between the drug in solution and that in the micelle. The apparent binding constant, K_{app} , can be expressed as:

$$K_{\text{app}} = \frac{(C_I)_m}{(C_I)_f (C_D - \text{CMC})} \quad (\text{Eq. 5})$$

⁸ Model LP1-350, Japan Spectroscopic Co., Tokyo, Japan.

⁹ Visking dialysis membrane, Union Carbide Corp., Chicago, Ill.

¹⁰ Sartorius-membranfilter, GmbH, 34 Göttingen, West Germany.

¹¹ PHM26 pH-meter, Radiometer, Copenhagen, Denmark.

¹² Du Nöuy tensiometer, Shimadzu, Co., Kyoto, Japan.

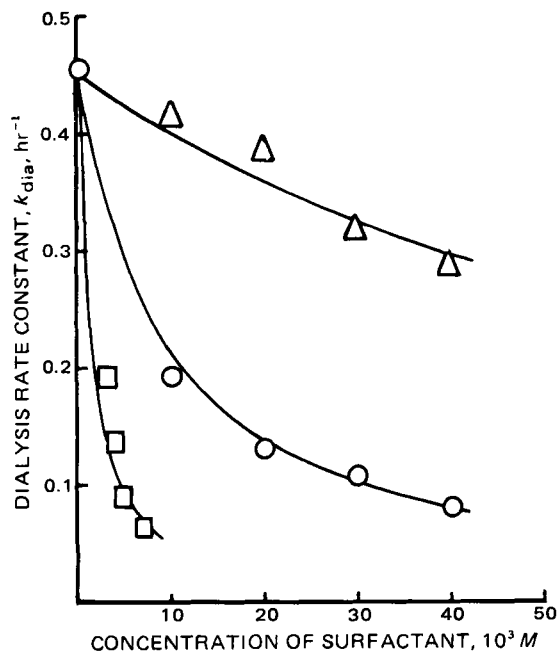

Figure 3—Plots of the pseudo first-order rate constant, k_{dia} , versus total surfactant concentration for the dialysis of propicillin at 37° and $\mu = 0.15$. Key: (○) I (pH 3.50); (△) II (pH 4.40); (□) III (pH 6.50). The points are experimental values. The solid curves were generated from Eq. 6 using the parameters in Table II.

where $(C_1)_f$ and $(C_1)_m$ represent the concentration of the drug free and bound with the surfactant micelle, respectively, and C_D is the total concentration of surfactant. When it is assumed that only free drug can permeate through the dialysis membrane, Eq. 6 is obtained from Eqs. 3 and 5:

$$k_{dia} = k_0 \frac{1}{1 + K_{app}(C_D - CMC)} \quad (\text{Eq. 6})$$

where k_0 represents the first-order dialysis rate constant of the drug in the absence of surfactant. Rearrangement of Eq. 6 gives:

$$\frac{k_0}{k_{dia}} - 1 = K_{app}(C_D - CMC) \quad (\text{Eq. 7})$$

Equation 7 predicts that plots of $(k_0/k_{dia} - 1)$ versus $(C_D - CMC)$ passing through the origin are linear. The values of CMC used for the calculation are 0.092 mM, 0.46 mM, and 0.32 mM for I, II, and III, respectively, which were determined in this laboratory in the presence of the antibiotic at 37° and $\mu = 0.15$. As illustrated in Fig. 4, the results obtained for propicillin with various surfactants revealed a linear relationship in accordance with Eq. 7. The apparent binding constant, K_{app} , was calculated from the slopes and the values are listed in Table I. During the periods of the dialysis experiments, there was negligible degradation of propicillin.

pH-Dependency of the Apparent Binding Constant in Micelle-Antibiotic Interactions—Penicillins have a pKa value of 2.7–2.9 (12) and exist in aqueous solutions in undissociated and ionized forms. The respective forms may yield different binding behavior in surfactant micellar solutions. Figure 5 shows the pH-dependency of K_{app} for propicillin in solutions of I, II, and III as determined by the dynamic dialysis method. Some of the data were those determined in a stability kinetic study, which will be described. In the solutions of I and II, the values of K_{app} for propicillin decreased markedly as the pH increased approaching a constant value. It is supposed that a considerable difference exists in the micellar interactions between undissociated species of propicillin and its ionized form. The relationship between the hydrogen ion activity of the bulk solution and the apparent binding constant can be represented by (see Appendix):

$$K_{app} = K_{HA} \frac{a_H}{a_H + K_a} + K_A \frac{K_a}{a_H + K_a} \quad (\text{Eq. 8})$$

where K_{HA} and K_A are the binding constants for the undissociated form of propicillin and its ionized form, respectively. Incorporation at pKa 2.76 of propicillin gave parameters of $K_{HA} = 489.0 \pm 27.0 M^{-1}$ and $K_A = 40.4 \pm 2.7 M^{-1}$ for I as the best fit to the data using a NONLIN computer

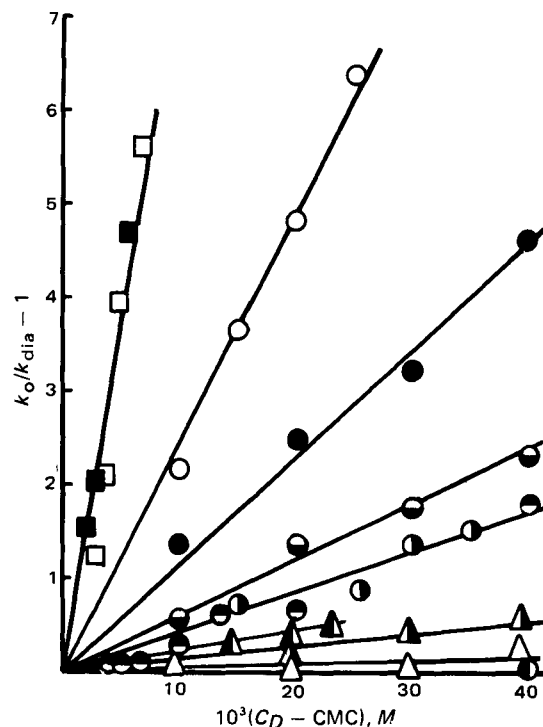

Figure 4—Plots according to Eq. 7 for the dialysis of cefazolin (○) and propicillin (other symbols) in the presence of I (circles), II (triangles), and III (squares) at various pHs, 37° , and $\mu = 0.15$. Key: (□) pH 6.50; (■) pH 4.00; (○) pH 3.00; (●) pH 3.50; (◐) pH 4.00; (◑) pH 5.00; (◒) pH 6.50; (△) pH 6.50; (▲) pH 4.00; (▲) pH 4.40; (●) pH 3.40 and pH 6.50.

program (13). The curves in Fig. 5 were generated for I and II from Eq. 8 by the use of these parameters as listed in Table II.

In the interaction of propicillin and the micelles of III, the apparent binding constant was virtually independent of the bulk solution pH. This indicates no significant difference in the magnitude of K_{HA} and K_A , and analysis of the data gave $K_{HA} = K_A = 810.1 M^{-1}$ as the mean of experimental data at all pH values.

A similar experiment was also carried out for the interaction between cefazolin [pKa = 2.54 (14)] and the micelle of I. The values of K_{app} were extremely low, being $\sim 3 M^{-1}$ in the wide pH range of 3–7, indicating negligible entrapment of the undissociated and ionized cefazolin into the micelles of I (Fig. 4).

Effect of Surfactants on the Stability of the Antibiotics—The acid-catalyzed degradation of β -lactam antibiotics was examined in the surfactant solutions of I, II, and III at $37 \pm 0.1^\circ$ and an ionic strength of 0.15. The degradation followed first-order kinetics with regard to the antibiotic concentration in all surfactant solutions. Typical results for propicillin obtained by linear semilogarithmic plots of the residual molar fraction of antibiotic versus time are shown in Fig. 6.

As illustrated in Fig. 7, the pseudo first-order rate constant for the degradation of propicillin at acidic pH was increased significantly by the

Table I—Apparent Binding Constant, K_{app} , between Propicillin and Various Surfactants^a

I		II		III	
pH	K_{app}, M^{-1}	pH	K_{app}, M^{-1}	pH	K_{app}, M^{-1}
1.10	459.3 ^b	1.61	175.0 ^b	1.10	856.0 ^b
1.92	404.9 ^b	2.60	119.0 ^b	4.00	793.8
3.00	247.2	3.00	91.3 ^b	6.50	780.4
3.50	115.1	3.50	28.5 ^b		
4.00	59.5	4.00	20.7		
5.00	42.5	5.00	13.2		
6.50	42.0	6.50	4.0		

^a The values were calculated from the experimental data according to Eq. 7 by the least-squares treatment at 37° and $\mu = 0.15$. ^b These values were determined in the stability study.

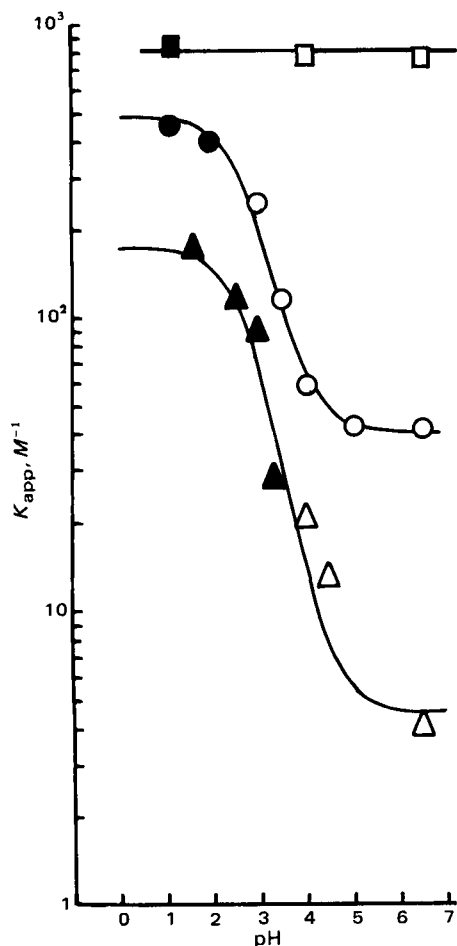

Figure 5—Plots of the apparent binding constant, K_{app} , of propicillin versus the bulk solution pH at 37° and $\mu = 0.15$. Key: (O, ●) I; (Δ , \blacktriangle) II; (\square , \blacksquare) III; (open symbols, dynamic dialysis; closed symbols, stability).

addition of anionic surfactant (II); whereas, it decreased on increasing the concentration of both nonionic and cationic surfactants (I and III). For other penicillins, similar results have been reported (3). In all cases, the rate constants first increased or decreased rapidly and then approached a constant value above the CMC of the surfactants, suggesting the formation of penicillin-micelle complexes.

According to the literature (9), the apparent first-order degradation rate constant thus, is expressed by:

$$k_{deg} = \frac{k_0 + k_m(C_D - CMC)}{1 + K_{app}(C_D - CMC)} \quad (\text{Eq. 9})$$

Rearrangement of Eq. 9 gives:

$$\frac{1}{k_0 - k_{deg}} = \frac{1}{k_0 - k_m} + \left(\frac{1}{k_0 - k_m} \right) \left(\frac{1}{C_D - CMC} \right) \frac{1}{K_{app}} \quad (\text{Eq. 10})$$

Equation 10 predicts that plots of $1/(k_0 - k_{deg})$ versus $1/(C_D - CMC)$ should give a straight line from which it should be possible to obtain k_m and K_{app} values.

Plots of Eq. 10 for the degradation of propicillin in the presence of I and III are shown in Figs. 8 and 9, respectively. The values of K_{app} for the various reaction systems are given in Table I.

Table II—Binding Constants for Undissociated and Ionized Propicillin with Various Surfactants^a

Surfactant	K_{HA}, M^{-1}	K_A, M^{-1}
I	489.0 ± 27.0	40.4 ± 2.7
II	171.8 ± 29.9	4.5 ± 1.3
III	810.1 ± 40.3 ^b	810.3 ± 40.3 ^b

^a The binding constants were calculated by nonlinear regression program, NONLIN, at 37° and $\mu = 0.15$. ^b This value is the mean ± SD of the experimental data.

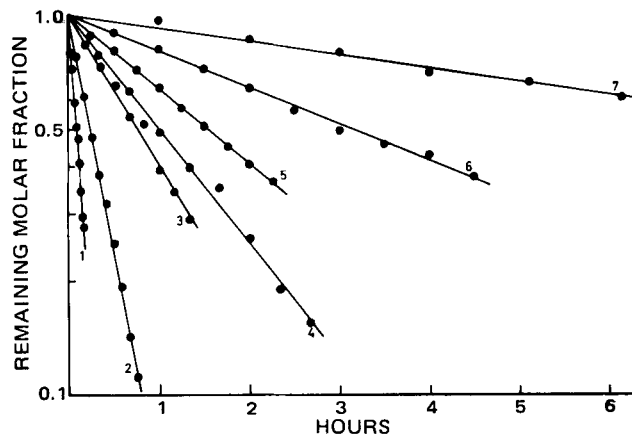

Figure 6—First-order plots for the degradation of propicillin in the presence of surfactants at various pHs, 37°, and $\mu = 0.15$. Key: 1 (3×10^{-3} M II, pH 1.61); 2 (control, pH 1.10); 3 (4.5×10^{-3} M II, pH 2.50); 4 (1×10^{-2} M I, pH 1.10); 5 (8.9×10^{-2} M III, pH 1.10); 6 (3.1×10^{-2} M III, pH 1.10); 7 (1×10^{-2} M I, pH 1.92).

Within an experimental period of <1 day, there was no influence of the surfactants on the neutral degradation of the antibiotic used in this study.

Effect of Surfactants on the Antibiotic Solubility—The saturable solubility of penicillin V, C_s , at pH 2.0 and 35° increased with concentration of I as shown in Table III. The data indicated that the aqueous solubility of penicillin V increased threefold in the presence of 10 mM I at pH 2.0 and 35°, showing that penicillins are solubilized by surfactant micelles.

DISCUSSION

Solutions of penicillin G are highly unstable at a gastric pH, the half-lives being 1 min at pH 1 and 7 min at pH 2 (15, 16). Such chemical inactivation of penicillin G in the gastric fluid has been reported to be responsible for the poor bioavailability of this antibiotic. The acid degradation rates of penicillin derivatives are known to depend on their 6-sidechain nature due to the rearrangement initiated by the attack of the sidechain amidocarbonyl on the β -lactam to produce the corresponding penicillic acid and penillic acid (16).

Considerable efforts have been made to stabilize acid-labile penicillins. Previous authors (17) succeeded in stabilizing potassium salts of penicillin G and penicillin V in simulated gastric juice by coating with cholesteryl acetate, yielding 1.6- and twofold higher urine levels, respectively, after oral administration of these pharmaceutical preparations to humans.

The previous (3) and present studies revealed a marked stability of penicillins in acid solutions with both cationic and nonionic micelles. Four kinds of derivatives, penicillin G, penicillin V, phenethicillin, and propicillin, can be stabilized to maximal extents of 6-, 10-, 8-, and 10-fold by the micelles of III and of 4-, 6-, 7-, and 13-fold by the micelles of I, respectively (3). These stabilization effects are attributed to incorporation of the penicillin molecules into both types of micelles. As is apparent from these results (3), the apparent binding constant between the penicillins and micelles increased with increasing lipophilic character of the penicillins, as expressed in terms of their octanol-water partition coefficients, P (12). This suggests that hydrophobic binding is involved in the interaction between the cationic or nonionic micelle and undissociated species of the penicillins. These strong interactions resulted in protection of the β -lactam ring sterically and/or electrostatically from intramolecular and nucleophilic attack of the sidechain amidocarbonyl oxygen. However, it is probable that due to the localized hydrogen ion activity surrounding the negatively charged micelle, the anionic micellar state by II leads to an increase in the rate of degradation. The maximal acceleration of the β -lactam cleavage of propicillin by micelles of II was predicted to be 60-fold at pH 1.6 and 37°.

In contrast to penicillins, the acid degradation of cefazolin, a relatively acid-unstable cephalosporin (14), was not influenced by the presence of any type of surfactant, like cephalothin described previously (3). This was due to the fact that cefazolin was not sufficiently bound to the micelles, the apparent binding constant being confirmed as almost negligible by the dynamic dialysis method (Fig. 4). The very weak interaction of

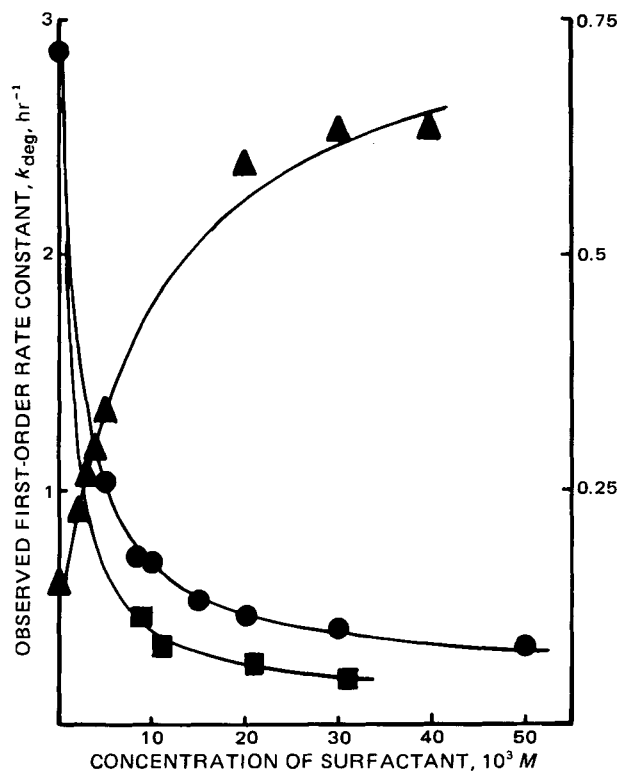

Figure 7—Plots of the pseudo first-order rate constant versus total concentration of surfactant for the degradation of propicillin at 37° and $\mu = 0.15$. Key: (●) I (pH 1.10, left scale); (▲) II (pH 3.00, right scale); (■) III (pH 1.10, left scale). The points are experimental values. The solid curves were generated from Eq. 9.

the cefazolin molecule with surfactant micelles undoubtedly is due to the low lipid solubility of the antibiotic itself.

The partitioning behavior of β -lactam antibiotics was investigated (12), both in *n*-octanol-water and isobutyl alcohol-water systems, as a function of the aqueous phase solution pH and showed that both the undissociated and ionized species could be partitioned into the oil phase, although the

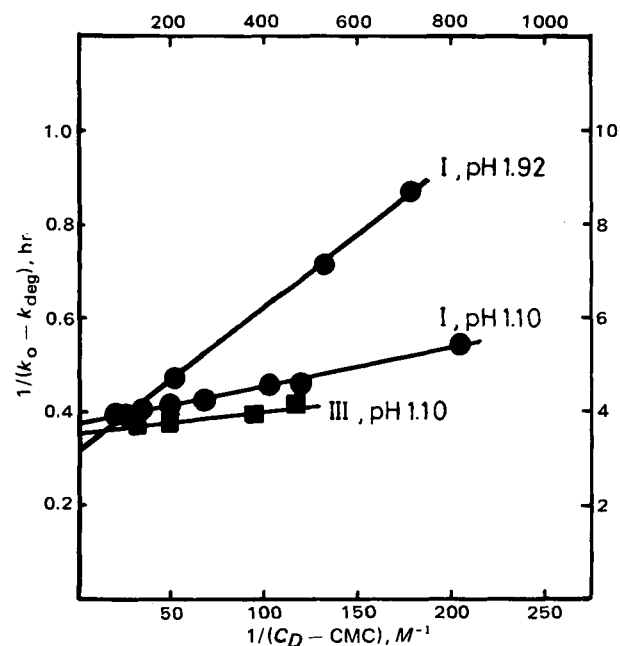

Figure 8—Double reciprocal plots according to Eq. 10 for the degradation of propicillin in the presence of I and III at 37° and $\mu = 0.15$. Key: upper and right scales for pH 1.10; lower and left scales for pH 1.92.

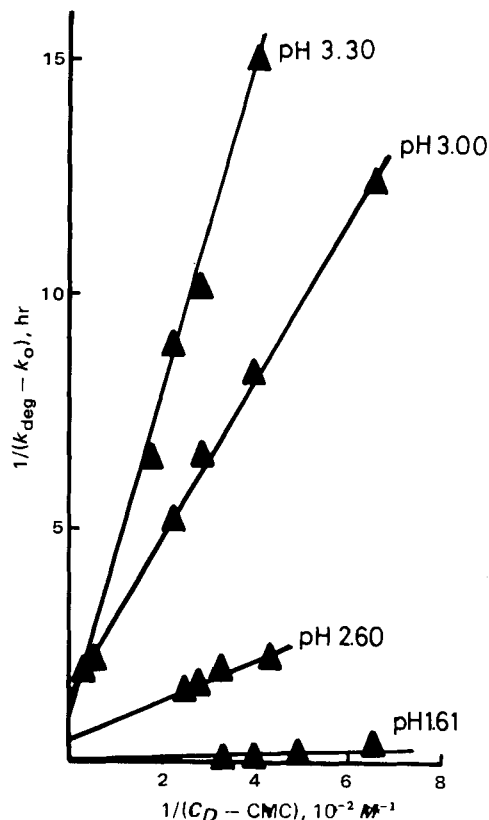

Figure 9—Double reciprocal plots according to Eq. 10 for the degradation of propicillin in the presence of II at 37° and $\mu = 0.15$.

former was far more lipophilic than the latter. As shown in Fig. 5, the pH dependency of the K_{app} values in the propicillin interaction with I was parallel to that of the apparent partition coefficients in oil-water systems. The interactions of propicillin with the micelles of II and III showed a marked contrast in the dependencies of their respective K_{app} values on the pH of the bulk aqueous solution. In the case of the micelle of II, K_{app} clearly decreased as the pH increased, while in the micelle of III, K_{app} exhibited independency in the wide pH range between 1 and 6. These results can be explained on the basis of the participation of electrostatic forces between the ionized species of the antibiotic and the ionized surfactant micelles in addition to the hydrophobic contribution.

Electrical repulsive forces may play a significant role between ionized propicillin and the anionized surfactant micelle to produce the deduced K_A value, as seen from the K_{HA}/K_A ratio being ~ 100 . Unlike the anionic case, the attraction due to the electrostatic forces between the ionized form of propicillin and cationic surfactant micelle may lead to an effective cancellation of charge within the molecule, resulting in $K_{HA} = K_A$. However, the magnitude of K_A is dependent on the differences both of the hydrogen ion activity and the acid dissociation behavior between aqueous and micellar phases (see Appendix).

Based on the present study, it should be emphasized that the acid-labile penicillins were significantly stabilized and solubilized by incorporating the unionized species into nonionic surfactant micelles, and the penicillin molecules entrapped in the micelle could then be easily released at neutral pH values by reducing the force in the interaction between the

Table III—Solubility of Propicillin in the Presence of I^a

Concentration of I, $10^3 M$	Solubility of Propicillin, $10^3 M$
0.0	0.72
3.0	1.21
5.0	1.55
7.0	1.89
10.0	2.40
20.0	4.09

^a Values at 37°, pH 2.00, and $\mu = 0.5$.

Explore Litigation Insights

Docket Alarm provides insights to develop a more informed litigation strategy and the peace of mind of knowing you're on top of things.

Real-Time Litigation Alerts



Keep your litigation team up-to-date with **real-time alerts** and advanced team management tools built for the enterprise, all while greatly reducing PACER spend.

Our comprehensive service means we can handle Federal, State, and Administrative courts across the country.

Advanced Docket Research



With over 230 million records, Docket Alarm's cloud-native docket research platform finds what other services can't. Coverage includes Federal, State, plus PTAB, TTAB, ITC and NLRB decisions, all in one place.

Identify arguments that have been successful in the past with full text, pinpoint searching. Link to case law cited within any court document via Fastcase.

Analytics At Your Fingertips



Learn what happened the last time a particular judge, opposing counsel or company faced cases similar to yours.

Advanced out-of-the-box PTAB and TTAB analytics are always at your fingertips.

API

Docket Alarm offers a powerful API (application programming interface) to developers that want to integrate case filings into their apps.

LAW FIRMS

Build custom dashboards for your attorneys and clients with live data direct from the court.

Automate many repetitive legal tasks like conflict checks, document management, and marketing.

FINANCIAL INSTITUTIONS

Litigation and bankruptcy checks for companies and debtors.

E-DISCOVERY AND LEGAL VENDORS

Sync your system to PACER to automate legal marketing.